

2

75

T. SPARK

75

2.5 V6

75

3.0 V6

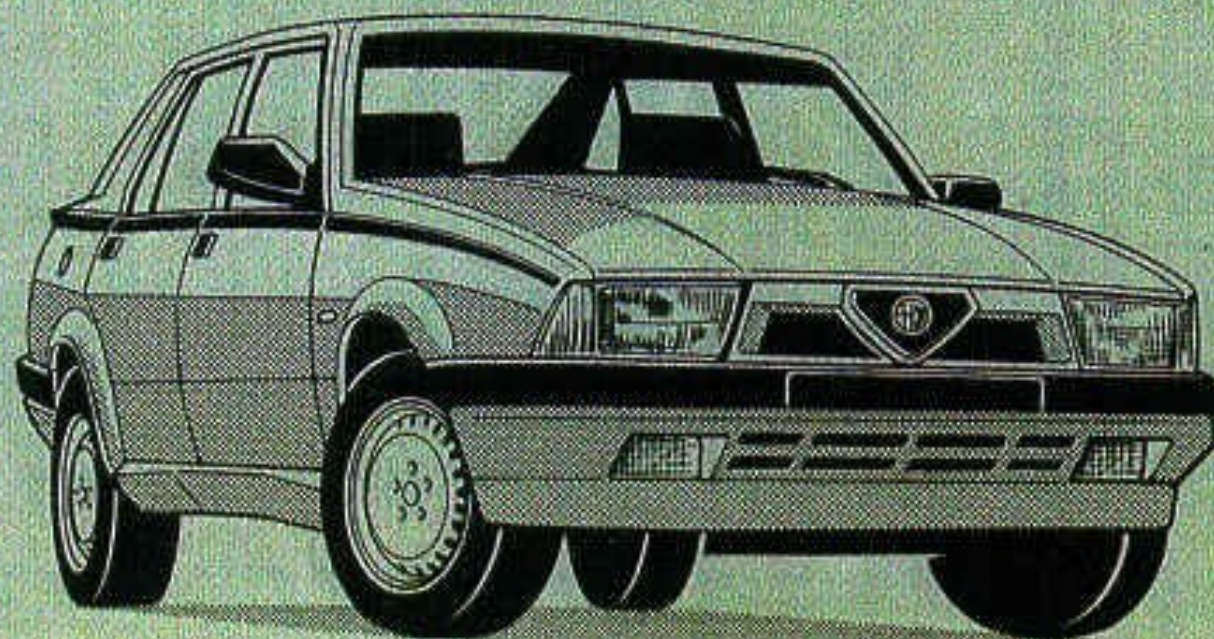

Alfa Romeo



OWNER'S MANUAL

INDEX (at the end of this manual you can find a complete alphabetical index)

GUARANTEE - SERVICE COUPON BOOKLET - SERVICE NETWORK	3
IDENTIFICATION	4
HOW TO USE YOUR CAR	
CONTROLS AND INSTRUMENTS	
Driver's position	8
Front control panel - Rear control panel	9
Instrument panel and switches	10
Warning lights - Instrument panel light dimmer	11
Alfa Romeo Control (ARC)	12
Digital clock	14
Instrument panel switches	15
Ignition switch and steering lock unit	16
Steering wheel adjustment - Levers on steering wheel	18
Outside lights	19
Direction indicators	20
Windscreen wiper and washer - Headlamp washer	21
Power windows	22
Internal lighting	23
Gear lever - Handbrake	24
Seats	25
Seat belts	28
Doors - Central door locking	30
Rear doors safety locks - Child-proof door locks	31
Internal rearview mirror	32
External rearview mirrors	33
External rearview mirror - Sun visors	34
Glovebox - Backshelf drawer	35
Front cigar lighter - Front and rear ashtray - Rear cigar lighter	36
Support handles - Filler cap cover	37
Boot opening	38
Bonnet opening	39
VENTILATION - DEMISTING & HEATING	40
CLIMATE CONTROL WITH AIR CONDITIONING SYSTEM	45
Maintenance - Compressor drive belt tension check - Belt replacement	50
IN AN EMERGENCY	
Spare wheel - Wheel changing	54
Jack - Jacking up the car	55
Towing the vehicle - Snow chains	56
Starting engine with an emergency battery	57
WARNINGS AND PRECAUTIONS	
Starting the engine - While driving	60
Brakes - Power brakes - Power steering - Parking - Windscreen wiper blades	62
Winter use - Fuel economy hints	63
Before starting out - When you sit in the driver's seat - When travelling - Suggestions for correct driving	64

LUBRICATION AND MAINTENANCE	
Precautions to take before maintenance	65
Routine maintenance schedule	66
Engine oil level check	68
Engine oil change	69-70
Engine oil filter change	71
Checking level and changing gearbox-differential oil	72
Air filter	73-74
Alternator and coolant pump drive belt	75
COOLING SYSTEM	76
Coolant level checking	78
Draining and replenishing the system	79
BRAKES	80-81
POWER STEERING	82-85
WHEELS	86
WINDSCREEN AND HEADLAMP WASHING LIQUID	87
ELECTRICAL EQUIPMENT	
Electronic ignition - Spark plugs - Alternator	88
Battery	89
Fusebox	90
Radio	91
Adjusting the beam height according to the load - Setting the headlight beams - Changing light bulbs	92
BODY	100-102
TOWING BRACKET	103-106
GENERAL DATA FOR 75 T. SPARK VERSION	107-109
Self-locking differential	109
Diagram of the air and fuel supply system	110
Electronic injection-twin ignition system engine	112
Car's dimensions	115
GENERAL DATA FOR 75 3.0 V6 VERSION	117-119
Self-locking differential	119
Air and fuel supply system	120
Digital electronic ignition system	122
Car's dimensions	124
SUNROOF VERSION	125
BRAKE SYSTEM WITH ANTI-LOCK BRAKING SYSTEM (ABS)	129
75 T. SPARK - 75 3.0 V6 RIGHT HAND DRIVE	133
75 2.5 V6 RIGHT HAND DRIVE - AUTOMATIC TRANSMISSION VERSION	139
ALPHABETICAL INDEX	151
LUBRICANTS - TYRE PRESSURES - CAPACITIES ...	inside back cover

The operation and maintenance instructions contained in this manual must be carefully observed by the owner desiring to get the best from this vehicle and to ensure long life for all its component parts.

Owners are recommended, in their own interest, to entrust all maintenance and repair work to ALFA ROMEO SERVICE DEALERS.

These are equipped with the proper tools and staffed by specially trained mechanics who are kept updated with ALFA ROMEO literature.

Alfa Romeo  ASSISTENZA TECNICA

IMPORTANT NOTICE TO OWNER

If you should have a problem or question concerning the servicing of your car, write or phone either your Selling Agent or your local Alfa Romeo Distributor. The name and address of the one nearest you appears in the "Guide to Service Network".

WARNING

Beware of the danger of carbon monoxide! Never run the engine in an enclosed space. The exhaust gases contain carbon monoxide, a deadly gas. Carbon monoxide is particularly dangerous as, being colourless, odourless and tasteless, its presence is very difficult to detect.

KEYS

A single key enables to perform the following functions:

- turning on the ignition
- steering lock
- locking front doors
- locking tank filler cap.

N.B. After each refuelling operation make sure tank filler cap is properly locked.

Features and data are approximate only. Alfa Romeo reserves the right to alter any features and data given in this manual without notice.

Some equipment features are optional extras. Refer to price list for a comprehensive list of options.

Descriptions, illustrations and specifications are those of the vehicle at the date of printing of this manual. Please note that this manual applies to all models in this range, some models, however, may not be available in all market areas. For detailed information, please contact your Dealer.

GUARANTEE

For the conditions of guarantee please refer to the **Service Coupon Booklet**.

SERVICE COUPON BOOKLET

The **Service Coupon Booklet** is supplied with every vehicle. This sets out the conditions governing the provision of Alfa Romeo services and the terms of the guarantee. Have the maintenance operations and tuning prescribed in the **Service Coupon Booklet** and in the **Maintenance** chapter of this manual carried out regularly and carefully. This is an essential condition to guarantee a long life of the mechanical parts (and thus lower running and fuel costs).

SERVICE NETWORK

The Alfa Romeo Services in Italy and abroad are listed in the **Guide** supplied with every vehicle. Always rely on your Alfa Romeo Dealers, who display the shield with the Alfa Romeo emblem and name.

IDENTIFICATION

Owners are advised to keep a record of the identification symbols in the spaces provided at the diagram below. Identification plates or metal stamping are located as follows:

- 1 - **In the engine compartment on the front cross piece on the left side:** identification plate and type approval plate.

Symbol _____

- 2 - **Inside luggage boot lid:** finish plate (paint type and make).

Symbol _____

- 3 - **On boot floor pan (to the right of the spare wheel housing):** vehicle identification number "VIN".

Symbol _____

On contacting the Factory or a Member of Alfa Romeo Service Organization please state: car model, chassis no., registration date, mileage covered and details of purchase.

- 4 - **On the floor of the luggage compartment (to the right of the spare wheel housing - stamped):** manufacturer's brand mark, body type and serial number

Symbol _____

- 5 - **On the engine block (on the rear left part, flywheel side - stamped):** manufacturer's brand mark, engine type and serial number

Symbol _____

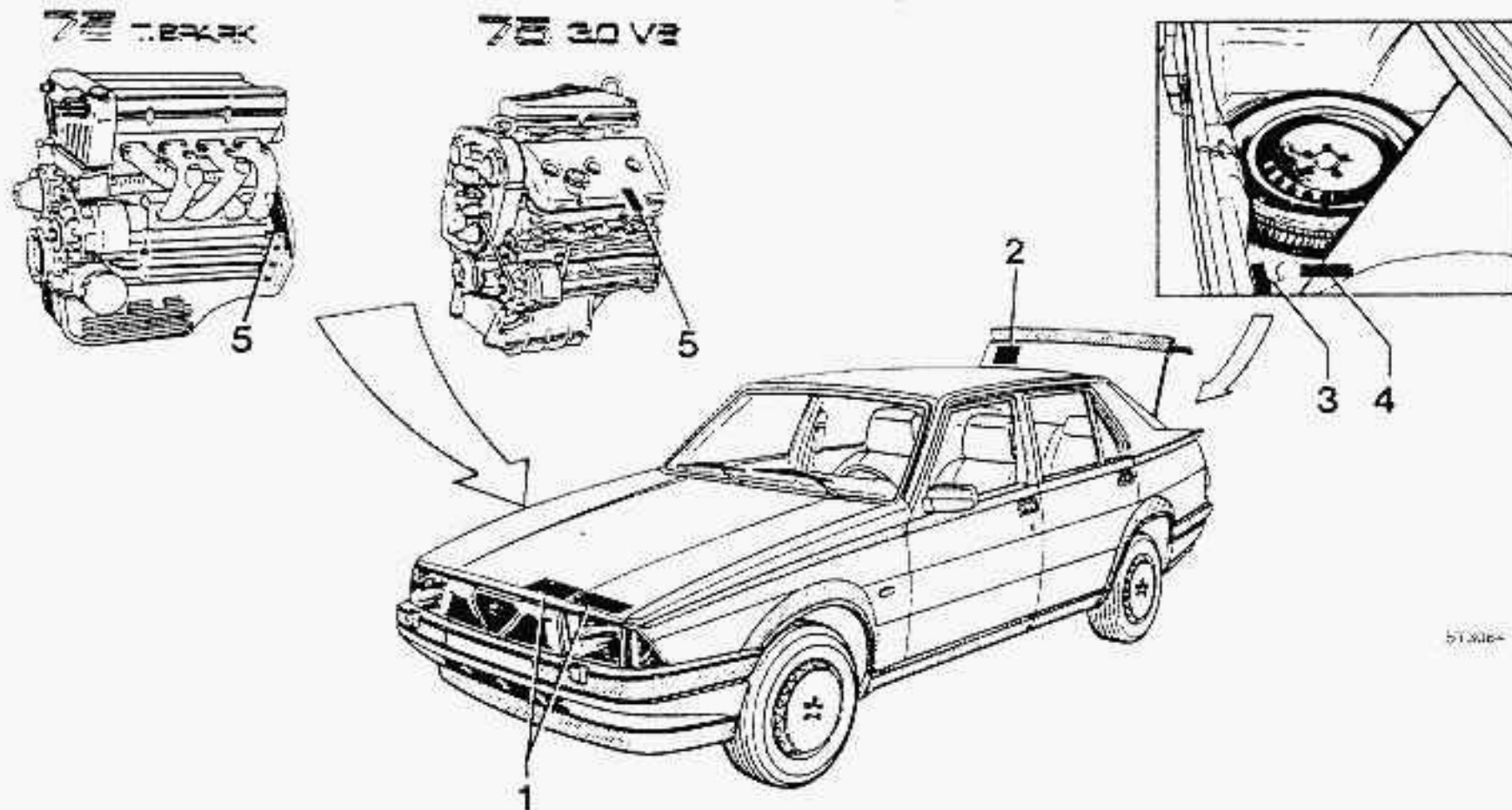



HOW TO USE YOUR CAR

IN AN EMERGENCY

WARNINGS AND PRECAUTIONS

LUBRICATION AND MAINTENANCE

GENERAL DATA



HOW TO USE YOUR CAR

CONTROLS AND INSTRUMENTS

DRIVER'S POSITION

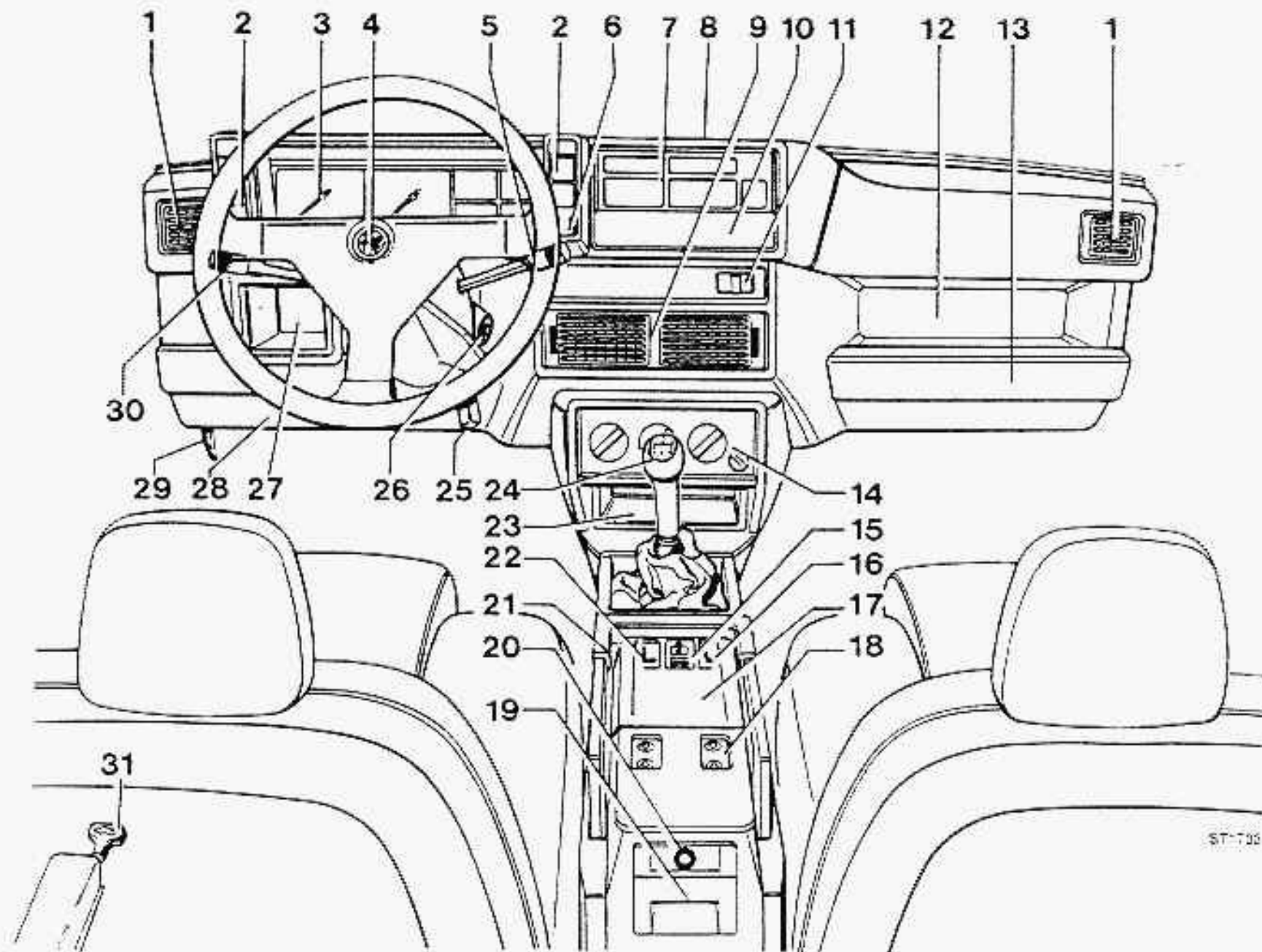

ST-706

- 1 - Air inlets
- 2 - Instrument panel switches
- 3 - Instrument panel
- 4 - Horn
- 5 - Windscreen wiper and washer lever and headlamp washer lever (some versions only)
- 6 - Instrument panel light dimmer
- 7 - Warning lights - Alfa Romeo Control - Clock
- 8 - Windscreen defrosting louvre
- 9 - Centre air vents
- 10 - Front ashtray

- 11 - Front cigar lighter
- 12 - Utility tray
- 13 - Glovebox
- 14 - Ventilation and heating controls
- 15 - Door mirrors remote control switch (some versions only)
- 16 - Passenger's backrest adjustment control switch (some versions only)
- 17 - Centre tray
- 18 - Rear power window controls (some versions only)
- 19 - Rear ashtray
- 20 - Rear cigar lighter (some versions only)

- 21 - Handbrake lever
- 22 - Driver's backrest adjustment control switch (some versions only)
- 23 - Radio housing
- 24 - Gear lever
- 25 - Steering wheel adjustment lever
- 26 - Ignition switch and steering lock/-antitheft
- 27 - Tray
- 28 - Fuse box
- 29 - Bonnet release
- 30 - Outside lights and direction indicators control lever
- 31 - Boot lid opening lever

FRONT CONTROL PANEL

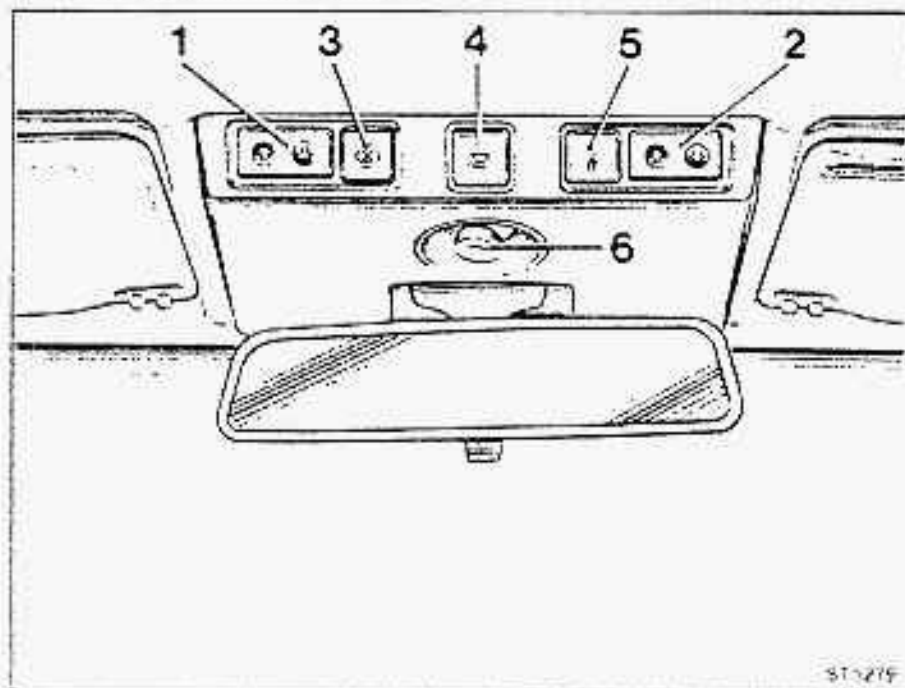

- 1 - Front left power window control
- 2 - Front right power window control
- 3 - Rear power window operation cut-out switch (some versions only)
- 4 - Ceiling light switch

REAR CONTROL PANEL

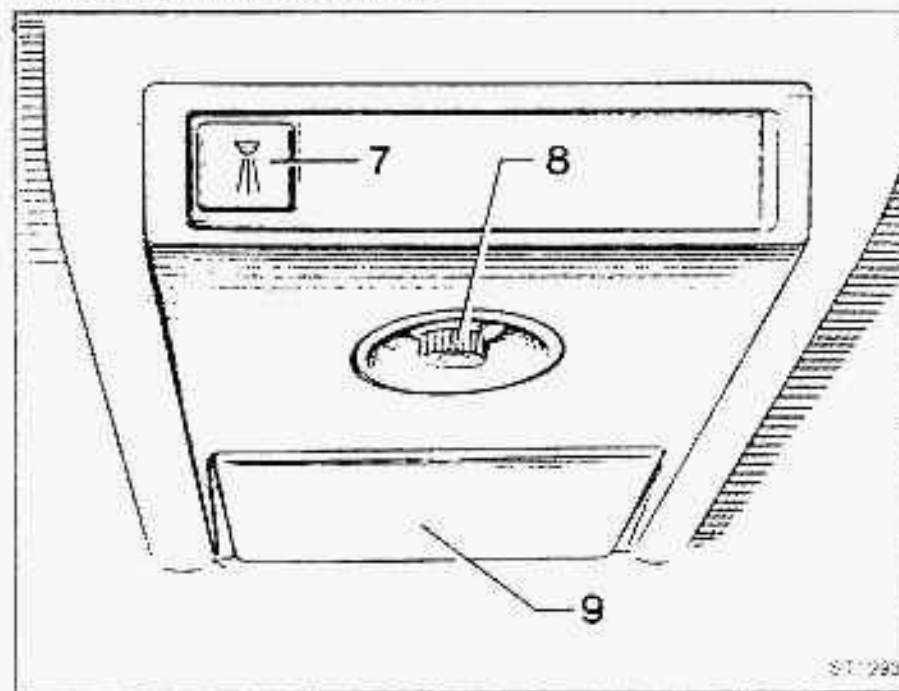

- 5 - Front spot light switch
- 6 - Front spot light
- 7 - Rear spot light switch
- 8 - Rear spot light
- 9 - Ceiling light

INSTRUMENT PANEL AND SWITCHES

- 1 - Rev. counter
- 2 - Speedometer
- 3 - Total odometer
- 4 - Fuel level gauge
- 5 - Fuel reserve warning light
- 6 - Engine oil pressure gauge
- 7 - Oil pressure warning light
- 8 - Coolant temperature gauge
- 9 - Coolant maximum temperature warning light
- 10 - Partial odometer
- 11 - Partial odometer zeroing button
- 12 - Road hazard light switch and warning light
- 13 - Heated rear screen switch and warning light
- 14 - Rear fog light switch and warning light
- 15 - Front fog light switch and warning light (on request)
- 16 - Instrument panel light dimmer

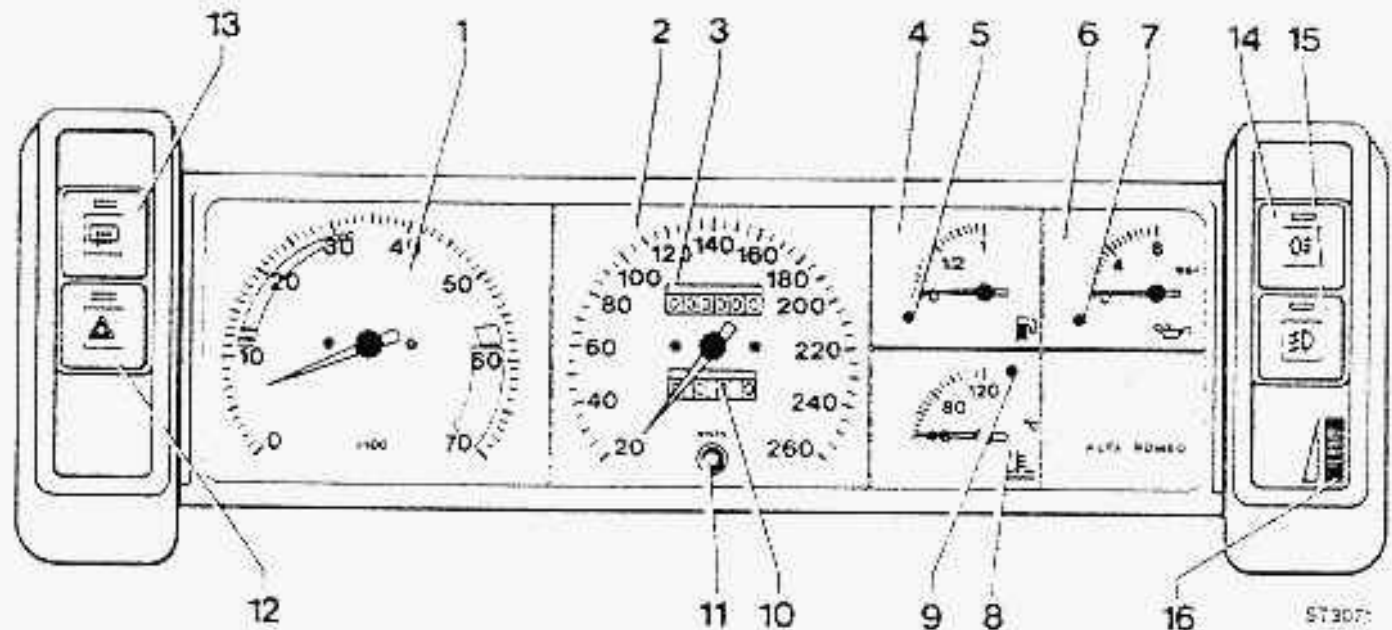
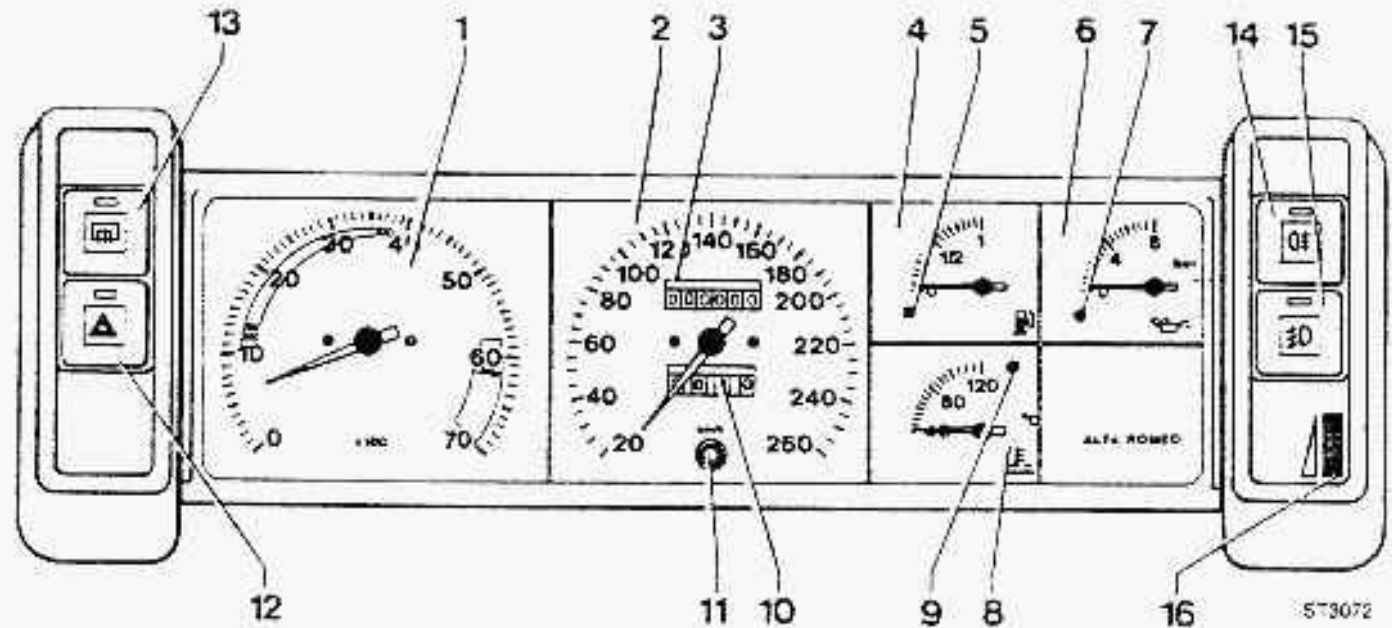

WARNING LIGHTS

In the centre of the instrument panel, there are warning lights indicating that the respective instruments have been switched on.

- 1 - Spare warning light
- 2 - Spare warning light
- 3 - Direction indicator warning light
- 4 - Parking light warning lamp
- 5 - High beam warning light
- 6 - Road hazard warning light

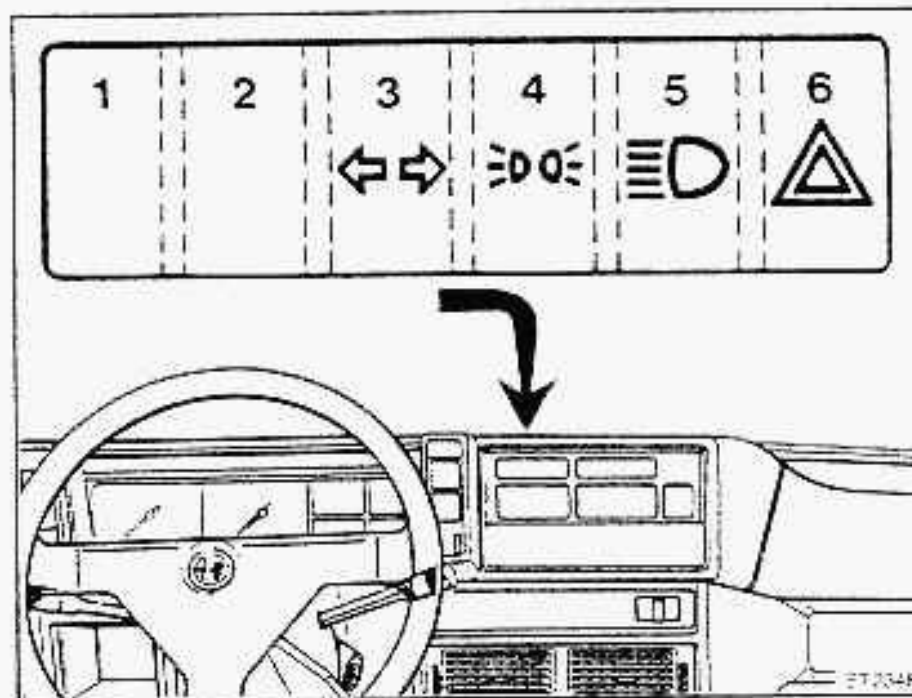

INSTRUMENT PANEL LIGHT DIMMER

With parking lights on, the instrument panel light can be adjusted by turning the dimmer A.

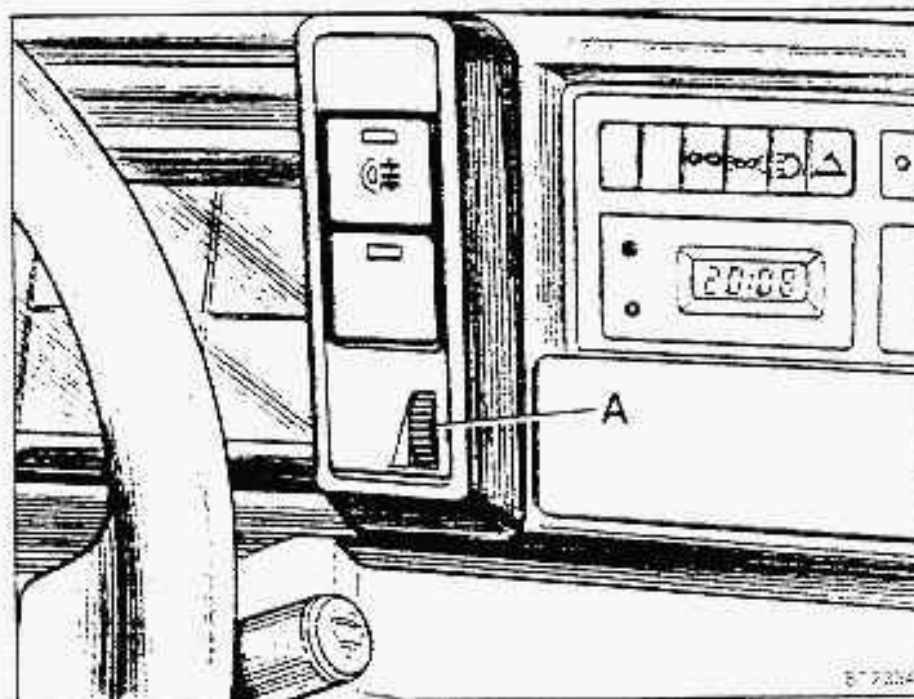

ALFA ROMEO CONTROL (ARC)

The Alfa Romeo Control warning device allows centralized, immediate verification of the correct functioning of the most important circuits, accessories and parameters for the vehicle and engine. Verification is carried out in two phases:

- with the engine off after the moment of ignition contact (key in position 1);
- with the engine running.

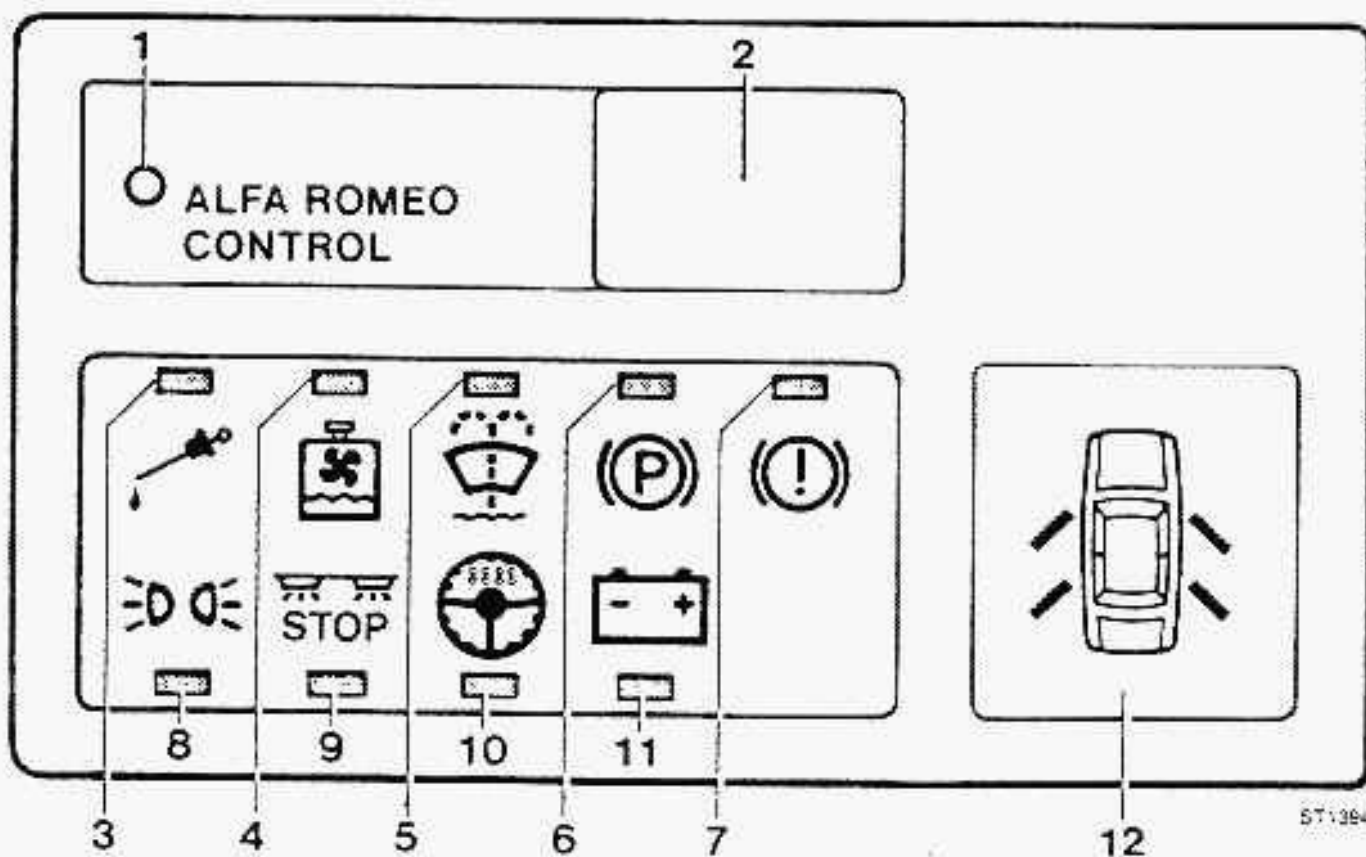











- 1 - Master warning light cut out button (warning light 2)
- 2 - Master warning light activated by the Alfa Romeo Control warning device
- 3 - Engine oil level warning light
- 4 - Coolant level warning light

- 5 - Windscreen washer liquid level warning light
- 6 - Handbrake warning light
- 7 - Brake pad wear and fluid level warning light
- 8 - Parking lights and rear fog lights efficiency warning light

- 9 - Stop lights efficiency warning light
- 10 - Warning lights function warning light
- 11 - Alternator warning light
- 12 - Open door warning light

The ARC device checks the following systems:

-  Minimum engine oil pressure circuit - Engine oil level
-  Engine coolant level
-  Windscreen washing liquid level
-  Handbrake on
-  Brake pad wear - Brake fluid level - Switch, fuse, bulbs and connectors of stop lights
-  Side lights and rear fog lights
-  Switch, fuse, bulbs and connectors of stop lights
-  Efficiency of warning lights (with relative circuits and sensors): minimum oil pressure - coolant temperature - fuel reserve
-  Alternator circuit
-  Door closing

With the engine running the following are checked

- correct supply of current by the alternator
- sufficient engine oil pressure

Check with engine switched off

When the ignition key is turned to position 1 all the warning lights will come on for a few seconds to test their efficiency (self-diagnosis).

After this period, if all the systems checked are efficient the lights will go off.

If there is a malfunction the light relative to the particular function will remain alight and the master warning light will start to flash.

After about a minute the light indicating the fault will become intermittent while the master warning light will remain constant.

Any further faults will be signalled by the flashing of the light relative to the function.

N.B.: Side lights, rear fog light and stop lights can only be tested when in use.

Important: The master warning light can be cut out at any time by means of pushbutton 1. In this case the lights signalling the faults will remain on.

The master warning light will only come on again if there are further faults, when the ignition is switched on (key in position 1) or when the engine is re-started.

Check with engine running

When the engine is started the device checks, in addition to the previously mentioned systems, the efficiency of the generator and the minimum oil pressure.

When the key is turned directly from position 0 to the engine ignition position, the ARC device follows this procedure:

- the master warning light and all the other lights will come on for 2-4 seconds to demonstrate their efficiency;
- they subsequently go off if the systems being checked are efficient;
- one or more red warning lights will come on if there are faults (see earlier for remarks on faults).

Steps to be taken if a fault is signalled

Stop the vehicle immediately and perform the following checks:

Warning lights 3-4-5-7: check relative levels.

If they are correct the fault lies in the control circuit.

Warning light 7 also monitors brake pad wear, there are two possibilities:

1. The light only comes on when the brake is applied: pads are beginning to wear.
2. The light stays on: the brake pads are seriously worn.

DIGITAL CLOCK

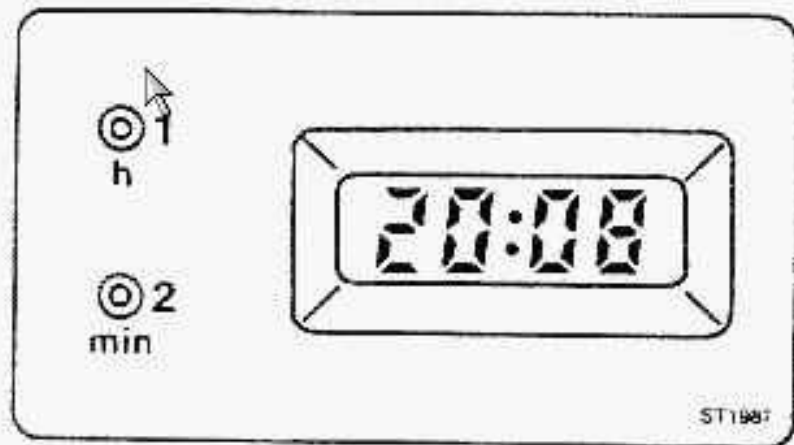

- 1 - Hours-set button
- 2 - Minutes-set button.

This electronic digital clock features a 24-hour display. Four digits display the time in hours and minutes; the colon flashes twice to indicate a second.

To reset the clock, first depress hours-set button 1 (with the tip of a pen) until the correct reading is obtained; then depress the minutes-set button 2 (digits change at a slower rate) until the minute reading is corrected. By depressing buttons 1 and 2 simultaneously all four digits are set to zero.

Note: In the event of power interruption (e.g. for battery removal, blown fuse) the clock circuitry stops operating.

When power is again supplied, the clock needs resetting.

INSTRUMENT PANEL SWITCHES

Placed on the sides of the instrument panel, press once to turn on and a second time to turn off. Its function will be indicated by the relative warning light on the button itself.

N.B.: Using road hazard lights, rear fog lights and when fitting and using fog lights be sure to observe local traffic regulations. Heated rear screen should be turned off as soon as the glass has cleared.

Note: The front and rear fog light systems meet the relevant CEE/ECE regulations.



Road hazard lights switch

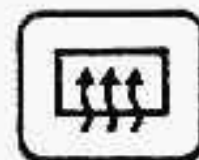
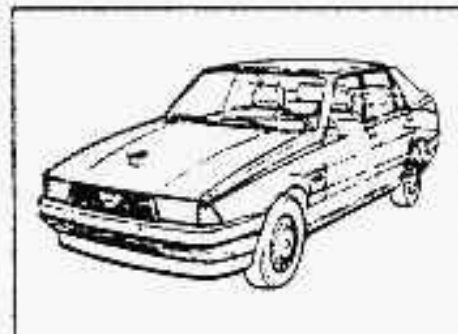

Heated rear screen switch

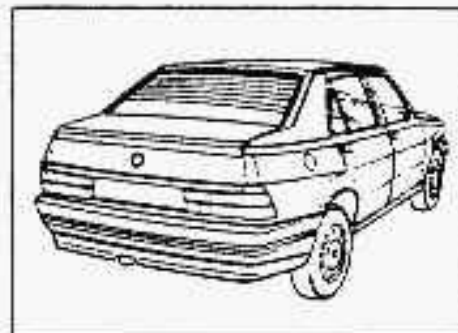

Rear fog light switch

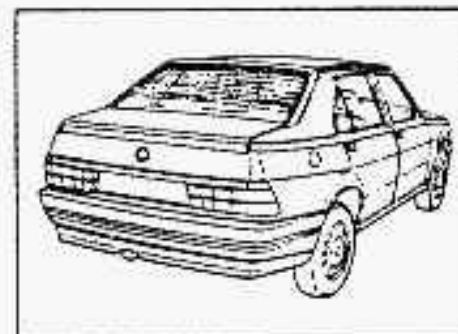

Fog light switch
(if so equipped)

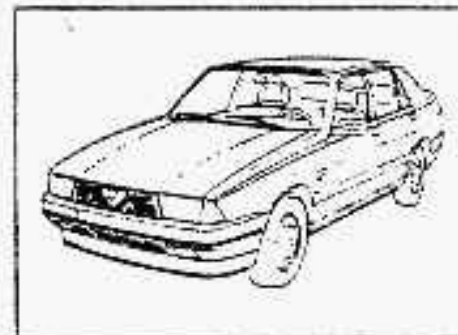

IGNITION SWITCH AND STEERING LOCK UNIT

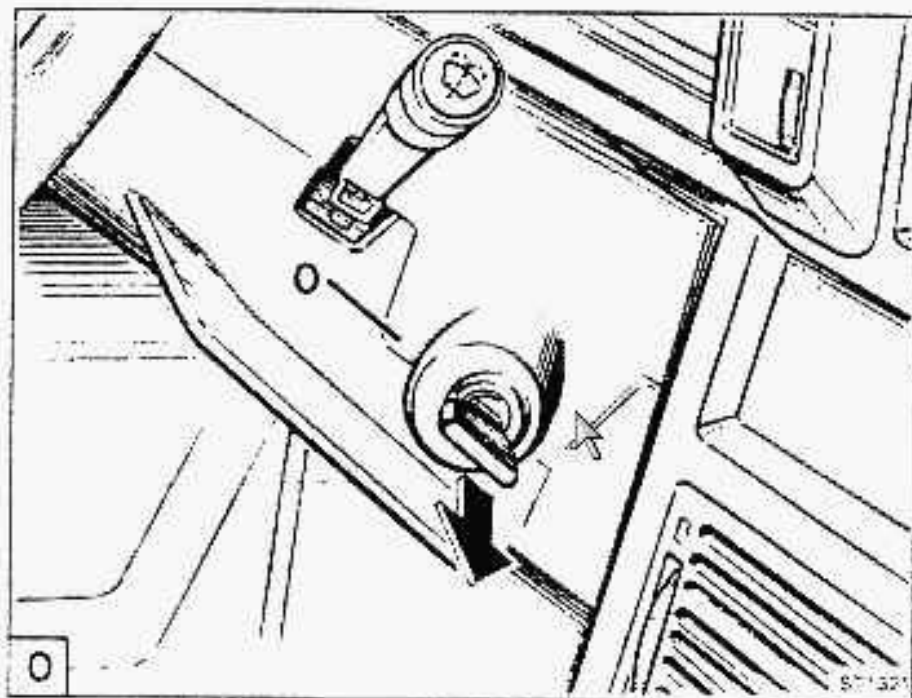

Position 0.
utilities cut out, with key
removed the steering wheel is
locked.

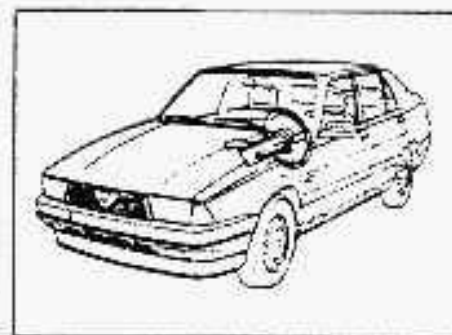

Important: The steering wheel can be freed only after the key is turned to position 1 (panel warning lights come on) and then turned back to position 0.

Remark: If the car is to be towed leave the key in position 0 (without removing it). See notes on page 56.

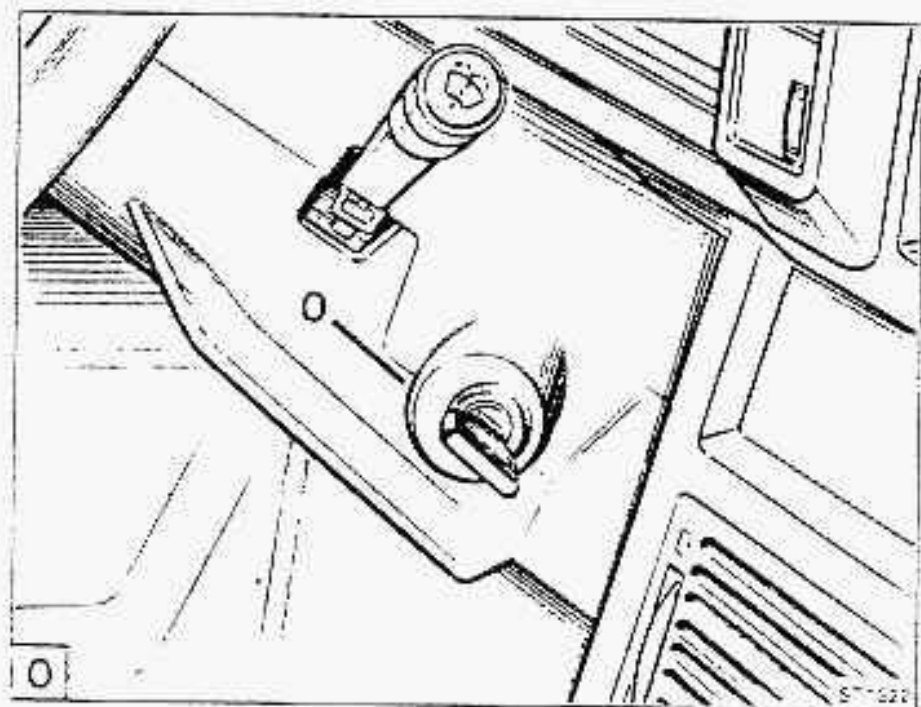

Position 0.
with key in utilities cut out,
wheel free.

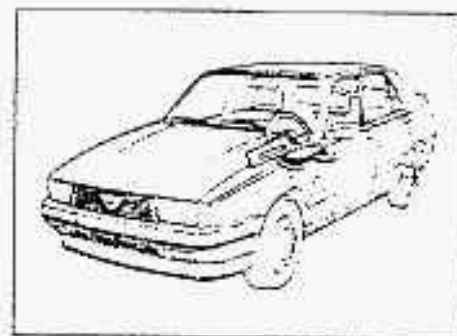



Position 1:
utilities cut in

If the engine doesn't start turn the key back to position 0 and repeat the process.
To prevent accidental starting when the engine is already running the ignition switch is equipped with a safety device which makes it impossible to pass from position 1 to position 2.

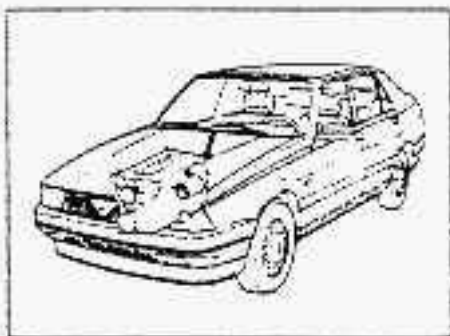

Position 2:
starting

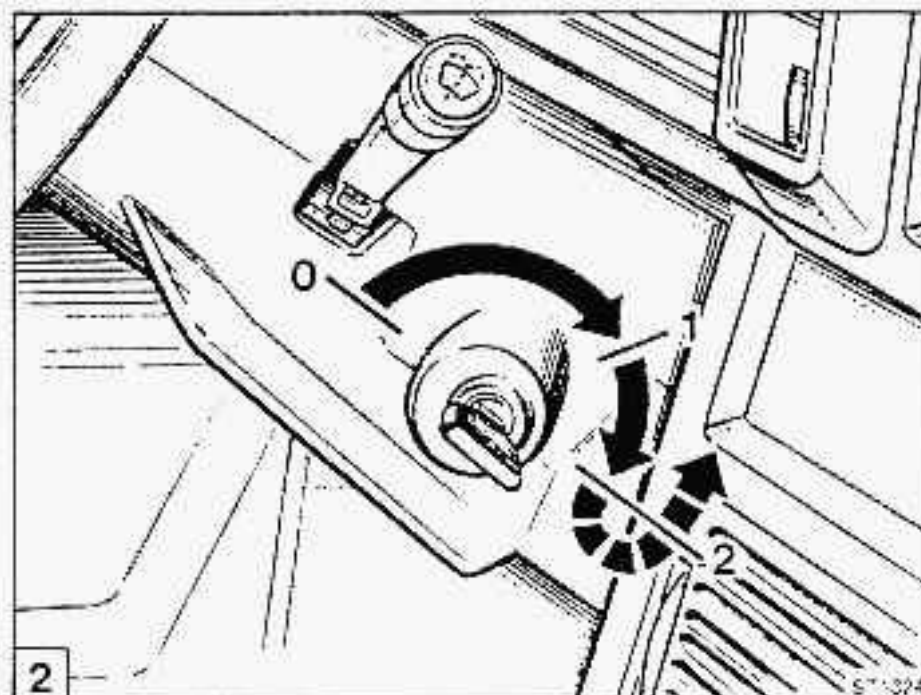
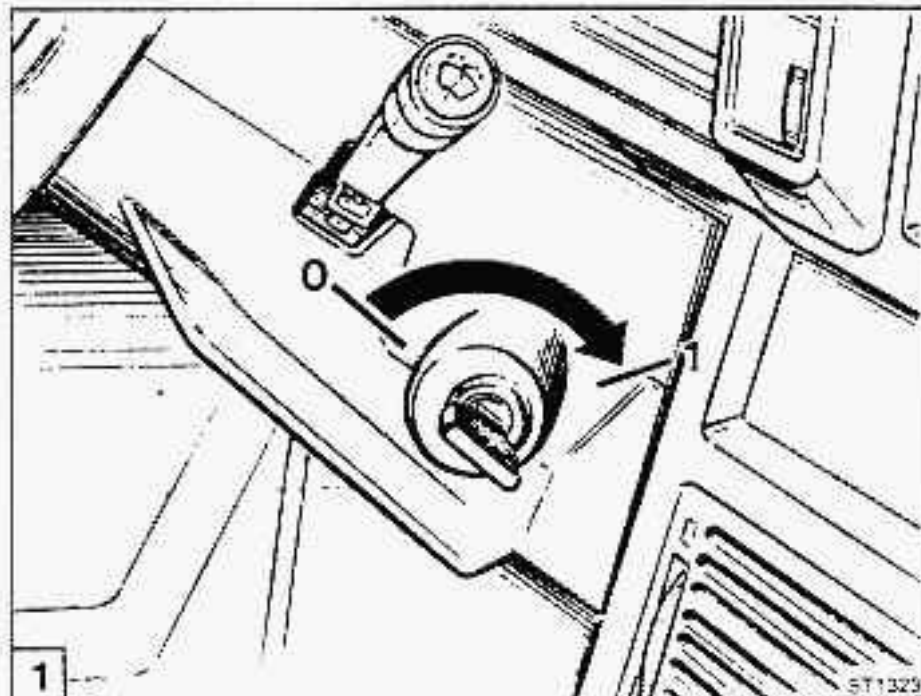

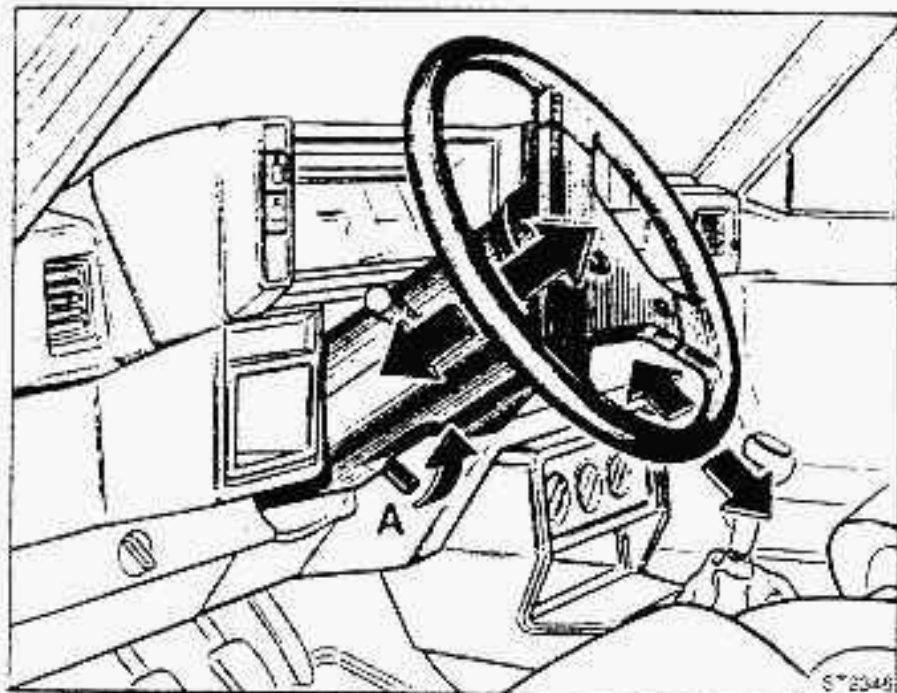

STEERING WHEEL ADJUSTMENT

Release by pulling the lever A toward the steering wheel. Set wheel in desired position (the steering column may be adjusted both axially and vertically) and lock the lever A.

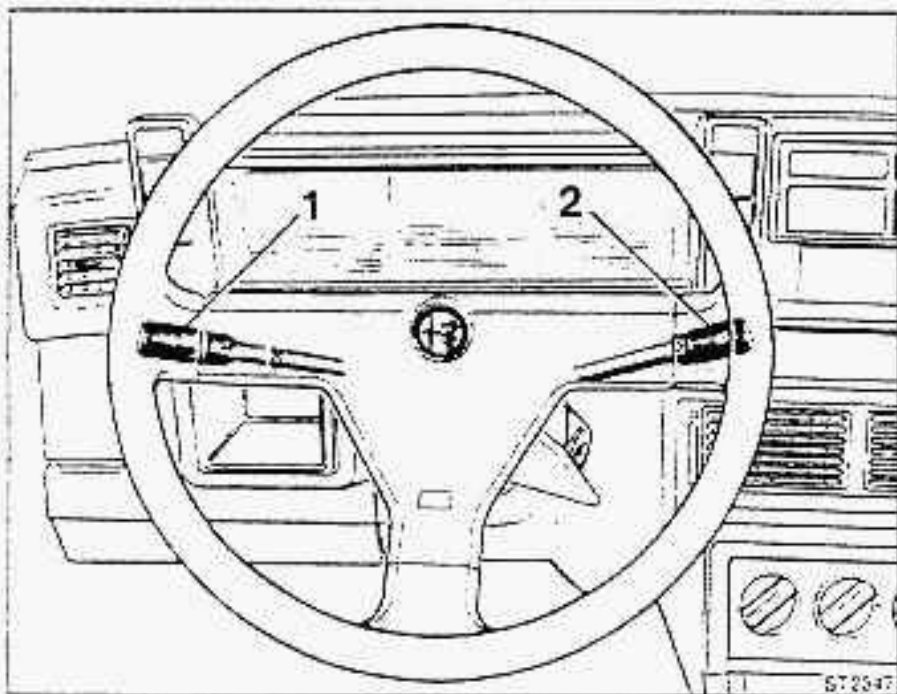

LEVERS ON STEERING WHEEL

- 1 — control for external lights and direction indicators
- 2 — control for windscreen wipers and washers and headlamp washers (on request).

OUTSIDE LIGHTS (Lever 1)

The outside lights are controlled by the lever shown in the figure.

Turning the lever anti-clockwise:

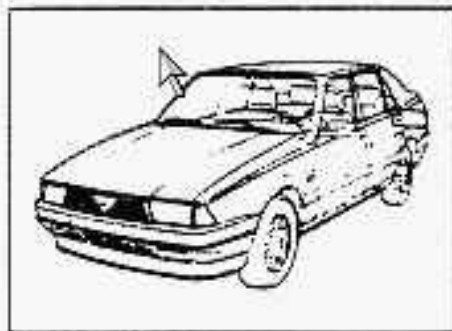

Position 1
(first notch).
parking lights.

Where so required by local regulations, when the parking lights are switched on together with the ignition or engine, dimmed brightness headlight low beams are automatically turned on (DIM-DIP position).

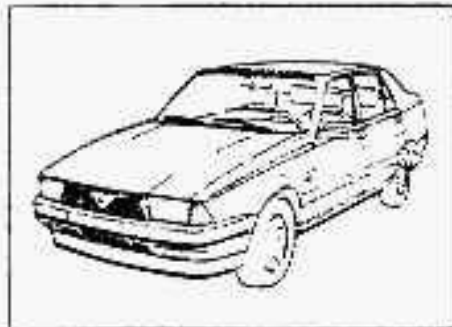
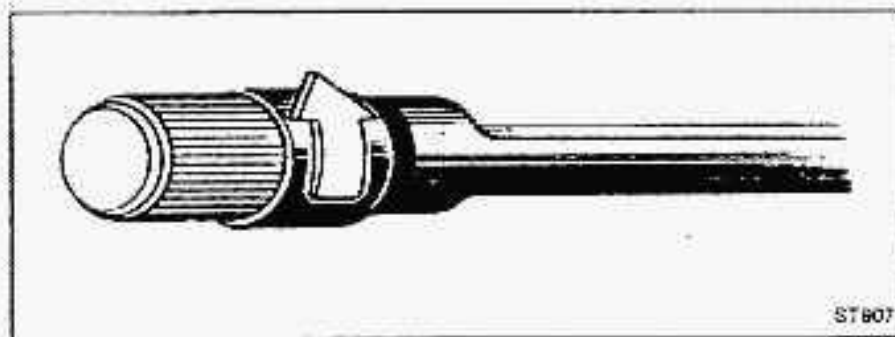

Position 2 (second notch).
change from low to high beam
- Button A at end of lever out:
low beam

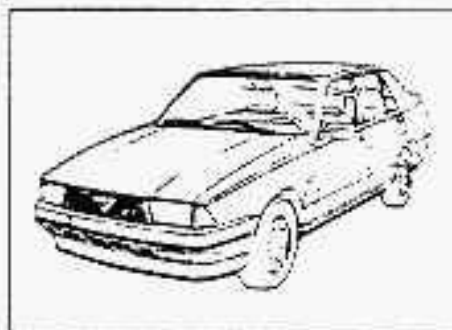
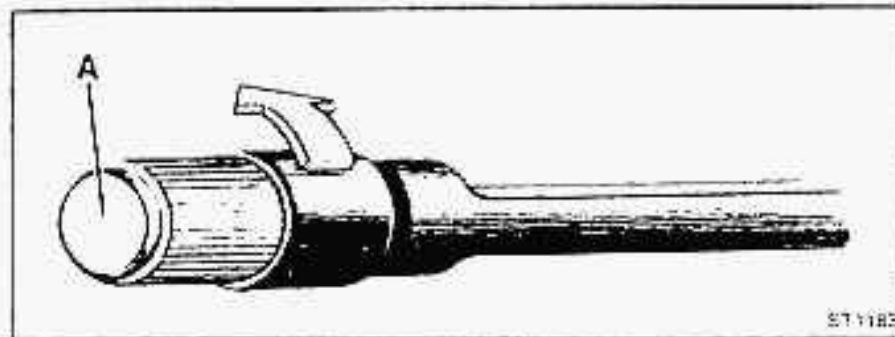

- Button A at end of lever in:
high beam

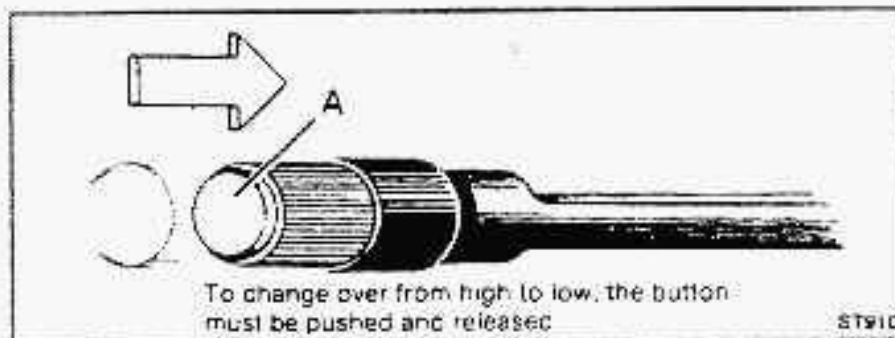

To change over from high to low, the button must be pushed and released

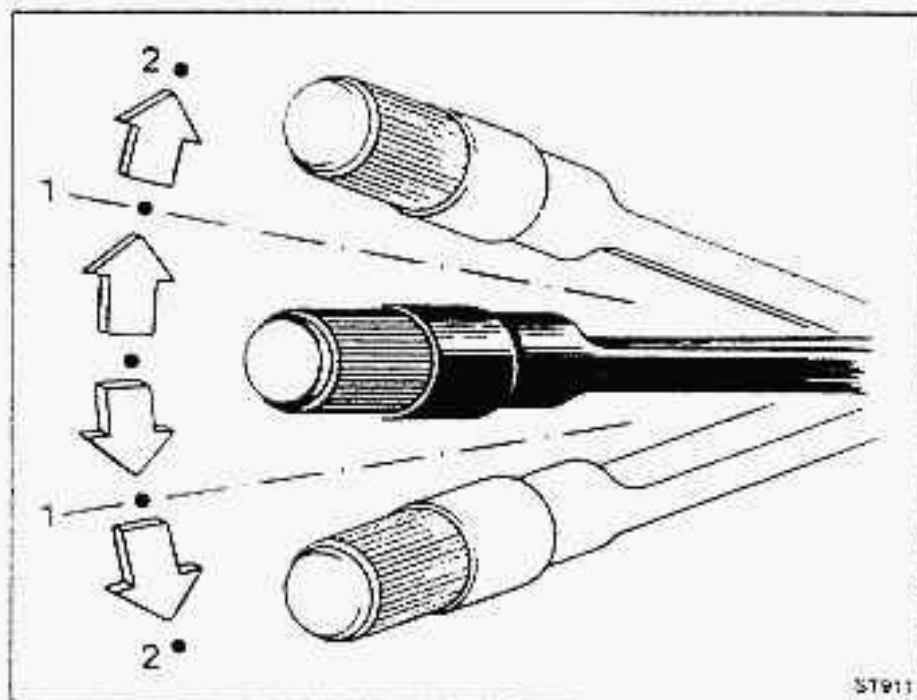
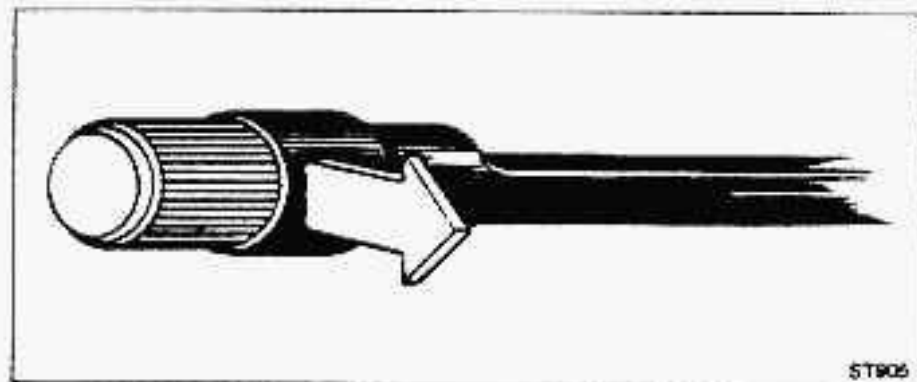

Flashing:

Pull lever towards steering wheel (even with lights off).

N.B.: It is the high beams that flash; to avoid fines be sure to observe local traffic regulations.



DIRECTION INDICATORS (Lever 1)

These are controlled by the same lever that controls the outside lights:

- lever up: right turn indicators;
- lever down: left turn indicators;

Lever in position 1 (overtaking position) the lever must be held in position for as long as required.

Lever in position 2: the lever remains in position and returns automatically when the steering is straightened up.

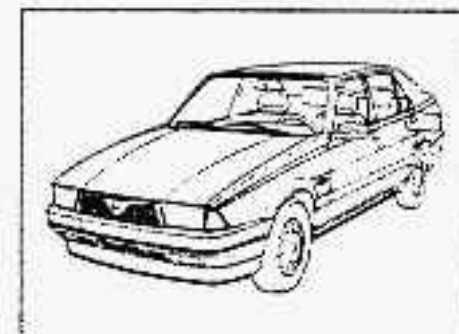
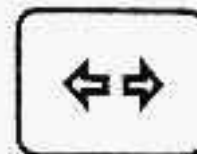

WINDSCREEN WIPER AND WASHER - HEADLAMP WASHER (Lever 2)

Windscreen wiper

The control lever has 4 positions:

- 0 — top: wipers off
- 1 — 1st notch: timed operation - the wipers complete one sweep automatically;
- 2 — 2nd notch: wipers operate at low speed;
- 3 — 3rd notch: the wipers operate at top speed.

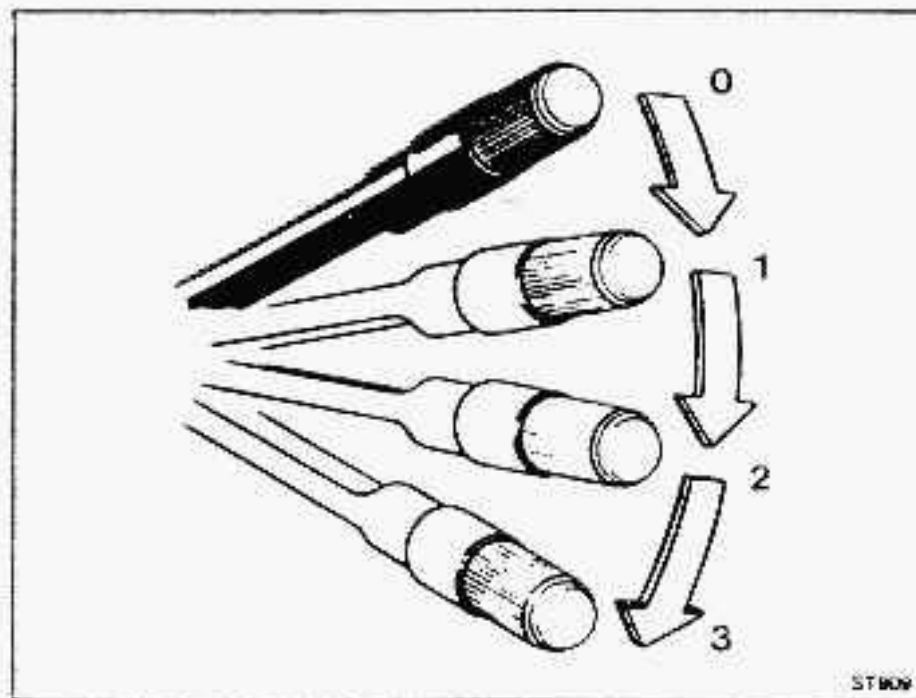
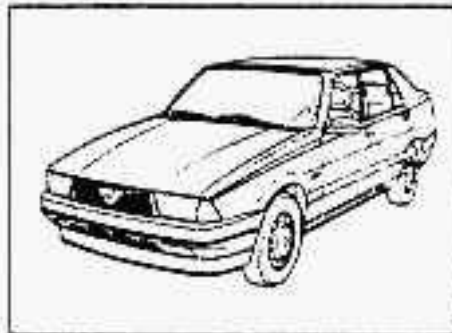

STRON

Windscreen washer and headlamp washers (on request and for some markets only)

The washer pump is operated by pulling the lever toward the wheel; the wipers will automatically complete one full cycle at the same time. The wipers automatically return to rest position. On request, the vehicle can be provided with headlamp washers with high-pressure water jets which go into action when, with parking lights on, the windscreen washer lever is operated.

The headlamp washer system is controlled by a timer.

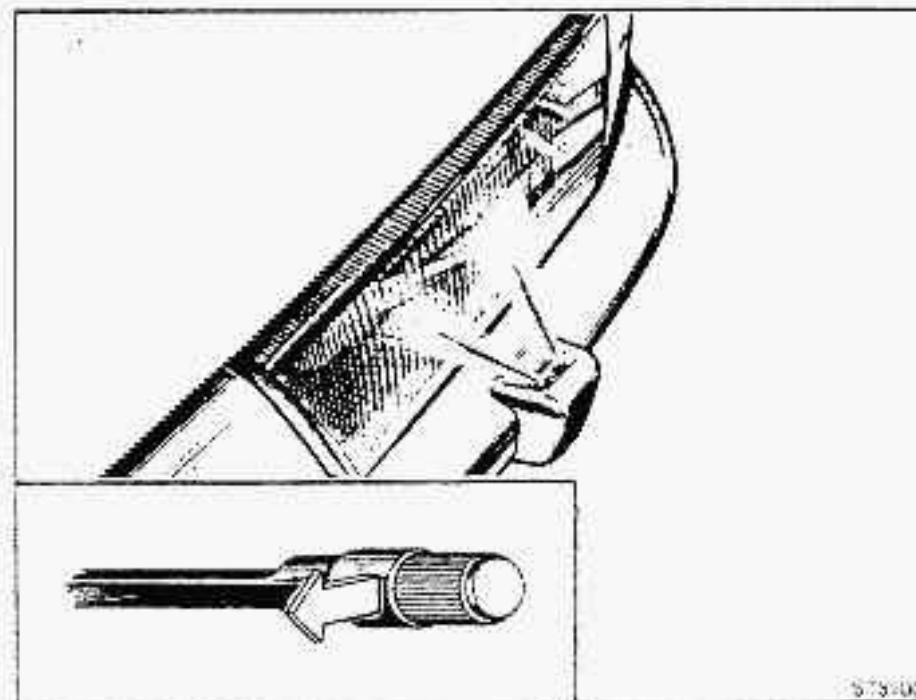
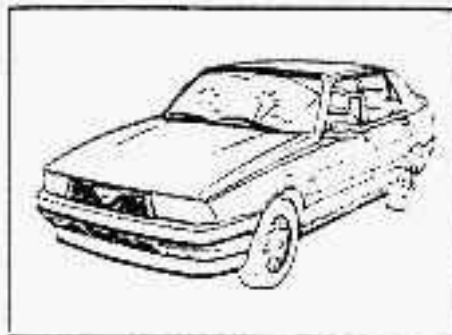

57300

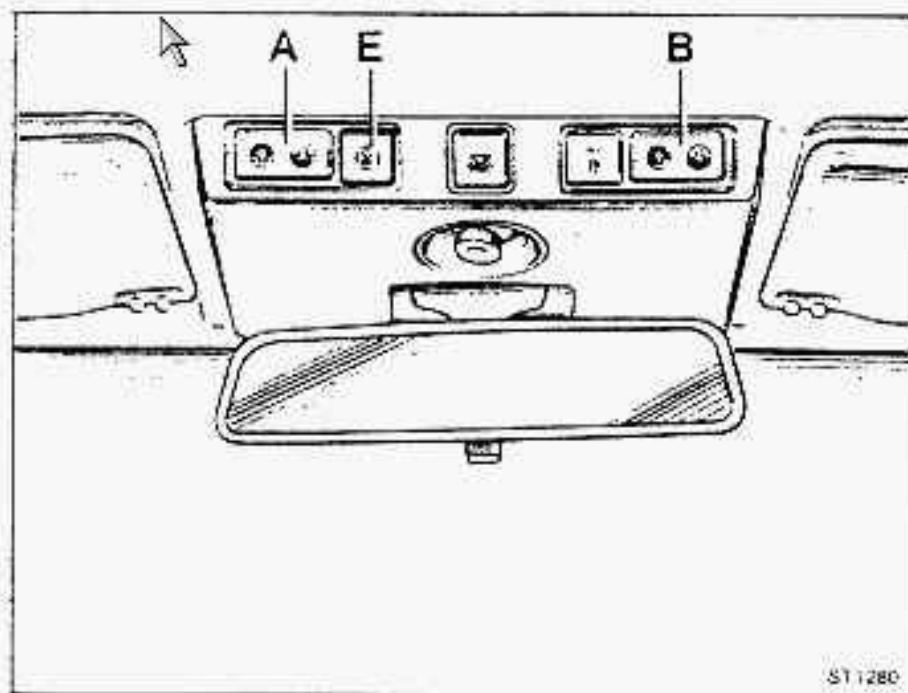

POWER WINDOWS

FRONT DOORS

To operate push the rocker-switch buttons above the internal rearview mirror:

Pushbutton A: left window

Pushbutton B: right window

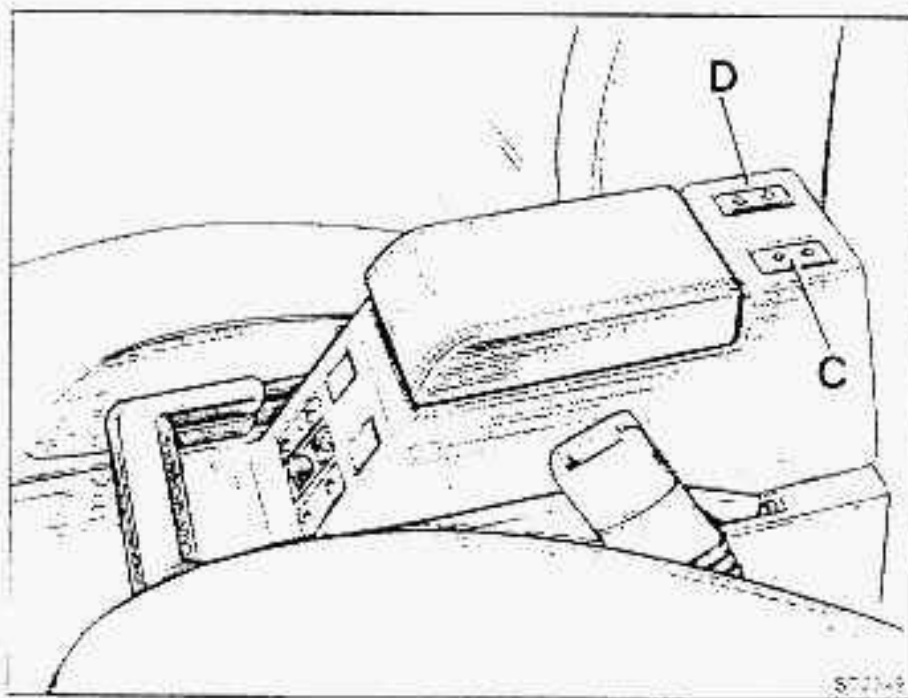
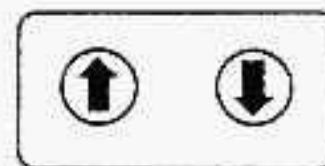

REAR DOORS

The windows of the rear doors are manually operated by the winder. Rear power windows may be fitted optionally (some versions only).

The switches are placed in the central panel:

Switch C: rear left window

Switch D: rear right window

Pushing button E will lock the switches controlling the rear power windows.

The engine must be running to provide power for the operation of the windows (or the ignition key in position 1).

Caution: Take care when operating the power windows. Do not keep the buttons pressed when the window is all the way up or down.

Important: When passengers remain in the car always remove the ignition key to prevent inadvertent operation of the windows as passengers (especially children) could be seriously harmed by the closing of a window.

INTERNAL LIGHTING

Front lighting

This consists of a ceiling light and an adjustable spot light. The ceiling light is automatically switched on with the opening of one of the doors and stays on for a period established by the Alfa Romeo Control (ARC) timing device. The ceiling light may be turned on and off manually by pressing switch A. The spot light is turned on by pressing switch B.



Ceiling light switch



Spot light switch

Rear lighting

This consists in an adjustable spot light, controlled by switch C.



Spot light switch

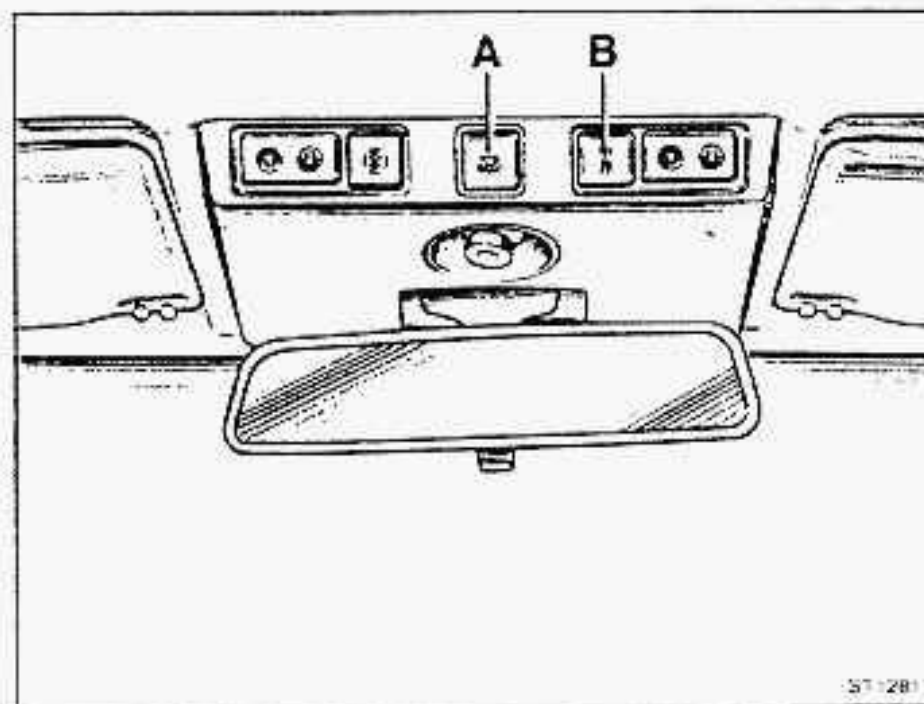

571281

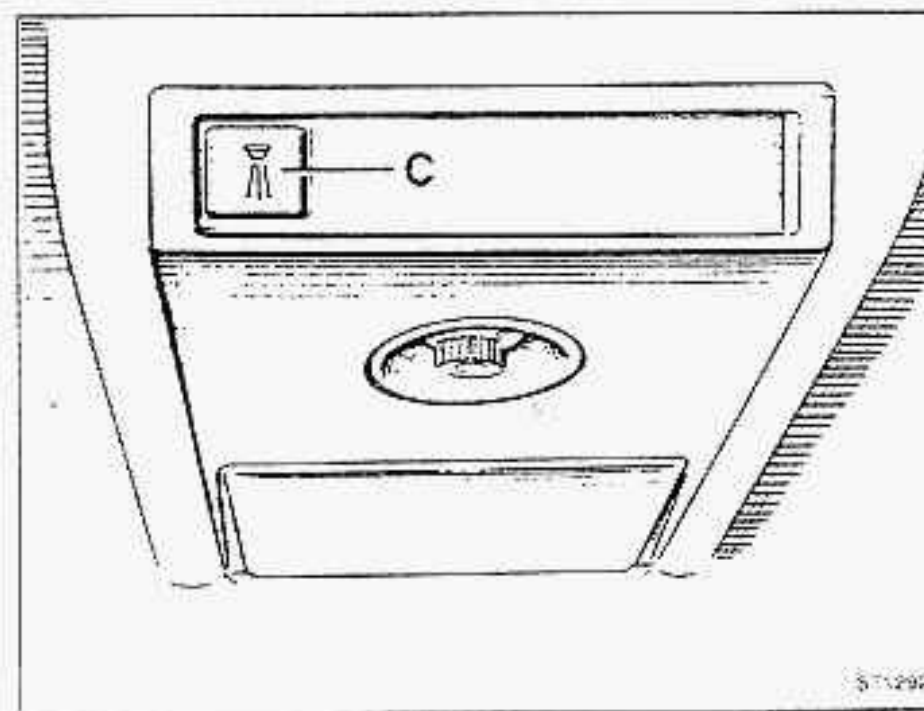

571299

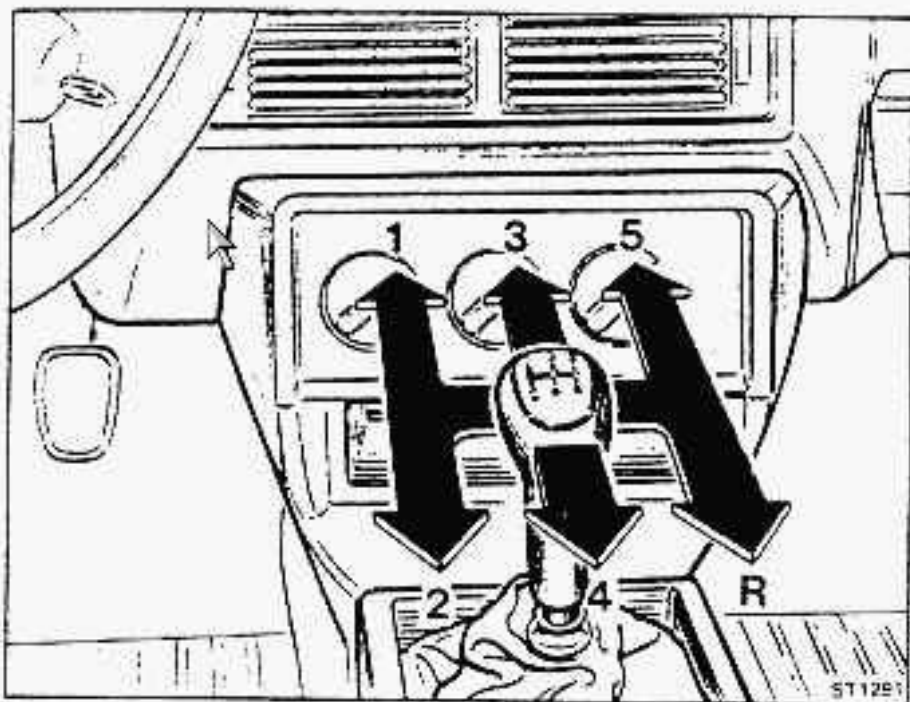

GEAR LEVER

The position of each speed is shown on the gear lever knob. Always wait until the vehicle has come to a complete standstill before engaging reverse (R). When changing gears always depress the clutch pedal fully.

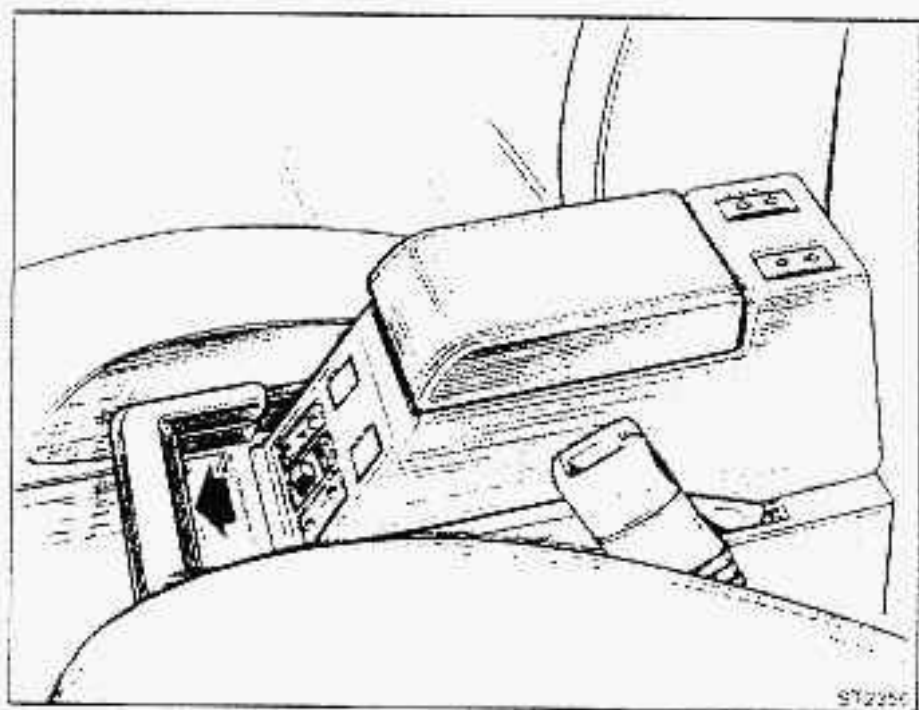

HANDBRAKE

To put the handbrake on for "parking" lift the lever until the brake is applied sufficiently. To release the lever lift it slightly upwards again and press on the inner part of the hand grip until the lock releases and then lower the lever still pressing on the inner part of the hand grip. For "emergency" operation it is recommended that the inner part of the hand grip be kept pressed.

2

SEATS

HORIZONTAL ADJUSTMENT

To slide the seat use the lever under the seat. after obtaining the position desired release the lever and ensure that the seat is secured.

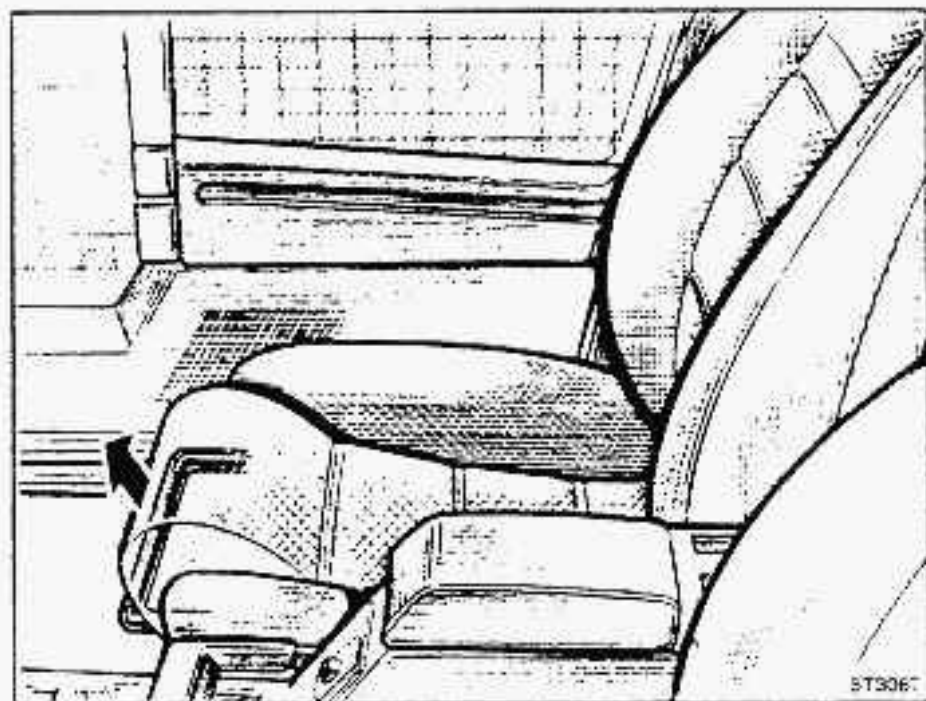

BACKREST ADJUSTMENT

To adjust the backrest raise the locking lever and set to the desired position. Release the lever (if the backrest is completely down, accompany it gently to the desired position after disengaging the lever in order to avoid violent movements).

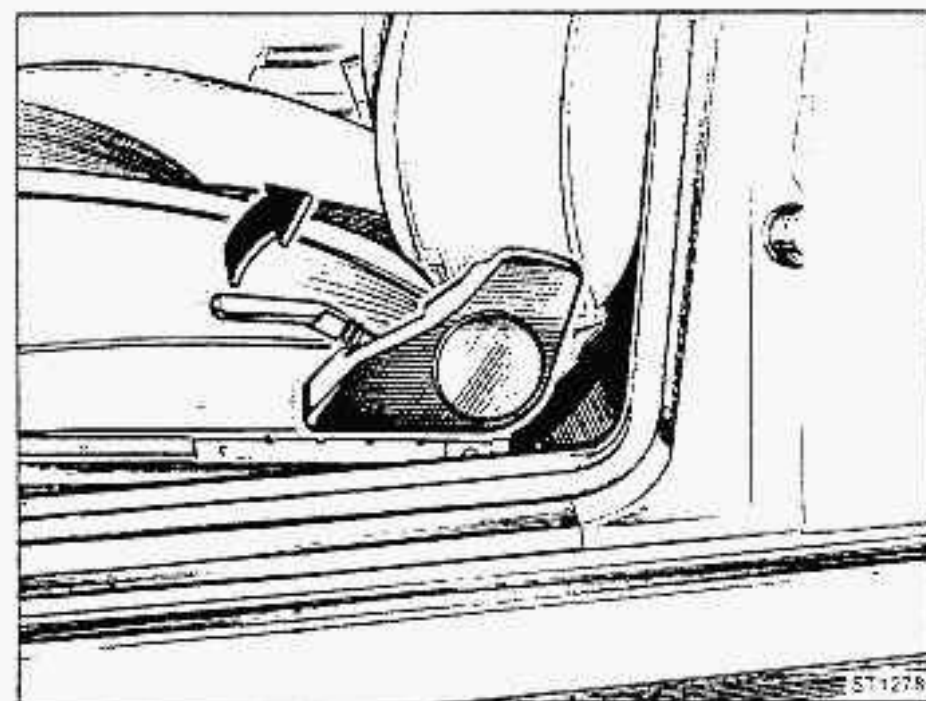

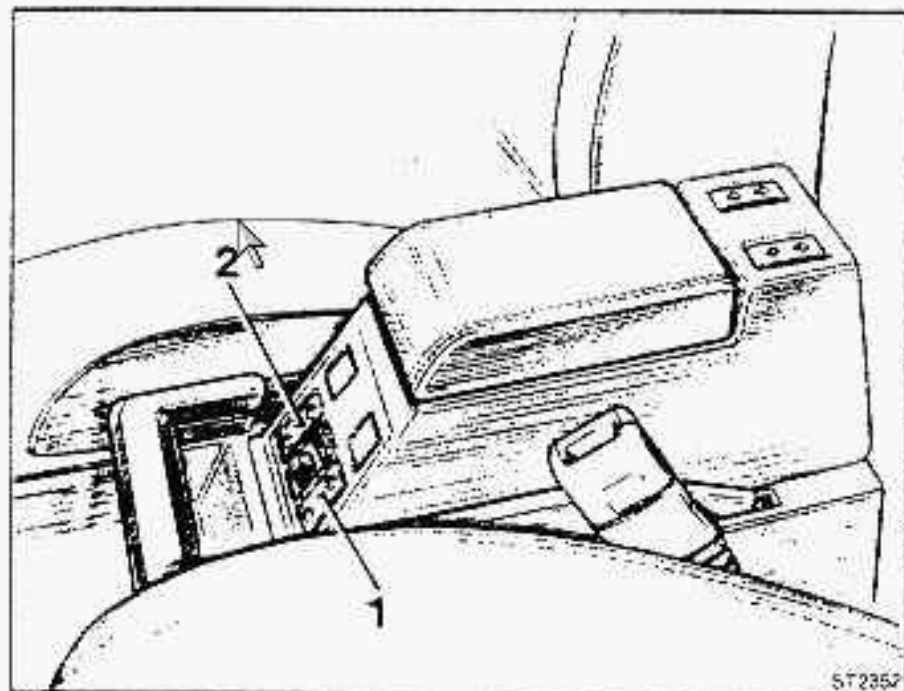

ELECTRICAL BACKREST ADJUSTMENT (when installed)

Adjust by pressing rocker switches 1 and 2, in the directions indicated by the symbols on the switches.

Pushbutton 1: adjusts the inclination of the driver's backrest
Pushbutton 2: adjusts the inclination of the passenger's backrest.



HEADREST

The height and inclination of the front seat headrests are adjustable (except in the 3.0 model), while the rear headrests are fixed to the seat.

Please note: The front headrests should be adjusted so that they correspond with the back of the head of the driver and the passenger. In order to avoid whiplash injury in the case of accidents, headrests should never be at neck height.



REAR CENTRE ARMREST

The rear seat an armrest which folds up into the backrest.

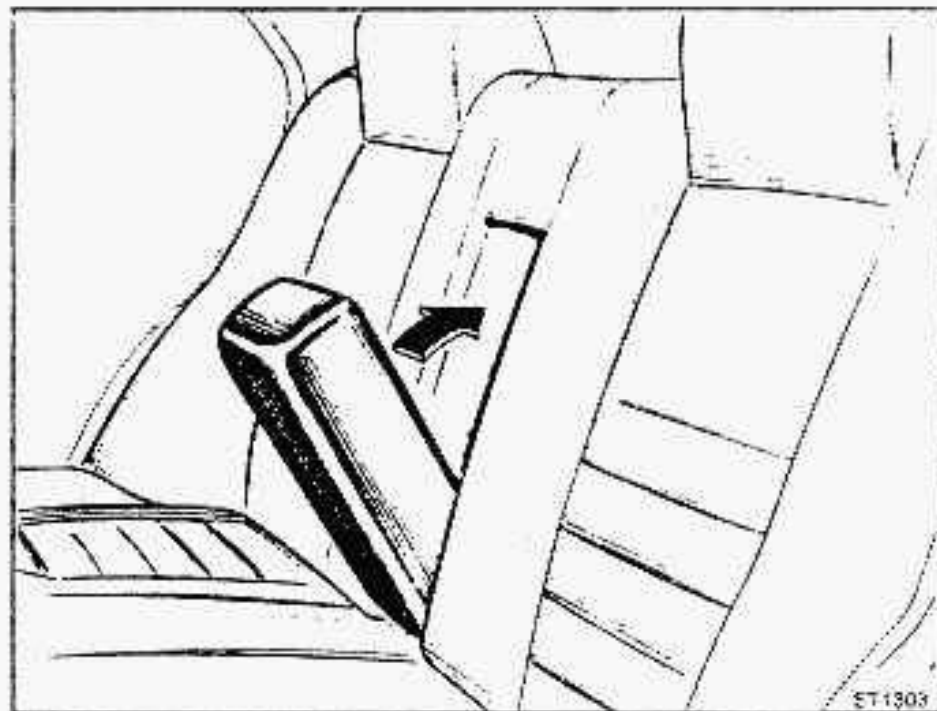

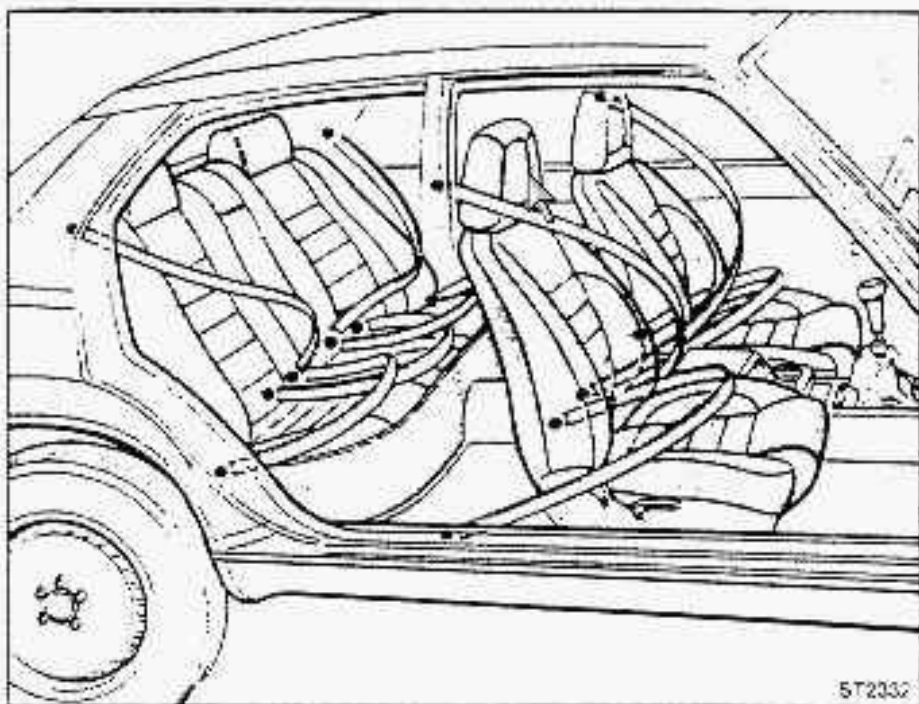

SEAT BELTS

The car is fitted with safety belts of lap and diagonal harness, inertia reel/auto retractor type at the front seats.

The rear seats are provided with anchor points - rear seat belts are only standard in countries where they are required by law. The 3.0 version is equipped as standard with seat belts at the sides of the rear seats. When not in use, roll up the latches in the belts and put them into the housings suitably provided in the seat back.

Fasten seat belts before driving off making sure they are adjusted and fit correctly.

Note: seat belts are designed for use by persons of adult height. It should also be borne in mind that seat belts should never be worn by a child seated on the knees of a passenger. Have the seat belts checked if they show signs of wear or malfunction. In case of an accident in which the belts are stressed they must be changed even if they show no signs of damage.

Warning: If the seatbelt has been subjected to stress, due to an accident for example, it should be replaced completely, including anchor points and bolts. Even if it shows no visible signs of damage, it could have lost its strength. The replacement should be carried out exclusively by an Alfa Romeo Service Dealer. Replace seatbelt as soon as it shows signs of wear or becomes faulty. Never carry out seatbelt repairs yourself, they should be carried out exclusively by an Alfa Romeo Service Dealer.



Front seat belts

Pull out the belt 2 (slide belt tongue 1 along belt) until it is extended sufficiently to connect the belt tongue to the buckle 3 on tunnel. Ensure the buckles are firmly latched. Usually seat belts enable the occupants to assume a comfortable seating position; however brusque movements should be avoided or the belt safety lock device will be operated.

To unfasten the belts push the button 4 of the buckle on the tunnel. Take care not to let the belt twist while being rewound on its reel. Slide the belt tongue along the belt to facilitate full rewinding.

Rear seat belts

The anchor points permit the installation of diagonal harness (or a combination of diagonal harness and lap type) seat belts for the side passengers and a lap type for the centre passenger.



DOORS

Central door locking

All four doors may be locked or unlocked simultaneously by operating the central door locking device.

The doors may be opened from the outside by pressing on handle 1. The front doors are fitted with lock 2. When the key is used to lock or unlock one of these doors all four doors are locked or unlocked at the same time (central door locking).

The same result is obtained by pressing down button 3 on the inside of the front doors (with doors closed). In order to open the doors from the inside (**with safety lock disengaged**), pull lever 5 near handle 4.

The hinge tie rods will keep the doors fully open or in an intermediate position as desired.

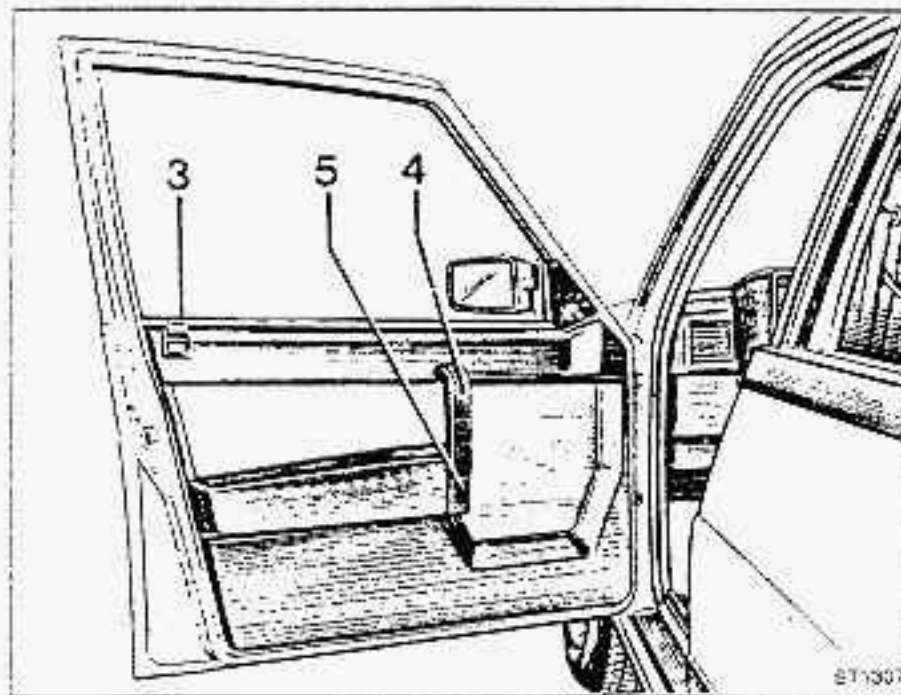
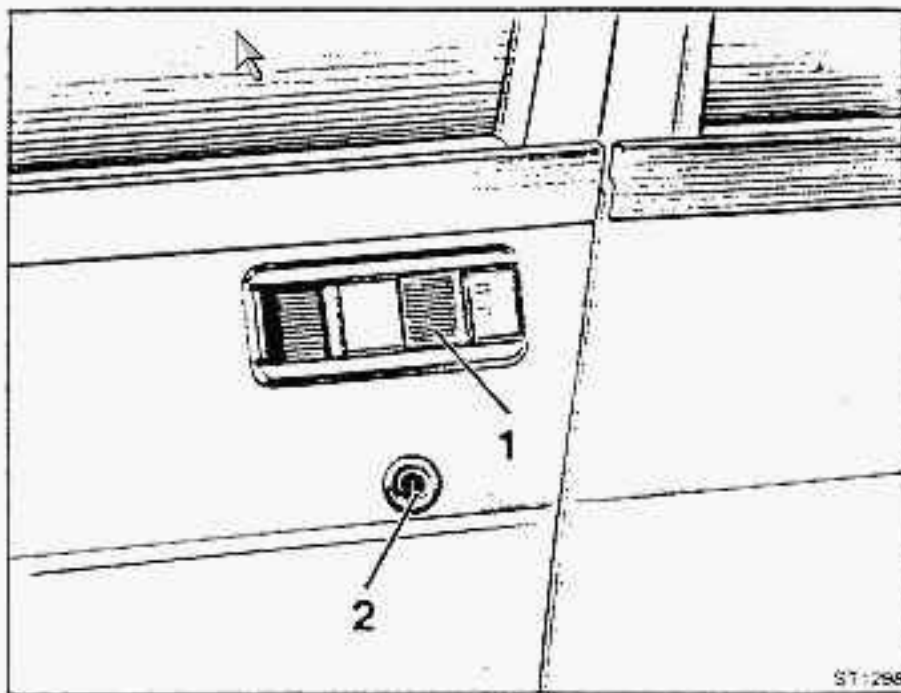

Warning. While the car is moving, doors should not be locked from the inside because, in the case of an accident, access to the interior of the car is difficult from the outside. If the child safety lock has been engaged on the rear doors, these can be opened only from the outside.

Rear doors safety locks

For the individual locking of the rear doors press down button 1. This may also be done with the door open.
In order to open the rear doors from the inside (with safety lock disengaged), pull lever 3 near handle 2.

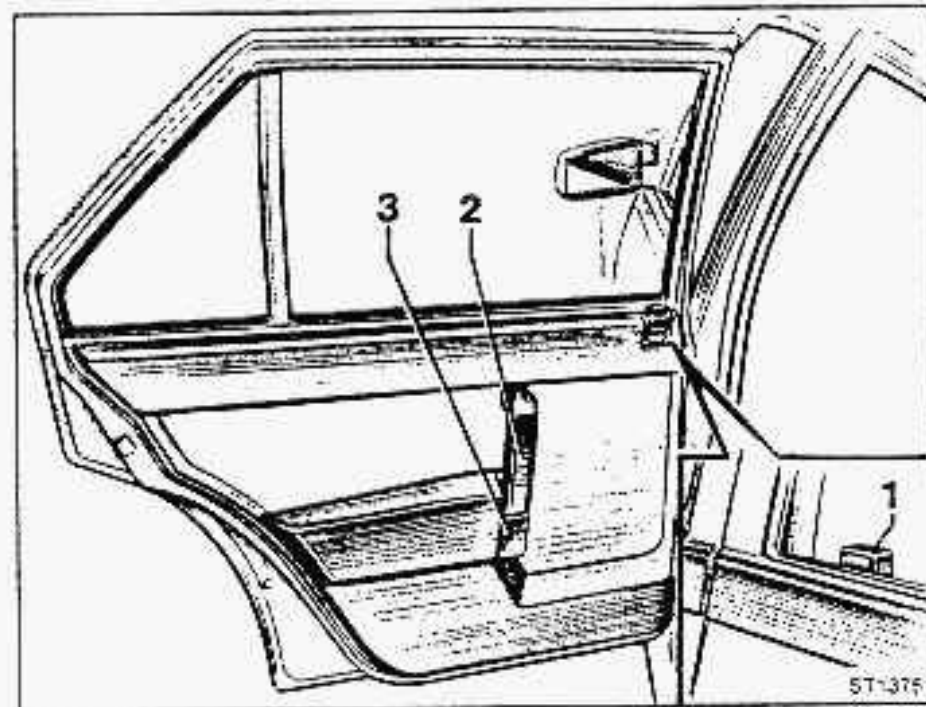

Child-proof door locks

This device prevents the opening of the rear doors from the inside, even if the door is not locked.
It is engaged by means of the lever on the door column.

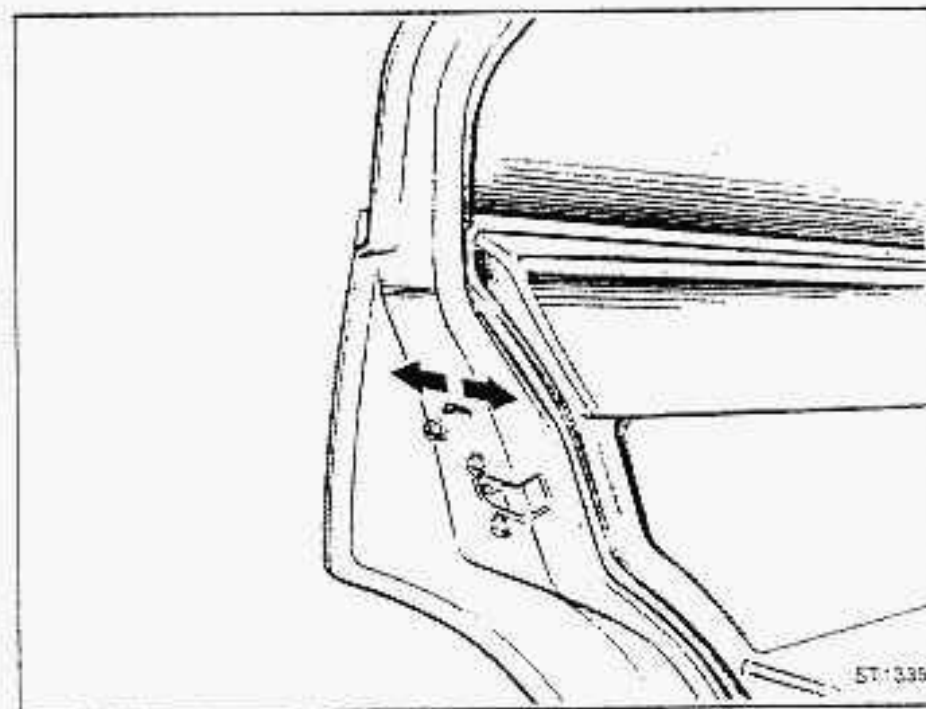

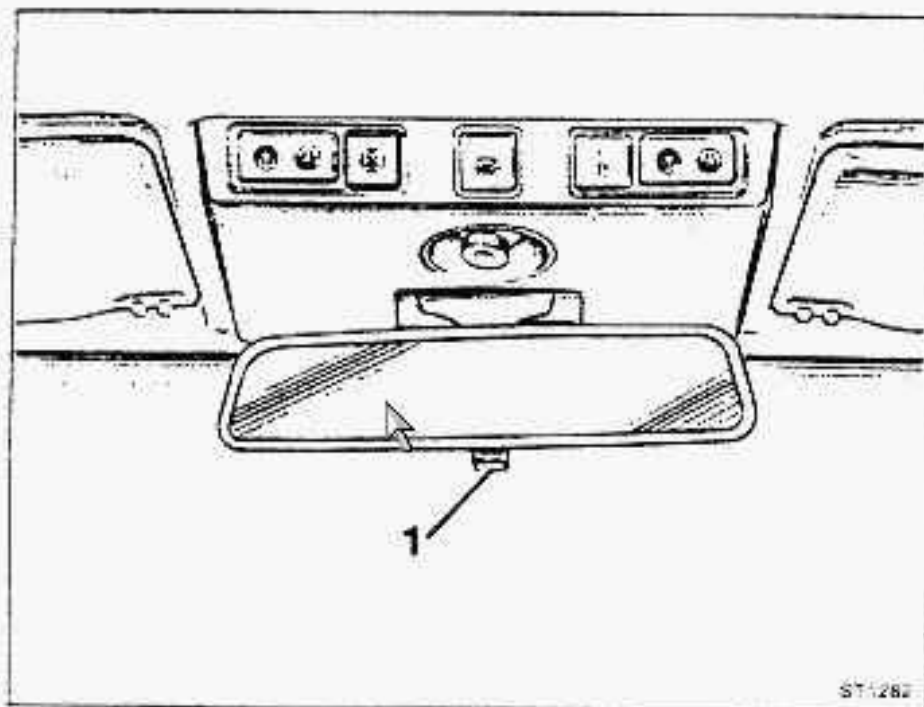

INTERNAL REARVIEW MIRROR

The rearview mirror has a day/night anti-dazzle device operated by a lever 1 at the bottom.

A = normal

B = anti-dazzle

It also has an anti-vibration safety bush (adjustable by means of bush 2).

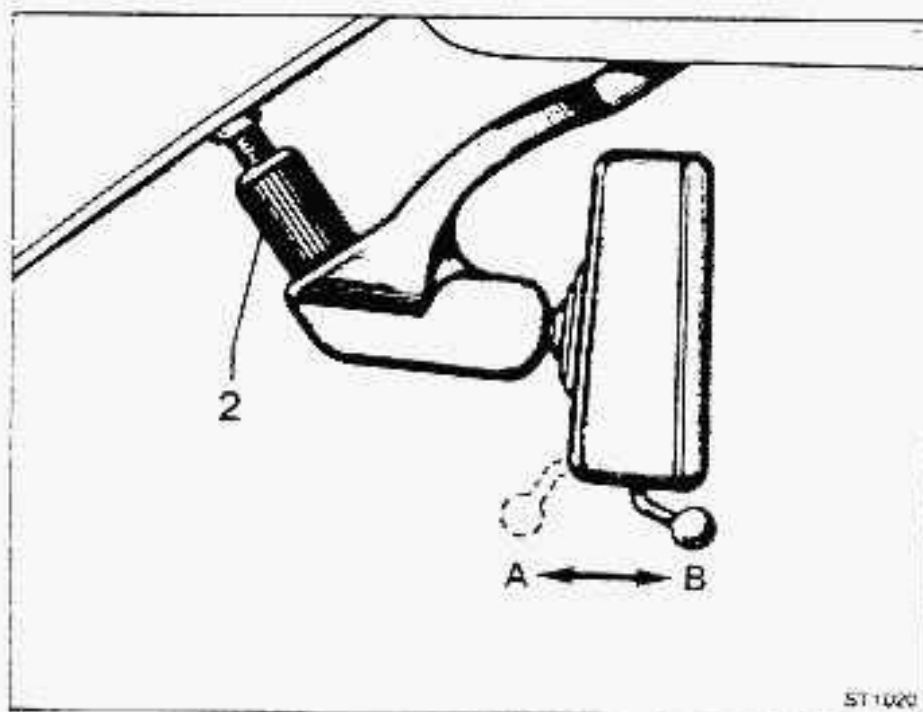

EXTERNAL REARVIEW MIRRORS (some versions only)

Both door mirrors are controlled by the switch 1.
Push the switch stalk as desired towards one of the four directions in which the mirror is adjustable (see illustration).
To adjust the driver's mirror move the switch 2 to the left. Move the switch 2 to the right for adjustment of the passenger's mirror.

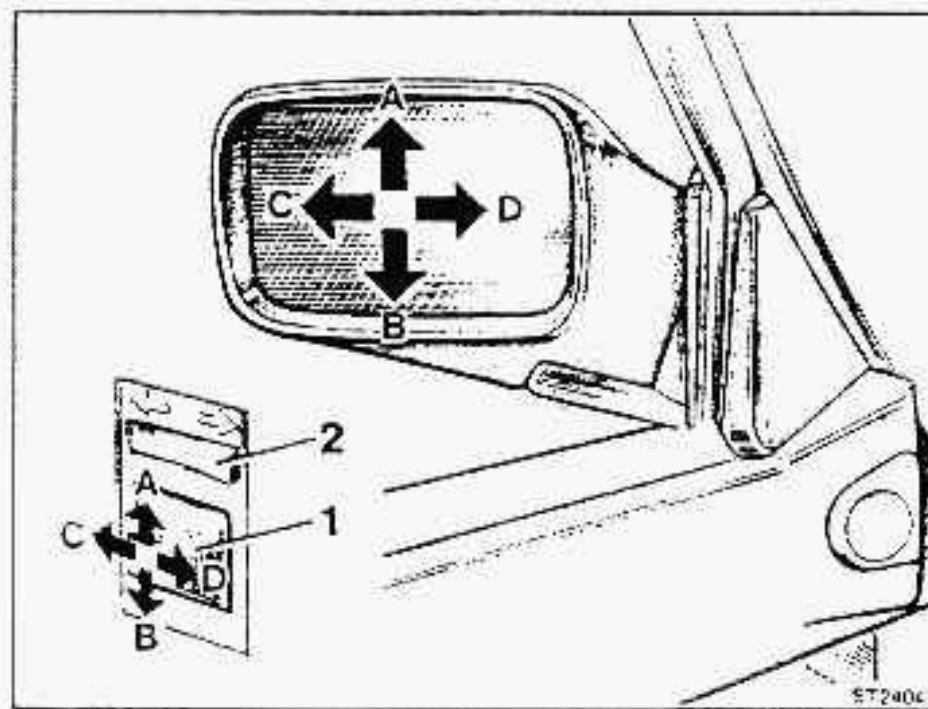
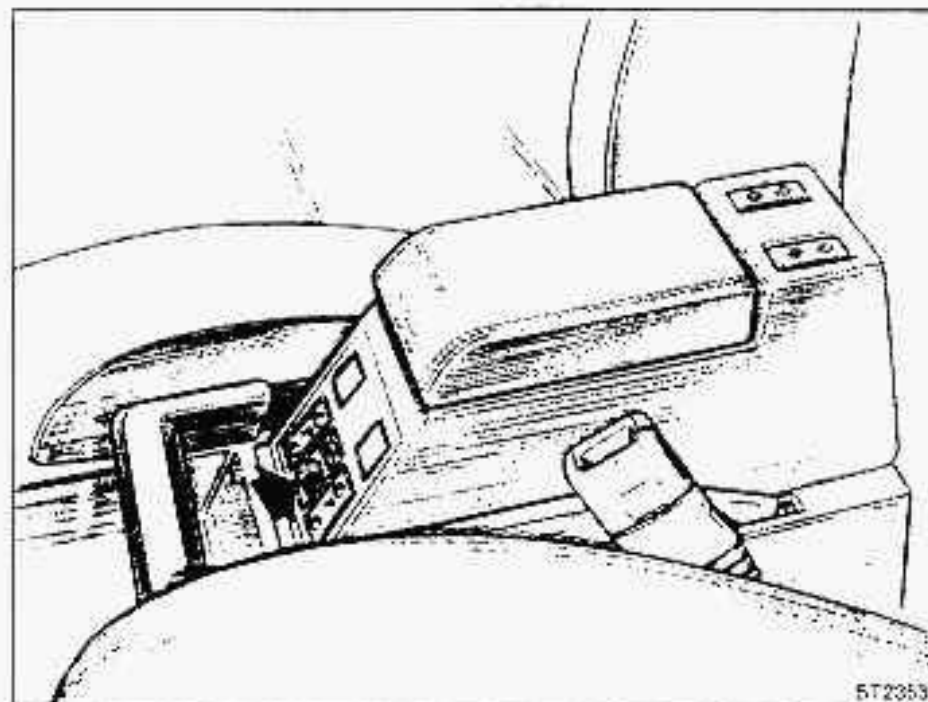

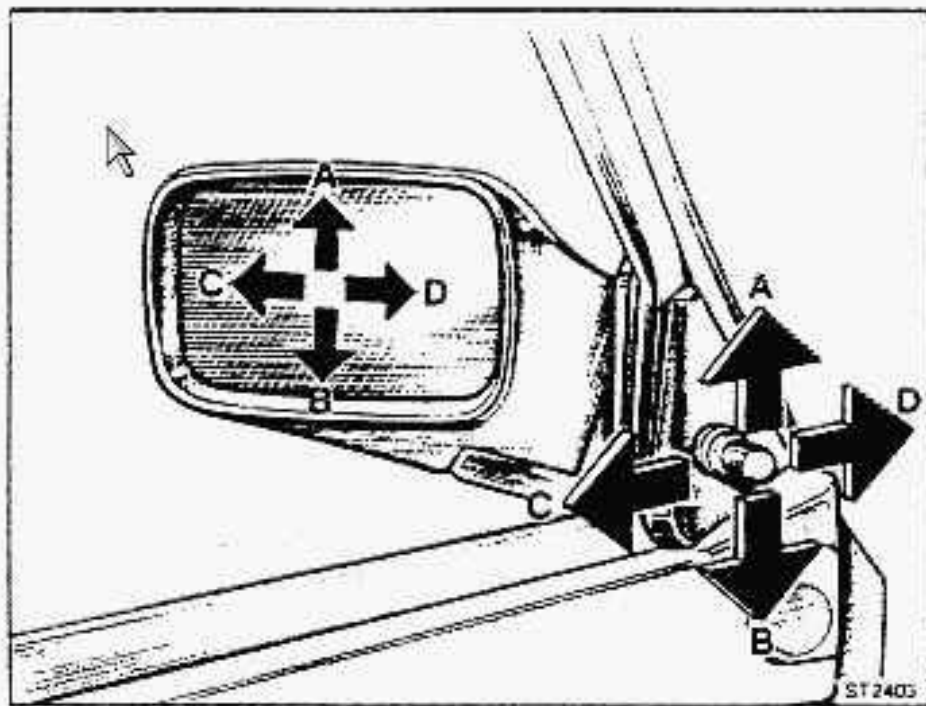

EXTERNAL REARVIEW MIRROR

This is mechanically adjustable by means of a control on the side panel near the mirror. During automatic washing or for space reasons it is possible to push the mirror group all the way forward or all the way back against the side of the vehicle.

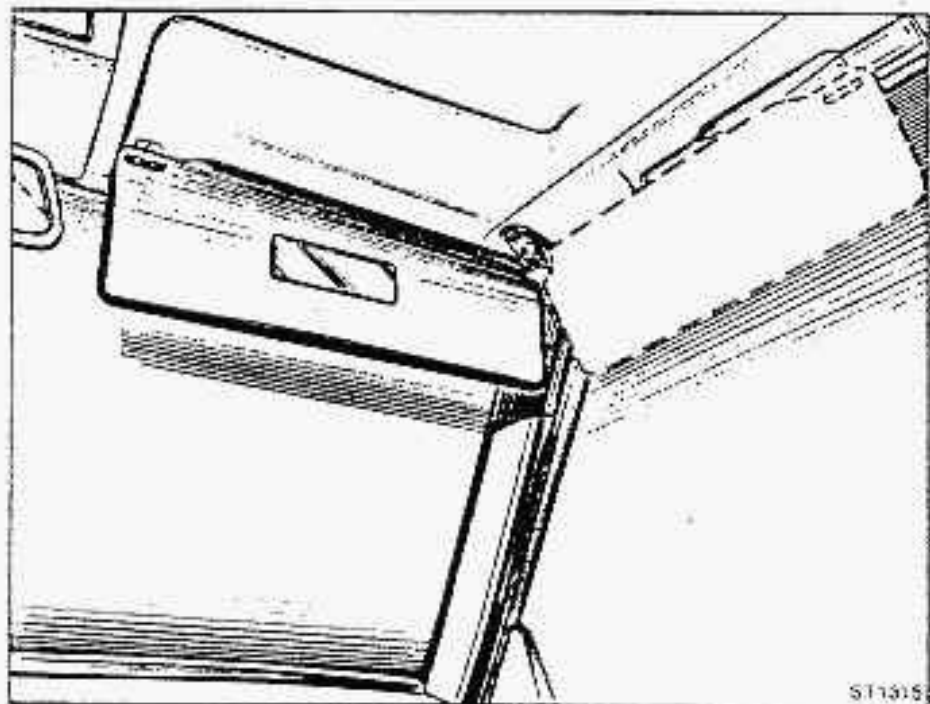

SUN VISORS

Sun visors can be moved laterally as required. The passenger's visor has a vanity mirror.



GLOVEBOX

Opposite the passenger there is a spacious glovebox. In order to open, pull lower border.

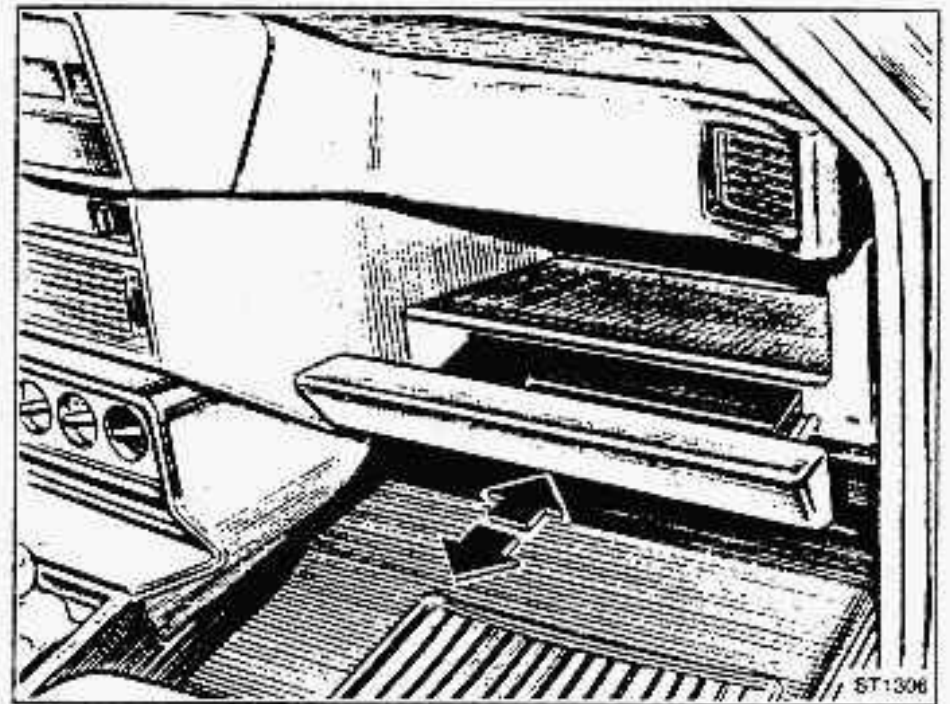

BACKSHELF DRAWER

The drawer is located under the backshelf and is protected by a cover. To open raise the cover.

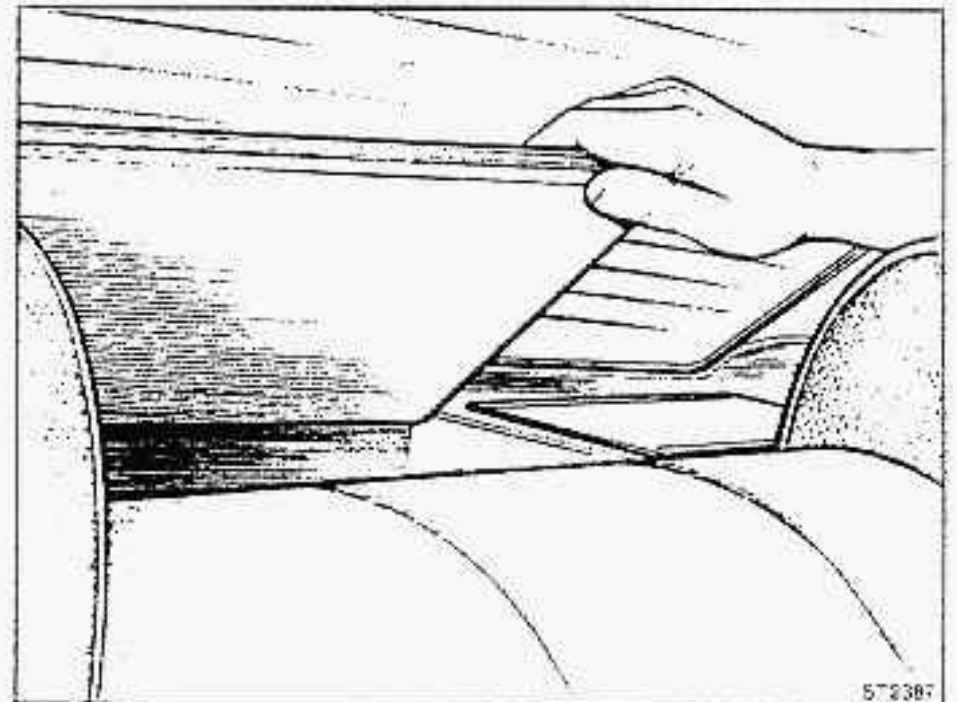

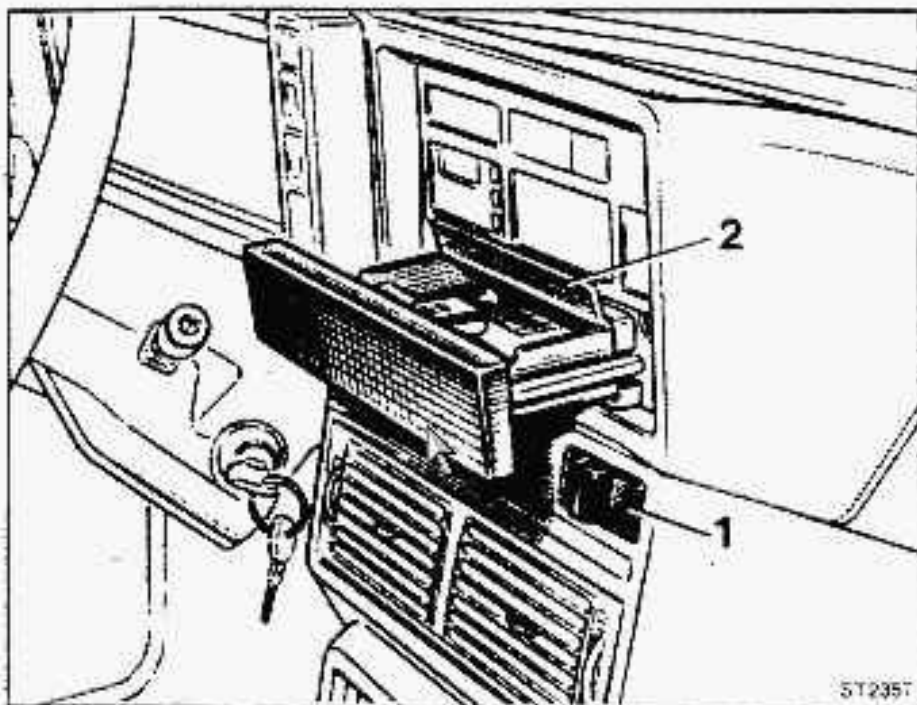

FRONT CIGAR LIGHTER

To use the cigar lighter 1 press the knob all the way. A click will indicate that the electrical elements have reached the necessary temperature. The knob will return to normal position and the cigar lighter can be extracted.

FRONT ASHTRAY

The front ashtray is situated on the dashboard. To empty it press down the inner spring 2 and extract.

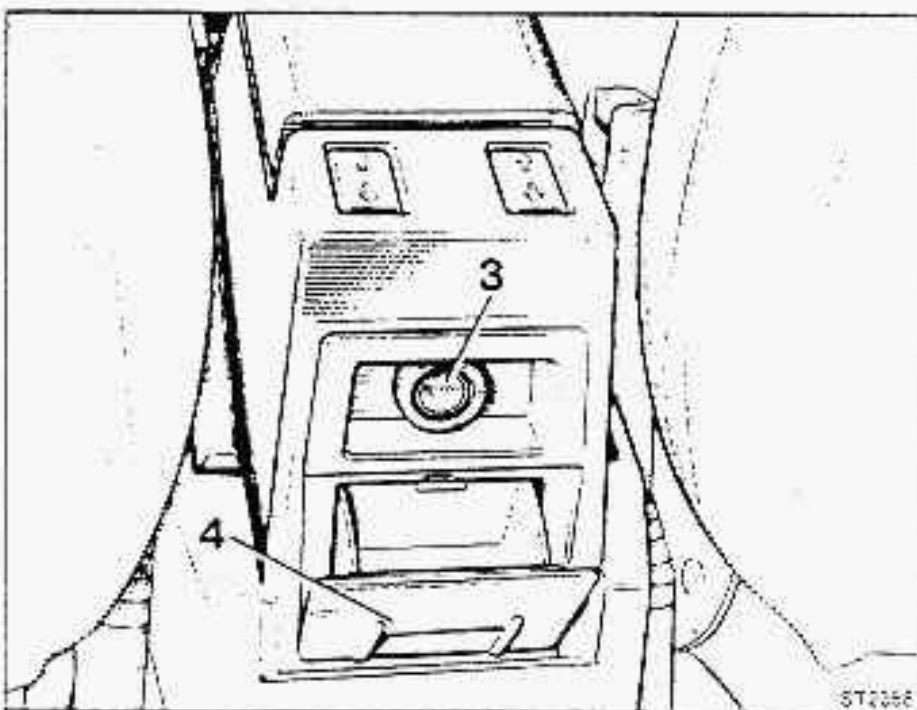

REAR CIGAR LIGHTER

To use the cigar lighter 3 press the knob all the way. A click will indicate that the electrical elements have reached the necessary temperature. The knob will return to normal position and the cigar lighter can be extracted.

REAR ASHTRAY

The rear ashtray 4 is situated in the rear part of the console. To empty it raise it vertically and extract. To replace centre the lower stop notches and push forward.

SUPPORT HANDLES

Located above side windows (with the exception of the front driver's side); the rear ones also have coat hooks.

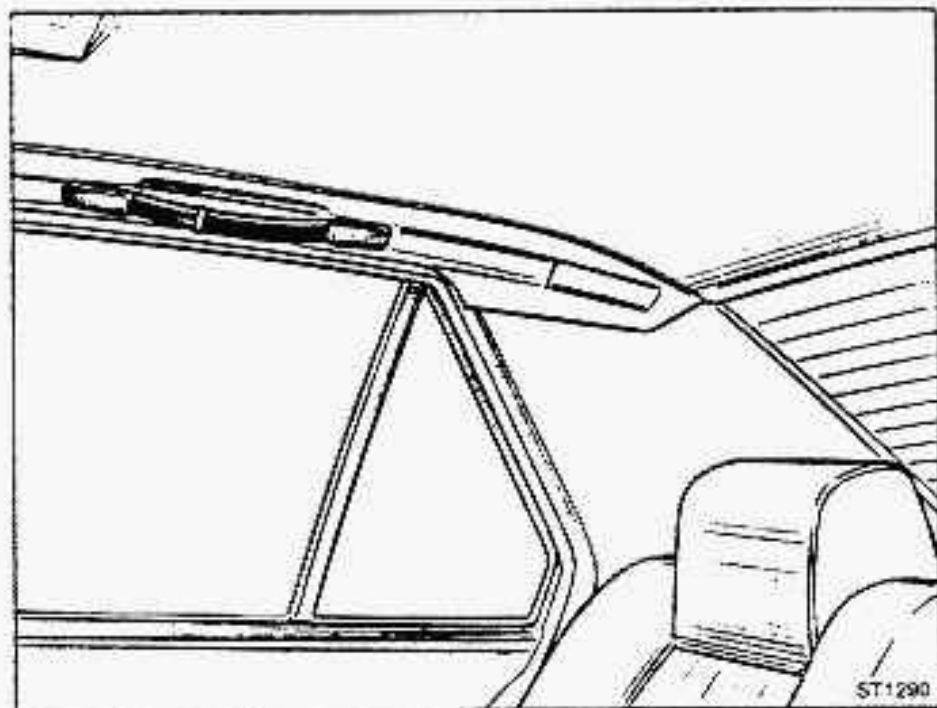

FILLER CAP COVER

This is located on the right side of the car and is fitted with a lock. After each filling, make sure the cap cover has been correctly locked into place.

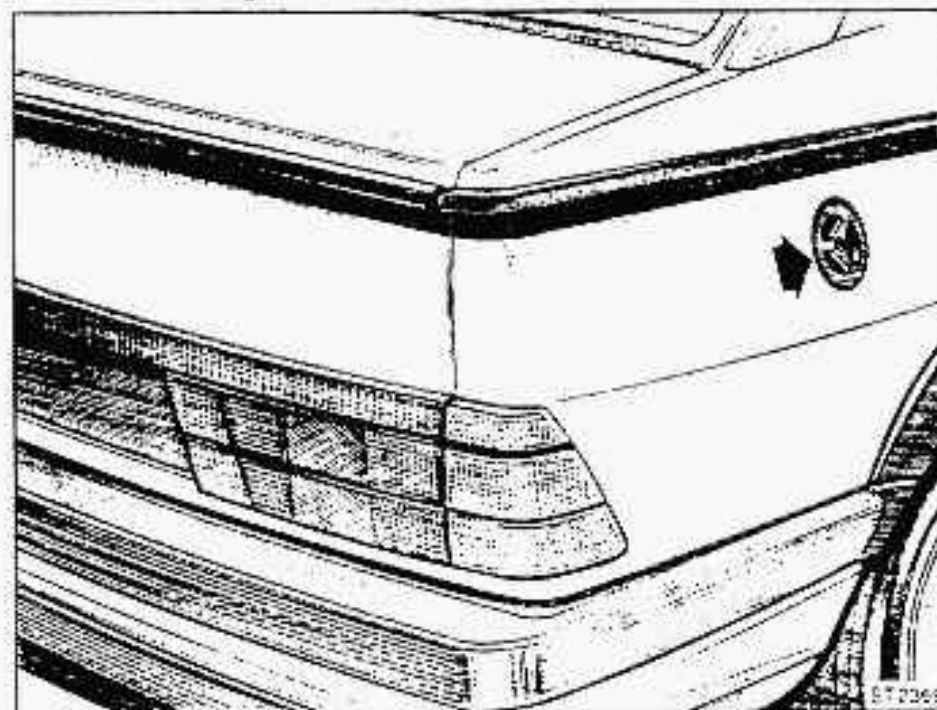

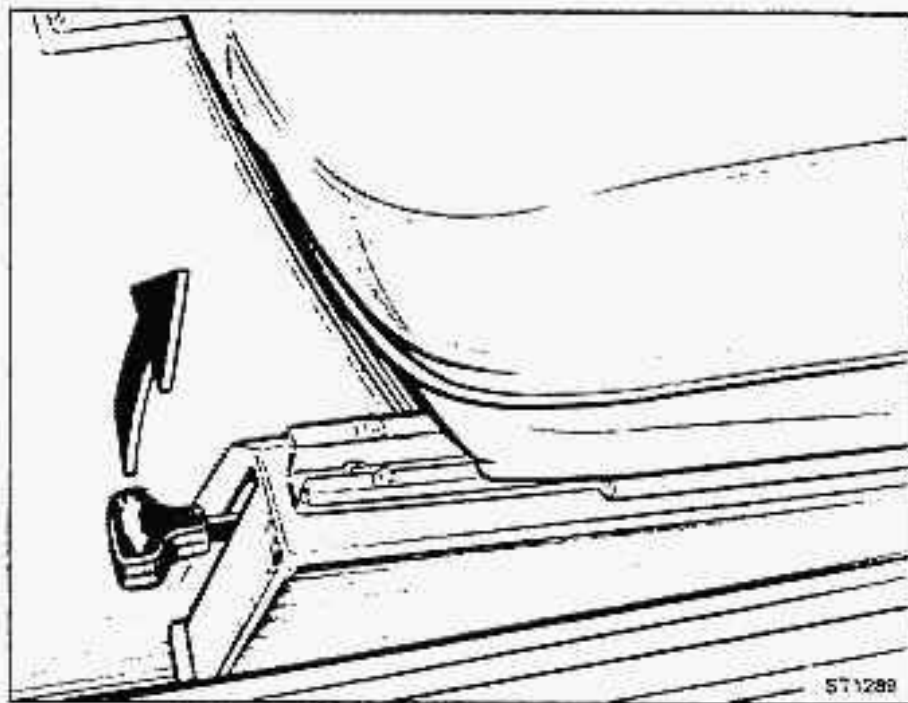

BOOT OPENING

To open the boot raise the lever shown. The boot lid is fitted with spring struts. With side lights on the boot is illuminated. Under the cushion of the rear seat there is a lever to open the boot in an emergency.

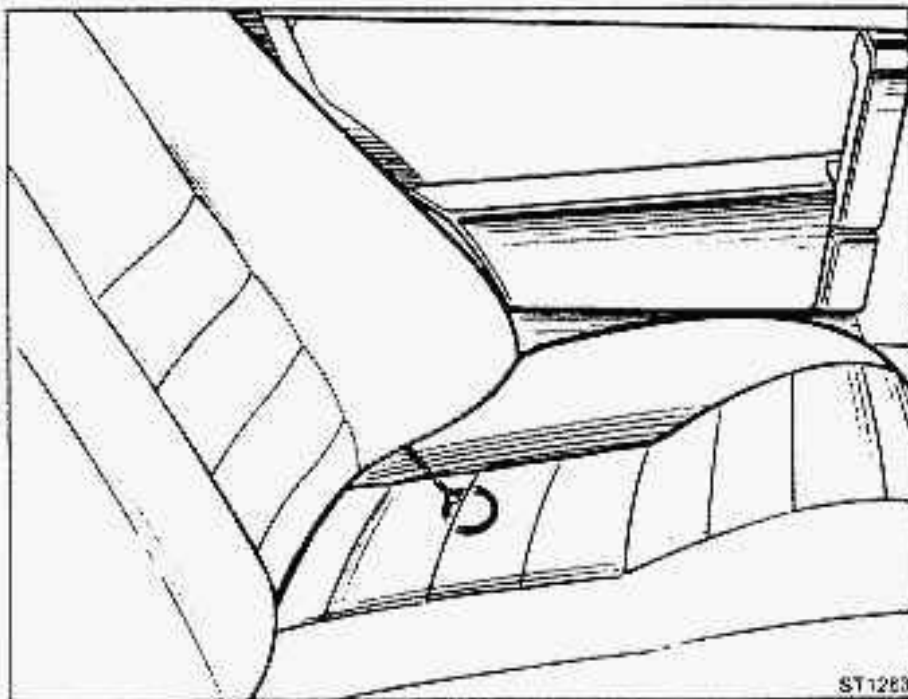

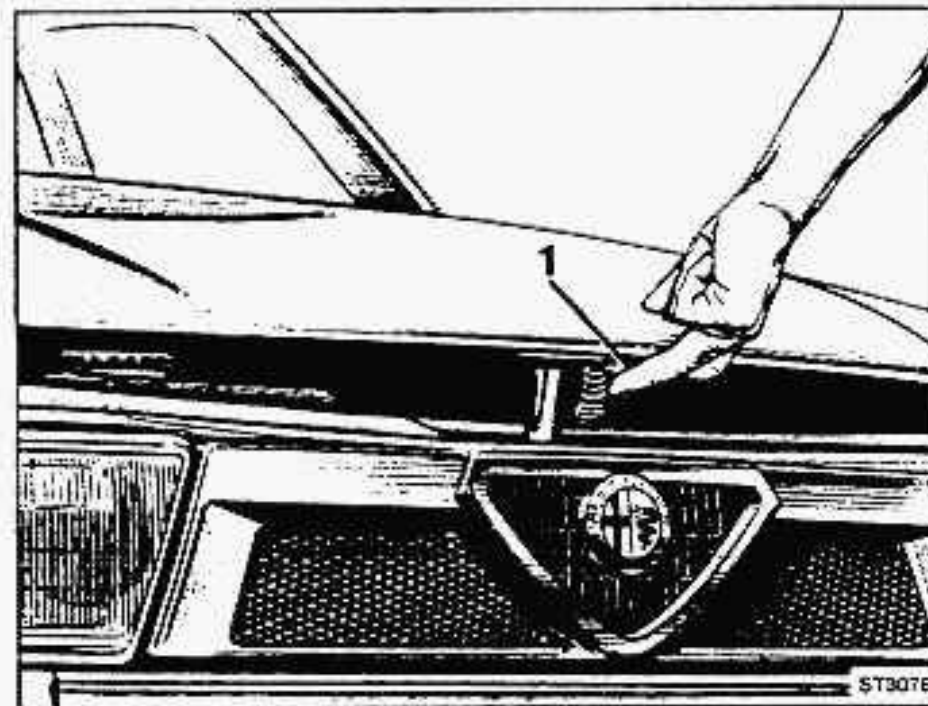
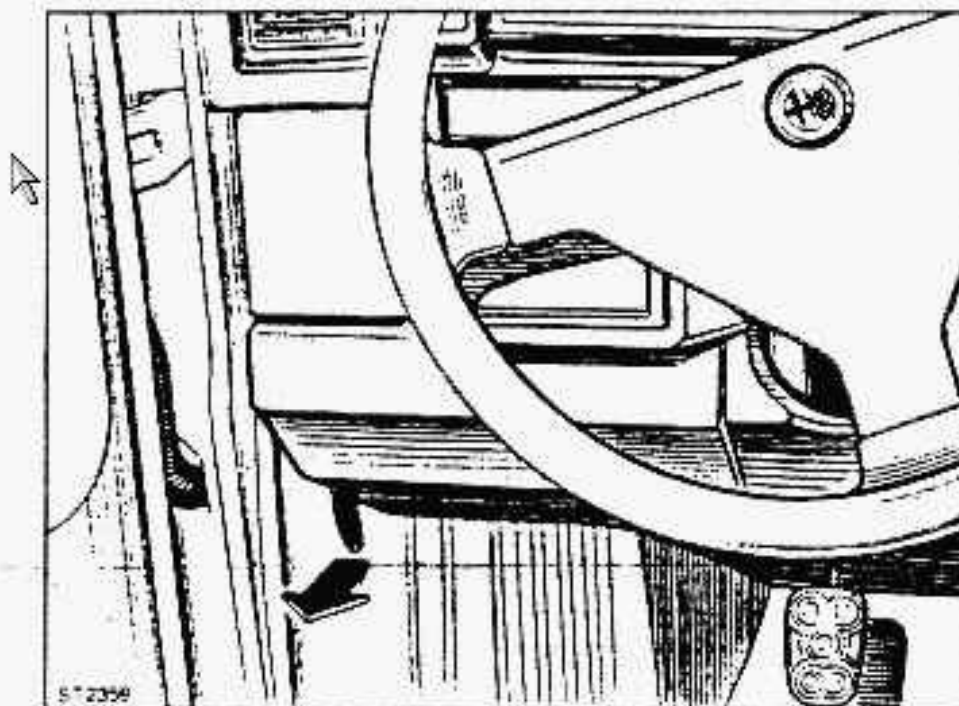

BONNET OPENING

To open bonnet, pull lever under the control panel. The bonnet will thus be released but with the safety catch still engaged. Raise the bonnet slightly until the safety catch 1 is accessible, push it upwards to release, then lift bonnet completely and place the support rod 2 in position, as indicated in the diagram. When the parking lights are on, the engine compartment will be automatically illuminated when the bonnet is raised.

To close bonnet, place the support rod 2 in its securing spring 3 located on the mudguard on the inside of the engine compartment; let the bonnet down, making sure that it is completely closed, and not just secured by the safety catch. In the latter case, do not press down on the bonnet (which will deform it) but raise it again and reclose.

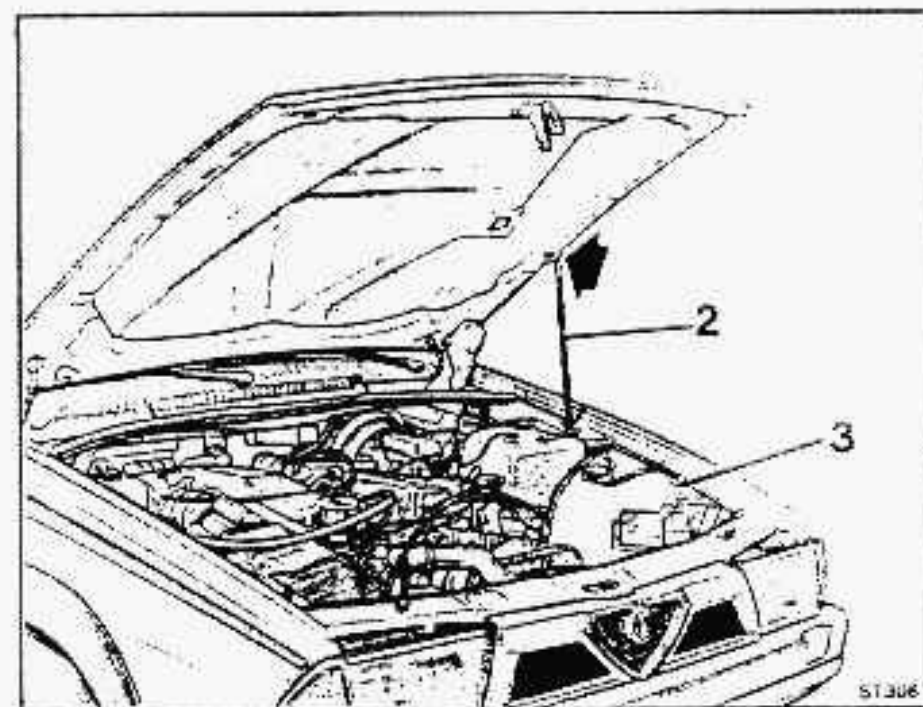

VENTILATION - DEMISTING & HEATING

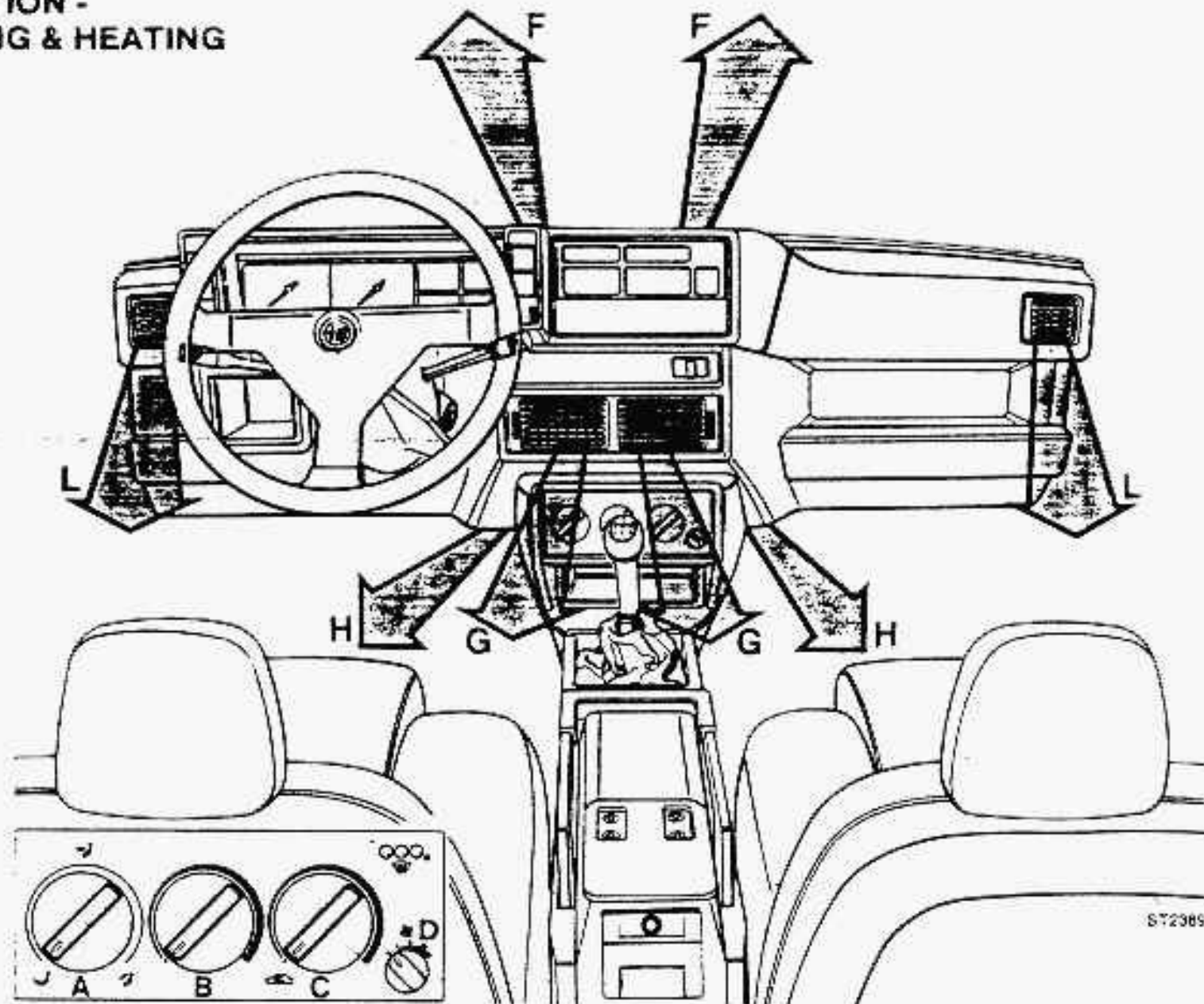

S72385

A Air flow control selector
 B Heating control
 C Ventilation control

D Blower control
 F Windscreen defrosting louvre
 G Centre adjustable vents

H Lower air outlets
 L Side air outlets

Side air outlets L

Connected to the ventilation system and adjustable, the air flow can also be directed towards the side windows (for defrosting or demisting) by adjusting the vent.

The side vents are always supplied from the ventilation system irrespective of the position of air flow control selector A.

1. Horizontal direction control.
2. Open/closed control (and regulation of air flow).

Maximum air flow is obtained with selector A in position , the central air vents G closed, and the blower (control D) at third speed.

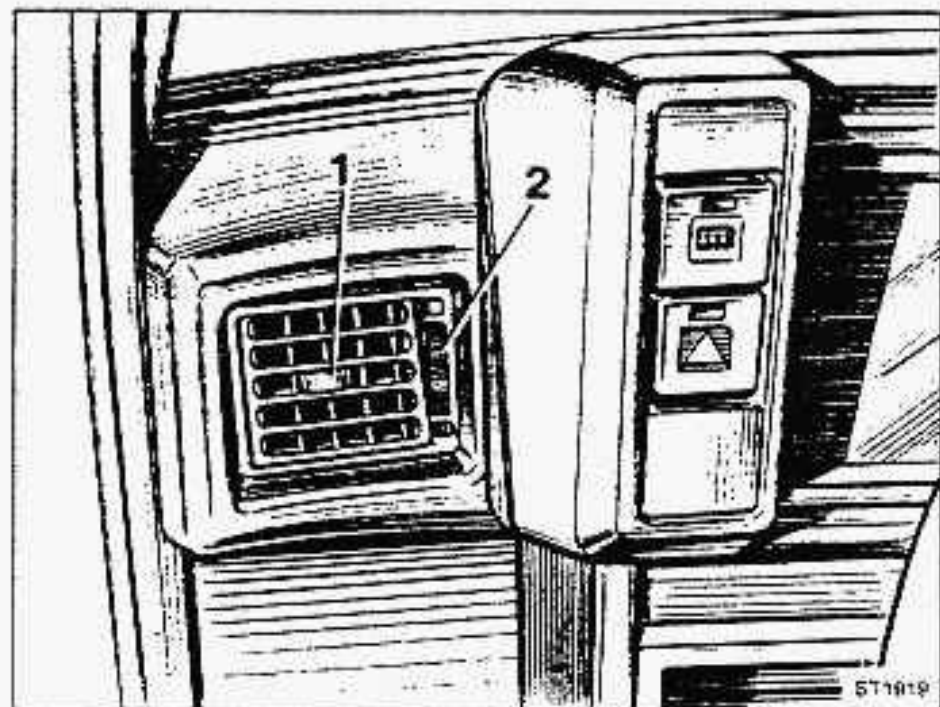

Centre vents G

Connected to the ventilation system; adjustable air flow and direction:

1. Horizontal direction control.
2. Open/closed control (and regulation of air flow).

The centre vents are always supplied from the ventilation system irrespective of the position of air flow control selector A.

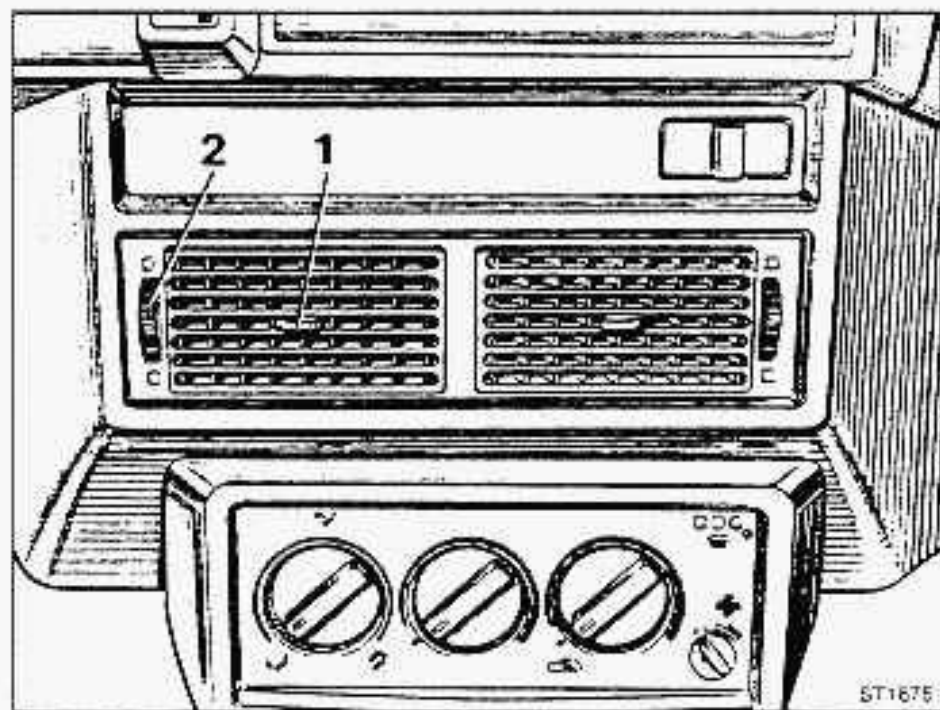

The text and illustrations which follow relate to the most common uses of the vent/heating system. The client is, of course, free to select any of the wide range of alternatives offered by the system.

Important

To ensure efficient defrosting with very low outside temperatures it is wise to start the engine and wait a few moments for the required temperature to be reached. When demisting only, on the other hand, cool ambient air alone may be sufficient; set control C in position fully clockwise. Controls A, B and D should remain in the position shown.

DEFROSTING/DEMISTING

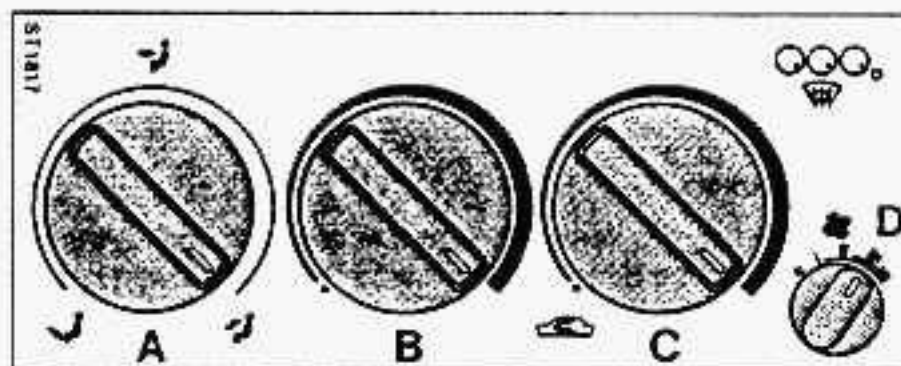

To clear the windscreen and side windows rapidly set the controls according to the diagram above:

- Air flow control selector A in position
- Heating control B in fully clockwise position.
- Ventilation control C in fully clockwise position.
- Blower control D at third speed.
- Centre vents G closed.



To demist the rear screen, press  on the side of the instrument panel.

CONTROLS

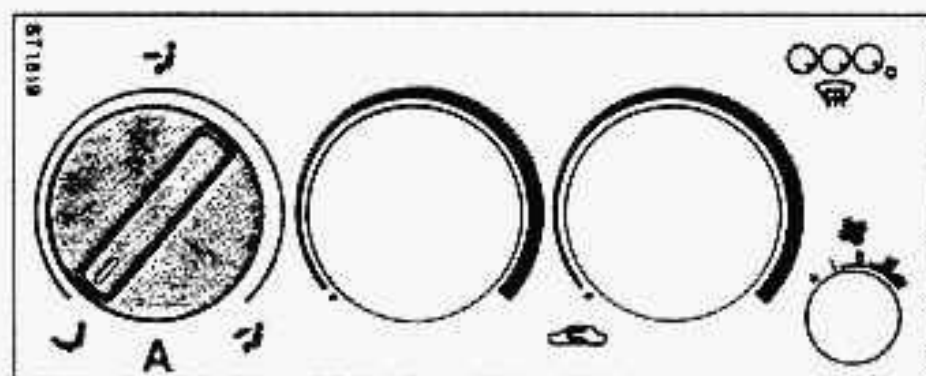
AIR FLOW CONTROL SELECTOR A:



permits the following air flow positions:

-  downward airflow (outlets H-G-L)
-  upward airflow (outlets G-L)
-  upward airflow (outlets F-G-L)

N.B.: Whatever the position of selector A, air is always blown from the central outlets G, unless they have been closed with the corresponding control.

HEATING CONTROL B:

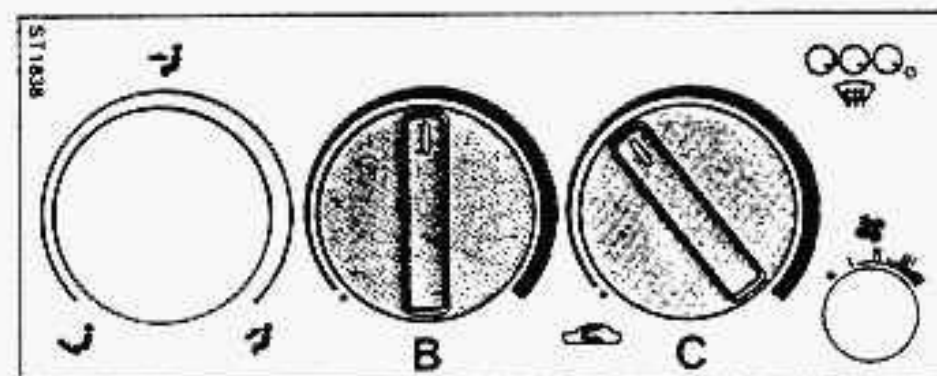

Controls the opening, closing and adjustment of the heating valve.

Control B in position ●:
heating off.

Control B turned clockwise:
gradual increase of the heating depending on the position of control B.

Control B turned fully clockwise:
maximum heating.

Turn control B to regulate the temperature and control C to obtain the quantity of external air desired. Then adjust the various vents to direct and regulate the air flow as desired.

VENTILATION CONTROL C

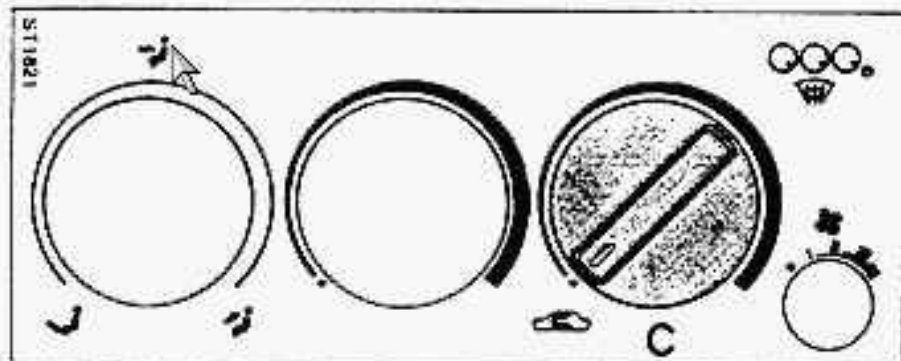

Regulates the quantity of air admitted to car's interior.
Set specific control C to the air flow desired. Then adjust the various vents to direct and distribute the air flow as required.

Control C in position  :
external air inlet closed.

Control C turned clockwise:
gradual opening of external air inlet.

Control C turned fully clockwise:
maximum opening of external air inlet.

BLOWER CONTROL D

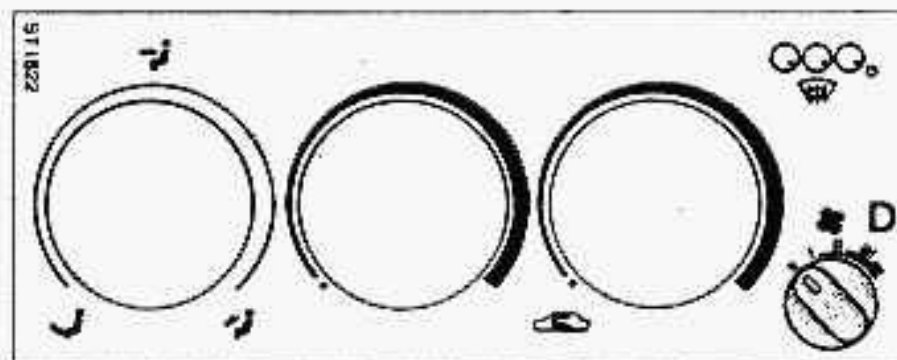

Regulates the quantity of forced air admitted to car's interior.

Control D in position ● :
blower off.

Control D in position I:
blower at first speed.

Control D in position II:
blower at second speed.

Control D in position III:
blower at maximum speed.

CLIMATE CONTROL WITH AIR CONDITIONING SYSTEM

For the location of the air outlets and their operation, see pages 40 and 41.

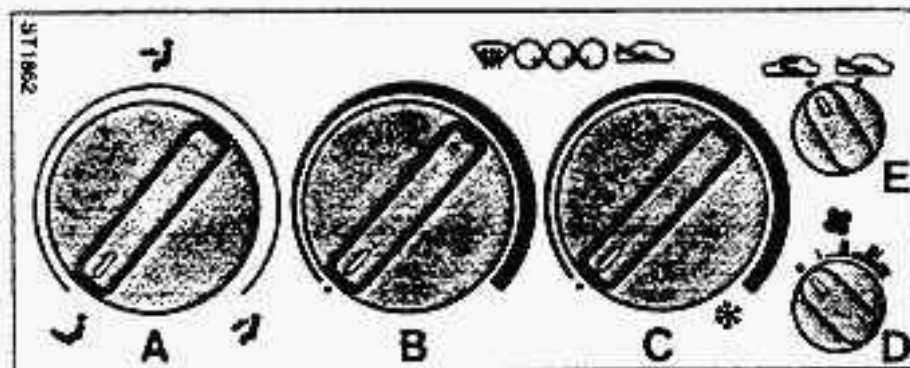

- A Air flow control selector
- B Heating control
- C Air conditioning thermostat control
- D Blower control
- E External air/internal circulation selector

The text and illustrations which follow relate to the most common uses of the climate control system. The client is, of course, free to select any of the wide range of alternatives offered by the system.

N.B.: Never operate the system at maximum output for prolonged time, i.e. with thermostat control (C) in max. position and fan control (D) in third speed. The best operating conditions are achieved by adjusting control C at 3/4 of its setting range and by rotating fan control in second speed.

In particular weather conditions (mild outside temperature) the climate control system can also be used with selector E in position , that is with admission of fresh air into the passenger compartment.

Warning: Before starting the engine check that the conditioner is off (control C in position ●) to avoid overloading the starting motor and the battery. The air conditioning system can only operate with the engine running.

Important

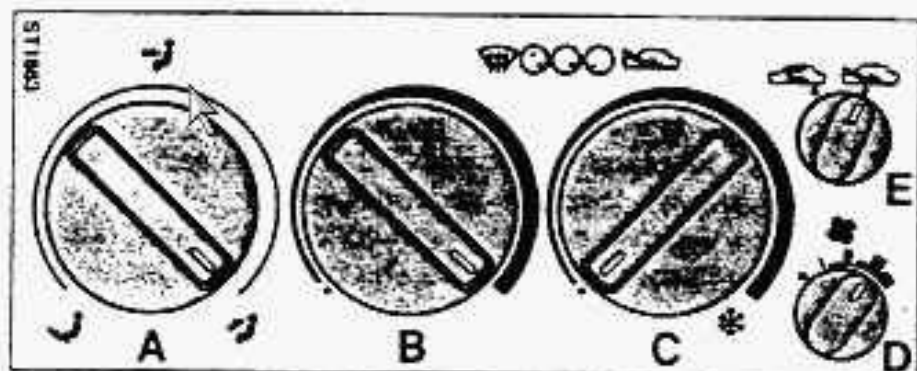

To ensure efficient defrosting with very low outside temperatures it is wise to start the engine and wait for a few moments for the required temperature to be reached. When demisting only fresh outside air alone may be sufficient.

DEFROSTING/DEMISTING WITH AIR CONDITIONING OFF



To clear the windscreen and side windows rapidly set the controls according to the diagram above:





- Air flow selector A in position .
- Heating control B in fully clockwise position.
- Thermostat control C in position ●.
- Selector E in position .
- Blower control D at third speed.
- Central vents G closed.

To demist the rear screen, press  on the side of the instrument panel.

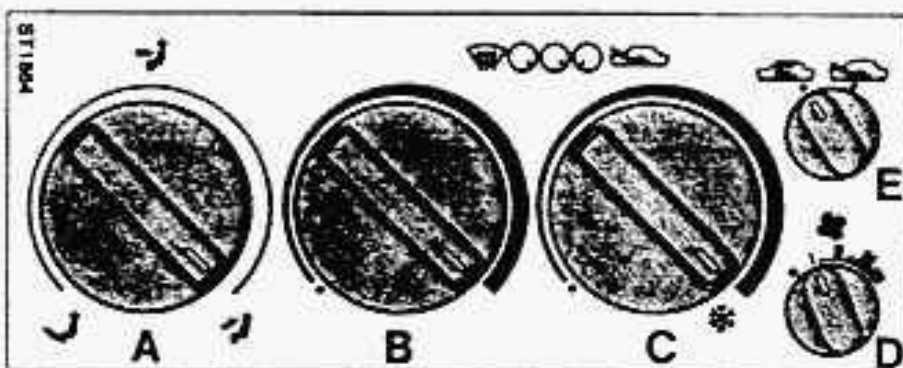
DEMISTING WITH AIR CONDITIONER



When the humidity is high both inside and outside the car the combined heat and air conditioning system may be used to accelerate demisting. In this case the controls should be set as follows:

- Air control selector A in position .
- Heating control B in fully clockwise position.
- Thermostat control C in position .
- Selector E in position .
- Blower control D to at least the first speed.
- Central vents G closed.

Warning

With the system operating in these conditions (combination of air conditioning and heating) when demisting is complete it is essential to turn off the heater before the air conditioner - that is set control B to position ● and then turn off the air conditioner (control C to ●). This will prevent a sudden and dangerous misting of the windows.

AIR CONDITIONING

Warning: before starting the engine check that the conditioner is off (control C in position ●).

To operate proceed as follows:

- Start the engine.
- Close the windows.
- Set heating control B to ●.
- Set selector E to .
- Set control D to at least the first speed (to enable the compressor).

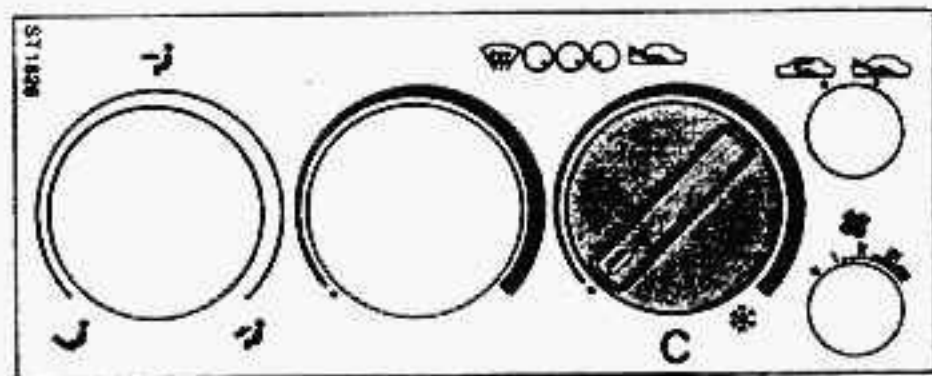

- Turn control C clockwise until the desired degree of cooling is obtained and set control D to obtain the required air flow.
- Using selector A and the central vents adjust the air flow distribution.

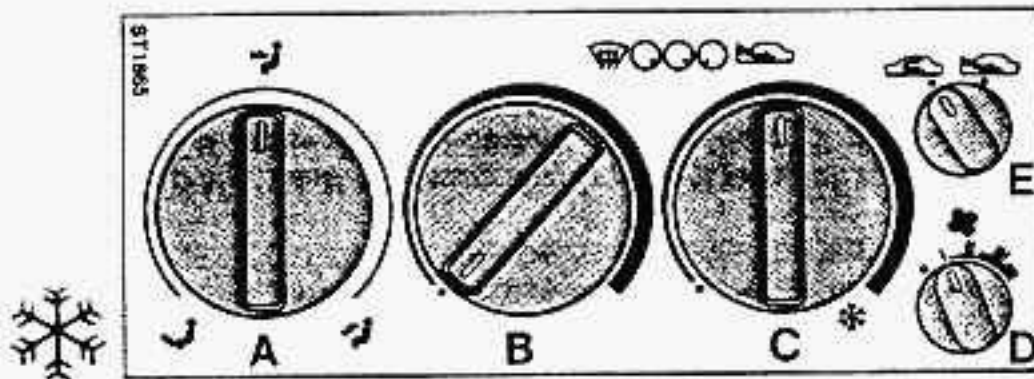

HEATING

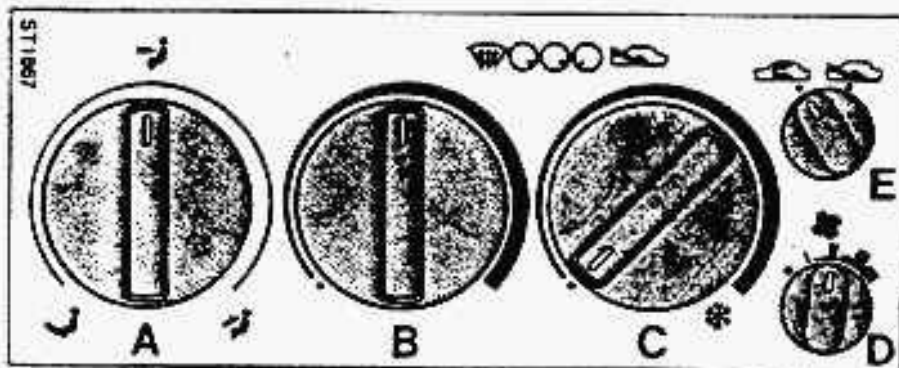

HEATING CONTROL B



Controls the opening, closing and adjustment of the heating valve.

Before turning on the heating ensure that the air conditioning is off (control C in position ●). Use control B to regulate the temperature and control E to regulate the flow of air from the outside.

As soon as the engine has reached the required temperature the system will be capable of heating the passenger compartment in a short time. The client can then blend heated and conditioned air as desired.

Set selector A to  or  position, and adjust the central and side vents to obtain the desired air flow distribution.

Control B in position ●:
heating off.

Control B turned clockwise:
gradual increase of heating resulting from the position of control B.

Control B turned fully clockwise:
maximum heating.

Set control C in position ●.





Set blower control D to obtain the desired air flow.

Set selector E to .

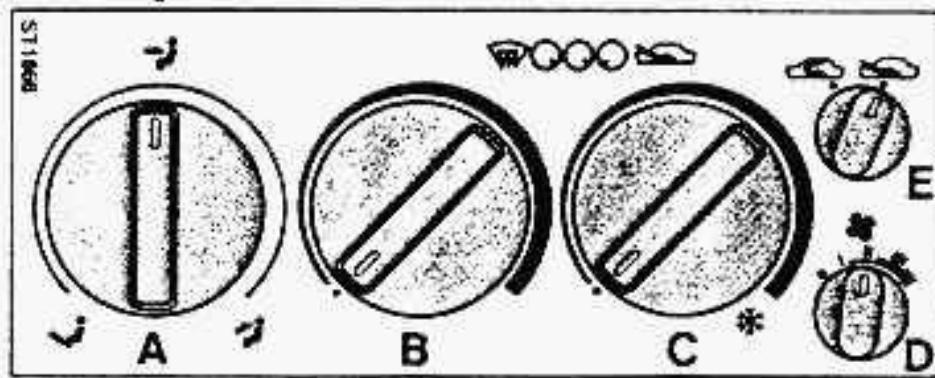
VENTILATION

The passenger compartment may be ventilated (even with windows closed) by admitting ambient (un-conditioned) air from the outside by proceeding as follows:



- Set control A to  or  position.
- Turn off conditioner (control C in position ).
- Turn off heating (control B in position ).
- Set selector E to: .
- If required turn on blower (control D).
- Adjust side and central vents to obtain the desired air distribution.

MAINTENANCE

Caution: Should the conditioner be left idle for long periods (especially during the winter months) it is wise to turn it on for a few minutes each week to keep the components properly lubricated.

One a year, preferably at the beginning of the summer, have the air conditioner tested for low charge and the compressor oil level checked by an Alfa Romeo Service Dealer.

Occasionally

Check tension of the compressor drive belt. Clean the condenser, if jets of air or water are used make sure that they do not strike the condenser radiating fins at a right angle.

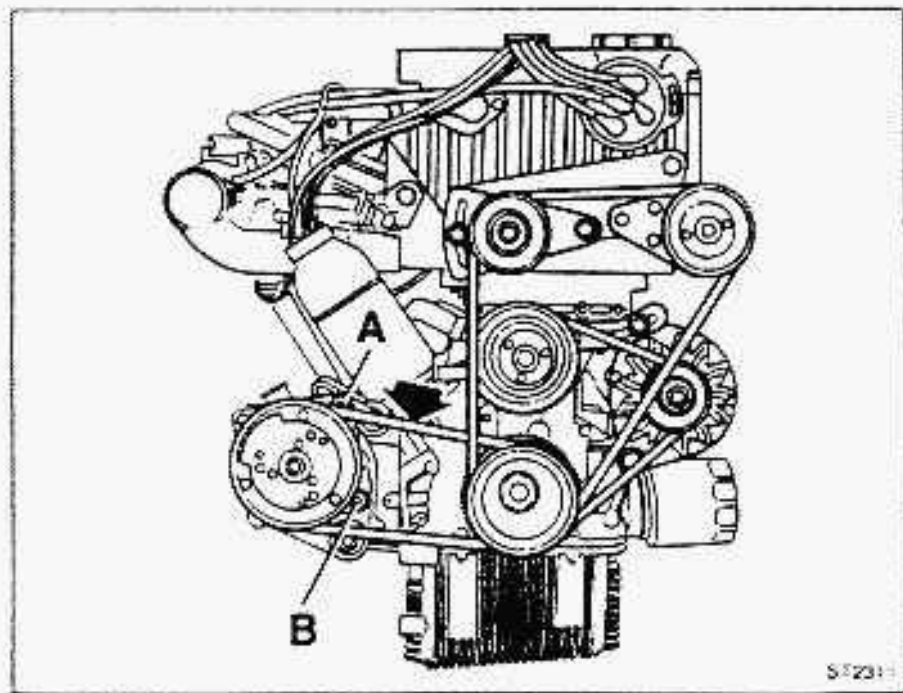

COMPRESSOR DRIVE BELT TENSION CHECK

75 T.SPARK model

The tension is correct when, on pressing the belt at the point indicated by the arrow, it yields about 15 mm. If the tension has to be increased slacken nuts A and B. Stretch the belt by moving the compressor outwards and tighten nut A. Check belt tension again. Tighten nut B.

BELT REPLACEMENT

Slacken nuts A and B. Move the compressor inwards and remove the old belt. Fit the new belt onto the pulleys and move the compressor outwards until the belt is stretched correctly. Then tighten nut A carefully and check belt tension; tighten nut B.

Note: To replace the compressor drive belt the power steering drive belt (if fitted) must be removed first (see page 85).

COMPRESSOR DRIVE BELT TENSION CHECK

7E 30 VE model

The tension is correct when, on pressing the belt at the point indicated by the arrow, it yields about 15 mm. If the tension has to be increased slacken nut A. Stretch the belt by moving the belt stretcher downwards and tighten nut A. Check belt tension again.

BELT REPLACEMENT

Slacken nut A. Move the belt stretcher upwards and remove the old belt. Fit the new belt onto the pulleys and move the stretcher downwards until the belt is stretched correctly. Then tighten nut A carefully and check belt tension.

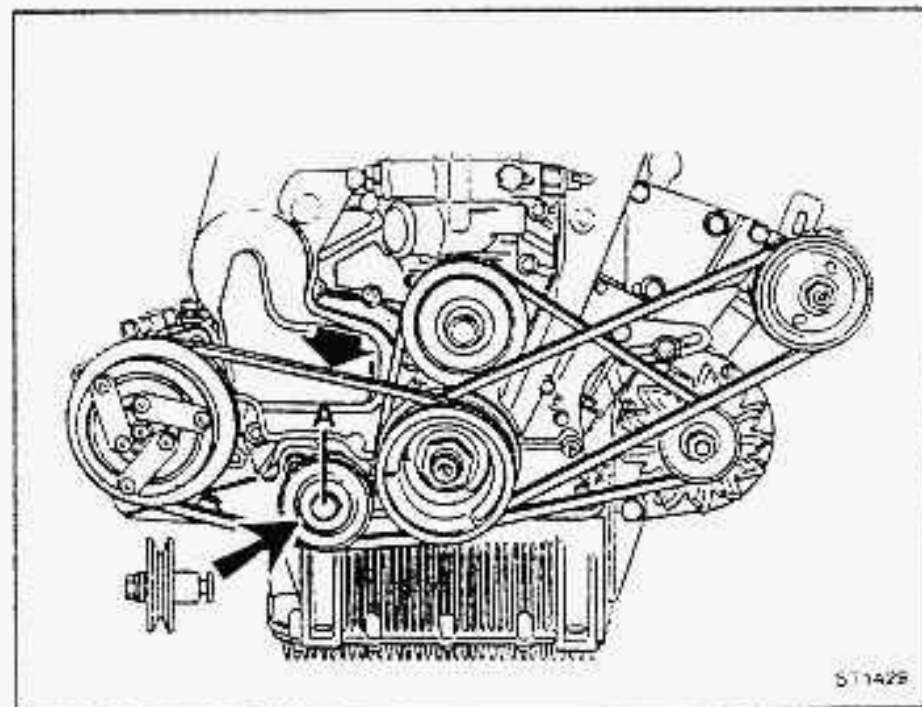

511429

IN AN EMERGENCY

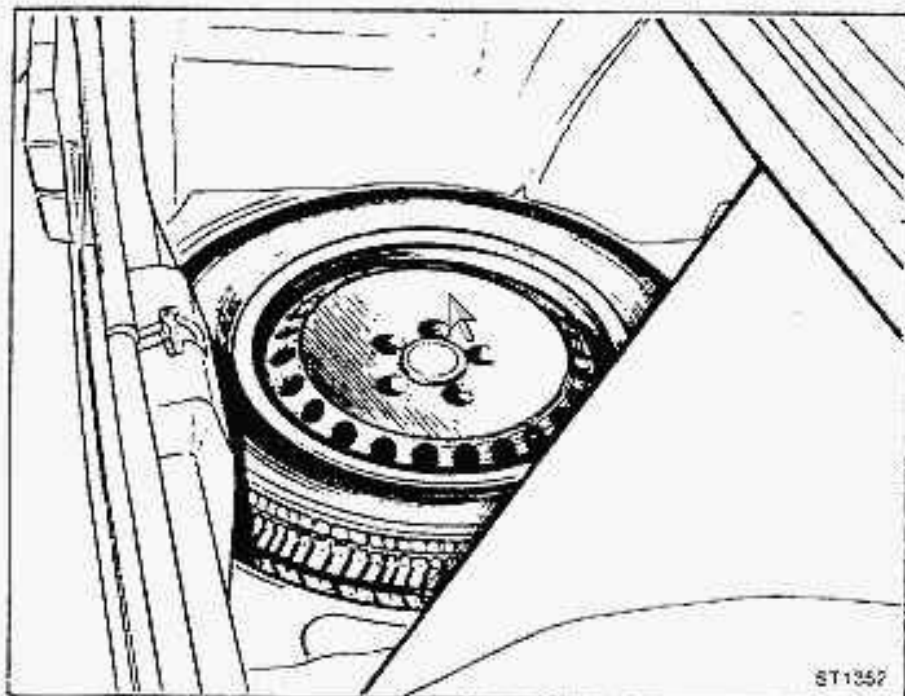

SPARE WHEEL

The spare wheel is stowed on the left side of the boot under the carpeting.

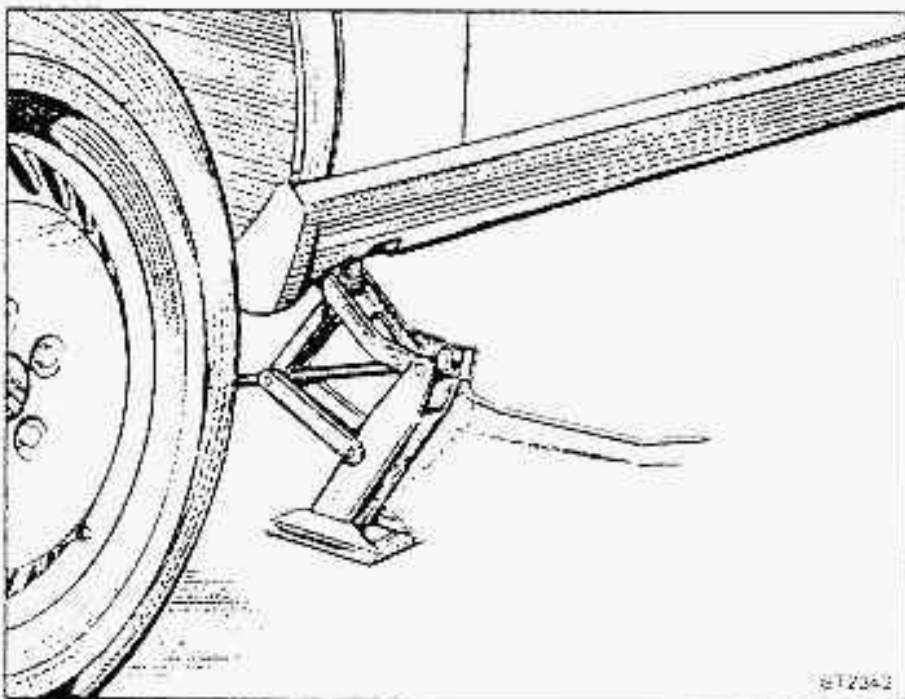

WHEEL CHANGING

Wheel removal

- Apply the handbrake
- Turn the nuts counterclockwise to unscrew.
- Insert jack arm in the socket nearest to the wheel to be changed and jack up the vehicle.
- Slacken the nuts and remove the wheel.

Replacing

- Fit the spare wheel and tighten the nuts (clockwise).
- Lower the vehicle and remove the jack.
- Tighten the nuts completely in diagonal order.
- Release the handbrake.
- As soon as possible check that the tyre pressure is as specified (see inside back cover).

N.B.: There should be no passengers in the car while it is being jacked up.

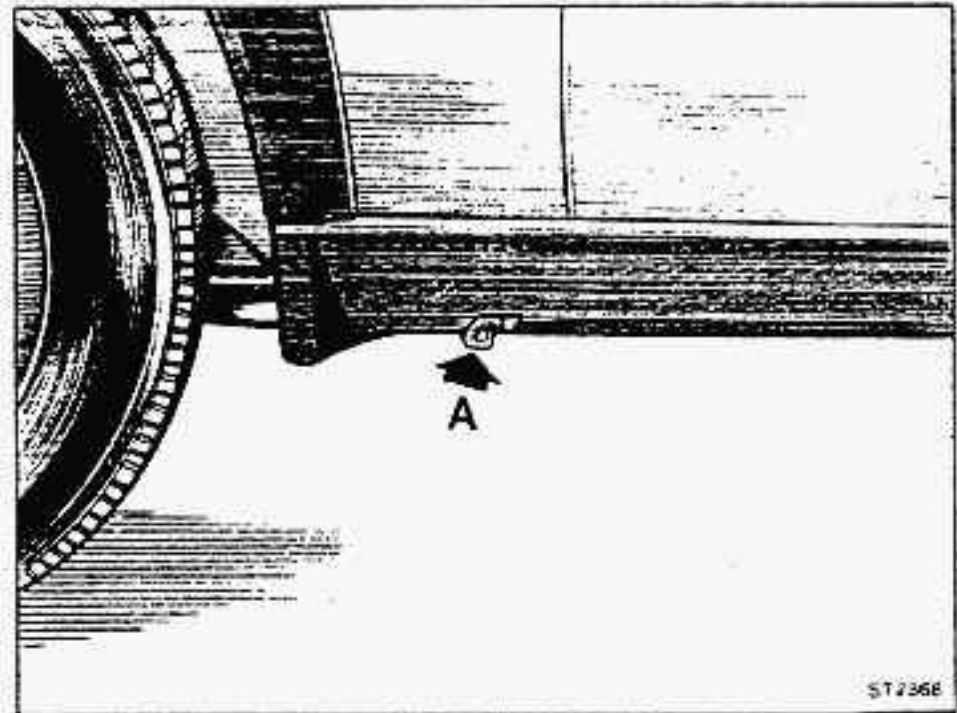
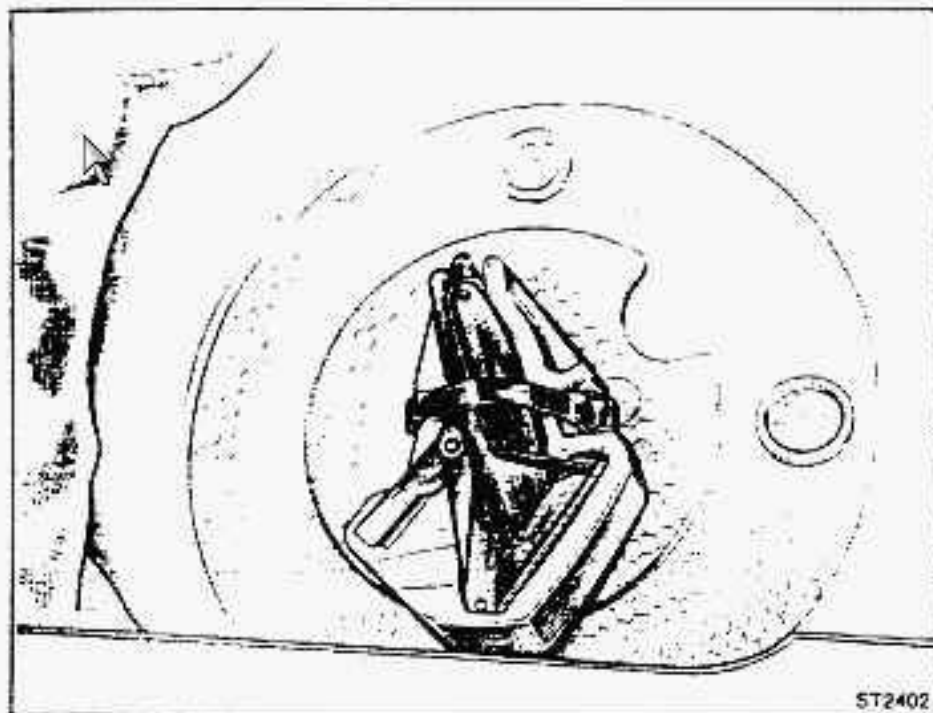

JACK

Jack location is in the boot under the spare tyre. After use, position the jack as shown and secure it with the rubber belt.

Important note: The jack must be used to change road wheels only. Never get under the car when it rests on the jack only.

JACKING UP PADS

Fit the bracket of the jack into the suitable jacking up pads located at the four corners of the body shell.

A — front end

B — rear end

Applying the jack out of the properly provided areas can cause damages to the car and injuries to the operator.

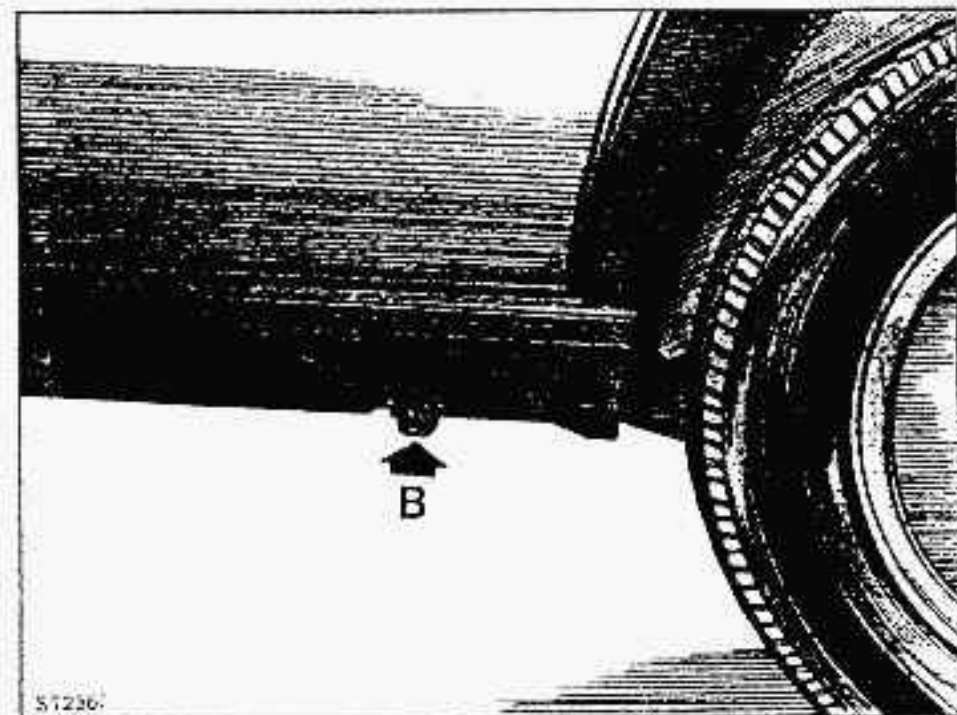

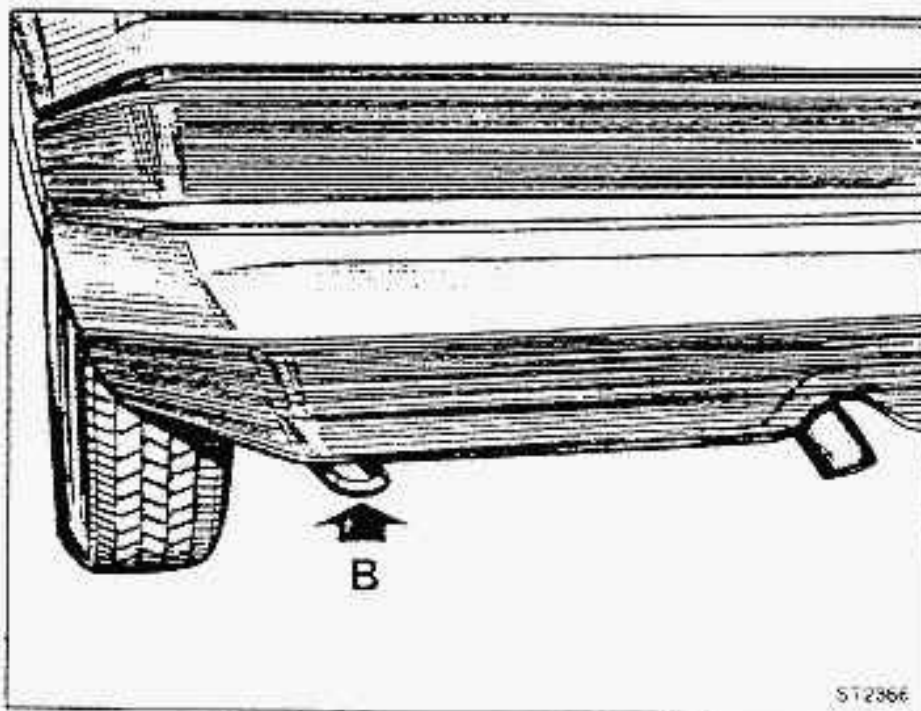
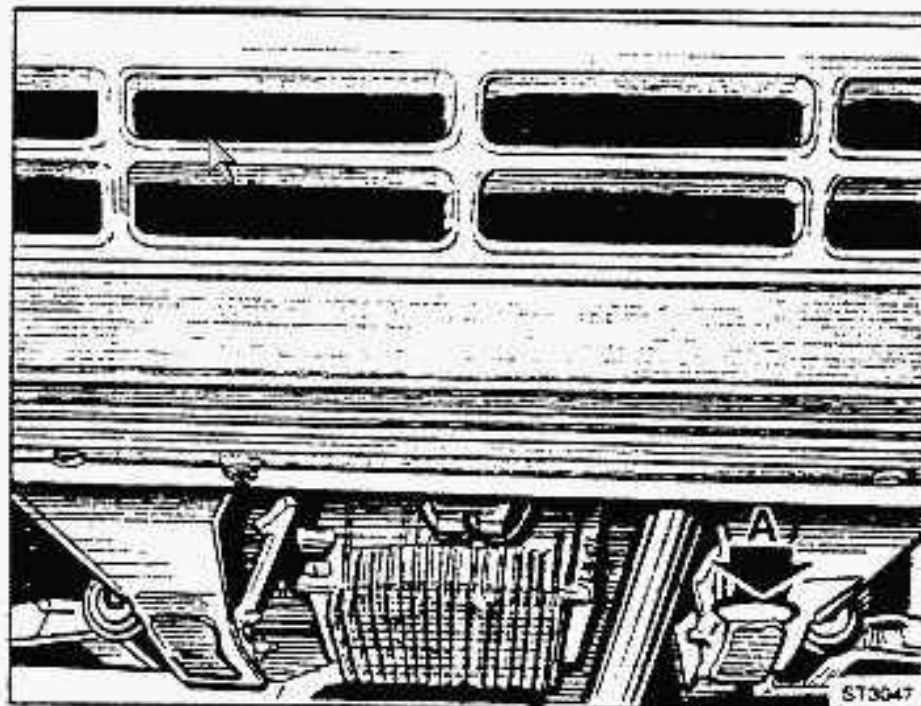

TOWING THE VEHICLE

N.B.: Always strictly observe regulations regarding the towing of vehicles. To tow the vehicle secure the towing link to the brackets shown (A front — B rear).

Turn ignition key to position 0.

Never withdraw the key from ignition switch as the steering will lock.

Important: The steering is freed only after passage of the key from position 1 (warning lights come on) and return to position 0.

Bear in mind that when the vehicle is being towed no power assistance is available to the brake system and therefore a considerably greater pedal effort will be required when braking. If the vehicle is equipped with power steering no power is available if the engine is not running and therefore increased steering effort will be required.

ENERGY ABSORBING BUMPERS (3.0 model)

The bumpers are mounted on energy absorbing units.

Important: Under no circumstances must towing be attempted by attaching chain or cables to the bumpers. Energy absorbing units can easily be damaged by towing and their low speed protective features can be rendered ineffective.

SNOW CHAINS

Chains must be fitted to the drive wheels (rear wheels). They must not protrude (from the tyre wall) more than 16 mm.

N.B.: For types and dimensions of approved tyres see inside back cover.

NOTE: To avoid serious damage to the tyres remove chains as soon as off snowy roads. Otherwise proceed very slowly and remove them as soon as possible.

STARTING ENGINE WITH AN EMERGENCY BATTERY

HOW TO USE JUMPER CABLES

In emergency situations it is possible to start the car by connecting its battery to that of another car.

Important: This must be done by qualified personnel as incorrect use can produce dangerous electrical charges.

To prevent damaging the vehicle's electrical system always follow the instructions of the jumper cable manufacturer carefully.

The cable must be sufficiently long for the vehicles not to touch.

Proceed in the following order:

- 1) Connect one end of a cable to the positive terminal of the discharged battery.
- 2) Connect the other end of the cable to the positive terminal of the booster battery.
- 3) Connect one end of the second cable to the negative terminal of the booster battery.
- 4) Connect the other end of the cable to the engine block of the car with the discharged battery.
- 5) Start the engine. If it does not start do not persist but contact the nearest Alfa Romeo Service Dealer.
- 6) With the engine running remove the jumper cables from the two cars in exactly the opposite order.

Warning: Remember that the battery generates hydrogen, a highly explosive gas. A spark, caused by the incorrect connection of the emergency cables, could cause the explosion of the battery.

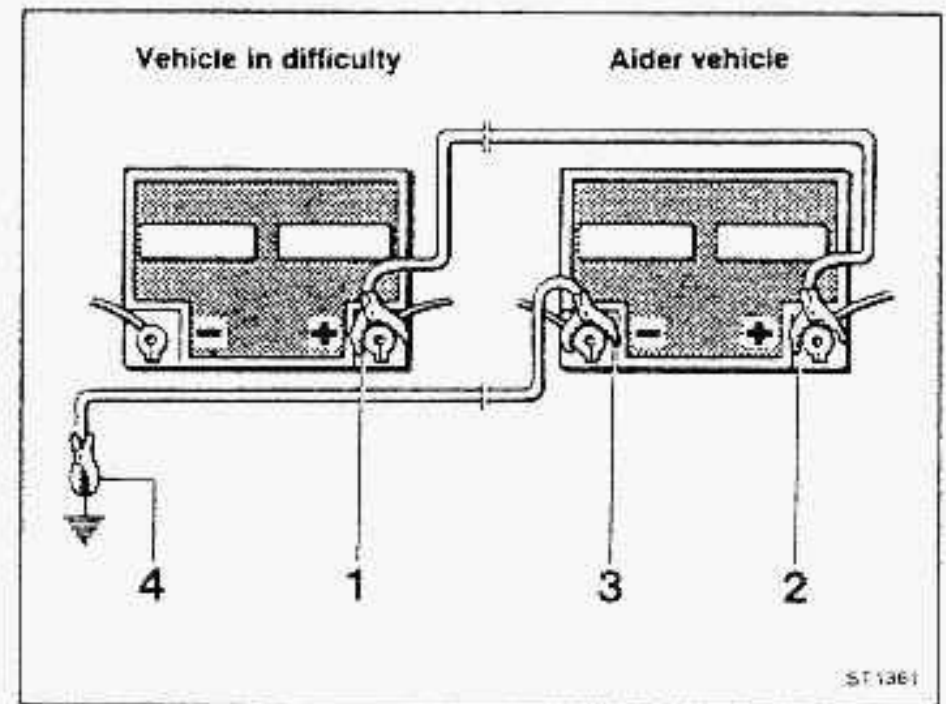



WARNINGS AND PRECAUTIONS

Warning

The following notes allow to obtain from the car the best performance, reliability and duration levels. Furthermore, it is suggested not to demand top performances (e.g. extreme pick-up and/or excessively long journeys at peak r.p.m., hard braking and so on) from the vehicle during the first period of run.

STARTING THE ENGINE

STARTING THE ENGINE FROM COLD

To facilitate starting (especially during the winter) depress clutch pedal right down without depressing the accelerator pedal.

The vehicle's fuel injection system is equipped with devices which, in addition to facilitating starting from cold, permit the engine to reach its running temperature in a short time.

If the engine does not start immediately wait for a few minutes and try again.

Do not subject the engine to sudden acceleration until it has warmed up to operating temperature.

STARTING WITH A HOT ENGINE

Press the clutch pedal right down.

If the engine is already hot depress the accelerator pedal slightly only if the engine does not start first time.

WHILE DRIVING

Before moving off ensure that the handbrake is released and that the Alfa Romeo Control device does not signal any faults (read the relative section carefully).

While driving check the instruments every so often:

REV. COUNTER

Do not exceed the maximum engine speed.

Avoid driving for long periods at a number of rpm in the warning area. Vehicles are fitted with a rev. limiting device which cuts out the ignition when an established limit is exceeded and restores it again automatically when engine falls beneath that limit.

COOLANT THERMOMETER AND MAXIMUM TEMPERATURE WARNING LIGHT

The lighting up of this warning light signals a fault in the cooling system (engine overheating). In this case the vehicle must be stopped immediately and checked by an **Alfa Romeo Service Dealer**.

ENGINE OIL PRESSURE GAUGE AND WARNING LIGHT

If the pressure is lower than that prescribed and/or with the lighting up of this warning light, stop the engine immediately and contact an **Alfa Romeo Service Dealer**.

Engine oil pressure (hot) - bar	
Idling	min. 0.5
Top speed	min. 3.5

ALTERNATOR

The alternator warning light should not come on - if it does stop the vehicle and check that the alternator and water pump drive belt is not slack or damaged (which would mean, above all, the absence of engine coolant circulation with very serious consequences). Only in the event of faults of an electrical nature is it possible to proceed for a short distance. Then the vehicle should be stopped as soon as possible and the fault corrected.

BRAKES

The brakes are fundamental for driving safety and it is thus essential that they be kept in perfect working order.

It is important to observe the following warnings:

- Do not drive with a foot resting on the brake pedal.
- Be sure that pedal movement is not obstructed by the carpet or anything else.
- Check efficiency before starting out.
- Check Alfa Romeo Control warning light.
- Carry out the maintenance programme scrupulously.

The vehicle is fitted with a dual braking system which ensures brake operation in the event of a fault, even if there is variation in the pedal travel or braking efficiency.

For safety reasons never drive in these conditions - stop the vehicle as soon as possible and have it checked by the nearest authorized Service Dealer.

For versions with anti-lock braking system (ABS), refer to page 129.

POWER BRAKES

The vehicle is equipped with power brakes which are operating only with running engine; which means that a higher effort is required when the engine is off, to obtain the same braking effect.

POWER STEERING (where fitted)

The vehicle is equipped with an engine - operated power steering. When the engine is stopped the power steering does not work, consequently a much higher steering effort is necessary. As the steering gear is a mechanical assy in strict relation with safety driving conditions, it is necessary to stop the vehicle and directly contact an **Alfa Romeo Service Dealer** even in case of a suspected fault.

PARKING

Engage handbrake, insert first gear, and turn steering wheel so that the vehicle is immediately stopped if the handbrake is accidentally disengaged.

Do not leave the key in position 1 (ignition on) as this will drain the battery.

WINDSCREEN WIPER BLADES

Check these periodically.

Worn or dirty blades can reduce visibility considerably. Clean them regularly by removing grease, dirt and tar to extend their working life. Before switching on the windscreen wipers remove any snow and ice that may be present.

Warning: When replacing the windscreen wiper blades follow the instructions on the package (available from spares).



WINDOWS

Do not stick transfers etc. on the window glass as they can cause distraction or obstruct vision.

WINTER USE

The Alfa Romeo Antifreeze mixtures in the cooling system give full protection against freezing at temperatures down to -20°C . Should the outside temperature fall further, the concentration should be increased by replacing part of the mixture with Alfa Romeo Concentrated Antifreeze.

It is recommended that this operation be entrusted to an Alfa Romeo Service Dealer

ANTIFREEZE			
 ALFA ROMEO Antifreeze std. no.3681.69956 Climaf fluid Permanent -20° std. 3681.69958 (diluted; ready for use)	 Antifreeze	Shell Antifreeze	 Antifreeze

Handbrake

Avoid using the handbrake unless it is absolutely necessary when the outside temperature is very low as the mechanism could freeze causing the rear wheels to lock.

FUEL ECONOMY HINTS

Fuel consumption is strictly dependent on ambient conditions and driving habits.

However, if the suggestions given below are followed, fuel consumption will be significantly reduced.

- Maximum performance must not be demanded of the car when engine is cold.
- While standing still (at traffic-lights, cross-roads, etc.) never race the engine unnecessarily.
- Drive as smoothly as possible, without repeated hard braking and fast getaways. Shift into the highest gear consistent with traffic and road conditions.
- Do not overload the car; it should be borne in mind that loading the roof rack with bulky objects significantly increases drag and, consequently, fuel consumption.
- If any type of roof rack is mounted for the transport of objects (parcel rack, ski racks, etc.), remove during the periods it is not used.
- If at all possible do not keep the side windows lowered; correct setting of the vent controls usually provides comfortable ventilation inside the car.
- Keep tyres inflated to recommended pressures (refer to inside back cover).

Perform regular servicing at the scheduled intervals. The list of service operations is found both in the Service Coupon Booklet and in the chapter "Lubrication and Maintenance" of this book; regular servicing is essential to ensure longer life of all mechanical components, thus lowering the running costs, and to reduce fuel consumption.

BEFORE STARTING OUT

- Check electrolyte level in battery.
- Check windscreen wipers.
- Check that headlamp lenses are clean.
- Check that all the lights are working.
- Check tyre pressure and wear.
- Check that there are no leaks of oil or other liquids under the body.
- Ensure all the baggage is stowed correctly.

WHEN YOU SIT IN THE DRIVER'S SEAT:

- Check that the horn works correctly.
- Adjust the seat to obtain a comfortable driving position.
- Check the rear view mirrors.
- Fasten seat belts.
- Check the correct operation of brakes and handbrake (make sure there are no objects hampering the movement of the brake pedal).
- Lock the doors using the safety catch if you have children aboard.
- Do not leave the car unattended with the engine running.

WHEN TRAVELLING

Drive with care and keep to the correct lane.
Use the indicators to warn of direction changes.
Switch on outside lights at sunset.

Always keep at a safe distance from the vehicle in front. This distance depends on the speed, weather conditions and the state of the road.

Reduce speed at night or in bad weather.
Observe speed limits and all other road signs.
Never drive in neutral gear.

In the event of an emergency stop switch on the road hazard lights and use the triangle to indicate the position of the car.
In the case of an emergency stop, park the vehicle as far off the road as possible, switch on the road hazard lights, and use the triangle to indicate the position of the car.

Warning: Never carry extra containers of fuel on the vehicle as in the case of leaks or accidents, they could explode or ignite.

SUGGESTIONS FOR CORRECT DRIVING

Never drive in neutral gear, especially downhill as the braking effort is increased considerably by the lack of the engine's braking effect.

When driving down a hill it is advisable to use the same gear that would be required to drive up it.

Never drive with a hand resting on the gear lever.

Do not rest a foot on the clutch pedal as even the slightest pressure could cause its premature wear.

PRECAUTIONS TO TAKE BEFORE MAINTENANCE

The engine compartment contains many moving parts, high-temperature parts and high-voltage cables that could present a serious risk for the novice.

Therefore, take the following precautions before opening the bonnet:

- Stop the engine and allow it to cool.
- Beware of the radiator fan. It could start up automatically due to coolant temperature.
- Never smoke or use open flames. The presence of petrol could cause a fire.
- Always have an extinguisher handy.
- Never use the tire-changing jack to raise the car for inspections underneath.

Caution: Minor maintenance operations improperly performed can jeopardize the running of the car.

When in doubt, contact an **Alfa Romeo Service Dealer**.

These maintenance operations refer to normal driving of the car under normal operating conditions.

To ensure proper operation, follow these suggestions carefully:

Every 500 kms. (or when refueling) check:

- Engine oil level.
- Coolant level.
- Brake fluid level.
- Tyre pressure.

Air filter

If you habitually drive on dusty roads, the air filter should be cleaned more often than indicated.

Brake pads

If your driving style is sporty, or over difficult or mountainous roads, the brake pads should be checked frequently.

Brake fluid

Brake fluid is hygroscopic, i.e. it absorbs water.

To avoid faulty braking, replace the fluid once a year, regardless of the mileage driven.

Battery

During hot weather, check the electrolyte level frequently.

Anti-freeze

Replace every two years regardless.

Notes

Under special driving conditions (e.g. on roads sprinkled with antifreeze salt and/or corrosive substances, rough road surfaces, etc.), often check the boots of the axle shafts and steering box, and clean and lubricate joints, hinges, door-catches, bonnet catch, etc.

When forced to use fuel, lubricants and/or fluids in general with characteristics different from those specified by the manufacturer (in emergencies), replace the fluids and relative filters at the earliest opportunity.

LUBRICATION AND MAINTENANCE



ROUTINE MAINTENANCE SCHEDULE

Miles/km x 1000

(Check each item at the respective distance)

Mileage intervals and maintenance list as provided in the Service Coupon Booklet

DESCRIPTION OF OPERATION

* = Specific operations for  750cc SPARK
 ** = Specific operations for  750cc 3.0 V6

		6/10	12/20	18/30	24/40	30/50	36/60	42/70	48/80	54/90	60/100	66/110	72/120	78/130	84/140	90/150	96/160	102/170	108/180	114/190	120/200			
FIRST SERVICE COUPON		•	•	•	•	•	•	•	•	•	•	•	•	•	•	•	•	•	•	•	•	•	Replace engine oil and oil filter and check lubricating system for leaks	
					•				•				•				•					•	Change gearbox/differential oil	
			•				•				•				•					•				Check level of gearbox/differential oil
		•	•	•	•	•	•	•	•	•	•	•	•	•	•	•	•	•	•	•	•	•	•	Check windscreen washing liquid level and top up if necessary. check windscreen wiper system
		•	•	•		•	•	•		•	•	•		•	•	•			•	•	•		•	Check brake and clutch fluid levels
					•					•				•				•						Change brake fluid (at least once a year)
			•		•		•		•		•		•		•		•		•		•		•	Check power steering fluid level
		•	•	•		•	•	•		•	•	•		•	•	•			•	•	•		•	Check antifreeze level and check cooling system for leaks
					•					•				•				•					•	Change antifreeze and check cooling circuit
		•	•	•	•	•	•	•	•	•	•	•	•	•	•	•	•	•	•	•	•	•	•	Check state of output shaft C.V. joints and steering box protective bellows
			•		•		•		•		•		•		•		•		•		•		•	Inspect braking system
		•	•	•	•	•	•	•	•	•	•	•	•	•	•	•	•	•	•	•	•	•	•	Check brake pad wear and replace if necessary
			•		•		•		•		•		•		•		•		•		•		•	Check handbrake travel and adjust if necessary
		•	•	•	•	•	•	•	•	•	•	•	•	•	•	•	•	•	•	•	•	•	•	Check tyre inflation pressures
			•		•		•		•		•		•		•		•		•		•		•	Check (if necessary) and adjust valve clearance. Check valve timing and timing chain tension *
			•				•				•				•					•			•	Check state of alternator, air conditioner compressor and servosteering drive belts (where fitted) and adjust tension if necessary

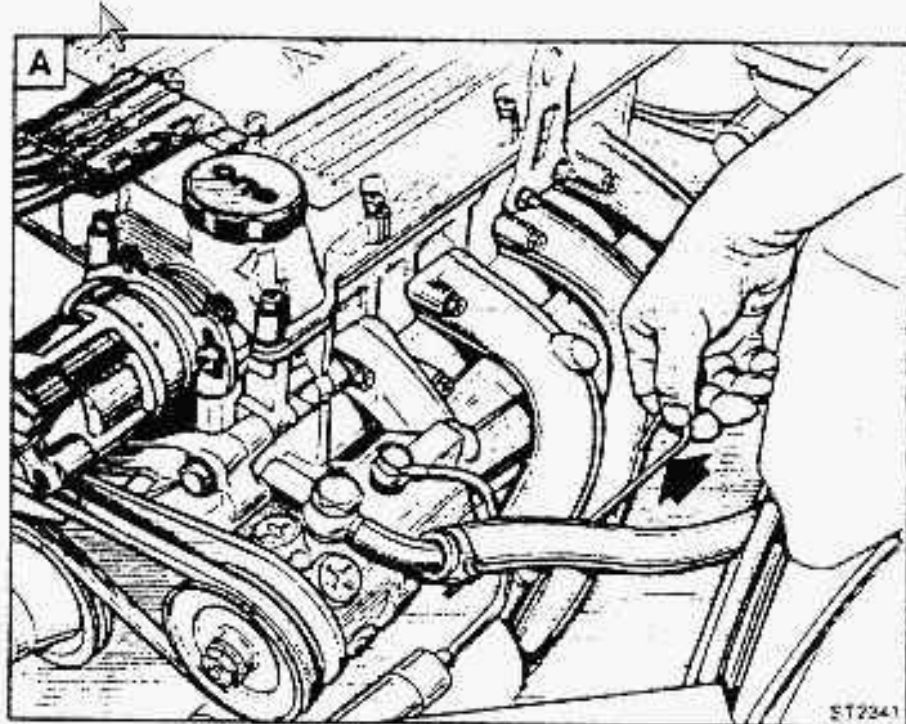

ET2341

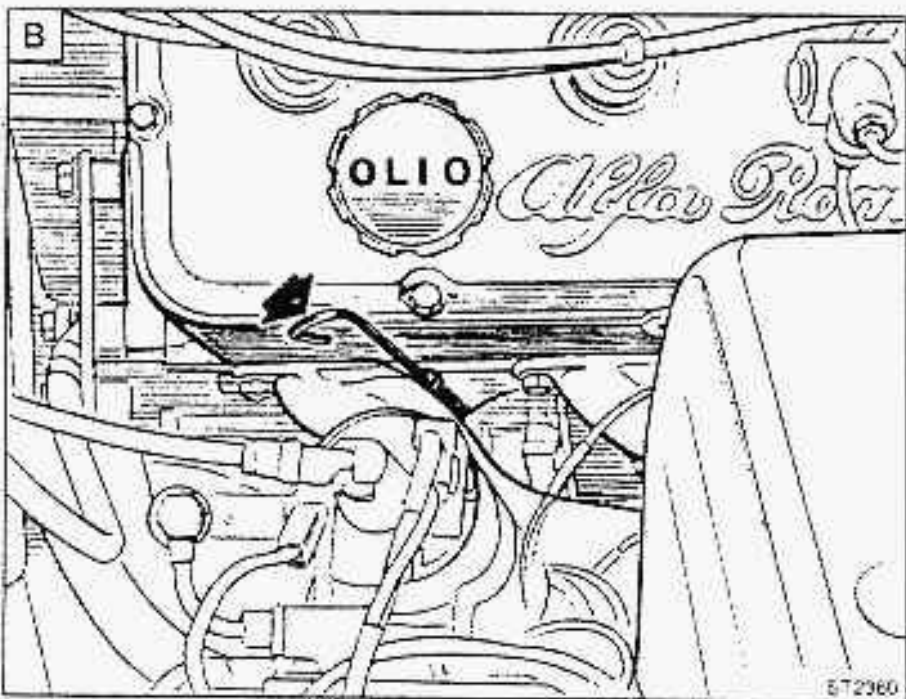

ET2360

ENGINE OIL LEVEL CHECK

The level is automatically checked by the Alfa Romeo Control device.

If a manual check is desired proceed as follows:

with a cold engine extract the dipstick and clean it. Then insert the dipstick as far as it will go and extract again. The oil level must be between the MIN and MAX marks.

A = Dipstick position for 2.0 version

B = Dipstick position for 3.0 version.

N.B.: Due to the detergent additives contained, the new oil will already appear dark after a brief period of engine operation.

This is completely normal, and it is therefore not necessary to change the oil more often than recommended.

Important: The lubricants used for the first filling, shown on the plate in the engine compartment and in the table "Lubricants" on inside back cover, are factory tested in order completely to meet the operating requirements.

These lubricants can be used both for topping up and changing (when topping up it is recommended that only the same type of oil as that already in the engine or main unit be used). In countries where the above mentioned lubricants are not available, **and otherwise when necessary**, it is possible to replace them with products of other leading makes, provided that they are in accordance with the grades given in the table.

ENGINE OIL CHANGE

(2.0 model)

To change the oil warm up the engine and proceed as follows.

- With the engine stopped drain off old oil thoroughly by removing filler cap 1 and dipstick 2, unscrewing plug 3 and letting all the oil flow out.
- Replace oil filter (see next paragraph).
- Clean sump plug and replace.
- Change oil (for quantity and type see inside back cover).
- Replace filler cap.
- Clean dipstick and check that the oil level is no higher than MAX.
- Re-insert dipstick as far as it will go.

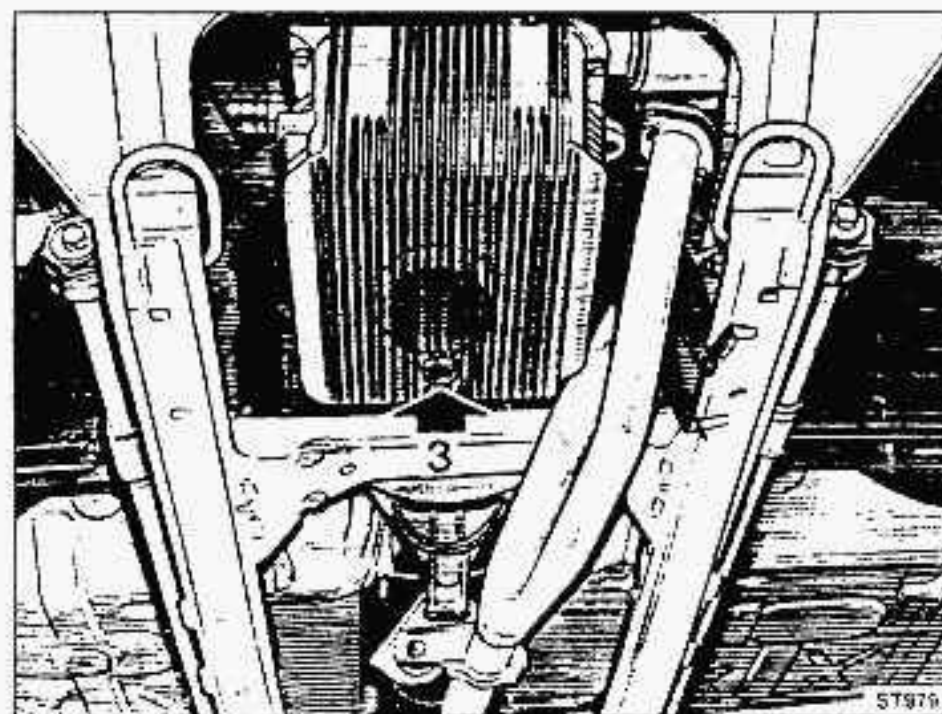
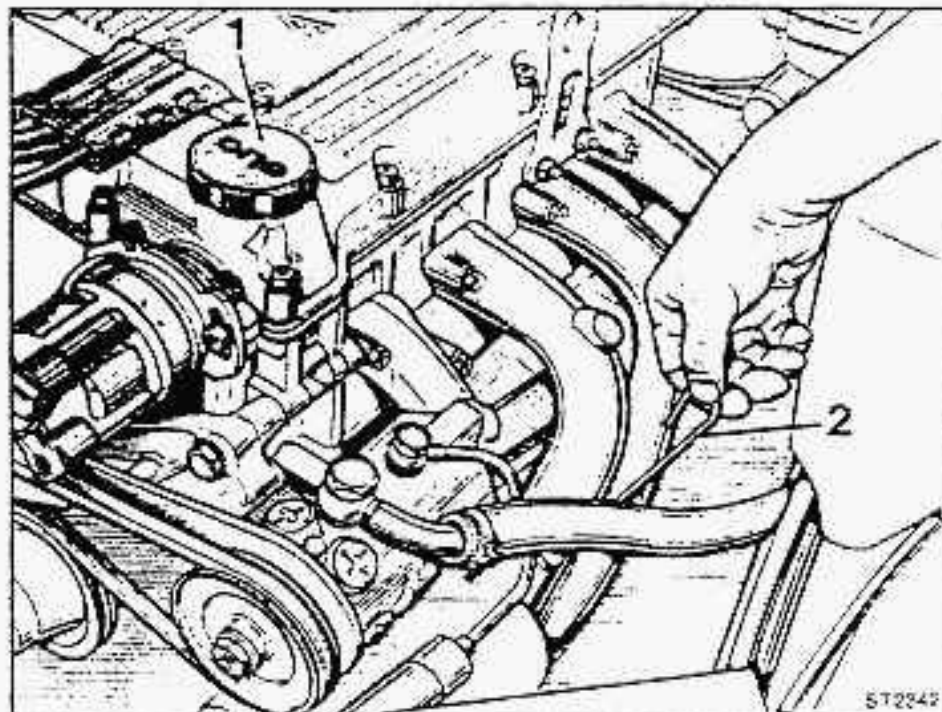

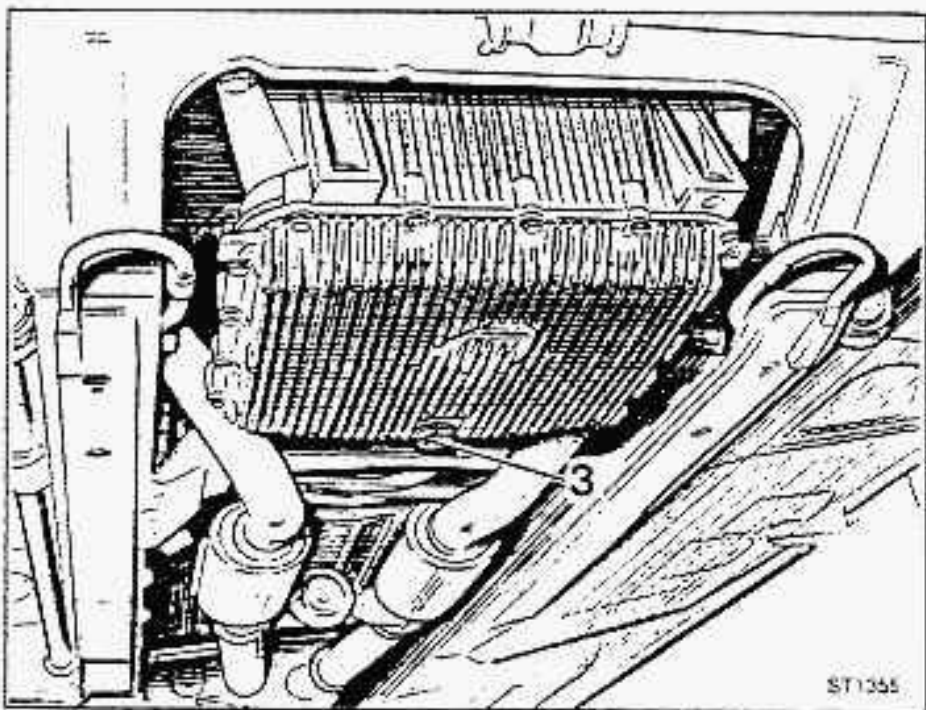
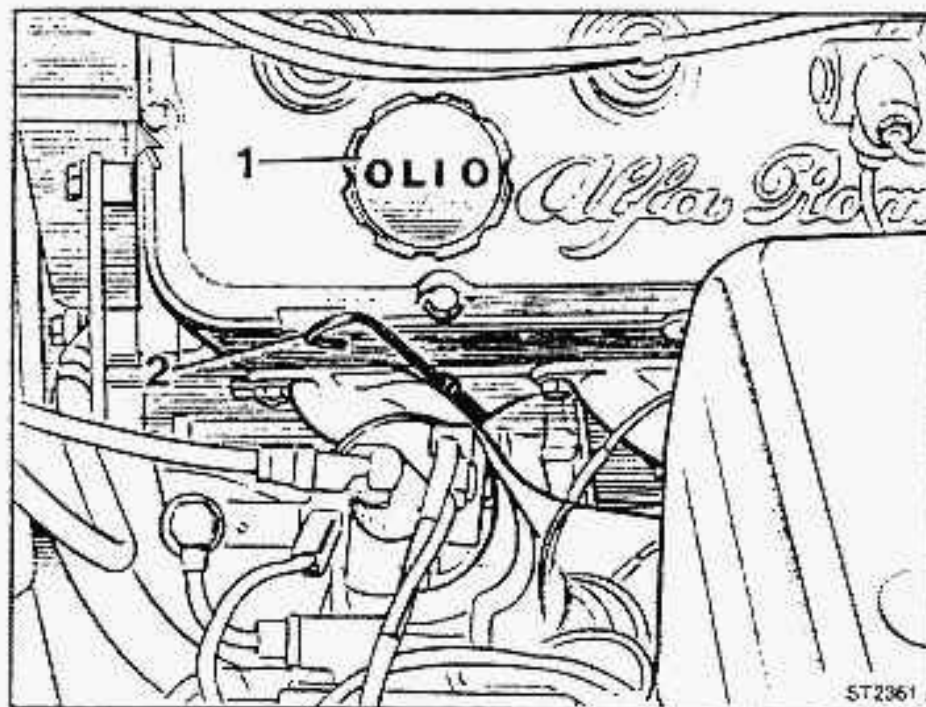

ENGINE OIL CHANGE

(3.0 model)

To change the oil warm up the engine and proceed as follows.

- With the engine stopped drain off old oil thoroughly by removing filler cap 1 and dipstick 2, unscrewing plug 3 and letting all the oil flow out.
- Replace oil filter (see next paragraph).
- Clean sump plug and replace.
- Change oil (for quantity and type see inside back cover).
- Replace filler cap.
- Clean dipstick and check that the oil level is no higher than MAX.
- Re-insert dipstick as far as it will go.



ENGINE OIL FILTER CHANGE

Free the filter using the spanner provided and then remove it. Lubricate gasket of the new filter with engine oil and screw it in by hand.

N.B.: For details of the guarantee covering the changing of the oil and the filter please refer to the Service Coupon booklet.

A = Oil filter position for 2.0 model

B = Oil filter position for 3.0 model

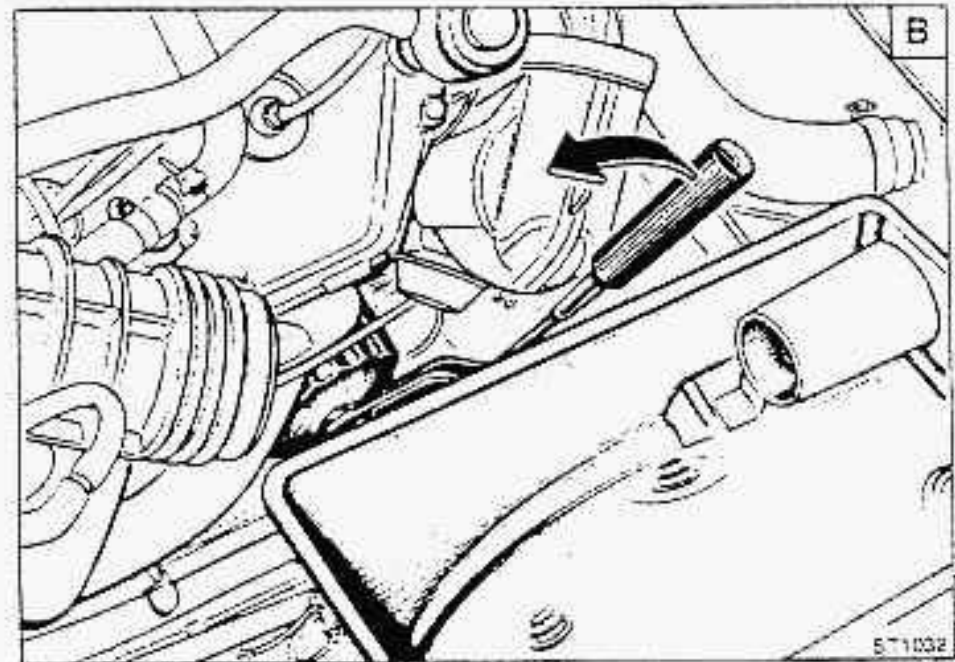
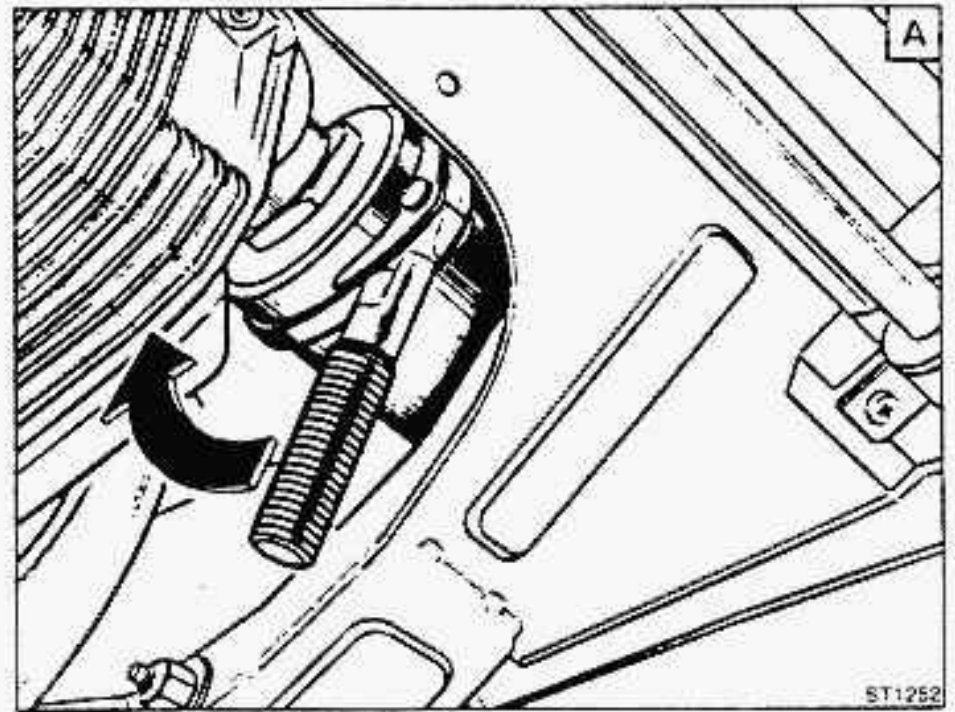

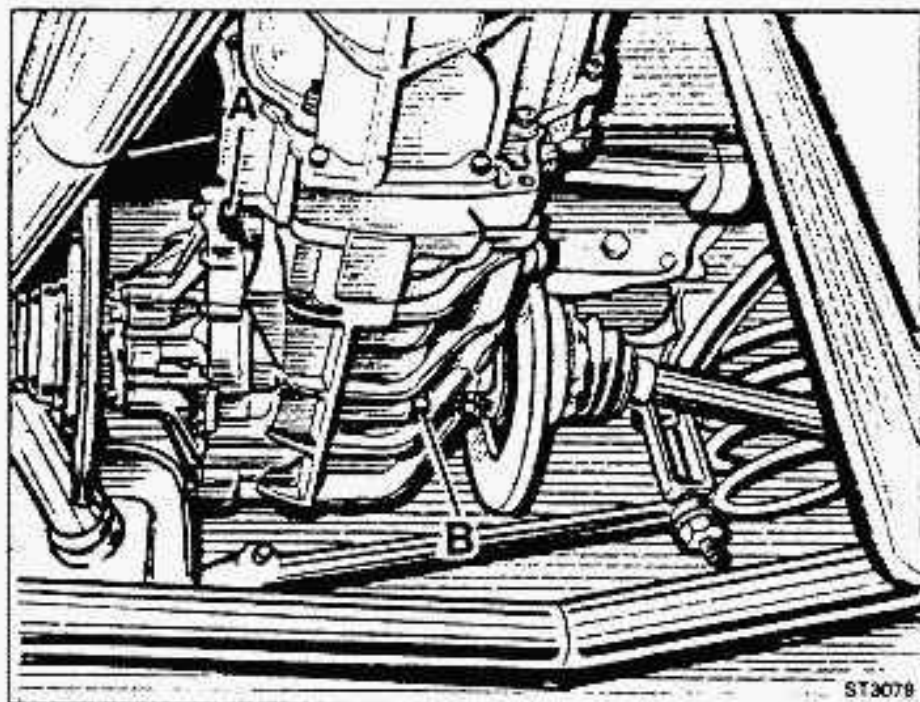

CHECKING LEVEL AND CHANGING GEARBOX-DIFFERENTIAL OIL

At the recommended intervals check the level of the oil in the gearbox-differential. After removing filler cap A check that the oil just reaches the lower part of the orifice.

To replace oil proceed as follows (oil should be warm before draining):

- With engine stopped drain off old oil by removing filler plug A and drain plug B.
- Let oil drain off completely.
- Clean drain plug B and screw it in again.
- Replenish with oil of the recommended type and quantity (see inside back cover) through filler plug A.
- Check that oil level just reaches the bottom of the filler orifice; clean and refit filler plug.

AIR FILTER

(2.0 model)

Cleaning or changing

- Loosen the 4 clips fastening the filter cover to the intake manifold.
- Raise the cover and take out the element.
- Clean the element with low pressure compressed air blown through from the bottom (opposite part to that marked "top").
- Fit the element into the filter in the correct position ("top" is marked).
- Fit cover to filter properly and secure it with 4 clips.

N.B.: The filter should never be cleaned with petrol, solvents or oil.

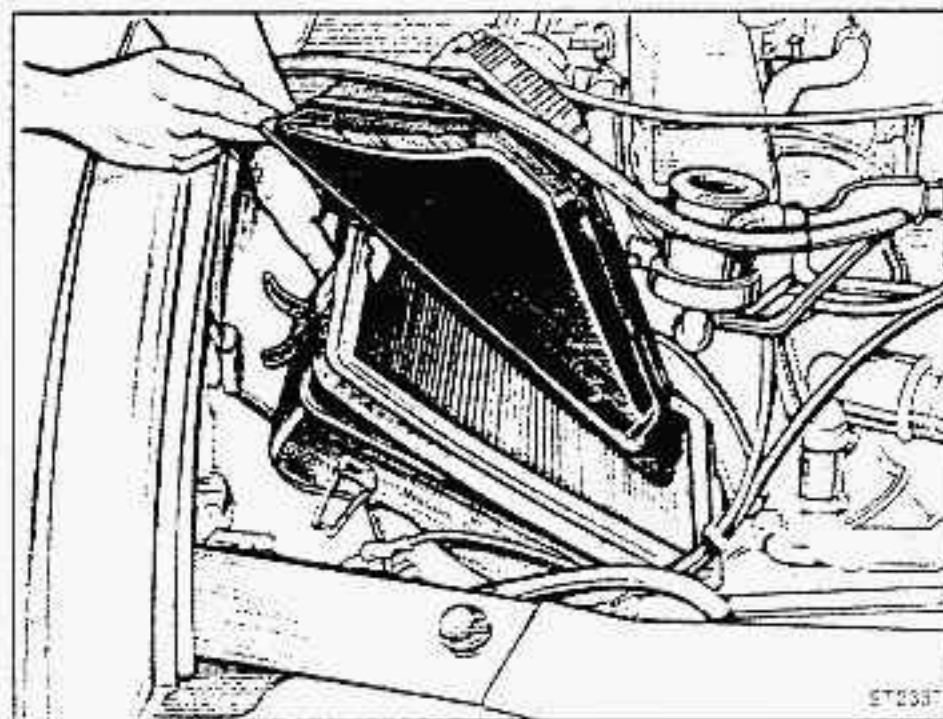
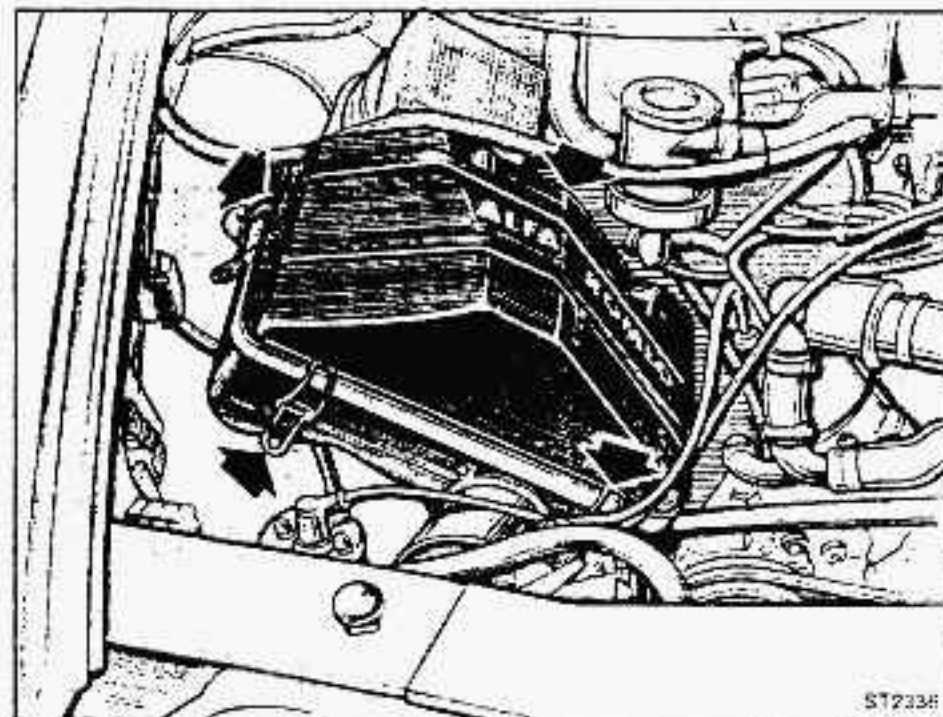

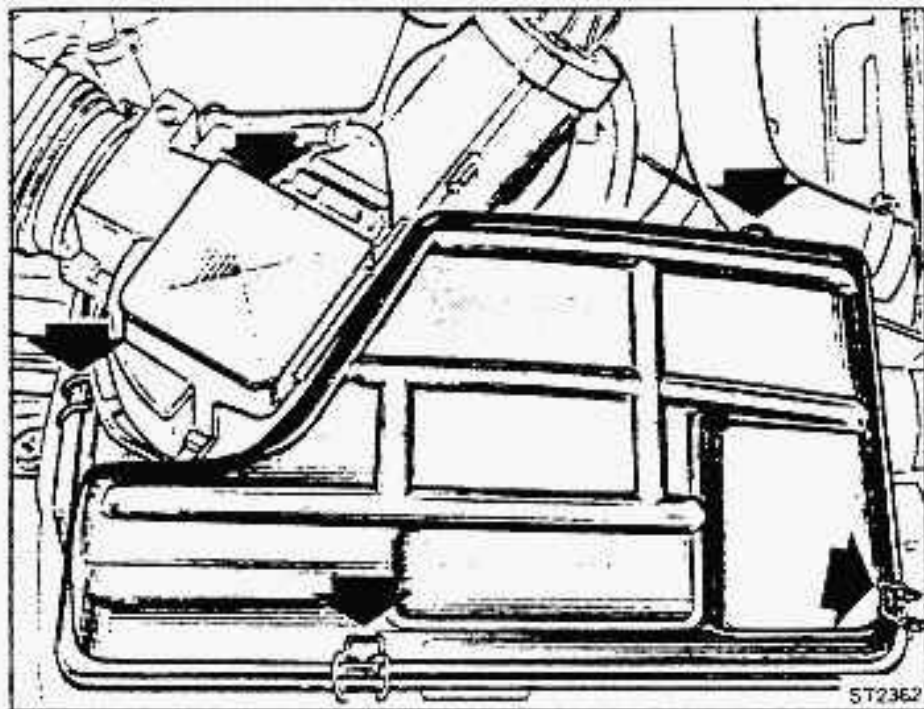

AIR FILTER (3.0 model)

Cleaning or replacing

- Loosen the 5 clips fastening the filter to the intake manifold
- Raise the cover and take out the element.
- Clean the element with low pressure compressed air blown on the part opposite that with "alto/top" printed on it.
- Fit the element in the correct position in the filter (ensure that the part marked "top" is at the top).
- Fit the cover in the correct position and secure it with the 5 clips.

Note: The filter should never be cleaned with petrol, solvents or oil.

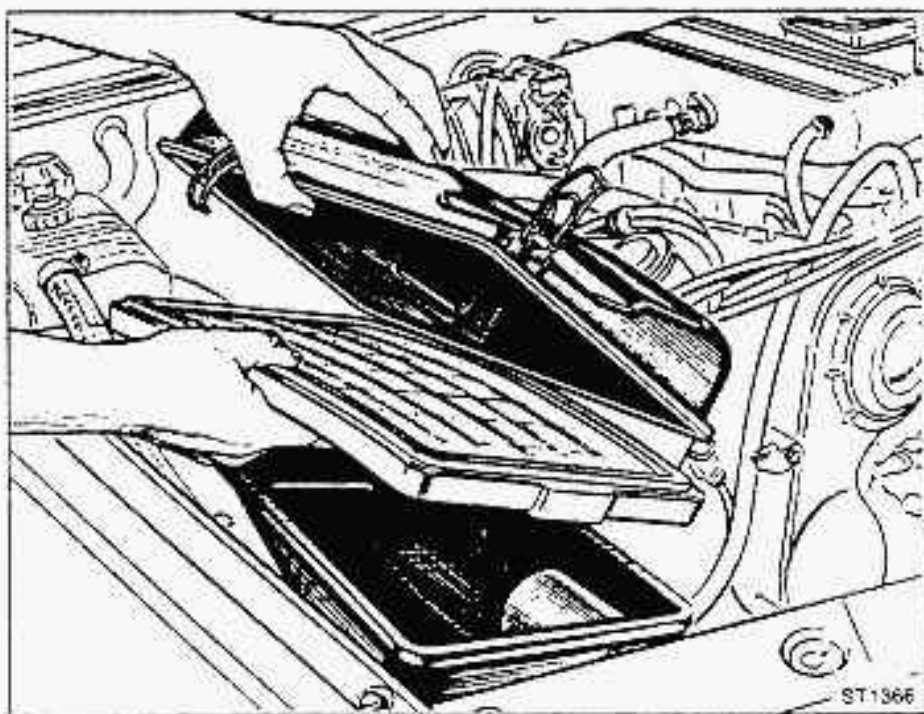

ALTERNATOR AND COOLANT PUMP DRIVE BELT

BELT TENSION ADJUSTMENT

The tension is correct when, on pressing the belt at the point indicated by the arrow, it yield about 15 mm.

If it is necessary to tighten it unscrew nuts A-B and screw C. Move the generator outwards to increase belt tension and re-tighten nut B; re-check the belt tension.

Tighten nut A and screw C.

REPLACING THE BELT

Slacken nuts A-B and screw C.

Move generator inwards and remove the old belt. Fit the new belt on the 3 pulleys and move the generator outward until belt tension is as specified.

Securely tighten nut B, check belt tension and re-tighten nut A and screw C.

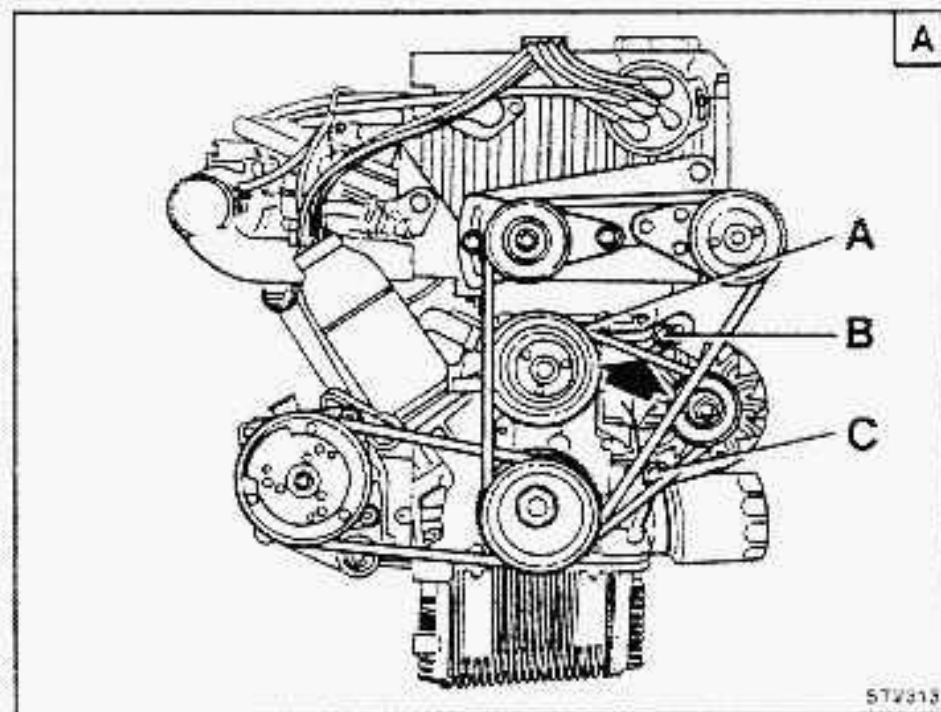

5T2913

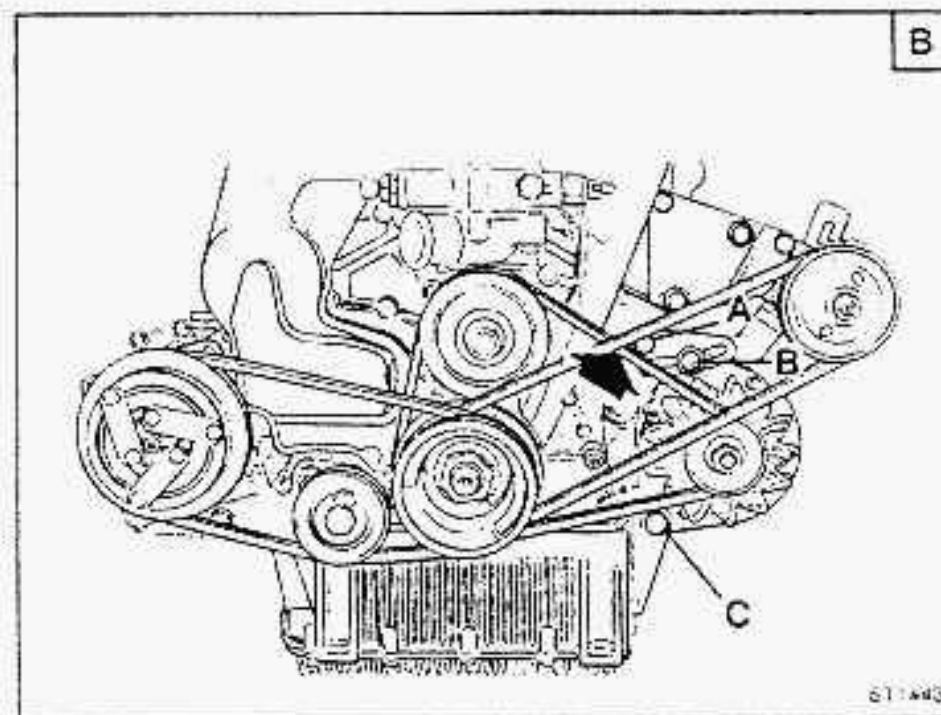

6T1445

A = 2.0 model
B = 3.0 model

Note: When changing the generator drive belt it is first necessary to remove the air conditioner (see pages 50 and 51) and power steering (see page 85) drive belts (if fitted).

COOLING SYSTEM

 T.SPARK model

- 1 - Radiator
- 2 - Electric fan thermal switch
- 3 - Thermostat
- 4 - Minimum level warning light (Alfa Romeo Control)
- 5 - Coolant level sensor
- 6 - Header tank plug
- 7 - Header tank
- 8 - Single throttle throat
- 9 - Coolant temperature gauge sensor
- 10 - Heater valve
- 11 - Heater
- 12 - Maximum coolant temperature warning light
- 13 - Coolant temperature gauge
- 14 - Thermal switch for maximum coolant temperature warning light
- 15 - Pump

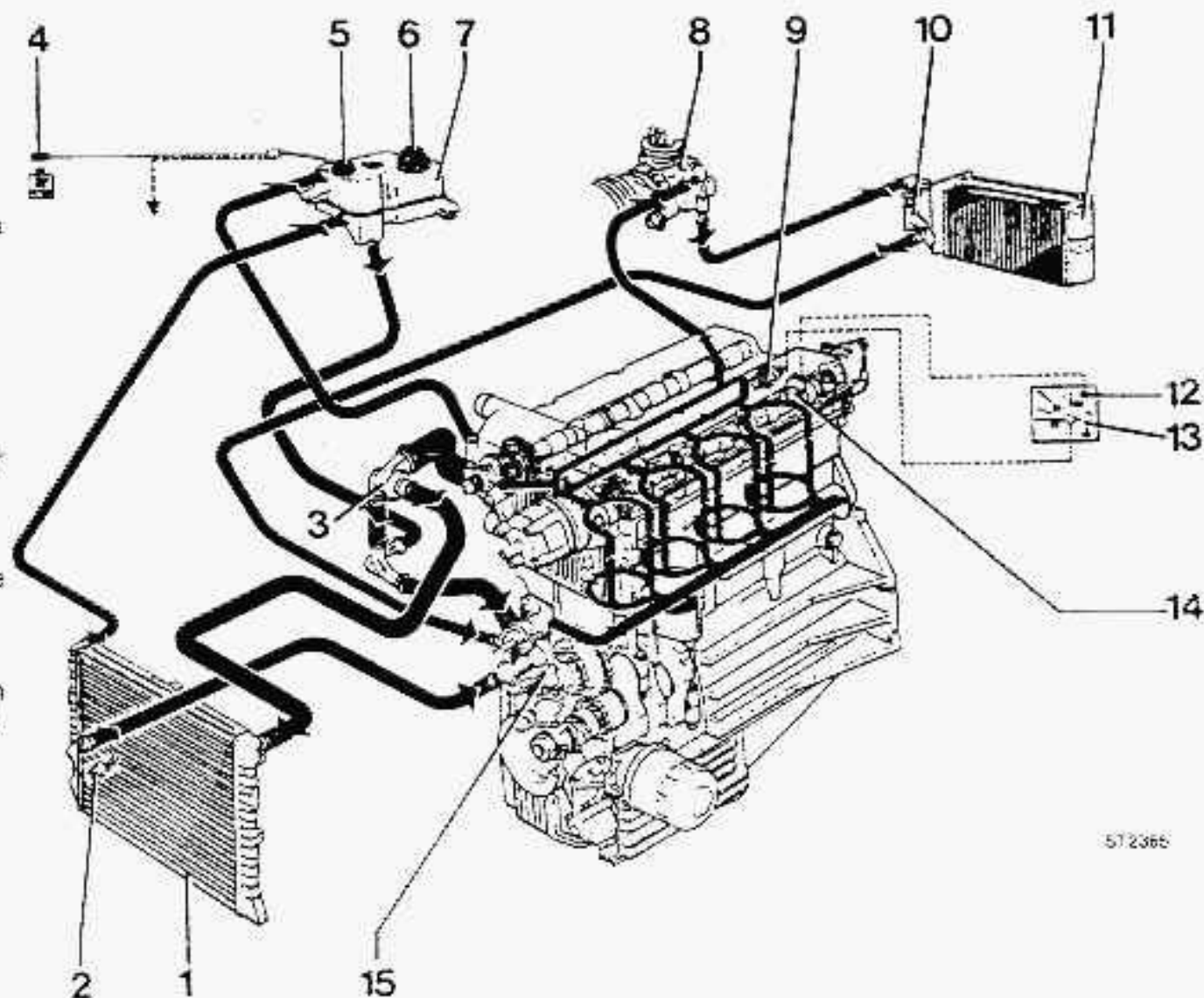

572366

The cooling system (for both fuel injection and carburettor versions) is of sealed type with header tank. The coolant, after cooling the engine, flows to thermostat. From here, depending on the temperature, the coolant is drawn directly by pump or sent to the radiator, where it is cooled. It then returns to the pump.

At the recommended intervals (or at least every 2 years) change the Alfa Romeo Antifreeze.

For this operation, or should it be necessary to increase the concentration (outside temperature below -20°C), take the vehicle to an **authorized Alfa Romeo Service Dealer**.

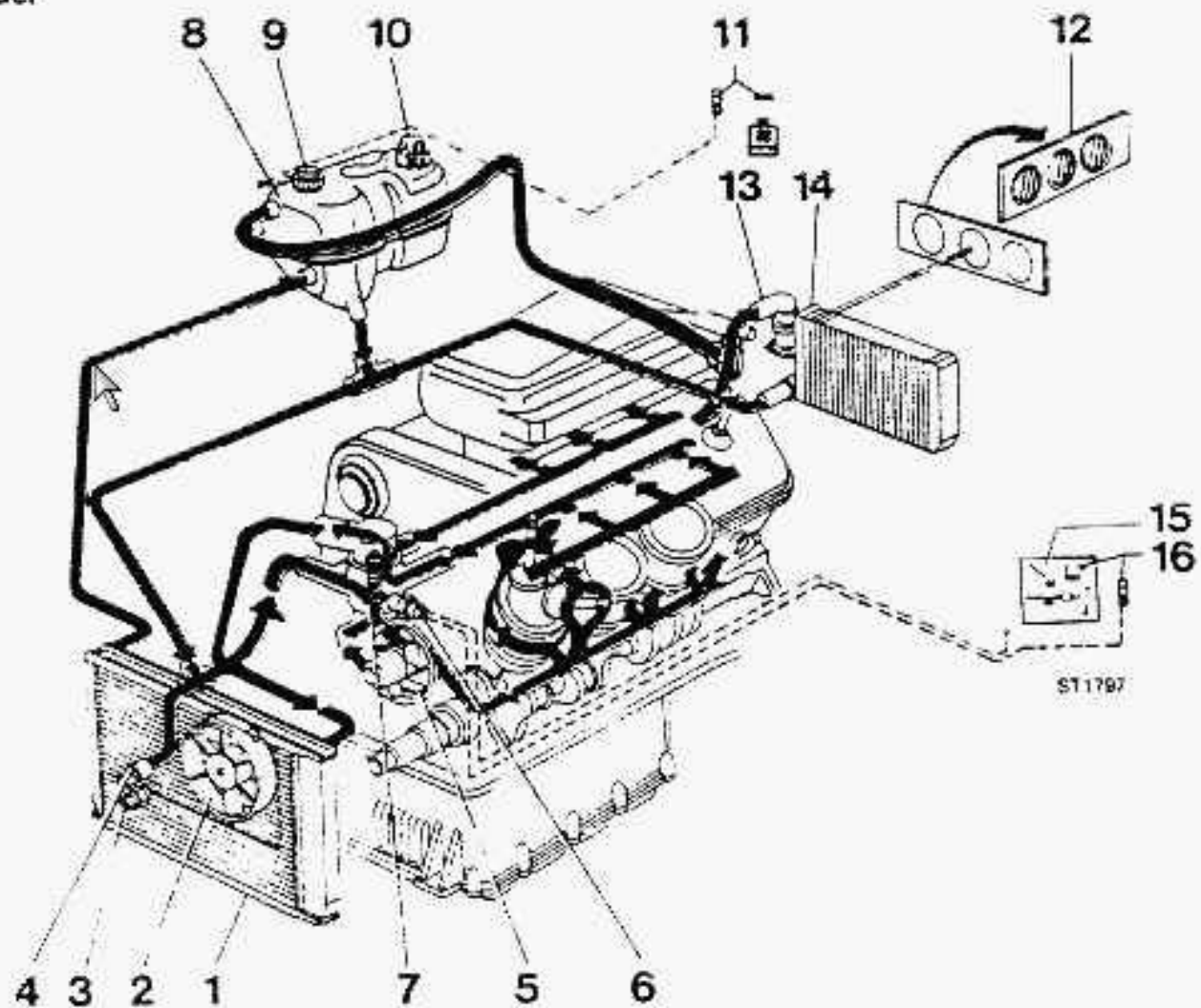

- 1 - Radiator
- 2 - Electric cooling fan
- 3 - Cooling fan sensor
- 4 - Sleeve clamp
- 5 - Pump
- 6 - Coolant temperature gauge sensor

- 7 - Thermostat
- 8 - Header tank
- 9 - Coolant level sensor
- 10 - Header tank plug
- 11 - Min. level warning light (Alfa Romeo Control)

- 12 - Heater control
- 13 - Heater valve
- 14 - Heater
- 15 - Coolant temperature gauge
- 16 - Max. coolant temperature warning light

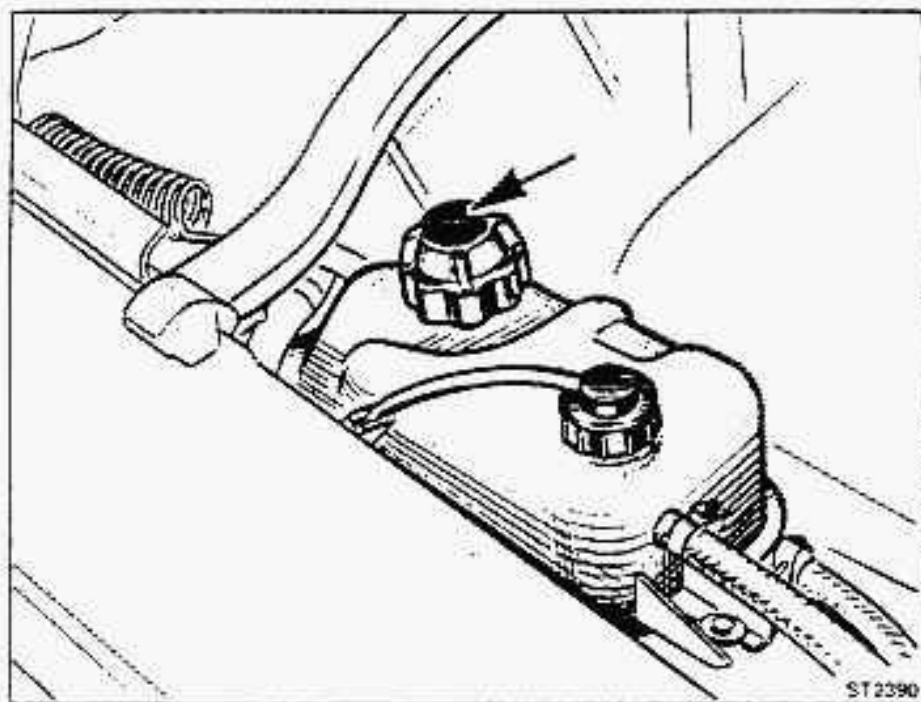

COOLANT LEVEL CHECKING

The coolant level is regulated by the Alfa Romeo Control device.

However, it is wise to check the coolant level in the header tank occasionally.

This should be done **with a cold engine** as with a hot engine the level can be considerably higher, even with the engine stopped. The level should always lie between MIN and MAX. If the system needs to be replenished, this must only be done in the header tank using **Alfa Romeo Antifreeze mixture** from the special containers available at Alfa Romeo Service Dealers; it should be introduced through the hole closed by plug indicated in the figure.

Warning: Never remove the header tank plug when the engine is hot, danger of scalding!

DRAINING AND REPLENISHING THE SYSTEM

Never remove the header tank cap when the engine is not!

- Open heater valve by means of control (max. heating).
- Remove plug from header tank.
- Slacken clamp indicated in the figure, remove sleeve and let coolant drain.
- Replace sleeve and tighten clamp.
- Pour the antifreeze into the header tank.
- Replace the header tank plug.
- Start the engine and check that there are no leaks.
- When the engine is cold check the level in the header tank and top up if necessary.

A = 2.0 model

B = 3.0 model

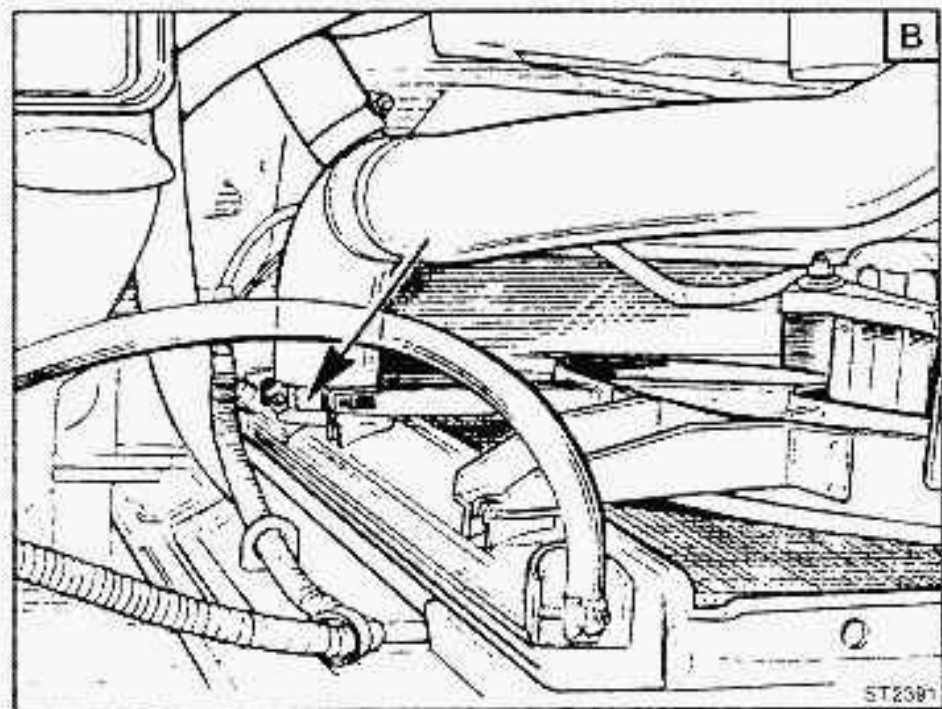
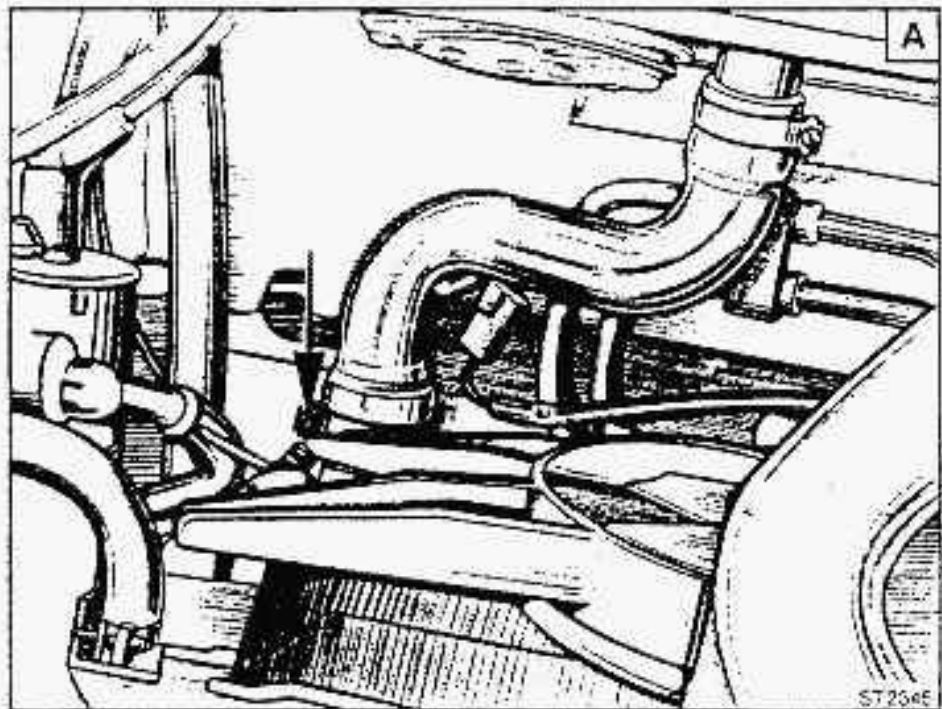

BRAKES

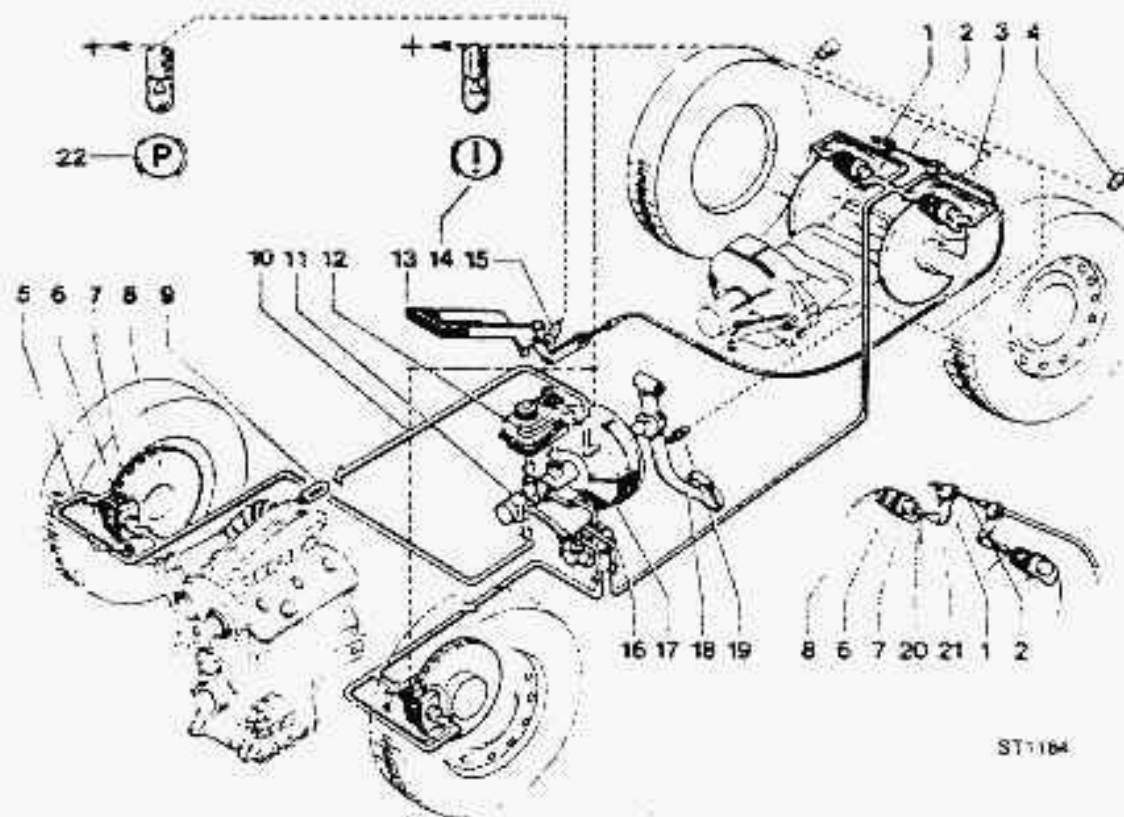

ST1184

- | | | |
|-----------------------------------|---|--|
| 1 - Handbrake pad operating lever | 8 - Engine vacuum port | 15 - Switch for handbrake warning light |
| 2 - Handbrake cable | 10 - Vacuum pipe | 16 - Rear wheel braking regulation valve |
| 3 - Handbrake cable sheath | 11 - Master cylinder | 17 - Power brake |
| 4 - Stop light bulbs | 12 - Fluid reservoir with warning light switches | 18 - Pedal |
| 5 - Air bleed screw | 13 - Handbrake lever | 19 - Stop light switch |
| 6 - Pads | 14 - Brake fluid low level and brake pad wear warning light | 20 - Handbrake push rods |
| 7 - Pad pistons | | 21 - Handbrake adjusting nuts |
| 8 - Discs | | 22 - Handbrake warning light |

BRAKES

The braking system is of the dual hydraulic type (separate front and rear circuits).

Valve 16, inserted in the rear braking circuit, regulates the braking action of the rear wheels.

Warning: the pressure regulation valve must never be tampered with.

Warning light 22 signals that the handbrake has been applied.

Warning light 14 (Alfa Romeo Control) comes on if the level of the brake fluid in the reservoirs falls below the minimum. If it comes on stop the car immediately and check the brake fluid level. If it is too low check the circuit for failure.

Warning lamp 14 signals also brake pad wear (both front and rear). If it comes on have the worn pads replaced as soon as possible.

Warning: If the vehicle is used mainly in mountainous or dusty areas and/or used for rallies or racing a more frequent inspection of the brake pads is advisable.

The handbrake is mechanically operated. If it is correctly adjusted the wheels become locked as lever 13 reaches the 4th to 6th notch.

Important: In the event of accident or damage to the chassis check that the brake vacuum servo is undamaged since even slight servo body damage may impair the operation of the brakes and require a greater pressure on the pedal.



BRAKE AND CLUTCH FLUID RESERVOIR

Care should be taken to prevent the level of the fluid in the reservoir from falling by more than a quarter below the maximum level.

Change the fluid at the recommended intervals (at least once a year).

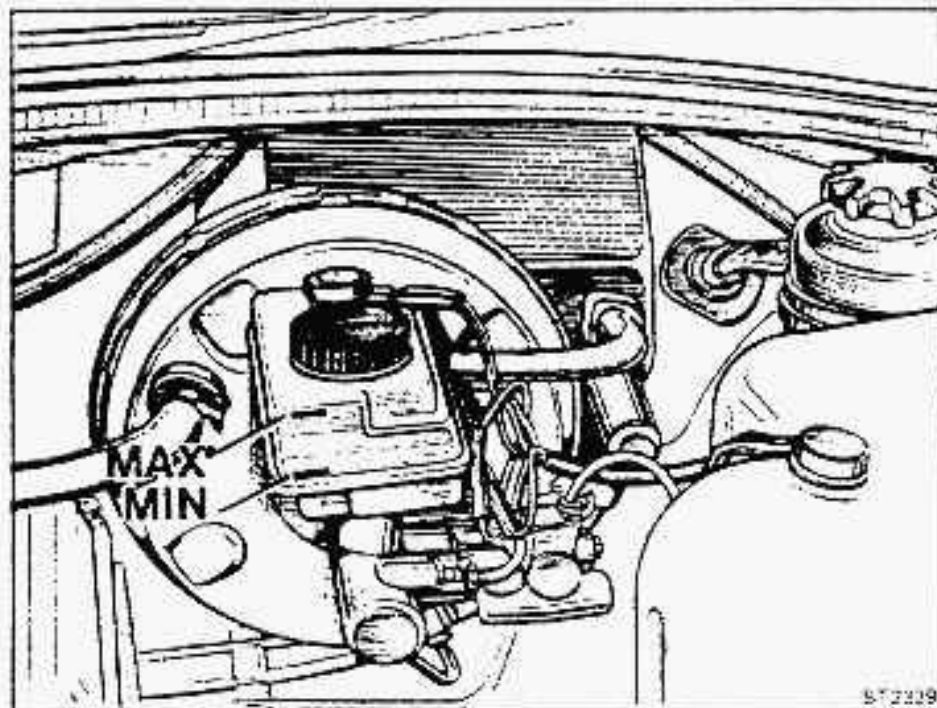
When changing or topping up it is absolutely essential to use **only the specified fluids** supplied in sealed containers which should be opened only at the moment of use. When adding fluid leave the filter in place so as to filter the fluid.



Brake and clutch fluid		BRAKE FLUID Order number 105.00.45.300.00.01
		BRAKE FLUID Super HD
		«S»

POWER STEERING

Hydraulic power steering not only makes driving easier but also safer.

The system is made up of a pump, driven by the crankshaft by means of a V-belt, which pumps the fluid under pressure to the power steering box.

 T. SPARK model

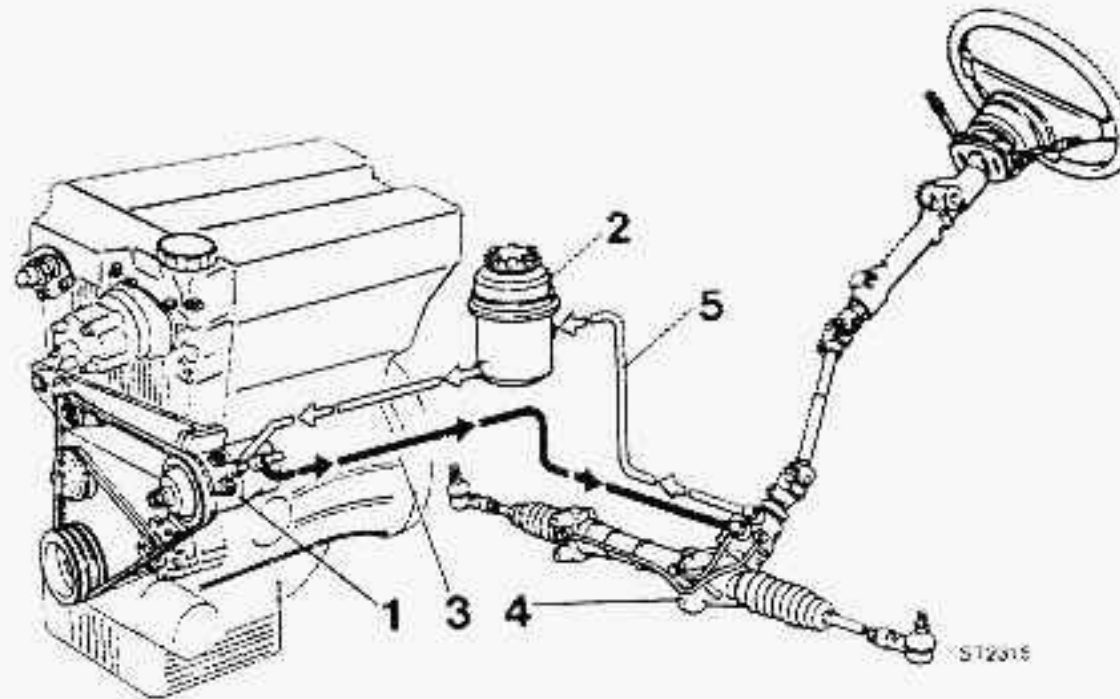

1. Pump
2. Fluid tank
3. Fluid delivery piping
4. Steering box
5. Fluid return piping

Important: Remember that **in the event of a system malfunction** (improbable if the vehicle is used normally and the prescribed checks and maintenance are performed) **it is still possible to steer the vehicle** but greater effort will be required. As the steering gear is a mechanical assy in strict relation with safety driving conditions, it is necessary to stop the vehicle and

directly contact an **Alfa Romeo Service Dealer** even in case of a suspected fault. As previously mentioned, the system is powered by the crankshaft so if the engine is stopped or the vehicle is being towed (neutral gear and engine off) a greater effort will be required to turn the steering wheel.



75 30 V8 model

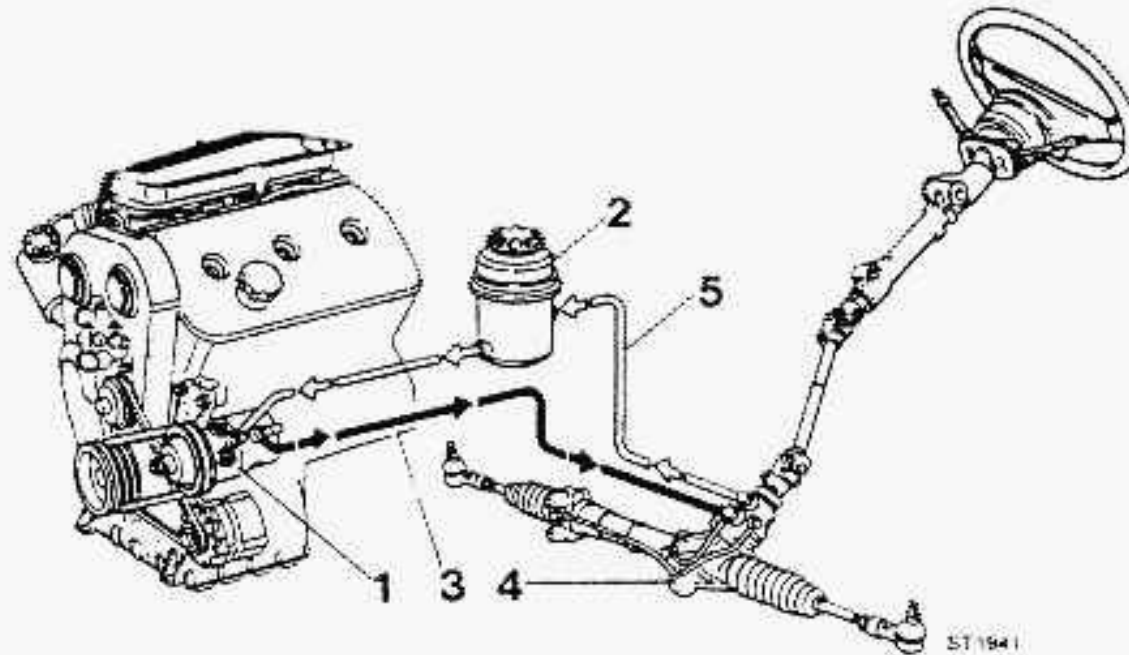

1. Pump
2. Fluid tank
3. Fluid delivery piping
4. Steering box
5. Fluid return piping

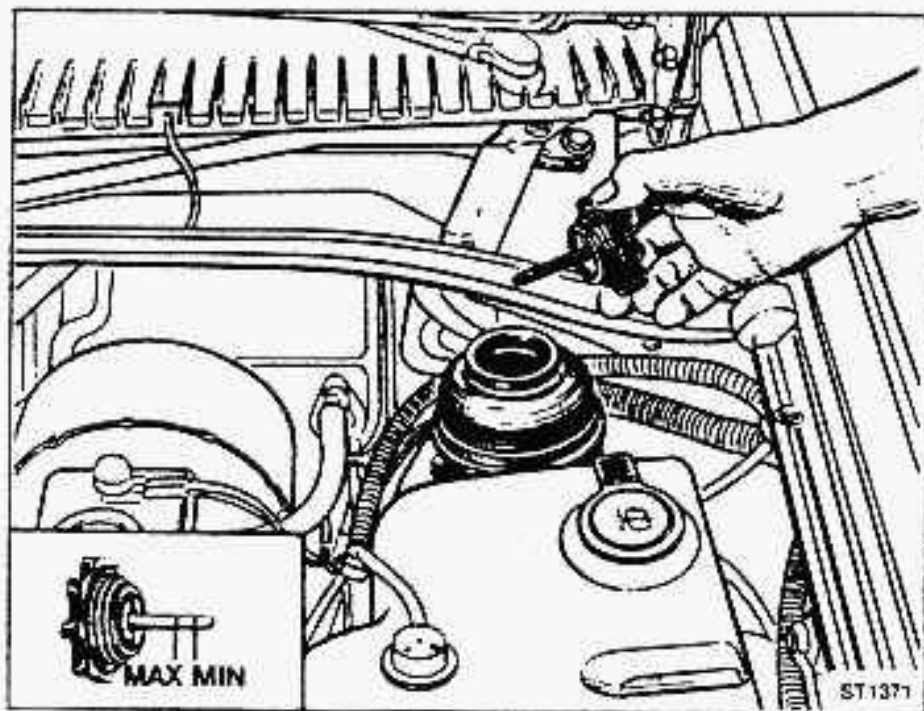

CHECKING THE FLUID LEVEL

Check the level of the fluid in the reservoir at the prescribed intervals; clean the cover of the reservoir and the surrounding area and then remove the cover - the fluid should be at MAX level. If it is not top up with one of the products specified (see "Lubricants" inside the back cover). Proceed as follows:

- Start the engine and wait until the level of the fluid in the reservoir stabilizes.
- With the engine running, turn the steering wheel all the way from left to right and back several times.
- Top up to the MAX level. Replace the cover on the reservoir.

N.B.: For maintenance or any repair operations which may be required it is advisable to contact an **Alfa Romeo Service Dealers.**

CHECKING PUMP DRIVE BELT TENSION

The tension is correct when, on pressing the belt at the point indicated by the arrow, it yields about 15 mm.

2.0 MODEL (figure A)

To tighten the belt slacken screws A and B. Stretch the belt by moving the belt stretcher upwards and tighten screw A. Re-check belt tension. Tighten screw B.

3.0 MODEL (figure B)

If it is necessary to tighten the belt slacken screws A-B-C-D-E. Stretch the belt by moving the pump upwards and tighten screws B-C. Re-check belt tension and tighten screws A-D-E.

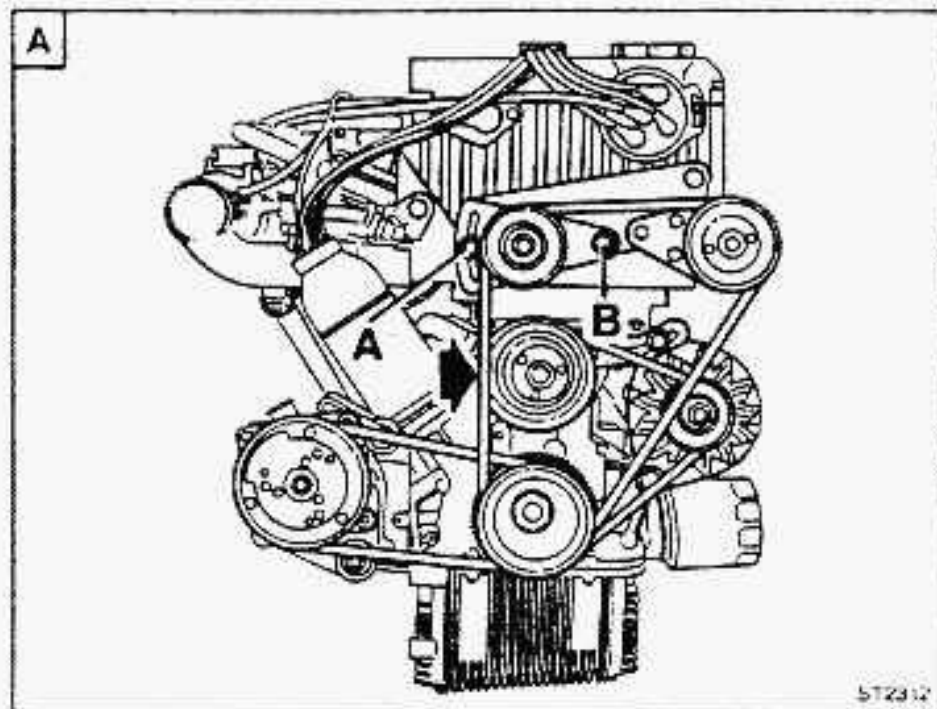

REPLACING THE BELT

2.0 MODEL (figure A)

Slacken screws A and B.

Move the belt stretcher down and remove the old belt. Fit the new belt on the pulleys and move the belt stretcher upwards until belt tension is as specified. Then securely tighten screw A and check belt tension. Tighten screw B.

3.0 MODEL (figure B)

Slacken screws A-B-C-D-E.

Move the pump downwards and remove the old belt. Fit the new belt on the pulleys and move the pump outwards until the belt tension is as specified. Then securely tighten screws B-C and check belt tension. Tighten screws A-D-E.

Note: Before replacing the pump drive belt it is first necessary to remove the compressor drive belt if the vehicle is equipped with air conditioning (see page 51).

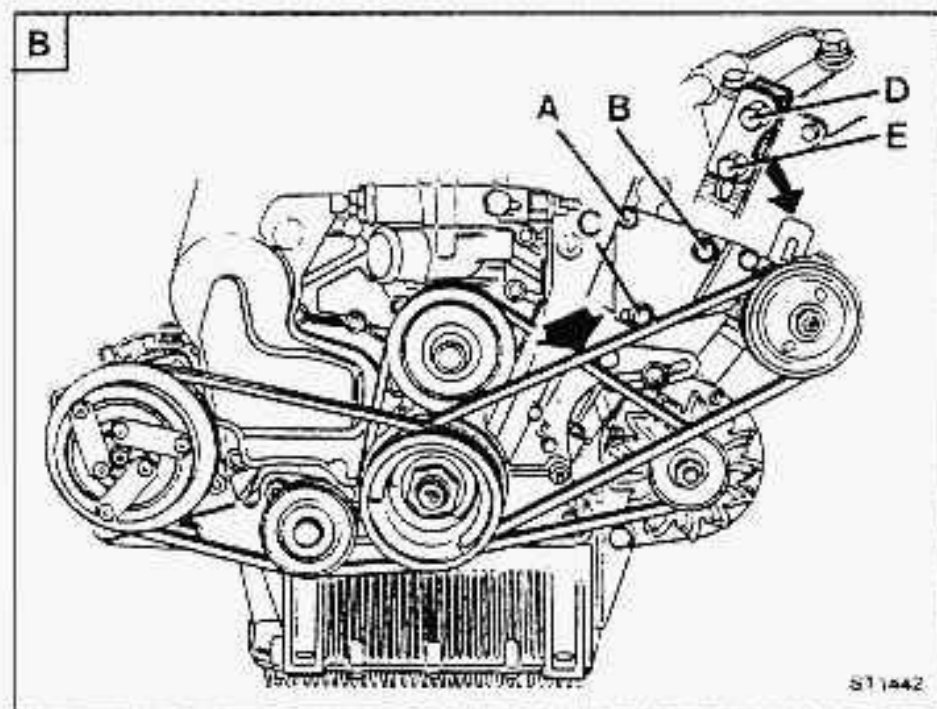

WHEELS

Important: Steel wheels and light alloy wheels use specific mounting bolts.

Therefore when steel wheels are replaced by light alloy wheels or viceversa it is essential to mount each type of wheel with specific mounting bolts.

Tighten the nuts to a torque of 10 kgm.

The vehicle is fitted with tubeless tyres.

For types and pressures see inside back cover.

Warning

- With new tires, it is suggested not to reach top speeds during the first 100 km (60 mi).
- Slow down before sharp curves.
- Avoid sudden acceleration and unnecessary braking.
- Avoid prolonged periods of high speed driving.
- Maintain wheels in balance and front & rear suspensions in alignment.
- Avoid striking the tyre sidewalls (e.g. while parking).
- Never tamper with the inflating valve.
- Do not insert any tool between the wheel rim and tyre bead.
- If the rim becomes warped change the wheel and replace the rim.
- If an excessive drop in pressure is noted change the wheel and have the tyre checked for leaks.
- For dynamic balancing use only balance weights suitable for tubeless tyres.

Important

When repairing never fit an inner tube.

TYRE PRESSURES

For inflation pressures refer to the inside back cover.

1) Correct

The tyre gives optimum performance and the tread works over its entire width, thus ensuring uniform tyre wear and long life.

2) Too low

The tyre will overheat, the sides of the tread will wear quickly and the tyre plies will tend to separate.

3) Too high

Riding comfort will be reduced, the tyre will be subject to excessive wear at the centre of the thread and will be vulnerable to knocks.



BALANCING

Each wheel, together with its tyre, is statically and dynamically balanced at the factory.

Whenever a tyre is changed (or wheels are interchanged) the wheel must be re-balanced. Remember that unbalanced wheels cause unstable steering, abnormal steering gear wear and uneven tyre wear.

Important: To balance light alloy wheels use original Alfa Romeo balance weights **only**.

INTERCHANGE

Wheels should be interchanged as shown in the diagram.
After changing re-inflate tyres to the specified pressures.
Tyres should be interchanged regularly to prevent uneven or excessive wear (it is recommended every 5000 km - 3,000 mi).
Radial tyres should not be moved from one side to the other of the vehicle, so that their rolling direction is not changed.

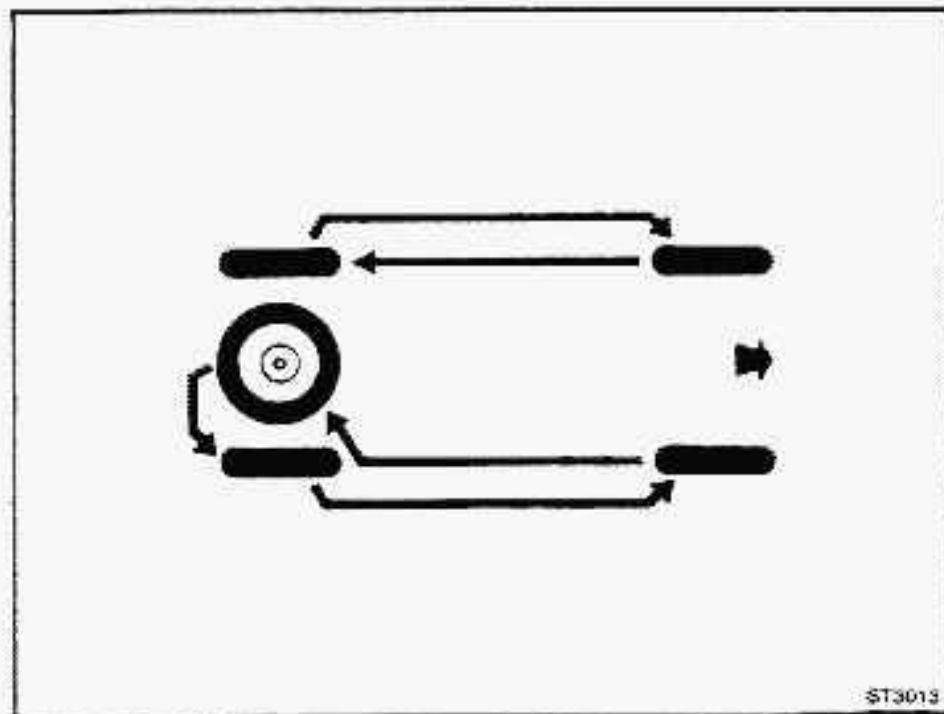

ST3013

WINDSCREEN AND HEADLAMP WASHING LIQUID

If warning light 5 of the Alfa Romeo Control (ARC, see page 12) lights up, top up with washing fluid through the hole indicated in the figure.

We recommend the use of suitable detergent liquids (which should possess anti-calcareous and anti-freeze properties). These are available commercially.

N.B.: Do not use the windscreen washer when the reservoir is empty to avoid damaging the pump motor.

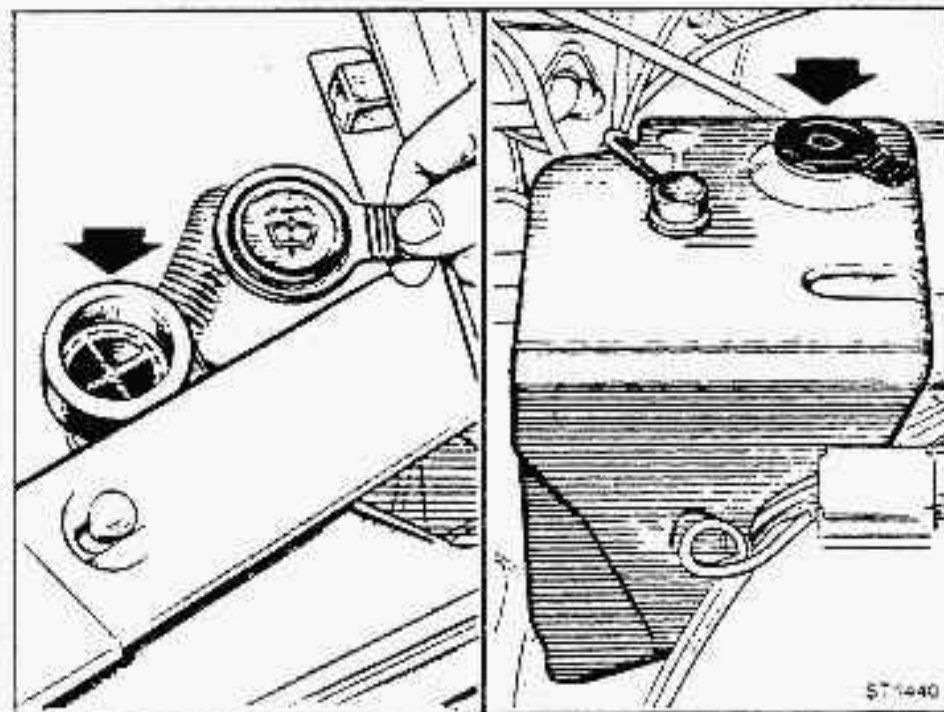

ST1440

ELECTRICAL EQUIPMENT

ELECTRONIC IGNITION

The breakerless distributor and the electronic module guarantee constant high level of performance under a wide range of operating conditions.

Important

If the engine ignition system appears to be developing trouble remember that all inspection and servicing operations must be performed according to a specific procedure to prevent damage to the system components and, **above all, injury to the operator.**

It is therefore recommended that the ignition system be checked for faults **only by Alfa Romeo Service Dealers.**

The following precautions must always be taken:

- Do not test for live circuits by earthing either high or low tension components.
- Do not break any electrical connection when the engine is running.
- Never start the engine if any electrical connection is broken.
- Do not supply current to the system if the electronic module has been removed from its housing.
- When using a timing light connect it directly to the battery terminals.

SPARK PLUGS

Check the state of the spark plugs at the prescribed intervals. No routine adjustment of the gap between the electrode and points is necessary.

Spark plugs are LODGE 25 HLD type (2.0 version) or LODGE 2 HL type (3.0 version).

If they have to be removed or changed tighten them with a cold engine to a torque of 2.5 - 3.5 kgm. Lubricate the thread before fitting.

ALTERNATOR

The following points should be borne in mind:

- The alternator must never be tampered with.
- When the engine is running do not disconnect battery or alternator terminals.
- Avoid overloading the alternator bearings. Check for proper belt tension (see page 75).
- For any inspection or repair work always contact **Alfa Romeo Service Dealers.**

BATTERY

It is located in the engine compartment.

The electrolyte level must be 4-5 mm higher than the plates. The battery must only be topped up with distilled water and never with acid. The terminals must be well-tightened and protected with neutral vaseline.

Furthermore, the following should be borne in mind:

- During the summer check the electrolyte level more frequently.
- When re-charging the battery, it must be completely disconnected from the vehicle electrical system; it is best to use a low strength re-charging current.
- Incorrect connection of the battery (reversed polarity) damages the alternator diodes.
- When electrical welding is carried out on the car disconnect the battery and make sure the positive terminal is properly insulated. **The engine must be still.**
- The electrolyte is an acid, corrosive substance, avoid contact with the skin, eyes or painted surfaces.
In case of contact, rinse immediately with cold water for some minutes, then consult a doctor.
- Never expose battery to flames or sparks because the hydrogen generated is a highly explosive gas.
- Never disconnect the battery terminals while the engine is running or the electronic components will be seriously damaged.

The battery fitted may be of the maintenance-free type which requires no replenishing of the electrolyte.

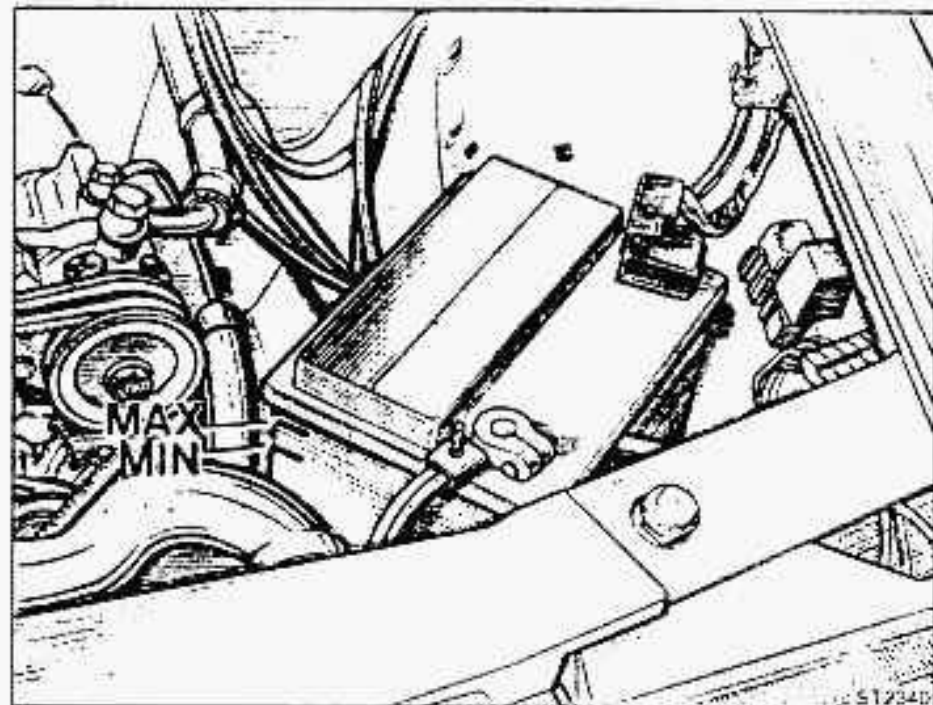

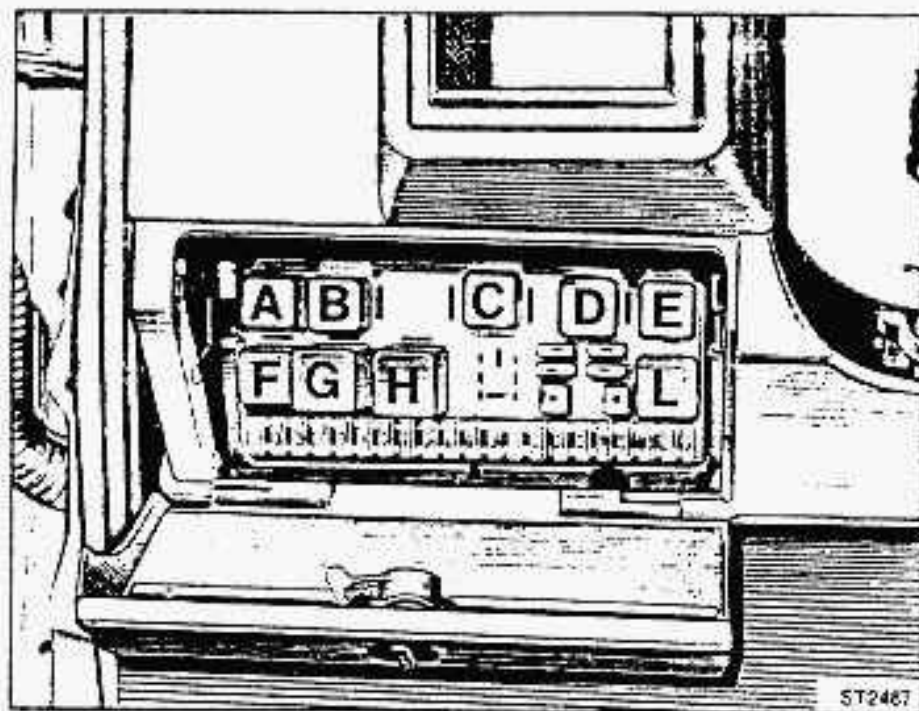

ST2467

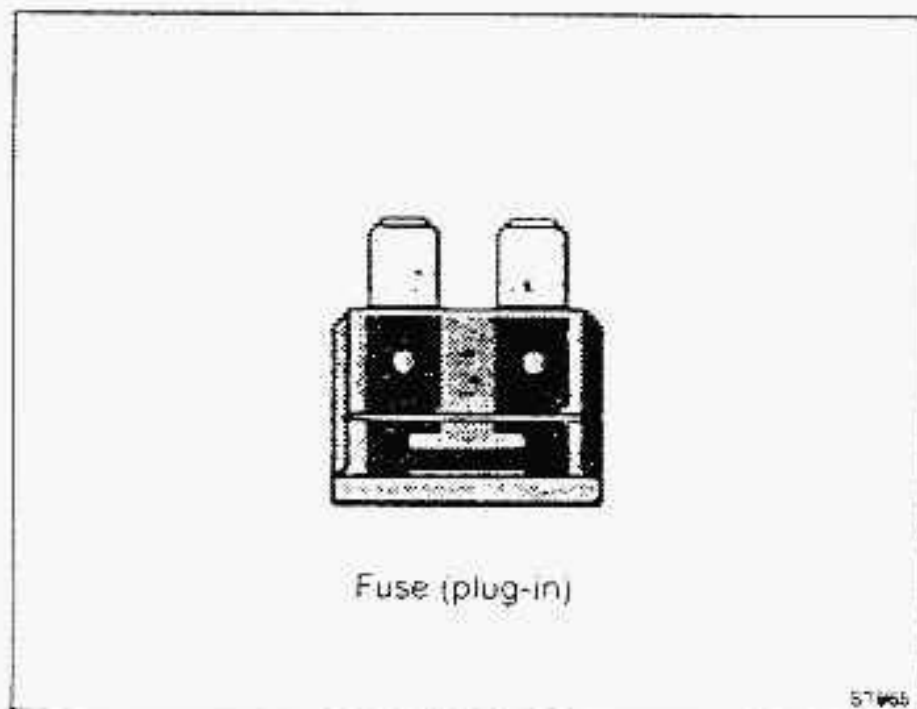

Fuse (plug-in)

57465

FUSEBOX

To inspect, rotate the knob and open the cover (hinged at bottom).

Fuse No.	Circuit protected	Amp Rating
1	Fog lights	15
2	Central door locking	10
3	Heated rear screen	20
4	Headlamp washers	20
5	Rear power windows	25
6	Front left & rear right side lights	7.5
7	Front right & rear left side lights	7.5
8	Left high beam	7.5
9	Right high beam	7.5
10	Right low beam	7.5*-10**
11	Left low beam	7.5
12	+ 30 battery and the ignition operated relay for the Alfa Romeo Control unit and ** instruments	10
13	Petrol pump* - + 15 relay coil, electronic injection group**	15
14	Instrument lighting	7.5
15	+ 15 switches - Instruments - Electronic control unit* - Windscreen wiper	15
16	Heater	20
17	+ 15 ceiling panel switches - Rear cigar lighter - Windscreen washer - Sunroof motor**	15
18	Front power windows	25
19	Ceiling light and spot - Clock - Radio - Antenna - Directions indicators - Light for fuse and relay container	15
20	+ 30 for possible optional utility* - + 30 for electronic injection control unit** - Petrol pump**	15
21	Stop lights - Front cigar lighter* - Rear fog light	15

* 1984 model

** 1985 model

The following circuits are not protected by fuses:
starting motor, generator, regulator, coil, horns, horn relay coil.

The box contains spare fuses (on the right).

If one or more fuses has to be replaced it is **vital to respect the amp ratings shown on facing page**: otherwise serious damage to the car could result.

If fuses have been replaced, restore spares with Alfa Romeo Genuine Parts. The use of similar fuses, even if with slightly different features, may jeopardize both operation and safety of your car.

The fusebox also contains the following relays:

- A - Fog lights
- B - Rear power windows
- C - Ceiling light
- D - Ignition - switch release
- E - Rear fog light (except vehicles fitted with fog lights)
Rear fog light relay (only vehicles fitted with fog lights)
- F - Heated rear screen
- G - Road hazard lights and flashers
- H - Windscreen wiper timer
- L - Ignition operated relay for the Alfa Romeo Control unit
-(3.0 V6) on-board instruments.

Warning: Prior to replacing a fuse switch off all lights and accessories and remove the ignition key to prevent damaging the electrical system.

Use the tweezers in the fusebox lid for extracting the fuses.

RADIO

The car is designed to receive a radio set.

The housings for the various components are located as follows:

- The radio itself in the central console under the ventilation controls.

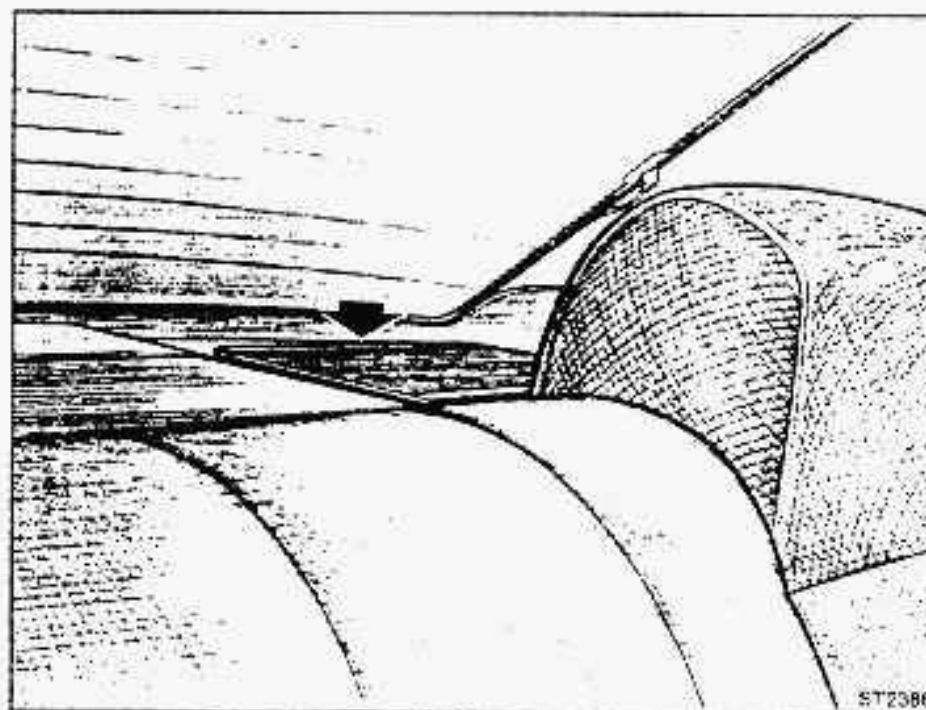

- The front speakers in the front door panels.
- The rear speakers, at the sides of the backshelf (see figure).

Standard wiring for the radio system consists of:

- Wires supplying power to the radio and antenna.
- Wires from the radio to the speakers.
- Co-axial cable for antenna.

Note: Alfa Romeo sells the radio, speakers and antenna made specifically for each vehicle. For installation of these components it is suggested to contact only **Alfa Romeo Service Dealers**, where proper installation will assure proper operation and guarantee coverage.

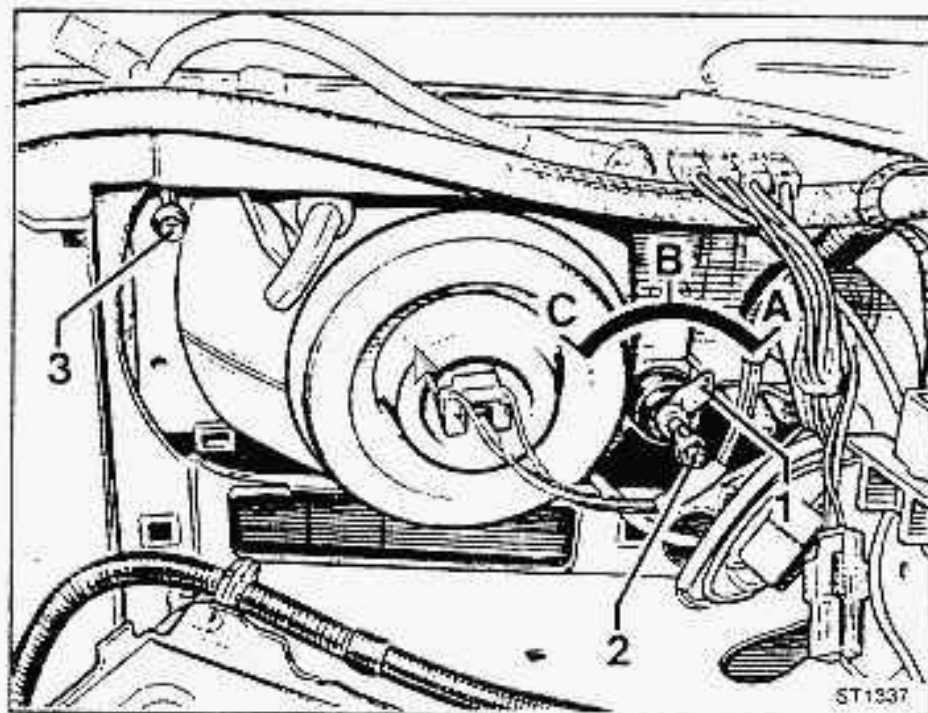

ADJUSTING THE BEAM HEIGHT ACCORDING TO THE LOAD

When the car is fully laden (with several persons or heavy baggage) the attitude of the car is altered and the height of both beams must be adjusted accordingly).

This operation is carried out by means of lever 1;

- A = vehicle unladen
- B = average load
- C = maximum load

SETTING THE HEADLIGHT BEAMS

For safety's sake and to avoid infringing traffic laws headlight beams should always be kept in the correct alignment.

We recommend periodic checks by Alfa Romeo Service Dealers who have the necessary equipment to obtain perfect alignment.

If necessary, adjust screws 2 and 3.

- 2) Adjusts vertical alignment of the beams.
- 3) Adjusts horizontal alignment of the beams.

CHANGING LIGHT BULBS

It is **absolutely essential** to use genuine Alfa Romeo bulbs, not only for safety reasons, but also to ensure the correct functioning of the Alfa Romeo Control device.

Important: Never let hands come in contact with halogen bulbs.

If this happens they must be carefully washed with alcohol before fitting.

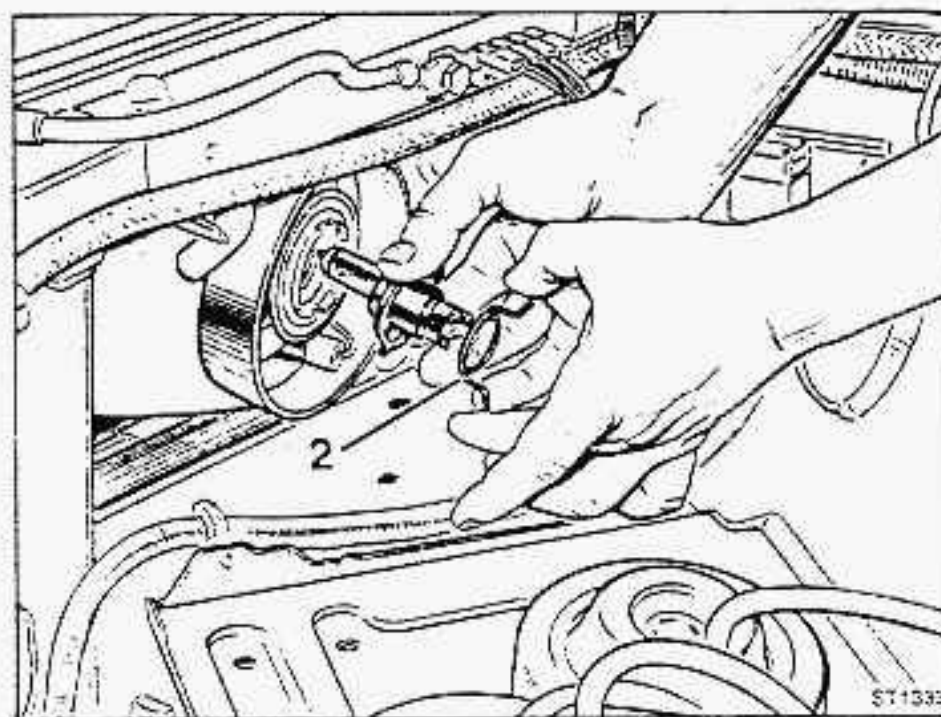
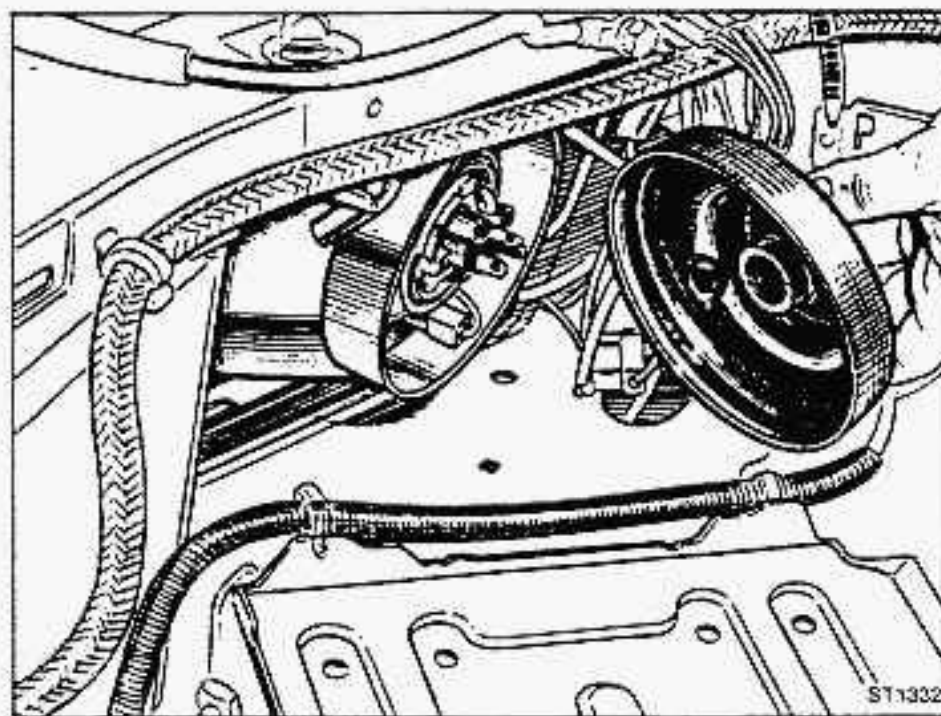
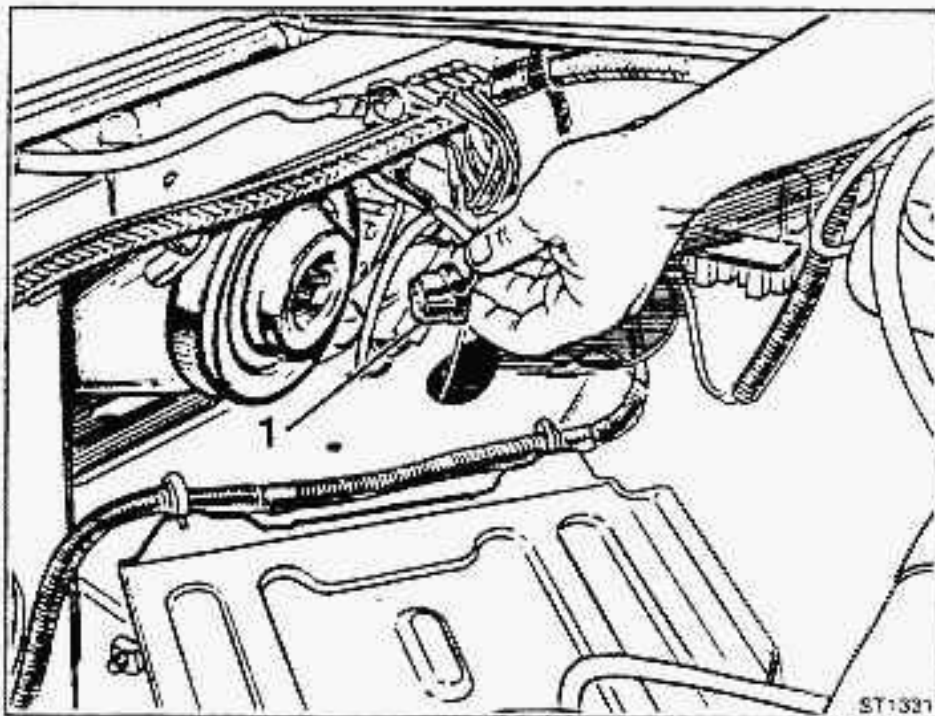

HEADLAMPS

- Remove connector 1 from bulb socket.
- Take off protective hood.
- Free retaining spring 2 from its seat and extract the bulb.
- Insert the new bulb and the retaining spring 2, mount protective hood and re-connect connector 1 by pushing it all the way in.

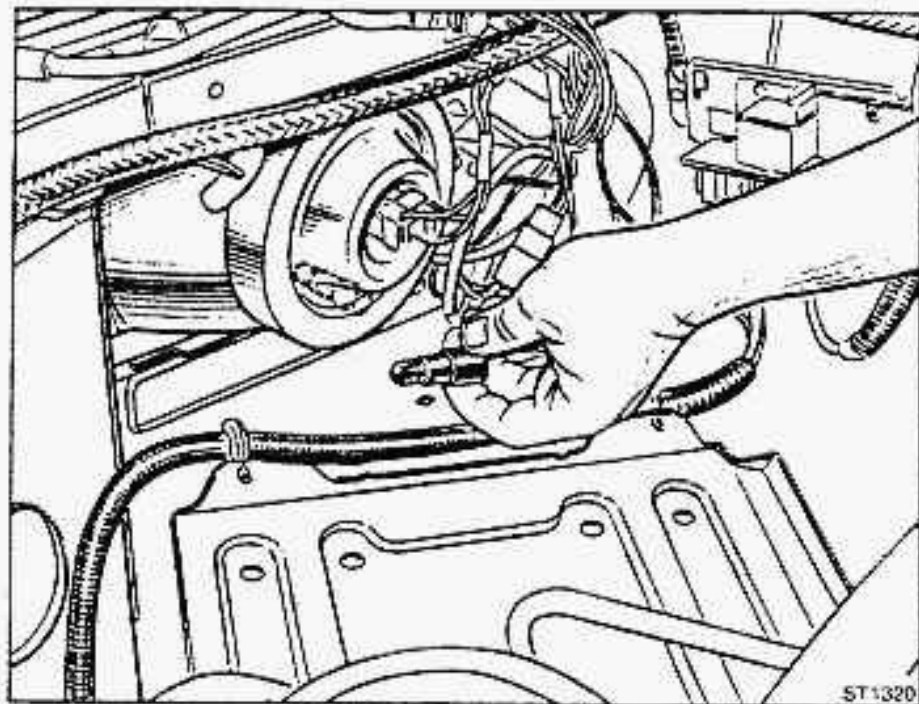

FRONT SIDE LIGHTS

- Lift lower border of protective hood.
- Remove the lamp-holder (pressure-fitted).
- Extract bulb (bayonet type).
- Insert new bulb (turning it clockwise in its seat) and re-fit the lamp-holder. Press it into its seat.
- Replace protective hood.

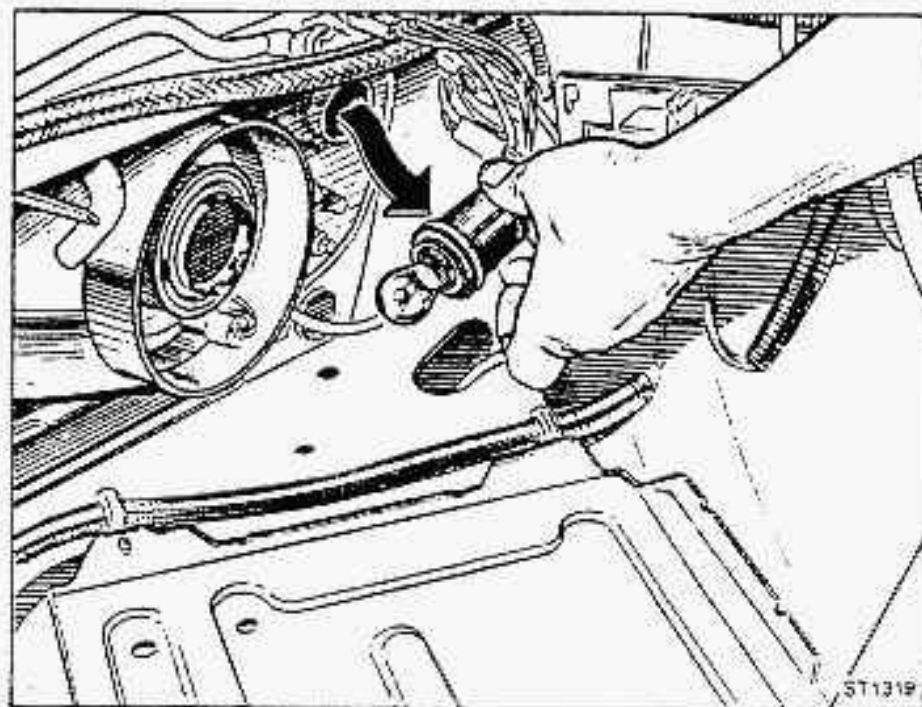

FRONT DIRECTION INDICATORS

- Turn the lamp-holder anti-clockwise and pull out.
- Replace the bulb (bayonet type).
- Replace the lamp-holder in the correct position and turn clockwise.



NUMBER PLATE LIGHT

- Unscrew the transparent plastic panel of the lamp-holder
- To extract the bulb, disconnect from contacts and pull away from lamp-holder.

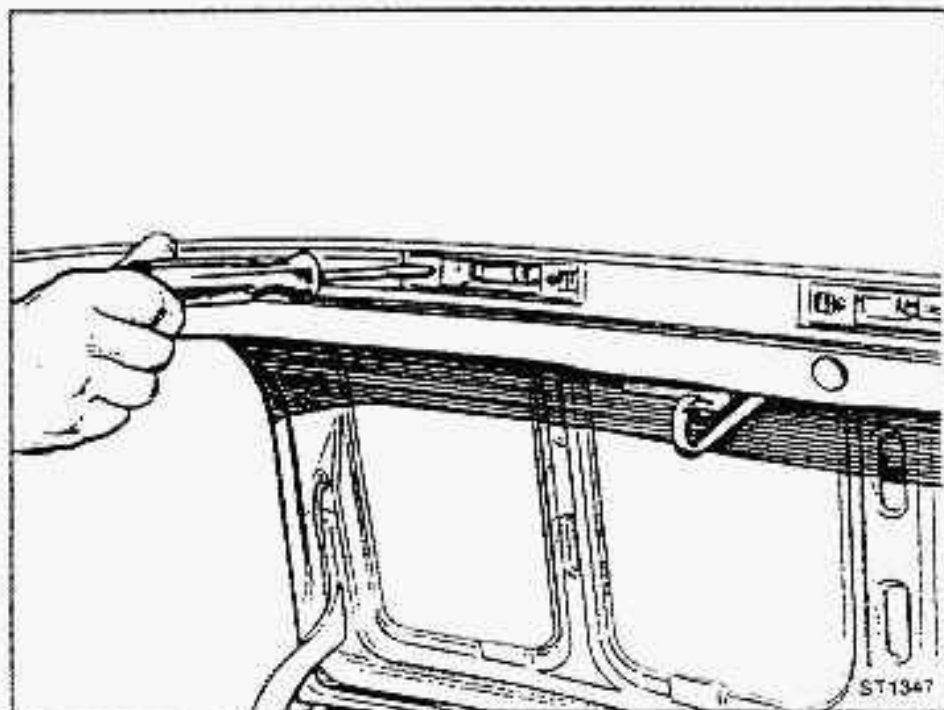

SIDE DIRECTION INDICATORS

- Push lamp in the direction of the front of the vehicle and release from rear securing spring.
- Detach lamp-holder and replace bulb.
- Re-fit taking care that the lamp-casing with wider flexible fin is placed facing the rear of the vehicle.
- Replace the lamp-holder in the correct position and turn clockwise.

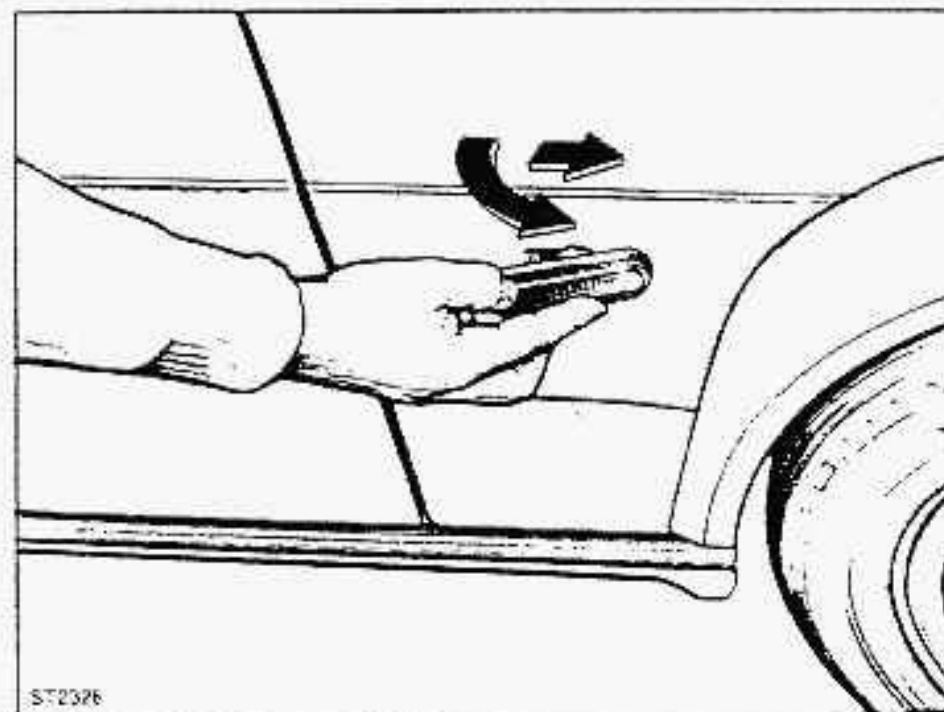

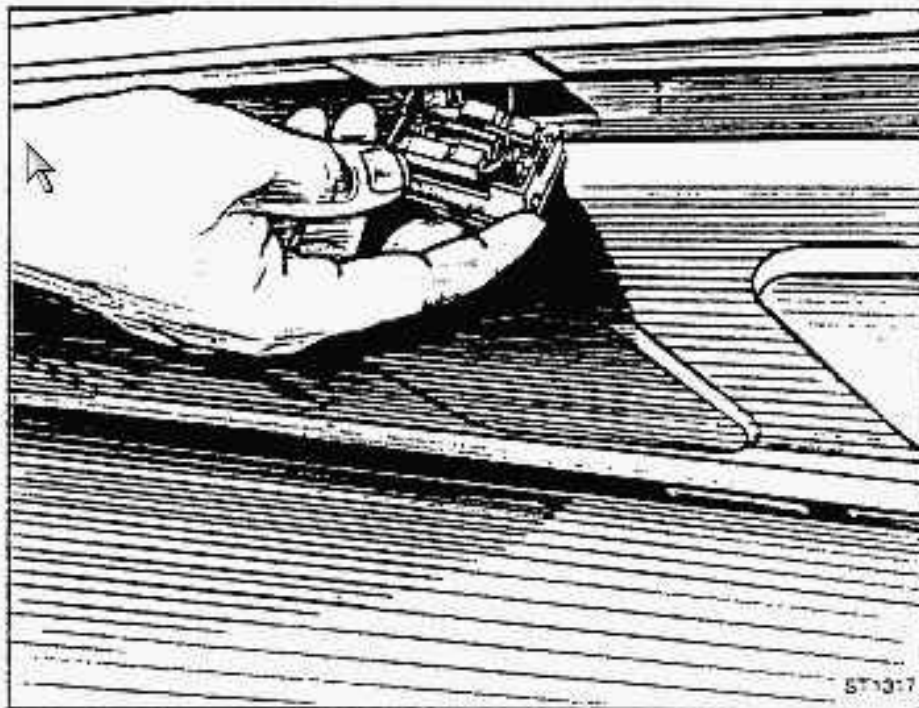

LUGGAGE AND ENGINE COMPARTMENT LIGHTS

Extract the pressure-fitted lamp-holders.
The bulb is pressure-fitted between two contact springs. With-
draw from springs and replace bulb.

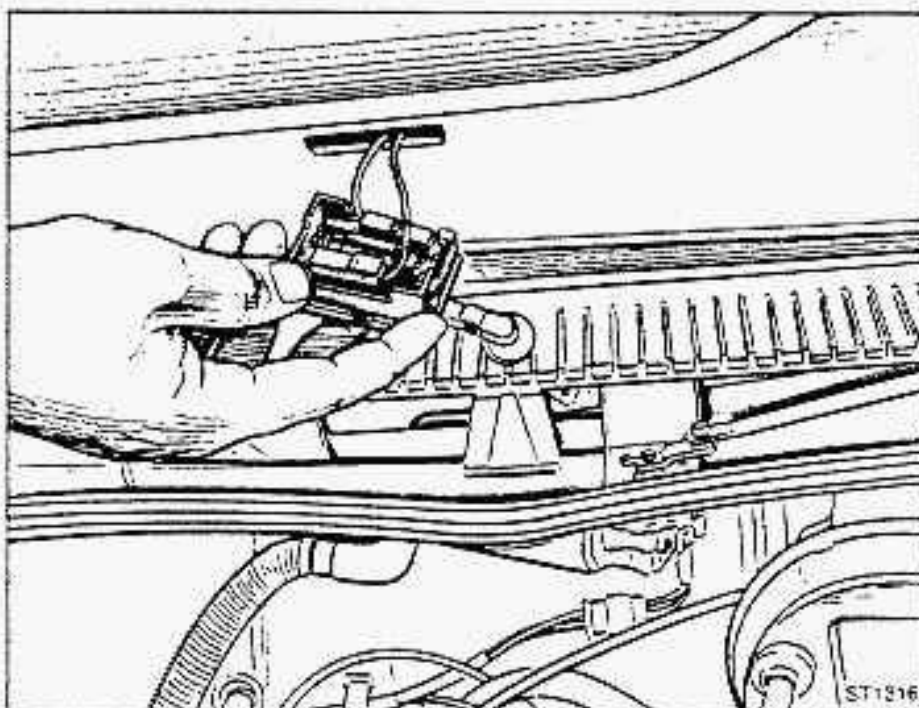

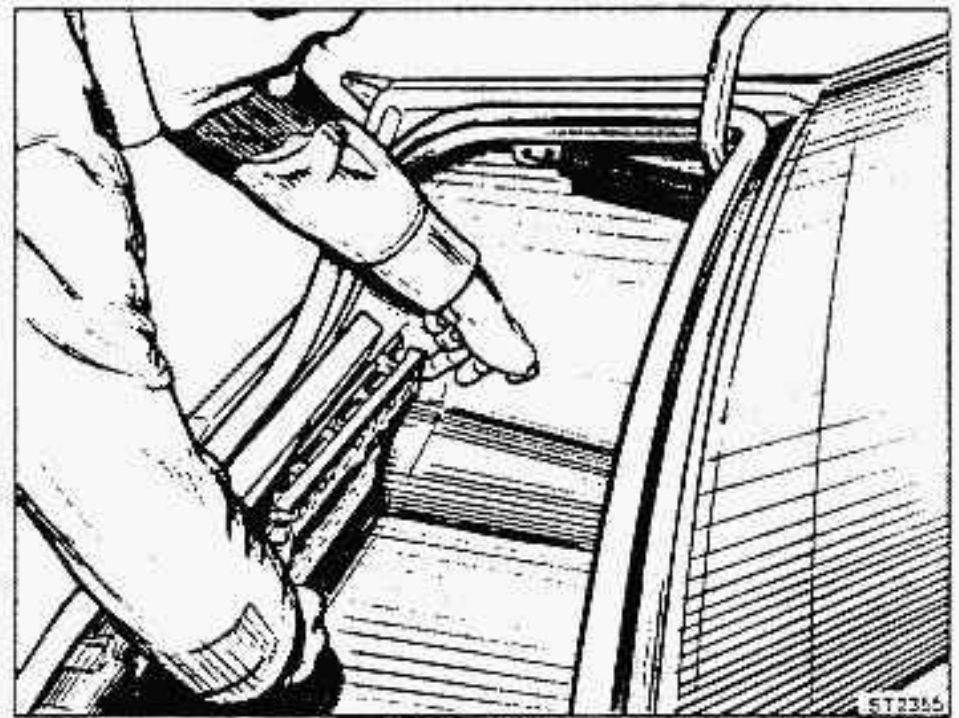

REAR LIGHT GROUP

- Press tabs A of the bulb support plate, and withdraw from its housing.
Proceed with care in order not to damage the bulbs or disconnect the power supply connectors.
- Replace the damaged bulb (for arrangement of the bulbs see further on).
- To replace plate, rest it correctly on the housing and push until in place.
- Ensure that the plate is securely seated in its housing.

BULB ARRANGEMENT

The diagram illustrates the arrangement of the bulbs on the left plate: the positions of the bulbs on the right plate are symmetrical.

Location of the bulbs is as follows:

- 1 reversing light bulb.
- 2 rear fog light bulb.
- 3 parking light bulb.
- 4 stop light bulb.
- 5 direction indicator light bulb.

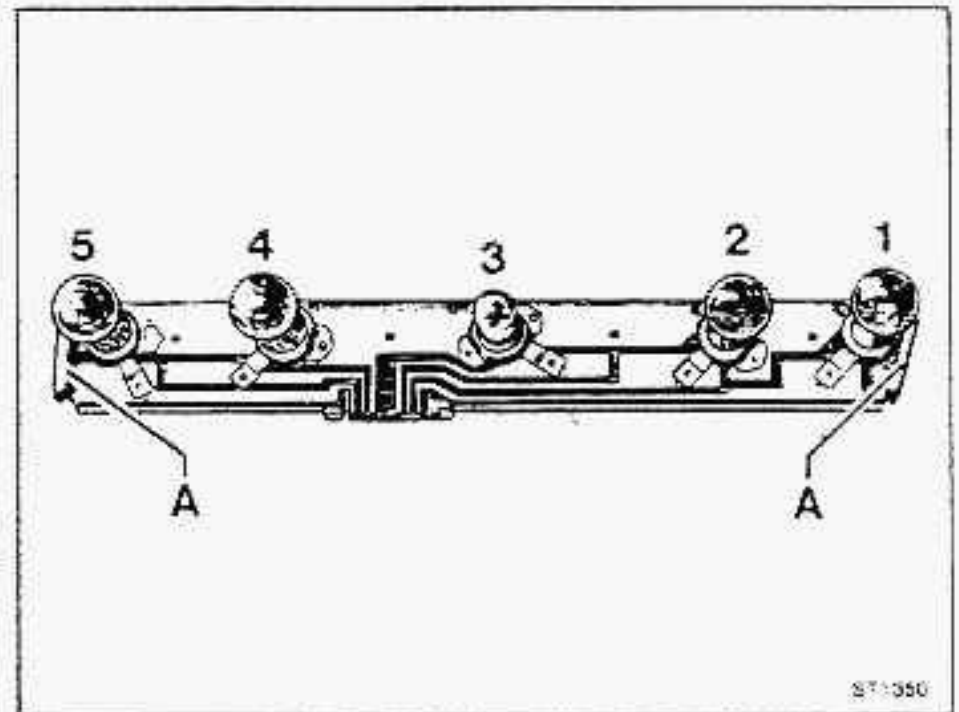

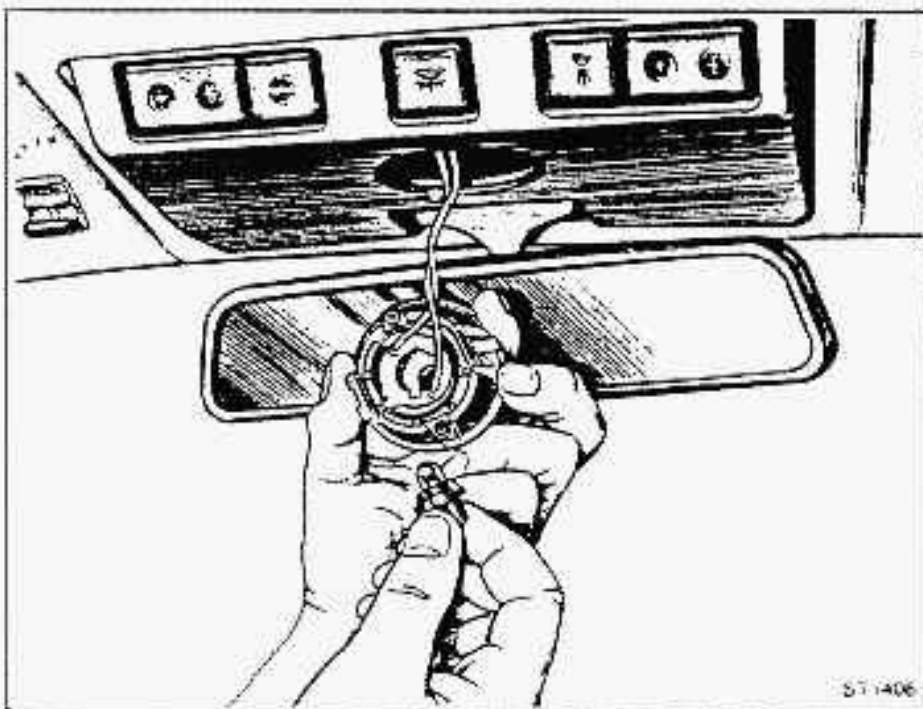
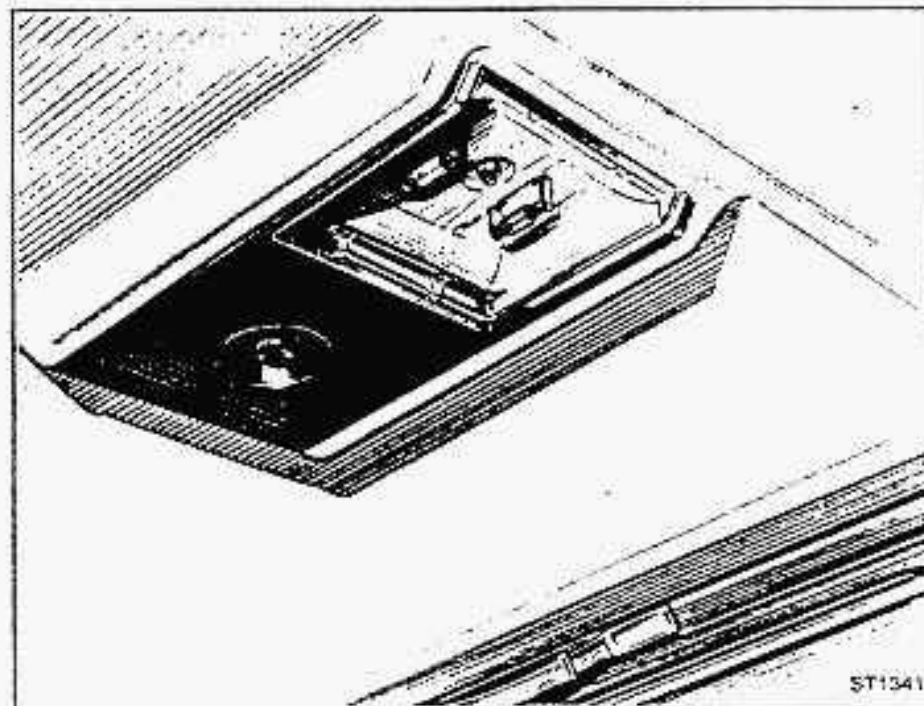
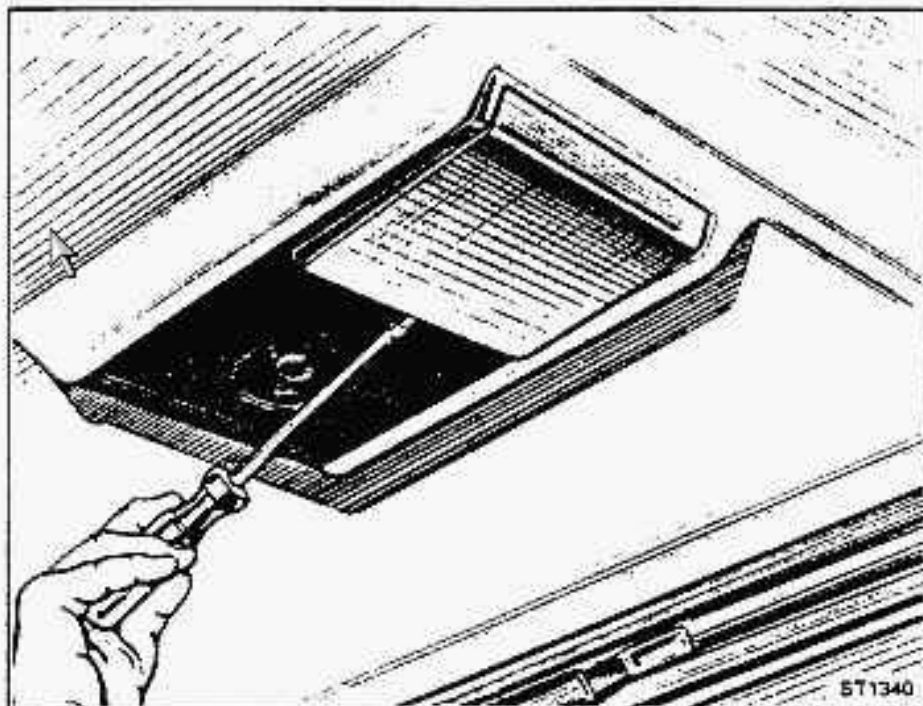

CEILING LIGHT

- Use screwdriver to remove the diffuser (pry on predetermined point).
- Withdraw the bulb from the contact spring which supports it.
- Replace the bulb.
- Replace the diffuser - ensure that it is positioned correctly and push upwards.

SPOT LIGHT

- Use screwdriver to remove the diffuser (pry on predetermined point).
- Replace the bulb.
- Insert spot light and push all the way in.

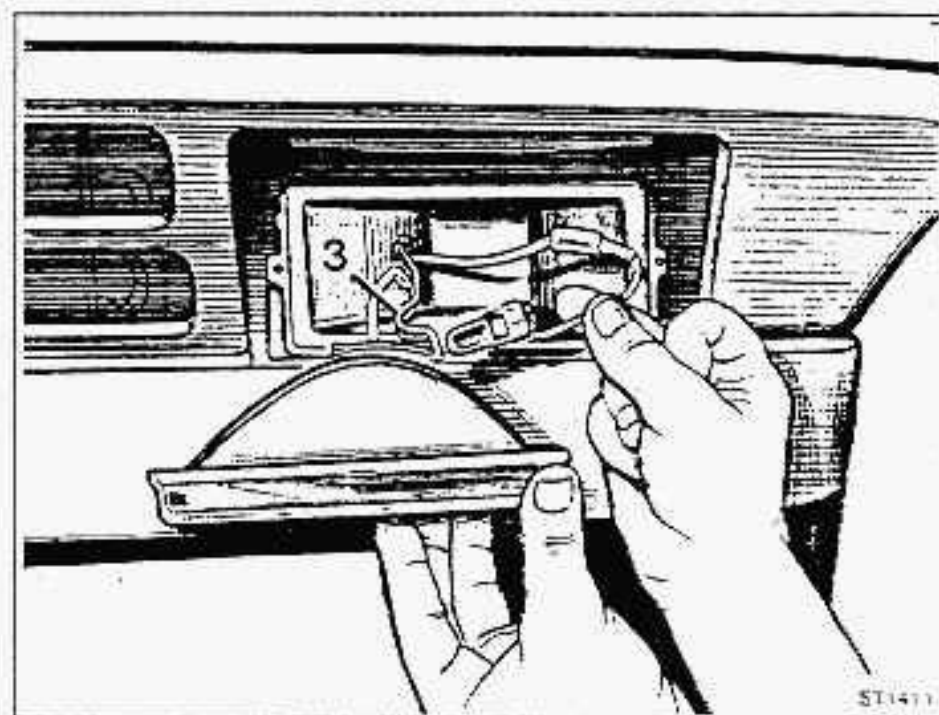
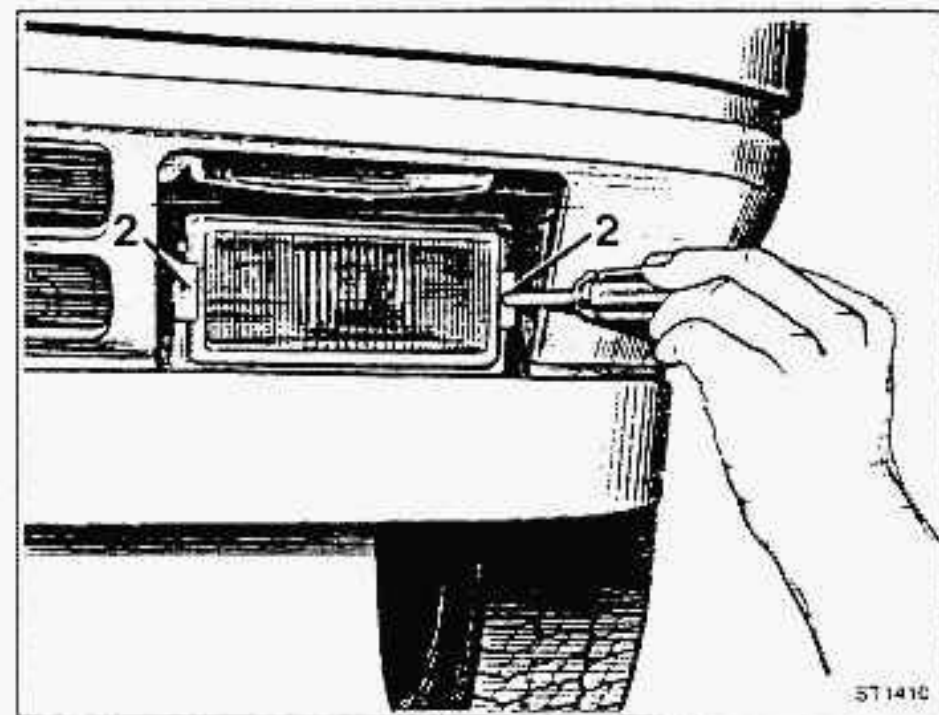
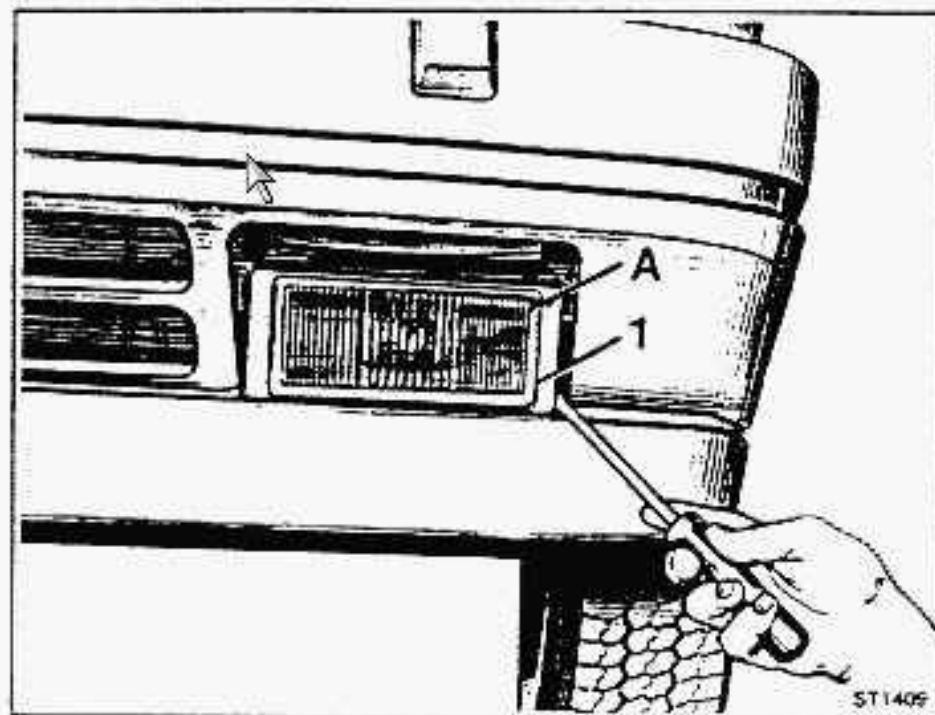

REPLACING FRONT FOG LIGHT BULBS (if so equipped)

- 1) Remove frame 1 (pressure fitted).
- 2) Loosen screws 2 and extract the lamp.
- 3) Disconnect the retaining spring 3 from the bulb.
- 4) Extract the bulb and replace.

To adjust the beam, turn screw A through the hole in the frame.

Important: Again, avoid touching the bulb with the hands. If this occurs, clean the bulb carefully with alcohol before refitting.

BODY

A complete range of car's care products (shampoo, wax, paint repair stick, cleaning solvent, polish, etc.) is supplied by Alfa Romeo Service Dealer.

The product main features are compatible with the paints, gaskets and finishes of the Alfa Romeo's vehicles.

It is suggested to entrust the product application to the skill personnel of our Service Dealers; in this way the best result will be ensured while avoiding inconveniences which may compromise the body guarantee coverage.

Special attention should be paid to prevent industrial polluting agents, tar stains dead insects, etc., from remaining on the car body for too long.

Avoid parking the vehicle under trees; leaves, buds etc., containing harmful substances to the paint, may fall in certain seasons.

In the above mentioned cases, it is therefore essential to wash the car as soon as possible.

When refueling or lubricating care should be taken not to splash petrol, brake fluid, coolant mixture or battery electrolyte on the paintwork.

Should it happen, immediately clean the body parts involved.

WASHING

The car should be washed according to how often it is used, weather and road conditions.

The car should be washed more frequently in winter, as dust and dirt deposits are harder to be removed.

Moreover, in many regions roads are covered with antifreeze chemicals which are very harmful to the car body.

Clean also the less visible parts such as mudguards, wheelwells, underbody etc...

Avoid washing the car under direct sunlight and observe the following precautions:

- Never wash a car if it has been exposed to the sunlight for a long time or if the bonnet is hot.
 - Clean the inside with a brush or a vacuum cleaner.
 - Flush the car all over with a water jet to remove the dust.
 - Prepare a shampoo-water solution and sponge the whole car body.
 - Finally wash the wheels and the car body lower part, by using another sponge.
 - Thoroughly rinse with water.
 - Dry with a chamois leather.
 - After drying, remove any trace of oil, grease or tar stains by applying wax and rubbing with a clean cloth.
- Do not use tools or any kind of abrasives.

Note: It is recommended to wash the car by hand; otherwise take care of cleaning dirtiest areas of the car body before entering a car wash.

CAR INACTIVITY

Should the vehicle remain idle for a long time, the following operations should be performed:

Car body:

Wash and clean the car.

Tires:

If possible raise the vehicle and remove the 4 wheels; otherwise insert wooden boards under the tires.

Electric system:

Disconnect the battery, periodically check and re-charge it if necessary.

CAR RE-STARTING

Before re-starting the vehicle after a long idle period, the following operations should be performed: *

- Replace engine oil and filter.
- Replace gearbox-differential oil.
- Replace brake liquid.
- Replace the coolant.
- Check and replace the fuel filter if necessary.
- Clean the air filter and replace if necessary.
- Check tire pressure and visually verify the absence of cuts and cracks; otherwise replace them.
- Check all the engine belt conditions.
- Re-install the battery after checking its full charge.
- In neutral gear, start the engine and let it idle for a few minutes.

Beware of carbon monoxide!

Perform this operation in the open air or in large, well-ventilated premises. Check that the coolant reaches the operative temperature without exceeding it.

Speed up for a few seconds until the engine runs at 2500-3000 rpm.

- Check that all the utilities, (headlights, turn indicators etc.), correctly work.

In case they do not work properly, carefully read the relevant section on the manual or contact an **Alfa Romeo Service Dealer**.

- * **N.B.:** To correctly perform the listed operations, refer to the relevant steps in the "Maintenance" chapter.

TOW HOOK

The vehicle is enabled to tow a trailer by applying a suitable tow hook.

Alfa Romeo supplies a tow hook complying with the local safety rules.

You are suggested to have the tow hook installed by the **Alfa Romeo Service Dealers**; in this way the best result will be ensured, while avoiding inconveniences which may compromise the guarantee coverage.

Important

When hooking a caravan or a trailer, check that the towing load values (specified on the Registration Book) and the maximum load allowed on the hook of the towing vehicle (printed on the label of the towing structure) are higher or at least equal to the trailer load values.

The scheme at page 104 or 105 shows the attachment points to the car body, which do not vary according to the tow hook shape and dimension.

For the mechanical connection between the towing bracket and the trailer, use the following hook:

— "ISO 50" Ball-type (Italian Std. CUNA NC 138-30).

ELECTRICAL SYSTEM

For the electrical connection, a 12V 7-way-connector ISO/DR 1724-1969 (see table CUNA NC 165-30) should be used.

Apart from the standard indicator devices, one 15W lamp for trailer inside lighting and an electrically operated brake (which should be directly shunted from the battery by means of a cable with a section not lower than 2.5 mm²), **circuits such as blower, refrigerator, internal lighting, etc., must not be connected with the car's electrical system.**

BRAKES

The trailer's braking system must be completely independent from the car's hydraulic system, which **must in no way be tampered with.**

NOTICE

The car/trailer unit should comply with the local rules.

The trailer gross weight is the actual load including all the accessories and personal belongings.

Before moving off, it is therefore suggested to check that the trailer gross weight does not exceed the limits prescribed on the Registration Book.

In no circumstances, should the vertical load on the rear axle exceed the value specified on the "Technical Data".

ATTACHMENT POINTS TO THE CAR BODY - **75 T.SPARK** model

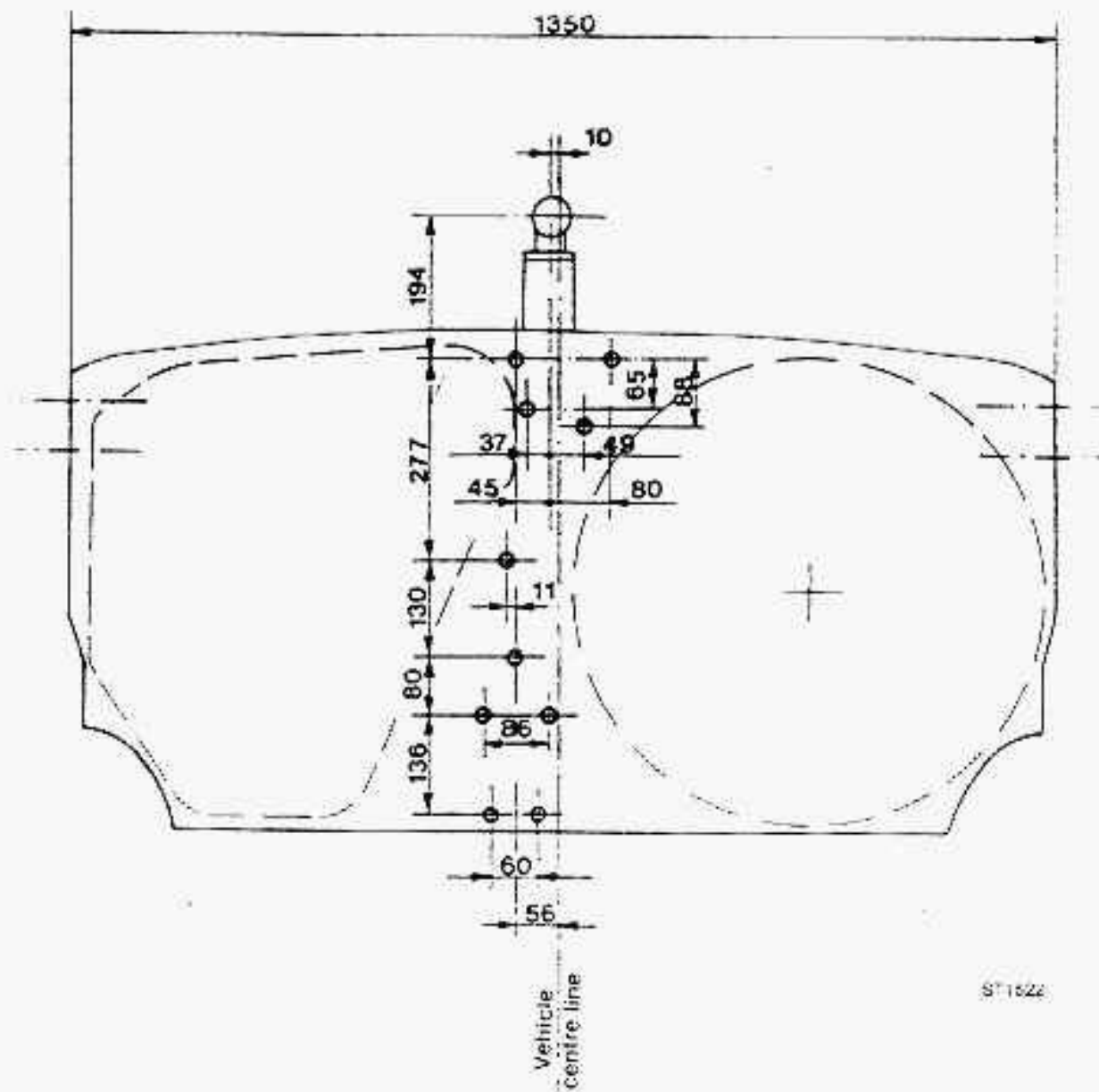
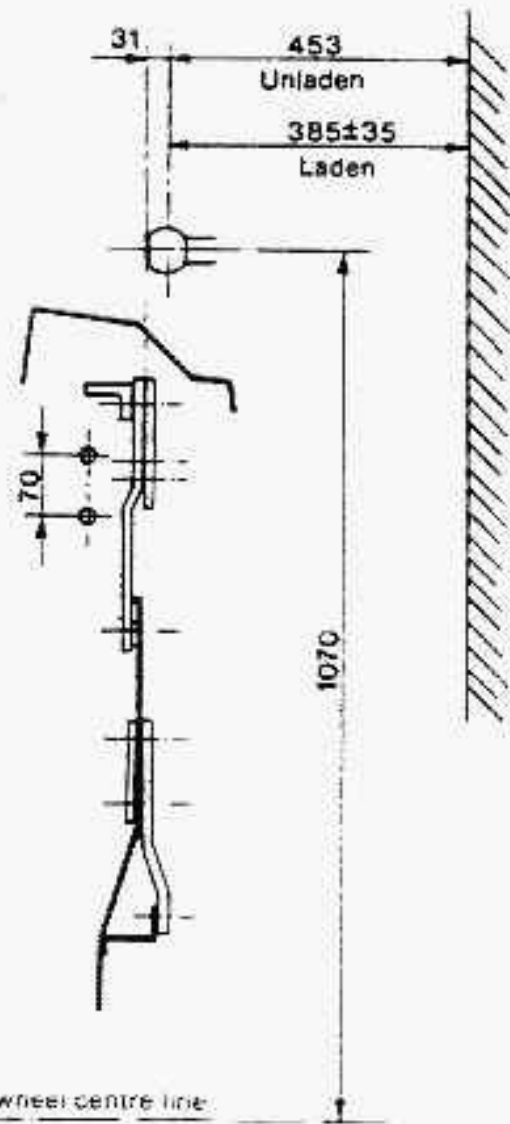

ST1522

ATTACHMENT POINTS TO THE CAR BODY - 7² 20 V₂ model

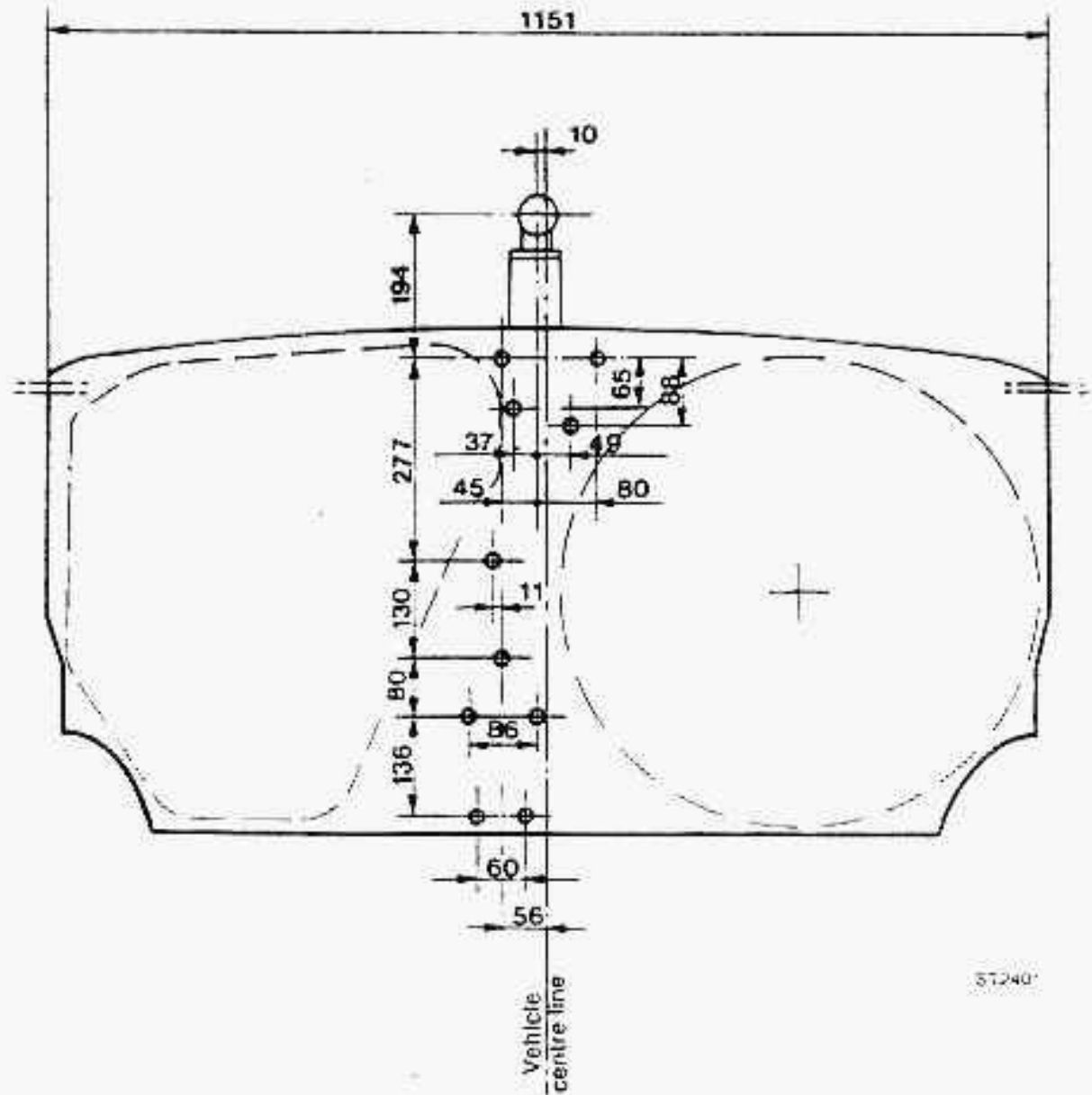
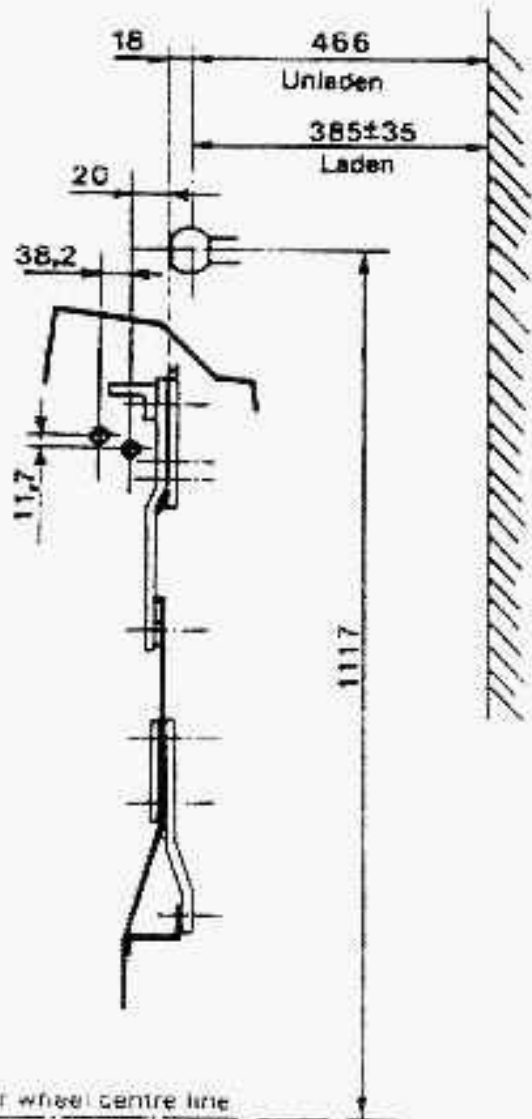

51240

WIRING DIAGRAM

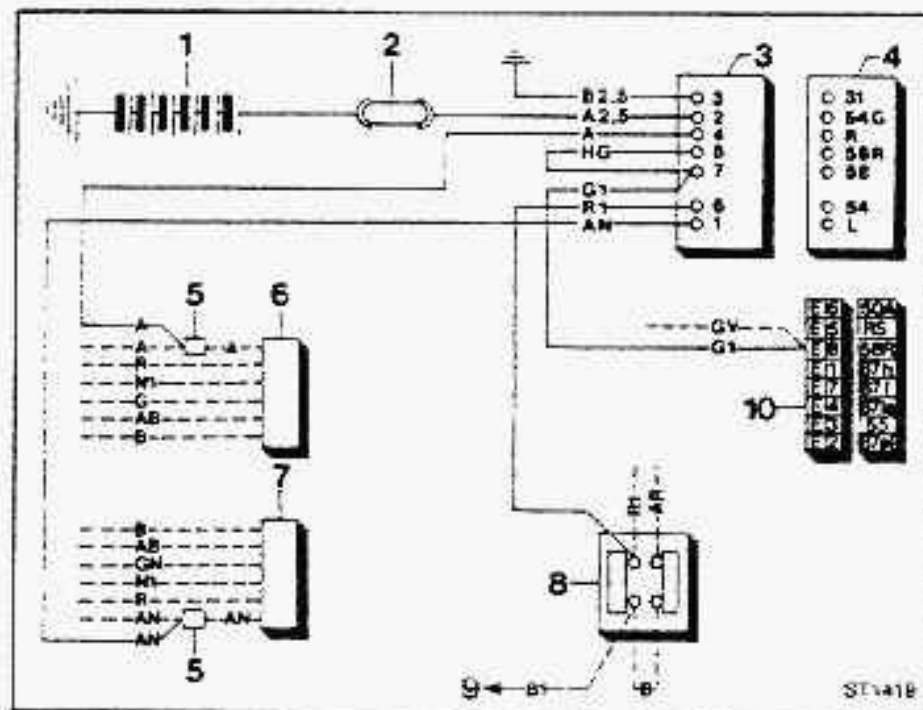

KEY

- 1 - Battery
- 2 - 25 A fuse
- 3 - Vehicle socket
- 4 - Trailer plug
- 5 - Simple joint
- 6 - Right tail light connection
- 7 - Left tail light connection
- 8 - Stop lights switch
- 9 - To the fusebox
- 10 - Fusebox connection E connected to yellow connection 8 ways of the circuitry

CABLE COLOUR CODE

A = Blue
 B = White
 G = Yellow
 H = Grey

N = Black
 R = Red
 M = Brown
 AB = Blue-White

AN = Blue-Black
 AR = Blue-Red
 GN = Yellow-Black
 HG = Grey-Yellow

The wire gauge is 0.5 mm² unless otherwise stated. Wires shown by dotted lines are part of the car's circuitry.

N.B.: The Alfa Romeo Control warning device monitors functions related only to the passenger car and not those of a possible trailer.

Modifications to the car's electrical system to provide electrical

connections with a trailer must strictly comply with the directions set out on pages 103 and 106, in this manual otherwise very serious damage to the Alfa Romeo Control warning device may result.

75

**GENERAL DATA FOR
T.SPARK MODEL**

MODEL	75 T.SPARK
FUEL SYSTEM	electronic injection
TOTAL DISPLACEMENT cm ³	1962
ENGINE	
No. of cylinders	4
Bore mm	84
Stroke mm	88.5
Max power HP DIN	148 (107 kW CEE) at 5800 rpm
Torque kgm DIN	16 at 2000 rpm 18 at 3000 rpm 19 at 4000 rpm
Engine idle speed	
Idling rpm	750 - 850

MODEL	75 T.SPARK
ELECTRICAL SYSTEM	
Battery	55 Ah - 12 V
Alternator	65 A - 14 V
CHASSIS	
Minimum turning circle m	10.1
No. of seats	5
Tyres	195/60 VR 14"
Boot capacity dm ³	500
Kerb weight (full tank)	kg 1160
Towing gross weight	kg 1200
Towing bar load	kg 60
Max roof rack load	kg 80

MODEL	
FUEL CONSUMPTION* (litres/100 km)	
Constant speed (90 kph)	6.0
Constant speed (120 kph)	8.4
Test bench (simulated urban journey)	9.9
PERFORMANCE	
Speed at 1000 rpm (in 5th gear) kph	34
Max speed kph	205
Acceleration	
Standing kilometre	5 29.2
From 0 to 100 kph	5 8.2
The performances given are for the use of the vehicle in normal C. European road conditions.	

- * Depending on which market the vehicle is sold on, the vehicle is fitted for running on premium grade and/or unleaded petrol with an R.O.N. octane number ≥ 95 . Clarification regarding the type of fuel to be used can be obtained from the Dealer selling the vehicle. **Alfa Romeo Service Dealers** are in any case able to adapt the fuel system according to the customer's requirements.

SELF-LOCKING DIFFERENTIAL

The new differential is the self-locking type with a slipping value equal to 25% and enables the transmission of power to the wheels, distributing it in such a way as to produce the slipping of one wheel with respect to the other, keeping it, in fact, within 25%.

This affords the vehicle improved roadholding on loose terrain and enables it to proceed even when the two driving wheels are on surfaces which have differing friction co-efficients.

DIAGRAM OF THE AIR AND FUEL SUPPLY SYSTEM

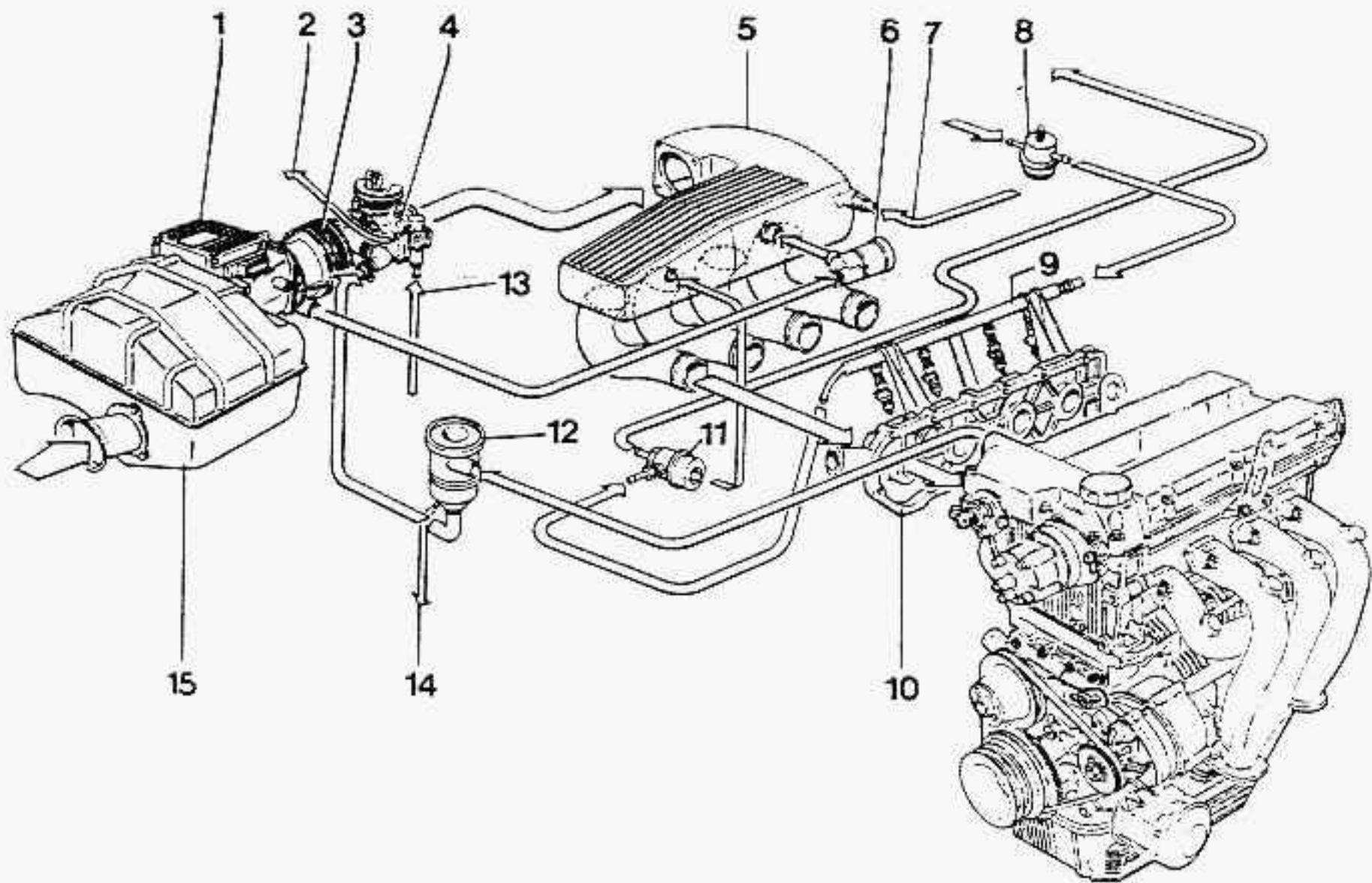

5T2364

- 1 - Air flow sensor
- 2 - Pipe for delivery of coolant from cylinder head to throttle throat
- 3 - Inlet duct
- 4 - Single throttle throat
- 5 - Air collector box
- 6 - Idle adjustment actuator
- 7 - Brake servo vacuum pipe
- 8 - Ping-damper
- 9 - Fuel supply manifold
- 10 - Inlet manifold
- 11 - Fuel pressure regulator
- 12 - Oil/vapour separator
- 13 - Pipe for delivery of coolant from throttle throat to heater core
- 14 - Oil drainage pipe
- 15 - Air cleaner

The aspirated air, after flowing through the air cleaner (15) goes to the air flow sensor (1) which transduces quantity and temperature of the aspirated air into electric signals and feeds them to the electronic control unit. These signals will enable the control unit to weigh the quantity of aspirated air (function of the density of the air) and consequently to determine exactly the amount of fuel to be injected.

Downstream of the air flow sensor there is the throttle throat (4) which controls the quantity of air aspirated by the engine. Then the air arrives at the air collector box (5) from which it is distributed to the four cylinders via the inlet manifold (10). Fitted to the manifold are the injectors that inject fuel to provide the fuel/air mixture.

Also fitted to the air collector box are the vacuum connection (7) of the brake servo, the union (11) of the fuel pressure regulator and the idle adjustment actuator (6) that introduces into the air collector box the air drawn upstream of the throttle throat (when the throttle is fully closed or partially open).

The oil/vapour separator (12) whose functions are to intercept the oil vapours returning the liquid particles to the oil sump via the drainage pipe (14) and to convey to the air inlet ducts the remnant vapours which will be aspirated by the engine and burned thus reducing the pollutant emissions.

The fuel sucked by the two electric supply pumps flows through the fuel filter and arrives to the ping damper (8) whose purpose is to clip the pressure peaks caused by the opening-closing cycle of the injectors.

From the ping damper, the fuel flows to the fuel supply manifold (9) whose ends are provided with the pressure regulator (11) which keeps the fuel pressure constant being constant the pressure, the injected quantity depends only on the injector opening time namely, on the duration of the electrical impulses fed by the electronic control unit.

ELECTRONIC INJECTION-TWIN IGNITION SYSTEM ENGINE

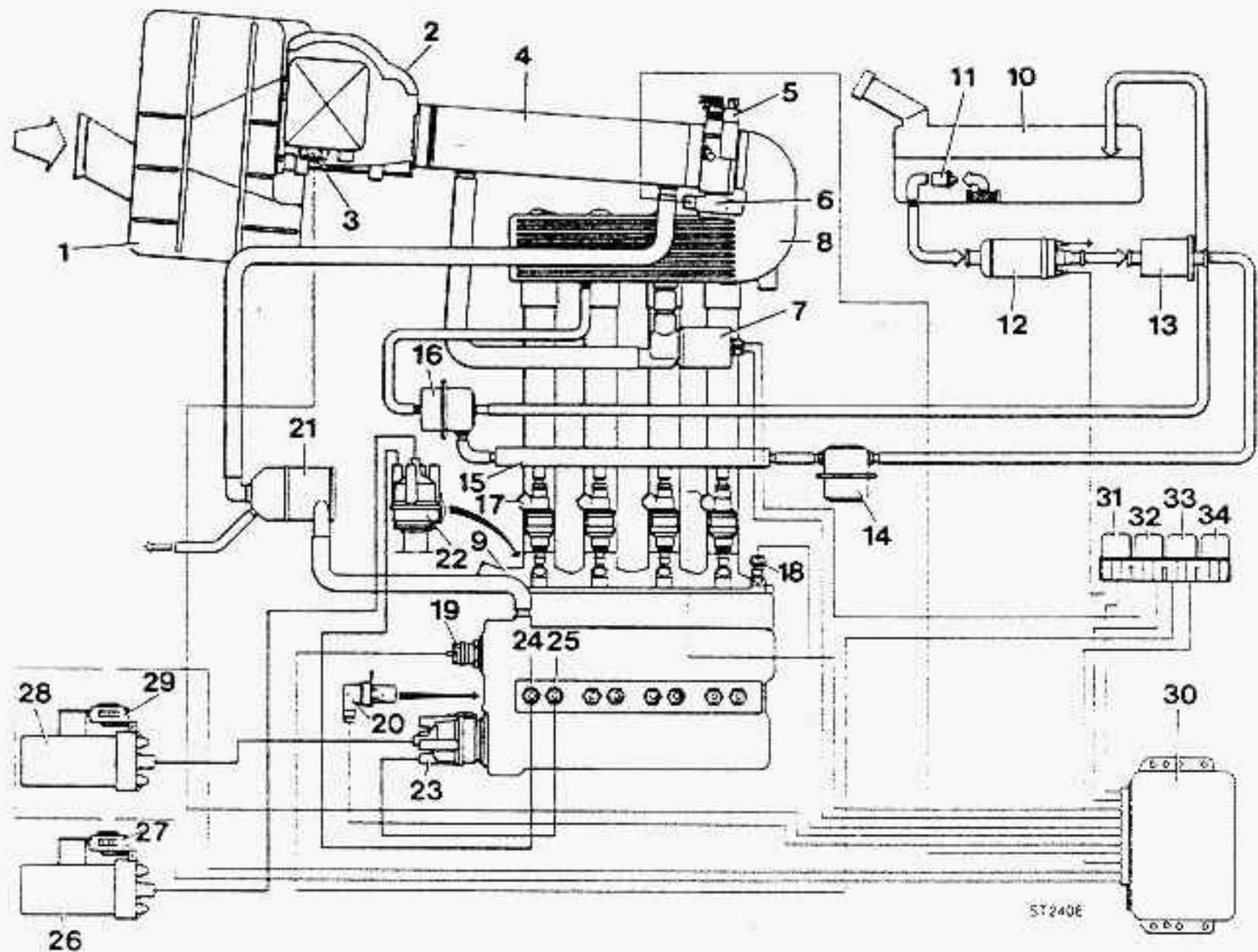

- 1 - Air cleaner
- 2 - Air flow sensor
- 3 - Aspirated air temperature sensor
- 4 - Inlet duct
- 5 - Single-throttle throat
- 6 - Throttle switch
- 7 - Idle adjustment actuator
- 8 - Air collector box
- 9 - Inlet manifold
- 10 - Fuel tank
- 11 - Additional fuel pump
- 12 - Main fuel pump
- 13 - Fuel filter
- 14 - Ping damper
- 15 - Fuel supply manifold
- 16 - Fuel pressure regulator
- 17 - Electroinjectors
- 18 - Coolant-temperature sensor
- 19 - Variable valve timing device
- 20 - RPM transducer
- 21 - Oil/vapour separator
- 22 - Front sparking plugs ignition distributor
- 23 - Rear sparking plugs ignition distributor
- 24 - Front sparking plugs
- 25 - Rear sparking plugs
- 26 - Ignition coil for front plugs (1)
- 27 - Power module of coil No. 1
- 28 - Ignition coil of rear plugs (2)
- 29 - Power module of coil No. 2
- 30 - Injection and ignition control unit
- 31 - Fuel pump relay
- 32 - Relay with diode
- 33 - Relay with variable valve timing device
- 34 - Main relay

The engine is equipped with an electronic injection system featuring a variable valve timing device on the inlet valve camshaft (19) and a newly conceived twin ignition system.

The electronic, twin ignition system, provided with two coils (26-28), two ignition distributors timed each other (22-23) and two sparking plugs per cylinder, permits to optimize the ignition of the mixture thus increasing the engine power output with the same consumption figures, thanks to shorter times of propagation of the firing front during the ignition stage ultimately attaining a higher engine efficiency.

Both twin ignition systems are controlled by a single group of sensors and a single electronic control unit (30) thus obtaining the double advantage of limiting the complexity of the whole system and of using univocal signals issued by the various sensors (2-3-6-18-20).

The engine is electronically controlled during all its stages of operation by acting on the following parameters:

- duration of fuel injection;
- timing of the ignition advance;
- cold starting ("choke" function);
- fuel supply on overrunning (cut-off);
- enrichment of the fuel/air mixture on acceleration;
- variation of the ignition angle during the various operation stages (acceleration, full-load etc.);
- idle speed;
- variable valve timing;
- max engine R.P.M. limiting.

The electronic control unit is provided with a memory that adjust timing and duration of fuel injection as well as the ignition advance according to engine R.P.M. and load. Also it takes into account the temperature of the aspirated air and coolant temperature and when the engine exceeds the maximum R.P.M. allowed resumining it when the engine slows down.

The fuel injection system also meters the fuel/air mixture during a cold start and the warming up stage keeping constant the idle speed irrespective of the ambient temperature.

Purpose of the variable valve timing (19) in turn controlled by

the E.C.U. is to control the intake valve camshaft timing to suit the engine variable operating conditions.

A further feature of the system is to cut-off the fuel supply on overrunning thus sparing fuel and improving the engine braking effect.

During acceleration, instead the fuel/air mixture is enriched to get faster rewing -up.

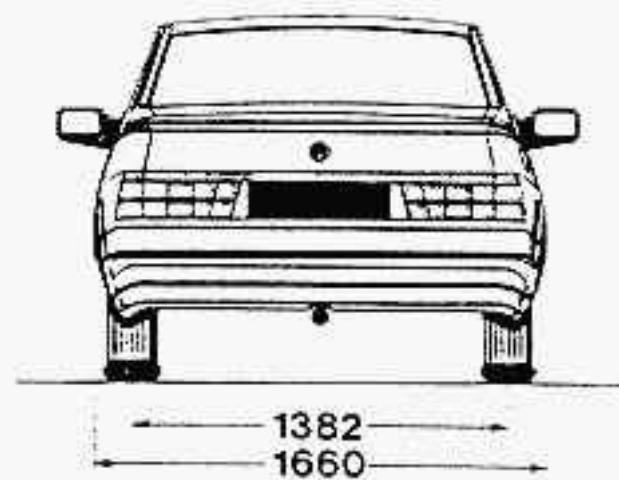
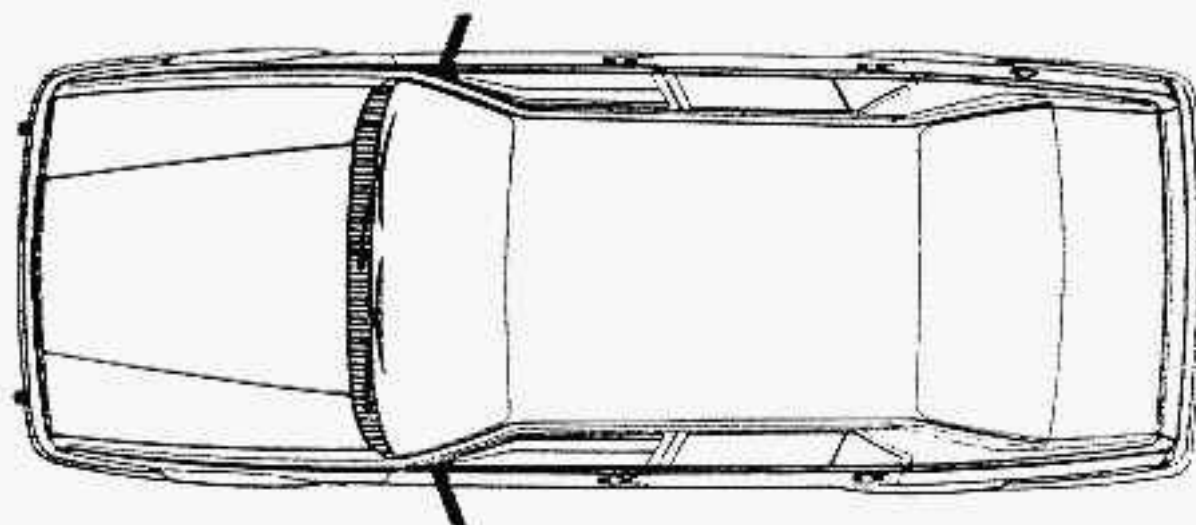
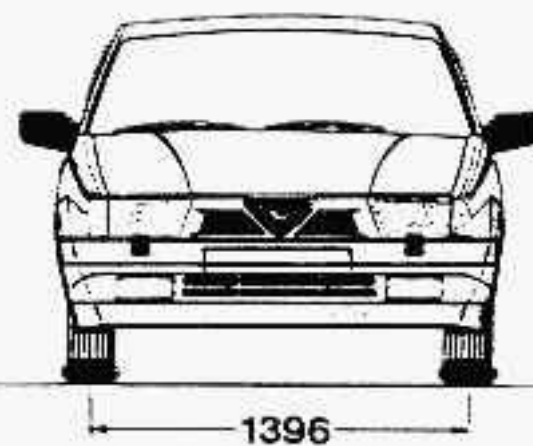
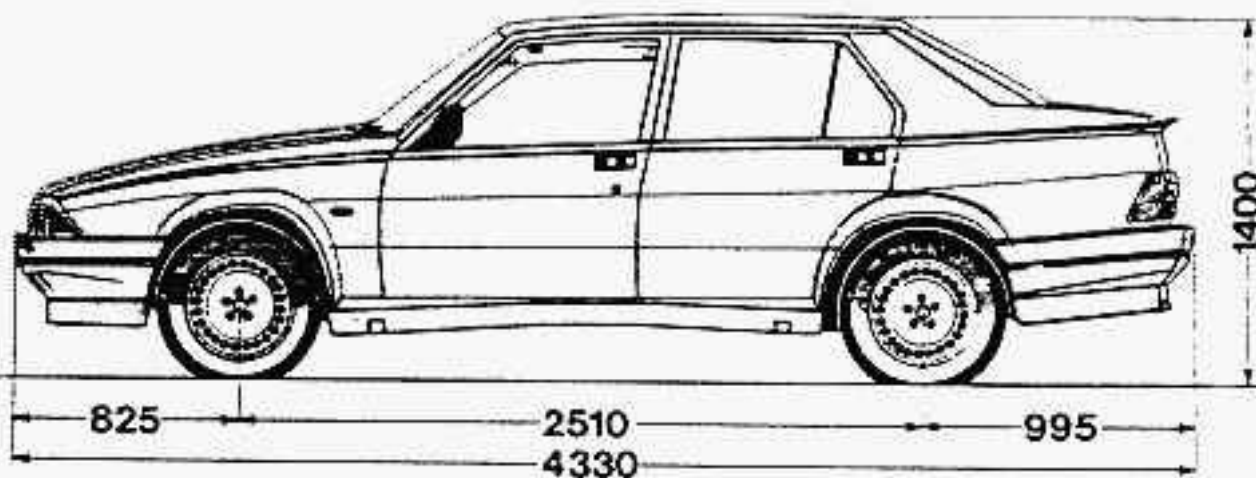

Dimensions in mm

5T3080

75

GENERAL DATA FOR

3.0 V6 MODEL

MODEL	78 30 V8
FUEL SYSTEM	electronic injection
TOTAL DISPLACEMENT cm ³	2959
ENGINE	
No. of cylinders	6-V, 60°
Bore	93 mm
Stroke	72.6 mm
Max power	188 HP DIN (136 kW CEE) at 5800 rpm
Torque	22 at 1000 rpm 24 at 2000 rpm 25 at 3000 rpm 25 at 4000 rpm
Engine idle speed	
Idling	700 - 900 rpm

MODEL	78 30 V8
ELECTRICAL SYSTEM	
Battery	60 Ah - 12 V
Alternator	70 A - 14 V
CHASSIS	
Minimum turning circle	10.1 m
No. of seats	5
Tyres	195/60 VR 14" 195/55 VR 15"
Boot capacity	380 dm ³
Kerb weight (full tank)	1300 kg
Towing gross weight	1300 kg
Towing bar load	60 kg
Max roof rack load	80 kg

MODEL	7E 30 VE
FUEL CONSUMPTION* (litres/100 km)	
Constant speed (90 kph)	7.4
Constant speed (120 kph)	8.2
Test bench (simulated urban journey)	12.9
PERFORMANCE	
Speed at 1000 rpm (in 5th gear)	39.4 kph
Max speed	220 kph
Acceleration	
Standing kilometre	5 28
From 0 to 100 kph	5 7.3
The performances given are for the use of the vehicle in normal C. European road conditions.	

- * The vehicle is designed for running on either premium grade petrol or unleaded petrol with an R.O.N. octane number ≥ 95 .

SELF-LOCKING DIFFERENTIAL

The new differential is the self-locking type with a slipping value equal to 25% and enables the transmission of power to the wheels, distributing it in such a way as to produce the slipping of one wheel with respect to the other, keeping it, in fact, within 25%.

This affords the vehicle improved roadholding on loose terrain and enables it to proceed even when the two driving wheels are on surfaces which have differing friction co-efficients.

AIR AND FUEL SUPPLY SYSTEM

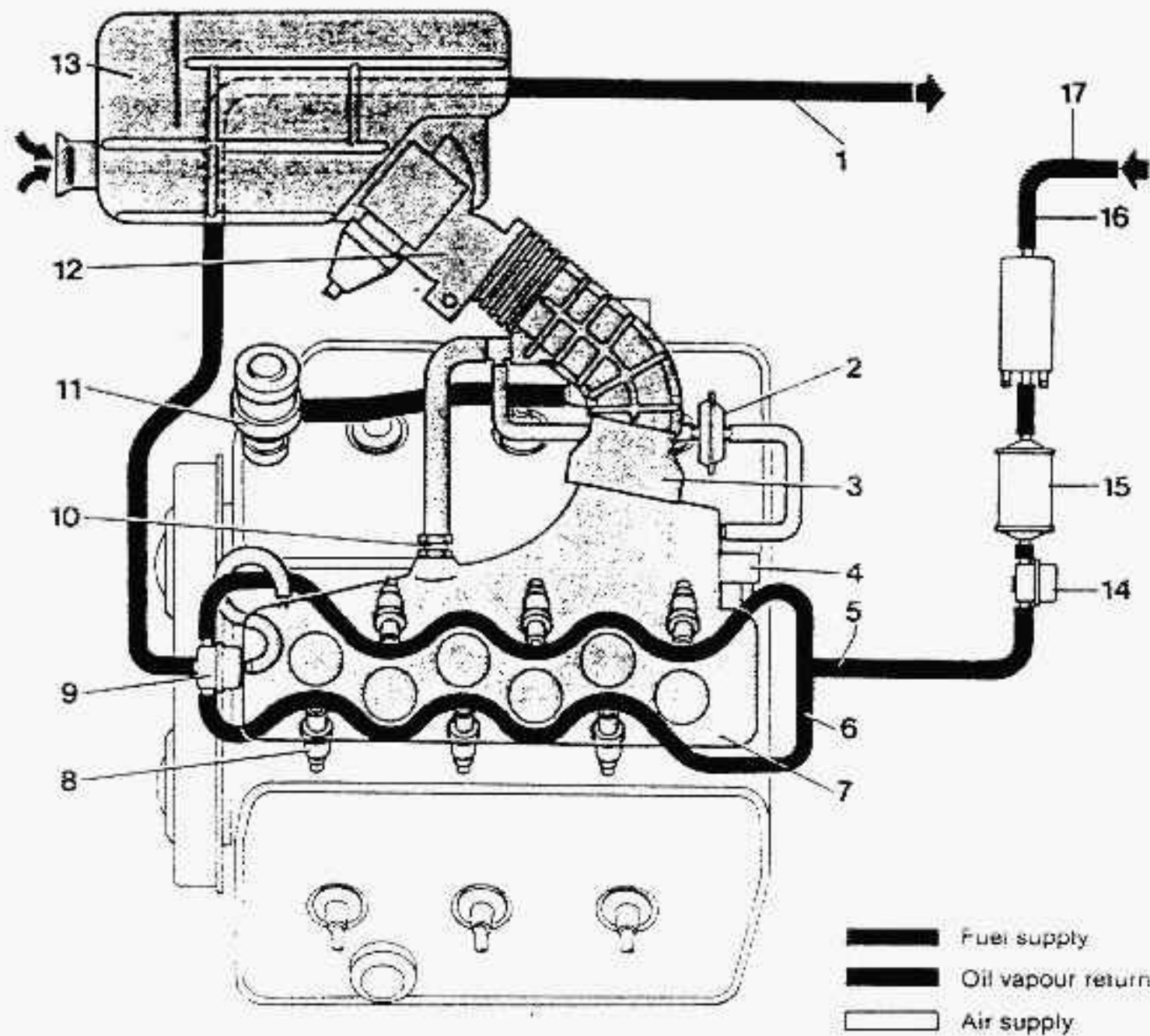

- 1 - Fuel return piping
- 2 - Auxiliary air solenoid valve
- 3 - Throttle body
- 4 - Cold starting electroinjector
- 5 - Fuel delivery piping
- 6 - Fuel system manifold
- 7 - Intake air box
- 8 - Electroinjector
- 9 - Pressure regulator
- 10 - Idle r.p.m. adjusting device
- 11 - Oil vapour sedimenter
- 12 - Air flow gauge
- 13 - Air filter
- 14 - Dashpot
- 15 - Fuel filter
- 16 - Fuel pump
- 17 - Fuel delivery line

The L-JETRONIC fuel injection system consists of an indirect fuel injection system managed by an electronic control unit that sets the injection time according to various engine operating parameters and to ambient conditions.

The parameters transduced into electric signals and sent to the E.C.U. by various sensors are the following:

- battery voltage
- signal of accelerator throttle position (either fully open or closed)
- engine coolant temperature
- amount of air aspirated by the engine
- signal of operation of starting motor
- engine speed-of-rotation.

In accord to the signals received the E.C.U. determines the injection time and sends to the injectors an electrical pulse of proportional duration.

The quantity of injected fuel in fact depends solely by the time the injectors remain open being the pressure of the fuel kept constant by a pressure regulator.

The E.C.U. is able to carry out the above stated stages almost instantly according to engine speed and load.

Also, it performs adjustments to suit particular engine operating conditions such as enriching the mixture during cold starts; cut-off of fuel supply on overrunning; increase of injection duration under full load and during fast get aways.

DIGITAL ELECTRONIC IGNITION SYSTEM

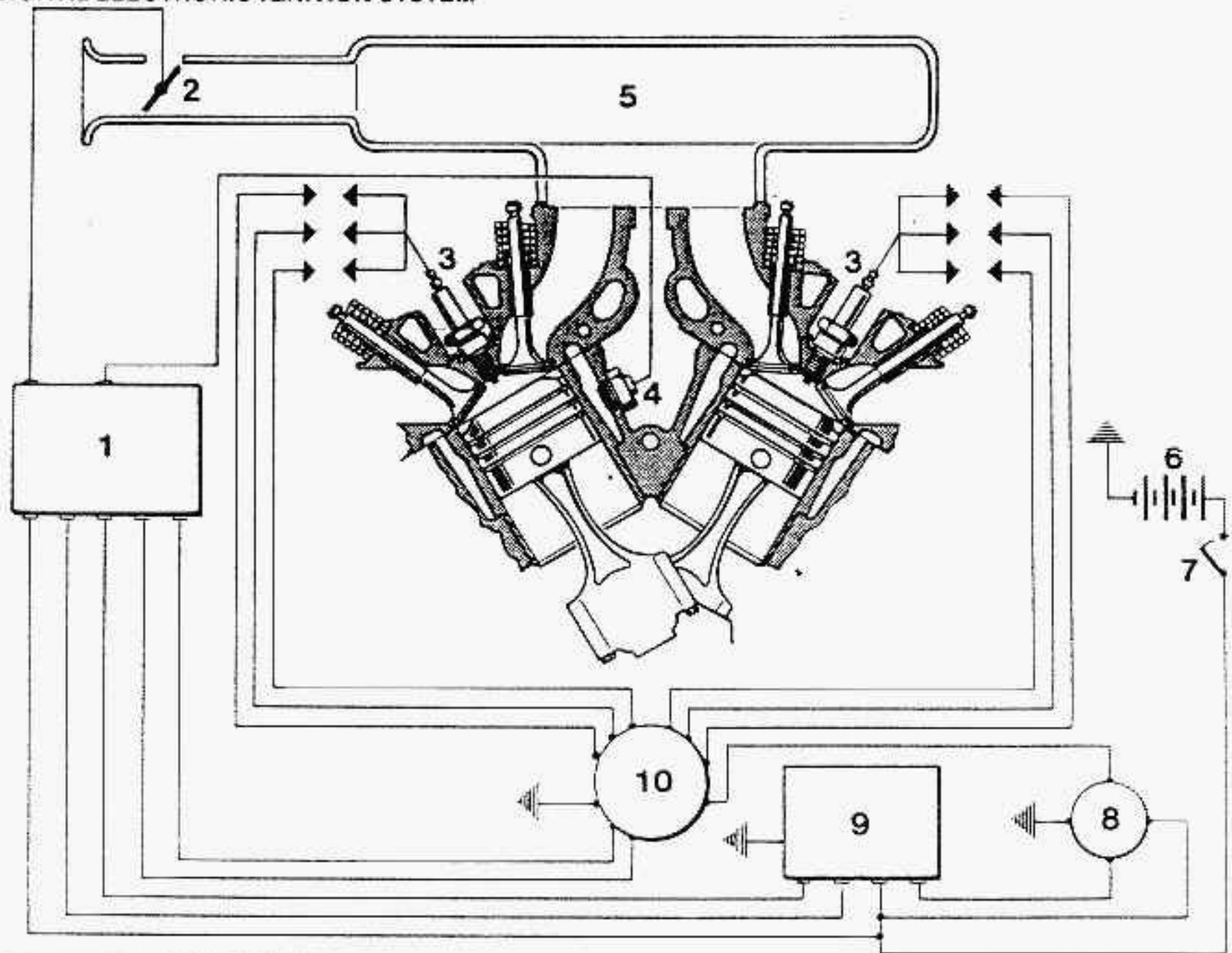

51201

- 1 - Electronic control unit
- 2 - Throttle sensor
- 3 - Spark plugs
- 4 - Engine temperature sensor
- 5 - Inlet duct
- 6 - Battery
- 7 - Ignition switch
- 8 - Ignition coil
- 9 - Power module
- 10 - Ignition distributor

The ignition system consists of an inductive discharge circuit which controls ignition time and the current flowing across the coil primary winding; this ensures ignition sparks of constant energy irrespective of engines speed.

The circuit consists broadly by the following components:

- Ignition distributor fitter with a Hall-effect sensor (which sends to the E.C.U. the signals needed to compute the ignition advance).
- Electronic control unit with microcomputer and program to optimize the advance according to the various engine operating conditions.
- Engine temperature sensor.
- Throttle sensor.
- Power module controlling the ignition coil.
- Ignition coil.

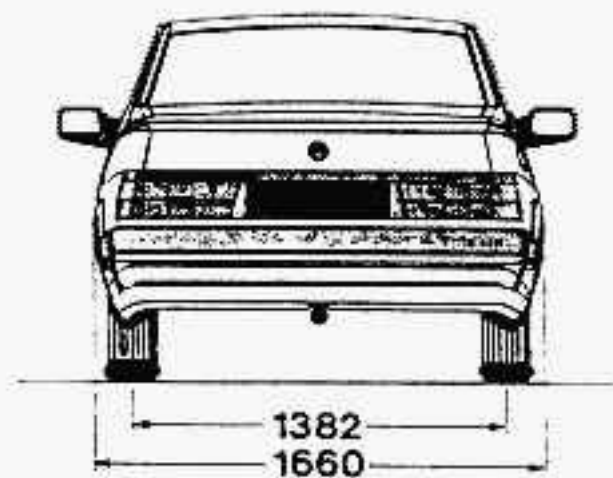
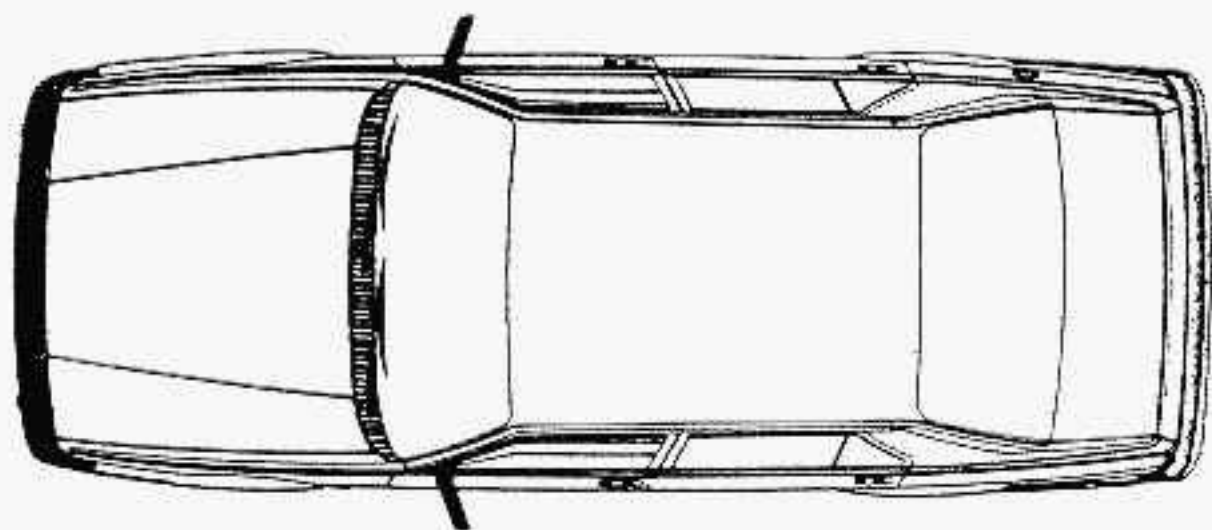
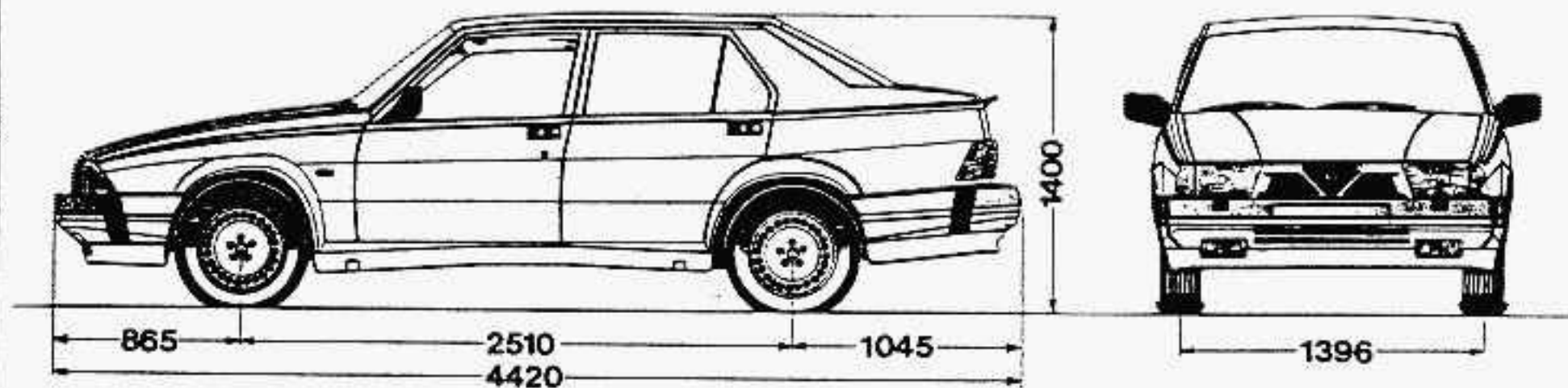

Dimensions in mm

5T3086

SUNROOF VERSION

125

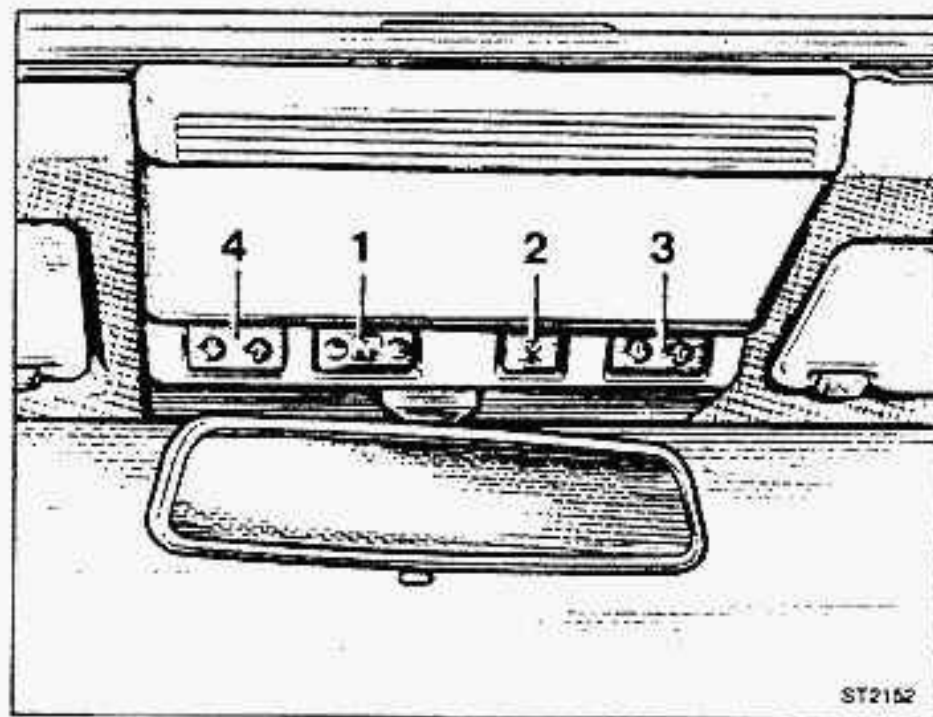

ST2152

On request, only for some markets, vehicle can be equipped with an electrically operated sunroof. This may only be operated if the ignition key is in running position (position 1). To open or close the roof use rocker switch 1 located above the rearview mirror.

The sunroof must be used with care; do not keep pressing the switch when the sunroof is fully open or closed.

- 1 - Rocker switch for electrically operated sunroof
- 2 - Rear power window operation cut-out switch
- 3 - Front right power window control
- 4 - Front left power window control

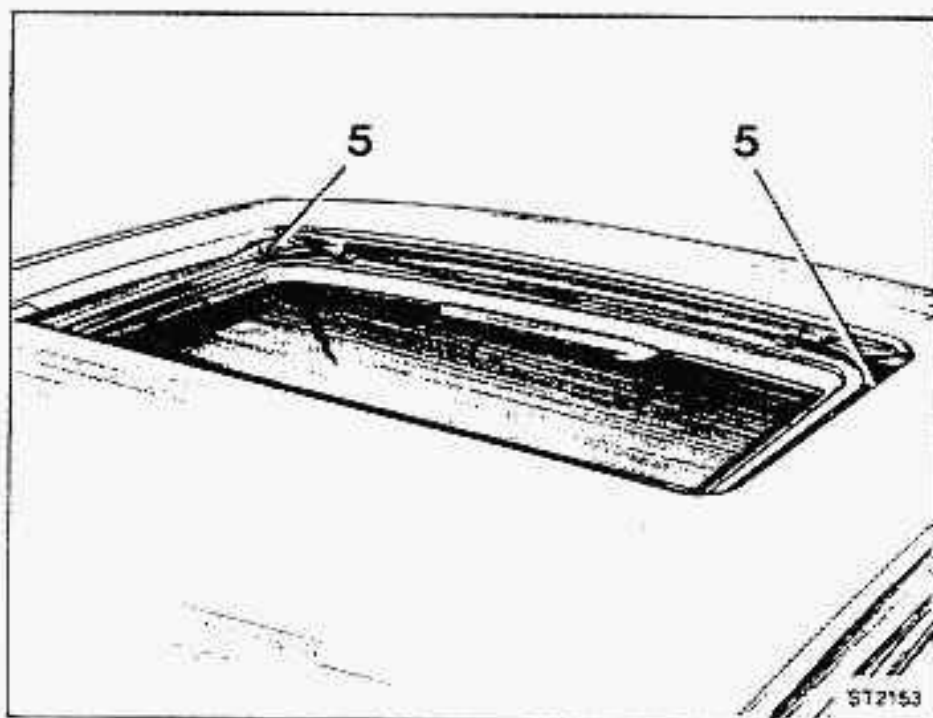

ST2153

Warning: Ensure, every so often, that holes 5 (for water drainage) in the sunroof cavity are not blocked. Remove any extraneous matter from the cavity area before closing the sunroof. It is wise, when parking or leaving the vehicle unattended, to close the sunroof completely to avoid damage to the inside of the car by rain etc. as well as for obvious security reasons.

Important: if passengers are left in the car it is advisable to remove the ignition key from the switch to prevent the risk of passengers (especially children) being hurt by accidental operation of the sunroof.

If the sunroof fails to function ensure that the relative fuse (fuse 17; 15A in the fusebox) has not blown (see also the wiring diagram, at page 128).

FRONT LIGHTING

Two roof lights located near the door pillars. They come on automatically when a door is opened. Duration is regulated by Alfa Romeo Control.

To switch them on or off manually press the front or back part.

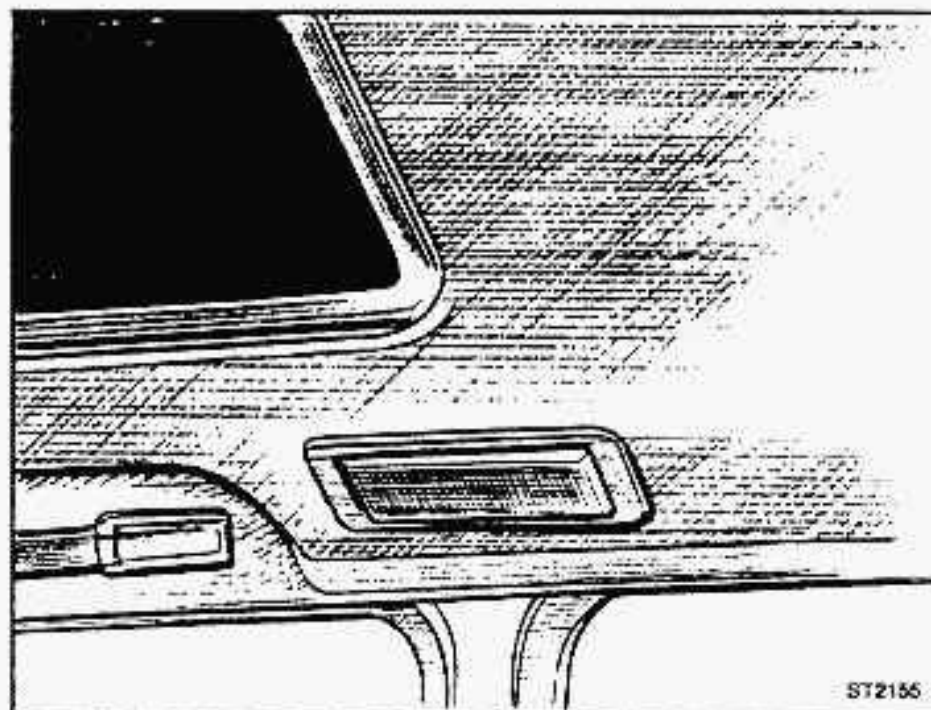

ST2155

REAR LIGHTING

Two reading lights located near the rear support handles.

To switch on or off use switch 6 on the reading light.

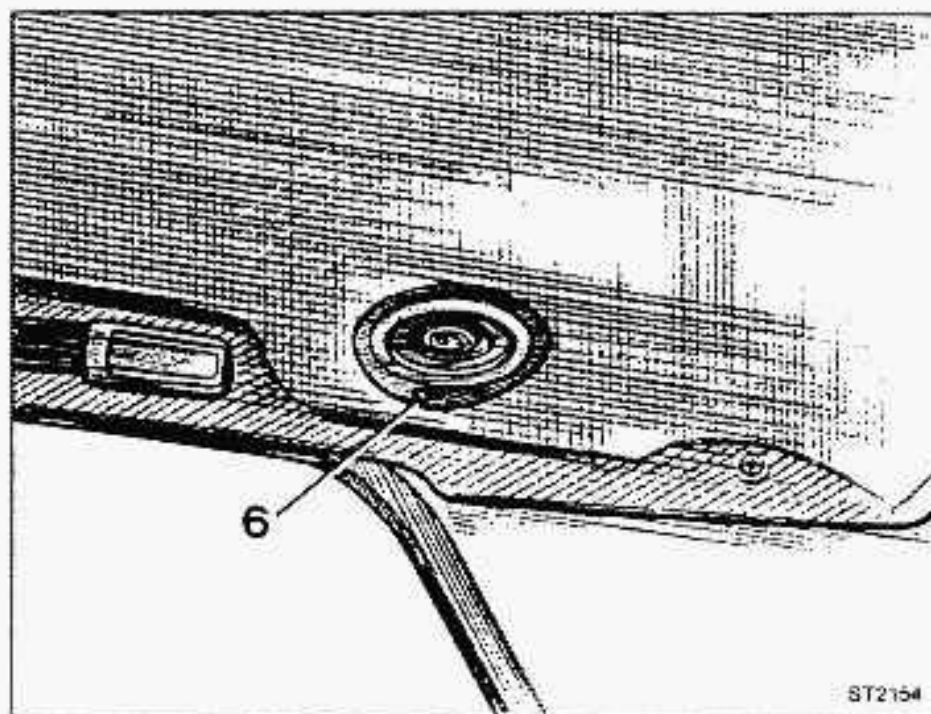

ST2154

VARIATIONS TO THE WIRING DIAGRAM

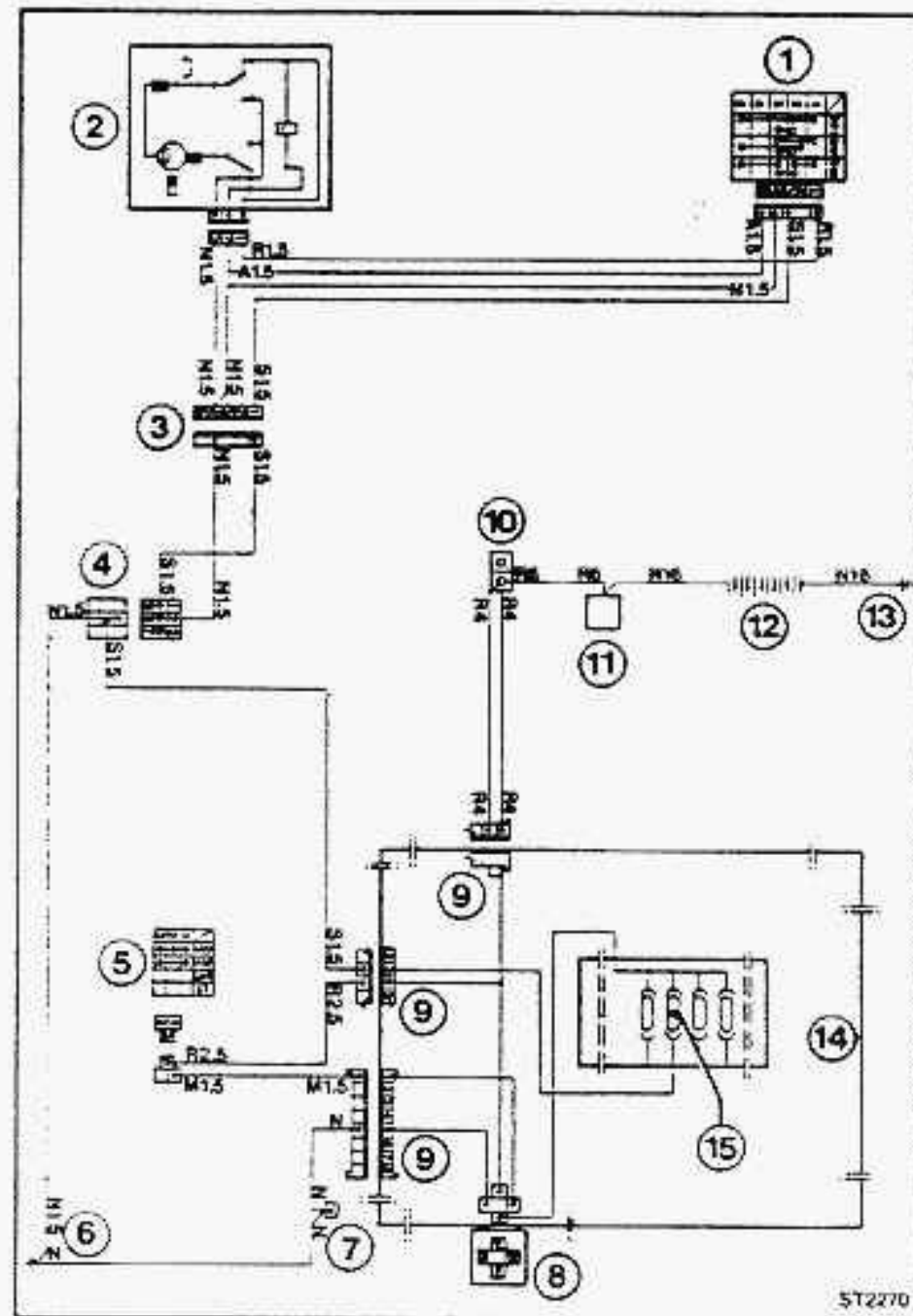

KEY

- 1 - Rocker switch for electrically operated sunroof
- 2 - Sunroof engine
- 3 - Joint (roof)
- 4 - Joint (left door post)
- 5 - Ignition switch and engine starting unit
- 6 - Earth (in the fusebox)
- 7 - Joint
- 8 - Electromagnetic switch
- 9 - Fusebox connections
- 10 - Terminal board
- 11 - Starter motor
- 12 - Battery
- 13 - Earth (under bonnet, right side)
- 14 - Fusebox
- 15 - Engine sunroof fuse (No. 17 - 15A)

CABLE COLOUR CODE

- A = Blue
 R = Red
 S = Pink
 N = Black
 M = Brown

The number after the cable colour code shows the wire gauge in mm².

The wire gauge is 0,5 mm² unless otherwise stated.

BRAKE SYSTEM WITH ANTI-LOCK BRAKING SYSTEM (ABS)

ANTI-LOCK BRAKING SYSTEM (ABS)

(On request, only for some markets)

As an optional, this car may be equipped with a brake system using the ABS anti-lock system, which represents the highest expression of automotive technology today in the area of active safety.

The function of the ABS system is to prevent the locking of one or more wheels, whatever the road surface conditions or the force of the braking action, ensuring constant control of the car and steering response.

By analysing the behaviour of a car wheel during braking (see figure), we note that braking traction varies according to the slippage of the wheel on the road surface, reaching the maximum value slippage of 5% to 15%, and its minimum value with slippage of 100% (wheel locked with car in motion).

In other words, there is the greatest braking efficiency when slippage between wheel and road surface has a value of 5% to 15%.

The purpose of the ABS system is to modulate the braking pressure in such a way as to maintain slippage within that range (5% - 15%), thus providing maximum traction and allowing the car to be stopped in the shortest possible distance.

In addition, a locked wheel can not absorb the lateral forces exerted on the tyre, thus depriving the car of steering response.

By utilizing sensors near each wheel, the system is able to detect the tendency of one or more wheels to lock and correct the slippage to the optimal value, with much better results than even the most expert driver can obtain, especially when road surface conditions are highly unfavourable.

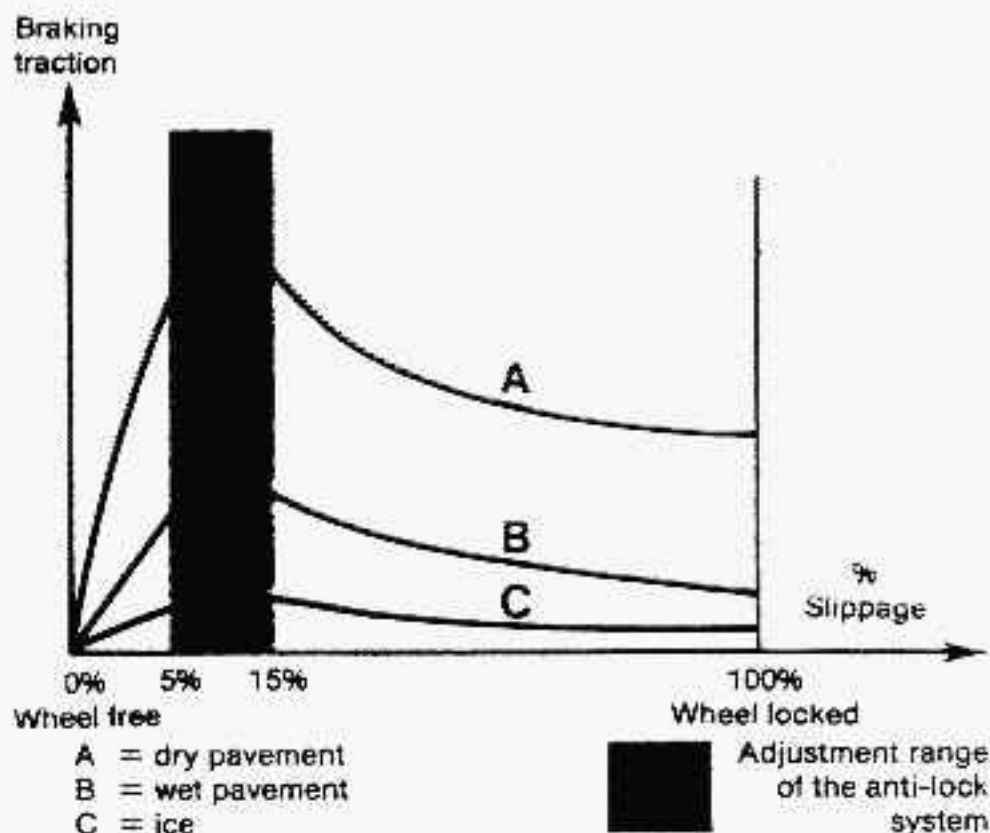

WARNING

When driving a car with the anti-lock system, you should keep the following suggestions in mind:

- When braking, you may feel light pulsations in the brake pedal: this means that the anti-lock system is in operation.
- Do not allow the performance of the system, in terms of active safety, induce you to take needless, unjustified risks.
- Your driving must in all cases be suitable for existing weather, road and traffic conditions.
- The maximum possible deceleration will always depend on the traction between tyres and road surface. It is obvious that on snow or ice traction is extremely low, so under such conditions the stopping distance remains long, even with the ABS system.

THE ANTI-LOCK BRAKING SYSTEM

The system is composed of an electronic control unit which processes signals received from sensors placed near each wheel, a solenoid-valve group which regulates the brake-fluid pressure in the hydraulic circuits and a pump with accumulator which keeps the brake fluid at high pressure.

The signals sent by the four sensors are processed by the electronic control unit and, if one or more wheels tend to lock when braking, the unit acts upon the solenoid-valve group to adjust the brake-fluid pressure in the part of the hydraulic circuit involved.

The pump-accumulator group serves to keep the brake fluid at a high pressure to ensure rapid modulation of the braking pressure.

When the engine is started, the electronic control unit also performs a two-second self-diagnosis routine on the whole system, shown by the appearance of the indicator light 1.

If all the parameters tested are acceptable, the light 1 switches off; if there is an anomaly in one or more system components, it remains lighted.

If the indicator light remains lighted, or comes on during driving, **you need not stop the car**; just go to an **Alfa Romeo Service Dealer** as soon as possible. Even if the ABS system is shut off following self-diagnosis (lighting of indicator light 1 after the two-second routine or when driving), the power-assisted brake system will continue to provide the powerful, dependable braking action typical of an Alfa Romeo.

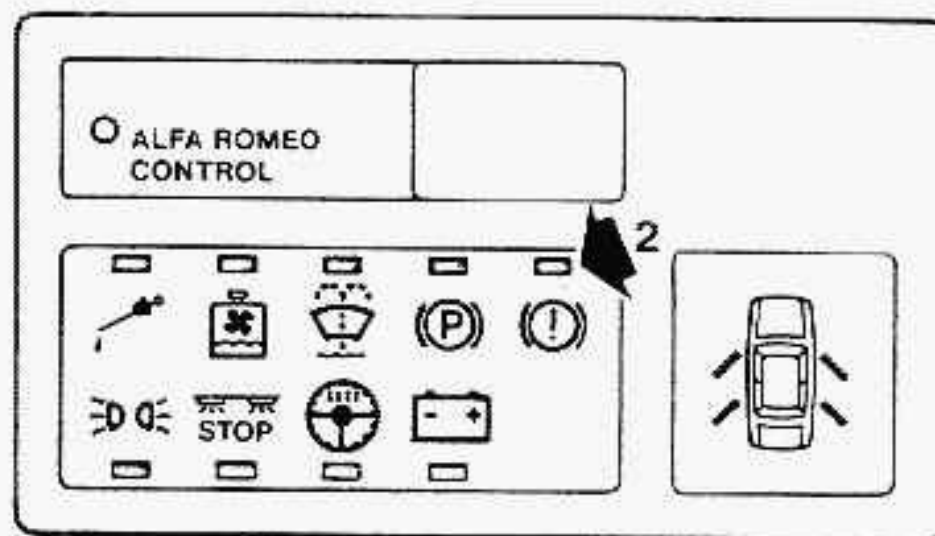
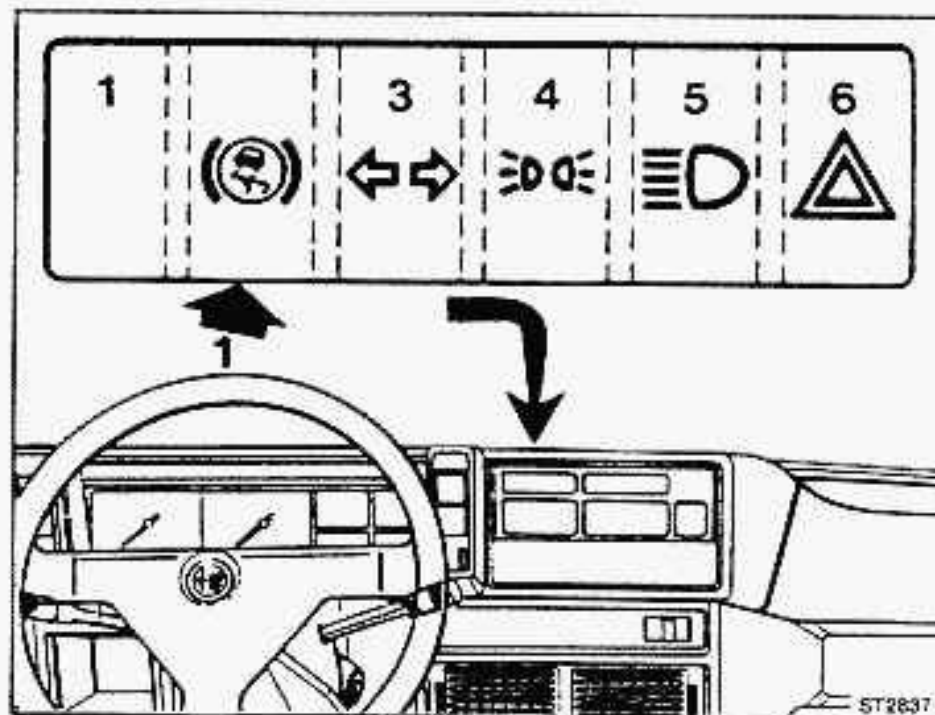

Caution: Should the ABS trouble indicator light 1 up at the same time as the low-brake-fluid/worn-brake-pad indicator (indicator light 2) on the Alfa Romeo Control, **stop the car immediately** without depressing the brake pedal violently and go to the nearest **Alfa Romeo Service Dealer**.

75

T.SPARK

75

3.0 V6

RIGHT HAND DRIVE

CONTROLS AND INSTRUMENTS

DRIVER'S POSITION

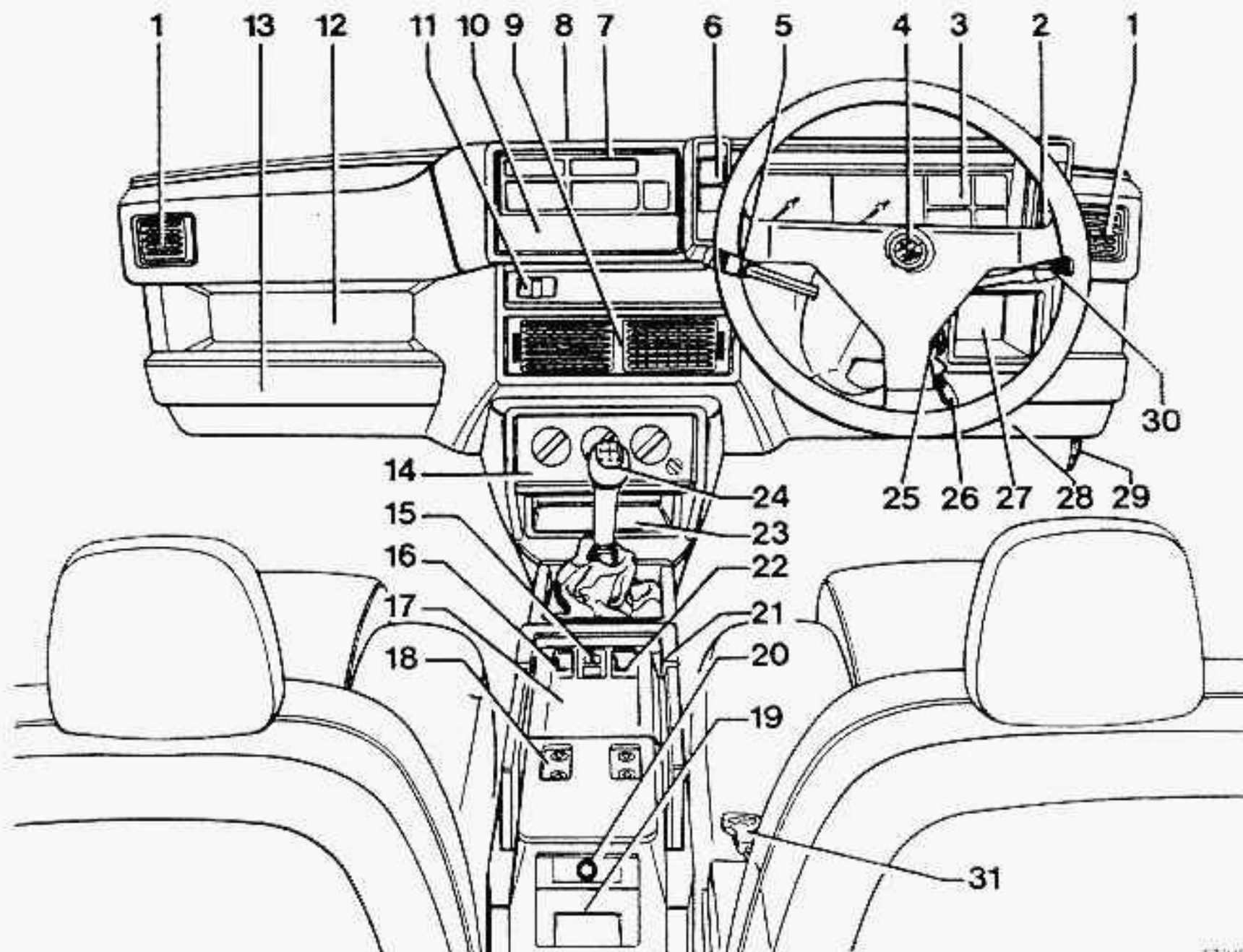

- 1 - Air inlets
- 2 - Instrument panel light dimmer
- 3 - Instrument panel
- 4 - Horn
- 5 - Outside lights and direction indicators control lever
- 6 - Instrument panel switches
- 7 - Warning lights - Alfa Romeo Control - Clock
- 8 - Windscreen defrosting louvre
- 9 - Centre air vents
- 10 - Front ashtray
- 11 - Front cigar lighter
- 12 - Utility tray
- 13 - Glovebox
- 14 - Ventilation and heating controls
- 15 - Door mirror remote control switch (passenger's mirror)
- 16 - Passenger's backrest adjustment control switch (some versions only)
- 17 - Centre tray
- 18 - Rear power window controls (some versions only)
- 19 - Rear ashtray
- 20 - Rear cigar lighter (some versions only)
- 21 - Handbrake lever
- 22 - Driver's backrest adjustment control switch (some versions only)
- 23 - Radio housing
- 24 - Gear lever
- 25 - Ignition switch and steering lock/antitheft
- 26 - Steering wheel adjustment lever
- 27 - Tray
- 28 - Fuse box
- 29 - Bonnet release
- 30 - Windscreen wiper and washer lever and headlamp washer lever (some versions only)
- 31 - Boot lid opening lever

INSTRUMENT PANEL AND SWITCHES

- 1 - Rev. counter
- 2 - Speedometer
- 3 - Total odometer
- 4 - Fuel level gauge
- 5 - Fuel reserve warning light
- 6 - Engine oil pressure gauge
- 7 - Oil pressure warning light
- 8 - Coolant temperature gauge
- 9 - Coolant maximum temperature warning light
- 10 - Partial odometer
- 11 - Partial odometer zeroing button
- 12 - Road hazard light switch and warning light
- 13 - Heated rear screen switch and warning light
- 14 - Rear fog light switch and warning light
- 15 - Front fog light switch and warning light (on request)
- 16 - Instrument panel light dimmer

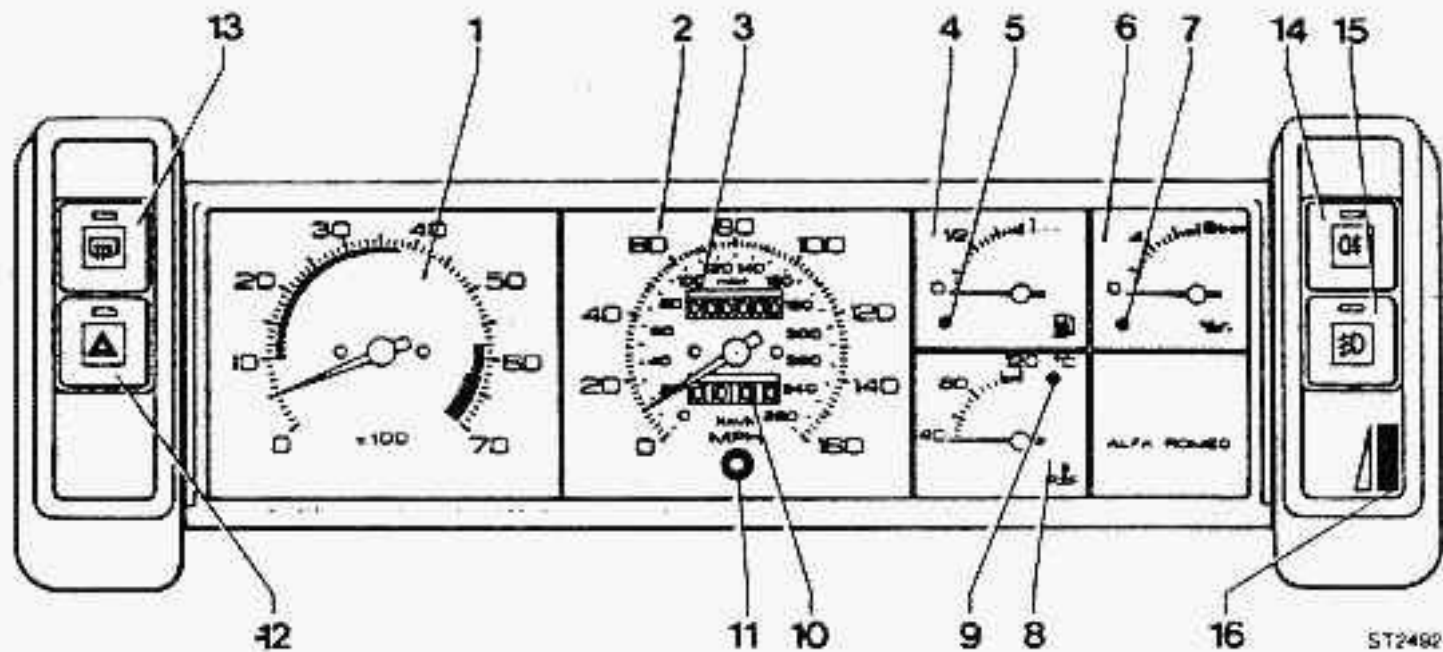

75 T.SP model

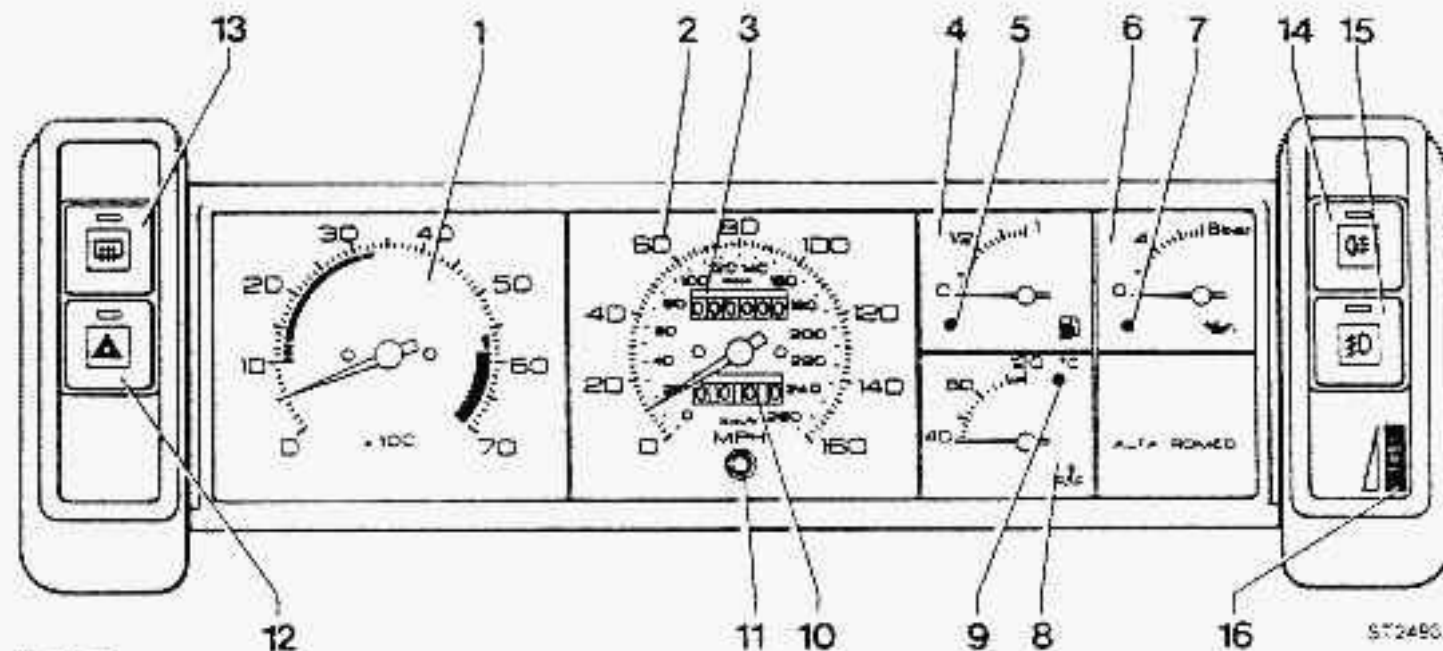

75 3.0 V6 model

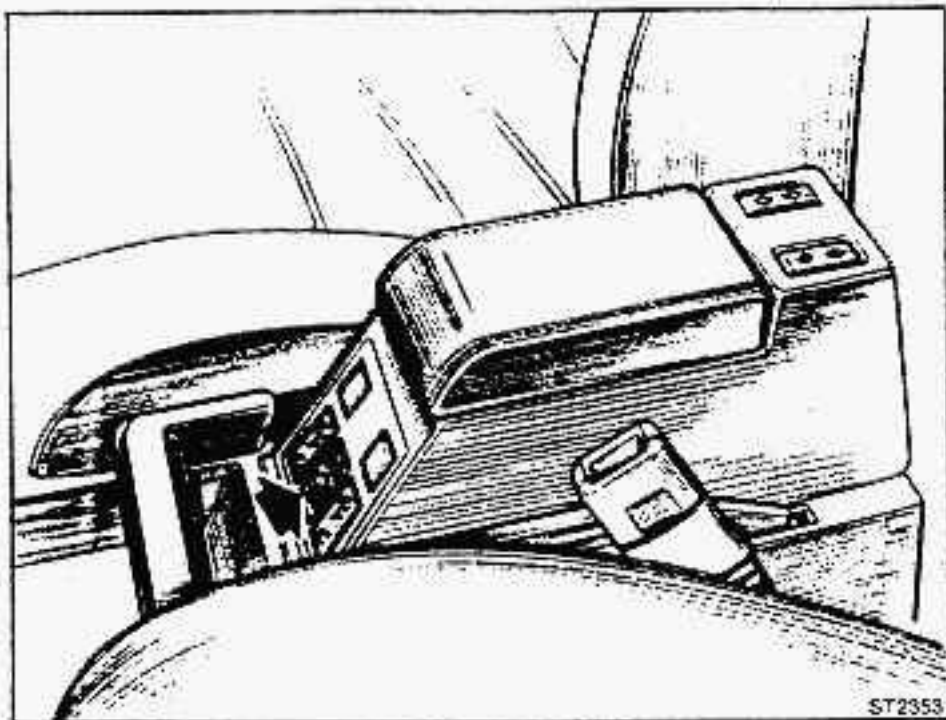

ELECTRICAL EXTERNAL REARVIEW MIRROR (Passenger's mirror)

The passenger's mirror is controlled by the switch 1. Push the switch stalk as desired towards one of the four directions in which the mirror is adjustable (see illustration). During automatic washing or for space reasons it is possible to push the mirror group all the way forward or all the way back against the side of the vehicle.

EXTERNAL REARVIEW MIRROR (Driver's mirror)

This is mechanically adjustable by means of a control on the side panel near the mirror. During automatic washing or for space reasons it is possible to push the mirror group all the way forward or all the way back against the side of the vehicle.

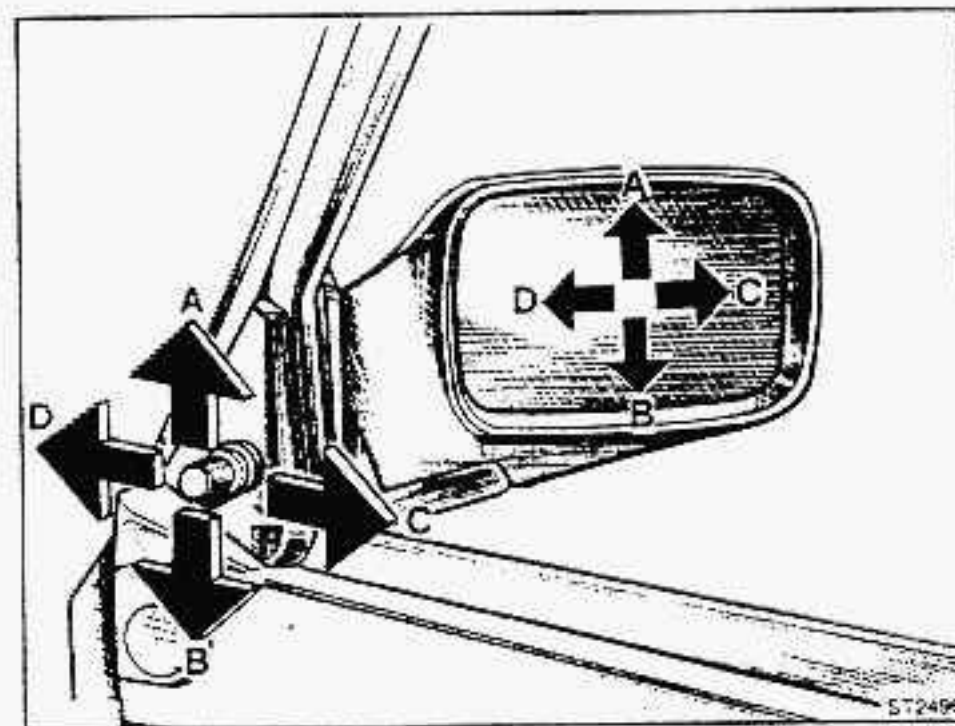
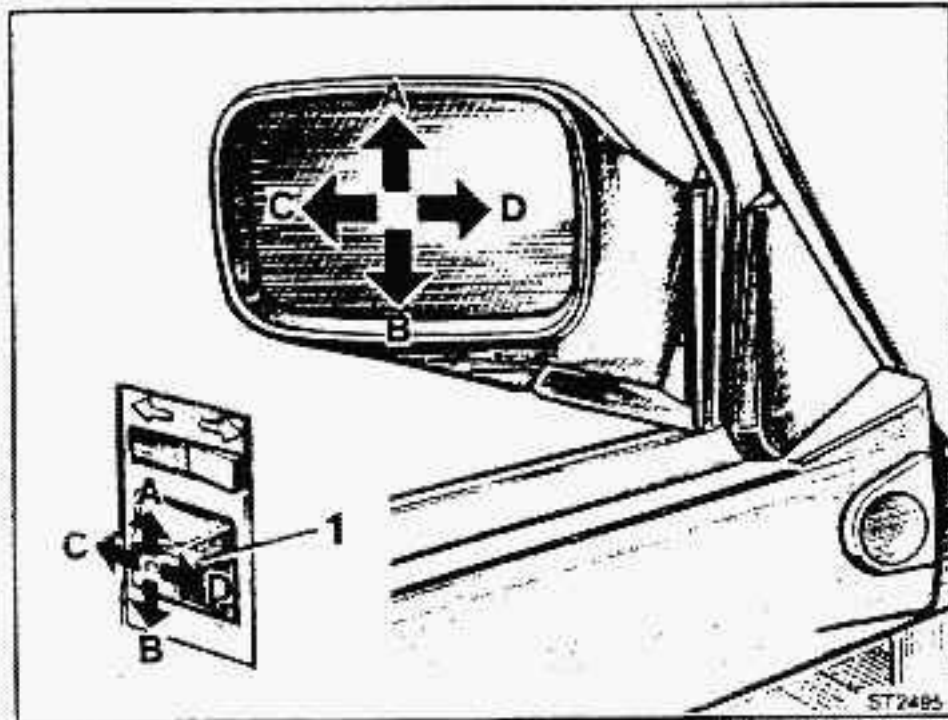

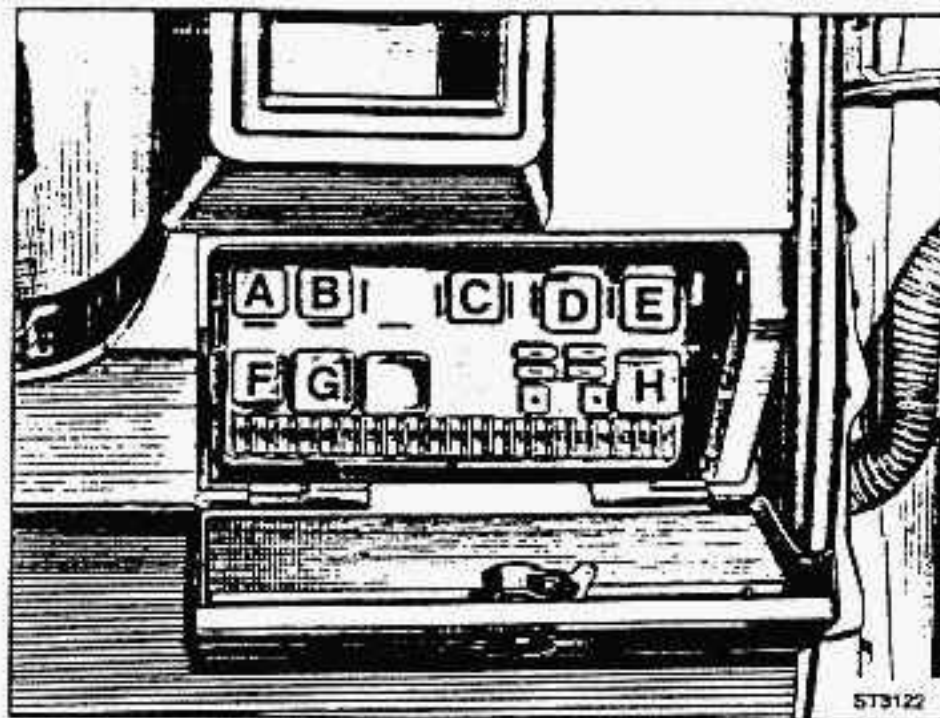

13	+ 15 Relay coil, electronic injection and ignition group	15
14	Instrument lighting	7.5
15	+ 15 Switches - Windscreen wiper - Windscreen washer pump	15
16	Heater	20
17	+ 15 Ceiling panel switches - Rear cigar lighter	15
18	Front power windows	25
19	Ceiling light and spot - Clock - Radio - Antenna - Directions indicators - Fusebox lighting	15
20	+ 30 For electronic injection control unit - Petrol pump	20
21	Stop lights - Front cigar lighter - Rear fog light	15

FUSEBOX

To inspect, rotate the knob and open the cover (hinged at bottom).

Fuse No.	Circuit protected	Amp Rating
1	Fog lights	15
2	Central door locking	10
3	Heated rear screen	20
4	Headlamp washers	20
5	Rear power windows	25
6	Front left & rear right side lights	7.5
7	Front right & rear left side lights	7.5
8	Left high beam - High beam warning light on instrument panel	7.5
9	Right high beam	7.5
10	Right low beam	10
11	Left low beam	7.5
12	+ 30 Direct current and relay ignition key for electronic control unit (ARC) and instruments	10

The following circuits are not protected by fuses: starting motor, generator, regulator, coil, horns, horn relay coil.

The box contains spare fuses (on the right).

If one or more fuses has to be replaced it is vital to respect the amp ratings; otherwise serious damage to the car could result. If fuses have been replaced, restore spares with Alfa Romeo Genuine Parts.

The use of similar fuses, even if with slightly different features, may jeopardize both operation and safety of your car.

The fusebox also contains the following relays:

- A - Fog lights (optional)
- B - Rear power windows (optional)
- C - Ceiling light
- D - Rear fog lights
- E - Heated rear screen
- F - Road hazard lights and direction indicators lights intermittence
- G - Windscreen wiper timer
- H - Ignition operated relay for the Alfa Romeo Control unit and instruments.

Warning: Prior to replacing a fuse switch off all lights and accessories and remove the ignition key to prevent damaging the electrical system. Use the tweezers in the fusebox lid for extracting the fuses.

75 2.5 V6

**RIGHT HAND DRIVE
AUTOMATIC TRANSMISSION VERSION**

CONTROLS AND INSTRUMENTS

DRIVER'S POSITION

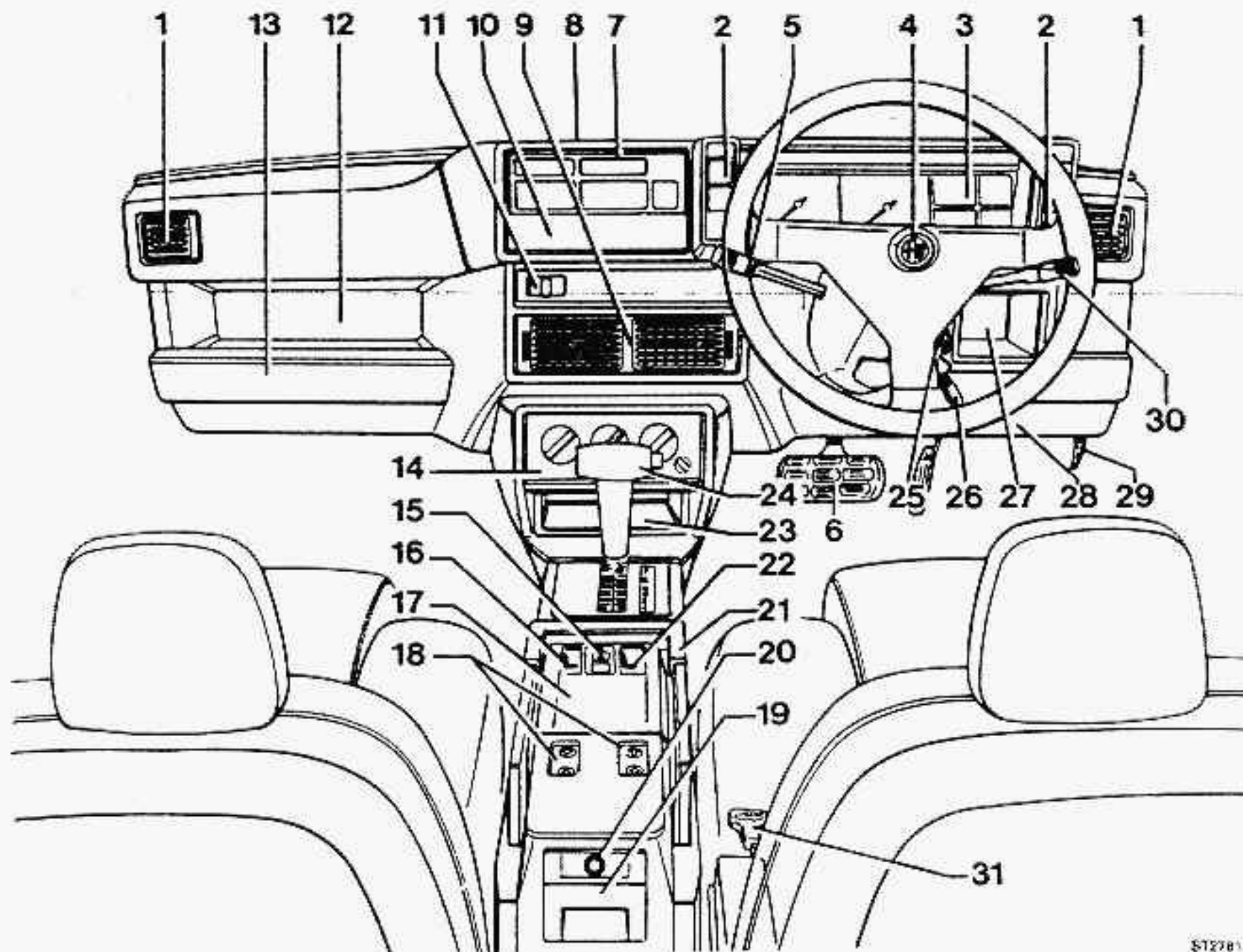

CONTROLS

- 1 - Air inlets
- 2 - Instrument panel switches
- 3 - Instrument panel
- 4 - Horn
- 5 - Lights and direction indicators lever
- 6 - Brake pedal
- 7 - Warning lights - Alfa Romeo Control - Clock
- 8 - Windscreen defrosting louvre
- 9 - Centre air vents
- 10 - Front ashtray
- 11 - Front cigar lighter
- 12 - Utility tray
- 13 - Glovebox
- 14 - Ventilation and heating controls
- 15 - Door mirror remote switch
- 16 - Passenger's backrest adjustment switch (if so equipped)
- 17 - Centre tray
- 18 - Rear power window (some versions only)
- 19 - Rear ashtray
- 20 - Rear cigar lighter (if so equipped)
- 21 - Handbrake lever
- 22 - Driver's seat backrest adjustment switch (if so equipped)
- 23 - Radio housing
- 24 - Gear lever
- 25 - Ignition switch and steering lock/antitheft
- 26 - Steering wheel adjustment lever
- 27 - Tray
- 28 - Fuse box
- 29 - Bonnet release
- 30 - Windscreen wiper and washer lever
- 31 - Boot lid opening lever

INSTRUMENTS AND SWITCHES

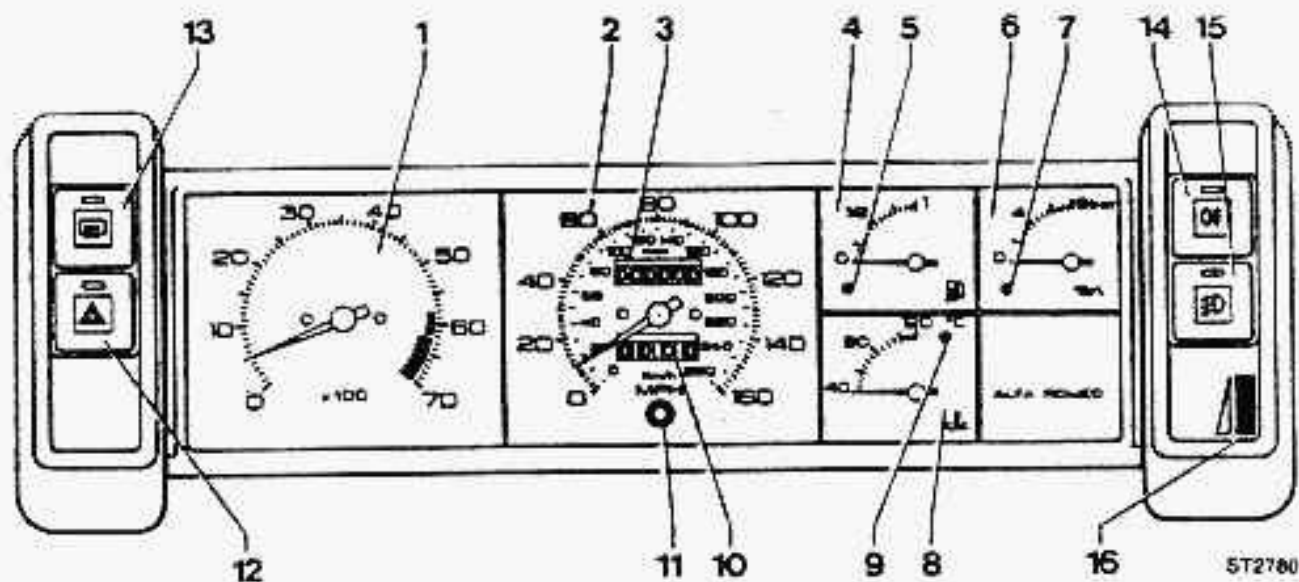

- 1 - Electronic rev. counter
- 2 - Electronic speedometer
- 3 - Odometer
- 4 - Fuel level gauge
- 5 - Fuel reserve warning light
- 6 - Engine oil pressure gauge
- 7 - Oil pressure warning light
- 8 - Coolant thermometer

- 9 - Coolant temperature warning light
- 10 - Partial odometer
- 11 - Partial odometer zeroing button
- 12 - Road hazard lights switch
- 13 - Heated rear screen switch
- 14 - Rear fog light switch
- 15 - Front fog lights switch
- 16 - Dimmer for instruments lights

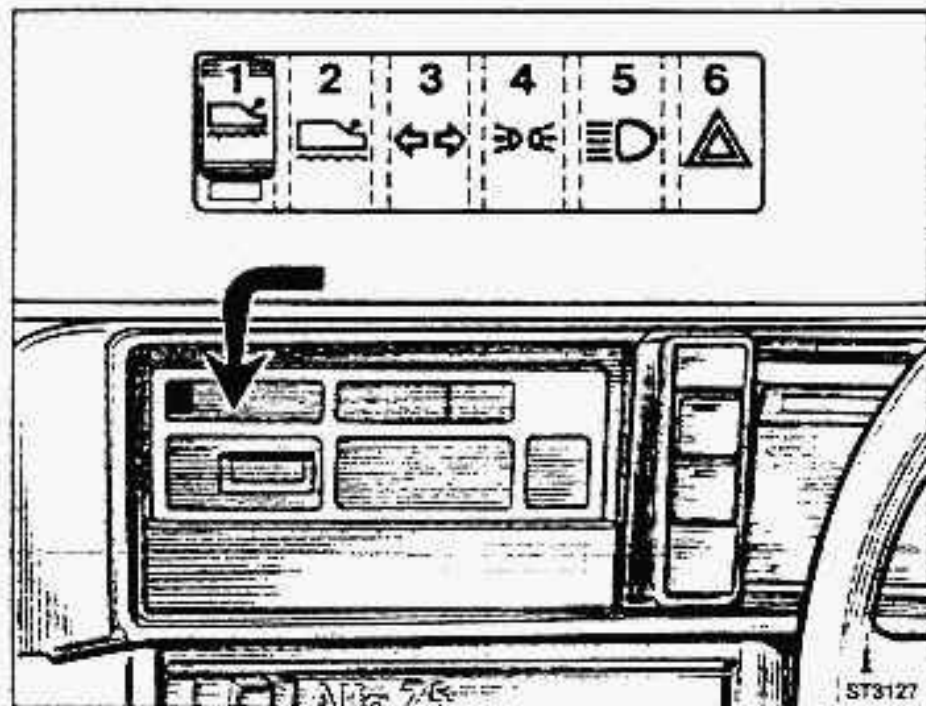

WARNING LIGHTS

In the center of the instrument panel, there are warning lights indicating that the respective instruments have been switched on.

- 1 - Switch for checking automatic transmission fluid level
- 2 - Automatic transmission fluid level warning light
- 3 - Direction indicator warning light
- 4 - Parking lights warning light
- 5 - High beam warning light
- 6 - Road hazard warning light

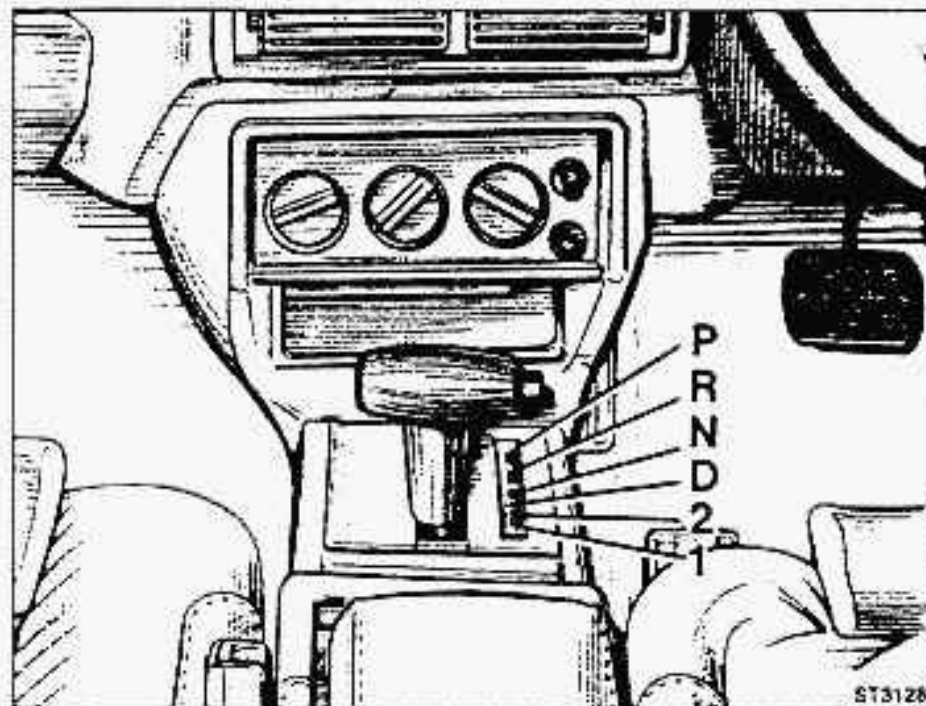

SELECTOR LEVER

The gearbox can be controlled by automatic or manual selection. For this purpose the driver operates the selector lever on the transmission tunnel which offers six positions.

These are as follows:

P-R-N-D-2-1.

Position D is used for the automatic selection of the gears.

Position P-R-N-2-1 are used only for manual selection.

Important note:

To engage R (reverse) or P (park) positions, depress the push-button shown in the illustration (Do not place the selector in park or reverse with car in motion).

When shifting from park or neutral to reverse or drive, the brake pedal should be fully applied and the vehicle should not be moving (see further information).

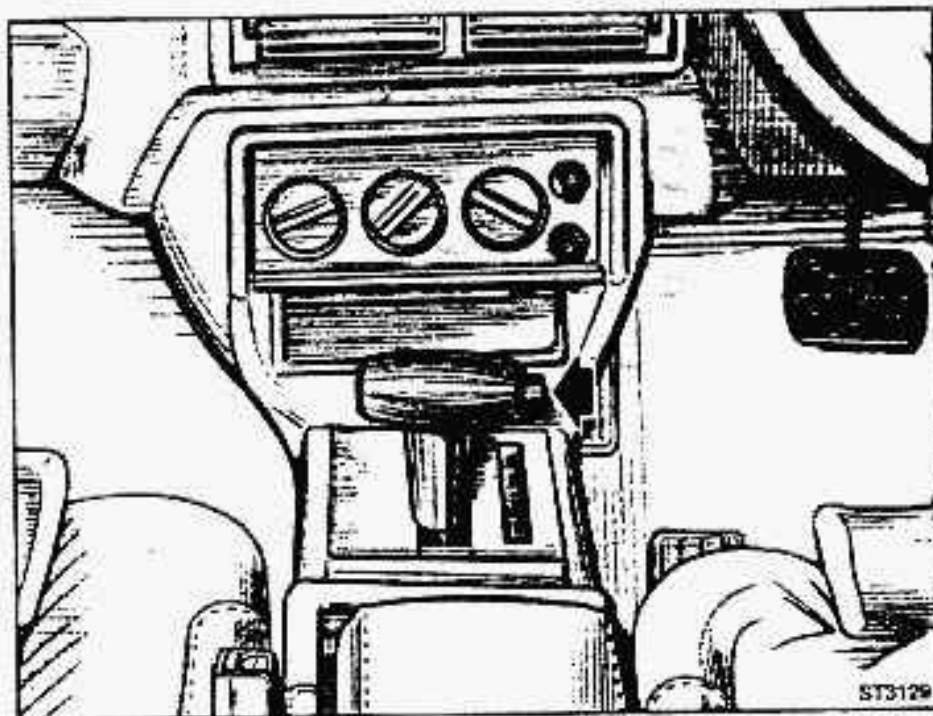

STARTING THE ENGINE

The engine may be started only with the selector lever in position P or N.
For safety reasons the handbrake must always be applied before starting the engine.

Important

Prior to shifting the selector lever from either P or N to any other position, let the engine run at idle (NO FASTER THAN 1200 rpm), depress the brake pedal and move the selector lever as desired. Depress the accelerator pedal only after the engagement of gear is felt.

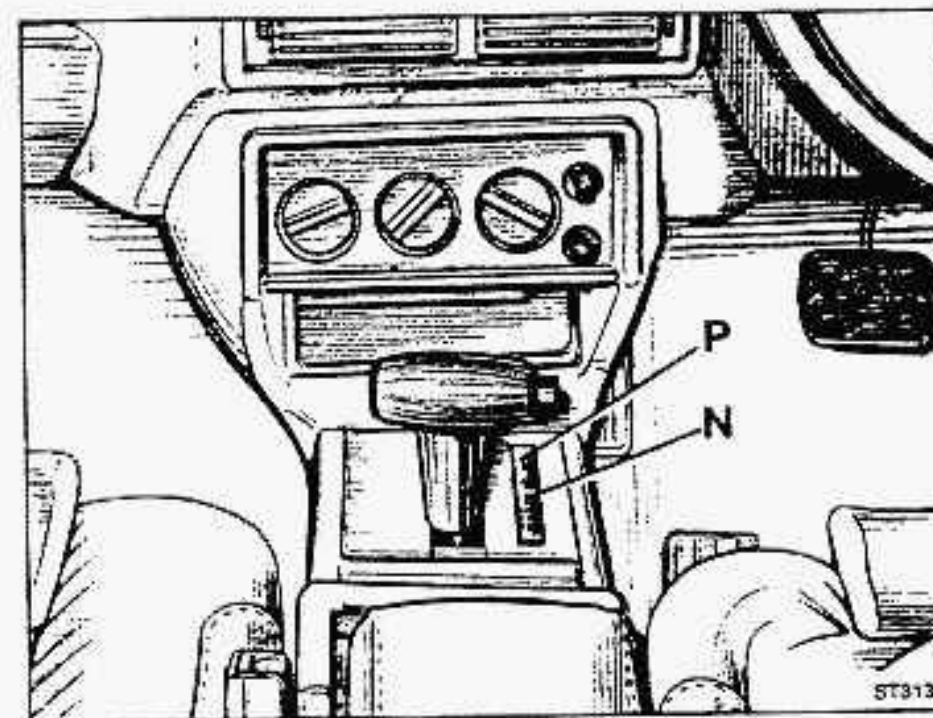

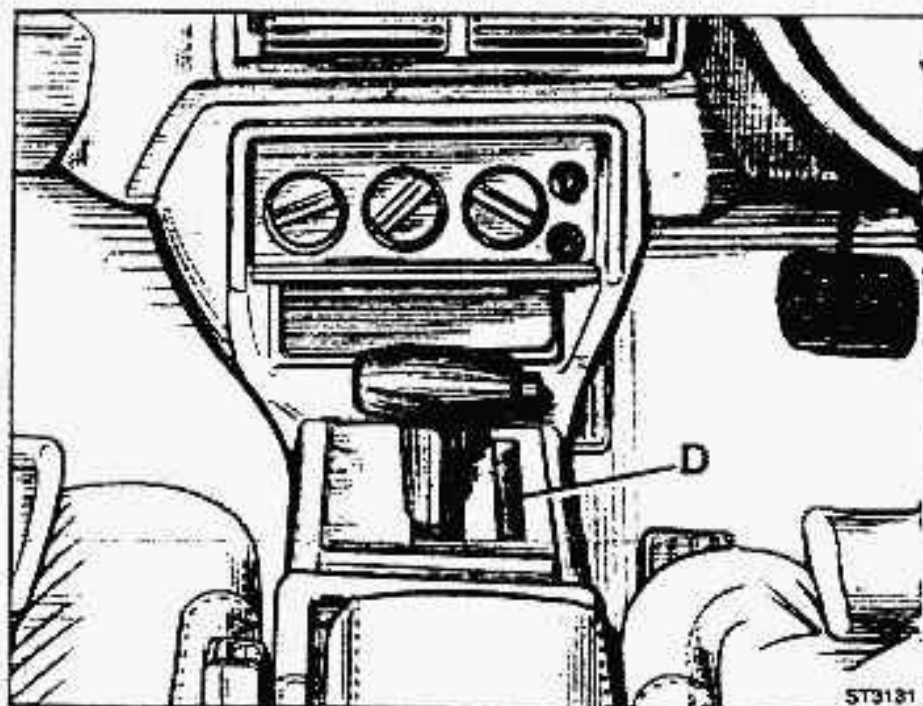

DRIVING OFF WHEN COLD

Following a cold start, with the engine idling, move the gear lever to Range "D" and wait for the gear to engage. Release the handbrake lever, and depress the accelerator gradually (for best fuel economy) when driving off.

Note: Engine should be allowed to reach normal operating temperature before full performance is demanded.

DRIVE "D" RANGE

Is used for all normal driving conditions and provides for best fuel economy.

Drive Range has three ratios: "1", "2" and "D".

The car starts from stop in "1" and shifts automatically through "2" and "D" Range according to the speed of the vehicle and the load on its engine.

Ranges "1" and "2" are available by means of manual selection to provide downhill engine braking and possible better control during severe winter conditions with heavy snow and ice. However, these ranges do not allow for best fuel economy.

DOWNSHIFTING

Is automatic and provides a larger margin of safety for passing. Downshifts are available merely by pushing the accelerator to the floor.

Abuse of this feature will increase the consumption of fuel markedly.

Note: If downshifting fails to occur or abrupt and jerky gear shifting takes place, have the kickdown mechanism checked for proper operation by an **Alfa Romeo Service Dealer**.

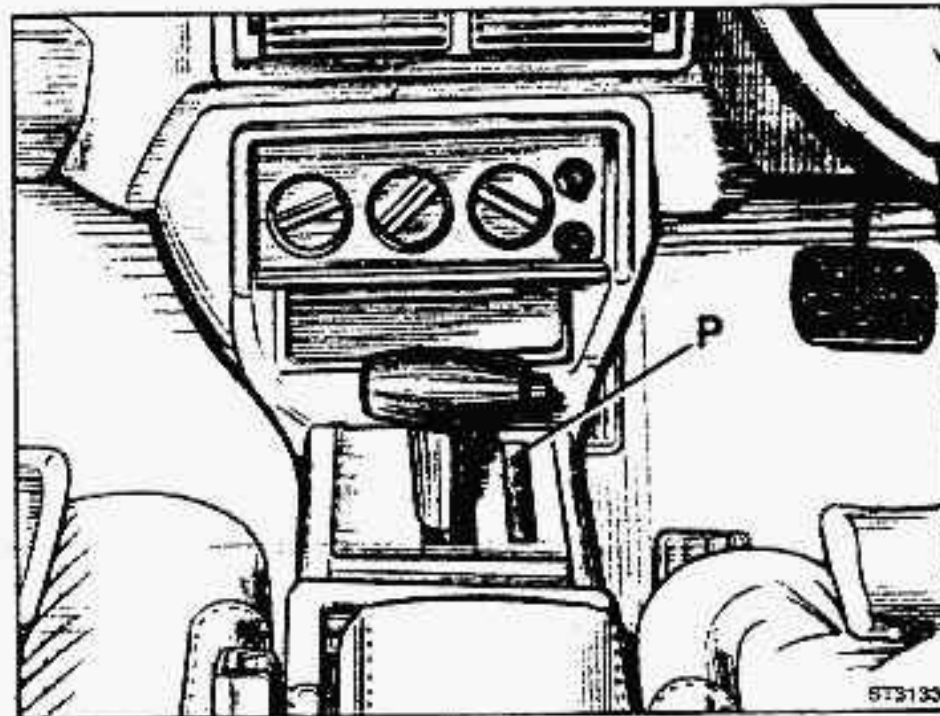
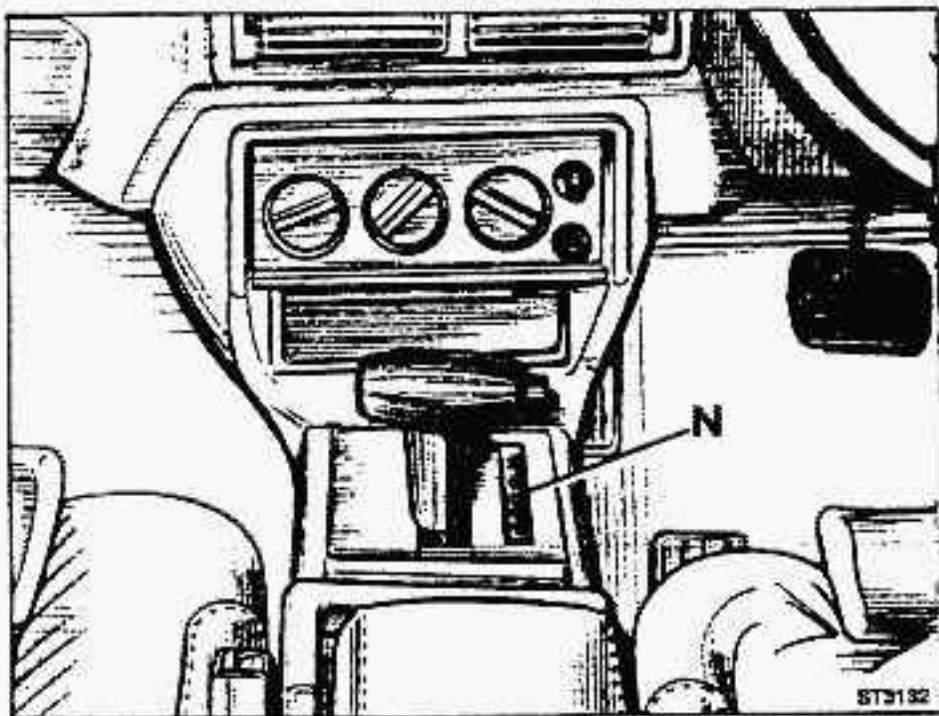

STOPPING THE CAR

To stop the car, depress the brake pedal. With the engine idling and a gear engaged the car may tend to creep on a level surface. If the car has to be pushed, shift the selector lever to N position (neutral).

PARK

When the car is stopped, engage the P (park) position: a device on the transmission output shaft safely and positively locks the rear wheels. Apply the handbrake when leaving car in this range. While performing inspections with the engine running, the selector lever must be shifted to P (park).

REVERSE

Engage the R position only after the car has been stopped. The brake pedal should be fully applied while shifting from P, N or D into reverse.

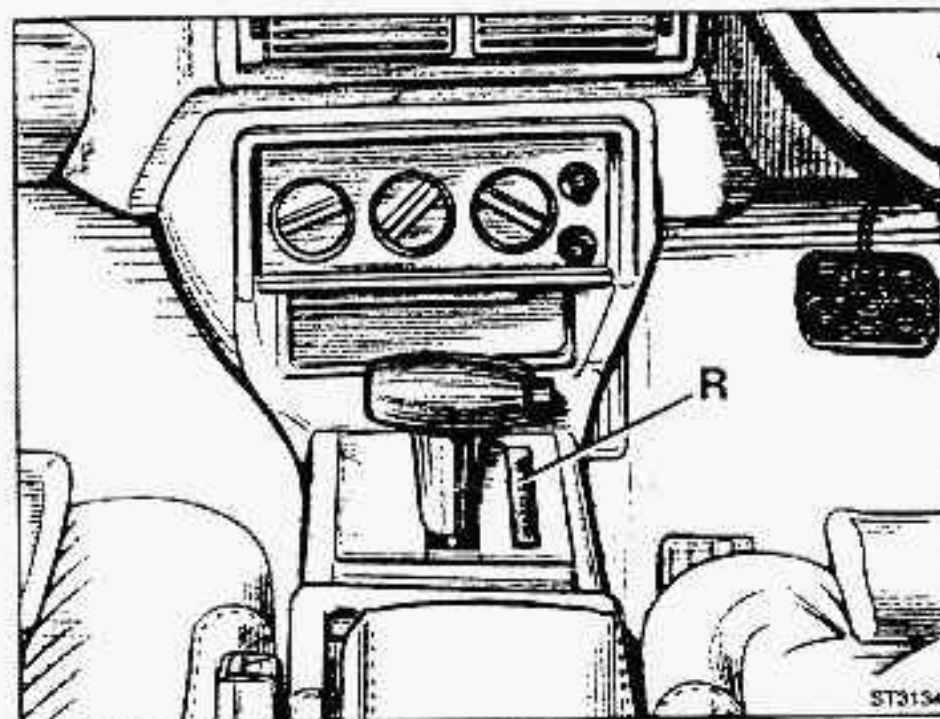

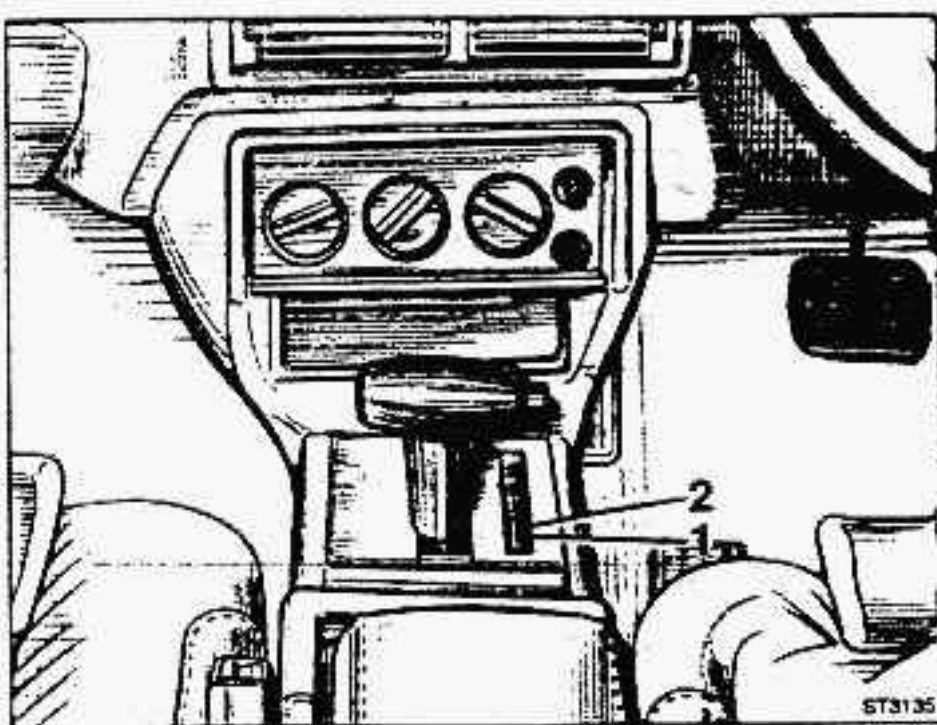

LOW RANGE

When the position 2 is selected, the transmission provides automatic shifts from 2 to 1 gear and viceversa; this range is used when climbing or descending long, moderately steep grades.

When the position 1 is selected, the transmission provides a start in 1st gear with no automatic upshift; this range is used for driving up very steep grades and for maximum down-hill braking.

The quick downshifting (kick down) is also possible with the selector lever in 2 position.

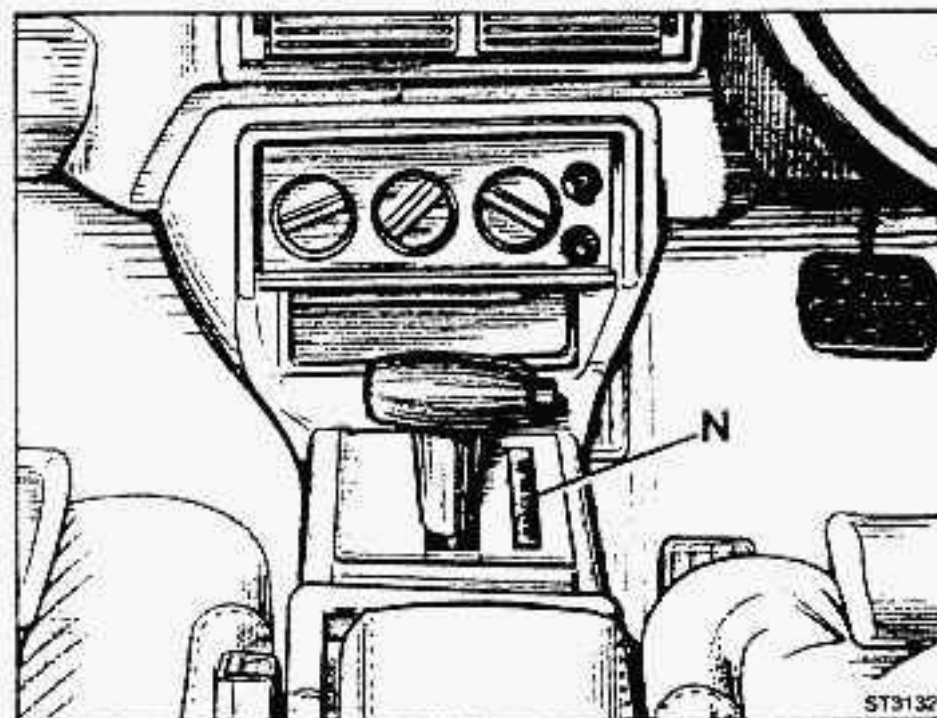

TOWING

- 1) "Flat Bed" towing is recommended over the conventional (tow truck) method if possible.
- 2) If "Flat Bed" transportation is not available, it is recommended to tow the car with the rear wheels off the ground to avoid excessive drive train wear/damage.

If recommendations 1 and 2 above are not available, the car may be safety towed with the selector lever in N at speeds of 50 km/h (30 mph) or less.

NOTE: Prior to being towed, about 1 kg of oil should be added to the automatic transmission fluid (refer to the inside back-cover for the type of oil) this additional quantity of fluid must however be drained off when towing is over.

Should it be necessary to tow the car more than 50 km (30 miles) have the axle shafts disconnected. In this condition no oil has to be added.

CHECKING THE TRANSMISSION FLUID LEVEL

This check should be performed with the engine idling, the oil at a temperature of 70 °C (158 °F), the gear selector lever at P position and the car on level ground; after having ascertained that these conditions are met, move the switch up (see page 142). The warning light must come on. When the light is illuminated, the fluid level is ok. When the light is not illuminated, the fluid level is low. If the lamp fails to light up, remove plug 1 and check fluid level: the level should be at the edge of the orifice. Refit the plug 1 and tighten it to the specified torque. If fluid level is as specified, no oil leakage from under the transmission exists and the light still does not come on, the cause is to be attributable to the signalling circuit wiring loom, ie: (burned out bulb, faulty float contact, broken connection, etc.). For checking and/or repairing, contact **Alfa Romeo Service Dealers** only.

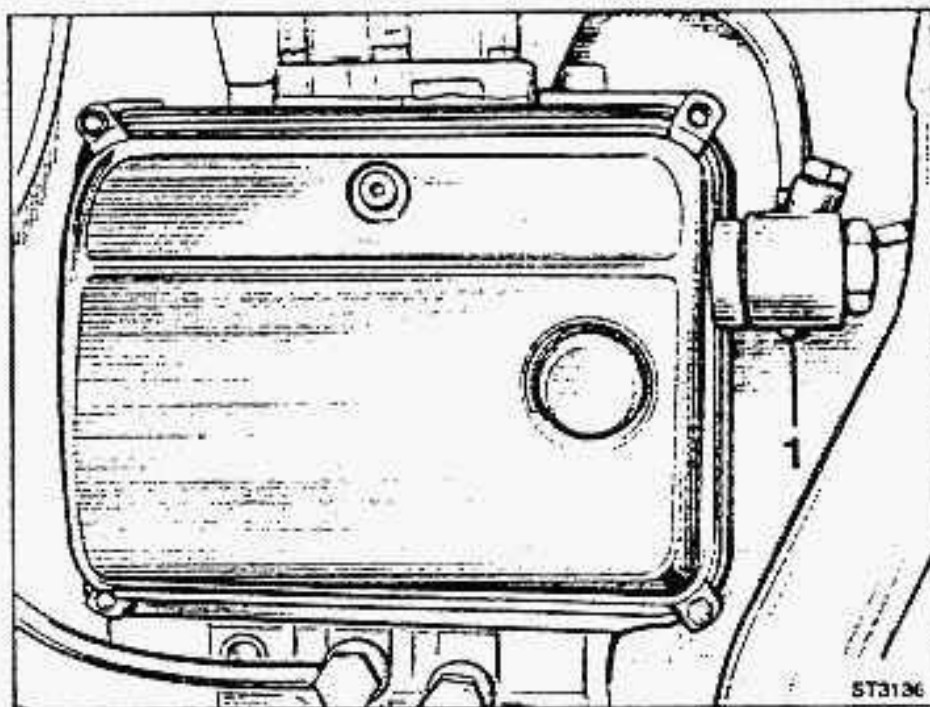

CHANGING THE TRANSMISSION FLUID

Fluid changing should be performed with the engine running, the fluid at ambient temperature (about 20 °C) and selector lever at P position.

Remove plug 3, let oil drain out, then refit the plug.

Remove plug 2 and pour new oil thru the hole; type of oil are as specified on inside backcover.

Refit filler plug 2 and tighten it to the specified torque; check fluid level by removing plug 1 as outlined at the previous paragraph. It is advisable that fluid change be entrusted to an **Alfa Romeo Service Dealer**.

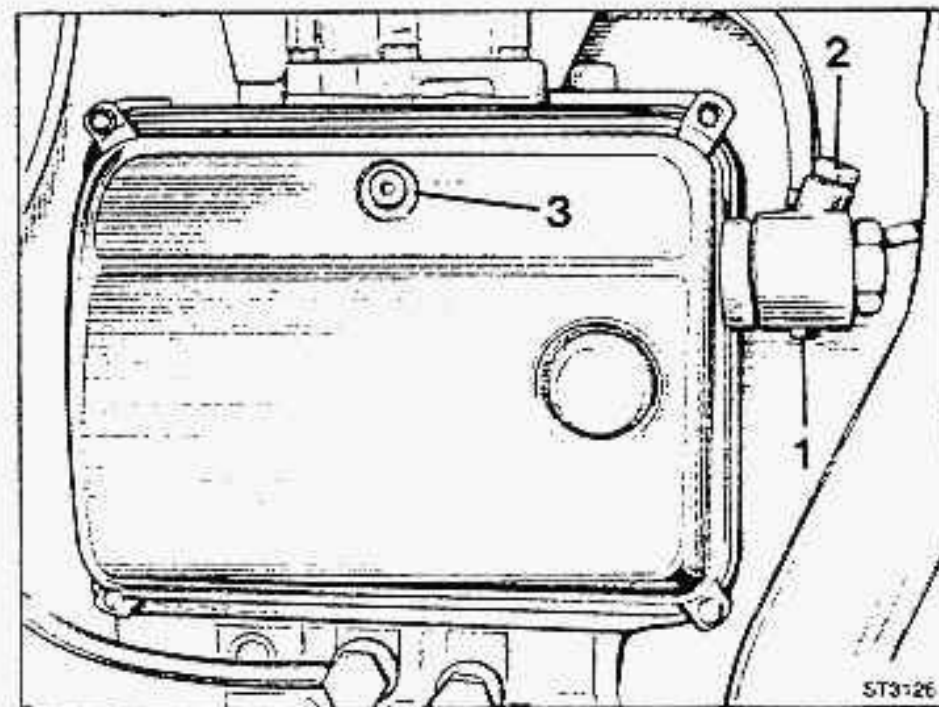

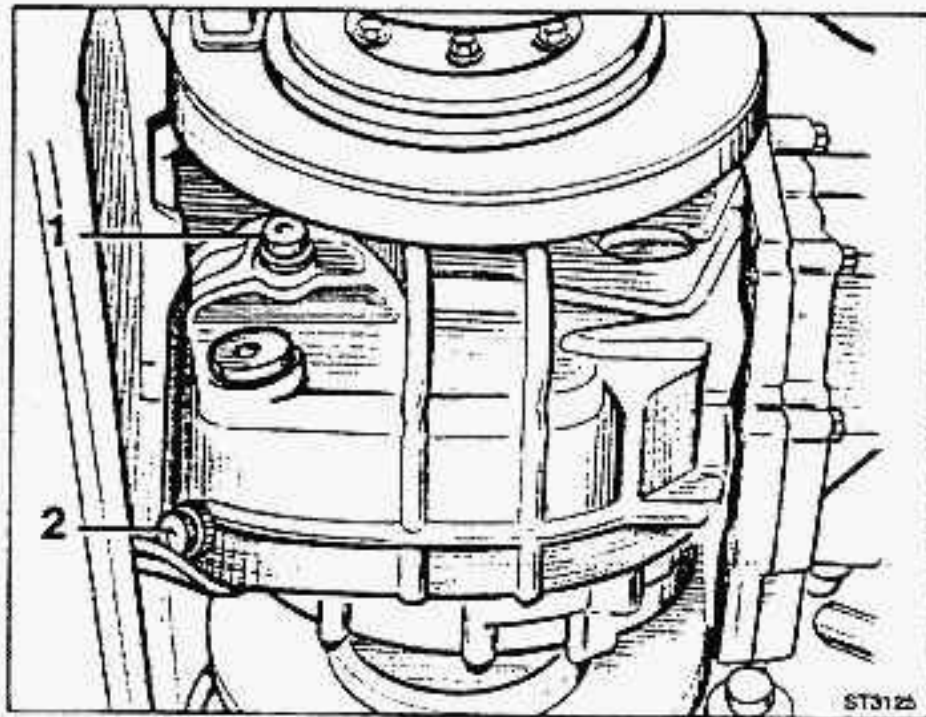

CHECKING AND CHANGING THE DIFFERENTIAL OIL

To check differential oil at the prescribed intervals, remove filler plug 1; oil level should be at the edge of filler orifice. Refit plug 1 and torque it as specified.

To change oil, proceed as follows (when hot):

- Drain off old oil by removing drain plug 2 and filler plug 1.
- Clean drain plug 2 and refit it.
- Replenish with oil of the prescribed type (refer to inside backcover) through filler plug 1. Check that oil level is at the edge of filler orifice; clean filler plug and fit it. Tighten the two plugs to the specified torque.

LIMITED SLIP DIFFERENTIAL (if so equipped)

The limited slip differential allows such a proportioning of the traction power transmitted to the road wheels as to limit the slipping of one wheel with respect to the other to a limited value.

This will improve the grip on surfaces having different friction coefficient and permit to proceed even when the two drive wheels rest on grounds with unequal friction coefficient.

CHECKING THE HYDRAULIC FLUID LEVEL

The car is equipped with a hydraulically-controlled device which keeps the car level, independently of load on car's rear end, by correcting the rear ride height.

Note: A single reservoir is used to store automatic ride height control fluid as well as power steering fluid. The reservoir is located near the radiator towards the passenger side of the vehicle.

The fluid level should be checked with the car in running order, i.e. unladen but with full oil, fluid and fuel tanks and the engine turning.

In these conditions the fluid level should be at the "MAX" reference mark (see illustration); if not, top up using **exclusively** the fluid specified (see inside backcover).

Note: Prior to remove the filler cap on the reservoir thoroughly clean the plug and the areas around it.

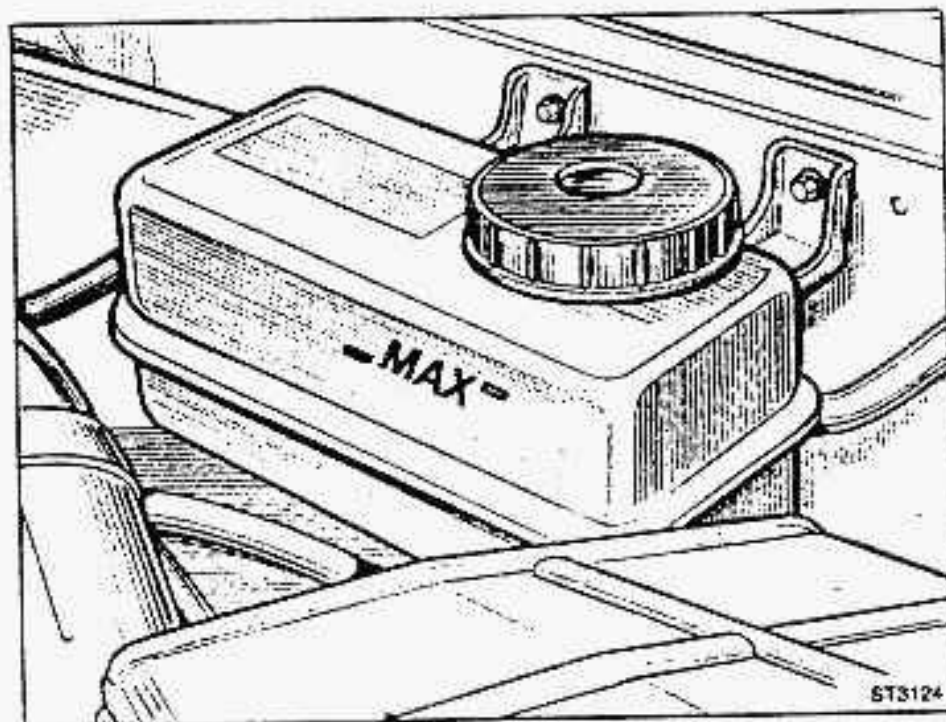
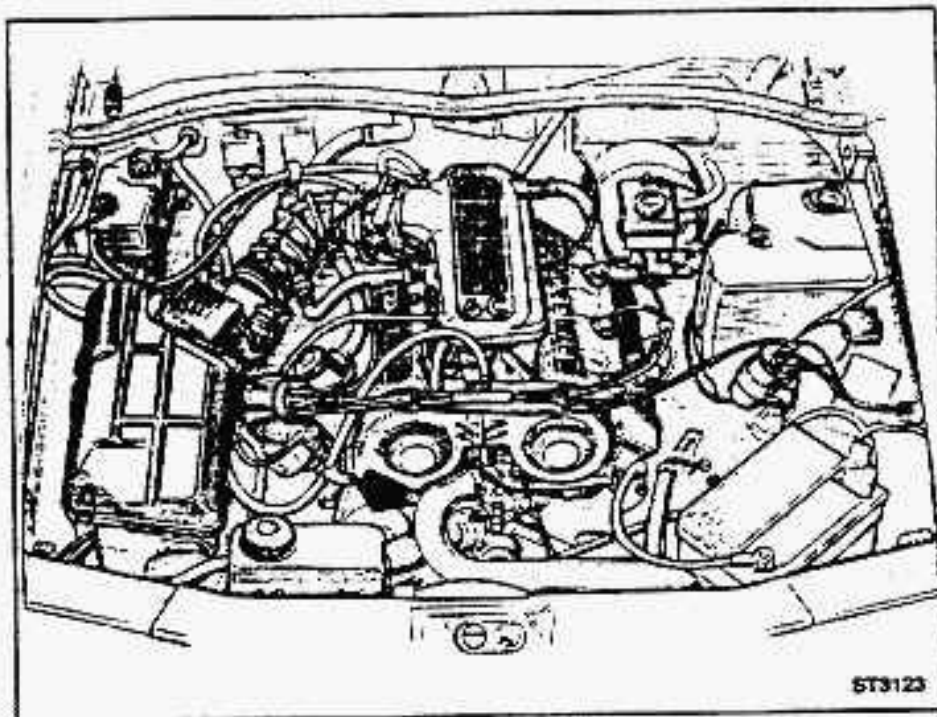

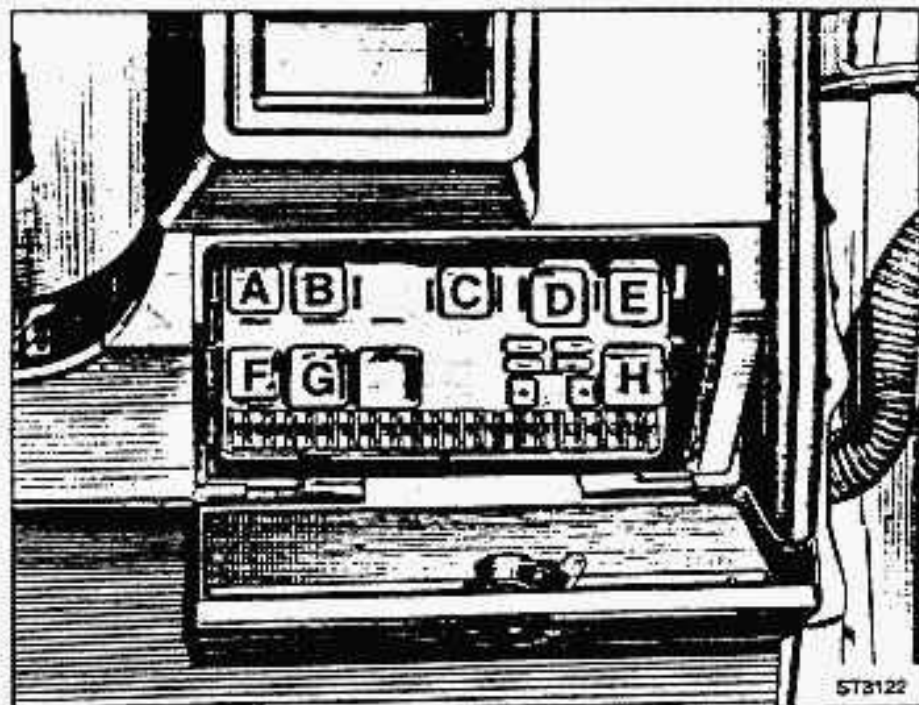

FUSEBOX

To inspect, rotate the knob and open the cover (hinged at bottom).

Fuse No.	Circuit protected	Amp Rating
1	Fog lights	15
2	Central door locking	10
3	Heated rear screen	20
4	Headlamp washers	20
5	Rear power windows	25
6	Front left & rear right side lights	7.5
7	Front right & rear left side lights	7.5
8	Left high beam - High beam warning light on instrument panel	7.5
9	Right high beam	7.5
10	Right low beam	10
11	Left low beam	7.5
12	+ 30 Direct current and relay ignition key for electronic control unit (ARC) and instruments	10

13	+ 15 Relay coil, electronic injection and ignition group ...	15
14	Instrument lighting	7.5
15	+ 15 Switches - Windscreen wiper - Windscreen washer pump	15
16	Heater	20
17	+ 15 Ceiling panel switches - Rear cigar lighter	15
18	Front power windows	25
19	Ceiling light and spot - Clock - Radio - Antenna - Directions indicators - Fusebox lighting	15
20	+ 30 For electronic injection control unit - Petrol pump	20
21	Stop lights - Front cigar lighter - Rear fog light	15

The following circuits are not protected by fuses: starting motor, generator, regulator, coil, horns, horn relay coil.

The box contains spare fuses (on the right).

If one or more fuses has to be replaced it is **vital to respect the amp ratings**: otherwise serious damage to the car could result. If fuses have been replaced, restore spares with Alfa Romeo Genuine Parts.

The use of similar fuses, even if with slightly different features, may jeopardize both operation and safety of your car.

The fusebox also contains the following relays:

- A - Fog lights (optional)
- B - Rear power windows (optional)
- C - Ceiling light
- D - Rear fog lights
- E - Heated rear screen
- F - Road hazard lights and direction indicators lights intermittence
- G - Windscreen wiper timer
- H - Ignition operated relay for the Alfa Romeo Control unit and instruments.

Warning: Prior to replacing a fuse switch off all lights and accessories and remove the ignition key to prevent damaging the electrical system. Use the tweezers in the fusebox lid for extracting the fuses.

ALPHABETICAL INDEX

A

Adjusting the beam height according to the load	92
Air and fuel supply system	120
Air conditioning system	45
Air filter	73-74
Alfa Romeo Control (ARC)	12
Alternator	61-88
Alternator and coolant pump drive belt	75
Ashtray (front and rear)	36
Automatic transmission version	139

B

Backshelf drawer	35
Battery	89
Body (washing the car)	101
Bonnet opening	38
Brake system with anti-lock braking system (ABS)	129
Brakes	62-80
Brakes system	81
Boot opening	38

C

Capacities	inside back cover
Car's dimensions	115-124
Car's keys	3
Central door locking	30
Changing gearbox-differential oil	72
Checking level gearbox-differential oil	72
Changing light bulbs	92
Child-proof door locks	31
Cigar lighters	36
Climate control	40
Climate control with air conditioning system	45
Clock (digital)	14
Compressor drive belt	51
Control panel (front and rear)	9
Coolant level checking	78
Cooling system	76-77

D

Diagram of the air and fuel supply system	110
Digital electronic ignition system	122
Direction indicators	20
Doors	30
Driver's position	8

E

Electrical equipment	88
Electronic ignition	88
Electronic injection-twin ignition system engine	112
Engine oil change	68-70
Engine oil level check	68
Engine oil filter change	71

F

Filler cap cover	37
Flashing	20
Fluid level (power steering)	84
Fluid reservoir (brake and clutch)	81
Fuel economy hints	63
Fusebox	90

G

Gear lever	24
General data (2.0 version)	107
General data (3.0 version)	117
Glovebox	35

H

Handbrake	24
Headlamp washer	21
Heated rear screen	15

I	
Identification	4
Ignition switch unit	16
Instrument panel	10
Internal lighting	23

J	
Jack	55
Jacking up the car	55

L	
Laying up the car	102
Levers on steering wheel	18
Light dimmer (instrument panel)	11
Lights (outside)	19
Lubricants	inside back cover

P	
Parking	62
Performance	109-119
Power steering	62-82
Power windows	22
Precautions to take before maintenance	65
Pump drive belt (power steering)	85

R	
Radio	91
Rear fog lights switch	15
Rearview mirrors	32-34
Relays	91
Replacing windscreen wipers	87
Right hand drive	133
Right hand drive (automatic transmission version)	139
Road hazard lights	15
Routine maintenance schedule	66

S	
Seats	25
Seat belts	28
Self-locking differential	109-119
Service coupon booklet	3
Service network	3
Setting the headlight beams	92
Snow chains	56
Spare wheel	54
Spark plugs	88
Starting engine with an emergency battery	57
Steering lock unit	16
Starting the engine	17-60
Steering wheel adjusting	18
Sun visors	34
Support handles	37
Switches (instrument panel)	10-15

T	
Tyres	86-inside back cover
Towing bracket	103
Towing the vehicle	56

V	
Ventilation	49

W	
Warnings and precautions	59
Warning lights	11
Washing liquid (windscreen and headlamp)	87
Wheels	54-86
Wheel changing	54
While driving	61
Windscreen wiper and washer	21
Windscreen wipers	62
Winter use	63

LUBRICANTS

PARTS TO LUBRICATE	Recommended grade	Recommended commercial equivalents		
		 Agip	Shell	<i>IP</i>
Engine	SAE 10 W / 50 API SF	* Agip Sint 2000 10 W/40	* Shell Super Plus Motor Oil 15 W/50	* IP Sintiax 10 W/40
Gearbox-/ differential	SAE 75 W / 90 API GL-5	Agip Rotra SX SAE 75 W/90	Shell Spirax 80 W/90 HD	IP Pontiax HDS SAE 75 W/90
Power steering Aut. transmission Automatic ride	DEXRON II	Agip ATF Dexron II D 21103	Shell Dexron II D 20137	IP Dexron fluid II D 21627
SAE — Society of Automotive Engineers API — American Petroleum Institute		* If the above lubricants are unavailable refer to the directions given about lubricants on page 68.		

CAPACITIES

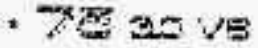
	litres		kg	litres
Cooling system Alfa Romeo coolant mixture	8.6 10*	Oil: Engine (at max level)**	5 6.0*	5.6 6.7*
Fuel Tank capacity	49 67*	Gearbox-differential	2.0	2.3
Fuel reserve	6	*  model		
See page 109 (2.0 version) or page 119 (3.0 version) for directions given about fuel.		** The quantity indicated is the amount necessary for a change.		

*TUBELESS TYRES

Inflation pressure when cold
kg/cm²

	Front	Rear
Rims 6½ J x 14" 195/60 VR 14" PIRELLI P600 MICHELIN MXV GOOD YEAR EAGLE NCT	At reduced load and normal speed 2.0	2.0
Rims 6 J x 15" On request, only for  195/55 VR 15" PIRELLI P600 MICHELIN MXV GOOD YEAR EAGLE NCT	At full load and high speed 2.2	2.5

Note: When changing tyres and/or rims always keep to the same rim-tyre combination with which car was originally supplied from the manufacturer.

* The vehicle is fitted with tubeless tyres. See page 86 for warnings regarding the use of tyres in general and specific recommendations for tubeless tyres.

Warning: In the event of long periods at high speed, pressure should be increased by 0.3 kg/cm² (4.3 psi).

 **Alfa Romeo**

ASSISTENZA TECNICA

ALFA-LANCIA INDUSTRIALE S.p.A. - V.le Alfa Romeo - I - 20020 ARESE (MILANO)

Publication 60490020 — XI/88 — 2a Ed. — 50g — Printed in Italy — Tipografia Torinese

All rights reserved — This book, or parts thereof, may not be reproduced in any form without permission of ALFA-LANCIA INDUSTRIALE S.p.A.