

















Model name	Model cycle	Model name	Model cycle
 <b>Audi 80</b> Audi 80 / S2 Audi 80 / S2 / RS2 Avant Audi 80 / S2 Coupé Audi 80 Cabriolet	1990 – 1995 1992 – 1995 1988 – 1996 1991 – 2000	 <b>A3</b> A3 / S3 (3-door) A3 / (5-door) A3 / S3 (3-door) A3 / S3 / RS3 Sportback A3 Cabriolet A3 / S3 (3-door) A3 / S3 Sportback A3 / S3 Limousine	1996 – 2003 1999 – 2003 2003 – 2012 2004 – 2012 from 2008 from 2012 from 2012 from 2013
 <b>Audi 100</b> Audi 100 Audi 100 Avant Audi 100 / A6 / S6 Audi 100 / A6 / S6 Avant	1988 – 1991 1988 – 1991 1991 – 1997 1991 – 1997	 <b>A4</b> A4 / S4 A4 / S4 / RS4 Avant A4 / S4 A4 / S4 Avant A4 / S4 / RS4 A4 / S4 / RS4 Avant A4 / S4 Cabriolet A4 / S4 / RS4 Cabriolet A4 / S4 A4 / S4 Avant A4 allroad A4 / S4 A4 / S4 / RS4 Avant A4 allroad	1995 – 2001 1996 – 2001 2001 – 2005 2001 – 2005 2005 – 2007 2005 – 2008 2002 – 2005 2005 – 2009 2007 – 2012 2008 – 2012 2009 – 2012 from 2012 from 2012 from 2012
 <b>Audi 200</b> Audi 200 / V8 Audi 200 Avant	1984 – 1991 1985 – 1991		
 <b>A1</b> A1 A1 e-tron A1 Sportback	from 2010 from 2011 from 2012		
 <b>A2</b> A2	2000 – 2005		

Continued on next page 

# Model Overview

## Audi

Model name	Model cycle	Model name	Model cycle
 <b>A5</b> A5 / S5 / RS5 A5 / S5 Cabriolet A5 / S5 Sportback A5 / S5 / RS5 A5 / S5 Cabriolet A5 / S5 Sportback	2007 – 2011 2009 – 2011 2009 – 2011 from 2011 from 2011 from 2011	 <b>Q3</b> Q3	from 2011
 <b>A6</b> A6 / S6 / RS6 A6 / S6 / RS6 Avant A6 allroad A6 / S6 / RS6 A6 / S6 / RS6 A6 / S6 / RS6 Avant A6 allroad A6 / S6 A6 Avant A6 allroad A6 hybrid	1997 – 2004 1998 – 2004 2001 – 2006 2004 – 2008 2008 – 2011 2004 – 2012 2006 – 2012 from 2011 from 2011 from 2012 from 2012	 <b>Q5</b> Q5 Q5 hybrid quattro	from 2008 from 2011
 <b>A7</b> A7	from 2010	 <b>Q7</b> Q7	from 2006
 <b>A8</b> A8 / S8 A8 / S8 A8 / S8 A8 hybrid	1994 – 2002 2002 – 2010 from 2010 from 2012	 <b>R8</b> R8 R8 Spyder	from 2007 from 2010
		 <b>TT</b> TT Coupé TT / TTS / TTRS Coupé TT Roadster TT / TTS / TTRS Roadster	1998 – 2006 from 2006 1999 – 2006 from 2007

**Legal Disclaimer:**

**This manual has been created exclusively for rescuers who have been specially trained in the area of providing emergency rescue after automobile accidents and who are therefore qualified to use the activities described in this manual. Furthermore, this manual shows the maximum possible equipment specification in the model overview.**

**Vehicle specifications and special options as well as Audi model availability are constantly subject to change. Therefore, Audi reserves the right to change the content of this manual at all times.**

**Please note: The information contained in this manual is not intended for customers or for repair shops and dealers. Customers may gather detailed information from their vehicle owner's manual regarding vehicle function as well as any occupant safety features and system descriptions. Repair shops and dealers obtain repair information through their normal channels.**

**(Status: 08/2013)**



**Hint:**

**The maximum possible equipment specification is always shown in the model overview.**

You will find "Rescue and Recovery involving Audi Vehicles" in a separate part of the same title.

The creation of this Rescue Data sheets is supported by Moditech Rescue Solutions ([www.moditech.com](http://www.moditech.com)). The vehicle overviews in the attachment are also included in interactive form in the data base "Crash Recovery System".







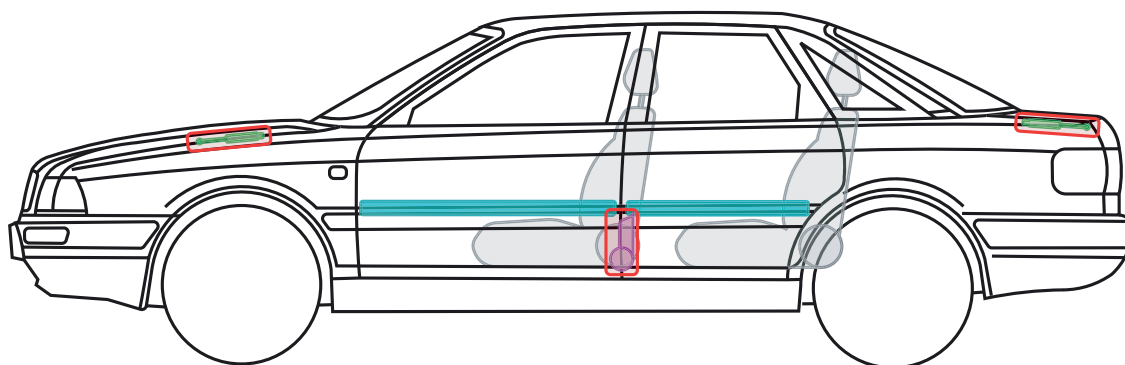
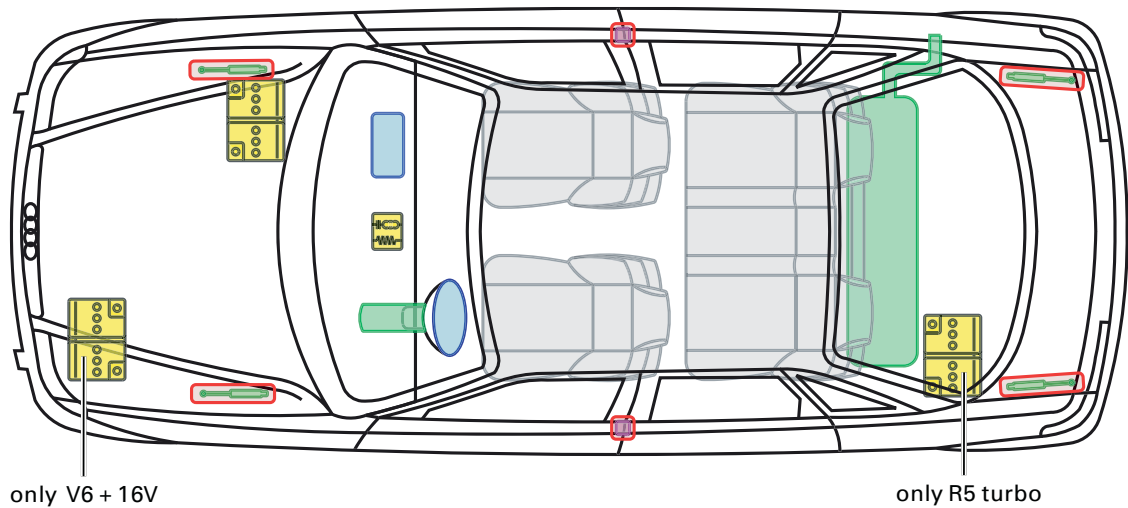

▶ Audi 80 / S2

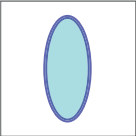
1990 – 1995

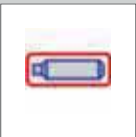

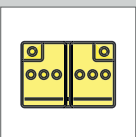
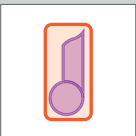
Legend

	Airbag		Reinforce- ment		Control module
	Gas generator		Rollover protection		Battery
	Pre-tensioner		Gas-pressure damper		Fuel tank

80 +S2 Limousine







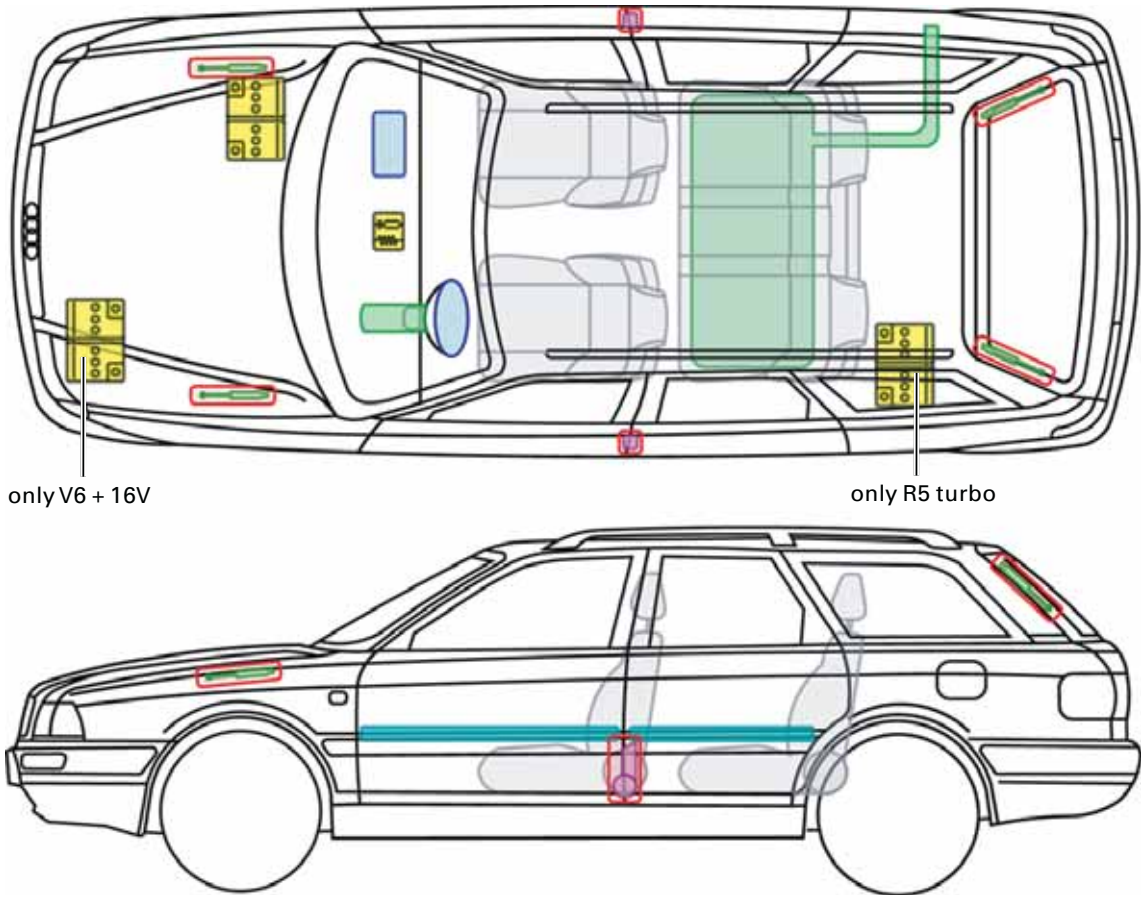

▶ Audi 80 / S2 / RS2 Avant

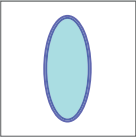
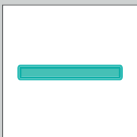
1992 – 1995

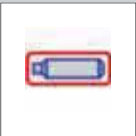

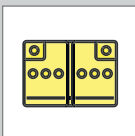
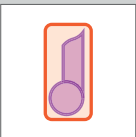
Legend

	Airbag		Reinforcement		Control module
	Gas generator		Rollover protection		Battery
	Pre-tensioner		Gas-pressure damper		Fuel tank

+S2/RS2 Avant

80







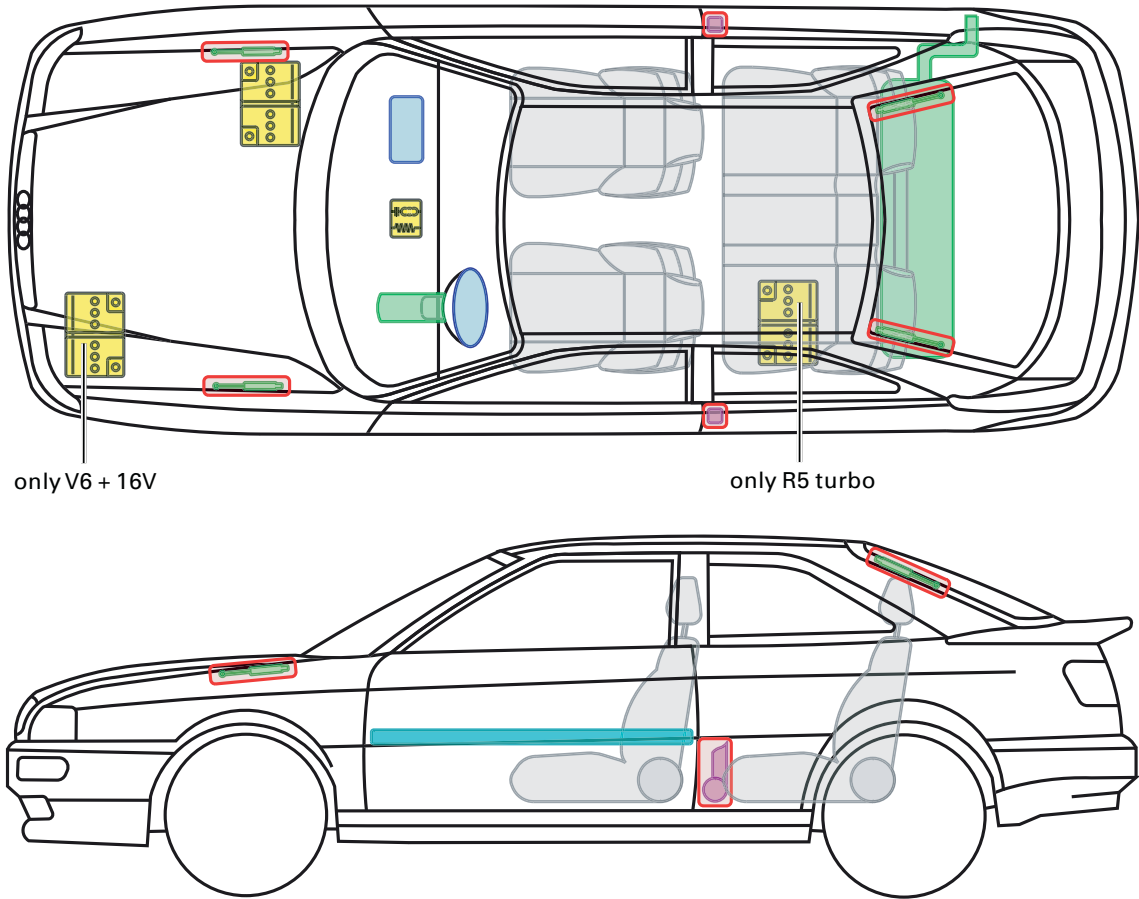

▶ Audi 80 / S2 Coupé

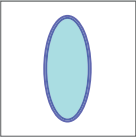
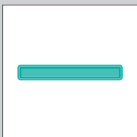
1988 – 1996

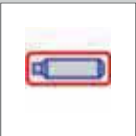

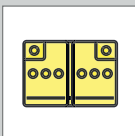
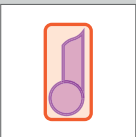
Legend

	Airbag		Reinforcement		Control module
	Gas generator		Rollover protection		Battery
	Pre-tensioner		Gas-pressure damper		Fuel tank

80 +S2 Coupé





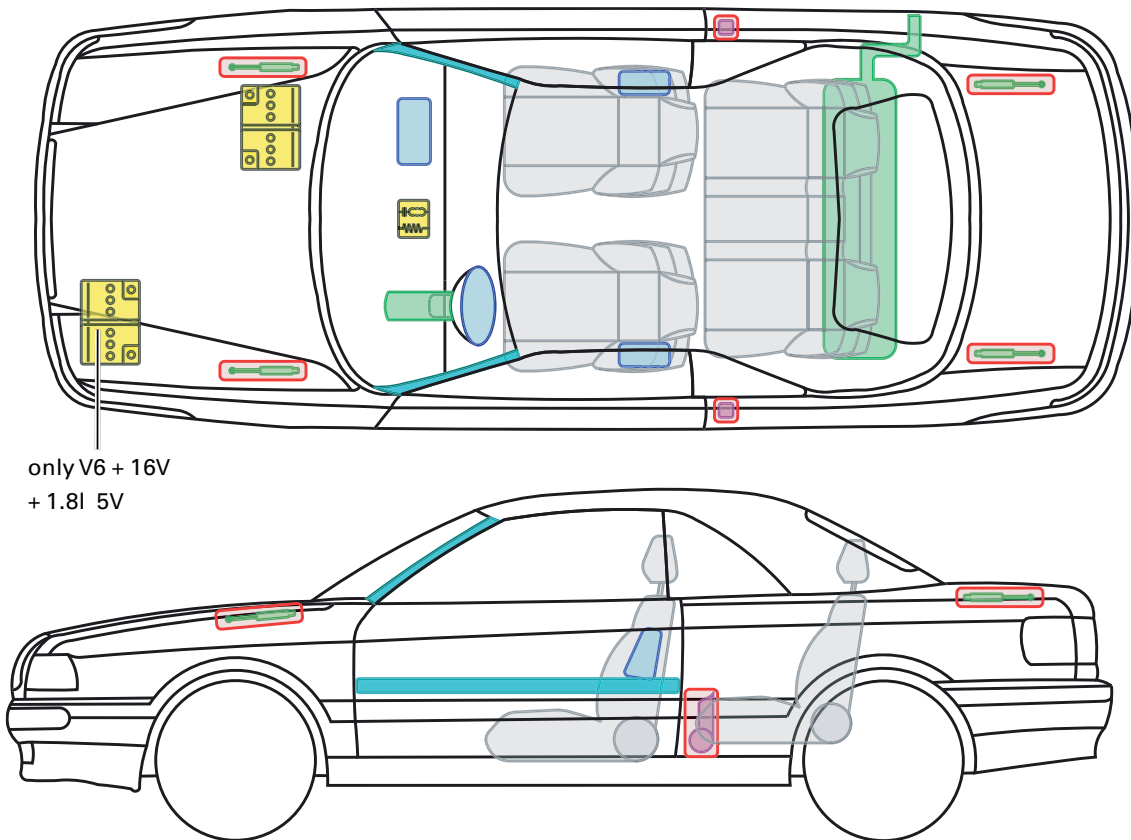

# Audi 80 Cabriolet

1991 – 2000

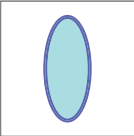
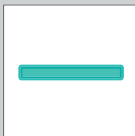
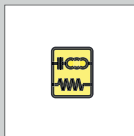

only V6 + 16V  
+ 1.8l 5V

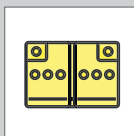
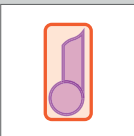
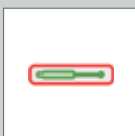
## Legend

	Airbag		Reinforce- ment		Control module
	Gas generator		Rollover protection		Battery
	Pre-tensioner		Gas-pressure damper		Fuel tank







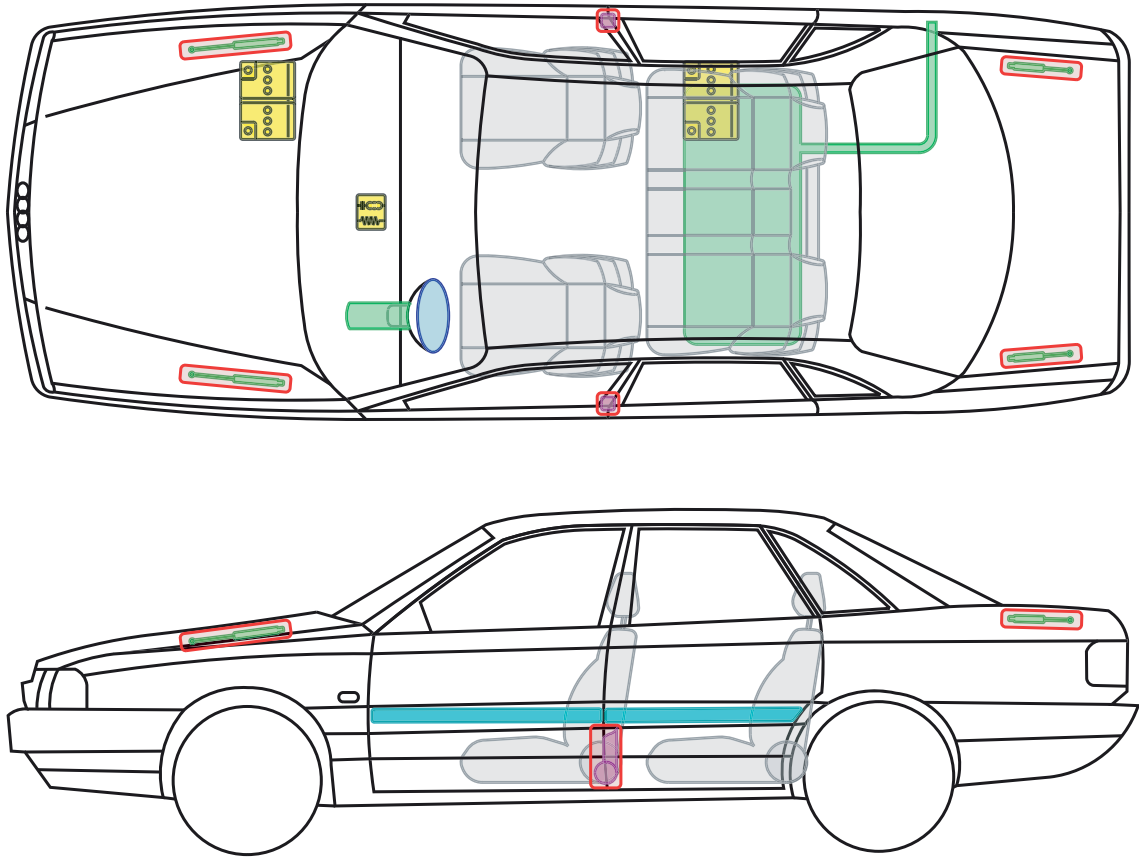

# Audi 100

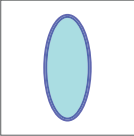
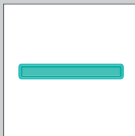
1988 – 1991

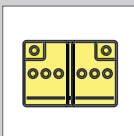
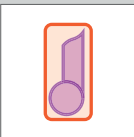
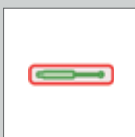

## Legend

	Airbag		Reinforcement		Control module
	Gas generator		Rollover protection		Battery
	Pretensioner		Gas-pressure damper		Fuel tank

100 Limousine





▶ Audi 100 Avant

1988 – 1991

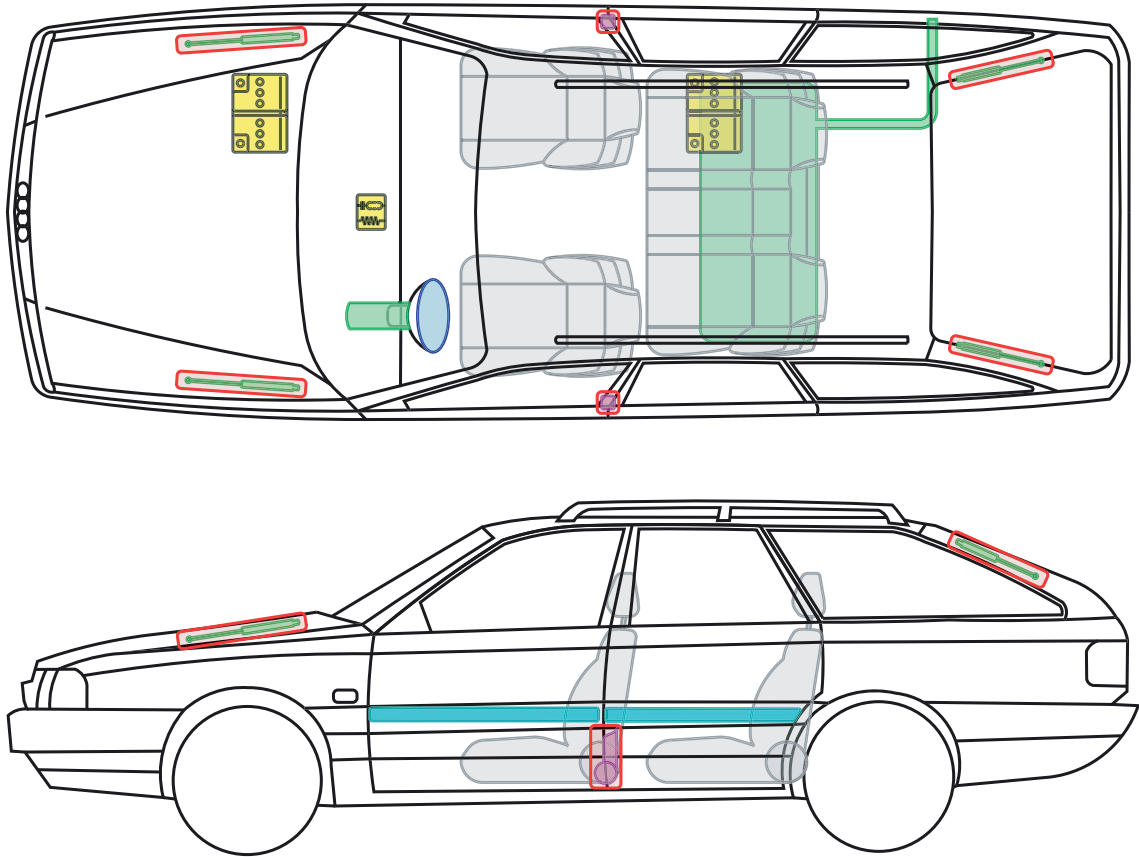

Legend

	Airbag		Reinforce-ment		Control module
	Gas generator		Rollover protection		Battery
	Pre-tensioner		Gas-pressure damper		Fuel tank





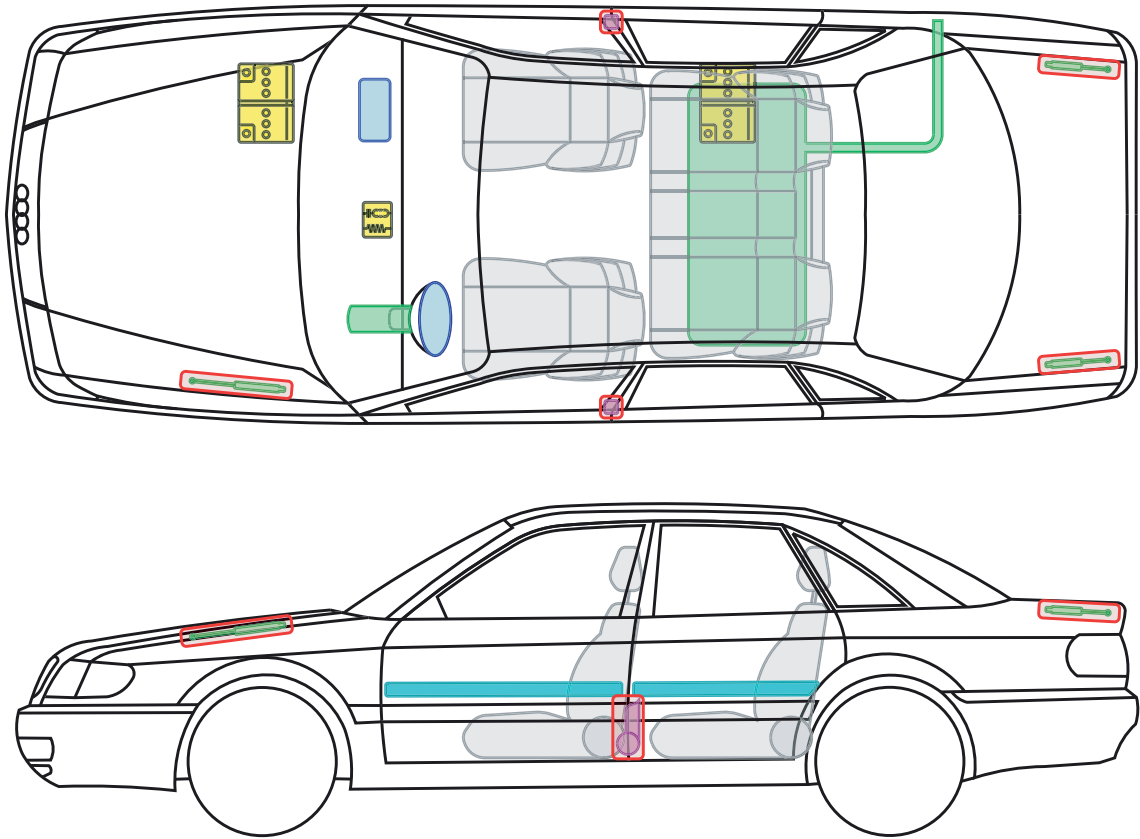

100 Avant

▶ Audi 100 / A6 / S6

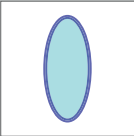
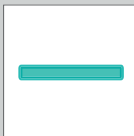
1991 – 1997

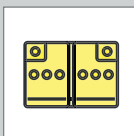
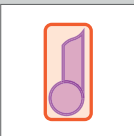
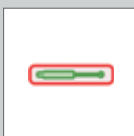

Legend

	Airbag		Reinforce- ment		Control module
	Gas generator		Rollover protection		Battery
	Preten- sioner		Gas-pressure damper		Fuel tank

100 +A6/S6 Limousine







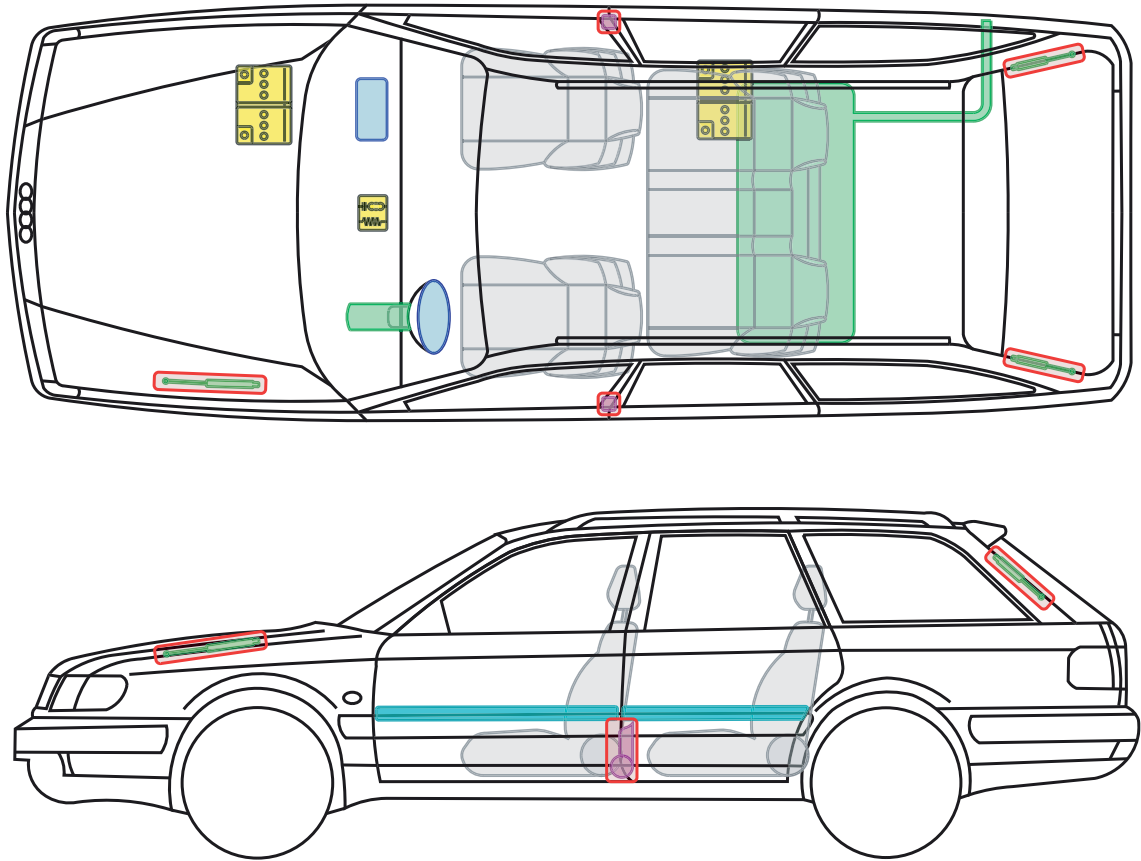

▶ Audi 100 / A6 / S6 Avant

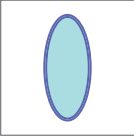
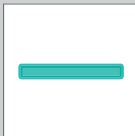
1991 – 1997

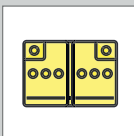
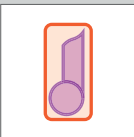
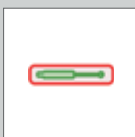

Legend

	Airbag		Reinforcement		Control module
	Gas generator		Rollover protection		Battery
	Pre-tensioner		Gas-pressure damper		Fuel tank

100 +A6/S6 Avant







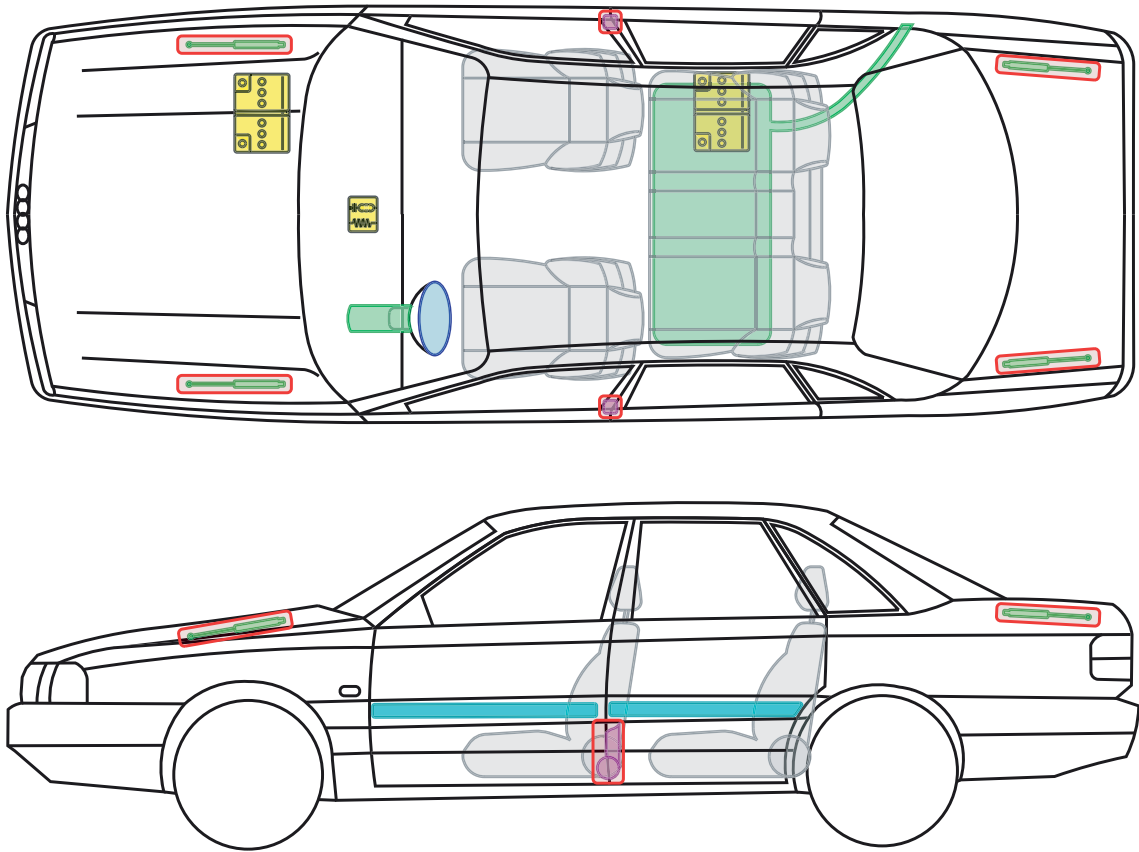

▶ Audi 200 / V8

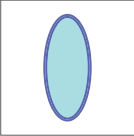
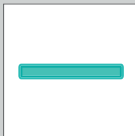
1984 – 1991

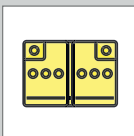
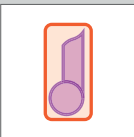
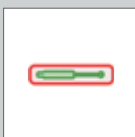

Legend

	Airbag		Reinforcement		Control module
	Gas generator		Rollover protection		Battery
	Pre-tensioner		Gas-pressure damper		Fuel tank

200 +V8 Limousine





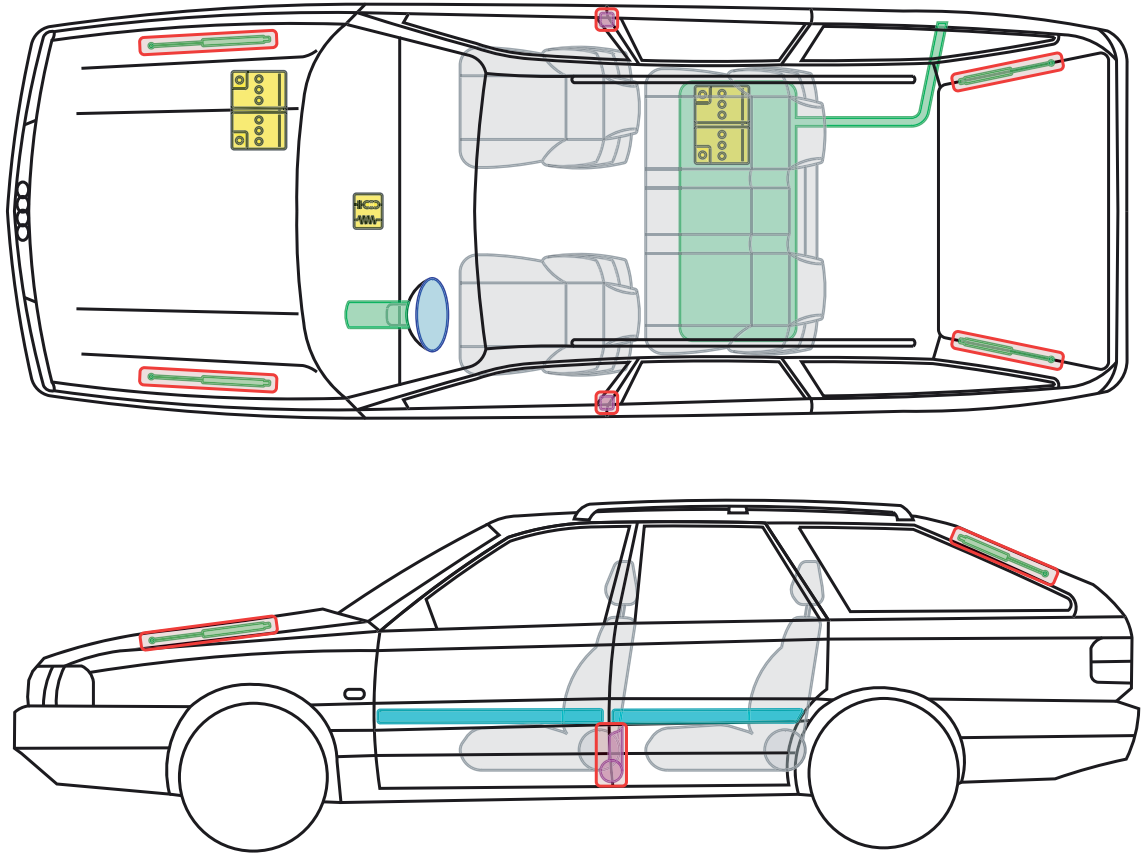

▶ Audi 200 Avant

1985 – 1991

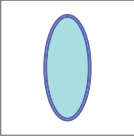
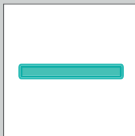
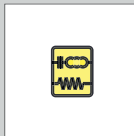

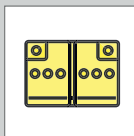
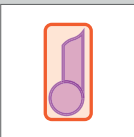
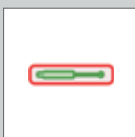
Legend

	Airbag		Reinforcement		Control module
	Gas generator		Rollover protection		Battery
	Pre-tensioner		Gas-pressure damper		Fuel tank





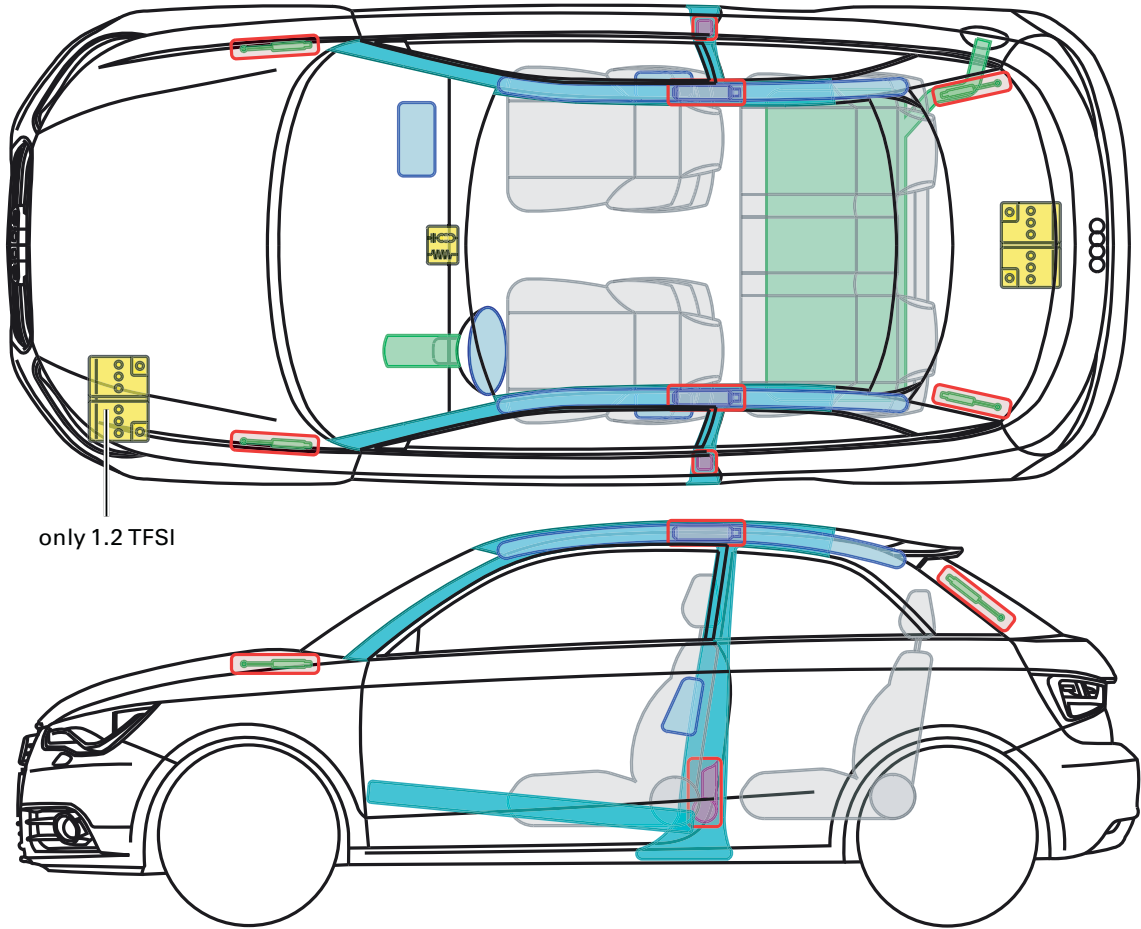

# Audi A1

from 2010

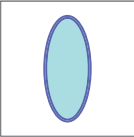
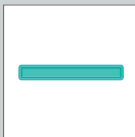
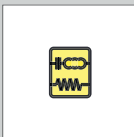

only 1.2 TFSI

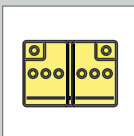
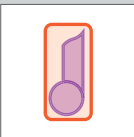
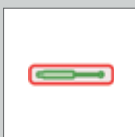
## Legend

	Airbag		Reinforcement		Control module
	Gas generator		Rollover protection		Battery
	Pre-tensioner		Gas-pressure damper		Fuel tank

A1 Limousine







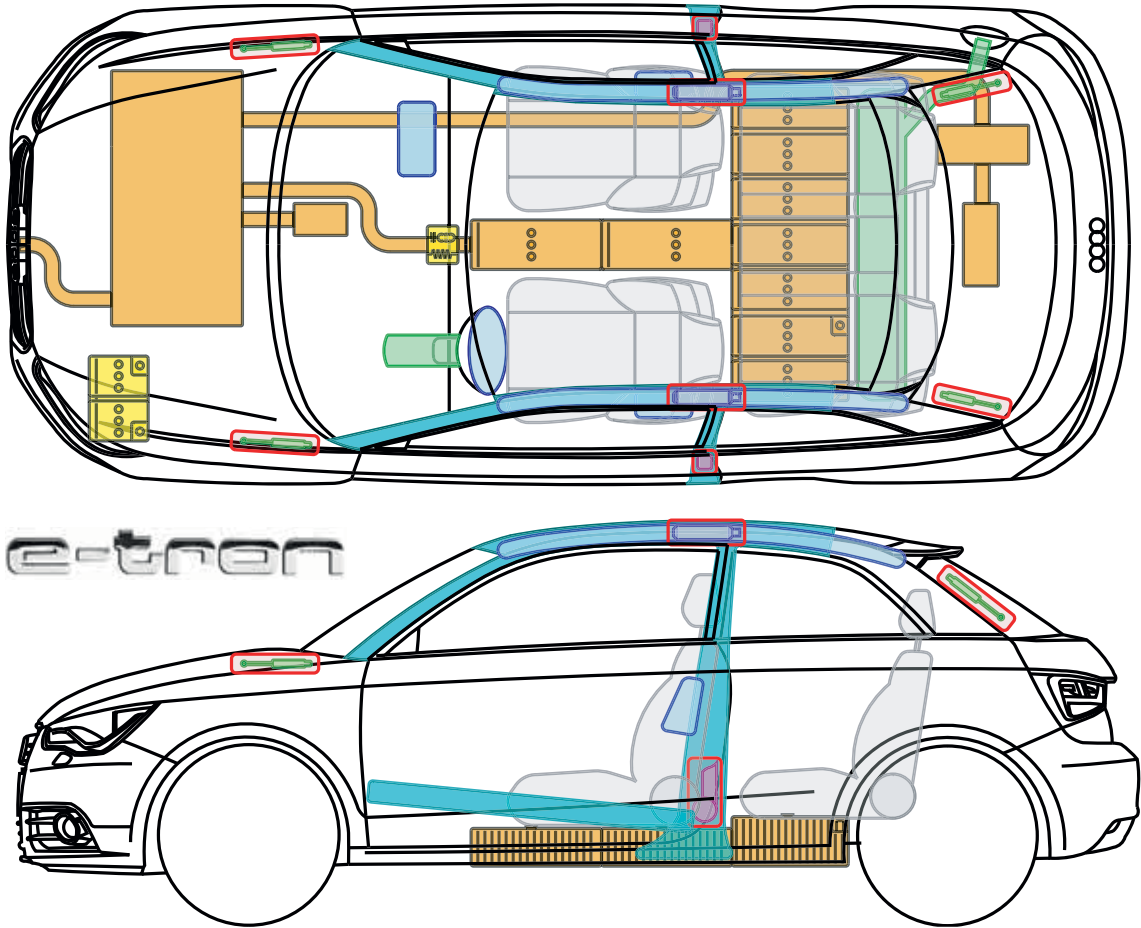

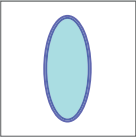

▶ Audi A1 e-tron

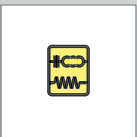
from 2011

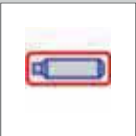

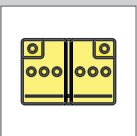
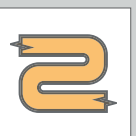
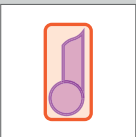
Legende

	Airbag		Reinforcement		Control module		High-voltage battery
	Gas generator		Rollover protection		12 V battery		High-voltage leads/components
	Pretensioner		Gas-pressure damper		Fuel tank		

A1 e-tron



# ▶ Audi A1 e-tron

from 2011

## Identifying feature

The Audi A1 e-tron can be identified by means of the „e-tron“ logo on the instrument cluster or on the wing.



Instrument cluster



Wing

## Hints

**⚠ In the case of accidents in which the pyrotechnic belt tensioners or airbags are deployed, the high-voltage system is deactivated. If the vehicle is connected to the charging point / socket, the charging cable is to be disconnected.**

In the case of accidents with deployed / undeployed airbags

- ▶ Place Vehicle in Park and set parking brake
- ▶ Switch off the ignition
- ▶ Disconnect the negative terminal of the 12V battery

**⚠ The electric motor is silent!**



It may not be possible to detect that the car is ready to go by the noises it makes when in operation, as the electric motor is silent. If the large needle in the dial on the left of the instrument cluster (power metre) is not on „OFF“ (for example on the „READY“ position), you have to expect that the electric motor may run or the internal combustion engine may start automatically.

## Identification of the high-voltage components

Identification of the high-voltage battery



Identification of the high-voltage battery is located underneath the vehicle, below the transmission tunnel and the rear seat.

It is a lithium-ion battery.

Identification of the remaining high-voltage components



All the high-voltage leads and the high-voltage connections are provided with orange insulation. These items must not be disconnected or damaged.







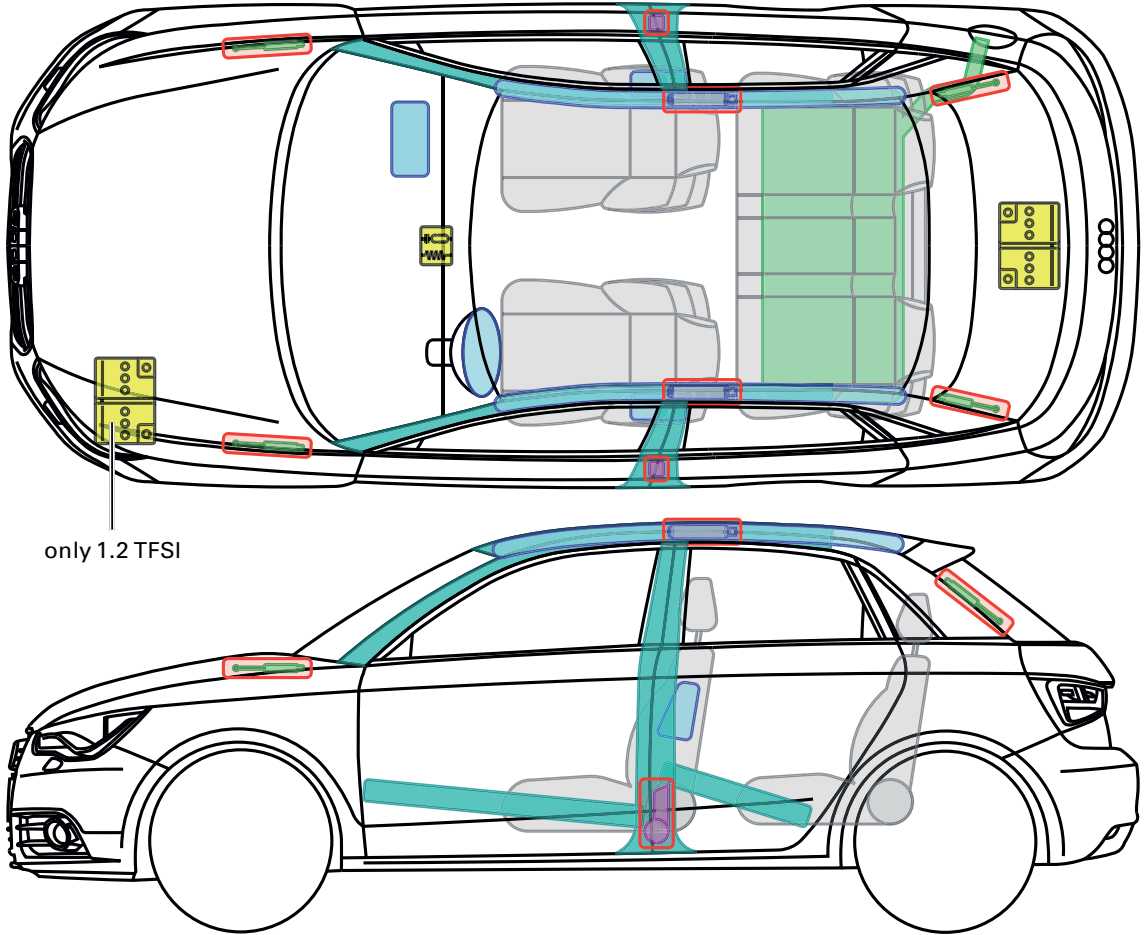

▶ Audi A1 Sportback

from 2012

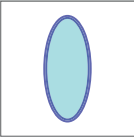
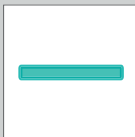
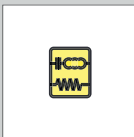

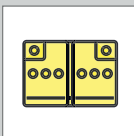
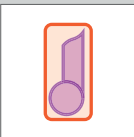
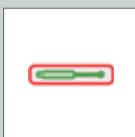
Legend

	Airbag		Reinforcement		Control module
	Gas generator		Rollover protection		Battery
	Pre-tensioner		Gas-pressure damper		Fuel tank

A1 Limousine





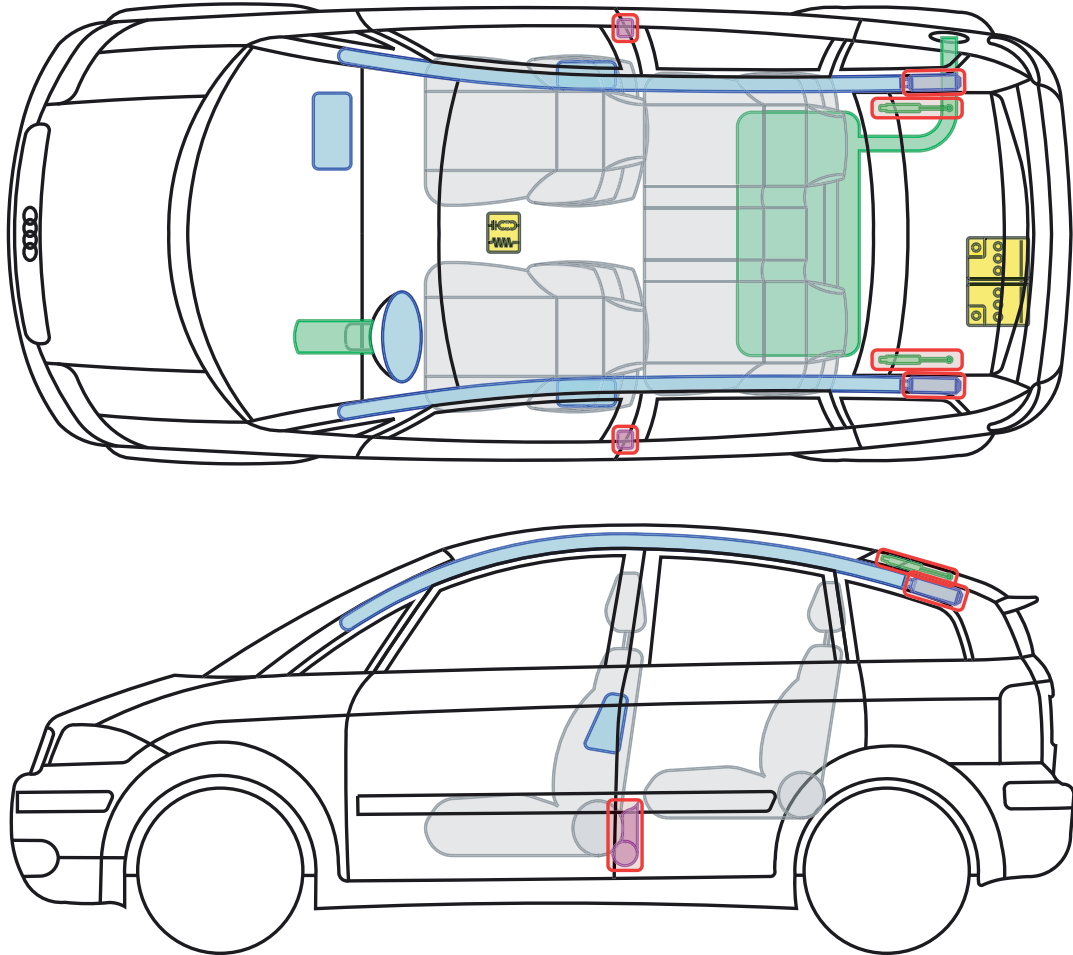

# Audi A2

2000 – 2005

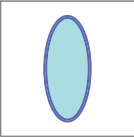
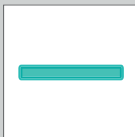
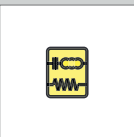

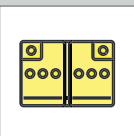
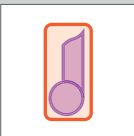
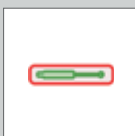
## Legend

	Airbag		Reinforcement		Control module
	Gas generator		Rollover protection		Battery
	Pre-tensioner		Gas-pressure damper		Fuel tank

A2 Limousine





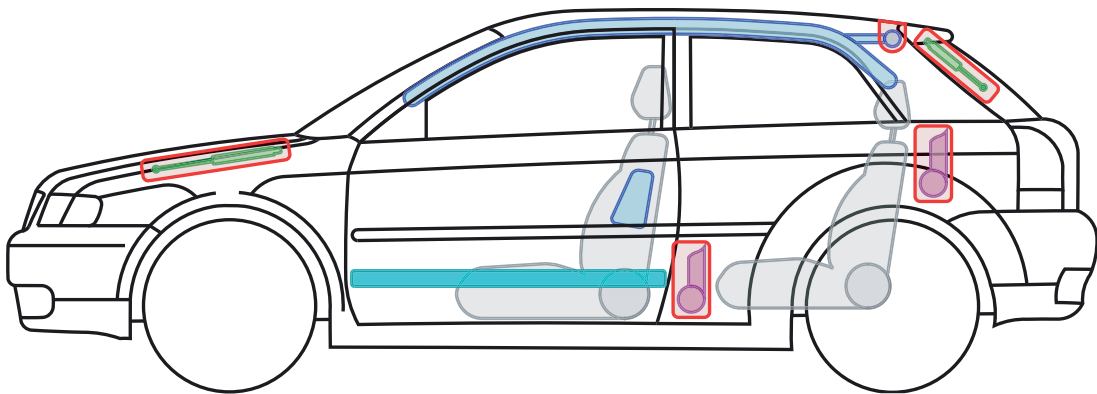
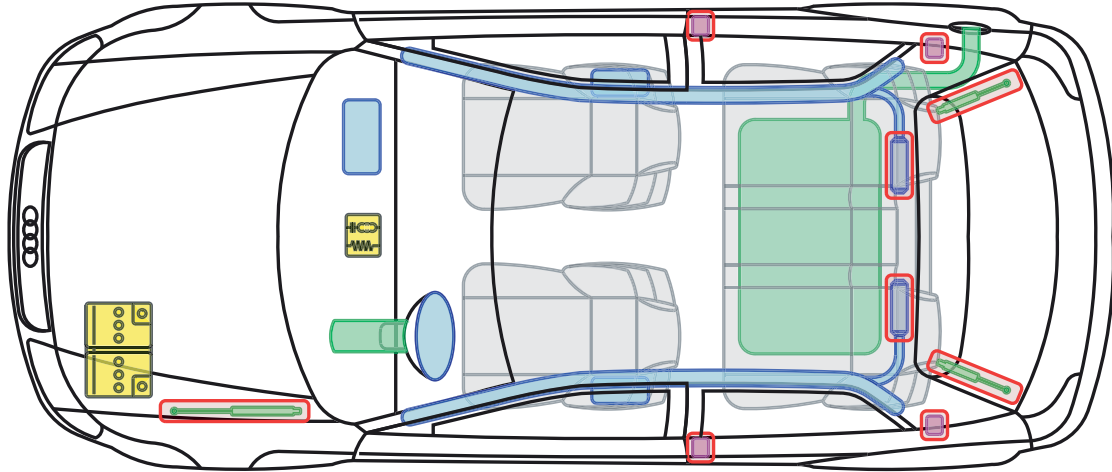

▶ Audi A3 / S3 (3-door)

1996 – 2003

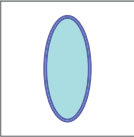
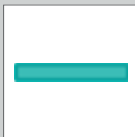
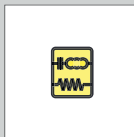

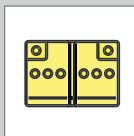
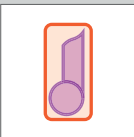
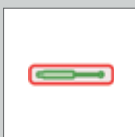
Legende

	Airbag		Reinforce- ment		Control module
	Gas generator		Rollover protection		Battery
	Pre-ten- sioner		Gas-pressure damper		Fuel tank

A3  
+S3 (3-door)





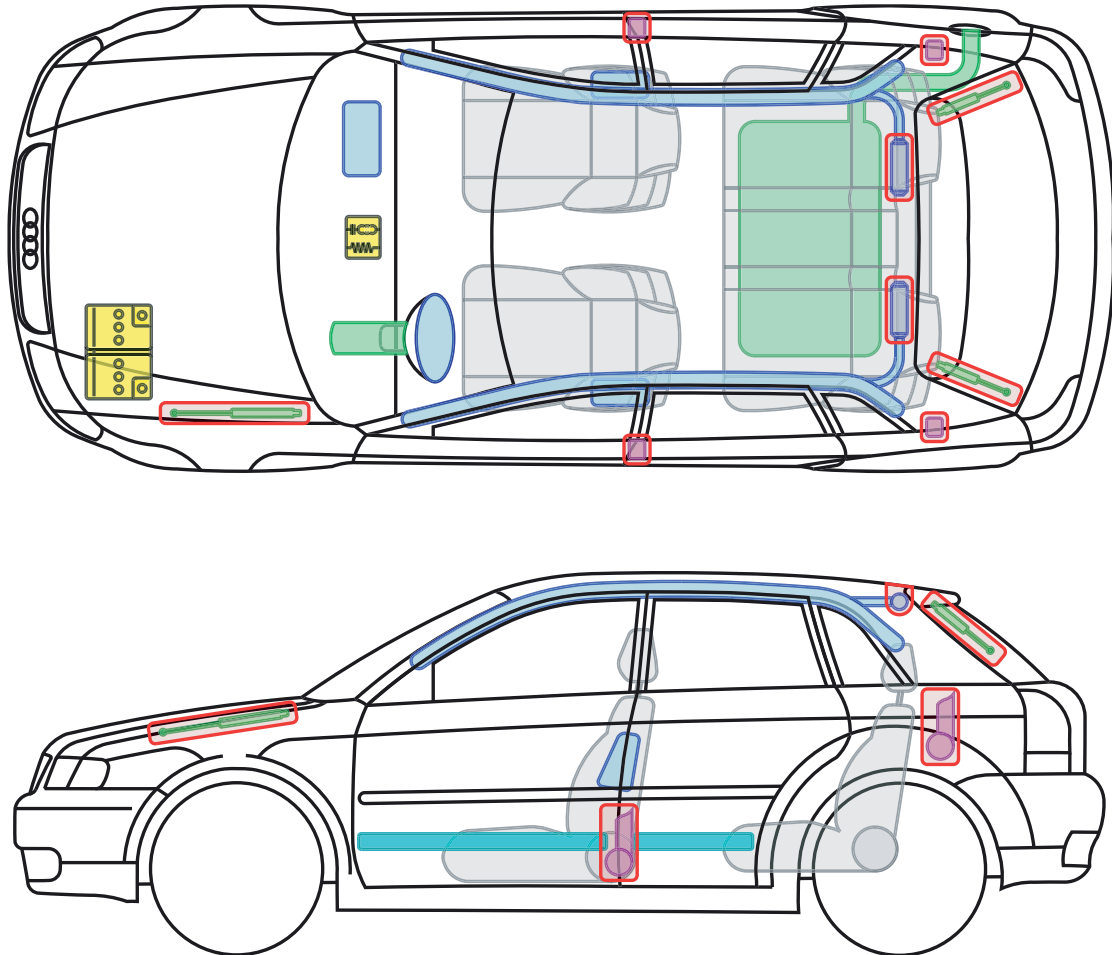

▶ Audi A3 (5-door)

1999 – 2003

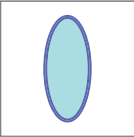
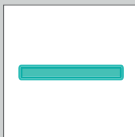
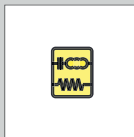

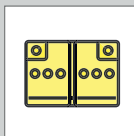
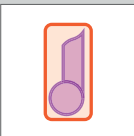
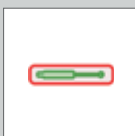
Legend

	Airbag		Reinforcement		Control module
	Gas generator		Rollover protection		Battery
	Pre-tensioner		Gas-pressure damper		Fuel tank

A3 (5-door)





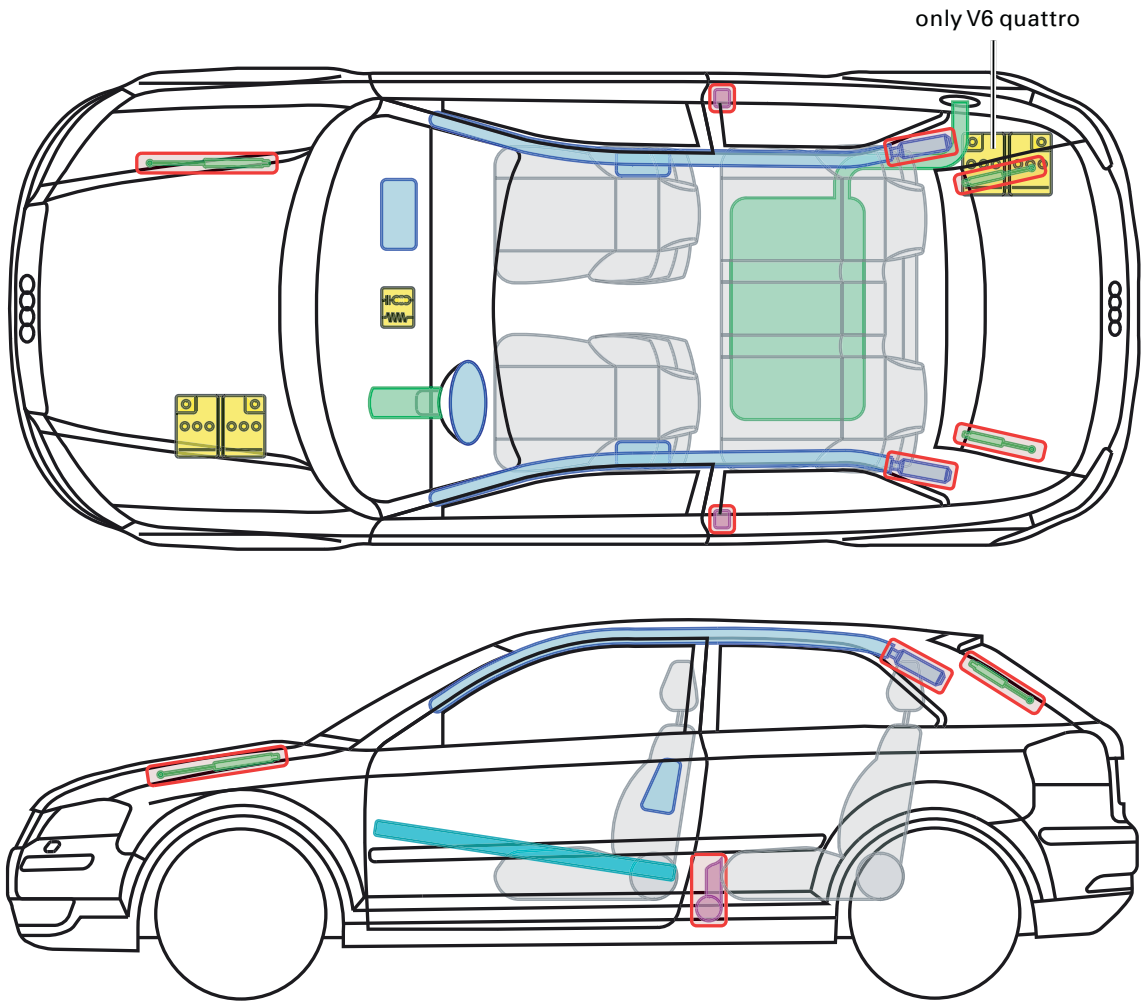

▶ Audi A3 / S3 (3-door)

2003 – 2012

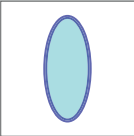
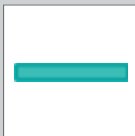
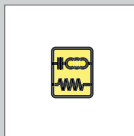

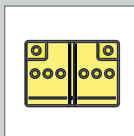
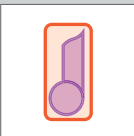
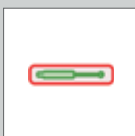
Legend

	Airbag		Reinforcement		Control module
	Gas generator		Rollover protection		Battery
	Pretensioner		Gas-pressure damper		Fuel tank

A3 +S3 (3-door)







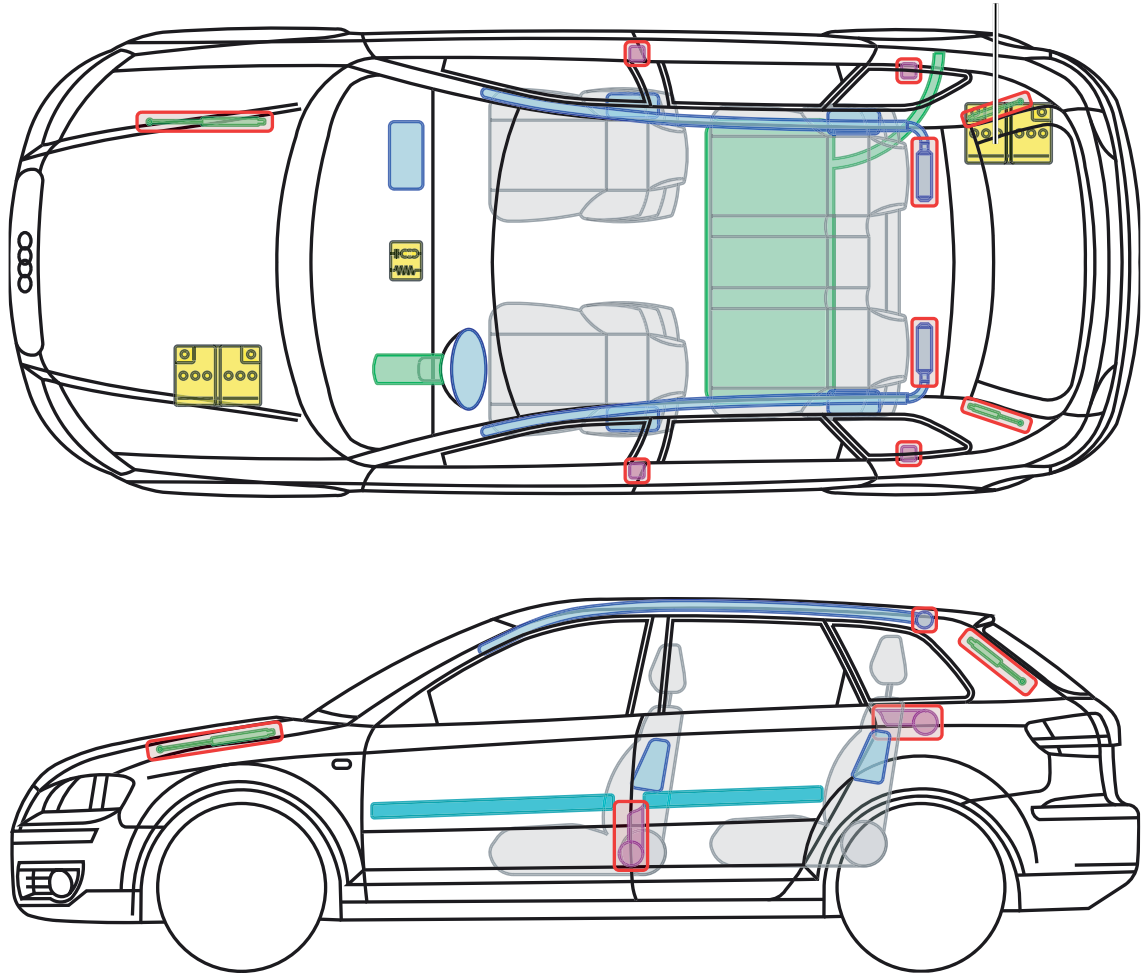

▶ Audi A3 / S3 / RS3 Sportback

2004 – 2012

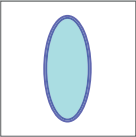
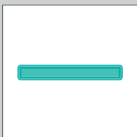
only V6 quattro + RS3

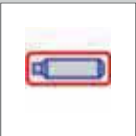

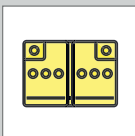
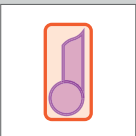
Legend

	Airbag		Reinforcement		Control module
	Gas generator		Rollover protection		Battery
	Pre-tensioner		Gas-pressure damper		Fuel tank

A3 +S3/RS3 Sportback







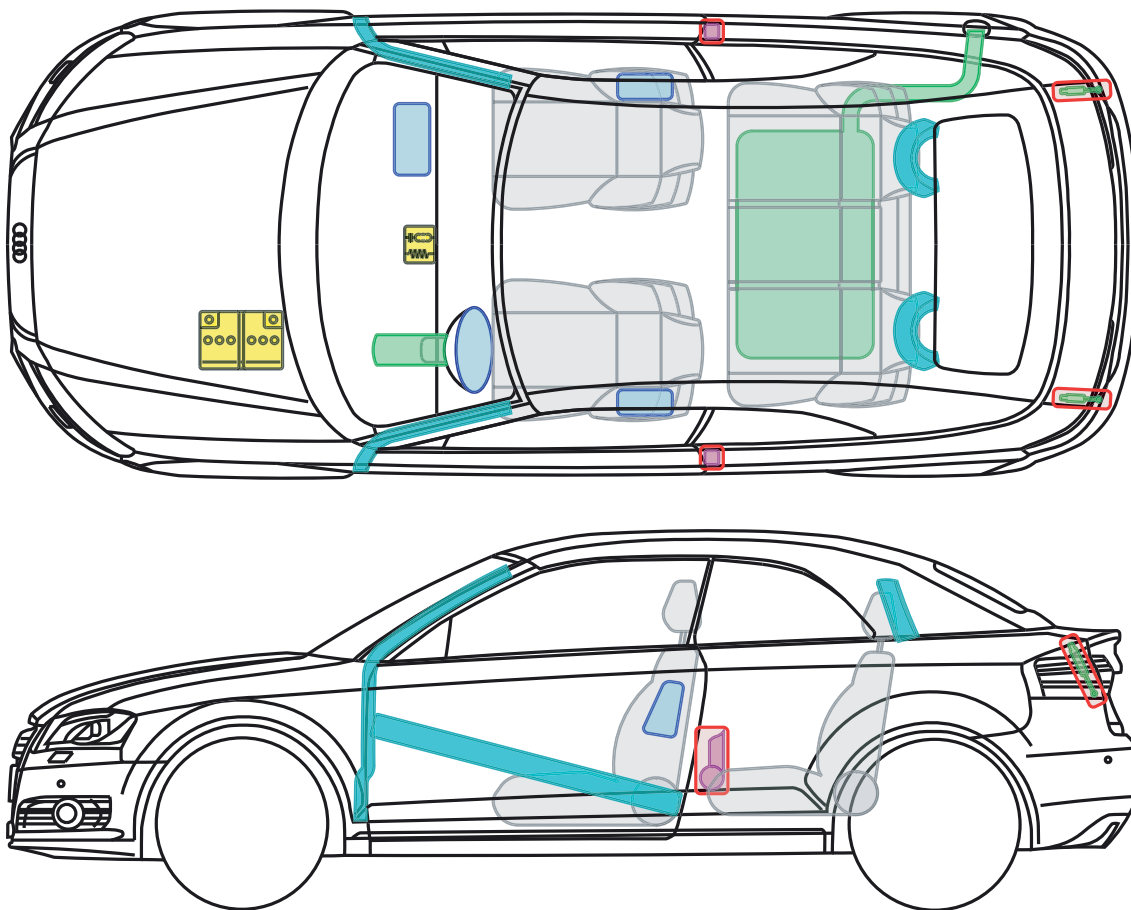

▶ Audi A3 Cabriolet

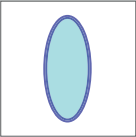
from 2008

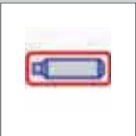

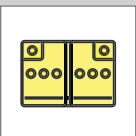
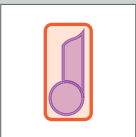
Legend

	Airbag		Reinforcement		Control module
	Gas generator		Rollover protection		Battery
	Pretensioner		Gas-pressure damper		Fuel tank

A3 Cabriolet





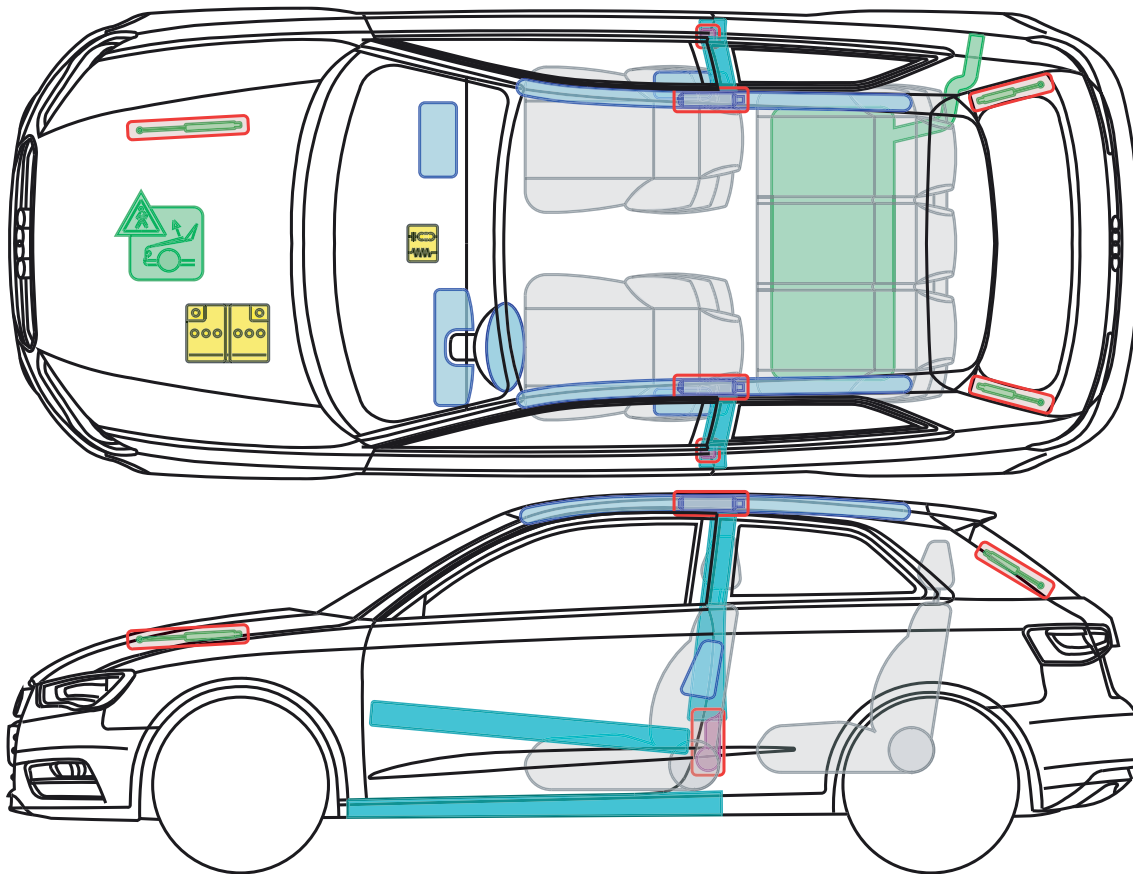

▶ Audi A3 / S3 (3-door)

from 2012

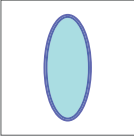
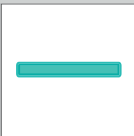
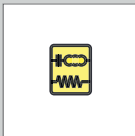
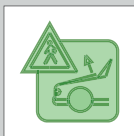
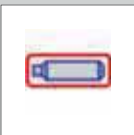

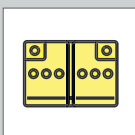
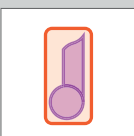
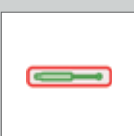
**Legend**

	Airbag		Reinforcement		Control module		Pedestrian protection system
	Gas generator		Overroll protection		12 V battery		
	Pre-tensioner		Gas pressure damper		Fuel tank		

+S3 (3-door)

A3







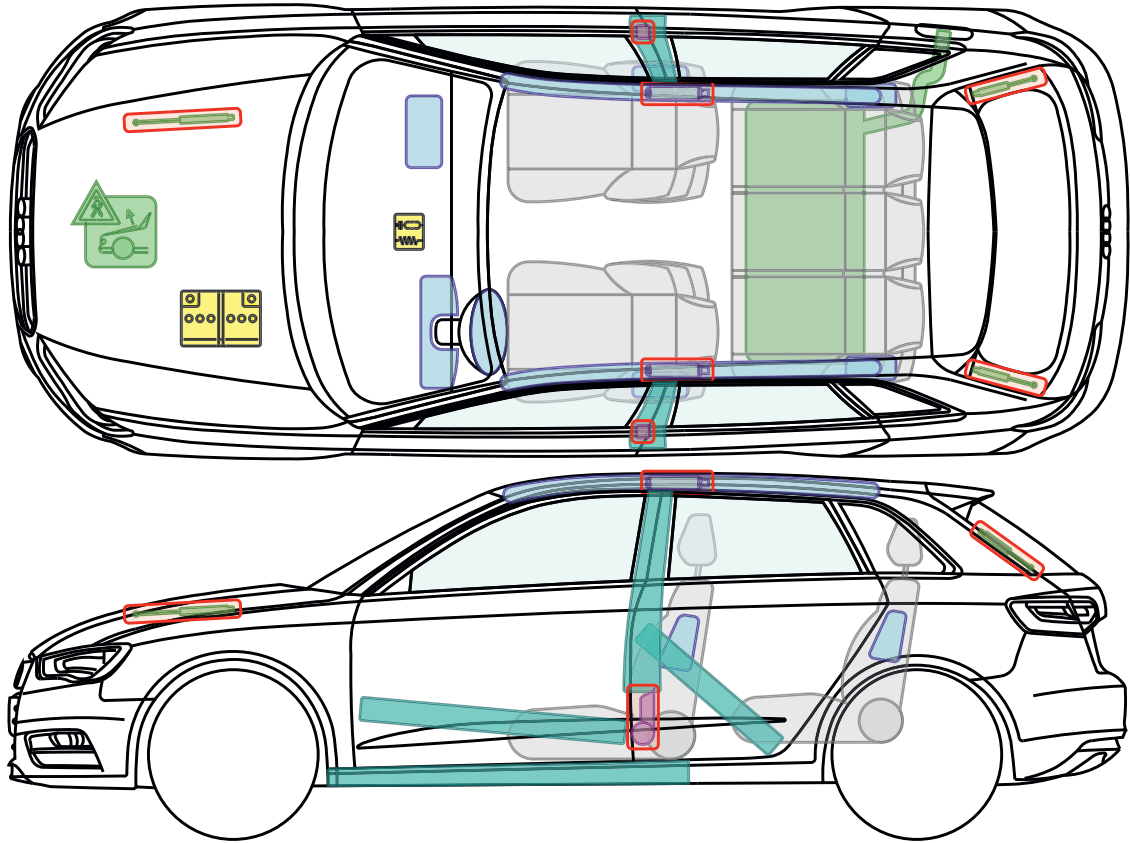

▶ Audi A3 / S3 Sportback

from 2012

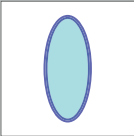
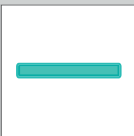
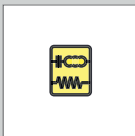
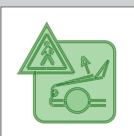
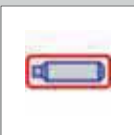

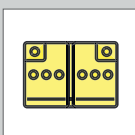
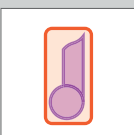
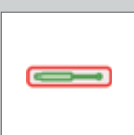
Legend

	Airbag		Reinforcement		Control module		Pedestrian protection system
	Gas generator		Overroll protection		12 V battery		
	Pre-tensioner		Gas pressure damper		Fuel tank		

A3 +S3 Sportback



▶ Audi A3 / S3 Limousine

from 2013

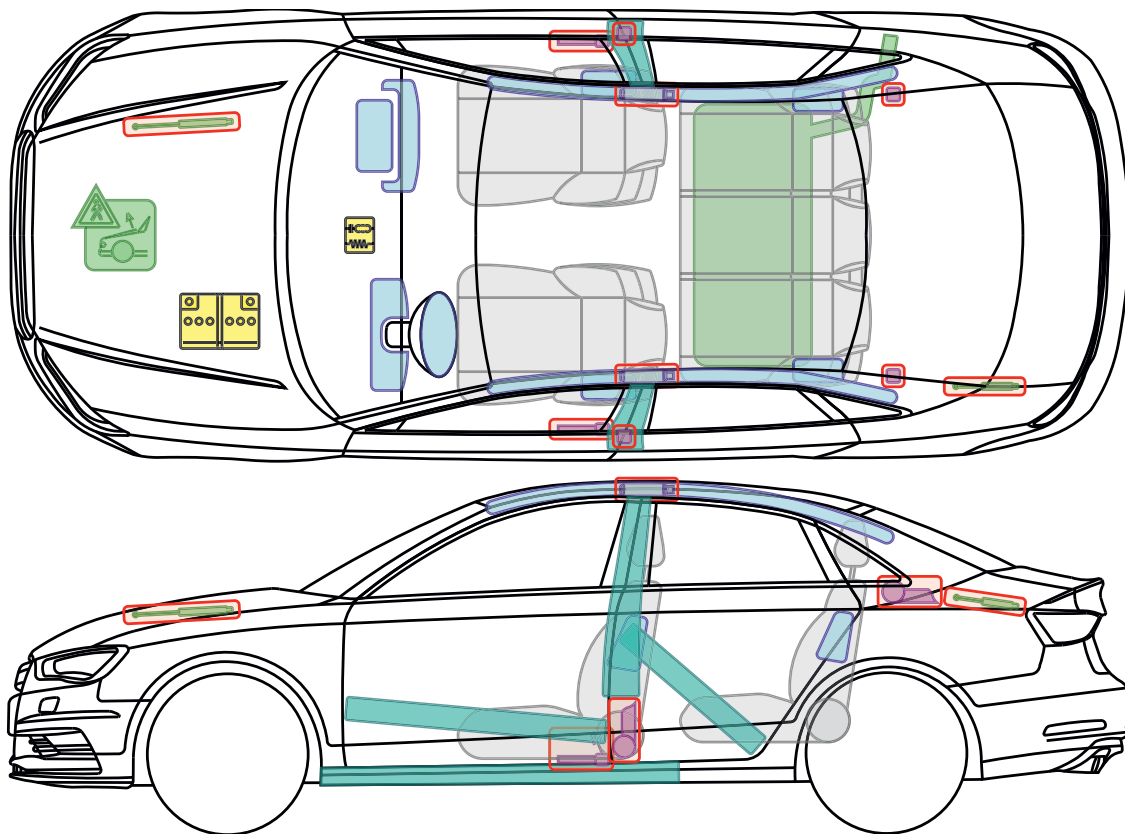

Legend

	Airbag		Reinforcement		Control module		Pedestrian protection system
	Gas generator		Overroll protection		12 V battery		
	Pretensioner		Gaspressure damper		Fuel tank		

A3 +S3 Limousine







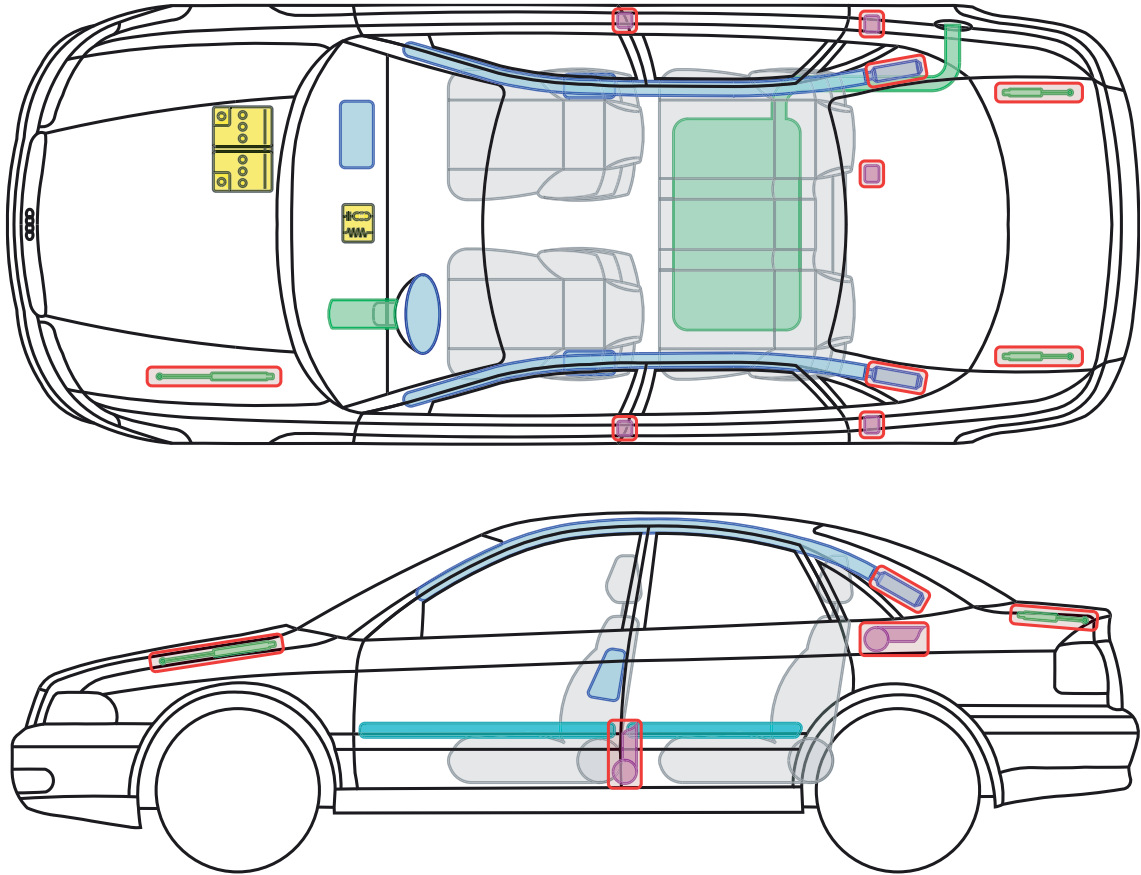

▶ Audi A4 / S4

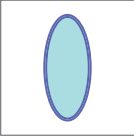
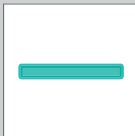
1995 – 2001

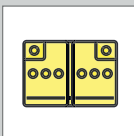
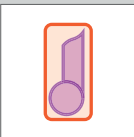
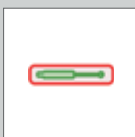

Legend

	Airbag		Reinforcement		Control module
	Gas generator		Rollover protection		Battery
	Pre-tensioner		Gas-pressure damper		Fuel tank

A4 +S4 Limousine







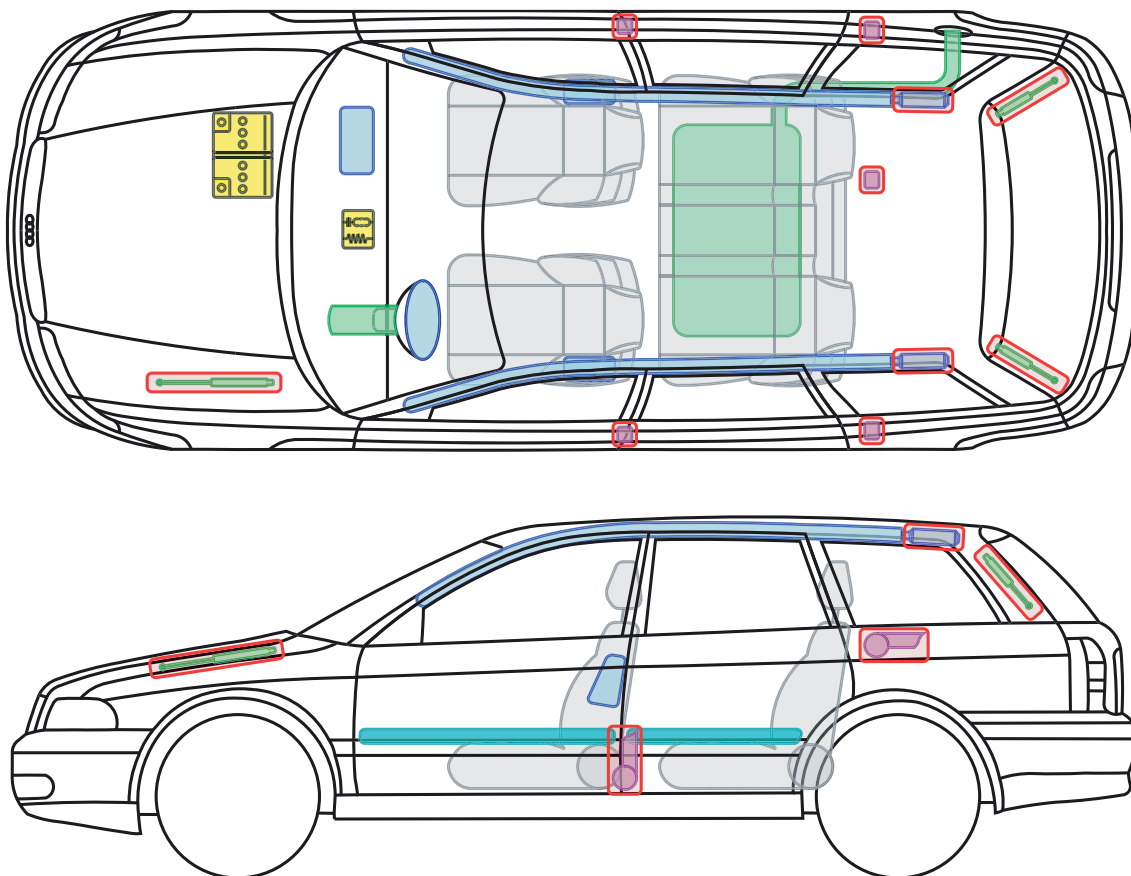

▶ Audi A4 / S4 / RS4 Avant

1996 – 2001

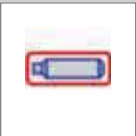

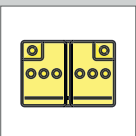
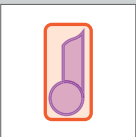
Legend

	Airbag		Reinforcement		Control module
	Gas generator		Rollover protection		Battery
	Pre-tensioner		Gas-pressure damper		Fuel tank

A4 +S4/RS4 Avant







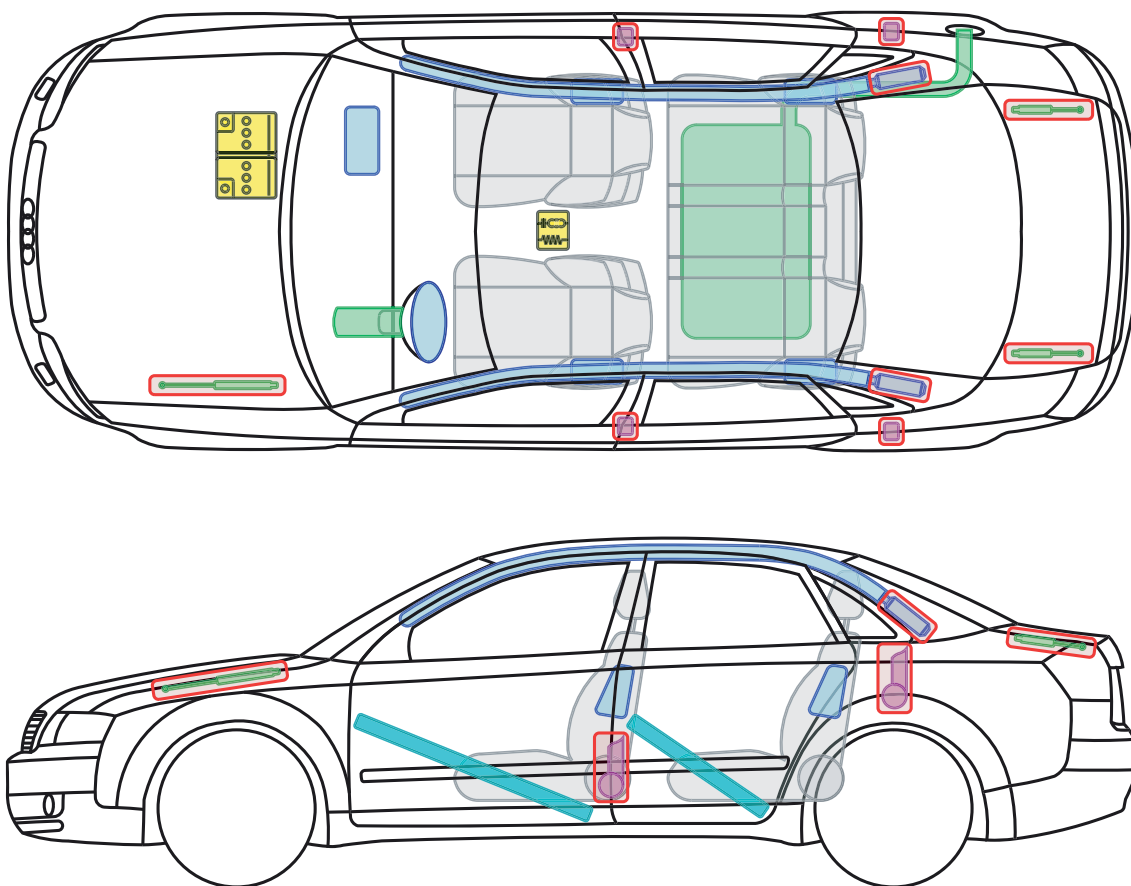

▶ Audi A4 / S4

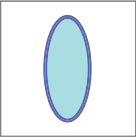
2001 – 2005

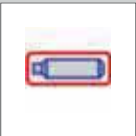

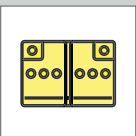
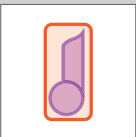
Legend

	Airbag		Reinforce-ment		Control module
	Gas generator		Rollover protection		Battery
	Pre-tensioner		Gas-pressure damper		Fuel tank

A4 +S4 Limousine







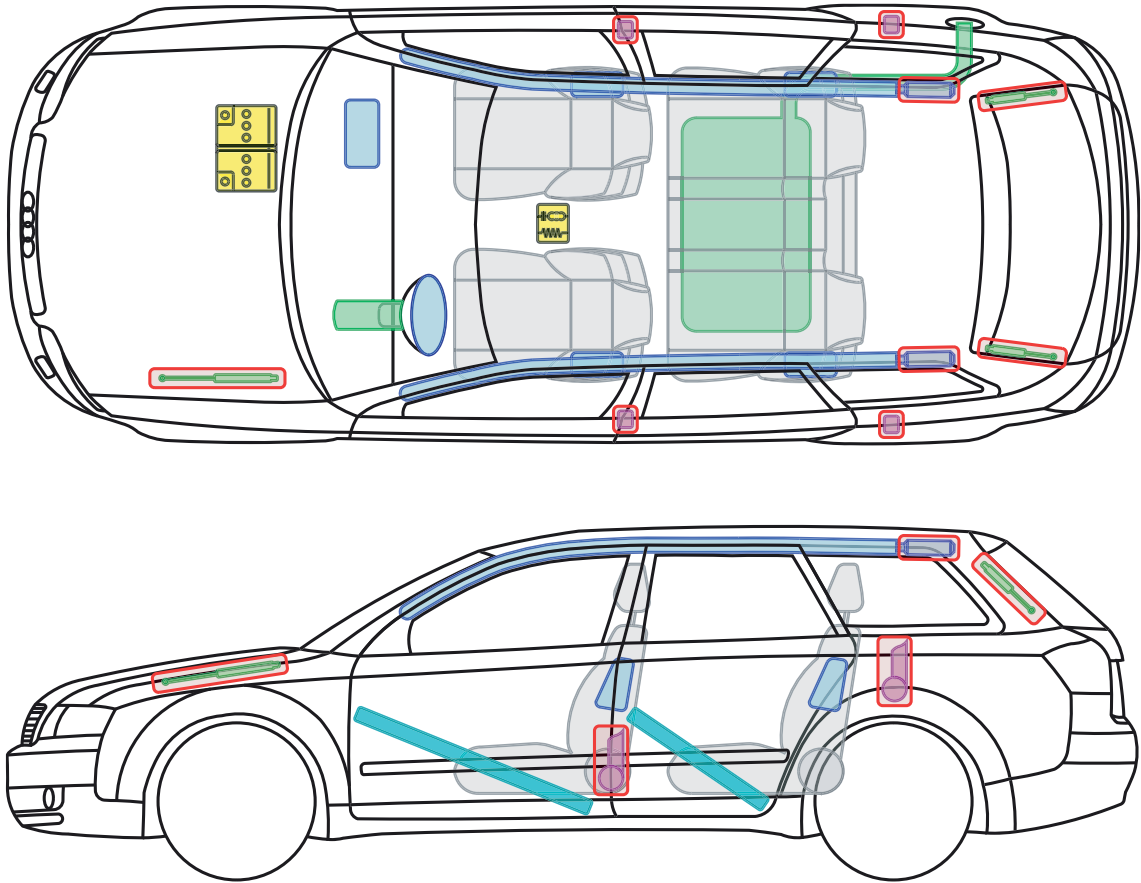

▶ Audi A4 / S4 Avant

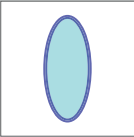
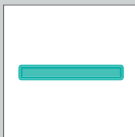
2001 – 2005

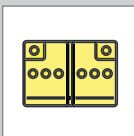
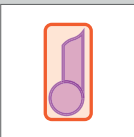
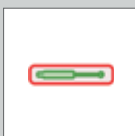

Legend

	Airbag		Reinforcement		Control module
	Gas generator		Rollover protection		Battery
	Pre-tensioner		Gas-pressure damper		Fuel tank

A4 +S4 Avant





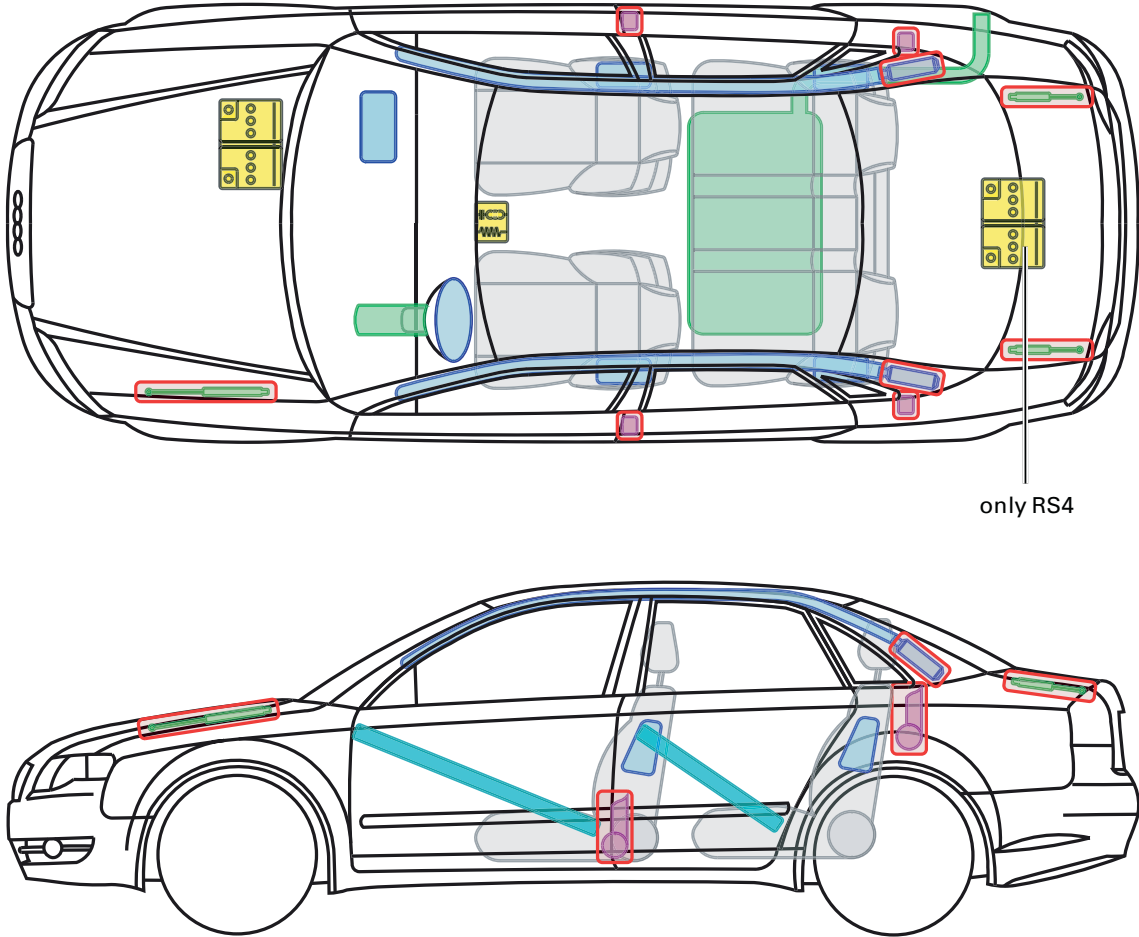

▶ Audi A4 / S4 / RS4

2005 – 2007

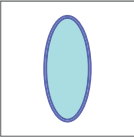
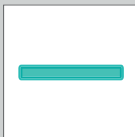
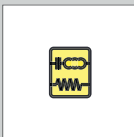

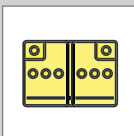
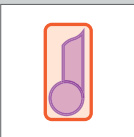
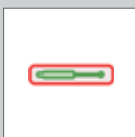
Legend

	Airbag		Reinforcement		Control module
	Gas generator		Rollover protection		Battery
	Pre-tensioner		Gas-pressure damper		Fuel tank

A4 +S4/RS4 Limous.





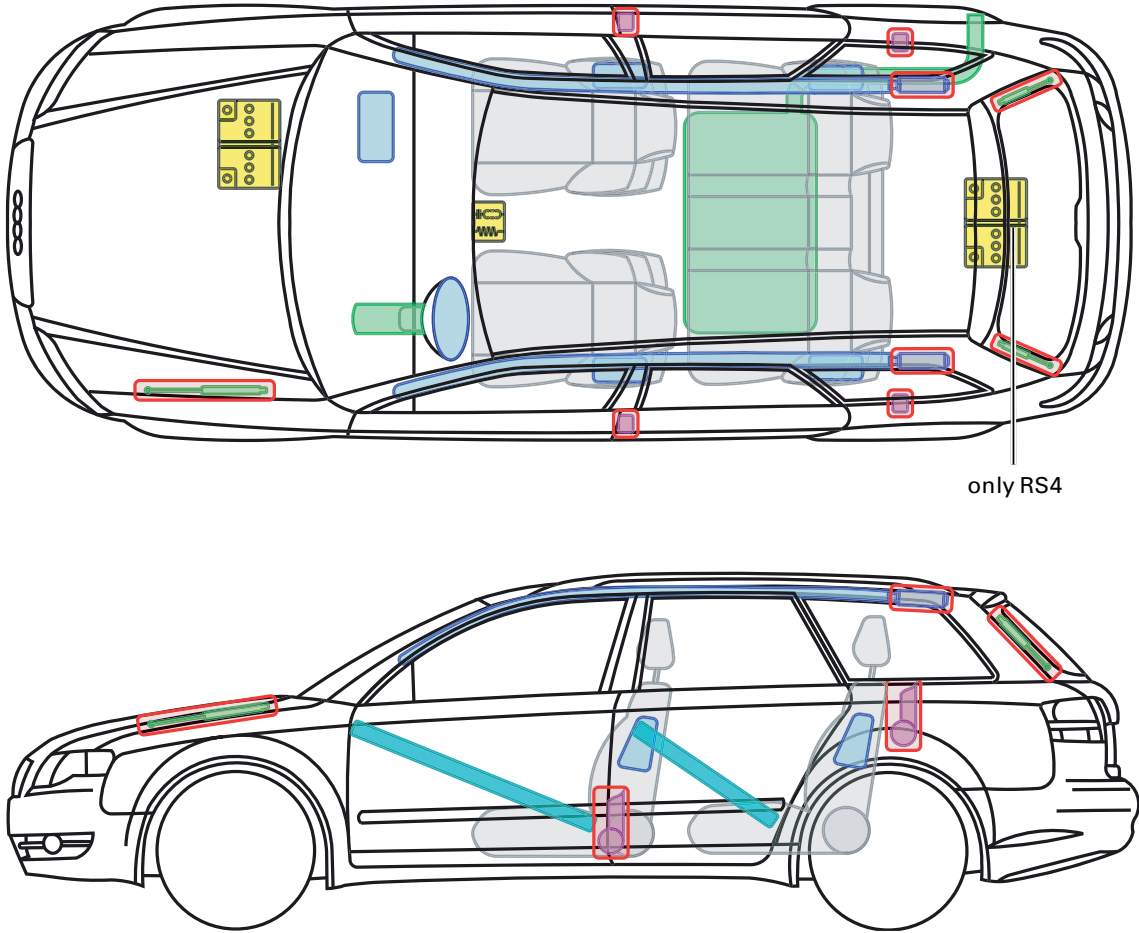

▶ Audi A4 / S4 / RS4 Avant

2005 – 2008

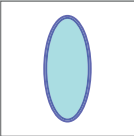
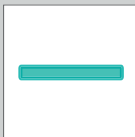
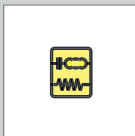

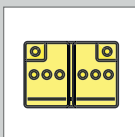
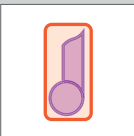
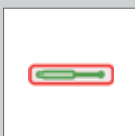
Legend

	Airbag		Reinforcement		Control module
	Gas generator		Rollover protection		Battery
	Pretensioner		Gas-pressure damper		Fuel tank

A4 +S4/RS4 Avant







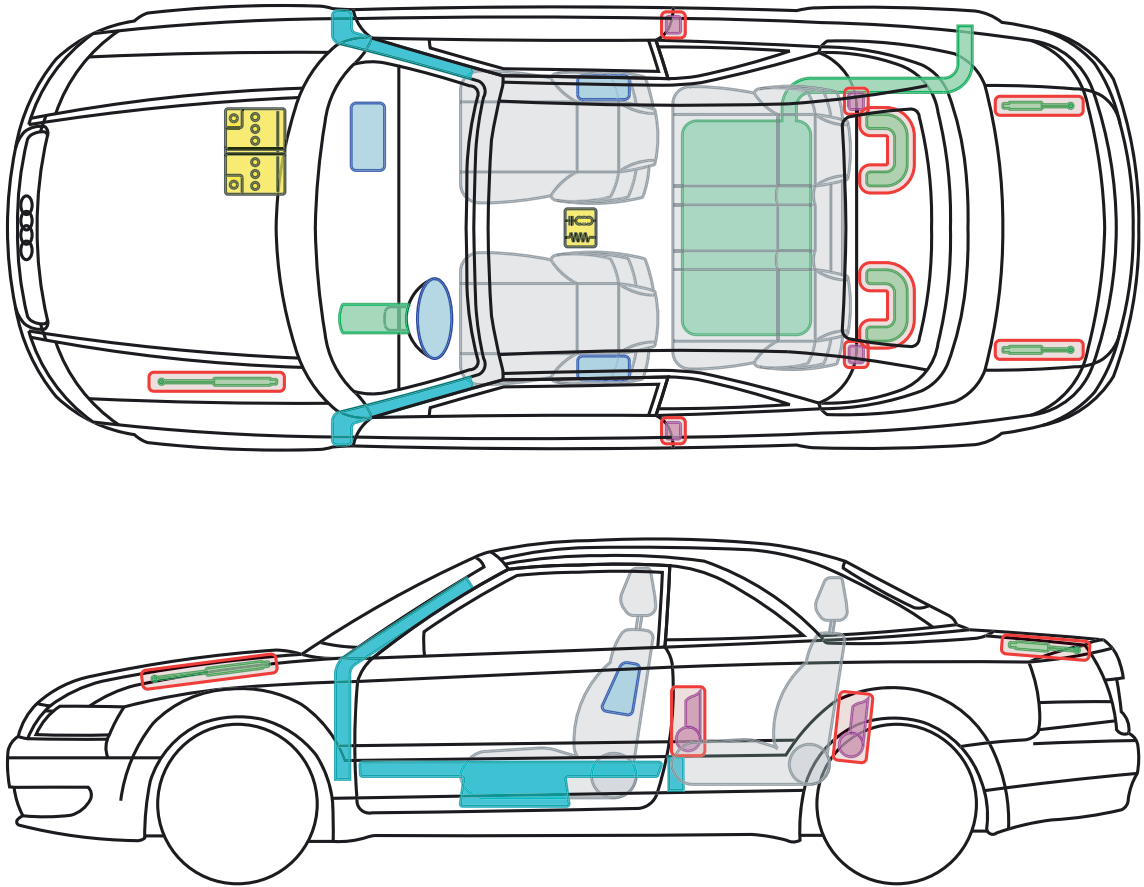

▶ Audi A4 / S4 Cabriolet

2002 – 2005

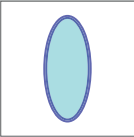
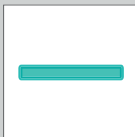
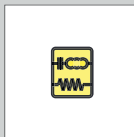

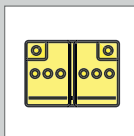
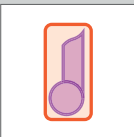
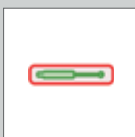
Legend

	Airbag		Reinforce- ment		Control module
	Gas generator		Rollover protection		Battery
	Pre-tensioner		Gas-pressure damper		Fuel tank



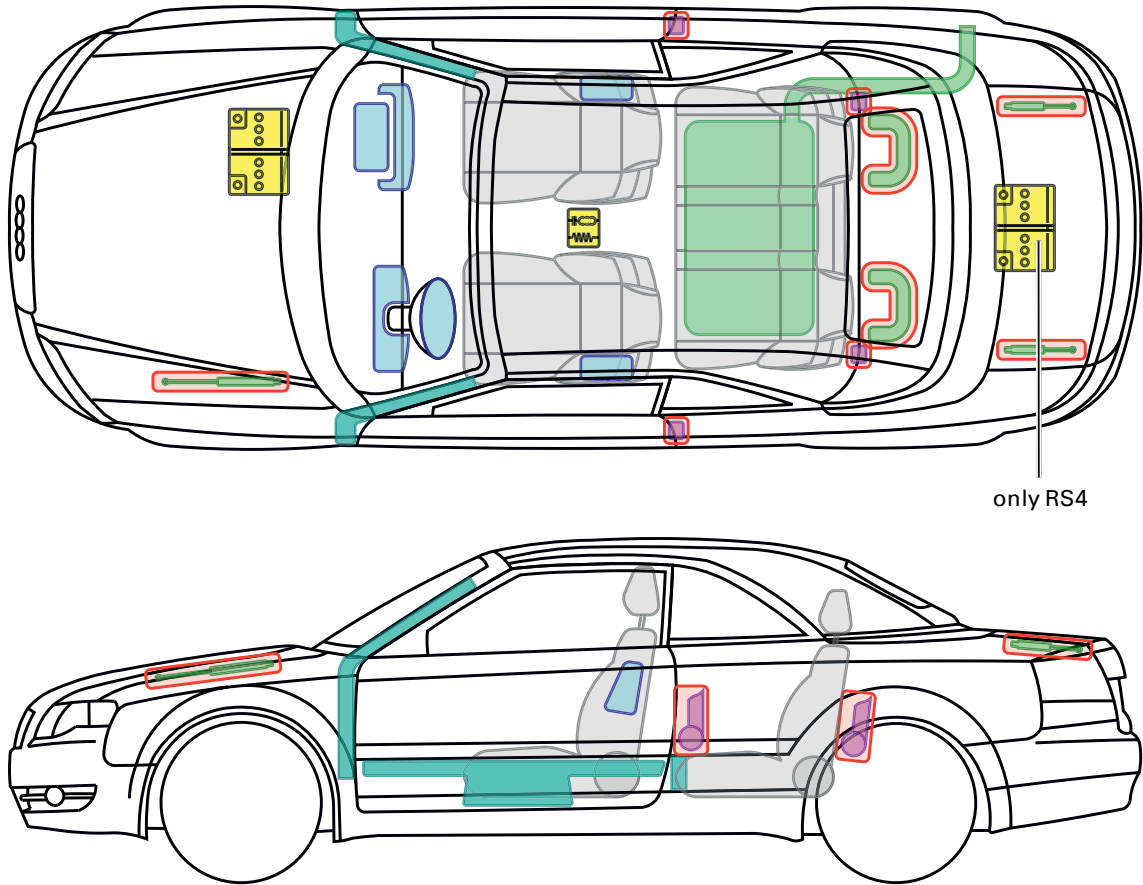

A4 +S4 Cabriolet

# Audi A4 / S4 / RS4 Cabriolet

2005 – 2009

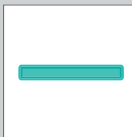
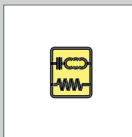

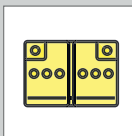
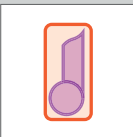
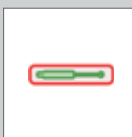
## Legend

	Airbag		Reinforce-ment		Control module
	Gas generator		Rollover protection		Battery
	Pre-tensioner		Gas-pressure damper		Fuel tank

A4 +S4/RS4 Cabriolet





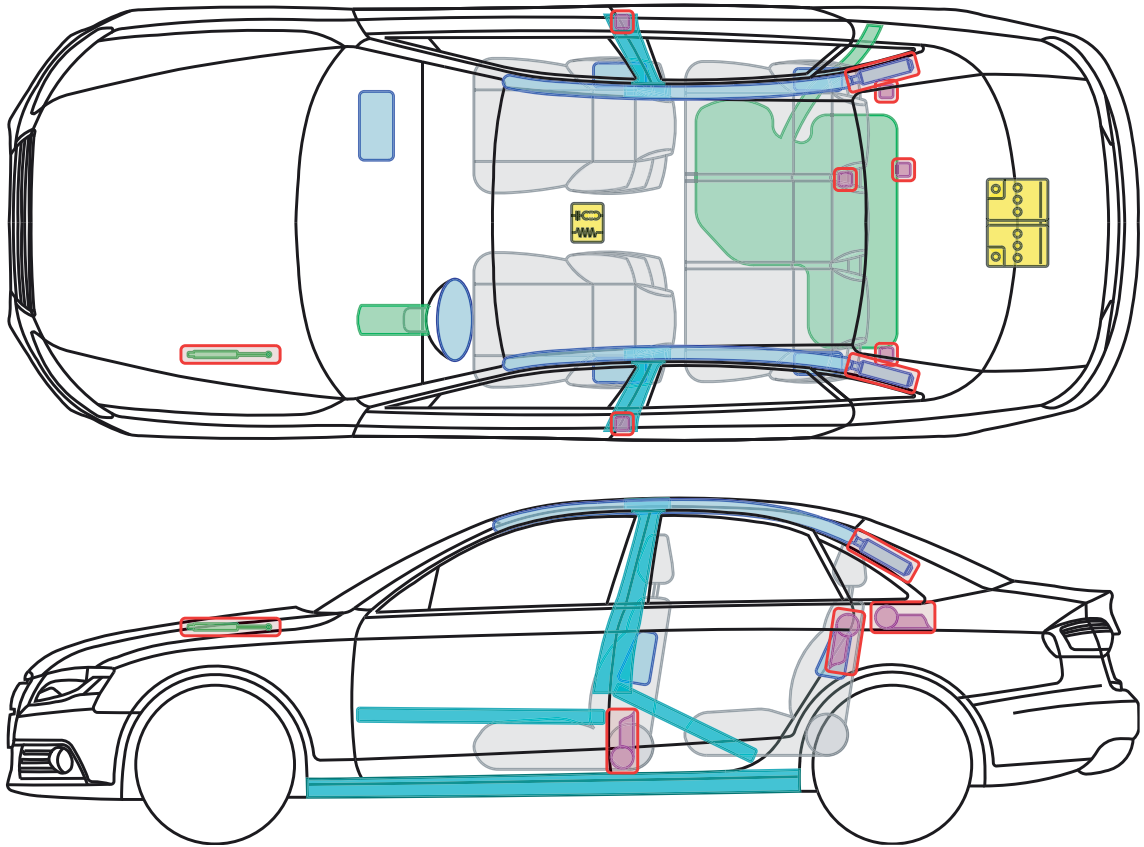

▶ Audi A4 / S4

2007 – 2012

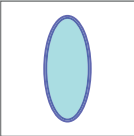
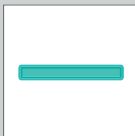
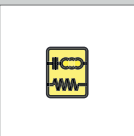

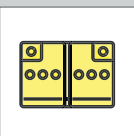
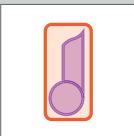
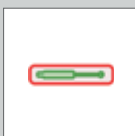
Legend

	Airbag		Reinforcement		Control module
	Gas generator		Rollover protection		Battery
	Pre-tensioner		Gas-pressure damper		Fuel tank

A4 +S4 Limousine





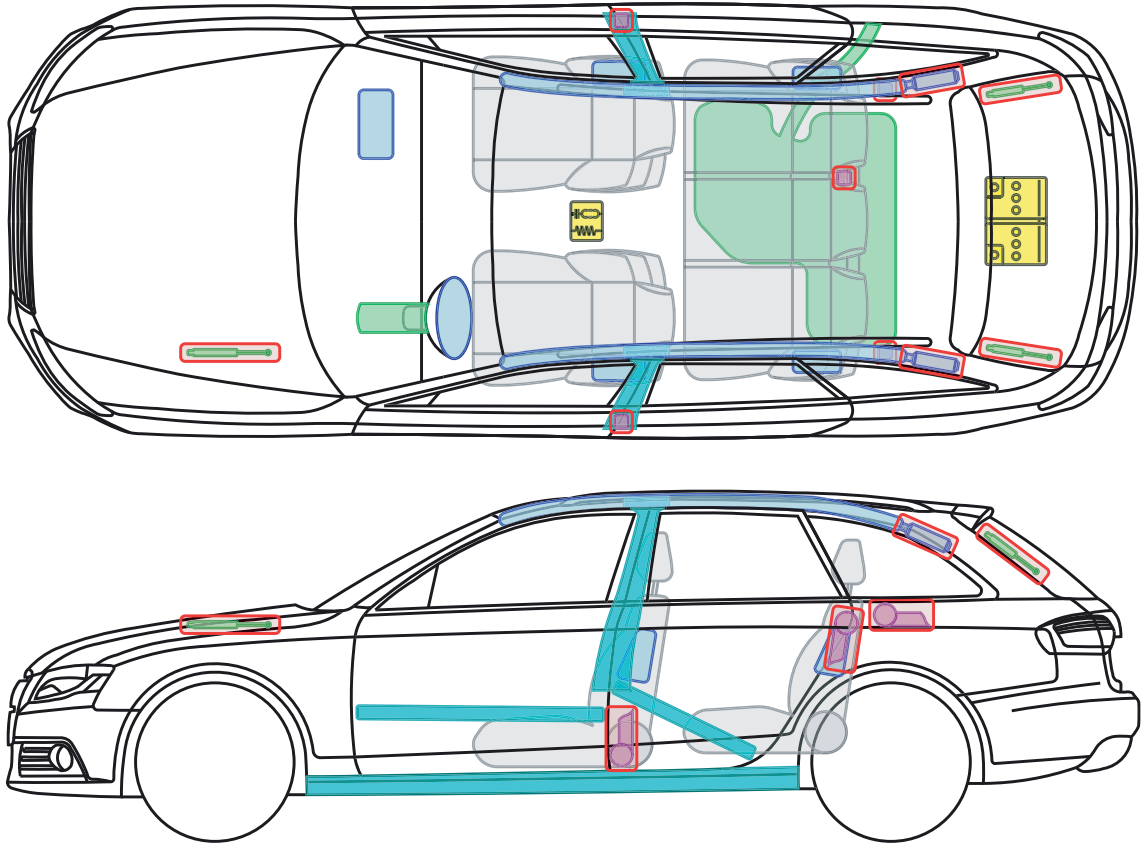

▶ Audi A4 /S4 Avant

2008 – 2012

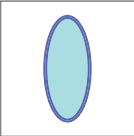
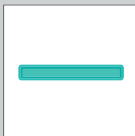
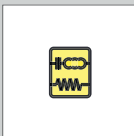

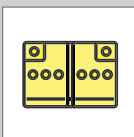
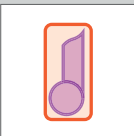
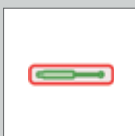
Legend

	Airbag		Reinforce- ment		Control module
	Gas generator		Rollover protection		Battery
	Pre-tensioner		Gas-pressure damper		Fuel tank

A4 +S4 Avant







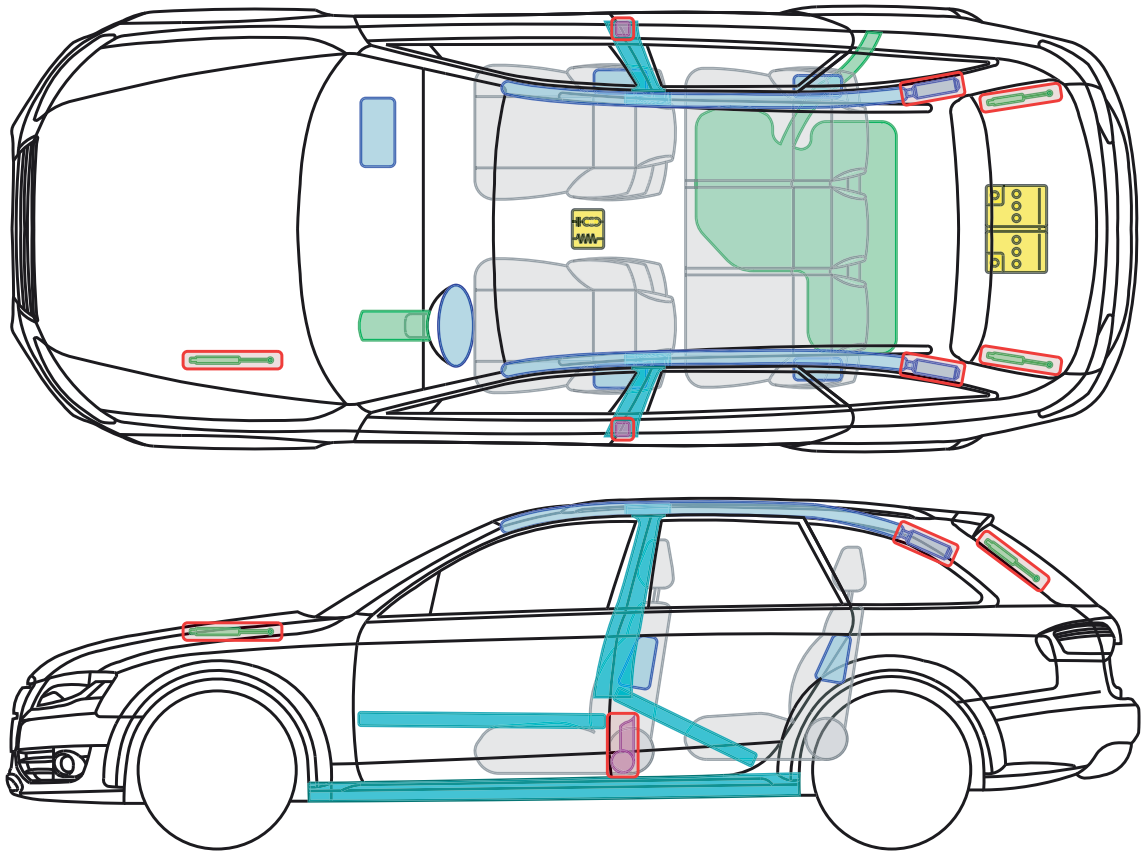

▶ Audi A4 allroad

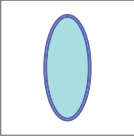
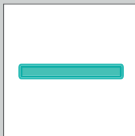
2009 – 2012

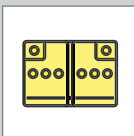
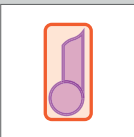
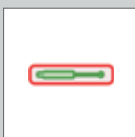

Legend

	Airbag		Reinforce- ment		Control module
	Gas generator		Rollover protection		Battery
	Pre-tensioner		Gas-pressure damper		Fuel tank

A4 allroad







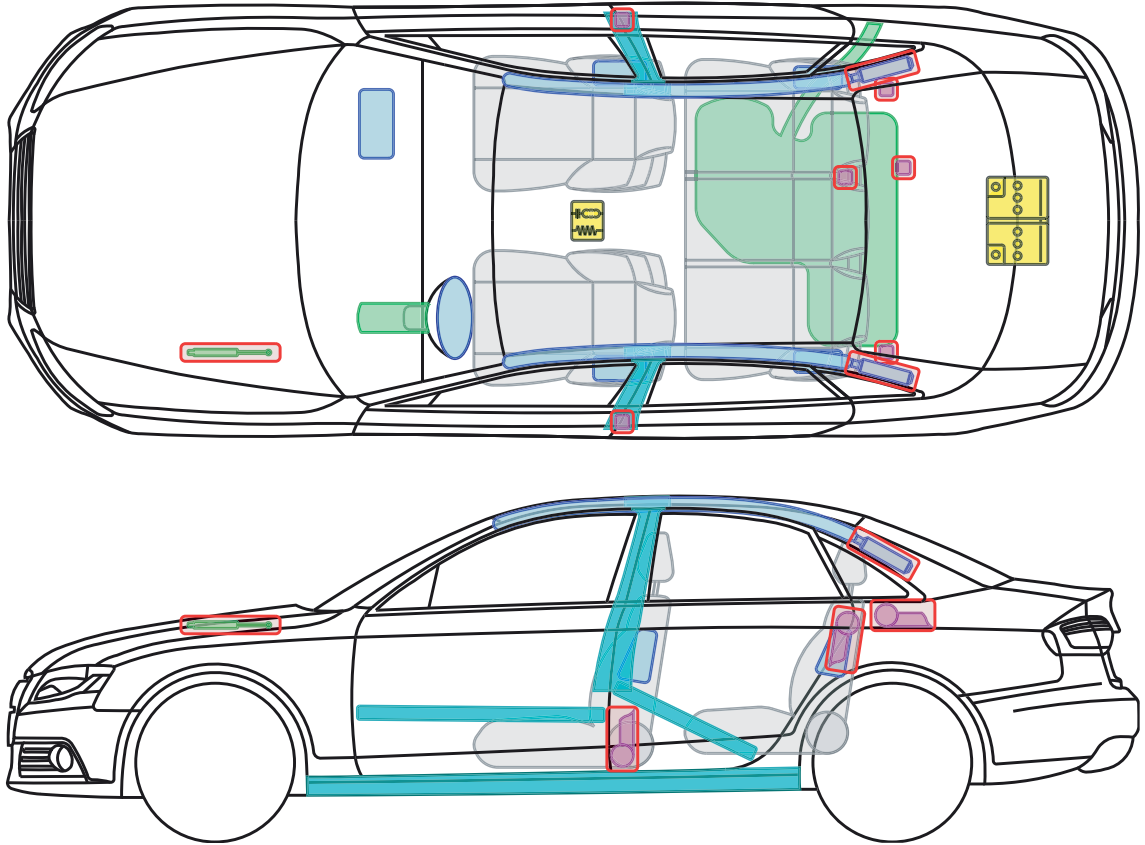

▶ Audi A4 / S4

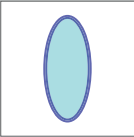
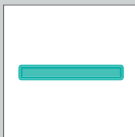
from 2012

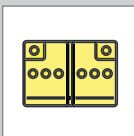
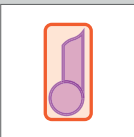
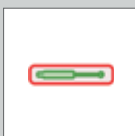

Legend

	Airbag		Reinforcement		Control module
	Gas generator		Rollover protection		Battery
	Pretensioner		Gas-pressure damper		Fuel tank

A4 +S4 Limousine





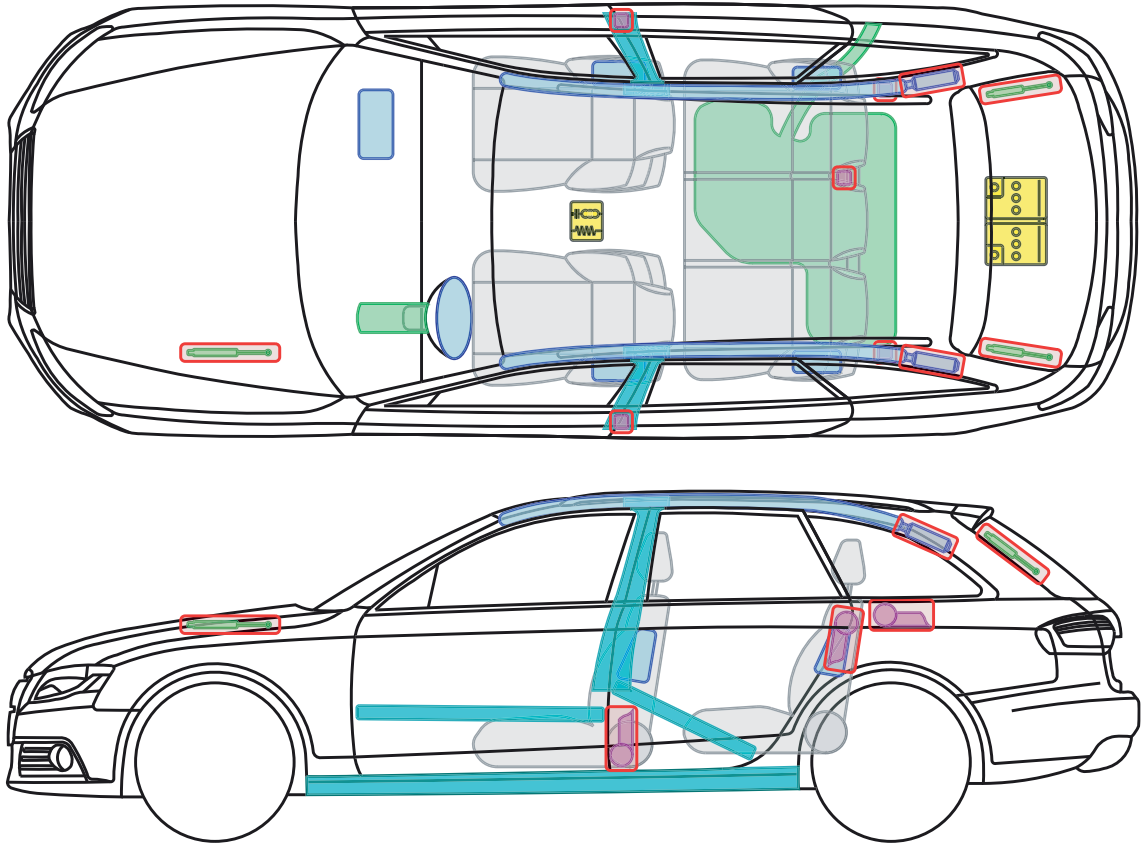

▶ Audi A4 / S4 / RS4 Avant

from 2012

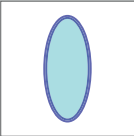
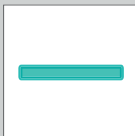
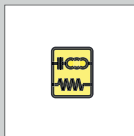

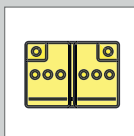
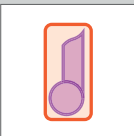
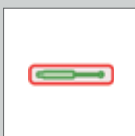
Legend

	Airbag		Reinforcement		Control module
	Gas generator		Rollover protection		Battery
	Pre-tensioner		Gas-pressure damper		Fuel tank

A4 +S4/RS4 Avant







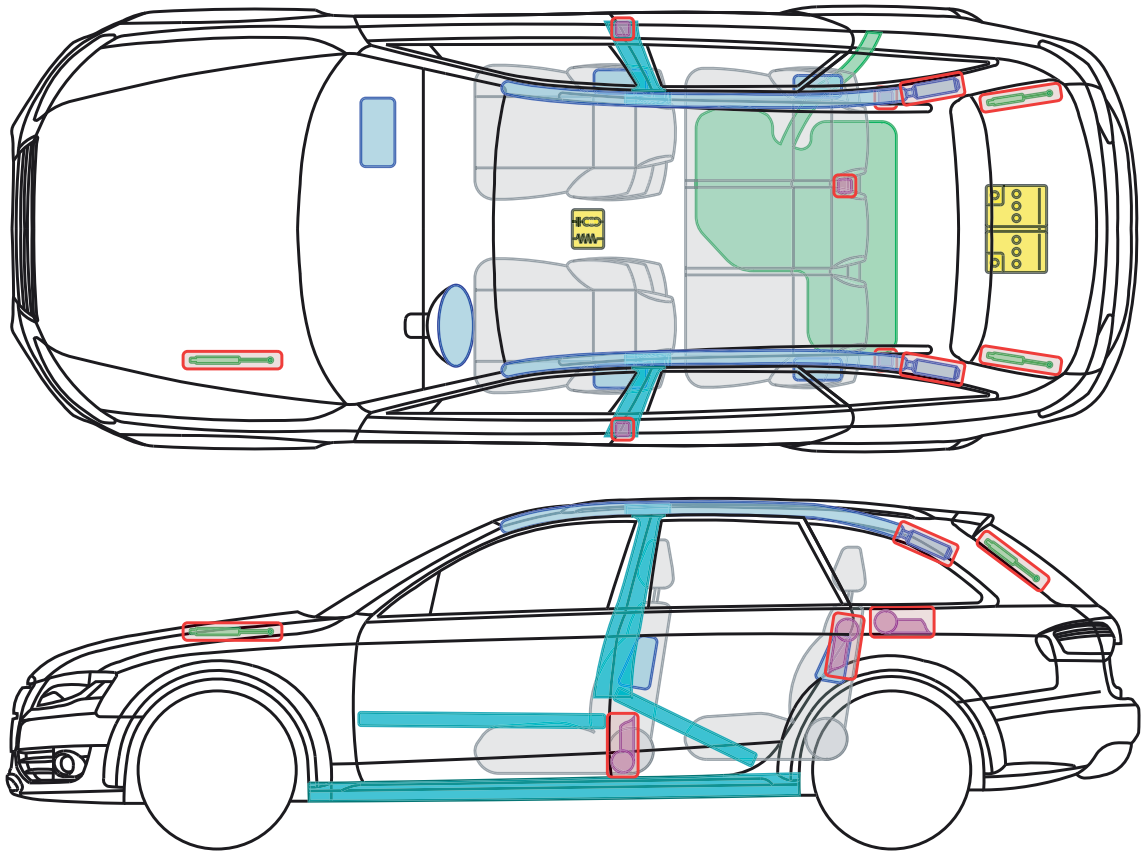

▶ Audi A4 allroad

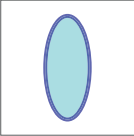
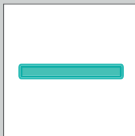
from 2012

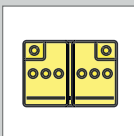
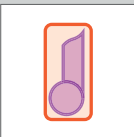
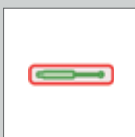

Legend

	Airbag		Reinforcement		Control module
	Gas generator		Rollover protection		Battery
	Pre-tensioner		Gas-pressure damper		Fuel tank

A4 allroad





▶ Audi A5 / S5 / RS5

2007 – 2011

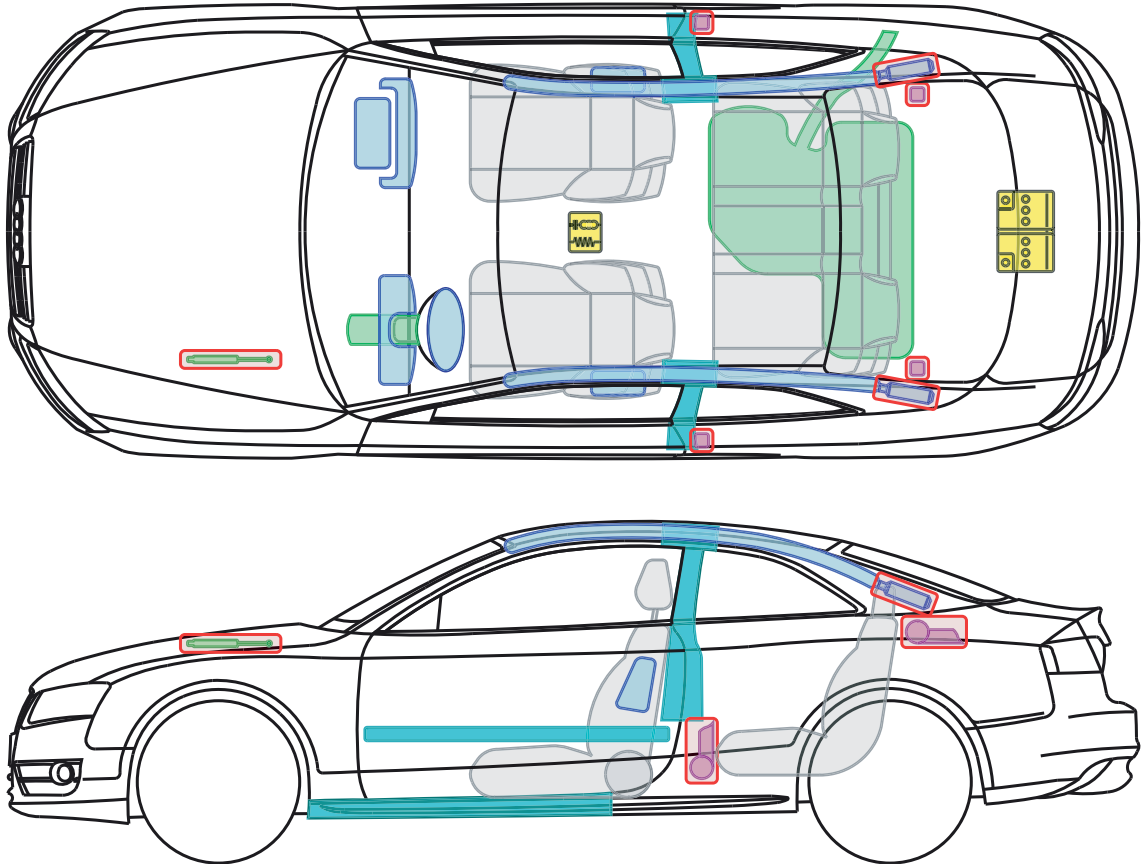

Legend

	Airbag		Reinforcement		Control module
	Gas generator		Rollover protection		Battery
	Pre-tensioner		Gas-pressure damper		Fuel tank

A5 +S5 Limousine





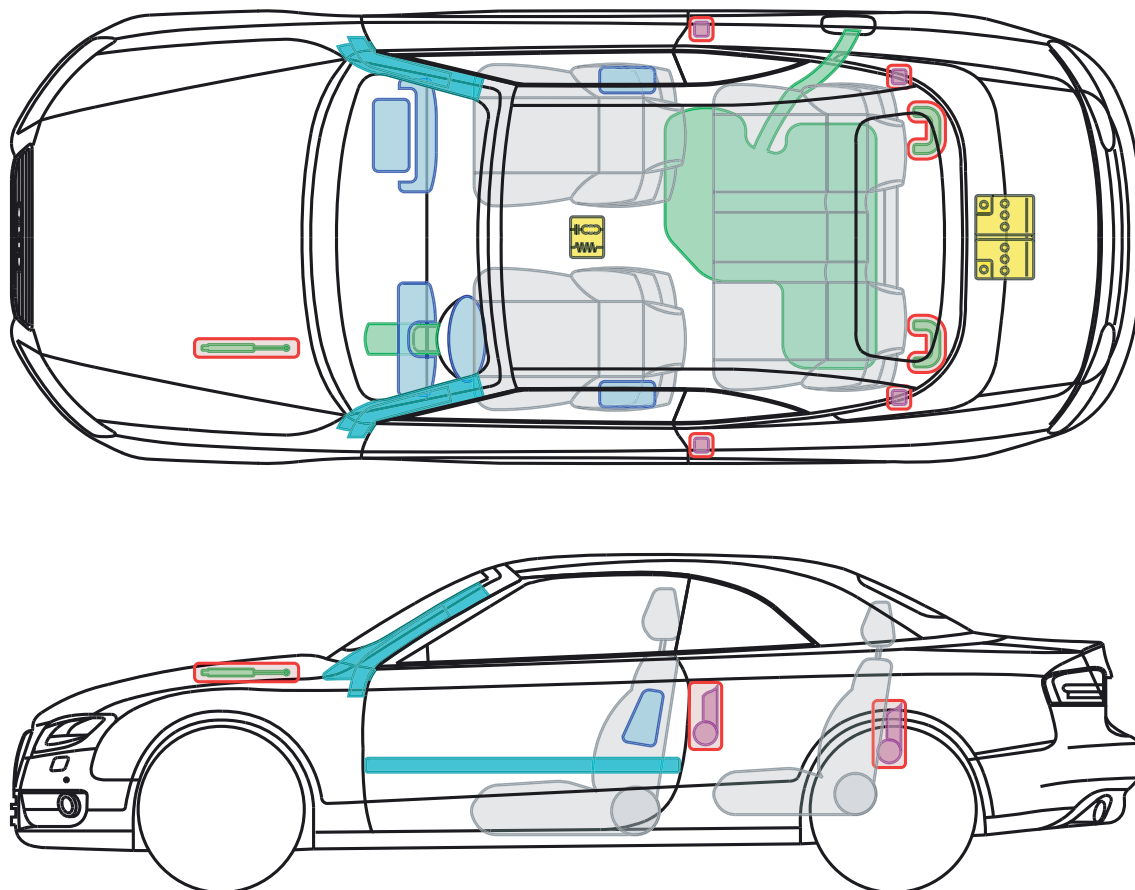

▶ Audi A5 / S5 Cabriolet

2009 – 2011

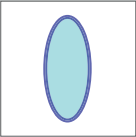
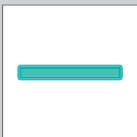
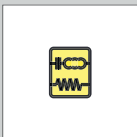
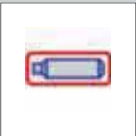

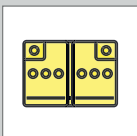
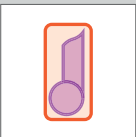
Legend

	Airbag		Reinforce- ment		Control module
	Gas generator		Rollover protection		Battery
	Pre-tensioner		Gas-pressure damper		Fuel tank

A5 +S5 Cabriolet







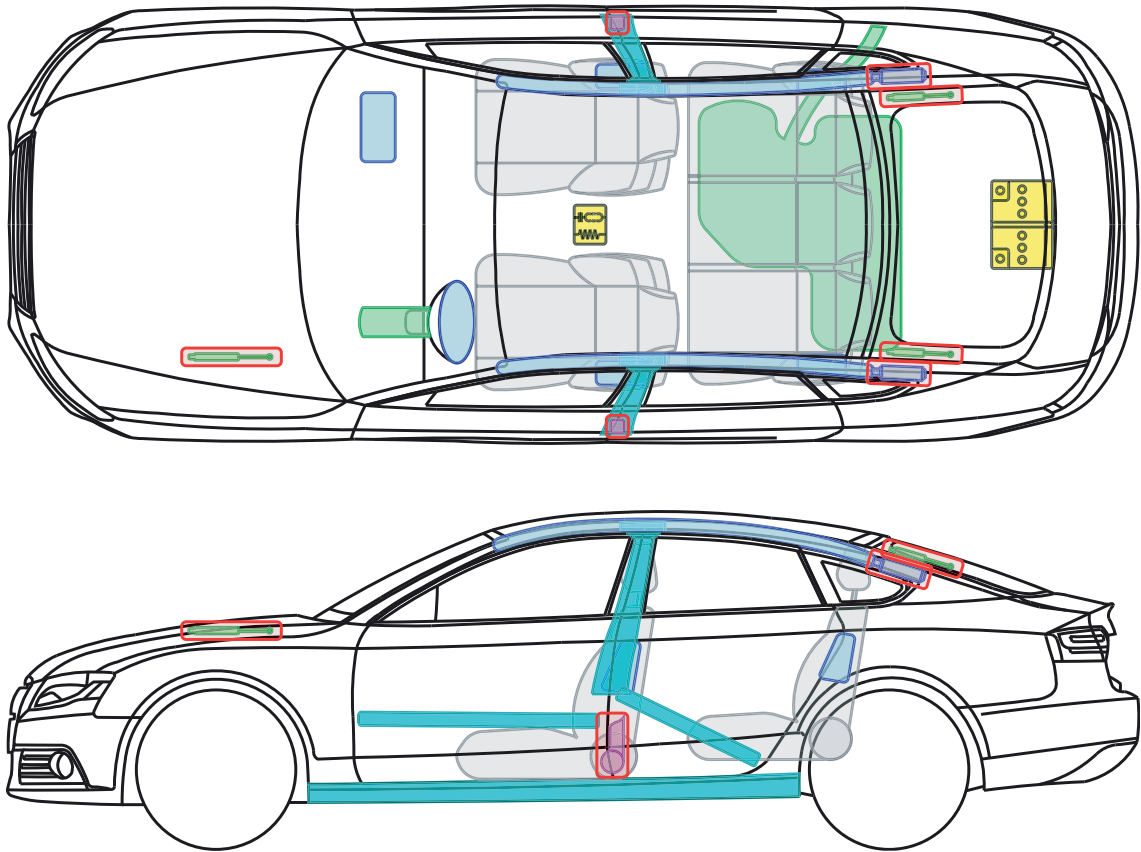

▶ Audi A5 / S5 Sportback

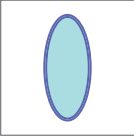
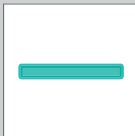
2009 – 2011

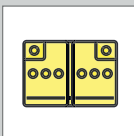
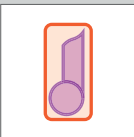
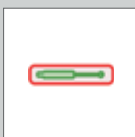

Legend

	Airbag		Reinforcement		Control module
	Gas generator		Rollover protection		Battery
	Pre-tensioner		Gas-pressure damper		Fuel tank

A5 +S5 Sportback



▶ Audi A5 / S5 / RS5

from 2011

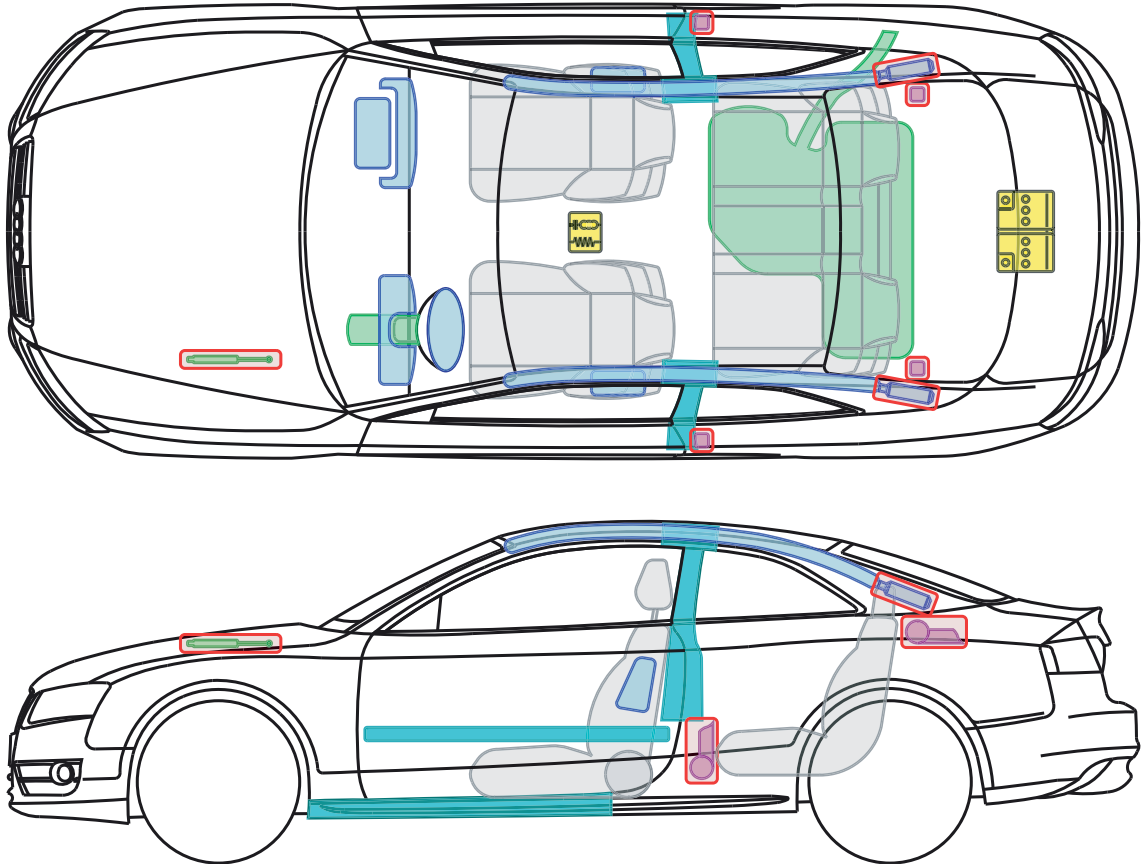

Legend

	Airbag		Reinforcement		Control module
	Gas generator		Rollover protection		Battery
	Pre-tensioner		Gas-pressure damper		Fuel tank

A5 +S5 Limousine





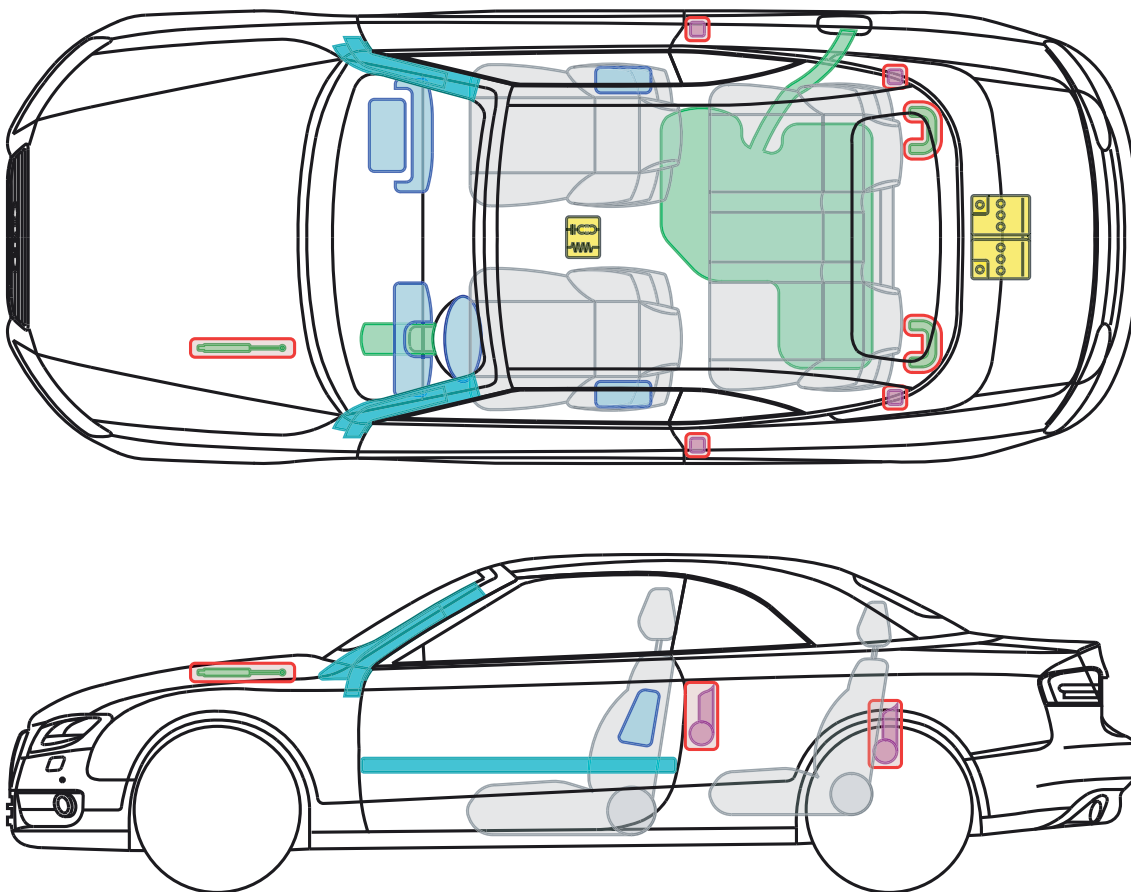

▶ Audi A5 / S5 Cabriolet

from 2011

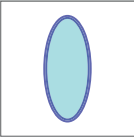
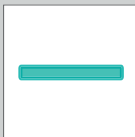
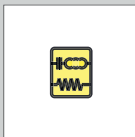

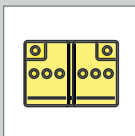
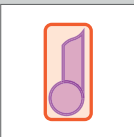
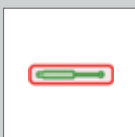
Legend

	Airbag		Reinforcement		Control module
	Gas generator		Rollover protection		Battery
	Pre-tensioner		Gas-pressure damper		Fuel tank

A5 +S5 Cabriolet







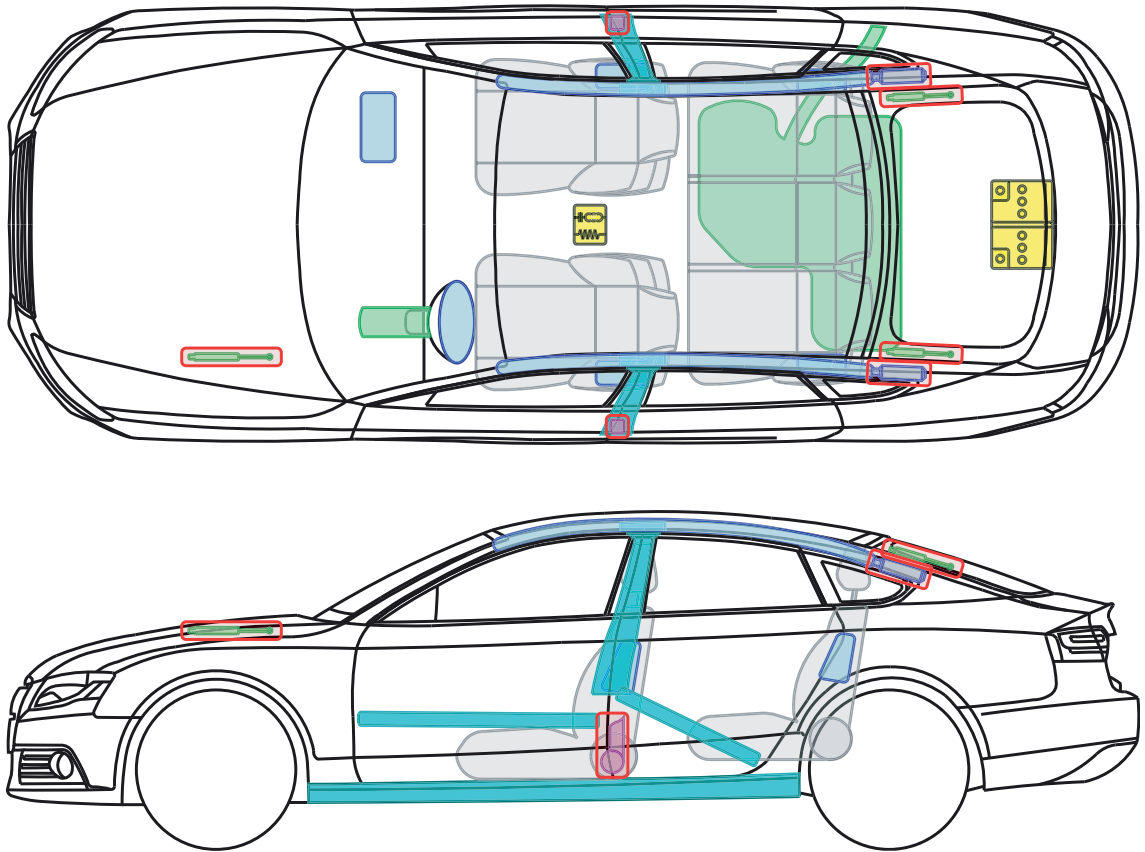

▶ Audi A5 / S5 Sportback

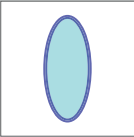
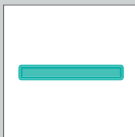
from 2011

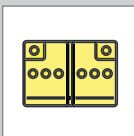
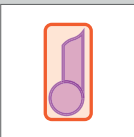
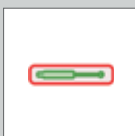

Legend

	Airbag		Reinforcement		Control module
	Gas generator		Rollover protection		Battery
	Pre-tensioner		Gas-pressure damper		Fuel tank



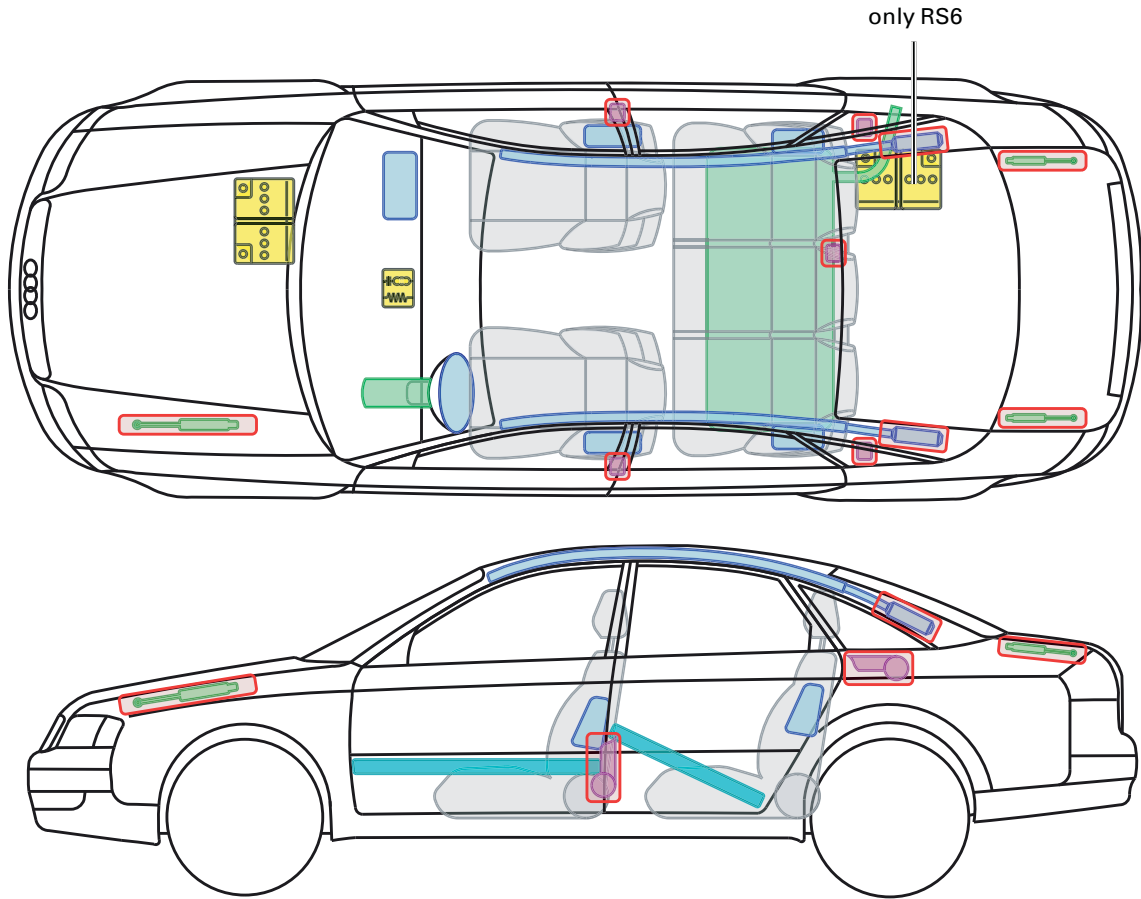

A5 +S5 Sportback

▶ Audi A6 / S6 / RS6

1997 – 2004

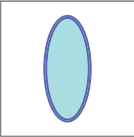
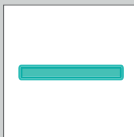
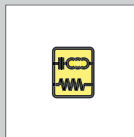

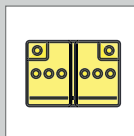
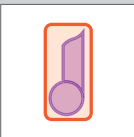
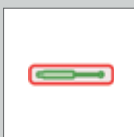
Legend

	Airbag		Reinforce-ment		Control module
	Gas generator		Rollover protection		Battery
	Pretensioner		Gas-pressure damper		Fuel tank





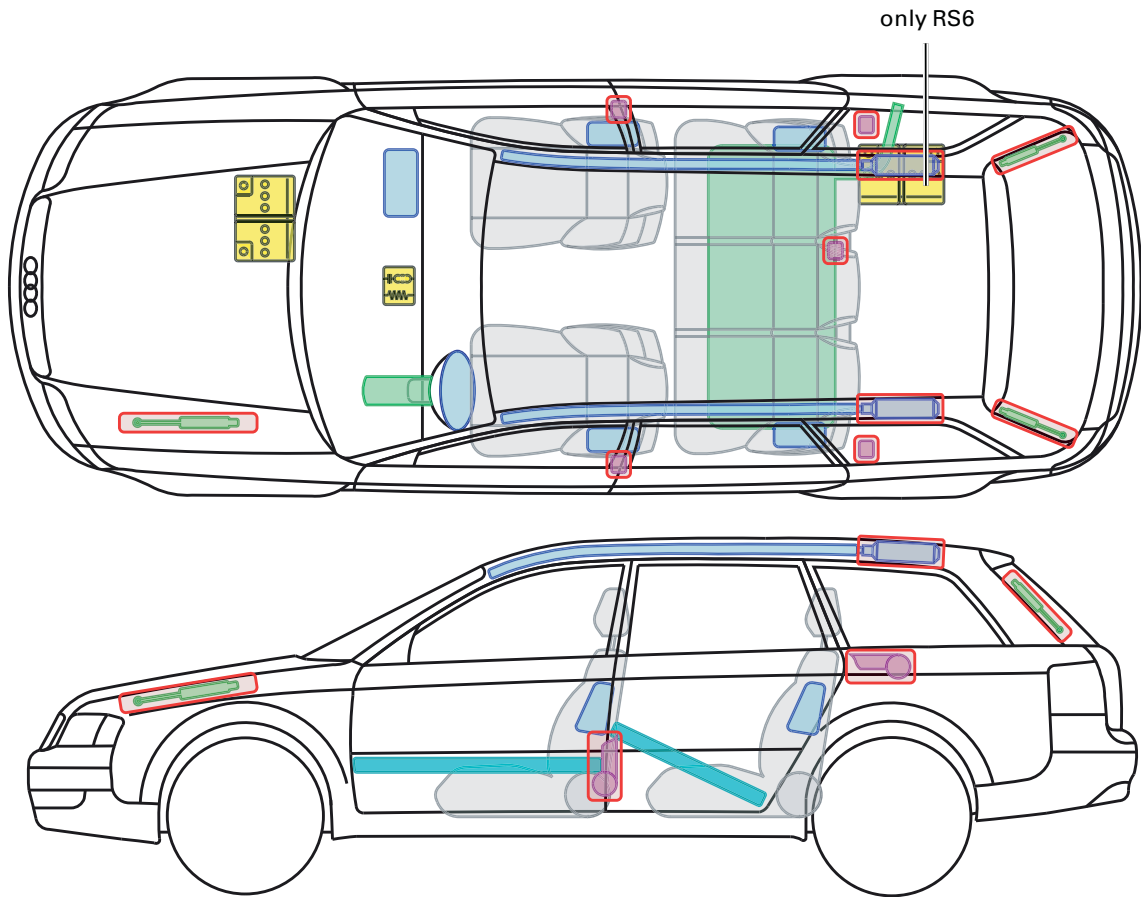

A6 +S6/RS6 Limous.

# Audi A6 / S6 / RS6 Avant

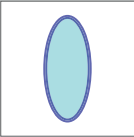
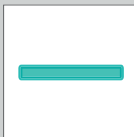
1998 – 2004

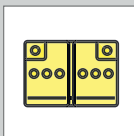
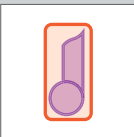
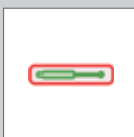

## Legend

	Airbag		Reinforcement		Control module
	Gas generator		Rollover protection		Battery
	Pretensioner		Gas-pressure damper		Fuel tank

A6 +S6/RS6 Avant









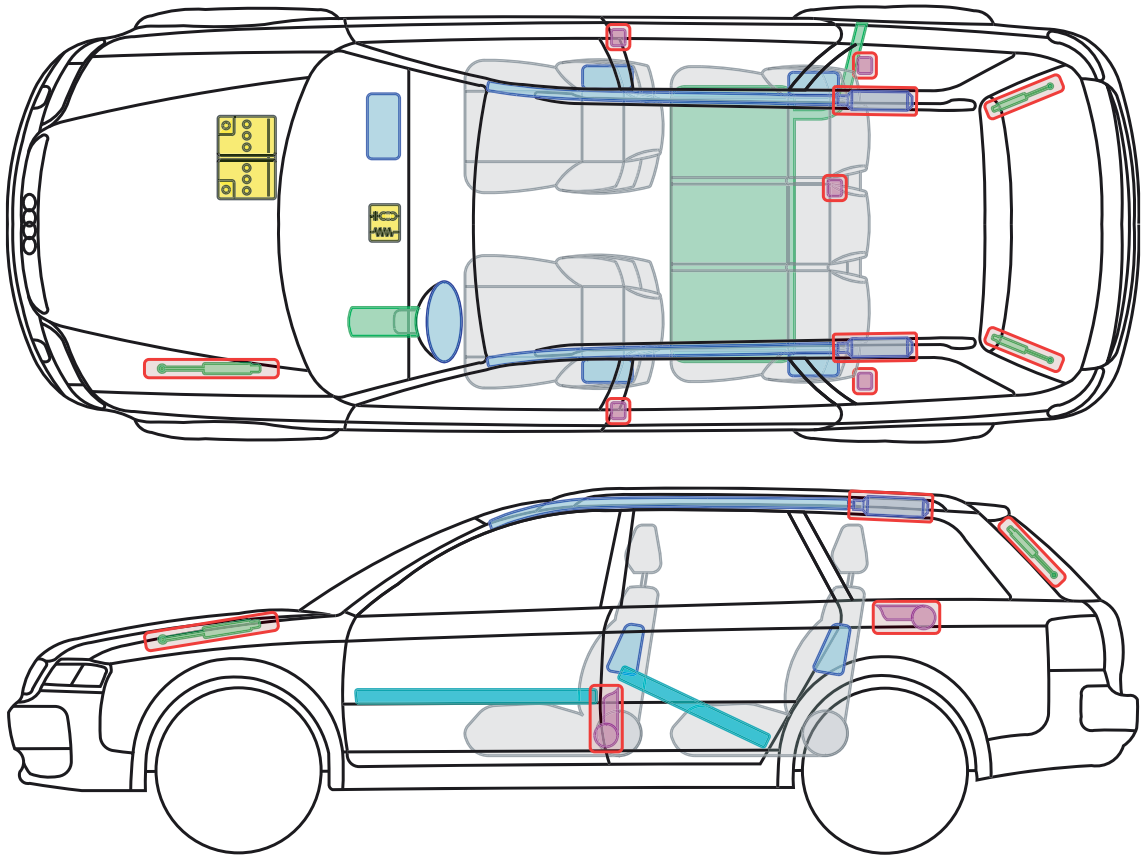

# Audi A6 allroad

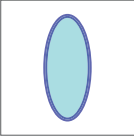
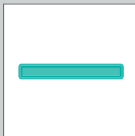
2001 – 2006

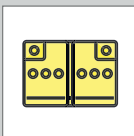
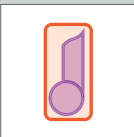
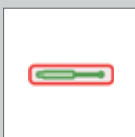

## Legend

	Airbag		Reinforce-ment		Control module
	Gas generator		Rollover protection		Battery
	Pre-tensioner		Gas-pressure damper		Fuel tank

A6 allroad





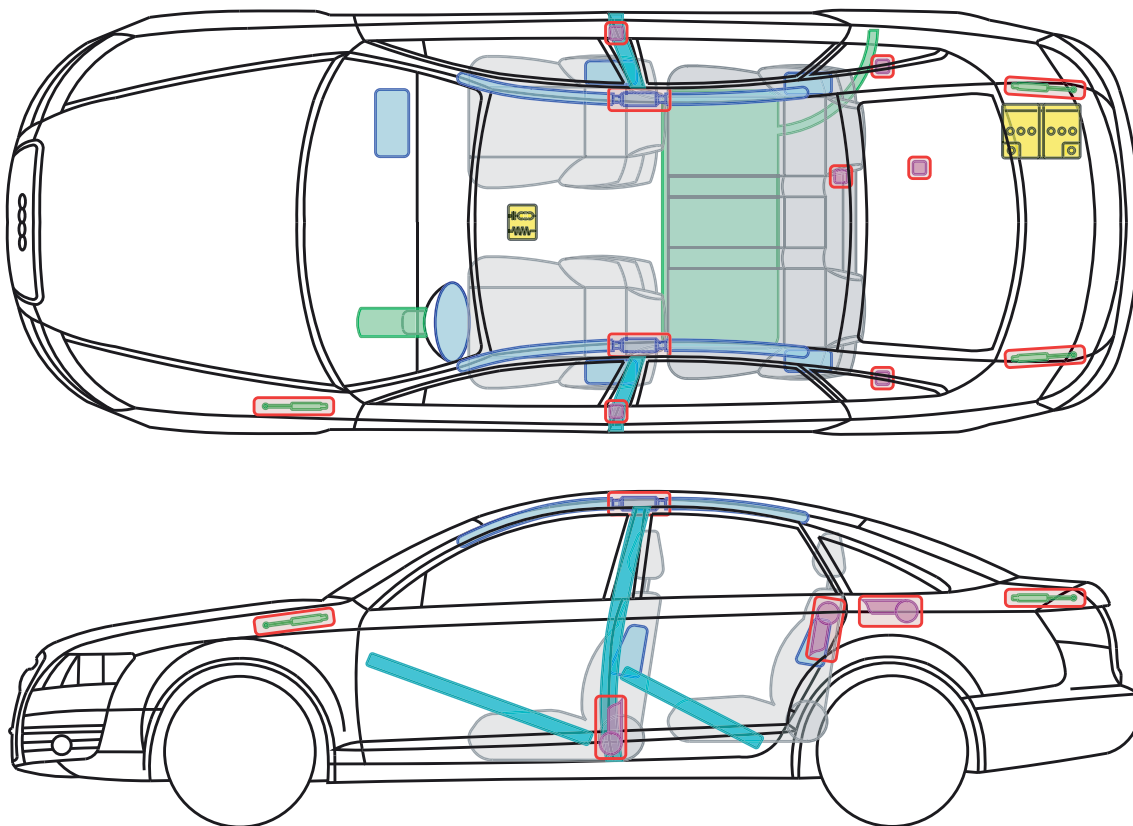

▶ Audi A6 / S6 / RS6

2004 – 2008

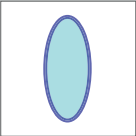
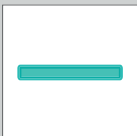
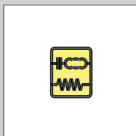
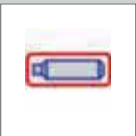

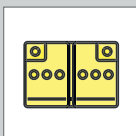
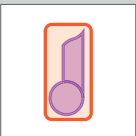
Legend

	Airbag		Reinforcement		Control module
	Gas generator		Rollover protection		Battery
	Pre-tensioner		Gas-pressure damper		Fuel tank

A6 +S6/RS6 Limous.



▶ Audi A6 / S6 / RS6

2008 – 2011

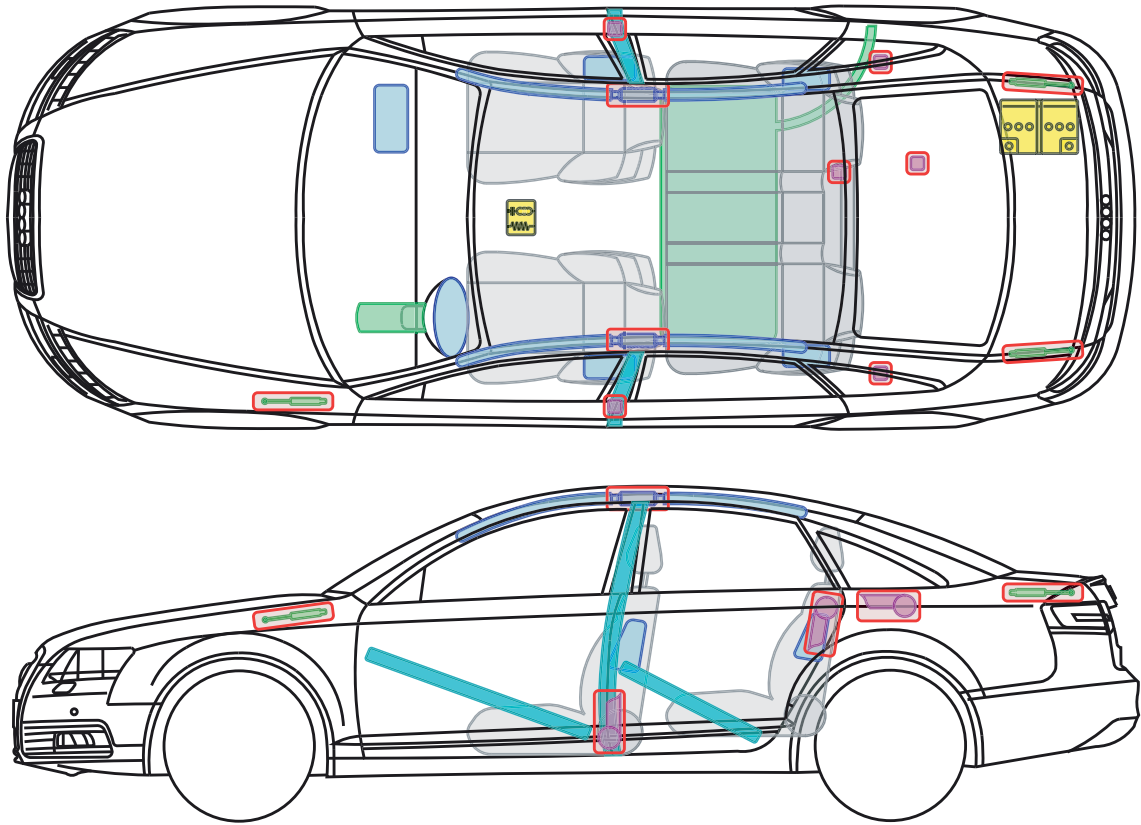

Legend

	Airbag		Reinforcement		Control module
	Gas generator		Rollover protection		Battery
	Pre-tensioner		Gas-pressure damper		Fuel tank

A6 +S6/RS6 Limous.





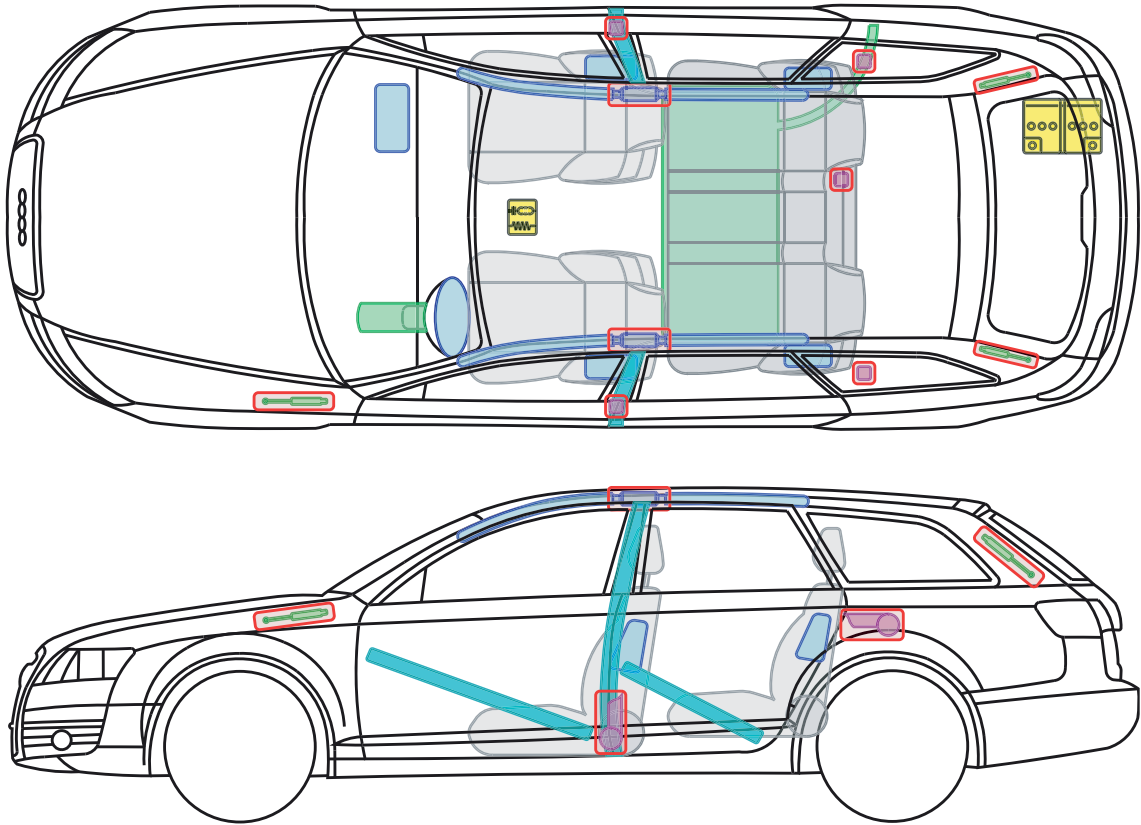

▶ Audi A6 / S6 / RS6 Avant

2004 – 2012

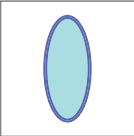
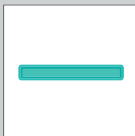
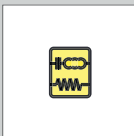

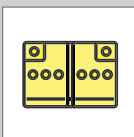
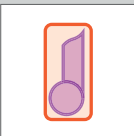
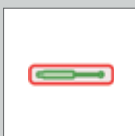
Legend

	Airbag		Reinforcement		Control module
	Gas generator		Rollover protection		Battery
	Pre-tensioner		Gas-pressure damper		Fuel tank

A6 +S6/RS6 Avant





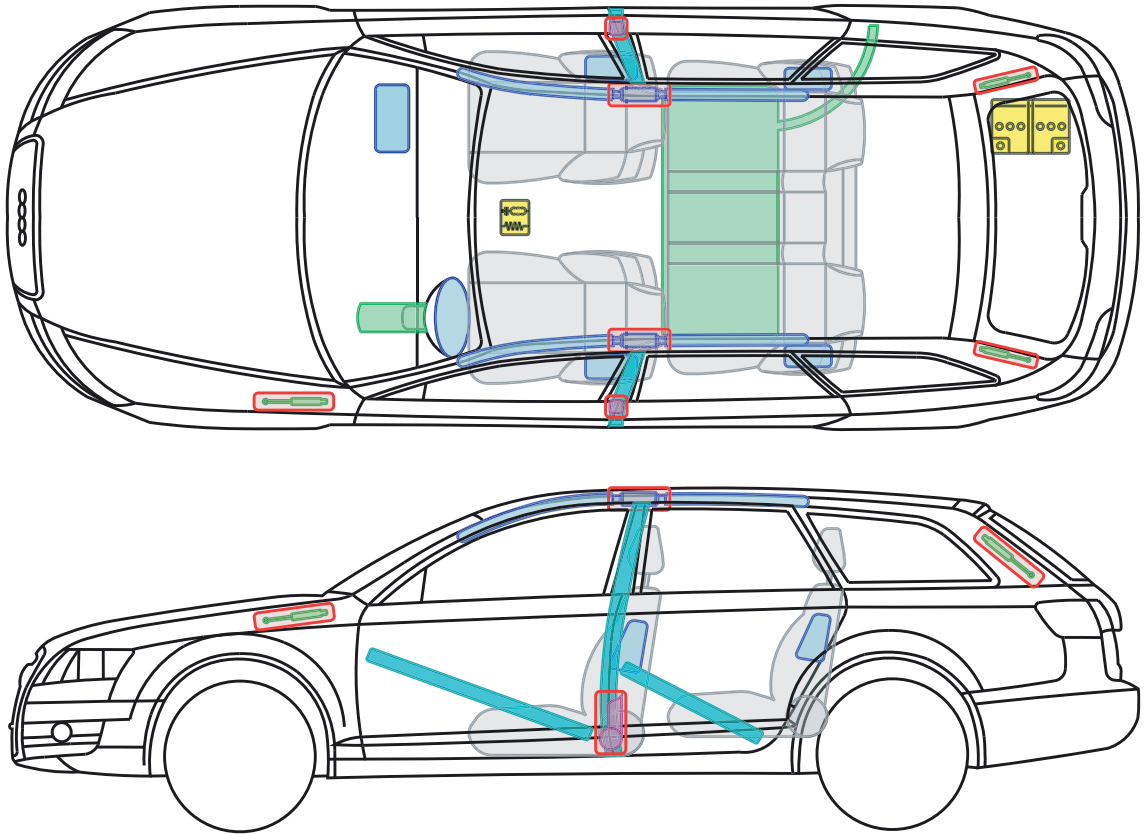

▶ Audi A6 allroad

2006 – 2012

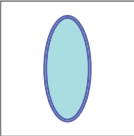
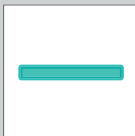
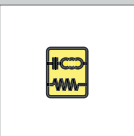

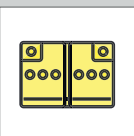
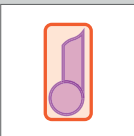
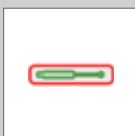
Legend

	Airbag		Reinforce- ment		Control module
	Gas generator		Rollover protection		Battery
	Pre-tensioner		Gas-pressure damper		Fuel tank

A6 allroad



▶ Audi A6 / S6

from 2011

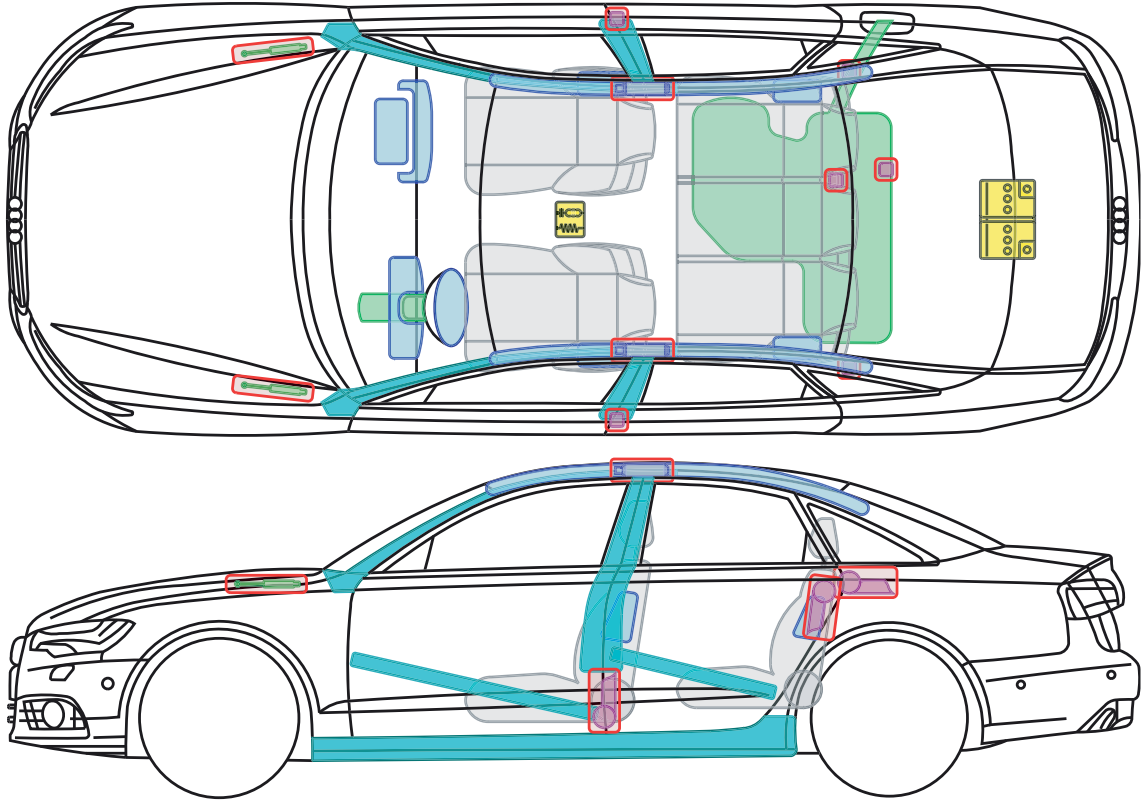

Legend

	Airbag		Reinforce- ment		Control module
	Gas generator		Rollover protection		Battery
	Preten- sioner		Gas-pressure damper		Fuel tank



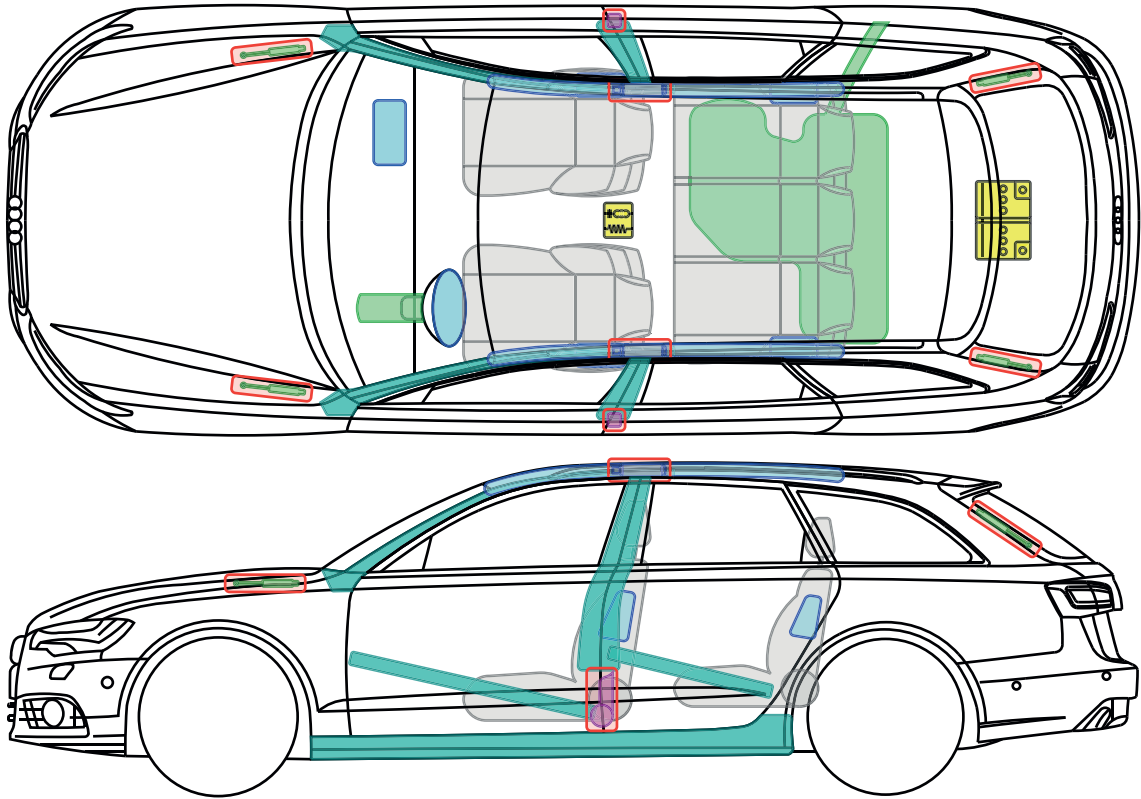

A6 +S6 Limousine

# Audi A6 Avant

from 2011

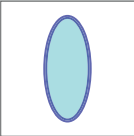
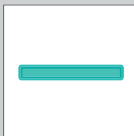
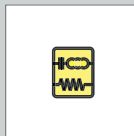

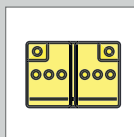
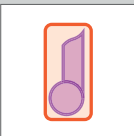
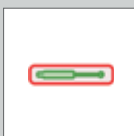
## Legend

	Airbag		Reinforcement		Control module
	Gas generator		Rollover protection		Battery
	Pre-tensioner		Gas-pressure damper		Fuel tank





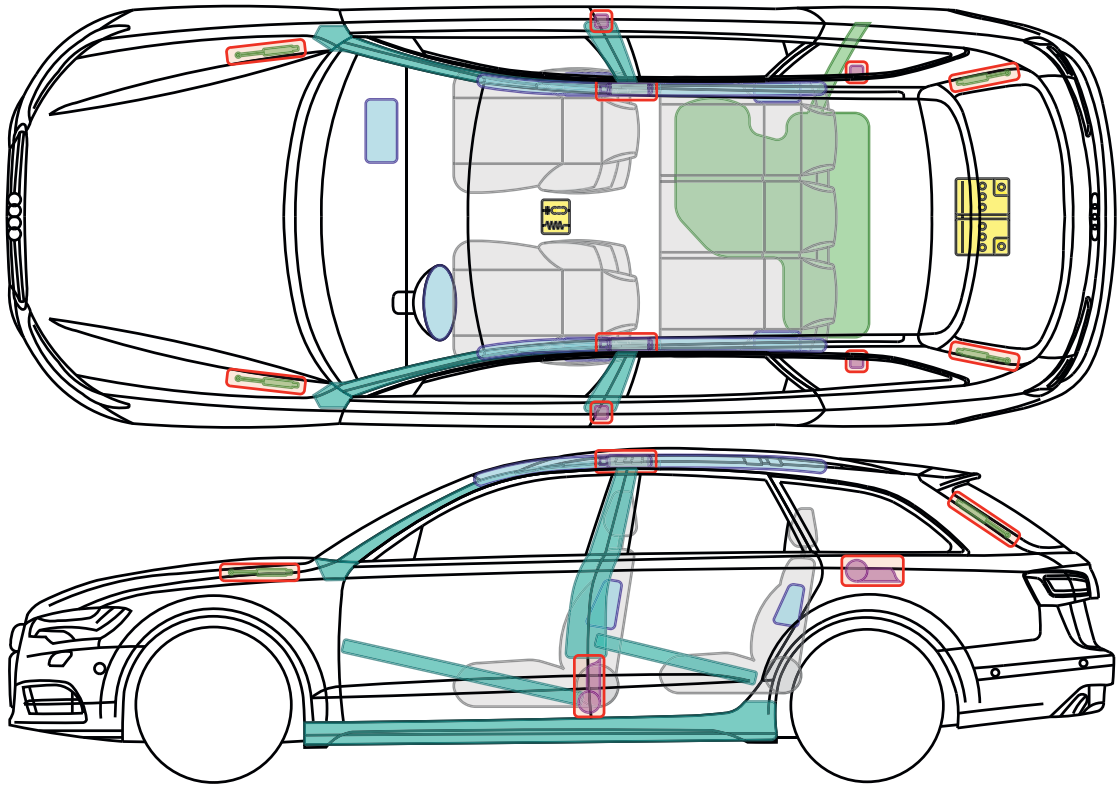

▶ Audi A6 allroad

from 2012

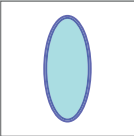
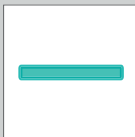
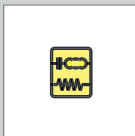

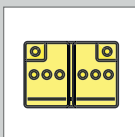
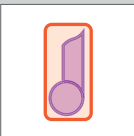
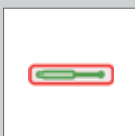
Legend

	Airbag		Reinforce- ment		Control module
	Gas generator		Rollover protection		Battery
	Pre-ten- sioner		Gas-pressure damper		Fuel tank

A6 allroad









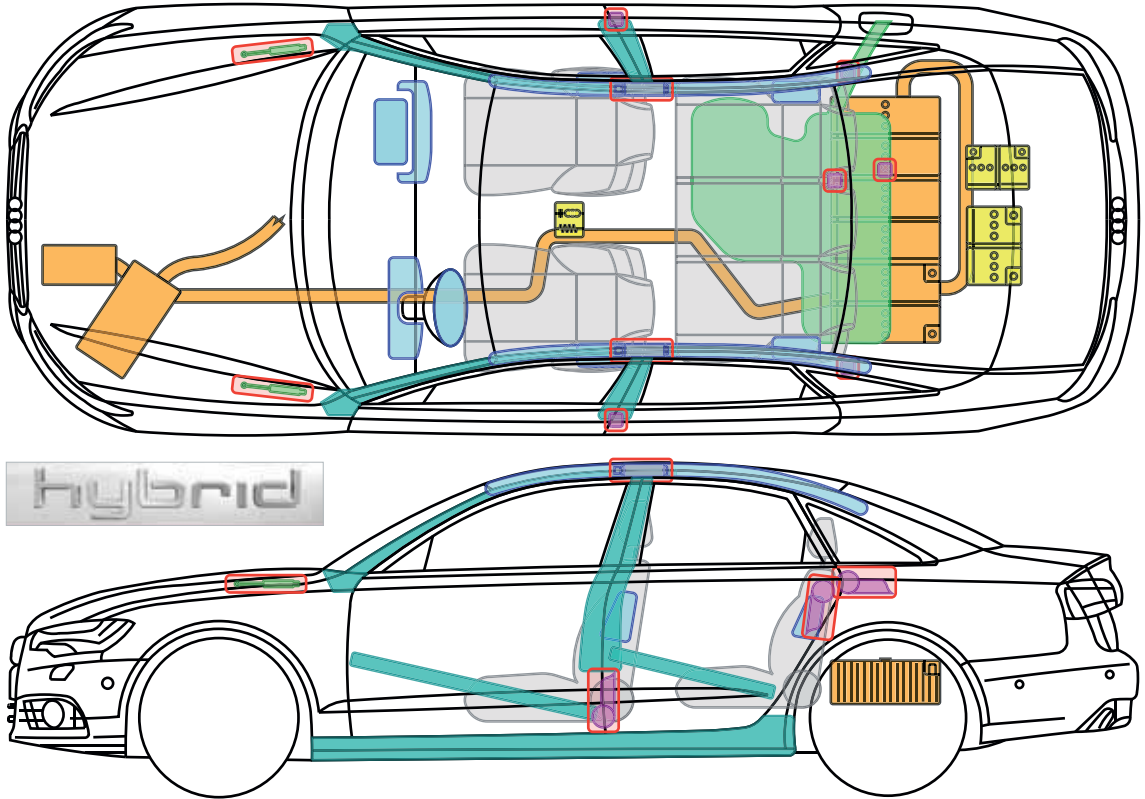

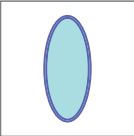
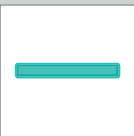
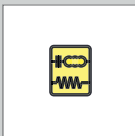

▶ Audi A6 hybrid

from 2012

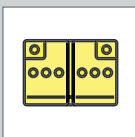

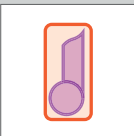
Legend

	Airbag		Reinforcement		Control module		High-voltage battery
	Gas generator		Overroll protection		12 V battery		High-voltage leads/components
	Pretensioner		Gas pressure damper		Fuel tank		

# Audi A6 hybrid

from 2012

## Identifying feature

The Audi A6 hybrid can be identified by means of the „hybrid“ logo and the orange cables in the engine compartment.



## Hints

**⚠ In the case of accidents in which the pyrotechnic belt tensioners or airbags are deployed, the high-voltage system is deactivated.**

In the case of accidents with deployed/undeployed airbags

- ▶ Place Vehicle in Park and set parking brake
- ▶ Switch off the ignition
- ▶ Disconnect the negative terminals of the 12V battery

**⚠ The electric motor is silent!**



It may not be possible to detect that the car is ready to go by the noises it makes when in operation, as the electric motor is silent. If the large needle in the dial on the left of the instrument cluster (power metre) is not on „OFF“ (for example on the „READY position), you have to expect that the electric motor may run or the internal combustion engine may start automatically.

## Switch off the ignition



**With the ignition switched on:**

Press START ENGINE STOP button without depressing brake pedal.

**⚠ Risk of Injury: By pressing the START ENGINE STOP button with depressing brake pedal, the engine starts!**



# ▶ Audi A6 hybrid

from 2012

## Disconnect the negative terminals of the 12V batteries

### Option A:

Release the luggage compartment floor by means of the screws indicated by the arrows (screwdriver in the car tool kit) Disconnect the ground cables from both 12V batteries (picture on right)

### Option B:

Lever up the luggage compartment floor by inserting a crowbar at the point indicated. Lift up the luggage compartment floor. Disconnect the ground cables from both 12V batteries (picture on right)

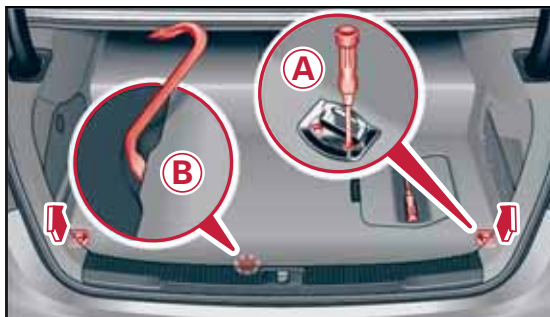

## Identification of the high-voltage components

Identification of the high-voltage battery



Identification of the The high-voltage battery is located under the luggage compartment floor.

It is a lithium-ion battery.

Identification of the remaining high-voltage components







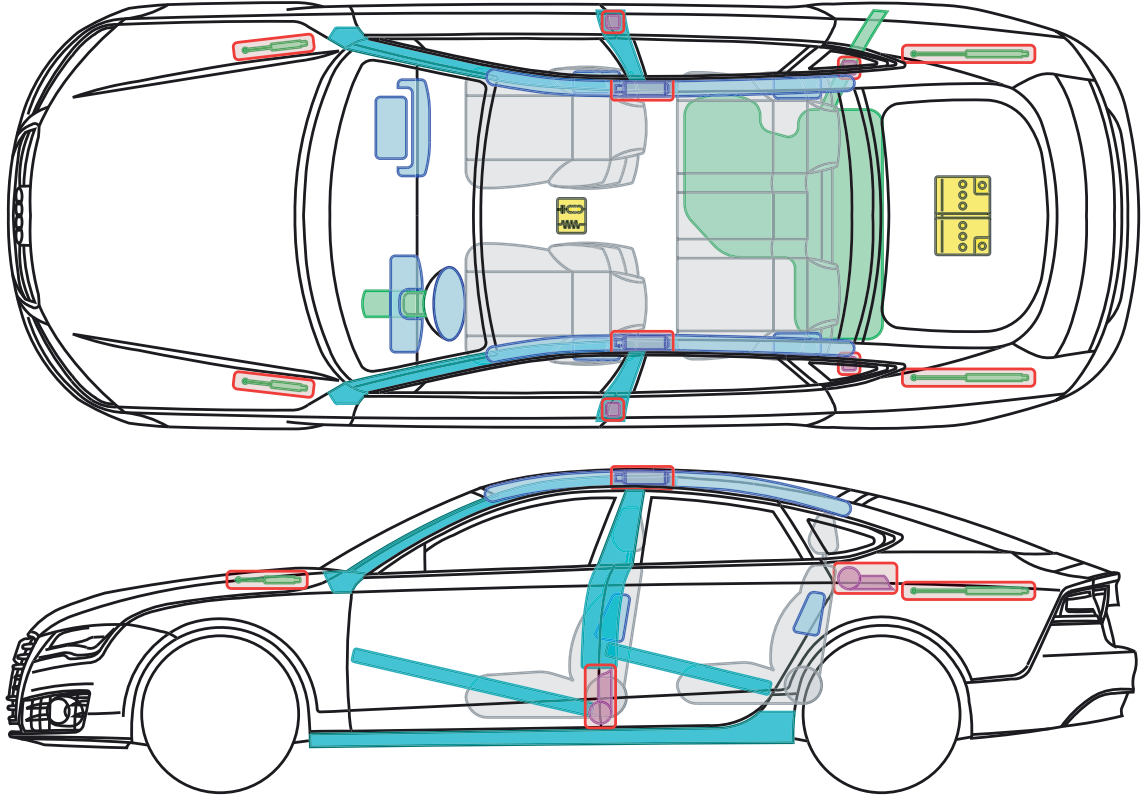

All the high-voltage leads and the high-voltage connections are provided with orange insulation. These items must not be disconnected or damaged.

# Audi A7 Sportback

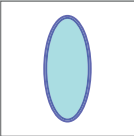
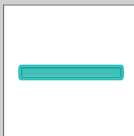
from 2010

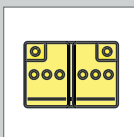
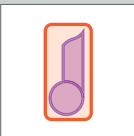
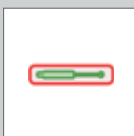

## Legend

	Airbag		Reinforce-ment		Control module
	Gas generator		Rollover protection		Battery
	Pre-tensioner		Gas-pressure damper		Fuel tank





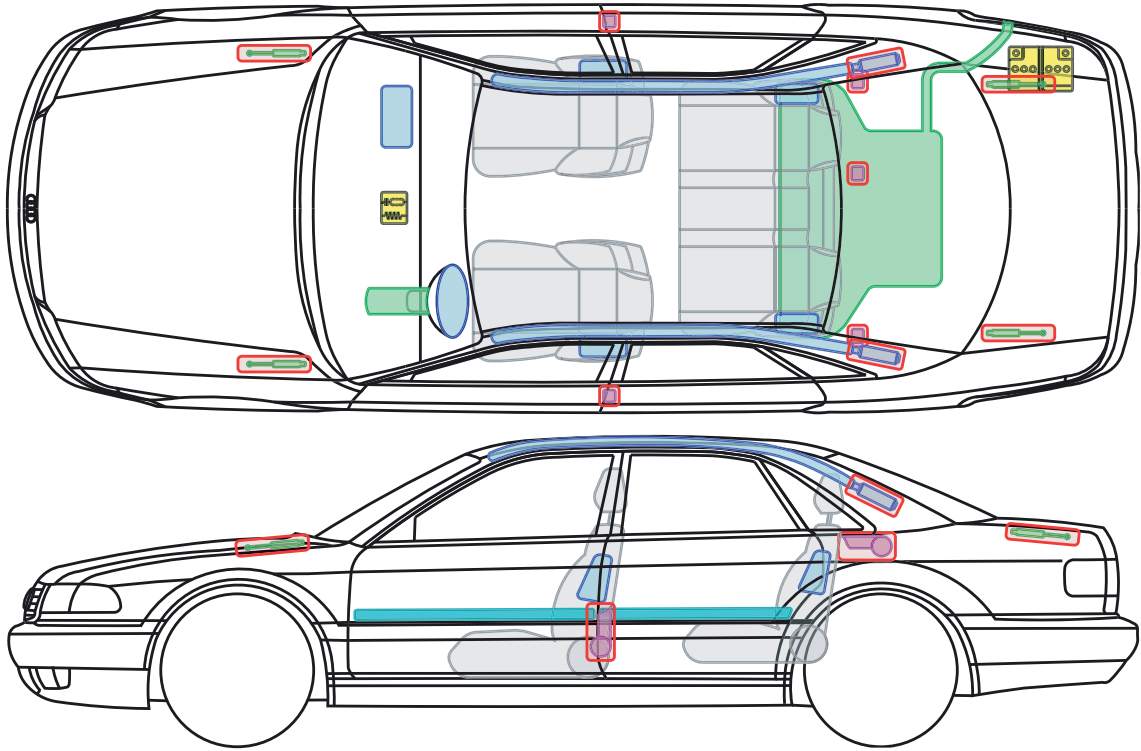

A7 Sportback

# Audi A8 / S8

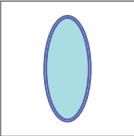
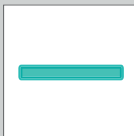
1994 – 2002

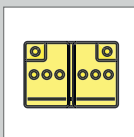
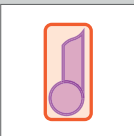
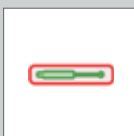

## Legend

	Airbag		Reinforce-ment		Control module
	Gas generator		Rollover protection		Battery
	Pre-tensioner		Gas-pressure damper		Fuel tank

A8 +S8 Limousine







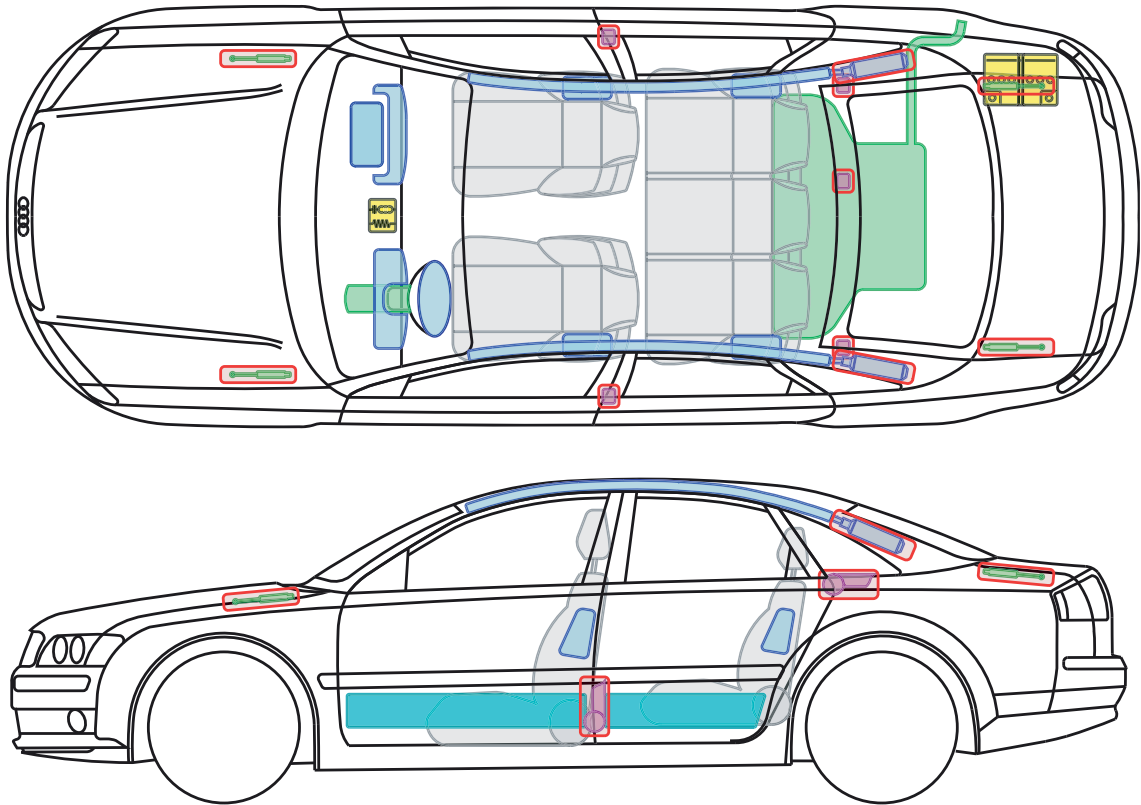

▶ Audi A8 / S8

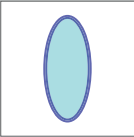
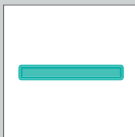
2002 – 2010

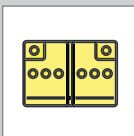
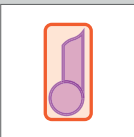
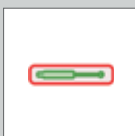

Legend

	Airbag		Reinforcement		Control module
	Gas generator		Rollover protection		Battery
	Pre-tensioner		Gas-pressure damper		Fuel tank





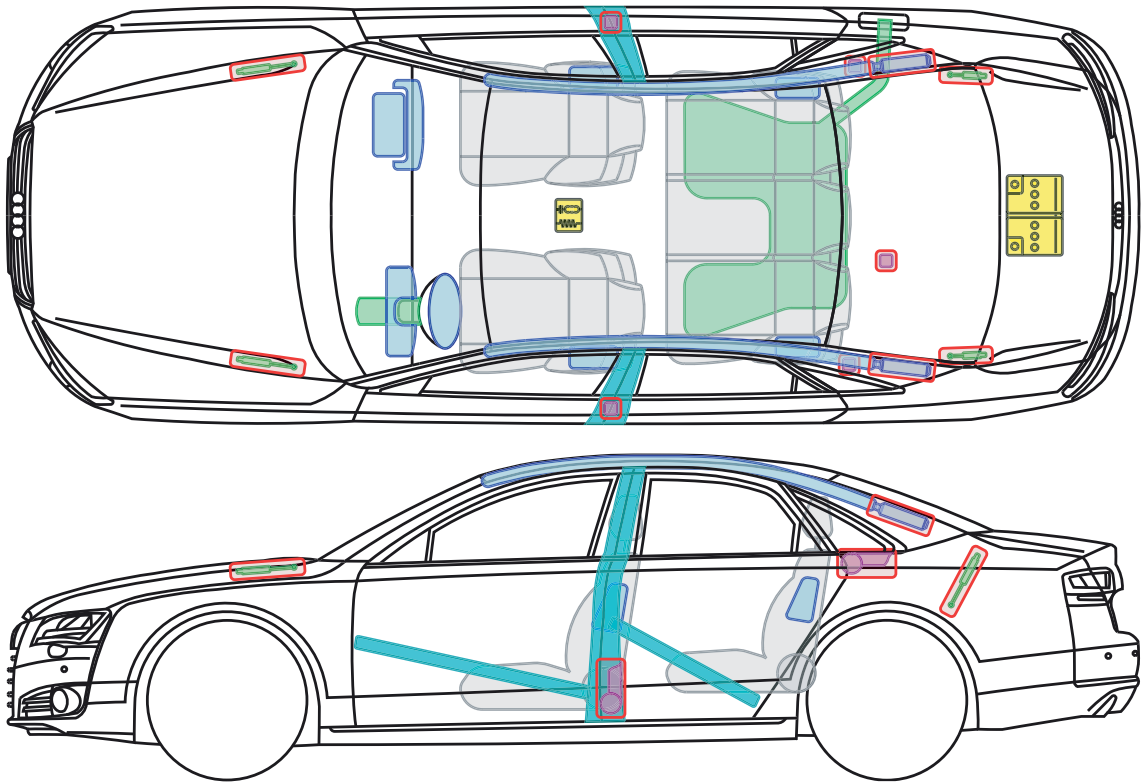

A8 +S8 Limousine

# Audi A8 / S8

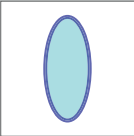
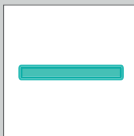
from 2010

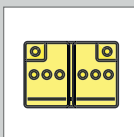
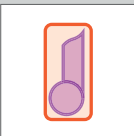
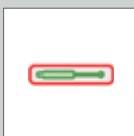

## Legend

	Airbag		Reinforce-ment		Control module
	Gas generator		Rollover protection		Battery
	Pre-tensioner		Gas-pressure damper		Fuel tank







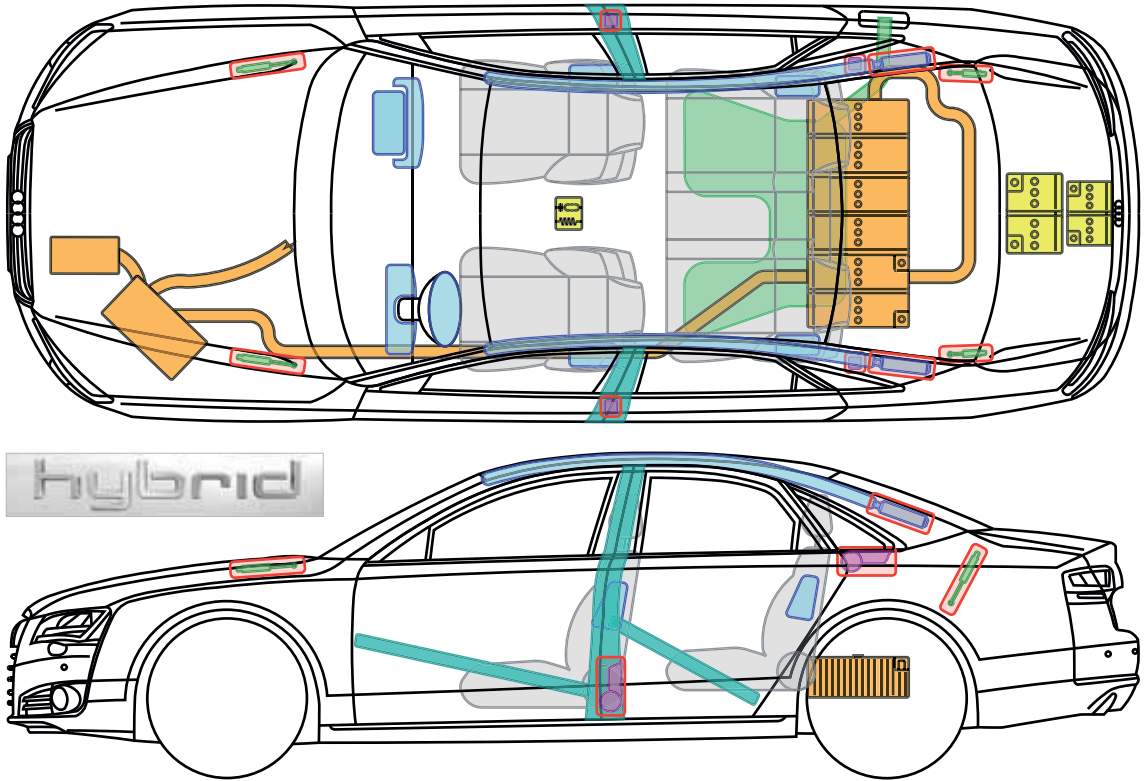

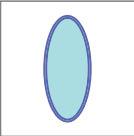
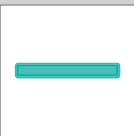
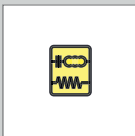

▶ Audi A8 hybrid

from 2012

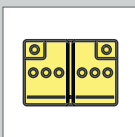

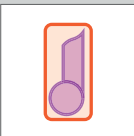
Legend

	Airbag		Reinforcement		Control module		High-voltage battery
	Gas generator		Overroll protection		12 V battery		High-voltage leads/components
	Pretensioner		Gas pressure damper		Fuel tank		

A8 hybrid



# Audi A8 hybrid

from 2012

## Identifying feature

The Audi A8 hybrid can be identified by means of the „hybrid“ logo and the orange cables in the engine compartment.



## Hints

**⚠ In the case of accidents in which the pyrotechnic belt tensioners or airbags are deployed, the high-voltage system is deactivated.**

In the case of accidents with deployed/undeployed airbags

- ▶ Place Vehicle in Park and set parking brake
- ▶ Switch off the ignition
- ▶ Disconnect the negative terminals of the 12V battery

**⚠ The electric motor is silent!**



It may not be possible to detect that the car is ready to go by the noises it makes when in operation, as the electric motor is silent. If the large needle in the dial on the left of the instrument cluster (power metre) is not on „OFF“ (for example on the „READY position), you have to expect that the electric motor may run or the internal combustion engine may start automatically.

## Switch off the ignition



**With the ignition switched on:**

Press START ENGINE STOP button without depressing brake pedal.

**⚠ Risk of Injury: By pressing the START ENGINE STOP button with depressing brake pedal, the engine starts!**



# ▶ Audi A8 hybrid

from 2012

## Disconnect the negative terminals of the 12V batteries

Lever up the luggage compartment floor. Lift up the tool box element. Disconnect the ground cables from both 12 V batteries (picture on right).

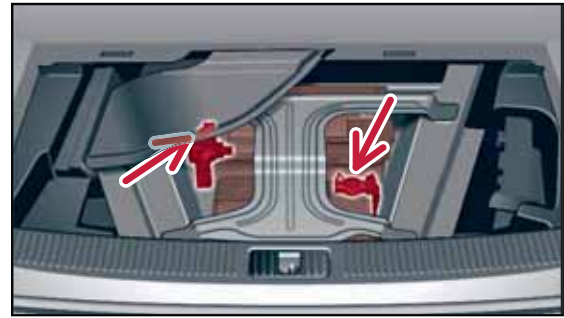
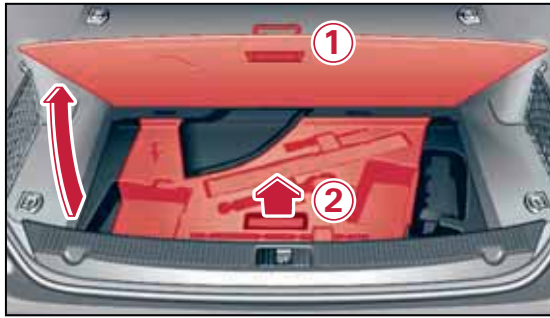

## Identification of the high-voltage components

Identification of the high-voltage battery



Identification of the high-voltage battery is located under the luggage compartment floor.

It is a lithium-ion battery.

Identification of the remaining high-voltage components



All the high-voltage leads and the high-voltage connections are provided with orange insulation. These items must not be disconnected or damaged.





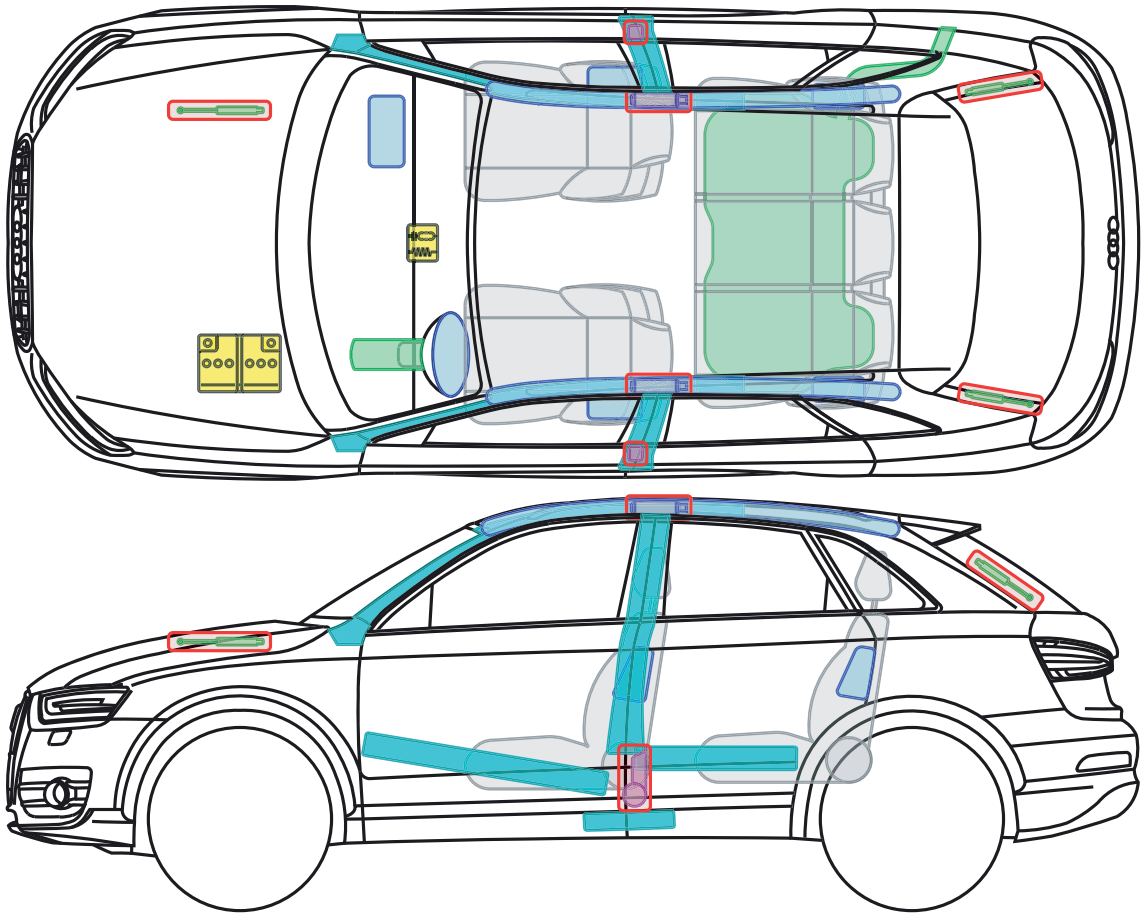

# Audi Q3

from 2011

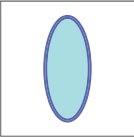
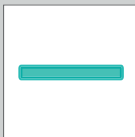
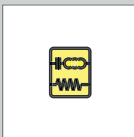

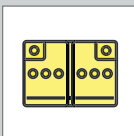
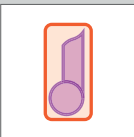
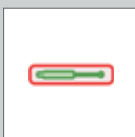
## Legend

	Airbag		Reinforcement		Control module
	Gas generator		Rollover protection		Battery
	Pretensioner		Gas-pressure damper		Fuel tank





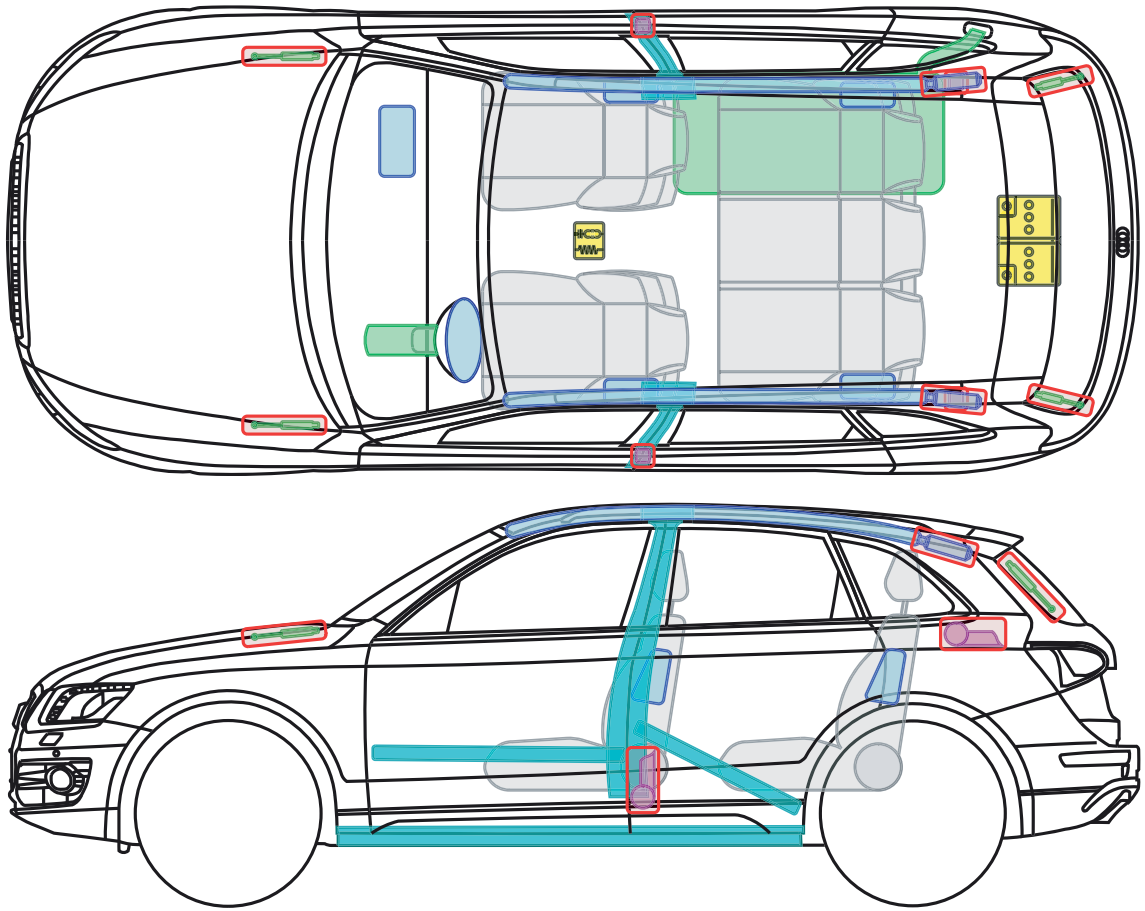

# Audi Q5

from 2008

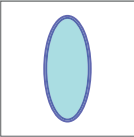
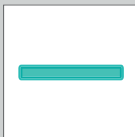
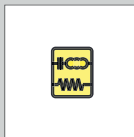

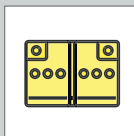
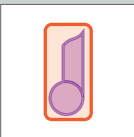
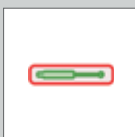
## Legend

	Airbag		Reinforce- ment		Control module
	Gas generator		Rollover protection		Battery
	Preten- sioner		Gas-pressure damper		Fuel tank





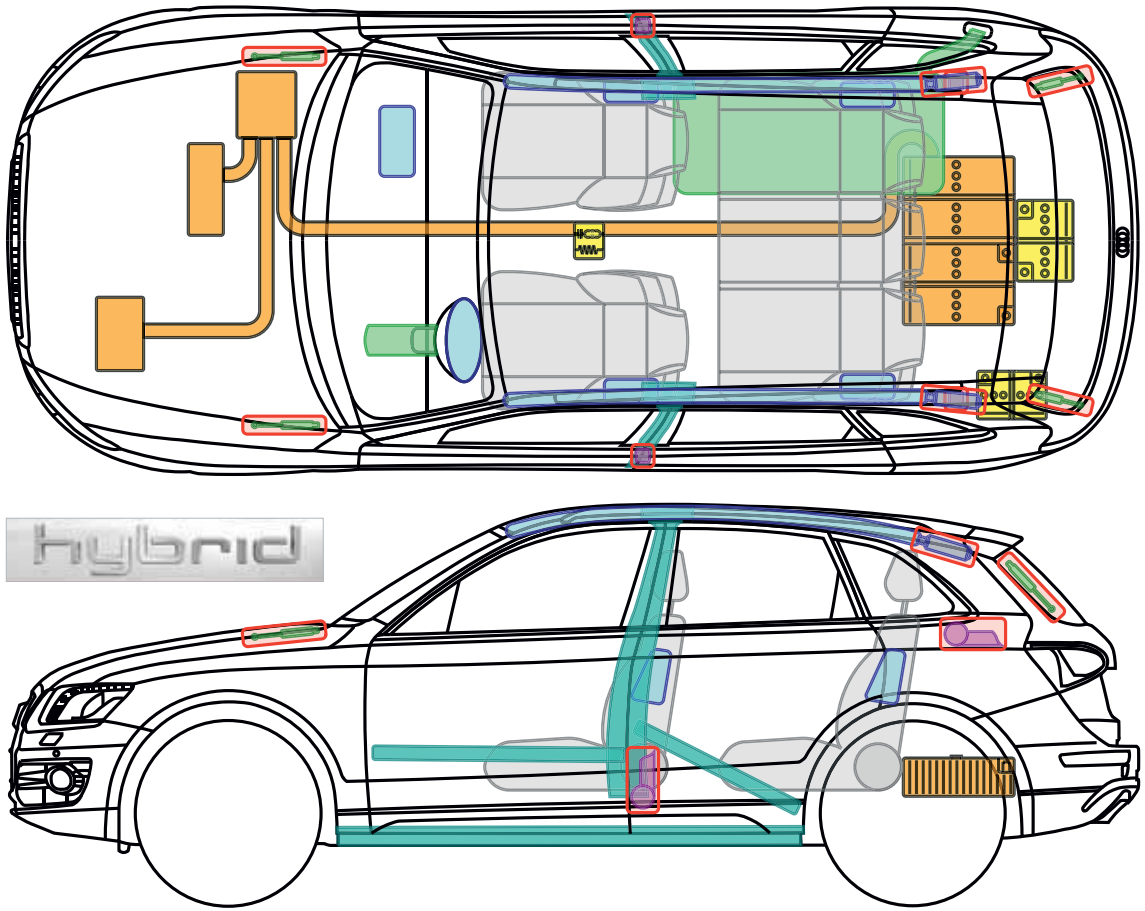

▶ Audi Q5 hybrid quattro

from 2011

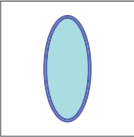
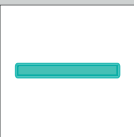
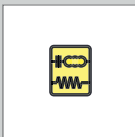
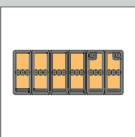

Hybrid

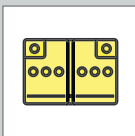
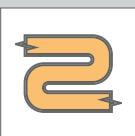
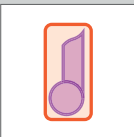
Legend

	Airbag		Reinforcement		Control module		High-voltage battery
	Gas generator		Overroll protection		12 V battery		High-voltage leads/components
	Pretensioner		Gas-pressure damper		Fuel tank		

Q5 hybrid quattro

# Audi Q5 hybrid quattro

from 2011

## Identifying feature

The Audi Q5 hybrid quattro can be identified by means of the „hybrid“ logo.



## Hints

**⚠ In the case of accidents in which the pyrotechnic belt tensioners or airbags are deployed, the high-voltage system is deactivated.**

In the case of accidents with deployed/undeployed airbags

- ▶ Place Vehicle in Park and set parking brake
- ▶ Switch off the ignition
- ▶ Disconnect the negative terminals of the 12V battery

**⚠ The electric motor is silent!**



It may not be possible to detect that the car is ready to go by the noises it makes when in operation, as the electric motor is silent. If the large needle in the dial on the left of the instrument cluster (power metre) is not on „OFF“ (for example on the „READY position), you have to expect that the electric motor may run or the internal combustion engine may start automatically.

## Switch off the ignition



**With the ignition switched on and the key in the ignition:**  
Switch off the ignition by pressing the key into the ignition lock **without** depressing brake pedal. Pull out the key.

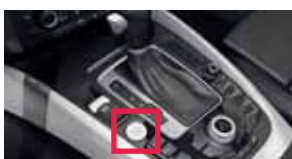

**With the ignition switched on and the key not in the ignition (possible with the convenience key):**  
Press START ENGINE STOP button **without** depressing brake pedal. If possible, take the convenience key outside the transmission range of the vehicle (5 meter).

**⚠ Risk of Injury: By pressing the key/the START ENINGE STOP button with depressing brake pedal, the engine starts!**



# ▶ Audi Q5 hybrid quattro

from 2011

## Disconnect the negative terminals of the 12V batteries

### Option A:

Release the luggage compartment floor by means of the screws indicated by the arrows (screwdriver in the car tool kit) Disconnect the ground cables from both 12V batteries (picture on right)

### Option B:

Lever up the luggage compartment floor by inserting a crowbar at the points indicated. Lift up the luggage compartment floor. Disconnect the ground cables from both 12V batteries (picture on right)



## Identification of the high-voltage components

Identification of the high-voltage battery



Identification of the The high-voltage battery is located under the luggage compartment floor.

It is a lithium-ion battery.

Identification of the remaining high-voltage components



All the high-voltage leads and the high-voltage connections are provided with orange insulation. These items must not be disconnected or damaged.



# Audi Q7

from 2006

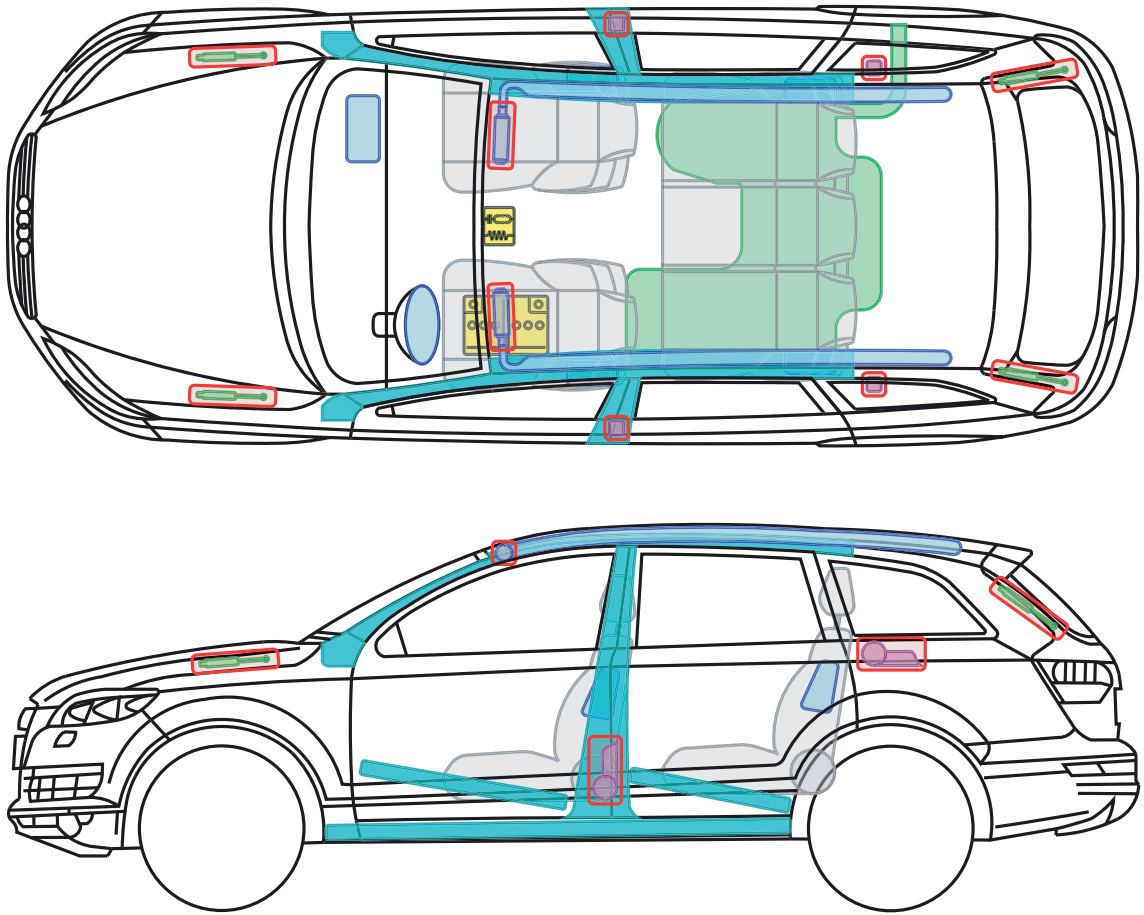

## Legend

	Airbag		Reinforcement		Control module
	Gas generator		Rollover protection		Battery
	Pre-tensioner		Gas-pressure damper		Fuel tank

Q7







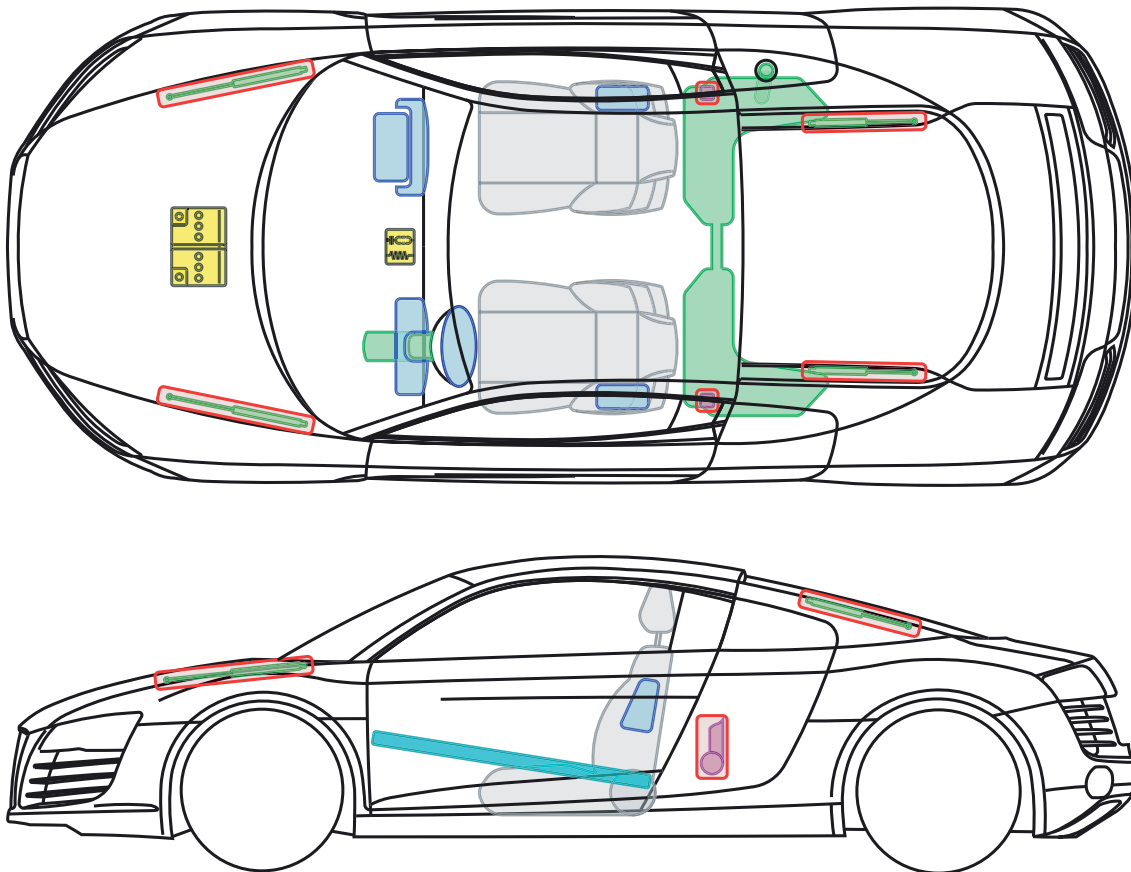

# Audi R8

from 2007

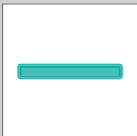
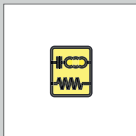
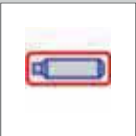

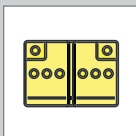
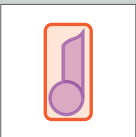
## Legend

	Airbag		Reinforcement		Control module
	Gas generator		Rollover protection		Battery
	Pretensioner		Gas-pressure damper		Fuel tank

R8





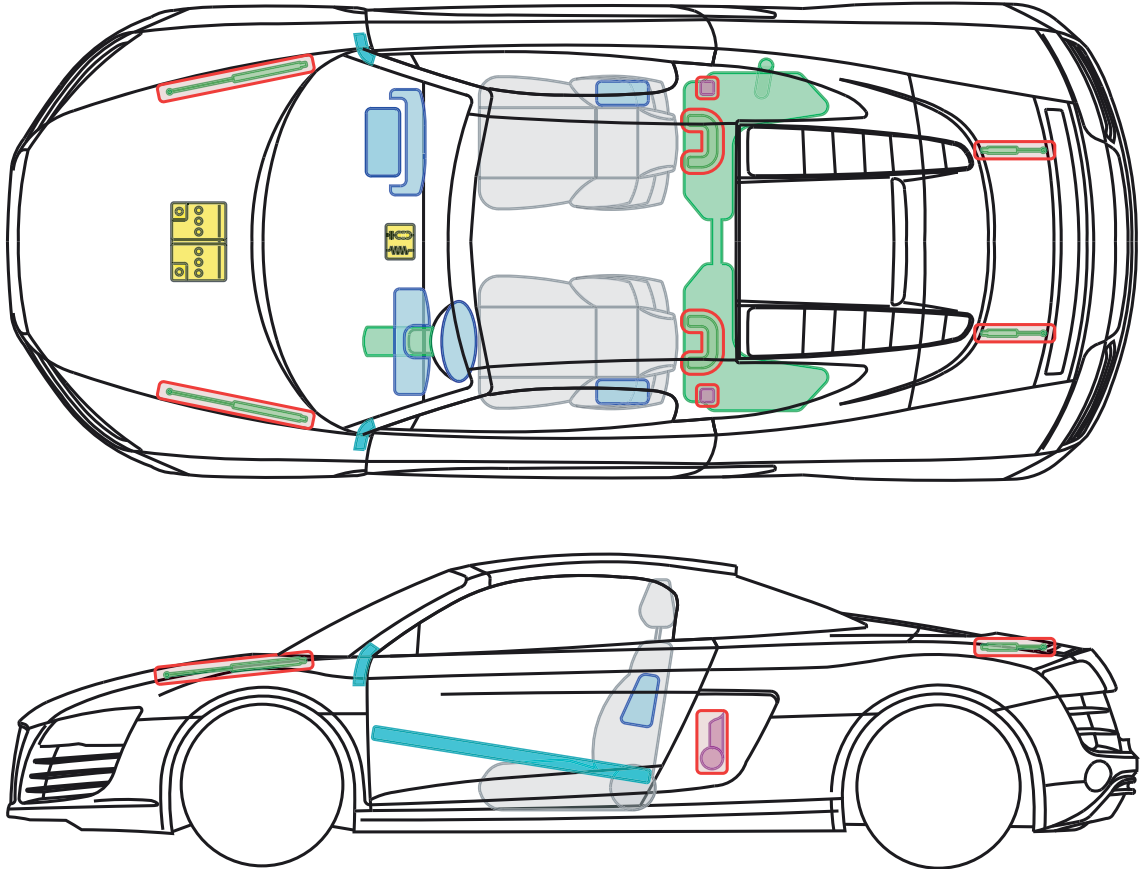

▶ Audi R8 Spyder

from 2010

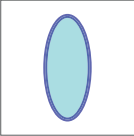
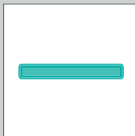
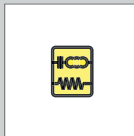

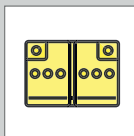
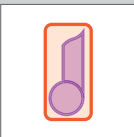
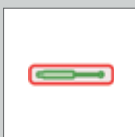
Legend

	Airbag		Reinforcement		Control module
	Gas generator		Rollover protection		Battery
	Pretensioner		Gas-pressure damper		Fuel tank





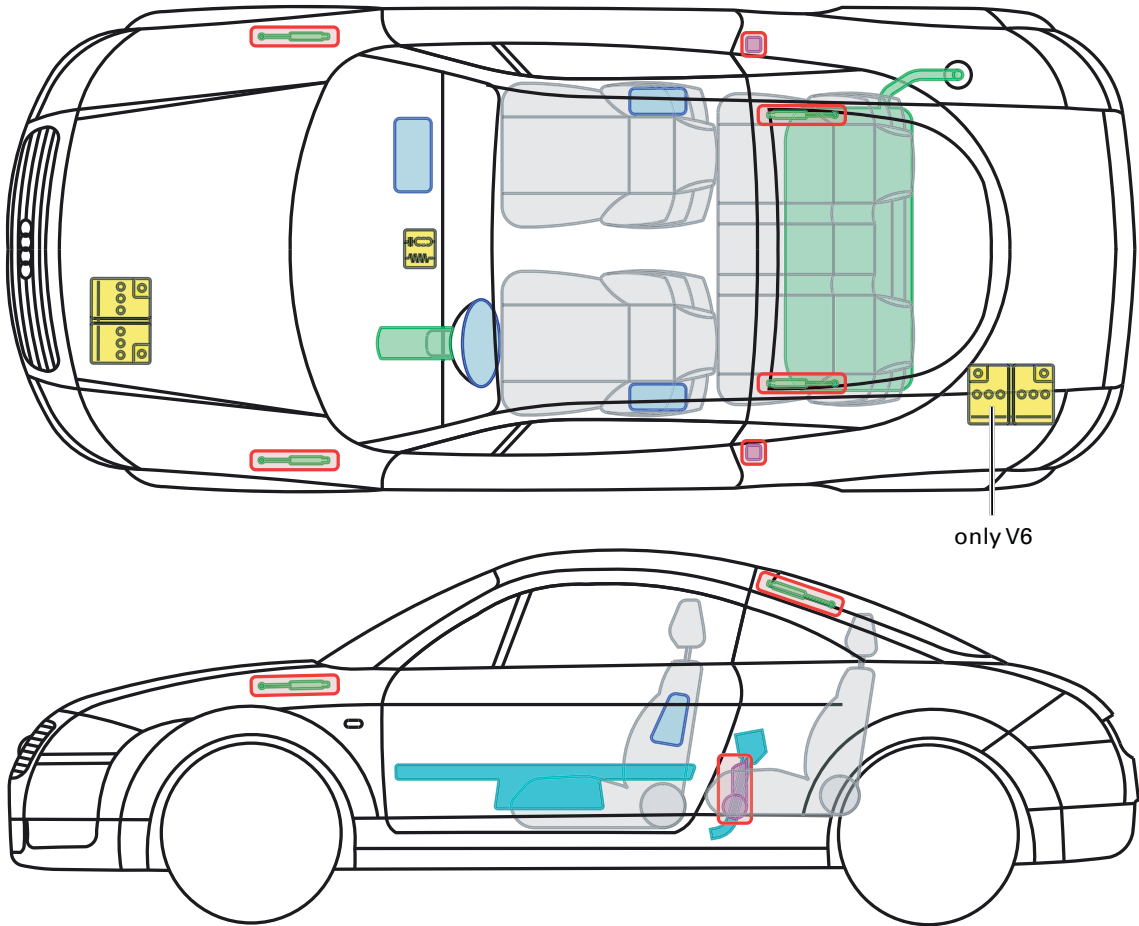

▶ Audi TT Coupé

1998 – 2006

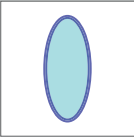
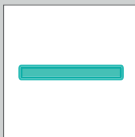
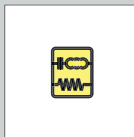

only V6

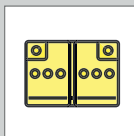
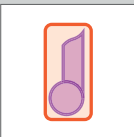
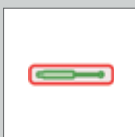
Legend

	Airbag		Reinforce- ment		Control module
	Gas generator		Rollover protection		Battery
	Preten- sioner		Gas-pressure damper		Fuel tank

Coupé





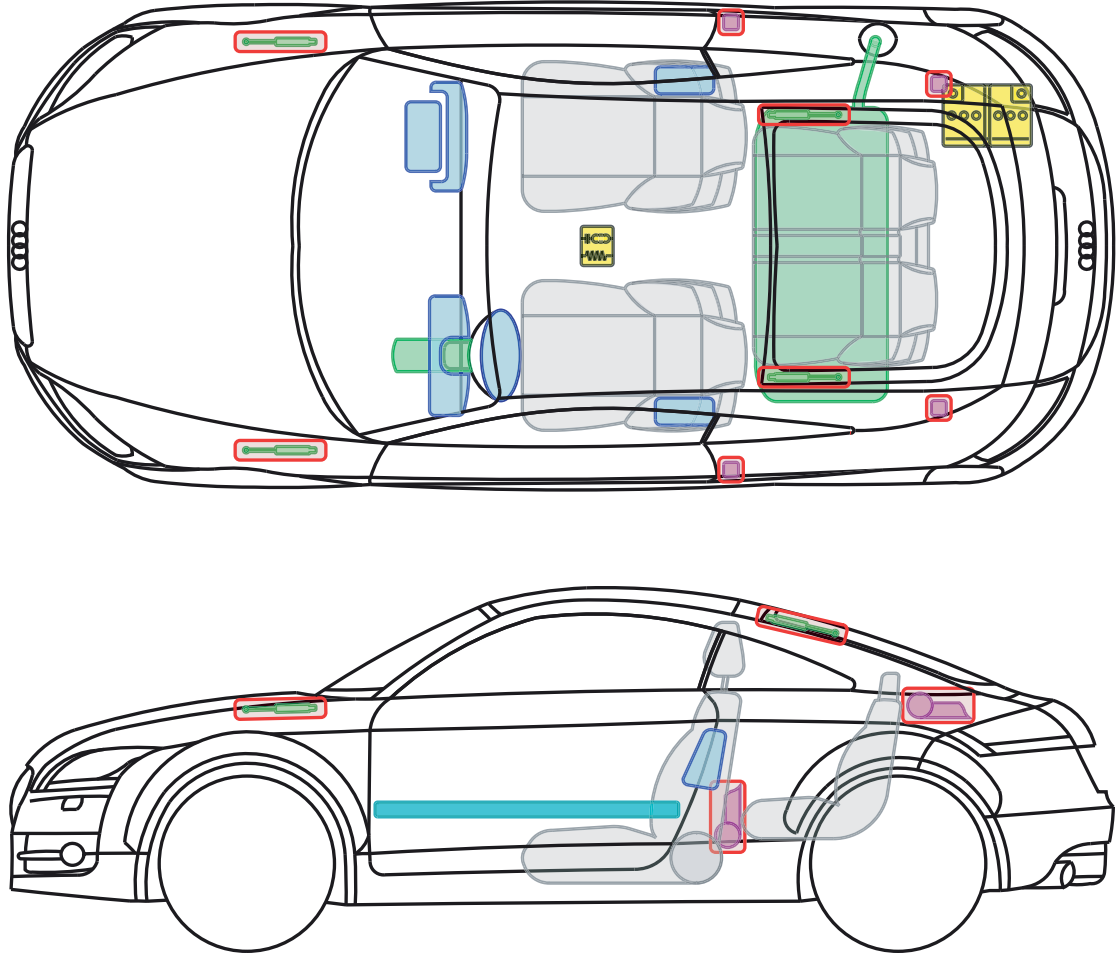

▶ Audi TT / TTS / TTRS Coupé

from 2006

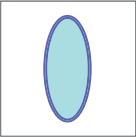
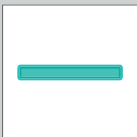
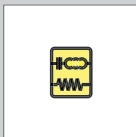
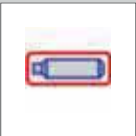

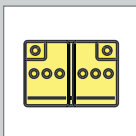
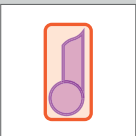
Legend

	Airbag		Reinforcement		Control module
	Gas generator		Rollover protection		Battery
	Pre-tensioner		Gas-pressure damper		Fuel tank

TTS/TTRS Coupé





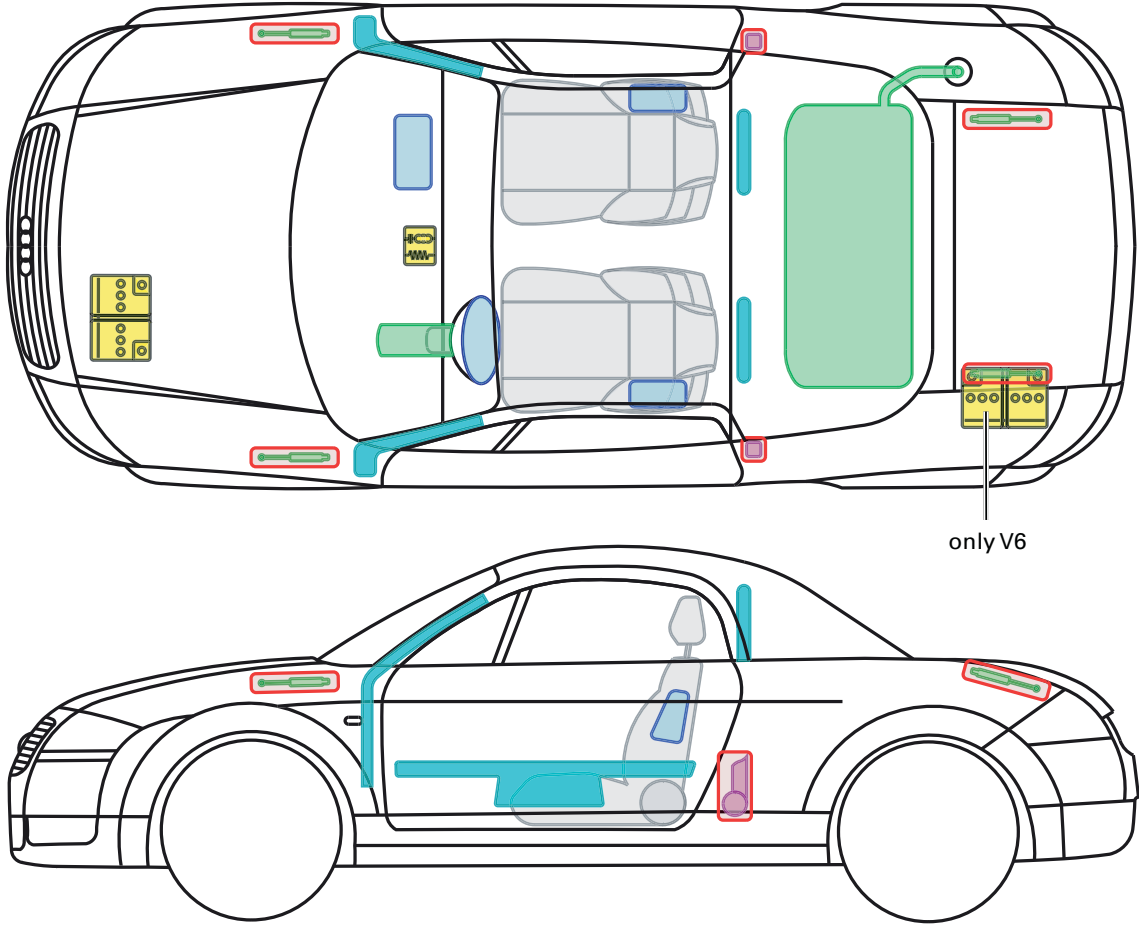

▶ Audi TT Roadster

1999 – 2006

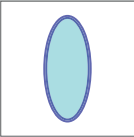
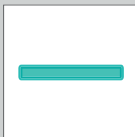
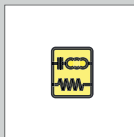

only V6

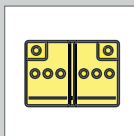
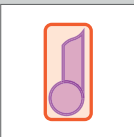
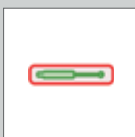
Legend

	Airbag		Reinforcement		Control module
	Gas generator		Rollover protection		Battery
	Pre-tensioner		Gas-pressure damper		Fuel tank

TT Roadster







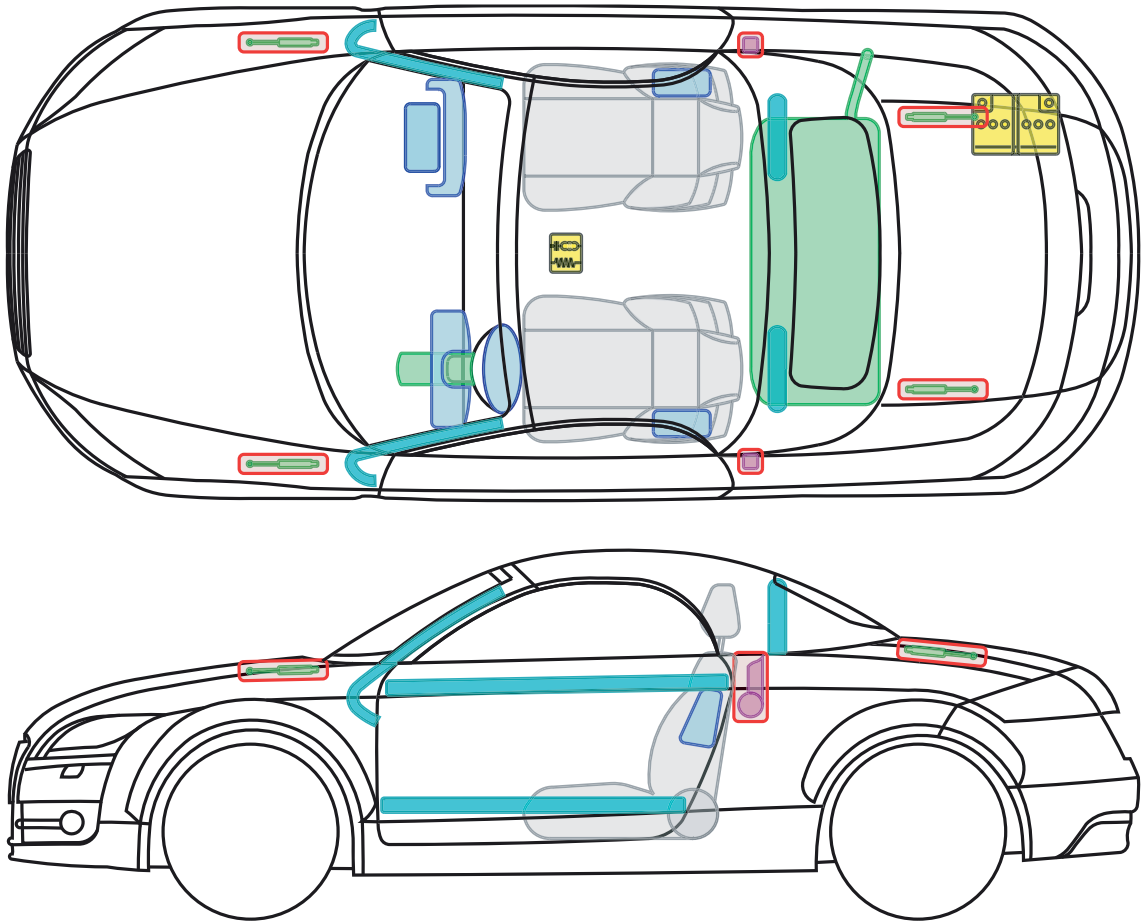

▶ Audi TT / TTS / TTRS Roadster

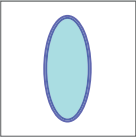
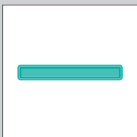
from 2007

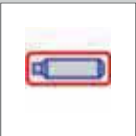

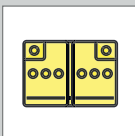
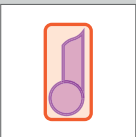
Legend

	Airbag		Reinforcement		Control module
	Gas generator		Rollover protection		Battery
	Pretensioner		Gas-pressure damper		Fuel tank