



**Owner's Manual**  
**Audi A3 | S3**



Audi A3 | S3

Audi A3 Sportback | A3 Sportback g-tron | S3 Sportback

Audi A3 Saloon | S3 Saloon

## Foreword

Thank you for choosing an Audi.

Your new Audi is a combination of superb craftsmanship and state-of-the-art technology. We recommend that you read this Owner's Manual carefully so that you quickly become familiar with your vehicle and can take full advantage of all its functions in everyday use.

In addition to information on how to use the controls and equipment, this Manual also contains important information on looking after your vehicle. This is relevant for your safety and will help preserve your car's value. The Manual also offers useful driving tips and advice, together with some suggestions on how to drive your car with minimum impact on the environment.

In addition to this Owner's Manual, the Service Wallet also includes the Quick Reference Guide, the Operating Manual for your infotainment system and the Service Schedule.

We wish you safe and enjoyable motoring with your Audi.

**AUDI AG**



### WARNING

Please read the important safety information about the front passenger's air-bag ⇒ *page 172*.



1425618V020

<b>Notes on this Owner's Manual</b> . . . . .	5	<b>Heating and cooling</b> . . . . .	77
<b>Controls</b> . . . . .	6	Heating system / air conditioner . . . . .	77
<b>Controls and displays</b> . . . . .	6	Auxiliary heating/ventilation . . . . .	82
Overview . . . . .	6	<b>Driving</b> . . . . .	86
<b>Instruments and warning/ indicator lamps</b> . . . . .	9	Steering . . . . .	86
Instruments . . . . .	9	Ignition lock . . . . .	86
Warning and indicator lamps . . . . .	14	Vehicles with ignition lock . . . . .	86
<b>Driver information system</b> . . . . .	27	Vehicles with convenience key . . . . .	88
Overview . . . . .	27	Driver messages . . . . .	91
Controls on windscreen wiper lever . . . . .	28	Kick-down feature . . . . .	92
Controls on multi-function steering wheel . . . . .	29	Electro-mechanical parking brake . . . . .	92
Boost display . . . . .	31	Hold assist . . . . .	95
Efficiency programme . . . . .	31	Hill hold assist . . . . .	95
Camera-based traffic sign recognition . . . . .	33	Speed warning function . . . . .	96
Rest recommendation . . . . .	35	Cruise control system . . . . .	97
Lap timer and engine oil temperature display . . . . .	36	Start/stop system . . . . .	98
Controls on windscreen wiper lever . . . . .	37	<b>g-tron</b> . . . . .	102
Controls on multi-function steering wheel . . . . .	39	Natural gas engine . . . . .	102
<b>Doors and windows</b> . . . . .	41	Filling the gas tank . . . . .	104
Central locking system . . . . .	41	<b>Automatic gearbox</b> . . . . .	106
Boot lid . . . . .	49	S tronic gearbox . . . . .	106
Child-proof catches . . . . .	50	<b>Audi adaptive cruise control</b> . . . . .	116
Electric windows . . . . .	51	Introduction . . . . .	116
Panorama sun roof . . . . .	52	General notes . . . . .	116
<b>Lights and vision</b> . . . . .	54	Adaptive cruise control . . . . .	117
Exterior lights . . . . .	54	<b>Audi pre sense</b> . . . . .	125
Interior lights . . . . .	60	Introduction . . . . .	125
Clear vision . . . . .	61	General notes . . . . .	125
Windscreen wipers . . . . .	62	Audi pre sense basic . . . . .	125
<b>Seats and storage</b> . . . . .	66	Audi pre sense front . . . . .	125
General notes . . . . .	66	Driver messages . . . . .	127
Front seats . . . . .	66	<b>Audi active lane assist</b> . . . . .	128
Head restraints . . . . .	68	Lane departure warning feature . . . . .	128
Ashtray . . . . .	69	<b>Audi side assist</b> . . . . .	132
Cigarette lighter . . . . .	69	Lane change assist feature . . . . .	132
Electrical socket . . . . .	70		
Storage . . . . .	70		
Luggage compartment . . . . .	73		

<b>Audi drive select</b> .....	136	<b>Your vehicle and the environment</b> .....	190
Adjusting the vehicle set-up .....	136	Running in .....	190
<b>Parking aids</b> .....	139	Driving through water on roads .....	190
General notes .....	139	Emission control systems .....	190
Rear parking aid .....	140	Taking the vehicle out of service .....	191
Parking system plus .....	140	How to improve economy and minimise pollution .....	191
Reversing camera .....	142	Environmental compatibility .....	192
Park assist .....	146	<b>Towing a trailer</b> .....	194
Adjusting graphic display and warning beeps .....	150	Driving the vehicle with a trailer or caravan .....	194
Fault warnings .....	151	Removable towing bracket .....	198
Towing bracket .....	151	<b>General maintenance</b> .....	204
<b>Safety</b> .....	152	<b>Care of vehicle and cleaning</b> ..	204
<b>Safety first</b> .....	152	General notes .....	204
General notes .....	152	Washing the vehicle .....	204
Correct sitting positions .....	154	Notes on cleaning and care .....	205
Child seats .....	157	<b>Checking and topping up fluids</b> .....	209
Fitting child seats .....	159	Fuel .....	209
Pedal area .....	161	Filling the tank .....	210
Stowing luggage safely .....	162	Bonnet .....	212
Pedestrian protection system .....	163	Engine oil .....	214
<b>Seat belts</b> .....	165	Cooling system .....	216
Why is it so important to use seat belts? .....	165	Brake fluid .....	218
Forces acting in a collision .....	166	Battery .....	218
How to wear seat belts properly .....	167	Windscreen washer .....	221
Belt tensioners .....	169	<b>Wheels and tyres</b> .....	223
<b>Airbag system</b> .....	171	Wheels .....	223
Description of airbag system .....	171	Run-flat tyres .....	229
Front airbags .....	172	Tyre pressure loss indicator .....	231
Knee airbag .....	175	<b>Accessories and modifications to the vehicle</b> .....	233
Side airbags .....	177	Accessories, replacement parts and repairs .....	233
Head-protection airbags .....	178	Modifications .....	233
Deactivating the front passenger's airbag .....	180	Radio transmitters and business equipment .....	233
<b>Driving tips</b> .....	182	Component protection .....	234
<b>Intelligent technology</b> .....	182		
Electronic stabilisation control (ESC) ..	182		
Brakes .....	184		
Electro-mechanical power steering ..	185		
Four-wheel drive (quattro) .....	186		
Power management .....	187		
Information saved in the control units	188		

<b>Self-help</b> .....	235
<b>Self-help</b> .....	<b>235</b>
General notes .....	235
Equipment .....	235
Tyre repair kit .....	237
Changing a wheel .....	238
Spare wheel .....	242
Jump-starting .....	244
Tow-starting / towing away .....	246
<b>Fuses and bulbs</b> .....	<b>250</b>
Fuses .....	250
Bulbs .....	253
Changing bulbs in headlight unit ....	256
Changing bulb for front fog light ....	262
A3/A3 Sportback: Changing bulbs for rear lights .....	263
A3 Saloon: Changing bulbs for rear lights .....	268
<b>Technical data</b> .....	272
<b>Technical data</b> .....	<b>272</b>
Vehicle identification data .....	272
Dimensions .....	273
Capacities .....	273
Explanation of technical data .....	273
Petrol engines .....	275
Diesel engines .....	284
<b>Index</b> .....	290

This Owner's Manual contains important information, tips, suggestions and warnings.

Please ensure that this Owner's Manual is always kept in the vehicle. It should always be available to anyone else driving the vehicle, i.e. anyone renting, borrowing or buying the vehicle from you.

This manual describes **the equipment available for the vehicle at the time of going to print**. Some of the equipment described here will not be available until a later date, or may only be available in certain markets.

Some sections of this Owner's Manual do not apply to all vehicles. If this is the case, a text at the start of the section indicates which vehicles it applies to, e.g. "Applies to vehicles: with auxiliary heater". This optional or vehicle-specific equipment is also marked with an asterisk "\*".

**Illustrations** are intended as a general guide, and may vary from the equipment fitted in your vehicle.

At the beginning of this Owner's Manual, you will find a **table of contents** showing all the items described in this manual in the order in which they appear. An **alphabetical index** is included at the end of the Owner's Manual.

All references to **positions** such as "left", "right", "front" or "rear" are given as seen facing in the direction of travel.

- \* Optional or vehicle-specific equipment
- The section is continued on the following page.

⇒ ⚠ Refers to a "WARNING" within the same section. If the WARNING symbol is followed by a page number the warning text referred to is included in a different section.

### WARNING

Texts with this symbol contain safety information. They warn you of serious dangers, possibly involving accident or injury.

### CAUTION

Texts with this symbol draw your attention to a possible risk of damage to your vehicle.

### For the sake of the environment

Texts with this symbol refer to points relevant to the protection of the environment.

### Note

Texts with this symbol contain additional information of a more general nature.

## Controls and displays

### Overview

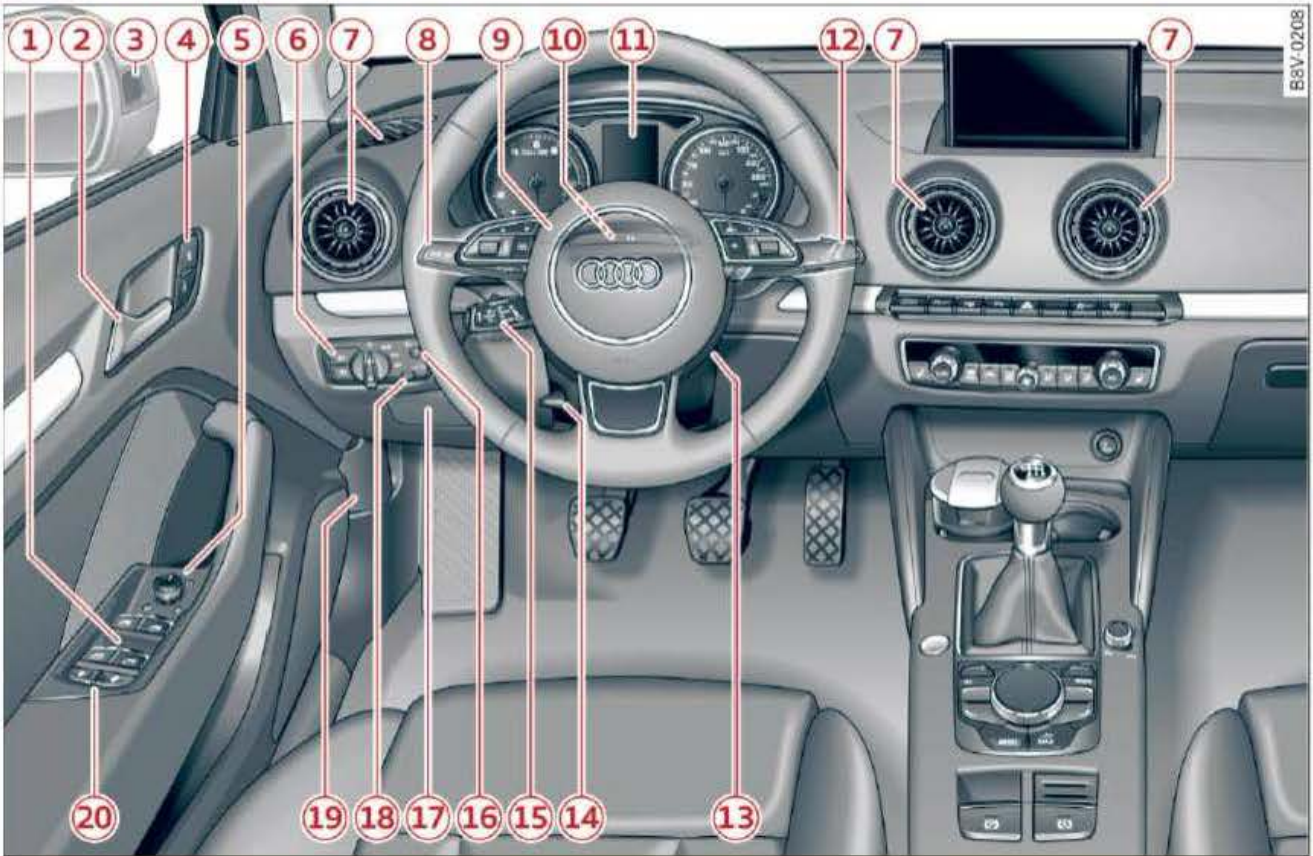

Fig. 1 Front cabin: Left side

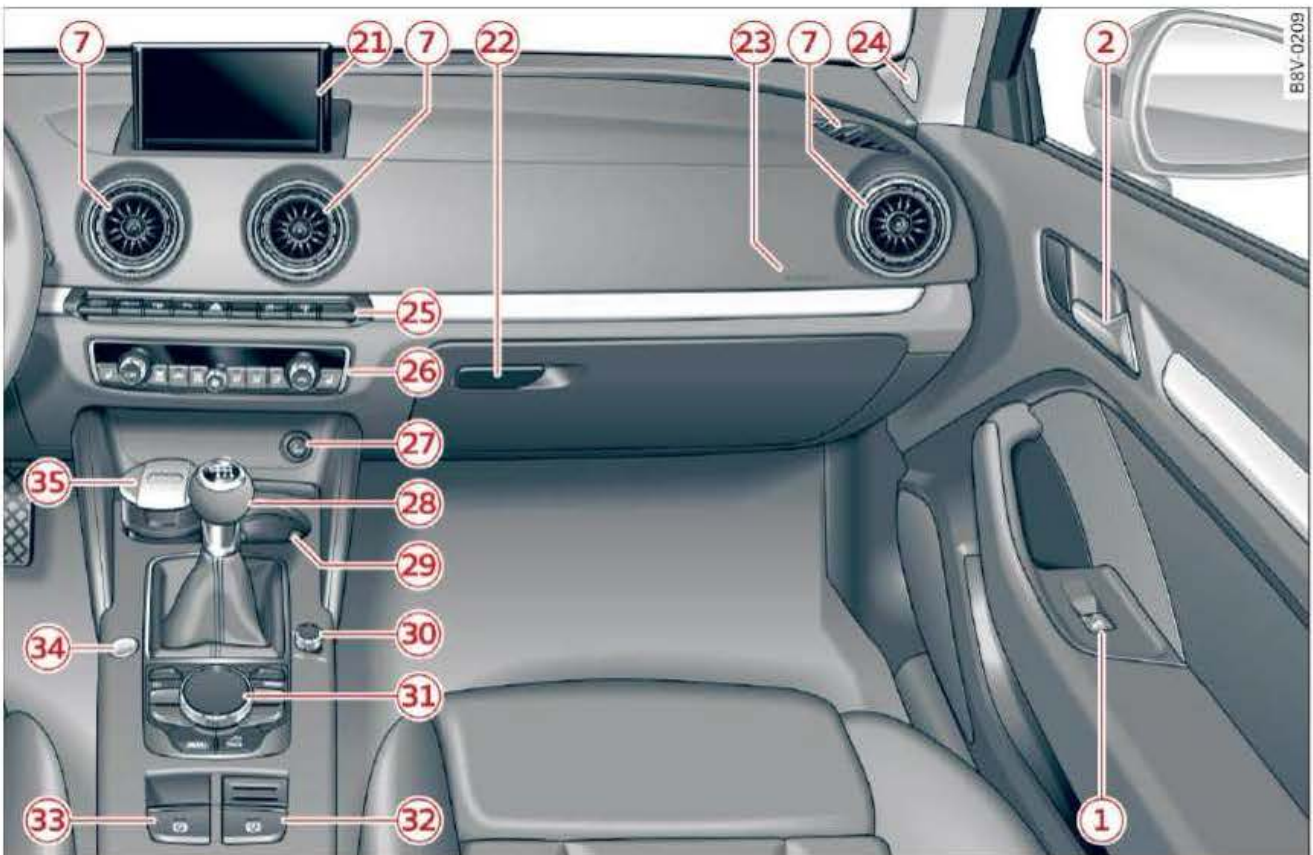

Fig. 2 Front cabin: Right side



① Electric windows .....	51	– Safety switch .....	51
② Door handle		②① Depending on equipment fitted: Sound system or MMI display (navigation system, radio, TV/ video)	
③ Audi side assist .....	132	②② Glove box with CD changer .....	71
④ Central locking switch .....	47	②③ Front passenger's airbag .....	172
⑤ Electric adjuster for exterior mirrors .....	61	②④ Loudspeaker (treble)	
⑥ Light switch .....	54	②⑤ Depending on equipment fitted, buttons for:	
⑦ Air outlets .....	77	– Drive select .....	136
⑧ Control lever for:		– Start/stop system .....	98
– Turn signals and main beam headlights .....	55	– Park assist .....	146
– Audi active lane assist .....	128	– Parking system plus (with op- tional reversing camera) .....	140
– Main beam assist .....	56	– Hazard warning lights .....	59
⑨ Steering wheel with horn and		– Electronic stabilisation control (ESC) .....	182
– Driver's airbag .....	172	– MMI display	
– Controls for on-board comput- er .....	29	– Airbag off display .....	180
– Controls for sound system, telephone, navigation system and speech dialogue system		②⑥ Console for the following (as ap- plicable):	
– Paddle levers for tiptronic gearshift (automatic gearbox)	111	– Heating/ventilation system or manual air conditioner .....	77
⑩ Reset button for trip recorder ..	10	– Automatic air conditioner ...	79
⑪ Instrument cluster .....	9	②⑦ Depending on equipment fitted:	
⑫ Control lever for:		– Cigarette lighter .....	69
– Windscreen wipers and wash- er .....	62	– Electrical socket .....	70
– On-board computer .....	27	②⑧ Depending on gearbox fitted, gear lever or selector lever for:	
⑬ Steering column with:		– Manual gearbox	
– Manual operation function for ignition (on vehicles with con- venience key) .....	91	– S tronic .....	106
– Ignition lock (on vehicles with mechanical ignition lock) .....	86	②⑨ Cup holder .....	70
⑭ Adjustable steering column ...	86	③① ON/OFF button for sound sys- tem/MMI	
⑮ Depending on equipment fitted:		③② MMI control console	
– Lever for cruise control .....	97	③③ Hold assist .....	95
– Adaptive cruise control .....	116	③④ Parking brake .....	92
⑯ Headlight range control .....	54	③⑤ <b>START ENGINE STOP</b> button ..	88
⑰ Knee airbag .....	175	③⑥ Centre console with optional equipment:	
⑱ Instrument lighting .....	60	– Ashtray .....	69
⑲ Bonnet lock release .....	213	– Carrier for car key and mobile phone .....	71 ▶
⑳ Child safety switch, depending on equipment fitted:			
– Electric child safety switch ..	50		

**i** Note

- Some of the items of equipment listed in this section are only fitted on certain models or are optional extras.
- Please refer to the separate operating manual for instructions on using the sound system or Multi Media Interface (MMI), where you will also find information on Audi connect.
- The arrangement of switches and controls on right-hand drive models\* may be slightly different from the layout shown on ⇒ *page 6*. However, the symbols used to identify the controls are the same.

# Instruments and warning/indicator lamps

## Instruments

### Instrument cluster overview

The instrument cluster is the driver's information centre.

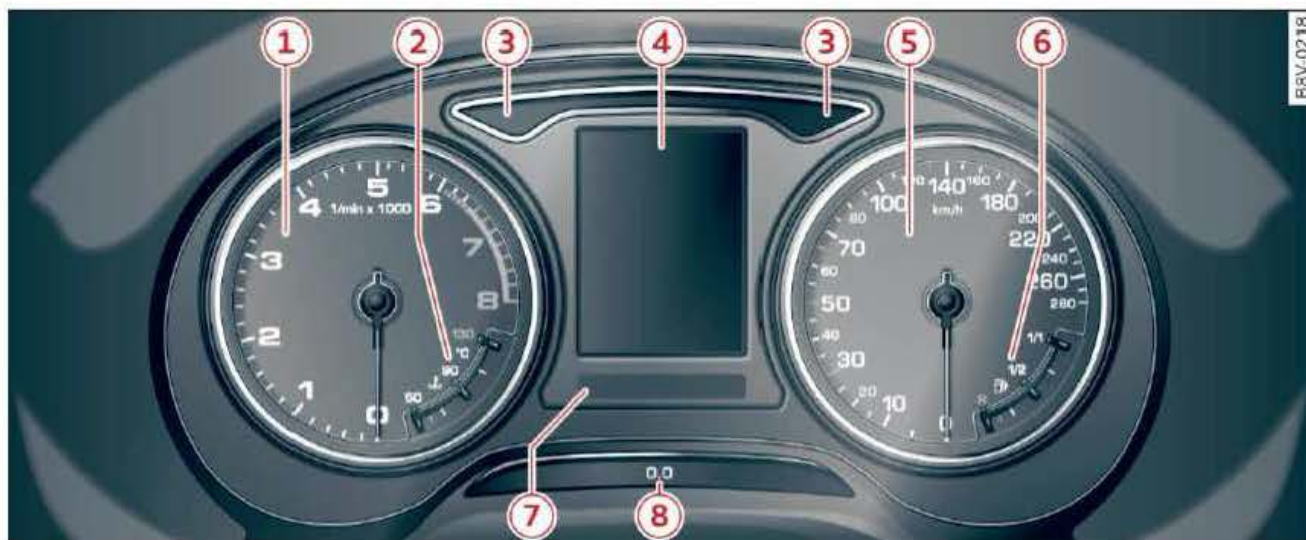

Fig. 3 Overview of instrument cluster

The instrument cluster is different on models with natural gas engine\* ⇒ page 103.

- |   |        |
|---|--------|
| ① Rev counter with warning lamps  |        |
| ② Coolant temperature gauge* or boost pressure display* . . . . .           | 11, 31 |
| ③ Indicator lamps (turn signals)  |        |
| ④ Display   |        |
| – Warning/indicator lamps and   | 14     |
| – Driver information system* . . .  | 27     |
| – Date* and time . . . . .  | 9      |
| – Mileage recorder . . . . .  | 10     |
| – Service interval display . . . . .  | 13     |
| ⑤ Speedometer with warning lamps  |        |
| ⑥ Fuel gauge . . . . .  | 11     |
| ⑦ Display for: Central warning/indicator lamp or system displays            | 14     |
| ⑧ Reset button for trip recorder <input type="text" value="0.0"/> . . . . . | 10     |

#### **i** Note

The needles on the dials in the instrument cluster are illuminated when the ignition is switched on. The main instrument lighting (for the dials and needles) comes on when

the vehicle's lights are switched on. The instrument lighting is dimmed automatically as the daylight starts to fade. This function is intended to remind the driver to switch on the dipped-beam headlights in good time when light conditions become poor.

### Setting the time/date



Fig. 4 Instrument cluster: Time and date display (example)

The date, time and display format can be changed using the sound system or MMI\* control console. Please refer to the MMI Operating Manual for further details. ▶

Depending on the equipment fitted, you can select a quartz clock or a GPS-controlled clock\*  on the MMI\*. Please refer to the sound system or MMI Operating Manual for more details.

### Note

- The date and time will be displayed for about 30 seconds after you switch off the ignition or open the driver's door.
- You can also call up the display when the ignition is switched off by pressing the  button ⇒ page 9, Fig. 3.

### Rev counter

The rev counter indicates the number of engine revolutions per minute.

It's a good idea to keep an eye on the rev counter and gear-change indicator because you can minimise engine wear by driving at moderate engine speeds.

The start of the red zone on the dial indicates the maximum engine speed which may be used briefly in all gears when the engine is warm and after it has been run in properly. However, it is advisable to change up a gear (on vehicles with manual gearbox) or move the selector lever to "D" (on vehicles with automatic gearbox) or lift your foot off the accelerator before the needle reaches the red zone.

In general it is best to avoid high engine speeds and to follow the recommendations given by the gear-change indicator. For further information please refer to ⇒ page 12, *Gear-change indicator* or ⇒ page 31, *Advanced gear-change indicator*.

### CAUTION

The rev counter needle  ⇒ page 9, Fig. 3 must only ever briefly go into the red zone on the scale; otherwise there is a risk of engine damage.



### For the sake of the environment

Changing up a gear early will help you to save fuel and minimise engine noise.



### Mileage recorder



Fig. 5 Instrument cluster: Mileage recorder and reset button

The mileage is stated in kilometres ("km") or miles ("mi"). You can switch the display from kilometres ("km") to miles ("mi") and vice versa on the sound system/MMI\*. Please refer to the sound system or MMI\* Operating Manual for more details.

### Odometer/trip recorder

-  - The odometer records the vehicle's total mileage.
-  - The trip recorder shows the distance that has been travelled since it was last reset. It is used to measure individual journeys. The last digit of the trip recorder indicates distances of 100 metres or tenths of a mile.

The trip recorder can be reset to zero by pressing the button  ⇒ page 9, Fig. 3.

### Fault display

If there is a fault in the instruments, the letters DEF appear in the trip recorder display. Have the fault rectified as soon as possible.

### Note

- The recorded mileage will be displayed for about 30 seconds after you switch off the ignition or open the driver's door.
- You can also call up the display when the ignition is switched off by pressing the  button ⇒ page 9, Fig. 3.

## Outside temperature display

The outside temperature is shown on the instrument cluster display. At temperatures below approx. +5°C a snowflake symbol appears next to the temperature display.

When the vehicle is stationary or travelling at very low speeds, the temperature displayed may be slightly higher than the actual outside temperature as a result of the heat radiated from the engine.



### WARNING

Do not rely on the outside temperature display as an ice warning. Bear in mind that there may be patches of ice on the roads even at outside temperatures around +5 °C – risk of accident!

### Note

The measurement units for temperature or speed, etc. can be changed via the sound system or MMI\*.

## Fuel gauge (petrol/diesel)

The gauge  ⇒ *page 9, Fig. 3* only works when the ignition is switched on. When the gauge reaches the reserve zone, the LED at the bottom of the dial will light up in red and the indicator lamp  will appear ⇒ *page 24*. The LED at the bottom of the dial will flash in red if the fuel level is very low.



The instrument cluster display  ⇒ *page 9, Fig. 3* shows how far you can travel on the fuel left in the tank.

The tank capacity of your vehicle is given in the Technical data section ⇒ *page 273*.

### CAUTION

Never run the tank completely dry. If there is an irregular fuel supply, misfiring can occur. Unburnt fuel can then enter the exhaust system. This can lead to overheating and damage to the catalytic converter.

## Coolant temperature gauge

On vehicles which do not have a coolant temperature gauge, a warning lamp  ⇒ *page 20* will be the sole indication if the coolant temperature is too high. Please refer to ⇒ .

The coolant temperature gauge  ⇒ *page 9, Fig. 3* only works when the ignition is switched on. In order to avoid possible damage to the engine, please read the following notes for the different temperature ranges.

### Engine cold

If the LEDs are still in the lower range of the display, this indicates that the engine has not yet reached operating temperature. Avoid high engine speeds, full acceleration and heavy engine loads.

### Normal temperature

In normal operation the LEDs will settle somewhere in the centre of the display once the engine has reached operating temperature. The LEDs may also rise further up the display when the engine is working hard at high outside temperatures. This is no cause for concern, provided the warning lamp  does not light up in the instrument cluster.

### Hot zone

If the LEDs reach the top part of the display and the warning lamp  appears in the instrument cluster display, the coolant temperature is too high ⇒ *page 20*.

### CAUTION

– Some vehicles have a boost pressure display in place of the temperature display. Vehicles with a natural gas engine have a separate gas fuel gauge in place of the temperature display. To ensure that your engine enjoys a long service life, you should avoid high engine speeds, full acceleration and heavy engine loads for the first 15 minutes or so after starting a cold engine. The amount of time the engine takes to warm up depends on the

outside temperature. On vehicles with a boost pressure display, you can use the engine oil temperature ⇒ page 36 as a guide if you are not sure whether the engine is warm.

- Additional lights and other accessories in front of the air inlet reduce the cooling effect of the radiator. At high outside temperatures and high engine loads, there is a risk of the engine overheating.
- The front spoiler also ensures proper distribution of the cooling air when the vehicle is moving. If the spoiler is damaged this can reduce the cooling effect, which could cause the engine to overheat. You should obtain professional assistance.

**i Note**

Diesel engines are so efficient that they may not reach their full operating temperature in very cold weather. This is quite normal and no cause for concern.

**Display**

Applies to vehicles: without driver information system



Fig. 6 Instrument cluster: Display without driver information system

The instrument cluster display shows the following:

Radio station or CD	
Time/date (after ignition is switched off)	⇒ page 9
Estimated range of fuel in tank	
Cruise control system	⇒ page 97
Driver messages and warning/indicator lamps	⇒ page 14

Service interval display	⇒ page 13
Mileage and trip recorder	⇒ page 10
Start/stop system	⇒ page 98
Seat belt warning system for rear seats	⇒ page 26
Gear-change indicator	⇒ page 12
Selector lever positions for automatic gearbox	⇒ page 106
Outside temperature	⇒ page 11
Fuel gauge	⇒ page 11

**Gear-change indicator**

Applies to vehicles: with gear-change indicator

*This additional indicator function can help to save fuel.*



Fig. 7 Instrument cluster: Gear-change indicator (for manual gearbox)



Fig. 8 Instrument cluster: Gear-change indicator in tiptronic mode (for automatic gearbox)

To familiarise yourself with the gear-change indicator, drive in the normal way to start with. A gear change will be recommended if the gear you are in is not the most economical choice.

If no gear change is recommended, you are already in the most economical gear. ▶

## Vehicles with manual gearbox

Meaning of the symbols in the display  
⇒ Fig. 7:

- ▶ **Shifting up a gear:** The suggested gear appears to the **right** of the current gear when a **higher gear** is recommended.
- ◀ **Shifting down a gear:** The suggested gear appears to the **left** of the current gear when a **lower gear** is recommended.

Gears may occasionally be skipped when a gear change is recommended (2 ▶ 4).

## Vehicles with automatic gearbox

The display is only visible in tiptronic mode  
⇒ page 111.

Meaning of the symbol on the display ⇒ Fig. 8:

- ↑ Shift up

### ! CAUTION

The gear-change indicator is intended to help save fuel. It is not intended to recommend the right gear for all driving situations. In certain situations, only the driver can choose the correct gear (for instance when overtaking, driving up a steep gradient or towing a trailer).

### i Note

The gear-change indicator in the instrument cluster ⇒ Fig. 7 goes out when you press the clutch pedal.

## Service interval display

The service interval display detects when the next service is due for your vehicle.



Fig. 9 Instrument cluster: Service interval display (example)



Fig. 10 MMI\* system display on dashboard: Service interval display (example)

There are two service interval display levels:

- **Inspection or oil change reminder:** After a certain mileage, a service reminder will appear in the instrument cluster display each time the ignition is switched on/off ⇒ Fig. 9. The distance or time remaining will be shown briefly.
- **Inspection or oil change due:** When your vehicle is due for an inspection, oil change or both, the corresponding reminder **Inspection due!**, **Oil change due!** or **Oil change and inspection due!** will appear briefly after you switch the ignition on/off.

The following description distinguishes between vehicles with sound system\* or MMI\*.

## Checking the service intervals\*

In the MMI\*, you can look up the distance and time remaining until the next oil change or next service inspection. To do so, select ▶

**MENU** button > **Systems / Car systems** > **Servicing & checks** > **Service intervals**.

You cannot check the service interval for the first 500 km or so after resetting the display or when your vehicle is new.

### Resetting the display (sound system\*)

Your qualified workshop resets the service interval display after each service.

If you change the oil yourself, you can reset the oil change display. In this case, the next oil change will be due after a fixed service interval of 15,000 km or one year.

To reset the display, select the following on the sound system: **SETUP** button > control button **Oil change interval** > **Reset oil change interv.** After you reset the display, it will show the fixed service intervals (15,000 km or one year)<sup>1)</sup>.

### Resetting the display (MMI\*)

Your qualified workshop resets the service interval display after each service.

If you change the oil yourself, you can reset the oil change display. In this case, the next oil change will be due after a fixed service interval of 15,000<sup>1)</sup> km or one year.

To reset the display, select **MENU** button > **Systems / Car systems** > **Servicing & checks** > **Service intervals** > **Reset oil change interval**. After you reset the display, it will show the fixed service intervals (15,000 km or one year)<sup>1)</sup>.

### ! CAUTION

- Do not reset the oil change interval display unless you have changed the oil.
- Keeping to the correct service intervals is most important for the service life and residual value of the vehicle (and especially for the life of the engine). Services must always be carried out promptly, even if the mileage is low.

- The time until the next oil change is not counted down if the battery is disconnected. If your vehicle is out of service for an extended period, please refer to the Service Schedule for details of the next service date.

## Warning and indicator lamps

### Description



Fig. 11 Instrument cluster: Display layout on vehicles with monochrome display (example)

- (A) Warning/indicator lamp
- (B) Driver message
- (C) Status line:
  - / Central warning/indicator lamp or additional display of activated system such as:
  - / Electronic parking brake
  - / Cruise control system\*
  - / Active lane assist\*

The **central warning/indicator lamp** (C) or may light up in addition to some of the warning and indicator lamps (A).

If the central warning/indicator lamp (C) lights up, observe the additional information (A) and (B) in the instrument cluster display.

There are two versions of the instrument cluster: one with a monochrome display, and one with a multi-coloured display. On the monochrome display, the warning and indicator lamps (A) appear only in white ⇒ Fig. 11. ►

<sup>1)</sup> May vary in different countries



In addition to those on the display, additional warning and indicator lamps are located within the rev counter and speedometer. These lamps light up or flash to indicate functions or faults. Some of the warning and indicator lamps may be accompanied briefly by a message **(B)** and, in some cases, a warning tone.

If several malfunctions occur, each of the indicator/warning lamps will be shown in succession for a short time on the display.



The warning/indicator lamps and driver messages on the display can be masked by further displays. If the warning/indicator lamp **(A)** is hidden by another display, the central warning/indicator lamp **(C)** remains lit until the malfunction is corrected.

You can have the messages displayed again on the driver information system. Depending on the equipment in your vehicle, you can use the following to operate the driver information system:



- Vehicles with controls on windscreen wiper lever ⇒ *page 28*
- Vehicles with controls on multi-function steering wheel ⇒ *page 30*

**Overview**

When you switch on the ignition, some of the warning and indicator lamps light up briefly to show that the associated systems are working properly. These systems are marked with a ✓ in the following tables. If one of these warning/indicator lamps does not light up, there is a fault in the associated system.

On vehicles with a monochrome display, if a white warning/indicator lamp **(A)** ⇒ *page 14, Fig. 11* appears, the central warning/indicator lamp **(C)**  /  also appears and indicates the priority level of the warning. Please read the corresponding explanation of the red and yellow symbols.

The following are examples of warning and indicator lamps on the display:

 <b>(A)</b>	Priority 1 (high priority) See red warning lamps
 <b>(C)</b>	
 <b>(A)</b>	Priority 2 (medium priority) See yellow indicator lamps
 <b>(C)</b>	
 <b>(A)</b>	Priority 3 (lower priority) These indicator lamps are for informational purposes
-- <b>(C)</b>	

**Red warning lamps**

	Central warning/indicator lamp (observe additional information on the instrument cluster display) <b>(C)</b> ⇒ <i>page 14, Fig. 11</i>
---	--

or

	Driver message for Audi pre sense* ⇒ <i>page 126</i>
---	---

	Brake system ✓ ⇒ <i>page 19</i>
--	------------------------------------

	Electro-mechanical parking brake ⇒ <i>page 19</i>
---	--

	Cooling system ⇒ <i>page 20</i>
---	------------------------------------













or



	Engine oil pressure ⇒ <i>page 21</i>
---	---

















or



















	
	

















	Alternator ⇒ page 21
or	
	
	
	Front seat belt ⇒ page 21
	Steering ✓ ⇒ page 185
	Steering lock ⇒ page 21
	Engine stopped while vehicle is moving ⇒ page 22
or	
	
	
	Gearbox malfunction ⇒ page 113
or	
	
	
	Adaptive cruise control* ⇒ page 118















**Yellow indicator lamps**

	Central indicator lamp (observe additional information on the instrument cluster display)
	Electronic stabilisation control (ESC) ✓ ⇒ page 22
	Electronic stabilisation control (ESC) ✓ ⇒ page 22
<b>ESC OFF</b>	Electronic stabilisation control (ESC) ⇒ page 182





	Anti-lock brake system (ABS) ✓ ⇒ page 22
	Safety systems ✓ ⇒ page 21
	Brake pads ⇒ page 23
	Electro-mechanical parking brake ⇒ page 19
	Hill hold assist* ⇒ page 23
or	
	
	
	Tyre pressure loss indicator ✓ ⇒ page 231
<b>TPMS</b>	Tyre pressure loss indicator ⇒ page 231
	Suspension control* ⇒ page 26
or	
	
	
<b>EPC</b>	Engine management system (petrol engines) ✓ ⇒ page 23
	Engine management system (diesel engines) ✓ ⇒ page 23
	Emission control system ✓ ⇒ page 23
	Diesel particulate filter* ⇒ page 23
or	
	
	



















	Engine speed governing ⇒ page 24
or	
	
	
	Engine oil level (min.) ⇒ page 24
or	
	
	
	Engine oil sensor ⇒ page 24
or	
	
	
	Engine temperature ⇒ page 20
or	
	
	
	Battery charge ⇒ page 21
or	
	
	
	Fuel tank system ⇒ page 24
	Washer fluid level ⇒ page 25
or	
	







	Windscreen wipers ⇒ page 25
or	
	
	
	Engine start system ⇒ page 25
or	
	
	
	Steering ✓/steering lock ⇒ page 185
	Steering lock ⇒ page 21
	Remote control key ⇒ page 91
or	
	
	
	Remote control key ⇒ page 91
	Battery in remote control key ⇒ page 43
	Bulb monitor ⇒ page 25
or	
	
	

	Headlight range control* ⇒ page 25
or	
	
	
	Adaptive light* ⇒ page 25
or	
	
	
	Light sensor/rain sensor* ⇒ page 26
or	
	
	
	Active lane assist* ⇒ page 129
	Gearbox ⇒ page 113
or	
	
	
	Speed warning function* ⇒ page 96

**Further indicator lamps**

	Turn signals ⇒ page 26
	
	Trailer turn signals* ⇒ page 26
	Cruise control system* ⇒ page 97

	Adaptive cruise control* ⇒ page 118
	Adaptive cruise control* ⇒ page 118
	Adaptive cruise control* ⇒ page 118
	Active lane assist* ⇒ page 129
	Audi hold assist* ⇒ page 95
	Start/stop system* ⇒ page 98
	Start/stop system* ⇒ page 98
	Vehicle in natural gas mode ⇒ page 103
	Main beam headlights ⇒ page 56
	Main beam assist* ⇒ page 56 or Adaptive headlight range control ⇒ page 57
	Remote control key ⇒ page 91
	Park assist* ⇒ page 146
	Park assist* ⇒ page 146
	Electro-mechanical parking brake ⇒ page 19
	Adaptive cruise control* ⇒ page 118
	Active lane assist* ⇒ page 129
	Audi side assist* ⇒ page 134
	Gearbox ⇒ page 113
	Audi hold assist* ⇒ page 95

	Electro-mechanical parking brake ⇒ page 19
	Camera-based traffic sign recognition* ⇒ page 33
	Rest recommendation* ⇒ page 35
	Child-proof catches (electric)* ⇒ page 50
	Auxiliary heating/ventilation* ⇒ page 82
	Rear seat belt ✓ ⇒ page 26
	Rear seat belt ✓ ⇒ page 26

### Brake system

If the warning lamp lights up, there is a fault in the brake system.

#### Stop vehicle and check brake fluid level

Stop the vehicle and check the brake fluid level. Obtain professional assistance if necessary.

#### Warning! Brake servo inoperative!

You need to apply much more force to operate the brakes if the brake servo fails. You should obtain professional assistance.

#### Warning! Fault in brake system. Contact workshop

If the ABS indicator lamp  and ESC indicator lamp  light up together with the brake warning lamp  and this driver message appears, the ABS, ESC and brake force distribution systems have failed ⇒ .

Drive to a qualified workshop without delay and have the fault corrected ⇒ .

#### Parking brake system fault! See owner's manual

– If the warning lamp and the message appear **after you switch on the ignition when the vehicle is stationary**, please check whether you can release the parking brake.

If the parking brake cannot be released you should obtain professional assistance. If the parking brake can be released but the warning lamp/message still appears, drive to a qualified workshop without delay and have the fault rectified.

- If the warning lamp and the message appear **while driving**, there may be a malfunction in the parking brake auto release or the emergency brake functions. You may not be able to apply or release the parking brake. Do not park the car on a gradient. Obtain professional assistance.

### WARNING

- Before opening the bonnet and checking the brake fluid level, observe the warning information on ⇒ page 212, *Working on components in the engine compartment*.
- If the brake warning lamp does not go out, or if it lights up when driving, the brake fluid level in the reservoir is too low - this may cause an increased accident risk. Stop the vehicle and do not drive on. You should obtain professional assistance.
- If the brake warning lamp lights up together with the ABS indicator lamp and the ESC indicator lamp, this can mean that the control function of the ESC/ABS is not working. Input from the functions that stabilise the vehicle is no longer available. This could cause the tail of the vehicle to skid sideways. Drive carefully to the nearest qualified workshop and have the fault rectified.

### / Electro-mechanical parking brake

The warning lamp  lights up when the parking brake is applied. The warning lamp will light up for about 20 seconds if the parking brake is applied with the ignition switched off.

#### Caution: Vehicle parked too steep

If the warning lamp flashes and the message appears, the brake may not be strong enough to hold the vehicle. The brakes have overheated. The vehicle can roll away, even on a gentle slope.

### Press brake pedal to release parking brake

To release the parking brake, press the brake pedal and simultaneously press the switch  (alternatively, use the auto release function ⇒ *page 94, Driving away from a standstill*).

### Parking brake!

There is a malfunction in the parking brake. Drive to a qualified workshop without delay and have the fault rectified.

### Parking brake!

There is a malfunction in the parking brake. Drive to a qualified workshop soon and have the fault rectified.

### Audi hold assist: only available when door is closed, seat belt is fastened and engine is running

If this message appears, make sure that the door is closed, the seat belt is buckled and the engine is running.

### Audi hold assist: unavailable

If this message appears, the system requirements have not been met.

### **Parking brake: not applied !**

If this message appears, it may be necessary to apply the parking brake.

### Please release parking brake

If this message appears, release the parking brake.

### Parking brake auto release: system fault

If this message appears, press the brake pedal and then release the parking brake.

### Parking brake system fault: anti-towing alarm blocked

### Parking brake: not applied automatically

### Caution: Vehicle parked too steep

### Parking brake is applied

If this message appears, press the brake pedal and then release the parking brake as necessary.

### Note

For further information on the parking brake refer to ⇒ *page 92*.

## / Cooling system

### Switch off engine and check coolant level

The coolant level is too low or the coolant temperature is too high.

Switch off the engine and do not drive on. Check the coolant level ⇒ *page 216*.

- If the coolant level is too low, add more coolant ⇒ *page 217*. Do not drive on until the warning lamp has gone out.
- If the coolant level is correct, the overheating may be caused by a malfunction of the radiator fan. Do not drive on. You should obtain professional assistance.

### Coolant temperature too high! Please let engine run with vehicle stationary

Let the engine cool down by running it at idling speed for a few minutes.

### Please warm up engine

Applies to certain types of engine only and indicates that the engine has not yet reached its proper working temperature.

### WARNING

- Never open the bonnet if you can see or hear steam or coolant escaping from the engine compartment; there is a risk of being scalded. Wait until you can no longer see or hear escaping steam or coolant.
- The engine compartment of any motor vehicle is a dangerous place. Before carrying out any work in the engine compartment, switch off the engine and

allow it to cool down. Please observe the important safety warnings ⇒ *page 212, Working on components in the engine compartment.*

### CAUTION

Do not drive on if the warning lamp  lights up; otherwise there is a risk of engine damage.

## Engine oil pressure

### Switch off engine! Oil pressure too low

Switch off the engine and do not drive on. Check the engine oil level ⇒ *page 215.*

- If the engine oil level is too low, add more oil ⇒ *page 214.* Do not drive on until the warning lamp has gone out.
- If the engine oil level is OK but the warning lamp still lights up, switch off the engine and do not drive on. You should obtain professional assistance.

### Note

The oil pressure warning lamp is not an indicator for the oil level. The oil level should therefore be checked regularly.

## Alternator / battery

### Alternator fault: Battery is not being charged

There is an alternator fault or a fault in the vehicle's electrical system.

Drive to a qualified workshop without delay. Avoid using electrical equipment that is not absolutely necessary (such as the radio) because this will drain the battery. If the battery charge is insufficient, obtain professional assistance.

### Low battery charge: Battery will be charged while driving

Starting reliability may be impaired.

If this message disappears after a while, the battery will have been sufficiently charged while driving.

If the message does not disappear again, drive to a qualified workshop without delay and have the fault rectified.

## Safety systems

The indicator lamp  monitors the safety systems and the pedestrian protection system.

### Safety system

If the indicator lamp  lights up or flashes, there is a malfunction in one of the safety systems.

Drive to a qualified workshop without delay and have the fault rectified.

### Pedestrian protection system

If the indicator lamp  lights up or flashes and the bonnet is in a raised position, the pedestrian protection system has been triggered. Please refer to ⇒ *page 163, Pedestrian protection system.*

### WARNING

Have the safety systems examined without delay; otherwise they may fail to trigger in an accident – this could result in serious or possibly fatal injury.

## Front seat belt

The warning lamp  lights up and does not go out until the driver's and passenger's seat belts have been fastened. When the vehicle has gathered speed you will also hear a warning chime.

### Note

For further information on the seat belts ⇒ *page 165.*

## Steering lock

### Do not drive vehicle: steering defective ▶

There is a malfunction in the electronic steering lock. The ignition can no longer be switched on.

**Do not** have the vehicle towed away, because you won't be able to steer it. You should obtain professional assistance.

 **Steering lock: malfunction. Please contact workshop**

There is a malfunction in the electronic steering lock.

Drive to a qualified workshop soon and have the fault rectified.

 **WARNING**

Your vehicle must not be towed if there is a fault in the electronic steering lock - risk of accident!

 **Engine**

 **Engine stopped: brake servo and power steering not possible**

There is a malfunction in the engine or fuel supply system.

Greater strength is required to steer and brake the vehicle if the engine stops while the vehicle is coasting. Carefully try to bring the coasting vehicle safely to a standstill out of the way of moving traffic. You should obtain professional assistance.

 **WARNING**



Greater strength is required to brake the vehicle if the engine stops while the vehicle is moving - risk of accident! Greater strength will be required to steer the vehicle unless the power steering is still providing assistance. The power steering may still be available if the vehicle is still coasting with the ignition switched on (and the battery charge is sufficient).

 **Electronic stabilisation control (ESC) and  anti-lock brake system (ABS)**



If the indicator lamp  flashes while the vehicle is in motion, the ESC or traction control system (ASR) is intervening.

If the indicator lamp  lights up, the ESC system has been switched off for system reasons. In this case, the ESC can be reactivated by switching the ignition off and then on again. If the indicator lamp goes out, this means the system is fully functional.

**Stabilisation control (ESC): sport. Warning! Restricted stability**

If the indicator lamp  lights up, the ESC sport mode has been activated via the  button ⇒ *page 183*. You can switch the ESC system back on by pressing the  button again.

**Stabilisation control (ESC): off. Warning! Restricted stability**



If the indicator lamp  lights up, the ESC system has been partially or completely switched off via the  button ⇒ *page 183*. In addition, **ESC OFF** will appear. You can switch the ESC system back on by pressing the  button again.

The system is activated when you switch on the ignition. If the indicator lamp  goes out, this means the system is fully functional.

**Stabilisation control (ESC): fault! See owner's manual**

**Stabilisation control (ESC/ABS): fault! See owner's manual**

**ABS: fault! See owner's manual**

If the indicator lamp  and the ABS indicator lamp  light up and the message appears, there is a malfunction in the anti-lock brake system or electronic differential lock. This will also cause an ESC malfunction. The vehicle can still be braked in the normal way (however the ABS control function will be out of action). ►



Drive to a qualified workshop without delay and have the fault rectified.

### WARNING

If the brake warning lamp  lights up together with the ABS indicator lamp and the ESC indicator lamp, this can mean that the control function of the ESC/ABS is not working. Input from the functions that stabilise the vehicle is no longer available. This could cause the vehicle to skid sideways. Drive carefully to the nearest qualified workshop and have the fault rectified.

### Note

For more information about the ESC and ABS systems, refer to *⇒ page 182*.

### Brake pads

#### Brake pads!

The brake pads are worn.

Drive to a qualified workshop without delay and have the brake pads checked.

### Hill hold assist

#### Hill hold assist: unavailable

If the indicator lamp  lights up and the message appears, the hill hold assist function is unavailable.

#### Manual control!

If this message appears, press the brake pedal.

Use the parking brake for the hill start *⇒ page 92*.

### **EPC Engine management (petrol engine)**

Applies to vehicles: with petrol engine

If the indicator lamp  lights up, there is a fault in the engine management system.

Drive slowly to a qualified workshop without delay and have the engine checked.

If the indicator lamp  lights up when starting the engine, there is a malfunction in the automatic start function. To start the engine, follow the steps described: Vehicles with mechanical ignition lock *⇒ page 87*, vehicles with convenience key *⇒ page 89*.

### Engine management (diesel engine)

Applies to vehicles: with diesel engine

If the indicator lamp  lights up when the ignition is switched on, the glow plugs are preheating.

If the indicator lamp flashes while the vehicle is moving, there is a fault in the engine management system.

Drive slowly to a qualified workshop without delay and have the fault rectified.

If the indicator lamp  lights up when starting the engine, there is a malfunction in the automatic start function. To start the engine, follow the steps described: Vehicles with mechanical ignition lock *⇒ page 87*, vehicles with convenience key *⇒ page 89*.

### Emission control system

If the indicator lamp  lights up or flashes, a fault has occurred which can reduce the quality of the exhaust gas and damage the catalytic converter.

Drive slowly to a qualified workshop without delay and have the fault rectified.

### Diesel particulate filter

Applies to vehicles: with diesel engine and diesel particulate filter

#### Particulate filter: system fault. See owner's manual

The diesel particulate filter requires regeneration. You can assist the self-cleaning function of the filter by driving as follows:

Drive at a speed of at least 60 km/h for about 15 minutes in 4th or 5th gear, or with the selector lever in position S on vehicles with automatic gearbox. Keep the engine speed at 

about 2000 rpm. As a result of the increase in temperature, the soot in the filter will be burned off. The indicator lamp will go out once the cleaning process has been completed successfully.

If the indicator lamp does **not** go out, drive to a qualified workshop without delay and have the fault rectified.

### WARNING

It is essential that you adjust your speed to suit the weather, road, terrain and traffic conditions. The recommended driving speed must never lead to the driver disregarding the traffic regulations.

### Note

For more information about the diesel particulate filter, refer to *⇒ page 190*.

### Engine speed governing

Applies to vehicles: with engine speed governing

#### Max. engine speed XXXX rpm

The engine speed will automatically be governed to the speed displayed in the driver information system. This protects the engine from overheating.

The rev limiter is deactivated as soon as the engine temperature is no longer within the critical range and you have taken your foot off the accelerator.

If the rev limiter has been activated because of a fault in the engine management system, the indicator lamp **EPC** will also light up. Make sure that the engine speed does not exceed the speed displayed in the driver information system, for example when shifting down a gear. Drive to a qualified workshop without delay and have the fault rectified.

### Engine oil level (min.)

#### Please check oil level !

You can continue driving for the time being but you should check the engine oil level as soon as possible *⇒ page 214*.

- If the engine oil level is too low, add more oil *⇒ page 216*.
- If the engine oil level is normal but the indicator lamp stays on, drive to a qualified workshop without delay and avoid high engine speeds.

### Engine oil sensor

#### Oil level! Sensor defective

The sensor for checking the engine oil level has failed. Drive to a qualified workshop soon and have the fault rectified.

### CAUTION

Please observe the procedure described in the Owner's Manual *⇒ page 215* and *⇒ page 216, Topping up the engine oil* .

### Fuel tank system (petrol/diesel)

#### Please refuel

When the indicator lamp lights up for the first time and the message appears, the following amount of fuel is left in the tank:

- Front-wheel drive vehicles: approx. 7 litres
- Four-wheel drive vehicles: approx. 8.5 litres

#### Tank system malfunction! Contact workshop

If the indicator lamp lights up and the message appears:

- there is a malfunction in the tank system, or
- on vehicles with a diesel engine, water may have collected in the fuel filter.

Drive to a qualified workshop without delay and have the fault rectified.

### CAUTION

Applies to vehicles with diesel engine: If poor-quality diesel fuel is used, it may be 

necessary to have the water separator<sup>1)</sup> on the **fuel filter** drained more frequently than is specified in the Service Schedule. This helps to prevent potential engine faults.



### For the sake of the environment

Never pour fuel down drains or into the ground.



### Note

For more information about filling the tank, refer to ⇨ *page 210*.



### Washer fluid level



### Please refill washer fluid

With the ignition switched off, top up the fluid for the windscreen washer and headlight washer system\* ⇨ *page 221*.



### Windscreen wipers



### Windscreen wiper defective

There is a malfunction in the windscreen wipers.

Drive to a qualified workshop without delay and have the fault rectified.



### Engine start system



### Engine start system: system fault.

#### Please contact workshop

Do **not** switch off the ignition; otherwise you may not be able to switch it on again.

Drive to a qualified workshop without delay and have the fault rectified.

#### Engine start system: malfunction. Please contact workshop.

There is a malfunction in the engine start system.

Drive to a qualified workshop soon and have the fault rectified.



### Bulb monitor

Applies to vehicles: with driver information system

If the indicator lamp  lights up, a bulb has failed. The message indicates the location of the bulb.

You should have the bulb replaced without delay.

#### Vehicle lights: malfunction!

There is a fault with the headlights or light switch. Drive to a qualified workshop soon and have the fault rectified.



### WARNING

- Bulbs are sensitive to pressure. The glass can break when you touch the bulb, causing injury.
- Incorrect handling of the high-voltage element of xenon gas-discharge bulbs\* can have potentially fatal consequences.



### Dynamic headlight range control

Applies to vehicles: with xenon headlight bulbs



### Headlight range control: system fault!

There is a malfunction in the dynamic headlight range control which may cause other road users to be dazzled.

Drive to a qualified workshop without delay and have the fault rectified.



### Audi adaptive light

Applies to vehicles: with Audi adaptive light



### Audi adaptive light: system fault!

There is a malfunction in the adaptive light. The dipped beam headlights will still be working normally.

Drive to a qualified workshop soon and have the fault rectified.

<sup>1)</sup> This function is not available on all export versions.

** Light sensor / rain sensor**

Applies to vehicles: with light sensor/ rain sensor

** Automatic headlights: system fault!**** Automatic wipers: system fault!**

The light sensor/rain sensor is out of action.

For safety reasons, the dipped beam headlights will then be switched on permanently when the light switch is set to the **AUTO** position. You can still switch the lights on and off in the normal way with the light switch. You can also continue to use all the other wiper functions that do not use the rain sensor.

Drive to a qualified workshop soon and have the fault rectified.

** Suspension control**



Applies to vehicles: with Audi drive select

** Suspension: system fault!**

There is a malfunction in the suspension control system.

Drive to a qualified workshop soon and have the fault rectified.

** Turn signals and hazard warning lights**

If the indicator lamp  or  flashes, the turn signals are on. If both indicator lamps flash, the hazard warning lights are on.

If one of the indicator lamps flashes twice as fast as usual, a turn signal bulb has failed. Drive carefully to a qualified workshop without delay and have the fault rectified. While you are towing a trailer, the indicator lamp does not indicate turn signal bulb failures on the vehicle or on the trailer.

** Note**

For more information about the turn signals and hazard warning lights, refer to *⇒ page 55*.

** Trailer turn signals**

Applies to vehicles: with towing bracket

If the indicator lamp  flashes, the turn signals are on in towing mode. The trailer must be properly connected *⇒ page 194*.

If a turn signal bulb on the trailer or vehicle fails in towing mode, the indicator lamp does **not** flash twice as fast to indicate the bulb failure.

** Rear seat belt**

Applies to vehicles: with seat belt warning system (rear)

The warning lamp  lights up briefly when the ignition is switched on.

If a rear seat belt is buckled/unbuckled, the corresponding indicator lamp lights up briefly.

 - If the indicator lamp lights up briefly, the corresponding rear seat is not occupied or the seat belt is not buckled. If the seat belt is unbuckled while the vehicle is moving, you will also hear a warning tone.

 - If the indicator lamp lights up briefly, the seat belt has been fastened.

** Note**

For further information on the seat belts *⇒ page 165*.

# Driver information system

## Overview

The driver information system automatically collects, processes and displays data. The **Systems / Car systems** menu allows you to control the settings for many items of equipment on the vehicle.

## Display

You can see the following in the driver information system:

Radio station or CD	
Time and date display	⇒ page 9
Mileage and trip recorder	⇒ page 10
Outside temperature	⇒ page 11
Service interval display	⇒ page 13
Warning/indicator lamps and driver messages	⇒ page 14
Digital speedometer	
Lap timer*	⇒ page 36
Cruise control system	⇒ page 97
Speed warning	⇒ page 96
Start/stop system	⇒ page 98
Gear-change indicator	⇒ page 12
Advanced gear-change indicator for manual gearbox	⇒ page 31
Selector lever positions for automatic gearbox	⇒ page 106
Main beam assist*	⇒ page 56
Seat belt warning system for rear seats	⇒ page 26
On-board computer display	⇒ page 27
Camera-based traffic sign recognition	⇒ page 33

## On-board computer display

The on-board computer has different journey memories:

- Short-term memory (on-board computer 1)
- Long-term memory (on-board computer 2)
- Efficiency programme

The following information can be displayed in sequence in on-board computers 1 and 2:

- Date
- Estimated range of fuel in tank
- Driving time
- Average fuel consumption
- Average speed
- Distance covered
- Current fuel consumption
- Engine oil temperature display\*

## On-board computer 1 (short-term memory)

The short-term memory processes the information on a journey from the time the ignition is switched on until it is switched off. If the journey is resumed **within two hours** after the ignition is switched off, the new figures are automatically included in the calculation. If the vehicle is left standing for over 2 hours, the short-term memory is automatically erased when you set off again.

## On-board computer 2 (long-term memory)

Unlike the short-term memory, the long-term memory is not erased automatically. In this way, you can determine the period for which you wish the on-board computer to supply driving information.

## Efficiency programme

The efficiency programme can help to save fuel ⇒ page 31.

## Operating logic

You can use the following to operate the driver information system, depending on the optional equipment in your vehicle:

- Controls on **windscreen wiper lever** ⇒ page 28, or
- Control buttons on **multi-function steering wheel\*** ⇒ page 29

## Controls on windscreen wiper lever

### Introduction

Applies to vehicles: with driver information system, with-out multi-function steering wheel

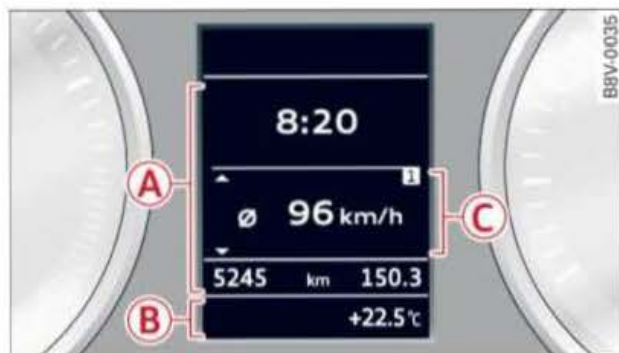

Fig. 12 Instrument cluster: Driver information system

The driver information system is operated using the controls on the windscreen wiper lever\* ⇒ page 28, Fig. 13.

The driver information system ⇒ Fig. 12 provides the following information:

- (A) Car information
- (B) Status line (selector lever position/current gear, gear-change indicator, main beam assist\*, start/stop system, outside temperature ⇒ page 11)
- (C) On-board computer

(A) Car information	
On-board computer	⇒ page 28
Efficiency programme	⇒ page 31
Digital speedometer	
Lap timer*	⇒ page 36
Driver messages and warning/indicator lamps	⇒ page 14

Driver messages for warning/indicator lamps are only displayed if at least one warning has occurred.

### Controls

Applies to vehicles: with driver information system, with-out multi-function steering wheel

The driver information system can be operated using the windscreen wiper lever.

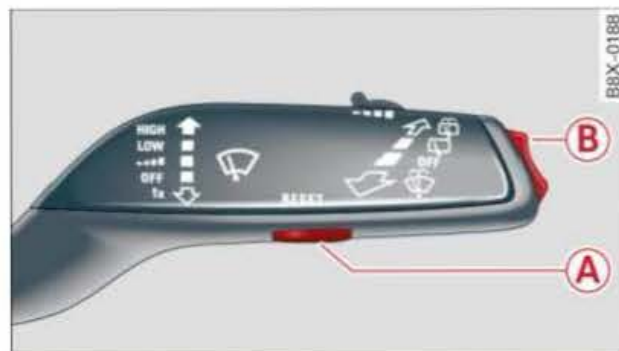



Fig. 13 Windscreen wiper lever: Driver information system controls

As well as the figures from the on-board computer (memories 1 and 2 and efficiency programme), the display can also show information from other systems.

The number **1** or **2** or the filling nozzle symbol  in the top corner of the on-board computer display shows which of the memories is currently active (i.e. on-board computer 1 or 2 or the efficiency programme).

### How to use the controls

- ▶ Switch on the ignition. The function that was last selected will be displayed.
- ▶ Press the **RESET** button (A) to switch between on-board computers **1** and **2** or the efficiency programme  or any active warnings or driver messages.
- ▶ To show more information further up or down the display, press the top or bottom part of the button (B).

### Calling up warning/indicator lamps and driver messages again

- ▶ Press the **RESET** button (A) (several times if necessary) until the driver message appears.

### Resetting figures to zero

- ▶ Select a figure in the desired on-board computer or the efficiency programme.
- ▶ Press and hold the **RESET** button (A) for at least one second. All figures of the selected ▶

on-board computer or the efficiency programme will be reset to zero.

### **i** Note

- The measurement units may be different on vehicles for some markets.
- The information in the memory is cancelled if the battery is disconnected.

## Controls on multi-function steering wheel

### Introduction

Applies to vehicles: with driver information system and multi-function steering wheel

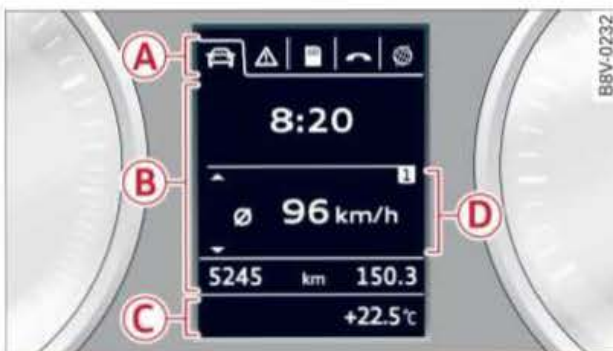

Fig. 14 Instrument cluster: Driver information system (example)

The driver information system is operated using the controls on the multi-function steering wheel\* ⇒ page 30, Fig. 15.

The data (B) stored in the driver information system is presented in different display tabs (A) ⇒ Fig. 14.

The driver information system ⇒ Fig. 14 provides the following information:

- (A) Display tab
- (B) Car information
- (C) Status line (selector lever position, gear-change indicator, main beam assist\*, start/stop system, outside temperature ⇒ page 11)
- (D) On-board computer

The following functions are available, depending on the equipment installed in your vehicle:

(A)	(B)
1st tab	<b>Vehicle functions:</b>
	On-board computer, time, date ⇒ page 30
	Efficiency programme ⇒ page 31
	Digital speedometer
	Assist systems Audi adaptive cruise control* ⇒ page 116 Audi active lane assist* ⇒ page 128
	Camera-based traffic sign recognition* ⇒ page 33
	Lap timer* ⇒ page 36
	Reduced display
2nd tab	<b>Driver messages and warning/indicator lamps</b>
	Service interval display ⇒ page 13
3rd tab	<b>Audio/radio</b>
4th tab	<b>Telephone*</b>
5th tab	<b>Navigation*</b>

The second tab is only visible if one or more warning/indicator lamps or driver messages are displayed or if the relevant system is switched on.

### **i** Note

- The on-board computer is operated using the buttons on the left side of the multi-function steering wheel.
- For information on how to use the other buttons and how to operate the audio, telephone\* and navigation\* functions, please refer to the separate MMI Operating Manual.

### Controls

Applies to vehicles: with driver information system and multi-function steering wheel

The driver information system can be operated via the multi-function steering wheel.



Fig. 15 Multi-function steering wheel: Driver information system controls



Fig. 16 Driver information system: Calling up the Vehicle functions menu

As well as the figures from the on-board computer (memories 1 and 2 and efficiency programme), the display can also show information from other systems.

The number **1** or **2** or the filling nozzle symbol  in the top corner of the on-board computer display shows which of the memories is currently active (i.e. on-board computer 1 or 2 or the efficiency programme).

The display tabs **A**  $\Rightarrow$  page 29, Fig. 14 will appear as soon as you press the button **1**  $\Rightarrow$  Fig. 15 on the multi-function steering wheel.

### How to use the controls

- ▶ Switch on the ignition. The function that was last selected will be displayed.
- ▶ To switch between the tabs, press the left or right side of the button **1**  $\Rightarrow$  Fig. 15.

- ▶ To show more information further up or down the display, scroll the thumbwheel **2** up or down.
- ▶ To confirm a selection, press the thumbwheel **2**.
- ▶ To call up a function assigned to the steering wheel button, press the button **4**. For further information please refer to  $\Rightarrow$  page 30.

### Calling up Vehicle functions

- ▶ Use button **1** to select the first display tab.
- ▶ Press the button **3**. The **Vehicle functions** menu will be displayed  $\Rightarrow$  Fig. 16.
- ▶ To select a menu item, scroll and press the thumbwheel **2**.

### Resetting figures to zero

- ▶ Select **On-board computer** or **Efficiency programme** from the **Vehicle functions** menu.
- ▶ Select a figure in the desired on-board computer or the efficiency programme.
- ▶ To reset the figures in the selected memory to zero, press the thumbwheel **2** for one second.

### Calling up warning/indicator lamps and driver messages again

- ▶ Keep pressing the button **1** until the tab marked  appears.

The tab marked  is only visible if a malfunction has occurred.

### Assigning a function to the steering wheel button

- ▶ Select: **MENU** button > control button **Systems / Car systems** > **Vehicle settings** > **Steering wheel button**.

The tab marked  is only visible if one or more warning/indicator lamps or driver messages are displayed.

### Note

- The measurement units may be different on vehicles for some markets.



- The information in the memory is cancelled if the battery is disconnected.
- For information on the efficiency programme, refer to ⇒ page 31.
- Please refer to the MMI\* Operating Manual for more information on the multi-function steering wheel.

## Boost display

Applies to vehicles: with boost pressure display



Fig. 17 Instrument cluster: Boost display

### Boost pressure display

The current boost level of the engine (that is the current charge pressure) is indicated by a bar which moves from left to right.

## Efficiency programme

### Description

Applies to vehicles: with driver information system



Fig. 18 Instrument cluster: Efficiency programme

### Calling up the efficiency programme

- ▶ Using the windscreen wiper lever\*: Keep pressing the **RESET** button (A) ⇒ page 28, Fig. 13 until the efficiency programme appears on the display.
- ▶ Using the multi-function steering wheel\*: Call up the vehicle functions by pressing

button (3) ⇒ page 30, Fig. 15 and select **Efficiency programme** ⇒ page 30 from the menu.

The efficiency programme can help to save fuel. It evaluates fuel efficiency data, shows a list of auxiliary equipment affecting fuel consumption ⇒ page 32, and suggests gear changes ⇒ page 31. It also provides economy tips ⇒ page 32 for saving fuel.

The efficiency programme uses the trip and fuel consumption data from on-board computer 1. When you clear the data from the efficiency programme on vehicles without multi-function steering wheel (⇒ page 28) or vehicles with multi-function steering wheel (⇒ page 30), the values in on-board computer 1 are reset to zero.

### Advanced gear-change indicator

Applies to vehicles: with manual gearbox and driver information system



Fig. 19 Instrument cluster: Advanced gear-change indicator on vehicles with monochrome display



Fig. 20 Instrument cluster: Advanced gear-change indicator on vehicles with colour display

Important: The efficiency programme must have been called up ⇒ page 31.

- ▶ Using the windscreen wiper lever\*: Keep pressing the **RESET** button (A) ⇒ page 28, ▶

Fig. 13 until the instrument cluster display shows the advanced gear-change indicator.

- Using the multi-function steering wheel\*: Scroll the thumbwheel ② ⇒ page 30, Fig. 15 until the display shows the advanced gear-change indicator.

The advanced gear-change indicator is based on the same logic as the “regular” gear-change indicator ⇒ page 12.

### ! CAUTION

The advanced gear-change indicator is intended to help save fuel. It is not intended to recommend the right gear for all driving situations. In certain situations, only the driver can choose the correct gear (for instance when overtaking, driving up a steep gradient or towing a trailer).

### i Note

The “regular” gear-change indicator disappears from the display when the advanced gear-change indicator appears.

## Auxiliaries

Applies to vehicles: with driver information system and automatic air conditioner



Fig. 21 Instrument cluster: Auxiliaries

- Using the windscreen wiper lever\*: Keep pressing the **RESET** button (A) ⇒ page 28, Fig. 13 in the efficiency programme until the instrument cluster display shows the auxiliaries.
- Using the multi-function steering wheel\*: Scroll the thumbwheel ② ⇒ page 30, Fig. 15 in the efficiency programme until the auxiliaries appear on the display.

The efficiency programme shows a list of auxiliary equipment currently affecting the vehicle's fuel consumption. The display shows up to three auxiliaries (B). The auxiliary load drawing the most power appears at the top of the list. If more than three auxiliaries are switched on, the ones currently using the most power are displayed.

In addition, a scale (A) indicates the overall current fuel consumption of all auxiliary equipment.

## Economy tips

Applies to vehicles: with driver information system



Fig. 22 Instrument cluster: Economy tip (Air conditioner switched on: close windows and sun roof)

Economy tips are displayed if the fuel consumption increases in certain situations. By following these economy tips, you can save fuel. The tips are displayed automatically and only appear in the efficiency programme. The economy tips automatically disappear again after a while.

- To clear an economy tip from the display immediately, press any of the controls on the windscreen wiper lever\*/multi-function steering wheel\*.

### i Note

- Once you have cleared an economy tip from the display, it will not appear again until the next time you switch on the ignition.
- The economy tips are not always displayed in every conceivable situation, but are deliberately spaced out over time.

## Active Cylinder Management

Applies to vehicles: with Active Cylinder Management (1.4 TFSI 103 kW engine)

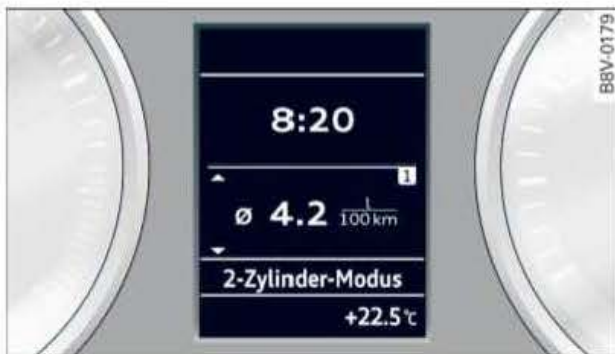

Fig. 23 Instrument cluster: 2-cylinder mode display

The engine shuts down two cylinders to save fuel under light-load conditions and automatically re-activates them when they are needed, the whole process being imperceptible to the occupants.

### Displaying the cylinder mode

Important: The on-board computer must be displayed.

- ▶ Using the windscreen wiper lever\*: Keep pressing the function selector switch **(B)** ⇒ page 28, Fig. 13 until the instrument cluster display shows the current or average fuel consumption.
- ▶ Using the multi-function steering wheel\*: Scroll the thumbwheel **(2)** ⇒ page 30, Fig. 15 until the instrument cluster display shows the current fuel consumption.

You are driving in 2-cylinder mode when the driver message **2-cylinder mode** is displayed.

### Basic conditions for 2-cylinder mode

The engine automatically runs on two cylinders when certain basic conditions are met. These include:

- Power demand is low.
- Vehicle is in a forward gear.
- Engine speed is between 1,300 and 3900 rpm.
- The selected interior temperature has been reached.
- Engine is warm.

## Camera-based traffic sign recognition

### Description

Applies to vehicles: with camera-based traffic sign recognition



Fig. 24 Instrument cluster: Traffic sign recognition (example)

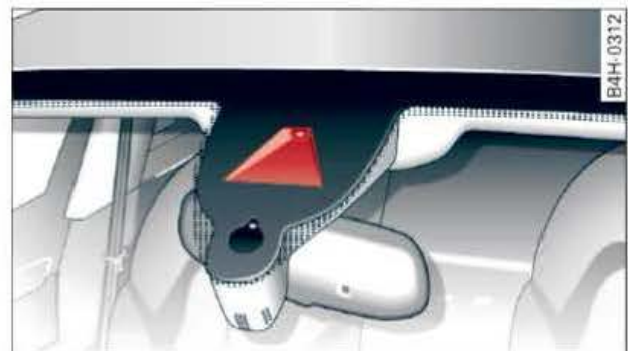



Fig. 25 Windscreen: Camera window for traffic sign recognition

Traffic signs detected by the camera appear in the instrument cluster display to keep you informed of current speed restrictions and no overtaking zones. In cases where the system is able to detect temporary speed limits applicable at certain times of day , in wet weather  or to vehicles towing a trailer  it will also display these traffic restrictions ⇒ Fig. 24.

### General notes

The traffic sign recognition system can detect standardised speed limit signs within the camera's range of vision. It makes use of the navigation data to evaluate the detected speed limits and show them on the display. Under certain conditions, the system will also display the applicable speed limits on roads without speed limit signs. ▶

Traffic sign recognition is not available in all countries. For a current list, see the Internet (e.g. [www.audi.com](http://www.audi.com)). The system is also subject to certain inherent restrictions and may be partially or completely unavailable in the following situations:

- If visibility is impaired by snow, rain, fog or heavy road spray.
- In dazzling light, e.g. from the sun or oncoming traffic.
- At high speeds.
- If the camera's range of vision ⇒ *Fig. 25* is impaired, e.g. by dirt or stickers. Notes on cleaning ⇒ *page 204*.
- If the traffic signs are partially or completely obscured, e.g. by trees, snow, mud or other vehicles.
- If traffic signs deviate from the standard appearance (round with red border).
- If traffic signs are damaged or bent.
- If matrix traffic signs are mounted on overhead gantries.
- If traffic signs or routes have changed (navigation data out of date).

Some types of slow moving vehicles (such as heavy goods vehicles) carry speed stickers which, if detected by the system, may affect the display.

### WARNING

Always direct your full attention to the road and surroundings, even when you are using traffic sign recognition. The actual traffic signs on your route always take precedence over the information on the display. It is always the driver's responsibility to assess the traffic situation and take appropriate care.

- Under adverse conditions, the traffic sign recognition system may misinterpret or fail to detect traffic signs. It is therefore possible that the speed limit display may occasionally be unavailable or even incorrect.

- The traffic sign recognition system does not warn you if you exceed the speed limit and does not alter the speed of your vehicle to obey the speed limit.
- The speed limit displayed in the instrument cluster (e.g. **50**) may apply in mph or km/h, depending on the units applicable in a particular country.

### Controls

Applies to vehicles: with camera-based traffic sign recognition



Fig. 26 Instrument cluster: Secondary display

### Calling up the traffic sign recognition

- ▶ Press the  button on the multi-function steering wheel.
- ▶ Scroll and press the thumbwheel to select **Traffic signs** from the **Vehicle functions** menu.

### Activating the secondary display

You can also activate traffic sign recognition in other display tabs, e.g. in the navigation display ⇒ *Fig. 26*.

- ▶ Select the following on the MMI\*: **MENU** button > control button **Systems / Car systems** > **Driver assist** > **Traffic signs** > **Display in instrument cluster** > **on**.

### Displaying signs for trailers

You can also display speed limits which apply specially to vehicles towing a trailer<sup>1)</sup>. ▶

<sup>1)</sup> Applies to factory-fitted towing brackets only

- ▶ Select the following on the MMI\*: **MENU** button > control button **Systems / Car systems** > **Driver assist** > **Traffic signs** > **Automatic trailer recognition** > **on**.

## Secondary display

If the instrument cluster is currently showing a function other than traffic sign recognition, the speed limit will be displayed in the top right-hand corner ⇒ *Fig. 26*. If the system is able to detect a temporary speed restriction in a given situation, it will update the display accordingly.

Temporary speed restrictions are displayed in the following situations:

- A temporary speed restriction for wet weather is detected while the windscreen wipers are operating.
- The vehicle is towing a trailer and the **Automatic trailer recognition** option in the MMI\* is **on**. In this case, restrictions applying to trailers are displayed<sup>1)</sup>.
- A speed restriction applying at certain times of day has been detected and corresponds to the time displayed in the instrument cluster.

### Note

If you activate the Signs for trailers option, the system will show the maximum national speed limit for vehicles towing a trailer. Different speed limits are not displayed for different types of towed transport vehicle.

## Driver messages

Applies to vehicles: with camera-based traffic sign recognition

### No traffic sign recognised

A speed limit was not detected (e.g. on a motorway with no speed restriction).

### Traffic sign recognition: outside operational area

The vehicle is in a country or region out of the system's range (i.e. the navigation system has no corresponding data).

### Traffic sign recognition: currently restricted

This message appears, for instance, in the event of a navigation system fault. The limited functionality may cause fewer speed limits to be displayed (which increases the possibility of an error).

### Traffic sign recognition: currently unavailable

The system is currently unable to function properly and will be deactivated. This can happen, for instance, if the camera is dirty and a navigation system malfunction occurs simultaneously.

### Traffic sign recognition: system fault

The function of the system is impaired; the system will be deactivated. Drive to a qualified workshop soon.

### Traffic sign recognition: currently restricted. No camera view

This message will appear if the camera view is obstructed ⇒ *page 33*.

## Rest recommendation

### General notes

Applies to vehicles: with rest recommendation function

*Under certain conditions, the system can detect that the driver needs to take a break.*

At the beginning of a trip, the system monitors the driver's general steering style. Using this as a reference, the system continuously compares the current steering input at speeds of between 65 km/h and 200 km/h. If the evaluation of the steering input implies a lapse in the driver's concentration, the system will then recommend a break ⇒ *page 36, Instrument cluster display*. ▶

<sup>1)</sup> Applies to factory-fitted towing brackets only

The rest recommendation  is designed for journeys on motorways and major roads.

### System limitations

The rest recommendation function may misinterpret the steering input in certain driving situations, such as the following:

- On twisty roads.
- On rough roads.
- In poor weather.
- During performance driving.
- When the driver's attention is distracted.

### Resetting the system

The system is automatically reset if you...

- switch off the ignition.
- release the driver's seat belt and open the driver's door.
- drive slower than 65 km/h for a while. If you subsequently increase your speed again, the system will reevaluate the driving style.

#### WARNING

- Never drive when you are tired. As a driver you are always responsible for ensuring that you are fit to drive.
- On long journeys, make sure to take adequate breaks at regular intervals.
- The system cannot always tell if you need a break.
- In certain situations, the system may misinterpret driving manoeuvres and inappropriately recommend a break.
- No acute warning is given if the driver falls into a microsleep.

#### Note

The system is not available with all equipment versions.

### Instrument cluster display

Applies to vehicles: with rest recommendation function

#### Rest recommendation

If the warning lamp lights up and the message appears, the evaluation of the steering

input has resulted in a rest recommendation. This is also indicated by a warning tone. Take a break as soon as possible.

The message may be displayed again once if necessary.

### Switching on/off

Applies to vehicles: with rest recommendation function

To switch the rest recommendation on/off\*:

Vehicles with sound system\*

- ▶ Select: **[SETUP]** button > control button  **Driver assist > Rest recommendation.**

Vehicles with MMI\*:

- ▶ Select: **[MENU]** button > control button **Systems / Car systems > Driver assist > Rest recommendation.**

#### Note

If you switch off the system, it will remain switched off the next time you switch on the ignition.

## Lap timer and engine oil temperature display

### Introduction

Applies to vehicles: with lap timer (S models)

The engine oil temperature is only shown in the lap timer display.

#### Lap timer



You can use the lap timer in the display  *page 37, Fig. 28* to record and evaluate lap times. The times are recorded in minutes, seconds and tenths of a second. The hour will appear in the display and the tenths of a second will disappear if the session lasts for over 60 minutes.

Individual lap times stop automatically after 99 hours 59 minutes and 59 seconds. A new lap will then start automatically.

The lap timer stops after a maximum of 30 laps. You can then evaluate the lap times or start a new session. ▶

## Engine oil temperature display

Engine oil temperatures below 60 °C are indicated by the symbol , followed by three dashes " - - " and the unit (°C).

The engine has reached its operating temperature in normal driving conditions when the oil temperature is between **80 °C** and **120 °C**. If the engine is running under increased load at high ambient temperatures, the oil temperature may increase above this value. This is no cause for concern, provided that the indicator/warning lamps  ⇒ page 21 or  ⇒ page 24 in the display do not start flashing.

## Operating logic

You can use the following to operate the lap timer, depending on the optional equipment in your vehicle:

- Controls on **windscreen wiper lever** ⇒ page 37, or
- Control buttons on **multi-function steering wheel\*** ⇒ page 39

### WARNING

Please direct your full attention at all times to the road! As the driver, you have full responsibility for the safety of the vehicle and other road users. For this reason, you should only use the lap timer functions in a manner that allows you to maintain control of the vehicle in all situations - accident risk!

### Note

You can call up information from the on-board computer while the stopwatch of the lap timer is running.

## Controls on windscreen wiper lever

### Calling up the lap timer and recording lap times

Applies to vehicles: with lap timer (S models)

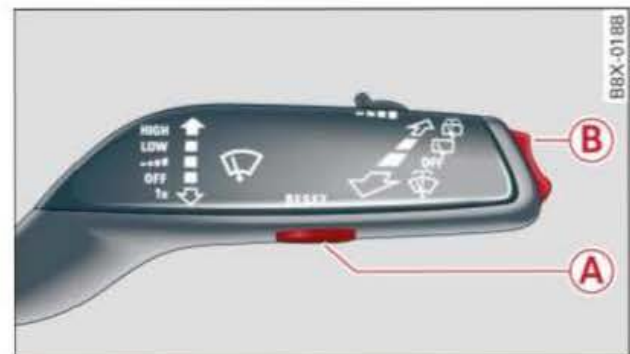

Fig. 27 Windscreen wiper lever: Controls





Fig. 28 Instrument cluster: Lap timer

## Calling up the lap timer

- ▶ Keep pressing the **RESET** button **A** ⇒ Fig. 27 until the lap timer ⇒ Fig. 28 appears on the display.

## Recording lap times

- ▶ To start recording a lap time, press the top part of the rocker switch **B**. The lap time is displayed in line **3** ⇒ Fig. 28.
- ▶ To finish measuring the current lap time, press the top part of the rocker switch **B** again. The next lap time starts running immediately. The previous lap time moves to the top of the display **1**. The current lap is shown in line **3**.

The  symbol will stay green if the current lap time is the best time so far. The  symbol will turn red if the lap time is not as good **2**.

### Displaying split times and interrupting the lap timer for a break

- ▶ Press the bottom part of the rocker switch **(B)** to display a split time **(3)**. The split time appears in line **(3)** for approximately 10 seconds. The current lap time continues running in the meantime.
- ▶ To interrupt the lap timer, e.g. to take a break (pause **(II)**), press and hold the bottom part of the rocker switch **(B)**.
- ▶ To resume recording of the lap time, press the top part of the rocker switch **(B)**.

If you interrupt the lap timer to take a break, you can resume recording later on, even if you switched off the ignition in the meantime.

Legend for centre display ⇒ Fig. 28:

<b>(1)</b>	Last recorded lap time
<b>(2)</b>	Symbols: - : Start time - : Worst lap time - : Best lap time - : Split time - : Pause
<b>(3)</b>	Current lap time
<b>(4)</b>	Menu: - Lap 1 (start lap) - New lap (start another lap) - Split time (lap sector time) - Pause (interrupt lap timer) - Reset (zero all lap times)

### Evaluating lap times and resetting the lap timer

Applies to vehicles: with lap timer (S models)

You can use the lap timer to evaluate the fastest, slowest and average lap times.



Fig. 29 Instrument cluster: Evaluating lap times

After you have evaluated the lap times, the lap timer starts a new session (i.e. continues with lap 1).

- ▶ To evaluate the session, press and hold the **[RESET]** button **(A)** ⇒ page 37, Fig. 27. The fastest lap "+", the slowest lap "-" and the average time "∅" will appear in the display.
- ▶ To reset the lap timer and clear the lap times, press the **[RESET]** button again for about 2 seconds.
- ▶ To restart the lap timer and record new laps, press the top part of the rocker switch **(B)** ⇒ page 37, Fig. 27.
- ▶ To exit the lap timer, briefly press the **[RESET]** button.

Explanation of evaluation in ⇒ Fig. 29:

<b>(A)</b>	Total number of laps
<b>(B)</b>	<b>+</b> : Best lap time
<b>(C)</b>	<b>-</b> : Worst lap time
<b>(D)</b>	<b>∅</b> : Average lap time
<b>(E)</b>	<b>▼ / ▲</b> : Page down/up
<b>(F)</b>	Delete entries and return to lap time recording

#### **i** Note

– Recorded lap times cannot be deleted individually from the overall results. ▶



- The data recorded in the lap timer remain stored after the ignition is switched off.

## Controls on multi-function steering wheel

### Calling up the lap timer and recording lap times

Applies to vehicles: with lap timer (S models) and multi-function steering wheel



Fig. 30 Multi-function steering wheel: Controls



Fig. 31 Instrument cluster: Lap timer

### Calling up the lap timer

- ▶ Press button **B** on the multi-function steering wheel and scroll the thumbwheel **A** ⇒ Fig. 30 until **Lap timer** ⇒ Fig. 31 is selected in the menu.
- ▶ Press the thumbwheel **A** to confirm your selection.

### Recording lap times

- ▶ To start the timer, press the thumbwheel **A** on the menu item **Lap 1 - select OK**. The lap time is displayed in line **3** ⇒ Fig. 31.
- ▶ To finish measuring the current lap time, press the thumbwheel **A** on the menu item **New lap - select OK**. The next lap time starts running immediately. The previous

lap time moves to the top of the display **1**. The current lap is shown in line **3**.

The **1** symbol will stay green if the current lap time is the best time so far. The **2** symbol will turn red if the lap time is not as good **2**.

### Displaying split times and interrupting the lap timer for a break

- ▶ To display a split time **3**, scroll the thumbwheel **A** until **Split time** appears in line **4**. Press the thumbwheel **A** to confirm your selection. The split time appears in line **3** for approximately 10 seconds. The current lap time continues running in the meantime.

If you want to take a break (pause **II**) immediately after displaying the split times, first press the thumbwheel **A** to confirm the menu item **Back - select OK**.

- ▶ To pause the timer, scroll the thumbwheel **A** until **Pause** appears in line **4**. Press the thumbwheel **A** to confirm your selection. The pause symbol **II** appears in line **3**.
- ▶ Press the thumbwheel **A** to resume the lap time.

If you interrupt the lap timer to take a break, you can resume recording later on, even if you switched off the ignition in the meantime.

Legend for centre display ⇒ Fig. 31:

<b>1</b>	Last recorded lap time
<b>2</b>	Symbols: <ul style="list-style-type: none"> <li>- <b>1</b>: Start time</li> <li>- <b>2</b>: Worst lap time</li> <li>- <b>3</b>: Best lap time</li> <li>- <b>3</b>: Split time</li> <li>- <b>II</b>: Pause</li> </ul>

③	Current lap time
④	Menu: - Lap 1 (start lap) - New lap (start another lap) - Split time (lap sector time) - Pause (interrupt lap timer) - Statistics (evaluate lap times) - Reset (zero all lap times)

### Evaluating lap times and resetting the lap timer

Applies to vehicles: with lap timer (S models) and multi-function steering wheel

You can use the lap timer to evaluate the fastest, slowest and average lap times.



Fig. 32 Instrument cluster: Evaluating lap times

After you have evaluated the lap times, you can resume the existing session or start a new session (i.e. start again with lap 1).

- ▶ To evaluate the lap times, scroll the thumbwheel (A) ⇒ page 39, Fig. 30 until **Statistics** appears in line (4) ⇒ page 39, Fig. 31. Press the thumbwheel (A) to confirm your selection. The fastest lap “+”, the slowest lap “-” and the average time “∅” will appear in the display. To display the individual lap times, scroll the thumbwheel (A) down ▼ or up ▲.
- ▶ Press the thumbwheel (A) to resume the current session.
- ▶ To reset the lap timer and clear the lap times, first press the thumbwheel (A). Then scroll the thumbwheel (A) ⇒ page 39, Fig. 30 until **Reset** appears in line (4) ⇒ page 39, Fig. 31. Press the thumbwheel (A) to confirm your selection.

- ▶ To restart the lap timer and record new laps, press the thumbwheel (A).
- ▶ To exit the lap timer, press button (B) on the multi-function steering wheel and scroll the thumbwheel (A) ⇒ page 39, Fig. 30 until a new menu item is selected. Press the thumbwheel (A) to confirm your selection.

Explanation of evaluation in ⇒ Fig. 32:

(A)	Total number of laps
(B)	+: Best lap time
(C)	-: Worst lap time
(D)	∅: Average lap time
(E)	▼ / ▲: Page down/up
(F)	Delete entries and return to lap time recording

### Note

- Recorded lap times cannot be deleted individually from the overall results.
- The data recorded in the lap timer remain stored after the ignition is switched off.

## Doors and windows

### Central locking system

#### Description

The vehicle can be locked and unlocked via the central locking system. You can use the following (depending on the equipment on your vehicle):

- Remote control key ⇒ *page 44*
- Lock on driver's door ⇒ *page 45*
- Sensor in front door handles on vehicles with convenience key\* ⇒ *page 45*
- Interior central locking switch ⇒ *page 47*

#### Unlocking one side of the vehicle only

When you lock the vehicle, the central locking system will lock the doors and the boot lid. When you unlock the vehicle, the central locking system will unlock either the driver's door *only*, or all the locks on the vehicle, depending on the setting you have selected in the MMI\* ⇒ *page 46*.

#### Automatic locking function (Auto Lock)

The Auto Lock function locks the doors and the boot lid when the vehicle exceeds a speed of about 15 km/h.

The vehicle is unlocked again when the ignition key is removed. Alternatively, the vehicle can also be unlocked via the central locking switch or by pulling one of the inside door handles. The Auto Lock function can be switched on and off on the sound system or MMI\* ⇒ *page 46*.



In the event of an accident in which the airbags inflate, the doors will be automatically unlocked to facilitate access and assistance.

#### Safelock mechanism

When you switch off the ignition, the message **Be aware of door safelock**. See **owner's manual** appears in the instrument cluster display as a reminder that the safelock mechanism is automatically activated when you lock the vehicle from the outside. The doors can then no longer be opened from the inside.

This makes it more difficult to break into the vehicle ⇒ .

It is possible to deactivate the safelock mechanism manually any time you lock the vehicle:

- Turn the key in the door lock to the lock position a second time **within 2 seconds**. Or:
- Press the  button on the remote control key a second time **within 2 seconds**. Or:
- Touch the sensor\* on one of the front door handles a second time **within 2 seconds** (applies to vehicles with convenience key). Or:
- Before locking the vehicle, press the  button for the interior monitor and tow-away protection\* ⇒ *page 48*.

The LED on the top of the driver's door trim acknowledges this procedure as follows: first it flashes rapidly for a short time, then it goes out for about 30 seconds, and finally it starts flashing again slowly.

If you switch off the safelock mechanism\*, the interior monitor and tow-away protection\* are automatically disabled.

#### Anti-theft alarm system\*

If the anti-theft alarm system senses interference with the vehicle it triggers an audible and visible alarm.

The anti-theft alarm system is automatically switched on when the vehicle is locked. It switches off automatically if you unlock the vehicle using the remote control or the sensor on the door handle (convenience key).

If you unlock the vehicle by inserting the key in the driver's door, you should switch on the ignition within 15 seconds to prevent the alarm from being triggered. On some export versions, the alarm is triggered immediately when you open a door.

To deactivate the alarm, press the  button on the remote control key/convenience key or switch on the ignition. The alarm also stops automatically after a certain period.

Switch off the interior monitor and tow-away protection if you wish to prevent the alarm ▶

from being triggered accidentally  
⇒ page 48.

### Turn signals

The turn signals will flash twice when the vehicle is unlocked and once when the vehicle is locked.

If the turn signals do not flash, one of the doors, the bonnet or the boot lid is still open. On vehicles with the convenience key, the ignition may still be switched on.

### Accidental lock-out

The central locking system prevents you from being locked out of the vehicle in the following situations:

- When the driver's door is open, the vehicle will not be locked if you press the central locking switch and then close the door ⇒ page 47.
- On vehicles with convenience key\*, the boot lid will be released again automatically if the key that was last in use is left inside the boot when the boot lid is closed.

To prevent yourself from being locked out, do not lock the vehicle with the remote control key/convenience key\* until all of the doors and the boot lid are closed.

#### WARNING

Do not leave anyone (especially children) in the car if it is locked from the outside and the safelock mechanism\* is activated: the doors and windows cannot then be opened from the inside. Locked doors could delay assistance in an emergency, potentially putting lives at risk.

#### Note

- Never leave any valuable items in the vehicle unattended. Even a locked vehicle is not a safe.
- If the LED on the driver's window sill lights up for about 30 seconds when the vehicle is locked, the central locking system or anti-theft alarm\* is not working

properly. You should have the malfunction repaired by a qualified workshop.

- The interior monitor of the anti-theft alarm\* system will only function as intended if the windows and the sun roof\* are closed.

### Set of keys



Fig. 33 Keys supplied with the vehicle

### Remote control key or convenience key

The convenience key is a remote control key with special functions ⇒ page 45, *Locking and unlocking the vehicle with the convenience key* and ⇒ page 88, *Vehicles with convenience key*. The remote control key will lock and unlock the car via the central locking system and start the engine. Press the release button ⇒ Fig. 33 -arrow- to make the key spring out of the handle and to fold it back in.

### Number of keys

You can check how many keys are initialised for your vehicle using the MMI\*. This feature enables used car buyers to make sure they have received all of the keys. Select: control button **Systems** or **Car systems** > **Servicing & checks** > **Initialised keys**.

### Replacing a key

If you should lose a key, please contact an Audi dealer. Have the remote control coding for *that* key deactivated. For this purpose you should bring all available keys with you. It is also important to notify your insurance company if a key has been lost. ▶

## Immobiliser

The immobiliser is designed to prevent unauthorised persons from driving the vehicle. It may not be possible to start the engine if there is another radio transmitter (e.g. an ignition key for another vehicle or a transponder) on the same key ring.

## Data stored on remote control key or convenience key

Data related to the service and maintenance of the vehicle are stored continuously on your remote control key or convenience key\*. Your Audi dealer can read out the data and will then be able to tell you what service work is required.

### WARNING

- Always take the key with you when leaving the vehicle - even if you only intend to be gone for a short time. This is especially important if children are left in the car. They might otherwise be able to start the engine or use power-operated equipment such as the electric windows - this could lead to injuries.
- Wait for the vehicle to come to a standstill before removing the ignition key from the lock. Otherwise the steering lock could engage suddenly, causing an accident.

### Note

The function of the remote control key may be impaired by interference from other nearby radio signals (for example from a mobile telephone or TV transmitter) if these are in the same frequency range.

## LED and battery in remote control key

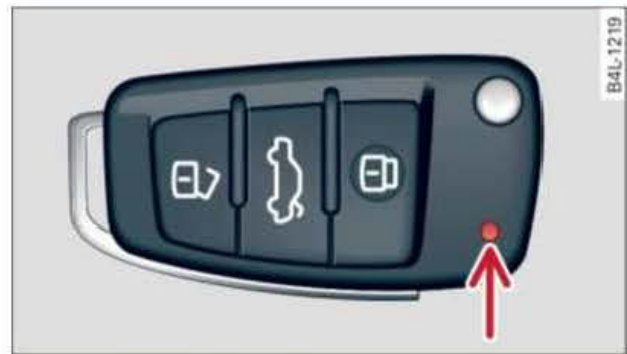



Fig. 34 Remote control key: LED



Fig. 35 Remote control key: Opening the cover

## LED on remote control key

The LED ⇨ Fig. 34 lights up when you press the buttons.

- ▶ The LED should flash once when you press one of the buttons briefly.
- ▶ The LED should flash repeatedly when you press and hold one of the buttons (convenience open/close\*).
- ▶ If the LED does not flash, the battery in the remote control key is flat. In addition, the indicator lamp  may light up and the message **Please change key battery** may appear on the instrument cluster display. Replace the battery.

## Replacing the battery for the remote control key

- ▶ Use a coin to lever off the cover ⇨ Fig. 35.
- ▶ Insert the new battery with the “+” symbol facing up.
- ▶ Press the cover back onto the key until it clicks into place.

We recommend having the battery changed by a qualified workshop if required. ▶

**For the sake of the environment**

Used batteries must be disposed of appropriately and must not be discarded with ordinary household waste.

**Note**

The new battery must be of the same type as the original one.

**Synchronising the remote control key**

If the remote control fails to lock or unlock the vehicle, it will be necessary to re-synchronise the system.

- ▶ Press the button on the remote control.
- ▶ Unlock the driver's door within 30 seconds by turning the key in the lock.
- ▶ Press button or .

**Locking and unlocking the vehicle by remote control**

Fig. 36 Remote control key/convenience key: Buttons

- ▶ To unlock the vehicle, press the button ⇒ Fig. 36.
- ▶ To lock the vehicle, move the selector lever to position P (automatic gearbox) and press the button ⇒ .
- ▶ To unlock the boot lid, press the button briefly.
- ▶ To lock the vehicle without activating the safelock mechanism\*, press the button a second time **within 2 seconds**.
- ▶ To open the boot lid, press the button for at least one second.

The vehicle will be locked again automatically if you do not open one of the doors or the

boot lid within 30 seconds after unlocking the car. This function prevents the vehicle from remaining unlocked if the unlock button is pressed by mistake. This does not apply if you press and hold the button for one second or longer.

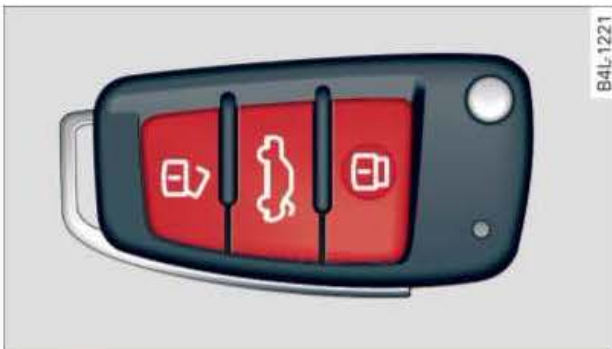
On vehicles with the **security central locking** feature (for unlocking one side of the vehicle only) ⇒ page 46, you can unlock just the driver's door and the tank flap by pressing the button once, or the whole vehicle by pressing the button twice.

**WARNING**

Do not leave anyone (especially children) in the car if it is locked from the outside and the safelock mechanism\* is activated: the doors and windows cannot then be opened from the inside. Locked doors could delay assistance in an emergency, potentially putting lives at risk.

**CAUTION**

Applies to vehicles with start/stop system and **[START ENGINE STOP]\*** button: The ignition remains on when the start/stop system stops the engine. Before leaving the vehicle, ensure that the ignition is switched off ⇒ page 89. Otherwise it will not be possible to lock the vehicle.

**Note**

- Do not use the remote control key/convenience key when the vehicle is out of sight.
- For further functions of the remote control key/convenience key, please refer to ⇒ page 51, *Convenience open / close function*.

### Locking and unlocking the vehicle with the key

If the central locking system should fail to operate, the driver's door can still be locked and unlocked by turning the key in the lock.

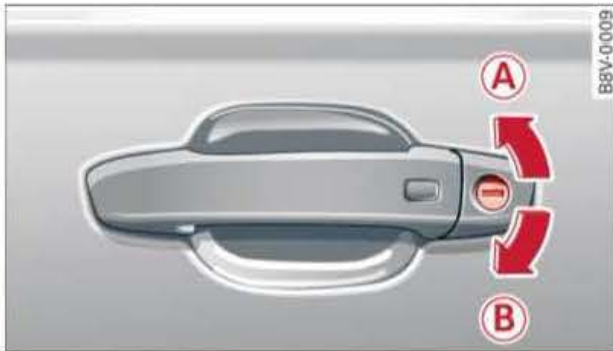

Fig. 37 Driver's door lock

- ▶ To unlock the driver's door, turn the key to the unlock position **A**.
- ▶ To lock the driver's door, move the selector lever to position P (automatic gearbox) and turn the key to the lock position **B** once ⇒ **⚠**.
- ▶ To lock the vehicle without activating the safelock mechanism\*, turn the key to the lock position **B** a second time **within 2 seconds**.

In order to switch off the anti-theft alarm\*, you must switch on the ignition within 15 seconds after opening the driver's door. Otherwise the alarm will be triggered.

The system will unlock either the whole vehicle or one door only, depending on the settings you have chosen on the driver information system\* (MMI\*) ⇒ page 46.

### ⚠ WARNING

Do not leave anyone (especially children) in the car if it is locked from the outside and the safelock mechanism\* is activated: the doors and windows cannot then be opened from the inside. Locked doors could delay assistance in an emergency, potentially putting lives at risk.

### ⚠ CAUTION

Applies to vehicles with start/stop system and **[START ENGINE STOP]\*** button: The ignition remains on when the start/stop system stops the engine. Before leaving the vehicle, ensure that the ignition is switched off ⇒ page 89. Otherwise it will not be possible to lock the vehicle.

### i Note

For further functions of the remote control key/convenience key, please refer to ⇒ page 51, *Convenience open / close function*.

### Locking and unlocking the vehicle with the convenience key

Applies to vehicles: with convenience key

*The front doors and the boot lid can be locked and unlocked without handling the remote control key.*

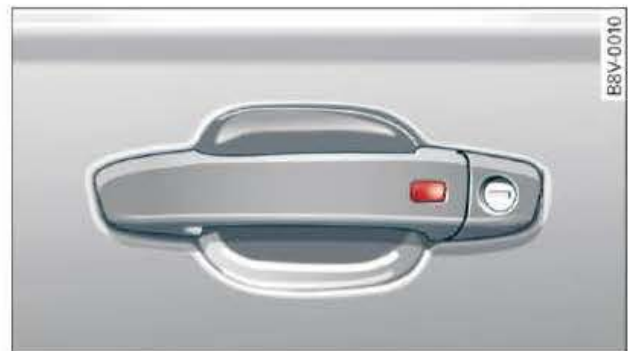

Fig. 38 Driver's door: Locking vehicle with convenience key

- ▶ To unlock the door automatically, take hold of the driver's/front passenger's door handle ⇒ Fig. 38.
- ▶ Then pull the door handle to open the door.
- ▶ To unlock/open the boot, press the release catch on the boot lid ⇒ page 49, Fig. 42.
- ▶ To lock the vehicle, move the selector lever to position P (automatic gearbox), close the door and touch the sensor on the driver's door handle **once** ⇒ **⚠**. Do not take hold of the door handle while doing so.
- ▶ To lock the vehicle without activating the safelock mechanism\*, touch the sensor on

the driver's door handle a second time **within 2 seconds**.

The vehicle can be locked/unlocked from the front doors and boot lid only. The remote control key has to be within a range of about 1.5 metres of the relevant door or the boot lid. It does not matter where you carry the key, for instance whether it is in your jacket pocket or in a handbag or briefcase.

The locking function may be affected if you grasp the door handle while the vehicle is being locked.

Once the doors have been locked, they cannot be opened again immediately. This will enable you to check that the driver's door is properly closed.

The system will unlock either the whole vehicle or one door only, depending on the settings you have chosen on the driver information system\* (MMI\*) ⇒ *page 46*.

### WARNING

Do not leave anyone (especially children) in the car if it is locked from the outside and the safelock mechanism\* is activated: the doors and windows cannot then be opened from the inside. Locked doors could delay assistance in an emergency, potentially putting lives at risk.

### CAUTION

Applies to vehicles with start/stop system and **START ENGINE STOP**\* button: The ignition remains on when the start/stop system stops the engine. Before leaving the vehicle, ensure that the ignition is switched off ⇒ *page 89*. Otherwise it will not be possible to lock the vehicle.

### Note

Please note the following points if the vehicle is left parked for long periods:

- To save electrical power, the proximity sensors are switched off after a few days. You will then need to pull the door han-

dle once to unlock the vehicle, and a second time to open it.

- To prevent the battery from becoming discharged and thus maintain the vehicle's starting ability for as long as possible, the power management system will gradually switch off convenience functions that are not required. In this case you may not be able to unlock the vehicle with this convenience function.

## Security central locking

Applies to vehicles: with security central locking

The security central locking feature allows you to unlock only the driver's door and the tank flap. All other doors and the boot lid remain locked.

### Unlocking driver's door and tank flap

- ▶ Press the  button on the remote control key/convenience key *once* or turn the key to the unlock position *once*.

### Unlocking all the doors, the boot lid and the tank flap simultaneously

- ▶ Press the  button on the remote control key/convenience key *twice* within 5 seconds or turn the key to the unlock position *twice* within 5 seconds.

The safelock mechanism\* and the anti-theft alarm\* are deactivated immediately even if you unlock only the driver's door, without unlocking the other doors.

You can change the settings for the security central locking system directly on vehicles with MMI\* ⇒ *page 46*.

## Adjusting the settings for the central locking system

Applies to vehicles: with driver information system

You can pre-select particular settings in the MMI\* or sound system.

On the sound system or MMI\*, you can select whether the vehicle is automatically locked at speeds above 15 km/h ("Auto Lock"). In addition, you can control whether or not the







exterior mirrors fold in when you lock the vehicle.

### Settings for unlocking doors (on vehicles with MMI)

You can specify which doors you wish to have unlocked when you unlock the vehicle.

- ▶ Select: Control button **Systems** or **Car systems** > **Vehicle settings** > **Central locking** > **Unlock doors**.

If you select **off/all**, the whole vehicle will be unlocked when you press the  button on the remote control key.

If you select **on/driver**, only the driver's door will be unlocked when you press the  button on the remote control key once. On vehicles with convenience key, only one front door will be unlocked (whichever door you grip by the handle). If you press the  button twice, the whole vehicle will be unlocked. The whole vehicle is always locked when you press the  button.

### Auto Lock setting (on vehicles with sound system)

- ▶ Select: **SETUP** button > control button  > **Central locking** > **Lock when driving**.

If you have selected this function, the whole vehicle is locked automatically when it reaches a speed of 15 km/h.

### Auto Lock setting (on vehicles with MMI)

- ▶ Select: Control button **Systems** or **Car systems** > **Vehicle settings** > **Lock when driving**.

If you select **on**, the whole vehicle is locked automatically when it reaches a speed of 15 km/h.

### Folding in exterior mirrors (on vehicles with MMI)

- ▶ Select: Control button **Systems** or **Car systems** > **Vehicle settings** > **Central locking** >

**Fold mirrors.** For more information, refer to *⇒ page 61, Adjusting the exterior mirrors.*

If you select **on** the exterior mirrors will be folded in automatically when you press the  button on the remote control key *⇒ page 61.*

**Unlock doors** - You can select whether **all** doors or only the **driver's** door are unlocked by the central locking system. The boot lid will also be unlocked if you select **all**. If you select **driver** on vehicles with convenience key\*, only one door will be unlocked (whichever door you grip by the handle).

When the **driver** setting is activated, you can still unlock all the doors and the boot lid by pressing the  button on the remote control key twice.



You can still unlock the whole vehicle. To do so, press the  button on the remote control key/convenience key **twice**. Alternatively, if your vehicle has a key *⇒ page 42, Fig. 33*, turn the key in the door lock to the unlock position twice within 2 seconds.

If you press the  button, the whole vehicle will be locked. At the same time you will hear an acoustic signal<sup>1)</sup>.

### Central locking switch



Fig. 39 Driver's door: Central locking switch

- ▶ To lock the vehicle, press the  button *⇒ .*
- ▶ To unlock the vehicle, press the  button *⇒ Fig. 39.*

<sup>1)</sup> This function is not available on all export versions.

Please note the following when you use the central locking switch to lock your vehicle:

- The doors and the boot lid cannot be opened from the *outside* (for safety reasons, when stopped at traffic lights, etc.).
- The LED in the central locking switch lights up when all of the doors are closed and locked.
- You can open the doors individually from the inside by pulling the inside door handle.
- In the event of an accident in which the airbags inflate, doors locked from the inside will be automatically unlocked to facilitate access and assistance.

### WARNING

- The central locking switch is still operative when the ignition is switched off and will automatically lock the entire vehicle when the  button is pressed.
- The central locking switch inside the vehicle is not operative when the safelock mechanism is activated if the vehicle has been locked from the outside.
- Locked doors could delay assistance in an emergency, potentially putting lives at risk. Do not leave anyone (especially children) in the vehicle.

### Deactivating the interior monitor and tow-away protection

Applies to vehicles: with anti-theft alarm system



**Fig. 40** Side trim in open driver's door: Button for interior monitor/tow-away protection

When the vehicle is locked, the alarm will be triggered if movements are detected in the interior (e.g. by animals) or if the vehicle's inclination is changed (e.g. during transport). You

can prevent the alarm from being triggered accidentally by switching off the interior monitor and/or tow-away protection.

- ▶ Switch off the ignition and press the button  $\Rightarrow$  Fig. 40 to deactivate the interior monitor and tow-away protection. The LED in the button will light up.
- ▶ If you now lock the vehicle, the interior monitor and tow-away protection will remain deactivated until the next time a door is opened.

If you switch off the interior monitor and tow-away protection, the safelock mechanism\* is automatically disabled.

### WARNING

Do not leave anyone (especially children) in the car if it is locked from the outside and the safelock mechanism\* is activated: the doors and windows cannot then be opened from the inside. Locked doors could delay assistance in an emergency, potentially putting lives at risk.

### Locking the passenger's door and rear doors\* manually

If the central locking system should fail to work at any time, each door will have to be locked separately.



**Fig. 41** Locking the door manually

The driver's door can be locked manually by turning the key in the door lock  $\Rightarrow$  page 45.

The mechanical locking device for the other doors is located on the end face of the front passenger's door and the rear doors\*. It is only visible when the door is open. ▶

- ▶ Pull the cap out of the opening.
- ▶ Insert the key in the slot inside and turn it as far as the stop to the right (if the door is on the right side) or to the left (if the door is on the left side).

Once the door has been closed it can no longer be opened from the outside. Pull the interior door handle once to unlock and open the door.

## Boot lid

### Opening and closing the boot lid



Fig. 42 Boot lid: Opening (release catch)



Fig. 43 Boot lid/handle on inside (example): Closing

### Opening boot lid

- ▶ Press the  button on the remote control key for at least one second, or
- ▶ Press the release catch on the boot lid ⇒ Fig. 42.

### Closing boot lid

- ▶ Pull down the boot lid by the handle on the inside and let it drop into the latch ⇒ Fig. 43 ⇒ .

### WARNING

- After closing the boot lid, always check that the catch has engaged properly. The boot lid could otherwise open suddenly when the vehicle is moving - this could result in an accident.
- The boot lid must always be completely closed when the vehicle is moving; otherwise toxic exhaust fumes can be drawn into the interior.

### Note

When the vehicle is locked, you can unlock the boot lid separately by pressing the  button on the remote control key. The boot lid will lock automatically when you close it again.

### Manual release of the boot lid

The boot lid can be released manually from the inside.



Fig. 44 (A3/A3 Sportback) Detail of inside of boot lid: Access to manual release



Fig. 45 (A3/A3 Saloon) Detail of inside of boot lid: Access to manual release

To access the manual release mechanism, fold down the rear seat backrest ⇒ page 73. ▶

The steps for manually releasing the boot lid vary according to the vehicle model.

### Manual release (A3/A3 Sportback)

- ▶ Use the blade of the ignition key to prise off the cover ① ⇒ Fig. 44.
- ▶ Insert the key in the opening behind the cover ② and pull the key in the direction of the arrow until the boot is unlocked.

### Manual release (A3 Saloon)

- ▶ Take the screwdriver out of the vehicle tool kit ⇒ page 236. Use the flat-blade side of the reversible insert.
- ▶ Use the screwdriver to prise off the cover ③ ⇒ Fig. 45.
- ▶ Insert the key in the opening behind the cover ④ and pull the key in the direction of the arrow until the boot is unlocked.

## Child-proof catches

### Mechanical child-proof catches

Applies to vehicles: with mechanical child-proof catches

The child-proof catches  prevent the rear doors being opened from the inside.



Fig. 46 Rear doors: Child-proof catches

- ▶ To **engage** the child-proof catch turn the ignition key in the direction of the arrow.
- ▶ To **disengage** the child-proof catch turn the ignition key in the opposite direction of the arrow.

When the child-proof catch is engaged, the inside door handle will not function, and the door can only be opened from the outside.

The child-proof catches only function for the door on which they were engaged.



### Electric child safety switches

Applies to vehicles: with electric child safety switches (A3 Sportback/A3 Saloon)

The child safety switches disable the rear windows and prevent the rear doors from being opened from the inside.



Fig. 47 Detail of driver's door: child safety switches

- ▶ To activate the child safety switches on the rear doors, press the left/right button  on the driver's door ⇒ Fig. 47. The LED in the button will light up.
- ▶ To deactivate the child safety switches on the rear doors, press the left/right button  on the driver's door. The LED in the button will go out.

The following functions are disabled by the child safety switches:

- Door handle on the inside of the corresponding rear door,
- Electric window in the corresponding rear door,

To activate the child safety switches on both sides, you need to press the  buttons one after the other.

### Driver message

#### Child-proof catch: system fault!

If this message appears, the child safety switches cannot be switched on. Drive to a qualified workshop soon and have the fault rectified. To prevent the rear doors from being opened from the inside, engage the mechanical child-proof catches ⇒ page 50. ▶

### ! WARNING

Always take the key with you when leaving the vehicle - even if you only intend to be gone for a short time. This is especially important if children are left in the car. They might otherwise be able to start the engine or use power-operated equipment such as the electric windows - this could lead to injuries.

## Electric windows

### Controls

The driver can operate all the electric windows.

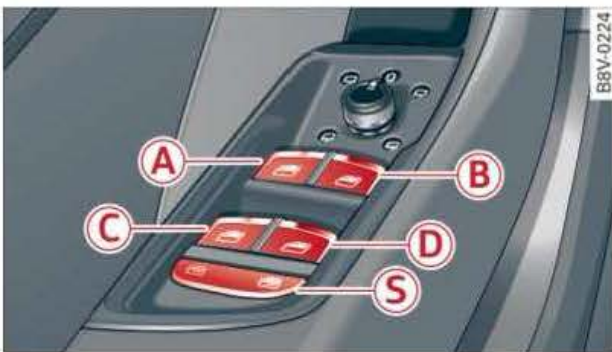

Fig. 48 Detail of the driver's door: Controls (example for A3 Sportback/A3 Saloon)

All electric windows have **two-stage switches**:

### Opening a window

- ▶ Press the switch as far as the **first stop** and hold it until the window has moved to the desired position.
- ▶ Press the switch briefly **to the second stop**: the window will automatically open all the way.

### Closing a window

- ▶ Pull the switch as far as the **first stop** and hold it until the window has moved to the desired position.
- ▶ Pull the switch briefly **to the second stop**: the window will automatically close all the way.

### Switches for electric windows

- (A) Switch ⇒ Fig. 48 for window in driver's door

- (B) Switch for window in front passenger's door
- (C) Switch\* for window in rear left door (A3 Sportback/A3 Saloon)
- (D) Switch\* for window in rear right door (A3 Sportback/A3 Saloon)
- (S) Safety switch\* (A3 Sportback / A3 Saloon)

### Child safety switch

When the safety switch (S) ⇒ Fig. 48 is activated, the symbol  in the switch is lit. The window switches in the rear doors are deactivated.

### ! WARNING

- Always take the key with you when leaving the vehicle - even if you only intend to be gone for a short time. This is especially important if children are left in the car. They might otherwise be able to start the engine or use power-operated equipment such as the electric windows - this could lead to injuries. The window switches are only deactivated when the driver's door or the front passenger's door is opened.
- Always be careful when closing the windows. Careless use of the electric windows can cause severe injuries.
- When locking the vehicle from the outside, make sure that nobody is inside the vehicle, as the windows cannot be opened from the inside in an emergency.



### i Note

The windows can be operated for about ten minutes after the ignition has been switched off. The window switches are only deactivated when the driver's door or the front passenger's door is opened.



### Convenience open / close function

The convenience open/close function allows you to open and close the windows and panorama sun roof\* conveniently from outside the vehicle via the central locking system. ▶

### Convenience open function

- ▶ Press and hold the  button on the remote control key until all the windows and the panorama sun roof\* have reached the desired position, or:
- ▶ First unlock the vehicle using the  button on the remote control key, then insert the key in the driver's door lock, turn it to the "unlock" position and hold it there until all the windows and the panorama sun roof\* have reached the desired position.

### Convenience close function

- ▶ Press and hold the  button on the remote control key until all the windows and the panorama sun roof\* are closed ⇨ , or
- ▶ Turn the key in the driver's door lock to the lock position and hold it there until all the windows and the panorama sun roof\* are closed.

### Convenience close function with convenience key\*

- ▶ Touch and keep your hand in contact with the sensor\* on one of the front door handles until all the windows and the panorama sun roof\* are closed. Do not rest your hand on the door handle while this is happening.

### Adjusting settings for convenience open function via MMI\*

- ▶ Select: **[MENU]** button > control button **Systems** or **Car systems** > **Vehicle settings** > **Central locking** > **Long press to open windows** and/or **Front windows on/off** and/or **Roof on/off\***.

#### WARNING

- Take care when closing the windows and the panorama sun roof\*. Careless or uncontrolled use can cause injuries.
- For safety reasons, you should only use the remote control open and close functions within about 2 metres of the vehicle. To avoid injuries, always keep an eye on the windows and the panorama sun roof\* when pressing the button to close

them. The windows and sun roof stop moving as soon as the button is released.

### What to do after a malfunction

*The one-touch open and close function must be reactivated if the battery has been disconnected.*

- ▶ Pull and hold the electric window switch until the window is fully closed.
- ▶ Release the switch and then pull it again for at least one second.

## Panorama sun roof

### Description

Applies to vehicles: with panorama sun roof

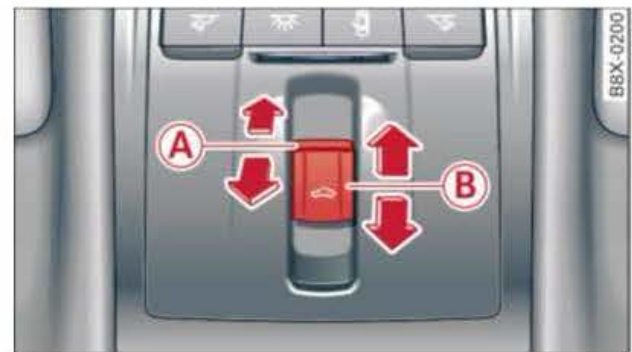

**Fig. 49** Detail of headliner: Button for panorama sun roof

The switch operates in two stages. Whenever the switch is pressed or pulled to the second stage, the sun roof automatically opens or closes all the way. The sun roof stops moving immediately if the switch is pressed in any direction.

#### **A** Tilting open and closed

- ▶ To tilt the sun roof fully open, briefly press the switch to the second position.
- ▶ To close the sun roof completely, briefly pull the switch downwards to the second position or briefly slide the switch forwards to the second position ⇨ .
- ▶ To set an intermediate position, press/pull the switch to the first position until the sun roof has reached the desired position. ▶

## B Opening and closing

- ▶ To slide the sun roof fully open, briefly slide the switch backwards to the second position.
- ▶ To close the sun roof completely, briefly slide the switch forwards to the second position or briefly pull the switch downwards to the second position ⇒ .
- ▶ To set an intermediate position, press the switch forwards/backwards to the first position until the sun roof has reached the desired position.

A wind deflector incorporated in the panorama sun roof adapts automatically to suit the position of the sun roof. This feature minimises wind noise in all roof positions.

The panorama sun roof can be operated for about ten minutes after the ignition has been switched off. The switch is deactivated immediately when one of the front doors is opened.

### Sun blind

The sun blind can be opened and closed by hand when the panorama sun roof is open in any position. The sun blind can be adjusted to any intermediate position.

#### WARNING

Take care when closing the panorama sun roof. Careless or uncontrolled use can cause injuries. For this reason, always take the ignition key with you when leaving the vehicle.

#### CAUTION

You should always close your panorama sun roof when leaving the car. Sudden rain could seriously damage your car's interior equipment, especially the on-board electronic systems.

#### Note

- Details on the convenience open/close function ⇒ *page 51*.
- The panorama sun roof can be opened only at temperatures above -20 °C.

## Closing the panorama sun roof manually

Applies to vehicles: with panorama sun roof

If the panorama sun roof detects a resistance while it is closing (e.g. caused by an object trapped in the mechanism), a safety cut-out will be triggered and the roof will open again automatically. If the roof will still not close automatically after you remove the object and operate the switch again, you can use the safety cut-out override to close it.

- ▶ After the sun roof opens automatically, pull and hold the switch within 5 seconds until the sun roof is closed.

If you release the switch before the panorama sun roof is fully closed, it will open again automatically.

## Lights and vision

### Exterior lights

#### Switching lights on and off



**Fig. 50** Dashboard: Light switch with headlight range control

#### Light switch ☀

Turn the switch ⇒ *Fig. 50* to the appropriate position. The corresponding symbol lights up when the lights are on.

0 - Lights off. On vehicles for some markets, the daytime running lights\* are switched on and off together with the ignition.

AUTO\* - The automatic headlights switch on (and off again) automatically according to the ambient light conditions (for instance at dusk, in the rain or in a tunnel). On vehicles with integrated daytime running lights\*, the daytime running lights or the dipped headlights (different versions for different countries) are switched on automatically, depending on the ambient light level.

☞☞ - Side lights

☞☞ - Dipped headlights

When you lock the vehicle, the lights are controlled as follows, depending on the position of the light switch:

- ☞☞ - Dipped headlights: The exterior lights are switched off completely.
- AUTO\*: The coming home\* function is switched on ⇒ *page 59*.

#### Front and rear fog lights

Press the corresponding switch ⇒ *Fig. 50*:

☞☞ - Front fog lights

☞☞ - Rear fog light(s)

#### All-weather lights\*

Applies to vehicles with LED headlights

Press the button ⇒ *Fig. 50*:

☞☞ - All-weather lights (in place of the front fog light switch ☞☞.)

On vehicles with all-weather lights, the front lights are adjusted automatically so that the headlights on your own vehicle do not blind you, for instance when driving on a wet road.

#### Headlight range control ☞☞

Your vehicle is equipped with a headlight range control to prevent oncoming traffic from being dazzled when the vehicle is heavily laden.

On vehicles with xenon headlights\* or LED headlights\*, the headlight beam settings are adjusted automatically (even during braking and acceleration).

On vehicles with halogen headlights, the knob ⇒ *Fig. 50* must be used to adjust the headlight beam settings:

- Briefly press the knob to release it.
- Turn the knob towards 3 or 0 to reduce or increase the range of the headlights.
- Briefly press the knob again to engage it.

0 - One or two front occupants, luggage compartment empty

1 - All seats occupied, luggage compartment empty

2 - All seats occupied, luggage compartment loaded

3 - Driver only, luggage compartment loaded

#### Audi adaptive light\*

The adaptive light is activated only when the light switch is set to AUTO. You can deactivate the adaptive light on the MMI\* ⇒ *page 58*.

When the lights are on, they are automatically adapted to bends in the road, depending on the speed of the vehicle and the steering ►



wheel angle. This feature provides better illumination when you drive through a corner. The system is active at speeds from approximately 10 km/h to 110 km/h.

**Static cornering light (turning light)\*** (on vehicles with adaptive light) - the turning light is automatically activated when the steering wheel angle exceeds a specified value (up to about 70 km/h) or when the turn signals are switched on (up to about 40 km/h). This feature provides better illumination at the side of the vehicle when you turn off at a junction.

**Speed-dependent light distribution\*** - The speed-dependent light distribution adjusts the vehicle lighting as required in towns, on motorways and on other main roads. Intersections can also be illuminated if your vehicle is equipped with a navigation system\*.

### Motorway light function\*

(On vehicles with adaptive light or LED headlights) - this function adjusts the vehicle lighting on motorways according to your speed.

#### WARNING

- The automatic headlights\* are only intended to assist the driver. The driver must always ensure that the headlights are used when required, and may have to switch them on manually when the light conditions or visibility are poor. For example, the light sensors are not able to detect fog. Therefore, you should always switch on the dipped headlights  in these conditions and when driving after dark.
- Observe all relevant statutory requirements when using the lighting systems described here.

#### CAUTION

To avoid dazzling the traffic behind you, the rear fog light should only be used in accordance with statutory regulations.

#### Note

- The light sensor for the automatic headlights\* is located in the mounting for the interior mirror. Do not affix any stickers on this section of the windscreen.
- Some of the settings for the exterior lighting can be adjusted  $\Rightarrow$  page 58.
- A buzzer will sound if you switch off the ignition and open the door when the exterior lighting is on.
- On vehicles for some markets, the rear lights remain off when the daytime running lights are switched on.
- In cool or damp weather, the inside of the headlights, turn signals or rear lights can sometimes mist up, due to the temperature difference between the interior and exterior of the car. They should clear again partially or completely soon after you switch on the headlights. This phenomenon has no influence on the life expectancy of the vehicle lights.
- If you are towing a trailer or caravan equipped with a rear fog light on a vehicle with a factory-fitted **towing bracket**, only the rear fog light on the trailer or caravan will light up.

### Turn signal and main beam lever

The turn signal lever also operates the main beam headlights, parking lights and headlight flasher.

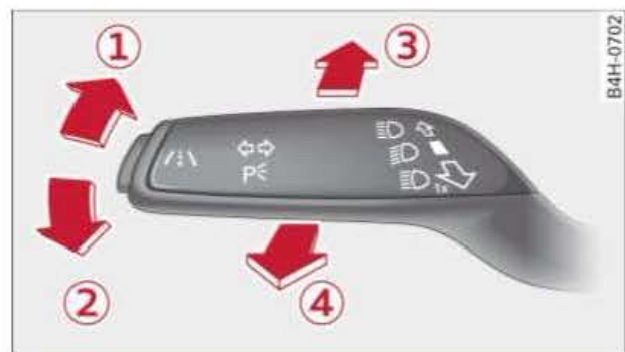

Fig. 51 Turn signal and main beam headlight lever

### Turn signals and parking lights

The turn signals will flash if you move the lever while the ignition is switched on. The parking light will come on if you move the turn signal lever while the ignition is switched off.

- ① - Turn signals/parking lights (right side)
- ② - Turn signals/parking lights (left side)

If you just tap the lever, the turn signals will flash three times (one-touch signalling).

### Main beam and headlight flasher

Move the lever to the appropriate position:

- ③ - Main beam headlights on (vehicles with main beam assist \*  $\Rightarrow$  page 56, vehicles with adaptive headlight range control\*  $\Rightarrow$  page 57)
- ④ - Main beam headlights off or headlight flasher

The indicator lamp  will light up in the instrument cluster.

#### WARNING

The main beam can dazzle other drivers. Risk of accident! Never use the main beam headlights or the headlight flasher if they could dazzle other drivers.

#### Note

A buzzer will sound if you open the door when the parking light is on.

### Main beam assist

Applies to vehicles: with main beam assist

The main beam assist automatically switches the main beam headlights on or off depending on the surrounding light conditions.

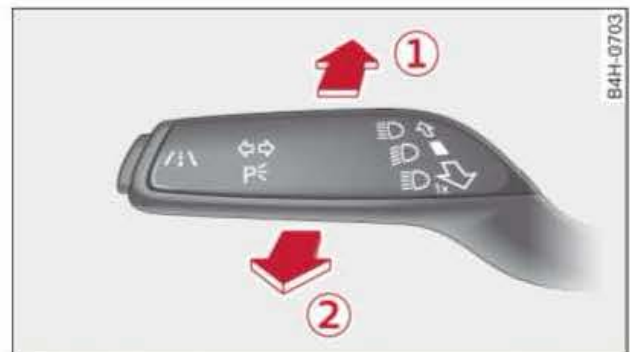



Fig. 52 Turn signal and main beam lever: Switching main beam assist on/off



Fig. 53 Instrument cluster: Indicator lamp for main beam assist

### Activating the main beam assist

Important: The light switch must be set to AUTO, the dipped beam headlights must be on and the main beam assist must be activated on the MMI\*  $\Rightarrow$  page 58.

- Push the lever to position ① to activate the main beam assist. The indicator lamp  will light up in the instrument cluster display  $\Rightarrow$  Fig. 53 and the main beams will be switched on/off automatically. An indicator lamp  lights up when the main beams are switched on.

### Switching the main beams on/off manually

If the main beams are not switched on or if the headlights are not dipped as expected, you can control the dip function manually: ►

- ▶ To switch on the main beams manually, push the lever to position ①. The indicator lamp  will light up. To dip the headlights again, pull the lever to position ②.
- ▶ To dip the headlights manually after the main beams have been switched on automatically, pull the lever to position ②.

### Flashing the headlights

- ▶ Pull the lever to position ② to flash the headlights when the main beam assist is activated. The main beam assist will remain activated.

### Driver messages in the instrument cluster display

#### Main beam assist: system fault!

Drive to a qualified workshop soon and have the fault rectified. You can still switch the main beam headlights on and off manually.

#### Main beam assist: currently unavailable. No camera view

The camera vision is impaired, e.g. by stickers or dirt.

The sensor is located between the interior mirror and the windscreen. Do not affix any stickers on this section of the windscreen.

#### WARNING

The main beam assist is only intended to assist the driver. The driver must always ensure that the headlights are used when required, and may have to switch them on or off manually, e.g. when the light conditions or visibility are poor. In the following situations manual intervention may be necessary:

- Hazardous weather conditions such as fog, heavy rain and snow or water splashes.
- Roads on which oncoming traffic is partially concealed (e.g. on motorways).
- Indiscernible road users (e.g. cyclists with poor lighting)
- Tight corners, steep hill crests or valleys
- Poorly lit towns

- Highly reflective objects, such as road signs
- Windscreen misted up, dirty, frosted or covered by stickers in front of the sensor

### Adaptive headlight range control

Applies to vehicles: with adaptive headlight range control

*The adaptive headlight range control automatically regulates the cone of light emitted by the main beam headlights depending on the ambient surroundings.*

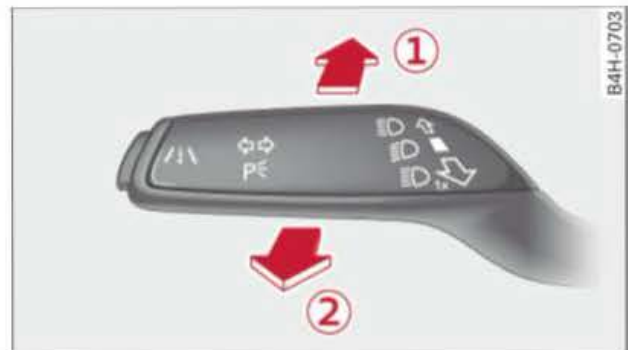

Fig. 54 Turn signal and main beam lever: Switching adaptive headlight range control on/off

A camera (located in the mounting for the interior mirror) detects light sources from other road users. The vertical and horizontal range of the headlights is varied smoothly and virtually steplessly between dipped and main beams. The system controls the activation/deactivation of the main beams depending on how far away the traffic is on either side of the road.

### Activating the adaptive headlight range control

Important: The light switch must be set to AUTO and the main beam assist function must be activated on the MMI\* ⇨ [page 58](#).

- ▶ Push the lever to position ① to activate the adaptive headlight range control. The indicator lamp  will light up in the instrument cluster display and the main beams will be switched on/off automatically. The indicator lamp  is lit when the main beams are partially or fully on.

### Switching the main beams on/off manually

If the main beams are not switched on or if the headlights are not dipped as expected, you can control the dip function manually:

- ▶ To switch on the main beams manually, push the lever to position ①. The indicator lamp  will light up. To dip the headlights again, pull the lever to position ②.
- ▶ To dip the headlights manually, pull the lever to position ②.

### Flashing the headlights

- ▶ Pull the lever to position ② to flash the headlights when the adaptive headlight range control is activated. The adaptive headlight range control remains activated.

Do not affix any stickers to the windscreen in the vicinity of the camera.

### Driver message in the instrument cluster display

#### Main beam assist: system fault!

Drive to a qualified workshop soon and have the fault rectified. You can still switch the main beam headlights on and off manually.

#### Main beam assist: currently unavailable. No camera view

The camera vision is impaired, e.g. by stickers or dirt.

The sensor is located between the interior mirror and the windscreen. Do not affix any stickers on this section of the windscreen.

#### WARNING

The adaptive headlight range control is only intended to assist the driver. The driver must always ensure that the headlights are used when required, and may have to switch them on or off manually, e.g. when the light conditions or visibility are poor. In the following situations manual intervention may be necessary:

- Hazardous weather conditions such as fog, heavy rain and snow or water splashes.
- Roads on which oncoming traffic is partially concealed (e.g. on motorways).
- Indiscernible road users (e.g. cyclists with poor lighting)
- Tight corners, steep hill crests or valleys
- Poorly lit towns
- Highly reflective objects, such as road signs
- Windscreen misted up, dirty, frosted or covered by stickers in front of the sensor

#### Note

The range of the headlight beams will be adjusted automatically when traffic in front is detected on either side of the road. This prevents you from dazzling other road users.

### Adjusting the settings for the exterior lighting

*You can change the settings for these functions on the sound system/MMI\*.*

Vehicles with sound system\*

- ▶ Press the **SETUP** button.
- ▶ Select **Lights** using the control button .

Vehicles with MMI\*

- ▶ Select: **MENU** button > control button **Systems / Car systems** > **Vehicle settings** > **Exterior lighting**.

### Automatic headlights

The following settings are available in the **Automatic headlights** menu:

**Activation time** - You can determine how soon the lights are switched on by using the settings **early**, **medium** or **late** to adjust the sensitivity of the light sensor.

**Main beam assist\*** - You can switch the main beam assist\* or adaptive headlight range control\* **on** and **off**. ▶

**Audi adaptive light\*** - You can switch the adaptive light **on** and **off**.

### Coming home, leaving home\*

The coming home function lights up the area round the vehicle after dark when the ignition has been switched off and the driver's door opened. To activate this function, select **Lights when getting out > on**.

The leaving home function lights up the area round the vehicle after dark when the vehicle is unlocked. To activate this function, select **Lights when unlocking > on**.

The coming home and leaving home functions are operational after dark when the light switch is set to **AUTO**.

### Daytime running lights\*

In countries which allow the daytime running lights to be switched off/on, this can be done via the MMI\*. In other countries, the daytime running lights stay on permanently.

### Headlamp converter for driving abroad\*

The asymmetric low beams of the headlights are designed to light up the near side of the road more intensely. On vehicles with **LED headlights\*** or **xenon headlights\*** with **turning light\***, the headlight dip settings must be modified if you drive a right-hand drive vehicle in a left-hand drive country, or vice versa. Otherwise you will dazzle oncoming traffic. On vehicles with regular halogen or xenon headlights, it is not necessary to change the dip settings.

To avoid dazzling oncoming traffic:

- On vehicles with LED headlights\* or xenon headlights\* with turning light\*, the headlamp converter must be activated. Press the **MENU** button. Select > control button **Systems / Car systems > Vehicle settings > Exterior lighting > e.g. Lights for driving on left**.

A message appears when the headlight settings have been changed:

Applies to left-hand drive vehicles:

**Headlamp converter active for driving on left. Range reduced!**

Applies to right-hand drive vehicles:

**Headlamp converter active for driving on right. Range reduced!**

#### **i** Note

If the headlamp converter is activated, this is displayed in the driver information system every time the ignition is switched on.

### Hazard warning lights



Fig. 55 Dashboard: Switch for hazard warning lights

The hazard warning lights are used to make other road users aware of your vehicle in hazardous situations.

- Press the switch  to switch the hazard warning lights on/off.

When you brake hard, the brake lights flash to alert other road users to the hazard. The hazard warning lights are switched on automatically after an emergency stop<sup>1)</sup>. The hazard warning lights are switched off automatically when you drive off again.

You can use the turn signals to indicate a change of direction (or lane) even when the hazard lights are on. The hazard lights will be interrupted temporarily. ►

<sup>1)</sup> This function is not available on all export versions.

The hazard warning lights also work when the ignition is switched off.

## Interior lights

### Front/rear interior lights



**Fig. 56** Front headliner: Switches for interior lights (example)



**Fig. 57** Rear headliner: LED reading lights\* (example)

Your interior lights may differ from the illustration, depending on the equipment in your vehicle.

#### Reading lights\*

Press the  button to switch the appropriate reading light on/off.

#### Interior lights (manual)

Press the  button to switch the interior lights on/off.

#### Interior lights (automatic)

Press the  button to control the interior lights automatically.

When the switch is on (in this case an LED in the  button will be lit), the interior lighting comes on automatically when the vehicle is unlocked, a door is opened or the key is pulled out of the ignition. The interior lighting goes out a few seconds after the doors are closed,

or when the vehicle is locked or the ignition is switched on. The lighting goes out automatically after a few minutes if a door is left open.

### Interior lights

Various optional lighting functions are available for the vehicle interior. The settings for certain functions can be adjusted on the MMI\*. Select: **MENU** button > control button **Systems / Car systems > Vehicle settings > Background lighting**.

### Instrument lighting

*The brightness of the lighting in the instrument cluster and the centre console can be adjusted as required.*



**Fig. 58** Instrument lighting

**Important:** The lights must be switched on.

- ▶ Briefly press the knob to release it.
- ▶ Turn the knob towards "-" or "+" to reduce or increase the brightness of the lighting.
- ▶ Briefly press the knob again to engage it.

#### Note

The needles and the dials in the instrument cluster are illuminated when the ignition is on and the dipped headlights are off. The illumination is automatically reduced as it becomes dark outside and is eventually switched off altogether. This function is intended to remind the driver to switch on the dipped headlights in good time.

## Clear vision

### Adjusting the exterior mirrors



Fig. 59 Driver's door: Adjuster knob for exterior mirrors (example)

Turn the knob to the appropriate position:

↔/↔ - In these positions you can adjust the exterior mirrors (left or right) by moving the knob in the desired direction.

☀ - The mirrors are heated\* (depending on the outside temperature and road speed).

↔ - The exterior mirrors are retracted\*.

### Tilt function for front passenger's exterior mirror\*

The mirror can be slightly tilted automatically to provide a better view of the kerb when parking backwards. This feature is operational when the knob is in position ↔.

You can adjust the tilted mirror surface by moving the knob in the desired direction. This new position is automatically stored and assigned to the remote control key when you take the car out of reverse.

The mirror returns to its original position as soon as you drive forwards at over 15 km/h or switch off the ignition.

### Folding mirrors in/out

To fold in the mirrors using the knob, turn it to the position marked ↔.

To fold the mirrors out, turn the knob to position ↔, ↔ or 0.

Applies to vehicles with MMI\*: You can use the settings in the MMI to have the mirrors fold in when you lock the vehicle ⇒ page 47. The mir-

rors will then fold in when you lock the vehicle, and will fold out again when you switch on the ignition.

### ⚠ WARNING

Convex or wide-angle\* exterior mirrors give a larger field of vision. However, they make objects look smaller and further away than they really are. If you use these mirrors to estimate the distance to vehicles behind you when changing lane, you could misjudge the distance. Risk of accident!

### ! CAUTION

- Applies to vehicles with electrically retractable exterior mirrors\*: If one of the mirror housings is knocked out of position (e.g. when parking), the mirrors must be fully retracted with the electric control. You will hear a loud noise when the mirrors snap back into place. Do not readjust the mirror housing by hand, as this will interfere with the mirror adjuster function.
- Applies to vehicles without electrically retractable exterior mirrors: If one of the mirror housings is knocked out of position (e.g. when parking), it must be returned to its proper position by hand.
- Before washing the vehicle in an automatic car wash, please make sure to retract the exterior mirrors to prevent them from being damaged. Electrically retractable exterior mirrors must NOT be folded in or out by hand. Always use the electrical power control.

### i Note

If the electrical adjustment should fail to operate, both of the mirrors can be adjusted by hand by lightly pressing the edge of the mirror glass.

### Anti-dazzle setting

Your vehicle is equipped with a manual or automatic\* anti-dazzle interior mirror.

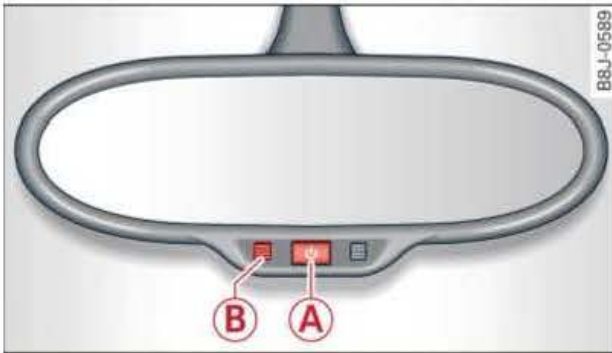

Fig. 60 Automatic anti-dazzle interior mirror\*

### Manual anti-dazzle interior mirror

► Pull the lever at the bottom of the mirror towards you.

### Automatic anti-dazzle mirrors\*

► Press button **A**. The indicator lamp **B** will light up. The interior mirror and driver's exterior mirror\* will darken automatically when bright light (e.g. from the headlights of a following vehicle) shines on the surface of the mirror.

### ⚠ WARNING

Electrolyte fluid can leak from a broken automatic anti-dazzle mirror. This fluid can cause irritation to the skin, eyes, and respiratory organs. Wash thoroughly with clean water should you come into contact with this fluid. Seek medical assistance if needed.

### ⚠ CAUTION

Electrolyte fluid can leak from a broken automatic anti-dazzle mirror. This fluid can damage plastic surfaces. Use a wet sponge or similar to remove the fluid as soon as possible.

### ℹ Note

– The automatic anti-dazzle mirrors may not function as intended if the light falling on the surface of the interior mirror is obstructed.

– The automatic anti-dazzle mirrors do not darken if the interior lighting is on or the car is in reverse gear.

### Sun visors

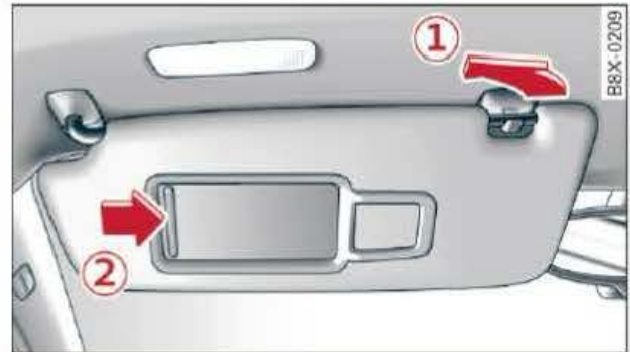

Fig. 61 Left side: Sun visor

The sun visor can be pulled out of its mounting and turned towards the door **1**.

The light\* for the make-up mirror comes on automatically when you slide open the mirror cover **2**.

## Windscreen wipers

### Switching on the windscreen wipers



Fig. 62 Windscreen wiper lever: Operating the windscreen wipers (example shows vehicle without rear window wiper)



Fig. 63 Windscreen wiper lever with rear window wiper: Operating the rear wiper



Important: The ignition must be switched on.

Move the windscreen wiper lever to the appropriate position:

① - Front wipers off

① - Intermittent wipe. Move switch **A** to the left or to the right to increase or reduce the wiper delay interval. While a vehicle with light/rain sensor\* is stationary, the windscreen wipers can be activated by pulling the lever briefly to position ⑤ (the wipers are activated automatically when the speed exceeds about 4 km/h). The higher the sensitivity level for the rain sensor (i.e. the further switch **A** is moved to the right), the sooner the windscreen wipers react to moisture on the windscreen.

② - Slow wipe

③ - Fast wipe

④ - Single wipe. If you hold the lever in this position, the wipers will switch from slow continuous wiping to fast continuous wiping after a while.

⑤ - Wash/wipe. The screen is given an extra wipe a few seconds later to remove any dribbles of water (if the vehicle is moving and the temperature is above approx. 4 °C). You can deactivate this function by moving the lever to position ⑤ again within 10 seconds after the extra wipe. The extra-wipe function is activated again the next time you switch on the ignition.

Headlight washers\*. The headlight washer system\* only operates when the dipped headlights are switched on. The headlights are also automatically washed intermittently when you move the lever to position ⑤.

Applies to vehicles with rear window wiper:

If the windscreen wipers are on and in operation, the rear window wiper will also be switched on automatically when you engage reverse gear.

⑥ - Rear wipe\*. The rear window is wiped approximately every 6 seconds.

⑦ - Rear wash/wipe\*. The number of wiper cycles depends on how long you hold the lever in position ⑦.

⑧ - Rear wiper\* off.

### WARNING

- The rain sensor is only intended to assist the driver. The driver is still obliged to manually operate the windscreen wipers as required depending on visibility.
- Do not use water-repellent coatings on the windscreen. In bad visibility conditions such as light rain, low sun or when driving at night these coatings can cause increased dazzle, which is a serious safety hazard. Such coatings can also cause the wiper blades to judder.
- Poor visibility can cause accidents. Always ensure that the wiper blades are in good condition ⇒ *page 64, Changing the windscreen wiper blades.*

### CAUTION

- In icy conditions, check that the wiper blades are not frozen to the windscreen. If the wiper blades are frozen to the windscreen when you switch on the windscreen wipers, this could damage the wiper blades.
- Make sure you switch off the windscreen wiper system (lever in position 0) before you use an automatic car wash. This will avoid inadvertent triggering of the wipers and possible damage to the wiper system.

### Note

- The windscreen wipers are deactivated when the ignition is switched off. You can activate the windscreen wipers after switching the ignition on again by moving the windscreen wiper lever to any position.
- Worn or dirty wiper blades can cause smearing on the glass. This can also impair the effectiveness of the rain sensor. Please check the wiper blades regularly.

- The windscreen washer jets are heated\* when the ignition is switched on if the outside temperature is low.
- If you stop briefly, e.g. at traffic lights, the wiper speed setting will automatically be reduced by one level.
- You can switch the rain sensor on or off in the **Driver assist** menu on vehicles with MMI\*.

### Cleaning windscreen wiper blades

Clean the wiper blades if the wipers leave smearing on the glass. Use a soft cloth and glass cleaning solution.

### Windscreen wipers

- ▶ Set the wiper arms to the service position ⇒ *page 64*.
- ▶ Lift the wiper arms away from the glass.

### Rear window wiper\*

- ▶ Lift the rear wiper arm away from the glass.

#### WARNING

Dirty wiper blades can impair the driver's view - risk of accident.

#### CAUTION

If the wipers still leave smearing on the glass after they have been cleaned, the wiper blades should be replaced ⇒ *page 64*.

### Changing the windscreen wiper blades

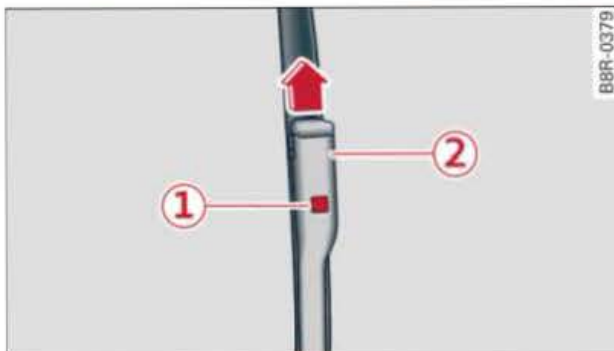

Fig. 64 Removing the wiper blades

### Service position / wiper change position

- ▶ To move the windscreen wipers to the service position, switch off the ignition and move the windscreen wiper lever briefly to position ④ ⇒ *page 62, Fig. 62*.
- ▶ To move the windscreen wipers back to their original position, switch on the ignition and move the windscreen wiper lever to position ④ ⇒ *page 62, Fig. 62*.

### Taking off the wiper blade

- ▶ Lift the wiper arm away from the glass.
- ▶ Press the release button ① on the wiper blade ⇒ *Fig. 64*. Keep hold of the wiper blade while doing so.
- ▶ Take off the wiper blade in the direction of the arrow.

### Fitting the wiper blade

- ▶ Fit the new wiper blade into the mounting on the wiper arm ②. You should hear it engage in the wiper arm.
- ▶ Fold the wiper arm back down onto the windscreen.
- ▶ Switch off the service position again.

#### WARNING

For safety, the wiper blades should be changed once or twice a year.

#### CAUTION

- The wipers must be in the service position before lifting them off the windscreen! Otherwise the wiper motor or the paintwork on the bonnet may be damaged.
- Never drive your vehicle or operate the windscreen wiper lever while the wiper arms are off the glass in a raised position. The wipers will otherwise automatically return to their park position and may damage the bonnet and windscreen.

#### Note

- You can also use the service position, for example, if you want to fix a cover over ▶

the windscreen in the winter to keep it clear of ice.

- You cannot activate the service position when the bonnet is open.

### Changing the rear wiper blade

Applies to vehicles: with rear window wiper (A3/A3 Sportback)



Fig. 65 Rear window wiper: Removing the wiper blade

### Taking off the wiper blade

- ▶ Lift the rear wiper arm away from the glass.
- ▶ Take hold of the wiper blade below the centre and pull the blade out of the retainer in the direction of the -arrow- ⇒ Fig. 65. Keep hold of the wiper arm while doing so.

### Fitting the wiper blade

- ▶ Press the mounting on the wiper blade into the retainer. While doing so, keep holding the plastic top end of the wiper arm.
- ▶ Fold the wiper arm back down onto the rear window.



### WARNING

For safety, the wiper blades should be changed once or twice a year.

## Seats and storage

### General notes

#### WARNING

The Safe driving chapter ⇒ page 152, *Safety first* contains important information, tips, suggestions and warnings that you should read and observe for your own safety and the safety of your passengers.

### Front seats

#### Manual adjustment of seats



Fig. 66 Front seat: Manual adjustment

- ① - Seat forwards/backwards: Lift the lever and move the seat.
- ② - Thigh support\*: Lift the handle and move the thigh support in or out.
- ③ - Angle\* of seat cushion: Pull/press the lever.
- ④ - Lumbar support\*: Press the appropriate side of the button.
- ⑤ - Seat height: Pull/press the lever.
- ⑥ - Backrest angle: Turn the knob.

#### WARNING

- Never adjust the front seats when the vehicle is moving - this could lead to an accident.
- Be careful when adjusting the seat height. Careless or uncontrolled use of the seat adjustment can cause injuries.
- Do not drive with the backrests of the front seats reclined too far as otherwise

the seat belt and airbag could fail to restrain the wearer properly in an accident, possibly leading to injury.

#### Electric adjustment of seats

Applies to vehicles: with electric seat adjustment

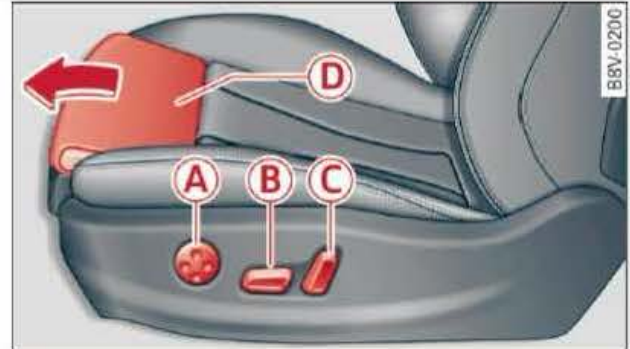

Fig. 67 Front seat: Electric adjustment

- Ⓐ - Lumbar support: Press the appropriate side of the button.
- Ⓑ - Seat height: Press the button up/down. To adjust the front of the seat cushion, press the front of the button up/down. To adjust the rear of the seat cushion, press the rear of the button up/down.
- Ⓒ - Backrest angle: Press the button forwards/backwards.
- Ⓓ - Thigh support\*: Lift the handle and move the thigh support in or out.

#### WARNING

- Never adjust the front seats when the vehicle is moving - this could lead to an accident.
- The electric seat adjustment also works when the ignition is off and when the key is not in the ignition. To avoid accidental injuries, never leave children unattended in the vehicle.
- Be careful when adjusting the seat height. Careless or uncontrolled use of the height adjustment can cause injuries.
- Do not drive with the backrests of the front seats reclined too far as otherwise the seat belt and airbag could fail to

restrain the wearer properly in an accident, possibly leading to injury.

### Easy entry function

Applies to vehicles: with easy entry function (A3)

The easy entry function facilitates access to the rear seats.



Fig. 68 Driver's seat: Easy entry controls



Fig. 69 Tips for using the easy entry feature, seat adjustment with memory function

### Tipping the front backrests forward

- ▶ Pull the lever ① ⇒ Fig. 68 forwards.
- ▶ Fold the backrest down until it locks. Then take hold of the seat by the backrest and push it all the way forwards ②.

### Returning front backrests to an upright position

- ▶ Take hold of the seat by the backrest and push it all the way back ③ ⇒ Fig. 69.
- ▶ Move the backrest back into its upright position until it engages ④.

The seat will then return to the position it was in before using the easy entry function.

#### WARNING

For safety reasons the front seat backrests must be locked while driving.

- When using the easy entry function, always slide the seat all the way back to ensure that it locks in position. Do not drive the vehicle unless the seat is properly locked in position.

#### Note

If the seat does not lock properly in position after using the easy entry function, slide the seat all the way back as far as the stop. Then adjust the seat position as desired.

### Front centre armrest

Applies to vehicles: with front centre armrest

The centre armrest can be adjusted to several positions.



Fig. 70 Armrest between driver's seat and front passenger's seat

- ▶ To adjust the angle, lift the armrest ⇒ Fig. 70 until it engages in the desired position.
- ▶ To lower the armrest again, lift the armrest slightly from the top click stop and then fold it back down. Then raise the armrest to the desired position if necessary.

You can move the armrest backwards or forwards.

There is a storage compartment underneath the armrest.

### Rear centre armrest

Applies to vehicles: with rear centre armrest

A storage compartment and cup holder are integrated in the armrest.



Fig. 71 Rear armrest

### Folding down armrest

- ▶ Fold the armrest all the way down.

### Opening storage compartment

- ▶ Release the catch at the top and lift the lid.

For information on how to operate the cup holders please refer to ⇒ page 70.

## Head restraints

### Front head restraints

Applies to vehicles: with adjustable head restraints



Fig. 72 Front seat: Adjusting standard head restraint

Applies to vehicles with super sports seats (not illustrated): The head restraint is integrated in the backrest and cannot be adjusted.

### Adjusting standard head restraint

Adjust the head restraint so that the top of the head restraint is level with the top of your head. If this is not possible, try to adjust the

head restraint as near as possible to this position.

- ▶ To raise or lower the head restraint, adjust the position of the head restraint until you feel it click into place ⇒ Fig. 72.

### Rear head restraints

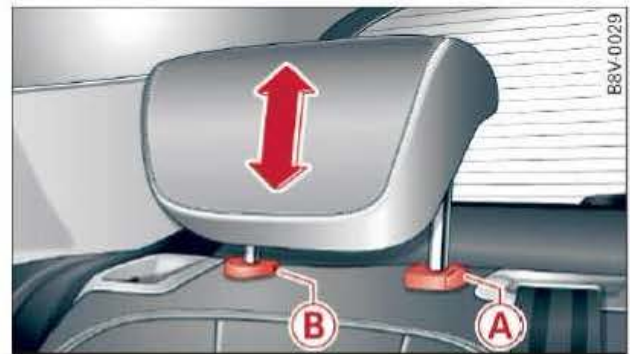

Fig. 73 Rear outer head restraint: Release point

Before carrying passengers on the rear seats, pull the head restraints on the occupied seats up at least one notch ⇒ ⚠.

### Adjusting head restraints

- ▶ To raise the head restraint, take hold of it on both sides and move it all the way up until you feel it click into place.
- ▶ To lower the head restraint, press button Ⓐ ⇒ Fig. 73 and slide the head restraint downwards.

### Removing head restraints

The backrest on the appropriate side has to be tipped forwards slightly in order to remove the head restraint.

- ▶ Take the screwdriver out of the vehicle tool kit ⇒ page 236.
- ▶ Release the backrest ⇒ page 73.
- ▶ Press button Ⓐ ⇒ Fig. 73 and slide the head restraint upwards as far as the stop ⇒ ⚠.
- ▶ Insert the screwdriver in the opening Ⓑ, press button Ⓐ and at the same time pull the head restraint out of the backrest ⇒ ⚠.
- ▶ Push the backrest up until it engages securely ⇒ ⚠ in *Extending the luggage compartment* on page 73.

## Installing head restraints

The backrest on the appropriate side has to be tipped forwards slightly in order to install the outer head restraints.

- ▶ Release the backrest ⇒ *page 73*.
- ▶ Push the posts of the head restraint into the guides until you feel them click into place. It should no longer be possible to pull the head restraint out of the backrest.
- ▶ Push the backrest up until it engages securely ⇒ ⚠ in *Extending the luggage compartment on page 73*.

### ⚠ WARNING

- Please observe the important safety warnings ⇒ *page 156, Correct adjustment of head restraints*.
- Remove the rear head restraints only if this is necessary in order to attach a child seat ⇒ *page 158*. Install the head restraint again immediately after removing the child seat. Travelling with the head restraints removed or not raised increases the risk of severe injuries.

## Ashtray

Applies to vehicles: with ashtray



Fig. 74 Front centre console: Ashtray

The ashtray is inserted in the centre console and can be placed on either the driver's or front passenger's side. Lift the lid to open the ashtray. Always put the ashtray safely back into the holder after removing it (e.g. after emptying it).

### ⚠ WARNING

Never put waste paper in the ashtray, as this could cause a fire.

## Cigarette lighter

Applies to vehicles: with cigarette lighter



Fig. 75 Centre console: Cigarette lighter

- ▶ Press in the cigarette lighter.
- ▶ When the cigarette lighter springs out, pull it out completely.

The cigarette lighter should only be used as a power source in exceptional circumstances, e.g. for the compressor of the tyre repair kit.

### ⚠ WARNING

The cigarette lighter only works when the ignition is on. Improper use can cause serious injury or start a fire. To avoid the risk of injury, never leave children unsupervised in the vehicle with the key.

### ⚠ CAUTION

- Always use the correct type of plugs to avoid damaging the sockets.
- The cigarette lighter socket should only be used for a short period of time as a power source for electrical equipment. Please use the electrical sockets\* in the vehicle when connecting equipment for longer periods.

### i Note

Using electrical appliances with the engine switched off will drain the battery.

## Electrical socket

Applies to vehicles: with electrical socket

Electrical equipment can be connected to the 12 Volt socket.



Fig. 76 Centre console: 12 Volt socket (front/rear)



Fig. 77 Side trim in luggage compartment: 12 Volt socket\* (example)

- ▶ Pull the dummy plug out of the socket on the centre console ⇒ Fig. 76, or
- ▶ Open the cover of the socket in the luggage compartment\* ⇒ Fig. 77.
- ▶ Insert the plug of the electrical appliance into the socket.

Electrical equipment can be connected to the 12 Volt socket. The appliances connected to the socket must not exceed a power rating of 120 W.

### WARNING

The socket will only work when the ignition is switched on. Improper use can cause serious injury or start a fire. To avoid the risk of injury, never leave children unsupervised in the vehicle with the key.

### CAUTION

Always use the correct type of plugs to avoid damaging the sockets.

### Note

Using electrical appliances with the engine switched off will drain the battery.

## Storage

### Cup holders



Fig. 78 Centre console: Front cup holders

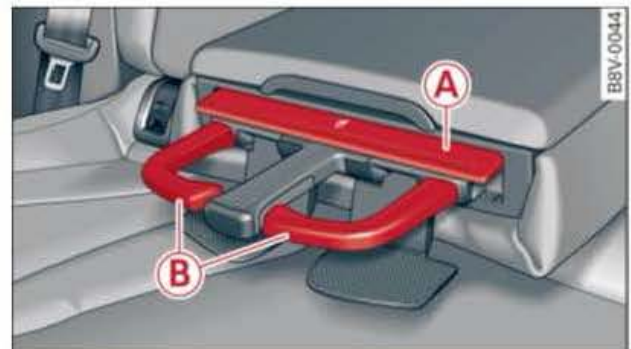

Fig. 79 Detail of the rear seat bench: Rear cup holder\*

### Front cup holder

- ▶ Place your drinks in the holder ⇒ Fig. 78. Two drinks can be placed in this cup holder. You can also stow larger plastic bottles or similar in the compartments in the door trim.

### Rear cup holder\*

- ▶ To open the cup holder, lightly press the front of the cup holder (A) ⇒ Fig. 79.
- ▶ To place a cup in the cup holder, swivel either of the arms (B) outwards.
- ▶ Then press the arm tight against the cup.
- ▶ To close the cup holder, slide it all the way back into the slot.



### ! WARNING

- Do not put any hot drinks in the cup holders while the vehicle is moving. You could be scalded if the hot liquid is spilt.
- Do not use hard china cups or glasses. These could cause injury in the event of an accident.

### ! CAUTION

You should avoid putting open drinks containers in the cup holders. The drinks could otherwise spill over and cause damage to e.g. the electrical equipment or the seat covers.

### i Note

Further cup holders are located on either side of the rear seats.

## Carrier for car key and mobile phone

Applies to vehicles: with carrier



Fig. 80 Front centre console: Carrier

The carrier is suitable for stowing the following items:

- Car key while you are driving (on vehicles with convenience key\*)
- Mobile phone

The carrier is inserted in the centre console and can be placed on either the driver's or front passenger's side. Always put the carrier safely back into the holder after removing it.

## Glove box



Fig. 81 Glove box

### Opening/closing

- ▶ To open the glove box, pull the handle in the direction of the arrow.
- ▶ To close the glove box, swivel the lid upwards until it engages.

### ! WARNING

To avoid the risk of injuries, always keep the glove box lid closed when driving.

## Further storage compartments

You will find further storage compartments and retainers at various points in the vehicle:

- In the top section of the glove box.
- In the centre console below the centre armrest\*.
- At the front end of the right front seat. This compartment can hold objects weighing up to 1 kg.
- Coat hooks on the B-pillars ⇨ !.

### ! WARNING

- Make sure that any items of clothing hanging from the coat hooks do not obstruct your view to the rear.
- Only use the coat hooks for light items of clothing and make sure that there are no heavy or sharp objects in the pockets.
- Do not use clothes hangers to hang up the clothing, as this could interfere with the function of the head-protection airbags.

## Roof carrier

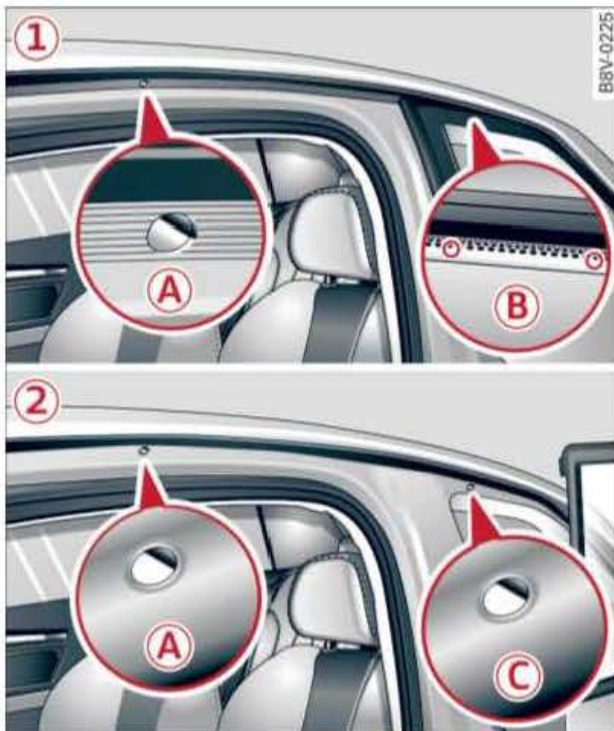

Fig. 82 1) A3, 2) A3 Saloon and A3 Sportback (without roof railings): Attachment points for roof carrier

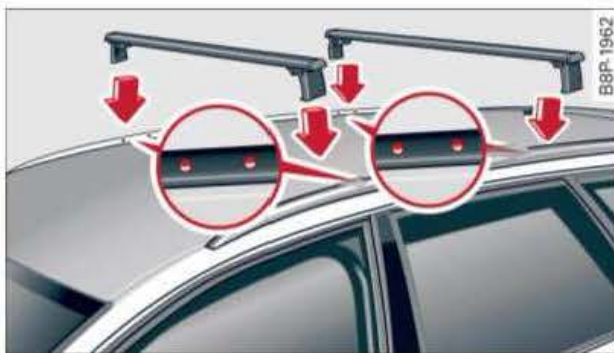

Fig. 83 A3 Sportback with roof railings: Attachment points for roof carrier

Note the following points if you intend to carry loads on the roof:

- Only use roof carrier cross bars designed for your vehicle. The cross bars form the basic elements of a complete roof carrier system. Additional elements/carrier systems are needed in order to transport luggage and sports equipment. We recommend using roof carriers and additional elements from the range of Audi Genuine Accessories.
- The feet of the roof carrier cross bars must be attached at the points provided on the roof ⇒ Fig. 82 / ⇒ Fig. 83.
- Applies to A3: The front attachment points (A) are only visible when the doors are open;

the rear attachment points (B) are marked by arrows on the top edge of the side window (1) ⇒ Fig. 82.

- Applies to A3 Sportback and A3 Saloon (without roof railings): The front and rear attachment points (A) and (C) are only visible when the doors are open (2) ⇒ Fig. 82.
- Applies to A3 Sportback (with roof railings): The attachment points are visible on the inside face of the roof railings ⇒ Fig. 83.
- The maximum permissible roof load for your vehicle is 75 kg. The load limit applies to the combined weight of the roof carrier, the additional elements and the load itself. Please do not exceed the maximum carrying load of the carrier system you are using. For details of the maximum axle loads and maximum gross vehicle weight, refer to ⇒ page 273.

### ⚠ WARNING

- Note the fitting instructions provided by the manufacturer of the roof carrier system. If you do not secure the roof carrier system and roof load correctly, they can become separated from the vehicle and cause an accident.
- The use of a roof carrier system affects the vehicle's handling by shifting the centre of gravity and increasing susceptibility to cross winds - risk of accident! Take extra care when driving and adjust your speed accordingly.

### ⚠ CAUTION

Please take care that the boot lid and panorama sun roof\* do not come into contact with the roof load when opened.

### 🌳 For the sake of the environment

The increased air resistance means that the vehicle uses more fuel. For this reason you should always take off the roof carrier when it is not in use.

## Luggage compartment

### General notes

#### WARNING

The Safe driving chapter ⇒ page 152, *Safety first* contains important information, tips, suggestions and warnings that you should read and observe for your own safety and the safety of your passengers.

### Luggage compartment cover

Applies to vehicles: with luggage compartment cover

The luggage compartment cover blocks the view into the luggage compartment.

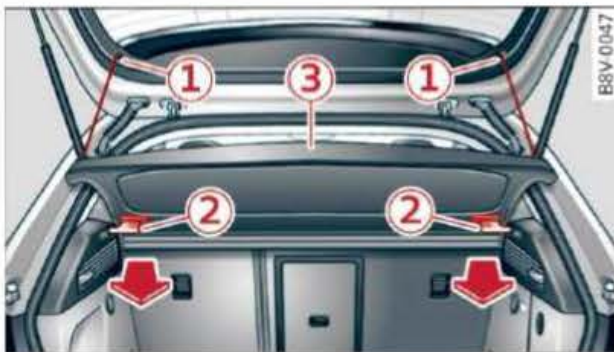



Fig. 84 Open boot lid with luggage compartment cover

### Removing

- ▶ Detach the cords ① and pull the cover ③ out of the retainers ② in the direction of the arrows.

### Installing

- ▶ Push the cover ③ horizontally into the retainers ② on the side trim until it engages.
- ▶ Attach the cords to the boot lid ① ⇒ .

#### WARNING

- The luggage compartment cover must always be fixed properly (risk of accident).
- The luggage compartment cover should not be used as a storage shelf. Items placed on this cover could cause injury in an accident or if the brakes are applied suddenly.

### Extending the luggage compartment

The backrests can be folded down separately or together.

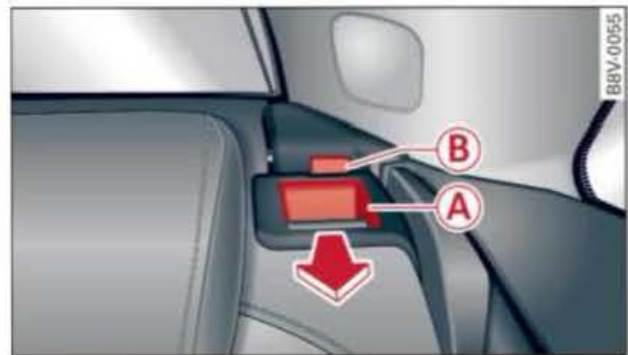



Fig. 85 Backrest: Release lever (example of left side)

### Folding down backrest

- ▶ Slide the head restraint(s) downwards ⇒ page 68.
- ▶ Press the release lever A in the direction indicated (arrow).
- ▶ Fold down the backrest.

### Returning backrest to an upright position

- ▶ Push the backrest up until it engages securely ⇒ . The red marking on the tab B should no longer be visible when the backrest is properly secured.

#### WARNING

- Make sure that the rear backrest is securely locked in position so that the seat belt can provide proper protection on the centre rear seat.
- The rear backrest must always be securely latched so that objects stored in the luggage compartment will not fly forward during sudden braking.

#### CAUTION

- If you need to adjust the front seats when either of the rear backrests is folded forwards, please take care to avoid damaging the rear head restraints. If necessary, remove the appropriate head restraints before you slide back the front seats.
- When returning the backrest to an upright position, make sure that the seat

belts for the outer rear seats are not caught up and damaged in the catches for the backrest.

### Lowering the floor panel

Applies to vehicles: with lowerable floor panel

You can lower the floor panel to increase the loading height in the luggage compartment.

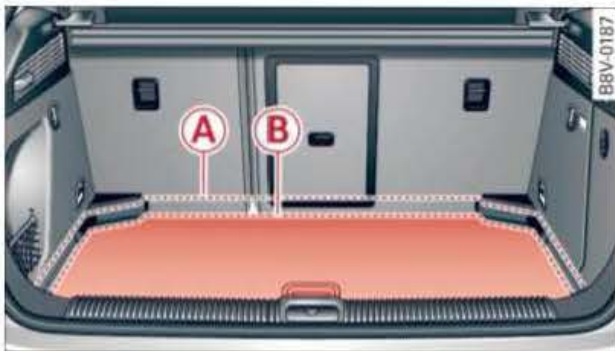

Fig. 86 Luggage compartment: Floor panel lowered

Depending on the equipment fitted on your vehicle, it may be possible to insert the floor panel lower down.

- ▶ To lower the floor panel, first lift it.
- ▶ Then pull the floor panel back slightly and re-insert it lower down at position **B**.

When you no longer need the extra height, you should return the floor panel to position **A**; this will make it easier to load and unload normal items of luggage.

### Fastening rings

Applies to vehicles: with fastening rings



Fig. 87 Luggage compartment: Location of fastening rings (example)

- ▶ Use the fastening rings to secure the load -arrows-.

- ▶ Please refer to the safety notes ⇒ page 163.

### Stretch net / storage net

Applies to vehicles: with stretch net/storage net

The stretch net can be used to secure and hold light items in the luggage compartment.



Fig. 88 Luggage compartment: Stretch net attached (example)



Fig. 89 Luggage compartment: Storage net hooked in place (A3/A3 Sportback)

### Stretch net

- ▶ To secure the stretch net, insert first the front hooks and then the rear hooks of the stretch net into the fastening rings -arrows- ⇒ Fig. 88.

### Storage net

Applies to A3/A3 Sportback

- ▶ To secure the storage net, insert the two hooks into the fastening rings **B** and attach the loops **A** to the retaining hooks\* **C**.



### WARNING

The storage net will hold a maximum weight of 5 kg. Heavier objects cannot be safely secured – risk of injury.

## Retaining hook

Applies to vehicles: with retaining hooks

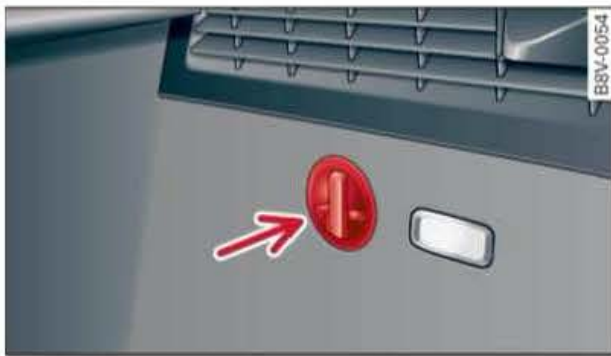

Fig. 90 Luggage compartment: Retaining hook (example of right side)

You can use the hooks to secure light items of luggage, such as shopping bags, etc.

### WARNING

The retaining hooks must only be used for light items. Heavier objects cannot be safely secured (injury risk).

## Reversible floor covering

Applies to vehicles: with reversible floor covering

The reversible floor covering protects the luggage compartment and the bumper against dirt and scratches.



Fig. 91 Luggage compartment: Reversible floor covering with backrest folded down (example)

You can use either the dirt-resistant or the decorative side of the reversible floor covering. When you are finished loading or unloading, fold the end of the reversible floor covering back in and close the boot lid. Fold away the reversible floor covering only when it is dry.

## Load-through hatch with bag

Applies to vehicles: with load-through hatch and removable bag

The bag can be used to transport long items (such as skis or snowboards).



Fig. 92 Backrest: Cover of load-through hatch

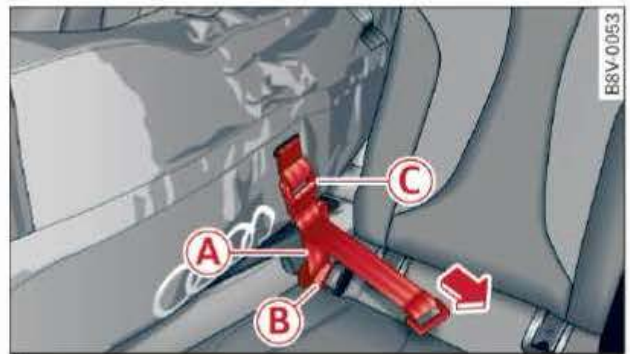





Fig. 93 Rear seat: Securing the bag

## Loading

- ▶ Fold down the centre armrest in the rear seat.
- ▶ Fold down the cover of the load-through hatch ⇒ Fig. 92.
- ▶ Push the bag (with the zip pointing towards the rear of the vehicle) through the hatch from the luggage compartment into the passenger compartment ⇒ .

## Securing the bag

- ▶ Insert the fastening belt  of the bag into the centre seat belt buckle  ⇒ Fig. 93.
- ▶ Tighten the fastening belt .

### WARNING

- The bag must be secured in place with the fastening belt after it has been loaded.

- Make sure that all objects transported in the load-through hatch are secured. They can be catapulted through the passenger compartment in case of a sudden braking manoeuvre - risk of injury!

 **Note**

- Fold up the bag only when it is dry.
- If you are transporting skis or snowboards, pull the fastening belt tight between the bindings.
- Place skis in the bag with their tips facing forwards, snowboards and ski poles with their tips facing backwards.

## Heating and cooling

### Heating system / air conditioner

#### Description

One of the following systems may be fitted in your vehicle:

- Heating and ventilation system or
- Manual air conditioner\* or
- Automatic air conditioner\*

The **heating and ventilation system** heats and ventilates the vehicle interior. The manual or automatic **air conditioner\*** cools and dehumidifies the air inside the vehicle. It operates most effectively with the windows and the panorama sun roof\* closed. If the vehicle has been standing in the sun, it may cool down faster if you open the windows briefly to let the hot air escape.

The pollution filter removes impurities, such as dust and pollen, from the air.

#### For the sake of the environment

Switch off the cooling mode on the air conditioner\* by pressing the **A/C** button if

you wish to save fuel. This will also reduce emissions. The LED in the button will go out when the air conditioner is switched off. The efficiency programme (on vehicles with driver information system) shows how your fuel consumption is being affected by auxiliary equipment. In addition, it provides tips for improving fuel economy ⇒ *page 31*.

#### Note

- Keep the air intake slots in front of the windscreen clear of snow, ice and leaves to ensure unimpaired heating and cooling, and to prevent the windows misting over.
- Condensation can drip off the air cooling system\* and form a pool underneath the vehicle. This is normal and does not indicate a leak.
- If you notice, for instance, that the seat\* or rear window heating is not working, it may have been temporarily switched off by the power management function. These systems will be available again as soon as sufficient electrical power is available.

#### Controls for heating/ventilation system or manual air conditioner



Applies to vehicles: with heating/ventilation system or manual air conditioner



Fig. 94 Heating/ventilation system or manual air conditioner\*: Controls

The rotary controls and switches are used to control the functions. The LED in the corre-

sponding button lights up when the function is switched on.

The rear window heating  ⇨ *page 81* and seat heating  ⇨ *page 81* are described in separate sections of this manual.

### Manual air conditioner\*

For a comfortable climate inside the vehicle:

- In the summer, adjust the temperature to just a few degrees below the outside temperature
- Do not turn the blower up too high
- Do not point the air outlets directly at the occupants
- Use the “indirect” setting on the air outlets ⇨ *page 78*

### Key-coded settings

Certain settings will be automatically stored and assigned to the remote control key in use.

- Heating and ventilation system: Seat heating (driver's side)
- Manual air conditioner: Seat heating (driver's side),  button.

### Switching air cooling\* on/off

The air cooling system only works when the blower is switched on. When the air cooling is switched off, the air is neither cooled nor dehumidified. The windows may mist up as a result. The air cooling is switched off automatically at low outside temperatures (below zero).







### Adjusting the blower speed



You should leave the blower on at a low setting to prevent the windows from misting up. To demist the windows, we recommend that you increase the blower speed and set the control to .

### Selecting the temperature

The rotary control can be used to adjust the temperature in small steps.

### Adjusting air distribution and air outlets

The rotary control with symbols , ,  and  is used to adjust the **air distribution**. A setting between  and  usually provides a comfortable environment.

At the  setting, the windscreen and side windows are defrosted or demisted as quickly as possible. The air recirculation is switched off, but can be switched on again manually by pressing the  button.

The round air outlets in the dashboard can be adjusted ⇨ *page 81*.

To prevent the front side windows from misting up in wet weather, we recommend opening the side air outlets, pointing them to the side and selecting the “spot” setting ⇨ *page 81*.

Foot-level air outlets are provided underneath the front seats to heat the rear cabin.

### Switching air recirculation on/off

In air recirculation mode, the air from the interior of the vehicle is filtered and recirculated. This setting prevents fumes etc. from entering the interior. We recommend switching on the air recirculation mode when driving through a tunnel or in traffic queues ⇨ .

The air recirculation mode is switched off when the control is in the defrost position .

### WARNING

For reasons of safety you should not leave the air recirculation switched on for too long. This mode prevents fresh air from entering the vehicle, so the windows can mist over if the air cooling\* is switched off. Bad visibility can cause an accident.



## Controls for automatic air conditioner



Applies to vehicles: with automatic air conditioner



BBV-0268

Fig. 95 Automatic air conditioner: Controls

The rotary controls are used to adjust the temperature and blower speed. The functions can be switched on and off by pressing the buttons. The LED in the corresponding button lights up when the function is switched on.

The rear window heating  ⇒ *page 81* and seat heating  ⇒ *page 81* are described in separate sections of this manual.

### Automatic air conditioner

We recommend pressing the **AUTO** button and setting the temperature to 22 °C (72 °F). The air conditioner is fully automatic, and will maintain the desired temperature at a constant level. The temperature of the air supplied to the interior, the blower speed and the air distribution are regulated automatically. When the heater is on, the blower normally only switches to a higher speed once the coolant has warmed up sufficiently (this does not apply to the *defrost* setting). **Key-coded settings:** The automatic air conditioner settings are automatically stored and assigned to the remote control key which is being used.

#### **A/C** Switching air cooling on/off

The air cooling mode is switched on/off when the **A/C** button is pressed. When the air cool-

ing is switched off, the air is neither cooled nor dehumidified. The windows may mist up as a result. The air cooling is switched off automatically at low outside temperatures (below zero).

#### **AUTO** Switching automatic mode on/off

The automatic mode is switched on when the **AUTO** button is pressed. The AUTO mode is switched off immediately when you operate any of the manual air controls. The automatic mode maintains a constant temperature inside the vehicle. Air temperature, output and distribution are regulated automatically. The “eco” mode\*<sup>1)</sup> is activated if you press the **AUTO** button briefly while automatic mode is active. Fuel is saved in “eco” mode\* because the settings respond more passively. The “eco” mode\* is on when eco appears in the console display. The “eco” mode\* is deactivated when you press the **AUTO** button again.

#### **Selecting the temperature**

The temperature setting can be controlled individually via the controls for the driver's and front passenger's side. The temperature can be adjusted between +16 °C (+60 °F) and +28 °C (+84 °F). Outside this range, **LO** or **HI** will appear on the air conditioner display. In ►

<sup>1)</sup> This function is not available on all export versions.



the two extreme settings the air conditioner operates continuously with maximum cooling or heating output, and the temperature is not regulated automatically.

**Synchronisation:** By pressing the **AUTO** button for 2 seconds, the temperature of the passenger's side can be set to the temperature of the driver's side. The settings remain synchronised until the temperature is changed on the passenger's side.

### **Adjusting the blower speed**

You should leave the blower on at a low setting to prevent the windows from misting up. You can adjust the blower speed manually. Press the **AUTO** button for automatic control of the blower speed.

### **Adjusting the air distribution**

Buttons , , and  are used to adjust the air distribution. Press the **AUTO** button for automatic air distribution.

The round air outlets in the dashboard can be adjusted ⇒ *page 81*.

To prevent the front side windows from misting up in wet weather, we recommend opening the side air outlets, pointing them to the side and selecting the "spot" setting ⇒ *page 81*.

Foot-level air outlets underneath the front seats and adjustable air outlets at the end of the centre console are provided to heat the rear cabin.

### **Switching the defroster on/off**

The windscreen and side windows are defrosted or demisted as quickly as possible. The air output is increased to maximum and most of the air comes out of the outlets below the windscreen. The air recirculation mode is deactivated. The temperature is regulated automatically. At setting  the **A/C** cooling mode is automatically activated depending on the ambient temperature.



The defroster is switched off when the **AUTO** button is pressed.

### **Switching air recirculation on/off**

The air recirculation mode can be switched on manually or automatically\*.

- To switch the manual air recirculation mode on/off, press the  button. The LED is lit when the function is on.
- The automatic\* air recirculation function must be activated on the MMI. Select: **MENU** button > control button **Systems / Car systems > A/C > Auto recirculation**. The air quality sensor, which is designed for the detection of diesel and petrol exhaust fumes, automatically switches the air recirculation mode on or off depending on the level of pollution in the outside air.

In air recirculation mode, the air from the interior of the vehicle is filtered and recirculated. This setting prevents fumes etc. from entering the interior. We recommend switching on the air recirculation mode when driving through a tunnel or in traffic queues ⇒ .

The air recirculation mode is switched off when the  or **AUTO** or  button is pressed.

If the engine is cold, the air conditioner will automatically switch to air recirculation mode when the vehicle is reversing.

### **WARNING**

For reasons of safety you should not leave the air recirculation switched on for too long. This mode prevents fresh air from entering the vehicle, so the windows can mist over if the air cooling is switched off. Bad visibility can cause an accident.

## Adjusting air outlets



Fig. 96 Dashboard: Adjusting air outlet

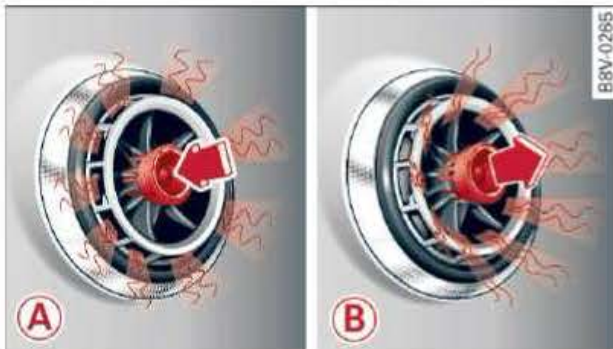

Fig. 97 Air outlet: Adjusting air flow character. A) Diffuse. B) Spot

The following settings are possible ⇒ Fig. 96:

- ① Air flow intensity
- ② Air flow direction
- ③ Air flow character (comfortable or vigorous)

To adjust the **air flow intensity**, turn the ribbed outer adjustment ring ① ⇒ Fig. 96. To shut off the air flow, turn the adjustment ring all the way to the right.

To adjust the **air flow direction**, move the inside grille ② in the air outlet.

To adjust the **air flow character**, pull/push the centre adjustment ring ③ ⇒ Fig. 96:

- **Diffuse** air flow setting (indirect/comfortable A): Press the centre adjustment ring slightly inwards ⇒ Fig. 97.
- **Spot** air flow setting (direct/vigorous B): Pull the centre adjustment ring slightly outwards ⇒ Fig. 97.

## Rear window heating



The LED in the  button (manual air conditioner ⇒ page 77, Fig. 94, automatic air conditioner ⇒ page 79, Fig. 95) is lit if the function is switched on. If rear window heating is activated with the ignition switched on, the battery management determines whether or not the battery charge level is sufficient for the rear window heating to be switched on. Otherwise the rear window heating operates when the engine is running, and switches off automatically after about 10 - 20 minutes, depending on the outside temperature.

To switch on the rear window heating permanently, press and hold the  button (with the inscription REAR\*) for at least two seconds. This setting will be stored for approximately 15 minutes after the ignition is switched off.

## Seat heating

Applies to vehicles: with seat heating

The seat heating has three levels. The heat level is indicated by an LED in each of the buttons (heating system/manual air conditioner ⇒ page 77, Fig. 94), (automatic air conditioner ⇒ page 79, Fig. 95).

- ▶ To switch on the seat heating, press the  button once.
- ▶ To reduce the level, press the  button again.
- ▶ To switch off the seat heating, press the  button repeatedly until all the LEDs have gone out.

The seat heating automatically switches from level 3 to level 2 after about 10 minutes.

### When not to switch on the seat heating

Do **not** switch on the seat heating in the following situations:

- Seat is unused
- A protective cover is fitted on the seat
- A child seat is fitted on the seat
- The seat is damp or wet

**! WARNING**

People with limited capacity to feel pain or sense temperature could burn themselves when using the seat heating. These people must not use the seat heating - risk of injury!

**! CAUTION**

To avoid damaging the heating elements of the seat heating, please do not kneel on the seat or apply sharp pressure at a single point.

**i Note**

- The setting for the driver's seat heating is assigned to the key in use.
- If the front passenger's seat heating was on when you last switched off the ignition, it will be switched on automatically only if the ignition is switched on again within 10 minutes.

**Supplementary heater**

Applies to vehicles: with diesel engine

On cold days, the interior of the vehicle warms up more quickly with the supplementary electric heater. The supplementary heater is switched on automatically as required, depending on the setting on the vehicle heating system.

Applies to vehicles with MMI\*: The “supplementary heater” function can be switched on/off. Select: **MENU** button > control button **Systems / Car systems > A/C > Supplementary heater**.

**Auxiliary heating/ventilation****Description**

Applies to vehicles: with auxiliary heating/ventilation

The auxiliary heating/ventilation system heats and ventilates the interior of the vehicle and can be used either when the engine is off or when driving (for instance while the engine is warming up).

There are two ways to control the system:

**Switching on/off manually** - You can switch the auxiliary heating/ventilation on and off immediately either:

- via the MMI\* ⇒ *page 83*, or
- using the remote control ⇒ *page 84*, or
- using the steering wheel button **4** ⇒ *page 30, Fig. 15* ⇒ *page 30, Assigning a function to the steering wheel button* on vehicles with multi-function steering wheel
- The auxiliary heating/ventilation is switched off when the blower **6** is switched off via the A/C controls ⇒ *page 79, Fig. 95*.

Either the auxiliary heating or the auxiliary ventilation will be switched on, depending on the ambient temperature and the temperature you have selected.

**Switching on/off automatically** (setting the timer) - You can use the timer to specify the time of day at which the temperature inside the vehicle is to reach the desired level. Your temperature setting and the ambient temperature will then determine when the auxiliary heating or auxiliary ventilation is switched on. You can set three different timers ⇒ *page 83* using the MMI\* or one timer using the remote control ⇒ *page 84*.

**Driver messages on the display**

**||| Auxiliary heating/ventilation: currently unavailable. Battery voltage too low.**

If this message appears, the battery is not sufficiently charged. In this case, the engine must be switched on in order to use the auxiliary heating.

**||| Auxiliary heating/ventilation: currently unavailable. Not enough fuel.**

To conserve fuel, the auxiliary heating cannot be switched on if the fuel level is low.

**||| Auxiliary heating/ventilation: system fault! Currently unavailable**

If this message appears, a system malfunction has occurred. Drive to a qualified workshop soon and have the fault rectified. ▶

**! WARNING**

- The auxiliary heating must not be allowed to run when the vehicle is in a confined space because it can give off toxic fumes.
- To avoid any possible fire risk, never have the auxiliary heating switched on when refuelling the vehicle.
- Because of the high temperatures which occur when the auxiliary heating is running, make sure when parking the car that the exhaust outlet under the car is not obstructed in any way and that the exhaust gases do not come into contact with flammable materials (fire risk).

**i Note**

- The auxiliary heating/ventilation system heats/cool the interior to the temperature you last selected on the air conditioner ⇒ *page 79*.
- At low outside temperatures some visible water vapour may form in the engine compartment. This is a normal phenomenon, and no cause for concern.
- The auxiliary heating/ventilation will not switch on or will switch itself off earlier than intended if the battery charge or fuel level is low.

**Switching on/off immediately via MMI\***

Applies to vehicles: with auxiliary heating/ventilation

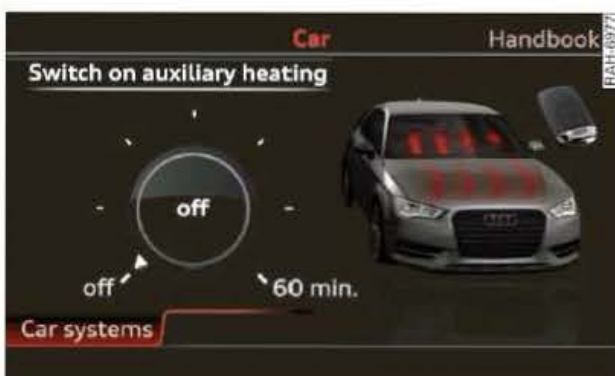

Fig. 98 MMI: Switching auxiliary heating on/off immediately

- ▶ To switch on the auxiliary heating/ventilation, select: **MENU** button > **Systems / Car systems > Auxiliary heating > Switch on**

**auxiliary heating** and turn the rotary push-button to select the desired running time.

- ▶ To switch off the auxiliary heating/ventilation, select: **MENU** button > **Systems / Car systems > Auxiliary heating > Switch off auxiliary heating**. Or:
- ▶ Switch off the blower on the air conditioner or heater control console ⇒ *page 77, Fig. 94* or ⇒ *page 79, Fig. 95*.

The symbol flashes on the air conditioner console when the auxiliary heating is switched on. The air conditioner console is illuminated when the auxiliary ventilation is switched on.

**i Note**

The auxiliary heating/ventilation can be switched on/off immediately even if a timer has been programmed.

**Setting a timer via MMI\***

Applies to vehicles: with auxiliary heating/ventilation



Fig. 99 MMI: Setting a timer

Set the **departure** time in the timer. The vehicle will be heated (in cold weather) or ventilated (in hot weather) so that the desired interior temperature is reached by the time specified in this setting.

**Setting the heating effect**

- ▶ If you want the auxiliary heating to defrost the windows, select: **MENU** button > **Systems / Car systems > Auxiliary heating > Program timers > Heating effect > defrost**.
- ▶ If you want the auxiliary heating to defrost the windows and heat the vehicle, select: **MENU** button > **Systems / Car systems >**

Auxiliary heating > Program timers  
Heating effect > warm.

### Setting the timers

- ▶ Select: **MENU** button > **Systems / Car systems** > **Auxiliary heating** > **Program timers** > e.g. **Timer 1: departure**.
- ▶ Set the time and date.
- ▶ To activate the timer, press the **BACK** button to go back one level.
- ▶ Use the rotary pushbutton to confirm the setting and activate the timer. A ✓ will appear in the box on the right ⇒ *Fig. 99*.

The departure time specifies when the vehicle interior is to reach the desired temperature. The auxiliary heating/ventilation switches off automatically about 10 minutes later.

After the departure time expires, the next calendar date is automatically entered on the MMI. To activate the auxiliary heating/ventilation for the following day, you then only have to confirm the setting (by setting a ✓ on the MMI ⇒ *Fig. 99*).

#### **i** Note

- To ensure that the timer operates correctly, check that the correct time and date are entered in the MMI settings. Please refer to the operating manual for your MMI system for details of how to set the date and time.
- The auxiliary heating/ventilation can be switched on/off immediately even if a timer has been programmed. This has no effect on the programmed timer setting as long as the auxiliary heating/ventilation is not switched off manually during the programmed period.

### Using the remote control to set the auxiliary heating

Applies to vehicles: with auxiliary heating/ventilation



**Fig. 100** Remote control for auxiliary heating: ① switching on immediately ② setting the timer

### Selecting a menu

- ▶ Press the **MENU** button on the remote control.
- ▶ You will see the symbols **|||** and **⌚** on the left side of the display. The arrow points to the selected menu. To change menus, press the **MENU** button again.





### Switching on immediately

- ▶ Select the **|||** menu ① ⇒ *Fig. 100*.
- ▶ To increase/reduce the running time, press the **>** or **<** button.
- ▶ To confirm the running time, press the **OK** button. The **|||** symbol will flash while the data are being transmitted to the vehicle.
- ▶ When the data have been successfully transmitted and the auxiliary heating/ventilation has been switched on, the time setting and the **|||** symbol will appear. The remote control switches off automatically after a few seconds.

### Setting the timer

- ▶ Select the **⌚** menu ②.
- ▶ Enter the hour, minutes and date, one after the other. Confirm each entry with the **OK** button. When you confirm the last entry, the **|||** symbol will flash and the data will be transmitted to the vehicle.
- ▶ When the data have been successfully transmitted, the time setting and the **⌚** symbol will appear. The remote control switches off automatically after a few seconds. ▶

### Checking / clearing the settings





- ▶ To check the settings, press the  button.
- ▶ To clear the settings, confirm the query  OFF? or  OFF? with the  button.

The timer settings entered on the remote control are displayed as Timer 1 on the MMI.

The range of the remote control transmitter is about 600 metres; however this can be greatly reduced by obstacles (buildings, etc.) between the remote control transmitter and the vehicle.

### Fault warnings

If any of the following symbols appear when you switch on the remote control, the remote control cannot be used to switch on the auxiliary heating:

-  - There is a system fault in the auxiliary heating.
-  - The auxiliary heating cannot be switched on because there is not enough fuel in the tank.
-  - The auxiliary heating cannot be switched on because the vehicle battery charge is too low.
-  - The vehicle could not receive the transmitted data.

### Changing the remote control battery

Applies to vehicles: with auxiliary heating/ventilation

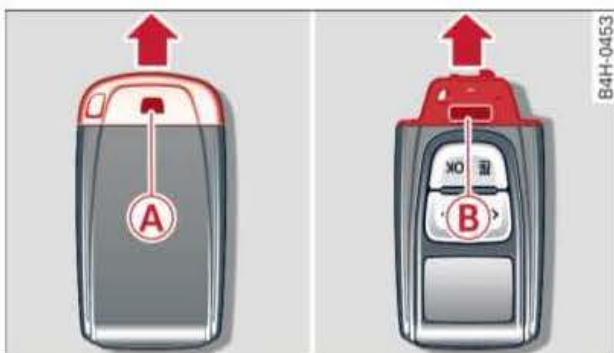





Fig. 101 Remote control: Changing battery

- ▶ Press the release button  and pull the cover in the direction of the arrow.

- ▶ Press the release button  on the battery carrier and pull out the battery carrier in the direction of the arrow.
- ▶ Insert the new battery with the  symbol facing downwards. The new battery must be of the same type as the original one (CR 2430).
- ▶ Slide the battery carrier carefully into the remote control and refit the cover.



### For the sake of the environment

Used batteries must be disposed of appropriately and must not be discarded with ordinary household waste.

## Driving

### Steering

#### Adjusting the steering wheel position

The height and reach of the steering wheel can be adjusted as required to suit the driver.



Fig. 102 Steering column: Lever for steering column adjustment

- ▶ Push the lever ⇒ Fig. 102 down ⇒ ⚠.
- ▶ Move the steering wheel to the desired position.
- ▶ Then push the lever towards the steering column until the catch engages.

#### ⚠ WARNING

- Never adjust the position of the steering wheel when the vehicle is moving - this could cause an accident.
- Press the lever upwards so it is secure and so that the position of the steering wheel cannot shift unexpectedly while the vehicle is moving - risk of accident!

## Ignition lock

Depending on the model, your vehicle is equipped with the following:

- Mechanical ignition lock ⇒ page 86 or
- Convenience key ⇒ page 88

## Vehicles with ignition lock

#### Starting the engine with the key

Applies to vehicles: with mechanical ignition lock

Insert the key in the ignition lock to switch on the ignition and start the engine.



Fig. 103 Ignition key positions

#### Steering lock

If the steering wheel cannot be turned, the steering lock has engaged.

Important: The selector lever (automatic gearbox\*) must be in position P in order to lock the steering.

- ▶ To lock the steering, turn the steering wheel with the ignition key removed until the steering lock engages.
- ▶ To release the steering lock, insert the ignition key in the lock and turn the key in the direction of the -arrow- while simultaneously turning the steering wheel.

#### Switching the ignition on/off and preheating the glow plugs

- ▶ To switch on the ignition, turn the ignition key to position ①.
- ▶ To switch off the ignition, turn the ignition key to position ②.

Diesel engines are preheated when the ignition is switched on .

#### Starting the engine

Your vehicle is equipped with an automatic start function. As soon as you turn the ignition key briefly to position ②, the engine starts automatically.



- ▶ **Manual gearbox:** Press the clutch pedal all the way down and move the gear lever into neutral.
- ▶ **Automatic gearbox:** Press the brake pedal and move the selector lever to position P or N.
- ▶ Turn the ignition key briefly to position ②. The ignition key automatically returns to position ①. Do not press the accelerator.

Electrical components with a high power consumption are switched off temporarily while you start the engine.

Diesel engines can take a few seconds longer than usual to start on cold days. Please keep your foot on the clutch pedal (manual gearbox) or brake pedal (automatic gearbox) until the engine starts. The indicator lamp  lights up while the glow plugs are preheating.

The preheating time depends on the outside temperature and the temperature of the coolant. When the engine is warm, or at outside temperatures above +8°C, the glow plug indicator lamp  will come on for approximately one second. This means that the engine can be started *immediately*.

If the engine fails to start immediately, switch off the starter and try again after about 30 seconds. To start the engine again, turn the ignition key to position ①.

### Start/stop system\*

Please note the information on ⇨ *page 98, Start/stop system*.

### Automatic start function fault

If the indicator lamp **EPC** (petrol engine) or  (diesel engine) lights up in conjunction with a fault when starting the engine, there is a fault in the automatic start function.

To start the engine, turn the ignition key to position ② and hold it in this position until the engine is running.

Drive to a qualified workshop soon and have the fault rectified.

### WARNING

- Never run the engine in confined spaces. The exhaust gases are toxic.
- Never remove the key from the ignition while the vehicle is moving. The steering lock would engage, and you would not be able to steer the car - risk of accident!
- Always take the key with you when you leave the vehicle. This is especially important if children are left in the car. They might otherwise be able to start the engine or use power-operated equipment such as the electric windows - this could lead to injuries.
- Never leave children or disabled people alone in the car. The doors could be locked with the remote control key and the occupants could become trapped in the vehicle. The vehicle occupants could be exposed to extremely high or low temperatures, depending on the time of year.

### CAUTION

Avoid high engine speeds, full throttle and extreme load conditions until the engine has reached its normal operating temperature, otherwise this can damage the engine.

### For the sake of the environment

Do not warm up the engine by running it with the car stationary. You should drive off immediately whenever possible. This will help avoid unnecessary exhaust emissions.

### Note

- If it is difficult to turn the ignition key to position ①, move the steering wheel (to take the load off the steering lock mechanism) until the key turns freely.
- When starting from cold the engine may be a little noisy for the first few seconds until oil pressure has built up in the hydraulic tappets. This is quite normal and no cause for concern.

- If the battery has been disconnected and then reconnected it will be necessary to leave the key in position ① for about 5 seconds before starting the engine.
- Vehicles with automatic gearbox: After switching off the ignition, you can only withdraw the ignition key if the selector lever is in position “P” (parking lock). The selector lever cannot be moved after the ignition key has been taken out.

### Switching off the engine with the key

Applies to vehicles: with mechanical ignition lock

#### Switching off the engine

- ▶ Stop the vehicle.
- ▶ Turn the ignition key to position ①.

#### Engaging the steering lock

Important: The selector lever must be in position P (automatic gearbox\*).

- ▶ Remove the ignition key while it is in position ① ⇒ page 88, Fig. 104 ⇒ ⚠.
- ▶ Turn the steering wheel until you hear the steering lock engage.

The steering lock acts as a theft deterrent.

### ⚠ WARNING

- Never switch off the engine until the vehicle is stationary. Otherwise you may not have the full benefit of the brake servo and power steering. You may need more strength to steer and brake the vehicle than you normally would. This would mean a greater risk of accidents and serious injury, because you cannot steer and brake in the normal manner.
- Never remove the key from the ignition while the vehicle is moving. The steering lock could engage suddenly, and you would not be able to steer the car.
- Always take the key with you when leaving the vehicle - even if you only intend to be gone for a short time. This is especially important if children are left in the car. They might otherwise be able to start the engine or use power-operated

equipment such as the electric windows - this could lead to injuries.

### ! CAUTION

If the engine has been working hard for a long time, there is a risk of heat building up in the engine compartment after the engine has been switched off; this could cause engine damage. For this reason, you should leave the engine idling for about 2 minutes before switching it off.

### i Note

– After the engine is stopped the radiator fan may run on for up to 10 minutes, even if the ignition is switched off. The fan may also start running again after some time if the coolant temperature rises due to a build-up of heat, or if the engine is hot and the engine compartment is heated up further by direct sunlight.

## Vehicles with convenience key

### Starting the engine with the **START ENGINE STOP** button

Applies to vehicles: with convenience key

You can use the **START ENGINE STOP** button to switch on the ignition and start the engine.



Fig. 104 Centre console: START ENGINE STOP button (vehicles with convenience key)

You can start your vehicle without handling the convenience key. You only need to have the key on your person. ▶

While you are driving, you can stow the convenience key in a special carrier\* ⇒ page 71.

### Switching the ignition on/off and preheating the glow plugs

If the indicator lamp  flashes when you switch on the ignition, the steering wheel is locked. In this case, turn the steering wheel slightly to the left/right.

- ▶ Manual gearbox: To switch the ignition on/off, press the **START ENGINE STOP** button without pressing the clutch pedal.
- ▶ Automatic gearbox: To switch the ignition on/off, press the **START ENGINE STOP** button without pressing the brake pedal.

Diesel engines are preheated when the ignition is switched on .

### Starting the engine

Your vehicle is equipped with an automatic start function. When you press the **START ENGINE STOP** briefly, the engine starts automatically.

- ▶ Manual gearbox: Press the clutch pedal all the way down and move the gear lever into neutral.
- ▶ Automatic gearbox: Press the brake pedal and move the selector lever to position P or N.
- ▶ Press the **START ENGINE STOP** button briefly to start the engine.

Electrical components with a high power consumption are switched off temporarily while you start the engine.

Diesel engines can take a few seconds longer than usual to start on cold days. Please keep your foot on the clutch pedal (manual gearbox) or brake pedal (automatic gearbox) until the engine starts. The indicator lamp  lights up while the glow plugs are preheating.

The preheating time depends on the outside temperature and the temperature of the coolant. When the engine is warm, or at outside temperatures above +8°C, the glow plug indicator lamp  will come on for approximately

one second. This means that the engine can be started *immediately*.

If the engine fails to start immediately, switch off the starter and try again after about 30 seconds.

On vehicles with a start/stop system\*, the ignition will be switched off if you press the **START ENGINE STOP**\* button during a stop phase.

### Start/stop system\*

Please note the information on ⇒ page 98, *Start/stop system*.

### Automatic start function fault

If the indicator lamp **EPC** (petrol engine) or  (diesel engine) lights up in conjunction with a fault when starting the engine, there is a fault in the automatic start function.

Press and hold the **START ENGINE STOP** button to start the engine.

Drive to a qualified workshop soon and have the fault rectified.

### WARNING

- Never run the engine in confined spaces. The exhaust gases are toxic.
- Always take the key with you when leaving the vehicle - even if you only intend to be gone for a short time. This is especially important if children are left in the car. They might otherwise be able to start the engine or use power-operated equipment such as the electric windows - this could lead to injuries.
- Never leave children or disabled people alone in the car. The doors could be locked with the remote control key and the occupants could become trapped in the vehicle. The vehicle occupants could be exposed to extremely high or low temperatures, depending on the time of year.

### CAUTION

Avoid high engine speeds, full throttle and extreme load conditions until the engine has reached its normal operating temperature, otherwise this can damage the engine.

### For the sake of the environment

Do not warm up the engine by running it with the car stationary. You should drive off immediately whenever possible. This will help avoid unnecessary exhaust emissions.

### Note

- When starting from cold the engine may be a little noisy for the first few seconds until oil pressure has built up in the hydraulic tappets. This is quite normal and no cause for concern.
- If the warning lamp  was flashing in the instrument cluster before the ignition was switched off, it will not be possible to switch on the ignition again ⇒ *page 185*.
- If you leave your vehicle with the ignition switched on, it will be switched off automatically after a while. Please note that electrical equipment such as the exterior lighting will also be switched off.

### Switching off the engine with the **START ENGINE STOP** button

Applies to vehicles: with convenience key

- ▶ Stop the vehicle.
- ▶ Vehicles with automatic gearbox: Move the selector lever to position P.
- ▶ Press the **START ENGINE STOP** button  
⇒ *page 88, Fig. 104*.

If you can't switch off the engine in the usual way, please refer to ⇒ *page 91, Starting the engine after a malfunction*.

### Steering lock<sup>1)</sup>

The steering will be locked if you switch off the engine with the **START ENGINE STOP**\* button, move the selector lever to position P (on vehicles with automatic gearbox\*) and open the driver's door.

The steering lock acts as a theft deterrent.

### Emergency Off function

If necessary in an emergency, the engine can be switched off while the vehicle is still moving. Press the **START ENGINE STOP**\* button twice in quick succession or hold it in for longer than two seconds.

### WARNING

- Never switch off the engine until the vehicle is stationary. Otherwise you may not have the full benefit of the brake servo and power steering. You may need more strength to steer and brake the vehicle than you normally would. This would mean a greater risk of accidents and serious injury, because you cannot steer and brake in the normal manner.
- Always take the key with you when you leave the vehicle. Otherwise the engine can be started or power-operated equipment such as the electric windows can be used. This could result in serious injury.

### CAUTION

If the engine has been working hard for a long time, there is a risk of heat building up in the engine compartment after the engine has been switched off; this could cause engine damage. For this reason, you should leave the engine idling for about 2 minutes before switching it off.

### Note

- After the engine is stopped the radiator fan may run on for up to 10 minutes, even if the ignition is switched off. The fan may also start running again after ▶

<sup>1)</sup> This function is not available on all export versions.

some time if the coolant temperature rises due to a build-up of heat, or if the engine is hot and the engine compartment is heated up further by direct sunlight.

### Starting the engine after a malfunction

Applies to vehicles: with convenience key

If the remote control key battery is exhausted or if radio interference or a system malfunction occurs, extra steps may be necessary in order to start the engine.

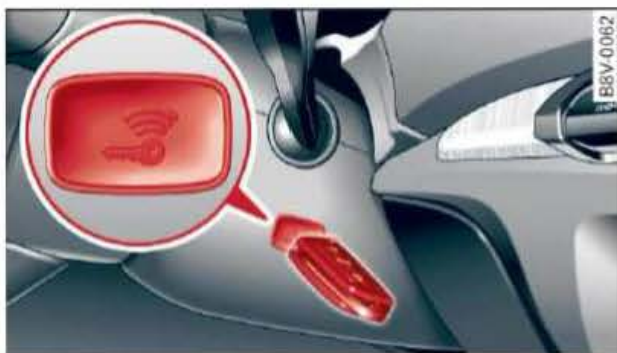

Fig. 105 Steering column/remote control key: Starting the engine after a malfunction

### Starting the engine manually

If the message **Key not recognised. See owner's manual** is displayed, you can still start the engine manually.

- ▶ Manual gearbox: Press the clutch pedal.
- ▶ Automatic gearbox: Press the brake pedal  
⇒ **!** in *Starting the engine with the START ENGINE STOP button on page 89*.
- ▶ Press the **START ENGINE STOP** button.
- ▶ Hold the remote control key against the symbol **Key** ⇒ *Fig. 105*, as shown in the illustration. The engine should start.
- ▶ If the engine does not start automatically, press the **START ENGINE STOP** button again.

Drive to a qualified workshop soon and have the fault rectified.

#### **i** Note

You can call up the driver message again by pressing the **START ENGINE STOP**\* button.

## Driver messages

### Switch off ignition before leaving car. Battery is being discharged

This message appears and the buzzer sounds if you open the driver's door while the ignition is switched on. Switch off the ignition to prevent the battery from being discharged.

### Pressing start/stop button again will switch off engine!

Press the **START ENGINE STOP**\* button again so that the engine can be switched off.

### Engine start system: system fault! Please contact workshop

A fault has occurred when starting the engine automatically (automatic start function). Drive to a qualified workshop soon and have the fault rectified. Press and hold the **START ENGINE STOP** button to start the engine.

### **Key** not recognised. See owner's manual

This message appears if there is no convenience key inside the vehicle or if the system cannot detect or identify the key. This can happen, for example, if the radio signal from the key is *obstructed* by a metal briefcase or similar, or if the key battery is weak. Electronic equipment, such as mobile phones, can also interfere with the radio signal from the key.

If you encounter any problems starting or stopping the engine, please refer to "What to do if the "START ENGINE STOP" button is in-operational" ⇒ *page 91*.

### **Key** not in vehicle?

If the indicator lamp **Key** lights up and the message appears, the convenience key was removed from the vehicle while the engine was running. If the convenience key is not in the vehicle you will not be able to switch on the ignition or restart the engine after it has been switched off. You will also not be able to lock the vehicle from the outside.

### Press brake pedal

This message appears on vehicles with an automatic gearbox if you try to start the engine without first pressing the brake pedal.

### Please press clutch pedal

This message appears on vehicles with a manual gearbox if you try to start the engine without first pressing the clutch pedal. The engine will only start if you press the clutch pedal.

### Please engage N or P

This message will appear if you try to start or switch off the engine when the selector lever is not in N or P. The engine can then not be started or switched off.

### Shift to P, vehicle can roll away. Doors can only be locked in P

For safety reasons, this message will appear and a warning buzzer will sound if the selector lever of the automatic gearbox is not in position P when you switch off the ignition with the **START ENGINE STOP**\* button. Put the selector lever in position P; otherwise the vehicle can roll away. If the lever is not in position P you will not be able to lock the vehicle using the locking sensor on the door handle or the convenience key.

## Kick-down feature

Applies to vehicles: with manual gearbox and efficiency mode

*The kick-down feature is designed to give maximum acceleration.*

If you press the accelerator right down past the point of resistance at full throttle when the drive select\* function is set to **efficiency\*** mode ⇒ *page 137*, the engine power is automatically controlled to give your vehicle maximum acceleration.



### WARNING

Please note that if the road surface is slippery or wet, the kick-down feature could cause the driving wheels to spin, which could result in skidding.

## Electro-mechanical parking brake

### Operation

*The electro-mechanical parking brake replaces the handbrake.*



Fig. 106 Centre console: Parking brake

- ▶ Pull switch **(A)** ⇒ *Fig. 106* to apply the parking brake. The warning lamps **(P)** in the switch and in the instrument cluster display will light up.
- ▶ To release the parking brake, press the brake or accelerator pedal with the ignition switched on and simultaneously press the switch **(A)**. The warning lamps **(P)** in the switch and on the display will go out.

Your vehicle is equipped with an electro-mechanical parking brake. The parking brake replaces the conventional handbrake, and is mainly intended to prevent the vehicle from rolling away accidentally.

However, the electro-mechanical parking brake also offers a number of convenience and safety features in addition to the functions of a normal handbrake.

### When driving away



- The parking brake auto release function releases the parking brake automatically when you wish to start moving ⇒ *page 94, Driving away from a standstill*.
- When driving away on a gradient, the parking brake auto release function prevents the vehicle from rolling back unintentionally. The braking force of the parking brake is only released when there is enough power at ▶

the wheels to make the vehicle move in the desired direction.

### Emergency braking function

An emergency braking function enables you to stop the vehicle even if the *conventional* foot brake should fail to work ⇒ *page 94, Emergency braking function*.

### Warning lamps

- The warning lamps  on the display and in the switch light up when the parking brake is applied with the ignition **switched on**.
- The warning lamps  on the display and in the switch light up for approximately 20 seconds when the parking brake is applied with the ignition **switched off**.



#### WARNING

- The accelerator pedal must on no account be pressed inadvertently when a gear is engaged and the engine is running with the vehicle stationary. The vehicle could otherwise start moving immediately and possibly cause an accident.
- It is not possible to apply the parking brake if the electrical power supply fails. In this case, park the vehicle on a level surface and select 1st gear (manual gearbox) or move the selector lever to position P (automatic gearbox) to prevent it from rolling. You should obtain professional assistance.



#### Note

- The parking brake can be applied at any time - even when the ignition is switched off. However, the ignition must be switched on and the brake pedal pressed before the parking brake can be released.
- The parking brake is applied automatically if the driver's door is opened while the ignition is on. This is to prevent the vehicle from accidentally rolling away.
- Any slight noise which may be heard when the parking brake is applied or re-

leased is quite normal and no cause for concern.

- The parking brake runs an automatic test cycle at regular intervals when the vehicle is parked. This may cause a slight noise, which is normal.
- If the warning lamp  appears, there may be a parking brake malfunction ⇒ *page 19*.
- If the electrical power supply fails, it is not possible to release the parking brake (if it was applied) or to apply the parking brake (if it was released) ⇒ . You should obtain professional assistance.

### Parking the car

- ▶ Press the brake pedal to bring the vehicle to a stop.
- ▶ Pull switch  ⇒ *page 92, Fig. 106* to apply the parking brake.
- ▶ Vehicles with automatic gearbox: Move the selector lever to position P.
- ▶ Switch off the engine ⇒ .
- ▶ Manual gearbox: Engage first gear.
- ▶ When parking on a hill or gradient, turn the steering wheel so that the vehicle would roll into the kerb if it did start to move accidentally.

#### WARNING

- Always take the key with you when leaving your vehicle - even if you only intend to be gone for a short time. This is especially important if children are left in the car. They might otherwise be able to start the engine, release the parking brake or use power-operated equipment such as the electric windows - this could lead to injuries.
- Do not leave anyone (especially children) in the vehicle when it is locked. Locked doors could delay assistance in an emergency, potentially putting lives at risk.

### Driving away from a standstill

The parking brake auto release function releases the parking brake automatically when you wish to start moving.

#### Applying the parking brake when stopping

- ▶ Pull switch  ⇒ page 92, Fig. 106 to apply the parking brake.

#### Releasing the parking brake when driving away

Important: The driver's door must be closed and the driver's seat belt must be buckled.

- ▶ Press the accelerator in the normal way: the parking brake will be released automatically and the vehicle will start moving.

You can apply the parking brake when stopping at traffic lights, etc. You do not then have to hold the car with the brake pedal, as the parking brake will stop it creeping forward while a gear is engaged in the automatic transmission. When you drive off in the normal way, the parking brake will be released automatically and the vehicle will start moving.

#### Driving away on a slope



When driving away on a gradient, the parking brake auto release function prevents the vehicle from rolling back unintentionally. The braking force of the parking brake is only released when there is enough power at the wheels to make the vehicle move in the desired direction.

#### Note

For safety reasons the parking brake will only release automatically if the driver's seat belt is engaged in its buckle and the driver's door is closed.

### Driving away when towing a trailer



Please note the following points to prevent the vehicle from rolling back unintentionally on a gradient.



- ▶ Pull and hold the switch  ⇒ page 92, Fig. 106 and press the accelerator. The parking brake will remain engaged and prevent any tendency to roll back down the slope.
- ▶ You can release the switch  as soon as the engine is delivering enough power to the wheels.



Depending on the weight of the vehicle and trailer and the steepness of the slope, there may be a tendency to roll back downhill when driving away from a standstill.

### Emergency braking function

This feature enables you to stop the vehicle if the main brake system should fail or if the pedal is obstructed.

- ▶ To stop the vehicle with the parking brake in an emergency, pull and hold the parking brake switch  ⇒ page 92, Fig. 106.
- ▶ The brakes will be released immediately if you release the switch  or press down the accelerator.

If you pull and hold the parking brake switch  at a road speed above about 3 km/h, this will initiate an emergency brake application. The brakes are then applied hydraulically at all four wheels. The effect is similar to heavy braking ⇒ .

To prevent the emergency braking function from being used accidentally, a warning buzzer sounds when the switch  is pulled. The brakes are released immediately when you release the switch  or press down the accelerator.

#### WARNING

You should only use the emergency braking function in a real emergency, for example if the brake system were to fail or if the brake pedal were to be obstructed. If you



use the emergency braking function by activating the parking brake switch, this has the same effect as heavy braking. Please remember that the ESC (and the integrated ABS, EDL and traction control functions) is still subject to certain physical limits. In a corner or in bad road or weather conditions an emergency stop can cause the vehicle to skid or lose steering control.

## Hold assist

Applies to vehicles: with hold assist



Fig. 107 Section of centre console: Button for hold assist

The hold assist helps the driver if the vehicle is stationary for a long period or very often, for instance at traffic lights, on steep gradients or in stop-and-go traffic.

### Switching on the hold assist

Important: The driver's door must be closed, the driver's seat belt buckled and the engine running.

- ▶ Press button **A** ⇒ Fig. 107 in the centre console to switch on the hold assist function. The LED in the button will light up.

### Stopping with the hold assist

- ▶ Once it detects that the vehicle has stopped, the hold assist keeps the vehicle stationary. You can now take your foot off the brake pedal.
- ▶ Drive off in the normal way: the brake will be released automatically and the vehicle will start moving.

### Switching off the hold assist

- ▶ Press button **A** to switch off the hold assist function. The LED in the button will go out.

In certain situations, the hold assist transfers the job of holding the vehicle to the parking brake. As soon as the parking brake is holding the vehicle still, the warning lamp **B** appears in the instrument cluster.

### **!** WARNING

The intelligent technology in the hold assist function cannot defy the laws of physics. Do not let the extra convenience afforded by the hold assist function tempt you into taking any risks when driving - this can cause accidents.

- The hold assist cannot keep the vehicle stationary in all conditions on a gradient (e.g. if the road is slippery or icy).
- Always ensure that the vehicle is stopped properly and safely - risk of accident!

### **!** CAUTION

Switch off the hold assist function before driving the vehicle into a car wash.

### **i** Note

- The last setting of the hold assist (on/off) is restored when the ignition is switched on. The LED in button **A** is lit when the hold assist is on.
- Automatic gearbox: When the hold assist function is switched on, it stops the vehicle from creeping forwards when you take your foot off the brake pedal.
- In certain situations, the hold assist cannot hold the vehicle. The LED in the button will go out.

## Hill hold assist

Applies to vehicles: with hill hold assist

*The hill hold assist function makes it easier to drive away on a slope.*

Important: The driver's door must be closed, the seat belt buckled and the engine running. ▶

The system is activated when you press and hold the brake pedal for **a few seconds**.

When you release the brake pedal the braking force will be maintained for a moment in order to hold the vehicle and make it easier for you to drive away.



### WARNING

- The intelligent technology in the hill hold assist function cannot defy the laws of physics. Do not let the extra convenience afforded by the hill hold assist function tempt you into taking any risks when driving – this can cause accidents.
- The hill hold assist function cannot keep the vehicle stationary in all conditions on a gradient (e.g. if the road is slippery or icy).
- If you do not drive away immediately after releasing the brake pedal the vehicle could start to roll back. You should therefore immediately press the brake pedal or apply the parking brake.
- If the engine should stall you must immediately press the brake pedal or apply the parking brake.
- If you are driving away on a slope in stop-and-go traffic press and hold the brake pedal for a few seconds before driving off. This will prevent the vehicle from rolling back unintentionally.



### Note



To find out whether your vehicle is equipped with the hill hold assist function please contact an Audi dealership or qualified workshop.

## Speed warning function

### Introduction

Applies to vehicles: with speed warning function

*The speed warning function can help you keep below a pre-set maximum speed.*

The speed warning function will warn you if the vehicle exceeds the pre-set maximum speed. The system gives an audible warning signal if the set speed is exceeded by about 3 km/h. At the same time, an indicator lamp  will light up in the instrument cluster display and the driver message **Speed limit exceeded!** will appear. The indicator lamp  will go out when the speed drops below the set speed limit again.

You are recommended to store this speed limit warning if you wish to be reminded of a particular speed limit. This could be when driving in countries with general speed limits, or if you need to keep below a particular speed when winter tyres are fitted, etc.



### Note

- Please bear in mind that, even with the speed warning function, it is still important to keep a check on the car's speed with the speedometer and to observe the statutory speed limits.
- On vehicles for some markets, the speed warning function warns you when you reach a speed of 120 km/h. This speed limit warning is preset at the factory.

### Setting speed limit warning

Applies to vehicles: with speed warning function

*You can use the sound system or MMI\* to set, alter or cancel the speed limit warning.*

### Vehicles with sound system

- ▶ Select: **[SETUP]** button > control button  **Driver assist > Speed warning.** ▶

## Vehicles with MMI

- ▶ Select: control button **Systems** or **Car systems** > **Driver assist** > **Speed warning**.

The speed limit warning can be adjusted in increments of 10 km/h between 30 and 240 km/h.

## Cruise control system

### Description

Applies to vehicles: with cruise control system

The cruise control system allows you to drive at a constant speed of 20 km/h or higher.

A constant speed is maintained by adjusting the engine power or braking the vehicle accordingly.

### ! WARNING

- Always direct your full attention to the road, even when you are using the cruise control system. It is always the driver who is responsible for determining the speed and for keeping a safe distance to the other vehicles on the road.
- For safety reasons, the cruise control system must not be used in city traffic, stop-and-go traffic, on roads with a lot of bends or in difficult or slippery driving conditions (such as ice, fog, loose grit or gravel, heavy rain, etc.) - risk of accident!
- When you take a turn-off, drive along a motorway exit lane or pass through road-work sections, please temporarily switch off the cruise control system.
- Make sure you do not unintentionally rest your foot on the accelerator - this will override the cruise control system which, as a result, will not brake the vehicle.

### i Note

- The cruise control system is suitable for driving in speed-restricted zones. As a driver you are always responsible for maintaining the correct speed.

- On vehicles with a manual gearbox, the set speed cannot be reached if the currently selected gear is too high or too low. Make sure to change up or down a gear in good time.
- The cruise control system remains active while you change gears (applies to both manual and automatic gearboxes).
- The brake lights come on when the system brakes the vehicle.

### Switching on

Applies to vehicles: with cruise control system



Fig. 108 Control lever for cruise control system

- ▶ Pull the lever to position ① ⇒ Fig. 108 to switch on the cruise control system.
- ▶ Drive at the speed you wish to set the system to.
- ▶ Press the button marked A to store the speed. The indicator lamp  in the instrument cluster will light up.

### Adjusting the speed

Applies to vehicles: with cruise control system

- ▶ **Briefly push** the lever towards ⊕/⊖ ⇒ page 97, Fig. 108 to increase or reduce the cruising speed in small steps.
- ▶ To increase or reduce the speed quickly, **hold** the lever towards ⊕/⊖ until you reach the desired cruising speed.

You can still use the accelerator pedal to increase speed in the normal way, for example to overtake another vehicle. Once you release the accelerator, the system will revert to the speed you stored initially. ▶

However, if the vehicle exceeds the programmed speed by more than 10 km/h for more than 5 minutes, the cruise control system will be deactivated temporarily. The indicator lamp  in the instrument cluster will go out, but the programmed speed will remain stored.

### Pre-selecting a speed

Applies to vehicles: with cruise control system

*You can pre-select a desired speed while the vehicle is stationary.*

- ▶ Switch on the ignition.
- ▶ Pull the lever to position ① ⇨ page 97, Fig. 108.
- ▶ Push the lever up towards ⊕ or down towards ⊖ in order to increase or reduce the cruising speed setting.
- ▶ Release the lever to store the indicated cruising speed.

This function allows you to enter the desired cruise control setting speed ahead of time, for example before joining a motorway. Once you are on the motorway, you can activate the cruise control system by pulling the lever to position ①.

### Switching off

Applies to vehicles: with cruise control system

#### Switching off temporarily

- ▶ Press the brake pedal, or
- ▶ Push the lever to position ② (click stop not engaged) ⇨ page 97, Fig. 108, or

#### Switching off completely

- ▶ Push the lever to position ② (click stop engaged), or
- ▶ Switch off the ignition.

The speed setting will remain stored after the system is temporarily deactivated. To resume the programmed cruising speed, release the brake pedal and pull the control lever to position ①.

The programmed cruising speed is deleted if you switch off the cruise control system completely or switch off the ignition.

### **WARNING**

Do not resume the programmed cruising speed if this is too high for the traffic conditions - this can cause accidents.

### **Note**

- The cruise control system will be deactivated if you keep your foot on the clutch pedal.
- The cruise control system is deactivated if the brakes become too hot while driving. If this happens on a slope, you can reduce the load on the brakes by selecting a lower gear.
- The ESC sport mode cannot be switched on when the cruise control system is activated.

## Start/stop system

### Description

Applies to vehicles: with start/stop system

The start/stop system can help to save fuel and reduce CO<sub>2</sub> emissions.

In start/stop mode, the engine is switched off automatically when the vehicle stops, e.g. at traffic lights. The ignition remains on during this stop phase. The engine is automatically started on demand.

The start/stop system is automatically activated each time you switch on the ignition.

#### Basic conditions for start/stop mode

- The driver's door must be closed.
- The driver's seat belt must be buckled.
- The bonnet must be closed.
- The vehicle must have been moving at over 4 km/h since the last stop.
- A trailer must not be hitched up to the vehicle. ▶

**! WARNING**

- Never switch off the engine until the vehicle is stationary. Otherwise you may not have the full benefit of the brake servo and power steering. You may need more strength to steer and brake the vehicle than you normally would. This would mean a greater risk of accidents and serious injury, because you cannot steer and brake in the normal manner.
- Never remove the key from the ignition while the vehicle is moving. The steering lock could engage suddenly, and you would not be able to steer the car.
- Always take the key with you when leaving the vehicle - even if you only intend to be gone for a short time. This is especially important if children are left in the car. They might otherwise be able to start the engine or use power-operated equipment such as the electric windows - this could lead to injuries.
- To avoid injury, make sure that the start/stop system is switched off before working in the engine compartment  
⇒ page 101.

**! CAUTION**

Always switch off the start/stop system  
⇒ page 101 before driving through water.

**Switching off / starting the engine**

Applies to vehicles: with start/stop system



Fig. 109 Instrument cluster: Engine switched off (stop phase)

**Vehicles with manual gearbox**

- ▶ When the vehicle stops, put the gear lever in neutral and take your foot off the clutch pedal. The engine will switch off. An indicator lamp (A) will light up in the instrument cluster display.
- ▶ The engine will start again automatically when you press the clutch pedal. The indicator lamp will go out.

**Vehicles with automatic gearbox**

- ▶ Stop the vehicle and keep your foot on the brake pedal. The engine will switch off. The indicator lamp (A) will appear on the display.
- ▶ The engine will start again automatically when you take your foot off the brake pedal. If the hold assist\* is switched on, the engine will not start until the accelerator is pressed. The indicator lamp (A) will go out.

**Further information for automatic gearboxes**

The engine is switched off when the selector lever is in position P, D, N or S or in manual mode. If the selector lever is in position P, the engine will remain off even if you take your foot off the brake. The engine will not start again until you press the accelerator or select another gear and take your foot off the brake.

The engine will start again if you move the selector lever to R during a stop phase.

If you do not want the engine to start, move the selector lever quickly from D through R to P.

**i Note**

- You can control whether or not the engine is switched off by varying the amount of pressure on the brake pedal. For instance, if you brake gently in stop-and-go traffic or before turning off at a junction, the engine will remain on while the vehicle is at a standstill. As soon as you press the brake pedal harder, the engine will be switched off.

- On vehicles with manual gearbox, you should keep your foot on the brake during a stop phase to prevent the vehicle from moving.
- If you press the **START ENGINE STOP** button\* during a stop phase, the ignition will be switched off.
- If the engine stalls on a vehicle with manual gearbox, you can start it again directly by pressing the clutch pedal immediately.
- Applies to vehicles with **START ENGINE STOP**\* button: The ignition remains on when you bring the vehicle to a halt and the start/stop system stops the engine. Before leaving the vehicle, ensure that the ignition is switched off; otherwise the battery will be drained.
- The display differs slightly on some models.

### General notes

Applies to vehicles: with start/stop system

*The on-board control system can override the start/stop function for various reasons.*





**Fig. 110** Instrument cluster with driver information system: Engine stop temporarily unavailable

### Engine does not switch off

Before each stop phase, the system checks that certain conditions have been met. The engine will **not** switch off in the following situations, for example.

- The engine has not yet reached the minimum temperature required for start/stop mode.

- The interior temperature selected on the air conditioner\* has not yet been reached.
- The exterior temperature is very high/low.
- The windscreen is being defrosted  
⇒ page 78, ⇒ page 80.
- The parking aid\* or park assist\* is switched on.
- The battery charge is too low.
- The steering wheel is close to full lock or the vehicle is being steered.
- Reverse gear has just been selected.
- The vehicle is on a steep gradient.

 will appear in the instrument cluster display, and  will simultaneously appear in the driver information system\*.

### Engine cuts in again automatically

The stop phase is interrupted in the following situations, for example. The engine cuts in automatically without intervention from the driver.

- The vehicle starts to roll (e.g. on a hill).
- The interior temperature deviates from the air conditioner setting.
- The windscreen is being defrosted  
⇒ page 78, ⇒ page 80.
- The brake pedal is pressed several times in succession.
- The battery charge drops to an insufficient level.
- The power consumption is high.

### Ignition is switched off automatically

To prevent the battery from being discharged, the ignition will be switched off **automatically** if certain conditions are met. For instance:

- The vehicle has already been driven.
- The start/stop system has switched off the engine.
- The driver's door is opened.
- The driver's seat belt is unbuckled.
- The brake pedal is not pressed.
- The vehicle is stationary.

If the dipped beam headlights are switched on in this case, the side lights will be turned on instead. After approx. 30 minutes, or when ►

you lock the vehicle, the side lights will be switched off.

If the start/stop system has not stopped the engine or if you have switched off the start/stop system manually, the engine will continue running and the ignition will not be switched off automatically ⇒ ⚠.

### ⚠ WARNING

Never run the engine in confined spaces. The exhaust gases are toxic.

### i Note

If you select D, N or S (on vehicles with automatic gearbox) after selecting reverse gear, the car must have been moving at over 10 km/h before the system can switch off the engine again.

## Switching the start/stop system off and on manually

Applies to vehicles: with start/stop system

*You can switch the system off manually if you don't want to use it.*



Fig. 111 Centre console: Switch for start/stop system

- To switch the start/stop system off or on manually, press the  $\overset{A}{\text{OFF}}$  button. The LED in the button will light up when the system is switched off.

### i Note

If you switch off the system during a stop phase, the engine will start again automatically.

## Driver messages in the instrument cluster display

Applies to vehicles: with start/stop system

### Automatic start/stop deactivated: Please restart engine manually

This message appears if certain conditions have not been met during the stop phase and the start/stop system **cannot** start the engine again automatically. In this case, the engine must be started manually.

### Automatic start/stop: system fault! Function unavailable

There is a malfunction in the start/stop system. Drive to a workshop soon and have the fault rectified.

## g-tron

# Natural gas engine

### Introduction

Applies to vehicles: with natural gas engine

Your vehicle will run on CNG (Compressed Natural Gas) and petrol. The fuel mode is changed over automatically.

### Using compressed natural gas (CNG)

In addition to petrol, vehicles with a natural gas engine will run on either CNG, e-gas or biomethane.

The tank must NOT be filled with any other available types of fuel, such as LNG (Liquefied Natural Gas), LPG (Liquefied Petroleum Gas) ⇒ ⚠ or hythane (a mixture of hydrogen and methane) ⇒ ⚠.

### Natural gas quality and fuel consumption

Natural gas is subdivided into two quality categories: Group H and Group L.

H-gas has a higher methane content and thus a higher calorific value than L-gas. The higher the calorific value of the natural gas, the lower the fuel consumption.

However, the methane content and the calorific value can vary within the same quality group. Consequently, the vehicle's fuel consumption can vary even if the gas tank is always filled with fuel of the same quality.

The quality of the natural gas is detected automatically. The engine management system adapts the vehicle set-up to variations in natural gas quality. It is therefore possible to mix both quality groups in the gas fuel tank. It is not necessary to run the gas tank dry before filling up with natural gas of a different quality group.

### Safe operation of natural gas powered vehicles

If you notice a gas odour or suspect that the natural gas fuel system may be leaking, please follow the instructions below ⇒ ⚠.

- Stop the vehicle immediately.
- Extinguish any cigarettes immediately.
- Switch off the ignition.
- Open all the doors and the boot lid to ensure an adequate supply of fresh air.
- Switch off or remove from the vehicle all items which could cause sparks or fire.
- Do NOT drive on if the gas odour persists.
- Obtain professional assistance and have the fault rectified.

### ⚠ WARNING

- Serious personal injury can result if you ignore a gas odour inside the vehicle or when filling the tank.
- Follow the instructions above  
⇒ *page 102, Safe operation of natural gas powered vehicles* if you notice a gas odour.
- Leave the danger area.
- If necessary, notify the rescue services.
- Natural gas is highly explosive and highly inflammable. Improper use of natural gas can cause accidents, serious burns and other injuries.
- The vehicle is not suitable for the use of liquefied natural gas (LNG) or liquefied petroleum gas (LPG) and must never be fuelled or driven with LNG or LPG. Liquefied gas can cause the natural gas tank to explode and can cause serious injuries.

### ⚠ CAUTION

The vehicle is not suitable for the use of hythane and must never be fuelled with hythane. Otherwise, serious damage to the engine and fuel system could result.

### ℹ Note

Have the natural gas fuel system checked at regular intervals by a qualified workshop.



## Instrument cluster overview

Applies to vehicles: with natural gas engine

The instrument cluster is the driver's information centre. It provides status information while the vehicle is being driven in natural gas mode and indicates how much fuel is in the gas tank.

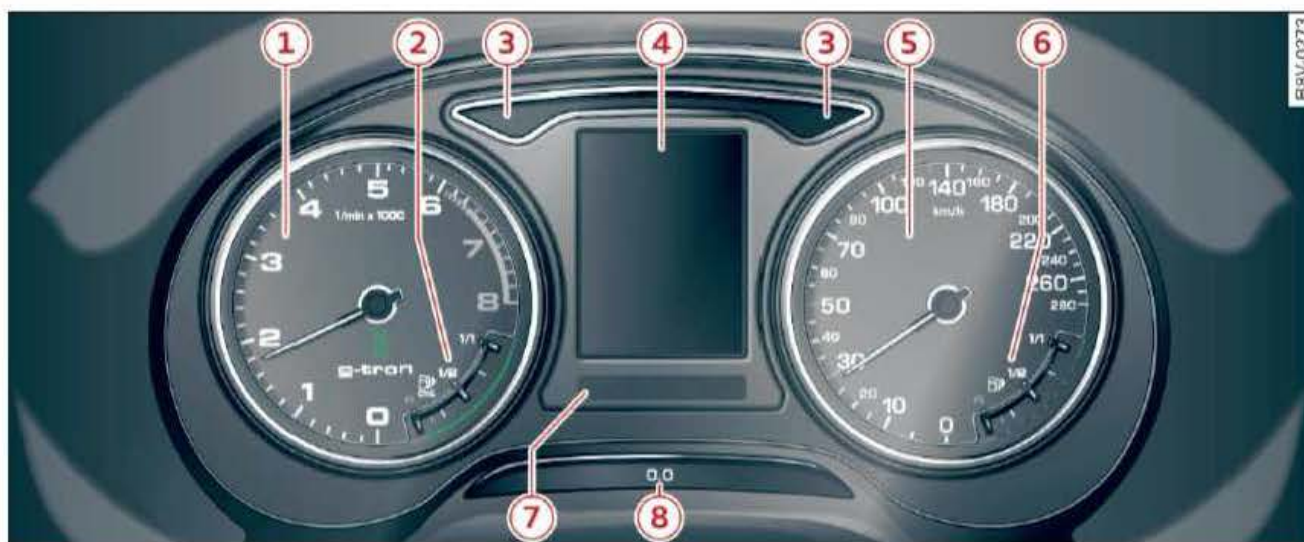

Fig. 112 Overview of instrument cluster for g-tron

- |   |     |
|---|-----|
| ① Rev counter with warning/indicator lamps                        | 10  |
| ② Fuel gauge for natural gas                                      | 104 |
| ③ Indicator lamps (turn signals)                                  |     |
| ④ Display   |     |
| – Warning/indicator lamps and                                     | 14  |
| – Driver information system*                                      | 27  |
| – Date* and time  | 9   |
| – Mileage recorder  | 10  |
| – Service interval display  | 13  |
| ⑤ Speedometer with warning lamps                                  |     |
| ⑥ Fuel gauge for petrol   | 11  |
| ⑦ Reset button for trip recorder <input type="text" value="0.0"/> | 10  |

### **i** Note

The needles on the dials in the instrument cluster are illuminated when the ignition is switched on. The main instrument lighting (for the dials and needles) comes on when the vehicle's lights are switched on. The instrument lighting is dimmed automatically as the daylight starts to fade. This function is intended to remind the driver to switch on the dipped-beam headlights in

good time when light conditions become poor.

## Driving in natural gas mode

Applies to vehicles: with natural gas engine

If you have just refuelled the gas tank or if the coolant temperature is too low, the engine will initially start running in petrol mode. The engine will switch to natural gas mode as soon as possible.

The indicator lamp  in the instrument cluster will light up as soon as the engine is running in natural gas mode ⇒ page 103, Fig. 112. The indicator lamp will go out if there is no more natural gas left in the tank. The engine will switch automatically to petrol mode.

## Gas fuel gauge

Applies to vehicles: with natural gas engine



Fig. 113 Instrument cluster: Gas fuel gauge



Fig. 114 Display: Combined fuel warning for petrol and natural gas

The gauge ⇒ Fig. 113 only works when the ignition is switched on. The LED at the bottom of the dial flashes for a few seconds after the ignition is switched on. When the gauge reaches the reserve zone, the LED at the bottom of the dial will light up in red. The LED at the bottom of the dial will flash if the gas level is very low.

When the gas fuel level is down to the reserve zone, the message **Please add CNG** will appear in the instrument cluster.

When both types of fuel (natural gas and petrol) are down to the reserve zone, a combined display ⇒ Fig. 114 will appear in the instrument cluster with the message **Please refuel** and the indicator lamp  ⇒ page 24.

The fuel range will also be displayed.

The tank capacities on your vehicle are given in the Technical data section ⇒ page 273.

### ! CAUTION

Never run the petrol tank completely dry. If there is an irregular fuel supply, misfir-

ing can occur. Unburnt fuel can then enter the exhaust system. This can lead to overheating and damage to the catalytic converter.

### i Note

If the vehicle is refuelled and parked immediately afterwards for a long period, the fuel level shown on the gas fuel gauge may be different when you restart the vehicle than it was immediately after refuelling. This does not mean that there is a fuel leak, but is a side-effect caused by a drop in pressure in the gas fuel tanks when the system cools down after refuelling.

## Filling the gas tank

Applies to vehicles: with natural gas engine

*Vehicles with a natural gas engine have two fuel tanks: one for natural gas and one for petrol.*



Fig. 115 Vehicle as seen from the rear right: Opening the fuel tank flap

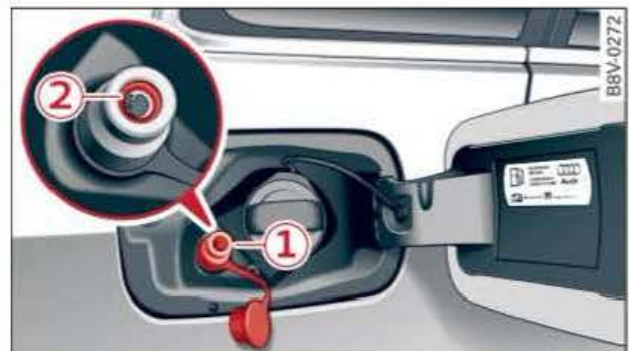



Fig. 116 Tank flap open: Gas filler neck ① and filler neck seal ②

When refuelling with petrol, please note the additional information and warnings ⇒ page 210.

Switch off the engine, ignition, mobile phone(s) and auxiliary heating before refuelling ⇒ .

Read and follow the instructions at the natural gas filling station. Before refuelling with natural gas, make sure that the correct type of fuel is used ⇒ *page 102, Using compressed natural gas (CNG)*.

The flap that covers the tank cap is unlocked and locked automatically by the central locking.

### Unscrewing the tank cap

The gas filler neck is behind the tank flap next to the petrol filler neck ⇒ *Fig. 116*.

- ▶ Press the left side of the flap to open it -arrow- ⇒ *Fig. 115*.

### Filling the tank

- ▶ Pull the cap off the gas filler neck ①.
- ▶ Make sure that the seal ② is securely seated in the gas filler neck.
- ▶ Fit the coupling of the fuelling line onto the gas filler neck.
- ▶ Lock the filler nozzle.
- ▶ Start the refuelling procedure.
- ▶ If you need to interrupt the fuelling procedure, press the stop button on the filler unit.

The compressor on the filler unit will be switched off automatically when the gas tank is full.

### Closing the tank cap

- ▶ Unlock the filler nozzle.
- ▶ Check that the seal on the gas filler neck ② has not become stuck on the filler coupling.
- ▶ If necessary, fit the seal back onto the gas filler neck.
- ▶ Press the cap onto the gas filler neck.
- ▶ Close the tank flap. Make sure you hear it click into place.

#### WARNING

- Natural gas is highly explosive and highly inflammable. Improper use of natural

gas can cause accidents, serious burns and other injuries.

- Make sure that the filler nozzle is correctly coupled with the gas filler neck before adding fuel. Stop fuelling immediately if you notice a gas odour.
- The vehicle is not suitable for the use of liquefied natural gas (LNG) or liquefied petroleum gas (LPG) and must never be fuelled or driven with LNG or LPG. Liquefied gas can cause the natural gas tank to explode and can cause serious injuries.

#### CAUTION

The vehicle is not suitable for the use of hythane and must never be fuelled with hythane. Otherwise, serious damage to the engine and fuel system could result.

#### Note

- The procedure for operating the filler coupling can vary on different gas filler units. If you are unsure, ask a trained member of staff at the filling station to demonstrate the filling procedure.
- In very hot weather, the overheating protection system on the gas filler unit may automatically deactivate the fuelling system.
- You may hear noises while refuelling. This is normal and does not mean that the system is damaged.
- The natural gas fuel system on the vehicle is suitable for refuelling both at domestic-type appliances using small compressors (time-fill) and at CNG filling stations using large compressors (fast-fill).

## Automatic gearbox

### S tronic gearbox

#### Introduction

Applies to vehicles: with S tronic gearbox

The vehicle is equipped with an electronically controlled dual-clutch gearbox (S tronic). Torque between the engine and the gearbox is transmitted via two independent clutches. They enable smooth, uninterrupted acceleration of the vehicle.

The gearbox shifts up or down automatically and continuously adapts the timing of the gear changes to your driving style.

When you drive at **moderate speeds** the gearbox will select the most economical shift programme. It will then change up early and delay the downshifts to give better fuel economy.

If you drive at **higher speeds** with heavy acceleration, if you open the throttle quickly, or if you use the kick-down or the car's maximum speed, the gearbox will automatically select the more "sporty" shift programmes.

If desired, you can also select the gears *manually (tiptronic mode)* ⇒ page 111, *Manual gear selection (tiptronic mode)*.

#### Selector lever positions

Applies to vehicles: with S tronic gearbox



Fig. 117 Instrument cluster: Selector lever positions

The current selector lever position and the current gear are shown in the instrument cluster display.

#### P – Parking lock

When the selector lever is in this position, the driven wheels are locked mechanically. The parking lock must only be engaged when the vehicle is *stationary* ⇒ ⚠.

The interlock button (the button in the selector lever handle) must be pressed in *and* the brake pedal must be depressed before moving the selector lever either in or out of position P.

#### R – Reverse gear

Reverse gear must only be engaged when the vehicle is *stationary* and the engine is idling ⇒ ⚠.

To move the selector lever to position R, press in the interlock button *and* at the same time press the brake pedal. The reversing light comes on when the selector lever is in the R position with the ignition on.

#### N – Neutral

In this position, the gearbox is in neutral.

#### D/S – Drive/Sport (standard position for driving forwards)

In selector lever position D/S, the gearbox can be operated in either the standard drive mode (D) or in sport mode (S). To select sport mode (S), briefly pull the selector lever back. The gearbox will switch back to drive mode (D) if you pull the selector lever again. The selected driving mode is shown in the instrument cluster display.

In the standard **drive mode** (D), the gearbox automatically selects the best gear ratio. This depends on the engine load, the road speed and the driving style.

Select **sport mode** (S) if you wish to take full advantage of the car's performance. This setting makes use of the engine's maximum power output. When accelerating the gear shifts may be noticeable.

Press the brake pedal when moving the selector lever from N to D/S if the vehicle is *stationary* or at speeds below 2 km/h ⇒ ⚠. ▶

## E – Efficiency\*

In efficiency mode ⇒ *page 136, Audi drive select*, the gearbox selects the next gear at lower engine speeds. Earlier upshifts give improved fuel economy because the full power reserves of the engine are not used.

In this mode, E is shown on the display instead of D ⇒ *Fig. 117*.

### WARNING

- The car can roll away even if the ignition is switched off.
- Never move the selector lever to R or P when driving, as this could cause an accident.
- In all selector lever positions except P the vehicle must always be held with the foot brake when the engine is running. This is because an automatic gearbox still transmits power even at idling speed, and the vehicle tends to “creep” - risk of accident!
- The accelerator pedal must on no account be pressed inadvertently when a gear is engaged with the vehicle stationary. The vehicle could otherwise start moving immediately (in some cases even if the parking brake is engaged) and possibly cause an accident.
- Do not press the accelerator while selecting a gear with the vehicle stationary and the engine running, as this could cause an accident.
- The driver should never get out of the vehicle when the engine is running and a gear is engaged. If you have to leave your vehicle while the engine is running, you must apply the parking brake and engage the parking lock P.
- To avoid accidents, apply the parking brake and put the selector lever in position P before opening the bonnet and working on the vehicle with the engine running. Please observe the important safety warnings ⇒ *page 212, Working on components in the engine compartment*.

### Note

- Drive select: You can select the sport program for gear changes by activating the **dynamic** mode. The instrument cluster display will show S instead of D.
- If the lever is moved accidentally to N when driving, take your foot off the accelerator and let the engine speed drop to idling before selecting D or S again.
- It is not possible to move the selector lever out of position P if the electrical power supply fails. In this case, the selector lever can be released manually. Left-hand drive vehicles ⇒ *page 114*, right-hand drive vehicles ⇒ *page 115*.

### Selector lever lock

Applies to vehicles: with S tronic gearbox

*The selector lever lock prevents gears from being engaged inadvertently, so that the vehicle is not set in motion unintentionally.*



Fig. 118 Selector lever lock

The selector lever lock is released as follows:

- ▶ Switch on the ignition.
- ▶ Press the brake pedal *and* at the same time press in the interlock button.

### Automatic selector lever lock

The selector lever is locked in the P and N positions when the ignition is on. To move the selector lever out of these positions the driver must press the brake pedal. To move out of position P, the interlock button must also be pressed. The following message appears in the display as a reminder for the driver when the selector lever is in position P or N: ▶

### When stationary apply footbrake while selecting gear

The selector lever lock only works if the vehicle is stationary or driving at speeds up to 2 km/h. At higher speeds the selector lever lock in the N position is disengaged automatically.

The selector lever lock is not engaged if the selector lever is moved quickly through position N (e.g. when shifting from R to D). This makes it possible, for instance, to “rock” the vehicle backwards and forwards if it is stuck in snow or mud. The selector lever lock engages automatically if the brake pedal is not depressed and the lever is in position N for more than about two seconds.

### Interlock button

The interlock button on the selector lever handle prevents the driver from inadvertently engaging particular gears. The illustration shows the selector lever positions in which the button has to be pressed, highlighted in colour ⇒ Fig. 118.

### Safety interlock for ignition key\*

The key can only be withdrawn from the ignition lock with the ignition switched off and the selector lever in position P. When the ignition key is removed, the selector lever is locked in position P.

#### Note

- If the selector lever does not lock automatically, a malfunction has occurred. In this case, the power transmission is interrupted to prevent the vehicle from moving unintentionally. Proceed as follows to engage the selector lever lock again:
  - Vehicles with 6-speed gearbox: briefly press the brake pedal.
  - Vehicles with 7-speed gearbox: press the brake pedal. Move the selector lever to position P or N and then select a gear.
- If the vehicle does not move forwards or backwards even though a gear is selected, proceed as follows:

- If the vehicle does not move in the desired direction, the system may have failed to engage the gear correctly. In this case, press the brake pedal and select the gear again.
- If the vehicle still does not move in the desired direction, a system malfunction has occurred. Seek professional assistance and have the system checked.

### General notes on driving an automatic

Applies to vehicles: with S tronic gearbox

*The gearbox changes the forward gears up and down automatically.*



Fig. 119 Detail of the centre console: Selector lever with interlock button

The engine can only be started when the selector lever is in P or N. In the case of low outside temperatures (below -10 °C), the engine can only be started when the selector lever is in position P.

### Driving away from a standstill

- ▶ Press and hold the brake pedal.
- ▶ Press and hold the interlock button (the button in the selector lever handle), set the selector lever to the desired position (e.g. D) ⇒ page 106 and release the interlock button.
- ▶ Wait for the gearbox to engage the gear (a slight movement can be felt).
- ▶ Release the brake and press the accelerator ⇒ .

### Stopping briefly

- ▶ Press the brake pedal to hold the vehicle when stationary (for instance at traffic lights).



- ▶ Do not press the accelerator.
- ▶ To prevent the vehicle from rolling away, apply the parking brake before moving off on steep gradients ⇒ .
- ▶ As soon as you accelerate as normal with your seat belt fastened, the parking brake will automatically be released and the vehicle will start moving.

### Stopping/parking the car

If you open the driver's door while the selector lever is not in position P, the vehicle can roll away. The message **Shift to P, otherwise vehicle can roll away. Doors to not lock if lever is not in P.** appears on vehicles with convenience key\*. A buzzer will also sound.

- ▶ Press and hold the brake pedal ⇒ .
- ▶ Apply the parking brake.
- ▶ Move the selector lever to P.

### Stopping on a slope

- ▶ *Always* keep your foot on the brake pedal to hold the vehicle and prevent it from rolling back down the slope ⇒ . Do **not** try to stop the vehicle "rolling back" by increasing the engine speed when a gear is engaged ⇒ .

### Driving away on a slope (vehicles without hill hold assist\* / Audi hold assist\*)

- ▶ Apply the parking brake.
- ▶ Once you have engaged a gear press the accelerator carefully. The parking brake will be released automatically if you are wearing your seat belt.

### Driving away on a slope (vehicles with hill hold assist\*)

- ▶ Once you have engaged a gear, release the footbrake and press the accelerator ⇒ *page 95, Hill hold assist.*

### Driving away on a slope (vehicles with hold assist\*)

- ▶ Once you have engaged a gear, release the footbrake and press the accelerator ⇒ *page 95, Hold assist.*

In some situations (such as on mountain roads or when towing a trailer or caravan) it can be advantageous to switch temporarily to the manual shift programme so that the gear ratios can be selected manually to suit the driving conditions ⇒ *page 111.*

On level ground it is sufficient to move the selector lever to P. On a gradient the parking brake should be applied first and the selector lever should be moved to P ⇒ *page 92.* This reduces the load on the locking mechanism and makes it easier to move the selector lever out of position P.



### WARNING

- The driver should never get out of the vehicle when the engine is running and a gear is engaged. If you have to leave your vehicle while the engine is running, you must apply the parking brake and engage the parking lock P.
- If the engine is running and a gear is engaged (D/S or R) or the vehicle is in "tiptronic" mode, you will need to hold the car with the footbrake. Otherwise, the car will "creep" forwards as the power transmission is not fully interrupted even when the engine is idling.
- The accelerator pedal must on no account be pressed inadvertently when the vehicle is stationary. The vehicle could otherwise start moving immediately (in some cases even if the parking brake is engaged) and possibly cause an accident.
- Do not press the accelerator while selecting a gear with the vehicle stationary and the engine running, as this could cause an accident.
- Never move the selector lever to R or P when driving at normal speeds, as this could cause an accident.
- Before you drive down a steep gradient, reduce the speed and use "tiptronic" to select a low gear.
- Never allow the brake to drag when driving downhill and do not use the brake

pedal too often or for long periods. Constant braking will cause the brakes to overheat and will considerably reduce the effectiveness of the brakes. It will increase the braking distance and could cause the brake system to fail.

- To avoid rolling back on gradients always hold the vehicle with the footbrake or parking brake if you have to stop.
- Never attempt to hold the vehicle with the clutch when stopping on a gradient. The clutch is disengaged automatically if it is overloaded and becomes too hot - accident risk! If the clutch is overloaded, the indicator lamp  will light up and a message will appear ⇒ *page 113*.

### CAUTION

- When you have stopped on a gradient, do not try to stop the vehicle rolling back by accelerating when a gear is engaged. This could cause the automatic gearbox to overheat and become damaged. Apply the parking brake or press the brake pedal in order to prevent the vehicle from rolling back.
- If you allow the car to roll with the selector lever in position N with the engine switched off, the automatic gearbox will be damaged as it will not be lubricated.
- In certain driving and traffic conditions, for instance in stop-and-go traffic, if you have to pull away frequently or if the vehicle creeps forwards over a long distance, the gearbox can overheat and become damaged. If the warning lamp  lights up, stop the vehicle at the first opportunity and let the gearbox cool down ⇒ *page 113*.
- In certain driving and traffic conditions, for instance in stop-and-go traffic, if you have to pull away frequently or if the vehicle creeps forwards over a long distance, the gearbox can overheat and become damaged. If the warning lamp  lights up, stop the vehicle at the first opportunity and let the gearbox cool down ⇒ *page 113*.

- If you allow the car to roll with the engine switched off, the S tronic gearbox will be damaged as it will not be lubricated ⇒ *page 246, Tow-starting / towing away*.

### Note

For safety reasons the parking brake will only release automatically if the driver's seat belt is engaged in its buckle.

### Downhill speed control

Applies to vehicles: with S tronic gearbox

*The downhill speed control function helps the driver when driving down steep gradients.*

Downhill speed control is activated on a downhill gradient when the selector lever is in D/S and the driver presses the brake pedal. The gearbox automatically selects a suitable gear for the gradient. The downhill speed control function attempts to maintain the speed at which the vehicle was travelling when the foot brake was applied (subject to the laws of physics and technical limitations of the power train). It may be necessary to adjust the speed again using the foot brake. The downhill speed control can change down to 3rd gear but no further, so it may be necessary to change to tiptronic mode on very steep gradients. In this case, change down manually to 2nd or 1st gear in tiptronic mode to use the engine braking effect and reduce the load on the brakes.

Downhill speed control is deactivated as soon as the road levels out again or you press the accelerator pedal.

On vehicles with cruise control system\* ⇒ *page 97*, downhill speed control is activated when you set a cruising speed.

### WARNING

The downhill speed control function cannot defy the laws of physics and may therefore not be able to maintain a constant speed in certain circumstances. Always be prepared to use the brakes!



### Manual gear selection (tiptronic mode)

Applies to vehicles: with S tronic gearbox/paddle levers

The tiptronic feature allows the driver to also change gears manually.



Fig. 120 Centre console: Manual gear selection using selector lever



Fig. 121 Steering wheel: Manual gear selection with paddle levers\*

### Gear selection with selector lever

The tiptronic mode can be selected either with the vehicle stationary or on the move.

- ▶ From position D/S, push the selector lever to the right into the tiptronic selector gate to activate tiptronic mode. As soon as the automatic gearbox has activated this mode, the letter **M** will appear on the display ⇒ page 106, Fig. 117; e.g. **M4** means that the vehicle is in 4th gear.
- ▶ Briefly push the selector lever forwards (+) ⇒ Fig. 120 to change up a gear.
- ▶ Briefly pull the selector lever back (-) to change down a gear.

### Gear selection with paddle levers\*

You can use the paddle levers when the selector lever is in position D/S or **M** (= tiptronic selector gate).

- ▶ To shift up a gear, briefly pull the paddle lever (+) ⇒ Fig. 121.
- ▶ To shift down a gear, briefly pull the paddle lever (-).

If you use the paddle levers when the selector lever is in positions D/S, the gearbox will remain in manual mode for a while. To switch back immediately to automatic mode after changing gears manually, pull the paddle lever (+) ⇒ Fig. 121 for approximately 1 second.

If you want to use the paddle levers permanently, push the selector lever from position D/S to the right into the tiptronic selector gate.

The gearbox automatically shifts up or down into the next gear before a critical engine speed is reached.

The gearbox only allows manual gear changes if the engine speed would remain within the permissible range.

### Kick-down feature

Applies to vehicles: with S tronic gearbox

The kick-down feature is designed to give maximum acceleration.

When the accelerator pedal is pressed right down past the point of resistance at full throttle, the gearbox will shift down to a lower gear, depending on road speed and engine speed. The upshift to the next higher gear is delayed until the engine reaches maximum rpm.

### ⚠ WARNING

Please note that if the road surface is slippery or wet, the kick-down feature could cause the driving wheels to spin, which could result in skidding.

### Coasting mode

Applies to vehicles: with S tronic gearbox, Audi drive select, except for 1.2 TFSI

In coasting mode, you can use the vehicle's kinetic energy to drive without using the accelerator on certain stretches of road. This saves ▶

fuel by allowing you to take your foot off the accelerator earlier and let the vehicle coast (for instance when approaching a speed restriction in a built-up area).

### Switching on coasting mode

Important: Selector lever must be in D, gradient must be less than 12 %.

- ▶ Select **efficiency** mode in drive select\*  
⇒ *page 136* (you only have to do this once).
- ▶ Take your foot off the accelerator.

If you have selected the “on-board computer” display, the message **Coasting** will then appear. The gearbox automatically disengages the clutch at speeds above 20 km/h and lets the vehicle coast without the engine braking effect. The engine ticks over at idling speed while the vehicle is coasting.

### Stopping coasting mode

- ▶ Press the brake pedal or accelerator.

To use the engine braking effect and overrun fuel cut-off again, all you need to do is tap the brake pedal briefly.

You can improve your fuel economy and help to reduce emissions by using a combination of the **coasting mode** (i.e. coasting with low fuel consumption on a longer stretch of road) and the **overrun fuel cut-off** (i.e. using the engine braking effect with no fuel consumption on a shorter stretch of road).

#### WARNING

- If you are approaching an obstruction when coasting mode is switched on, please remember that the vehicle will not slow down as quickly as usual when you take your foot off the accelerator - risk of accident!

- The vehicle can pick up speed if you are driving down a slope in coasting mode - risk of accident!
- If other people are using your car, you should draw their attention to the coasting mode.

#### Note



- Coasting mode is only available in **efficiency** mode (drive select\*).
- The message **Coasting** only appears when the current fuel consumption display is selected. The gear is no longer displayed when you are in coasting mode (e.g. E instead of E7).
- The coasting mode is deactivated temporarily on gradients of 15 % or greater.

### Launch control programme

Applies to vehicles: with launch control / 6-speed S tronic gearbox / diesel engines 125 kW and higher / petrol engines 140 kW and higher

*The launch control programme enables maximum acceleration.*

Important: The engine must be warm and the steering wheel must be pointing straight-ahead.

- ▶ Deactivate the start/stop system\*  
⇒ *page 101*. The LED in the button  will light up.
- ▶ Deactivate the hold assist\* ⇒ *page 95*. The LED in the button will go out.
- ▶ Press the  button once briefly while the engine is running<sup>1) 2)</sup>.
- ▶ Briefly pull the selector lever back from position D/S to select position S, or move the selector lever to the right into the tiptronic gate, or select **dynamic** mode in drive select\* ⇒ *page 136*.

1) On vehicles with driver information system, the ESC lamp lights up permanently and the message **Stabilisation control (ESC): sport. Warning! Restricted stability** appears temporarily in the instrument cluster to indicate the deactivation status.

2) Vehicles **without** driver information system: The indicator lamp flashes slowly.

- ▶ Press the brake pedal firmly with your left foot and hold it down for at least one second.
- ▶ At the same time, press the accelerator all the way down with your right foot until the engine revs are high and steady.
- ▶ Take your left foot off the brake.

### WARNING

- Always adapt your driving style to the traffic conditions.
- Only use the launch control programme when road and traffic conditions permit, and make sure your manner of driving and accelerating the vehicle does not inconvenience or endanger other road users.
- Please note that the driven wheels may start to spin when the sport mode is switched on, causing the vehicle to lose grip, in particular on slippery or wet roads - danger of skidding!
- When acceleration has been completed, you should deactivate the sport mode again by briefly pressing the  button.

### Note

- The gearbox may be hot after you have used the launch control programme. In this case, the programme may not be available for several minutes. The programme will be available again after a cool-down period.
- Accelerating with the launch control programme places a heavy load on all parts of the vehicle. This can result in increased wear and tear.

### Back-up programme

Applies to vehicles: with S tronic gearbox

*A back-up system is in place should a fault occur in the control system.*

If all selector lever positions are highlighted in the instrument cluster display, a system malfunction has occurred. In this case, the

S tronic gearbox will switch to a backup programme. The vehicle can still be driven in the backup programme, however only at reduced speed and not in all gears. In certain cases, you may not be able to select **reverse gear**.

### CAUTION

If the gearbox switches to the back-up programme, drive to a qualified workshop without delay and have the fault rectified.

### Gearbox malfunction

 **Gearbox malfunction: please stop the vehicle and select P.**

There is a malfunction in the gearbox. Park the vehicle safely and do not drive on. Obtain professional assistance.

 **Gearbox overheating! Please stop vehicle!**

The gearbox is overheating and could be damaged. Stop the vehicle and let the gearbox cool down with the engine idling and the selector lever in position P. If the indicator lamp and the message disappear, drive to a qualified workshop soon and have the fault rectified. Do not drive on if the warning lamp stays on and the message does not disappear. You should obtain professional assistance.

 **Gearbox malfunction: you can continue driving**

Drive to a qualified workshop soon and have the fault rectified.

 **Gearbox malfunction: no reverse gear (you can continue driving)**

Drive to a qualified workshop without delay and have the fault rectified.

 **Gearbox malfunction: you can continue driving in D until engine off**

Park your vehicle well away from moving traffic. You should obtain professional assistance.

 **Gearbox overheating: please adapt driving style**

You can continue driving at moderate speed. You can resume normal driving if the indicator lamp goes out.

### Gearbox: please press brake pedal and select gear again

If a gearbox malfunction has occurred due to overheating, this message will appear once the gearbox has cooled down again.

### Releasing the selector lever manually (left-hand drive vehicles)

Applies to vehicles: with S tronic gearbox

*The selector lever can be released manually if the electrical power supply should fail.*



Fig. 122 Selector lever: Removing the cover



Fig. 123 Manually releasing the selector lever from position P



This section describes how to manually release the selector lever on left-hand drive vehicles.

The manual release mechanism is located on the right underneath the selector gate. Releasing the selector lever requires a certain degree of practical skill. We therefore advise you to obtain professional assistance.

To release the selector lever, you will need the screwdriver from the vehicle's tool kit, which

is located in the luggage compartment ⇒ page 236. Use the flat-blade side of the reversible screwdriver insert.

### Removing the selector lever cover

- ▶ Apply the parking brake  ⇒  to prevent your vehicle from moving.
- ▶ Insert the flat-blade side of the screwdriver into the opening at the side of the gear lever boot and lever off the boot and lever off the boot ⇒ Fig. 122.
- ▶ Take hold of the corners of the selector lever boot by hand and carefully turn it inside out over the gear knob ⇒ Fig. 123.

### Releasing the selector lever manually

- ▶ Press the yellow release mechanism sideways with the screwdriver and hold it in place ⇒ Fig. 123.
- ▶ Now press the interlock button on the selector lever  and move the selector lever to position N.
- ▶ After manually releasing the selector lever make sure you clip the gear lever boot back into the gearshift gate.

If the power supply should ever fail (discharged battery, etc.) and the vehicle has to be pushed or towed, the selector lever must first be moved to position N. This is possible after operating the manual release mechanism.

### WARNING

The selector lever must not be moved out of position P if the parking brake is not applied. If this is not possible, use the brake pedal to hold the vehicle. On a slope the vehicle could otherwise start to move inadvertently after shifting the selector lever out of position P - accident risk!

## Releasing the selector lever manually (right-hand drive vehicles)

Applies to vehicles: with S tronic gearbox

The selector lever can be released manually if the electrical power supply should fail.



Fig. 124 Selector lever: Removing the cover

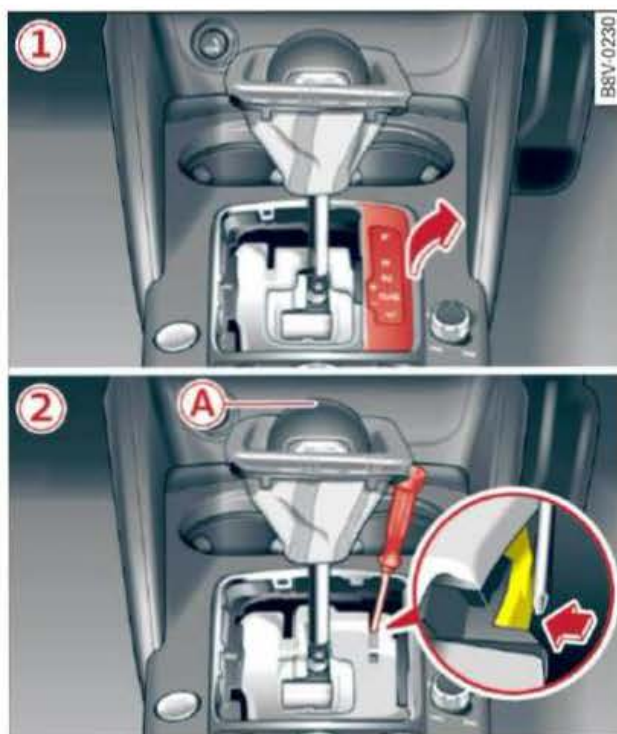

Fig. 125 Manually releasing the selector lever from position P

This section describes how to manually release the selector lever on right-hand drive vehicles.

The manual release mechanism is located on the right underneath the selector gate. Releasing the selector lever requires a certain degree of practical skill. We therefore advise you to obtain professional assistance.

To release the selector lever, you will need the screwdriver from the vehicle's tool kit, which is located in the luggage compartment

⇒ page 236. Use the flat-blade side of the reversible screwdriver insert.

### Removing the selector lever cover

- ▶ Apply the parking brake (P) ⇒ ⚠ to prevent your vehicle from moving.
- ▶ Insert the flat-blade side of the screwdriver into the opening at the side of the gear lever boot and lever off the boot ⇒ Fig. 124.
- ▶ Take hold of the corners of the selector lever boot and carefully turn it inside out over the gear knob ① ⇒ Fig. 125.
- ▶ Take out the panel for the selector lever position indicator and let it hang down to one side, suspended by the cable ① ⇒ Fig. 125.

### Releasing the selector lever manually

- ▶ Press the yellow release mechanism sideways with the screwdriver and hold it in place ② ⇒ Fig. 125.
- ▶ Now press the interlock button on the selector lever (A) and move the selector lever to position N.
- ▶ After manually releasing the selector lever, make sure you fit the panel for the selector lever position indicator back in the selector gate and clip the gear lever boot back into place.

If the power supply should ever fail (discharged battery, etc.) and the vehicle has to be pushed or towed, the selector lever must first be moved to position N. This is possible after operating the manual release mechanism.

### ⚠ WARNING

The selector lever must not be moved out of position P if the parking brake is not applied. If this is not possible, use the brake pedal to hold the vehicle. On a slope the vehicle could otherwise start to move inadvertently after shifting the selector lever out of position P - accident risk!

## Audi adaptive cruise control

### Introduction

Applies to vehicles: with Audi adaptive cruise control

The adaptive cruise control is a combined speed and distance control system. It assists the driver by controlling the road speed and the distance to the vehicle in front within certain limits imposed by the system. The adaptive cruise control system can accelerate and brake when it detects a vehicle in front. This provides maximum comfort both on long motorway journeys and, in conjunction with an automatic gearbox\*, in congested traffic.

### General notes

#### General notes

Applies to vehicles: with Audi adaptive cruise control and Audi pre sense front



Fig. 126 Front of vehicle: Sensor

These general notes apply to the adaptive cruise control\* and pre sense front\* ⇒ *page 125*.

The area surrounding the radar sensor ⇒ *Fig. 126* must be kept free of stickers, deposits and any other substances which could impair the function of the adaptive cruise control and pre sense front systems. Notes on cleaning ⇒ *page 204*. Please bear the above in mind if technical modifications are made to the front of the vehicle.

The functionality of the adaptive cruise control and pre sense front systems is restricted in certain situations:

- Objects cannot be detected until they are within the range of the sensor ⇒ *page 117, Fig. 129*.
- The ability of the system to detect objects in front is limited when they are too close, travelling out of line, or moving into your lane.
- Vehicles that are not clearly discernible, e.g. a motorcycle or cyclist travelling in front of you and vehicles with high ground clearance or a protruding load, are often identified late or are not detected at all.
- When driving through bends ⇒ *page 117*.
- When vehicles are stationary ⇒ *page 117*.

#### WARNING

Please always direct your full attention to the road, even when you are using the adaptive cruise control and pre sense front ⇒ *page 125* is activated. It is always the driver who is responsible for pulling away safely and maintaining a safe speed and distance from other road users. The purpose of pre sense front is to assist the driver. The driver must always intervene manually to avoid an impending collision. As the driver you are always responsible for braking in good time.

- For safety reasons, the adaptive cruise control must not be used on roads with a lot of bends or in poor weather or difficult or slippery driving conditions (such as ice, fog, loose grit or gravel, heavy rain, etc.) - risk of accident!
- When you take a turn-off, drive along a motorway exit lane or pass through road-work sections, please temporarily switch off the adaptive cruise control system. This is to ensure that the vehicle does not accelerate to the cruising speed in such situations.
- The adaptive cruise control system will not brake the vehicle automatically if you rest your foot on the accelerator pedal. Resting your foot on the accelerator pedal overrides the speed and distance control function.

- The adaptive control system does not react and the functionality of pre sense front is restricted when you approach stationary traffic, such as the end of a traffic jam.
- The adaptive cruise control and pre sense front systems do not react to pedestrians, animals or crossing or oncoming traffic.
- Reflecting objects, such as crash barriers, the entrance to a tunnel, heavy rain or ice can impair the function of the radar sensor.

### ! CAUTION

Impacts or damage to the bumper, wheel arches or underbody can cause misalignment of the sensor. The adaptive cruise control and pre sense front systems can be impaired as a result. Have the systems checked by a qualified workshop.

### When driving through a corner

Applies to vehicles: with Audi adaptive cruise control and Audi pre sense front

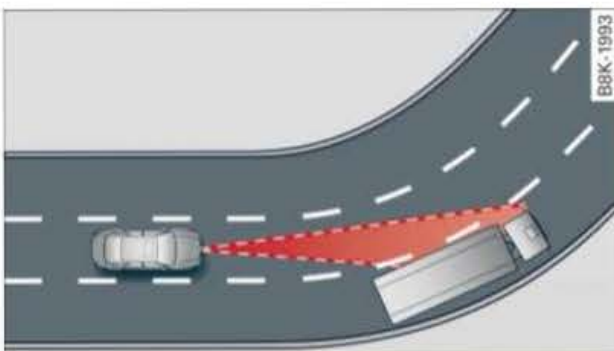

Fig. 127 Example: Driving into a bend

When driving into a bend ⇒ Fig. 127 and driving out of a bend, the adaptive cruise control system may react to a vehicle travelling in the next lane and therefore brake the vehicle. You can prevent this from happening by accelerating briefly.

### Stationary vehicles

Applies to vehicles: with Audi adaptive cruise control and Audi pre sense front

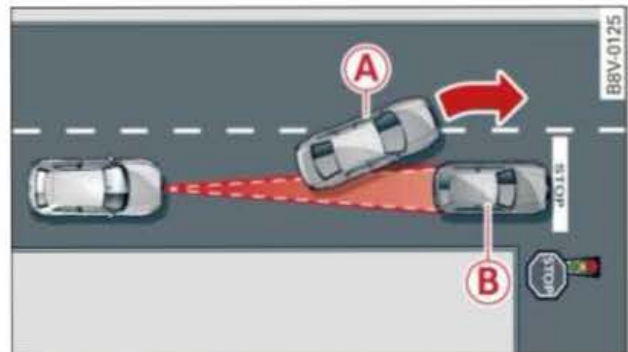

Fig. 128 Example: Vehicle changing lane and vehicle stationary

### Adaptive cruise control

The adaptive cruise control system only reacts to moving objects or vehicles which have already been detected as moving objects. For example, if a vehicle (A), which has already been detected by the adaptive cruise control, turns off or changes lane and another stationary vehicle (B) is located in front of that vehicle, the system will not react to the stationary vehicle. Press the brake pedal to slow down.

### Pre sense front

Pre sense front only reacts to stationary objects at low speed.

## Adaptive cruise control

### Description

Applies to vehicles: with Audi adaptive cruise control

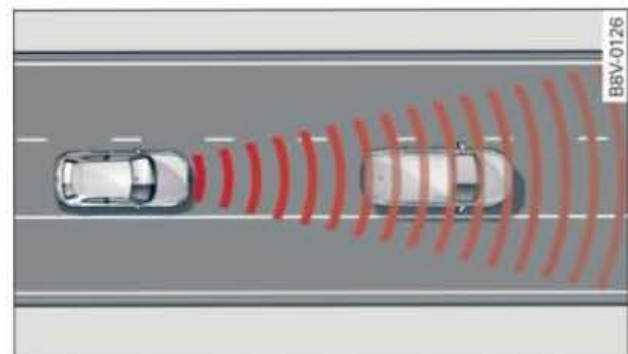

Fig. 129 Sensor range

### What can the adaptive cruise control do?

The adaptive cruise control uses a radar and video camera. The radar is subject to certain system limitations ⇒ page 116.

When there is no traffic in front, the adaptive cruise control works just like a normal cruise control system by maintaining a constant speed. When you draw closer to a vehicle in front which is detected by the system, the adaptive cruise control matches your speed to that vehicle by automatically applying the brakes, and then maintains a constant distance (which you can adjust in the settings). As soon as it detects no more vehicles in front, the adaptive cruise control accelerates back up to the cruising speed.

Applies to vehicles with automatic gearbox\*: In congested traffic, the adaptive cruise control can brake down to a standstill (subject to general system limitations) and accelerate again under certain conditions ⇒ *page 120, Vehicles with automatic gearbox.*

In addition, the start/stop system may operate in the usual way while the vehicle is at a standstill ⇒ *page 98.*

### Which functions can the driver control?

When you switch on the adaptive cruise control, you can set your current speed as the “cruising speed” ⇒ *page 118, Switching on/off.*

While you are driving, you can interrupt the cruise control ⇒ *page 121* or change the speed setting ⇒ *page 120* at any time.

You can also change the following settings:

- Distance ⇒ *page 122*
- Driving program ⇒ *page 122*
- Driving mode ⇒ *page 122*

### Switching on/off

Applies to vehicles: with Audi adaptive cruise control

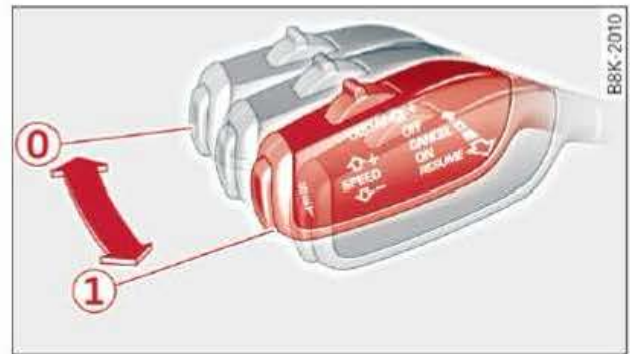

Fig. 130 Control lever: Switching on/off



Fig. 131 Instrument cluster display: adaptive cruise control

Depending on the equipment in your vehicle, different cruising speeds may apply to the adaptive cruise control:

**ACC (assist package):** You can set any speed<sup>1)</sup> between 30 and 200 km/h.

**ACC:** You can set any speed<sup>1)</sup> between 30 and 150 km/h.

Indicator lamps and messages in the instrument cluster display will provide you with information about the current driving situation and settings.

### Switching on the adaptive cruise control

- ▶ Pull the lever towards you to position ① ⇒ *Fig. 130*. **ACC: standby** will appear on the instrument cluster display. ▶

<sup>1)</sup> The speed limits vary in different countries and depend on the units of speed on the speedometer.



## Setting the speed and activating the cruise control

- ▶ To set the current speed as the cruising speed, press the **SET** button ⇒ Fig. 130. The speed setting is indicated by the LEDs **(A)** in the speedometer and is also shown briefly in the system status indicator **(D)** ⇒ Fig. 131.
- ▶ Vehicles with automatic gearbox: To activate the cruise control when the vehicle is stationary, the Audi hold assist\* function must have been activated or you must press the brake pedal.

## Switching off the adaptive cruise control

- ▶ Push the lever away from you to position **(O)** until it engages. The message **ACC: off** will appear.

The LEDs indicating the stored speed in the speedometer dial will go out.

## **(B)** Warning and indicator lamps

 - The adaptive cruise control is switched on. No vehicle has been detected in front. A constant cruising speed is being maintained.

 - A vehicle in front has been detected. The adaptive cruise control regulates the speed to maintain a constant distance to the vehicle in front, and brakes and accelerates the vehicle automatically.

 - Automatic gearbox: The adaptive cruise control is switched on. A vehicle in front has been detected. Your vehicle is stationary and will not be set in motion again automatically.

 - The adaptive cruise control alone is not able to brake the vehicle sufficiently to maintain a safe distance to the vehicle in front. You must intervene ⇒ page 123, *Driver intervention prompt*.

## **(C)** Graphical display in instrument cluster

If the adaptive cruise control is not shown on the instrument cluster display, you can call up the display using the controls on the multi-function steering wheel ⇒ page 29.

The graphical display shows you when a vehicle in front is detected and indicates how far away you are from that vehicle:

**No vehicle** - No vehicle has been detected in front.

**Vehicle in white** - A vehicle has been detected in front.

**Vehicle in red** - Driver intervention prompt ⇒ page 123.

The two **arrows** on the **scale (C)** indicate the distance to the vehicle in front. If there is no vehicle in front, no arrows will be shown. If a vehicle is detected in front, the arrows will be on the scale.

The green area of the scale represents the distance setting (for information on how to change the distance setting, refer to ⇒ page 122). When the actual distance is shorter (or is likely to become shorter) than the distance selected, the arrows move into the red area of the scale.

### **WARNING**

Vehicles with automatic gearbox: If you press the **SET** button at a speed of less than 30 km/h, the vehicle will automatically accelerate up to the minimum speed setting of 30 km/h.

### **Note**

- The speed setting is cleared for safety reasons when you switch off the ignition or the adaptive cruise control system.
- When the adaptive cruise control is activated, you cannot switch on the ESC sport mode.

### Setting a new speed

Applies to vehicles: with Audi adaptive cruise control



Fig. 132 Control lever: Setting a new speed

- ▶ **Briefly** push the lever up or down to increase or reduce the speed in steps.
- ▶ To increase or reduce the speed quickly, press and **hold** the lever up or down until the red LED **A** reaches the desired speed ⇒ page 118, Fig. 131.

Following any changes, the new stored speed will be displayed briefly in the system status indicator ⇒ page 118, Fig. 131 **D**.

### Vehicles with manual gearbox

Applies to vehicles: with Audi adaptive cruise control

The adaptive cruise control is available in second gear or higher (when driven in the normal engine speed range).

When the adaptive cruise control is switched on, you must press the clutch pedal in the normal way in order to change gear. The adaptive cruise control will remain activated when you change gear or press the clutch pedal.

You do **not** need to press the accelerator after selecting a gear and releasing the clutch. The adaptive cruise control will regulate the speed for you.

The adaptive cruise control will be switched off automatically if you keep the clutch pedal depressed for too long or if you change gears incorrectly or use the clutch pedal improperly.

### Note

You cannot switch on the adaptive cruise control during a gear change.

### Vehicles with automatic gearbox

Applies to vehicles: with Audi adaptive cruise control

The adaptive cruise control assists you when driving in congested traffic. When the adaptive cruise control has detected a vehicle in front and that vehicle stops, it applies the brakes (subject to system limitations) and holds the vehicle at a standstill. When the start/stop system is active, the engine is switched off under certain conditions. The engine can be switched on again...

- ▶ by the start/stop system ⇒ page 98.
- ▶ if the vehicle in front drives away.
- ▶ if you pull the lever to position **2** ⇒ page 121, Fig. 133.
- ▶ if you tap the accelerator pedal.

To resume adaptive cruise control mode when the engine is running:

- ▶ Tap the accelerator pedal, or
- ▶ Pull the lever towards you to position **2** ⇒ page 121, Fig. 133.

### Using the adaptive cruise control to set the vehicle in motion<sup>1)</sup>

The message **ACC: automatic go** appears briefly after the adaptive cruise control has detected an object in front and braked the vehicle to a standstill. In this mode, your vehicle can drive off automatically.

If the message **ACC: automatic go** is on the display and the vehicle in front drives off, your vehicle will automatically start moving ⇒ **A**.

You can reactivate the **ACC: automatic go** message briefly by pulling the lever to position **2** ⇒ page 121, Fig. 133.

The **ACC: automatic go** mode is deactivated if you press the brake pedal. ▶

<sup>1)</sup> Not available on vehicles for some markets.

## Conditions for deactivation of the system

For safety reasons, the adaptive cruise control is deactivated when the vehicle is stationary:

- if the driver's door is opened.
- if the vehicle remains stationary for over 3 minutes.
- if the driver's seat belt is unbuckled.

### WARNING

If the **ACC: automatic go<sup>1)</sup>** message appears, your vehicle will start moving even if there is an obstacle between your car and the vehicle in front - risk of accident!

### Note

- If your vehicle does not start moving as expected with the adaptive cruise control, even though the **ACC: automatic go<sup>1)</sup>** message is displayed, you can set the vehicle in motion by tapping the accelerator with your foot.
- The start/stop system operates normally while you are driving with the adaptive cruise control.

## Interrupting the cruise control

Applies to vehicles: with Audi adaptive cruise control

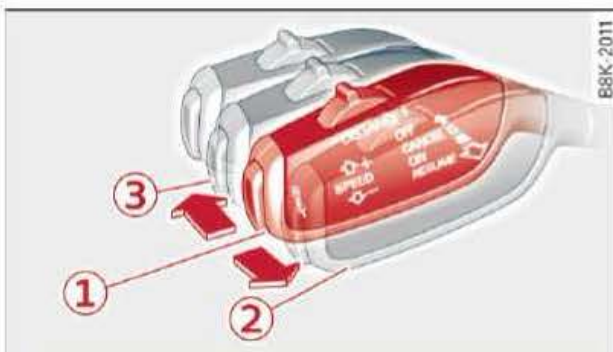

Fig. 133 Control lever

Important: The adaptive cruise control must be on.

## Overriding the cruise control

Occasionally you may want to exceed the stored cruising speed while the adaptive cruise

control is switched on, for instance in order to overtake a vehicle.

- ▶ To accelerate manually, pull the lever towards you to position ② and hold it in this position. The message **ACC: override** will appear. Or:
- ▶ Press the accelerator.
- ▶ To reactivate the cruise control, release the lever or take your foot off the accelerator.

## Interrupting the cruise control while driving

- ▶ Move the lever to position ③. The message **ACC: standby** will appear. Or:
- ▶ Apply the brakes.
- ▶ To reactivate the cruise control and accelerate back up to the target speed, move the lever to position ②.

## Interrupting the cruise control while stationary

Applies to vehicles with automatic gearbox:

- ▶ Push the lever away from you to position ③. The message **ACC: standby** will appear.
- ▶ To reactivate the cruise control, press the brake pedal and pull the lever towards you to position ②.

### WARNING

It is dangerous to activate the cruise control and accelerate back up to a target speed which is too high for the current road, traffic or weather conditions - risk of accident!

<sup>1)</sup> Not available on vehicles for some markets.

### Setting the distance

Applies to vehicles: with Audi adaptive cruise control



Fig. 134 Control lever: Setting the distance

- ▶ To display the current distance setting, briefly press the rocker switch ⇒ Fig. 134.
- ▶ To increase or reduce the distance by one level, briefly press the rocker switch to the right or left again. The distance between the two vehicles will be shown on the instrument cluster display.

When you draw closer to a vehicle detected in front, the adaptive cruise control matches your speed to that vehicle by applying the brakes, and then maintains a constant distance (which you can adjust in the settings). If the vehicle in front accelerates, the adaptive cruise control will also accelerate, up to the target speed you have specified.

The higher the speed, the higher the distance in metres ⇒ ⚠. We recommend you to use the setting: **distance 3**. You will then be following the general recommendations of automobile clubs, traffic authorities, etc.

The actual distance maintained by the adaptive cruise control can be longer or shorter, depending on the traffic situation, your current speed, and the driving style of the driver in front.

🚗—🚗— distance 1: This setting is equivalent to a distance of 28 metres at a speed of 100 km/h (time-based distance of 1 second).

🚗—🚗— distance 2: This setting is equivalent to a distance of 36 metres at a speed of 100 km/h (time-based distance of 1.3 seconds).

🚗—🚗— distance 3: This setting is equivalent to a distance of 50 metres at a speed of 100 km/h (time-based distance of 1.8 seconds).

🚗—🚗— distance 4: This setting is equivalent to a distance of 67 metres at a speed of 100 km/h (time-based distance of 2.4 seconds).

#### ⚠ WARNING

When setting the distance, the driver is responsible for adhering to the locally applicable laws and regulations.

#### i Note

**Distance 3** is set automatically each time the ignition is switched on. If you would prefer to have a different distance as the default setting, you can have the **adaptive cruise control** menu extended/activated by a qualified workshop.

### Setting the driving program

Applies to vehicles: with Audi adaptive cruise control

You can select different driving programs for the adaptive cruise control on vehicles without Audi drive select\*.

- ▶ On the MMI\*, select: **MENU** button > control button **Systems / Car systems** > **Driver assist** > **Adaptive cruise control** > **Driving program** > **comfort/standard/dynamic**.

### Selecting the driving mode

Applies to vehicles: with Audi adaptive cruise control

On vehicles with drive select, the driving program for the adaptive cruise control is selected via the driving mode.

- ▶ Select the desired driving mode with the rotary pushbutton: **efficiency\***, **comfort**, **auto**, **dynamic** or **individual\*** ⇒ page 136.

## Driver intervention prompt

Applies to vehicles: with Audi adaptive cruise control



Fig. 135 Instrument cluster: Driver intervention prompt

In some situations the adaptive cruise control system alone is not able to brake the vehicle sufficiently to maintain a safe distance to the vehicle in front. The driver intervention prompt warns you to take action in these situations.

The warning lamp  and instrument cluster display draw your attention to the danger ⇒ Fig. 135. In addition, a tone will sound. Press the brake pedal to slow down.

## Driver messages

Applies to vehicles: with Audi adaptive cruise control

### ACC: not available

The system cannot detect objects reliably and will be deactivated. The sensor is out of alignment or defective. Drive to a qualified workshop and have the fault rectified.

### ACC: currently unavailable - no sensor vision

### ACC and Audi pre sense: currently unavailable. No sensor vision

These messages appear if the radar sensor vision is impaired, e.g. by leaves, snow, heavy road spray or dirt. Clean the sensor ⇒ page 116, Fig. 126.

### ACC: currently unavailable. Gradient too steep

The maximum possible road gradient for safe operation of the adaptive cruise control has

been exceeded. The adaptive cruise control cannot be switched on.

### ACC: only available in D, S or M

Move the selector lever to position D/S or M.

### ACC: parking brake applied

The adaptive cruise control system is deactivated if the parking brake is applied. The adaptive cruise control will be available again when the parking brake is released.

### ACC: currently unavailable. Stabilisation control input

This message appears if the electronic stabilisation control (ESC) intervenes. In this case, the adaptive cruise control will automatically be switched off.

### ACC off: manual control!

This message appears if the vehicle rolls backwards when driving away on a slight gradient, even though the adaptive cruise control is active. Press the brake pedal to prevent the vehicle from rolling back or colliding with an object behind.

### ACC: currently unavailable. Speed too low

This message appears on vehicles with manual gearbox if the current speed is too low for ACC mode.

You cannot store speed settings below 30 km/h. The cruise control system switches off if the speed falls below 20 km/h.

### ACC: available from 2nd gear up

The adaptive cruise control only operates in 2nd gear or higher (on vehicles with manual gearbox).

### ACC: engine speed

This message appears if the driver does not change gear in time when the adaptive cruise control accelerates or brakes the vehicle. The adaptive cruise control is switched off if the engine speed is not maintained within the permissible range. This is indicated by a warning tone. ▶

### ACC: clutch pedal pressed

Vehicles with manual gearbox: Cruise control mode is deactivated if the clutch pedal is pressed for a relatively long period.

•••

Three white dots appear if a setting made with the control lever cannot be implemented. This might happen after stopping, for example, if the adaptive cruise control cannot set the vehicle in motion because the driver has unbuckled the seat belt.

### **Door open**

Vehicles with automatic gearbox: You cannot switch on the adaptive cruise control if the vehicle is stationary and a door is open.

## Audi pre sense

### Introduction

Applies to vehicles: with Audi pre sense basic or Audi pre sense front

Pre sense basic and pre sense front can take action to protect the occupants in certain hazardous conditions, subject to the limitations of the system.

Because the different on-board systems are networked, pre sense basic can detect critical situations and take action to prepare the occupants for a potential impending collision.

Pre sense front uses a radar sensor and video camera\*. It remains active (subject to the limitations of the system) even when the adaptive cruise control\* is switched off.

### General notes

#### General notes

Applies to vehicles: with Audi pre sense front or Audi adaptive cruise control



#### WARNING

Please observe the general safety warnings on [⇒ page 116, General notes](#).

### Audi pre sense basic

#### Description

Applies to vehicles: with Audi pre sense basic

Pre sense basic functions are activated at speeds above 30 km/h.

The system can activate the following functions in certain situations:

- Seat belt tensioning (e.g. during hard braking): The seat belts on the front seats have reversible tensioners. Provided an accident does not occur, the belts are loosened again slightly and kept ready for activation.
- Windows and sun roof\* automatic close function (e.g. during understeer or oversteer): The sun roof\* is closed completely but a small gap is left when the windows are closed.

Drive select: the activation threshold is different in dynamic mode.



#### WARNING

The protection provided by pre sense basic is still subject to the prevailing physical limits. It is a driver assist function and cannot prevent a collision on its own. Do not let the extra safety provided tempt you into taking any risks when driving – this can cause accidents.

- Due to inherent system limitations, false activation of the system is possible.



#### Note

- Certain pre sense basic functions are deactivated when the ESC sport mode is switched on and when reversing.
- The functions of the pre sense basic system may also be unavailable if a fault develops in the ESC system or airbag control unit.
- For pre sense basic, please note that if the front passenger's airbag has been deactivated, the reversible belt tensioner on the passenger's side will be deactivated as well.

### Audi pre sense front

#### Description

Applies to vehicles: with Audi pre sense front or Audi adaptive cruise control

Pre sense front informs you if you are too close to the vehicle in front for an extended period. In certain situations it can warn you if there is a danger of collision, and can initiate the application of the brakes.

Given sufficient time to react, it can assess a dangerous situation where a vehicle in front brakes suddenly or where you are driving fast and approach a much slower vehicle. The pre sense front will not react if it is not in a position to detect the danger.



## Warnings

Applies to vehicles: with Audi pre sense front or Audi adaptive cruise control



Fig. 136 Instrument cluster: Collision warning

The system draws the driver's attention to hazardous situations:

- Vehicles with adaptive cruise control: A **distance warning** is given if you are too close to the vehicle in front for more than just a moment. If the vehicle in front were to brake hard, a collision would no longer be avoidable. This is indicated by a warning lamp .
- A **collision warning** is given if the vehicle in front is much slower than you or if it brakes hard. If this warning is given, you may need to take evasive action or brake hard to avoid a collision. The driver message **Audi pre sense**  **Distance!** ⇒ Fig. 136 and a warning tone draw your attention to the danger. On vehicles equipped with adaptive cruise control, the warning lamp  will also light up.

If you do not take appropriate action in time, the pre sense front will assist by applying the brakes.

- In the event of an impending collision, an **acute warning** will be given initially in the form of a brake jolt. In addition, the instrument cluster display ⇒ Fig. 136 draws your attention to the danger. On vehicles equipped with adaptive cruise control, the warning lamp  will also light up.
- If you do not respond to the acute warning, the pre sense front can, subject to general system limitations, apply the brakes with in-

creasing brake force<sup>1)</sup>, in order to slow the vehicle down and take the impact out of a potential collision. In addition, the message **Audi pre sense - Input** will appear.

- At low road speeds, pre sense front can initiate a full brake application<sup>1)</sup> just before an impending collision.
- If the pre sense front detects that you are not braking hard enough in the event of an impending collision, it will increase the brake pressure.

## WARNING

- The protection provided by pre sense front is still subject to the prevailing physical limits. It is a driver assist function and cannot prevent a collision on its own. The driver must always intervene personally. As the driver you are always responsible for braking in good time. Do not let the extra safety provided tempt you into taking any risks when driving – this can cause accidents.
- Due to inherent system limitations, false activation of the system is possible.
- Please note that the sensor is not always able to detect all objects which may represent a potential hazard (accident risk).
- Pre sense front does not react to people, animals, crossing traffic or objects that cannot be clearly recognised ⇒ page 116, General notes.
- Reflecting objects, such as crash barriers, the entrance to a tunnel, heavy rain or ice can impair the function of the radar sensor and the ability of the system to detect a collision risk.

## CAUTION

Impacts or damage to the bumper, wheel arches or underbody can cause misalignment of the sensor. This can impair the function of the pre sense front system. Have the systems checked by a qualified workshop.

<sup>1)</sup> Not available on vehicles for some markets.



**i Note**

- The automatic brake application with increasing brake force can be cancelled by applying the brakes yourself or by pressing the accelerator firmly or by taking evasive action.
- For driver messages relating to pre sense refer to ⇒ *page 127*.
- Please note that pre sense front can apply the brakes unexpectedly. Always secure your luggage to prevent damage and possible injury.
- Certain pre sense front functions are deactivated when the ESC sport mode is switched on and when reversing.
- The functions of pre sense front will be unavailable if a fault develops in the adaptive cruise control\* ⇒ *page 123* / ⇒ *page 127*.

**Settings on the infotainment system**

Applies to vehicles: with Audi pre sense front or Audi adaptive cruise control

- ▶ Select the following on the MMI\*: **MENU** button > control button **Systems / Car systems** > **Driver assist** > **Audi pre sense**.

Depending on the equipment in your vehicle, two different operating concepts are used:

- Concept 1: When the Audi pre sense is switched off via the **System** setting, it remains deactivated the next time you switch on the ignition.
- Concept 2: When the Audi pre sense is switched off via the **System** setting, it is automatically activated again the next time you switch on the ignition.

**Switching the system on/off**

**System** - Audi pre sense can be switched **on/off**. This allows you to deactivate the early warning and prevent Audi pre sense from applying the brakes automatically.

**Early warning** - The distance and collision warnings can be switched **on/off** permanently.

**i Note**

- The pre sense is deactivated if you restrict or switch off the ESC ⇒ *page 183*.
- Switch off pre sense while the vehicle is being loaded onto a car transporter, train or ferry boat, etc. This prevents the pre sense system from activating a warning in an inappropriate situation.

**Driver messages**

Applies to vehicles: with Audi pre sense or Audi adaptive cruise control

**Audi pre sense: currently unavailable. No sensor vision**

This message appears if the radar sensor vision is impaired, e.g. by leaves, snow, heavy road spray or dirt. Clean the sensor ⇒ *page 116, Fig. 126*.

**Audi pre sense: off**

This message appears in certain situations, e.g. when the ESC is switched to sport mode ⇒ *page 183*.

**Audi pre sense: system fault!**

This message appears if the functions of the pre sense system are impaired. An impairment can occur, for example, if a sensor fails.

If the message remains displayed permanently, drive to a qualified workshop and have the fault rectified.

## Audi active lane assist

### Lane departure warning feature

#### Description

Applies to vehicles: with Audi active lane assist

The active lane assist uses a camera in the windscreen to detect lane markings (subject to general system limitations). If you approach one of the detected lane markings, the system corrects the steering to warn you that the vehicle might be about to cross one of the markings. You can override this steering input at any time. The steering wheel vibrates slightly if you cross a lane marking. The vibration warning must be activated beforehand in the MMI\*. The active lane assist is functional when it detects a demarcation line on at least one side of the lane in which you are driving.

The system does not warn you if you operate the turn signal before crossing a lane marking. In this case, it assumes that you intend to change lanes.

As the system is designed for driving on motorways and other major roads, it is only active above a speed of about 65 km/h (may vary in different export markets).

#### WARNING

- The system initiates a corrective steering input to warn the driver that the vehicle is about to leave the lane. As the driver you are always responsible for staying in your own lane.
- The system can assist you to keep the vehicle in the lane, however it is not capable of driving on its own. Never take your hands off the steering wheel.
- In certain situations, e.g. during heavy braking, the system may not correct the steering.
- In certain circumstances, not all of the lane markings may be detected by the camera. A corrective steering input can

only be initiated if the system detects a lane marking on the side in question.

- Variations in the road surface or objects on the road may be misinterpreted as lane markings. In this case, the steering may be corrected unexpectedly or not at all.
- The camera's view may occasionally be obstructed, for example by vehicles travelling in front, rain, snow, heavy road spray, adverse light or a dirty windscreen. If this happens, the active lane assist may not detect the lane markings or may respond incorrectly.
- In certain circumstances, for instance if visibility is poor, the setting for the steering input may be switched from "early" to "late" <sup>1)</sup>.
- In certain driving conditions, such as ruts in the road surface, adverse cambers or side winds, the assistance provided by the steering correction may be insufficient to keep the vehicle in the middle of the lane.
- For safety reasons, the active lane assist must not be used in poor weather or in difficult or slippery road conditions (such as ice, fog, loose grit or gravel, heavy rain, snow, etc.) - risk of accident!

<sup>1)</sup> This function is not available on all export versions.

## Switching on/off

Applies to vehicles: with Audi active lane assist



Fig. 137 Turn signal lever; Button for active lane assist

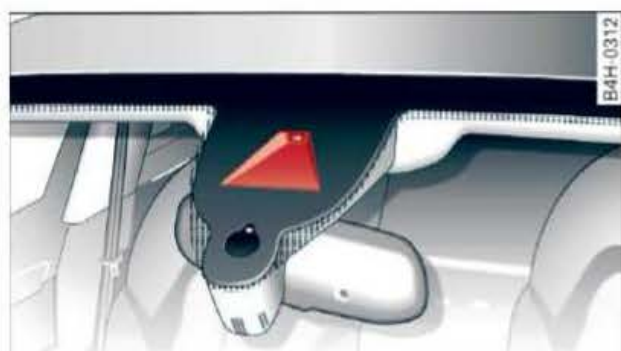





Fig. 138 Windscreen: Camera window for active lane assist

- ▶ Press the button ⇒ Fig. 137 to switch the system on/off. The indicator lamp  or  in the instrument cluster will light up or go out.

### Indicator lamps

 **Ready:** The indicator lamp lights up when the system is fully functional. The system is ready to intervene.

 **Not ready:** The indicator lamp lights up when the system is switched on but not ready to intervene. The causes for this can include the following:

- There are no lane markings.
- The system cannot detect the relevant lane markings (e.g. temporary markings for road works or markings obscured by snow, dirt, rain or adverse light).
- The vehicle's speed is below 65 km/h, the speed at which the lane assist system is activated (the threshold may vary in different export markets).
- The lane is narrower than 2.5 m or wider than 5.5 m.

- The bend is too tight.
- You have taken your hands off the steering wheel.

### Note

- Make sure that the camera window ⇒ Fig. 138 is not covered with stickers or similar objects. Notes on cleaning ⇒ page 204.
- On vehicles for some export markets: once the system is activated, it is "ready" each time the ignition is switched on.

## Instrument cluster display

Applies to vehicles: with Audi active lane assist



Fig. 139 Instrument cluster: Monochrome display



Fig. 140 Instrument cluster: Multi-coloured display

Different controls are used to operate the active lane assist, depending on the equipment in your vehicle:

- Controls on **windscreen wiper lever** ⇒ page 28, or
- Control buttons on **multi-function steering wheel\*** ⇒ page 30

### Monochrome display

Refer to ⇒ Fig. 139.

(A)	Solid lines: The active lane assist is switched on and ready to give warnings on the side indicated.
(A)	Flashing line (left or right): The active lane assist warns you by vibrating the steering wheel before you cross the lane demarcation.
(B)	Unfilled line(s): The active lane assist is switched on but not ready to give warnings.
	No lines: The active lane assist is switched off.

### Multi-coloured display

Refer to ⇒ Fig. 140.

(A)	White solid lines: The active lane assist is switched on and ready to give warnings on the side indicated.
(A)	Red line (left or right): The active lane assist warns you by vibrating the steering wheel before you cross the lane demarcation.
(B)	Grey solid lines: The active lane assist is switched on but not ready for warning.
	No lines: The active lane assist is switched off.

### Driver messages in the instrument cluster display

Should the active lane assist experience a fault, the indicator lamp  in the instrument cluster display will go out and one of the following messages will appear:

#### Audi active lane assist: currently unavailable. No camera view

This message is displayed when the camera is no longer functional after the system has continuously failed to detect the lane markings. This can have the following causes:

- The outside of the camera window  
⇒ page 129, Fig. 138 is dirty or frosted. Remove dirt or ice from this area of the windscreen.

- The inside of the camera window is misted up. In this case, wait for the camera window to demist before switching on the active lane assist system again.
- Due to the road conditions, the system has not been able to detect the lane markings for a long period. Do not switch the active lane assist system on again before the lane markings are discernible.

#### Audi active lane assist: currently unavailable

A temporary fault is preventing the active lane assist system from functioning. Try switching on the active lane assist system again later.

#### Audi active lane assist: system fault!

Drive to a qualified workshop soon and have the fault rectified.

#### Audi active lane assist: please continue steering vehicle

This message will appear if you do not steer the vehicle yourself. In this case, the active lane assist will switch to “not ready for warning” but will not be deactivated completely. The system can assist you to keep the vehicle in the lane. However it is your own responsibility to steer and control the vehicle.

### Setting the steering input time and vibration warning

Applies to vehicles: with Audi active lane assist

You can change the active lane assist settings on the MMI to suit your individual preferences.

- Select: **MENU** button > control button **Systems / Car systems** > **Driver assist** > **Audi active lane assist**.

#### Steering input<sup>1)</sup>

**early:** If this setting is selected, a continuous steering input assists the driver to keep the vehicle in the middle of the lane. ►

<sup>1)</sup> This function is not available on all export versions.

**late:** If this setting is selected, the steering is not corrected until just before a wheel touches a detected lane marking.

### Vibration warning

You can switch the additional steering wheel vibration warning on/off.

#### **WARNING**

When the vibration warning is switched off, no visual warnings are given in the instrument cluster display if you cross a lane marking.

#### **Note**

Your personal settings are stored automatically and assigned to the remote control key which is being used (only applies to some countries).

## Audi side assist

### Lane change assist feature

#### Description

Applies to vehicles: with Audi side assist



Fig. 141 Area covered by the radar sensors



Fig. 142 Warning lamp on exterior mirror

The side assist function assists the driver in monitoring following traffic and the blind spots on both sides of the car. Within certain limits imposed by the system, it warns you if it detects vehicles approaching quickly or travelling at about the same speed as your own vehicle in the area covered by the sensors ① ⇒ Fig. 141. If it judges a lane change to be critical, the warning lamp ② on the exterior mirror lights up ⇒ Fig. 142.

The warning lamp on the left-hand mirror assists the driver when changing lane towards the left and the warning lamp on the right-hand mirror assists the driver when changing lane towards the right.

#### Information mode

As long as you do not operate the turn signal, the side assist will merely *inform* you of the presence of vehicles that it has detected and judges to be critical. In this case, the warning

lamp on the relevant exterior mirror will light up at low intensity.

The intensity of the warning lamp in this information mode is kept relatively low, so that it does not distract you while you are looking at the road in front.

#### Warning mode

If you operate the turn signal, the side assist will *warn* you if it registers what it judges to be a critical vehicle. In this case, the warning lamp on the relevant exterior mirror will flash brightly. Please check the situation in the exterior mirror and by looking back over your shoulder ⇒ ⚠ in *General notes on page 133*.

#### **i** Note

- You can adjust the brightness of the warning lamp on the exterior mirror ⇒ *page 134*.
- Please refer to the notes on the use of a towing bracket ⇒ *page 133*.

## General notes

Applies to vehicles: with Audi side assist

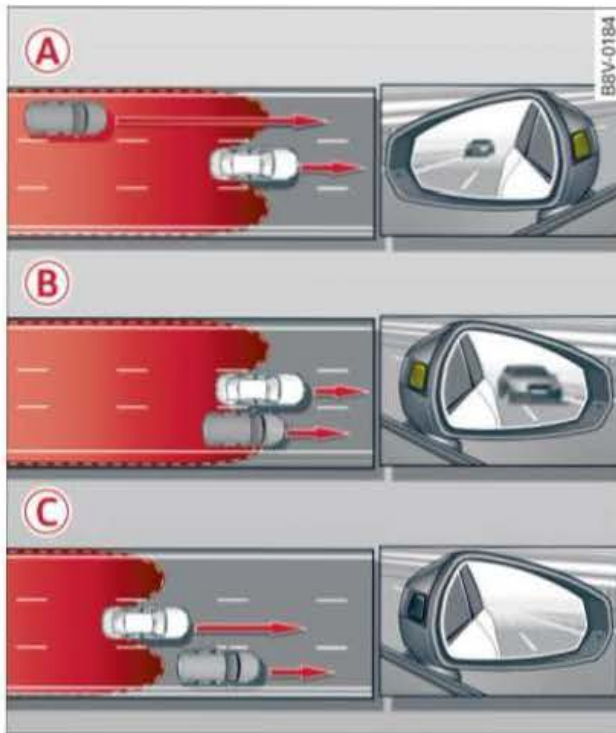

Fig. 143 Driving situations



Fig. 144 Rear of the vehicle: Location of the sensors (example)

The side assist is active above a speed of about 30 km/h.

### A Vehicles approaching from behind

In certain cases, a vehicle is judged to be critical in the event of a lane change even if it is still some distance away. The faster a vehicle approaches, the earlier the warning will appear on the exterior mirror.

### B Vehicles moving at a similar speed

The warning lamp in the relevant exterior mirror will warn you of vehicles that are moving with the flow of traffic at about the same speed as you if they are judged to be critical in the event of a lane change. In all cases, the

side assist will give a warning for the vehicles it has detected at the latest when they enter the “blind spot”.

### C Other vehicles being overtaken

When you are overtaking another vehicle slowly, with a speed differential of less than 15 km/h, the warning lamp in the exterior mirror will light up as soon as the other vehicle enters your blind spot.

If you are overtaking another vehicle quickly, with a speed differential of more than 15 km/h, the warning lamp will not light up.

### System limitations

The radar sensors are designed for normal lane widths and monitor the lanes immediately to the left and right of your vehicle. In certain situations the warning lamp on one of the exterior mirrors may light up even if no vehicle is travelling in an area that could be critical in the event of a lane change. For example:

- When you are travelling in a narrow lane or when you are not travelling in the centre of the lane. In this case the system may monitor another lane and register a vehicle that is *not* in fact travelling in an adjacent lane.
- When you are driving into a bend. The side assist may react to a vehicle two lanes away.
- If the system detects other objects (such as crash barriers, etc).
- In poor weather conditions. The functionality of the side assist is then restricted.

The radar sensors ⇨ Fig. 144 must not be obstructed by stickers, bicycle racks, deposits or any other substances which could impair the function of the system. The side assist must not be used when towing a trailer. For notes on cleaning, please refer to ⇨ page 204.

### ⚠ WARNING

- Always watch the road and the area surrounding the vehicle. The side assist feature is not a substitute for the full concentration of the driver. The driver is always responsible for the safety of lane changes and other manoeuvres.

- In certain situations, the system may not function properly, or the functionality of the system may be restricted. For example:
  - If other vehicles are approaching very quickly, or if you are overtaking other vehicles quickly. The warning lamp may not light up in time.
  - In poor weather conditions, such as heavy rain, snow or road spray.
  - If you are travelling in very wide lanes, in tight bends or over crests. The system may not detect vehicles in the adjacent lane because they are outside the area covered by the sensors.

### CAUTION

Impacts or damage to the bumper, wheel arches or underbody can cause misalignment of the sensors. This can impair the functionality of the system. Have the systems checked by a qualified workshop.

### Note

The warning lamps on the exterior mirrors may not be properly visible if tinted foil is affixed to the side windows on the driver's or passenger's side.

## Switching on and off

Applies to vehicles: with Audi side assist

The system can be switched on and off on the MMI\*.

- ▶ Select: **MENU** button > control button **Systems / Car systems** > **Driver assist** > **Audi side assist**. Select **off** to switch off the system.

The warning lamps in the exterior mirrors light up briefly each time the ignition is switched on to indicate that the system is activated.

## Adjusting brightness of warning lamp

Applies to vehicles: with Audi side assist

*The brightness of the warning lamp can be adjusted on the MMI\*.*

- ▶ Select: **MENU** button > control button **Systems / Car systems** > **Driver assist** > **Audi side assist**.

The brightness of the warning lamp in both the information and warning modes is regulated automatically according to the ambient light level. If you are in very dark or very light surroundings when you adjust the brightness of the warning lamp, the automatic brightness control may already have reached the lowest or the brightest setting. In such a case it is possible that you won't notice a difference while you are adjusting the brightness or that you will only notice it once the light surroundings have changed.

Please adjust the brightness of the warning lamp for the information mode so that it does not distract you while you are looking at the road in front. When you change the brightness, the warning lamp on the exterior mirror will light up briefly with the intensity set for the information mode. The intensity of the lamp in the warning mode is linked to the intensity in the information mode and is adjusted automatically.

### Note

- The side assist is not active while the settings are being adjusted.
- Your personal settings are stored automatically and assigned to the remote control key which is being used.

## Driver messages

Applies to vehicles: with Audi side assist

Should the side assist be deactivated automatically, a driver message will appear in the instrument cluster display. ▶



 **Audi side assist: currently unavailable.**  
**No sensor vision**

The radar sensors are blocked. The area in front of the sensors must not be obstructed by bicycle racks, stickers, deposits or any other substances. If necessary, clean the area in front of the sensors ⇒ *page 133, Fig. 144.*

 **Audi side assist: currently unavailable**

The side assist is temporarily inoperative and cannot be switched on (for instance if the battery is not sufficiently charged).

 **Audi side assist: system fault!**

The system cannot detect vehicles reliably and will be deactivated. The sensors are out of alignment or defective. Have the system checked by a qualified workshop soon.

 **Audi side assist: not available when towing**

The side assist function will be switched off automatically when the electrical connector for the trailer socket is plugged in on vehicles with a factory-fitted towing bracket. If the towing bracket is not factory-fitted the side assist function may not be switched off automatically. The side assist must not be used when towing a trailer.

## Audi drive select

### Adjusting the vehicle set-up

#### Introduction

Applies to vehicles: with Audi drive select

Drive select allows you to use different set-ups on your vehicle. The four modes **efficiency\***, **comfort**, **auto** and **dynamic** allow the driver, for example, to change from a sporty mode to a more comfortable one via the drive select button in the centre console or via the MMI\*. In addition, the **individual\*** mode allows you to adapt the vehicle set-up to suit your personal driving style. For example, you might choose to combine a more dynamic engine set-up with a lighter steering response.

#### Description

Applies to vehicles: with Audi drive select

The possible vehicle set-up in each mode depends on which equipment is installed on your vehicle. The engine and steering are basic parts of your vehicle which are always included in the set-up.

#### Engine and automatic gearbox\*

The response of the engine and automatic gearbox\* to accelerator pedal movements will be more spontaneous or balanced, depending on which mode you select. In efficiency\* mode the automatic gearbox\* selects the next gear at lower engine speeds and the coasting mode is activated ⇒ *page 111*. This helps to reduce fuel consumption.

#### Suspension control (Audi magnetic ride)\*

The suspension control uses sensors to collect information on steering movements, braking and acceleration input by the driver, road surface quality, road speed and vehicle loading. With drive select you can choose between dynamic and comfort-oriented suspension set-ups (dynamic and comfort modes), or opt for a more balanced set-up (auto mode).

#### Steering

The degree of power assistance can be varied. Various modes are possible ⇒ *page 137*. The light, indirect steering response in comfort mode is particularly suitable on long motorway trips, for instance. The steering has a tighter, more direct feel in dynamic mode.

The steering response is even more agile on vehicles with progressive steering\*.

#### Cornering light\*

The cornering light adapts itself to the contour of the corner at speeds from approximately 10 km/h to 110 km/h. The swivel action and light distribution are also adjusted according to the operating mode.

#### Air conditioner\*

The air conditioner runs in a particularly economical mode when the efficiency\* setting is selected. When this function is selected, **eco\*** is shown in the display of the automatic air conditioner.

#### Cruise control system\*

The acceleration response is particularly economical in efficiency\* mode.

#### Adaptive cruise control\*

The acceleration mode can be varied from comfort to sport by changing the setting in drive select. The setting also determines whether the response of the adaptive cruise control to the driving style of the driver in front is more balanced or spontaneous. The efficiency\* mode chooses a set-up for maximum economy.

#### Note

- On some models the vehicle's maximum speed can only be obtained in the auto and dynamic modes.
- On vehicles with manual gearbox, an **E** appears in the gear-change indicator when efficiency\* mode is activated.

- On vehicles with automatic gearbox, if you select efficiency\* mode when the selector lever is in position D, E will automatically appear in the instrument cluster display.
- Please note that the efficiency\* mode is not available in towing mode.

### Selecting the driving mode

Applies to vehicles: with Audi drive select

You can choose between efficiency\*, comfort, auto, dynamic and individual\*.



Fig. 145 Centre console: Button for drive select



Fig. 146 MMI: drive select

- ▶ To select the mode, press the **drive select** button ⇒ Fig. 145 repeatedly until the desired

### Configuring individual mode

You can configure your own personal vehicle set-up.

- ▶ Select: **MENU** button > **Systems / Car systems** > control button **Set individual**. The **individual\*** mode will be automatically activated when you select the menu.

The **individual\*** driving mode will automatically be activated when you have finished configuring the settings.

mode appears in the instrument cluster display. Or:

- ▶ Select the following on the MMI\*: **MENU** button > **Systems / Car systems** > **efficiency\*, comfort, auto, dynamic or individual\***.

You can change the mode while the vehicle is stationary or moving. If traffic conditions permit, take your foot off the accelerator briefly after you change the mode so that the new mode is also activated for the engine.

**efficiency\*** - trims the vehicle to an especially fuel-saving set-up and helps the driver adopt an economical driving style.

**comfort** - alters the vehicle set-up for a more comfortable ride and is suitable for long motorway trips, for instance.

**auto** - gives an overall impression of a comfortable but dynamic ride and is a good choice of set-up for everyday use.

**dynamic** - gives the vehicle a tighter set-up and is ideal for performance driving.

**individual\*** - ⇒ page 137.

The last selected mode is still active when you restart the vehicle.

#### **! WARNING**

Always keep an eye on the traffic when using the drive select controls - Risk of accident!

Systems	comfort	auto	dynamic
Engine and Gearbox	Comfortable	Balanced	Dynamic
Steering	Comfortable	Balanced	Dynamic
Cornering light*	Comfortable	Balanced	Dynamic
Audi adaptive cruise control*	Comfortable	Balanced	Dynamic
Suspension control*	Comfortable	Balanced	Dynamic
Engine sound*	Subdued	Subdued/dynamic <sup>a)</sup>	Dynamic

<sup>a)</sup> Subdued in position D and dynamic in position S.



#### Note

Your settings in **individual\*** mode are stored automatically and assigned to the remote control key currently in use.

## Parking aids

### General notes

Applies to vehicles: with rear parking aid/parking system plus/reversing camera/park assist

Various systems are available to help you when parking or manoeuvring in tight spaces, depending on the equipment fitted on your vehicle.

The **rear parking aid** gives an acoustic warning if there are any obstacles *behind* the car ⇒ *page 140*.

When you are parking, the **parking system plus** warns you acoustically and optically about obstacles detected *in front of* and *behind* the vehicle ⇒ *page 140*. On vehicles with **park assist**, the area detected at the side of the vehicle  ⇒ *page 140, Fig. 147* is also monitored.

The **reversing camera** uses the MMI display to show a picture of the area behind the vehicle captured by the camera. This picture helps you to park the vehicle parallel or perpendicular to the roadside. In addition, you are assisted by the functions of the parking system plus ⇒ *page 142*.

The **park assist** helps you to find suitable parking spaces, to manoeuvre the vehicle into spaces parallel or perpendicular to the roadside and to drive out of spaces parallel to the kerb ⇒ *page 146*.

#### WARNING

- Always watch the road and the area surrounding the vehicle. The electronic systems cannot replace the full concentration of the driver. The driver is always responsible for safety during parking and all other manoeuvres.
- Please note that certain surfaces, such as clothing fabrics, cannot be detected or displayed by the system - risk of accident!
- The sensors and cameras have blind spots in which neither people nor objects are registered. It is particularly impor-

tant to ensure that there are no small children or animals near the vehicle - risk of accident!

- Always keep a close watch on the area around the vehicle and make full use of the rear-view mirrors.

#### CAUTION

- The system may not always be able to detect objects such as the following:
  - Chains, trailer draw bars, posts or fences
  - Objects above the sensors, such as wall protrusions, etc.
  - Objects with certain surfaces or structures, such as wire fences or powder snow
- As your car moves closer to low obstacles, they may disappear from the sensors' field of vision. Please note that you will no longer be warned about these obstacles.
- Impacts or damage to the radiator grille, bumper, wheel arches or underbody can cause misalignment of the sensors. This can impair the effectiveness of the parking aids. Have the systems checked by a qualified workshop.

#### Note

- In certain situations, a warning may be given by the system even if there is no obstacle within range of the sensors. This can be caused by the following, for instance:
  - Certain road surfaces or long grass
  - External ultrasound sources, e.g. from street cleaning vehicles
  - Heavy rain or snow or dense exhaust fumes
- To familiarise yourself with the system, we recommend that you practise parking in a quiet location or a car park. The weather and light conditions should be good.

- You can change the display and adjust the volume and pitch of the beeps ⇒ *page 150*.
- On vehicles *without* MMI\*, you can have these settings changed by an Audi dealer or qualified workshop.
- Please refer to the notes on "Towing a trailer" ⇒ *page 151*.
- There is a slight delay in the picture displayed on the MMI.
- To ensure that the acoustic parking aid works properly, the sensors must be kept clean and free of snow and ice.

## Rear parking aid

### Description

Applies to vehicles: with rear parking aid

*The rear parking aid is an acoustic parking system.*



### Description

Sensors are located in the rear bumper. When the sensors detect an obstacle, you are alerted by acoustic signals (beeps).

Please ensure that the sensors are kept free of stickers, deposits and any other substances which could impair the function of the system. Notes on cleaning ⇒ *page 204*.

The measuring range of the sensors starts at about:

Rear	Side	0.90 m
	Centre	1.60 m

The acoustic signals sound with increasing frequency as you approach the obstacle. A warning tone will sound continuously when the vehicle is less than approx. 0.30 m away from the obstacle. Stop reversing immediately ⇒  in *General notes on page 139*, ⇒  in *General notes on page 139*!

The volume of the warning beeps will be gradually reduced after about four seconds if the vehicle remains at a constant distance from a detected obstacle (it will not be reduced if the obstacle is closer than 0.30 m).

## Activating

The parking aid is switched on automatically when reverse gear is engaged. You will hear a brief acknowledgement tone.

## Parking system plus

### Description

Applies to vehicles: with parking system plus/park assist

*The parking system plus provides acoustic and visual assistance when parking.*

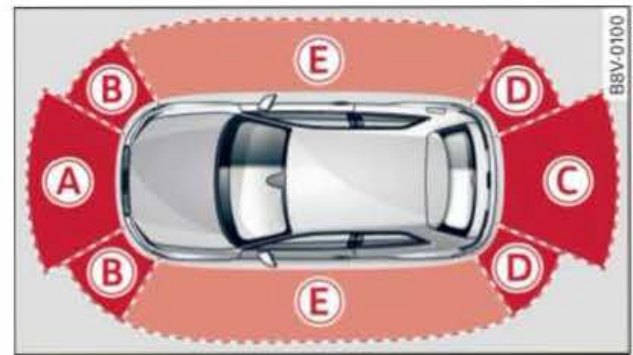

Fig. 147 Display zones



Sensors are located in the front and rear bumpers. When the sensors detect an obstacle, you are alerted by acoustic signals (beeps) and a graphic display.

Please ensure that the sensors are kept free of stickers, deposits and any other substances which could impair the function of the system. Notes on cleaning ⇒ *page 204*.

Approximate range for each display zone:

(A)	1.20 m
(B)	0.90 m
(C)	1.60 m
(D)	0.90 m
(E)*	0.90 m <sup>a)</sup>

a) Applies to vehicles with park assist

The acoustic signals sound with increasing frequency as you approach the obstacle. A warning tone will sound continuously when the vehicle is less than approx. 0.30 m away from the obstacle (or less than approx. 0.20 m away in zone (E)\*). Stop moving immediately ⇒  in *General notes on page 139*, ⇒  in *General notes on page 139*!

The volume of the warning beeps will be gradually reduced after about four seconds if the vehicle remains at a constant distance from a detected obstacle (it will not be reduced if the obstacle is closer than 0.30 m).

**i Note**

Zone **(E)\*** is detected and analysed as the vehicle is moving past. When you switch on the ignition or after the vehicle has been stationary for a while or a door is opened, the ambient surroundings may have changed. Zone **(E)\*** is displayed in black on the MMI display for this reason.

**Switching on/off**

Applies to vehicles: with parking system plus/park assist



Fig. 148 Centre console: Switch for parking aid



Fig. 149 MMI: Proximity graphic (vehicles with park assist\*)

**Switching on**

- ▶ Engage reverse gear, or
- ▶ Press the **P** switch in the centre console ⇒ Fig. 148. You will hear a brief acknowledgement tone and the LED in the switch will light up.

**Switching off**

- ▶ Drive forwards faster than 10 km/h, or

- ▶ Press the **P** switch, or
- ▶ Switch off the ignition.

**Segments in the graphic display**

You can estimate the distance to an obstacle by referring to the segments in front of and behind the vehicle (vehicles with parking system plus\*) or the segments surrounding the vehicle (vehicles with park assist\*) ⇒ Fig. 149. The red lines (on some equipment versions only) indicate the anticipated path of the vehicle, depending on the steering wheel angle. A white segment indicates an obstacle that has been detected beyond the path of travel. Red segments represent objects detected within the path of travel. The closer the vehicle gets to the obstacle the closer the segments move towards the vehicle in the graphic. At the latest when the penultimate segment is highlighted the vehicle has reached the danger (collision) zone. Obstacles within the danger (collision) zone are shown in red, even if they are beyond the path of travel. Stop moving immediately ⇒ **⚠** in General notes on page 139, ⇒ **!** in General notes on page 139!

## Reversing camera

### Introduction

Applies to vehicles: with parking system plus with reversing camera

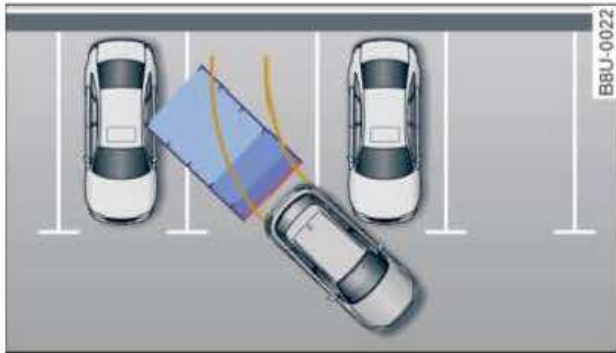

**Fig. 150** Diagram: Parking perpendicular to the roadside

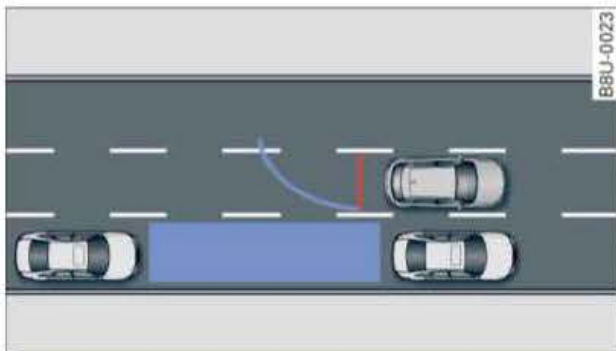

**Fig. 151** Diagram: Parking parallel to the roadside

In this system, a reversing camera is provided in addition to the parking system plus  
⇒ page 140.

You can use the system to *park perpendicular to the roadside*, e.g. in a parking bay or garage ⇒ Fig. 150. Alternatively, you can *park parallel to the roadside*, e.g. next to the kerb ⇒ Fig. 151.

### General notes

Applies to vehicles: with parking system plus with reversing camera



**Fig. 152** ①: Area covered by the reversing camera; ②: area NOT covered by the reversing camera (example)



**Fig. 153** Boot lid: Location of reversing camera (example)

The reversing camera is located above the rear number plate. Please ensure that the lens of the reversing camera ⇒ Fig. 153 is kept free of deposits and any other substances which could impair the function of the parking aid. Notes on cleaning ⇒ page 204.

① ⇒ Fig. 152 represents the area covered by the reversing camera. Only this area is shown in the picture on the MMI display. Objects out of range of the camera in area ② do not appear in the picture.

The accuracy of the orientation lines and the blue area markings decreases if the **dynamic** mode is activated ⇒ page 136.

### ⚠ WARNING

- Please observe the safety warnings ⇒ ⚠ in General notes on page 139.
- For safety reasons, you should not use the system if the position and installation angle of the reversing camera have



been changed, e.g. due to an accident. Have it checked by a qualified workshop.

- Only use the reversing camera to assist you if it is supplying you with a good and clear picture. The quality of the picture can be impaired by adverse light, dirt on the lens or a defect.
- Only use the reversing camera when the boot lid is completely closed. The orientation lines and blue markings are not shown when the boot lid is open. Please make sure that there are no objects mounted to the rear end of the vehicle which could block the view of the reversing camera.
- The camera lens enlarges and distorts the field of vision. Objects on the screen are modified and depicted inaccurately.
- In certain situations, people or objects on the display may appear closer or further away than they really are:
  - Objects which are not touching the ground, such as the bumper of a parked vehicle, a tow-bar or the rear end of a truck. In this case, do not use the orientation lines as a guide.
  - When you are reversing from a horizontal surface up a gradient or down a hill.
  - When approaching protruding objects.
  - When the vehicle has been loaded with a greater load on the rear.

### CAUTION

- Please observe the safety warnings ⇨  in *General notes on page 139*.
- The orange orientation lines on the MMI display show the path of the rear end of the vehicle if you were to reverse using the current steering angle. NB: The front end of the vehicle swings out further than the rear. Please make sure you keep a sufficient distance between the vehicle and any obstacles to make sure that the exterior mirror or edge of the vehicle do not collide with the obstacles.

### Switching on/off

Applies to vehicles: with parking system plus with reversing camera

#### Switching on

- ▶ Engage reverse gear, or
- ▶ Press the **P** switch in the centre console ⇨ *page 141, Fig. 148*. You will hear a brief acknowledgement tone and the LED in the switch will light up.

#### Switching between the reversing camera and graphic display

- ▶ Press the control button for **Graphic**  ⇨ *page 144, Fig. 154* to show the graphic display on the screen.
- ▶ Press the control button for **Rear view** to display the picture from the reversing camera.

#### Switching off

- ▶ Drive forwards faster than 10 km/h, or
- ▶ Press the **P** switch, or
- ▶ Switch off the ignition.

### Note

The graphic on the left of the display helps identify the critical area of the vehicle.

### Parking perpendicular to the roadside

Applies to vehicles: with parking system plus with reversing camera

*This view can be used when parking your vehicle in a garage or parking bay.*

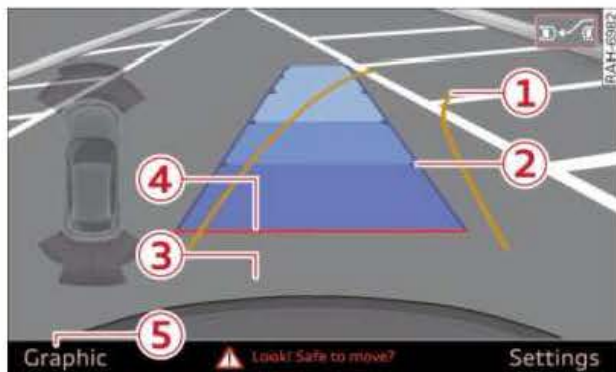

Fig. 154 MMI: Approaching a parking space

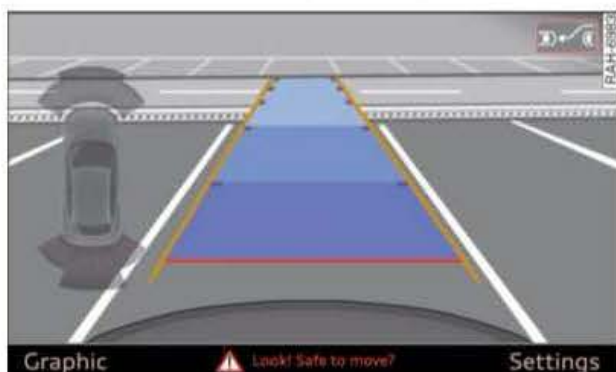

Fig. 155 MMI: Aligning the vehicle

- ▶ Switch on the MMI\* and select reverse gear.
- ▶ The orange orientation lines (1) represent the path of the vehicle. Turn the steering wheel until the orange orientation lines are pointing towards the parking space ⇒ Fig. 154. You can estimate the distance to an obstacle by referring to the markings (2). Each marking is equivalent to approx. 1 metre. The blue marking is an extension of the vehicle outline and reaches about five metres to the rear of the vehicle.
- ▶ Reverse into the space and adapt the steering angle to the parking space, using the orange lines to assist you ⇒ ⚠ in General notes on page 142, ⇒ ⚠ in General notes on page 143. (3) indicates the rear bumper. Stop moving, at the latest, when the red orientation line (4) is bordering on an obstacle.

### Parking parallel to the roadside

Applies to vehicles: with parking system plus with reversing camera

*This view can be used when parking your vehicle at the roadside.*

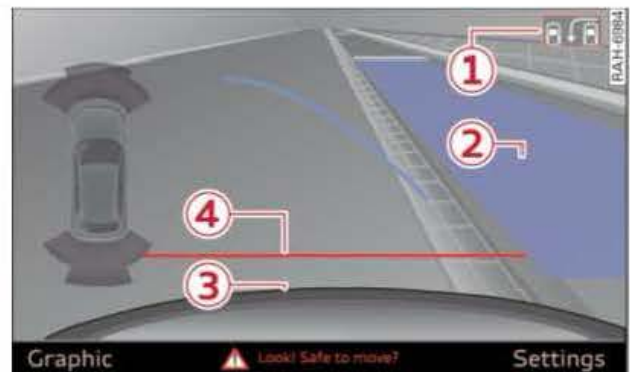

Fig. 156 MMI: Blue area marking aligned in parking space

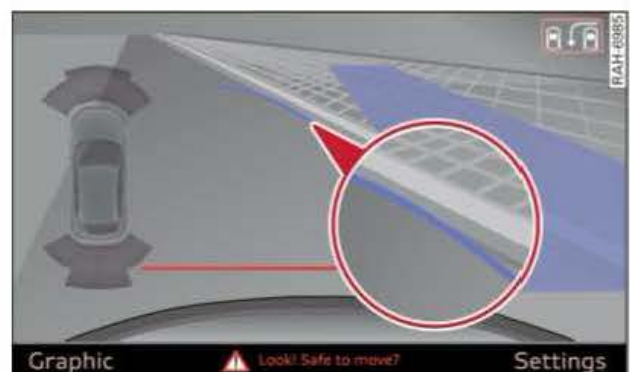

Fig. 157 MMI: Blue marking touches edge of pavement

The section below describes how to park on the **right** side of the road. The procedure for parking on the left is similar.

If an obstacle (such as a wall) is located next to the parking space, please follow the instructions for "Parking next to obstacles" ⇒ page 145.

- ▶ Operate the right turn signal.
- ▶ Position your car beside a parked vehicle in front of the space where you want to park. The distance from the vehicle should be about 1 metre.
- ▶ Switch on the MMI\* and select reverse gear. The parking aid will be switched on and the **perpendicular parking** view will be displayed.
- ▶ Press the appropriate control button on the MMI\* control console to select (1) ▶

⇒ Fig. 156. The **parallel parking** display will appear.

- ▶ Reverse and align your vehicle in such a way that the blue area marking ② borders onto the vehicle behind or onto the parking space line marking ⇒ ⚠ in General notes on page 142, ⇒ ⚠ in General notes on page 143. The blue marking is an extension of the vehicle outline and reaches about five metres to the rear of the vehicle. The long side of the blue marking should border onto the kerb. The complete blue area marking must fit into the parking space.
- ▶ When the vehicle is stationary turn the steering wheel to the right as far as it will go.
- ▶ Reverse into the parking space until the blue curve ⇒ Fig. 157 touches the kerb ⇒ ⚠ in General notes on page 142, ⇒ ⚠ in General notes on page 143. Stop the vehicle.
- ▶ When the vehicle is stationary turn the steering wheel to the left as far as it will go.
- ▶ Continue to reverse into the parking space until the vehicle is standing parallel to the kerb ⇒ ⚠ in General notes on page 142, ⇒ ⚠ in General notes on page 143. ③ indicates the rear bumper. Stop moving, at the latest, when the red orientation line ④ is bordering on an obstacle. Keep a close watch on the front of your vehicle.

### Parking next to obstacles

If an obstacle (such as a wall) is located next to the parking space, the clearance at the side of the vehicle must be larger. Position the long side of the blue area in such a way that there is sufficient distance to the obstacle. The area marking must NOT touch the obstacle. You must also start turning the steering wheel much earlier. The blue curve ⇒ Fig. 157 must **not** touch the obstacle - make sure there is sufficient clearance.

#### **i** Note

The orientation lines and markings appear on the left or right side, depending on which turn signals are on.

### Towing mode

Applies to vehicles: with parking system plus with reversing camera and towing bracket

*This view helps you to position the vehicle in front of a trailer.*



Fig. 158 Infotainment display: Rear view

- ▶ Press the front right control button on the MMI\* control console repeatedly until ① ⇒ Fig. 158 is selected. The **Towing mode** display will appear.
- ▶ You can now position your vehicle in front of the trailer ⇒ ⚠ in General notes on page 142, ⇒ ⚠ in General notes on page 143. The orange orientation line ② indicates the anticipated path of the tow-bar. You can use the blue lines ③ to estimate the distance to the trailer hitch.

## Park assist

### Description

Applies to vehicles: with park assist

The park assist helps the driver to manoeuvre the vehicle into and out of parking spaces.

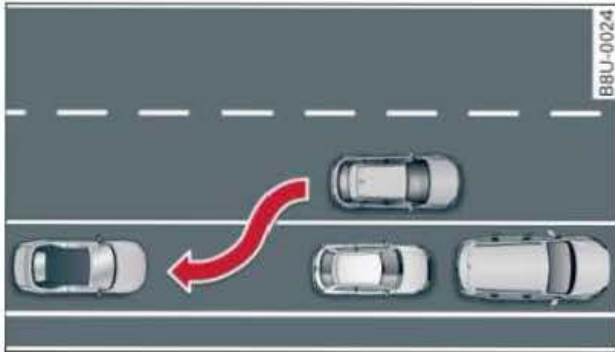

Fig. 159 Diagram: Parking parallel to the roadside

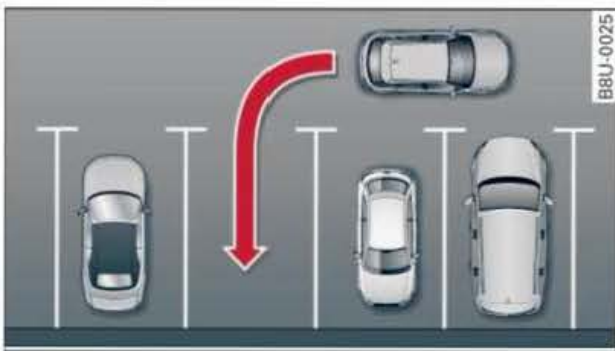

Fig. 160 Diagram: Parking perpendicular to the roadside

The park assist helps you to find suitable parking spaces, to manoeuvre the vehicle into spaces parallel or perpendicular to the roadside and to drive out of spaces parallel to the kerb. The parking space can be located between two vehicles or behind one vehicle. The park assist takes over the steering while the driver is parking the vehicle in the usual way.

The parking system plus is an integral component of the park assist ⇒ *page 140* and helps you during the parking manoeuvre.

The park assist sensors are located on the sides of the front and rear bumpers. Please ensure that the sensors are kept free of stickers, deposits and any other substances which could impair the function of the system. Notes on cleaning ⇒ *page 204*.

In short parking spaces, the parking aid warning tone will sound continuously when the ve-

hicle is less than approx. 0.20 m away from the obstacle. Stop moving immediately!

### ! WARNING

- Please observe the safety warnings ⇒ ! in *General notes on page 139*.
- Please note that the park assist only handles the steering. As the driver you are always responsible for braking and accelerating.
- It is the driver's responsibility to decide whether a parking space shown in the display is suitable for the vehicle.
- The front of the vehicle swings out during the parking manoeuvre. Please take all necessary measures to ensure that other road users are not endangered.
- The steering wheel turns rapidly on its own when parking the vehicle and leaving the space. Injury may result if a person reaches between the spokes on the steering wheel when it is turning.

### ! CAUTION

- Please observe the safety warnings ⇒ ! in *General notes on page 139*.
- In certain situations, the park assist will guide the vehicle onto or across the kerb, for instance if other vehicles are parked on the kerb. You should always be ready to take over the steering wheel in order to prevent damage to the tyres and/or wheel rims.
- Certain road conditions, such as loose gravel, snow or ice can cause unexpected results when parking.

### ! CAUTION

- The sensors may not always be able to detect objects such as trailer draw bars, thin rails, fences, posts, waste bins and trees, etc. This could result in damage to your car.
- Please note that the system may not always be able to detect the surface of certain objects or substances, such as wire fences or powder snow, etc. You should

therefore check that the parking space is really large enough before parking the vehicle.

- Please note that low obstacles detected by the system may no longer be registered by the sensors as the car moves closer, so the system will not give any further warning. Failure to respond to a parking system warning can result in damage to your vehicle and other property. Please bear this in mind, for example, when using the park assist to park behind a truck. Always keep a close watch on the area in front of and behind the vehicle while parking, and intervene promptly if necessary.
- To prevent damage to the sensors when washing the vehicle with a high-pressure cleaner or a steam cleaner, do not hold the cleaner less than 10 cm away from the sensors and do not keep the cleaner pointed directly at the sensors.

### **i** Note

- The electronic stabilisation control (ESC) must not be switched off during the parking manoeuvre ⇒ *page 183*.
- The park assist cannot be used to park the vehicle on tight bends.
- If you achieve different results with the park assist after a tyre change, have the system adjusted by a qualified workshop.
- The park assist cannot be used to park the vehicle if a trailer is attached and the electrical connector for the trailer socket is plugged in.

## Switching on and off

Applies to vehicles: with park assist



Fig. 161 Centre console: Switch for park assist



Fig. 162 Instrument cluster: Looking for a parking space. **A** parallel to the roadside, **B** perpendicular to the roadside

- ▶ To park parallel to the roadside, press the **P** button once ⇒ *Fig. 161*. Display **A** ⇒ *Fig. 162* will appear in the instrument cluster. Or:
- ▶ To park perpendicular to the roadside, press the **P** button twice. Display **B** will appear.
- ▶ The LED in the **P** button is lit if the park assist is switched on.
- ▶ To switch off the park assist, press the **P** button. The LED in the **P** button will go out.

### Looking for a parking space

Applies to vehicles: with park assist



**Fig. 163** Instrument cluster: Prompt to keep driving forwards (a parking space has been detected)

The section below describes how to park parallel to the roadside. The procedure for parking perpendicular to the roadside is similar.

Important: For the best parking result, you should maintain a distance of approx. 1 metre to the row of parked cars.

- ▶ Activate the turn signal for the side on which you want to park.
- ▶ To park parallel to the roadside, drive forwards at not more than 30 km/h. Or:
- ▶ To park perpendicular to the roadside, drive forwards at not more than 20 km/h.
- ▶ The system will display a parking space when it finds one ⇒ Fig. 163. Please check that the parking space is suitable for your vehicle.

If you exceed a speed of about 50 km/h, the park assist will be switched off.

The park assist will display a parking space only if it is long and wide enough for the vehicle.

If you operate the left turn signal, the display will show the left side of the road (and vice-versa).

#### **i** Note

- The arrows ▶ or ◀ in the instrument cluster display indicate the side of the road on which the park assist intends to park the vehicle.
- You can activate the park assist after you have already driven past a parking space (as long as you were driving slowly

enough). To do so, press the **P** button and operate the turn signal.

- The best parking results will be achieved if you position the vehicle as parallel as possible to the line of parked cars or the kerb before you start the actual parking manoeuvre.
- If there are suitable parking spaces on both sides of the road (for instance on a one-way street), you can change the direction of the turn signals to park on the other side, even if you have already activated the park assist.

### Parking parallel to the roadside

Applies to vehicles: with park assist

*The driver is responsible for parking the vehicle.*





**Fig. 164** Instrument cluster: Prompt to select reverse gear



**Fig. 165** Instrument cluster: Manoeuvring several times in a parking space

- ▶ Drive forwards until the arrow is displayed behind the vehicle ⇒ Fig. 164 ⇒ ⚠ in Description on page 146, ⇒ ⚠ in Description on page 146.
- ▶ After stopping for a moment, select reverse gear. ▶

- ▶ Wait until the following text appears in the display: **Steering assistant active. Monitor area around vehicle!**
- ▶ Take your hands off the steering wheel.
- ▶ Watch the road. When the road is clear, press the accelerator gently ⇒  in Description on page 146, ⇒  in Description on page 146.
- ▶ Follow the instructions on the display ⇒ page 149 and the acoustic warning tones until the parking manoeuvre is complete. The arrows show the required direction of travel.



The park assist automatically steers the vehicle into the parking space while the driver operates the pedals (accelerator, brake, clutch\*). The maximum parking speed is 7 km/h. The park assist will be deactivated if you drive too fast or move the steering wheel by hand. To continue the parking manoeuvre, press the  button again. The park assist display will reappear in the instrument cluster.

### Driving out of a parking space parallel to the roadside

Applies to vehicles: with park assist

*The driver is responsible for manoeuvring the vehicle out of the parking space.*

If the vehicle is parked parallel to the roadside, the park assist can help you to manoeuvre the vehicle so that you can drive straight out of the parking space.

- ▶ Start the engine.
- ▶ Press the  button ⇒ page 147, Fig. 161.
- ▶ Wait until the following text appears in the instrument cluster display: **To leave parking space select reverse gear and operate turn signal.**
- ▶ Operate the appropriate turn signal.
- ▶ Engage reverse gear.
- ▶ Take your hands off the steering wheel.
- ▶ Watch the road. When the road is clear, press the accelerator gently ⇒  in Description on page 146, ⇒  in Description on page 146.

- ▶ Follow the instructions on the display ⇒ page 149 and the acoustic warning tones until you are clear to leave the parking space.
- ▶ The procedure is over when no more manoeuvring is necessary in order to drive out of the space. Take over the steering.

The park assist automatically steers the vehicle out of the parking space while the driver operates the pedals (accelerator, brake, clutch\*). The maximum manoeuvring speed is 5 km/h. The park assist will be deactivated if you drive too fast or move the steering wheel by hand. To continue the parking manoeuvre, switch the engine off/on. Then press the  button again. Alternatively, drive out of the parking space without using the park assist.

### Driver messages

Applies to vehicles: with park assist

#### **Steering input activated. Monitor area around vehicle!**

The park assist is ready. You can now park the vehicle. Watch the road ⇒  in Description on page 146.

#### **Park assist: ended.**

#### **Park assist: ended. Continue steering vehicle!**

The park assist has finished the parking manoeuvre.

#### **Park assist deactivated. Continue steering vehicle!**

The park assist has interrupted the parking manoeuvre.

#### **Steering input detected. Continue steering vehicle!**

The steering assistant has been deactivated because the driver has intervened in the steering. To continue the parking manoeuvre, press the  button again.

#### **Park assist: not available. Speed too high**

#### **Park assist: speed too high**

Reduce your speed! For the best results when passing the line of parked cars where you want to park, do not drive faster than 30 km/h (if parking parallel to the roadside) or 20 km/h (if parking perpendicular to the roadside) ⇒ *page 148*.

**P<sub>off</sub>** **Park assist: ended. Speed too high**

**P<sub>off</sub>** **Speed too high. Continue steering vehicle!**

You were driving too fast into the parking space. Do not exceed 7 km/h when driving into the parking space.

**P<sub>off</sub>** **To leave parking space select reverse gear and operate turn signal**

The park assist is ready. You can leave the parking space. Watch the road ⇒  in *Description on page 146*.

**P<sub>off</sub>** **Stabilisation control (ESC) input. Continue steering vehicle!**

Take over the steering. Finish parking without the park assist or drive out of the parking space.

**P<sub>off</sub>** **Please take over steering and continue driving.**

The park assist has finished manoeuvring the vehicle out of the parking space.

**P<sub>off</sub>** **Stabilisation control (ESC) off. Continue steering vehicle!**

The park assist has interrupted the parking manoeuvre, because the ESC has been switched off. Take over the steering or switch on the ESC ⇒ *page 183* and start the parking manoeuvre again ⇒ *page 148*.

**P<sub>off</sub>** **Assist function unavailable for leaving parking space. Space too small**

The assist function is unable to automatically steer the vehicle out of the parking space because the space is too small. Manoeuvre the vehicle out of the parking space without using the park assist.

**P<sub>off</sub>** **Park assist: not available in towing mode**

**P<sub>off</sub>** **Trailer in use. Continue steering vehicle!**

The park assist cannot be used to park the vehicle when towing a trailer.

**P<sub>off</sub>** **Park assist: time limit exceeded**

**P<sub>off</sub>** **Time limit exceeded. Continue steering vehicle!**

The parking manoeuvre was not completed within about six minutes after the park assist was activated. To continue the parking manoeuvre, press the  button again.

**P<sub>off</sub>** **Park assist: not available**

**P<sub>off</sub>** **System unavailable. Continue steering vehicle!**

The park assist cannot be used to park the vehicle. Try repeating the parking manoeuvre or switching the ignition off and on again.

**Not stopped long enough**

After you select reverse gear, the vehicle has to remain stationary for a moment so that the park assist can activate the steering. Follow the directions given in the display.

**P<sub>off</sub>** **Park assist: system fault!**

**P<sub>off</sub>** **System fault. Continue steering vehicle!**

Please contact a qualified workshop. The park assist cannot be used to park the vehicle if a system fault occurs.

## Adjusting graphic display and warning beeps

Applies to vehicles: with parking system plus/reversing camera/park assist

*The settings for the graphic display and acoustic signals are controlled via the MMI\*.*

► Select:  button > control button **Systems / Car systems** > **Driver assist** > **Parking aid**.

### Display

**on\*** - The graphic display (parking system plus) or the reversing camera image (parking system plus with reversing camera\*) will be displayed when the parking aid is activated. ►



**off** - The parking aid gives only acoustic warning signals when it is activated.

### Warning beeps

**Front volume** - Volume for the front and side\* zones

**Rear volume** - Volume for the rear zone

**Front frequency** - Pitch of the beeps for the front and side\* zones

**Rear frequency** - Pitch of the beeps for the rear zone

**In-car entertainment fader** - The volume of the current audio or video source is reduced when the parking aid is switched on.

You will hear a short test tone each time you make a new setting.

#### Note



- You can also change the warning beep settings directly from the graphic display or reversing camera\* picture. Simply press the control button for **Settings**.
- The settings will be automatically stored and assigned to the remote control key in use.



## Fault warnings

Applies to vehicles: with parking system plus/park assist/reversing camera

If you hear a continuous warning tone for a few seconds and the LED in the P<sub>⊕</sub> button starts flashing when you switch on the parking aid, or while the parking aid is activated, a system fault has occurred. If the fault is not corrected before you switch off the ignition, it will only be indicated by the flashing LED in the P<sub>⊕</sub> button the next time you switch on the parking aid by engaging reverse gear.

### Parking system plus\*/parking system plus and park assist\*

If a sensor malfunctions, the  symbol will be shown on the MMI display in front of or behind the vehicle. If a rear sensor malfunctions, obstacles will only be displayed in zones  and  ⇔ page 140, Fig. 147. If a front

sensor malfunctions, obstacles will only be displayed in zones  and .

Drive to a qualified workshop soon and have the fault rectified.

## Towing bracket

Applies to vehicles: with parking system plus/park assist/reversing camera and towing bracket

When the trailer socket is connected, the rear parking sensors are NOT activated when you select reverse gear or press the P<sub>⊕</sub> button. This may not apply if the power socket was NOT factory-fitted. This results in the following restrictions:

### Parking system plus\*/parking system plus and park assist\*

There is no rear distance warning. However, the system will still give a warning when obstacles are detected while driving forwards. The proximity graphic will switch over to towing mode.

### Parking system plus and reversing camera\*

There is no distance warning at the rear and at the sides in area . However, the system will still give a warning when obstacles are detected while driving forwards. The proximity graphic will switch over to towing mode. The image of the reversing camera will then be shown without orientation lines and blue area markings.

## Safety first

### General notes

#### Safety is the first priority

*Your safety is our first priority.*

This chapter contains important information, tips, suggestions and warnings that you should read and observe for your own safety and the safety of your passengers.

#### WARNING

- The information in this chapter is important for the driver of the vehicle and all passengers. The other chapters in this manual (and, where applicable, in the other literature supplied with the vehicle) contain further important notes which you should read and observe for your own safety and that of your passengers.
- Ensure that the complete vehicle wallet is always in the vehicle. This is especially important when you lend or sell the vehicle to others.

#### Safety features

*The safety features listed here are part of the vehicle's occupant restraint system. They work together to help reduce the risk of injury in a wide variety of accident situations.*

Your safety and the safety of your passengers should not be left to chance. In the event of an accident, the safety features incorporated in your vehicle are capable of reducing the risk of injury. These are just a few of the safety features in your Audi:

- Optimised three-point seat belts for all seats
- Belt tensioners for the front seats
- Belt height adjustment for the front seats
- Front airbags (driver's airbag, front passenger's airbag, driver's knee airbag)
- Side airbags in the front and rear\* backrests
- Head-protection airbags
- “ISOFIX” anchorages for “ISOFIX” child seats on the front seat\* and rear seats
- Head restraints for all seats
- Adjustable steering column
- Pre sense basic\* (preventive occupant protection)
- Pedestrian protection system\*

These individual safety features are harmonised to provide you and your passengers with the best possible protection in accident situations. However, they can only be effective if you and your passengers sit in the correct position and adjust and use the safety equipment properly.

For these reasons, this chapter explains why these safety features are so important, how they can protect you, what you need to remember when using them, and how you and your passengers can gain the most benefit from them. There are also a number of important safety warnings which you and your passengers should always observe in order to minimise the risk of injury.

#### Safety is everyone's responsibility!

#### Before every trip

*The driver is responsible for the safety of the passengers and the safe operation of the vehicle at all times.*

For your own safety and the safety of your passengers, always note the following points before every trip:

- ▶ Make sure that all lights and turn signals are working properly.
- ▶ Check the tyre pressures.
- ▶ Make sure that all windows are clean and give good visibility to the outside.
- ▶ Secure all luggage and other items carefully ⇒ page 162.
- ▶ Make sure that no objects can interfere with the pedals.
- ▶ Adjust the front seat, head restraint and mirrors correctly.
- ▶ Make sure that the front passenger's head restraint is adjusted to the correct position. ▶

- ▶ Make sure that the head restraints for the rear passengers are in the fully raised position.
- ▶ Make sure that children are protected with suitable safety seats and properly worn seat belts ⇒ *page 157*.
- ▶ Sit in the correct position in your seat. Make sure that your passengers are sitting in the correct positions ⇒ *page 66*.
- ▶ Fasten your seat belt correctly. Make sure that your passengers do the same ⇒ *page 165*.

### What affects driving safety?

*Safety on the road is directly related to how you drive, and can also be affected by the passengers in the vehicle.*

- ▶ The driver is responsible for the safety of the vehicle and all its occupants. If your ability to drive is impaired in any way, you endanger yourself and other road users ⇒ . Therefore:
  - ▶ Do not let yourself be distracted by passengers or by using a mobile phone, etc.
  - ▶ Never drive when your driving ability is impaired (by medication, alcohol, drugs, etc.).
  - ▶ Obey all traffic regulations and speed limits and always maintain a safe distance to the vehicle in front.
  - ▶ Always adjust your speed to suit the road, traffic and weather conditions.
  - ▶ Take frequent breaks on long trips. Do not drive for more than two hours without a stop.
  - ▶ If possible, avoid driving when you are tired or stressed.



#### WARNING

- Distractions while driving or any kind of impairment to your driving ability increase the risk of accident and injury.
- Do not place loose objects on the dash panel. These objects could fly around the interior when the vehicle is moving (under acceleration or whilst cornering) and distract the driver - this could lead to an accident.

## Correct sitting positions

### Correct driving position

The correct driving position is important for safe driving.

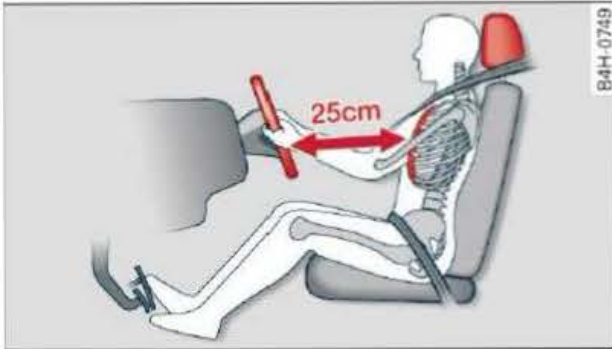

Fig. 166 Adjust seat and sit in correct position

For your own safety, and to reduce the risk of injury in the event of an accident, we recommend the following driving position.

- ▶ Adjust the driver's seat and steering wheel so there is a distance of at least 25 cm between your breastbone and the centre of the steering wheel ⇒ Fig. 166.
- ▶ Adjust the height and fore/aft position of the driver's seat so that you are able to press the pedals to the floor without fully straightening your legs ⇒ ⚠.
- ▶ Adjust the backrest to an upright position so that your back remains in contact with the upholstery.
- ▶ Adjust the longitudinal position of the steering wheel so that your arms are slightly bent and you can read the dials and instruments easily.
- ▶ Make sure that you can comfortably reach the top of the steering wheel.
- ▶ Applies to vehicles with adjustable head restraints: Adjust the head restraint so that the top of the head restraint is level with the top of your head. If this is not possible, try to adjust the head restraint as near as possible to this position.
- ▶ Fasten your seat belt correctly ⇒ page 165.
- ▶ Keep both feet in the footwell so that you are in full control of the vehicle at all times.

For detailed information on how to adjust the driver's seat, see ⇒ page 66, *Front seats*.

### ⚠ WARNING

A driver who is not sitting in the correct position or who is not wearing a seat belt can be fatally injured if the airbag is triggered.

- Adjust the driver's seat and steering wheel so there is a distance of at least 25 cm between your breastbone and the centre of the steering wheel ⇒ Fig. 166.
- While driving, always hold the steering wheel with both hands on the outside of the rim at about the 9 o'clock and 3 o'clock position. This reduces the risk of injury if the driver's airbag inflates.
- Never hold the steering wheel at the 12 o'clock position, or with your hands inside the rim or on the steering wheel hub. This could result in serious injuries to the arms, hands and head if the driver's airbag inflates.
- To reduce any risk of injury to the driver during a sudden brake application or in an accident, never drive with the backrest tilted too far back. The airbag system and seat belts can only provide proper protection when the backrest is in an upright position and the driver is wearing the seat belt in the correct position. The further the backrest is tilted back, the greater the risk of injury due to incorrect positioning of the belt webbing or an incorrect sitting position.
- Adjust the head restraint properly so that it can give maximum protection.

### Correct position for the front passenger

The front seat passenger must sit at least 25 cm away from the dash panel so that the airbag has enough room to inflate and give maximum protection in an accident.

For your own safety and to reduce the risk of injury in the event of an accident, we recommend adjusting the front passenger's seat as follows:

- ▶ Adjust the backrest to an upright position so that your back remains in contact with the upholstery.
- ▶ Adjust the head restraint so that the top of the head restraint is level with the top of your head. If this is not possible, try to adjust the head restraint as near as possible to this position.
- ▶ Keep both feet in the footwell in front of the seat.
- ▶ Fasten your seat belt correctly ⇒ *page 167*.

In **exceptional cases** you can disable the front passenger's airbag via the key-operated switch\* ⇒ *page 180*.

For detailed information on how to adjust the front passenger's seat, see ⇒ *page 66, Front seats*.



#### WARNING

A passenger who is not sitting in the correct position or who is not wearing a seat belt can be fatally injured if the airbag is triggered.

- Adjust the front passenger's seat so there is a distance of at least 25 cm between your breastbone and the dash panel.
- Always keep your feet on the floor when the vehicle is moving; never rest them on the instrument panel, out of the window or on the seat. If you sit in an incorrect position, you increase your risk of injury in the event of sudden braking or an accident. If the airbag is triggered, you could sustain potentially fatal injuries by sitting out of position.
- To reduce the risk of injury to the front passenger in the case of sudden braking or an accident, the passenger should never travel in a moving vehicle with the backrest reclined. The airbag system and seat belt can only provide proper protection when the backrest is in an upright position and the passenger is wearing the seat belt in the correct position. The further the backrest is tilted back, the greater the risk of injury due to incorrect

positioning of the belt webbing or an incorrect sitting position.

- Always adjust the head restraints properly for maximum protection.

#### Correct position for rear passengers

*Rear seat passengers should sit upright with both feet on the floor and wear their seat belts properly whenever the vehicle is moving.*

To reduce any risk of injury in the event of sudden braking or an accident, passengers in the rear seats must observe the following:

- ▶ Before carrying passengers on the rear seats, pull the head restraints on the occupied seats all the way up ⇒ *page 68*.
- ▶ Keep both feet in the footwell in front of the rear seat.
- ▶ Fasten your seat belt correctly ⇒ *page 168*.
- ▶ Use appropriate child restraint systems for children travelling in the vehicle ⇒ *page 157*.



#### WARNING

Rear passengers sitting out of position can suffer severe injuries.

- Always adjust the head restraints to the fully raised position for maximum protection.
- Seat belts only offer maximum protection when the backrest is in an upright position and the passengers are wearing the seat belts properly. By not sitting upright, rear passengers increase the risk of injury due to incorrect positioning of the seat belt webbing.

### Correct adjustment of head restraints

Properly adjusted head restraints are an important part of the vehicle's occupant protection system. They can help to reduce the risk of injuries in most accident situations.



Fig. 167 Head restraint (seen from the front)

The head restraints must be adjusted properly to provide maximum protection.

- ▶ Adjust the front head restraints so that the top of the head restraint is level with the top of your head. If this is not possible, try to adjust the head restraint as near as possible to this position.
- ▶ Before carrying passengers on the rear seats, pull the head restraints on the occupied seats all the way up ⇒ page 68.

For more information on how to adjust the head restraints, see ⇒ page 68.

#### WARNING

- Travelling with the head restraints removed or incorrectly adjusted increases the risk of severe injuries.
- Incorrectly adjusted head restraints can also increase the risk of injury during sudden or unexpected braking or other manoeuvres.

### Examples of incorrect seating positions

Occupants can suffer severe or fatal injuries if they sit in an incorrect position while the vehicle is moving.

Seat belts can only provide maximum protection if the belt webbing is positioned correctly. Sitting out of position greatly reduces the

effectiveness of the seat belts and increases the risk of injury since the belt webbing is not worn in the position for which it is designed. The driver is responsible for the safety of all vehicle occupants, especially for children.

- ▶ Never allow anyone to sit out of position while the vehicle is moving ⇒ .

The following list shows just some examples of incorrect sitting positions which can be dangerous to all occupants. The list is not complete, but will help to make you aware of possible dangers which can be avoided.

#### Therefore, whenever the vehicle is moving:

- Never stand up in the vehicle.
- Never stand on the seats.
- Never kneel on the seats.
- Never travel with the backrest reclined too far.
- Never lean against the dash panel.
- Never lie down on the rear seat.
- Never sit on the front edge of a seat.
- Never sit sideways.
- Never lean out of the window.
- Never put your feet out of the window.
- Never put your feet on the dash panel.
- Never put your feet on the seat cushion.
- Never ride in the footwell.
- Never travel on a seat without wearing the seat belt.
- Never climb into the luggage compartment.

#### WARNING

- Sitting out of position increases the risk of severe injuries.
- Sitting out of position exposes the occupants to potentially fatal injuries: if the airbags inflate they can strike any occupant who is not in one of the designed seat positions.
  - Before starting a trip, sit in the correct position and stay in this position as long as the vehicle is moving. Before every trip, make sure all passengers are sitting in the correct positions and remain

correctly seated at all times ⇒ *page 66, Front seats.*

## Child seats

### Safety notes for using child seats

*To reduce the risk of injury in the event of an accident, children must always use child restraint systems when travelling in the car.*

Please note the information in this Owner's Manual when installing and using child seats. Follow the manufacturer's instructions and observe any statutory requirements.

For safety reasons, we recommend that child seats be installed on the rear seats. You should only use a child seat on the front passenger seat in exceptional circumstances.

#### WARNING

To avoid serious or fatal injury, children travelling in the vehicle must always be protected with child restraint systems appropriate to their height, weight and age.

- Children under 1.50 m tall or younger than 12 must not travel in the vehicle if there are no suitable child seats. Please observe any other applicable regulations in the country in which you are travelling.
- Babies and children must never travel on another occupant's lap.
- Never allow more than one child to occupy one child seat.
- Never leave a child without supervision in a child seat.
- Never allow a child to travel unrestrained or to stand up or kneel on a seat while the car is moving. In an accident, the child could be catapulted through the car, causing possibly fatal injuries to itself and other occupants.
- To ensure proper protection by the child restraint, it is important to wear the seat belts in the correct position ⇒ *page 167*. Always check that the belt is properly positioned according to the instructions provided by the manufacturer of the

child seat. Incorrectly worn seat belts can give rise to injuries even in a minor collision.

- If children are out of position when the car is moving, they are at greater risk of injury during a sudden braking manoeuvre or in an accident. This is particularly the case if the child is travelling on the front passenger's seat and the airbag system is triggered in an accident. This incorrect sitting position can result in serious or even fatal injury.
- If you are using a child seat on the front passenger seat in which the child faces the direction of travel, you should move the front passenger seat as far back as possible.
- Child seats in which the child faces the rear of the car are located directly in the path of the front passenger's airbag if it inflates. In this case, the child could sustain serious or fatal injuries if the airbag were to be deployed.
  - Applies to vehicles on which the front passenger's airbag cannot be deactivated: Do NOT use a rearward-facing child seat on the front passenger's seat.
  - Applies to vehicles with key-operated switch for deactivating the front passenger's airbag: Do NOT use a rearward-facing child seat on the front passenger's seat while the front passenger's airbag is active. If you have no alternative but to use a rearward-facing child seat on the front passenger's seat, the front passenger's airbag must be deactivated beforehand via the key-operated switch\* ⇒ *page 180*. Make sure that the front passenger's airbag is reactivated by means of the key-operated switch\* as soon as the child seat is no longer needed on the front passenger's seat.
- Always replace the child seat with a new one after an accident as damage not externally visible may have occurred.

### Child safety and side airbags

Applies to vehicles: with side airbags



**Fig. 168** Illustration of a dangerous sitting position near the opening for the side airbag

Make sure that children do not lean out of the child seat towards the door trim. If the side airbag\* were to inflate in an accident, it could strike the child on the head and cause serious injury.

#### WARNING

- To avoid injury, the child's head must always be well away from the opening for the side airbag ⇒ *page 177, Side airbags*.
- Do not leave or place any objects in the area of inflation for the side airbag.

### Child seat categories

Only use child restraint systems that are officially approved and suitable for the child.



**Fig. 169** Child seat categories

Child restraint systems are covered by the European standard ECE-R 44. An orange label is usually attached to child seats which have been tested in accordance with this standard. Information on weight categories, ISOFIX size

class and the approval category of the child seat can be found on this label.

Child seats are divided into five weight categories:

#### Child seats: categories 0 and 0+

Rearward-facing carry cots are most appropriate for these categories (up to 13 kg). Our recommendation: Audi carry cot with optional ISOFIX base.

#### Child seats: category 1

In this category (9 to 18 kg), rearward or forward-facing child seats with an integrated seat belt system are most appropriate. Rearward-facing child seats should be used for as long as safely possible. Our recommendation: Audi child seat with ISOFIX base.

#### Child seats: categories 2 and 3

Child seats with backrests used in conjunction with seat belts are most appropriate for these categories (15 to 36 kg). Our recommendation: Audi child seat "youngster plus".

#### WARNING

- Categories 0, 0+ and 1 (rearward-facing): Never install a rearward-facing child seat on the front passenger's seat unless the front passenger's airbag has been deactivated – this can result in potentially fatal injuries to the child. If you have no alternative but to let a child travel on the front passenger's seat, the front passenger's airbag must be deactivated\* beforehand ⇒ *page 180*.
- Categories 1 (forward-facing), 2 and 3: The back of the child seat should be flush with the backrest of the vehicle seat. If the rear head restraint obstructs you when installing the child seat, adjust\* or remove it completely ⇒ *page 68*. After removing the child seat, install the passenger's head restraint again immediately and adjust it to the correct position. Travelling with the head restraints removed or incorrectly adjusted increases the risk of severe injuries.



- Categories 2 and 3: The shoulder section of the belt must be fitted across the centre of the child's collar bone close to the torso. It must never run against or across the neck. The lap belt must be worn tightly across the hips, and not over the stomach or abdomen. Pull the belt tight if necessary to take up any slack.
- Wait for as long as possible before changing up to the next child seat group.

**i Note**

We recommend child seats from the range of Audi Genuine Accessories: [www.audi.com/childseats](http://www.audi.com/childseats).

## Fitting child seats

### Securing child seats with ISOFIX



Fig. 170 Rear seat: Securing child seat with ISOFIX (example)

Child seats of the categories 0, 0+ and 1 with ISOFIX can be secured without a seat belt using the ISOFIX anchorages on the outer rear seats and also, on some vehicles, on the front passenger's seat.

- ▶ Push the mountings on the child seat into the ISOFIX anchorages until they engage audibly ⇒ Fig. 170.
- ▶ Pull on the child seat to check whether both sides have engaged properly.
- ▶ Rear seats: If possible secure the child seat additionally to the top tether<sup>1)</sup> anchorage ⇒ page 160.

If you wish to attach an ISOFIX child seat to the ISOFIX anchorages in your vehicle, please ensure that it is approved for the seats in your vehicle. The following table ⇒ *table on page 159* shows the installation options. The necessary information can be found on the orange label on the child seat.

An ISOFIX child seat categorised as “vehicle-specific”, “restricted” or “semi-universal” (**IL**) is suitable for a seat if:

- your vehicle is listed in the model list provided by the child seat manufacturer and
- your child seat is marked with IL in the following table.

An ISOFIX child seat categorised as “universal”, (**IUF**) is suitable for a seat if:

- your child seat is marked with IUF in the following table and
- the child seat can be secured with top tether ⇒ page 160.

Weight class	ISOFIX size category	Outer rear seats	Front passenger's seat*
Category 0: up to 10 kg	E	IL	IL
Category 0+: up to 13 kg	E	IL	IL
	D		
	C		
Category 1: 9 to 18 kg	D	IL IUF	IL
	C		
	B		
	B1		
	A		

**⚠ WARNING**

– Note the important safety notes ⇒ ⚠ in *Safety notes for using child seats on page 157*, ⇒ ⚠ in *Child seat categories on page 158* and the instructions provided by the child seat manufacturer.

<sup>1)</sup> This function is not available for all export versions.

- Never install a rearward-facing child seat on the front passenger's seat unless the front passenger's airbag has been deactivated - this can result in potentially fatal injuries to the child.
- The anchorages in the vehicle are designed only for child seats with ISOFIX. Do not attempt to secure other types of child seat, seat belts or other objects to these anchorages - this could result in serious or possibly fatal injury.

### Securing child seats with ISOFIX and top tether

Applies to vehicles: with top tether



Fig. 171 Rear seat bench (A3/A3 Sportback): Top tether anchorages



Fig. 172 Rear seat bench (A3 Saloon): Top tether anchorages

- ▶ Push up the head restraint behind the child seat.
- ▶ Push the mountings on the child seat into the ISOFIX anchorages until they engage audibly ⇒ page 159.
- ▶ Pull on the child seat to check whether both sides have engaged properly.
- ▶ Guide the top tether strap of the child seat **underneath** or **past both sides** of the head restraint (depending on the type of child seat) towards the rear.

- ▶ Applies to A3/A3 Sportback: Hook the strap into the top tether anchorage ⇒ Fig. 171.
- ▶ Applies to A3 Saloon: Fold the cover open and hook the strap into the top tether anchorage ⇒ Fig. 172.
- ▶ Pull the tether strap tight so that the top of the child seat rests securely against the backrest.

### ⚠ WARNING

- Note the important safety notes ⇒ ⚠ in Safety notes for using child seats on page 157, ⇒ ⚠ in Child seat categories on page 158 and the instructions provided by the child seat manufacturer.
- The anchorages in the vehicle are designed only for one child seat with ISOFIX and top tether. Do not attempt to secure other types of child seat, seat belts or other objects to these anchorages - this could result in serious or possibly fatal injury.

### Securing child seats with seat belt

If you wish to use a child seat in the approval category "universal" (u), please ensure that it is approved for the seats in your vehicle. The following table shows the installation options. The necessary information can be found on the orange label on the child seat.



Weight class	Front passenger's seat	Rear	
		Outer seats	Centre seat
Category 0 up to 10 kg	u	u	u
Category 0+ up to 13 kg	u	u	u
Category 1 9 to 18 kg	u	u	u

Weight class	Front passenger's seat	Rear	
		Outer seats	Centre seat
Category 2 15 to 25 kg	u	u	u
Category 3 22 to 36 kg	u	u	u

To adjust the front passenger's seat to the child seat and to achieve the best possible seat belt positioning, move

- the front passenger's backrest as far forward as possible and
- the front passenger's seat as far upwards as possible.

### WARNING

- Note the important safety notes ⇒  in *Safety notes for using child seats on page 157*, ⇒  in *Child seat categories on page 158* and the instructions provided by the child seat manufacturer.
- Never install a rearward-facing child seat on the front passenger's seat unless the front passenger's airbag has been deactivated – this can result in potentially fatal injuries to the child.

## Pedal area

### Pedals

*The pedals must always be free to move and must never be obstructed by floor mats or any objects in the footwell.*

- ▶ Make sure that none of the pedals is obstructed and all of the pedals can be pressed all the way down to the floor.
- ▶ Make sure that all pedals are able to return freely to their original positions.

Only use floor mats which leave the pedal area free and can be securely fastened in the footwell.

If one of the brake circuits should fail, increased brake pedal travel will be required to bring the vehicle safely to a stop.

### WARNING

- Any obstructions that restrict pedal travel can cause loss of vehicle control and critical situations in traffic.
- Never place objects in the driver's footwell. Such objects could move under the pedals and interfere with their proper function. In the event of sudden braking or a change of direction, you would not be able to use the pedals. This could result in a loss of control and possibly cause an accident.

### Floor mats on the driver's side

*Use only floor mats which can be securely fastened in the footwell and do not obstruct the pedals.*

- ▶ Make sure that floor mats are securely fastened and cannot interfere with the pedals ⇒ .

Use only floor mats that leave the pedal area unobstructed and are firmly secured to prevent them from slipping. You can obtain suitable floor mats from your dealer or a specialist retailer.

### WARNING

- Any obstructions that restrict pedal travel can cause loss of vehicle control and increase the risk of serious personal injury.
- Always make sure that floor mats are properly secured.
  - Never lay or install additional floor mats or other floor coverings over the existing floor mats; this would restrict the pedal area and possibly obstruct the pedals, which could cause an accident.

## Stowing luggage safely

### Loading the luggage compartment

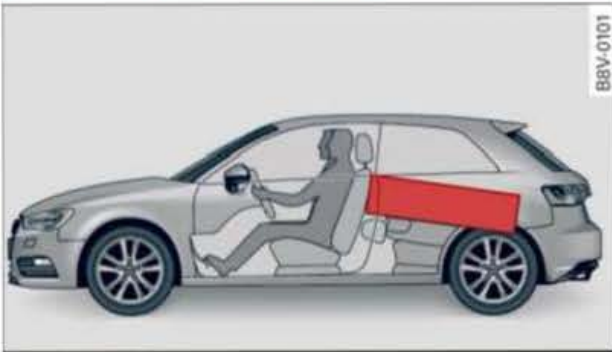

**Fig. 173** Heavy items should be placed as far forwards as possible (example).

All luggage and other objects must be safely secured in the luggage compartment. To maintain safe handling on the road, please observe the following points:

- ▶ Distribute the load evenly in the luggage compartment.
- ▶ Place heavy items as far forward as possible in the luggage compartment and secure them properly ⇒ *Fig. 173*.
- ▶ Secure the load with the stretch net\* or with non-elastic straps secured to the fastening rings ⇒ *page 74*.

#### **WARNING**

- Loose items in the luggage compartment are a safety hazard: they can move suddenly and impair the handling of the vehicle as a result of the change in weight distribution.
- In an accident or a sudden manoeuvre, loose objects in the passenger compartment can be flung forward – risk of injury! Always stow objects safely in the luggage compartment and secure them on the fastening rings\*. Use suitable securing straps, particularly when transporting heavy objects.
- Transporting heavy objects may affect the vehicle's handling by shifting the centre of gravity – this could cause an accident. Take extra care when driving and adjust your speed accordingly.

- Never exceed the maximum axle loads or the maximum gross weight for the vehicle ⇒ *page 272*. Exceeding the permitted axle loads or gross weight limit can affect the vehicle's handling characteristics, and increase the risk of accidents, personal injuries or damage to the vehicle.
- Never leave your vehicle unattended when the boot lid is open. Children could climb into the boot and close the boot lid from the inside. In this case the child would be unable to get out of the vehicle without help. This could have fatal consequences.
- Never allow children to play in or around the vehicle. Always close and lock the boot lid and all the doors when you leave the vehicle.
- Never let passengers ride in the luggage compartment. All occupants must be properly restrained by the seat belts at all times ⇒ *page 165*.

#### **CAUTION**

Make sure that no hard objects chafe against the wires of the heating element in the rear window and damage them.

#### **Note**

- Adjust the tyre pressure to match the vehicle loading - the correct pressures are specified on the sticker on the end face of the driver's door.
- Air circulation in the vehicle helps reduce fogging of the windows. Used air escapes through ventilation slots in the rear of the vehicle. Make sure that these ventilation slots are not obstructed.
- Suitable belts for securing loads to the fastening rings\* are commercially available.

## Fastening rings

Unsecured loads are a hazard to all vehicle occupants.

There are fastening rings in the luggage compartment which can be used to secure luggage and other objects ⇒ *page 74*.

- ▶ Use the fastening rings to secure items safely in the luggage compartment ⇒ .

During a collision or an accident, even small and light objects can possess so much energy that they can cause very severe injuries. The amount of this “kinetic energy” depends on the speed of the vehicle and the weight of the object. The most significant factor, however, is the speed of the vehicle.

For example: an object weighing 4.5 kg is lying unsecured in the vehicle. During a frontal collision at a speed of 50 km/h, this object generates a force corresponding to 20 times its weight. That means that the effective weight of the object increases to about 90 kg. You can imagine the severity of the injuries which might be sustained if this “projectile” strikes an occupant as it flies through the passenger compartment.

### WARNING

If items of luggage or other objects are secured to the fastening rings with inappropriate or damaged tensioning straps, injuries could result in the event of sudden braking or a collision.

- To prevent pieces of luggage or other objects from flying forward, always use appropriate tensioning straps which are properly secured to the fastening rings.
- Never secure a child seat on the fastening rings.

## Pedestrian protection system

### Description

Applies to vehicles: with pedestrian protection system

The pedestrian protection system will automatically be activated when the front of the vehicle collides with a pedestrian. The bonnet is raised several centimetres to create an additional crush zone above the engine.

The sensors of the pedestrian protection system are located in the front bumper. In rare cases, the system can be triggered because the possibility that a pedestrian has been hit cannot be ruled out by the sensors, for example:

- in a collision with a street post,
- in a collision with an animal, or
- if you drive into a pile of snow, or
- in the event of ground contact, e.g. when driving on extremely poor road surfaces.

If the system has been activated, press the bonnet back into its original position ⇒  in *Servicing the pedestrian protection system on page 164* and have the system serviced by a qualified workshop.

### WARNING

- Never change or replace the bumper or bonnet as a part of tuning measures. This can impair the effectiveness of the pedestrian protection system and invalidate the operating permit for your vehicle. The manufacturer cannot be held liable for damage which occurs as a result of failure to comply with these stipulations, and such damage is not covered under warranty.
- False activation of the pedestrian protection system is possible.

### Servicing the pedestrian protection system

Applies to vehicles: with pedestrian protection system



Fig. 174 Bonnet: Pedestrian protection system triggered

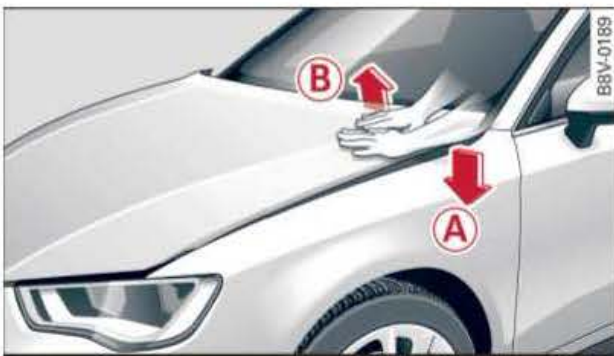





Fig. 175 Pressing back/checking the bonnet

When the pedestrian protection system has been triggered, the bonnet is raised by several centimetres ⇒ Fig. 174. In addition, the following message will appear:  **Safety system: system fault! See owner's manual.**

- ▶ To engage the bonnet again, press it down with both hands on the left side of the vehicle in area **A** ⇒ Fig. 175 ⇒ .
- ▶ To check whether the bonnet is properly engaged, pull the rear edge of the bonnet **B** upwards. If the bonnet can be lifted, press it down again.
- ▶ When the bonnet has engaged properly, repeat the procedure on the right side of the vehicle.
- ▶ Drive to the nearest qualified workshop without delay and have the pedestrian protection system serviced ⇒ .

In the event of a fault in the system, the following message will appear: **Safety system: system fault! See owner's manual..**

Drive to a qualified workshop without delay and have the fault rectified.

#### WARNING

- Do not press back the bonnet unless both of your hands are flat on top of the bonnet. If you do this, you cannot catch your fingers between the bonnet and body. Take care when pressing back the bonnet: careless or uncontrolled movements can cause injury to yourself or others - risk of injury!
- The system can only be activated once. If the pedestrian protection system has been triggered, have it replaced without delay by a qualified workshop.
- All repairs to the bumper and the pedestrian protection system must only be carried out by a qualified workshop working to the specifications of the Audi factory. Improper repairs can impair the effectiveness of the system and invalidate the operating permit for your vehicle.
- The relevant safety requirements must be observed when individual components of the system or the entire vehicle are scrapped. Your authorised dealer is familiar with these regulations and will be pleased to pass on the information to you.

## Seat belts

### Why is it so important to use seat belts?

#### Seat belts provide effective protection

The common belief that passengers can brace their weight with their hands in a minor collision is false.



Fig. 176 Driver with properly positioned seat belt - good protection if the brakes are applied suddenly

It is an established fact that seat belts provide good protection in accidents. Therefore wearing a seat belt is required by law in most countries.

Properly worn seat belts hold the occupants in the best position for maximum protection ⇒ Fig. 176. The seat belts are capable of absorbing much of the kinetic energy arising in a collision. Also they help to prevent uncontrolled movements which could lead to severe injuries ⇒ page 165, *Important safety notes when using seat belts*.

If they wear the seat belts correctly, the passengers benefit greatly from the ability of the belts to reduce the kinetic energy gradually. The front crumple zones and other passive safety features (such as the airbag system) are also designed to absorb the kinetic energy generated in a collision. Taken together, all these features reduce the forces acting on the occupants and consequently the risk of injury.

Although these examples are based on a frontal collision, the physical principles involved are the same in other types of accidents. This is why it is so important to put on the seat belts before every trip - even when "just driv-

ing around the corner". Ensure that your passengers wear their seat belts as well ⇒ ⚠.

Properly worn seat belts have been shown to be an effective means of reducing the potential for injury and improving the chances of survival in a serious accident ⇒ page 166, *Forces acting in a collision*.

For information on how children can travel safely in the car refer to ⇒ page 157, *Child seats*.

#### ⚠ WARNING

- Seat belts must be put on before every trip - even when driving in town. This also applies to the rear passengers (injury risk).
- During pregnancy, women should always ensure they wear a seat belt. The best way to protect the unborn child is to protect the mother ⇒ page 168, *Wearing and adjusting the seat belts during pregnancy*.

#### Important safety notes when using seat belts

There are a number of safety points concerning the seat belts which you should remember. This will help to reduce the risk of injury in an accident.

#### ⚠ WARNING

- The seat belts can only provide maximum protection if the seats are adjusted properly ⇒ page 66, *Front seats*.
- To ensure proper protection, it is important to wear the seat belts in the correct position ⇒ page 167, *How to wear seat belts properly*. Ensure that the seat belts are worn exactly as recommended in this chapter. Belts which are not worn properly can increase the risk of injury in accidents considerably.
- Do not allow the seat belt to become twisted or jammed, or to rub on any sharp edges.

- Never allow two passengers (even children) to share the same seat belt. It is especially dangerous to place a seat belt over a child sitting on your lap.
- Do not wear the belt over hard or fragile objects (such as glasses or pens, etc.) because this can cause injuries.
- Loose, bulky clothing (such as an overcoat over a jacket) impairs the proper fit and function of the belts.
- The belts must be kept clean, otherwise the retractors may not work properly  
⇒ *tab. Cleaning the interior on page 206.*
- The slot in the seat belt buckle must not be blocked with paper or other objects, as this can prevent the latch plate from engaging properly.
- The latch plate of the belt must always be engaged in the correct buckle for that seat, otherwise the belt will not be fully effective.
- Check the condition of the seat belts at regular intervals. If you notice that the belt webbing, fittings, retractor mechanism or buckle of any of the belts is damaged, the belt must be replaced by a qualified workshop.
- The seat belts must not be removed or modified in any way. Do not attempt to repair a damaged belt yourself.
- Seat belts which have been worn in an accident and stretched must be replaced by a qualified workshop. The belt anchorages should also be checked.

## Forces acting in a collision

### The physical principles involved in a frontal impact

*Very large forces are generated during a collision; these forces have to be absorbed.*

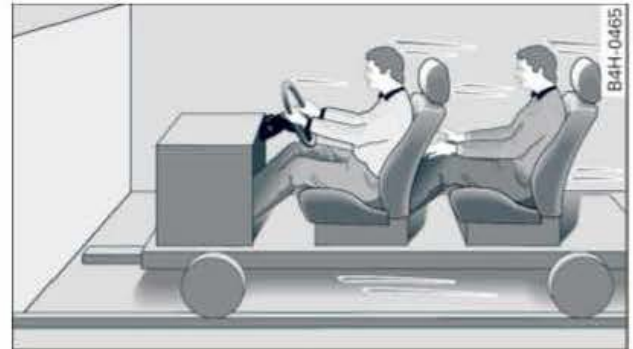

**Fig. 177** Passengers of a vehicle which is headed for a brick wall. They are not using seat belts.



**Fig. 178** The vehicle crashes against the wall

The physical principles involved in a frontal collision are relatively simple:

Both the moving vehicle and the passengers possess energy, which is known as “kinetic energy” ⇒ *Fig. 177*. The amount of “kinetic energy” depends on the speed of the vehicle and the weight of the vehicle and passengers. The higher the speed and the greater the weight, the more energy there is to be absorbed in an accident.

The most significant factor, however, is the speed of the vehicle. If the speed doubles from 25 km/h to 50 km/h, for example, the kinetic energy increases by a factor of four. Because these passengers are not restrained by seat belts, the entire amount of kinetic energy has to be absorbed at the point of impact ►



⇒ Fig. 178. This would result in serious or potentially fatal injury.

Even at urban speeds of 30 km/h to 50 km/h, the forces acting on the occupants in a collision can reach the equivalent of 1 ton (1000 kg) or more. At greater speed these forces are even higher. Again: if the speed doubles, the forces increase by a factor of four.

Passengers who do not wear seat belts are not “attached” to the vehicle. In a frontal collision they will continue to move forward at the speed their car was travelling just before the impact.

### What happens to passengers not wearing seat belts?

*Passengers not wearing seat belts risk fatal injuries in the event of an accident.*



**Fig. 179** A driver not wearing a seat belt can be thrown forwards



**Fig. 180** A rear passenger not wearing a seat belt can be thrown forwards

In a frontal collision, unbelted passengers will be thrown forwards and make violent contact with the steering wheel, dashboard, windscreen, etc ⇒ Fig. 179. Passengers not wearing their belts risk being thrown out of the

car. This could result in potentially fatal injuries.

The common belief that occupants can brace their weight with their hands in a minor collision is false. Even at low speeds the forces acting on the body in a collision are so great that it is not possible to hold yourself in the seat.

It is also important for the rear passengers to wear seat belts, as they could otherwise be thrown forwards violently in an accident. Rear passengers who do not use seat belts endanger not only themselves but also the other occupants ⇒ Fig. 180.

## How to wear seat belts properly

### Putting on the three-point seat belts

*Always fasten your seat belts before driving off.*



**Fig. 181** Positioning of head restraints and seat belts



**Fig. 182** Driver's seat: Belt buckle and latch plate

- ▶ Adjust the front seat and head restraint correctly before putting on the seat belt  
⇒ page 66, *Front seats*.

- ▶ To fasten the belt, take hold of the latch plate and pull it slowly across your chest and lap ⇒ .
- ▶ Insert the latch plate into the buckle for the appropriate seat and push it down until it is securely locked with an audible click ⇒ *Fig. 182*.
- ▶ Pull the belt to check that it is now securely fastened.

The three-point inertia reel belts are tensioned automatically. The retractor system gives complete freedom of movement, as long as the pull on the belt is slow. Hard braking locks the belt. The belt will also lock when you accelerate, drive up or down a steep hill or in a sharp curve.

### WARNING

- Always make certain that the belt is positioned properly ⇒ *Fig. 181* - risk of injury ⇒ *page 168, Adjusting the seat belts*.
- The latch plate of the belt must always be engaged in the correct buckle for that seat. Otherwise the belt will not be fully effective and the danger of injury increases.

### Adjusting the seat belts

Always position seat belts properly for maximum safety.

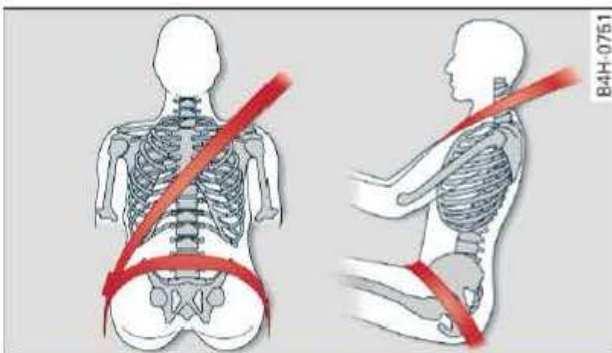

**Fig. 183** Adjusting shoulder/lap belt

The following features allow you to match the position of the seat belt to your height:

- Belt height adjustment
- Seat height adjustment (front seats)

### WARNING

- The shoulder section of the belt should be fitted across the centre of the collar bone close to the body. To fasten the belt, take hold of the belt above the latch plate and pull it slowly down across your chest. Wear the lap portion of the seat belt as low as possible over the hips so that there is no pressure on the lower abdomen. The belt should always be worn tightly ⇒ *Fig. 183*. Pull the belt tight if necessary to take up any slack.
- Always make sure that belt is positioned properly. Incorrectly worn seat belts can give rise to injuries even in a minor collision.
- Seat belts worn too loose can result in injuries because they allow excessive forward movement in a crash; the occupant will be brought to a sudden stop by the belt webbing.

### Wearing and adjusting the seat belts during pregnancy

To afford the best protection for the unborn child it is important for the mother to wear the seat belt properly at all times.



**Fig. 184** Positioning seat belts during pregnancy

Women should always ensure they adjust the seat belt correctly during pregnancy.

- ▶ Adjust the front seat and head restraint correctly before putting on the seat belt ⇒ *page 66, Front seats*.
- ▶ To fasten the belt, take hold of the latch plate and pull it slowly down across your chest. Wear the lap portion of the seat belt ▶

as low as possible over the hips so that there is no pressure on the stomach  
⇒ Fig. 184, ⇒ ⚠.

- ▶ Insert the latch plate into the buckle for the appropriate seat and push it down until it is securely locked with an audible click  
⇒ page 167, Fig. 182.
- ▶ Pull the belt to check that it is now securely fastened.

### ⚠ WARNING

During pregnancy, women should especially make sure to wear the lap portion of the seat belt as low as possible across the hips so that there is no pressure on the stomach.

### Seat belt height adjustment

Seat belt height adjusters can be used to adjust the height of the shoulder portion of the seat belt.



Fig. 185 Belt height adjustment for the front seats: guide fitting

The shoulder section of the belt should be fitted across the centre of the collar bone close to the body ⇒ ⚠ in *Adjusting the seat belts* on page 168.

- ▶ Take hold of the guide fitting and *slide* it **upwards** ②, or
- ▶ *Compress* the adjuster ① and *slide* the guide fitting **downwards** ②.
- ▶ After adjusting, pull the shoulder belt sharply to check that the catch on the guide fitting is engaged securely.

### i Note

- It is also possible to adjust the height of the front seats to obtain the best position for the front seat belts.
- The shoulder section of the belt should be fitted across the centre of the collar bone close to the body. The lap belt must be worn tightly over the hips. It must not be positioned over the stomach. Pull the belt tight if necessary to take up any slack.

### Taking off the seat belts

The red button releases the belt from the buckle.



Fig. 186 The latch plate of the belt springs out of the buckle

- ▶ Press the red button in the seat belt buckle. The latch plate will spring out of the buckle.
- ▶ Guide the belt back by hand so that it is taken up by the retractor.

## Belt tensioners

### How the belt tensioners work

The seat belts for the driver and front passenger are equipped with belt tensioners.

The seat belts on the front seats are tensioned automatically in frontal, side and rear-end impacts above a certain degree of severity. This helps to reduce the forward motion of the occupants.

In a less severe accident, or in the event of a rollover, the belt tensioners are not activated. ▶



### WARNING

- Any work on the tensioner system or removal and installation of system components for other repairs must be performed by a qualified workshop.
- The belt tensioners can only be activated once. If they have been activated at any time, the system must be replaced.



### Note

- Some smoke may be released when the belt tensioners are activated. This does not mean there is a fire in the vehicle.
- The relevant safety requirements must be observed when the vehicle or components of the system are scrapped. Your authorised dealer is familiar with these regulations and will be pleased to pass on the information to you.

## Airbag system

### Description of airbag system

#### General notes on airbag system

*The airbag is an integral part of the car's passive safety system.*

In conjunction with the three-point seat belts, the airbag system gives the front occupants additional protection for the head and chest and for the area around the driver's knees in the event of a severe frontal collision.

In a severe side collision the side\* airbags and the head-protection airbags reduce the risk of injury to the occupants in the areas of the body facing the impact ⇒ .

In addition to their normal function of protecting the occupants in a collision, the seat belts also hold them in a position where the airbags can inflate properly and provide maximum protection.

The airbag system will only work with the ignition on. The airbag system is monitored electronically; the airbag warning lamp indicates whether the system is functioning properly.

#### The main parts of the airbag system are:

- The electronic monitoring system (control unit and sensors)
- The two front airbags and the driver's knee airbag
- The front side airbags and the side airbags\* in the outer rear seats
- The head-protection airbags
- The warning lamp  in the instrument cluster

#### There is a fault in the airbag system if the warning lamp

- does not come on when the ignition is switched on.
- does not go out about 4 seconds after the ignition is switched on.

- goes out and then comes on again after the ignition is switched on.
- comes on or flickers while the car is moving.

#### WARNING

- The airbags are not a substitute for the seat belts; they are an integral part of the car's overall passive safety system. The airbags can only offer effective protection if the occupants are wearing their seat belts. For this reason it is very important to wear the seat belts at all times ⇒ *page 165, Why is it so important to use seat belts?*
- The seat belts and airbags can only provide maximum protection if the occupants are seated correctly ⇒ *page 66, Front seats.*
- If you do not wear a seat belt, if you lean forward, or are not seated correctly while the vehicle is in motion, you are at greater risk of injury should the airbag system be triggered in an accident.
- Components of the airbag system are located in various parts of the vehicle. If repairs to other vehicle components make it necessary to perform work on the airbag system or to remove or install parts of the airbag system, this may cause damage to the airbag system. As a result, the airbags may not inflate correctly or may not be triggered at all in an accident situation. For this reason, you should always have the work carried out by a qualified workshop.
- If a fault should occur in the airbag system, have the system checked immediately by a qualified workshop. Otherwise the system may fail to trigger in an accident.
- Do not attempt to modify components of the airbag system in any way.
- Never make any alterations to the front bumper or the body.
- Do not remove the front seats.
- The airbag system can only be activated once; if the airbag has been triggered, the system must be replaced. Should the

airbag system or airbag modules have to be replaced, the qualified workshop carrying out the replacement will document all details in the appropriate section of the Service Schedule.

- If you sell the vehicle, remember to pass on the complete Service Wallet to the new owner. If the front passenger's airbag has been deactivated, it is important that the new owner is also given the relevant documents.
- The relevant safety requirements must be observed when the vehicle or components of the airbag or belt tensioner systems are scrapped.

### When are the airbags triggered?

One or more airbag systems are triggered in severe collisions, depending on the circumstances.

The airbag system is not triggered in minor collisions, or in rear collisions, or if the car overturns. In these situations, the occupants are protected by wearing the seat belts.

### Factors determining the triggering response

It is not possible to define the exact triggering response of the airbag system in all possible situations, since the circumstances in different types of accident will vary considerably. Important factors include, for example, the nature (hard or soft) of the object which the car hits, the angle of impact, vehicle speed and so on.

Whether the airbags are triggered depends primarily on the vehicle deceleration rate resulting from the collision. By processing the signals from the sensors located in the vehicle, the electronic control unit is immediately able to evaluate the severity of the collision and activate the restraint systems accordingly. If the deceleration rate is below the pre-

defined reference value in the control unit the airbags will not be triggered, even though the accident may cause extensive damage to the car.

### Note

The airbag releases a fine dust when it inflates. This is quite normal and does not mean there is a fire in the vehicle.

## Front airbags

### Important notes on front passenger's airbag



Fig. 187 Front passenger's sun visor: Airbag sticker

A sticker<sup>1)</sup> with important information about the front passenger's airbag is provided on the front passenger's sun visor. Please refer to the safety notes in the following chapters:

- Child seats and front passenger's airbag  
⇒ page 157, *Safety notes for using child seats*
- Safe distance from front passenger's airbag  
⇒ page 174, *Important safety notes on the front airbag system*
- Objects between front passenger and front passenger's airbag  
⇒ page 174, *Important safety notes on the front airbag system*

<sup>1)</sup> Still under development at the time of printing. Not available in all export vehicles.

### Description of front airbags

The airbag system is not a substitute for the seat belts.



Fig. 188 Steering wheel: Driver's airbag



Fig. 189 Dashboard: Front passenger's airbag

The front airbag for the driver is located in the padded hub of the steering wheel ⇒ Fig. 188. The front airbag for the front passenger is in the dashboard above the glove box ⇒ Fig. 189. The locations of the airbags are marked with the word "AIRBAG".

In conjunction with the three-point seat belts, the front airbags give additional head and chest protection for the driver and front passenger and for the area around the driver's knees in the event of a severe frontal collision ⇒ ⚠ in *Important safety notes on the front airbag system* on page 174.

### How the front airbags work

When fully inflated, the airbags reduce the risk of head or chest injury.



Fig. 190 Front airbags in inflated condition

The driver's and front passenger's airbag are triggered in certain frontal collisions ⇒ Fig. 190. Further airbag systems may also be triggered, depending on the circumstances.

When the system is triggered, the airbags fill with a propellant gas and open out in front of the driver and front passenger ⇒ Fig. 190. In order to provide the desired extra protection in an accident, the airbags have to inflate extremely rapidly (within fractions of a second). The fully deployed airbags cushion the forwards movement of the front occupants and help to reduce the risk of injury to the head and the upper part of the body.

Special openings in the airbag allow the gas to escape at a controlled rate to restrain the forward movement of the occupant's head and torso. Once the impact has been absorbed, the airbag deflates sufficiently for the front occupants to see forward.

### Important safety notes on the front airbag system

There are a number of safety points concerning the airbag system which you should remember. This will help to reduce the risk of injury in an accident.



Fig. 191 Minimum distance from steering wheel

#### WARNING

- It is important for the driver and front passenger to maintain a distance of at least 25 cm from the steering wheel or dashboard ⇒ Fig. 191. The airbag system will not be able to give the required protection if you sit too close to the steering wheel or dashboard. There is also a risk of injury if the airbags are inflated. The front seats and head restraints must always be positioned correctly for the height of the occupant.
- If you do not wear a seat belt, if you lean forward or to the side, or are not seated correctly while the vehicle is in motion, you are at greater risk of injury. Should the airbag system be triggered in an accident there is an even greater risk of injury.
- Never let a child travel on the front seat without an appropriate restraint system. If the airbag is triggered in an accident, the child could sustain serious or fatal injuries ⇒ page 157, *Child seats*.
- Child seats in which the child faces the rear of the car are located directly in the path of the front passenger's airbag if it inflates. In this case, the child could sustain serious or fatal injuries if the airbag were to be deployed.

- Applies to vehicles on which the front passenger's airbag cannot be deactivated: Do NOT use a rearward-facing child seat on the front passenger's seat.
- Applies to vehicles with key-operated switch for deactivating the front passenger's airbag: Do NOT use a rearward-facing child seat on the front passenger's seat while the front passenger's airbag is active. If you have no alternative but to use a rearward-facing child seat on the front passenger's seat, the front passenger's airbag must be deactivated beforehand via the key-operated switch\* ⇒ page 180. Make sure that the front passenger's airbag is reactivated by means of the key-operated switch\* as soon as the child seat is no longer needed on the front passenger's seat.
- Occupants sitting in the front of the car must never carry any objects or pets in the space between them and the airbags, or allow children or other passengers to travel in this position.
- Do not cover or stick anything on the steering wheel hub or the soft plastic surface of the airbag unit on the passenger's side of the dashboard, and do not obstruct or modify them in any way. These parts should only be cleaned with a dry cloth (or with a cloth moistened with plain water). It is also important not to attach any objects such as cup holders or telephone mountings to the surfaces covering the airbag units.
- Any work on the airbag system or removal and installation of the airbag components for other repairs (such as repairs to the steering wheel or removal of seats) must be performed by a qualified workshop.



## Knee airbag

### Description of the knee airbag

Applies to vehicles: with knee airbag

The knee airbag system can give additional protection to a driver wearing a seat belt.

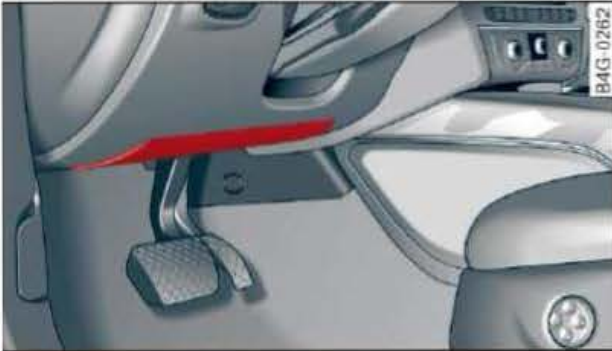

Fig. 192 Airbag (driver's side)

The knee airbag on the driver's side is located in the dash panel underneath the steering wheel ⇒ Fig. 192.

The knee airbag provides extra protection for the driver's knees and thighs in addition to the protection already given by the seat belt.

In addition to its normal function of restraining an occupant, the seat belt also holds the driver in a position where the airbag can provide extra protection in a frontal collision.

The airbag system is just one component of the vehicle's restraint system and cannot replace the function of the seat belts. Please always remember that the airbags can only protect you if you are wearing your seat belt properly. That is why it is so important to wear your seat belt at all times (not just because it's the law) ⇒ page 165, *Why is it so important to use seat belts?*.

Please also bear in mind that the airbags are only inflated in certain types of accident and that they can only be triggered once. The seat belts are also intended to protect you in situations where the airbags are not triggered or have already been triggered (e.g. if your vehicle collides with a second vehicle following an initial impact).

That is just one reason why an airbag cannot replace a seat belt. The airbag system is most

effective when used in conjunction with the seat belts. Always fasten your seat belt properly for this reason.

Please note that, although the knee airbag system is designed to reduce the risk of serious injury, the airbags can cause other injuries when inflated (such as inflammation, bruising, abrasion and friction burns).

### The basic parts of the knee airbag system (driver's side) are:

- The electronic control unit
- An inflatable airbag (airbag and gas generator) for the driver
- The airbag warning lamp in the instrument cluster

### The knee airbag system is NOT triggered in the following situations:

- If the ignition is off
- In a frontal collision if the retardation rate measured by the control unit is too low
- In side-on collisions
- If your vehicle is hit from behind
- If the vehicle overturns
- If a system malfunction occurs (warning/indicator lamp on) ⇒ page 21

#### WARNING

- The seat belt and knee airbag system can only protect the driver if he/she is sitting in the correct position ⇒ page 154.
- Have the system checked immediately by your Audi dealer if the airbag warning lamp lights up while you are driving ⇒ page 21.

### How the knee airbag works

Applies to vehicles: with knee airbag

*When fully inflated, the knee airbag can reduce the risk of injury to the driver's legs.*



**Fig. 193** Inflated airbags provide protection in a frontal collision

The driver's and front passenger's airbag are triggered in certain frontal collisions ⇒ *page 173, Fig. 190*. Further airbag systems may also be triggered, depending on the circumstances.

When the system is triggered, the airbag is filled with propellant gas and inflated between the lower part of the dash panel and the driver ⇒ *Fig. 193*.

Although the airbag is not a soft cushion, it can absorb the energy of an impact and thus help to reduce the risk of injury to the lower limbs.

All this happens in a fraction of a second and many people are not even aware that the airbags have been triggered. Airbags are released with considerable force. For the protection of occupants, it is important that no objects are in the path of the airbags when they are inflated.

When the seat belts are worn correctly, fully inflated airbags will retard and restrain the forward movement of the occupants, thus helping to reduce the risk of injury.

### Important safety notes on knee airbag system

Applies to vehicles: with knee airbag

*Airbags are intended as an additional restraint measure. Always wear your seat belt correctly and sit in the correct position in your seat.*

There are many things that you and your passengers need to know and do to ensure that the seat belts and airbags can provide additional protection.

#### WARNING

An airbag can cause serious injury while it is inflating. If you wear your seat belt incorrectly or sit in the wrong position in your seat while the vehicle is moving, this significantly increases the risk of injury and can have fatal consequences.

- The knee airbag system cannot protect you properly if you are sitting too close to one of the airbags. When adjusting the driver's seat, it is important to ensure that the following distances for the driver's torso and knees are maintained:
  - At least 25 cm (10 inches) between chest and steering wheel/dash panel
  - At least 10 cm (4 inches) between knees and lower part of dash panel
- The risk of injury is increased if you lean forward or to the side, if the seat is incorrectly adjusted, or if you are not wearing your seat belt. The risk is even higher if the airbag is triggered.
- Please always ensure that the knee airbag can inflate freely. Any objects between your body and the airbag will increase the risk of injury in the event of an accident, as they will impede the inflation of the airbag and can be catapulted towards your body.
  - Never transport items in the footwell in front of the driver's seat. Bulky objects (such as shopping bags) could impede the airbag or prevent it from inflating. Small items could be thrown through the vehicle and cause injury to

you or your passengers when the airbags are triggered.

- Ensure that there are no cracks, deep scratches or other damage to the dash panel in the vicinity of the knee airbag.

## Side airbags

### Description of side airbags

Applies to vehicles: with side airbags

The airbag system is not a substitute for the seat belts.



Fig. 194 Side airbags: Location in driver's seat (example)

The side airbags are integrated in the backrests of the front seats and outer rear seats\*. The locations of the airbags are marked with the word "AIRBAG".

In conjunction with the three-point seat belts, the side airbags give the occupants additional protection for the whole upper part of the body (i.e. the chest, stomach and pelvis) in the event of a severe side collision ⇒ **⚠** in *Important safety notes on the side airbag system on page 178*.

In a side collision the side airbags reduce the risk of injury to the areas of the body facing the impact.

### How the side airbags work

Applies to vehicles: with side airbags

When fully inflated, the side airbags reduce the risk of injuries to the upper part of the body.



Fig. 195 Inflated front and rear\* side airbags (example)

In certain types of side collision the side airbags (front and rear\*) are triggered on the impact side of the vehicle ⇒ Fig. 195. Further airbag systems may also be triggered, depending on the circumstances.

When the system is triggered, the airbag is filled with propellant gas.

In order to provide the desired extra protection in an accident, the airbags have to inflate extremely rapidly (within fractions of a second). The airbag releases a fine dust when it inflates. This is quite normal and does not mean there is a fire in the vehicle.

When fully deployed, the airbags cushion the impact for the occupants and help to reduce the risk of injury to the whole upper part of the body (i.e. the chest, stomach and pelvis) on the side facing the door.

### Important safety notes on the side airbag system

Applies to vehicles: with side airbags

*There are a number of safety points concerning the airbag system which you should remember. This will help to reduce the risk of injury in an accident.*

#### WARNING

- If you do not wear a seat belt, if you lean forward, or are not seated correctly while the vehicle is in motion, you are at greater risk of injury should the side airbags be triggered in an accident. This applies particularly to children if they are not properly protected by a child restraint system.
- If children are not seated correctly, they are at greater risk of injury should the airbag system be triggered in an accident. This is particularly the case if the child is travelling on the front passenger's seat and the airbag system is triggered in an accident. This could result in serious or potentially fatal injury ⇒ *page 157, Child seats.*
- It is also important not to attach any accessories (such as cup holders) to the doors. This would impair the protection offered by the side airbags (front and rear\*).
- The sensors for the airbags are located in the front doors. You must therefore not make any modifications to the doors or door trim (e.g. retrofitting loudspeakers), as this could impair the function of the side airbags. Any damage to the front doors could lead to faults in the system. Repairs or any other work on the front doors must therefore always be carried out by a qualified workshop.
- The built-in coat hooks should only be used for lightweight clothing. Do not leave any heavy or sharp-edged objects in the pockets.
- Do not apply excessive force to the sides of the backrests (such as hard knocks or

kicks), as this could damage parts of the system. The side airbags could then fail to operate when required.

- If you intend to fit protective covers over the seats, these must be of the specific type approved for use on Audi seats with side airbags. Conventional seat covers would obstruct the side airbag when it inflates out of the backrest, and seriously reduce the airbag's effectiveness.
- Any damage to the original seat upholstery or around the seams of the side airbag units must be repaired immediately by a qualified workshop.
- Any work involving the side airbag system or removal and installation of the airbag components for other repairs (such as repairs to the seats) must always be performed by a qualified workshop. Otherwise the airbag system may fail to work properly.

#### Note

All the other airbags in the car will remain functional if the front passenger's airbag has been deactivated.

## Head-protection airbags

### Description of head-protection airbags

Applies to vehicles: with head-protection airbags

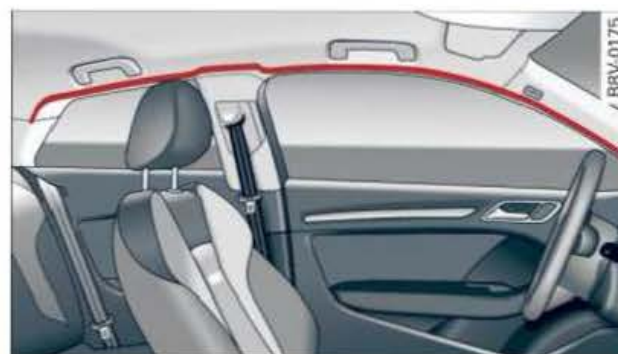

**Fig. 196** Location of head-protection airbags above the doors (example)

The head-protection airbags are located above the doors on the left and right sides of the vehicle. The locations of the airbags are marked with the word "AIRBAG".

In conjunction with the three-point seat belts and side airbags, the head-protection airbags give the occupants additional protection against head and neck injuries in a severe side collision ⇒ **⚠** in *Important safety notes on the head-protection airbags on page 179*.

Together with other design features (including cross-braces in the seats and the overall strength of the body structure), the head-protection and side airbag system offers an effective further improvement to occupant protection in side impacts.

### How the head-protection airbags work

Applies to vehicles: with head-protection airbags

*When fully inflated, the airbags reduce the risk of head or chest injury in a side collision.*



**Fig. 197** Head-protection airbags in inflated condition (example)

In certain types of side collision, the head-protection airbag is triggered on the impact side of the vehicle ⇒ *Fig. 197*. Further airbag systems may also be triggered, depending on the circumstances.

When the system is triggered, the airbag fills with a propellant gas and covers the entire area in front of the side windows, including the door pillars. In this way the system is able to protect both the front and the rear occupants on the side of the vehicle where the impact occurs. The head-protection airbag inflates to soften the impact if an occupant strikes parts of the interior or objects outside the vehicle with their head. By reducing the head impact and restraining uncontrolled movement of the head, the airbag also reduces the forces acting on the neck.

In order to provide the desired extra protection in an accident, the airbags have to inflate extremely rapidly (within fractions of a second). The airbag releases a fine dust when it inflates. This is quite normal and does not mean there is a fire in the vehicle.

### Important safety notes on the head-protection airbags

Applies to vehicles: with head-protection airbags

*There are a number of safety points concerning the airbag system which you should remember. This will help to reduce the risk of injury in an accident.*

#### **⚠** WARNING

- It is important to ensure that the area around the openings for the head-protection airbags remains unobstructed at all times, so that the airbags can inflate properly if needed.
- The built-in coat hooks should only be used for lightweight clothing. Do not leave any heavy or sharp-edged objects in the pockets. When using the coat hooks, do not hang the clothes on coat hangers.
- The space between the passengers and the head-protection airbags must never be occupied by children, other passengers or pets. Passengers should never lean out or put a hand or arm out of the window while the vehicle is in motion.
- Do not move the sun visors out to cover the side windows if there is anything attached to them (such as pens or a remote control for the garage door). These objects could cause injury if the head-protection airbag is triggered.
- The sensors for the airbags are located in the front doors. You must therefore not make any modifications to the doors or door trim (e.g. retrofitting loudspeakers), as this could impair the function of the side airbags. Any damage to the front doors could lead to faults in the system. Repairs or any other work on the

front doors must therefore always be carried out by a qualified workshop.

- Where sun blinds are fitted on the rear doors, these must not obstruct or impair the airbags in any way.
- If unsuitable accessories are installed near the head-protection airbag, the protection afforded by the airbag can be seriously impaired if the system is triggered. When the head-protection airbag opens, parts of these accessories could be thrown into the vehicle and injure passengers ⇒ *page 233*.
- Any work involving the head-protection airbags, or removal and installation of the airbag components for other repairs (such as repairs to the roof liner), must always be performed by a qualified workshop. Otherwise the airbag system may fail to work properly.

## Deactivating the front passenger's airbag

Applies to vehicles: with key-operated switch for front passenger's airbag

*If an airbag has been deactivated, it should be reactivated as soon as possible so that it can continue to give the required protection.*



**Fig. 198** Glove box: Key-operated switch for deactivating front passenger's airbag



**Fig. 199** Centre console: Warning lamp lights up when passenger's airbag is deactivated

The key-operated switch for deactivating the front passenger's airbag is located in the glove box ⇒ *Fig. 198*.

- ▶ To deactivate the front passenger's airbag, use the key to turn the key-operated switch to 0.
- ▶ The front passenger's airbag can be reactivated by turning the key to position 1.

### Deactivating front passenger's airbag when a child seat is in use

If you have no alternative but to install a rearward-facing child seat on the front passenger's seat you must deactivate the front passenger's airbag beforehand.

We recommend that child seats should be fitted on the rear seat so that the front passenger's airbag can remain functional and provide protection in an accident ⇒ *page 157*.

### Monitoring of airbag system

The indicator lamp  ⇒ *page 21* will light up for a few seconds every time the ignition is switched on.

If the front passenger's airbag has been deactivated, the indicator lamp "PASSENGER AIRBAG OFF" or  AIRBAG OFF or "Airbag deactivated" will light up constantly as a reminder ⇒ *Fig. 199*. In addition, the following message will appear briefly:

#### Passenger airbag off

Once you have reactivated the passenger airbag, the following message will appear briefly:

#### Passenger airbag on



**WARNING**

- If you have no alternative but to install a rearward-facing child seat on the front passenger's seat, the front passenger's airbag must be deactivated beforehand. Potentially fatal injuries to the child can result if the front passenger's airbag is not deactivated ⇒ *page 157!*
- If you have deactivated the front passenger's airbag, reactivate it as soon as the child seat is no longer needed so that the airbag can continue to give the required protection.
- It is the driver's responsibility to ensure that the key-operated switch is set to the correct position.

**Note**

All the other airbags in the car will remain functional if the front passenger's airbag has been deactivated with the key-operated switch.

## Intelligent technology

### Electronic stabilisation control (ESC)

#### Description

ESC increases the car's stability. It reduces the tendency to skid and improves the stability and roadholding of the vehicle. The ESC detects critical handling situations, such as understeer, oversteer and wheelspin on the driven wheels. It stabilises the vehicle by braking individual wheels or by reducing the engine torque. The indicator lamp  in the instrument cluster starts flashing as soon as the ESC intervenes.

The ESC incorporates the functions of the anti-lock brake system (ABS), the brake assist system, the traction control system (ASR), the electronic differential lock (EDL), the electronic limited slip differential\* (front-wheel drive), the selective wheel torque control\* (four-wheel drive) and the trailer stabilisation system\* ⇨ *page 195*. The ESC also helps to stabilise the vehicle by changing the steering wheel torque.

#### Anti-lock brake system (ABS)

ABS prevents the wheels from locking up under braking until the vehicle has reached a virtual standstill. You can continue to steer the vehicle even when the brakes are on full. Keep your foot on the brake pedal and do not pump the brakes. You will feel the brake pedal pulsate while the anti-lock brake system is working.

#### Brake assist system

The brake assist system can shorten the braking distance. The braking force is automatically boosted if you press the brake pedal quickly in an emergency. You must keep pressing the brake pedal until the danger has passed. On vehicles with adaptive cruise control\*, the response of the brake assist system will be more sensitive if you are too close to the vehicle in front.

#### Traction control system (ASR)

In the event of wheelspin, the traction control system reduces the engine torque to match the amount of grip available. This helps the car to start moving, accelerate or climb a gradient.

#### Electronic differential lock (EDL)

When the EDL detects wheelspin, it brakes the spinning wheel and directs the power to the other driven wheel (or wheels on quattro\* versions). This function is active up to about 100 km/h.

To prevent the disc brake of the braked wheel from overheating, the EDL cuts out automatically if subjected to excessive loads. The vehicle can still be driven. The EDL will switch on again automatically when the brake has cooled down.

#### Trailer stabilisation system\*

If you are using your vehicle to tow a trailer, please bear in mind that trailers have a tendency to sway. If the ESC detects that the trailer is swaying and this is affecting the towing vehicle, it will automatically brake the vehicle where possible in order to stabilise the trailer. The trailer stabilisation system is not available for all export versions.

#### Electronic limited slip differential\* / selective wheel torque control\*

An electronic limited slip differential (front-wheel drive) or selective wheel torque control function (four-wheel drive) intervenes when cornering by braking the unladen wheel(s) on the inside of the bend individually as required. This minimises understeer and neutralises the car's handling under power to enable precision cornering. The relevant system may not intervene in the wet or snow.

#### Multicollision brake assist system

The "multicollision brake assist system" can assist the driver and reduce the risk of skidding and further collisions during an accident by automatically applying the brakes. ►



The “multicollision brake assist system” acts in frontal, side and rear collisions when the airbag control unit detects a threshold trigger condition during an accident and the accident occurs at a road speed in excess of 10 km/h. The ESC will automatically brake the vehicle (unless the ESC, hydraulic brake system or vehicle’s electrical system have been damaged during the accident).

The following conditions override the automatic brake application in an accident:

- There is no automatic braking if the driver presses the accelerator.
- The vehicle is braked manually if the brake pressure applied by pressing the brake pedal is higher than the brake pressure initiated by the system.
- The “multicollision brake assist system” is not available if an ESC malfunction occurs.



### WARNING

- The grip provided by the ESC, ABS, ASR, EDL, electronic limited-slip differential and selective wheel torque control systems is still subject to the physical limits of adhesion. Always bear this in mind, especially on wet or slippery roads. If you notice the systems cutting in, you should reduce your speed immediately to suit the road and traffic conditions. Do not let the extra safety provided tempt you

into taking any risks when driving – this can cause accidents.

- Remember that the accident risk always increases if you drive fast, especially in corners or on a wet or slippery road, or if you follow too close behind the vehicle in front of you. Please bear in mind that even ESC, ABS, brake assist, EDL, electronic limited slip differential, selective wheel torque control and ASR cannot compensate for the increased accident risk.
- When accelerating on a uniformly slippery surface (for instance all four wheels on ice or snow), press the accelerator gradually and carefully. The driven wheels may otherwise start to spin (in spite of the integrated control systems), which would impair the car’s stability and could lead to an accident.

### Note

- To ensure that the ABS and ASR systems work properly, all four wheels must be fitted with identical tyres. Any differences in the rolling radius of the tyres can cause the system to reduce engine power when this is not desired.
- The systems can make noises when they intervene.
- If the indicator lamp  or  appears, there may be a malfunction ⇨ page 22.

## Switching the ESC on/off

The ESC is switched on automatically when the engine is started.













Fig. 200 Centre console (top): ESC button

The ESC operates in several levels. Depending on which level is selected, the stabilising function of the ESC is restricted or switched off, and the vehicle is stabilised to a greater or lesser degree.

In the following special situations, it may be advisable to switch on the ESC sport mode to allow a certain amount of wheel spin:

- Rocking the car backwards and forwards to free it

– Driving in deep snow or on loose surfaces

	Sport mode on	ESC/ASR off	Sportmodus off or ESC/ASR on
<b>Characteristics</b>	The ESC intervenes less for stabilisation purposes and the traction control system (ASR) is switched off ⇒  .	The ESC intervenes a lot less for stabilisation purposes and the traction control system (ASR) is switched off ⇒  .	The stabilising function of the ESC and traction control system (ASR) is fully available again.
<b>Controls</b>	Press the  OFF button briefly.	Press the  OFF button for longer than 3 seconds.	Press the  OFF button again.
<b>Indicator lamps</b>	 lights up.	 and  * light up.	 goes out, or  and  * go out.
<b>Driver messages</b>	<b>Stabilisation control (ESC): sport. Warning! Restricted stability</b> (on vehicles with driver information system*)	<b>Stabilisation control (ESC): off. Warning! Restricted stability</b> (on vehicles with driver information system*)	<b>Stabilisation control (ESC): on</b> (on vehicles with driver information system*)

### WARNING

You should switch off the ESC only if your driving ability and the traffic conditions allow you to do so safely - danger of skidding!

- The stabilising functionality is restricted in ESC sport mode. The driven wheels may start to spin, causing the vehicle to lose grip, in particular on slippery or wet roads.
- When the ESC/traction control system (ASR) is switched off, the vehicle will not be stabilised.

### Note

- If a malfunction occurs in the Audi magnetic ride system, the ESC sport mode cannot be switched on and the ESC cannot be switched off. If the ESC sport mode is activated or the ESC is off, the ESC will automatically be reactivated.
- The ESC sport mode cannot be switched on (i.e. the ESC/ASR cannot be switched off) while the cruise control system\* or adaptive cruise control\* is actively regulating the speed.

## Brakes

### New brake pads

New brake pads do not give full braking effect for the first 400 km, they must first be “bedded in”. However, you can compensate for the slightly reduced braking effect by applying more pressure on the brake pedal. Avoid placing a heavy load on the brakes during the running-in period.

### Wear

The rate of wear on the **brake pads** depends a great deal on how you drive and the conditions in which the vehicle is operated. Negative factors are, for instance, city traffic, frequent short trips or hard driving with abrupt starts and stops.

### Noises

Brake noise may develop in certain situations, depending on the speed, braking force and ambient conditions (such as temperature and relative humidity).

### Effect of moisture and salt

In certain conditions, such as in heavy rain, early morning dew, or after washing the car or driving through water, the full braking effect ►

can be delayed by moisture (or in winter by ice) on the discs and brake pads. The brakes should be “dried” by pressing the pedal to restore full braking effect.

When you are driving at higher speeds with the windscreen wipers on, the brake pads are very briefly brought into contact with the brake discs. This automatic process which goes unnoticed by the driver is carried out at regular intervals and is intended to improve braking response in wet conditions.

The effectiveness of the brakes can also be temporarily reduced if the car is driven for some distance without using the brakes when there is a lot of salt on the road in winter. The layer of salt that accumulates on the discs and pads can be removed with a few cautious brake applications.

### Corrosion

There may be a tendency for dirt to build up on the brake pads and corrosion to form on the discs if the car is used infrequently, or if you only drive low mileages without using the brakes very much.

If the brakes are not used frequently, or if corrosion has formed on the discs, it is advisable to clean off the pads and discs by braking firmly a few times from a moderately high speed ⇒ ⚠.

### Faults in the brake system

If the brake pedal travel should ever increase *suddenly*, this may mean that one of the two brake circuits has failed. Drive immediately to the nearest qualified workshop and have the fault rectified. On the way to the dealer, be prepared to use more pressure on the brake pedal and allow for longer stopping distances.

### Low brake fluid level

Malfunctions can occur in the brake system if the brake fluid level is too low. The brake fluid level is monitored electronically.

### Brake servo

The brake servo amplifies the pressure you apply to the brake pedal. It only works when the engine is running.

#### WARNING

- When applying the brakes to clean off deposits on the pads and discs, select a clear, dry road. Be sure not to inconvenience or endanger other road users; do not risk an accident.
- Never let the car coast with the engine switched off (this can cause accidents).

#### CAUTION

- Never let the brakes “drag” by leaving your foot on the pedal when you do not really intend to brake. This overheats the brakes, resulting in longer stopping distances and greater wear.
- Before driving down a long, steep gradient, it is advisable to reduce speed and select a lower gear. In this way you will make use of the engine braking effect and relieve the load on the brakes. If you still have to use the brakes, it is better to brake firmly at intervals than to apply the brakes continuously.

#### Note

- If the brake servo is out of action, you must apply considerably more pressure to the brake pedal than you normally would.
- If you wish to equip the car with accessories such as a front spoiler or wheel covers, it is important that the flow of air to the front wheels is not obstructed, otherwise the brakes can overheat.

## Electro-mechanical power steering

*Electro-mechanical power steering assists the driver when steering.*

The degree of power assistance is adapted *electronically*, depending on the speed. ►

If the power steering should fail at any time or the engine is switched off (for instance when being towed), the car can still be steered. However, substantially more effort than normal will be required to turn the steering wheel.

### Warning/indicator lamps and driver messages

#### Do not drive vehicle: steering defective

If the warning lamp lights up permanently and the message appears, there may be a power steering failure.

Do **NOT** drive on. You should obtain professional assistance.

#### Do not drive vehicle: steering defective

There is a malfunction in the electronic steering lock. The ignition can no longer be switched on.

**Do not** have the vehicle towed away, because you won't be able to steer it. You should obtain professional assistance.

#### Steering: system fault. You can continue driving

If the indicator lamp lights up, the steering response may be heavier or lighter than usual. In addition, it is possible that the steering wheel will be off centre when driving in a straight line.

Drive slowly to a qualified workshop and have the fault rectified.

#### Steering lock: malfunction. Please contact workshop



There is a malfunction in the electronic steering lock.

Drive to a qualified workshop soon and have the fault rectified.

### WARNING

Have the system malfunction repaired by a qualified workshop as soon as possible – risk of accident.

### Note

You can drive on if the warning/indicator lamp  or  lights up only briefly.

## Four-wheel drive (quattro)

Applies to vehicles: with four-wheel drive

*On quattro models the engine power is distributed to all four wheels.*

### General notes

On four-wheel drive vehicles, the engine power is distributed to all four wheels. The distribution of power is controlled automatically according to your driving style and the road conditions. Also refer to ⇒ page 182, *Electronic stabilisation control (ESC)*.

The four-wheel drive is specially designed to complement the superior engine power of your Audi. This combination gives the car exceptional handling and performance capabilities - both on normal roads and in more difficult conditions, such as snow and ice. Even so (or perhaps especially for this reason), it is important to observe certain safety points ⇒ .

### Winter tyres

Thanks to its four-wheel drive, your car will have plenty of *traction* in winter conditions, even with the standard tyres. Nevertheless, we still recommend that winter tyres or all-season tyres should be fitted *on all four wheels* when winter road conditions are expected, mainly because this will give a better *braking response*.

### Snow chains

On roads where snow chains are mandatory, this also applies to cars with four-wheel drive ⇒ page 228, *Snow chains*.

### Replacing tyres

On vehicles with four-wheel drive, all four tyres must have the same rolling circumference. Also avoid using tyres with varying tread depths ⇒ page 225, *Replacing wheels and tyres*.

## Off-roader?

Your Audi does not have enough ground clearance to be used as an off-road vehicle. It is therefore best to avoid rough tracks and uneven terrain as much as possible. Also refer to ⇨ page 273.

### WARNING

- Even with four-wheel drive, you should always adjust your speed to suit the conditions. Do not let the extra safety afforded by four-wheel drive tempt you into taking any risks when driving – this can cause accidents.
- The braking ability of your car is limited by the grip of the tyres. In this respect, your car is no different from a car without four-wheel drive. So do not be tempted to drive too fast on icy or slippery roads just because the car still has good acceleration in these conditions (accident risk).
- On wet roads bear in mind that the front wheels may start to “aquaplane” and lose contact with the road if the car is driven too fast. If this should happen, there will be no sudden increase in engine speed to warn the driver, as with a front-wheel drive car. So do not drive too fast in the wet: adjust your speed to suit the conditions (accident risk).

## Power management

**This system helps to ensure reliable starting**

*The power management controls the distribution of electrical energy and thus helps to ensure that there is always enough power available to start the engine.*

If a vehicle with a conventional electrical system is left parked for a long time, the battery will gradually lose its charge because certain electrical equipment (such as the immobiliser) continues to draw current even when the ignition is off. In some cases there may not be enough power available to start the engine.

Your vehicle is equipped with an intelligent power management system to control the distribution of electrical energy. This significantly improves reliability when starting the engine, and also prolongs the life of the battery.

The main functions incorporated in the power management system are **battery diagnosis**, **residual current management** and **dynamic power management**.

### Battery diagnosis

The battery diagnosis function constantly registers the condition of the battery. Sensors detect the battery voltage, battery current and battery temperature. This enables the system to calculate the current power level and charge condition of the battery.

### Residual current management

The residual current management reduces power consumption while the vehicle is parked. It controls the supply of power to the various electrical components while the ignition is switched off. The system takes the battery diagnosis data into consideration.

Depending on the power level of the battery, the individual electrical components are switched off one after the other to prevent the battery from losing too much charge and to ensure that the engine can be started reliably.

### Dynamic power management

While the vehicle is moving, this function distributes the available power to the various electrical components and systems according to their requirements. The power management ensures that on-board systems do not consume more electrical power than the alternator can supply, and thus maintains the maximum possible battery power level.

### Note

- The power management system is not able to overcome the given physical limits. Please remember that the power and life of the battery are limited.

– If the indicator lamp  ⇒ page 21 appears, the starting ability may be impaired.

### Points to remember

*Starting ability has first priority.*

Short trips, city traffic and low temperatures all place a heavy load on the battery. In these conditions a large amount of power is consumed, but only a small amount is supplied. The situation is also critical if electrical equipment is in use when the engine is not running. In this case power is consumed when none is being generated.

In these situations you will be aware that the power management system is intervening to control the distribution of electrical power.

#### When the vehicle is parked for long periods

If you do not drive your vehicle for a period of several days or weeks, the power management will gradually shut off the on-board systems one by one, or reduce the amount of current they are using. This limits the amount of power consumed and helps to ensure reliable starting even after a long period. Certain convenience features, such as remote control unlocking, may not be available. These functions will be restored when you switch on the ignition and start the engine.

#### With the engine switched off

If you listen to the radio or use other electrical equipment when the engine is not running, this will discharge the battery.

On vehicles with driver information system\*, a message will appear before the battery power drops to a level where the starting ability is impaired.

This message advises you to start the engine in order to recharge the battery.

#### When the engine is running

Although the alternator generates electrical power, the battery can still become dis-

charged while the vehicle is being driven. This can occur when a lot of power is being consumed but only a small amount supplied, especially if the battery is not fully charged initially.

To restore the necessary energy balance, the system will then temporarily shut off the electrical components that are using a lot of power, or reduce the current they are consuming. Heating systems in particular use a large amount of electrical power. If you notice, for instance, that the seat heating\* or the rear window heater is not working, they may have been temporarily switched off or regulated to a lower heat output. These systems will be available again as soon as sufficient electrical power is available.

You may also notice that the engine runs at a slightly faster idling speed. This is quite normal, and no cause for concern. The increased idling speed allows the alternator to meet the greater power requirement and charge the battery at the same time.

### Information saved in the control units

The vehicle is fitted in the factory with electronic control units that, among other things, control the engine and the gearbox. The control units also monitor the exhaust system and the airbags.

The control units continually analyse data relevant to the vehicle while you are driving. In the event of faults or anomalies in the vehicle data, only these data are saved. As a rule, faults are shown by the warning lamps in the instrument cluster.

Data saved in the control units can only be read and analysed with special equipment.

A qualified workshop is only able to recognise and deal with faults by using the relevant saved data. Among other things, the saved data may contain the following information:

- Data relating to the engine and the gearbox
- Speed



- Direction of travel
- Braking force
- Seat belt warning system data

The control units installed will not under any circumstances record conversations in the vehicle.

### Event data recorder

Your vehicle is **not** equipped with an event data recorder.

In an event data recorder, information about the vehicle is temporarily saved. In the event of an accident, you can therefore obtain detailed information about the course of events. On vehicles with an airbag system, accident-related data such as impact speed, seat belt status, seat positions and trigger times can be saved. The exact information saved depends on the manufacturer.

The installation of an event data recorder is subject to the agreement of the vehicle's owner. This process is governed by legislation in some countries.

### Reprogramming control units

All data for controlling components are saved in the control units. Some convenience features, such as one-touch signalling, single door unlocking and display messages can be reprogrammed using special workshop equipment. If any convenience features are reprogrammed, the information in this Owner's Manual will no longer be accurate for the features that have been changed. We recommend having the reprogramming confirmed by an Audi workshop in the "Workshop remarks" section of your Service Schedule.

Your Audi dealer will be able to provide you with information about possible reprogramming options.

### Event memory

There is a diagnostic connection for reading out the event memory located in the footwell on the driver's side of the vehicle. Information regarding the operation and status of the vehicle's electronic control units is stored in the

event memory. The event memory should only be read out and erased by a qualified workshop.



#### WARNING

The diagnostic connection must not be used for other purposes. Incorrect use can cause malfunctions – risk of accident!

## Your vehicle and the environment

### Running in

A new vehicle should be run in over a distance of 1,500 km. For the first 1,000 km the engine speed should not exceed 2/3 of the maximum permissible engine speed – do not use full throttle and do not tow a trailer or caravan. From 1,000 to 1,500 km you can gradually increase the engine rpm and road speed.

During its first few hours of running, the internal friction in the engine is greater than later on when all the moving parts have bedded down.

How the vehicle is driven for the first 1,500 km also influences the engine quality. After this period you should continue driving at moderate engine speeds, in particular when the engine is cold. This helps to reduce wear and tear on the engine and increases the potential mileage which can be covered by the engine.

You should also avoid driving with the engine speed too *low*. Change down to a lower gear when the engine no longer runs “smoothly”. Excessively high engine speeds are prevented by an automatic rev limiter.

### Driving through water on roads

Please note the following in order to prevent damage to the vehicle when driving through water (e.g. on flooded roads):

- The water level must not be higher than the vehicle's underbody.
- Do not drive faster than walking pace.



#### WARNING

After driving through water, mud, sludge, etc., the braking effect can be delayed slightly due to moisture on the discs and brake pads. Applying the brakes carefully

several times will remove the moisture and restore the full braking effect.



#### CAUTION

- Parts of the vehicle (e.g. engine, gearbox, running gear or electrical components) can be badly damaged when driving through water.
- Always switch off the start/stop system\*  
⇒ *page 98* before driving through water.



#### Note

- It is advisable to check the depth at the deepest point before approaching the water.
- Do NOT stop the vehicle, drive in reverse or switch off the engine before you are out of the water.
- Bear in mind that waves created by oncoming traffic could exceed the permissible wading depth of your vehicle.
- Avoid driving through salt water (corrosion).

## Emission control systems

### Catalytic converter

**Applies to vehicles with petrol engine:** The vehicle must only be used with unleaded petrol; otherwise the catalytic converter will be irreparably damaged.

Never allow the fuel tank to run completely dry, as the irregular supply of fuel can cause misfiring. This allows unburnt fuel to enter the exhaust system, which can cause overheating and damage to the catalytic converter.

### Diesel particulate filter

**Applies to vehicles with diesel engine:** The diesel particulate filter can filter out almost all soot particles contained in the exhaust gas. In normal driving conditions the filter is self-cleaning. In addition, the diesel particulate filter is also automatically regenerated at certain intervals. In this case, the indicator ►



lamp  does not come on. An increased idling speed and a certain odour may be noticed while this is happening.

Should the self-cleaning or automatic regeneration function of the filter not be able to operate, e.g. when the vehicle is continuously used only for short trips, the filter becomes obstructed with soot and the indicator lamp  for the diesel particulate filter lights up ⇒ *page 23*.

### WARNING

The exhaust system is very hot when the vehicle is being driven and after the engine has been switched off.

- Never touch the tailpipes when they are hot – you could burn yourself!
- Because of the high temperatures which can occur in the emission control system (catalytic converter or diesel particulate filter), do not park the vehicle where the exhaust can come into contact with flammable materials under the car (e.g. on grass or at the forest edge). - Fire hazard!
- Do not apply any underseal agents in the area around the exhaust system - fire hazard!

## Taking the vehicle out of service

If you wish to take your vehicle out of service for a long period of time, contact a qualified workshop. Here you will receive advice on necessary measures, for example regarding corrosion protection, maintenance and storage. In addition, please observe the general notes on the battery ⇒ *page 218*.

## How to improve economy and minimise pollution

Fuel economy, environmental impact and wear on the engine, brakes and tyres depend largely on the way you drive the vehicle. By

adopting an economical driving style and anticipating the traffic situation ahead, you can reduce fuel consumption by 10-15%. The following section gives you some tips on lessening the impact on the environment and reducing your operating costs at the same time.

### Anticipate well in advance

A car uses most fuel when accelerating. If you anticipate hazards and speed changes well in advance, you will need to brake less and thus accelerate less. Wherever possible, let the car slow down gradually **with a gear engaged**, for instance when you can see that the next traffic lights are red. This takes advantage of the engine braking effect, reducing wear on the brakes and tyres. Emissions and fuel consumption will drop to zero due to the overrun fuel cut-off.

### Change gear early to save fuel

An effective way of saving fuel is to *change up quickly* through the gears. Running the engine at high rpm in the lower gears uses an unnecessary amount of fuel.

**Manual gearbox:** Shift up to second gear as soon as possible. If possible, we recommend shifting up to the next gear at approx. 2,000 rpm. You can minimise your fuel consumption by always selecting the highest possible gear that will allow the engine to run smoothly in a given driving situation.

**Automatic gearbox:** Press the accelerator slowly and avoid using the “kick-down” feature.

### Avoid driving at high speed

Avoid travelling at top speed. Fuel consumption, exhaust emissions and noise levels all increase very rapidly at higher speeds. Driving at moderate speeds will help to save fuel.

### Do not let the engine idle for longer than necessary

Engine idling periods are automatically reduced on vehicles with start/stop system. On vehicles without a start/stop system, it is worthwhile switching off the engine at level ▶

crossings, for instance, or at traffic lights with a long red phase. The fuel saved after about 5 seconds can be greater than the amount of fuel needed to restart a warm engine (the exact fuel saving depends on the engine version).

The engine takes a very long time to warm up when it is running at idling speed. Mechanical wear and pollutant emissions are also especially high during this initial warm-up phase. It is therefore best to drive off immediately after starting the engine. Avoid running the engine at high speed.

### Regular servicing

Regular servicing can establish a basis for good fuel economy before you start driving. A well-serviced engine gives you the benefit of **improved fuel efficiency** as well as maximum reliability and an enhanced resale value. A poorly maintained engine can consume up to ten percent more fuel than necessary.

### Avoid short trips

The engine and emission control system need to reach their **proper working temperature** in order to minimise fuel consumption and emissions.

A cold engine uses disproportionately more fuel. The engine only reaches its working temperature after about *four* kilometres, when fuel consumption will return to a normal level.

### Check tyre pressures

Always make sure the tyres are inflated to the correct pressures ⇒ *page 224* to save fuel. If the tyre pressures are just 0.5 bar too low, this can increase the fuel consumption by as much as 5 %. Due to the greater rolling resistance, under-inflation also increases **tyre wear** and impairs handling.

Do not use **winter tyres** all through the year; they will increase fuel consumption by up to 10 %.

### Avoid carrying unnecessary loads

Every kilo of **extra weight** will increase the fuel consumption, so it is worth checking the luggage compartment occasionally to make sure that no unnecessary loads are being transported.

The roof carrier increases the **air resistance** of the vehicle and should be removed when not in use. This will save about 12 % of fuel at speeds of between 60 and 75 mph.

### Save electrical energy

The engine drives the alternator to generate electricity. This means that fuel consumption rises when more power is required for electrical equipment. Switch off electrical equipment when it is not needed. Electrical equipment which uses a lot of electricity includes the blower (at a high setting), the rear window heating and the seat heating\*.

## Environmental compatibility

Environmental protection is a top priority in the design, choice of materials and production of your new Audi.

### Design measures for economical recycling

- Joints and connections designed for ease of dismantling
- Modular construction to facilitate dismantling
- Increased use of single-grade materials
- Plastic parts and elastomers are labelled in accordance with ISO 1043, ISO 11469 and ISO 1629

### Choice of materials

- Nearly all materials used can be recycled
- Similar types of plastics grouped together for easy recycling
- Recycled materials used in manufacture
- Reduced vapour emissions from plastics
- CFC-free refrigerant in air conditioner



**Compliance with the laws prohibiting the use of:** Cadmium, asbestos, lead, mercury and chrome VI.

### **Manufacturing methods**

- Using recycling material for manufacturing plastic parts
- Solvent-free cavity sealing
- Solvent-free wax for protecting the vehicles in transit
- Solvent-free adhesives
- No CFCs used in production
- Surplus materials used extensively for energy conversion and building materials
- Overall water consumption reduced
- Heat recovery systems
- Water-soluble paint

## Towing a trailer

### Driving the vehicle with a trailer or caravan

#### Technical requirements

*The towing bracket must comply with certain technical requirements.*

Your car is intended mainly for transporting passengers and luggage. However, if suitably equipped, it can also be used to tow a trailer or caravan.

If the car is supplied with a **factory-fitted** towing bracket it will already have the necessary technical modifications and meet the statutory requirements.

A 13-pin socket is provided to make the electrical connection between the car and the trailer. If the trailer you wish to tow has a **7-pin plug**, the necessary adapter cable can be obtained from a specialist retailer.

If a towing bracket is to be fitted after the car is purchased, this must be done according to the instructions of the towing bracket manufacturer ⇒ *page 202*.

#### WARNING

If a towing bracket is retrofitted, the installation should be carried out by a qualified workshop.

- In particular in high outside temperatures it is not possible to drive up long steep gradients without a suitable cooling system. The engine would then overheat.
- Incorrect installation can result in a safety risk.

#### Points to check before towing

*There are a number of points which need to be checked before towing a trailer or caravan.*

- ▶ Observe the maximum permitted trailer weights ⇒ *page 272*.

#### Trailer weights

Never exceed the maximum permitted trailer weights.

If you do not load the trailer up to the maximum permitted trailer weight, you can then climb correspondingly steeper gradients.

The maximum trailer weights listed are only applicable for **altitudes** up to 1000 m above sea level. With increasing altitude the engine power and therefore the car's climbing ability are impaired because of the reduced air density, so the maximum trailer weight has to be reduced accordingly. The weight of the car and trailer must be reduced by about 10% for every further 1000 m (or part thereof). This figure refers to the combined weight of the (loaded) vehicle and (loaded) trailer.

The figures for the **draw bar weight** that appear on the identification plate of the towing bracket are for certification purposes only. The correct figures for your specific model, which may be *lower* than these figures for the towing bracket, are given in the registration documents and in ⇒ *page 272*. Also refer to ⇒ *page 273*.

#### Exterior lighting

Before starting a journey, make sure that all the lights for the trailer are working properly.

#### Distributing the load

Distribute loads in the trailer so that heavy objects are as near to the axle as possible. Loads carried in the trailer must be secured to prevent them slipping. A badly distributed load can also affect handling. This can activate the trailer stabilisation feature and cause the vehicle to reduce speed.

Where possible, operate the trailer with the maximum permitted **draw bar weight** on the ball joint of the towing bracket, but do not exceed the specified limit.

#### Tyre pressure

Check the tyre pressures on your car and adjust for "full load" conditions (refer to the



sticker listing the tyre pressures on the end face of the driver's door ⇒ *page 224, Fig. 227*). It may also be necessary to adjust the tyre pressures on the trailer according to the recommendations of the trailer manufacturer.

### Exterior mirrors

Check whether you can see enough of the road behind the trailer with the standard mirrors. If this is not the case you should have additional mirrors fitted. Both exterior mirrors should be mounted on hinged extension brackets. Adjust the mirrors to give sufficient vision to the rear.

### Headlights

Before starting a journey, check the headlight beam settings with the trailer hitched up. Adjust the headlight settings if necessary.

If the car is equipped with manual headlight range control, you only need to turn the adjuster control as required, see ⇒ *page 54*.

The headlight beam settings will be adjusted automatically if your vehicle is equipped with dynamic headlight range control\*.

### Power supply

To ensure that the engine can be started again after the ignition is switched off, the power management system ⇒ *page 187* controls the distribution of electrical power and gradually switches off unnecessary electrical equipment. The trailer is supplied with power during this period. The power supply to the trailer is interrupted while the engine is being started.

### Removable ball joint coupling

Vehicles with a factory-fitted towing bracket are equipped with a *removable* ball joint coupling. This is stored in the spare wheel well or in a separate bag on the floor of the luggage compartment, together with the necessary fitting instructions.

### Note

We recommend having the car serviced between the normal inspection intervals if it used frequently for towing a trailer.

### Trailer stabilisation system

Applies to vehicles: with towing bracket

*Trailer stabilisation helps to reduce the risk of the vehicle skidding when towing a trailer.*

### When is the trailer stabilisation system<sup>1)</sup> activated?

Trailer stabilisation is active when the following requirements are met:

- The ESC must be switched on ⇒ *page 183* and fully functional (no ESC malfunction).
- The trailer connector must be properly secured in the vehicle socket.
- The vehicle speed must be higher than approx. 60 km/h.

### How trailer stabilisation works

In many cases, the driver can stabilise a swaying trailer by manually braking the vehicle.

However, if the ESC detects that the trailer is swaying and this is affecting the towing vehicle, it will automatically brake the vehicle in order to stabilise the trailer. The indicator lamp  will flash in the instrument cluster. If possible, do not turn the steering wheel at this stage.

In order to warn traffic behind you, the brake lights will come on during this automatic braking operation.

A trailer may sway quite considerably without the trailer stabilisation system intervening. This can happen when the swaying movements of the light-weight trailer are not or hardly passed on to the towing vehicle and are therefore not detected by the ESC. ►

<sup>1)</sup> Not available on vehicles for some markets.

If the system for activating the trailer brake lights is defective, this will be indicated in the instrument cluster display ⇒ *page 25*.

### Requirements for correct functioning of the trailer stabilisation system

If these conditions are not met in full, the trailer stabilisation system will only intervene to a limited extent or not at all ⇒ .

- The electrical connection between the towing vehicle and the trailer must be functioning correctly.
- The load on the trailer must be properly secured.
- The tyre pressures on both the vehicle and the trailer must be adapted to the load that is being carried.
- Where possible, operate the trailer with the maximum permitted draw bar weight.
- The trailer overrun brake must be set correctly. This is important to ensure that the trailer can be braked correctly, to avoid the vehicle and trailer “jack-knifing” and to prevent excess braking of the trailer.
- At low outside temperatures, both the towing vehicle **and** the trailer should be fitted with winter tyres.

#### WARNING

It is essential that you adjust your speed to suit the weather, road and traffic conditions. Do not let the trailer stabilisation system tempt you into taking any risks when driving – this can cause accidents.

- The ESC and trailer stabilisation system cannot defy the laws of physics. This should be kept in mind, particularly on slippery and wet roads and when towing a trailer with a light load.
- The trailer stabilisation system is functional, regardless of whether the trailer has a mechanical overrun brake or not.
- The trailer stabilisation system is not always able to detect swaying of trailers

with a light load and will therefore not intervene.

- A trailer can still “jack-knife” on slippery roads with little grip, even if the towing vehicle is equipped with the trailer stabilisation system.
- Trailers with a high centre of gravity may even tip over before they start to sway sideways.
- If you are not towing a trailer, but the trailer socket is being used (e.g. for an illuminated bicycle rack), the trailer stabilisation system may be activated in extreme driving conditions.
- Please note the additional information and warnings ⇒ *page 196, Driving tips*.

### Driving tips

*Driving with a trailer always requires extra care.*

#### Weight distribution

Try to avoid towing a loaded trailer with an unladen vehicle. If this cannot be avoided, drive extra slowly to allow for the unbalanced weight distribution.

#### Speed

Normally, you must not exceed 80 km/h when towing a trailer or caravan. However, if the trailer/caravan meets certain technical requirements<sup>1)</sup>, you can drive at max. 100 km/h. Please observe any other regulations applicable in the country in which you are travelling.

The stability of the car and trailer is reduced with increasing speed. For this reason it is advisable not to drive at the maximum permissible top speed in unfavourable road, weather or wind conditions. This applies especially on a downhill gradient. ►

<sup>1)</sup> Including trailer stabilisation system\* or yaw damper

You should always reduce speed immediately if the trailer shows the slightest sign of **swaying**. Never try to stop the swaying by accelerating further.

Always brake in good time. If the trailer has an **overrun brake**, apply the brakes *gently at first* and then firmly. This will prevent the jerking that can be caused by the trailer wheels locking. Change down in good time before going down a steep hill so that you can use the engine braking effect to slow down the vehicle.

**Swaying and pitching** can be reduced by stabiliser aids. We recommend having stabiliser aids installed when towing trailers with a high trailer weight. They can be purchased and installed at a qualified workshop.

### Electronic stabilisation control

The ESC - in particular in conjunction with the trailer stabilisation system ⇒ *page 195* - makes it easier to stabilise a trailer if it starts to skid or sway. You should therefore keep the ESC switched on at all times.

### Overheating

In hot weather, keep an eye on the coolant temperature gauge ⇒ *page 11*. When climbing long hills with the engine running fast in low gear, the coolant temperature can increase. Reduce speed immediately if the needle moves to the right end of the scale. For information on the warning lamp  refer to ⇒ *page 20*.

## Accessories

Applies to vehicles: with steel towing bracket

*Before mounting equipment and accessories (e.g. bicycle rack) please observe the following notes.*

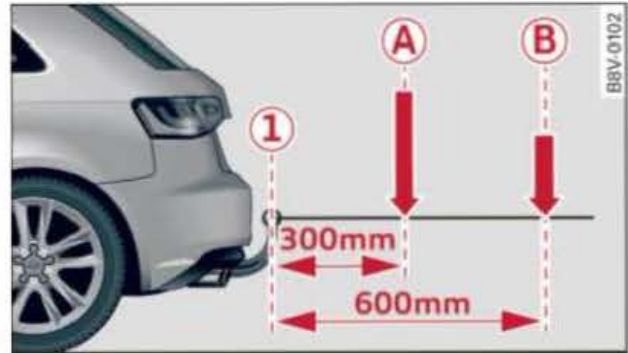

**Fig. 201** Load distribution of equipment and accessories (illustration shows an example vehicle)

**The following description does not apply to towing brackets made of aluminium.**

The equipment/accessories mounted must not protrude more than 700 mm from the ball joint ①.

The total weight (mounted equipment plus the load) must not exceed 75 kg.

The maximum load depends on where the centre of gravity lies.

The maximum weight decreases as the distance between the centre of gravity and the ball joint ① increases.

The following limits apply:

If the distance is 300 mm, the total weight (incl. the equipment mounted) ① must not exceed 75 kg.

If the distance is 600 mm, the total weight (incl. the equipment mounted) ② must not exceed 35 kg.

Only bicycle racks for a **maximum of three** bicycles may be used.

### Equipment mounted on the towing bracket

Please make sure that the equipment mounted has been approved by the manufacturer for use on the ball joint. If you mount unsuitable equipment, this can cause damage to the ▶

towing bracket. In an extreme case, damage to the towing bracket could cause it to break ⇒ ⚠.

### ⚠ WARNING

- Make sure that the equipment and accessories have been approved for use on Audi vehicles.
- Use of unsuitable equipment can result in severe damage to the towing bracket. The towing bracket could then break while using the equipment or while pulling a trailer (accident risk).
- Never use tools of any kind when fitting and removing the ball joint. This could damage the mechanism which locks the ball joint in place and impair its safety (accident risk).
- When using equipment mounted to an **aluminium** towing bracket rather a steel bracket, the load carried must be reduced (e.g. two bicycles instead of three). If loads are too heavy this can lead to damage and, in extreme cases, cause the towing bracket to break.

## Removable towing bracket

### Introduction

Applies to vehicles: with removable towing bracket

*Special care is required when fitting and removing the towing bracket.*



**Fig. 202** Luggage compartment: Ball joint for towing bracket (stowage example)

The removable ball joint attachment for the towing bracket is stored under the floor panel

or in a separate bag on the floor of the luggage compartment.

The ball joint can be fitted and removed by hand.

### Equipment mounted on the towing bracket

Please note that the ball joint attachment can be damaged by using unsuitable equipment that is mounted onto the towing bracket (e.g. bicycle carrier). Due to the material construction, such damage to the towing bracket dramatically increases safety risks and in extreme cases could lead to breakage of the towing bracket while towing ⇒ ⚠.

Therefore, ensure **before buying** such equipment that it is suitable for mounting onto the vehicle's towing bracket and that it is approved for this purpose. In order to avoid damage to the ball joint from unsuitable equipment we recommend that equipment for the towing bracket be acquired through an Audi dealer. Also refer to ⇒ *page 233*.

### ⚠ WARNING

- Only mount equipment on the towing bracket of your vehicle if you are certain it will not damage the bracket. Use of unsuitable equipment can result in severe damage to the towing bracket. The towing bracket could then break while pulling a trailer and cause an accident.
- Never use tools of any kind when fitting and removing the ball joint. This could damage the mechanism which locks the ball joint in place and impair its safety (accident risk).

### **i** Note

- Do not attempt to modify or repair the ball joint or other towing bracket components.
- Should you have any difficulties when using the towing bracket, or suspect that it is not fitted properly, contact a qualified workshop.



- Before setting off, always check that the ball joint is secured properly ⇒ *page 200*.
- Never disengage the ball joint with the caravan / trailer still hitched or with a bicycle rack or similar accessory still attached.
- It is advisable to remove the ball joint when you are not towing a trailer. Check whether the plug is properly inserted in the mounting fixture and that the bumper cover is fitted.
- The ball joint must be removed if you intend to clean the car with a steam cleaning attachment. Check whether the plug is properly inserted in the mounting fixture and that the bumper cover is fitted.
- For installation and removal of the ball joint we recommend that the gloves provided be used.

### Fitting the ball joint (step 1)

Applies to vehicles: with removable towing bracket



Fig. 203 Area below rear bumper: Removing bumper cover (example)



Fig. 204 Area below rear bumper: Pulling out plug

The two fasteners for the cover are located on the underside of the bumper ⇒ *Fig. 203*.

- ▶ Remove the cover from the rear bumper. To do so, turn the two fasteners 90° anti-clockwise ⇒ *Fig. 203*.
- ▶ Remove the plug ⇒ *Fig. 204* from the mounting fixture.
- ▶ Check that the mounting fixture is free of dirt; clean if necessary ⇒ ⚠.

Continued ⇒ *page 199, Fitting the ball joint (step 2)*.

### ⚠ WARNING

It is important to keep the mounting fixture clean. Otherwise the ball joint may fail to engage securely (accident risk).

### Fitting the ball joint (step 2)

Applies to vehicles: with removable towing bracket



Fig. 205 Removable towing bracket: Ball joint

**The spring mechanism inside the ball joint must be in the "ready" position.**

- ▶ Check that the red marking (2) ⇒ *Fig. 205* on the knob is inside the green zone on the ball joint.
- ▶ Check that the locking ball (1) is inside the hole in the shaft section of the ball joint.
- ▶ Check that the knob protrudes visibly from the ball joint, so that there is a clear gap (3) between the knob and the ball joint.

The ball joint can only be installed if the internal spring mechanism is in the **ready** position.

Continued ⇒ *page 200, Fitting the ball joint (step 3)*.

### Fitting the ball joint (step 3)

Applies to vehicles: with removable towing bracket

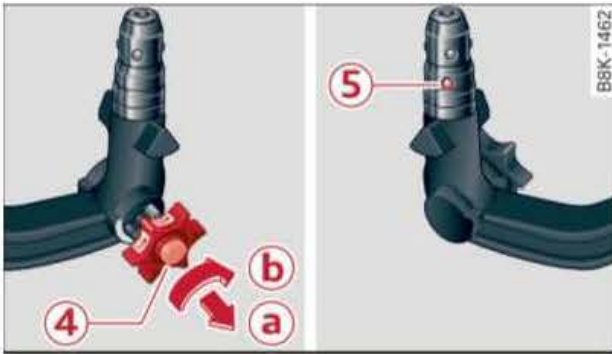

Fig. 206 Removable towing bracket: Setting the spring mechanism to the "ready" position



Fig. 207 Removable towing bracket: Inserting the ball joint

### Setting the spring mechanism to the "ready" position (if required)

- ▶ Insert the key (4) ⇒ Fig. 206 for locking the ball joint into the lock on the knob and turn it clockwise.
- ▶ Pull out the knob in direction (a), hold and turn in direction (b) until the locking ball (5) engages ⇒ ⚠.

### Inserting the ball joint

- ▶ With the spring mechanism in the "ready" position, insert the ball joint into the mounting fixture and push it upwards ⇒ Fig. 207 in the direction indicated (arrow) ⇒ ⚠. The spring mechanism should then engage automatically with an audible click.
- ▶ Lock the ball joint by turning the key anti-clockwise.
- ▶ Take out the key and press the cover cap on to the lock.

Continued ⇒ page 200, Fitting the ball joint (step 4).

### ⚠ WARNING

- If it is not possible to set the spring mechanism to the "ready" position as described above, please contact a qualified workshop and, for safety reasons, do not use the ball joint.
- To avoid injury, keep your hands away from the knob when inserting the ball joint in the mounting fixture.

### i Note

Make sure that the knob can turn freely when the ball joint is inserted.

### Fitting the ball joint (step 4)

Applies to vehicles: with removable towing bracket

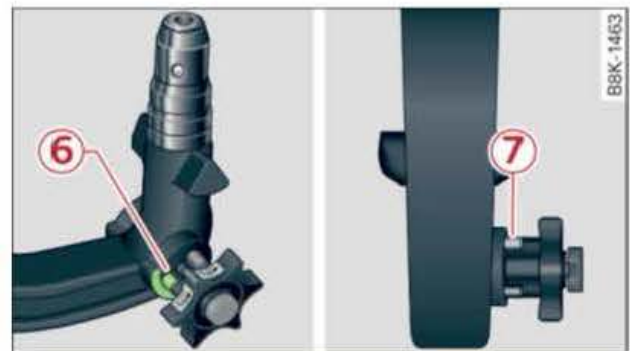

Fig. 208 Removable towing bracket: Safety check



Fig. 209 Area below rear bumper: Connecting socket (A), safety cable attachment (B)

### Safety check

- ▶ Check that the green marking (6) ⇒ Fig. 208 on the knob is inside the green zone on the ball joint.
- ▶ Check that the knob is directly against the ball joint, so that there is no gap (7) between the knob and the ball joint.

- ▶ Check that the ball joint is locked and the key is removed (so that the knob cannot be pulled out).
- ▶ Check that the ball joint fits tightly in the mounting fixture (try moving it about to check).

### Electrical socket for trailer

- ▶ To plug in the electrical connection for the trailer, swivel the connecting socket down from underneath the bumper **(A)** ⇒ Fig. 209.

### Safety cable attachment\*

When you hitch a trailer up to your vehicle, hook the safety cable into the attachment provided<sup>1)</sup> **(B)** ⇒ Fig. 209. If your vehicle does not have a safety cable attachment, loop the safety cable around the ball joint.

If the safety check is not satisfactory, the ball joint must be fitted again properly.

#### **!** WARNING

To avoid accidents, the ball joint must meet all the safety requirements listed in the safety check. The towing bracket must not be used if any one of these requirements is not met. Please contact a qualified workshop.

### Removing the ball joint

Applies to vehicles: with removable towing bracket

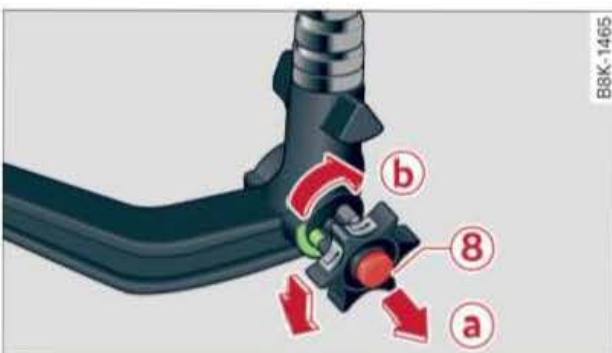

Fig. 210 Removable towing bracket: Removing the ball joint



Fig. 211 Area below rear bumper: Fitting the plug

- ▶ Take off the cover cap and insert the key **(8)** ⇒ Fig. 210 in the lock on the knob.
- ▶ Unlock the ball joint by turning the key clockwise.
- ▶ Take hold of the ball joint and pull out the knob in direction **(a)**.
- ▶ Keep hold of the knob and turn it as far as it will go in direction **(b)**.
- ▶ Release the knob. The spring mechanism will remain in the "ready" position ⇒ **(A)**.
- ▶ Pull the ball joint down out of the mounting fixture.
- ▶ Insert the plug into the mounting fixture ⇒ Fig. 211.
- ▶ Swivel the electrical socket upwards as far as the stop.
- ▶ Stow the ball joint underneath the floor panel or in the bag on the floor of the luggage compartment, depending on your vehicle configuration.
- ▶ Insert the bumper cover with the retaining tabs first and turn both fasteners 90° until they are secure.

#### **!** WARNING

- Make sure that the plug is properly fitted in the mounting fixture for the towing bracket. Otherwise the ball joint may fail to engage securely the next time it is attached if dirt has accumulated in the mounting fixture.
- On vehicles in which the ball joint is stowed in a bag on the floor of the luggage compartment, the bag must always be secured to the front right fastening

<sup>1)</sup> This equipment is not available for all export versions.

ring. Otherwise the bag could be catapulted through the interior of the vehicle in the event of sudden braking or an accident - risk of injury and accident!

### A3: Towing bracket (retrofitting)

The vehicle can be retrofitted with a towing bracket.

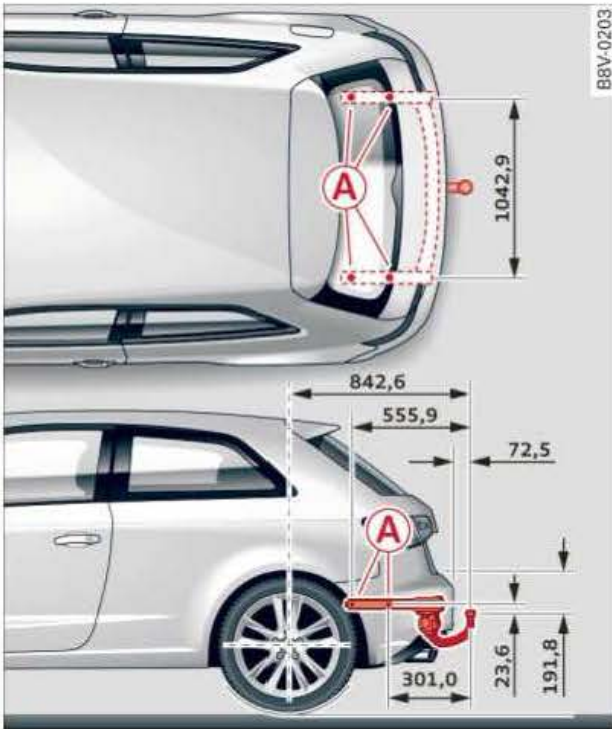

Fig. 212 A3: Positions of securing points (viewed from above and from side)

If a towing bracket is to be fitted after the car is purchased, this must be done according to the instructions of the towing bracket manufacturer. The towing bracket is bolted to the vehicle body on the inside of the spare wheel well. The securing points are marked with an **A** ⇒ Fig. 212.

Qualified workshops are familiar with the method of installation and any modifications which may be required for the cooling system.

### ⚠ WARNING

If a towing bracket is retrofitted, the installation should be carried out by a qualified workshop.

- If the towing bracket is incorrectly fitted, this could cause a safety risk.

– For your own safety, please observe the instructions provided by the manufacturer of the towing bracket.

### ⚠ CAUTION

If the connector socket is not fitted correctly, this could cause damage to the vehicle's electrical system.

### A3 Sportback: Towing bracket (retrofitting)

The vehicle can be retrofitted with a towing bracket.



Fig. 213 A3 Sportback: Positions of securing points (viewed from above and from side)

If a towing bracket is to be fitted after the car is purchased, this must be done according to the instructions of the towing bracket manufacturer. The towing bracket is bolted to the vehicle body on the inside of the spare wheel well. The securing points are marked with an **A** ⇒ Fig. 213.

Qualified workshops are familiar with the method of installation and any modifications which may be required for the cooling system. ►

**! WARNING**

If a towing bracket is retrofitted, the installation should be carried out by a qualified workshop.

- If the towing bracket is incorrectly fitted, this could cause a safety risk.
- For your own safety, please observe the instructions provided by the manufacturer of the towing bracket.

**! CAUTION**

If the connector socket is not fitted correctly, this could cause damage to the vehicle's electrical system.

**A3 Saloon: Towing bracket (retrofitting)**

The vehicle can be retrofitted with a towing bracket.

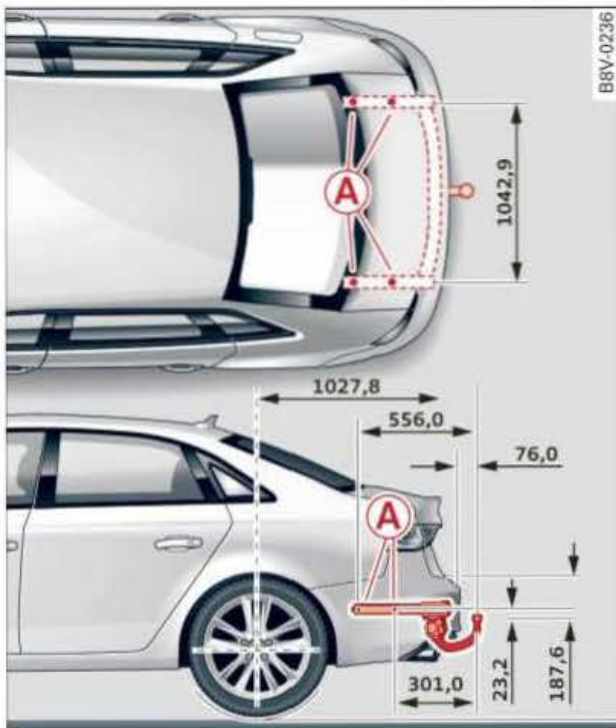

Fig. 214 A3 Saloon: Positions of securing points (viewed from above and from side)

If a towing bracket is to be fitted after the car is purchased, this must be done according to the instructions of the towing bracket manufacturer. The towing bracket is bolted to the vehicle body on the inside of the spare wheel well. The securing points are marked with an **A** ⇒ Fig. 214.

Qualified workshops are familiar with the method of installation and any modifications which may be required for the cooling system.

**! WARNING**

If a towing bracket is retrofitted, the installation should be carried out by a qualified workshop.

- If the towing bracket is incorrectly fitted, this could cause a safety risk.
- For your own safety, please observe the instructions provided by the manufacturer of the towing bracket.

**! CAUTION**

If the connector socket is not fitted correctly, this could cause damage to the vehicle's electrical system.

## Care of vehicle and cleaning

### General notes

Regular and careful care helps to maintain the value of the vehicle. This may also be one of the requirements for upholding any warranty claims in the event of corrosion or paint defects.

Qualified workshops carry stocks of suitable car care products. Please follow the instructions for use on the packaging.



#### WARNING

- Cleaning products and other materials used for car care can damage health if misused.
- Car care products can contain toxic substances and must always be kept in a safe place out of reach of children.



#### For the sake of the environment

- Please choose care products that are not harmful to the environment.
- Surplus cleaning materials should not be disposed of together with ordinary household waste.

### Washing the vehicle

The longer residues like insects, bird droppings, resinous tree sap or road salt are allowed to remain on the vehicle, the more damage they can do to the paintwork. High temperatures (for instance in direct sunlight) further intensify the corrosive effect.

Before washing, soak heavy dirt with plenty of water.

After the period when salt is put on the roads, have the underside of the vehicle washed thoroughly.

#### High-pressure cleaners

When cleaning the vehicle with a high-pressure cleaner, always follow the operating instructions for the equipment. This applies

particularly to the operating pressure and the spraying distance. Do not point the spray jet directly at the seals on the windows, doors, boot lid, bonnet or sun roof\*, or at the tyres, rubber hoses, insulating material, sensors\* or camera lenses\*. Maintain a distance of at least 40 cm.

Do not use a high-pressure cleaner to remove snow and ice.

Never use high-pressure cleaners with a round-jet nozzle or "dirt blasters".

The water must not be hotter than 60 °C.

#### Automatic car washes

Spray the vehicle with water before washing.

Ensure that the windows and sun roof\* are closed and that the windscreen wipers are switched off. Follow the car wash operator's rules and recommendations, especially if any accessories are attached to your vehicle.

If possible use a brushless car wash.

#### Washing by hand

Clean the car with a soft sponge or brush, starting on the roof and working down. Use solvent-free cleaning agents.

#### Washing matt-painted vehicles by hand

To avoid damaging the paintwork when washing the car, first remove any dust, sand and grit. Insects, grease stains and fingerprints are best removed using a special cleaning agent for matt-painted surfaces.

Apply the product with a micro-fibre cloth. Do not apply too much pressure to avoid damaging the paintwork.

Rinse the car thoroughly with water. Then clean the car with a neutral shampoo and a soft micro-fibre cloth.

Rinse the car with lots of water again and then let it dry in the air. Remove any water stains with a chamois.



Stubborn dirt, such as bird droppings or resinous tree sap, is best removed with plenty of water and a micro-fibre cloth.

**⚠ WARNING**

- Follow the rules and recommendations of the car wash operator and do not wash the vehicle with the ignition switched on – risk of accident.
- To avoid cutting yourself on sharp metal parts, always wear suitable protection when cleaning the underside of the car or inside the wheel arches.
- After the car has been washed, the full braking effect can be delayed by moisture (or in winter by ice) on the discs and brake pads – risk of accident. The brakes should be dried by pressing the pedal to restore full braking effect.

**! CAUTION**

- Before washing the vehicle in an automatic car wash, please make sure to retract the exterior mirrors to prevent

damage. Always use the electrical power control to fold the mirrors in/out on vehicles with electrically retractable exterior mirrors\*.

- Do not wash the vehicle in direct sunlight – otherwise the paint can be damaged.
- Do not use insect sponges or abrasive household sponges, etc. – they can damage the surfaces.
- Matt-painted vehicle parts:
  - Do not use polish or wax – otherwise the paintwork can be damaged.
  - Never use car-wash programmes that include wax coatings. This could spoil the matt finish.
  - Do not attach any stickers or magnet labels to matt-painted parts as these could damage the paintwork when they are removed.

**🌱 For the sake of the environment**

The car should only be washed in special wash bays. This prevents oily water from getting into the public drains.

## Notes on cleaning and care

For cleaning and care of individual components on the vehicle, please refer to the tables below. These are recommendations only. If

you have special questions or certain components are not listed, please ask your qualified workshop. Please also refer to the notes ⇨ ⚠.

### Cleaning the exterior

Component	Situation	Remedy
<b>Wiper blades</b>	Dirt/deposits	⇨ page 64
<b>Headlights/ rear lights</b>	Dirt/deposits	Soft sponge with mild detergent <sup>a)</sup>
<b>Sensors/ camera lenses</b>	Dirt/deposits	Sensors: soft cloth with solvent-free cleaning agent Camera lenses: soft cloth with alcohol-free cleaning agent
	Snow/ice	Small brush/solvent-free de-icer spray
<b>Wheels</b>	Road salt	Water
	Brake dust	Acid-free cleaning agent
<b>Tailpipes</b>	Road salt	Water; suitable stainless steel cleaning product if necessary
<b>Ornamental trim/ mouldings</b>	Dirt/deposits	Mild detergent <sup>a)</sup> ; suitable stainless steel cleaning product if necessary

Component	Situation	Remedy
Paintwork	Paint damage	Refer to the vehicle data sticker for the paint no. and touch up using a paint pen ⇒ <i>page 272</i>
	Fuel overflow	Rinse with water without delay
	Surface rust	Surface rust remover, apply wax afterwards; contact your qualified workshop with any questions
	Corrosion	Have it removed by your qualified workshop
	Water no longer pearls off clean paintwork	Apply wax (at least twice a year)
	Paint has lost its shine, gloss cannot be restored by waxing	Treat with a suitable polish; finish with wax coating if polish does not contain wax compounds
Carbon parts	Dirt/deposits	Same treatment as painted parts ⇒ <i>page 204</i>
Decals	Dirt/deposits	Soft sponge with mild detergent <sup>a)</sup>

a) Mild detergent: not more than two tablespoons of pH-neutral detergent to one litre of water

### Cleaning the interior

Component	Situation	Remedy
Windows	Dirt/deposits	Glass cleaning agent, then wipe dry
Ornamental trim/mouldings	Dirt/deposits	Mild detergent <sup>a)</sup>
Plastic parts	Dirt/deposits	Damp cloth
	Heavier dirt/deposits	Mild detergent <sup>a)</sup> ; solvent-free plastic cleaning agent if necessary
Displays	Dirt/deposits	Soft cloth with LCD cleaner
Controls and displays	Dirt/deposits	Soft brush, then soft sponge with mild detergent <sup>a)</sup>
Seat belts	Dirt/deposits	Mild detergent <sup>a)</sup> (allow to dry before retracting)
Fabrics, leatherette, Alcantara	Surface dirt	Vacuum cleaner
	Water-based stains, e.g. coffee, tea, blood, etc.	Absorbent cloth and mild detergent <sup>a)</sup>
	Fat-based stains, e.g. oil, make-up, etc.	Apply mild detergent <sup>a)</sup> , dab off dissolved grease or colour particles with absorbent cloth; if necessary treat with water
	Special dirt/stains, e.g. ballpoint pen, nail varnish, dispersion paint, shoe cream, etc.	Special stain remover (dab off with absorbent fabric); if necessary treat with mild detergent <sup>a)</sup>



Component	Situation	Remedy
Natural leather	Fresh dirt/stains	Cotton cloth with mild detergent <sup>a)</sup>
	Water-based stains, e.g. coffee, tea, blood, etc.	Fresh stains: absorbent cloth Dried stains: stain remover suitable for leather
	Fat-based stains, e.g. oil, make-up, etc.	Fresh stains: absorbent cloth and suitable stain remover for leather Dried stains: grease removal spray
	Special dirt/stains, e.g. ballpoint pen, nail varnish, dispersion paint, shoe cream, etc.	Stain remover suitable for leather
	Care of vehicle	Regularly apply leather-care cream with ultra-violet protection and impregnating compound; if necessary use special colour leather cream
Carbon parts	Dirt/deposits	Same treatment as plastic parts

<sup>a)</sup> Mild detergent: not more than two tablespoons of pH-neutral detergent to one litre of water

### WARNING

Do not use water-repellent coatings on the windscreen. In bad visibility conditions such as light rain, low sun or when driving at night these coatings can cause increased dazzle, which is a serious safety hazard. Such coatings can also cause the wiper blades to judder.

### CAUTION

- **Headlights/rear lights**
  - Never clean the headlights/rear lights with a dry cloth or sponge.
  - Do not use cleaning agents containing alcohol. This could cause the glass to crack!
- **Wheels**
  - Do not use paint polish or other abrasive agents.
  - If the protective paint coating on the wheel rim is scratched or damaged by stone chips etc., the damaged area should be touched up without delay.
- **Sensors/camera lenses**
  - Never remove snow and ice from the camera lens using warm or hot water - danger of cracks appearing on the lens.

- Never clean the camera lens with cleaning agents which are abrasive or contain alcohol - danger of scratches and cracks appearing.
- **Windows and windscreen**
  - Remove snow and ice from windows and exterior mirrors with a plastic scraper only. To avoid scratches, the scraper should only be pushed in one direction and not moved to and fro.
  - Never use warm or hot water to remove snow and ice from windows and mirrors. This could cause the glass to crack!
  - To avoid damaging the heating element, do not put stickers on the inner side of the rear window.
- **Ornamental trim/mouldings**
  - Do not use chrome cleaning agents.
- **Paintwork**
  - The vehicle must be free of dirt and dust before applying polish/wax - otherwise the paintwork may be damaged.
  - Do not polish/wax the vehicle in direct sunlight - this can damage the paint!
  - Do not attempt to polish out surface rust deposits - this can damage the paint!

- **Displays**
  - Displays must not be cleaned with a dry cloth – this can scratch the display!
- **Control consoles**
  - Do not let any liquid get inside the control consoles – risk of damage!
- **Seat belts**
  - Do not remove the seat belts to clean them.
  - Do not use chemical cleaning agents, corrosive liquids, solvents or sharp instruments to clean the seat belts or their components – this can damage the belt webbing!
  - If you find any damage to the belt webbing, the belt fittings, the belt retractor or the buckle, have the belt in question replaced by a qualified workshop.
- **Fabrics/leatherette/Alcantara**
  - Do not use leather care products, solvents, wax polish, shoe cream, stain removers, or any similar products on leatherette/Alcantara fabrics.
  - To avoid damage, stubborn stains should be removed by a qualified workshop.
  - Never use steam cleaners, brushes, hard sponges or similar utensils.
  - Sharp-edged objects on clothing, such as zip fasteners, rivets or belts, can also damage the surface of the fabric.
  - Please make sure you close any velcro fasteners, e.g. on your clothing, as these could otherwise damage the upholstery.
- **Natural leather**
  - Do not use solvents, wax polish, shoe cream, stain removers, or any similar products on leather fabrics.
  - Sharp-edged objects on clothing, such as zip fasteners, rivets or belts, can also damage the surface of the fabric.
  - Never use steam cleaners, brushes, hard sponges or similar utensils.
  - Avoid exposing leather to direct sunlight for long periods, otherwise it may tend to lose some of its colour. If the

car is left for a prolonged period in the bright sun, it is best to cover the leather.

#### Note

- It is much easier to remove dead insects if the car has been waxed recently.
- Regular waxing can help protect against surface rust.

## Checking and topping up fluids

### Fuel

#### Petrol grade

Applies to vehicles: with petrol engine

*The correct grade of petrol is listed inside the fuel tank flap.*

The vehicle is equipped with a catalytic converter and must only be run on **unleaded petrol**. The petrol must comply with the EN 228 or DIN 51626-1 standard and must be **sulphur-free**. You can fuel your vehicle with fuels containing a maximum of 10% ethanol (E10). The petrol grades have different **octane ratings** (RON).

The following headings relate to the sticker on the inside of your vehicle's tank flap:

#### Unleaded fuel only RON/ROZ 95 Super, Premium or min. RON/ROZ 91 Normal

The use of premium petrol (95 RON) is recommended. If that type of fuel is not available, regular petrol (RON 91) can be used with a slight loss of power.

#### Unleaded fuel only, min. RON/ROZ 95 Super, Premium

Premium petrol (at least 95 RON) must be used.

If premium petrol is not available, the engine can be run on regular petrol with 91 RON as an *emergency measure*. In this case only use moderate engine speeds and a light throttle. Fill up with premium or Super Plus petrol as soon as possible.

#### Unleaded fuel only RON/ROZ 98 Super Plus or min. RON/ROZ 95 Super, Premium

The use of Super Plus petrol (98 RON) is recommended. If that type of fuel is not available, premium petrol (RON 95) can be used with a slight loss of power.

If premium petrol is not available, the engine can be run on regular petrol with 91 RON as an *emergency measure*. In this case only use

moderate engine speeds and a light throttle. Fill up with premium or Super Plus petrol as soon as possible.

#### ! CAUTION

- Do **NOT** fuel your vehicle with high-ethanol fuel blends (e.g. E50 or E85). This will damage the fuel system.
- Just one tank of leaded fuel or fuel with metallic additives will permanently impair the efficiency of the catalytic converter.
- You should use only petrol additives which have been approved by Audi. Additives with so-called octane boosters or antiknock additives can contain metallic additives that cause significant damage to the engine and the catalytic converter. Do not use such additives.
- Metal-based fuels, which can be identified from the marking on the fuel dispenser, must not be used. LRP fuel (lead replacement petrol) also contains high concentrations of metallic additive. Risk of engine damage!
- High engine speed and full throttle can damage the engine when using petrol with an octane rating lower than the correct grade for the engine.

#### i Note

- You can use higher octane fuel than your engine requires.
- In countries where sulphur-free fuel is not available, you may use low-sulphur fuel instead.

#### Diesel fuel

Applies to vehicles: with diesel engine

*Please note the information on the inside of the fuel tank flap.*

The use of **sulphur-free diesel** to EN 590 (in Germany: EN 590 or DIN 51628) is recommended. If that type of fuel is unavailable, **diesel** to EN 590 can be used. It must have a cetane number (CN) of at least 51. The cetane ▶

number indicates the ignition quality of the diesel fuel.

### Winter-grade diesel

Diesel fuel can thicken in winter. For this reason petrol stations in some countries also offer winter diesel.

#### CAUTION

- The vehicle is **not** designed for the use of biodiesel (FAME fuel). The fuel system would be damaged if you used biodiesel.
- Do not mix fuel additives (“thinners”, petrol or similar additives) with the diesel fuel.
- If poor-quality diesel fuel is used, it may be necessary to have the water separator<sup>1)</sup> on the **fuel filter** drained more frequently than is specified in the Service Schedule. This helps to prevent potential engine faults ⇒ *page 24*.

#### For the sake of the environment

Never pour fuel down drains or into the ground.

## Filling the tank

### Procedure for filling the tank



**Fig. 215** Vehicle as seen from the rear right: Opening the fuel tank flap



**Fig. 216** Fuel tank flap with tank cap attached

When refuelling with natural gas, please note the additional information and warnings ⇒ *page 104*.

The flap that covers the tank cap is unlocked and locked automatically by the central locking.

#### Unscrewing the tank cap

- ▶ Press the left side of the flap to open it -arrow- ⇒ *Fig. 215*.
- ▶ Unscrew the tank cap anti-clockwise.
- ▶ Hook the cap onto the open flap ⇒ *Fig. 216*.

#### Closing the tank cap

- ▶ Screw on the tank cap clockwise until it clicks audibly.
- ▶ Close the tank flap. Make sure you hear it click into place.

When the automatic filler nozzle is operated correctly it will switch itself off as soon as the tank is “full”. Do not try to put in more fuel after the nozzle cuts out, as this will fill the expansion chamber in the fuel tank.

The correct fuel grade for your vehicle is given on a sticker on the inside of the tank flap. Further notes on fuel ⇒ *page 209*.

The tank capacity of your vehicle is given in the **Technical data** section ⇒ *page 273*.

#### WARNING

Fuel is highly inflammable and can cause serious burns and other injuries.

<sup>1)</sup> This equipment is not available on all export versions.

- For safety reasons always switch off the auxiliary heating\* before refuelling the vehicle.
- When filling your tank or a spare fuel canister with fuel, do not smoke and keep away from naked flames. Risk of explosion!
- Observe all relevant statutory regulations on using, storing and transporting spare fuel canisters.
- For safety reasons we do not recommend carrying a spare fuel canister in the vehicle. The canister could become damaged in an accident and leak.
- If, in exceptional circumstances, you have to carry a spare fuel canister, please observe the following warnings:
  - Never fill fuel into the spare fuel canister with the canister placed in or on top of the vehicle. An electrostatic charge could build up during filling, causing the fuel vapour to ignite. Danger of explosion. Always place the canister on the ground to fill it.
  - Insert the filler nozzle as far as possible into the spare fuel canister.
  - If the spare fuel canister is made of metal, the filler nozzle must be in contact with the canister during filling. This helps prevent an electrostatic charge building up.
  - Make sure you never spill fuel in the vehicle or in the luggage compartment. Fuel vapour is explosive. Risk of fatal accident!

### CAUTION

- If any fuel is spilt onto the vehicle, it should be removed immediately as it could otherwise damage the paintwork.
- Never run the tank completely dry. If there is an irregular fuel supply, misfiring can occur. As a result unburnt fuel can enter the exhaust system and cause damage to the catalytic converter(s).

- When filling the fuel tank after having run it completely dry on a vehicle with a **diesel engine** the ignition must be switched on for at least 30 seconds without starting the engine. When you then start the engine it may take longer than normal (up to one minute) for the engine to start firing. This is because air needs to be bled from the fuel system while starting.



### For the sake of the environment

Do not overfill the fuel tank – this may cause the fuel to overflow if it becomes warm.



### Note

Diesel vehicles are equipped with an incorrect fuelling protection system<sup>1)</sup>. This system ensures that the tank can only be fuelled from a diesel filler nozzle.

- If the filler nozzle is old, damaged or too small, it may not be able to open the protection mechanism on the fuel tank. In this case, try turning the filler nozzle before inserting it in the fuel filler neck, use a different filling pump or seek professional assistance.
- The protection mechanism will not open if you try to add fuel from a reserve canister. You can get round this simply by adding the diesel fuel slowly.

<sup>1)</sup> May vary in different countries

### Releasing the tank flap manually

The tank flap can be released manually if the central locking system should fail to operate.

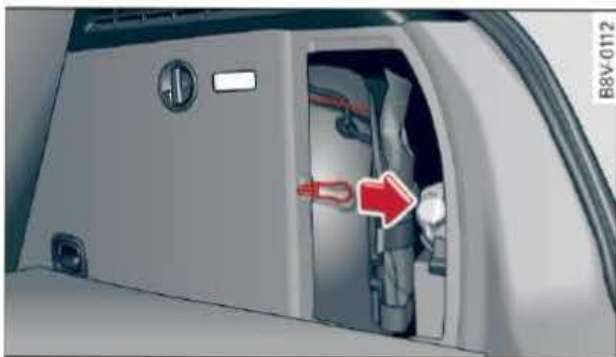

Fig. 217 Luggage compartment (rear right): Manual release (example)

The manual release mechanism is located in the side trim on the right of the luggage compartment.

- ▶ Remove the cover in the side trim.
- ▶ Release the ring from its holder and carefully pull the ring -arrow- ⇨ ⚠. The tank flap is then released.
- ▶ Press the left side of the tank flap to open it ⇨ page 210, Fig. 215.

### ⚠ CAUTION

Pull the ring only until you feel resistance; otherwise you may damage the manual release mechanism (you cannot hear it releasing the tank flap).

## Bonnet

### Working on components in the engine compartment

Extra caution is necessary when working on components in the engine compartment.

Always be aware of the danger of injury and scalding as well as the risk of accident or fire when working in the engine compartment (e.g. when checking and refilling fluids). Always observe the warnings listed below and follow all normal safety precautions. The engine compartment of any motor vehicle is a potentially hazardous area ⇨ ⚠.

### ⚠ WARNING

- Switch off the engine.
- Remove the ignition key.
- Apply the parking brake.
- On vehicles with manual gearbox place the gear lever in neutral, on vehicles with automatic gearbox move the selector lever to position P.
- Wait for the engine to cool down.
- Keep children away from engine compartment.
- Never spill fluids on a hot engine. These fluids can cause a fire (e.g. radiator anti-freeze).
- Take care not to cause short circuits in the electrical system, especially when working on the battery.
- When working in the engine compartment be aware that the radiator fan may start running suddenly, even if the ignition is switched off – risk of injury.
- Do not unscrew the cap on the expansion tank when the engine is hot. The cooling system is under pressure.
- Protect face, hands and arms by covering the cap with a large, thick rag to protect against escaping coolant and steam.
- Never remove the engine cover panel - risk of burns!
- If any tests have to be performed with the engine running, there is an extra safety risk from the rotating parts, such as the drive belts, alternator and radiator fan, etc., and from the high-voltage ignition system.
- Observe the following additional warnings if work on the fuel system or the electrical system is necessary:
  - Always disconnect the battery
  - Do not smoke
  - Never work near open flames
  - Always keep an approved fire extinguisher immediately available.

**!** CAUTION

When topping up fluids make sure the correct fluid is put into the correct filler opening. This can otherwise cause serious malfunctions or engine damage.

**🌱 For the sake of the environment**

Inspect the ground underneath your vehicle regularly so that any leaks are detected at an early stage. If you find spots of oil or other fluids, have your vehicle inspected in the workshop.

**i Note**

On right-hand drive vehicles\* some of the containers / reservoirs mentioned below are located on the other side of the engine compartment.

**Opening the bonnet**

The bonnet is released from inside the vehicle.



Fig. 218 Detail of footwell on driver's side: Release lever



Fig. 219 Release catch under the bonnet

The wiper arms should be resting on the windscreen: make sure they are not in a raised position. Otherwise the paint may get damaged.

The bonnet can be released only when the driver's door is open.

- ▶ Pull the lever under the dashboard in the direction indicated (arrow) ⇒ Fig. 218.
- ▶ Lift the bonnet slightly ⇒ ⚠.
- ▶ Press the release catch under the bonnet upwards ⇒ Fig. 219. This will release the arrester hook.
- ▶ Open the bonnet.

**⚠ WARNING**

To avoid the risk of being scalded, never open the bonnet if you see steam or coolant escaping from the engine compartment. Wait until no steam or coolant can be seen before opening the bonnet.

**Closing the bonnet**

- ▶ To close the bonnet, pull it down to overcome the spring pressure.
- ▶ Then let it drop into the catches; *do not press down* ⇒ ⚠.

**⚠ WARNING**

- For safety reasons the bonnet must always be completely closed when the vehicle is moving. After closing it always check that it is properly secured. The bonnet must be flush with the adjacent body panels.
- Should you notice that the bonnet is not safely secured when the vehicle is moving, stop the vehicle immediately and close the bonnet properly, otherwise it could cause an accident.

## Engine compartment layout

Main components for checking and refilling

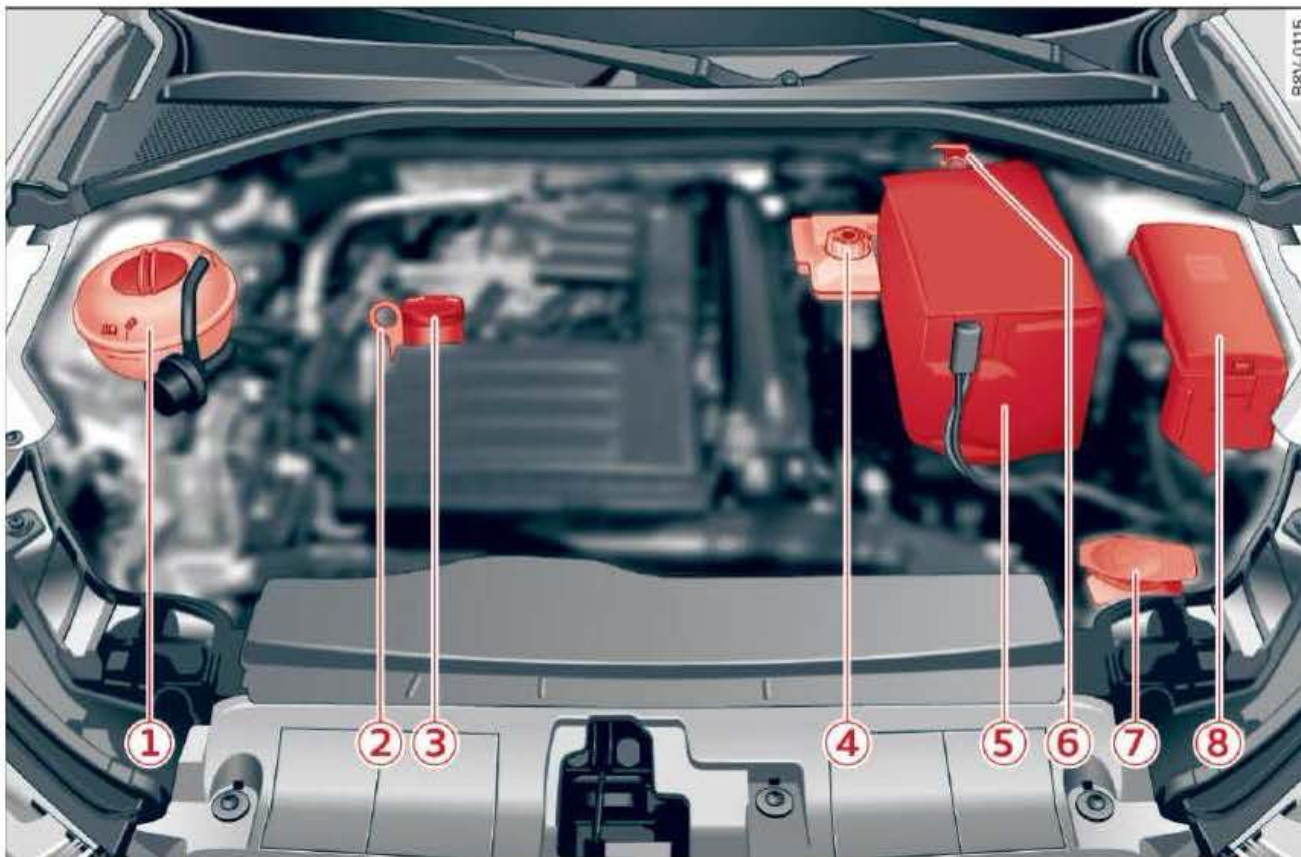

Fig. 220 Typical locations of fluid containers, engine oil dipstick and engine oil filler cap

① Coolant expansion tank (⚡) ...	217
② Engine oil dipstick* .....	215
③ Engine oil filler cap (🔑) .....	216
④ Brake fluid reservoir (⊖) .....	218
⑤ Battery (+) beneath a cover ...	219
⑥ Earth point on body (-)	
⑦ Windscreen washer container (🚿) .....	221
⑧ Fuse box .....	250

The positions of the engine oil filler cap and the oil dipstick (items ③ and ② ⇒ Fig. 220) may be different on some engine versions.

## Engine oil

### Choosing the correct engine oil grade

The service interval display in the instrument cluster of your vehicle will inform you when it is time for an oil change. We recommend having the oil changed by a qualified workshop.

If you have to top up the oil between oil changes, use the grades of oil specified in the table in accordance with VW standards. You will need to know whether

- the vehicle is being serviced based on the flexible or fixed oil change service (see last service record in Service Schedule).
- the vehicle has a petrol or diesel engine (see sticker on inside of fuel tank flap).
- a diesel particulate filter is fitted on the vehicle (see Delivery Inspection section of Service Schedule).



	Oil Change Service (flexible)	Oil change service (fixed)
Petrol engine	VW 504 00	VW 502 00 Alternatively: VW 504 00 <sup>a)</sup>
Diesel engine	VW 507 00	With diesel particulate filter: <b>VW 507 00</b>  Without diesel particulate filter: <b>VW 505 01</b> Alternatively: VW 507 00 <sup>b)</sup>

a) When using fuel complying with EN 228 or DIN 51626-1

b) When using fuel complying with EN 590 or DIN 51628

### **i** Note

If the oil grades specified in the table are not available, you can use one of the following grades as a substitute. To prevent damage to the engine, this should not be done more than once between oil changes and no more than 0.5 litres should be used.

- Petrol engines: ACEA A3 or API SN (API SM) standard
- Diesel engines: ACEA C3 or API CJ-4 standard

### **i** Note

- For **China**: Only oil complying with VW standard **502 00** with viscosity **SAE 5W-40** may be used on vehicles with a petrol engine.
- The flexible oil change service is not available in all countries.

## Checking the oil level

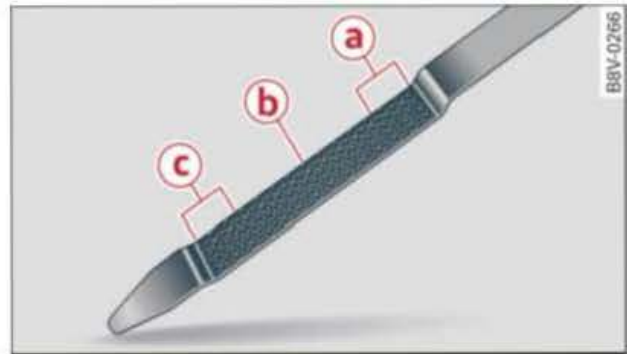

Fig. 221 Guide for oil dipstick

### Checking oil level

- ▶ Park your vehicle on a level surface.
- ▶ Allow the warm engine to run briefly at idling speed and then switch off the ignition.
- ▶ Wait approx. two minutes.
- ▶ Pull out the dipstick. Wipe the dipstick with a clean cloth and insert it again, pushing it in as far as it will go.
- ▶ Then pull the dipstick out again and check the oil level ⇒ Fig. 221. If the oil level is too low, add more engine oil ⇒ page 216.

#### Oil level in area **a**

- ▶ Do *not* top up oil.

#### Oil level in area **b**

- ▶ Oil *can* be topped up. *After topping up* the oil level should be in area **a**.

#### Oil level in area **c**

- ▶ Oil *must* be topped up. *After topping up* the oil level should be in area **a**.

Depending on how you drive and the conditions in which the car is used, oil consumption can be up to 0.5 ltr./1000 km. Oil consumption is likely to be higher for the first 5000 km. For this reason the engine oil level must be checked at regular intervals, preferably when filling the tank and before a journey.

### Topping up the engine oil



Fig. 222 Engine compartment: Engine oil filler cap

- ▶ Switch off the engine.
- ▶ Unscrew cap  from oil filler opening ⇒ Fig. 222, ⇒ page 214, Fig. 220.
- ▶ Carefully add 0.5 litres of suitable oil ⇒ page 214.
- ▶ After two minutes check the oil level once again ⇒ page 215, *Checking the oil level*.
- ▶ Top up with oil if necessary.
- ▶ Replace the oil filler cap carefully and push the dipstick all the way in.

#### WARNING

- Ensure that no oil comes into contact with hot engine components when topping up: this could cause a fire.
- Wash your skin thoroughly if it comes into contact with engine oil.

#### CAUTION

- The oil level must never be above area , as this may result in damage to the catalytic converter or to the engine. Contact a qualified workshop to extract the engine oil if necessary.
- No additives should be used with engine oil. Any damage caused by the use of such additives would not be covered by the factory warranty.

#### For the sake of the environment

- Never pour oil down drains or into the ground.
- Always observe statutory requirements when disposing of empty oil canisters.

## Cooling system

### Coolant

The engine cooling system is filled at the factory with a mixture of conditioned water and coolant additive. This coolant must not be changed.

The coolant level is monitored by a warning lamp in the instrument cluster ⇒ page 20. However, we recommend that it should be checked occasionally.

If you do need to top up the coolant, use a mixture of water and coolant additive. We recommend mixing coolant additive with distilled water.

### Coolant additive

The coolant additive contains anti-freeze and corrosion protection agent. Only use one of the following coolant additives. It is possible to mix these additives.

Coolant additive	Specification
G12++	TL 774 G
G13	TL 774 J
Only if the above grades are not available: G12+	TL 774 F

The amount of coolant additive which needs to be mixed with the water depends on the temperatures to be expected in the winter season. If the anti-freeze concentration is too low, the coolant can freeze and cause engine damage.

	Coolant additive	Frost protection
Countries with warm climate	min. 40 %, max. 45 %	min. -25 °C
Countries with cold climate	min. 50 %, max. 60 %	max. -40 °C

## ! CAUTION

- Have your qualified workshop check the cooling system before the winter season to make sure that the anti-freeze concentration is adequate for the conditions to be expected. This applies particularly if you drive into a colder climate zone.
- To prevent damage to the engine, do not use a different type of anti-freeze additive if the approved type of additive is not available. In this case use only water and bring the coolant concentration back up to the correct level as soon as possible by putting in the specified additive.
- Always top up with fresh, unused coolant.
- Radiator sealants must not be added to the coolant.

## Topping up coolant



Fig. 223 Engine compartment: Markings on coolant expansion tank

## Checking coolant level

- ▶ Park your vehicle on a level surface.
- ▶ Switch off the ignition.
- ▶ Read off the coolant level on the coolant expansion tank ⇒ Fig. 223. When the engine is cold, the coolant level should be between the marks. When the engine is warm, it may be slightly above the top mark.

## Topping up coolant

Important: The coolant expansion tank must not be empty ⇒ !.

- ▶ Wait for the engine to cool down.

- ▶ Cover the cap on the expansion tank with a cloth, and carefully unscrew the cap anti-clockwise ⇒ !.
- ▶ Add coolant in the correct concentration ⇒ page 216 up to the top mark.
- ▶ You should make sure that the fluid level remains stable. If necessary, add more coolant.
- ▶ Screw the cap on again tightly.

Any loss of coolant normally indicates a leak in the cooling system. Drive to a qualified workshop without delay and have the cooling system checked. If there are no leaks in the system, a loss of coolant can only occur if the coolant boils and is forced out of the system as a result of overheating.

## ! WARNING

- The cooling system is under pressure. Do not unscrew the cap on the expansion tank when the engine is hot: you could be scalded by escaping steam.
- The coolant and coolant additive can be a health hazard. Store the coolant additive in the original container in a safe place out of reach of children – risk of poisoning.
- When working in the engine compartment be aware that the radiator fan may start running suddenly, even if the ignition is switched off – risk of injury.

## ! CAUTION

Do not add coolant if the expansion tank is empty. Air could have got into the cooling system - risk of engine damage! In this case, do NOT drive on. You should obtain professional assistance.

## Brake fluid



Fig. 224 Engine compartment: Markings on brake fluid reservoir

### Checking brake fluid level

The brake fluid level must be between the MIN and MAX marks ⇒ *page 214, Fig. 220*.

If the level goes down noticeably in a short time, or drops below the MIN mark, there may be a leak in the brake system. You should obtain professional assistance. The brake fluid level is also monitored by a warning lamp in the instrument cluster ⇒ *page 19*.

In right-hand drive vehicles the brake fluid reservoir is on the other side of the engine compartment.

### Changing brake fluid

Your vehicle's Service Schedule will tell you the regular intervals at which the brake fluid is due for renewal. We recommend that you have the brake fluid changed by a qualified workshop during a service.

#### WARNING

- Brake fluid is poisonous; it must be stored in the sealed original container in a safe place out of the reach of children.
- Heavy use of the brakes may cause a vapour lock if the brake fluid is left in the system for too long. This would seriously affect the efficiency of the brakes and the safety of the car – risk of accident.

#### CAUTION

Brake fluid must not be allowed to come into contact with the vehicle's body, otherwise it will attack the paintwork.

## Battery

### General notes

All work on batteries requires specialist knowledge.

The battery is located in the engine compartment and is almost **maintenance-free**. It is checked as part of the Inspection Service.

### Disconnecting the battery

The battery should always be left connected. If the battery is disconnected, some of the vehicle's functions will become inoperative (e.g. electric windows). These functions will require resetting after the battery is reconnected. For this reason, the battery should only be disconnected from the vehicle's electrical system when absolutely necessary.

Function	Resetting
One-touch function of the electric windows	⇒ <i>page 52, What to do after a malfunction</i>
Remote control key or convenience key	If the vehicle does not respond to the key, the key will have to be synchronised ⇒ <i>page 44</i>
Digital clock	⇒ <i>page 9</i>
ESC indicator lamp	The indicator lamp will go out after driving a few yards

### If the vehicle is not used for long periods

If you do not drive your vehicle for a period of several days or weeks, the power management will gradually shut off the on-board systems one by one, or reduce the amount of current they are using. This limits the amount of power consumed and helps to ensure reliable starting even after a long period ⇒ *page 187*. Certain convenience features, such as remote control unlocking, may not be available. These functions will be restored when you switch on the ignition and start the engine. Even though some systems are deactivated automatically, certain electrical equipment continues to

draw current even when the ignition is off. If the vehicle is left standing for long periods, this can result in total battery discharge. If the battery is allowed to discharge completely, an internal chemical reaction destroys the battery. To avoid this, the battery should be recharged at least once a month ⇒ page 220. Do not disconnect the battery; otherwise the anti-theft alarm system\* will be out of operation.

**Winter conditions**



Cold weather is very hard on the battery. The starting capacity may be reduced as a result. For this reason, have the battery checked and charged if necessary before the start of winter.



**! WARNING**

- All work on batteries requires specialist knowledge. For queries regarding the vehicle battery please seek the assistance of a qualified workshop - risk of chemical burns / risk of explosion!
- The battery must not be opened. Do not attempt to make any changes to the electrolyte level of the battery. Otherwise, there is a risk that a mixture of oxygen and hydrogen gas can accumulate and cause an explosion.

**Important safety warnings for handling a car battery**

*All work on batteries requires specialist knowledge.*

	Wear safety glasses!
	Battery acid is extremely corrosive. Wear protective gloves and safety glasses.
	Keep open flames, sparks, uncovered lights and lit cigarettes away from the battery!

	A highly explosive mixture of gases is given off when the battery is under charge!
	Keep children away from the battery and battery acid.

**! WARNING**

Always be aware of the danger of injury and chemical burns as well as the risk of accident or fire when working on the battery and the electrical system.

- Wear safety glasses. Do not allow acid or lead particles to come into contact with eyes, skin or clothing.
- Battery acid is extremely corrosive. Wear protective gloves and safety glasses. Do not tilt the battery - acid can leak out of the vapour vent. If electrolyte should splash into the eyes rinse at once for several minutes using clear water. Then seek medical care immediately. Neutralize any acid splashes on the skin or clothing with soap solution, and rinse off with plenty of water. If acid is swallowed by mistake, consult a doctor immediately.
- Keep open flames, sparks, uncovered lights and lit cigarettes away from battery. Avoid sparks (including those from static charges) when handling cables and electrical equipment. Never cross the battery poles. The resulting high-energy sparks can cause injury.
- A highly explosive mixture of gases is given off when the battery is under charge. Only charge battery in a well ventilated area.
- Keep children away from the battery and battery acid.
- Switch off all electrical equipment before starting any work on the vehicle electrical system. Remove the ignition key. The minus cable of the battery must be disconnected. When changing a light bulb, it is sufficient to only turn off the light.

- Before disconnecting the battery, turn off the anti-theft alarm system\*! Otherwise the alarm will be triggered.
- When disconnecting the battery from the vehicle's electrical system, first disconnect the minus cable and then the plus cable.
- Before reconnecting the battery, turn off all electrical equipment. First connect the plus cable, then the minus cable. The battery cables must NOT be connected to the wrong battery poles – this can cause an electrical fire.
- Never charge a frozen or thawed out battery - risk of explosion and chemical burns! A battery must be replaced once it has frozen. When it is discharged the battery can freeze at temperatures around 0°C.
- Make sure that the vapour hose is always attached to the battery.
- Never use a damaged battery - risk of explosion! Replace a damaged battery immediately.

### ! CAUTION

- Never disconnect the car's battery with the engine running or with the ignition turned on, otherwise the electrical system or electrical components will be damaged.
- Do not expose the battery to direct sunlight over a long period of time, as the intense ultraviolet radiation can affect the battery housing.
- If the car is left standing for long periods, protect the battery from frost. The battery will be destroyed if it is allowed to freeze ⇒ *page 220*.

### Charging the battery

Terminals for charging the battery are fitted in the engine compartment.



Fig. 225 Engine compartment: Terminals for jump leads and battery charger

- ▶ Note the warnings ⇒ ⚠ in *Important safety warnings for handling a car battery on page 219* and ⇒ ⚠.
- ▶ Switch off all electrical equipment. Remove the ignition key.
- ▶ Open the bonnet ⇒ *page 213*.
- ▶ Open the battery cover.
- ▶ Connect the charger cables to the **positive battery terminal (+)** and the **earth point on the body (-)** (not the negative terminal on the battery) as specified.
- ▶ Now connect the battery charger to the mains and switch on.
- ▶ After charging the battery: switch off the battery charger and disconnect the mains cable.
- ▶ Now disconnect the charger cables.
- ▶ Fold the cover back onto the battery in its correct position.
- ▶ Close the bonnet ⇒ *page 213*.

When it is discharged the battery can freeze at temperatures around 0°C. You must not use a battery which has frozen, even after it has thawed, because the ice may have cracked the battery casing and allowed the battery acid to escape ⇒ ⚠.

### Charging the battery

Only use battery chargers with a **maximum charge voltage of 14.8 V** (the battery cables do not have to be disconnected). The battery must not be opened while you are charging it. ▶

Important: Before you charge the battery make sure you read the manufacturer's instructions for using the battery charger.

### WARNING

Always replace a frozen battery. Never recharge it - risk of explosion!

### Note

Use only the terminals in the engine compartment to charge the battery.

## Replacing the battery

A replacement battery must have the same specifications as the original equipment battery.

Your vehicle is equipped with an intelligent power management system to control the distribution of electrical energy ⇒ *page 187*. The power management function ensures that the battery is charged much more efficiently than on vehicles without a power management system. For this additional power to be available after replacing the battery, we recommend that the replacement battery used is of the same make and type as the original-equipment battery. After changing the battery, the power management system must be initialised by a qualified workshop to ensure that the replacement battery is charged to an optimum level.

A replacement battery must have the same capacity, voltage (12 V) and current rating. It must also have the same dimensions as the original, factory-fitted battery and have sealed caps. The battery must comply with the standards TL 825 06 (dated April 2008 or later) and VW 7 50 73 (April 2010 or later).

### CAUTION

– Vehicles with e.g. start/stop system\* or auxiliary heating/ventilation\* are equipped with a special deep cycle battery (e.g. AGM type). The on-board electronic systems may develop problems if you fit a different type of battery. For this rea-

son, if you need to replace the vehicle battery, make sure that the specifications of the new battery match the original exactly.

- Make sure that the vent hose is always attached to the original opening on the side of the battery. Gases or battery acid can otherwise escape and possibly cause damage.
- The battery holder and clamps must always be correctly secured.
- Before starting any work on the battery, always observe the warnings listed under ⇒ *page 219, Important safety warnings for handling a car battery*.



### For the sake of the environment

✗ Batteries contain toxic substances including sulphuric acid and lead. They must be disposed of appropriately and must not be put together with ordinary household waste. Make sure the battery removed from the vehicle cannot tip over. Otherwise, sulphuric acid could escape.

## Windscreen washer



**Fig. 226** Engine compartment: Cap of windscreen washer container

The container for the windscreen washer  contains the cleaning fluid for the windscreen, the rear window and the headlight washer system\* ⇒ *page 214, Fig. 220*. Container capacity ⇒ *page 273*.

Clean water should be used when topping up. If possible, use soft water to prevent scaling on the washer jets. Always add washer fluid to the water (with anti-freeze additive in winter). ►

 **CAUTION**

- Never put in radiator anti-freeze or other additives.
- Never use washer fluid which contains paint thinners or solvents as it can damage the paintwork.



## Wheels and tyres

### Wheels

#### General notes

- ▶ When driving with **new tyres**, be especially careful during the first 500 km.
- ▶ If you have to drive over a kerb or similar obstacle, drive very slowly and as near as possible at a right angle to the kerb.
- ▶ Inspect the tyres regularly for damage (cuts, cracks or blisters, etc.). Remove any foreign bodies embedded in the treads.
- ▶ Damaged wheels and tyres must be replaced immediately.
- ▶ Keep grease, oil and fuel off the tyres.
- ▶ Replace any missing valve caps as soon as possible.
- ▶ Mark the wheels before taking them off so that they rotate in the same direction when put back.
- ▶ When removed, the wheels or tyres should be stored in a cool, dry and preferably dark place.

#### New tyres

New tyres do not give maximum **grip** straight away and should therefore be “run in” by driving carefully and at moderate speeds for about the first 500 km. This will also help to make the tyres last longer.

The **tread depth** of new tyres may *vary*, according to the type and make of tyre and the tread pattern.

#### Concealed damage

Damage to tyres and rims is often not readily visible. If you notice unusual **vibration** or the car **pulling to one side**, this may indicate that one of the tyres is damaged. Reduce speed immediately if there is any reason to suspect that damage may have occurred. Inspect the tyres for damage. If no external damage is visible, drive slowly and carefully to the nearest qualified workshop and have the car inspected.

#### Tyres with directional tread pattern

An arrow on the tyre sidewall indicates the direction of rotation on tyres with directional tread. Always note the direction of rotation indicated when mounting the wheel. This guarantees optimum grip and helps to avoid aquaplaning, excessive noise and wear.

#### Wheels with bolted rim flange\*

Light-alloy wheels with a bolted rim flange consist of several components. A special technique is applied to bolt these components together. Apart from safety and true running this also ensures that the wheel functions correctly and that there is no leakage. Damaged rims must therefore be replaced; you must never attempt to repair or dismantle them ⇒ ⚠.

#### Wheels with bolted trim parts\*

Light-alloy wheels can be fitted with interchangeable trim parts which are attached to the rim using self-locking bolts. Should you wish to replace damaged trim parts please contact a qualified workshop.

#### Retrofitting accessories

Qualified workshops have full information on the technical requirements when installing or changing tyres, rims or wheel trims.

#### WARNING

Never remove the bolts on a wheel with bolted rim flange\* (accident risk).

#### CAUTION

- Please note that summer and winter tyres are optimised for the prevailing road conditions at different times of year. We recommend that you use winter tyres during the winter months. At low temperatures, summer tyres lose their elasticity and grip, and braking performance also suffers as a result. Cracks can form in the tread block on summer tyres if they are used at very cold temperatures, and this can cause permanent damage to the tyres. An increase in

rolling noise and tyre imbalance may result from this damage. Audi cannot accept responsibility for this type of damage.

- Machined, polished or chrome-plated rims must not be used during the winter months. The process used to manufacture these types of wheel rim does not provide adequate surface protection against corrosion, and the rims can be permanently damaged by road salt or similar. There is no guarantee or warranty entitlement in such cases.

### Tyre service life

*Correct inflation pressures and sensible driving habits will increase the service life of your tyres.*



**Fig. 227** Open driver's door (LHD vehicle): Sticker listing tyre pressures

- ▶ Check the tyre pressures at least once a month and, in addition, before starting a long journey.
- ▶ The tyre pressures should only be checked when the tyres are *cold*. The slightly raised pressures of warm tyres must not be reduced.
- ▶ The pressures must be altered accordingly if you are transporting a heavy load or driving at high speeds.
- ▶ On vehicles with tyre pressure monitoring system, store the new tyre pressures ⇒ *page 231*.
- ▶ Avoid fast cornering and hard acceleration.
- ▶ Inspect the tyres for irregular wear from time to time.

The service life of your tyres depends on the following factors:

### Tyre pressure

The tyre inflation pressures are listed on a sticker on the end face of the driver's door ⇒ *Fig. 227*.

Under-inflation or over-inflation will reduce the life of the tyres considerably and also impair the car's handling. Correct inflation pressures are very important, especially at **high speeds**.

If you prefer an extra-smooth ride and the vehicle is not fully loaded, you can select the tyre pressure for a normal load (no more than three people travelling in the vehicle). Should you wish to drive with a full load, you must increase the tyre pressure to the specified maximum.

The tyre pressure must be adjusted according to the load the vehicle is carrying. We recommend adhering to the tyre pressure specifications for a maximum load.

Remember to check the pressure of the compact temporary spare wheel\*.

On vehicles with wheel covers, **valve extensions** are fitted instead of dust caps. It is not necessary to remove the valve extensions when checking and adjusting tyre pressures.

### Driving habits

Fast cornering, heavy acceleration and hard braking (squealing tyres) all increase tyre wear.

### Wheel balancing

The wheels on new vehicles are balanced. However, various factors encountered in normal driving can cause them to become unbalanced, which results in steering vibration.

Unbalanced wheels should be rebalanced, as they otherwise cause excessive wear on steering, suspension and tyres. A wheel must also be rebalanced when a new tyre is fitted or if a tyre is repaired.

## Incorrect wheel alignment

Incorrect wheel alignment causes excessive tyre wear, impairing the safety of the vehicle. If you notice excessive tyre wear, you should have the wheel alignment checked by a qualified workshop.

### WARNING

- Always adjust the tyre pressures to match your driving style.
- Under-inflated tyres flex more and can overheat when carrying heavy loads or driving at high speeds. This can cause tread separation and tyre blow-out, which could result in an accident.

### For the sake of the environment

Under-inflated tyres will increase the fuel consumption.

## Tread wear indicators

The tread wear indicators show the condition of the tyre treads.



Fig. 228 Tyre tread: Tread wear indicators

The original tyres on your vehicle have 1.6 mm high “tread wear indicators” running across the tread. Depending on the make, there will be 6 to 8 of them spaced at equal distances around the tyre. Markings on the tyre sidewall (for instance the letters “TWI” or a triangle) indicate the positions of the tread wear indicators.

The minimum tread depth required by law in Germany is 1.6 mm (measured in the tread grooves next to the tread wear indicators). Different figures may apply in other countries.

### WARNING

To avoid putting safety at risk, the tyres must be replaced at the latest when the tread is worn down to the tread wear indicators.

- Especially in difficult driving conditions such as wet or icy roads, it is important that the tyres have sufficient tread depth. The tread depth should be the same on the tyres of both the front and the rear axles.
- The decrease in driving safety due to insufficient tread depth is particularly evident in vehicle handling, when there is a risk of aquaplaning in deep puddles of water and when driving through corners. Braking is also adversely affected.
- The speed has to be adapted accordingly, otherwise there is a risk of losing control over the vehicle.

## Changing wheels round



Fig. 229 Changing wheels round

To ensure that the wear is equal on all tyres the wheels should be changed round from time to time according to the system ⇒ Fig. 229. All the tyres will then last for about the same time.

## Replacing wheels and tyres

*It is important to use the correct wheels and tyres when replacement is necessary.*

- ▶ All four wheels must be fitted with tyres of the same type, size (rolling circumference) and preferably the same tread pattern. ▶

- ▶ If possible, tyres should be replaced at least in pairs and not individually (i.e. both front tyres or both rear tyres together).
- ▶ Never use tyres whose actual size exceeds the dimensions of the factory-approved makes of tyre.
- ▶ If you wish to fit the vehicle with non-standard rims or tyres, it is advisable to consult a qualified workshop **before** purchasing.

The tyres and wheel rims are an essential part of the vehicle's design. The tyres and rims approved by Audi are specially matched to the characteristics of the vehicle and make a major contribution to good roadholding and safe handling ⇨ ⚠.

The sizes of the rims and tyres approved for your vehicle are listed in the vehicle's documents (e.g. EC Certificate of Conformity or COC document <sup>1)</sup>). The vehicle documents vary depending on the country in which the vehicle is registered.

Understanding the tyre designations makes it easier to choose the correct tyres. The following designations are marked on the tyre sidewall, for example:

### **205 / 55 R 16 91 W**

This contains the following information:

205	Tyre width in mm
55	Height/width ratio in %
R	Letter <b>R</b> for radial
16	Rim diameter in inches
91	Load rating code
W	Speed rating code letter

The **manufacturing date** is also indicated on the tyre sidewall (possibly only on the *inner* side of the wheel):

### **DOT ... 4113 ...**

means, for example, that the tyre was produced in the 41st week of 2013.

**Please note that with some types of tyre, the actual tyre size can differ from the nominal size marked on the tyre (for instance 205/55 R 16 91 W), and there may be significant differences in the contours of the tyres, even though the tyres are marked with the same nominal size designation. When replacing the tyres, it is therefore important to make sure that the actual size of the new tyres does not exceed the dimensions of the factory-approved makes of tyre.**

**Failure to observe this requirement can affect the clearance needed for the tyres. This could result in contact between the tyres and suspension components or bodywork. The brake lines could also be damaged and the vehicle's safety could be severely impaired ⇨ ⚠.**

**If you use tyres that are approved by Audi you can be sure that the actual tyre dimensions will be correct for your vehicle. If you decide to fit a different type of tyre, you must obtain the appropriate manufacturer's certificate from the tyre retailer to confirm that the tyres are suitable for your vehicle. Keep this certificate in a safe place.**

**A qualified workshop will be able to advise you on which tyres may be fitted to your vehicle.**

On vehicles with **four-wheel drive**, all four tyres must always be fitted with tyres of the same type, make and tread pattern, as otherwise the driveline can be damaged by continuous variations in the wheel speeds. In the event of a puncture, you may use the factory-supplied compact temporary spare wheel for a short time. Refit the normal road wheel as soon as possible.

It is best to have all servicing of wheels and tyres performed by a qualified workshop. They have the necessary special tools and replacement parts, trained personnel and facilities for disposing of the old tyres. ▶

<sup>1)</sup> COC = certificate of conformity

 **WARNING**

- It is very important to ensure that the tyres you have chosen have adequate clearance. When selecting replacement tyres, do not rely entirely on the nominal tyre size marked on the tyre; with some makes of tyre the effective tyre size can differ significantly from the nominal dimensions, even though the tyres have the same size designation. Inadequate tyre clearance can result in damage to the tyres or the vehicle, causing a serious safety risk. It may also invalidate the vehicle's type approval for use on public roads.
- Avoid running the car on tyres that are more than 6 years old. If you have no alternative, you should drive slowly and with extra care at all times.
- Run-flat tyres may only be used on vehicles which were originally equipped with run-flat tyres. The vehicle must have a suitable suspension system and a factory-fitted tyre pressure loss indicator which indicates a loss of tyre pressure. The unauthorised use of run-flat tyres can cause an accident or damage your vehicle. Please ask a qualified workshop whether run-flat tyres can be used on your vehicle. When using run-flat tyres, it is important that all four wheels have run-flat characteristics. Do not fit normal tyres in combination with run-flat tyres!
- If wheel trims are fitted after the car is purchased, ensure that there is an adequate flow of air for cooling the brakes.

 **For the sake of the environment**

Old tyres must be disposed of according to the laws in the country concerned.

 **Note**

- Tyres with the marking “AO” or “RO” are specially matched to your Audi. We recommend that you use these tyres only. When used as intended, they meet the highest standards in safety and vehicle

handling. Your specialist retailer will be glad to provide more information.

- Never mount used tyres if you are not sure of their previous history.
- For technical reasons it is not normally possible to use wheel rims from other vehicles. In some cases this also applies to rims from other vehicles of the same model.

### Wheel bolts

*The wheel bolts are designed to suit the rims on your car.*

The **wheel bolts** are matched to the rims. When installing different wheels (for instance alloy wheels or wheels with winter tyres) it is important to use the correct wheel bolts with the right length and correctly shaped bolt heads. This is essential for the secure fit of the wheels and for the proper function of the brake system.

A qualified workshop will have full information on the technical requirements when installing or changing tyres, rims or wheel trims.

The wheel bolts should be clean and turn easily.

A special adapter is required to turn the anti-theft wheel bolts\* ⇨ [page 239](#).

### Winter tyres

*Winter tyres will significantly improve the car's handling in winter road conditions.*

- ▶ Winter tyres must be fitted **on all four** wheels.
- ▶ Only use winter tyres of the correct type approved for your vehicle.
- ▶ Please note that the maximum permissible speed for winter tyres may be lower than for summer tyres.
- ▶ Also note that winter tyres are no longer effective when the **tread** is worn down.
- ▶ After fitting the wheels you must always check the tyre pressures. The correct tyre

pressures are listed on a sticker which can be seen when you open the driver's door  
⇒ page 224.

In winter road conditions winter tyres will considerably improve the car's handling. Due to their type of construction (width, rubber compound, tread pattern), summer tyres give less grip on ice and snow. This applies particularly to vehicles equipped with **wide section tyres** or **high speed tyres** (code letters H, V or Y on the sidewall).

Only use winter tyres of the correct type approved for your vehicle. The sizes of the winter tyres approved for your vehicle are listed in the vehicle's documents (e.g. EC Certificate of Conformity or COC document <sup>1)</sup>). The vehicle documents vary depending on the country in which the vehicle is registered. Also refer to ⇒ page 225.

Winter tyres are no longer fully effective when the **tread** is worn down to a depth of 4 mm.

The performance of winter tyres is also severely impaired by **ageing**, even if the tread is still much deeper than 4 mm.

Winter tyres are subject to the following **maximum speed limits** according to speed rating code letter: ⇒ 

Speed rating code letter	Maximum speed limit
Q	160 km/h
S	180 km/h
T	190 km/h
H	210 km/h
V	240 km/h (please note relevant restrictions)

In Germany vehicles capable of exceeding these speeds must have an appropriate **sticker** attached so it is visible to the driver. Suitable stickers are available from qualified workshops. Please observe any other regulations applying in other countries.

"All-weather" tyres can also be used instead of winter tyres.

### Using winter tyres with V-rating

Please note that the generally applicable 240 km/h speed rating for winter tyres with the letter "V" is subject to **technical restrictions; the maximum permissible speed for your vehicle may be significantly lower**. The maximum speed limit for tyres with a V-rating depends directly on the maximum axle weights for your car and on the listed weight rating of the tyres being used.

It is best to contact a qualified workshop to check the maximum speed which is permissible for the V-rated tyres fitted on your car on the basis of this information.



#### WARNING

Exceeding the maximum speed permitted for the winter tyres fitted on your car can cause tyre failure, resulting in a loss of control of the vehicle – risk of accident.



#### For the sake of the environment

Summer tyres should be fitted again as soon as possible; they give better handling on roads which are free of snow and ice. Summer tyres produce less rolling noise, do not wear down as quickly and, most importantly, reduce fuel consumption.

### Snow chains

*Snow chains will improve the vehicle's handling on snow-covered roads.*

- ▶ Snow chains can be used on the *front* wheels only.
- ▶ Check that the snow chains are correctly seated after driving for a few yards. Note the fitting instructions provided by the manufacturer.
- ▶ Keep your speed below 50 km/h.
- ▶ If there is a risk that you may get stuck in the snow even though the snow chains are ▶

<sup>1)</sup> COC = certificate of conformity

fitted, it is a good idea to deactivate the traction control (ASR) in the ESC system  
⇒ page 183, *Switching the ESC on/off*.

Snow chains will improve *braking ability* as well as *traction* in winter conditions.

For technical reasons snow chains may only be used on tyres with certain wheel rim/tyre combinations.

Only use snow chains with **fine-pitch links**. The links must not protrude more than 13.5 mm from the tyres (including tensioner).

Remove **wheel covers** (if fitted) and trim rings before attaching snow chains.

Remove the chains when roads are *free of snow*. Otherwise they will impair handling, damage the tyres and wear out very quickly.

**Four-wheel drive:** Where snow chains are compulsory on certain roads, this normally also applies to cars with four-wheel drive. Snow chains may only be fitted to the *front* wheels (also on vehicles with four-wheel drive).

For technical reasons snow chains may only be used on tyres with certain wheel rim/tyre combinations.

### A3/A3Sportback

Rim size	Rim offset	Tyre size
6Jx16 (steel)	48 mm	205/55
6Jx17 (aluminium)	48 mm	205/50

### A3 Saloon

Rim size	Rim offset	Tyre size
6.5Jx16 (steel)	43 mm	205/55
6.5Jx17 (aluminium)	43 mm	205/50

## Run-flat tyres

### Introduction

Applies to vehicles: with run-flat tyres

*Run-flat tyres allow you to continue your journey in the event of a loss of tyre pressure.*

Run-flat tyres have reinforced sidewalls which support the tyre in the event of a loss of pressure.

Run-flat tyres must only be used on vehicles which have a tyre pressure loss indicator\*.

**Genuine Audi run-flat tyres** can be identified by the marking "AOE" on the **sidewall**.

### What are the benefits of run-flat tyres?

Run-flat tyres ensure that you remain mobile, even in the event of a loss of tyre pressure. In this case, you should be able to keep driving for **at least 30 km** if conditions are favourable, however you **must not drive faster than 80 km/h** ⇒ ⚠ in *Driving with run-flat tyres on page 230*.

The tyre pressures are constantly checked by the tyre pressure loss indicator. When the run-flat system becomes active (instrument cluster display), it is still the driver's responsibility to check the tyre(s) affected and to decide whether it is possible to continue driving. Please also observe the notes ⇒ page 230, *Driving with run-flat tyres*.

### When is it no longer possible to continue driving with the help of the run-flat tyres?

- If the electronic stabilisation control (ESC) is out of operation or is triggered continuously when the run-flat system is active.
- If the tyre pressure loss indicator is not working.
- If one of the tyres has been severely damaged in an accident, etc. If a tyre has been badly damaged there is a risk that parts of the tread can be thrown off and cause damage to the fuel lines, brake pipes or fuel filler.
- If damage to the tyres (e.g. tears in the sidewalls) becomes apparent. ▶

- You must stop driving if severe vibrations occur, or if the wheel starts overheating and gives off smoke.

### **WARNING**

Ask your qualified workshop whether, and if so which, run-flat tyres can be used on your vehicle. Unauthorised use of these tyres can invalidate the vehicle's type approval for use on public roads. Furthermore, this could cause damage to your vehicle and possibly also result in an accident.

### **Note**

- If you cannot continue driving, even with run-flat tyres, please obtain professional assistance.
- You should obtain professional assistance if you are in any doubt regarding the rims and tyres for your vehicle.

## **Driving with run-flat tyres**

Applies to vehicles: with run-flat tyres

*Please remember that the vehicle's handling will be impaired.*

Driving a vehicle with a deflated tyre, or with insufficient tyre pressure, is an abnormal situation. However, since the handling of a vehicle equipped with run-flat tyres is only slightly impaired, it is important to remember that you are driving with a deflated tyre. If you have to make use of the run-flat system, note the following points:

- ▶ The electronic stabilisation control (ESC) must be switched on.
- ▶ Do not exceed 80 km/h ⇨ .
- ▶ Anticipate the traffic situation well in advance.
- ▶ Be careful when accelerating.
- ▶ Avoid unnecessary braking and steering manoeuvres.
- ▶ Reduce speed in good time before corners and potential hazards.

Please refer to ⇨ *page 229, When is it no longer possible to continue driving with the help of the run-flat tyres?*

### **Effects on handling when driving with defective tyres**

If one of the **front tyres is defective**, your vehicle will tend to pull slightly towards that side and braking performance will be impaired.

A **defective rear tyre** will also make the vehicle pull slightly to one side, and the braking response will again be slightly impaired. These effects will be most noticeable when driving in a corner.

### **WARNING**

- When using the run-flat system the changes in vehicle handling will be noticeable when braking, in corners and during fast acceleration.
- The maximum permitted speed of 80 km/h is subject to road and weather conditions. Always observe the relevant rules and regulations. Run-flat tyres allow you to continue your journey in the event of a loss of tyre pressure. However, the driver remains responsible for the safety of the vehicle and for restoring the correct tyre pressure and having defective parts replaced ⇨ *page 230*. For these reasons you should always adjust your driving to suit the circumstances.

### **CAUTION**

We recommend that you drive with great care when using the run-flat system. Avoid abrupt manoeuvres.

## **Renewing defective components on run-flat tyres**

Applies to vehicles: with run-flat tyres

*The run-flat tyres have been specially developed for your vehicle and matched to its requirements.*

If you have to drive with low tyre pressure or with a completely deflated tyre, you should ▶



always take the vehicle to an authorised qualified workshop and have the defective parts inspected and the condition corrected.

### WARNING

- We recommend that you have the run-flat tyre renewed and also have the rim checked by a qualified workshop to identify any damage.
- Using tyres or rims which have not been approved can cause damage to the vehicle. Vehicle handling can be impaired and driving safety can no longer be guaranteed. This can also void the vehicle's certification for use on public roads.

### CAUTION

It is not permitted to combine run-flat tyres with standard tyres on your vehicle.

### Note

The tyre repair kit can be used for run-flat tyres ⇒ *page 237*.

## Tyre pressure loss indicator

### Tyre pressure loss indicator in instrument cluster

Applies to vehicles: with tyre pressure monitoring

The tyre pressure loss indicator in the instrument cluster informs the driver if the tyre pressure is too low or a system malfunction has occurred.



Fig. 230 Instrument cluster: Indicator lamp with message

The tyre pressure loss indicator makes use of the ABS sensors to compare the rolling cir-



cumference and the vibration of the tyres. If changes in the inflation pressure are detected on one or more tyres, the driver is alerted by an indicator lamp  and a message in the instrument cluster display ⇒ *Fig. 230*. If only one tyre is affected, the display will indicate its position.



Monitoring of the tyre pressures is based on the tyre pressures you have stored. Each time you change a tyre, change the wheels round or change the tyre pressures on your vehicle (e.g. when switching from partial load to full load and vice-versa), you must store the new tyre pressures in the menu display ⇒ *page 232*. Monitoring of the tyre pressures is based on the tyre pressures you have stored. The tyre pressures recommended for your vehicle are given on the sticker attached to the driver's door pillar ⇒ *page 224*.

The rolling circumference and vibration can change and cause a tyre pressure warning if:

- The inflation pressure in one or more tyres is too low.
- The tyre has suffered structural damage.
- The wheels were changed or the tyre pressures were changed and the new tyre pressures were not stored ⇒ *page 232*.
- The vehicle load is not balanced (more load on one side).
- There is more load on the wheels of one of the axles (e.g. when towing a trailer or driving up or down a gradient).
- You are driving with snow chains.
- You are driving with the temporary spare wheel.
- Only one wheel of an axle has been changed.

### Indicator lamps

 - Loss of pressure on one or more tyres ⇒ . Check and change or repair the tyre(s). Check and adjust the tyre pressures again on all four wheels. Then store the tyre pressures in the menu display ⇒ *page 232*.

 (Tyre pressure loss indicator) **Tyre pressure! System fault.** If  appears and the indicator lamp  in the instrument cluster

display flashes for approx. one minute and then remains lit after you have switched on the ignition or while you are driving, there is a fault in the system. Try to store the correct tyre pressures ⇒ *page 232*. If the indicator lamp does not go out or if it comes on again after a short time, drive to a qualified workshop without delay and have the fault rectified.

### **WARNING**

- If the tyre pressure loss indicator appears in the instrument cluster display, slow down immediately and avoid any severe braking or steering manoeuvres. As soon as you can do so safely, stop and check the tyres and the tyre pressures.
- It is the driver's responsibility to ensure that the tyre pressures are correct. For this reason you must check the tyre pressures regularly.
- Under certain conditions (e.g. driving at high speeds, on ice and snow or on poor road surfaces) the tyre pressure loss indicator may not appear immediately.
- Ask a qualified workshop whether run-flat tyres can be used on your vehicle. Unauthorised use of these tyres can invalidate the vehicle's type approval for use on public roads. Furthermore, this could cause damage to your vehicle and possibly also result in an accident.

### **Note**

- If a malfunction occurs in the ESC/ABS system, the tyre pressure loss indicator will also be out of action.
- When driving with snow chains, a system malfunction can occur.
- The tyre pressure loss indicator on your Audi is specially matched to tyres with the marking "AO" or "RO" ⇒ *page 225*. We recommend that you use these tyres.

### **Storing tyre pressure settings**

Applies to vehicles: with tyre pressure loss indicator

*When you change a tyre or the tyre pressure on your vehicle, you must confirm the change on the system.*

#### **Vehicles with sound system**

- ▶ Before storing the new tyre pressures, check that the current pressures on all four wheels correspond to the specified values and adapt the pressures to the current load ⇒ *page 224*.
- ▶ Select: **[SETUP]** button > control button  **Store tyre pressures** > **Store**.

#### **Vehicles with MMI\***

- ▶ Before storing the new tyre pressures, check that the current pressures on all four wheels correspond to the specified values and adapt the pressures to the current load ⇒ *page 224*.
- ▶ Select: control button **Systems** or > **Car systems** > **Servicing & checks** > **Tyre pressure monitoring** > **Store tyre pressures**.

### **Note**

Do not store the tyre pressures if you are driving with snow chains.

## Accessories and modifications to the vehicle

### Accessories, replacement parts and repairs

*Always ask your dealer or specialist retailer for advice before purchasing accessories and replacement parts.*

Your car is designed to offer a high standard of active and passive safety. For this reason, we recommend that you ask your Audi dealer for advice before fitting accessories or replacement parts. Audi dealers have the latest information from the manufacturer and can recommend accessories and replacement parts which are suitable for your requirements. They can also answer any questions you might have regarding official regulations.

We recommend you to use only **Audi accessories** and **Audi Genuine Parts**. Audi has tested these products for suitability, reliability and safety. Audi dealers have the necessary experience and facilities to ensure that the parts are installed properly.

Although the market is constantly scrutinised, Audi cannot judge or assume responsibility for the reliability, safety and suitability of non-genuine products - even though in some instances, these parts may have been approved by an officially recognised technical testing authority or accompanied by an official approval certificate.

Any **retro-fitted equipment** which has a direct effect on the vehicle and/or the way it is driven (e.g. cruise control system or electronically-controlled suspension) must be approved for use in your vehicle and bear the **e** mark (the European Union's approval symbol).

If any **additional electrical components** are fitted which do not serve to control the vehicle itself (for instance a refrigerator box, laptop or ventilator fan, etc.), these must bear

the **CE** mark (manufacturer conformity declaration in the European Union).

#### WARNING

Never attach accessories (such as cup holders or telephone brackets) to the surfaces covering the airbag units or the areas around the airbags: this could cause injury if the airbag is triggered.

### Modifications

*Modifications must always be carried out according to our specifications.*

Unauthorised modifications to the electronic components, software, wiring or data transfer in the vehicle may cause malfunctioning. Due to the way the electronic components are linked together in networks, other systems may be affected by the faults. This can seriously impair safety, lead to excessive wear of components, and also invalidate the type approval for your vehicle.

You will appreciate that your Audi dealer cannot be held liable for any damage caused by modifications and/or work performed incorrectly.

We recommend that all work should be performed by an Audi workshop using **Audi Genuine Parts**.

#### WARNING

Incorrectly performed modifications or other work on your vehicle can lead to malfunctions and cause accidents.

### Radio transmitters and business equipment

#### Transmitters

An external aerial is required in order to operate radio equipment inside the vehicle. The maximum range of the equipment can only be achieved with an external aerial.

Retrofit installations of radio transmitters in the vehicle are subject to official approval and ►

can affect the type approval for your vehicle. In extreme cases this could mean that you lose the type approval for your vehicle.

Qualified workshops will be able to inform you about options for installing and operating radio transmitters.

### Business equipment

Retrofit installation of business or other equipment in the vehicle is permitted, provided the equipment cannot interfere with the driver's immediate control of the vehicle. Any such equipment must carry the **CE** mark. Any retrofit equipment that could influence the driver's control of the vehicle must have a type approval for road vehicles and must carry the **e** mark.

#### WARNING

- Loose or incorrectly secured radio equipment could be catapulted through the vehicle during sudden driving/braking manoeuvres or in the event of an accident. This poses a risk of injury to occupants.
- Always ensure that radio equipment is properly secured outside the deployment area of the airbags or stowed safely while the vehicle is moving.
- Mobile telephones or radio equipment which are operated inside the vehicle without a correctly installed external aerial can create excessive magnetic fields that could cause a health hazard.

#### CAUTION

If you use radio equipment in the car without an external aerial, the electromagnetic radiation in the vehicle could exceed the recommended limits. This also applies to external aerials which have not been correctly installed.

- Do not operate radio equipment in the vehicle unless an external aerial is properly connected.

#### Note

Please observe the relevant regulations and follow the instructions in the operating manual for the radio equipment.

## Component protection

Some electronic control units and components, such as the sound system or navigation system, are equipped with component protection at the factory.

The purpose of the component protection is as follows:

- To prevent factory-fitted equipment from being re-installed and used freely in other vehicles (e.g. if they have been stolen)
- To prevent components from being used outside the vehicle
- To enable the legitimate installation and/or replacement of components and control units by a qualified service workshop

Possible text messages and remedy:

Device	Text message	Possible remedy
Instrument cluster display	SAFE CP	Contact a qualified workshop.
Sound system or navigation system display	Some functions of the infotainment system are currently unavailable. Please switch on ignition.	Switch on the ignition. If the component protection is still not deactivated, contact a qualified workshop.

## Self-help

### General notes

- ▶ If your vehicle experiences technical problems, stop the car well away from moving traffic. If you have a flat tyre, you should park the car on a level surface. Be particularly careful if you are on a slope.
- ▶ Apply the parking brake.
- ▶ Switch the hazard warning lights on.
- ▶ Put on your high-visibility vest ⇒ *page 235*.
- ▶ Place the warning triangle in a visible location ⇒ *page 235*.
- ▶ Instruct all passengers to leave the car when it is safe to do so. They should wait in a safe place (for instance behind the roadside crash barrier).

#### WARNING

You should note the procedure described above for your own safety and that of other road users.

## Equipment

### High-visibility vest

Applies to vehicles: with high-visibility vest



Fig. 231 Rear seats: Compartment for high-visibility vest

- ▶ To open the lid, turn the catch anti-clockwise.

Other road users can see you sooner when you are wearing the high-visibility vest.

#### Note

– Wear the high-visibility vest whenever you have to leave the vehicle near mov-

ing traffic, e.g. in breakdowns or when loading or unloading the vehicle.

- Always observe the relevant rules and regulations in the country you are travelling in.

### Warning triangle

Applies to vehicles: with warning triangle



Fig. 232 A3/A3 Sportback with boot lid open: warning triangle

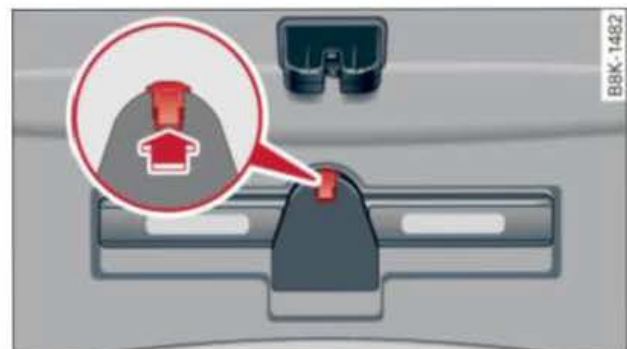

Fig. 233 A3 Saloon with boot lid open: warning triangle

The factory-supplied warning triangle is attached to the inside of the boot lid.

#### A3/A3 Sportback:

- ▶ To open the cover, turn the catch ① ⇒ *Fig. 232* and swivel the cover downwards ②.
- ▶ Pull the warning triangle out of the retainer.

#### A3 Saloon:

- ▶ To remove the warning triangle, push the tab in the direction indicated by the arrow ⇒ *Fig. 233* and pull the retainer down.

The retainer on the boot lid is specifically designed to hold the warning triangle supplied as an Audi Genuine Accessory.

### First-aid kit

Applies to vehicles: with first-aid kit



**Fig. 234** Right front seat: Stowing the first-aid kit (example)

- Pull the handle to open the compartment.

The storage compartment will hold a maximum weight of 1.0 kg.

On vehicles with factory-fitted fire extinguisher\*, the first-aid kit is stowed in the compartment in the door trim.

### Fire extinguisher

Applies to vehicles: with fire extinguisher

The factory-fitted fire extinguisher is located in the front area of the front passenger's seat (secured in a holder).

- Remove the fire extinguisher by pressing on the tab marked "PRESS".
- To secure the fire extinguisher, put it in the holder and fasten the securing belt.

Check how the fire extinguisher works before you need to use it. The instructions for use are shown on the fire extinguisher.

### WARNING

If the fire extinguisher is not secured properly it could be catapulted through the vehicle during driving and braking manoeuvres or in the event of an accident. This poses a risk of injury to occupants.

### Note

The fire extinguisher must comply with legal requirements. Observe the expiry date of the fire extinguisher.

### Tool kit/tyre repair kit/compressor

Applies to vehicles: with tool kit/tyre repair kit/compressor



**Fig. 235** Luggage compartment (example): Stowing the tools, tyre repair kit and jack\*



**Fig. 236** Luggage compartment: Floor panel folded up (A3 and A3 Sportback top, A3 Saloon bottom)

The tools, tyre repair kit\* and compressor\* are stowed in the luggage compartment. Some equipment is stowed behind the side trim (A\*) or (B) and some under the floor panel (C) ⇒ Fig. 235.

### Floor panel

- A3/A3 Sportback: Lift the floor panel up by the plastic handle (C) until it is fixed in position behind the retaining tabs on the two side sections ⇒ Fig. 236 (top illustration).
- A3 Saloon: Engage the plastic hooks on the luggage compartment seal ⇒ Fig. 236 (bottom illustration).

## Side panel

- ▶ Turn the catch to open and remove the cover  
A\* / B ⇒ Fig. 235.

## Tyre repair kit

### Preparations

Applies to vehicles: with tyre repair kit

- ▶ Please refer to the important safety notes on ⇒ page 235.
- ▶ Apply the parking brake.
- ▶ Manual gearbox: Engage first gear.
- ▶ Vehicles with automatic gearbox: Move the selector lever to position P.
- ▶ Check whether a repair is possible using the tyre repair kit ⇒ page 237.

### Using the tyre repair kit

Applies to vehicles: with tyre repair kit



Fig. 237 Tyres: Irreparable tyre damage

Repaired tyres are only suitable for temporary use. Replace the damaged tyre as quickly as possible ⇒ ⚠.

If the tyre was damaged by an object, such as a nail, do not remove it from the tyre.

The tyre repair kit can be used at outside temperatures down to  $-20^{\circ}\text{C}$ .

### The tyre repair kit must NOT be used:

- On cuts and punctures larger than 4 mm 1 ⇒ Fig. 237
- If the wheel rim has been damaged 2.
- if you have been driving with very low pressure or a completely flat tyre 3.

In these cases, you should seek professional assistance.

### ⚠ WARNING

- Please note that the tyre repair kit is not suitable for use in every situation and should only be used as a temporary measure.
- Do not allow the sealant to come into contact with your eyes, skin or clothing.
- If you do come into contact with the sealant immediately rinse the eyes or skin affected with clean water.
- Make sure you do not breathe in the fumes.
- If you accidentally swallow tyre sealant, immediately rinse your mouth thoroughly and drink a large amount of water. Do not induce vomiting. Immediately contact a doctor.
- Change clothing immediately if it becomes soiled with the tyre sealant.
- If any allergic reactions should occur get medical help immediately.
- Keep the sealant away from children.

### i Note

- If sealant should leak out, leave it to dry. When it has dried, you can pull it off like a piece of foil.
- Observe the expiry date stated on the sealing compound can. Have the sealing compound exchanged by a qualified workshop.
- Please observe the relevant regulations.

### Tyre repairs

Applies to vehicles: with tyre repair kit



Fig. 238 Tyres: Filling the tyre

Important: The tyre repair kit must be at hand and ready for use ⇨ *page 236*.

### Filling the tyre

- ▶ Shake the tyre sealant can well.
- ▶ Screw the enclosed filling hose onto the sealant can as far as it will go. This will automatically pierce the foil sealing the can.
- ▶ Take the valve cap off the tyre valve and use the enclosed valve insert tool to unscrew the valve insert ⇨ *Fig. 238*.
- ▶ Place the valve insert onto a clean surface.
- ▶ Remove the sealing plug from the filling hose and insert the hose into the tyre valve.
- ▶ Hold the tyre sealant can upside down and fill the complete contents into the tyre.
- ▶ Then disconnect the hose and screw the valve insert firmly back into the tyre valve.

### Inflating the tyre

- ▶ Screw the compressor filling hose (from the tyre repair kit) onto the tyre valve and plug the connector into an electrical socket in the vehicle.
- ▶ Pump the tyre up to 2.0 to 2.5 bar and monitor the pressure shown on the pressure gauge.
- ▶ If the tyre pressure remains lower than the value specified above, drive the vehicle approx. 10 metres forwards or backwards, so that the sealant can spread evenly in the tyre.

#### WARNING

- Please observe the manufacturers' safety notes on the compressor and the instructions supplied with the tyre sealant can.
- If it was not possible to build up a tyre pressure of 2.0 bar within six minutes this means that the tyre is too badly damaged. Do not drive on.
- Seek professional assistance if the repair of a tyre puncture is not possible with the sealing compound.

#### Note

Do not use the compressor for longer than 6 minutes at a time, as it could overheat.

When the compressor has cooled down, you can use it again.

### After repairing a tyre

Applies to vehicles: with tyre repair kit

- ▶ Affix the sticker "max. 80 km/h", which is enclosed with the tyre repair kit, to the dashboard where the driver will see it.
- ▶ After about 10 minutes, stop to check the tyre pressure.
- ▶ If tyre pressure is less than 1.3 bar, the tyre is too badly damaged. Do not drive on.

#### WARNING

After repairing a tyre please note the following points:

- Do not drive faster than 80 km/h.
- Avoid heavy acceleration, hard braking and fast cornering.
- Vehicle handling could be impaired.
- If the tyre is too badly damaged, you should seek professional assistance.

#### For the sake of the environment

A used can of sealing compound can be returned to your qualified workshop for disposal.

#### Note

After repairing a tyre, remember to buy a new tyre sealant can at a qualified workshop.

## Changing a wheel

### Preparations

*Certain preparations must be made before you change the wheel.*

- ▶ Please refer to the important safety notes on ⇨ *page 235*.
- ▶ Apply the parking brake.
- ▶ Manual gearbox: Engage first gear.
- ▶ Vehicles with automatic gearbox: Move the selector lever to position P.
- ▶ If you are towing a trailer, unhitch it from your vehicle.



- ▶ Take out the tools ⇒ *page 236* and spare wheel ⇒ *page 242*.

### WARNING

If you have to change the tyre on a gradient, block the wheel opposite the wheel being changed by placing a stone or similar object under it to prevent the vehicle from rolling away.

### Removing the hub cap/wheel bolt caps



Fig. 239 Wheel: Hub cap



Fig. 240 Wheel: Wheel bolts with caps

### Hub caps\*

- ▶ Insert the hook (provided in the vehicle's tool kit) in the hole in the hub cap ⇒ *Fig. 239*.
- ▶ Pull off the hub cap.

### Wheels with wheel bolt caps\*

- ▶ Slide the plastic clip (provided in the vehicle's tool kit) onto the wheel bolt cap until it engages ⇒ *Fig. 240*.
- ▶ Pull off the cap using the plastic clip.

### Anti-theft wheel bolts

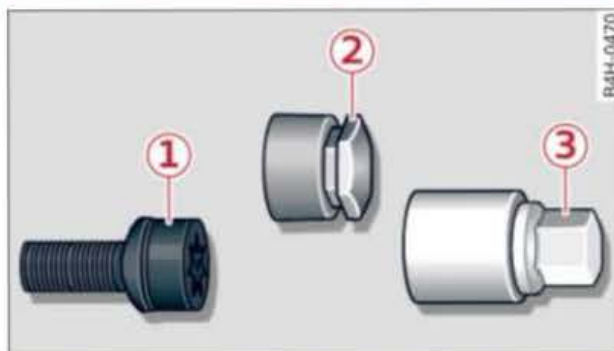

Fig. 241 Anti-theft wheel bolt with wheel bolt cap and adapter

To release the anti-theft wheel bolts, you need a special adapter (provided in the vehicle's tool kit).

- ▶ Pull off the hub cap\* or wheel bolt cap\* ② ⇒ *Fig. 241*.
- ▶ Slide the adapter ③ all the way onto the anti-theft wheel bolt ①.
- ▶ Fit the box spanner (provided in the vehicle's tool kit) as far as it will go over the adapter ③.
- ▶ Loosen the wheel bolt ⇒ *page 239*.

### Note

Note the code number of the anti-theft wheel bolt and keep it in a safe place – not in your vehicle. If you need a replacement adapter, give the code number to your Audi dealer.

### Loosening the wheel bolts



Fig. 242 Wheel: Loosening the wheel bolts

- ▶ Fit the box spanner (provided in the vehicle's tool kit) as far as it will go over the wheel bolt<sup>1)</sup>.
- ▶ Turn the wheel bolt approx. one turn anti-clockwise -arrow-. To apply the necessary torque, hold the box spanner near the end. If the wheel bolt is very tight, you may be able to loosen it by pushing down the end of the spanner carefully with your foot. Hold on to the car for support and take care not to slip.

### WARNING

To avoid accidents, the wheel bolts should only be loosened slightly (one turn) before raising the vehicle with the jack\*.

### Raising the vehicle

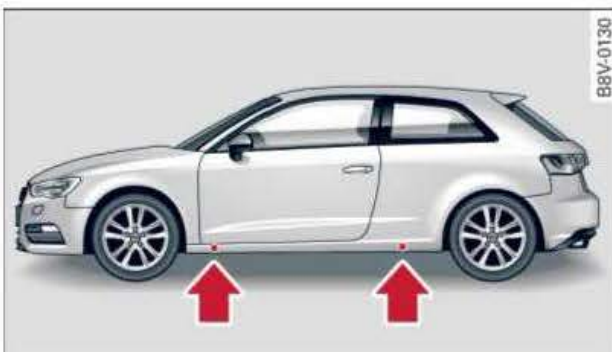

Fig. 243 Sills: markings (example)

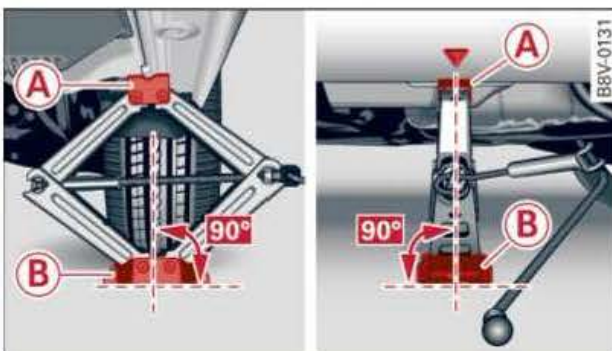



Fig. 244 Door sill: Applying the jack under the door sill

- ▶ Always provide a firm base for the jack\* on the ground. (The jack can be found in the vehicle's tool kit). If necessary use a large, strong board or similar support. On a hard, slippery surface (such as tiles) use a rubber

mat or similar to prevent the jack from slipping ⇒ .

- ▶ Locate the marking on the door sill closest to the wheel being changed ⇒ Fig. 243. The jacking point is located behind the marking under the door sill.
- ▶ Wind up the jack\* under the jacking point until the claw (A) ⇒ Fig. 244 of the jack is directly below the jacking point.
- ▶ Align the jack\* so that the claw (A) grips the jacking point under the door sill and the movable base plate of the jack (B) is flat on the ground. The base plate (B) must be positioned vertically underneath the jacking point (A).
- ▶ Raise the vehicle until the defective wheel is clear of the ground.

### WARNING

- Make sure the jack\* is stable. If the ground underneath the jack\* is slippery or soft, the jack can slip or sink in - risk of injury!
- Use only the jack\* supplied with your vehicle to raise the vehicle. If you use a jack from a different vehicle, your vehicle may slip off the jack - risk of injury!
- Apply the jack\* only at the jacking points located behind the markings on the door sill and align it properly. Otherwise there is a risk of injury since the jack\* can slip off suddenly if it is not properly engaged.
- The height of the parked vehicle can change as a result of variations in loading.
- Never start the engine when the vehicle is on the jack - risk of accident.
- If work has to be done under the vehicle, ensure that it is safely supported on stands designed for the purpose, otherwise there is a risk of injury.

<sup>1)</sup> An adapter is required to unscrew or tighten the anti-theft wheel bolts ⇒ page 239.

**! CAUTION**

The vehicle must not be lifted up on its sills. Only apply the jack\* at the jacking points located behind the markings on the door sill. Otherwise your vehicle could be damaged.

**Taking off / putting on the wheel**

Fig. 245 Wheel: Hexagonal socket for turning wheel bolts



Fig. 246 Wheel: Mounting pin in wheel bolt hole nearest to the top

**Taking off the wheel**

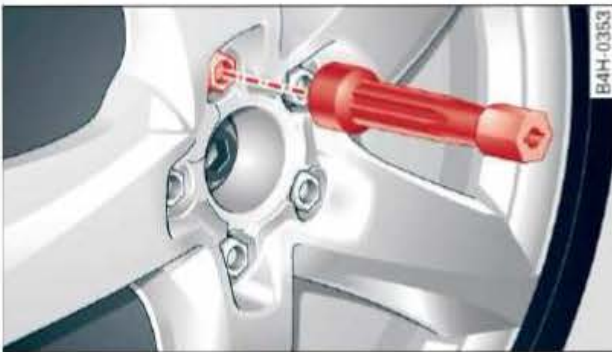
- ▶ Using the hexagonal socket in the screwdriver handle (provided in the vehicle's tool kit), unscrew the top wheel bolt and place it on a clean surface ⇒ Fig. 245.
- ▶ Screw in the mounting pin (provided in the vehicle's tool kit) by hand in place of the wheel bolt ⇒ Fig. 246.
- ▶ Then unscrew the other wheel bolts.
- ▶ Take off the wheel ⇒ !. The mounting pin stays where it is.

**Putting on the wheel**

When putting on a tyre with directional tread pattern, refer to ⇒ page 241.

- ▶ Put on the wheel, using the mounting pin to guide it into place ⇒ !.
- ▶ Screw in the wheel bolts and tighten them lightly using the hexagonal socket.
- ▶ Then unscrew the mounting pin and tighten the remaining wheel bolt lightly.
- ▶ Carefully lower the car with the jack\*.
- ▶ Tighten the wheel bolts in diagonal sequence with the box spanner.

The wheel bolts should be clean and turn easily. Before putting on the wheel, inspect the condition of the wheel and hub mounting surfaces. These surfaces must be clean before mounting the wheel.

**! WARNING**

Do not use the hexagonal socket in the screwdriver handle to tighten the wheel bolts. It is not possible to tighten the bolts to the required torque using the hexagonal socket - risk of accident!

**! CAUTION**

When removing/fitting the wheel the rim may hit and damage the brake disc. For this reason, please take care and get a second person to assist you.

**i Note**

The wheel bolts are easier to remove from the wheel rim if you use the hexagonal socket in the screwdriver handle. The reversible screwdriver blade should be removed as a precautionary measure when the tool is used for this purpose.

**Tyres with directional tread pattern**

A directional tread pattern can be identified by arrows on the sidewall that point in the direction of rotation. Always note the direction of rotation indicated when mounting the wheel. This is important so that these tyres can give maximum grip and avoid excessive noise, tread wear and aquaplaning.

If you ever have a puncture and need to fit the spare wheel\* in the wrong direction, please ▶

drive with extra care because the tyre will not give optimum performance in this situation. Bear this in mind particularly when driving on wet roads.

To benefit from the advantages of tyres with this type of tread pattern, the defective tyre should be replaced and refitted as soon as possible so that all tyres again rotate in the correct direction.

### After changing a wheel

- ▶ Fit the hub cap or wheel bolt caps back on, as required.
- ▶ Put the tools and jack back in the luggage compartment.
- ▶ If the replaced wheel will not fit into the spare wheel well, stow it safely in the luggage compartment ⇒ *page 162*.
- ▶ Check the tyre pressure of the fitted wheel as soon as possible.
- ▶ On vehicles with tyre pressure monitoring system, adjust the tyre pressure and store it via the sound system or MMI\* ⇒ *page 232*.
- ▶ The wheel bolts should be tightened to 120 Nm. Have this checked as soon as possible with a torque wrench. Until then, drive with caution.
- ▶ Have the flat tyre replaced as quickly as possible.

## Spare wheel

### General notes

Applies to vehicles: with compact temporary spare wheel



Fig. 247 Luggage compartment: Floor panel folded up (A3 and A3 Sportback top, A3 Saloon bottom)



Fig. 248 Compact temporary spare wheel (example)

The compact temporary spare wheel ⇒ *Fig. 248* is only intended for temporary use over short distances. Have the damaged wheel checked as soon as possible by a qualified workshop and, if necessary, replaced.

Please note the following restrictions when using the compact temporary spare wheel. The compact temporary spare wheel is designed specifically for this model. For this reason, do not use a spare wheel from a different type of vehicle. ▶

### Removing the compact temporary spare wheel (A3 and A3 Sportback)

- ▶ Lift the floor panel up by the plastic handle until it is fixed in position behind the retaining tabs on the two side sections ① ⇒ Fig. 247.
- ▶ Remove the bass box\* if necessary ⇒ page 243.
- ▶ Turn the plastic knob anti-clockwise.
- ▶ Take out the spare wheel.

### Removing the compact temporary spare wheel (A3 Saloon)

- ▶ Lift the floor panel by the plastic handle.
- ▶ Engage the plastic hooks on the luggage compartment seal ② ⇒ Fig. 247.
- ▶ Remove the bass box\* if necessary ⇒ page 243.
- ▶ Turn the plastic knob anti-clockwise.
- ▶ Take out the spare wheel.

### Snow chains

For technical reasons, snow chains must not be used on the compact temporary spare wheel.

Should you have a puncture on one of the front wheels when using snow chains, fit the compact temporary spare wheel in place of one of the rear wheels. You can then attach the snow chains to the wheel taken from the rear and use this wheel to replace the punctured front wheel.

#### WARNING

- The tyre pressure must be checked as soon as possible after fitting the spare wheel – an incorrectly inflated tyre can increase the risk of accident. You can find the tyre pressures here ⇒ page 224, Fig. 227.
- Do not drive faster than 80 km/h when the compact temporary spare wheel is fitted – higher speeds can cause an accident.
- Avoid heavy acceleration, hard braking and fast cornering when the compact

temporary spare wheel is fitted – risk of accident!

- Never use two or more compact spare tyres at the same time – risk of accident.
- No other type of tyre (normal summer or winter tyres) may be fitted on the compact temporary spare wheel.

### Removing the bass box

Applies to vehicles: with bass box.

You must remove the bass box before you can take out the spare wheel\*.

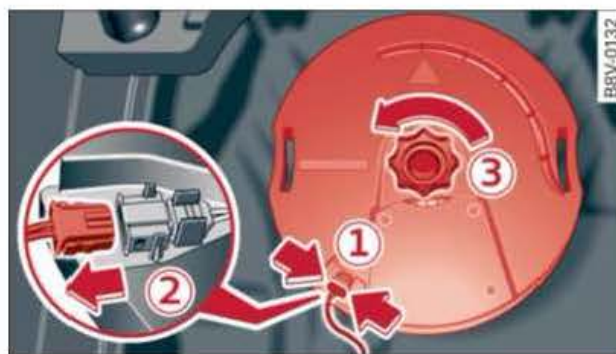

Fig. 249 Spare wheel well: Bass box

### Removing the bass box

- ▶ Lift the floor panel ⇒ page 242, Fig. 247.
- ▶ Compress the retaining tabs ① ⇒ Fig. 249 on the connector.
- ▶ Unplug the connector ② and move the disconnected cable clear to one side.
- ▶ Unscrew bolt ③.
- ▶ Carefully take out the bass box.

### Installing the bass box

- ▶ Carefully place the bass box in the well of the rim. Make sure that the inscription "FRONT" on the bass box points to the front of the vehicle.
- ▶ Plug the connector back in again.
- ▶ Secure the bass box with the screw.
- ▶ Fold the floor panel back down.

## Jump-starting

### General information on jump-starting

*Jump leads: Observe information provided by the manufacturer.*

If the battery is discharged the battery of a second vehicle can be used to jump-start the vehicle. Suitable jump leads are required. Both batteries must have the same voltage (V) and a similar capacity (Ah).

### Jump leads

Only use jump leads with insulated battery clamps. On vehicles with a petrol engine we recommend that the leads should have a cable core of at least 25 mm<sup>2</sup>, on vehicles with a diesel engine the cable core should be at least 35 mm<sup>2</sup>. In most cases the **positive cable** is red and the **negative cable** is black.



### WARNING

- When it is discharged the battery can freeze at temperatures around 0°C. Never try to jump-start a car if the battery has frozen - risk of explosion and acid burns. A battery must be replaced once it has frozen.
- The engine compartment is a dangerous area and working here can lead to serious injuries. Before carrying out any work in the engine compartment please read and observe the warnings ⇒ *page 212*.
- Incorrect handling of the jump leads may result in the battery exploding (risk of serious injury). Please observe the following rules to minimise the risk of injury:
  - The non-insulated parts of the battery clamps must not be allowed to touch. The jump lead attached to the positive battery terminal must not touch metal parts of the vehicle: this can cause short circuiting.
  - Position the jump leads in such a way that they cannot come into contact with any moving parts in the engine compartment.

- Do not bend over the batteries - risk of acid burns.
- The screw plugs on the battery cells must be screwed in firmly.
- Keep sparks, flame and lighted cigarettes away from batteries: the gases given off can cause an explosion.
- Do not attach the negative cable to parts of the fuel system or to the brake pipes.



### CAUTION

- The vehicles must not touch each other, otherwise electricity could flow as soon as the positive terminals are connected and the boosting battery could be discharged.
- If the jump leads are not connected correctly this can result in serious damage to the electrical system of the vehicle.
- The discharged battery must be properly connected to the vehicle's electrical system.
- Please note that the method described below for connecting the leads is intended for jump-starting your vehicle. If jump-starting another vehicle, you should not connect the negative lead (-) to the negative terminal of the discharged battery, but directly to the engine block or a solid metal part bolted to the engine block. If the battery of the other vehicle does not have a gas vent, there is a risk that a mixture of oxygen and hydrogen gas can accumulate and cause an explosion.



### Note

Switch off the car telephone if necessary. Details will be given in the manufacturer's instructions for the car telephone.

## Starting the engine

The two jump leads must be connected in the correct sequence.

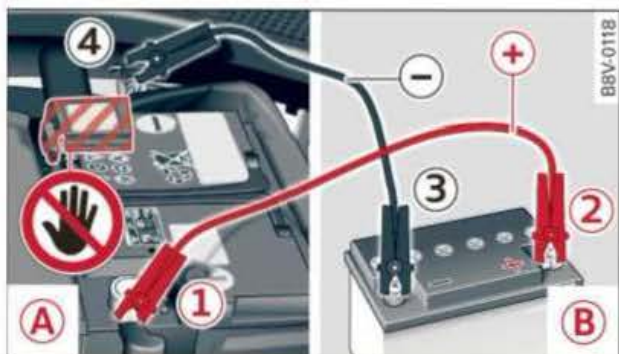

Fig. 250 Jump-starting with the battery of another vehicle: (A) – Discharged battery, (B) – Boosting battery

The battery is located at the front left of the engine compartment. Open the cover to access the positive terminal of the battery. **Never jump-start a battery which has frozen, even after it has thawed** ⇒ ⚠ in *General information on jump-starting on page 244!* **If a battery has frozen it must be replaced.** Please note that the described method of connecting the leads is meant for jump-starting your vehicle.

### Preparations

1. Please read ⇒ *page 244, General information on jump-starting* carefully before proceeding.
2. Apply the parking brake and move the gear lever to neutral (manual gearbox) or move the selector lever to P (automatic gearbox).
3. Switch off all electrical equipment and the ignition on both vehicles.

### Connecting and disconnecting the jump leads

4. Connect one end of the red jump lead to the positive terminal (1) ⇒ *Fig. 250* of the discharged battery (A) ⇒ ⚠ in *General information on jump-starting on page 244*.
5. Connect the other end of the red jump lead to the positive terminal (2) of the boosting battery (B).
6. Connect one end of the black lead **preferably to the earth point** or alternatively

to the negative battery terminal (3) on the vehicle providing assistance (B).

7. Connect the other end of the black jump lead **only** to the **earth point** (4) of the jump-start connection on **your vehicle** (A) ⇒ ⚠.
8. Position the jump leads in such a way that they cannot come into contact with any moving parts in the engine compartment.

### Starting the engine

9. Start the engine of the vehicle with the boosting battery and let it run at idling speed.
10. Start the engine of the car with the discharged battery and wait two or three minutes until the engine is running smoothly.
11. If the engine fails to start: do not operate the starter for longer than 10 seconds. Wait for about 30 seconds and try again.
12. Switch on the blower and the rear window heating on the vehicle which has been jump-started in order to offset excessive voltage which may occur when disconnecting the leads. The headlights must be switched off!
13. Disconnect the leads in exactly the *opposite* sequence to that described in ⇒ *page 245, Connecting and disconnecting the jump leads* with the engines running. Make sure that the leads cannot come into contact with any moving parts in the engine compartment.
14. Switch off the blower and the rear window heating again.

Please refer to ⇒ ⚠ in *General information on jump-starting on page 244*.

### ⚠ CAUTION

Do not use the negative battery terminal when jump-starting (this could cause a malfunction in the on-board electrical system).

**i Note**

- Connect the battery clamps so they have good metal-to-metal contact with the battery terminals.
- The battery is vented to the outside to prevent gases entering the vehicle's interior.

## Tow-starting / towing away

### General notes

Some experience is required to tow or tow-start a vehicle, especially when using a tow-rope. Both drivers should be familiar with the technique required for towing. Inexperienced drivers should not attempt to tow-start or tow away another vehicle.

Do not pull too hard with the towing vehicle and take care to avoid jerking the tow-rope. When towing off-road, there is always a risk that the anchorage points may be overloaded.

### Tow-bar / tow-rope

It is easier and safer to tow the vehicle with a tow-bar. You should only use a tow-rope if you do not have a tow-bar. It is advisable to use a tow-rope made of elastic synthetic fibre or similarly elastic material.

### Notes on towing vehicles

The vehicle can be towed with a tow-bar or tow-rope. When the engine is not running, the gearbox will not be adequately lubricated if the following speed/distance restrictions are not observed:

- The vehicle must not be towed faster than **50 km/h**.
- The vehicle must not be towed further than **50 km**.

### Additional notes on towing by breakdown truck

If one of the axles has to be raised in order to tow the vehicle, please refer to the following

table to determine the appropriate axle for your gearbox/drive combination:

	Front-wheel drive	Four-wheel drive
Manual gearbox	Front or rear axle	Front or rear axle
Automatic gearbox	Front axle	Front axle

**Four-wheel drive:** If the vehicle is to be towed with one of the axles raised, the ignition must be switched off; otherwise the drive train can be damaged.

### Notes on tow-starting

**Automatic gearbox:** For technical reasons, your vehicle must not be tow-started.

**Manual gearbox:** As a general rule, tow-starting is not recommended. If the engine will not start, it is best to try starting it using the battery of another vehicle ⇒ *page 244* before attempting to tow start. If this is not possible, you can try to push-start or tow-start the vehicle ⇒ *page 247, Tow-starting*.

**⚠ WARNING**

There is a high risk of accidents when towing/tow-starting, as the towed vehicle can easily be driven into the towing vehicle.

**! CAUTION**

- If it is not possible to tow the vehicle as described above (e.g. due to a gearbox failure or if the vehicle has to be towed further than 50 km), it must be transported on a special car transporter or trailer.
- Towing a vehicle with the wrong axle raised can cause serious damage to the gearbox.

**i Note**

- Automatic gearbox: It is not possible to move the selector lever out of position P if the electrical power supply fails. Before the vehicle can be recovered/manoeuvred you must manually release the selector lever; left-hand drive vehicles



⇒ page 114, right-hand drive vehicles

⇒ page 115.

- Please observe the relevant regulations when towing or tow-starting.

## Towing away

Please observe the important safety warnings on ⇒ page 246.

### Preparations

- ▶ Attach the tow-rope or the tow-bar only to the towing anchorages provided for this purpose ⇒ page 248, ⇒ page 248.
- ▶ Please ensure that the tow-rope is not twisted as it could otherwise become unscrewed from the towline anchorage while the vehicle is being towed.
- ▶ The hazard warning lights of both vehicles must normally be switched on ⇒ page 59. However, observe any regulations to the contrary.

### Towing vehicle (front)

- ▶ Ensure that the tow-rope is taut before you drive off.
- ▶ Engage the clutch very gently when starting to move (manual gearbox) and press the accelerator slowly.
- ▶ Avoid unnecessary braking and manoeuvres.

### Vehicle being towed (rear)

- ▶ Ensure that the ignition is switched on, the steering wheel is not locked, and that you can operate the turn signals, horn or windscreen wipers if necessary ⇒ .
- ▶ The brake servo only works when the engine is running. The power steering only works when the ignition is on and the vehicle is moving<sup>1)</sup>. Otherwise you will need to press the brake pedal significantly harder and apply more force to move the steering wheel.
- ▶ Please ensure that the steering wheel is unlocked and that it moves freely.
- ▶ Release the parking brake ⇒ page 92.

- ▶ Manual gearbox: Put the gear lever in neutral.
- ▶ Automatic gearbox: Move the selector lever to position N.
- ▶ Ensure that the tow-rope remains taut at all times when towing.

### WARNING

If the vehicle has no electrical power, do NOT use a tow-bar or tow-rope to tow the vehicle

### Note

You can use the turn signals to indicate a change of direction (or lane) even when the hazard lights are on. The hazard lights will be interrupted temporarily.

## Tow-starting

Please observe the important safety warnings on ⇒ page 246.

Important: Your vehicle must be fitted with a manual gearbox. If your vehicle has a petrol engine, it must not be towed further than 50 metres ⇒ .

- ▶ Attach the tow-rope or the tow-bar only to the towing anchorages provided for this purpose ⇒ page 248, ⇒ page 248.
- ▶ Engage second or third gear before moving off.
- ▶ Press the clutch and hold the pedal down.
- ▶ Switch on the ignition.
- ▶ Once both vehicles are moving, release the clutch.
- ▶ As soon as the engine starts, press the clutch pedal and put the gear lever in neutral.

### CAUTION

When tow-starting the vehicle, do not tow it further than 50 metres; otherwise the catalytic converter could be damaged.

<sup>1)</sup> Important: The battery must be adequately charged.

### Front towline anchorage



Fig. 251 Front bumper (right side): Removing cover



Fig. 252 Front bumper (right side): Towline anchorage screwed in

The screw connection for the towline anchorage is located behind a cover cap on the right side of the front bumper.

- ▶ Take the towline anchorage out of the vehicle's tool kit ⇒ *page 236*.
- ▶ To detach the cover cap from the bumper press the *top left* part of the cap inwards ⇒ *Fig. 251*.
- ▶ Screw the towline anchorage into the screw connection as far as it will go ⇒ *Fig. 252* and tighten it with the box spanner.
- ▶ Put the towline anchorage back in the tool kit after use.

#### WARNING

If the towline anchorage is not screwed in as far as the stop, there is a risk of the screw connection shearing off during towing - risk of accident!

### Rear towline anchorage



Fig. 253 Right side of the rear bumper: Cover cap



Fig. 254 Right side of the rear bumper: Towline anchorage screwed in

### Vehicles with towline anchorage

On vehicles which do not have a factory-fitted towing bracket\*, a screw connection is located behind a cover cap on the right side of the rear bumper.

- ▶ Take the towline anchorage out of the vehicle tool kit ⇒ *page 236*.
- ▶ To remove the cover cap from the bumper, press it in at the *top* -arrow- and pull it out at the *bottom* ⇒ *Fig. 253*.
- ▶ Screw the towline anchorage into the screw connection as far as it will go ⇒ *Fig. 254* and tighten it with the box spanner.
- ▶ Put the towline anchorage back in the tool kit after use.

### Vehicles with towing bracket\*

The removable ball joint must be attached before you can use the towing bracket ⇒ *page 198*.

- ▶ Insert the ball joint ⇒ *page 198*.
- ▶ Attach the tow-bar or the tow-rope to the ball joint.

On some models, the shape of the cap can vary.

Vehicles which have a factory-fitted towing bracket\* do **not** have a screw connection at the rear for the towline anchorage.

 **WARNING**

If the towline anchorage is not screwed in as far as the stop, there is a risk of the screw connection shearing off during towing - risk of accident!

 **CAUTION**

To avoid damaging the towing bracket\*, only use tow-bars with suitable attachments. If a tow-bar is not available, a tow-rope may be used.

## Fuses and bulbs

### Fuses

#### Fuses in vehicle interior



Fig. 255 Area near steering column on LHD vehicle: Cover

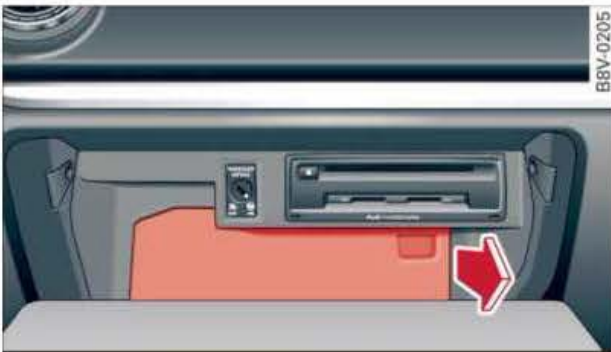

Fig. 256 Open glove box on RHD vehicle: Cover

Access to the fuses is different on left-hand and right-hand drive vehicles.

- LHD vehicles: The fuses are located behind a cover near the steering column ⇒ Fig. 255.
- RHD vehicles: The fuses are located behind a cover in the glove box ⇒ Fig. 256.

#### Changing fuses

To see whether a fuse has blown, check whether the metal strip has melted.

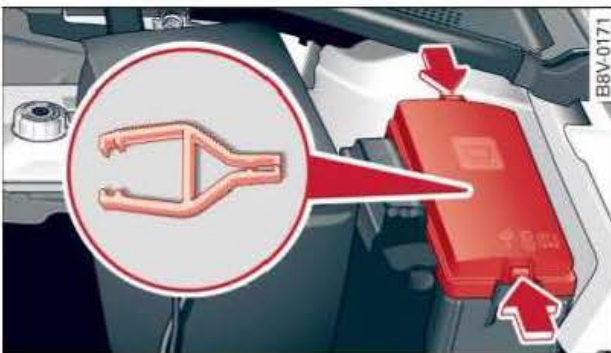

Fig. 257 Engine compartment, left-hand side: Fuse cover

#### Fuses in vehicle interior

- ▶ Switch off the ignition and the failed component.
- ▶ Refer to the following tables to identify the fuse for the failed component ⇒ page 251.
- ▶ Remove the cover: LHD vehicles ⇒ page 250, Fig. 255 or RHD vehicles ⇒ page 250, Fig. 256.
- ▶ Take the plastic clip from inside the fuse cover in the engine compartment ⇒ Fig. 257.
- ▶ Use the plastic clip to pull out the blown fuse and replace it with a fuse of the same rating.
- ▶ Replace the cover.

#### Fuses in engine compartment

- ▶ Switch off the ignition and the failed component.
- ▶ Refer to the following tables to identify the fuse for the failed component ⇒ page 252.
- ▶ Release the fuse cover ⇒ Fig. 257.
- ▶ Take the plastic clip from inside the fuse cover ⇒ Fig. 257.
- ▶ Use the plastic clip to pull out the blown fuse and replace it with a fuse of the same rating.

The various electrical circuits are protected by fuses. The fuses are located behind a cover below the steering wheel and on the left side of the engine compartment.

#### ⚠ WARNING

Never attempt to repair a fuse or replace a blown fuse by fitting a fuse with a higher ampere rating. This could damage the electrical system - risk of fire!

#### ⚠ CAUTION

- If more than one fuse rating is listed in a row in the following tables e.g. 5/10/20, this is due to differences in the equipment of your vehicle. Blown fuses should always be replaced with a fuse of the same rating.
- If a newly replaced fuse blows again after a short time, the electrical system

must be checked by a qualified workshop as soon as possible.

**Note**

- Unassigned fuse locations are not shown in the tables below.
- Some of the items of equipment listed in the tables below are only fitted on certain models or are optional extras.

**Fuses in vehicle interior**

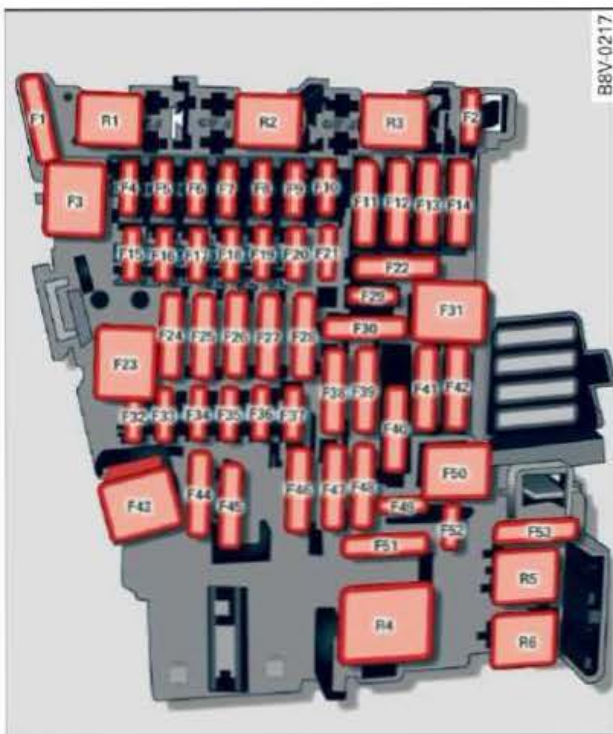

Fig. 258 Interior: Fuse layout

No.	Electrical equipment	amps
F2	Seat adjuster	10
F3	Hydraulic pump for soft top (Cabriolet)	40
F4	MMI control console, MMI components	7.5
F5	Gateway	5
F6	Anti-theft alarm system	5
F7	Air conditioner/heater console, selector lever (automatic gearbox), auxiliary heating, relay coil for rear window heating	10

No.	Electrical equipment	amps
F8	Diagnostics, switch for electronic parking brake, light switch, rain/light sensor, interior lighting	10
F9	Steering column switch module	1
F10	Display	5
F11	Reversible belt tensioners (driver's side)	25
F12	MMI system	15/20
F13	Control unit for suspension control	20
F14	Air conditioner blower	30
F15	Electric steering column lock	10
F16	MMI system	7.5
F17	Instrument cluster	5
F18	Reversing camera	7.5
F19	Control unit for convenience key system	7.5
F23	Exterior lighting (right side)	40
F24	Panorama roof/control unit for soft top, soft top lock (Cabriolet)	20/30
F25	Door/s, driver's side (e.g. electric windows)	30
F26	Seat heating	30
F27	Sound amplifier	30
F28	Control unit for soft top, electronics (Cabriolet)	5
F29	Interior lights	7.5
F31	Exterior lighting (left side)	40
F32	Driver assistance systems	7.5
F33	Airbag	5
F34	LEDs for buttons/switches, coil for neck heating relay (Cabriolet) and electrical socket relay, interior sound, reversing light switch, temperature sensor, oil level sensor	7.5

No.	Electrical equipment	amps
F35	Diagnostics, headlight range control, air quality sensor, automatic anti-dazzle mirrors	10
F36	Cornering light (right side) / LED headlight (right side)	15
F37	Cornering light (left side) / LED headlight (left side)	15
F39	Door/s, passenger's side (e.g. electric windows)	30
F40	Cigarette lighter, electrical sockets	20
F41	Reversible belt tensioners (front passenger's side)	25
F42	Central locking system	40
F43	Windscreen washer system	30
F44	Four-wheel drive	15
F45	Electrically adjustable seat (driver's side)	15
F47	Rear window wiper	15
F49	Starter, clutch sensor	5
F53	Rear window heating	30

The seats with electric adjustment\* are protected by **circuit breakers**. These reset automatically after a few seconds when the overload has been corrected.

**i Note**

Please note that the above list, while correct at the time of printing, is subject to alterations.

**Fuses on left side of engine compartment**



Fig. 259 Engine compartment: Fuse layout

No.	Electrical equipment	amps
F1	ESC control unit	40
F2	ESC control unit	40
F3	Engine control unit (petrol/diesel)	15/30
F4	Engine cooling, engine components, supplementary heater relay coils (1+2), secondary air pump relay	5/10
F5	Engine components, tank system	7.5/10
F6	Brake light sensor	5
F7	Engine components, coolant pumps	7.5/10/ 15
F8	Lambda probe	10/15
F9	Engine components, exhaust flap, control unit for automatic glow period	5/10/20
F10	Fuel injectors, fuel control unit	15/20
F11	Supplementary heater, heating rod 2	40
F12	Supplementary heater, heating rod 3	40

No.	Electrical equipment	amps
F13	Automatic gearbox control unit	15/30
F15	Horn	15
F16	Ignition coil/CNG shut-off valve (natural gas engine)	20/7.5
F17	ESC control unit, engine control unit	7.5
F18	Terminal 30 (reference voltage)	5
F19	Windscreen wipers	30
F20	Horn	10
F22	Terminal 50, diagnostics	5
F23	Starter	30
F24	Supplementary heater, heating rod 1	40
F31	Vacuum pump	15
F32	LED headlights	5
F37	Auxiliary heating	20

### Note

Please note that the above list, while correct at the time of printing, is subject to alterations.

## Bulbs

### General notes

*Changing bulbs requires a certain degree of practical skill.*

LED\* and xenon\* lights are maintenance-free and cannot be changed. For repairs, please contact a qualified workshop.

If you decide to change bulbs in the engine compartment yourself, be aware of the safety risks involved ⇒  *in Working on components in the engine compartment on page 212.*

You must only replace a bulb with a bulb of the same type. Information regarding e.g. the wattage can be found on the base of the bulb.

Different types of headlight/rear light system are available:

– Halogen system

- Xenon system
- LED system

### WARNING

- Take particular care when working on components in the engine compartment if the engine is warm - risk of burns!
- Bulbs are sensitive to pressure. The glass can break when you touch the bulb, causing injury.
- Do not change xenon\* gas-discharge bulbs yourself. Incorrect handling of the high-voltage element of xenon gas-discharge bulbs can have potentially fatal consequences.
- When changing bulbs, please take care not to injure yourself on sharp edges, in particular on the headlight housing.

### CAUTION

- Always switch off the ignition before carrying out any work on the electrical system - danger of short circuiting!
- Switch off the lights or parking lights before you change a bulb.
- Take good care to avoid damaging any components.

### For the sake of the environment

A qualified workshop can advise you how to dispose of used bulbs in the proper manner.

### Note

- Please check at regular intervals that all lighting (especially the exterior lighting) on your vehicle is functioning properly. This is not only in the interest of your own safety, but also in that of all other road users.
- Before changing a bulb, make sure you have the correct new bulb.
- Do not touch the glass part of the bulb with your bare hands; use a cloth or paper towel instead. Otherwise, the fingerprints left on the glass will vaporise as a result of the heat generated by the bulb, ▶

be deposited on the reflector and impair its surface.

### Bulbs at front of vehicle

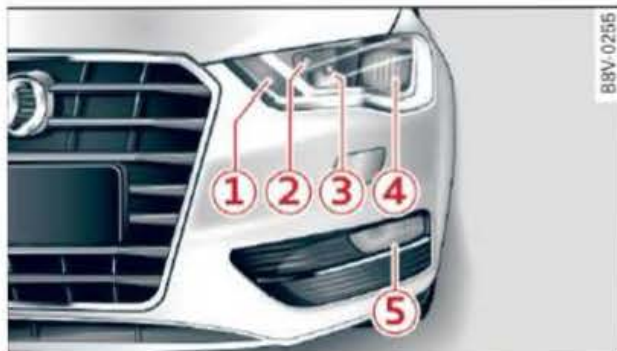

Fig. 260 Halogen headlights: Overview of left side of vehicle

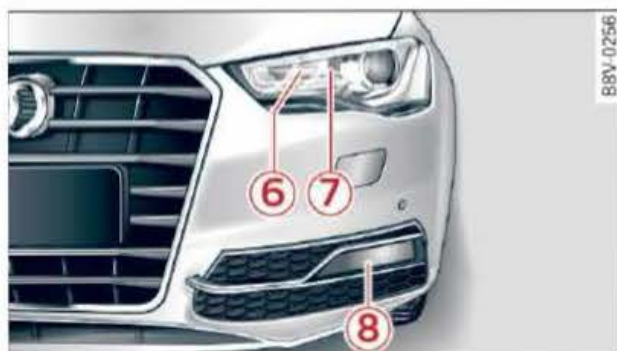

Fig. 261 Xenon headlights: Overview of left side of vehicle

You must only replace a bulb with a bulb of the same type. Information regarding e.g. the wattage can be found on the base of the bulb.

The description for changing the bulb refers to the left headlight; the procedure for the right headlight is similar.

### Halogen headlights

The following bulbs can be changed on vehicles with halogen headlights ⇒ Fig. 260:

Bulb (12 V)	Version
① Turn signal	PWY 24 W
② Side light	W 5 W
③ Main beam headlight/ daytime running light	55/15 W (H15 LL)
④ Dipped-beam headlight (LongLife)	55 W (H7 LL)
⑤ Front fog light <sup>a)</sup>	35 W (H8)

<sup>a)</sup> The front fog lights on some models will differ in appearance from those shown.

### Xenon headlights\*

On vehicles with xenon headlights ⇒ Fig. 261, you can change the following bulbs yourself:

Bulb (12 V)	Version
⑥ Turn signal	PWY 24 W
⑦ Turning light*	35 W (H8)
⑧ Front fog light <sup>a)</sup>	35 W (H8)

<sup>a)</sup> The front fog lights on some models will differ in appearance from those shown.

### LED headlights\*

The bulbs cannot be changed on vehicles with LED headlights.

### A3: Bulbs at rear of vehicle



Fig. 262 Halogen system, rear light: Bulbs in side panel and boot lid



Fig. 263 Xenon/LED system, rear light: Bulbs in side panel and boot lid

You must only replace a bulb with a bulb of the same type. Information regarding e.g. the wattage can be found on the base of the bulb.

The description for changing the bulb refers to the left rear light unit; the procedure for the right rear light unit is similar.



### Halogen system, rear lights

The following bulbs can be changed on vehicles with halogen rear lights ⇒ Fig. 262:

Bulb (12 V)	Version
① Brake light/tail light (side panel)	W 21 W
② Turn signal (rear) (side panel)	PY21 W
③ Reversing light (boot lid)	H 6 W
④ Tail light (boot lid)	W 16 W
⑤ Tail light/rear fog light (boot lid)	W 21 W

### Xenon/LED system, rear lights\*

The following bulbs can be changed on vehicles with xenon and LED rear lights ⇒ Fig. 263:

Bulb (12 V)	Version
⑥ Reversing light (side panel)	H 6 W
⑦ Rear fog light (side panel)	H 21 W

The remaining bulbs are LEDs and are therefore maintenance-free.

### A3 Sportback: Bulbs at rear of vehicle



Fig. 264 Halogen system, rear light: Bulbs in side panel and boot lid



Fig. 265 Xenon/LED system, rear light: Bulbs in side panel and boot lid

You must only replace a bulb with a bulb of the same type. Information regarding e.g. the wattage can be found on the base of the bulb.

The description for changing the bulb refers to the left rear light unit; the procedure for the right rear light unit is similar.

### Halogen system, rear lights

The following bulbs can be changed on vehicles with halogen rear lights ⇒ Fig. 264:

Bulb (12 V)	Version
① Brake light/tail light (side panel)	W 21 W
② Turn signal (rear) (side panel)	RY 10 W
③ Tail light (boot lid)	W 16 W
④ Reversing light (boot lid)	H 6 W
⑤ Tail light/rear fog light (boot lid)	W 21 W

### Xenon/LED system, rear lights\*

The following bulbs can be changed on vehicles with xenon and LED rear lights ⇒ Fig. 265:

Bulb (12 V)	Version
⑥ Reversing light (side panel)	H 6 W
⑦ Rear fog light (side panel)	H 21 W

The remaining bulbs are LEDs and are therefore maintenance-free.

### A3 Saloon: Bulbs at rear of vehicle

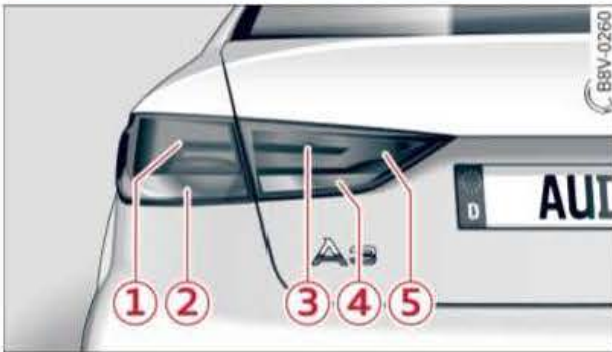

Fig. 266 Halogen system, rear light: Bulbs in side panel and boot lid



Fig. 267 Xenon/LED system, rear light: Bulbs in side panel and boot lid

You must only replace a bulb with a bulb of the same type. Information regarding e.g. the wattage can be found on the base of the bulb.

The description for changing the bulb refers to the left rear light unit; the procedure for the right rear light unit is similar.

### Halogen rear lights

The following bulbs can be changed on vehicles with halogen rear lights ⇒ Fig. 266:

Bulb (12 V)	Version
① Brake light/tail light (side panel)	W 21 W
② Turn signal (rear) (side panel)	RY 10 W
③ Tail light (boot lid)	W 16 W
④ Reversing light (boot lid)	H 6 W
⑤ Tail light/rear fog light (boot lid)	W 21 W

### Xenon/LED rear lights\*

The following bulbs can be changed on vehicles with xenon and LED rear lights ⇒ Fig. 267:

Bulb (12 V)	Version
⑥ Reversing light (side panel)	H 6 W
⑦ Rear fog light (side panel)	H 21 W

The remaining bulbs are LEDs and are therefore maintenance-free.

## Changing bulbs in headlight unit

### Removing bulbs for dipped headlights

Applies to vehicles: with halogen headlights

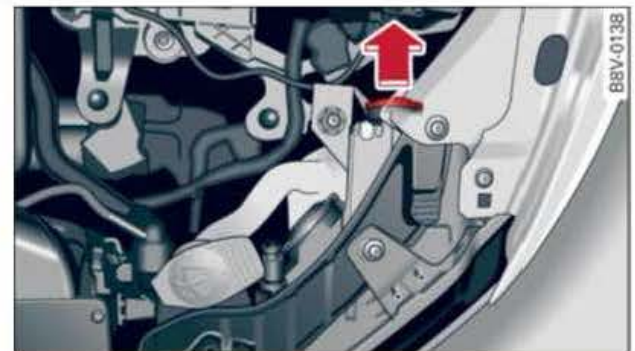

Fig. 268 Engine compartment: Removing cover (dipped headlights)

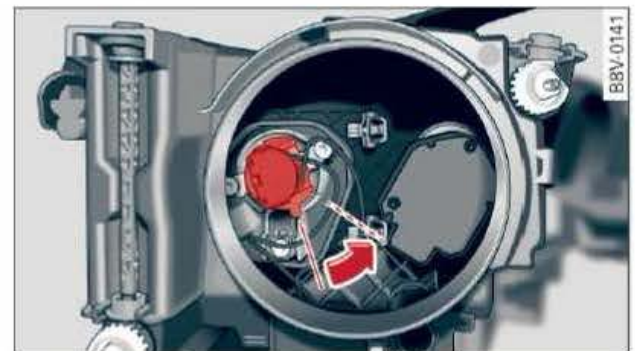

Fig. 269 Bulb housing: Bulb holder for dipped headlights

For illustration purposes, ⇒ Fig. 268 shows the inside of the unit with the headlight removed.

- ▶ Switch off the lights and the ignition.
- ▶ Please refer to ⇒ ⚠ in General notes on page 253.
- ▶ Open the bonnet.

- ▶ Pull off the cover in the direction of the arrow ⇒ Fig. 268.
- ▶ Turn the connector anti-clockwise ⇒ Fig. 269.
- ▶ Disconnect the connector from the base of the bulb.
- ▶ Replace the bulb ⇒ page 257, *Changing halogen bulbs*.

### Changing halogen bulbs

Applies to vehicles: with halogen headlights

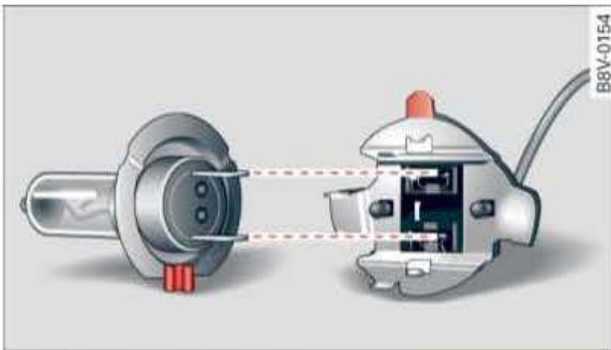

Fig. 270 Inserting the bulb correctly

The new bulb can only be fitted correctly in one position. Please note that the lug on the bulb should be facing the opposite direction to the lug on the bulb connector.

### Installing bulb for dipped beam headlight

Applies to vehicles: with halogen headlights

When changing the bulb, you can check the position of the bulb through the headlight glass.

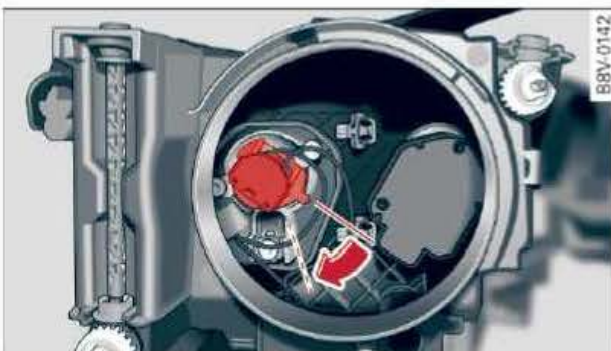



Fig. 271 Bulb housing: Fitting the bulb

- ▶ If necessary, use a cloth to remove any fingerprints from the glass part of the bulb.

- ▶ Insert the bulb with the lug on the connector between 4 and 5 o'clock ⇒ Fig. 271 ⇒  in General notes on page 253.
- ▶ Look through the headlight glass to check that the bulb is in the correct position.
- ▶ Turn the connector as far as the stop.
- ▶ Replace the cover.
- ▶ Check whether the new bulb is working.
- ▶ Have the headlight settings checked as soon as possible.

### CAUTION

Make sure that the cover is correctly seated to ensure that water cannot enter the headlight housing and to prevent the headlight from malfunctioning.

### Changing bulb for main beam headlights/daytime running lights

Applies to vehicles: with halogen headlights

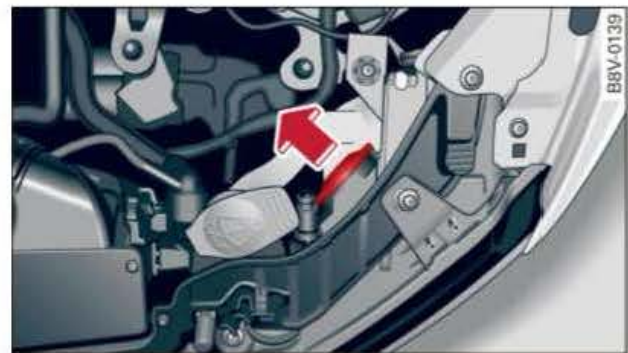



Fig. 272 Engine compartment: Removing cover (main beam headlights/daytime running lights)



Fig. 273 Bulb holder for main beam headlights/daytime running lights

For illustration purposes, ⇒ Fig. 273 shows the inside of the unit with the headlight removed.

- ▶ Switch off the lights and the ignition. ▶

- ▶ Please refer to ⇒  in *General notes on page 253*.
- ▶ Open the bonnet.
- ▶ Pull off the cover ⇒ *Fig. 272*.
- ▶ Turn the connector as far as the stop in the direction of the arrow ⇒ *Fig. 273* and remove the light unit from the headlight housing.
- ▶ Replace the bulb (together with the holder).

### Installing bulb for main beam headlights/daytime running lights

Applies to vehicles: with halogen headlights

When changing the bulb, you can check the position of the bulb through the headlight glass.



Fig. 274 Bulb housing: Fitting the bulb

- ▶ If necessary, use a cloth to remove any fingerprints from the glass part of the bulb.
- ▶ Insert the bulb ⇒ *Fig. 274* ⇒  in *General notes on page 253*.
- ▶ Look through the headlight glass to check that the bulb is in the correct position.
- ▶ Carefully turn the bulb holder clockwise until the contacts engage.
- ▶ Replace the cover.
- ▶ Check whether the new bulb is working.
- ▶ Have the headlight settings checked as soon as possible.

### CAUTION

Make sure that the cover is correctly seated to ensure that water cannot enter the headlight housing and to prevent the headlight from malfunctioning.

### Removing bulb for side lights

Applies to vehicles: with halogen headlights

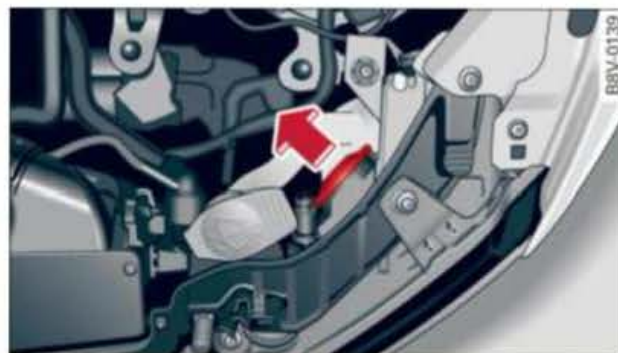



Fig. 275 Engine compartment: Removing cover (side lights)



Fig. 276 Bulb holder for side lights

For illustration purposes, ⇒ *Fig. 276* shows the inside of the unit with the headlight removed.

- ▶ Switch off the lights and the ignition.
- ▶ Please refer to ⇒  in *General notes on page 253*.
- ▶ Open the bonnet.
- ▶ Pull off the cover in the direction of the arrow ⇒ *Fig. 275*.
- ▶ Pull the bulb connector out in the direction of the arrow ⇒ *Fig. 276*.
- ▶ Pull the defective bulb out of the connector and replace the bulb.

### Installing bulb for side lights

Applies to vehicles: with halogen headlights



Fig. 277 Bulb housing: Inserting the bulb holder

- ▶ If necessary, use a cloth to remove any fingerprints from the glass part of the bulb.
- ▶ Refit the bulb in the headlight housing ⇒ Fig. 277 ⇒ ⚠ in General notes on page 253.
- ▶ Press the connector carefully into the bulb housing until the bulb is securely seated ⇒ Fig. 277.
- ▶ Replace the cover.
- ▶ Check whether the new bulb is working.

#### ! CAUTION

Make sure that the cover is correctly seated to ensure that water cannot enter the headlight housing and to prevent the headlight from malfunctioning.

### Removing bulbs for turn signals

Applies to vehicles: with halogen headlights

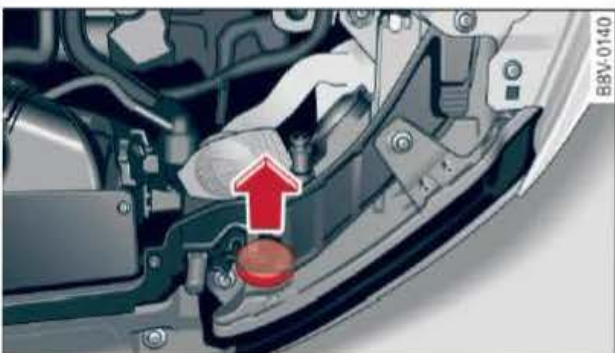

Fig. 278 Engine compartment: Removing cover



Fig. 279 Bulb holder for turn signal

For illustration purposes, ⇒ Fig. 279 shows the inside of the unit with the headlight removed.

- ▶ Switch off the lights and the ignition.
- ▶ Please refer to ⇒ ⚠ in General notes on page 253.
- ▶ Open the bonnet.
- ▶ Pull off the cover ⇒ Fig. 278.
- ▶ Pull the bulb connector out in the direction of the arrow ⇒ Fig. 279.
- ▶ Pull the defective bulb out of the connector and replace the bulb.

### Installing bulb for turn signal

Applies to vehicles: with halogen headlights



Fig. 280 Bulb housing: Inserting the bulb holder

- ▶ If necessary, use a cloth to remove any fingerprints from the glass part of the bulb.
- ▶ Refit the bulb in the headlight housing ⇒ Fig. 280 ⇒ ⚠ in General notes on page 253. Turn the bulb connector slightly to the left and right until it engages in the holder.
- ▶ Press the connector carefully into the bulb housing until the bulb is securely seated.
- ▶ Replace the cover.
- ▶ Check whether the new bulb is working. ▶

**! CAUTION**

Make sure that the cover is correctly seated to ensure that water cannot enter the headlight housing and to prevent the headlight from malfunctioning.

**Removing bulbs for turn signals**

Applies to vehicles: with xenon headlight bulbs

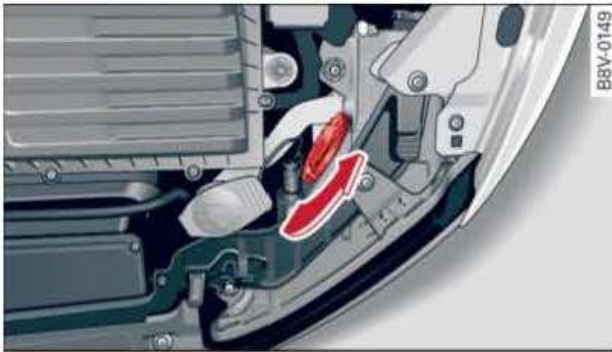



Fig. 281 Engine compartment: Removing cover



Fig. 282 Bulb holder for turn signal

For illustration purposes, ⇒ Fig. 282 shows the inside of the unit with the headlight removed.

- ▶ Switch off the lights and the ignition.
- ▶ Please refer to ⇒  in General notes on page 253.
- ▶ Open the bonnet.
- ▶ Pull off the cover ⇒ Fig. 281.
- ▶ Pull the bulb connector out in the direction of the arrow ⇒ Fig. 282.
- ▶ Pull the defective bulb out of the connector and replace the bulb.

**Installing bulb for turn signal**

Applies to vehicles: with xenon headlight bulbs



Fig. 283 Bulb housing: Tightening the bulb holder

- ▶ If necessary, use a cloth to remove any fingerprints from the glass part of the bulb.
- ▶ Refit the bulb in the headlight housing ⇒ Fig. 283 ⇒  in General notes on page 253. Turn the bulb connector slightly to the left and right until it engages in the holder.
- ▶ Press the connector carefully into the bulb housing until the bulb is securely seated.
- ▶ Replace the cover.
- ▶ Check whether the new bulb is working.

**! CAUTION**

Make sure that the cover is correctly seated to ensure that water cannot enter the headlight housing and to prevent the headlight from malfunctioning.

### Removing bulb for turning light

Applies to vehicles: with xenon headlight bulbs

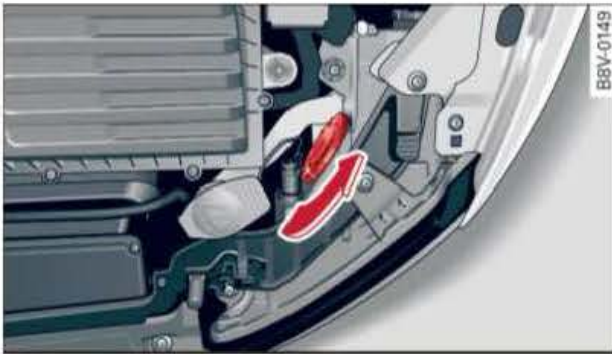

Fig. 284 Engine compartment: Removing cover on bulb housing



Fig. 285 Bulb holder for turning light

For illustration purposes, ⇒ Fig. 285 shows the inside of the unit with the headlight removed.

- ▶ Switch off the lights and the ignition.
- ▶ Please refer to ⇒ ⚠ in General notes on page 253.
- ▶ Open the bonnet.
- ▶ Turn the cover anti-clockwise and remove it ⇒ Fig. 284.
- ▶ Turn the bulb connector as far as the stop in the direction of the arrow ⇒ Fig. 285 and remove the connector and bulb from the headlight housing.
- ▶ Release the bulb from the connector.

### Installing bulb for turning light

Applies to vehicles: with xenon headlight bulbs



Fig. 286 Bulb housing: Tightening the bulb holder

- ▶ If necessary, use a cloth to remove any fingerprints from the glass part of the bulb.
- ▶ Refit the bulb in the headlight housing ⇒ Fig. 286 ⇒ ⚠ in General notes on page 253. Turn the bulb connector slightly to the left and right until it engages in the holder.
- ▶ From this position, turn the bulb connector further in the direction of the arrow until it is seated securely.
- ▶ Fit the cover back on and turn it as far as the stop to tighten.
- ▶ Check whether the new bulb is working.

#### ! CAUTION

Make sure that the cover is correctly seated to ensure that water cannot enter the headlight housing and to prevent the headlight from malfunctioning.

## Changing bulb for front fog light

### Removing fog light

Applies to vehicles: with front fog lights

To change the bulb, you must remove the fog light. Removing the light requires a certain degree of practical skill.



Fig. 287 Detail from front of vehicle, left side: Removing trim



Fig. 288 Detail from front of vehicle, left side: Fog light

- ▶ Switch off the ignition and the lights.
- ▶ Take the hook for removing hub caps and the screwdriver out of the tool kit ⇒ page 236.
- ▶ Insert the hook in the hole **A** ⇒ Fig. 287.
- ▶ Insert the screwdriver through the ring on the hook in order to pull it.
- ▶ Use the screwdriver to pull off the trim ⇒ Fig. 287 and remove it from the bumper.
- ▶ Use the cross-head blade of the reversible screwdriver insert ⇒ page 236 to remove the screws **1** ⇒ Fig. 288.
- ▶ Carefully take out the fog light housing.

### Changing bulb for front fog light

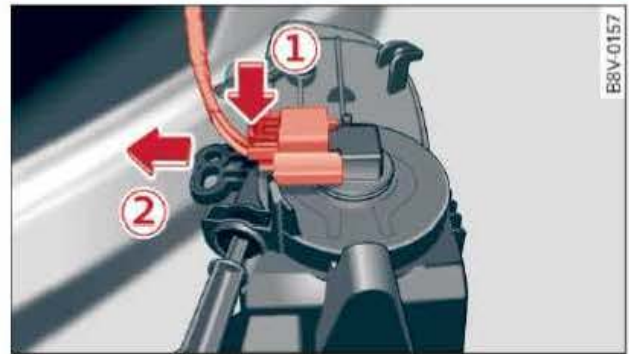

Fig. 289 Fog light housing removed

- ▶ Press down the tab **1** and unplug the electrical connector **2** ⇒ Fig. 289.
- ▶ Turn the bulb holder anti-clockwise and take it out.
- ▶ Fit the new bulb.
- ▶ If necessary, use a cloth to remove any fingerprints from the glass part of the bulb.
- ▶ Fit the bulb holder into the bulb housing and turn it clockwise to tighten. Plug in the electrical connector again.
- ▶ Check whether the new bulb is working.
- ▶ Re-install the fog light unit. The studs **2** ⇒ page 262, Fig. 288 help to locate the unit in the correct position.
- ▶ Tighten the screws **1** ⇒ page 262, Fig. 288 and refit the trim panel.
- ▶ Put the tools and jack back in the luggage compartment.

### **i** Note

To install the fog light, follow the instructions for removal in reverse order.



## A3/A3 Sportback: Changing bulbs for rear lights

### Removing outer rear light

Applies to vehicles: with halogen system (A3/A3 Sportback)

To change the bulbs, you must remove the rear light. Removing the light requires a certain degree of practical skill.

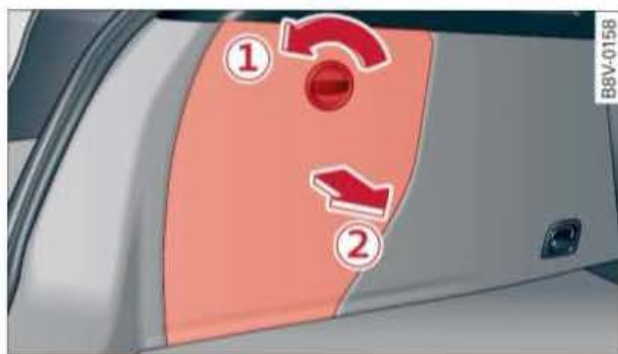

Fig. 290 Luggage compartment: Location of the retaining screw for the rear light (example on left side)



Fig. 291 Releasing rear light from luggage compartment (example on left side)

- ▶ Check which of the bulbs is defective.
- ▶ Open the boot lid.
- ▶ Take the screwdriver out of the vehicle tool kit ⇒ page 236. Use the flat-blade side of the reversible insert.
- ▶ Remove the cover from the side trim ⇒ Fig. 290. On vehicles with side compartment, a coin is required in order to release the cover.
- ▶ Insert the screwdriver into one of the horizontal holes on the head of the retaining screw in order to turn it ⇒ Fig. 291.
- ▶ Slacken the screw by turning it anti-clockwise (you may have to reapply the screwdriver several times).

- ▶ Follow the remaining directions on ⇒ page 263.

### ! CAUTION

When removing or installing the rear light, take care not to cause any damage.

- Removing the rear light in particular can lead to the paintwork or rear light becoming damaged. This is another reason why we recommend having the bulbs changed by a qualified workshop.

### i Note

Follow the same procedure for installing/removing the rear light when replacing an LED rear light unit.

### Removing outer rear light (continued)

Applies to vehicles: with halogen system (A3/A3 Sportback)

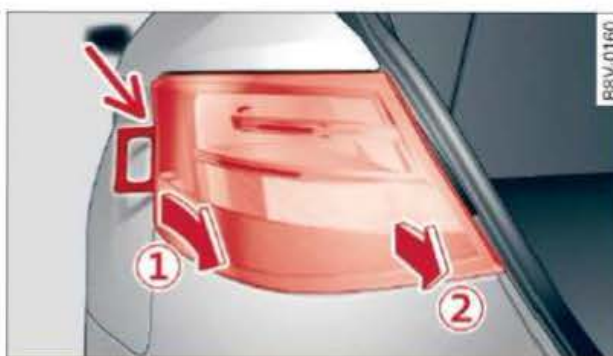

Fig. 292 Removing rear light

- ▶ Take the plastic spatula out of the vehicle tool kit.
- ▶ Carefully slide the plastic spatula into the gap between the rear light and the body -arrow- ⇒ Fig. 292.
- ▶ Gradually ease out the rear light by pulling alternately with one hand towards arrow ① and with the other towards arrow ② ⇒ Fig. 292 and take out the rear light unit.
- ▶ Remove the bulb carrier: A3 ⇒ page 264, A3 Sportback ⇒ page 264.

### i Note

Make sure you have a soft cloth ready to place under the glass on the rear light, to avoid any scratches.

### Removing bulb carrier

Applies to vehicles: with halogen system (A3)

When changing a bulb, you must first remove the bulb carrier.

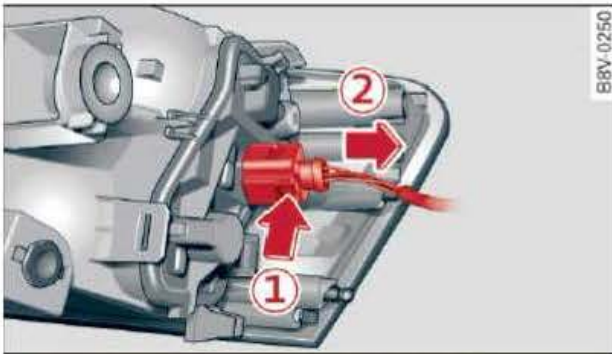

Fig. 293 Rear light: Unplugging connector

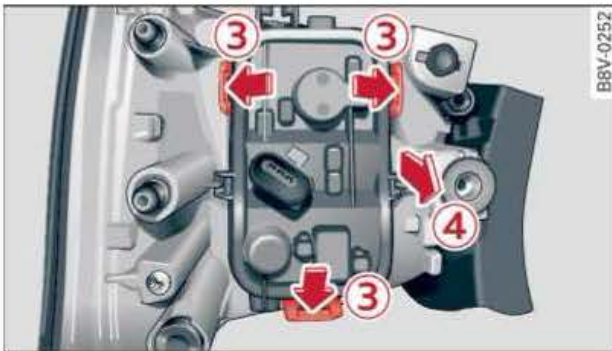

Fig. 294 Securing tabs between bulb carrier and rear light

- ▶ First release the connector ① and then pull it out immediately ② ⇒ Fig. 293.
- ▶ Push the securing tabs ③ away from the bulb carrier and lift it off ④ ⇒ Fig. 294.
- ▶ Renew the defective bulb ⇒ page 264.

### Removing bulb carrier

Applies to vehicles: with halogen system (A3 Sportback)

When changing a bulb, you must first remove the bulb carrier.

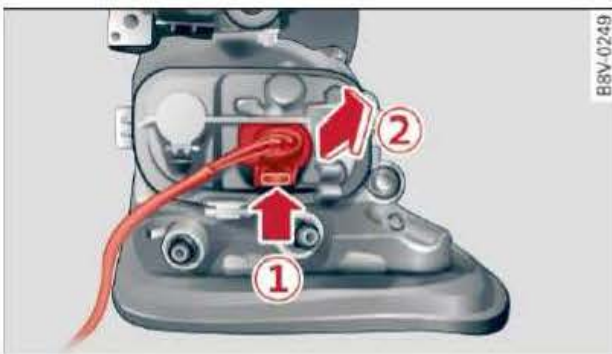

Fig. 295 Rear light: Unplugging connector

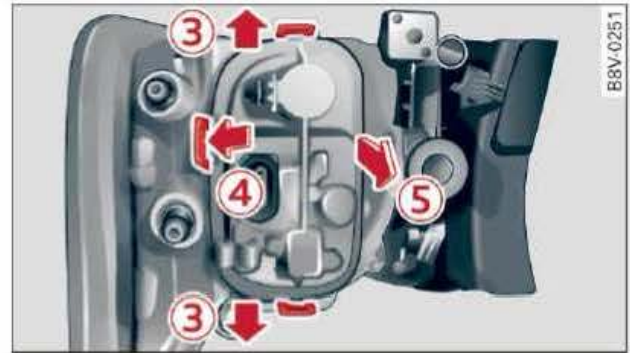

Fig. 296 Securing tabs between bulb carrier and rear light

- ▶ First release the connector ① and then pull it out immediately ② ⇒ Fig. 295.
- ▶ Pull or push the securing tabs ③ and ④ away from the bulb carrier and lift it off ⑤ ⇒ Fig. 296.
- ▶ Renew the defective bulb ⇒ page 264.

### Changing a bulb

Applies to vehicles: with halogen system (A3/A3 Sportback)

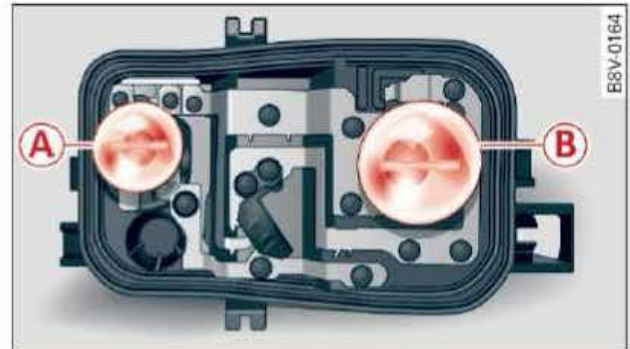

Fig. 297 Position of the bulbs on the bulb carrier (example: left rear light)

The table below gives an overview of the bulb positions.

Bulb ① has a plug-in connection and can be changed simply by pulling out the old bulb and inserting a new one.

Bulb ② is secured by a bayonet fastener:

- ▶ Lightly press the defective bulb ② into the bulb carrier, then turn it anti-clockwise and remove it.
- ▶ Fit the new bulb ②, pressing it into the bulb holder and turn it clockwise as far as it will go.

- ▶ If necessary, use a cloth to remove any fingerprints from the glass part of the bulb (A)/(B).
- ▶ Check whether the new bulb is working.
- ▶ Re-install the bulb carrier ⇒ page 265.

### Position of bulbs

Pos. ⇒ Fig. 297	Bulb function
A	Tail light/brake light
B	Turn signal

### Installing bulb carrier

Applies to vehicles: with halogen system (A3/A3 Sportback)

- ▶ Check that the seal is seated correctly on the bulb carrier.
- ▶ Position the bulb carrier on the rear light and align it with the securing tabs.
- ▶ Lightly press the bulb carrier into the rear light until it engages. Make sure that all three securing tabs click into place.
- ▶ Re-install the rear light ⇒ page 265.

### Installing outer rear light

Applies to vehicles: with halogen system (A3/A3 Sportback)



Fig. 298 Fitting the rear light

- ▶ Insert the rear light in the direction of the arrow.
- ▶ Gently press in the rear light at various points on the body.
- ▶ Apply light pressure on the rear light and fit the screw from the luggage compartment side to secure the rear light. Tighten the screw with the screwdriver (do not over-tighten).

- ▶ Make sure that all bulbs for the rear lights are working.
- ▶ Refit the cover in the side trim in the luggage compartment.
- ▶ Put the tools and jack back in the luggage compartment.

### Removing bulb carrier from boot lid

Applies to vehicles: with halogen system (A3)

The boot lid must be open to change the bulbs.



Fig. 299 Open boot lid: Removing cover from boot lid interior trim

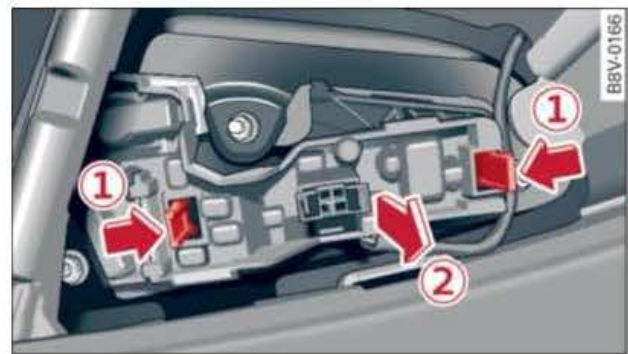

Fig. 300 Removing bulb carrier

- ▶ Check which of the bulbs is defective.
- ▶ Take the screwdriver out of the vehicle tool kit ⇒ page 236. Use the flat-blade side of the reversible insert.
- ▶ Insert the screwdriver into the opening in the cover ⇒ Fig. 299 and detach the cover.
- ▶ Release the bulb carrier at position ① ⇒ Fig. 300 and carefully pull it off in the direction of the arrow ②.
- ▶ Changing the bulb ⇒ page 266.

### Removing bulb carrier from boot lid

Applies to vehicles: with halogen, xenon or LED system (A3 Sportback)

The boot lid must be open to change the bulbs.



**Fig. 301** Open boot lid: Removing cover from boot lid interior trim

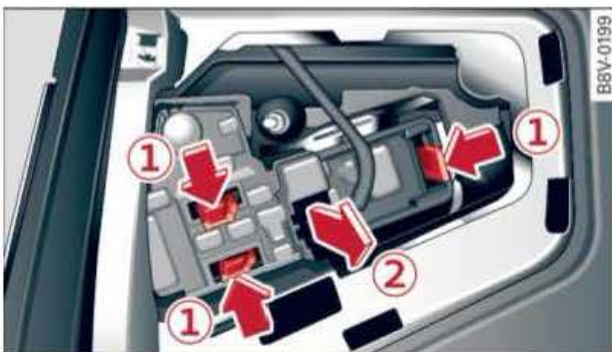
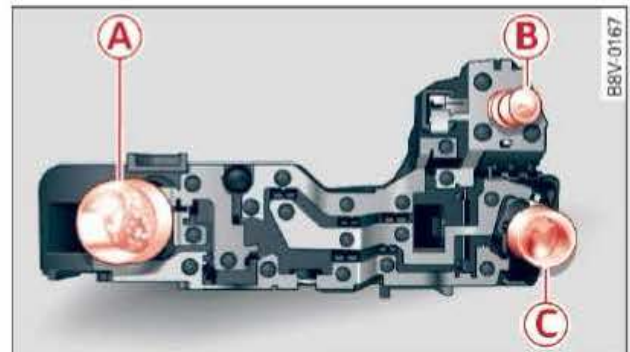

**Fig. 302** Removing bulb carrier

- ▶ Check which of the bulbs is defective.
- ▶ Take the screwdriver out of the vehicle tool kit ⇒ *page 236*. Use the flat-blade side of the reversible insert.
- ▶ Insert the screwdriver into the opening in the cover ⇒ *Fig. 301* and detach the cover.
- ▶ Release the bulb carrier at position ① ⇒ *Fig. 302* and carefully pull it off in the direction of the arrow ②.
- ▶ Change the bulbs (halogen system) ⇒ *page 266*.
- ▶ Change the bulbs (xenon/LED system) ⇒ *page 267*.

### Changing bulbs for inner rear lights

Applies to vehicles: with halogen system (A3/A3 Sportback)



**Fig. 303** Position of the bulbs on the bulb carrier (example: inner left rear light)

The table below gives an overview of the bulb positions.

Bulbs ① and ③ have a plug-in connection and can be changed simply by pulling out the old bulb and inserting a new one.

Bulb ② is secured by a bayonet fastener:

- ▶ Lightly press the defective bulb ② into the bulb carrier, then turn it anti-clockwise and remove it.
- ▶ Fit the new bulb ②, pressing it into the bulb holder and turn it clockwise as far as it will go.
- ▶ If necessary, use a cloth to remove any fingerprints from the glass part of the bulb ①/②/③.
- ▶ Check whether the new bulb is working.
- ▶ Re-install the bulb carrier ⇒ *page 266*.

#### Position of bulbs

Pos. ⇒ <i>Fig. 303</i>	Bulb function
A	Tail light/rear fog light
B	Reversing light
C	Tail light

### Installing bulb carrier for inner rear light

Applies to vehicles: with halogen system (A3/A3 Sportback)

- ▶ Position the bulb carrier on the rear light and align it so that it is securely seated. ▶

- ▶ Press the bulb carrier into the rear light until it engages.
- ▶ Replace the cover in the interior trim.
- ▶ Make sure that all bulbs for the rear lights are working.
- ▶ Put the tools and jack back in the luggage compartment.

### Removing bulb carrier from boot lid

Applies to vehicles: with xenon or LED system (A3)

The boot lid must be open to change the bulbs.



Fig. 304 Open boot lid: Removing cover from boot lid interior trim



Fig. 305 Removing bulb carrier

- ▶ Check which of the bulbs is defective.
- ▶ Take the screwdriver out of the vehicle tool kit ⇒ page 236. Use the flat-blade side of the reversible insert.
- ▶ Insert the screwdriver into the opening in the cover ⇒ Fig. 304 and detach the cover.
- ▶ Release the bulb carrier at position ① ⇒ Fig. 305 and carefully pull it off in the direction of the arrow ②.
- ▶ Changing the bulb ⇒ page 266.

### Changing bulbs for inner rear lights

Applies to vehicles: with xenon or LED system (A3/A3 Sportback)

All bulbs can be changed easily on the bulb carrier.

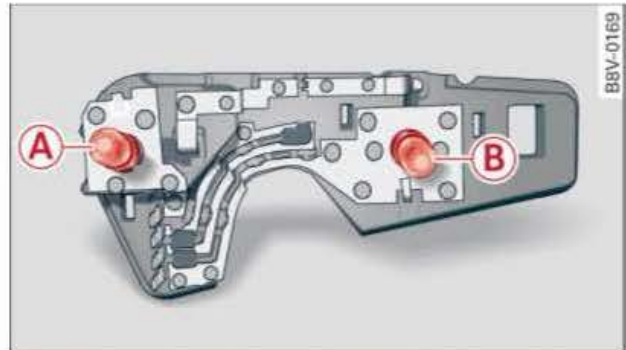

Fig. 306 Position of the bulbs on the bulb carrier (example: inner left rear light)

The bulbs are secured with a bayonet fastener. The table below gives an overview of the bulb positions.

- ▶ Lightly press the defective bulb into the bulb carrier, then turn it anti-clockwise and remove it.
- ▶ Fit the new bulb, pressing it into the bulb holder and turn it clockwise as far as it will go.
- ▶ If necessary, use a cloth to remove any fingerprints from the glass part of the bulb.
- ▶ Check whether the new bulb is working.
- ▶ Re-install the bulb carrier ⇒ page 267.

### Position of bulbs

Pos. ⇒ Fig. 306	Bulb function
A	Reversing light
B	Rear fog light

### Installing bulb carrier for inner rear light

Applies to vehicles: with xenon or LED system (A3/A3 Sportback)

- ▶ Position the bulb carrier on the rear light and align it so that it is securely seated.
- ▶ Press the bulb carrier into the rear light until it engages.
- ▶ Replace the cover in the interior trim. ▶

- ▶ Make sure that all bulbs for the rear lights are working.
- ▶ Put the tools and jack back in the luggage compartment.

## A3 Saloon: Changing bulbs for rear lights

### Removing outer rear light

Applies to vehicles: with halogen system (A3 Saloon)

To change the bulbs, you must remove the rear light. Removing the light requires a certain degree of practical skill.



Fig. 307 Releasing rear light (example on left side)



Fig. 308 Removing rear light

### Releasing rear light

- ▶ Check which of the bulbs is defective.
- ▶ Open the boot lid.
- ▶ Take the screwdriver and the Torx bit out of the vehicle tool kit ⇒ page 236.
- ▶ Remove the cover ① ⇒ Fig. 307.
- ▶ Use the screwdriver with the appropriate Torx bit to loosen both screws ② ⇒ Fig. 307.

### Removing rear light

- ▶ Take the plastic spatula out of the vehicle tool kit ⇒ page 236.

- ▶ Carefully slide the plastic spatula into the gap between the rear light and the body -arrow- ⇒ Fig. 308.
- ▶ Gradually ease out the rear light by pulling alternately with one hand towards arrow ① and with the other towards arrow ② ⇒ Fig. 308 and take out the rear light unit.
- ▶ Unplug the electrical connector ⇒ page 268.

### ! CAUTION

When removing or installing the rear light, take care not to cause any damage.

- Removing the rear light in particular can lead to the paintwork or rear light becoming damaged. This is another reason why we recommend having the bulbs changed by a qualified workshop.

### i Note

Follow the same procedure for installing/removing the rear light when replacing an LED rear light unit.

### Unplugging the connector and removing the bulb carrier

Applies to vehicles: with halogen system (A3 Saloon)

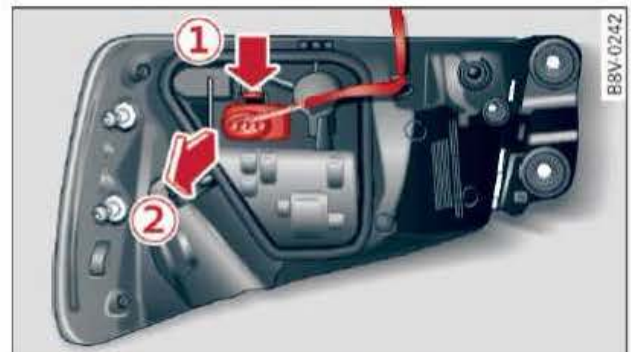

Fig. 309 Rear light: Unplugging connector

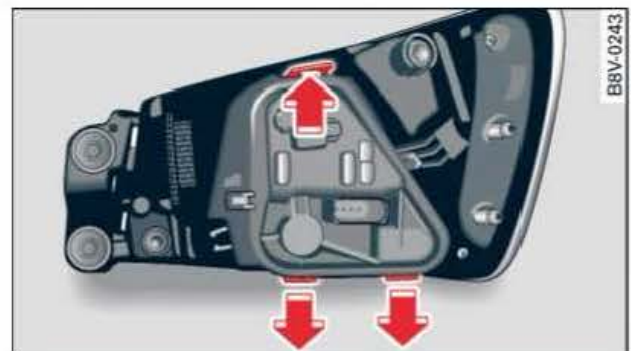

Fig. 310 Securing tabs between bulb carrier and rear light

## Unplugging the connector

- ▶ First release the connector ① and then pull it out immediately ② ⇒ Fig. 309.

## Removing bulb carrier

When changing a bulb, you must first remove the bulb carrier. There are three securing tabs on the inside of the rear light.

- ▶ Push the securing tabs -arrows- away from the bulb carrier and lift it off ⇒ Fig. 310.
- ▶ Renew the defective bulb ⇒ page 269.

### **i** Note

Make sure you have a soft cloth ready to place under the glass on the rear light, to avoid any scratches.

## Changing a bulb

Applies to vehicles: with halogen system (A3 Saloon)

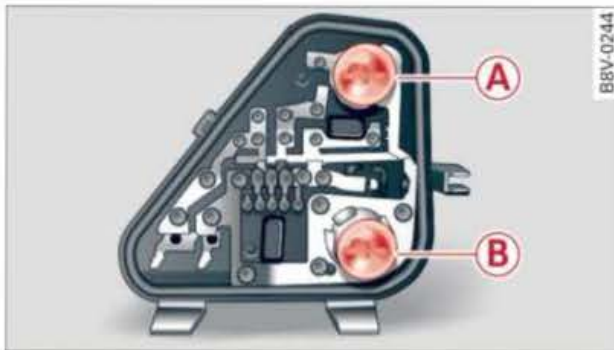

Fig. 311 Position of the bulbs on the bulb carrier (example for left rear light)

The table below gives an overview of the bulb positions.

Bulb ① has a plug-in connection and can be changed simply by pulling out the old bulb and inserting a new one.

Bulb ② is secured by a bayonet fastener:

- ▶ Lightly press the defective bulb ② into the bulb carrier, then turn it anti-clockwise and remove it.
- ▶ Fit the new bulb, pressing it into the bulb holder and turn it clockwise as far as it will go.
- ▶ If necessary, use a cloth to remove any fingerprints from the glass part of the bulb ① or ②.

- ▶ Check whether the new bulb is working.
- ▶ Re-install the bulb carrier ⇒ page 269.

## Position of bulbs

Pos. ⇒ page 264, Fig. 297	Bulb function
A	Tail light/brake light
B	Turn signal

## Installing bulb carrier

Applies to vehicles: A3 Saloon

- ▶ Check that the seal is seated correctly on the bulb carrier.
- ▶ Position the bulb carrier on the rear light and align it with the securing tabs.
- ▶ Lightly press the bulb carrier into the rear light until it engages. Make sure that all the securing tabs click into place.
- ▶ Re-install the rear light ⇒ page 269.

## Installing outer rear light

Applies to vehicles: A3 Saloon



Fig. 312 Fitting the rear light

- ▶ Insert the rear light in the direction of the arrow ①.
- ▶ Gently press in the rear light at various points on the body.
- ▶ Lightly press in the rear light and attach it with the both bolts ②.
- ▶ Replace the cover ③ over the screws.
- ▶ Make sure that all bulbs for the rear lights are working.
- ▶ Put the tools and jack back in the luggage compartment.

### Removing bulb carrier from boot lid

Applies to vehicles: with halogen system (A3 Saloon)

The boot lid must be open to change the bulbs.



Fig. 313 Open boot lid (A3 Saloon): Removing cover from boot lid interior trim

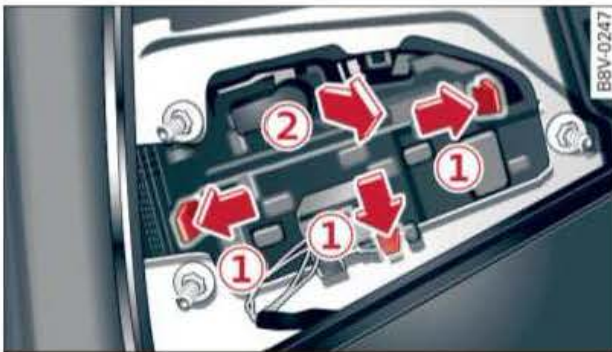

Fig. 314 Boot lid (A3 Saloon): Removing bulb carrier

- ▶ Check which of the bulbs is defective.
- ▶ Take the screwdriver out of the vehicle tool kit ⇒ page 236. Use the flat-blade side of the reversible insert.
- ▶ Use the screwdriver to lever open the cover ⇒ Fig. 313.
- ▶ Release the bulb carrier at position ① ⇒ Fig. 314 and carefully pull it off in the direction of the arrow ②.
- ▶ Change the bulbs (halogen system) ⇒ page 270.

### Changing bulbs for inner rear lights

Applies to vehicles: with halogen system (A3 Saloon)

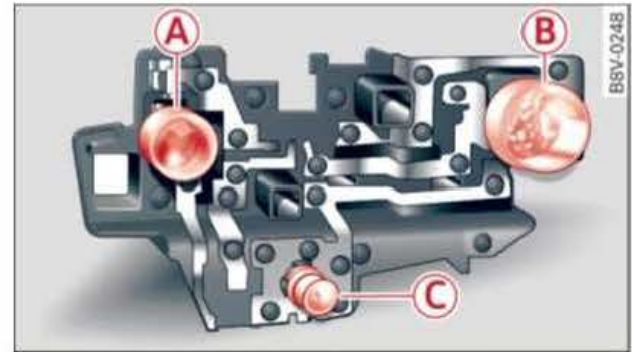

Fig. 315 Position of the bulbs on the bulb carrier (example for inner left rear light)

The table below gives an overview of the bulb positions.

Bulbs ① and ② have a plug-in connection and can be changed simply by pulling out the old bulb and inserting a new one.

Bulb ③ is secured by a bayonet fastener:

- ▶ Lightly press the defective bulb ③ into the bulb carrier, then turn it anti-clockwise and remove it.
- ▶ Fit the new bulb ③, pressing it into the bulb holder and turn it clockwise as far as it will go.
- ▶ If necessary, use a cloth to remove any fingerprints from the glass part of the bulb ①/②/③.
- ▶ Check whether the new bulb is working.
- ▶ Re-install the bulb carrier ⇒ page 270.

#### Position of bulbs

Pos. ⇒ page 266, Fig. 303	Bulb function
A	Tail light
B	Tail light/rear fog light
C	Reversing light

### Installing bulb carrier for inner rear light

Applies to vehicles: with halogen system (A3 Saloon)

- ▶ Position the bulb carrier on the rear light and align it so that it is securely seated. ▶



- ▶ Press the bulb carrier into the rear light until it engages.
- ▶ Fold the cover open completely.
- ▶ Put the tools and jack back in the luggage compartment.
- ▶ Make sure that all bulbs for the rear lights are working.

### Removing bulb carrier from boot lid

Applies to vehicles: with xenon or LED system (A3 Saloon)

The boot lid must be open to change the bulbs.



Fig. 316 Open boot lid: Removing cover from boot lid interior trim

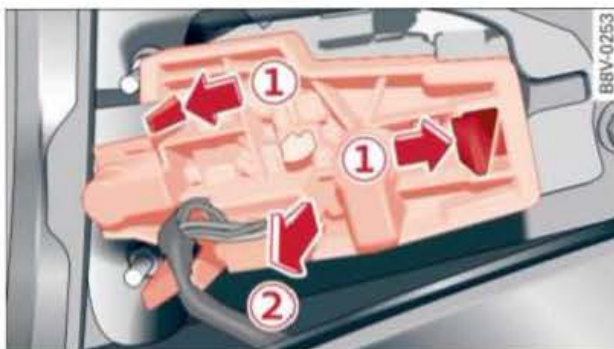

Fig. 317 Removing bulb carrier

- ▶ Check which of the bulbs is defective.
- ▶ Take the screwdriver out of the vehicle tool kit ⇒ *page 236*. Use the flat-blade side of the reversible insert.
- ▶ Use the screwdriver to lever open the cover ⇒ *Fig. 316*.
- ▶ Release the bulb carrier at position ① ⇒ *Fig. 317* and carefully pull it off in the direction of the arrow ②.
- ▶ Changing the bulb ⇒ *page 271*.

### Changing bulbs for inner rear lights

Applies to vehicles: with xenon or LED system (A3 Saloon)

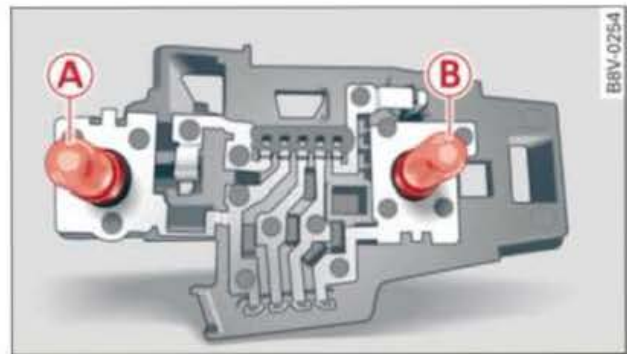

Fig. 318 Position of the bulbs on the bulb carrier (example for inner left rear light)

The bulbs are secured with a bayonet fastener. The table below gives an overview of the bulb positions.

- ▶ Lightly press the defective bulb into the bulb carrier, then turn it anti-clockwise and remove it.
- ▶ Fit the new bulb, pressing it into the bulb holder and turn it clockwise as far as it will go.
- ▶ If necessary, use a cloth to remove any fingerprints from the glass part of the bulb.
- ▶ Check whether the new bulb is working.
- ▶ Re-install the bulb carrier ⇒ *page 271*.

### Position of bulbs

Pos. ⇒ <i>page 267</i> , <i>Fig. 306</i>	Bulb function
A	Reversing light
B	Rear fog light

### Installing bulb carrier for inner rear light

Applies to vehicles: with xenon or LED system (A3 Saloon)

- ▶ Position the bulb carrier on the rear light and align it so that it is securely seated.
- ▶ Press the bulb carrier into the rear light until it engages.
- ▶ Fold the cover open completely.
- ▶ Put the tools and jack back in the luggage compartment.
- ▶ Make sure that all bulbs for the rear lights are working.

## Technical data

### Vehicle identification data



Fig. 319 Engine compartment: Vehicle ID number

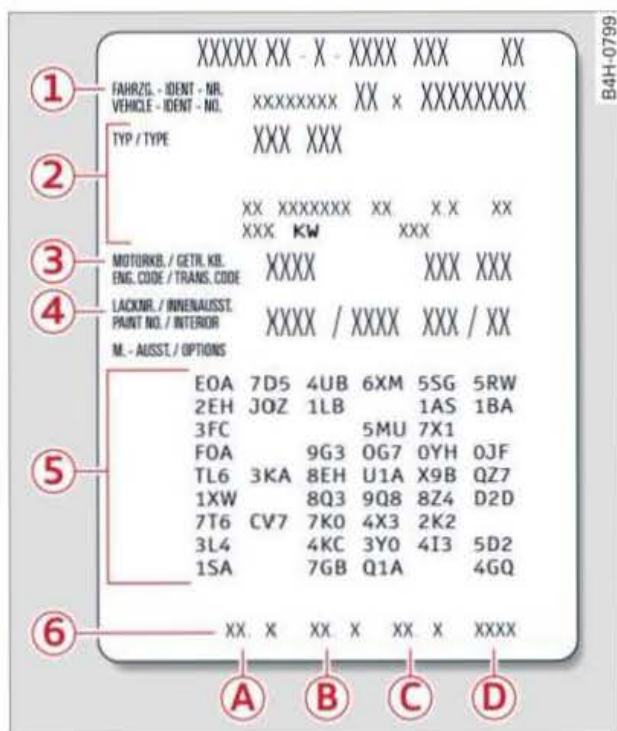

Fig. 320 Vehicle data sticker

#### Chassis number on MMI

► Select: **MENU** button > control button **Systems / Car systems** > **Servicing & checks** > **Chassis number**.

#### Chassis number

The chassis number can be found on the MMI, on the vehicle data sticker and behind the windscreen on the driver's side\*. The chassis number is also located on the right of the en-

gine compartment (as seen in the direction of travel). The number is stamped on the top side rail ⇒ Fig. 319 and is partially covered.

#### Type plate

The type plate is located on the passenger's door pillar. Vehicles for certain export countries have no type plate.

#### Vehicle data sticker

The vehicle data sticker ⇒ Fig. 319 is under the carpet trim in the luggage compartment in the spare wheel well. One section of the vehicle data sticker is attached to the inside cover of the Service Schedule before the vehicle is handed over.

The sticker lists the following data:

- ① Vehicle identification number (chassis number)
- ② Vehicle type / engine power / gearbox type
- ③ Engine and gearbox code letters
- ④ Paint No. / Interior equipment No.
- ⑤ Optional equipment codes
- ⑥ Fuel consumption and emissions\*

#### Engine code

You can check the engine code on the instrument cluster.

Important: The engine must be switched off and the ignition must be switched on.

– Press and hold the **[0.0]** button ⑧ ⇒ page 9, Fig. 3 for at least 15 seconds.

#### Fuel consumption and emissions<sup>1)</sup>

Information on the vehicle's fuel consumption and emissions is given at the bottom of the vehicle data sticker ⑥:

- A Urban cycle consumption (ltr./100 km)
- B Extra-urban cycle consumption (ltr./100 km)

<sup>1)</sup> All the figures are not available for all export versions. In this case, the fields contain place holders, for example 99.9.

- Ⓒ Combined cycle consumption (ltr./100 km)
- Ⓓ Combined CO<sub>2</sub> emissions (g/km)

The specified values were determined in accordance with the required test procedures. The specifications do **not** refer to an individual vehicle, but serve only as a basis for compar-

ing the different types of vehicles. In addition, the consumption figures achieved during normal driving may differ from the test values, depending in particular on special equipment fitted, vehicle loading, personal driving style, road and traffic conditions, environmental factors and the condition of the car.

## Dimensions

The dimensions can vary depending on the model version, equipment variant and measurement standards used in specific countries.

		A3	S3
Length	mm	4237	4254
Width	mm	1777	1777
Width across mirrors	mm	1966	1966
Height, unladen	mm	1421	1401

		A3 Sportback	S3 Sportback
Length	mm	4310-4324	4324
Width	mm	1785	1785
Width across mirrors	mm	1966	1966
Height, unladen	mm	1414-1436	1404

		A3 Saloon	S3 Saloon
Length	mm	4456-4472	4469-4472
Width	mm	1796	1796
Width across mirrors	mm	1960	1960
Height, unladen	mm	1391-1416	1392

Take care not to damage low-mounted parts of the car (such as the spoiler or exhaust system) on steep ramps, uneven road surfaces or roadside kerbs, etc. Please bear this in mind, especially when the vehicle is fully laden.

Windscreen washer	ltr.	approx. 3.1
Windscreen and headlight washer system*	ltr.	approx. 4.7

## Capacities

Fuel tank front-wheel drive	ltr.	approx. 50
Fuel tank four-wheel drive	ltr.	approx. 55
Fuel tank Natural gas	kg	~ 15

## Explanation of technical data

The figures for some markets can vary due to different export versions and test procedures.

Please note that the details listed in the **vehicle's registration documents** can be taken as correct.

### Performance figures

The performance figures were measured without equipment which may influence performance, such as mudflaps or extremely wide-section tyres.

### Kerb weight (unladen weight)

In accordance with GB 1589 for China: the kerb weight does not include the driver.

In accordance with 92/21/EEC for Europe and certain other markets: the kerb weight includes an allowance of 75 kg for the driver and luggage.

### Maximum weights/loads for towing<sup>1)</sup>

When towing, the **gross vehicle weight** and the **maximum rear axle weight** may be exceeded by up to 50 kg.

### Maximum trailer weights<sup>1)</sup>

The maximum trailer weights are calculated in accordance with the currently applicable version of 92/21/EEC.

### Maximum draw bar loading<sup>1)</sup>

The vertical load exerted by the trailer drawbar on the ball joint of the towing bracket must not exceed **75 kg**.

In the interest of safety, we recommend applying the **maximum permitted draw bar weight**. **The stability of the trailer could be adversely affected if too little weight is applied.**

If the **maximum** permitted drawbar weight cannot be obtained, e.g. when using small or light trailers, statutory regulations require that the drawbar weight be at least 4% of the actual trailer weight (for single-axle trailers or twin-axle trailers with an axle spacing less than 1.0 m).

### Notes for following tables

MG = Manual gearbox / AG = Automatic gearbox

1) Maximum speed is achieved in the second highest gear.

2) The specified trailer weights apply only to vehicles with a factory-fitted towing bracket. Towing bracket not available for China.

3) In some markets, this engine has different performance/torque specifications (see car documentation). The performance figures may be slightly different.

4) Figures were not available at time of publication.

5) Governed

---

<sup>1)</sup> The information applies only to vehicles with a factory-fitted towing bracket. Towing bracket not available for China.

## Petrol engines

### A3 1.2, 4-cylinder

Power output	77 kW at 5000 rpm		
Maximum torque	175 Nm at 1400 - 4000 rpm		
Drive	FWD		
		<b>MG</b>	<b>AG</b>
Maximum speed	km/h	193 <sup>1)</sup>	193 <sup>1)</sup>
Acceleration from 0 - 100 km/h	sec.	10.3	10.3
Kerb weight (unladen weight)	kg	1225	1245
Gross vehicle weight	kg	1710	1730
Maximum front axle weight	kg	910	935
Maximum rear axle weight	kg	905	905
Trailer <sup>2)</sup> without brakes	kg	610	620
Trailer <sup>2)</sup> with brakes on gradients up to 8 %	kg	1500	1500
Trailer <sup>2)</sup> with brakes on gradients up to 12 %	kg	1300	1300
Weight of vehicle and trailer <sup>2)</sup> on gradients up to 12 %	kg	3060	3080

Footnotes ⇨ page 274

### A3 1.4, 4-cylinder (90<sup>3)</sup> kW)

Power output	MG: 90 <sup>3)</sup> kW at 5000 - 6200 rpm AG: 90 <sup>3)</sup> kW at 5000 rpm		
Maximum torque	200 <sup>3)</sup> Nm at 1400 - 4000 rpm		
Drive	FWD		
		<b>MG</b>	<b>AG</b>
Maximum speed	km/h	203 <sup>1)</sup>	203 <sup>1)</sup>
Acceleration from 0 - 100 km/h	sec.	9.3	9.2
Kerb weight (unladen weight)	kg	1250	1270
Gross vehicle weight	kg	1735	1755
Maximum front axle weight	kg	920	935
Maximum rear axle weight	kg	930	915
Trailer <sup>2)</sup> without brakes	kg	620	630
Trailer <sup>2)</sup> with brakes on gradients up to 8 %	kg	1600	1600
Trailer <sup>2)</sup> with brakes on gradients up to 12 %	kg	1400	1400
Weight of vehicle and trailer <sup>2)</sup> on gradients up to 12 %	kg	3185	3205

Footnotes ⇨ page 274

### A3 1.4, 4-cylinder (103 kW) with Active Cylinder Management

Power output	103 kW at 5000 rpm		
Maximum torque	250 Nm at 1500 - 3500 rpm		
Drive		FWD	
		<b>MG</b>	<b>AG</b>
Maximum speed	km/h	213	213 <sup>1)</sup>
Acceleration from 0 - 100 km/h	sec.	8.3	8.3
Kerb weight (unladen weight)	kg	1270	1280
Gross vehicle weight	kg	1755	1765
Maximum front axle weight	kg	935	950
Maximum rear axle weight	kg	925	920
Trailer <sup>2)</sup> without brakes	kg	630	640
Trailer <sup>2)</sup> with brakes on gradients up to 8 %	kg	1700	1700
Trailer <sup>2)</sup> with brakes on gradients up to 12 %	kg	1500	1500
Weight of vehicle and trailer <sup>2)</sup> on gradients up to 12 %	kg	3305	3315

Footnotes ⇒ page 274

### A3 1.8, 4-cylinder

Power output	FWD: 132 kW at 5100 - 6200 rpm quattro: 132 kW at 4500 - 6200 rpm			
Maximum torque	FWD: 250 Nm at 1250 - 5000 rpm quattro: 280 Nm at 1350 - 4500 rpm			
Drive		FWD		quattro
		<b>MG</b>	<b>AG</b>	<b>AG</b>
Maximum speed	km/h	232	232 <sup>1)</sup>	228
Acceleration from 0 - 100 km/h	sec.	7.1	7.2	6.7
Kerb weight (unladen weight)	kg	1305	1325	1425
Gross vehicle weight	kg	1790	1810	1910
Maximum front axle weight	kg	970	1010	1030
Maximum rear axle weight	kg	915	925	975
Trailer <sup>2)</sup> without brakes	kg	650	660	710
Trailer <sup>2)</sup> with brakes on gradients up to 8 %	kg	1800	1800	1800
Trailer <sup>2)</sup> with brakes on gradients up to 12 %	kg	1600	1600	1600
Weight of vehicle and trailer <sup>2)</sup> on gradients up to 12 %	kg	3440	3460	3560

Footnotes ⇒ page 274

**S3 2.0, 4-cylinder**

Power output	221 <sup>3)</sup> kW at 5500 - 6200 rpm			
Maximum torque	380 <sup>3)</sup> Nm at 1800 - 5500 rpm			
Drive			quattro	
			<b>MG</b>	<b>AG</b>
Maximum speed	km/h		250 <sup>5)</sup>	250 <sup>5)</sup>
Acceleration from 0 - 100 km/h	sec.		5.2	4.8
Kerb weight (unladen weight)	kg		1470	1490
Gross vehicle weight	kg		1955	1975
Maximum front axle weight	kg		1035	1050
Maximum rear axle weight	kg		1005	1005

 Footnotes ⇨ *page 274*

### A3 Sportback 1.2, 4-cylinder

Power output	77 kW at 5000 rpm		
Maximum torque	175 Nm at 1400 - 4000 rpm		
Drive	FWD		
		<b>MG</b>	<b>AG</b>
Maximum speed	km/h	193 <sup>1)</sup>	193 <sup>1)</sup>
Acceleration from 0 - 100 km/h	sec.	10.5	10.5
Kerb weight (unladen weight)	kg	1255	1275
Gross vehicle weight	kg	1740	1760
Maximum front axle weight	kg	930	955
Maximum rear axle weight	kg	930	925
Trailer <sup>2)</sup> without brakes	kg	620	630
Trailer <sup>2)</sup> with brakes on gradients up to 8 %	kg	1500	1500
Trailer <sup>2)</sup> with brakes on gradients up to 12 %	kg	1300	1300
Weight of vehicle and trailer <sup>2)</sup> on gradients up to 12 %	kg	3090	3110

Footnotes ⇒ page 274

### A3 Sportback g-tron 1.4, 4-cylinder (81 kW)

Power output	81 kW at xxx-xxx <sup>4)</sup> rpm		
Maximum torque	200 Nm at xxx-xxx <sup>4)</sup> rpm		
Drive	FWD		
		<b>MG</b>	<b>AG</b>
Maximum speed	km/h	-- <sup>4)</sup>	-- <sup>4)</sup>
Acceleration from 0 - 100 km/h	sec.	-- <sup>4)</sup>	-- <sup>4)</sup>
Kerb weight (unladen weight)	kg	-- <sup>4)</sup>	-- <sup>4)</sup>
Gross vehicle weight	kg	-- <sup>4)</sup>	-- <sup>4)</sup>
Maximum front axle weight	kg	-- <sup>4)</sup>	-- <sup>4)</sup>
Maximum rear axle weight	kg	-- <sup>4)</sup>	-- <sup>4)</sup>
Trailer <sup>2)</sup> without brakes	kg	-- <sup>4)</sup>	-- <sup>4)</sup>
Trailer <sup>2)</sup> with brakes on gradients up to 8 %	kg	-- <sup>4)</sup>	-- <sup>4)</sup>
Trailer <sup>2)</sup> with brakes on gradients up to 12 %	kg	-- <sup>4)</sup>	-- <sup>4)</sup>
Weight of vehicle and trailer <sup>2)</sup> on gradients up to 12 %	kg	-- <sup>4)</sup>	-- <sup>4)</sup>

Footnotes ⇒ page 274



**A3 Sportback 1.4, 4-cylinder (90<sup>3</sup>) kW)**

Power output	MG: 90 <sup>3</sup> ) kW at 5000 - 6200 rpm AG: 90 <sup>3</sup> ) kW at 5000 rpm		
Maximum torque	200 <sup>3</sup> ) Nm at 1400 - 4000 rpm		
Drive		FWD	
		<b>MG</b>	<b>AG</b>
Maximum speed	km/h	203 <sup>1</sup> )	203 <sup>1</sup> )
Acceleration from 0 - 100 km/h	sec.	9.5	9.3
Kerb weight (unladen weight)	kg	1280	1300
Gross vehicle weight	kg	1765	1785
Maximum front axle weight	kg	935	960
Maximum rear axle weight	kg	950	945
Trailer <sup>2</sup> ) without brakes	kg	640	650
Trailer <sup>2</sup> ) with brakes on gradients up to 8 %	kg	1600	1600
Trailer <sup>2</sup> ) with brakes on gradients up to 12 %	kg	1400	1400
Weight of vehicle and trailer <sup>2</sup> ) on gradients up to 12 %	kg	3215	3235

Footnotes ⇨ page 274

**A3 Sportback 1.4, 4-cylinder (103 kW) with Active Cylinder Management**

Power output	103 kW at 5000 rpm		
Maximum torque	250 Nm at 1500 - 3500 rpm		
Drive		FWD	
		<b>MG</b>	<b>AG</b>
Maximum speed	km/h	213	213 <sup>1</sup> )
Acceleration from 0 - 100 km/h	sec.	8.4	8.4
Kerb weight (unladen weight)	kg	1300	1310
Gross vehicle weight	kg	1785	1795
Maximum front axle weight	kg	955	970
Maximum rear axle weight	kg	945	945
Trailer <sup>2</sup> ) without brakes	kg	650	650
Trailer <sup>2</sup> ) with brakes on gradients up to 8 %	kg	1700	1700
Trailer <sup>2</sup> ) with brakes on gradients up to 12 %	kg	1500	1500
Weight of vehicle and trailer <sup>2</sup> ) on gradients up to 12 %	kg	3335	3345

Footnotes ⇨ page 274

**A3 Sportback 1.8, 4-cylinder**

Power output	FWD: 132 kW at 5100 - 6200 rpm quattro: 132 kW at 4500 - 6200 rpm				
Maximum torque	FWD: 250 Nm at 1250 - 5000 rpm quattro: 280 Nm at 1350 - 4500 rpm				
Drive		FWD		quattro	
		<b>MG</b>	<b>AG</b>		<b>AG</b>
Maximum speed	km/h	235	235 <sup>1)</sup>		228
Acceleration from 0 - 100 km/h	sec.	7.2	7.3		6.8

**In accordance with GB 1589 for China**

Kerb weight (unladen weight)	kg		1415		
Gross vehicle weight	kg		1865		
Maximum front axle weight	kg		1025		
Maximum rear axle weight	kg		945		

**In accordance with 92/21/EEC for Europe and certain other markets**

Kerb weight (unladen weight)	kg	1335	1355		1455
Gross vehicle weight	kg	1820	1840		1940
Maximum front axle weight	kg	990	1020		1055
Maximum rear axle weight	kg	945	945		1000
Trailer <sup>2)</sup> without brakes	kg	660	670		720
Trailer <sup>2)</sup> with brakes on gradients up to 8 %	kg	1800	1800		1800
Trailer <sup>2)</sup> with brakes on gradients up to 12 %	kg	1600	1600		1600
Weight of vehicle and trailer <sup>2)</sup> on gradients up to 12 %	kg	3470	3490		3590

Footnotes ⇒ page 274

**S3 Sportback 2.0, 4-cylinder**

Power output	221 <sup>3)</sup> kW at 5500 - 6200 rpm				
Maximum torque	380 <sup>3)</sup> Nm at 1800 - 5500 rpm				
Drive				quattro	
				<b>MG</b>	<b>AG</b>
Maximum speed	km/h			250 <sup>5)</sup>	250 <sup>5)</sup>
Acceleration from 0 - 100 km/h	sec.			5.3	4.9
Kerb weight (unladen weight)	kg			1500	1520
Gross vehicle weight	kg			1985	2005
Maximum front axle weight	kg			1050	1070
Maximum rear axle weight	kg			1025	1020

Footnotes ⇒ page 274

**A3 Saloon 1.2, 4-cylinder**

Power output	77 kW at 5000 rpm		
Maximum torque	175 Nm at 1400 - 4000 rpm		
Drive	FWD		
		<b>MG</b>	<b>AG</b>
Maximum speed	km/h	--4)	--4)
Acceleration from 0 - 100 km/h	sec.	--4)	--4)
Kerb weight (unladen weight)	kg	--4)	--4)
Gross vehicle weight	kg	--4)	--4)
Maximum front axle weight	kg	--4)	--4)
Maximum rear axle weight	kg	--4)	--4)
Trailer <sup>2)</sup> without brakes	kg	--4)	--4)
Trailer <sup>2)</sup> with brakes on gradients up to 8 %	kg	--4)	--4)
Trailer <sup>2)</sup> with brakes on gradients up to 12 %	kg	--4)	--4)
Weight of vehicle and trailer <sup>2)</sup> on gradients up to 12 %	kg	--4)	--4)

Footnotes ⇨ page 274

**A3 Saloon 1.4, 4-cylinder (90<sup>3)</sup> kW)**

Power output	MG: 90 <sup>3)</sup> kW at 5000 - 6200 rpm AG: 90 <sup>3)</sup> kW at 5000 rpm		
Maximum torque	MG: 200 <sup>3)</sup> Nm at 1400 - 4000 rpm AG: 200 <sup>3)</sup> Nm at 1500 - 4000 rpm		
Drive	FWD		
		<b>MG</b>	<b>AG</b>
Maximum speed	km/h	212	211 <sup>1)</sup>
Acceleration from 0 - 100 km/h	sec.	9.4	9.3
Kerb weight (unladen weight)	kg	1290	1310
Gross vehicle weight	kg	1765	1785
Maximum front axle weight	kg	925	950
Maximum rear axle weight	kg	945	945
Trailer <sup>2)</sup> without brakes	kg	640	650
Trailer <sup>2)</sup> with brakes on gradients up to 8 %	kg	1600	1600
Trailer <sup>2)</sup> with brakes on gradients up to 12 %	kg	1400	1400
Weight of vehicle and trailer <sup>2)</sup> on gradients up to 12 %	kg	3215	3235

Footnotes ⇨ page 274

**A3 Saloon 1.4, 4-cylinder (103 kW) with Active Cylinder Management**

Power output	103 kW at 5000 rpm		
Maximum torque	250 Nm at 1500 - 3500 rpm		
Drive	FWD		
		<b>MG</b>	<b>AG</b>
Maximum speed	km/h	219	217 <sup>1)</sup>
Acceleration from 0 - 100 km/h	sec.	8.4	8.4
Kerb weight (unladen weight)	kg	1315	1325
Gross vehicle weight	kg	1790	1800
Maximum front axle weight	kg	945	960
Maximum rear axle weight	kg	945	945
Trailer <sup>2)</sup> without brakes	kg	650	660
Trailer <sup>2)</sup> with brakes on gradients up to 8 %	kg	1700	1700
Trailer <sup>2)</sup> with brakes on gradients up to 12 %	kg	1500	1500
Weight of vehicle and trailer <sup>2)</sup> on gradients up to 12 %	kg	3340	3350

Footnotes ⇨ *page 274*

**A3 Saloon 1.8, 4-cylinder**

Power output	FWD: 132 kW at 5100 - 6200 rpm quattro: 132 kW at 4500 - 6200 rpm			
Maximum torque	FWD: 250 Nm at 1250 - 5000 rpm quattro: 280 Nm at 1350 - 4500 rpm			
Drive		FWD		quattro
		MG	AG	AG
Maximum speed	km/h	242	242 <sup>1)</sup>	235
Acceleration from 0 - 100 km/h	sec.	7.2	7.3	6.8
Kerb weight (unladen weight)	kg	1345	1370	1470

**In accordance with GB 1589 for China**

Kerb weight (unladen weight)	kg		1420		
Gross vehicle weight	kg		1870		
Maximum front axle weight	kg		1025		
Maximum rear axle weight	kg		950		

**In accordance with 92/21/EEC for Europe and certain other markets**

Kerb weight (unladen weight)	kg	1345	1370		1470
Gross vehicle weight	kg	1820	1845		1945
Maximum front axle weight	kg	985	1010		1040
Maximum rear axle weight	kg	940	940		1000
Trailer <sup>2)</sup> without brakes	kg	670	680		730
Trailer <sup>2)</sup> with brakes on gradients up to 8 %	kg	1800	1800		1800
Trailer <sup>2)</sup> with brakes on gradients up to 12 %	kg	1600	1600		1600
Weight of vehicle and trailer <sup>2)</sup> on gradients up to 12 %	kg	3470	3495		3595

 Footnotes ⇨ *page 274*
**S3 Saloon 2.0, 4-cylinder**

Power output	221 <sup>3)</sup> kW at 5500 - 6200 rpm			
Maximum torque	380 <sup>3)</sup> Nm at 1800 - 5500 rpm			
Drive			quattro	
			MG	AG
Maximum speed	km/h		250 <sup>5)</sup>	250 <sup>5)</sup>
Acceleration from 0 - 100 km/h	sec.		5.3	4.9
Kerb weight (unladen weight)	kg		1505	1525
Gross vehicle weight	kg		1980	2000
Maximum front axle weight	kg		1055	1075
Maximum rear axle weight	kg		1030	1030

 Footnotes ⇨ *page 274*

## Diesel engines

### A3 1.6 TDI, 4-cylinder (77/81 kW)

Power output	77 kW at 3000 - 4000 rpm 81 kW at 3200 - 4000 rpm (e)			
Maximum torque	77 kW: 250 Nm at 1500 - 2750 rpm 81 kW: 250 Nm at 1500 - 3000 rpm (e)			
Drive		FWD		e model
		<b>MG</b>	<b>AG</b>	<b>MG</b>
Maximum speed	km/h	195	195	200
Acceleration from 0 - 100 km/h	sec.	10.7	10.7	10.5
Kerb weight (unladen weight)	kg	1305	1325	1280
Gross vehicle weight	kg	1790	1810	1765
Maximum front axle weight	kg	985	1010	970
Maximum rear axle weight	kg	900	895	890
Trailer <sup>2)</sup> without brakes	kg	650	660	640
Trailer <sup>2)</sup> with brakes on gradients up to 8 %	kg	1700	1700	1300
Trailer <sup>2)</sup> with brakes on gradients up to 12 %	kg	1500	1500	1000
Weight of vehicle and trailer <sup>2)</sup> on gradients up to 12 %	kg	3340	3360	2815

Footnotes ⇒ page 274

### A3 2.0 TDI, 4-cylinder (81 kW)

Power output	81 kW at -- <sup>4)</sup> rpm			
Maximum torque	250 Nm at -- <sup>4)</sup> rpm			
Drive		FWD		
		<b>MG</b>		
Maximum speed	km/h	-- <sup>4)</sup>		
Acceleration from 0 - 100 km/h	sec.	-- <sup>4)</sup>		
Kerb weight (unladen weight)	kg	-- <sup>4)</sup>		
Gross vehicle weight	kg	-- <sup>4)</sup>		
Maximum front axle weight	kg	-- <sup>4)</sup>		
Maximum rear axle weight	kg	-- <sup>4)</sup>		
Trailer <sup>2)</sup> without brakes	kg	-- <sup>4)</sup>		
Trailer <sup>2)</sup> with brakes on gradients up to 8 %	kg	-- <sup>4)</sup>		
Trailer <sup>2)</sup> with brakes on gradients up to 12 %	kg	-- <sup>4)</sup>		
Weight of vehicle and trailer <sup>2)</sup> on gradients up to 12 %	kg	-- <sup>4)</sup>		

Footnotes ⇒ page 274

**A3 2.0 TDI, 4-cylinder (110 kW)**

Power output	110 <sup>3)</sup> kW at 3500 - 4000 rpm				
Maximum torque	320 <sup>3)</sup> Nm at 1750 - 3000 rpm				
Drive		FWD		quattro	
		<b>MG</b>	<b>AG</b>	<b>MG</b>	
Maximum speed	km/h	216	213	214	
Acceleration from 0 - 100 km/h	sec.	8.6	8.3	8.4	
Kerb weight (unladen weight)	kg	1355	1370	1435	
Gross vehicle weight	kg	1840	1855	1920	
Maximum front axle weight	kg	1030	1035	1040	
Maximum rear axle weight	kg	925	915	975	
Trailer <sup>2)</sup> without brakes	kg	670	680	710	
Trailer <sup>2)</sup> with brakes on gradients up to 8 %	kg	1800	1800	1800	
Trailer <sup>2)</sup> with brakes on gradients up to 12 %	kg	1600	1600	1800	
Weight of vehicle and trailer <sup>2)</sup> on gradients up to 12 %	kg	3490	3505	3770	

Footnotes ⇨ page 274

**A3 2.0 TDI, 4-cylinder (135 kW)**

Power output	135 kW at 3500 - 4000 rpm				
Maximum torque	380 Nm at 1750 - 3250 rpm				
Drive		FWD		quattro	
		<b>MG</b>			<b>AG</b>
Maximum speed	km/h	234			230
Acceleration from 0 - 100 km/h	sec.	7.3			6.8
Kerb weight (unladen weight)	kg	1365			1470
Gross vehicle weight	kg	1850			1955
Maximum front axle weight	kg	1030			1070
Maximum rear axle weight	kg	925			985
Trailer <sup>2)</sup> without brakes	kg	680			730
Trailer <sup>2)</sup> with brakes on gradients up to 8 %	kg	1800			1800
Trailer <sup>2)</sup> with brakes on gradients up to 12 %	kg	1600			1800
Weight of vehicle and trailer <sup>2)</sup> on gradients up to 12 %	kg	3500			3805

Footnotes ⇨ page 274

**A3 Sportback 1.6 TDI, 4-cylinder (77/81 kW)**

Power output	77 kW at 3000 - 4000 rpm 81 kW at 3200 - 4000 rpm (e)			
Maximum torque	77 kW: 250 Nm at 1500 - 2750 rpm 81 kW: 250 Nm at 1500 - 3000 rpm (e)			
Drive		FWD		e model
		<b>MG</b>	<b>AG</b>	<b>MG</b>
Maximum speed	km/h	195	195	200
Acceleration from 0 - 100 km/h	sec.	10.9	10.9	10.7
Kerb weight (unladen weight)	kg	1335	1355	1315
Gross vehicle weight	kg	1820	1840	1800
Maximum front axle weight	kg	1010	1030	985
Maximum rear axle weight	kg	930	930	920
Trailer <sup>2)</sup> without brakes	kg	660	670	650
Trailer <sup>2)</sup> with brakes on gradients up to 8 %	kg	1700	1700	1300
Trailer <sup>2)</sup> with brakes on gradients up to 12 %	kg	1500	1500	1000
Weight of vehicle and trailer <sup>2)</sup> on gradients up to 12 %	kg	3370	3390	2850

Footnotes ⇒ page 274

**A3 Sportback 2.0 TDI, 4-cylinder (81 kW)**

Power output	81 kW at -- <sup>4)</sup> rpm			
Maximum torque	250 Nm at -- <sup>4)</sup> rpm			
Drive		FWD		
		<b>MG</b>		
Maximum speed	km/h	-- <sup>4)</sup>		
Acceleration from 0 - 100 km/h	sec.	-- <sup>4)</sup>		
Kerb weight (unladen weight)	kg	-- <sup>4)</sup>		
Gross vehicle weight	kg	-- <sup>4)</sup>		
Maximum front axle weight	kg	-- <sup>4)</sup>		
Maximum rear axle weight	kg	-- <sup>4)</sup>		
Trailer <sup>2)</sup> without brakes	kg	-- <sup>4)</sup>		
Trailer <sup>2)</sup> with brakes on gradients up to 8 %	kg	-- <sup>4)</sup>		
Trailer <sup>2)</sup> with brakes on gradients up to 12 %	kg	-- <sup>4)</sup>		
Weight of vehicle and trailer <sup>2)</sup> on gradients up to 12 %	kg	-- <sup>4)</sup>		

Footnotes ⇒ page 274



**A3 Sportback 2.0 TDI, 4-cylinder (110 kW)**

Power output	110 <sup>3)</sup> kW at 3500 - 4000 rpm			
Maximum torque	320 <sup>3)</sup> Nm at 1750 - 3000 rpm			
Drive		FWD		quattro
		<b>MG</b>	<b>AG</b>	<b>MG</b>
Maximum speed	km/h	216	213	214
Acceleration from 0 - 100 km/h	sec.	8.7	8.4	8.5
Kerb weight (unladen weight)	kg	1385	1395	1465
Gross vehicle weight	kg	1870	1880	1950
Maximum front axle weight	kg	1040	1045	1060
Maximum rear axle weight	kg	945	935	1005
Trailer <sup>2)</sup> without brakes	kg	690	690	730
Trailer <sup>2)</sup> with brakes on gradients up to 8 %	kg	1800	1800	1800
Trailer <sup>2)</sup> with brakes on gradients up to 12 %	kg	1600	1600	1800
Weight of vehicle and trailer <sup>2)</sup> on gradients up to 12 %	kg	3520	3530	3800

Footnotes ⇨ page 274

**A3 Sportback 2.0 TDI, 4-cylinder (135 kW)**

Power output	135 kW at 3500 - 4000 rpm			
Maximum torque	380 Nm at 1750 - 3250 rpm			
Drive		FWD		quattro
		<b>MG</b>		<b>AG</b>
Maximum speed	km/h	234		230
Acceleration from 0 - 100 km/h	sec.	7.4		6.9
Kerb weight (unladen weight)	kg	1395		1500
Gross vehicle weight	kg	1880		1985
Maximum front axle weight	kg	1055		1090
Maximum rear axle weight	kg	950		1010
Trailer <sup>2)</sup> without brakes	kg	690		750
Trailer <sup>2)</sup> with brakes on gradients up to 8 %	kg	1800		1800
Trailer <sup>2)</sup> with brakes on gradients up to 12 %	kg	1600		1800
Weight of vehicle and trailer <sup>2)</sup> on gradients up to 12 %	kg	3530		3835

Footnotes ⇨ page 274

**A3 Saloon 1.6 TDI, 4-cylinder (77 kW)**

Power output	77 kW at 3000 - 4000 rpm			
Maximum torque	250 Nm at 1500 - 2750 rpm			
Drive		FWD		
		<b>MG</b>	<b>AG</b>	
Maximum speed	km/h	198	198	
Acceleration from 0 - 100 km/h	sec.	10.9	10.9	
Kerb weight (unladen weight)	kg	1350	1365	
Gross vehicle weight	kg	1825	1840	
Maximum front axle weight	kg	1000	1015	
Maximum rear axle weight	kg	930	930	
Trailer <sup>2)</sup> without brakes	kg	670	680	
Trailer <sup>2)</sup> with brakes on gradients up to 8 %	kg	1700	1700	
Trailer <sup>2)</sup> with brakes on gradients up to 12 %	kg	1500	1500	
Weight of vehicle and trailer <sup>2)</sup> on gradients up to 12 %	kg	3375	3390	

Footnotes ⇒ page 274

**A3 Saloon 2.0 TDI, 4-cylinder (81 kW)**

Power output	81 kW at -- <sup>4)</sup> rpm			
Maximum torque	250 Nm at -- <sup>4)</sup> rpm			
Drive		FWD		
		<b>MG</b>		
Maximum speed	km/h	-- <sup>4)</sup>		
Acceleration from 0 - 100 km/h	sec.	-- <sup>4)</sup>		
Kerb weight (unladen weight)	kg	-- <sup>4)</sup>		
Gross vehicle weight	kg	-- <sup>4)</sup>		
Maximum front axle weight	kg	-- <sup>4)</sup>		
Maximum rear axle weight	kg	-- <sup>4)</sup>		
Trailer <sup>2)</sup> without brakes	kg	-- <sup>4)</sup>		
Trailer <sup>2)</sup> with brakes on gradients up to 8 %	kg	-- <sup>4)</sup>		
Trailer <sup>2)</sup> with brakes on gradients up to 12 %	kg	-- <sup>4)</sup>		
Weight of vehicle and trailer <sup>2)</sup> on gradients up to 12 %	kg	-- <sup>4)</sup>		

Footnotes ⇒ page 274

**A3 Saloon 2.0 TDI, 4-cylinder (110 kW)**

Power output	110 <sup>3)</sup> kW at 3500 - 4000 rpm				
Maximum torque	320 <sup>3)</sup> Nm at 1750 - 3000 rpm				
Drive		FWD		quattro	
		<b>MG</b>	<b>AG</b>	<b>MG</b>	
Maximum speed	km/h	220 <sup>3)</sup>	219	220	
Acceleration from 0 - 100 km/h	sec.	8.7	8.4	8.5	
Kerb weight (unladen weight)	kg	1390	1415	1475	
Gross vehicle weight	kg	1865	1890	1950	
Maximum front axle weight	kg	1025	1050	1045	
Maximum rear axle weight	kg	950	940	1010	
Trailer <sup>2)</sup> without brakes	kg	690	700	730	
Trailer <sup>2)</sup> with brakes on gradients up to 8 %	kg	1800	1800	1800	
Trailer <sup>2)</sup> with brakes on gradients up to 12 %	kg	1600	1600	1800	
Weight of vehicle and trailer <sup>2)</sup> on gradients up to 12 %	kg	3515	3540	3800	

 Footnotes ⇨ [page 274](#)

## Numbers and Symbols

360° display ..... 140

### A

A/C (automatic air conditioner) ..... 79  
 A/C (manual air conditioner) ..... 78  
 ABS  
   see Anti-lock brake system ..... 182  
 Acceleration figures ..... 275  
   see also Technical data ..... 275  
 Accelerator pedal ..... 161  
 Accessories ..... 70  
 Active Cylinder Management ..... 33  
 Active lane assist ..... 128  
   Cleaning area around camera ..... 205  
   Driver messages ..... 129  
   Indicator lamp ..... 129  
   Setting steering vibration ..... 130  
   Setting time of warning ..... 130  
   Switching on/off ..... 129  
 Adaptive cruise control ..... 116  
   Automatic gearbox ..... 120  
   Cleaning sensors ..... 205  
   Congested traffic ..... 120  
   Driver intervention prompt ..... 123  
   Driver messages ..... 123  
   General notes ..... 116  
   Vehicles with manual gearbox ..... 120  
 Adaptive light ..... 54, 57  
   Indicator lamp ..... 25  
 Advanced gear-change indicator (efficiency programme) ..... 31  
 Advanced key  
   see Convenience key ..... 88  
 Airbag ..... 171  
   Deactivating front passenger's airbag ..... 180  
   Front airbags ..... 172  
   Head-protection airbag ..... 178  
   Important safety notes on knee airbag system ..... 176  
   Knee airbag ..... 175  
   Side airbags ..... 177  
   Warning lamp ..... 21

Air conditioner (automatic)  
   Adjusting air outlets ..... 80, 81  
   Air distribution, air outlets ..... 80  
   Air recirculation mode ..... 80  
   AUTO (automatic mode) ..... 79  
   Auxiliary heating/ventilation ..... 82  
   Blower ..... 80  
   Controls ..... 79  
   Defrosting windows ..... 80  
   Drive select ..... 136  
   Key-coded settings ..... 79  
   Rear window heating ..... 81  
   Selecting temperature ..... 79  
   Synchronisation ..... 79  
 Air conditioner (manual)  
   Adjusting air outlets ..... 78, 81  
   Air distribution, air outlets ..... 78  
   Air recirculation mode ..... 78  
   Blower ..... 78  
   Controls ..... 77  
   Defrosting windows ..... 78  
   Key-coded settings ..... 78  
   Rear window heating ..... 81  
   Temperature selection ..... 78  
 Air distribution, setting (automatic air conditioner) ..... 80  
 Air distribution, setting (heating/ventilation system or manual air conditioner) ... 78  
 Air outlets, adjusting ..... 81  
 Air outlets, adjusting (heating/ventilation system) ..... 78  
 Air outlets, adjusting (manual air conditioner) ..... 78  
 Air recirculation mode  
   Automatic air conditioner ..... 80  
   Heating/ventilation system ..... 78  
   Manual air conditioner ..... 78  
 Alarm system  
   see Anti-theft alarm system ..... 41  
 All-weather lights (LED headlights) ..... 54  
 Alterations to the vehicle ..... 233  
 Alternator (warning lamp) ..... 21  
 Anti-dazzle exterior mirrors ..... 62  
 Anti-dazzle interior mirror ..... 62  
 Anti-freeze  
   Coolant ..... 216  
   Windscreen washer system ..... 221

- Anti-lock brake system ..... 182
    - Indicator lamp ..... 22
  - Anti-theft alarm system ..... 41
    - Interior monitor ..... 48
    - Tow-away protection ..... 48
  - Anti-theft wheel bolts ..... 239
  - Armrest, front ..... 67
  - Armrest, rear ..... 68
  - Ashtray ..... 69
  - ASR
    - see Traction control system ..... 182
  - Audi active lane assist
    - see Active lane assist ..... 128
  - Audi adaptive cruise control
    - see Adaptive cruise control ..... 116
  - Audi adaptive light
    - see Adaptive light ..... 54
  - Audi magnetic ride
    - see Suspension control ..... 136
  - Audi pre sense
    - see Pre sense ..... 125
  - Audi side assist
    - see Side assist ..... 132
  - AUTO
    - Automatic air conditioner ..... 79
    - Automatic headlights ..... 54
  - Auto Lock (central locking system) ..... 41
  - Automatic air conditioner
    - see Air conditioner (automatic) ..... 79
  - Automatic gearbox ..... 106
    - Back-up programme ..... 113
    - Downhill speed control ..... 110
    - Driving tips ..... 108
    - Kick-down ..... 111
    - Launch control programme ..... 112
    - Malfunction ..... 107
    - Manual gear selection ..... 111
    - Manual release of selector lever (left-hand drive) ..... 114
    - Manual release of selector lever (right-hand drive) ..... 115
    - Safety interlock for ignition key ..... 86
    - Selector lever lock ..... 107
    - Selector lever positions ..... 106
    - Steering wheel with paddle levers ..... 111
  - S tronic ..... 106
  - tiptronic ..... 111
  - Automatic headlights ..... 54, 58
  - Auxiliaries (efficiency programme) ..... 32
  - Auxiliary heating/ventilation ..... 82
    - Remote control ..... 84, 85
  - Average fuel consumption ..... 28, 30
  - Average speed ..... 28, 30
  - Axle loads ..... 275
  - Axle weights
    - see Technical data ..... 275
- ## B
- Background lighting ..... 60
  - Bandages
    - see First-aid kit ..... 236
  - Bass box ..... 243
  - Battery ..... 218
    - Charge ..... 21, 187
    - Charging ..... 220
    - Connecting/disconnecting ..... 218
    - Indicator lamp ..... 21
    - Jump-starting ..... 244
    - Power management ..... 187
    - Replacing ..... 221
    - Winter conditions ..... 218
  - Belts
    - see Seat belts ..... 165
  - Belt tensioners ..... 169
  - Bicycle rack
    - On towing bracket ..... 197
  - Biodiesel ..... 209
  - Bioethanol
    - see Ethanol (fuel) ..... 209
  - Blower
    - Automatic air conditioner ..... 80
    - Heating/ventilation system ..... 78
    - Manual air conditioner ..... 78
  - Boost ..... 31
  - Boot
    - see Luggage compartment ..... 162
  - Boot lid
    - Central locking system ..... 49
    - Manual release ..... 49
  - Brakes ..... 184
    - Brake assist system ..... 182
    - Brake fluid ..... 218
    - Brake pads worn ..... 23

- Brake pedal ..... 161
  - Brake servo ..... 184
  - Driving away on a slope ..... 95
  - Emergency braking function ..... 94
  - Indicator lamp ..... 23, 25
  - New brake pads ..... 184
  - Parking brake ..... 92
  - Warning lamp ..... 19
  - Bulb failure
    - Changing bulbs ..... 253
    - Indicator lamp ..... 25
  - Bulbs
    - Dipped headlights ..... 256
  - Bulbs, changing ..... 253
    - Bulb size (front) ..... 254
    - Daytime running lights ..... 257
    - Front bulbs ..... 254
    - Front fog lights ..... 262
    - Inner rear lights . 265, 266, 267, 270, 271
    - Main beam headlights ..... 257
    - Outer rear lights ..... 263, 268
    - Rear bulb size (A3 Saloon) ..... 256
    - Rear bulb size (A3 Sportback) ..... 255
    - Rear bulb size (A3) ..... 254
    - Rear bulbs (A3 Saloon) ..... 256
    - Rear bulbs (A3 Sportback) ..... 255
    - Rear bulbs (A3) ..... 254
    - Side lights ..... 258
    - Turning light (xenon headlights) ..... 261
    - Turn signals (halogen headlights) ..... 259
    - Turn signals (xenon headlights) ..... 260
- C**
- Camera-based traffic sign recognition ... 33
  - Capacities
    - Fuel tank ..... 273
    - Washer fluid reservoir ..... 273
  - Capacity ..... 275
  - Caps for wheel bolts, removing ..... 239
  - Car care ..... 204
  - Care
    - see Cleaning ..... 204
  - Car keys ..... 42
  - Catalytic converter ..... 190
  - CD-ROM player (navigation system) ..... 71
  - CD changer ..... 71
  - Central locking system ..... 41
    - Boot lid ..... 49
    - Central locking switch ..... 47
    - Convenience key ..... 45
    - Electric windows ..... 51
    - Folding in exterior mirrors ..... 46
    - Locking doors manually ..... 48
    - Panorama sun roof ..... 51
    - Remote control key ..... 44
    - Security central locking ..... 46
    - Settings ..... 46
  - Central warning/indicator lamp ..... 14
  - Centre console lighting, adjusting bright-  
ness ..... 60
  - Cetane number (diesel) ..... 209
  - Charge pressure display ..... 31
  - Child-proof catches
    - Rear doors ..... 50
  - Child safety switch
    - Windows ..... 51
  - Child safety switches
    - Rear doors, electric window switches ... 50
  - Child seats ..... 157
    - Categories ..... 158
    - Fitting ..... 159
    - ISOFIX ..... 159
    - ISOFIX and top tether ..... 160
    - Side airbags ..... 158
  - Cigarette lighter ..... 69
  - Cleaning ..... 204
    - Cleaning/de-icing windows ..... 206
    - Cleaning/treating natural leather ..... 207
    - Cleaning Alcantara ..... 206
    - Cleaning carbon parts ..... 206, 207
    - Cleaning controls and displays ..... 206
    - Cleaning fabrics ..... 206
    - Cleaning leatherette ..... 206
    - Cleaning plastic parts ..... 206
    - Cleaning seat upholstery ..... 206
    - Cleaning vehicle ..... 204
  - Clock ..... 9
    - GPS reception ..... 9
  - Closing
    - Bonnet ..... 213
    - Panorama sun roof ..... 52
    - Windows ..... 51

- Coasting mode ..... 111
  - Coat hooks ..... 71
  - Colour code ..... 272
  - Coming home ..... 59
  - Compartments ..... 70
  - Consumption (fuel) ..... 28, 30, 272
  - Controls and displays (overview) ..... 6
  - Control units ..... 188
  - Convenience key
    - Indicator lamp ..... 91
    - Locking and unlocking the vehicle ..... 45
    - Manual operation ..... 91
    - Starting engine (START ENGINE STOP button) ..... 88
    - Switching off engine (START ENGINE STOP button) ..... 90
    - Switching on ignition ..... 88
  - Convenience open/close ..... 51
  - Cooling mode (automatic air conditioner) 79
  - Cooling mode (manual air conditioner) ... 78
  - Cooling system
    - Anti-freeze ..... 216
    - Checking coolant level ..... 217
    - Coolant temperature gauge ..... 11
    - Topping up coolant ..... 217
    - Warning lamp ..... 20
  - Cornering light ..... 54, 57, 136
  - Courtesy light ..... 60
  - Cross bars (roof) ..... 72
  - Cruise control system
    - Adjusting stored speed ..... 97
    - Description ..... 97
    - Pre-selecting a speed ..... 98
    - Switching off ..... 98
    - Switching on ..... 97
  - Cup holders ..... 70
  - Current fuel consumption ..... 27, 28, 30
  - Cylinder management system
    - see Active Cylinder Management ..... 33
  - Cylinders ..... 275
- D**
- Date display ..... 9
  - Date, setting ..... 9
  - Daytime running lights ..... 54
    - Changing bulbs ..... 257
  - Daytime running lights, switching on/off . 59
  - Deactivating front passenger's airbag ... 180
  - Defrosting (windows)
    - Automatic air conditioner ..... 80
    - Heating/ventilation system ..... 78
    - Manual air conditioner ..... 78
  - DEF (instrument cluster) ..... 10
  - Deluxe automatic air conditioner
    - see Air conditioner (automatic) ..... 79
  - Diagnostic connection ..... 188
  - Diesel
    - Diesel particulate filter ..... 190
    - Draining fuel filter ..... 24
    - Engine oil ..... 214
    - Fuel ..... 209
    - Indicator lamp ..... 23
    - Preheating glow plugs (button) ..... 88
    - Preheating glow plugs (key) ..... 86
  - Dimensions
    - Vehicle dimensions ..... 273
  - Dipped headlights
    - Changing bulbs ..... 256
  - Directional tread (tyres) ..... 241
  - Distance covered ..... 28, 30
  - Door catches, bonnet and boot lid warning ..... 28, 29
  - Doors
    - Child-proof catches ..... 50
    - Child safety switches ..... 50
  - Doors, locking manually ..... 48
  - Downhill speed control ..... 110
  - Draining fuel filter (diesel) ..... 24
  - Driver information system ..... 27
    - Boost ..... 31
    - CD/radio display ..... 28, 29
    - Controls on multi-function steering wheel ..... 29
    - Controls on windscreen wiper lever .... 28
    - Door catches, bonnet and boot lid warning ..... 28, 29
    - Driver messages ..... 14
    - Efficiency programme ..... 31
    - Engine oil temperature display ..... 36
    - Gear-change indicator ..... 31
    - Lap timer ..... 36
    - On-board computer ..... 28, 30
    - Outside temperature display ..... 28, 29

- Service interval display ..... 13
  - Warning and indicator lamps ..... 14
  - Drive select ..... 136
    - Indicator lamp ..... 26
  - Driving
    - Run-flat tyres ..... 230
  - Driving away from a standstill
    - Hill hold assist ..... 95
    - Hold assist ..... 95
    - Parking brake auto release ..... 94
    - When towing a trailer ..... 94
  - Driving on left ..... 59
  - Driving on right ..... 59
  - Driving safety ..... 153
  - Driving through water ..... 190
  - Driving time ..... 28, 30
  - Dust filter
    - see Pollution filter ..... 77
- E**
- E10
    - see Ethanol (fuel) ..... 209
  - ECO mode (automatic air conditioner) ... 79
  - Economical driving ..... 191
  - Economy tips (efficiency programme) .... 32
  - EDL
    - see Electronic differential lock ..... 182
  - Efficiency programme ..... 31
    - Auxiliaries ..... 32
    - Description ..... 31
    - Economy tips ..... 32
    - Gear-change indicator ..... 31
  - Electrical accessories
    - see Electrical socket ..... 70
  - Electrical socket ..... 69, 70
  - Electric seat adjustment ..... 66
  - Electric windows ..... 51
    - Child safety switch ..... 51
    - Child safety switches ..... 50
    - Convenience open/close ..... 51
    - Malfunction ..... 52
  - Electro-mechanical parking brake
    - see Parking brake ..... 92
  - Electro-mechanical power steering ..... 185
    - Indicator lamp ..... 185
  - Electronic differential lock ..... 182
    - Indicator lamp ..... 22
  - Electronic immobiliser
    - see Immobiliser ..... 42
  - Electronic limited slip differential ..... 182
  - Electronic stabilisation control (ESC) ... 182
    - Indicator lamp ..... 22
  - Emission control systems
    - Catalytic converter ..... 190
    - Diesel particulate filter ..... 190
  - Emission control system (indicator lamp) . 23
  - Emissions ..... 272
  - Engine
    - Coolant ..... 216
    - Engine data ..... 275
    - Jump-starting ..... 244
    - Preheating glow plugs ..... 88
    - Preheating glow plugs (key) ..... 86
    - Start/stop system ..... 98
    - Starting (button) ..... 88
    - Starting (driver messages for convenience key) ..... 91
    - Starting (key) ..... 86
    - Switching off (button) ..... 90
    - Switching off (driver messages for mechanical ignition lock) ..... 91
    - Switching off (key) ..... 88
  - Engine code ..... 272
  - Engine compartment
    - Closing bonnet ..... 213
    - Layout ..... 214
    - Opening bonnet ..... 213
    - Safety notes ..... 212
  - Engine data
    - see Technical data ..... 275
  - Engine management (indicator lamp) ... 23
  - Engine oil ..... 214
    - Changing ..... 214
    - Checking oil level ..... 215
    - Consumption ..... 215
    - Dipstick ..... 214, 215
    - Indicator lamp ..... 24
    - Oil change service ..... 214
    - Service intervals ..... 214
    - Temperature display ..... 36
    - Topping up ..... 216
    - Warning lamp ..... 21



- Engine speed governing (indicator lamp) . 24
- Engine start/stop mode  
see Start/stop system . . . . . 101
- Engine start system (warning lamp) . . . . . 25
- Environmental tips  
Environmental compatibility . . . . . 192  
Filling the tank . . . . . 210, 211  
Leaks . . . . . 213  
Minimising pollution . . . . . 191  
Rear window heating . . . . . 81  
Roof carrier . . . . . 72
- EPC (engine management) . . . . . 23
- ESC  
Electronic stabilisation control . . . . . 182  
Multicollision brake assist system . . . . . 182  
Sport mode . . . . . 183
- ESP  
see ESC . . . . . 182
- Ethanol (fuel) . . . . . 209
- Event memory . . . . . 188
- Exterior lights . . . . . 54  
Changing bulbs . . . . . 253
- Exterior mirrors  
Adjusting . . . . . 61  
Anti-dazzle setting . . . . . 62  
Folding in . . . . . 61  
Heating . . . . . 61
- F**
- Fastening rings . . . . . 74, 163
- Filling the tank . . . . . 210  
Fuel gauge (petrol/diesel) . . . . . 11  
Gas tank capacity . . . . . 273  
Opening fuel tank flap . . . . . 210  
Petrol/diesel tank capacity . . . . . 273  
Releasing fuel tank flap manually . . . . . 212
- Fire extinguisher . . . . . 236
- First-aid kit . . . . . 236
- Fixed oil change service . . . . . 214
- Flexible oil change service . . . . . 214
- Floor mats . . . . . 161
- Floor panel, lowering . . . . . 74
- Fog lights . . . . . 54  
Changing bulb . . . . . 262
- Folding in exterior mirrors  
Central locking system . . . . . 46
- Footwell light . . . . . 60
- Four-wheel drive . . . . . 186
- Front seats  
see Seats . . . . . 66, 73
- Front window  
see Windscreen . . . . . 62
- Fuel . . . . . 209  
Consumption . . . . . 272  
Current fuel consumption . . . . . 28, 30  
Ethanol . . . . . 209  
Fuel gauge . . . . . 9  
Fuel gauge (petrol/diesel) . . . . . 11  
Gas fuel gauge . . . . . 104  
Natural gas . . . . . 102  
Saving fuel . . . . . 136  
Tank capacity . . . . . 273  
Warning light . . . . . 24
- Fuel economy  
Coasting mode . . . . . 111  
Driving style . . . . . 191  
Efficiency programme . . . . . 31
- Fuel range . . . . . 28, 30
- Fuses  
Changing . . . . . 250  
Fuse list . . . . . 251  
In vehicle interior . . . . . 250
- G**
- Gas odour . . . . . 102
- Gear-change indicator . . . . . 12
- Gear-change indicator (efficiency programme) . . . . . 31
- Gearbox malfunction (indicator lamp) . . . . . 113
- Generator  
see Alternator (warning lamp) . . . . . 21
- Glove box . . . . . 71  
CD changer . . . . . 71
- GPS clock . . . . . 9
- Gross vehicle weight . . . . . 275
- H**
- Handbrake  
see Parking brake . . . . . 92
- Hazard warning lights . . . . . 59  
Indicator lamp . . . . . 26
- Headlamp converter . . . . . 59

- Headlight range control ..... 54
    - Indicator lamp ..... 25
  - Headlights ..... 54
    - Changing bulbs ..... 253, 257
    - Driving on left, driving on right ..... 59
    - Headlamp converter ..... 59
    - Headlight range control ..... 54
    - Indicator lamp ..... 25
    - Washer system ..... 62
    - Washing ..... 205
  - Head restraints
    - Adjusting ..... 68, 156
    - Removing/installing ..... 68
  - Heater (supplementary heater for diesel engine) ..... 82
  - Heating
    - Exterior mirrors ..... 61
    - Rear window ..... 81
    - Seats ..... 81
    - Washer jets ..... 62
  - Heating/ventilation system
    - Adjusting air outlets ..... 78, 81
    - Air distribution, air outlets ..... 78
    - Air recirculation mode ..... 78
    - Blower ..... 78
    - Controls ..... 77
    - Key-coded settings ..... 78
    - Rear window heating ..... 81
    - Temperature selection ..... 78
  - High-visibility vest ..... 235
  - Hill hold assist ..... 95
  - Hill starting
    - see Hill hold assist ..... 95
  - Hook ..... 75
  - Horn ..... 6
  - Hub caps, removing ..... 239
- I**
- Identification data
    - Chassis number ..... 272
  - Ignition
    - Switching on/off (with button) ..... 88
    - Warning lamp ..... 25
  - Ignition lock
    - Mechanical ..... 86
  - Imbalance (wheels) ..... 224
  - Immobiliser ..... 42
  - Indicator lamps
    - see Warning lamps ..... 14
  - Inflation pressures (tyres) ..... 224, 231
  - Inspection intervals
    - On vehicles with driver information system ..... 13
  - Instrument cluster ..... 9
    - Natural gas engine ..... 103
    - Petrol or diesel engine ..... 9
  - Instruments ..... 9
    - Adjusting brightness ..... 60
  - Interior lights ..... 60
  - Interior mirrors
    - see Mirrors ..... 62
  - Interior monitor ..... 48
  - Intermittent wipe (windscreen wipers) ... 62
  - ISOFIX (securing child seats) ..... 159
- J**
- Jack ..... 236, 240
    - Jacking points ..... 240
  - Jump-starting ..... 244
- K**
- Kerb weight ..... 273, 275
  - Key-coded settings
    - Automatic air conditioner ..... 79
    - Heating/ventilation system ..... 78
    - Manual air conditioner ..... 78
  - Key-operated switch for front passenger's airbag ..... 180
  - Keys ..... 42
    - Checking number of keys ..... 42
    - Driver messages (for convenience key) .. 91
    - Driver messages (for mechanical ignition lock) ..... 91
    - Key not recognised ..... 91
    - Locking and unlocking the vehicle . 44, 45
    - Replacement keys ..... 42
    - Replacing the battery ..... 43
  - Kick-down
    - Automatic gearbox ..... 111
    - Manual gearbox ..... 92

Knee airbag .....	175
Description .....	175
How it works .....	176
Important safety notes .....	176

## L

Lane assist	
see Active lane assist .....	128
Lane change assist feature	
see Side assist .....	132
Lane departure warning feature	
see Active lane assist .....	128
Lap timer .....	36
Evaluating lap times .....	38, 40
Starting .....	37, 39
Launch control programme (automatic gearbox) .....	112
Leaving home .....	59
LED headlights	
All-weather lights .....	54
Lights	
Adaptive light .....	54, 57
Adjusting sensitivity of automatic headlights .....	58
Background lighting .....	60
Changing bulbs .....	253
Coming/leaving home .....	59
Daytime running lights, switching on/off .....	59
Dipped headlights .....	54
Exterior lights .....	54
Front/rear fog lights .....	54
Headlamp converter .....	59
Headlight flasher .....	55
Headlight range control .....	54
Headlights .....	54
Interior/reading lights .....	60
Main beam assist .....	56
Main beam headlights .....	55
Motorway light .....	55
Parking lights .....	55
Side lights .....	54
Light sensor/rain sensor	
Headlights .....	54
Indicator lamp .....	26
Intermittent wipe (windscreen wipers) .....	62
Load-through hatch with bag .....	75

Locking	
Locking passenger's door manually .....	48
Locking/unlocking	
By remote control .....	44
With the central locking switch .....	47
With the convenience key .....	45
With the key .....	45
Long-term memory .....	27
Luggage compartment .....	73
Cover .....	73
Electrical socket .....	70
Extending .....	73
Fastening rings .....	74
Load-through hatch with bag .....	75
Loading .....	162
Lowering floor panel .....	74
Retaining hook .....	75
Reversible floor covering .....	75
Stowing luggage safely .....	162
Stretch net .....	74
Lumbar support .....	66

## M

Main beam headlights .....	55
Main beam assist .....	56
Maintenance intervals	
On vehicles with driver information system .....	13
Make-up mirrors .....	62
Manual gearbox	
Kick-down .....	92
Manual operation	
Convenience key .....	91
Emergency braking function .....	94
Panorama sun roof .....	53
Manual release	
Boot lid .....	49
Fuel tank flap .....	212
Selector lever (left-hand drive) .....	114
Selector lever (right-hand drive) .....	115
Matt paintwork, washing .....	204
Maximum speed .....	275
see also Technical data .....	275
Mileage recorder .....	10

Mirrors	
Adjusting exterior mirrors	61
Anti-dazzle setting	62
Make-up mirrors	62
Mobile phones	233
Modifications	233
Motorway light	55
Mounting pin (for changing wheels)	236
Multi-function steering wheel	30
On-board computer	30
Multicollision brake assist system	182

## N

Natural gas engine	102
CNG	102
Fuel gauge	104
Fuel system leak	102
Instrument cluster	103
LNG	102, 105
Odour	102
Operating mode	103
Refuelling	104
Tank cap	104
Tank capacity	273
Navigation system	
CD-ROM player	71
Noises	
When refuelling with natural gas	105
Number of keys	42

## O

Octane rating (petrol)	209
Odour	
Gas	102
Oil	
see Engine oil	215
Oil change intervals	
On vehicles with driver information system	13
Oil change service	214
On-board computer	27, 28
Controls (multi-function steering wheel)	30
Controls (windscreen wiper lever)	28
Opening	41
Bonnet	213
Boot lid	49

Fuel tank flap	210
Panorama sun roof	52
Windows	51
Outside temperature display	11, 28
Overrun fuel cut-off	191
Overview (controls and displays)	6

## P

Paddle levers (automatic gearbox)	111
Paint damage	206
Paint No.	272
Panorama sun roof	52
Convenience open/close	51
Manual operation	53
Park assist	146
Description	146
Driver messages	149
Driving out of a parking space	149
Finding a parking space	148
Parking	148
Parking aid	139
Cleaning sensors/camera	205
Parking aids	
360° display	140
Adjusting graphic display/warning	
beeps	150
Cleaning reversing camera	142
Malfunction	151
Park assist	146
Parking system plus	140
Rear parking aid	140
Reversing camera	142
Towing bracket	151
Parking brake	92
Driving away from a standstill	94
Driving away when towing a trailer	94
Emergency braking function	94
Indicator lamp	19
Parking the car	93
Power supply failure	92
Releasing/applying	92
Warning lamp	19, 92
Parking lights	55
Parking system	
see Parking aids	140, 142
Parking (automatic gearbox)	108, 109
Particulate filter (diesel)	190

- Pedals ..... 161
- Pedestrian protection system ..... 163  
 Servicing ..... 164
- Performance figures ..... 275  
*see also* Technical data ..... 275
- Performance (engine) ..... 275
- Petrol ..... 209
- Polishing ..... 206
- Pollen filter  
*see* Pollution filter ..... 77
- Pollution filter ..... 77
- Power management ..... 187  
 Indicator lamp ..... 21
- Power steering  
*see* Electro-mechanical power steering ..... 185
- Preheating glow plugs  
 With button ..... 88  
 With key ..... 86
- Pre sense  
 Driver messages ..... 123, 127  
 General notes ..... 116  
 Settings ..... 127
- Pressure (tyres) ..... 231
- Protective mat  
*see* Reversible floor covering ..... 75
- Q**
- quattro  
*see* Four-wheel drive ..... 186
- R**
- Radio-controlled clock  
*see* Clock ..... 9
- Radio-operated remote control  
*see* Remote control keys ..... 42
- Radio equipment ..... 233
- Radio transmitters ..... 233
- Rain sensor/light sensor  
 Headlights ..... 54  
 Indicator lamp ..... 26  
 Intermittent wipe (windscreen wipers) . 62  
 Switching on/off ..... 62
- Rear lights  
 Changing bulbs ..... 253  
 Changing inner  
 bulbs ..... 265, 266, 267, 270, 271  
 Changing outer bulbs ..... 263, 268  
 Indicator lamp ..... 25
- Rear seats, folding down ..... 73
- Rear view mirrors  
*see* Mirrors ..... 62
- Rear window  
 Washing ..... 62
- Rear window heating ..... 81
- Recommended gear ..... 12, 31
- Remote control  
 Auxiliary heating/ventilation ... 82, 84, 85
- Remote control keys ..... 42  
 LED ..... 42, 43  
 Locking and unlocking the vehicle ..... 44  
 Replacing the battery ..... 43  
 Synchronisation ..... 44
- Repairs ..... 233
- Replacement parts ..... 233
- Reset button (trip recorder) ..... 10
- Rest recommendation ..... 35
- Rev counter ..... 9, 10
- Reverse gear (automatic gearbox) ..... 106
- Reversible floor covering ..... 75
- Reversing camera  
*see* Parking aids ..... 140, 142
- RME (fuel) ..... 209
- Roof carrier ..... 72
- Roof load ..... 72
- Run-flat tyres ..... 229  
 Driving ..... 230  
 Renewing defective components ..... 230
- Running in  
 New brake pads ..... 184  
 New engine ..... 190  
 New tyres ..... 223
- S**
- Safelock mechanism ..... 41, 45  
*see also* Central locking system ..... 41
- Safety ..... 153  
 Airbag system ..... 171  
 Child seats ..... 157

- Correct sitting position ..... 154
- Gas odour ..... 102
- Head restraints ..... 156
- Luggage ..... 162
- Pedal area ..... 161
- Seat belts ..... 165
- Safety interlock (ignition key) ..... 86
- Safety systems (warning lamp) ..... 21
- Screwdriver ..... 236
- Seat belts ..... 165
  - Adjusting seat belts ..... 168
  - Belt tensioners ..... 169
  - Cleaning ..... 206
  - During pregnancy ..... 168
  - Height adjustment ..... 169
  - Indicator lamp (rear) ..... 26
  - Putting on ..... 167
  - Securing child seats ..... 160
  - Taking off ..... 169
  - Warning lamp ..... 21
- Seat heating ..... 81
- Seats
  - Adjusting ..... 66
  - Correct sitting position ..... 154
  - Easy entry function ..... 67
  - Folding down ..... 73
- Security central locking ..... 46
- Selector lever (automatic gearbox)
  - Manual release (left-hand drive) ..... 114
  - Manual release (right-hand drive) ..... 115
  - Positions ..... 106
- Self-help ..... 235
- Service interval display
  - On vehicles with driver information system ..... 13
- Service intervals ..... 214
- Service position
  - see Wiper blades, changing ..... 64
- SETUP (basic settings) ..... 9
- Short-term memory ..... 27
- Side assist ..... 132
  - Adjusting brightness ..... 134
  - Area covered by sensors ..... 133
  - Cleaning sensors ..... 205
  - Switching on and off ..... 134
- Side lights ..... 54
  - Changing bulb ..... 258
- Ski bag
  - see Load-through hatch with bag ..... 75
- Snow chains ..... 228
  - Four-wheel drive ..... 186
- Spanner ..... 236
- Spare key ..... 42
- Speed limits
  - see Camera-based traffic sign recognition ..... 33
- Speedometer ..... 9, 28, 29
- Speed warning ..... 96
- Sport mode ..... 183
- Star button ..... 30
- Start/stop system ..... 98
  - Driver messages ..... 101
  - Engine cuts in automatically ..... 100
  - Engine does not switch off ..... 100
  - Indicator lamps ..... 99
  - Switching off/on ..... 101
  - Switching off/starting the engine ..... 99
- START ENGINE STOP button (convenience key) ..... 88, 90
- Starting with jump leads ..... 244
- Starting (engine)
  - Automatic start function (button) ..... 88
  - Automatic start function (key) ..... 86
  - Malfunction (button) ..... 89
  - Malfunction (key) ..... 87
  - With button ..... 88
  - With key ..... 86
- Steering
  - Electro-mechanical power steering ... 185
  - Locking the steering (ignition key) ..... 88
  - Locking the steering (START ENGINE STOP button) ..... 90
  - Locking (ignition key) ..... 86
  - Warning lamp ..... 21
- Steering wheel
  - Adjusting ..... 86
  - Controls ..... 30
  - Multi-function steering wheel ..... 29
  - Paddle levers (automatic gearbox) ..... 111
- Storage compartments ..... 70, 71
- Storage net ..... 74
- Stretch net ..... 74
- S tronic gearbox
  - see Automatic gearbox ..... 106

- Sun roof  
 see Panorama sun roof ..... 52
- Sun visors ..... 62
- Supplementary heater (vehicles with diesel engine) ..... 82
- Suspension control ..... 136  
 Indicator lamp ..... 26
- Switching off (engine)  
 With button ..... 90  
 With key ..... 88
- Switching the ignition on/off (with key) .. 86
- Symbols  
 see Warning lamps ..... 14
- ## T
- Tailgate  
 see Boot lid ..... 49
- Tank  
 Gas fuel gauge ..... 104  
 Natural gas ..... 104
- Tank cap  
 Gas tank ..... 104
- Technical data ..... 272
- Temperature display  
 Coolant ..... 9  
 Outside temperature ..... 11, 28
- Temperature selection  
 Automatic air conditioner ..... 79  
 Heating/ventilation system ..... 78  
 Manual air conditioner ..... 78
- Tightening torque (wheel bolts) ..... 242
- Time, setting ..... 9
- tiptronic (automatic gearbox) ..... 111
- Tools ..... 236
- Top tether and ISOFIX (securing child seats) ..... 160
- Torque  
 Engine capacity ..... 275  
 Wheel bolts ..... 242
- Tow-away protection ..... 48
- Tow-starting ..... 246
- Towing ..... 194  
 Automatic braking ..... 195  
 Indicator lamp ..... 26  
 Retrofitting towing bracket ..... 202, 203  
 Towing bracket ..... 198  
 Trailer stabilisation ..... 195  
 Trailer weights ..... 194, 275  
 Turn signals ..... 26
- Towing away ..... 246
- Towing bracket  
 Parking aids ..... 151
- Towline anchorage ..... 248
- TPMS (tyre pressure monitoring system) 231
- Traction control system ..... 182  
 Indicator lamp ..... 22
- Traffic sign recognition  
 see Camera-based traffic sign recognition ..... 33
- Trailer  
 Accessories ..... 197  
 Trailer stabilisation ..... 195  
 Trailer weights  
 see Technical data ..... 275
- Tread depth ..... 225
- Trip recorder, resetting ..... 10
- Turning light ..... 54, 57
- Turning light (xenon headlights)  
 Changing bulbs ..... 261
- Turn signals ..... 55  
 Indicator lamp ..... 26
- Turn signals (halogen headlights)  
 Changing bulbs ..... 259
- Turn signals (xenon headlights)  
 Changing bulbs ..... 260
- Type plate  
 Chassis number ..... 272
- Tyre Mobility System (tyre repair kit) .... 237
- Tyre repair kit ..... 236
- Tyres  
 Accessories ..... 223  
 Changing ..... 238  
 Directional tread ..... 241  
 Four-wheel drive ..... 186  
 Inflation pressures ..... 224  
 Repair kit ..... 236, 237  
 Run-flat tyres ..... 229  
 Service life ..... 224  
 Tread wear indicators ..... 225  
 Tyre pressure loss indicator ..... 231  
 Tyre pressure (towing a trailer) ..... 194

**U**

- Unlocking/locking
  - By remote control ..... 44
  - With the central locking switch ..... 47
  - With the convenience key ..... 45
  - With the key ..... 45

**V**

- Vehicle
  - Raising ..... 240
  - Taking out of service ..... 191
- Vehicle data sticker ..... 272
- Vehicle identification data
  - Vehicle ID number (VIN) ..... 272

**W**

- Warning lamps ..... 14
- Warning triangle ..... 235
- Washer fluid level (indicator lamp) ..... 25
- Washing ornamental trim/mouldings ..... 205, 206
- Washing rear lights ..... 205
- Washing tailpipes ..... 205
- Washing wheel rims ..... 205
- Waxing ..... 206
- Weights ..... 275
  - see also* Technical data ..... 275
- Wheel bolt caps
  - Removing ..... 239
- Wheel bolts ..... 227
  - Anti-theft ..... 239
  - Loosening ..... 239
  - Torque ..... 242
- Wheels ..... 223
  - Changing ..... 238, 241
  - Changing wheels round ..... 225
  - Rims ..... 223
  - Tyre pressure loss indicator ..... 231
  - Washing ..... 205
- Windows
  - Cleaning/de-icing ..... 206
  - Defrosting (automatic air conditioner) .. 80
  - Defrosting (heating/ventilation system) 78
  - Defrosting (manual air conditioner) .... 78

## Windscreen

- Defrosting (automatic air conditioner) .. 80
- Defrosting (heating/ventilation system) 78
- Defrosting (manual air conditioner) .... 78
- Washing ..... 62
- Windscreen washer system ..... 62, 221
  - Reservoir capacity ..... 273

## Windscreen wipers

- Changing blades ..... 64, 65
- Cleaning wiper blades ..... 64
- Indicator lamp ..... 25
- Lifting wipers off windscreen ..... 64
- Switching on/off ..... 62

## Winter conditions

- Battery ..... 218
- Cooling system ..... 216
- De-icing windows ..... 206
- Defrosting windows (automatic air conditioner) ..... 80
- Diesel ..... 209
- Seat heating ..... 81
- Snow chains ..... 228
- Tyres ..... 227
- Washing the vehicle ..... 204
- Windscreen washer system ..... 221
- Winter tyres ..... 227
- Wiper blades, changing ..... 64, 65
- Wrench ..... 236

**X**

- Xenon headlights ..... 54, 59, 253



© 2013 AUDI AG

AUDI AG works continuously to develop and further improve all models. You will appreciate that we must therefore reserve the right to alter any part of the vehicle and its equipment or technical specifications at any time. No legal commitment can therefore be implied by the information, illustrations or descriptions in this Manual.

No part of this publication may be reprinted, reproduced or translated without the written

permission of AUDI AG. All rights under the laws of copyright are expressly reserved by AUDI AG. Subject to alteration and amendment. Printed in Germany.

**Date of publication: 08.08.2013**



**For the sake of the environment**

This paper was bleached without use of chlorine.

**Owner's Manual**  
**Audi A3 | S3**  
**Audi A3 Sportback | A3 Sportback g-tron | S3 Sportback**  
**Audi A3 Saloon | S3 Saloon**  
**Englisch 10.2013**  
**142.561.8V0.20**



1425618V020

[www.audi.com](http://www.audi.com)