



Owner's Manual for the Vehicle.
With a quick reference guide
for your convenience.



325Ci
330Ci

Congratulations, and thank you for choosing a BMW.

Thorough familiarity with your vehicle will provide you with enhanced control and security when you drive it. We therefore have this request:

Read this Owner's Manual to get summarized information, before you start out in your new BMW. It contains important data and instructions intended to assist you in gaining maximum use and satisfaction from the unique range of technical features on your BMW. The manual also contains information on care and maintenance designed to enhance operating safety and contribute to maintaining the value of your vehicle throughout an extended service life.

This Owner's Manual should be considered a permanent part of this vehicle. It should stay with the vehicle when sold to provide the next owner with important operating, safety and maintenance information.

This manual is supplemented by a Service and Warranty Information Booklet (US models) or a Warranty and Service Guide Booklet (Canadian models). We recommend that you read this publication thoroughly.

Your BMW is covered by the following warranties:

- New Vehicle Limited Warranty
- Limited Warranty Rust Perforation
- Federal Emissions System Defect Warranty
- Federal Emissions Performance Warranty
- California Emission Control System Limited Warranty

Detailed information about these warranties is listed in the Service and Warranty Information Booklet (US models) or in the Warranty and Service Guide Booklet (Canadian models).

We wish you an enjoyable driving experience.

BMW AG

Notes on the Owner's Manual

We have made every effort to ensure that you are able to find what you need in this Owner's Manual as quickly as possible. The fastest way to find certain topics is by using the detailed index at the end. If you wish to gain only an initial overview of your vehicle, you will find this in the first chapter.

The detailed table of contents immediately following the index is intended to arouse your curiosity about your BMW and stimulate you to read about it.

Should you wish to sell your BMW at some time in the future, please remember to hand over this Owner's Manual to the new owner; it is part of the vehicle.

If you have any questions, a BMW center will be glad to advise you.

© 2000 BMW AG
Munich, Germany
Reprinting, including excerpts,
only with the written consent of
BMW AG, Munich.
Part number 01 41 0 155 478
US English VIII/00
Printed in Germany
Printed on environmentally friendly paper
(bleached without chlorine, suitable for recycling).

Symbols used

 Indicates instructions or precautions that must be followed precisely in order to avoid the possibility of personal injury and serious damage to the vehicle. ◀

 Contains information that will assist you in gaining the optimum benefit from your vehicle and enables you to care more effectively for your vehicle. ◀

 Refers to measures that can be taken to help protect the environment. ◀

◀ Marks the end of a specific item of information.

* Indicates special equipment, country-specific equipment and optional extras.

 Identifies systems or components, which your BMW center can either activate or adapt to suit an individual driver's requirements ("Car Memory", "Key Memory"). Refer to page 54. ◀

The individual vehicle

On purchasing your BMW, you have decided in favor of a model with individualized equipment and features. This Owner's Manual describes all models and equipment that BMW offers within the same group.

We hope you will understand that equipment and features are included which you might not have chosen for your vehicle. Any possible differences can easily be identified, since all optional accessories are marked with an asterisk *.

If your BMW features equipment which is not described in this Owner's Manual (car radio or telephone, for instance), Supplementary Owner's Manuals are enclosed. We ask you to read these manuals as well.

Status at time of printing

BMW pursues a policy of continuous, ongoing development that is conceived to ensure that our vehicles continue to embody the highest quality and safety standards combined with advanced, state-of-the-art technology. For this reason, it is possible that the features described in this Owner's Manual could differ from those on your vehicle. Nor can errors and omissions be entirely ruled out. You are therefore asked to appreciate that no legal claims can be entertained on the basis of the data, illustrations or descriptions in this Owner's Manual.

For your own safety



Use unleaded gasoline only. Fuels containing up to and including 10% ethanol or other oxygenates with up to 2.8% oxygen by weight (i.e. 15% MTBE or 3% methanol plus an equivalent amount of co-solvent) will not void the applicable warranties respecting defects in materials or workmanship. Field experience has indicated significant differences in fuel quality (volatility, composition, additives, for example) among gasolines offered for sale in the United States and Canada. The use of poor quality fuels may result in driveability, starting and stalling problems especially under certain environmental conditions, such as high ambient temperature and high altitude. Should you encounter driveability problems which you suspect could be related to the fuel you are using, we recommend that you respond by switching to a recognized high-quality brand. Failure to comply with these recommendations may result in unscheduled maintenance. Follow the relevant safety rules when you are handling gasoline. ◀



Important safety information!

For your own safety, use genuine parts and accessories approved by BMW.

When you purchase accessories tested and approved by BMW and Original BMW Parts, you simultaneously acquire the assurance that they have been thoroughly tested by BMW to ensure optimum performance when installed on your vehicle.

BMW warrants these parts to be free from defects in material and workmanship.

BMW will not accept any liability for damage resulting from installation of parts and accessories not approved by BMW.

BMW cannot test every product from other manufacturers to verify if it can be used on a BMW safely and without risk to either the vehicle, its operation, or its occupants.

Original BMW Parts, BMW Accessories and other products approved by BMW, together with professional advice on using these items, are available from all BMW centers.

Installation and operation of non-BMW approved accessories such as alarms, radios, amplifiers, radar detectors,

wheels, suspension components, brake dust shields, telephones (including operation of any portable cellular phone from within the vehicle without using an externally mounted antenna) or transceiver equipment (such as C.B., walkie-talkie, ham radio or similar) may cause extensive damage to the vehicle, compromise its safety, interfere with the vehicle's electrical system or affect the validity of the BMW Limited Warranty. See your BMW center for additional information.

Do not use a key or the remote control to lock the doors or the luggage compartment with anyone inside the vehicle. See Owner's Manual for more details. ◀



Maintenance, replacement, or repair of the emission control devices and systems may be performed by any automotive repair establishment or individual using any certified automotive part. ◀

Symbol on vehicle parts



Indicates that you should consult the relevant section of this Owner's Manual for information on a particular part or assembly.

The following only applies to vehicles owned and operated in the US.

REPORTING SAFETY DEFECTS

If you believe that your vehicle has a defect that could cause a crash or could cause injury or death, you should immediately inform the National Highway Traffic Safety Administration (NHTSA) in addition to notifying BMW of North America, Inc., P.O. Box 1227, Westwood, New Jersey 07675-1227, Telephone (201) 307-4000.

If NHTSA receives similar complaints, it may open an investigation, and if it finds that a safety defect exists in a group of vehicles, it may order a recall and remedy campaign. However, NHTSA cannot become involved in individual problems between you, your dealer, or BMW of North America, Inc.

To contact NHTSA, you may either call the Auto Safety Hotline toll-free at 1-800-424-9393 (or 366-0123 in Washington, D.C. area) or write to: NHTSA, U.S. Department of Transportation, Washington, D.C. 20590. You can also obtain other information about motor vehicle safety from the Hotline.



Overview

Controls and features

Operation, care
and maintenance

Owner service procedures

Advanced technology

Technical data

Index



Contents

Overview

- Cockpit 16
- Instrument cluster 18
- Indicator and warning lamps 20
- Multifunction steering wheel (MFL) 24
- Hazard warning flashers 25
- Warning triangle 25
- First-aid kit 25
- Refueling 26
- Fuel specifications 27
- Tire inflation pressure 28

Controls and features

- Opening and closing:**
 - Keys 32
 - Electronic vehicle immobilizer 33
 - Central locking system 34
 - Opening and closing – from the outside 34
 - Opening and closing – from the inside 38
 - Luggage compartment lid 39
 - Luggage compartment 41
 - Alarm system 42
 - Electric power windows 44
 - Sliding/Tilt sunroof 45
- Adjusting:**
 - Seats 47
 - Seat and mirror memory 51
 - Steering wheel 52
 - Mirrors 52
 - Car Memory, Key Memory 54
- Passenger safety systems:**
 - Safety belts 55
 - Airbags 57
 - Transporting children safely 60

Driving:

- Steering/Ignition lock 63
- Starting the engine 63
- Switching off the engine 64
- Parking brake 65
- Manual transmission 66
- Automatic transmission with Steptronic 67
- Turn signal indicator/Headlamp flasher 70
- Washer/Wiper system 70
- Rear window defroster 72
- Cruise control 73

Everything under control:

- Odometer 75
- Tachometer 75
- Energy Control 75
- Fuel gauge 76
- Temperature gauge 76
- Service Interval Display 76
- Check Control 77
- Computer 77

Technology for driving comfort and safety:

- Park Distance Control (PDC) 81
- Automatic Stability Control plus Traction (ASC+T) 82
- Dynamic Stability Control (DSC) 83
- Tire Pressure Control (RDC) 85

- Controls and features**
- Lamps:**
 - Side lamps/Low beams 87
 - Instrument panel lighting 87
 - High beams/Parking lamps 88
 - Fog lamps 88
 - Interior lamps 88
 - Controlling the climate for pleasant driving:**
 - Air conditioner 90
 - Automatic climate control 96
 - Seat heating 101
 - Roller sun blind 101
 - Interior convenience:**
 - HiFi system 101
 - Glove compartment 102
 - Storage facilities 102
 - Cellular phone 104
 - Ashtray, front 104
 - Cigarette lighter 105
 - Ashtray, rear 105
 - Clothes hooks 105
 - Loading and transporting:**
 - Through-loading system 106
 - Ski bag 107
 - Cargo loading 108
 - Roof-mounted luggage rack 109
- Operation, care and maintenance**
- Special operating instructions:**
 - Break-in procedures 112
 - Driving notes 113
 - Catalytic converter 113
 - Antilock Brake System (ABS) 115
 - Disc brakes 117
 - Brake system 118
 - Winter operation 119
 - Power steering 121
 - Cellular phones 121
 - Radio reception 121
 - Wheels and tires:**
 - Tire inflation pressure 122
 - Tire condition 122
 - Tire replacement 123
 - Tire rotation 124
 - Wheel and tire combinations 125
 - Winter tires 126
 - Snow chains 126
 - Approved wheel and tire specifications 127
- Under the hood:**
- Hood 130
 - Engine compartment 132
 - Washer fluids 134
 - Washer nozzles 134
 - Engine oil 135
 - Coolant 137
 - Brake fluid 138
 - Vehicle Identification Number 139
- Care and maintenance:**
- The BMW Maintenance System 140
 - Caring for your vehicle 141
 - Airbags 146
 - Vehicle storage 147
- Laws and regulations:**
- Technical modifications 148
 - California Proposition 65 Warning 148
 - ODB interface socket 149

Contents

Repairs

Replacement procedures:

- Onboard tool kit [152](#)
- Windshield wiper blades [152](#)
- Lamps and bulbs [152](#)
- Changing a wheel [159](#)
- Battery [162](#)
- Fuses [166](#)
- Microfilter/Activated-charcoal filter [166](#)

In case of electrical malfunction:

- Fuel filler door [167](#)
- Sliding/tilt sunroof [167](#)

Assistance, giving and receiving:

- Jump-starting [168](#)
- Towing the vehicle [169](#)

Advanced technology

- Adaptive Transmission Control (ATC) [174](#)
- Airbags [175](#)
- Automatic Stability Control plus Traction (ASC+T)/Dynamic Stability Control (DSC) [175](#)
- Radio reception [176](#)
- Safety belt tensioner [176](#)
- Interior rearview mirror with automatic dimming feature [177](#)
- Rain sensor [178](#)
- Tire Pressure Control (RDC) [179](#)
- Self-diagnostics [180](#)
- Xenon lamps [181](#)

Technical data

- Engine data [184](#)
- Dimensions [185](#)
- Weights [186](#)
- Capacities [187](#)
- Electrical system [188](#)
- V-belts [188](#)

Index

- Everything from A to Z [192](#)
- Owner service procedures [199](#)



Cockpit 16
 Instrument cluster 18
 Indicator and warning lamps 20
 Multifunction steering wheel
 (MFL) 24
 Hazard warning flashers 25
 Warning triangle 25
 First-aid kit 25
 Refueling 26
 Fuel specifications 27
 Tire inflation pressure 28

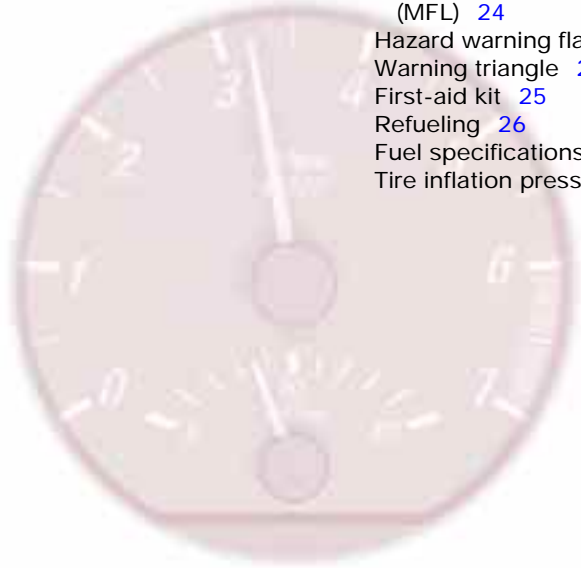

Overview

Controls and features

Operation, care and maintenance

Owner service procedures

Advanced technology

Technical data

Index

16 Cockpit

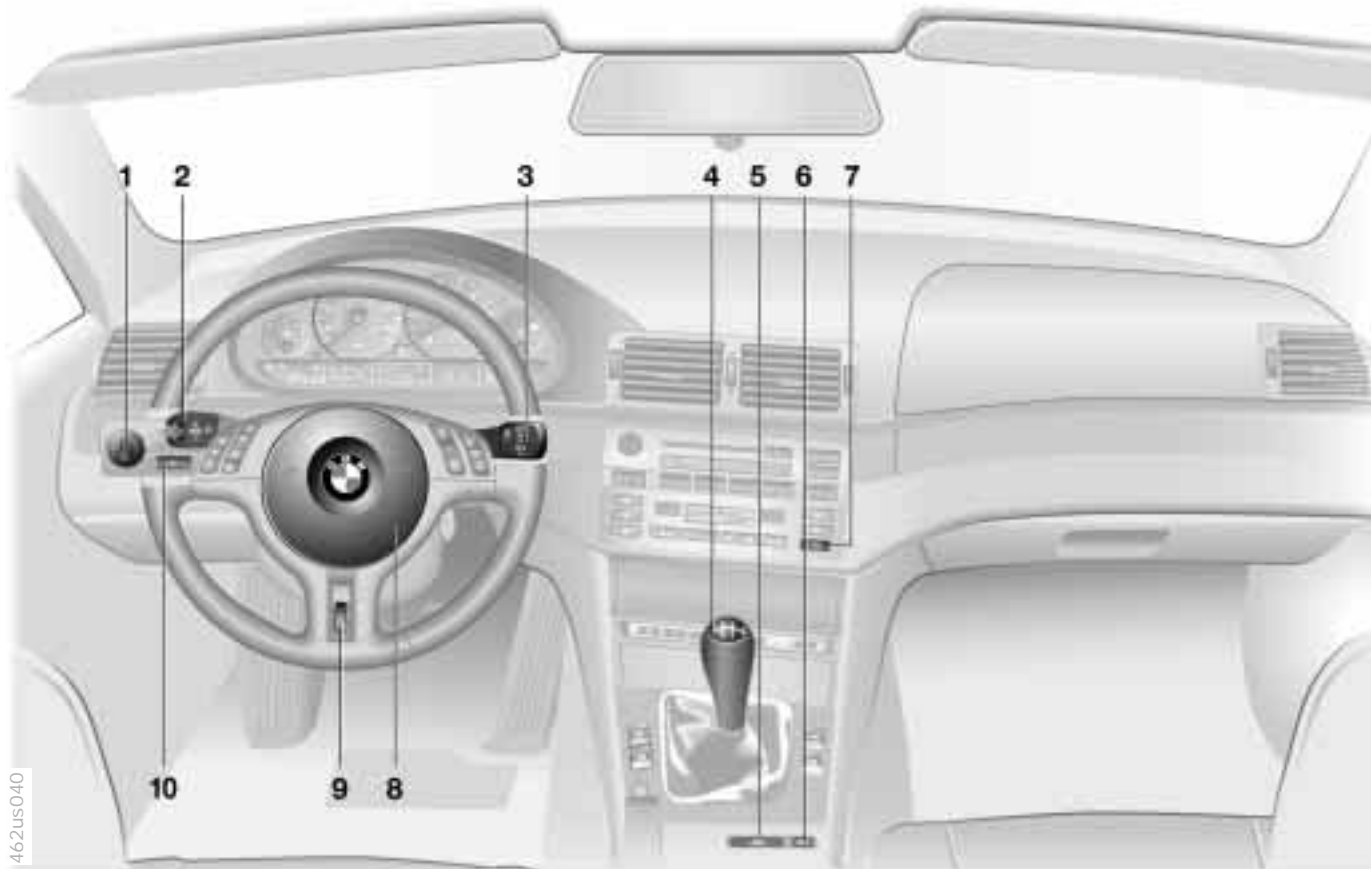

- 1 Parking lamps/Low beams [87](#)
- 2 ▷ Turn signal indicator [70](#)
 - ▷ Parking lamps [88](#)
 - ▷ High beams [88](#)
 - ▷ Headlamp flasher [70](#)
 - ▷ Computer [77](#)
- 3 Washer/Wiper system [70](#)
- 4 Shift lever/Selector lever* [66](#)

For vehicles equipped with manual transmission:
To shift into reverse, push the gear shift lever to the left, overcoming the slight resistance
- 5 Hazard warning flashers [25](#)
- 6 Central locking system [34](#)
- 7 Rear window defroster [72](#)
- 8 Horn: the entire surface functions as the horn
- 9 Adjusting steering wheel [52](#)
- 10 Front fog lamps [88](#)

18 Instrument cluster



Instrument cluster

- 1 Fuel gauge with indicator lamp for fuel reserve [76](#)
- 2 Indicator lamp for turn signal indicator [23](#)
- 3 Speedometer
- 4 Indicator lamp for:
 - ▷ Battery charge current [20](#)
 - ▷ High beams [23](#)
 - ▷ Engine oil pressure/Engine oil level [20, 22](#)
- 5 Tachometer and Energy control [75](#)
- 6 Engine coolant temperature gauge with "Coolant temperature too high" indicator [76](#)
- 7 Indicator and warning lamps (clockwise) for:
 - ▷ Parking brake/Brake hydraulic system/Cornering Brake Control (CBC/DBC) [20](#)
 - ▷ Antilock Brake System (ABS) [22](#)
 - ▷ Brake pads [22](#)
 - ▷ Tire Pressure Control (RDC)* [20, 22](#)
 - ▷ Airbags [21](#)
 - ▷ Please fasten safety belts [21](#)
 - ▷ Cruise control [23](#)
- 8 Set button for the clock [78](#)
- 9 Program display for automatic transmission* [69](#)
Indicator lamp for automatic transmission* [21, 69](#)
- 10 Indicator lamp for Automatic Stability Control plus Traction (ASC+T)/Dynamic Stability Control (DSC)* and ADB [22](#)
- 11 Indicator for:
 - ▷ Odometer [75](#)
 - ▷ Trip odometer [75](#)
 - ▷ Clock [78](#)
 - ▷ Service Interval [76](#)

Indicator for computer, operation using the turn signal lever, refer to page [77](#):

 - ▷ Clock
 - ▷ Outside temperature
 - ▷ Average fuel consumption
 - ▷ Range
 - ▷ Average speed
- 12 Indicator for Check Control [77](#)
- 13 Trip odometer, reset to zero [75](#)

- 14 Indicator and warning lamps (clockwise) for:
 - ▷ Front fog lamps [23](#)
 - ▷ Add washer fluid [22](#)
 - ▷ Coolant level [23](#)
 - ▷ Electronic Throttle Control (EML)* [23](#)
 - ▷ Service Engine Soon [22](#)

 You can display the outside temperature and distance driven in different units of measurement. ◀

Technology that monitors itself

Many of the systems of your BMW monitor themselves automatically, both during engine starts and while you are driving. Indicator and warning lamps that are identified by "●" are tested for proper functioning whenever the ignition key is turned. They each light up once for different periods of time.

If a fault should occur in one of these systems, the corresponding lamp does not go out after the engine is started, or it lights up while the vehicle is moving. You will see how to react to this below.

Red: stop immediately



Battery charge ●
The battery is no longer being charged. There is a malfunction of the alternator V-belt or in the charging circuit of the alternator. Please contact the nearest BMW center.



If the V-belt is defective, do not continue driving, otherwise, the engine could be damaged due to overheating. If the V-belt is defective, increased steering effort is also required. ◀



Engine oil pressure ●
Stop the vehicle immediately and switch off the engine. Check the engine oil and top off as required. If the oil level is correct, please contact the nearest BMW center.



Do not continue driving. If you do so, the engine could be damaged because of inadequate lubrication. ◀



Tire Pressure Control (RDC) ●
In addition, an acoustic signal is sounded: a tire failure has occurred. Reduce vehicle speed immediately to stop the vehicle. Avoid hard brake applications. Do not oversteer. For additional information, refer to page [85](#).



Brake hydraulic system ●
If the lamp comes on when the parking brake is not engaged: check the brake fluid level. Before driving further, be sure to read the notes on pages [118](#) and [138](#).



Brake warning lamp for Canadian models.

Indicator and warning lamps

Red and yellow: continue driving cautiously



The brake warning lamp and the yellow indicator lamps both light up for ABS and ASC+T/DSC:



The entire ABS, CBC, ASC+T/DSC and ADB system has failed. Continue driving cautiously and defensively. Avoid hard brake applications.



Please have the system checked by your BMW center as soon as possible. For additional information, refer to pages [82](#), [116](#).



Indicator and warning lamps for CBC, ABS and ASC+T/DSC and ADB/DBC for Canadian models.



Red: an important reminder



Parking brake

Comes on when the parking brake is applied – an acoustic signal also sounds when starting off. For additional information, refer to page [65](#).



Brake warning lamp for Canadian models.



Please fasten safety belts ●

A warning signal will sound at the same time. Lights up for a few seconds or until the safety belt is fastened.

For additional information on safety belts, refer to page [55](#).



Airbags ●

Please have the system inspected by your BMW center. For additional information, refer to pages [57](#), [175](#).

Orange: consult the nearest BMW center



Automatic transmission

Because of a malfunction, the automatic transmission shifts only in the emergency program. Please consult the nearest BMW center. For additional information, refer to page [69](#).

22 Indicator and warning lamps

Yellow: check as soon as possible



Antilock Brake System (ABS) ●

ABS has been deactivated in response to system malfunction.

Conventional braking efficiency is available without limitations. Please have the system inspected by your BMW center.

For additional information, refer to page [116](#).



ABS warning lamp for Canadian models.



Engine oil level

Lights up while driving:

The oil level is at the absolute minimum; therefore, add engine oil as soon as possible. Do not drive more than 30 miles (50 km) until you do. For additional information, refer to page [135](#).



Engine oil level

Comes on after the engine has been shut off: add more engine oil the next time you stop for gas.

For additional information, refer to page [135](#).



Brake pads ●

Have the brake pads checked.

For additional information, refer to page [118](#).



Tire Pressure Control (RDC) ●

Check tire inflation pressure: refer to pages [27](#), [85](#).



Automatic Stability Control plus Traction (ASC+T)/Dynamic Stability Control (DSC) ●

Indicator lamp flashes:

The system is active and governs drive force and braking force.

The indicator lamp stays lit:

ASC+T has been switched off by means of the switch or it is defective, or, the DSC has been turned off, ADB is operational.

Please consult the nearest BMW center in the event of a malfunction.

For additional information, refer to page [82](#).



Automatic Stability Control plus Traction (ASC+T)/Dynamic Stability Control (DSC) and brake warning lamp ●

The indicator lamps remain on: The DSC and ADB are switched off by means of the switch or are defective.

Please consult the nearest BMW center.

For additional information, refer to page [82](#).



The indicator lamps remain on:

The DSC and ADB are switched off by means of the switch or are defective.

Please consult the nearest BMW center.

For additional information, refer to page [82](#).



Indicator and warning lamps DSC and ADB for Canadian models.



Add washer fluid

The washer fluid is too low. Top off the fluid at the earliest

opportunity.

For additional information, refer to page [134](#).



Service Engine Soon ●

If the indicator lamp comes on either continuously or intermittently, this indicates a fault in the emissions-related electronic systems.

Although the vehicle remains operational, you should have the systems checked by your BMW center at the earliest possible opportunity.

For additional information, refer to page [149](#).



Service Engine Soon warning lamp for Canadian models.

Indicator and warning lamps



Engine electronics* ●

There is a fault in the engine's electronic control system. The electronics will allow you to continue driving with reduced engine output or reduced engine speed. Please have the system inspected by your BMW center.



Add coolant

The coolant level is too low. Top off the coolant at the earliest opportunity.
For additional information, refer to page [137](#).

Green: for your information



Turn signal indicator

Flashes when the turn signal is on. Rapid flashing indicates a system malfunction.

For additional information, refer to page [70](#).



Cruise control

Lights up when the cruise control is activated. Available for operation via the multifunction steering wheel.

For additional information, refer to page [73](#).



Front fog lamps

Lights up whenever you switch on the front fog lamps.

For additional information, refer to page [88](#).

Blue: for your information



High beams

Comes on when the high beams are on or the headlamp flasher is actuated.

For additional information, refer to pages [70](#), [88](#).

24 Multifunction steering wheel (MFL)

The controls integrated in the multifunction steering wheel are provided so that you can operate a number of accessories quickly and without being distracted from traffic conditions. You may operate:

- ▷ Selected radio functions,
- ▷ the cruise control,
- ▷ selected cellular phone functions.



In order to operate a system via the MFL, the corresponding systems must be switched on. ◀

Refer to the individual accessory manuals for more detailed descriptions.



- | | |
|---|--|
| 1 Radio/Telephone: select | 6 Horn: the entire surface functions as the horn |
| 2 Press briefly:
Receive a call, initiate dialing and terminate a call
Press longer:
Voice recognition*: switch on and off | 7 Cruise control: activate stored setting (resume) |
| 3 Radio/Telephone: volume | 8 Cruise control: store and accelerate (+); decelerate and store (-) |
| 4 Radio/Telephone: scan backward or scan station keys or scroll through the phone listings | 9 Cruise control: activate/interrupt/deactivate |
| 5 Radio/Telephone: scan forward or scan station keys or scroll through the phone listings | |

Hazard warning flashers



The button flashes on and off when the hazard warning flashers are on.

To help you locate the switch in an emergency, the button is also illuminated whenever the vehicle's lamps are on.

 The turn signal indicator function takes precedence over the hazard warning flashers function. Starting from ignition key position 1, you are therefore able to use the turn signal indicators, even if the hazard warning system has been activated. ◀

Warning triangle*



The warning triangle is stored in a recess on the left-hand side of the luggage compartment where it is quickly available.

 Comply with legal requirements that cover the availability of a warning triangle in the vehicle. ◀

First-aid kit*



The first-aid kit is located under the passenger seat.

To open: pull the handle and fold the cover down.

To close: fold the cover up.

 Some of the articles in the first-aid kit may be used within a limited time only. For this reason, check the expiration dates of each of the items regularly, and replace any with passed dates. You can purchase replacements in any drugstore or pharmacy. Comply with legal requirements that cover the availability of a first-aid kit in the vehicle. ◀



Fuel filler door

 Before filling the tank, shut off the engine. If you do not, fuel cannot be filled into the tank and the "Service Engine Soon" lamp may come on. ◀

Press on the rear edge of the fuel filler door to open and close it.

Regarding unlocking it if the central locking system malfunctions, refer to page [167](#).

 When handling fuels, comply with all of the applicable safety precautions and regulations pertaining to fuels.

Never carry spare fuel containers in your vehicle. Whether empty or full, these containers can leak, cause an explosion, or lead to fire in the event of a collision. ◀



Simple and environmentally friendly

 Open the filler cap carefully to prevent fuel from spraying out. Fuel spray may cause injury. ◀

Keep the filler cap in the bracket attached to the fuel filler door.

When refueling, insert the filler nozzle completely into the filler pipe. Pulling the nozzle out of the pipe during refueling

- ▷ results in premature pump shutoff
- ▷ and will reduce the effect of the vapor recovery system on the pump.

The fuel tank is full, whenever the fuel nozzle shuts off the first time, as is specified for proper service.

Fuel tank capacity: refer to page [187](#).

 Close the fuel cap carefully after refueling until a "click" is heard. While closing, be sure not to squeeze the strap which is fastened to the cap. A loose or missing cap will activate the Service Engine Soon warning lamp. ◀

Fuel specifications

The engine uses lead-free gasoline only.

Required fuel:

- ▷ Premium Unleaded Gasoline, min. 91 AKI.
AKI = Anti Knock Index

 Do not use leaded fuels. The use of leaded fuels will cause permanent damage to the system's oxygen sensor and the catalytic converter. ◀

Tire inflation pressure



Proper inflation pressures are on a sticker attached to the B-pillar and visible with the driver's door open.

Check tire pressures

On the next page you will find all the tire pressure and ambient air temperature specifications stated in the units usually used in your country (psi; kilopascal).

For vehicles with RDC (Tire Pressure Control):

After correcting the tire inflation pressure, reactivate the system. Refer to page [85](#).

 Check tire inflation pressures, including the space-saver spare tire, or spare tire, regularly, at least every two weeks and before beginning any extended driving. Otherwise, incorrect tire pressure can lead to tire damage and accidents. Inflate the spare tire to the highest inflation specified for your vehicle. ◀

28 Tire inflation pressure

Comply with tire approval specifications

The inflation pressures in the table apply to tires from BMW-approved manufacturers. Your BMW center is familiar with these manufacturers.

Higher pressures may be specified for tires made by other manufacturers. You will find a list of approved tires beginning on page [127](#).

Your vehicle is equipped with tires that meet US and European standards. We recommend the exclusive use of BMW-approved tires.

BMW	Tires				
	All pressure specifications in the table are indicated in psi (kilopascal) for cold tires (cold = ambient temperature)				
325Ci	All summer tires	30 (210)	35 (240)	35 (240)	42 (290)
	All winter tires	33 (230)	38 (260)	38 (260)	45 (310)
330Ci	All summer and winter tires	33 (230)	38 (260)	38 (260)	45 (310)
All	Space-saver spare tire			61 (420)	

For all-season tires, use the same tire inflation pressure as for summer tires. When using extra load tires (205/50 R 17), the inflation pressure increases by 3 psi (20 kilopascal) for summer tires. 330Ci: when using 225/45 R 17 91 W tires, the air pressure decreases by 3 psi (20 kilopascal).

**Opening and closing:**

Keys 32

Electronic vehicle

immobilizer 33

Central locking system 34

Opening and closing – from the
outside 34Opening and closing – from the
inside 38

Luggage compartment lid 39

Luggage compartment 41

Alarm system 42

Electric power windows 44

Sliding/Tilt sunroof 45

Adjusting:

Seats 47

Seat and mirror memory 51

Steering wheel 52

Mirrors 52

Car Memory, Key Memory 54

Passenger safety systems:

Safety belts 55

Airbags 57

Transporting children safely 60



Driving:

- Steering/Ignition lock 63
- Starting the engine 63
- Switching off the engine 64
- Parking brake 65
- Manual transmission 66
- Automatic transmission with Steptronic 67
- Turn signal indicator/Headlamp flasher 70
- Washer/Wiper system 70
- Rear window defroster 72
- Cruise control 73

Everything under control:

- Odometer 75
- Tachometer 75
- Energy Control 75
- Fuel gauge 76
- Temperature gauge 76
- Service Interval Display 76
- Check Control 77
- Computer 77

Technology for driving comfort and safety:

- Park Distance Control (PDC) 81
- Automatic Stability Control plus Traction (ASC+T) 82
- Dynamic Stability Control (DSC) with Automatic Differential Brake (ADB) and Dynamic Brake Control (DBC) 83
- Tire Pressure Control (RDC) 85

Lamps:

- Side lamps/Low beams 87
- Instrument panel lighting 87
- High beams/Parking lamps 88
- Fog lamps 88
- Interior lamps 88

Controlling the climate for pleasant driving:

- Air conditioner 90
- Automatic climate control 96
- Seat heating 101
- Roller sun blind 101

Interior convenience:

- HiFi System 101
- Glove compartment 102
- Storage facilities 102
- Cellular phone 104
- Ashtray, front 104
- Cigarette lighter 105
- Ashtray, rear 105
- Clothes hooks 105

Loading and transporting:

- Through-loading system 106
- Ski bag 107
- Cargo loading 108
- Roof-mounted luggage rack 109

Overview**Controls and features****Operation, care and maintenance****Owner service procedures****Advanced technology****Technical data****Index**

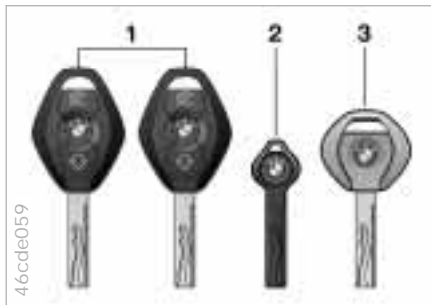

- 1 The remote control master keys determine Key Memory functions. Refer to page [54](#)

 There is an extended-life battery in every master key that is charged automatically in the ignition lock as you drive.

At least once a year, drive for an extended period with a master key that you do not use otherwise to charge the battery. Refer also to page [35](#). ◀

- 2 Store spare key in a safe place, such as in your wallet. This key is not intended for constant use

- 3 Door and ignition key

The locks for the luggage compartment lid and the glove compartment cannot be operated with this key – this is recommended for valet parking, for instance.

Replacement keys

Replacement keys are available exclusively through your BMW center. Checking vehicle ownership is mandatory, since the keys are part of a security system, refer to "Electronic vehicle immobilizer" on page [33](#).

 If possible, take all of the master keys that belong to the vehicle with you when you pick up your replacement key. Whenever you receive a new replacement key, turn that key to position 2 in the ignition lock once (ignition switched on) and then back. This allows the electronic vehicle immobilizer to "learn" the new key. ◀

Electronic vehicle immobilizer



The key to security

Your BMW is equipped with a passive anti-theft system. This electronic immobilization system is designed to reduce the susceptibility of the vehicle to theft by making it impossible to start the engine using any means other than the special keys furnished with the vehicle. Your BMW center can cancel the electronic system authorization for individual keys (in the event of loss, for instance). A deactivated key can no longer be used to start the engine.

How the electronics work

At the heart of this system is an electronic chip that is integrated into the key. The lock mechanism itself is actually a dual-function device, serving as a communications interface designed to allow the vehicle's electronics system to maintain a continuous stream of variable, vehicle-specific signals with the electronic circuitry in the key. The system will not release the ignition, fuel injection and starter unless it recognizes an "authorized" key.

 Force applied to the key can damage the integrated electronic circuitry. A damaged key can no longer be used to start the engine. ◀

The concept

The central locking system is ready for operation whenever the driver's door is closed. The system engages and releases the locks on the

- ▷ doors
- ▷ luggage compartment lid
- ▷ fuel filler door at the same time.

The central locking system can be operated

- ▷ from outside via the door lock and using the remote control
- ▷ from inside by pressing a button.

Activating it from inside does not lock the fuel filler door (see page 38). When the system is actuated from the outside, the anti-theft system is activated simultaneously. Both the door locks and the safety lock buttons remain locked. The alarm system is also armed or disarmed.

The central locking system unlocks automatically in the event of an accident. In addition, the hazard warning flashers and interior lamps come on.

Opening and closing – from the outside**Using the key**

One turn of the key in the driver's door lock unlocks the driver's door only. Turning the key a second time will unlock the passenger-side door, the luggage compartment lid and the fuel filler door.



You can have a signal set as an acknowledgment message that the vehicle is closed correctly. ◀

Convenience operation

You can also operate the power windows and sliding/tilt sunroof from the door lock.

- ▷ To open: with the door closed, hold the key in the "Unlock" position.
- ▷ To close: with the door closed, turn the key to the "Lock" position and hold it.



Watch during the closing process to be sure that no one is injured. Releasing the key stops the operation. ◀

Manual operation

(in the event of electrical malfunction)

Turn the key to the extreme left or right to unlock/lock the door.

Opening and closing – from the outside

Using the remote control

The remote control gives you an exceptionally convenient method for unlocking and locking your vehicle. Furthermore, it provides two additional functions that can only be executed by means of the remote control:

- ▷ Turn on the interior light, refer to page 36.
With this function, you can also "search for" your vehicle – when parked in an underground garage for instance.
- ▷ Open the luggage compartment, refer to page 37.
The luggage compartment lid will open slightly, regardless of whether it was locked or unlocked.

The anti-theft system is also deactivated simultaneously when you unlock the vehicle, the alarm system is disarmed, and the interior lamps are turned on. When you lock the vehicle, the systems are activated and armed, and the lamps go off.

 You can have a signal set as an acknowledgment message that the vehicle is closed correctly. ◀



Master keys

Keys with remote control are master keys. Refer to page 32.

 Children might be able to lock the doors from the inside. For this reason, always take the vehicle keys with you so that the vehicle can be opened again from the outside at any time. ◀

 Master keys that are used repeatedly are always ready for operation since the battery in the key is charged automatically in the ignition lock as you drive.

If it is no longer possible to unlock the vehicle using the remote control, the battery is discharged. Use this key while driving for an extended period in order to recharge the battery. Refer also to page 32.

To prevent unauthorized use of the remote control, surrender only the door and ignition key or the spare key (refer to page 32) e.g. when leaving the vehicle for valet parking.

In the event of a system malfunction, please contact your BMW center. You can also obtain replacement keys there. ◀

36 Opening and closing – from the outside



To unlock the vehicle

Press button 1 to unlock the driver's door only

Press the button twice in order to unlock the entire vehicle.

Convenience opening mode

Press and hold button 1. The windows and the sliding/tilt sunroof are opened.



To lock and secure

Press button 2.



To switch on the interior lamps

After locking the vehicle, press button 2 again.

Switching off tilt alarm* and interior motion sensor*

Press button 2 again immediately after locking.

For additional information: refer to page [43](#).

Opening and closing – from the outside



To open the luggage compartment lid

Press button 3.

The luggage compartment lid will open slightly, regardless of whether the lid was previously locked or unlocked.

 Before and after a trip, be sure that the luggage compartment lid was not opened unintentionally. ◀

Panic-Mode (triggering alarm)

By pressing button 3 for two to five seconds, the alarm can be sounded in the event of danger, if it has been armed ahead of time.

Pressing on button 1 will turn the alarm off.

The LED (light-emitting diode) will light up briefly whenever you press on the individual buttons.

Non-BMW systems

The proper functioning of the remote control system may be affected by other devices or equipment operating in the immediate vicinity of your vehicle.

If this should occur, you can still open and close the vehicle using the master key in either the door or luggage compartment locks.

For US owners only

The transmitter and receiver units comply with part 15 of the FCC (Federal Communication Commission) regulations. Operation is governed by the following:

FCC ID: LX8EWS
LX8FZVS
LX8FZVE

Compliance statement:

This device complies with part 15 of the FCC Rules. Operation is subject to the following two conditions:

- ▷ This device may not cause harmful interference, and
- ▷ this device must accept any interference received, including interference that may cause undesired operation.

 Any unauthorized modifications or changes to these devices could void the user's authority to operate this equipment. ◀



Use this button to operate the central locking system whenever the doors are closed. The doors and luggage compartment lid are unlocked or locked only. The anti-theft alarm system is not activated.

 If only the driver's door was unlocked from the outside and you press the button, then the passenger-side door, the luggage compartment lid and the fuel filler door will unlock if the driver's door is open. The driver's door will be locked if it is closed. ◀

 If you desire, the central locking system will secure the locks as soon as you start to drive. This can be adjusted to be key-specific. ◀

To unlock and open the doors

- ▷ Either unlock the doors at the same time using the button for the central locking system and then pull each of the release handles above the armrests, or
- ▷ pull the release handle for each door twice: the first pull unlocks the door, and the second one opens it.

To engage the locks

- ▷ Either use the central locking button to lock both doors at once, or
- ▷ press the individual safety lock buttons down. As an added design feature to prevent the driver from being inadvertently locked out of the vehicle, the driver's door safety lock button will not engage as long as the door is open.



Children might be able to lock the doors from the inside. For this reason, take the vehicle's keys with you so that the vehicle can be opened again from the outside at any time. ◀



The lock

Only the master keys (refer to page 32) fit in the lock for the luggage compartment lid.



To secure separately

Turn the master key to the right past the resistance point and then pull it out in the horizontal position.

This locks the luggage compartment lid and disconnects it from the central locking system. If you surrender only the door and ignition key, for valet parking, for instance (refer to page 32), this will prevent unauthorized access to the luggage compartment.



Opening from outside

Press the button in the handle recess (arrow):
The luggage compartment lid opens slightly.
The luggage compartment is lit when the luggage compartment lid is opened.

Manual operation

(in the event of electrical malfunction)
Turn the master key to the left to the stop – the luggage compartment lid will open slightly.
The luggage compartment is locked again as soon as you close the lid.
Opening from the inside, refer to page 40.

40 Luggage compartment lid



Opening from the inside*

If the luggage compartment lid has not been locked separately, you can open it with this button in the footwell on the driver's side when the vehicle is stationary.

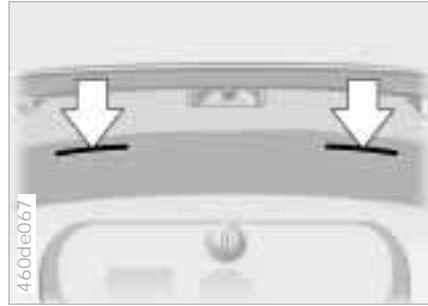

Closing

The handle recesses in the interior trim panel of the luggage compartment lid (arrows) make it easier to pull the lid down.

 To avoid injuries, be sure that the travel path of the luggage compartment lid is clear when it is closed, as with all closing procedures. ◀

 Do not drive with the luggage compartment lid open, since exhaust fumes could penetrate the interior of the vehicle. Should it be absolutely necessary to operate the vehicle with the luggage compartment lid open:

- ▷ Close all windows and the sliding/tilt sunroof as well.
- ▷ Increase the air supply for the air conditioner or automatic climate control to a high level. Refer to page 90 or 96. ◀

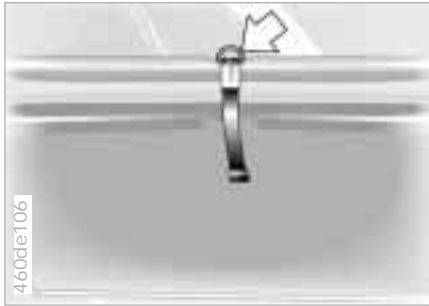

Lift the floor panel up and hook it

To raise and secure the floor panel, lift it by the ring and use the hanger to hook it into the rubber seal on the run-off gutter (arrow).

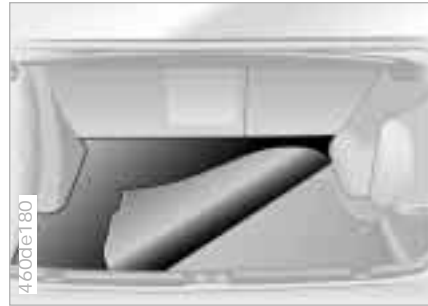

Floor mat

You can turn the floor mat over if needed (e.g. for transporting soiled objects). The rubberized side may be washed. It reduces movement of objects placed on it.

To secure your luggage, use the luggage nets* or flexible straps that you can attach to the fittings at the inner corners of the luggage compartment. Refer also to "Cargo loading" on page [108](#).

The concept

The vehicle alarm system responds:

- ▷ When a door, the hood or the luggage compartment lid is opened.
- ▷ To movement inside the vehicle (interior motion sensor).
- ▷ To a change of the vehicle's tilt – if someone attempts to steal the wheels or tow the vehicle without authorization, for example.
- ▷ If there is an interruption in battery voltage.

The system responds to unauthorized vehicle entry and attempted theft by simultaneously activating the following:

- ▷ Sounding an alarm for 30 seconds.
- ▷ The hazard warning flashers are activated for approx. five minutes.
- ▷ The high beams flash on and off in sync with the hazard warning flashers.

To activate and deactivate the alarm system

When the vehicle is locked or unlocked by using a key or with the remote control, the alarm system is also simultaneously armed or disarmed.

The interior motion sensor and the tilt alarm sensor are activated approx. 30 seconds after you have finished locking the vehicle.

If the alarm system has been armed correctly, the hazard warning flashers flash once.

 You can have a signal set as acknowledgment for both arming and disarming the alarm system. ◀

You can also open the luggage compartment lid when the system is armed by pressing button 3 of the remote control (refer to page 37). When it is closed, the lid is once again secured.



Indicator lamp displays

The indicator lamp is located under the interior rearview mirror.

- ▷ When the indicator lamp flashes continuously: the system is armed.
- ▷ If the indicator lamp flashes during arming of the system: the door(s), the hood or luggage compartment lid are not properly closed. Even if you do not close the indicated area, the system begins to monitor the remaining areas, and the indicator lamp flashes continuously after
 - ▷ 10 seconds. However, the interior motion sensor is not activated.
 - ▷ If the indicator lamp goes out when the system is disarmed: no manipulation or attempted intrusions have been detected in the period since the system was armed.

- ▷ If the indicator lamp flashes for 10 seconds when the system is disarmed: an attempted entry has been detected in the period since the system was armed.

Following triggering of an alarm, the indicator lamp will flash continuously.

Avoiding an unintentional alarm

The tilt alarm sensor and interior motion sensor may be switched off at the same time. You can do this to prevent a false alarm from being triggered (in garages with elevator ramps, for instance), or when the vehicle is transported by trailer or train:

Locking the vehicle twice (= arming the system). Press button 2 on the remote control twice in succession or lock the vehicle twice with the key. Refer to page 34.

The indicator lamp lights up briefly and then flashes continuously. The tilt alarm sensor and the interior motion sensor are deactivated as long as the system is armed.

Reset the alarm to reactivate the tilt alarm sensor and the interior motion sensor.



Interior motion sensor

The transmitter and receiver of the interior motion sensor are located in a trim panel in the vehicle's roof.

For the interior motion sensor to function properly, the windows and sliding/tilt sunroof must be closed.

However, you should switch off the interior motion sensor (see previous column) if you wish to leave the windows or sliding/tilt sunroof open.



Open and close the windows

From ignition key position 1:

- ▷ Press the switch up to but not past the pressure point:
The window will lower slightly or the rear vent window will open slightly, as long as you keep pressing the switch.
- ▷ Press the switch briefly past the pressure point:
The window will move automatically. Pressing the switch again stops the opening cycle.

You can close the windows in the same manner by pulling the switch. The rear vent window does not close automatically.

After the ignition has been switched off:

You can still operate the power windows for up to 15 minutes, as long as neither of the front doors has been opened.

 Remove the key from the ignition lock and close the doors when you leave the vehicle, so that children cannot operate the power windows and possibly injure themselves. ◀

To use the convenience mode via the door lock or the remote control, refer to page [34](#) or [36](#).

Safety feature

A contact strip is located on the inside upper frame of each of the windows. If pressure is exerted against this contact strip while a window is being raised, the system will respond by stopping the window and then retracting it a bit.

 Despite this safety feature, be extremely careful to ensure that the closing path of the windows is not obstructed. Otherwise, an object might not touch the contact strip in some situations (very thin objects, for instance). You can disable this safety feature by pressing the switch beyond the resistance point and holding it. ◀

Sliding/tilt sunroof*

 Exercise care when closing the sliding/tilt sunroof and keep it in your field of vision until it is completely closed. Failure to do so can result in injuries.

Remove the key from the ignition lock and close the doors when you leave the vehicle so that children cannot operate the sunroof and possibly injure themselves. ◀

Avoid low air pressure or drafts in the passenger compartment whenever the sunroof is open or up by keeping the vent outlets on the instrument panel open, and if necessary, by increasing the air supply. Refer to page 92 or 99.

If the sunroof is completely open, air disturbances may be caused in the vehicle when you are driving at higher speeds. Close the roof as far as necessary until this natural phenomenon ceases.

To operate the door lock or the remote control by using the convenience operating mode, refer to page 34 or 36.



Lifting – Opening – Closing

From ignition key position 1, press the switch or slide it to the desired direction until you feel resistance.

When lifting, the headliner will retract several inches.

 Do not use force to close the headliner whenever the sunroof is open, because the mechanism will be damaged. ◀

After the ignition has been switched off, you can still operate the sliding/tilt sunroof for up to 15 minutes, as long as no door has been opened.

Automatic opening and closing

- ▷ Press the switch past the pressure point: the sunroof travels to either the fully-closed or fully-open position.
- ▷ With the sunroof open, press the switch briefly toward "Lift": the sunroof automatically extends to its fully raised position.

Pressing the switch again briefly stops the motion immediately.

46 Sliding/tilt sunroof*

Safety feature

If the sliding/tilt sunroof encounters resistance at a point roughly past the middle of its travel when it is closing, the closing cycle is interrupted and the sunroof will retract slightly.



At any rate, even with this safety function, make sure that the closing path is clear, otherwise, in borderline cases (e.g. with thin objects), the limit for triggering the sunroof's closing force cannot be guaranteed. You can override this safety feature by pressing the switch beyond the pressure point and holding it. ◀

Power loss or malfunction

In the event of an electrical malfunction, you can operate the sliding/tilt sunroof manually, refer to page [167](#).

Seat adjustment

For your personal safety when adjusting the seat position, please follow the instructions below carefully:

 Never try to adjust your seat while driving the vehicle. The seat could respond with an unexpected movement, and the ensuing loss of vehicle control could lead to an accident. Be sure that the safety belt remains firmly against your body at all times. In the event of a frontal impact, a loose lap belt could slide over the hips, leading to abdominal injury. In addition, the safety belt's restraint effectiveness is reduced if the belt is worn loosely. Never ride with the backrest reclined to an extreme angle (especially important for the front passenger to remember), otherwise, you run the risk that you will slide under the safety belt during an accident, thus negating the protection the safety belt provides. ◀

Correct sitting posture

To reduce strain on the spinal column, sit all the way back in the seat and rest your back fully against the backrest.

The ideal sitting posture is achieved with your head extending from your spine in a straight line.

For long-distance driving, you may wish to increase the backrest angle slightly to reduce muscular tension. You should be able to grasp the steering wheel at its highest point with your arms slightly bent.

After a seat adjustment, adjust the height of the safety belt also. Refer to page 55.

Mechanical seat



- 1 Backward/Forward adjustment**
Pull up on the lever and slide your seat into the desired position. After releasing the lever, gently move the seat backward or forward to ensure that it snaps securely into place.
- 2 Cushion height**
Pull the lever and apply weight to or remove weight from the seat to reach the desired position.



3 Backrest angle

Pull the lever and apply weight to or remove weight from the backrest as required.

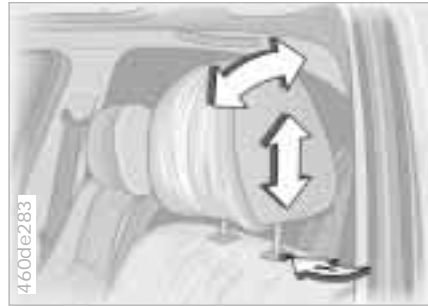

Adjustments

Height: adjust by pulling up or pushing down.



In order to move to the lowest positions, press button 1. ◀

To adjust the angle of the front head restraints: rotate them in the desired direction.



Head restraints reduce the risk of injury to the cervical vertebra in the event of an accident. Adjust the head restraint so that its center is approximately at the height of your ears. ◀

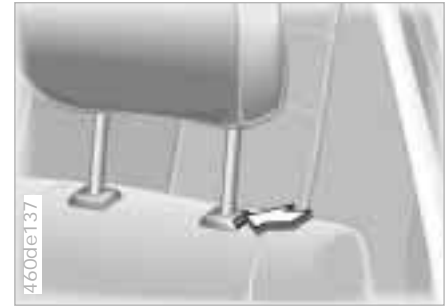

Removal

- ▷ Pull the head restraint upward to the stop.
- ▷ Press the button (arrow) and remove the head restraint.

Installation

- ▷ Press the button (arrow) and insert the head restraint into the guides.
- ▷ Adjust the head restraint.

Entering the rear



Pull up on the lever and flip the backrest toward the front.

The outside levers hold the safety belt in order to make it easier to reach.

 Lock both backrests while driving, otherwise there is a danger of an unexpected movement causing an accident. ◀

BMW sports seat*

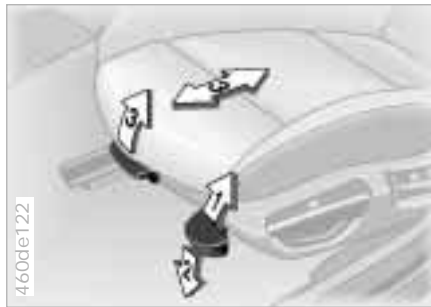

With this seat, you can also adjust the tilt angle and the thigh support:

- 1 To adjust the tilt angle upward:
Pull the lever as often as necessary to reach the desired angle.
- 2 To adjust the tilt angle downward:
Push the lever as often as necessary to reach the desired angle.
- 3 Thigh support area:
Pull the lever and adjust the position of the cushion for thigh support to suit you.

Lumbar support*



You can adjust the backrest's contour for additional support in the curvature of your spine's lumbar region.

The upper hips and spinal column receive supplementary support to help you maintain a relaxed, upright posture.

- ▷ Press the front/rear of switch:
Increase/decrease curvature.
- ▷ Press the upper/lower end of the switch:
Increase the upper/lower curvature.

50 Power seat*



- 1 Backward/Forward adjustment
 - 2 Cushion height
 - 3 Backrest angle
- The head restraint is adjusted manually.

 Please refer to the adjustment instructions on page 47 to reduce the risk of personal injury. ◀



BMW Sports Seat

- 1 Tilt angle
- 2 Backward/Forward adjustment
- 3 Cushion height
- 4 Backrest angle

Adjust the head restraints (refer to page 48) and the thigh support (refer to page 49) manually.

 Please refer to the adjustment instructions on page 47 to reduce the risk of personal injury. ◀

Seat and mirror memory*

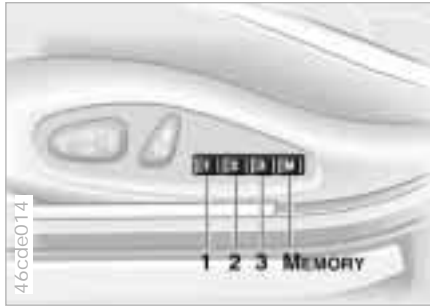

You can store and recall three different driver's seat and outside mirror positions.

The adjustment setting of the lumbar support is not saved in the memory.

To store

- 1 Turn the key to ignition key position 1 or 2.
- 2 Adjust your seat and outside mirrors to the desired position.
- 3 Press the **MEMORY** button: the indicator lamp in the button lights up.
- 4 Press memory button 1, 2 or 3, as desired: indicator lamp goes out.

To select a stored setting

Convenience function:

- 1 Open the driver's door after unlocking or turn the ignition key in position 1.
- 2 Briefly press memory button 1, 2 or 3, as desired.

The adjustment cycle is canceled immediately if you press a seat adjustment switch or one of the memory buttons.

Security function:

- 1 With the driver's door closed and the ignition key either removed or in position 0 or 2
- 2 Maintain pressure on the desired memory button (1, 2 or 3) until the adjustment process is completed.

If you accidentally press the **MEMORY** button: press the button again; the indicator lamp goes out.

 Do not select a memory position while the vehicle is moving. If you do so, there is a risk of accident from unexpected seat movement. ◀



Your BMW center can adjust your vehicle's systems in such a manner that your personalized settings are automatically set for the seat and outside mirror positions when you unlock the vehicle with your personal remote control. ◀



If you make use of this method of adjustment, be sure that the footwell behind the driver's seat is unobstructed before unlocking the vehicle. If you fail to do so, persons or objects could be injured or damaged if the seat should move backward. ◀

**Passenger side exterior mirror tilt function**

(automatic curb monitor*)

- 1 Move the mirror selector switch 1 to the "driver's mirror" position.
- 2 When the selector lever is placed in "Reverse," the passenger-side mirror tilts downward. This allows the driver to see the area directly adjacent to the vehicle during parking (curbs, etc.).

You can deactivate this automatic feature: set the mirror selection switch to the "passenger side" position.



- 1 Push the locking lever downward.
- 2 Adjust the steering wheel (fore/aft and up/down) to the desired position.
- 3 Pull the lever back in to clamp the steering wheel in the new position.



Do not adjust the steering wheel while the vehicle is moving. If you do so, there is a risk of accident from unexpected movement. ◀

**Exterior mirrors**

- 1 Switch for 4-way adjustment
- 2 Selection switch for changing between mirrors

Mirrors

You can also adjust the mirrors manually by pressing against the outer edges of their lenses.

 The mirror on the passenger's side features a lens with a more convex surface than the mirror installed on the driver's side. When estimating the distance between yourself and other traffic, bear in mind that the objects reflected in the mirror are closer than they appear. Estimations of the distance to following traffic should therefore not be regarded as precise. ◀

Electric defrosting

Both mirrors are automatically defrosted with the ignition key in position 2.



Interior rearview mirror

To reduce glare from vehicles behind you when you are driving at night, tilt the mirror by turning the button.

Lighted vanity mirror*

Fold down the sun visor and slide the cover panel to the side as required.

The mirror lamps operate from ignition key position 1.

Sun visors

These can be folded down toward the windshield or swiveled out against the side window.



Interior rearview mirror with automatic dimming feature*

By responding to the effects of ambient light and the glare from following traffic, this mirror automatically dims through an infinitely-variable range.

The mirror switches to its clear, undimmed mode whenever the transmission is placed in reverse gear (selector lever in "Reverse").

To ensure that the mirror continues to operate properly, keep the two photocells clean and unobstructed. One photocell (arrow) is in the mirror glass, while the other is offset somewhat on the other side of the mirror.

For an explanation of the electrochromic technology used in this mirror, refer to page [177](#).



How the system functions

You have probably frequently wished that you could configure individual functions of your vehicle to reflect your own personal requirements. In engineering your vehicle, BMW has included several user-defined functions in the vehicle's design. Your BMW center can make these settings for you in accordance with your wishes.

There are settings related to the vehicle ("Car Memory") and settings related to individuals ("Key Memory"). You can have up to four different basic settings adjusted for four different persons. The only requirement is that each person uses his or her own remote control key.

When your vehicle is unlocked with the remote control, the vehicle recognizes the individual user by means of a data exchange with the key, and makes adjustments accordingly.

In order for you to distinguish between different keys, colored decals are supplied together with the keys.

What the system can do

Your BMW center can provide you with details on the capabilities of the Car Memory and Key Memory systems. A few examples follow below:

Examples for Car Memory:

- ▷ Various signals used as acknowledgement when locking or unlocking your vehicle.
- ▷ Deactivating/activating the Follow-Me-Home lamps function.
- ▷ Activating/deactivating daytime running lamps*.

Examples for Key Memory:

- ▷ Automatic adjustment of the driver's power seat.
- ▷ Locking your vehicle after starting off.
- ▷ When unlocking your vehicle, first unlock the driver's door, then the rest of the vehicle.



You will see this symbol throughout the Owner's Manual. It is to remind you at appropriate places of the settings that are available to you. ◀



Drive with your safety belt on

Fasten your safety belt at the beginning of every trip.

To fasten:

Make sure you hear the catch engage in the belt buckle.

To release:

Press the red button in the buckle. Hold the belt and guide it back into its reel.

The two rear safety belt buckles which are integrated in the rear seat are for passengers sitting on the left and right. The belt buckle with the word "CENTER" is intended exclusively for passengers sitting in the middle.

For care instructions, refer to page [144](#).

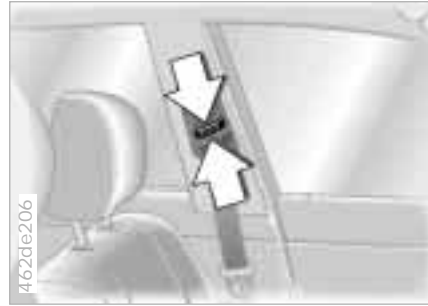

Safety belt height adjustment

You can adjust the safety belts to fit your own physical dimensions by using the safety belt height adjustment.

Slide the button downward or upward.



For your safety, please comply with the following instructions for wearing safety belts. If you do not, the safety belts may not be able to provide their maximum protection. The following information also applies to your passengers:

Never allow more than one person to wear a single safety belt. Never allow infants or small children to ride in a passenger's lap.

Avoid twisting the belt while routing it firmly across your hips and shoulder. Do not allow the belt to rest against hard or fragile objects in your pockets. Never route the belt across your neck, do not run it across sharp edges and ensure that the belt does not become caught or jammed.

Avoid wearing clothing that prevents the belt from fitting properly. Pull on the belt periodically to readjust the tension across your shoulder. In the event of a frontal impact, a loose lap belt could slide over your hips, leading to abdominal injury. In addition, the safety belt's restraint effectiveness is reduced if the belt is worn loosely.

Expectant mothers should also wear the safety belt, taking special care to place the lap belt over the lower hips, where it does not exert pressure on the abdominal area. ◀

56 Safety belts

For child restraint system installation, refer to page [61](#).



If the safety belt system has been subjected to the stresses involved in an accident or otherwise damaged: Have the entire safety belt mechanism replaced by your BMW center, including the safety belt tensioner. In addition, have your BMW center inspect the safety belt anchors. If a child restraint system was in the vehicle during an accident, consult the manufacturer's instructions regarding replacement. ◀



Please comply with the instructions for the center safety belt on page [106](#). ◀

Child restraint systems*



Do not install a rear-facing child restraint system in the front passenger seat of your vehicle. If you do so, the child could be injured in an accident when the airbag is triggered. Children should always ride in the rear and the restraint systems should be secured with the outer belts. The centre seat belt should only be used when it is necessary to secure three child restraint systems. Do not modify the child restraint system in any way. If you do so, it will not provide your child with maximum protection. ◀

Airbags

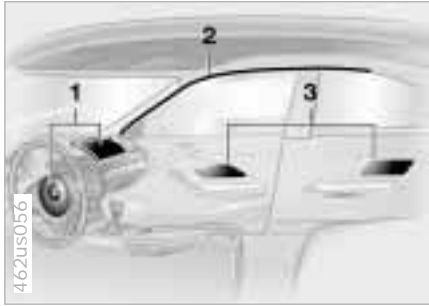

- 1 Front airbags for driver and passenger
- 2 Side impact Head Protection System (front)
- 3 Side airbags for driver and passenger (front and rear*)

Protective effect

The front airbags protect the front-seat occupants in the event of a severe frontal collision on which the protection afforded by the belts alone may no longer be sufficient. The side impact Head Protection System and the side airbags help provide protection in the event of a collision from the side. Each of the side airbags is designed to help support the occupant's upper body.

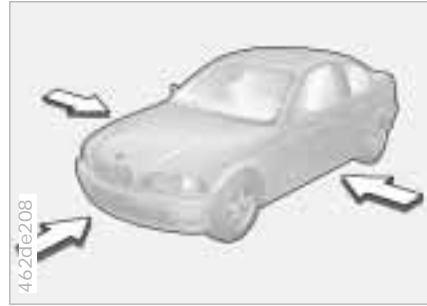

 The side airbags in the rear passenger area* of your vehicle may already have been deactivated either at the time of manufacture or by a BMW center. You may have them activated if you desire to do so. Please contact your BMW center for additional information. ◀

The illustration depicts schematically the primary directions of vehicle impact that initiate airbag deployment.

 The airbags will not be triggered in the event of a minor accident, a vehicle roll-over, or collisions from the rear. ◀

Operational status



The indicator lamp in the instrument cluster displays the operational status of the airbag system from ignition key position 1 and higher.

System operational:

- ▷ The indicator lamp comes on briefly then goes out.

System malfunction:

- ▷ The indicator lamp fails to come on.
- ▷ The indicator lamp comes on briefly before going out, and then lights up again.

If there is a system malfunction, there is a risk that the airbags will not be triggered within their normal response range, even if the level of impact would normally have triggered them.

Have your BMW center inspect the system immediately.

 The airbag indicator lamp also comes on if the safety belt tensioners have been triggered. ◀

Sitting correctly with airbags

 For your safety, comply with the following instructions for the airbags. If you do not, the airbags may not be able to provide their maximum protection. All passengers in the vehicle should be aware of and comply with this information:

The airbags are supplemental restraint devices designed to provide extra protection; they are not a substitute for safety belts. Wear your safety belt at all times. The airbags will not be triggered in the event of a minor accident, a vehicle roll-over, or collisions from the rear. In these instances, the safety belt provides optimal protection.

Airbags are located under cover panels in the steering wheel, in the instrument panel, in the side trim panels in the front and rear*, in the roof panels, and in the sides of the inside roof lining.

Adjust your seat to a position that provides maximum distance between you and the steering wheel, the instrument panel and the door while still allowing comfortable and safe access to all vehicle controls.

To avoid sustaining hand and arm injuries, always grasp the steering wheel on the rim with the hands at the 9 and 3 o'clock positions. Do not place your

hands on the center pad.

Never allow any objects to obstruct the area between the airbag and an occupant.

Do not use the cover panel above the passenger-side airbag as a storage area.

Do not apply adhesive materials to the cover panels of the airbags, cover them or modify them in any other way.

Do not install a rear-facing child restraint system in the front passenger seat of this vehicle.

Children under 13 years of age and children less than 5 feet (150 cm) tall should ride only in the rear seat.

Infants or small children should never be held on the lap of a passenger.

If your vehicle is equipped with side airbags in the rear passenger area*, be sure that child restraints are mounted correctly and provided with the greatest-possible distance between the airbags in the side trim panels. Do not allow children to lean out of the child's seat in the direction of the side trim panels. If they do so, serious injuries can occur if the airbag is triggered. ◀



At all times, occupants should sit upright and be properly restrained (infants and small children in appropriate child restraint systems; larger children and adults using the safety belts). Never let an occupant's head rest near or on a side airbag because the inflating airbag could cause a serious or fatal injury. Please note that the word "Airbag" imprinted on the door trim panel indicates the airbag's location.

Accident research shows that the safest place for children in an automobile is in the rear seat. However, a child sitting in the rear seat and not properly restrained may place his or her head on or near the airbag, if so equipped. For example, a child – even though belted – may fall asleep with his or her head against the side airbag. It may be difficult for a driver to ensure that children in the rear seat will remain properly positioned at all times and not place their heads on or near the side airbag. Therefore, we recommend that the rear seat side airbags, if so equipped, be deactivated if children will travel in the rear seat.

The rear seat side airbags may already have been deactivated, either at the time of manufacture or by a BMW

Airbags

center. Labels in the door opening should indicate the status of your rear seat side airbags. If you are uncertain of their status, or wish to have the airbags activated or deactivated, please contact your BMW center. ◀

Even when all these guidelines are observed, there is still a small residual risk of injuries to the face, hands and arms occurring in isolated instances. The ignition and inflation noise may induce a mild temporary hearing loss in sensitive individuals.

For additional information concerning the airbag system, refer to pages [146](#) and [175](#).



This is the right way for a child to sit in a child restraint when rear side airbags (arrow) are provided.



This is the right way for a larger child to sit wearing the safety belt when rear side airbags (arrow) are provided.

60 Transporting children safely



LATCH attachment of the child seat

Remove the cover cap on the outer mount by pulling it toward the front. When reattaching it, make sure that the recess points upward.

To remove the cover cap easily, flip the rear backrest forward halfway. (Refer to page [106](#)).

The illustration shows the mounts for a LATCH child-restraint system in the right rear seat.

 To mount the LATCH child-restraint system, please follow the manufacturer's operating and safety precautions. ◀

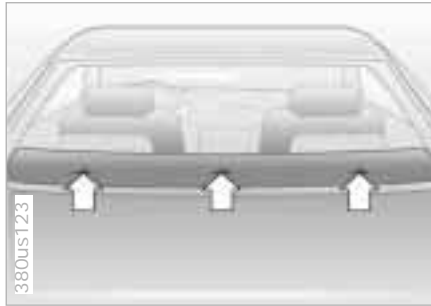

Commercially available child seats complying with the legal standard are designed to be secured with a lap belt or with the lap belt portion of a combination lap/shoulder belt. Improperly or inadequately installed restraint systems can increase the risk of injury to children. Always read and follow the instructions that come with the system.

If you use a child restraint system with a tether strap, three additional tether anchorage points (refer to the arrows in the illustration) have been provided. Depending on the location selected for seating in the rear passenger area, attach the tether strap to the corresponding anchorage point to secure the child restraint system. Remove the cover first on the middle location.

If the respective seating position is fitted with a headrest lift the headrest and pass the tether strap between the headrest and the seat back.

Adjust the tether strap according to the child restraint manufacturer's instructions.



Before installing any child restraint system or child seat, please read the following:

Never install a rear-facing child restraint system in the front passenger seat of this vehicle.

Your vehicle is equipped with an airbag supplemental restraint system for the front passenger. Because the backrest on any rear-facing child restraint system (of the kind designed for infants under 1 year and 20 lbs./9 kg) would be within the airbag's deployment range, you should never mount such a device in the front passenger seat, since the impact of the airbag against the child restraint's backrest could lead to serious or fatal injuries.

If it is necessary for a child (not an infant) to ride in the front seat, certain precautions should be taken. First, move the passenger seat as far away from the instrument panel as possible. This important precaution is intended to

maximize the distance between the airbag and the child. Older children should be tightly secured with the safety belt. Younger children should be secured in an appropriate forward-facing child restraint system that has first been properly secured with a safety belt.

Never install a rear-facing child restraint system in the front passenger seat. We strongly urge you to carefully read and comply with the instructions for installation and use provided by the child restraint's manufacturer whenever you use such a device.

Always ensure that all occupants (of all ages) remain properly and securely restrained at all times. ◀

All rear seating positions in your vehicle meet the recommendations of SAE J1819, an industry recommended practice for securing child restraint systems in motor vehicles.

62 Transporting children safely



Lock the safety belt

Extract the entire length of the belt from the inertia reel mechanism. Allow the reel to retract the belt somewhat and engage the buckle, then tighten the belt against the child restraint system. The retraction mechanism is now locked. The belt cannot be extracted further. Always comply with the installation instructions provided by the manufacturer of the child restraint system.

Unlock the safety belt

Release the safety belt, remove the child's seat and pull the safety belt out to its end position on the belt retractor.

Child seat security

All of the rear belt retractors and the front passenger's safety belt can be locked for mounting and securing child restraint systems.

Information pertaining to this is located in the immediate vicinity of the buckle latch of each safety belt.



0 Steering lock engaged

The key can only be inserted or removed in this position.

After removing the key, turn the steering wheel slightly to the left or right until the lock engages.

If the key is not removed, a signal will sound after the driver's door has been opened.

 Vehicles with automatic transmission:

Do not move the selector lever from the "Park" position until the engine is running (ignition key at position 2). In order to turn the key back to position 0 or to remove it, move the selector lever into position "Park" first (Interlock). ◀

1 Steering lock disengaged

Turning the steering wheel slightly to the right or left often makes it easier to turn the key from 0 to 1. Individual electrical devices are ready for operation.

2 Ignition on

All electrical devices and accessories are available for use.

3 Starting the engine

 Vehicles with manual transmission:
Step on the clutch when starting the vehicle. A lockout prevents the engine from starting if the clutch is not depressed. ◀

Before starting

- ▷ Engage the parking brake.
- ▷ Put manual-shift gear lever in the idling position or in P for automatic transmissions.
- ▷ Step on the clutch pedal.

 Do not run the engine in enclosed areas. The exhaust gases contain carbon monoxide, an odorless and colorless, but highly toxic gas. Breathing the exhaust gases poses an extreme health risk, and can lead to unconsciousness and death. Do not leave the vehicle unattended with the engine running. An unattended vehicle with a running engine represents a potential safety hazard. ◀

64 Starting the engine

Do not press the accelerator pedal while starting the engine.

 Do not actuate the starter for too short a time, but do not actuate it for more than approx. 20 seconds. Release the ignition key immediately when the engine starts. Do not allow the engine to warm up by leaving it running while the vehicle remains stationary. Instead, begin driving immediately at a moderate engine speed. ◀

If the engine does not start on the first attempt (if it is very cold or hot, for instance):

▷ Press the accelerator pedal halfway down while engaging the starter.

Cold starts at very low temperatures, starting at about +5°F (-15°C) and at high altitudes above 3,300 ft (1,000 meters):

▷ On the first start attempt, engage the starter for a longer period (approx. 10 seconds).

▷ Press the accelerator pedal halfway down while engaging the starter.

Engine idle speed is controlled by the engine computer system. Increased speeds at start-up are normal and should decrease as the engine warms up. If engine speed does not decrease, service is required.

To prevent the battery from discharging, always deactivate electrical devices that are not in use. Switch the ignition off when the vehicle is not being driven.

Switching off the engine

Turn the ignition key to position 1 or 0.



Do not remove the ignition key while the vehicle is still moving. If you did so, the steering lock would engage when the steering wheel is turned.

Whenever you leave the vehicle, always remove the ignition key and lock the steering wheel.

Vehicles with manual transmission: Always apply the parking brake when parking on slopes and inclined surfaces, since placing the shift lever in 1st gear or reverse may not provide adequate resistance to rolling.

Vehicles with automatic transmission: Place the selector lever in "Park." ◀

Parking brake



To engage

The parking brake is designed primarily to prevent the vehicle from rolling when it is parked. It operates against the rear wheels.

The lock engages automatically when you lift the lever, and the indicator lamp in the instrument panel comes on when the ignition key is in position 2. Refer to page [21](#).

To release

Pull up slightly on the lever, press the button (arrow) and lower the lever.

 If, in exceptional circumstances, it should be necessary to engage the parking brake while the vehicle is in motion, do not pull the lever with excessive pressure. Keep your thumb pressed against the release button while carefully pulling the lever up to apply moderate pressure. Excessive pressure can lead to over-braking and loss of traction (fishtailing) at the rear axle. The brake lamps do not come on when the parking brake is applied.

Vehicles with manual transmission: Always apply the parking brake when parking on slopes and inclined surfaces, since placing the shift lever in 1st gear or reverse may not provide adequate resistance to rolling.

Vehicles with automatic transmission: Place the selector lever in "Park." ◀

To avoid corrosion and one-sided braking, apply the parking brake lightly from time to time when coasting to a standstill (at a traffic signal, for instance), provided that it is safe to do so.

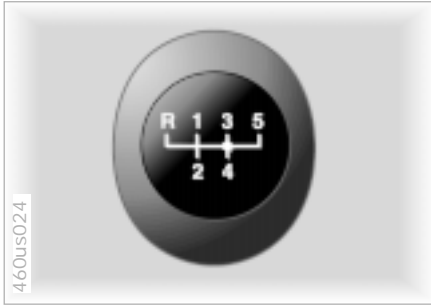

Press the clutch pedal all the way down each time you shift, pressing the manual-shift gear lever into its proper end position.

Depress the clutch when starting the vehicle, too, otherwise, lockout will prevent the engine from starting if the clutch is not depressed.

The shift lever's neutral plane (dot in the illustration) is located between 3rd and 4th gears.

When shifting from each gear into "Neutral," the shift lever returns automatically to this neutral position because of its spring loading.

Reverse

Select only when the vehicle is stationary. Press the shift lever to the left to overcome the slight resistance.

As you do this, the backup lamps will turn on automatically when the ignition key is in position 2.



Do not hold the vehicle in place on slopes by slipping or "riding" the clutch. Use the parking brake instead. Otherwise, riding the clutch will cause tremendous wear and tear to the clutch. ◀

You have the option of driving with a normal automatic transmission or switching to manual.

When you move the selector lever from the "D" position to the left into the M/S range, the performance-oriented shift programs of the automatic transmission are engaged. As soon as you even begin to move the selector lever toward the "+" or tap "-", Steptronic shifts the gear and manual operation becomes active. Whenever you want to use the automatic mode again, move the selector lever to the right into position "D."

The automatic transmission with Steptronic is equipped with Adaptive Transmission Control (ATC). ATC reacts with precision to your individual driving style and the current driving conditions. It is for this reason that various shift programs are used.

You will find additional information about ATC in the chapter called "Advanced Technology" on page [174](#).



Selector lever positions

P R N D M/S + -

Starting the engine

The engine can only be started in selector lever positions P ("Park") or N ("Neutral").

Range selection

A detent prevents inadvertent shifts into certain selector lever positions. To disengage the detent, press the button on the front of the shift knob (arrow).

 While the vehicle is stationary and before shifting out of "Park" or "Neutral," depress the brake, otherwise you will not be able to move the selector lever (Shiftlock).

Hold the footbrake down until starting off. Otherwise the vehicle will "creep" when a drive position is engaged. ◀

 If you leave the vehicle with the engine running, move the selector lever to the "Park" or "Neutral" position and apply the parking brake. If you fail to do this, the vehicle could move. Do not leave the vehicle unattended with the engine running. An unattended vehicle with a running engine represents a potential safety hazard. ◀

P Park

Select only when the vehicle is stationary. The transmission locks to prevent the rear wheels from turning.

R Reverse

Select only when the vehicle is stationary.

N Neutral

Select only if your journey is interrupted for a longer period.

D Drive (automatic shift program)

This position is designed for driving under all normal operating conditions. All forward gears are available, the Adaptive Transmission Control (ATC) is fully operational.

"Kickdown"

In the "Kickdown" mode, you achieve maximum performance. To activate this mode, depress the accelerator pedal beyond the full-throttle position, at which a resistance point must be overcome.



M/S Manual mode and Sport Program

Shifting from D into M/S activates the Sport Program and indicates SD in the gear indicator. This position is recommended for a performance-oriented driving style.

With the first brief touch, the automatic transmission shifts from the Sport Program to the manual mode. When you move the selector lever forward in the "+" direction, the transmission shifts up. When the lever is moved back in the "-" direction, the transmission shifts down. M1 to M5 appear in the gear indicator.

Upshifts or downshifts will be carried out by the ATC only at appropriate engine and road speeds, e.g. the engine will not downshift if engine speed is too high. The gear selected will appear briefly in the instrument cluster followed by the current gear.

 To accelerate quickly in the manual mode (to pass another vehicle, for instance), shift down manually or employ the kickdown mode. ◀

Shifting from M/S to the selector lever positions P, R and N is possible only by going through D.

In the following situations, the Steptronic "thinks" for you in the manual mode:

- ▷ In order to prevent the engine from overrevving, the transmission shifts automatically to the next higher gear just before the engine speed cutoff point.
- ▷ If you do not do anything to intervene, it will automatically downshift at lower speeds.
- ▷ In the kickdown mode, the transmission shifts down to the lowest gear which is possible, depending on the engine speed.
- ▷ Depending on the situation – when driving in adverse winter conditions, for example – you may also start out in 2nd or 3rd gear.



Possible displays

P R N D SD M1 M2 M3 M4 M5

Electronic transmission control module



If the indicator lamp comes on, there is a malfunction in the transmission system.

Bring the vehicle to a stop. Move the transmission selector lever to "P." Set the parking brake and turn the engine off (ignition key to position 0).

Wait a few seconds, then start the engine.

If the indicator lamp goes out after a few seconds, normal transmission performance has been restored. You may continue to drive as usual.

If the indicator lamp does not go out, you can place the selector lever in all positions. However, the vehicle will now only operate in 3rd and 4th gear.

If this happens, avoid extreme engine loads and consult the nearest BMW center.



Do not work in the engine compartment when a drive gear (forward or reverse) is engaged. If you do this, the vehicle could move. ◀

For towing or jump-starting, refer to the information beginning on page [168](#).

70 Turn signal indicator/Headlamp flasher



- 1 High beams (blue indicator lamp)
- 2 Headlamp flasher (blue indicator lamp)
- 3 Turn signal indicator (green indicator accompanied by periodic clicking sound from the relay)

If the indicator lamp and the clicking from the relay are both faster than normal, one of the turn signal indicators has failed.

To signal briefly

Press the lever up to but not beyond the detent. It will then return to the center position when released.

Washer/Wiper system



- 0 Wipers retracted
- 1 Intermittent mode or rain sensor
- 2 Normal wipe
- 3 Fast wipe
- 4 Brief wipe
- 5 Cleaning windshield
- 6 Rotary dial for controlling the wipe interval or the sensitivity of the rain sensor

Washer/Wiper system



1 Intermittent mode or rain sensor*

Intermittent mode:

You can use rotary dial 6 to select from four wipe intervals.

In addition, the wipe interval is varied automatically depending on road speed.

Rain sensor:

The rain sensor is positioned on the windshield, directly ahead of the interior rearview mirror. When the rain sensor is activated, the windshield wiper is controlled automatically, depending on the degree of wetness on the windshield (in both snow and rain). You do not have to be concerned with switching the windshield wiper on or off or adjusting the wipe interval between

intermittent and full wipe. Instead, you can concentrate fully on the traffic conditions. This is especially important under adverse weather conditions.

To activate the rain sensor:

From ignition key position 1 and up, you can move the lever to position 1. The wipers travel once across the windshield, regardless of the weather.

You can leave the lever permanently in position 1. It is then only necessary to activate the rain sensor from ignition key position 1 and up. To do this,

- ▷ turn rotary dial 6 briefly or
- ▷ use cleaning windshield 5.

To adjust the sensitivity of the rain sensor:

Turn rotary dial 6.

Deactivating the rain sensor:

Put lever in position 0.



Turn the rain sensor off when passing through an automatic car wash. Failure to do so could result in damage caused by undesired wiper activation. ◀

2 Normal wiper speed

When the vehicle is stationary, the wipers switch automatically to intermittent wipe (not on vehicles with rain sensor).

3 Fast wiper speed

When the vehicle is stationary, the wipers operate at normal speed (not on vehicles with rain sensor).

5 Cleaning windshield

The system sprays washer fluid against the windshield and activates the wipers for a brief period.

If you pull the lever only briefly, the system sprays washer fluid onto the windshield without activating the wipers.

Cleaning headlamps*

When the vehicle's lighting system is switched on, the headlamps will also be cleaned every fifth time cleaning windshield is activated.



Do not use the washers if there is any danger that the fluid will freeze on the windshield. If you do so, your vision could be obscured. Use an antifreeze agent. Refer to page [134](#).

Do not use the washers if the reservoir is empty, otherwise, the washer pump could be damaged. ◀

Windshield washer jets

The windshield washer jets are heated* automatically when the ignition key is in position 2.



The illustration shows the button set-up for vehicles equipped with automatic climate control. For other layouts, refer to page [90](#).

To activate

Press the button: as long as the indicator lamp remains on, the rear window defroster continues at high output (rapid thaw).

After the indicator lamp goes out, the defroster continues operating at reduced power for a limited period before deactivating automatically.

To deactivate

Press the button if the indicator lamp is on.

Cruise control



Starting at about 20 mph (30 km/h), you can maintain and store any vehicle speed that you specify.



Do not use cruise control on twisting roads, when high traffic density prevents driving at a constant speed, when the road surface is slick (snow, rain, ice), or when the road surface is loose (rocks, sand). ◀

To activate the system

From ignition key position 1:
Press button 1. The indicator lamp in the instrument cluster comes on. You can now use the cruise control.

To store and maintain speed or to accelerate

Press button 3 briefly:

The system registers and maintains the current vehicle speed. Every time you tap the button, the speed increases by approx. 0.6 mph (1 km/h).

Press and hold button 3:

The vehicle accelerates without pressure on the accelerator pedal. When you release the button, the system registers and maintains the current speed.



If, on a downhill gradient, the engine braking effect is not sufficient, the set cruise control speed may be exceeded. Speed can drop on uphill grades if the engine output is insufficient. ◀

To decelerate

Press button 2 briefly:

Whenever cruise control is active, your speed will reduce by approx. 0.6 mph (1 km/h) each time you tap the button.

Press and hold button 2:

With the cruise control active, the system automatically reduces the throttle opening to slow the vehicle. When you release the button, the system registers and maintains the current speed.



To resume the stored setting

Press button 4:

The vehicle accelerates to and maintains the last speed stored. When you turn the ignition key to position 0, the stored speed is deleted and the system is deactivated.

To deactivate the system

When the cruise control has been interrupted, press button 1 again. The indicator lamp goes out and the stored speed is deleted.

To interrupt the cruise control

When the system is activated, press and hold button 1. The indicator lamp stays on. You can use the cruise control again as desired.

In addition, cruise control is canceled automatically:

- ▷ If the brakes are applied.
- ▷ When you apply pressure to the clutch pedal, and when you move the automatic transmission selector lever from "Drive" to "Neutral."
- ▷ If you exceed or fall below the programmed speed for an extended period (by depressing the accelerator, for example).



1 Odometer

You can activate the displays shown in the illustration with the ignition key in position 0 by pressing the button in the instrument cluster (arrow).

2 Trip odometer

To reset the trip odometer to zero, press the button (arrow) with the ignition key in position 1 and up.



Avoid engine speeds in the red warning zone of the gauge.

To protect the engine, the fuel supply is automatically interrupted in this zone; you will notice a loss of power.



Indicates current fuel consumption in mpg (in l/100 km on Canadian vehicles). You can check your current driving style to see whether it is conducive to economy and minimum exhaust emissions.

When the vehicle is stationary, the display goes to "Maximum" (zero on Canadian vehicles).

76 Fuel gauge



When you switch on the ignition, the indicator lamp comes on briefly to confirm that the system is operational. Once the indicator lamp stays on continuously, there are still approx. 2 gallons (8 liters) of fuel remaining in the fuel tank.

For fuel tank capacity, refer to page [187](#).

If the tilt of the vehicle varies (extended driving in mountainous areas, for example), there may be slight fluctuations of the needle.



Fill the fuel tank well before it is empty. Driving to the last drop of fuel can result in damage to the engine and/or the catalytic converter. ◀

Temperature gauge



Blue

The engine is still cold. Drive at moderate engine and vehicle speeds.

Red

When you switch on the ignition, the indicator lamp comes on briefly to confirm that the system is operational.

If the lamp comes on while operating the vehicle: the engine is overheated. Stop and switch the engine off immediately and allow it to cool down.

Between the blue and red zones

Normal operating range. It is not unusual for the needle to rise as far as the edge of the red zone in response to high outside temperatures or severe operating conditions. Checking coolant level: refer to page [137](#).

Service Interval Display



Remaining distance for service

The displays shown in the illustration appear for a few seconds when the ignition key is in position 1 or after the engine is started.

The next service due appears with the message OILSERVICE or INSPECTION, together with the distance remaining before the next scheduled service. The computer bases its calculations of the remaining distance on the previous driving style.

A flashing message and a "-" in front of the number mean that the service interval has already been exceeded by the distance shown on the display. Please contact your BMW center for an appointment.

Check Control

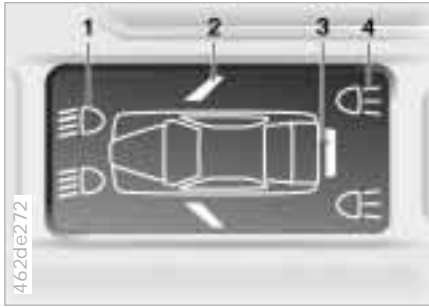

The following information and/or conditions are indicated using symbols, starting with the ignition key position 2, until the condition has been corrected.

- 1 Inspect the low beam and high beam headlamps, as well as the side lamps
- 2 Door open
- 3 Luggage compartment lid open
- 4 Check brake and tail lamps.

When you open the driver's door after stopping with the lights still on, a warning signal sounds for LIGHTS ON.

Computer

77



Mode selection

From ignition key position 1 on, you can call up information from the computer using the button in the turn signal lever. Every time you press the button briefly in the direction of the steering column, you can call up a new function for display.

The displays appear in the following order:

Time, outside temperature, average fuel consumption, cruising range, average vehicle speed.

From ignition key position 1 on, the last active setting is displayed.

Clock

If you wish to have a permanent time display, you can make this adjustment in the radio display (refer to the Radio Owner's Manual).

You can adjust the clock and the time display in the car radio as follows.



Adjustments

From ignition key position 1:

To set ahead: turn the right button to the right.

To set back: turn the right button to the left.

The adjustment speed will increase the longer you hold the button down.

To change the display mode: press the knob briefly.

Every time you press the knob, the clock display alternates between the 12-hour or 24-hour mode.

In ignition key position 0: the time is displayed for a few seconds after you press the left button (refer to "Odometer" on page 75).

Outside temperature

You can change the units of measure (°C/°F) for the outside temperature display by pressing the right-hand reset button in the instrument cluster while the temperature display is active.

Computer

Ice warning

If the outside temperature drops to about 37.5 °F (+3 °C), then the computer will automatically switch to show the outside temperature. In addition, a signal sounds as a warning and the display flashes for a brief period.

This warning will repeat itself whenever the temperature has reached at least 43 °F (+6 °C) since the last warning, and has then dropped further to 37.5 °F (+3 °C).

 Ice warnings do not exclude the possibility that surface ice can still occur at temperatures above 37.5 °F (+3 °C), e.g. on bridges and shady roads. ◀



Average fuel consumption

If you continue to hold the button on the turn signal lever, the average fuel consumption last displayed is recalculated from that point in time.



Range

The computer bases its calculations of the cruising range on the previous driving style and the amount of fuel remaining.



Average speed

If you continue to hold the button on the turn signal lever, the average fuel consumption last displayed for that speed is recalculated from that point in time.

Any time spent when the vehicle is stationary and the engine is shut off is ignored for the calculation.

Park Distance Control (PDC)*

The concept

The PDC assists you when you back into a parking space. A signal warns you of the distance to an obstacle. To do this, four ultrasonic sensors in the rear bumper measure the distance to the nearest object. The range for the sensors located at both rear corners ends approx. 2 ft (60 cm) behind the bumpers. The range for the two middle sensors is slightly less than 4.9 ft (1.50 meters).

The system starts to operate automatically about one second after you select reverse with the ignition key in position 2. PDC is deactivated when you shift back out of reverse.

Acoustical signals

The distance to the nearest object is indicated by a tone sounding at various intervals. As the distance between vehicle and object decreases, the intervals between the tones become shorter. A continuous tone indicates the presence of an object less than 1 ft (30 cm) away.

The warning signal is canceled after approx. three seconds if the distance to the obstacle remains constant during this time (if you are moving parallel to a wall, for instance).

System malfunctions will be indicated by a continuous high-pitched tone when the system is activated the first time. Please refer the problem to your BMW center.



The PDC does not remove the driver's personal responsibility for evaluating the distance between the vehicle and any obstacles. Even when sensors are involved, there is a blind spot in which objects cannot be detected. This applies especially in those cases where the system approaches the physical limits of ultrasonic measurement, as occurs with tow bars and trailer couplings, and in the vicinity of thin and painted objects. Certain sources of sound, such as a loud radio, could drown the PDC signal tone. ◀



Keep the sensors clean and free of ice or snow in order to ensure that they continue to operate effectively. Do not subject the sensors to high-pressure washers for a prolonged period of time. Always maintain a distance of more than 4 in (10 cm). ◀

The concept

This system enhances driving stability and traction, especially when you are just starting off, accelerating or in curves.

ASC+T recognizes the danger present in traction loss and will increase driving stability and traction by reducing the engine's output, and if necessary, by applying the brakes to the rear wheels.

ASC+T is available as soon as the engine starts up.

Indicator lamp

The indicator lamp in the instrument cluster goes out shortly after you switch on the ignition.

Refer to pages [21](#) and [22](#).

Indicator lamp flashes:
ASC+T controls the drive forces.

If the indicator lamp fails to go out after the engine is started, or if it comes on during normal driving and stays on:

There is a system malfunction or the system was deactivated with the button. Consequently, interventions to increase driving stability (as described in the preceding column) are not available. However, you can still drive the vehicle as usual, but without ASC+T. Please consult your BMW center in the event of a malfunction, refer to pages [21](#) and [22](#).

**Deactivating the ASC+T**

Press the button; the indicator lamp comes on and stays on.

The illustration shows the arrangement of the buttons if the vehicle is fully equipped. This may vary, depending on the equipment actually installed.

In the following rare situations, it may be effective to deactivate the ASC+T for a brief period:

- ▷ When rocking the vehicle or starting off in deep snow or on loose surfaces.
- ▷ When driving with snow chains.
Refer also to page [119](#).



To maintain vehicle stability, always drive with the ASC+T activated whenever possible. ◀

Reactivating the ASC+T

Press the button again; the indicator lamp goes out.

 The laws of physics cannot be repealed, even with ASC+T. It will always be the driver's responsibility to drive in a manner that matches road conditions. We therefore urge you to avoid using the additional safety margin of the system as an excuse for taking risks. ◀

For additional details concerning ASC+T, please refer to the chapter "Advanced Technology" on page [175](#).

The Concept

DSC maintains vehicle stability, even in critical driving situations.

The system optimizes vehicle stability during acceleration and when starting from a full stop, as well as optimizing traction. In addition, it recognizes unstable vehicle conditions, such as understeering or oversteering, and, as far as is possible within the laws of physics, helps keep the car on a steady course by reducing the engine speed and brake applications to the individual wheels.

The DSC is operational every time you start the engine. DSC contains the functions of ADB and CBC, refer to page [116](#).

The ADB (automatic differential braking) copies the function of conventional differential and transverse lock through brake intervention, and increases traction whenever conditions merit, e.g. when driving on snow-covered roads.

If the DSC is switched off the ADB will still be in ready mode.

Indicator lamp



The indicator lamp on the instrument panel will go out shortly after the ignition has been started. Refer to pages [21](#) and [22](#).

If the indicator lamp flashes: ASC+T or DSC control the drive and braking forces.

The indicator lamp stays lit: DSC has been switched off via the button; ADB is operational. ADB intervention not indicated.



The indicator lamp and the brake warning lamp will light up continuously:

The DSC, ADB and DBC have been turned off with the switch or are defective.



The vehicle will remain completely operational, however, without DSC. In the event of a fault, please see your BMW center. Refer to pages [21](#) and [22](#).



Indicator and warning lamps for Canadian models.





Switch off the DSC/Activate the ADB

Press the DSC button briefly; the indicator lamp lights up continuously.

The DSC has been switched off; ADB is operational.

In the following exceptional circumstances, it may be effective to deactivate the DSC for a short period:

- ▷ When rocking the vehicle or starting off in deep snow or on loose surfaces
 - ▷ When driving on snow-covered grades, in deep snow, or on a snow-covered surface that has been packed down from being driven on.
 - ▷ When driving with snow chains.
- Refer also to page [119](#).

The gain in traction is achieved by a reduction in stabilizing intervention.

Switch the DSC and ADB off

Hold down the DSC switch for at least 3 seconds. The indicator and the yellow brake warning lamps will remain on the entire time.

In this case, no interventions to increase stability and traction for engine and brakes are carried out.

 To maintain vehicle stability, always drive with the DSC on whenever possible. ◀

Switch the DSC and ADB back on

Press the button again; the indicator lamp or the indicator lamps will go out.

 The laws of physics cannot be repealed, even with DSC. It will always be the driver's responsibility to drive in a manner that matches road conditions. We therefore urge you to avoid using the additional safety margin of the system as an excuse for taking risks.

Whenever the ADB has been activated, the DSC is deactivated and will not perform any stabilizing intervention. Do not make any modifications to the DSC system. Allow only authorized technicians to perform work on the DSC. ◀

For additional details concerning DSC, please refer to the chapter "Advanced Technology" on page [175](#).

Tire Pressure Control (RDC)*

The concept

RDC monitors the tire pressures at all four wheels, even when the vehicle is moving. The system provides an alert whenever the inflation pressure drops significantly below the specified pressure in one or more tires.

In order for the system to "learn" the correct tire inflation pressure, check the inflation pressure in all tires according to the inflation pressure table (page 28) and make corrections as necessary. Then activate the system.



This indicator lamp in the instrument cluster will inform you if the tire pressure is not correct.



Depending on the type of equipment, the switch either has the letters RDC on it or the RDC-symbol.

Activate the system

- 1 Turn ignition key to position 2 (do not start the engine).
- 2 Press the switch long enough for the yellow indicator lamp in the instrument cluster to light up for a few seconds.
- 3 After a few minutes driving time, RDC sets the current inflation pressure in the tires as the target values to be monitored.

You will only have to repeat this procedure following a correction of the tire inflation pressure. Otherwise, RDC functions automatically when the ignition key is in position 2, and thus operates whenever the vehicle is driven.

In the event of tire pressure loss

If the inflation pressure has dropped significantly over a long period of time (which is normal for any tire), the indicator lamp will come on with a yellow lamp.

This alerts you to have the tires inflated to the specified pressures as soon as possible.



If you are prompted to check the tire pressure shortly after a correction has been made, this indicates that the corrected values were not accurate. Please check the inflation pressure again and make corrections according to the inflation pressure table. Then activate the system once again. ◀

In the event of a flat tire

If there is a tire failure with loss of pressure, the indicator lamp comes on with a red lamp. In addition, an acoustic signal is sounded.

If this occurs, reduce vehicle speed immediately to stop the vehicle in a safe location. Avoid hard brake applications. Do not oversteer. Replace the wheel and flat tire.

 The space-saver spare tire is provided for temporary use only in the event of tire pressure loss. It does not have RDC electronics and is not monitored. A full-size spare tire that has the same dimensions as the tires already mounted on the vehicle is equipped with the necessary RDC electronics, and will be also monitored once the tires have been mounted and the system activated. ◀



RDC cannot alert you to severe and sudden tire damage caused by external factors. ◀



Have the tires changed by your BMW center. Your BMW center has been trained to work with the RDC system and is equipped with the necessary special tools. ◀

System interference

Local devices using the same radio frequency can interfere with the RDC.

The yellow indicator lamp will come on during the malfunction.

The indicator lamp also comes on

- ▷ in the event of a system fault.
- ▷ if a wheel is mounted without the appropriate electronics.
- ▷ if, in addition to the spare tire, additional wheels with RDC electronics are on board.

Please contact your BMW center for additional information.

Side lamps/Low beams



Side lamps



With the switch in this position, the front, rear and side vehicle lighting is switched on.

For lighting on one side for parking as an additional feature, refer to page [88](#).

Low beam headlamps



When you switch the ignition off with the low beam headlamps on, only the side lamps will remain on.



"Follow-me-home lamps:"

If you activate the headlamp flasher after parking the vehicle, then the low-beam headlamps will come on for a short time. You can also have this function deactivated. ◀

"LIGHTS ON" warning

When you open the driver's door after turning the ignition key to position 0, buzzer sounds for a few seconds to remind you that the headlamps have not been switched off.

Daytime-driving lamps*

If you desire, the light switch can be left in the second position:

When the ignition is switched off, the external lighting is also switched off.

Instrument panel lighting 87



Turn the rotary dial to adjust the illumination intensity.



- 1 High beams (blue indicator lamp)
- 2 Headlamp flasher (blue indicator lamp)
- 3 Parking lamps

Parking lamp, left or right

As an additional feature, you can illuminate your vehicle on either side for parking, if you wish to do so:

With the ignition key in position 0, push the lever in the appropriate direction. The lever engages in the turn signal position.



Front fog lamps



A green indicator lamp appears in the instrument cluster to indicate that the front fog lamps are on.



The interior lamps operate automatically.

To switch the interior lamps on and off manually

Press the button briefly.

If you want the interior lamps to remain off all the time, press and hold the button for approx. 3 seconds.

To revert to normal operation, press the button briefly.

Footwell lamps*

The footwell lamps operate in the same way as the interior lamps.



Reading lamps front

The reading lamps can be switched on and off with the switch adjacent to each lamp.



Reading lamps rear



The reading lamps can be switched on and off with the switch adjacent to each lamp.

 In order to prevent battery discharge, all of the lamps in the vehicle are switched off automatically approx. 15 minutes after the ignition key has been turned to position 0. ◀

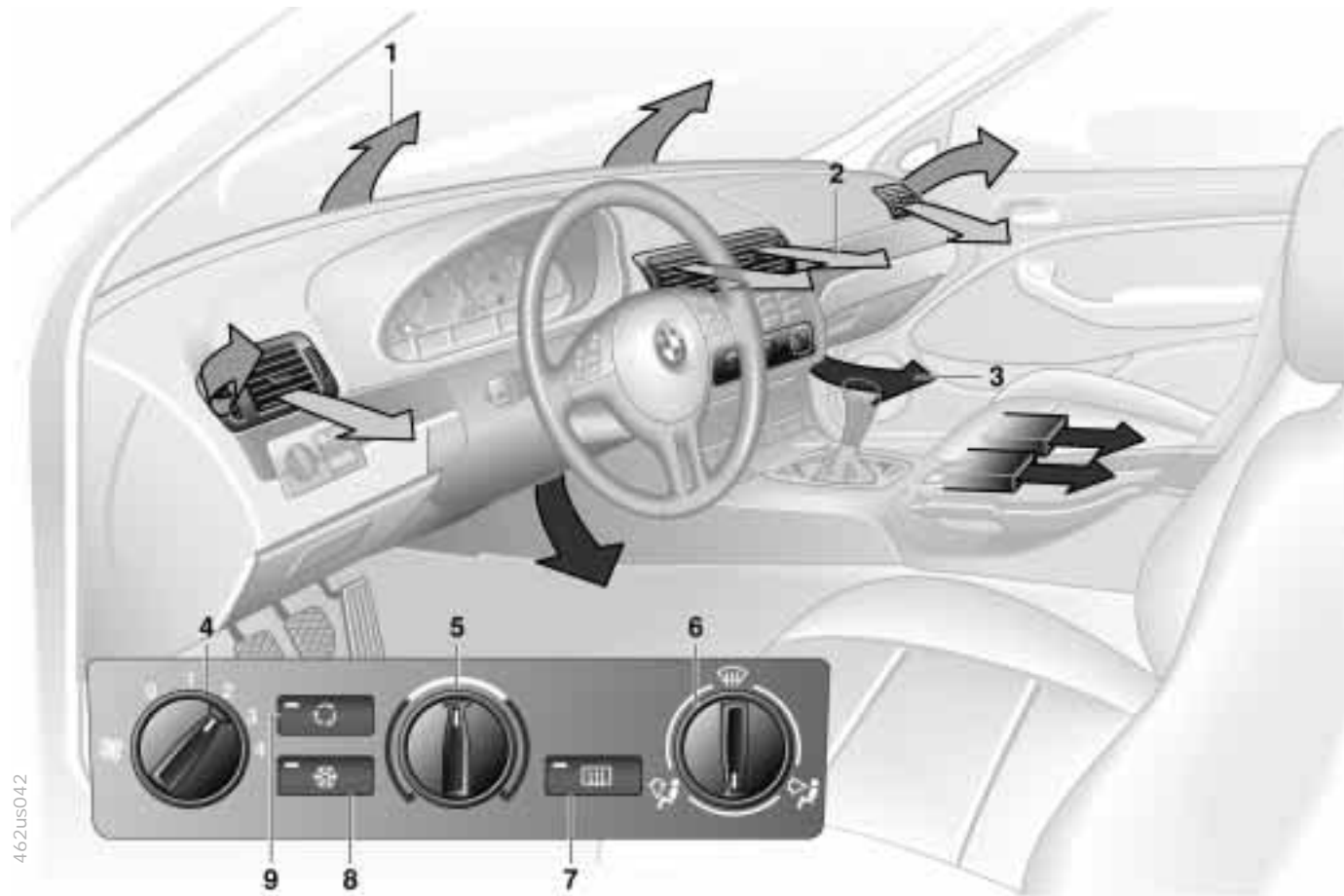
90 Air conditioner



Air conditioner

- 1 Air onto the windshield and onto the side windows
- 2 Air for the upper body area
The side rotary dials open and close the air supply through an infinitely-variable range; the levers will change the direction of the air flow. The center rotary dial controls the temperature of the air as it flows out. Refer to page [92](#)
- 3 Air for the front footwell
There are also vent outlets for the footwell in the rear as well
- 4 Air supply
Heating and ventilation are available starting with position 1. Refer to page [92](#)
- 5 Temperature [92](#)
- 6 Air distribution toward
 - ▷ the windows 
 - ▷ the upper body 
 - ▷ the footwell 
 You can also make all intermediate settings. Refer to page [92](#)
- 7 Rear window defroster [92](#)
- 8 Air conditioner [92](#)
- 9 Recirculated-air mode [92](#)





Air supply

You can select blower speeds from 1 to 4. The heating and ventilation become more and more effective as the air supply settings are increased. In position 0, the blower and the heater are switched off. By using position 0, you can totally block the interior ventilation outlets by pressing the button for the recirculated-air mode.

Temperature

In order to increase the temperature of the passenger compartment, turn it to the right (red). Temperature regulation will keep the interior temperature you have selected constant.

Air distribution

You can direct air to flow onto the windows , toward the upper body  and into the footwell . You can also make all intermediate settings. In the  setting, there is a low flow of air onto the windows to keep them free of condensation. The "6 o'clock" setting is recommended as a normal setting (refer also to the illustration and overview on page 90).

Rear window defroster

When the rear window defroster is activated, the indicator lamp comes on. The rear window defroster switches off automatically. Refer to page 72.

Air conditioner

The air is cooled and dehumidified and – depending on the temperature setting – rewarmed when the air conditioner system is switched on. Depending on the weather, the windshield may fog over briefly when the engine is started. Use the button to switch the air conditioner off at outside temperatures below approx. 41 °F (+5 °C). This will help to prevent the windows from fogging up. If the windows fog over after switching the air conditioner off, switch it back on.



Condensation forms in the air conditioner system during operation, which then exits under the vehicle. Traces of condensed water of this kind are thus normal. ◀

Recirculated-air mode

You can respond to unpleasant external odors by temporarily blocking the outside air. The system then recirculates the air already within the vehicle.



If the windows fog over in the recirculated air mode, switch this mode off and increase the air supply as required. ◀

Air conditioner

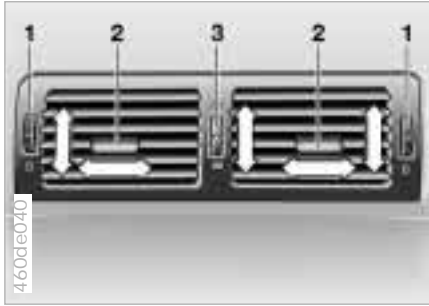

Draft-free ventilation

You can adjust the air outlets for the upper body area to select the optimum air flow rates and directions for your personal requirements:

Use rotary dials 1 to open and close the air outlets through an infinitely-variable range. You can adjust the direction of the air flow with levers 2.

Set the outlets so that the air flows past you and is not directed straight at you.

Rotary dial 3 allows you to mix the air from the outlets for your upper body by warming or cooling the air as desired.

Microfilter

An activated-charcoal microfilter, which traps incoming dust and pollen, has been installed in your vehicle. Your BMW center will replace it during regularly scheduled maintenance. A substantial reduction in air supply indicates that the filter must be replaced before normal maintenance.

For additional details on the filter change, refer to page [166](#).



Rapid ventilation

- 1 Set the blower speed rotary dial for the air flow rate to position 4.
- 2 Switch on the air conditioner.
- 3 Turn the rotary temperature control completely to the left (blue).
- 4 Rotary control for air distribution in position .
- 5 Open the air outlets for the upper body.



Rapid heating

- 1 Set the blower speed rotary control for the air flow rate to position 3.
- 2 Turn the rotary temperature control completely to the right (red).
- 3 Rotary control for air distribution in position .



Defrost the windshield and side windows

- 1 Set the blower speed rotary control for the air flow rate to position 4.
- 2 Turn the rotary temperature control completely to the right (red).
- 3 Rotary control for air distribution in position .
- 4 Switch on the rear window defroster to defrost the rear window.



Heating

When the windows are free of ice and condensation, we recommend the following settings:

- 1 Set the blower speed rotary control for the air flow rate to position 2.
- 2 Use the rotary temperature control to select an interior temperature which is comfortable for you.
- 3 Rotary control for air distribution in position .

96 Automatic climate control*

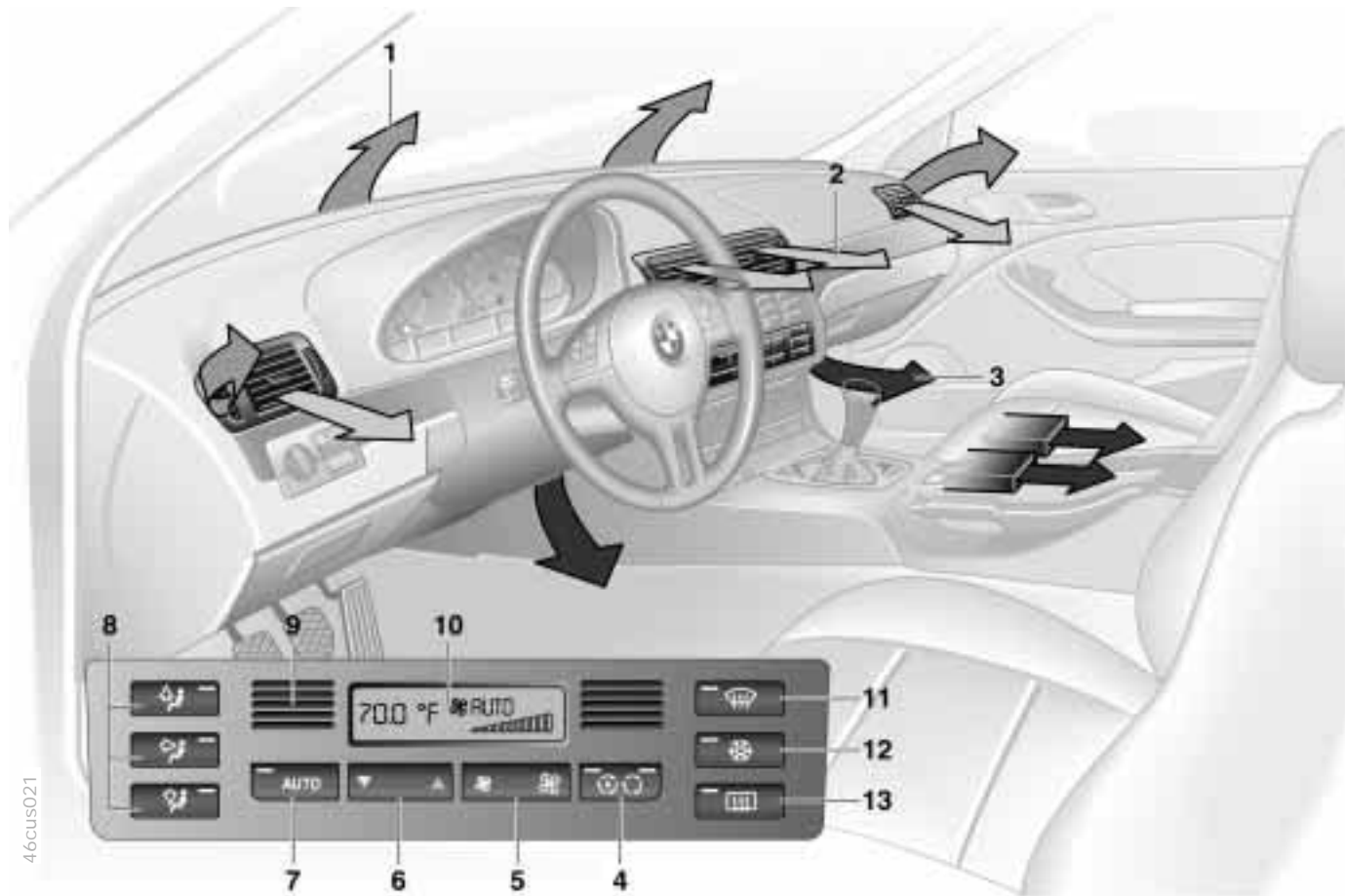

46cus021

- 1 Air onto the windshield and onto the side windows
- 2 Air for the upper body area
The side rotary dials open and close the air supply through an infinitely-variable range; the levers will change the direction of the air flow. The center rotary dial adjusts the temperature of the air as it flows out, see page [100](#)
- 3 Air for the front footwell
There are also vent outlets for the footwell in the rear as well
- 4 Recirculated air mode/Automatic recirculated air control (AUC) [99](#)
- 5 Air supply [99](#)
- 6 Temperature [98](#)
- 7 Automatic air distribution [98](#)
- 8 Individual air distribution [98](#)
- 9 Air grill for interior temperature sensor – please keep clear and unobstructed
- 10 Display for temperature and air supply [98](#)
- 11 To defrost the windshield and side windows [99](#)
- 12 Air conditioner [99](#)
- 13 Rear window defroster [72](#), [100](#)

Tips for pleasant driving

Use the automatic system (switch on AUTO – button 7). Select an interior temperature that is comfortable for you – e.g. 72 °F (+22 °C). Whenever the outside temperature is above 41 °F (+5 °C), you can also use the air conditioner 12. This will dry the air as well as preventing condensation on the window surfaces – if there are passengers with damp clothing, for example. Set the air outlets 2 so that the air flows past you and is not directed straight at you. Set the rotary dial between the air outlets 2 for the upper body to a medium position, since air that is somewhat cooler promotes driving without fatigue.



Detailed setting options are described for you in the following section.

Automatic air distribution

The AUTO program assumes the adjustment of the air distribution and the air supply for you and in addition adapts the temperature to external influences (summer, winter) to meet preferences you can specify. This program maintains a comfortable in-car climate regardless of the season. Select an interior temperature that is comfortable for you – e.g. 72 °F (+22 °C). The temperature selected and  AUTO for the air supply appear in display 10, refer to the overview on page 96. Open the air outlets for the upper body area. Switch on the air conditioner in warm weather. The maximum cooling capacity is achieved when you set rotary dial 3 (refer to page 100) to cold.

Individual air distribution

You can cancel the AUTO program by selecting specific distribution patterns to suit your own individual requirements.

You can direct air to flow onto the windows , toward the upper body , and into the footwell .

Temperature

The figures in the display provide a general indication of interior temperature. We recommend 72 °F (+22 °C) as a comfortable setting, even if the air conditioner is on. When you start the vehicle, the system ensures that the selected temperature is reached as quickly as possible. It then maintains this temperature, regardless of the season.

Set rotary dial 3 (refer to "Draft-free ventilation" on page 100) to a medium setting, since air that is somewhat cooler promotes driving without fatigue. You can use this setting for mixing air to make minor comfort modifications.



You can set uncontrolled heater output up to 90 °F (+32 °C). The air conditioner is at full cooling output at 60 °F (+16 °C). ◀

Automatic climate control*

Air supply

 By pressing the left or right half of the button, you can vary the air supply. By doing this, you switch off the automatic control of the air supply. Nevertheless, the automatic air distribution remains unchanged.

When you set the lowest blower speed by pressing the left half of the button, all of the displays are canceled: the blower, heating and air conditioner are switched off, and the air supply is stopped. You can reactivate the system by pressing any button for the automatic climate control.

To defrost the windshield and side windows

 This program quickly removes ice and condensation from the windshield and side windows.

Air conditioner

 The air is cooled and dehumidified and – depending on the temperature setting – rewarmed when the air conditioner system is switched on.

Depending on the weather, the windshield may fog over briefly when the engine is started.

Use the button to switch the air conditioner off at outside temperatures below approx. 41 °F (+5 °C). This will help to prevent the windows from fogging up.

If the windows fog over after switching the air conditioner off, switch it back on.

 Condensation forms in the air conditioner system during operation, that then exits under the vehicle. Traces of condensed water of this kind are thus normal. ◀

Automatic recirculated air control (AUC)

 If there are unpleasant odors or pollutants in the outside air, you can temporarily block the air supply from the outside. The system then recirculates the air already within the vehicle. By repeated actuation of the button, you can select one of three different operation modes.

- ▷ Indicator lamps off: fresh air flows into the vehicle.
- ▷ Left-hand indicator lamp on – AUC mode: the system detects pollutants in the outside air and responds by deactivating the outside air supply as required. The system then recirculates the air already within the vehicle. Depending on the air quality, the automatic system then switches back and forth between outside air supply and recirculation of the air within the vehicle.
- ▷ Right-hand indicator lamp on: the supply of outside air is permanently blocked. The system recirculates the air already within the vehicle.

 If the windows fog over in the recirculated air mode, switch this mode off and increase the air supply as required. ◀

Rear window defroster



When the rear window defroster is activated, the indicator lamp comes on. The rear window defroster switches off automatically. Refer to page [72](#).

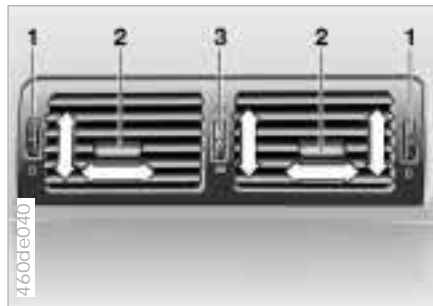

Draft-free ventilation

You can adjust the blower controls for the upper body area to select the optimum air flow rates and directions for your personal requirements:

Use rotary dials 1 to open and close the air outlets through an infinitely-variable range. You can adjust the direction of the air flow with levers 2.

Set the outlets so that the air flows past you and is not directed straight at you.

Rotary dial 3 allows you mix the air from the outlets for your upper body by warming or cooling the air as desired.

Microfilter/Activated-charcoal filter

The microfilter traps incoming dust and pollen. The activated-charcoal filter helps clean the incoming outside air of gaseous pollutants. Your BMW center will replace this combined filter during the regularly scheduled maintenance. A substantial reduction in air supply indicates that the filter must be replaced before normal maintenance.

For further information about filter replacement, refer to page [166](#).

Seat heating*



The seat cushion and backrest can be heated with ignition key in position 2.

You can call up different heating modes by repeatedly pressing the button.

When the three indicator lamps are illuminated, the highest heating mode is activated. One lamp indicates the lowest heating mode. The temperature is regulated with a thermostat in each mode.

You can also switch the higher heating modes off directly:

Press the button and hold it slightly longer.

Roller sun blind*



To actuate, press the button briefly with the ignition key in position 1.

The illustration depicts the arrangement of the buttons if the vehicle is fully equipped. This may vary, depending on the equipment actually installed.

HiFi system*



HiFi system – harman kardon

Special acoustical effects are activated or deactivated every time you press the button.

When the system is activated, the impression of a significantly larger passenger compartment is created at all seating areas, together with an improvement of the stereo effect.

When reception is weak, the system frequently switches between stereo and mono operation. Switch it off.



To open

Pull the handle and the lamp comes on.

To close

Flip the door up.

To lock

Use one of the master keys. A master key must also be used for unlocking.

 If you turn over only your door and ignition keys for valet parking (refer to page 32), for example, access to the glove compartment is not possible. ◀

 To prevent injury in the event of a crash, close the glove compartment immediately after use. ◀

Rechargeable flashlight

The flashlight is located on the left-hand side of the glove compartment. It features integral overload protection, so it can be left in its holder continuously.

 Be sure that the flashlight is switched off when it is inserted into its holder. Failure to comply with this precaution could lead to overcharging and damage. ◀



To open the storage compartment in the front center armrest: press the button (arrow) and lift upward.

You will find additional storage compartments in the doors and in the center console above the ashtray. Storage nets are located on the backrests of the front seats.

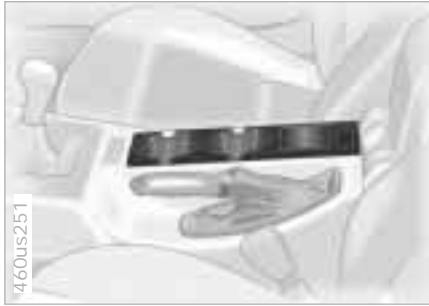

Cup holder, coin box

A coin box and two cup holders are provided in the center console.



Rear center armrest*

There is a cup holder (for two drinks) and a garbage bag holder located in the rear center armrest.

- ▷ Beverage holder: press to open.



Storage package*

For your convenience, there are:

- ▷ Two flip-out sockets on the rear center console (arrows).
- ▷ An eyeglass storage compartment* (not shown in the illustrations) in the front center console above the ashtray.

Ashtray, front



Handsfree system

In vehicles with telephone preparation* or a communications package*, the trim piece for the hands free microphone is located in the headliner near the interior lamp.

For further information on the cellular phone, refer to the separate Owner's Manual.



To open

Press briefly in the direction indicated by the arrow.

To extinguish a cigarette, tap off the ash and gently press the tip into the funnel.

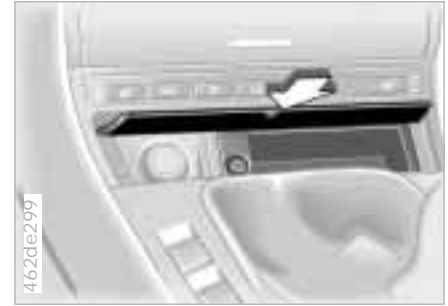

To empty

Open the lid and press down (arrow): You can now pull the ashtray upward for removal.

Cigarette lighter



Press the lighter in. Remove the lighter as soon as it pops back out.

 Hold or touch the hot cigarette lighter by the knob only. Holding or touching it in other areas could result in burns.

The cigarette lighter remains operational when the ignition key has been removed. For this reason, children should never be left in the vehicle unattended. ◀

Cigarette lighter socket

Suitable for attaching power supplies for flashlights, car vacuum cleaners, etc., up to a rating of approx. 200 watts at 12 volts. Avoid damaging the socket due to inserting plugs of different shapes or sizes.

Ashtray, rear



To open

Push the cover open.

To empty

Press on the edge of the raised cover in the opening direction (arrow). You can now pull the ashtray upward for removal.

Clothes hooks



Press on the upper edge to flip it up. For additional information, refer to page [113](#).

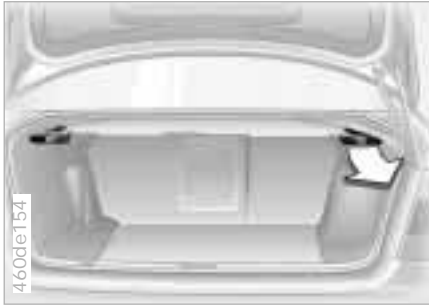

The rear backrest is divided into two sections (one-third and two-thirds of the width of the seat). For carrying longer objects, you can fold down either section of the backrest separately. To unlock, pull the lever corresponding to the section (arrow).



The rear backrest section will move forward slightly when it is unlocked. Reach into the gap and pull the backrest down.

 When you fold back the backrest, be sure that the retainer engages correctly. If it is not correctly engaged, transported cargo could enter the passenger compartment from the luggage compartment during brake applications or evasive maneuvers and endanger the vehicle occupants. ◀

The fittings at the inner corners of the luggage compartment provide you with a convenient means of attaching luggage nets* and flexible straps for securing suitcases and luggage. Refer also to "Cargo loading" on page 108.

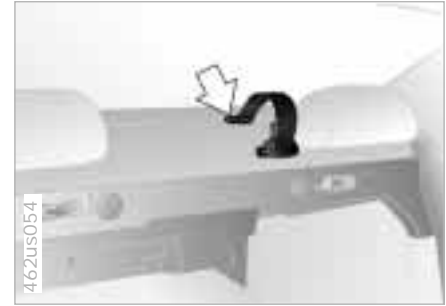

Center 3-point-safety belt in the rear*

You can retract the 3-point-safety belt in the rear, before folding the through-loading system back: Loosen the safety belt and put the buckle latch that is on the end of the safety belt into the bracket mounted on the rear window shelf (arrow).

 To install a child restraint system always use the outer belts. The centre seat belt should only be used when it is necessary to secure three child restraint systems. Do not modify the child restraint system in any way. If you do so, it will not provide your child with maximum protection. ◀

Ski bag*

The ski bag allows the safe and clean transport of up to four pairs of skis or up to two snowboards.

The length of the ski bag and the additional space provided in the luggage compartment make it possible to carry skis up to 6.8 feet long (2.10 meters). Because of the tapered shape of the bag, the ski bag can only accommodate two pairs of skis up to 6.8 feet long (2.10 meters).



Loading

- 1 Fold the center armrest outward. Loosen the trim from the upper Velcro® fastener and place it on the armrest.
- 2 Press button 1 downward and swing the cover forward.
- 3 Extend the ski bag between the front seats. The zipper provides convenient access to stored items. It may be opened to allow the ski bag to dry.
- 4 Press knob 2: the cover in the luggage compartment will unlock.

To store the ski bag, perform the above steps in reverse sequence.

 Secure the skis or other objects in the bag by tightening the strap with the buckle. ◀

Please be sure that your skis are clean before loading them into the bag. Avoid damage from sharp edges during loading.

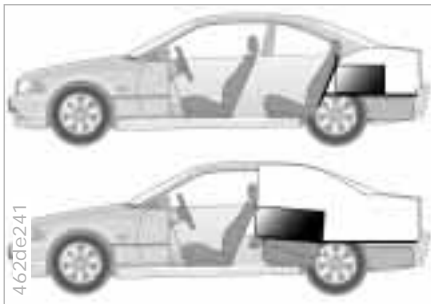

Stowing cargo

If you are transporting a load in your BMW:

- ▷ Load heavy cargo as far forward as possible – directly behind the backrests or the luggage compartment partition – and as low as possible.
- ▷ Cover sharp edges and corners.
- ▷ Do not pile objects higher than the top edge of the backrest.



- ▷ If you are transporting very heavy loads when the rear seat is not occupied, secure the outer safety belts in the opposite buckles (refer to the illustration).

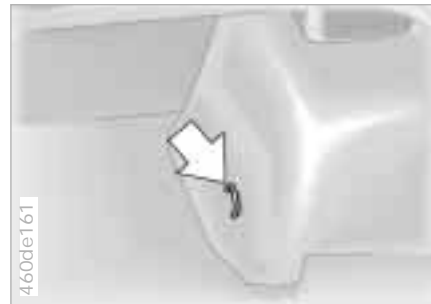

Securing the load

- ▷ For small, light items, use the rubber-lined non-skid side of the floor mat or secure with a luggage net* or flexible straps (refer to page 41).
- ▷ For large, heavy pieces, see your BMW center for load-securing devices*. Lashing eyes (arrow) are provided at the inner corners of the luggage compartment for attaching these load-securing devices.
- ▷ Comply with the information enclosed with the load-securing devices.

 Always position and secure the load correctly. If you do not, it can endanger the passengers during braking or evasive maneuvers. Do not exceed the permissible gross weight and axle loads (refer to page 186), otherwise the vehicle's operating safety is no longer assured and you are in violation of the law. Do not stow heavy or hard objects in the passenger compartment without securing them. Otherwise they would be thrown around during braking and evasive maneuvers and endanger the occupants. ◀



Anchors

Access to the anchors:
To open the cover (arrow) please use the tool included with the roof-rack system.

A special roof-rack system is available for your BMW as an optional extra. Please comply with the precautions included with the installation instructions.

Because roof racks raise the center of gravity of the vehicle when loaded, they exercise a major effect on its handling and steering response.

You should therefore always remember not to exceed the approved roof weight, the approved gross vehicle weight or the axle loads when loading the rack. Pertinent specifications are

listed under "Technical Data," page 186.

Make sure that the load is not too heavy, and attempt to distribute it evenly.

Always load the heaviest pieces first (on the bottom). Be sure that adequate clearance is maintained for raising the sliding/tilt sunroof, and that objects do not project into the opening path of the luggage compartment lid.

Secure the roof luggage correctly and securely to prevent it from shifting or being lost during driving (danger to following traffic).

Drive smoothly and avoid sudden acceleration or braking. Do not corner at high speeds.

The roof load increases aerodynamic resistance, which in turn increases fuel consumption and places additional stress on the vehicle itself.



Special operating instructions:

- Break-in procedures 112
- Driving notes 113
- Catalytic converter 113
- Antilock Brake System (ABS) 115
- Disc brakes 117
- Brake system 118
- Winter operation 119
- Power steering 121
- Cellular phones 121
- Radio reception 121

Wheels and tires:

- Tire inflation pressure 122
- Tire condition 122
- Tire replacement 123
- Tire rotation 124
- Wheel and tire combinations 125
- Winter tires 126
- Snow chains 126
- Approved wheel and tire specifications 127

Under the hood:

- Hood 130
- Engine compartment 132
- Washer fluids 134
- Washer nozzles 134
- Engine oil 135
- Coolant 137
- Brake fluid 138
- Vehicle Identification Number 139

Care and maintenance:

- The BMW Maintenance System 140
- Caring for your vehicle 141
- Airbags 146
- Vehicle storage 147

Laws and regulations:

- Technical modifications 148
- California Proposition 65 Warning 148
- OBD interface socket 149

Overview**Controls and features****Operation, care and maintenance****Owner service procedures****Advanced technology****Technical data****Index**

To ensure that your vehicle provides maximum economy throughout a long service life, we request that you comply with the following recommendations.

Engine and differential

Up to 1,200 miles (2,000 km):

Drive at varying engine and road speeds, but do not exceed 4,500 rpm or a speed of 100 mph (160 km/h):

Obey your local and state maximum speed limits.

Do not apply full throttle and avoid pressing the accelerator beyond the kickdown point.

Once you have driven 1,200 miles (2,000 km), engine speed and vehicle speed can be gradually increased.

Follow the same break-in procedure if either the engine or the differential is replaced in the future.

Tires

Due to technical factors associated with their manufacture, tires do not achieve their full traction potential until an initial break-in period has elapsed. For this reason drive cautiously during the initial 200 miles (300 km).

Obey your local and state maximum speed limits.



When the vehicle is operated on wet or slushy roads, a wedge of water may form between the tire and the road surface. This phenomenon is referred to as aquaplaning, or hydroplaning, and can lead to partial or complete loss of traction, vehicle control and braking effectiveness. Reduce your speed on wet roads. ◀

Brake system

Approximately 300 miles (500 km) must elapse before the brake pads and discs achieve the optimal pad-surface and wear patterns required for trouble-free operation and long service life later on.

To break-in the separate parking brake drums, apply the parking brake lightly when coasting to a standstill (at a traffic signal, for instance), provided that traffic conditions allow you to do so. To avoid corrosion, repeat this procedure from time to time.



The brake lamps do not come on when the parking brake is set. Vacuum for the brake system servo unit on your BMW is available only when the engine is running. When you move the vehicle with the engine off – when towing, for example – substantially higher levels of pedal force will be required to brake the vehicle. ◀

Clutch

The clutch will also begin to function optimally after about 300 miles (500 km). Engage the gears carefully during the break-in period.



Brakes:

Do not drive with your foot resting on the brake pedal. Even light but consistent pedal pressure can lead to high temperatures, brake wear, and possibly to brake failure.

Aquaplaning:

When driving on wet or slushy roads, reduce vehicle speed. If you do not, a wedge of water may form between the tires and the road surface. This phenomenon is referred to as aquaplaning or hydroplaning. It is characterized by a partial or complete loss of contact between the tires and the road surface. The ultimate results are loss of steering and braking control.

Driving through water:

Do not drive through water on the road if it is deeper than 1 foot (30 cm), and then only at walking speed. Otherwise, the vehicle's engine, the electrical systems and the transmission may be damaged.

Rear window shelf:

Never use it to store heavy or hard objects, otherwise, occupants could be injured if the vehicle is braked hard.

Clothes hooks:

When suspending clothing from the hooks, be sure that they will not obstruct the driver's vision. Do not hang heavy objects on the hooks. If you do so, they could cause personal injury during braking or evasive maneuvers. ◀

The catalytic converter reduces harmful exhaust emissions.

It is designed for use with unleaded fuel only. Even minute quantities of lead would be enough to permanently damage both the catalytic converter and the system oxygen sensor.

To ensure efficient, trouble-free engine operation and to avoid potential damage:

- ▷ Be sure to comply with the scheduled maintenance requirements.
- ▷ Fill the fuel tank well before it is empty.
- ▷ Tow-start only when the engine is cold. If you attempt to tow-start with a warm engine, unburned residual fuel in the catalytic converter could ignite and cause damage. It is better to jump-start the vehicle with outside assistance.
- ▷ Avoid other situations in which the fuel is not burned, or burns incompletely, such as engaging the starter frequently or for extended periods, or repeated start attempts in which the engine does not start (stopping and restarting an engine which is running properly does not present a problem). Never allow the engine to run with any of the spark plug cables disconnected.

114 Catalytic converter



Be sure to comply with the preceding instructions to prevent unburned fuel from reaching the catalytic converter. If you do not, the catalytic converter could respond by overheating, leading to serious damage.

Very high temperatures occur in any vehicle equipped with a catalytic converter. Heat shields are installed adjacent to some sections of the exhaust system. Never remove these shields; do not apply undercoating to their surfaces. When driving, standing at idle, and parking the vehicle, take extra care to avoid contact between the exhaust system and flammable materials (grass, hay, leaves, etc.). Such contact could lead to a fire, resulting in serious personal injury and property damage. ◀

Antilock Brake System (ABS)

The concept

ABS enhances active safety by helping to prevent the wheels from locking under braking. This is because locked wheels are dangerous. When the front wheels slide, the driver loses steering control over the vehicle. Traction loss at the rear wheels can cause the rear end to break into an uncontrolled skid.

The system can achieve the shortest braking distances possible under most conditions (on straight-aways and in curves, on asphalt, ice, wet road surfaces, etc.).

ABS is designed to meet two essential requirements during every brake application:

- ▷ To help provide vehicle stability.
- ▷ To help maintain steering control and maneuverability – on all types of road surfaces (asphalt, concrete, mud, on wet road surfaces, snow, ice).

Braking with ABS

At approx. 6 mph (10 km/h), the system becomes operative. Whenever the vehicle's speed drops below approx. 4 mph (6 km/h), the ABS is deactivated. This means that the wheels can lock in the final phase of a panic stop – a factor of no significance in actual use.

If you are in a situation that requires full braking, you will exploit the full benefits of the ABS system if you apply maximum brake pressure ("panic stop"). Since the vehicle maintains steering responsiveness, you can nevertheless avoid possible obstacles with a minimum of steering effort.

The ABS system closed-loop control circuit cycles in fractions of a second. A pulsation at the brake pedal, together with the sounds associated with the hydraulic controls, tells you that the brake system is within its maximum limit range and reminds you that you should adapt road speed to the road conditions.

On road surfaces that have a loose surface layer on a firm base with good traction (on gravel or snow, for example), or when snow chains are mounted, braking distances may be longer than with locked wheels. However, ABS continues to provide enhanced vehicle stability and steering response under these conditions.

Information for your safety

Not even ABS can suspend the laws of physics. ABS cannot prevent the consequences of brake applications with inadequate clearances for safety between vehicles, when exceeding the speed limit, or the risks involved when aquaplaning occurs. Responsibility for these types of situations remains in the hands (and at the feet) of the driver. You should never allow the added safety of ABS to lull you into a false sense of security, or mislead you into taking increased risks.



Do not make any modifications to the ABS system.

Service procedures on ABS are to be performed by authorized technicians only. ◀

**Antilock Brake System (ABS)/
Cornering Brake Control (CBC)**

CBC is an advanced engineering design of the ABS. When braking while cornering at high speed or braking during high lateral acceleration, or when braking during a lane change, vehicle stability is improved and steering response is enhanced.

In the event of a malfunction

ABS If the ABS warning lamp in the instrument cluster lights up, refer to page 22. The brake system then reverts to conventional operation as on vehicles without ABS. However, have the brake system checked by your BMW center as soon as possible. To prevent undetected defects and cumulative faults from adversely affecting the brake system, refer any problems to your BMW center at the earliest opportunity.



ABS warning lamp for Canadian models.



If the brake warning lamp, and the ABS and ASC+T/DSC indicator lamps come on, refer to page 21, then the entire ABS, CBC, ASC+T/DSC control system has failed. Continue driving cautiously and defensively. Avoid full brake applica-

tions. This could cause the vehicle to lose stability and you might no longer be able to control it.

Have the system checked by your BMW center as soon as possible.



Indicator and warning lamps for CBC, ABS and ASC+T/DSC and ADB for Canadian models.

Dynamic Brake Control (DBC)*

DBC is included in the DSC, refer to information beginning on page 83.

If you step on the brake rapidly, this system automatically produces maximum braking force boost and thus helps to achieve the shortest possible braking distance during "panic stops." All of the benefits of the ABS system are exploited under these circumstances.

Do not reduce the pressure on the brake pedal for the duration of the brake application. When the brake pedal is released, the DBC is deactivated.



In the event of a malfunction, the yellow brake warning lamp comes on. Normal braking efficiency and ABS are still fully available. Have the system checked and repaired at your BMW center as soon as possible.



Please observe the section "Information for your safety" concerning the ABS system, which also applies to the DSC system. ◀

Disc brakes

Disc brakes furnish optimum deceleration and braking control and greater fade resistance under heavy use.

When the vehicle is driven only occasionally, during extended periods when the vehicle is not used at all, and in operating conditions where brake applications are less frequent, there is an increased tendency for corrosion of the discs and accumulation of contamination on the brake pads. This occurs because the minimal pressure that must be exerted by the pads to clean the discs by brake applications is not reached.

If the brake discs are corroded, they will tend to respond to braking with a pulsating effect that even extended brake applications will fail to cure.

 For your own safety: use only brake pads that BMW has approved for your particular vehicle model. BMW cannot evaluate non-approved brake pads to determine if they are suited for use, and therefore cannot ensure the operating safety of the vehicle if they are installed. ◀

Driving notes

When driving in wet conditions and in heavy rain, it is effective to apply light pressure to the brakes every few miles or kilometers. Be aware of traffic conditions to ensure that this maneuver does not endanger other road users. The heat which is generated by the brake applications helps to dry the brake pads and discs.

Maximum braking force is obtained while the wheels are not locked, but rather when they are still barely turning immediately prior to locking. ABS maintains this state automatically. If the antilock brake system ever fails, you should revert to pumping the brakes (refer to page 120).

Extended or steep mountain descents should be driven in the gear in which only minimal periodic brake applications is required. This avoids excessive strain on the brakes and possible impairment of the braking effect.

You can further increase the engine's braking effect by selecting a lower gear, downshifting as far as first gear. When driving a vehicle with automatic transmission, you can still downshift into first gear. Refer to page 67.

If engine braking should prove to be inadequate, you should still avoid extended, continuous braking. Instead of maintaining low to moderate pressure over an extended period of time, you should decelerate by applying more substantial pressure to the brake pedal (watch for following traffic), releasing the pedal, and then repeating the application (staggered braking). The cooling phases between active braking intervals prevent the brakes from overheating, thus ensuring that full braking capacity remains available at all times.

 Do not coast with the clutch depressed or with the shift lever or selector lever in Neutral. Do not drive with the engine shut off. The engine provides no braking effect when the clutch is depressed or the transmission is in Neutral, and there is no power-assist for braking or steering when the engine is not running. Never allow floor mats, carpets or any other objects to protrude into the area around the brake, clutch or accelerator pedals, which can obstruct pedal travel. ◀

Brake fluid level



If the brake warning lamp comes on with the parking brake released:

The brake fluid level is too low in the reservoir (refer to page 138).

If the brake fluid level is too low and brake pedal travel has become noticeably longer, there may be a defect in one of the hydraulic circuits of the brake system.



Brake warning lamp for Canadian models.



Proceed to the nearest BMW center. Higher brake application pressure may be necessary under these conditions, and brake pedal travel may be significantly longer. Please remember to adapt your driving style accordingly. ◀

Brake pads



If the warning lamp for the brake pads lights up:

Only the minimum pad thickness still remains on the brake pads. Proceed to the nearest BMW center as soon as possible to have the pads replaced.



For your own safety: use only brake pads that BMW has approved for your particular vehicle model. BMW cannot evaluate non-approved brake pads to determine if they are suited for use, and therefore cannot ensure the operating safety of the vehicle if they are installed. ◀

Winter operation

The onset of winter is often accompanied by rapid changes in weather. Adaptations in driving style should be accompanied by preparations on the vehicle itself to ensure that your progress through the winter remains safe and trouble-free.

Coolant

Be sure that the coolant mixture contains the year-round ratio of 50:50 water and extended-duty antifreeze/corrosion protection. This mixture provides protection against freezing down to approx. -34 °F (-37 °C). Replace the coolant every four years.

Locks

BMW door lock deicer can be used to free them if frozen. This deicer also contains lubricant.

After using the deicer, we recommend you treat the door lock with BMW lock cylinder lubricant.

Rubber seals and components

To prevent the weather-stripping from freezing, apply a spray-on rubber treatment or silicone spray to the door, hood and luggage compartment lid seals.



A full range of car care products is available from your BMW center. ◀

Snow chains*

BMW snow chains can be mounted on both summer and winter tires. Mount them in pairs on the rear wheels only and comply with the manufacturer's safety precautions. Do not exceed a maximum speed of 30 mph (50 km/h). In this rare situation, it may be effective to deactivate the ASC+T/DSC system for a brief period of time. Refer to page [82](#).

Starting off

When starting up from a full stop in deep snow or when "rocking" the vehicle to free it, it may be effective to deactivate the ASC+T/DSC system for a brief period of time. Refer to page [82](#).

Driving on low-traction road surfaces

Use smooth, gentle pressure to control the accelerator pedal. Avoid excessive engine speeds and shift to the next higher gear at an early point. On downhill grades or slopes, shift down to the next lower gear at an early point. Maintain an adequate distance between yourself and the vehicle ahead.

Brakes

Winter road conditions substantially reduce the amount of traction available between the tires and the road surface; the resulting increase in braking distance is considerable and should always be kept in mind.

ABS is intended to prevent the wheels from locking during brake applications, thus helping to maintain vehicle stability and steering response.

If the ABS does not respond in a critical braking situation and the wheels lock: reduce the pressure on the brake pedal until the wheels just start to roll again while still maintaining enough force to continue braking.

Then increase the pedal pressure, reduce the pressure when the wheels lock, reapply pressure etc.

This staggered braking procedure will reduce stopping distances while helping you maintain steering control. You can then attempt to steer around hazards after you have reduced pressure on the brake pedal.



Do not shift down on slick road surfaces. Doing so could cause the rear wheels to lose traction and skid, that could result in the loss of vehicle control. ◀



Depress the clutch during hard braking on road surfaces that provide only poor or uneven traction. ◀

Skid control

Depress the clutch and let up on the accelerator pedal, or place the selector lever for the automatic transmission in the "Neutral" position. Countersteer carefully and attempt to regain control of the vehicle.

Parking

Engage 1st or reverse gear. If your vehicle is equipped with an automatic transmission, place the selector lever in Park. On vehicles with manual transmission, also apply the parking brake when parking on inclined surfaces. In order to prevent the parking brake pads from locking due to frost or corrosion, dry them by gently applying the parking brake as the vehicle is coming to a stop. Make sure that following traffic is not endangered.



The brake lamps do not come on when the parking brake is applied. ◀

Power steering

If the steering response changes, e.g. high steering effort:

Have your BMW center inspect this system.



If the power steering fails, increased effort will be required to steer the vehicle. ◀

Cellular phone*

Mobile communications systems (cellular phone, radio, etc.) are permitted with an output up to 10 watts only. Mobile communications devices not specifically designed for use in your vehicle may trigger malfunctions while operating your vehicle. BMW can neither test nor assume responsibility for every individual product being offered on the market. We recommend that you consult your BMW center before purchasing any device of this kind.

To ensure that your BMW continues to provide reliable and trouble-free operation, do not use a cellular phone or other radio device with an antenna located inside the passenger compartment. The antenna should always be mounted on the outside of the vehicle.



Before loading the vehicle on a car-carrier train or driving it through a car wash, remove the antenna. ◀

Radio reception

The reception and sound quality obtained from mobile radios varies according to a variety of factors, including the broadcast range of the transmitter and the directional orientation of the antenna. Interference factors such as high-tension power lines, buildings and natural obstructions can all lead to unavoidable reception interference, regardless of how well the vehicle's sound system is operating.

Climatic factors such as intense solar radiation, fog, rain and snow can also interfere with reception.

Car telephones or cellular phones not approved by BMW can also cause interference in the radio during a telephone call. This phenomenon assumes the form of a low-pitched hum emanating from the speaker system.

Please refer to the Owner's Manual provided with your sound system for detailed information on its use.

Information for your safety

The factory-approved radial tires are matched to the vehicle and have been selected to provide optimum safety and driving comfort on your vehicle.

It is not merely the tire's service life, but also driving comfort and – above all else – driving safety that depend on the condition of the tires and the maintenance of the specified tire pressure.

Incorrect inflation pressure is a frequent cause of tire damage. It also significantly influences the roadholding ability of your BMW.

 Be sure to check the tire inflation pressure – including the space-saver spare tire or the spare tire – on a regular basis, at least twice a month and before doing any extended driving. Refer to page 27. If this is not done, incorrect tire pressures can cause driving instability and tire damage, ultimately resulting in an accident. ◀

**Tire tread – tire damage**

Inspect your tires frequently for tread wear, signs of damage and for foreign objects lodged in the tread. Check the tread depth.

Tread depth should not be allowed to go below 0.12 in (3 mm), even though the legally specified minimum tread depth is only 0.063 in (1.6 mm). At a tread depth of 0.063 in (1.6 mm), tread depth indicators (arrow) in the tread-groove base indicate that the legally-permissible wear limit has been reached. Below 0.12 in (3 mm) tread depth, there is an increased risk of aquaplaning, even at relatively moderate speeds and with only small amounts of water on the road.



Do not drive on a deflated (flat) tire. A flat tire greatly impairs steering and braking response, and can lead to complete loss of control over the vehicle.

Avoid overloading the vehicle so that the permitted load on the tires is not exceeded. Overloading can lead to overheating and increases the rate at which damage develops inside the tires. You could have a blowout as a result.

Unusual vibrations encountered during normal vehicle operation can indicate tire failure or some other vehicle defect. This is also true for irregularities in the vehicle's handling characteristics, such as a pronounced tendency to pull to the left or right. Should this occur, respond by immediately reducing your speed. Proceed carefully to the nearest BMW center or professional tire center, or have the vehicle towed in to have it and its tires inspected.

Tire damage (up to and including blow-outs) can endanger the lives of both the vehicle occupants and other road users. ◀

Tire replacement

To maintain good handling and vehicle response, use only tires of a single tread configuration from a single manufacturer. BMW tests and approves wheel/tire combinations, beginning on page 127.

DOT Quality Grades

Treadwear

Traction AA A B C

Temperature A B C



All passenger vehicle tires must conform to Federal Safety Requirements in addition to these grades. ◀

Tread wear

The tread wear grade is a comparative rating based on the wear rate of the tire when tested under controlled conditions on a specified government test course.

For example, a tire graded 150 would wear one and one-half (1 ½) times as well on the government course as a tire graded 100. The relative performance of tires depends upon the actual conditions of their use, however, and may depart significantly from the norm due to variations in driving habits, service practices and differences in road characteristics and climate.

Traction

The traction grades, from highest to lowest, are AA, A, B, and C. Those grades represent the tire's ability to stop on wet pavement as measured under controlled conditions on specified government test surfaces of asphalt and concrete. A tire marked C may have poor traction performance.



The traction grade assigned to this tire is based on straight-ahead braking traction tests, and does not include acceleration, cornering, hydroplaning, or peak traction characteristics. ◀

Temperature

The temperature grades are A (the highest), B, and C, representing the tire's resistance to the generation of heat and its ability to dissipate heat when tested under controlled conditions on a specified indoor laboratory test wheel. Sustained high temperature can cause the material of the tire to degenerate and reduce tire life, and excessive temperature can lead to sudden tire failure. The grade C corresponds to a level of performance which all passenger vehicle tires must meet under the

Federal Motor Vehicle Safety Standard No. 109. Grades B and A represent higher levels of performance on the laboratory test wheel than the minimum required by law.



The temperature grade for this tire is established for a tire that is properly inflated and not overloaded. Excessive speed, underinflation, or excessive loading, either separately or in combination, can cause heat buildup and possible tire failure. ◀

Uniform Tire Quality Grading

Quality grades can be found where applicable on the tire sidewall between tread shoulder and maximum section width. For example:

Tread wear 200 Traction AA
Temperature A



Do not use retreaded tires. Driving safety may be impaired by their use. This is due to the possible variations in casing structures and, in some cases, to their extreme age, factors that can lead to a decrease in their durability. ◀

Tire age

The date on which the tire was manufactured is indicated by the code on the sidewall:

DOT ... 4100 means that the tire was manufactured in week 41 of 2000.

BMW recommends the replacement of all tires when the tires are no more than 6 years old, even if a tire life of 10 years is possible.

Spare tires over 6 years old should be used only in case of emergency. A tire in this condition should be replaced by a new tire immediately, and should not be mounted together with new tires.

Tire rotation**Between the axles**

The tread wear patterns at the front end differ from those at the rear – the actual patterns will vary according to individual driving conditions. In the interests of safety and maintaining optimal handling characteristics, tire rotation is not recommended.

If a proposed interaxle rotation of tires is based on economic considerations, one should consider whether the costs for the rotation are likely to be recaptured by any increase in the service life of the tires that might be realized. In principle, tire rotation should be performed at short intervals (maximum 3,000 miles/5,000 km). Consult your BMW center for more information.

Should you decide to rotate the tires, it is essential to comply with the following:

Rotate tires on the same side only, since braking characteristics and road grip could otherwise be adversely affected.

Following rotation, the tire inflation pressure should always be corrected.



If different tire sizes are mounted on the front and rear axles (refer to page 127), the wheels may not be rotated from one axle to the other. ◀

Wheel and tire combinations

The right choice

Use only BMW-approved tires, beginning on page 127.

Due to the high speeds this vehicle can reach, the use of specific brands, specifications and sizes is mandatory. Consult any BMW center for details. Comply with local/national regulations.

 The correct wheel/tire combination has an effect on the different systems such as ABS, ATC, ASC+T/DSC and ADB/DBC, whose functioning would be otherwise impaired if the incorrect wheel/tire combinations were used. For this reason, use only tires of the same manufacture and tread configuration. In the event of a flat tire, for example, remount the approved wheel/tire combination as soon as possible. ◀

Codes on the tires and wheels

The tire codes will aid you in selecting the correct tire.

The codes on radial tires:

Example: 225/50 R 16 92 W

Nominal width in mm _____

Aspect ratio in % _____

Radial tire ID code _____

Rim diameter in inches _____

Load rating (not on ZR tires) _____

Speed rating (before R on ZR tires) _____

The speed rating indicates the approved maximum speed for the tire.

Summer tires:

S = up to 112 mph (180 km/h)
 T = up to 118 mph (190 km/h)
 H = up to 130 mph (210 km/h)
 V = up to 150 mph (240 km/h)
 W = up to 167 mph (270 km/h)
 Y = up to 187 mph (300 km/h)
 ZR = over 150 mph (240 km/h)

Winter tires and all-season tires:

Q M+S = up to 100 mph (160 km/h)
 T M+S = up to 118 mph (190 km/h)
 H M+S = up to 130 mph (210 km/h)

Codes stamped on light-alloy wheels:

Example: 7 J x 16 H 2

Rim width in inches _____

Code letter for flange type _____

Symbol for full-drop center rim _____

Rim diameter in inches _____

Hump on the 2 rim shoulders _____

Protect tire valve from dirt by using screw-on valve stem caps. Dirt in the valves frequently leads to slow leaks.

Choosing the right tire

BMW recommends winter tires (M+S radial tires) for driving in adverse winter road conditions. So-called all-season tires with the M+S identification mark do indeed possess better winter traction than summer tires that have the H, V, W, Y and ZR speed ratings, they generally fail to provide the same levels of performance as winter tires.

In the interest of safe tracking and steering response, install winter tires made by the same manufacturer having the same tread configuration on all four wheels.

Mount only winter tires which have been approved by BMW. Any BMW center will be glad to provide you with information on the best winter tires for your particular driving conditions.

Do not exceed specified maximum speeds

Never exceed the maximum speed for which the tires are rated. Unprofessional attempts by laymen to service tires can lead to damage and accidents.

Have this work performed by skilled professionals only. Any BMW center has the required technical knowledge and the proper equipment and will be happy to assist you. ◀

Tire condition, tire pressure

Winter tires display a perceptible loss in their ability to cope with winter driving conditions once the tread wears to below 0.16 in (4 mm), and therefore in the interest of safety, should be replaced.

Comply with the specified tire inflation pressures – and be sure to have the wheel and tire assemblies balanced every time you change the tires.

Storage

Always store tires in a cool, dry place. Store them away from light whenever possible. Protect the tires against contact with oil, grease and fuel.

Snow chains*

Use narrow-link BMW snow chains on winter tires only in pairs and only on the rear wheels. Comply with all manufacturer's safety precautions when mounting the chains.

Tire specifications	Steel rim	Light-alloy wheel
BMW 325Ci		
All season tires		
205/55 R 16 91 H M+S		7Jx16
Summer tires		
205/55 R 16 91 V	-	7Jx16
225/50 R 16 92 W		
225/50 ZR 16		
205/50 R 17 93 W extra load	-	7Jx17
225/45 R 17 91 W	-	8Jx17
Front: 225/45 ZR 17	-	7.5Jx17
Rear: 245/40 ZR 17		8.5Jx17
Winter tires (M+S)		
205/55 R 16 91 Q	-	7Jx16
225/50 R 16 92 Q		
205/50 R 17 93 Q extra load	-	7Jx17
225/45 R 17 91 Q	-	8Jx17
Space-saver spare tire		
T 115/90 R 16 92 M	3.0Bx16	
T 125/90 R 16 98 M	3.5Bx16	-
T 125/80 R 17 99 M	3.5Bx17	-

Comply with the specifications for tires and wheels in the vehicle's documents. If you install tire sizes not approved by the manufacturer, an entry in the vehicle's documents may be necessary.

Snow chains*

You cannot mount snow chains with the following tires:

225/50 R 16 92 W
 225/50 R 16 92 Q M+S
 225/50 ZR 16
 225/45 R 17 91 W
 225/45 R 17 91 Q/T/H M+S
 245/40 ZR 17

Mixed tires

For details concerning tire manufacturers for mixed tires, refer to the vehicle's documents.

128 **Approved wheel and tire specifications**

Tire specifications	Steel rim	Light-alloy wheel
BMW 330Ci		
All season tires		
205/50 R 17 93 H/V M+S extra load	-	7Jx17
Summer tires		
205/50 R 17 93 W extra load	-	7Jx17
225/45 R 17 91 W	-	8Jx17
Front: 225/45 ZR 17		7.5x17
Rear: 245/40 ZR 17		8.5x17
Winter tires (M+S)		
205/50 R 17 93 Q extra load		7Jx17
225/45 R 17 91 Q	-	8Jx17
Space-saver spare tire		
T 125/80 R 17 99 M	3.5Bx17	-

Comply with the specifications for tires and wheels in the vehicle's documents.

If you install tire sizes not approved by the manufacturer, an entry in the vehicle's documents may be necessary.

Snow chains*

You cannot mount snow chains with the following tires:

225/45 R 17 91 W
225/45 R 17 91 Q M+S
245/40 ZR 17

Mixed tires

For details concerning tire manufacturers for mixed tires, refer to the vehicle's documents.



Do not work on your vehicle without appropriate skills. Always switch off the engine and allow it to cool down before working in the engine compartment. Always disconnect the battery before working on any electrical systems or equipment. Comply with all applicable instructions and warnings. Failure to work in an informed, professional manner when servicing components and materials constitutes a safety hazard for vehicle occupants and other road users. If you are not familiar with the guidelines, please have the operations performed by your BMW center. ◀

**To unlock**

Pull the lever located under the left-hand side of the instrument cluster.

**To open**

Pull the release handle and open the hood.

Hood



To close

Allow the hood to fall from a height of about 12 inches (30 cm) so that it audibly engages.



To avoid injuries, be sure that the travel path of the hood is clear when it is closed, as with all closing procedures. If it is determined that the hood is not completely closed while driving, stop immediately and close it securely. ◀

132 Engine compartment - BMW 325Ci, 330Ci

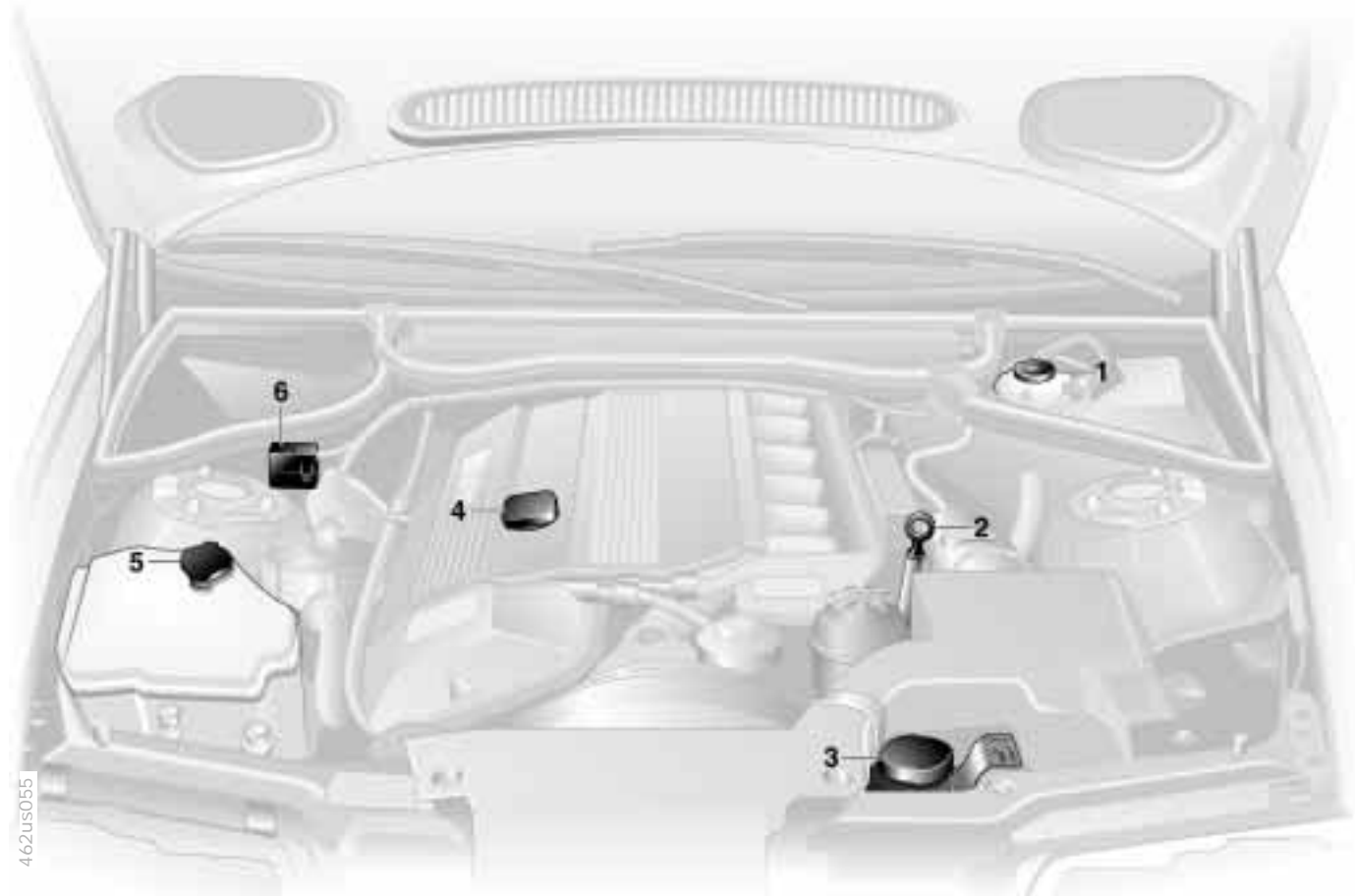

Engine compartment – BMW 325Ci, 330Ci

- 1 Brake fluid reservoir [138](#)
- 2 Dipstick for the engine oil [135](#)
- 3 Coolant expansion tank [137](#)
- 4 Engine oil filler neck [135](#)
- 5 Reservoir for the headlamp* and windshield washer system [134](#)
- 6 Auxiliary terminal for jump starting [168](#)

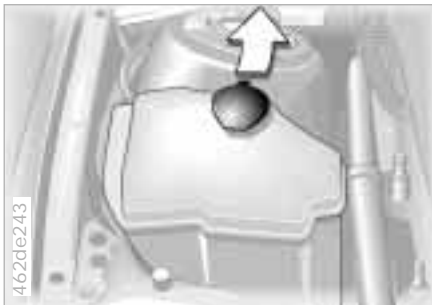

Headlamp* and windshield washer system

Capacity: approx. 5.6 US quarts (5.3 liters).

Fill with water and – if required – with a washer antifreeze (according to manufacturer's recommendations).

 We recommend that you mix the washer fluid before adding it to the reservoir. ◀

 Antifreeze for the washer systems is flammable. For this reason, keep it away from sources of flame and store it in its original container. Store it so that it is inaccessible to children. Comply with the instructions on the containers. ◀

Washer nozzles

Windshield washer

The spray from the nozzles should be directed so as to ensure effective cleaning, even at high speeds. Use a needle to adjust the nozzles as required, or have them adjusted by your BMW center.

Headlamp washer system*

Have this system adjusted by your BMW center as required.

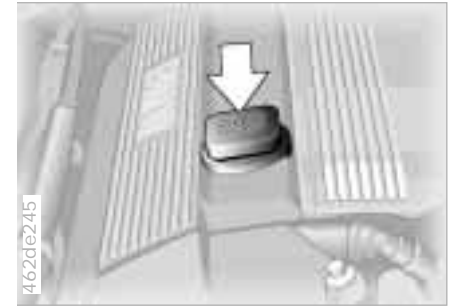
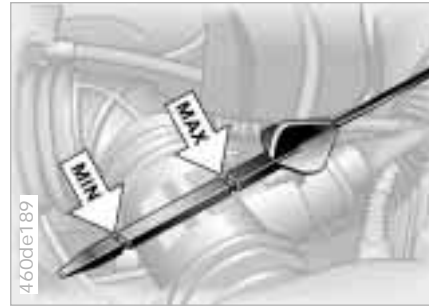

Checking the oil level

- 1 Park the vehicle on a level surface.
- 2 Shut the engine off after it has reached normal operating temperature.
- 3 After approx. 5 minutes, pull the dipstick out and wipe it off with a clean lint-free cloth, paper towel, or similar material.
- 4 Carefully push the dipstick all the way into the guide tube and pull it out again.
- 5 The oil level should be between the two marks on the dipstick.

As with fuel economy, oil consumption is directly influenced by your driving style and vehicle operating conditions.

The oil volume between the two marks on the dipstick corresponds to approx. 1.1 US quarts (1 liter). Do not fill beyond the upper mark on the dipstick. Excess oil will damage the engine.

To add oil

Wait until the level has dropped to just above the lower mark before adding oil. However, never let the oil drop below the lower mark.

 BMW engines are designed to operate without oil additives; the use of additives could lead to damage in some cases. This is also true for the manual transmission, the automatic transmission, the differential and the power steering. ◀

Specified engine oils

The quality of the engine oil is extremely important for the function and life of an engine. Based on extensive testing, BMW has approved only certain types of engine oils.

Use only approved "BMW High Performance Synthetic Oil."

If you are unable to obtain "BMW High Performance Synthetic Oil," you may use small volumes of other approved synthetic oils for topping up between oil changes. Use only oils with the specification API SH or higher.

 Ask your BMW center for details concerning the specific "BMW High Performance Synthetic Oil" or synthetic oils that have been approved. ◀

You can also call BMW of North America at 1-800-831-1117 or visit this website: www.bmwusa.com to obtain this information.

Viscosity ratings

Viscosity is the oil flow rating as established in SAE classes.

The selection of the correct SAE class depends on the climatic conditions in the area where you drive your BMW.

 Approved oils are in SAE classes 5W-40 and 5W-30. ◀

These kinds of oil may be used for driving in all ambient temperatures.

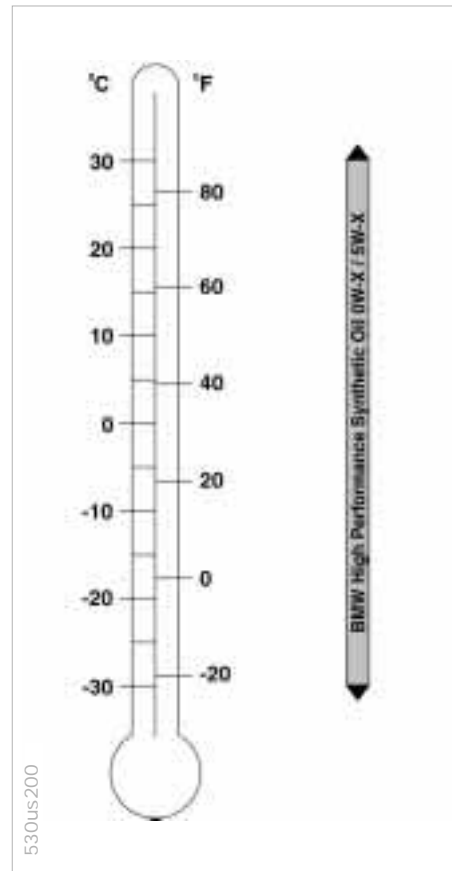

Engine oil

 Always observe all environmental protection laws when disposing of used oil. ◀

Recommendation: have the oil changed by your BMW center only.

 Continuous exposure to used oil has caused cancer in laboratory testing.

For this reason, thoroughly wash any areas of skin that come into contact with oil using soap and water. Always store oils, grease and similar materials so that they are inaccessible to children. Comply with warning labels and information on containers. ◀

Coolant

 Do not add coolant to the cooling system when the engine is hot. If you attempt to do so, escaping coolant can cause burns.

To avoid the possibility of damage later on, never use anything other than factory-approved, nitrite and amino-free extended-duty antifreeze with corrosion inhibitor. Your BMW center is familiar with the official specifications.

Antifreeze and anticorrosion agents are hazardous to health. You should always store it in its original container and in a location that is inaccessible to children. Extended-duty antifreeze with corrosion inhibitor contains ethylene glycol, a flammable substance. For this reason, do not spill antifreeze with corrosion inhibitor on hot engine parts. It could ignite and cause burns. ◀

 Comply with the applicable environmental laws regulating the disposal of extended-duty antifreeze with corrosion inhibitor. ◀



Checking coolant level

Correct coolant level for cold engine (approx. 68 °F or +20 °C):

Unscrew the cap from the expansion tank.

The coolant level is correct when the upper end of the red float is at least even with the upper edge of the filler neck (refer to the arrow in the illustration), but no more than 0.8 in (2 cm) above it – that is, up to the second mark on the float (refer also to the schematic diagram next to the filler neck).

Adding coolant

Wait until the engine cools before removing the cap from the expansion tank. The needle of the coolant temperature gauge in the instrument cluster must be located in the blue zone. If it is not, there is a danger of scalding.

- 1 Turn the cap slightly counterclockwise in order to allow accumulated pressure to escape. Then open.
- 2 If the coolant is low, slowly add coolant until the correct level is reached – do not overfill.

The coolant is a mixture of water and extended-duty antifreeze with corrosion inhibitor. Always maintain the prescribed all-season 50:50 mixture ratio for year-round protection against internal corrosion. No other additives are required.

Replace the coolant every four years.

Brake fluid

If the brake warning lamp comes on and the parking brake has been released:

Check the brake fluid level and if necessary, fill it back up to the "MAX" mark.

For adding brake fluid or for determining and correcting the cause of brake fluid loss, consult your BMW center. Your BMW center is familiar with the specifications for factory-approved brake fluids (DOT 4).

Brake fluid loss can result in extended pedal travel. Comply with the information provided on page [118](#).



Brake fluid is hygroscopic, that is, it absorbs moisture from the air over time.

In order to ensure the safety and reliability of the brake system, have the brake fluid changed every two years by an authorized BMW center. Refer also to the Service and Warranty Information Booklet (US models) or the Warranty and Service Guide Booklet (Canadian models). Brake fluid is hazardous to health and damages the vehicle's paint. You should always store it in its original container and in a location that is inaccessible to children.

Do not spill the fluid and do not fill the brake fluid reservoir beyond the "MAX" mark. The brake fluid could ignite upon contact with hot engine parts and cause serious burns. ◀



Comply with the applicable environmental laws regulating the disposal of brake fluid. ◀



In the engine compartment, on the right-hand strut dome (arrow).



The BMW Maintenance System has been designed as a reliable means of providing maximum driving and operating safety – and as cost-effectively as possible for you.

Please keep in mind that regular maintenance is not only necessary for the safety of your vehicle, but also plays a significant role in maintaining the resale value of the vehicle.

Service Interval Display

Advanced technology is employed to calculate the optimal maintenance intervals. These are then indicated in the Service Interval Display. While conventional systems rely on distance traveled alone to determine when service is due, the BMW Maintenance System has for years considered the

actual conditions under which the vehicle operates, because miles can be traveled in many different ways: From a maintenance point of view, 62,000 miles (100,000 km) of short-distance urban driving are not equivalent to the same distance covered at moderate speeds in long-distance highway travel.

The BMW Maintenance System includes the Engine Oil Service and Inspections I and II.

Determining the maintenance intervals according to the actual use of the vehicle covers every kind of operating situation. However, even those who drive only short distances – i.e. significantly less than 6,000 miles (10,000 km) annually – should have the engine oil changed at least every 2 years since oil deteriorates over time, regardless of use.

Service and Warranty Information Booklet (US models)/Warranty and Service Guide Booklet (Canadian models)

For additional information on maintenance intervals and procedures, please refer to the Service and Warranty Information Booklet (US models), or the

Warranty and Service Guide Booklet (Canadian models).

As a precaution against rust, it is advisable to have the body checked for damage from rocks or gravel at the same time, depending upon operating conditions.



Have your BMW center perform maintenance and repair.

Your BMW center is always informed on the latest maintenance work and repair techniques and equipped with the required special tools. In addition, checking parts known from experience to be subject to wear is a permanent part of the maintenance specifications. Be sure that all maintenance work is confirmed in the Service and Warranty Information Booklet (US models), or in the Warranty and Service Guide Booklet (Canadian models). These entries are your verification for the regular maintenance of your vehicle and are required for the performance of warranty repairs. ◀

Caring for your vehicle

Washing your vehicle

You can have your BMW washed in an automatic car wash, even when it is new. Car wash systems that do not employ brushes are preferable.

Wipe away tough dirt and loosen and remove dead insects before washing the vehicle.

In order to avoid spots, do not wash the vehicle when the hood is warm, or during or immediately after exposure to strong sunlight.

When using an automatic car wash, be sure that:

- ▷ The car wash system is suited for the dimensions of your vehicle.
- ▷ No damage will occur on vehicles with attached body accessories (such as spoilers or antennas). Consult the car wash operator if necessary.
- ▷ The wheels and tires of your vehicle cannot be damaged by the conveyance devices of the car wash system.
- ▷ The vehicle is cleaned with minimum brush pressure, and that ample water is available for washing and rinsing.

Vehicles with rain sensor:
Clean the windshield regularly. Wax from automatic car washes or insects can cause malfunctions in the function of the rain sensor.



Deactivate the rain sensor when going through car washes (refer to page 71), as otherwise the wipers could be damaged if they inadvertently start working. ◀

Parts of the vehicle that are inaccessible to the automatic washer – such as door sills, door and hood edges, etc. – should be cleaned by hand.

In the winter months, it is especially important to be sure that the vehicle is washed on a regular basis. Large quantities of dirt and road salt are difficult to remove, and they also damage the vehicle.



If spray wands or high-pressure washers are used, be sure to maintain an adequate distance between the spray source and the vehicle's surface. Inadequate distance and excessive pressure can damage or weaken the finish, making it more susceptible to subsequent attack.

In addition, moisture could penetrate to vehicle components, leading to long-term damage. ◀



When cleaning the headlamps, please observe the following: do not wipe dry with a cloth (scratches). Never use abrasives or strong solvents to clean the covers. Remove dirt and contamination (such as insects) by soaking with BMW Car Shampoo and then rinsing with plenty of water. Always use a deicer spray to remove accumulated ice and snow – never use a scraper. ◀



After washing the vehicle, apply the brakes briefly to dry them. Braking efficiency might otherwise be reduced by the moisture and the brake rotors could also be corroded. ◀

Exterior finish

To provide effective corrosion protection, multilayer paintwork is applied at the factory. Cathaphoretic immersion priming techniques are supplemented using special body-cavity protectants, with the application of specially-developed and extensively tested materials. A layer of flexible PVC is first applied to the undercarriage. Following this, a comprehensive undercoating treatment with a wax-based protectant is applied. Regular maintenance makes an important contribution to maintaining the safety and value of your vehicle.

Increasing awareness of the effects of harmful environmental factors on vehicle finishes have led paint and vehicle manufacturers to initiate ongoing programs designed to further improve the durability of their finishes. Despite this, environmental factors that occur locally or regionally can have negative effects on the finish of your vehicle. Use the factors to determine the frequency and extent of your efforts to maintain the vehicle finish.

Depending upon material and type of impact (perforation of paint layer), physical stresses from sand, road salt, gravel, etc., can cause corrosion to start extending beneath the finish, starting at the point of impact.

Road dirt, tar spots, dead insects, animal droppings (strong alkali effect) and tree excretions (resins and pollen) all contain substances capable of causing damage when allowed to remain on the finish of your vehicle for any period of time. This includes spots, etching, flaking, and separations in the top coat.

In industrial areas, deposits of flue dust, lime, oily soot, precipitation containing sulfur-dioxide (acid rain) and other environmental pollutants will damage the vehicle's finish unless adequate care is provided – even though this is generally limited to the outside horizontal surfaces.

In coastal regions, high levels of atmospheric salt and humidity promote corrosion.

In tropical zones, temperatures of over 105 °F (+40 °C) in the shade prevail, in addition to heavy ultraviolet radiation and high humidity. Under these conditions, light paints can reach temperatures of up to 175 °F (+80 °C) and dark paints up to 250 °F (+120 °C).

Caring for your vehicle

Caring for the vehicle's finish

Regular washing is a preventive measure against long-term effects from substances that are harmful to the vehicle's finish, especially if you drive your vehicle in areas with high levels of air pollution or aggressive natural substances (tree resins, pollen).

Nevertheless, you should immediately remove especially aggressive substances. Failure to do so can lead to changes in the paint's chemical structure or to discoloration. Gasoline spilled during refueling, oil, grease and brake fluid should always be cleaned away immediately, as should bird droppings.

Any contamination remaining on the surface of the vehicle will be especially conspicuous after washing. Use cleaning fluid or alcohol with a clean cloth or cotton pad to remove. Remove tar spots with tar remover. After cleaning, the affected areas should be waxed to ensure continued protection.

 Use the cleaning and car-care products available at your BMW center. ◀

Waxing your vehicle

Protect the finish using carnauba or synthetic-based waxes only.

The best way to determine when the finish needs to be waxed is by noting when water stops beading on the surface.

You can use a glass cleaner to remove any wax or silicone that may have been left on the windows during waxing.

 Use the cleaning and car-care products available at your BMW center. ◀

Paint damage

You can touch up small areas of paint damage with a BMW spray paint or a BMW touchup stick.

The paint color code for your vehicle is provided on a sticker located on the right hand-side under the hood and on the first page of your Service and Warranty Information Booklet (US models) or Warranty and Service Guide Booklet (Canadian models).

Damage caused by flying stones, scratches, etc., must be touched up without delay to prevent rust from forming.

If corrosion has started to form in an area with paint damage, remove all rust and clean the area. Then prime the area with a BMW Primer Stick. Finally, apply the finish coat. Wait a few days, then polish the repaired area. Finish by applying a wax preservative.

More extensive paint damage should be repaired professionally in accordance with the manufacturer's instructions. Your BMW center uses original BMW finish materials in accordance with approved repair procedures.

Window care

You can use window and glass cleaner to clean inside window surfaces and mirrors without smearing and streaking. Never use polishing pastes or abrasive (quartz) cleansers on mirror lenses.

Clean the wiper blades with soapy water. The wiper blades should be replaced twice a year – before and after the winter months. This is especially important for vehicles with a rain sensor.



Use only wiper blades approved by BMW. ◀

Caring for other vehicle components and materials

Light-alloy wheels should be treated with alloy wheel cleaner, especially during the winter months. However, do not use aggressive products containing acids, strong alkalis or abrasive cleaning agents, nor steam cleaners operating at temperatures above 140 °F (+60 °C). (Follow the manufacturer's instructions.)

If your vehicle has chrome parts*, such as the window frames and door handles, clean these parts carefully with ample clean water and a shampoo supplement if desired, especially if they have an accumulation of road salt. Use a chrome polish for an additional treatment.

Plastic components, vinyl upholstery, headliners, lamp lenses, the clear cover of the instrument panel and components with a sprayed dull black surface can be cleaned with water (add plastic shampoo as required). Do not allow moisture to soak through the seats or headliner. Never use solvents such as lacquer thinner, heavy-duty grease remover, fuels, or similar substances.

Rubber components should be cleaned with water only; a rubber treatment or silicone spray may also be applied.

Do not remove safety belts to clean them. Clean them with mild soapy water only. Do not use chemicals or dry cleaners to clean safety belts, since this could damage the belt fabric.

After cleaning, never allow the inertia reel to retract the belts until they are completely dry. Dirty safety belts prevent the inertia reel mechanism from retracting the strap properly, and thus constitute a safety hazard.

Heavily soiled floor carpets and mats* can be cleaned with an interior cleaner. The floor mats can be removed from the vehicle for cleaning.

Use only a damp cloth to clean trim panels made of real wood* and other parts constructed of real wood*. Follow up by drying with a soft cloth.



Use the cleaning and car-care products available at your BMW center. ◀

Caring for your vehicle

Care of upholstery materials

Depressions in the upholstery that result from everyday use can be brushed smooth by brushing against the nap with a lightly dampened brush.

The tendency of the pile to lie in a particular direction on velour upholstery is not a quality defect. Just as with home textiles or clothing, this cannot be avoided.

Lint on upholstery materials, textile or leather remnants that have been worn into the upholstery may be removed with a lint brush or a Velcro® brush. A cleaning glove is available for particularly "stubborn" lint. Stains and fairly large areas of dirt should be cleaned off without delay, using lukewarm water and an interior cleaner, stain remover or appropriate cleaning fluid. Brush the fabric afterwards to restore its appearance.

If the vehicle will be stored for an extended period or if it is exposed to intense sunlight, cover all the seats or the windows to prevent fading.



Use the cleaning and car-care products available at your BMW center. ◀

The buildup of an electrostatic charge on the seat covers, particularly if atmospheric humidity is low, can give the occupants an unpleasant electric shock if they touch metal body parts after leaving the vehicle. Although this is not dangerous in any way, it can be avoided by touching a bare or polished metal part of the vehicle while getting out.

Leather care

The leather* upholstery used by BMW is a natural product of the highest quality, processed using state-of-the-art methods to ensure that it will maintain its high quality for years to come, provided that it is properly cared for.

Because this product is manufactured using natural materials, you must make allowance for its special characteristics and for the peculiarities of its use and care.

Regular periodic cleaning and care are essential, as dust and road dirt act as abrasives in the pores and creases of the material. This leads to wear spots and premature brittleness on the surface of the leather. We therefore suggest that you clean the leather with a vacuum cleaner or cloth at frequent intervals.

For cleaning, use BMW leather cleaning foam.

Since dirt and grease gradually attack the protective layer of the leather, the cleaned surfaces should be treated with BMW leather care agent. This also acts as an antistatic agent.

For protection against dampness or moisture, treat the leather with a BMW impregnating agent.

146 Caring for your vehicle

We recommend that you perform this procedure twice a year on leather exposed to normal use.

Spills should be wiped up immediately. Remove grease and oil stains by dabbing with spot remover. Avoid rubbing.

If the upholstery is to be exposed to intense sunlight or if the vehicle is to be stored for an extended period, cover all leather surfaces (or, better yet, the windows) to prevent fading.

 Use the cleaning and car-care products available at your BMW center. ◀



Cleaning agents can contain substances that are dangerous or that pose health risks. For this reason, always comply with the warnings and danger notices on the packaging. Open the doors or windows on your vehicle whenever cleaning the interior. Never clean your vehicle with solvents or other materials not specifically intended for this purpose. ◀

Airbags

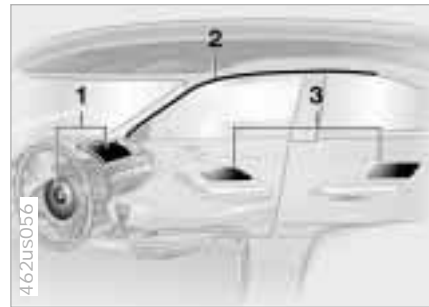

- 1 Front airbags for driver and passenger
- 2 Side airbags for driver and passenger (front)
- 3 Side airbags for driver and passenger (front and rear*)

Airbags

Important safety notices



Do not attempt to remove the gas generators of the airbag supplemental restraint system from the vehicle. Testing and servicing must be performed by trained technicians only. In the event of a malfunction, deactivation, or triggered actuation (as a response to an accident) of the airbag restraint system, consult your BMW center for repairs or service operations. Do not modify or tamper with either the wiring or the individual components in the airbag system. These include the padded steering wheel hub, the instrument panel, the side trim panels of the front or rear doors and the roof pillars or the sides of the headliner. Do not apply adhesive materials to these components or cover them over or alter them in any other way. Do not attempt to remove or dismantle the steering wheel.

To ensure compliance with official safety regulations, entrust disposal of airbag generators to a BMW center. Unprofessional attempts to service the system could lead to failure in an emergency or undesired airbag activation, either of which could result in personal injury. ◀

Vehicle storage

Consult your BMW center regarding special procedures if you intend to store the vehicle for more than three months.

Any BMW center will be glad to inform you of the advisability, legal requirements and factory recommendations regarding technical modifications on your vehicle. For this purpose, the BMW center will require the Vehicle Identification Number and, in some cases, also the engine number.

Light-Emitting Diodes (LEDs)

Light-emitting diodes installed behind translucent lenses serve as the light source for many of the controls and displays in your vehicle. The concept behind their operation is related to that employed for lasers.

 Do not remove the protective lens and avoid staring directly at the unfiltered beam for extended periods (several hours), as inflammation of the iris could result. ◀

California laws require us to state the following warning:

 Engine exhaust, some of its constituents, and certain vehicle components contain or emit chemicals known to the State of California to cause cancer and birth defects or other reproductive harm. ◀

OBD interface socket



The OBD interface socket for onboard diagnostics is located on the driver's side, on the left-hand bottom of the instrument panel and under a cover panel. The cover has the letters "OBD" on it.

The purpose of the OBD system is to assure proper emission control system operation for the vehicle's lifetime by monitoring emission-related components and systems for wear and malfunction.



An illuminated indicator informs you of the need for service, not that you need to stop the vehicle. Your system should be checked, however, at the earliest possible opportunity.

If the indicator blinks or flashes, this indicates a high level of engine misfire. Reduce speed and contact your nearest BMW center immediately. Severe engine misfire over even a short period of time can seriously damage emission control components, especially the catalytic converter.



Service Engine Soon warning lamp for Canadian models.



If the fuel filler cap is not firmly screwed on, the OBD system can detect leaking vapor and the indicator will light up. If the fuel filler cap is then tightened, the indicator will usually go out after a short period of time. ◀



**Replacement procedures:**

Onboard tool kit [152](#)
Windshield wiper blades [152](#)
Lamps and bulbs [152](#)
Changing a wheel [159](#)
Battery [163](#)
Fuses [166](#)
Microfilter/Activated-charcoal filter [166](#)

In case of electrical malfunction:

Fuel filler door [167](#)
Sliding/tilt sunroof [167](#)

Assistance, giving and receiving:

Jump-starting [168](#)
Towing the vehicle [169](#)

Overview**Controls and features****Operation, care and maintenance****Owner service procedures****Advanced technology****Technical data****Index**

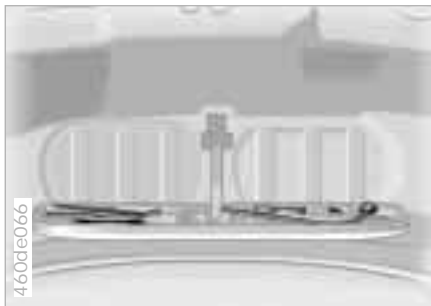

The onboard tool kit is located in the luggage compartment lid.

Loosen the wingnut to open.

Windshield wiper blades



- 1 Rotate the wiper arm completely out from the windshield.
- 2 Position the wiper blade at an angle and pull the release spring (arrow).
- 3 Fold the wiper blade down and unhook it toward the windshield.
- 4 Pull the wiper blade past the wiper arm toward the top.
- 5 Insert a new wiper blade and apply pressure until you hear it engage.

 Use only wiper blades approved by BMW. ◀

Lamps and bulbs

The lamps and bulbs are essential factors contributing to the safety of your vehicle. For this reason, follow the instructions below carefully when replacing a bulb. If you are not familiar with any of the procedures, consult your BMW center.

 Do not touch the glass portion of a new bulb with your bare hands since even small amounts of impurities burn into the surface and reduce the service life of the bulb. Use a clean cloth, paper napkin, or a similar material, or hold the bulb by its metallic base. ◀

A replacement bulb set is available from your BMW center.

 Whenever working on the electrical system, switch off the electrical accessory you are working on or disconnect the cable from the negative terminal of the battery. Failure to do this could result in short circuits. To prevent injuries and damage, comply with any instructions provided by the bulb manufacturer. ◀

Lamps and bulbs



The illustration shows the left-hand side of the engine compartment.

1 Low beams

H7 bulb, 55 watts

2 High beams

H7 bulb, 55 watts

 The H7 bulb is pressurized. Therefore, wear safety glasses and protective gloves. Failure to comply with this precaution could lead to injury if the bulb is accidentally damaged during replacement. ◀

- 1 Press the two locks at the front and turn left to release the bulb holder.
- 2 Remove and replace the bulb.

 When cleaning the headlamps, please observe the following: do not wipe dry with a cloth (scratches). Never use abrasives or strong solvents to clean the covers. Remove dirt and contamination (such as insects) by soaking with BMW Car Shampoo and then rinsing with plenty of water. Always use a deicer spray to remove accumulated ice and snow – never use a scraper. ◀

Xenon lamps*

The service life of these bulbs is very long and the probability of a failure is very low, provided that they are not switched on and off an unusual number of times. Nevertheless, if one of the lamps should fail, you can continue driving with great caution using the front fog lamps if local laws permit this.

 Because of the extremely high voltages involved, any work on the lighting system including replacement of the bulb should be performed only by technicians with the appropriate qualifications. Failure to comply with this creates a risk of fatal injury. ◀



The illustration shows the left-hand side of the engine compartment.

Parking lamps

5 watt bulb

- 1 Turn the bulb holder to the left (arrow) and remove it.
- 2 Remove and replace the bulb.



Front turn signal indicators

21 watt bulb

- 1 Using a screwdriver, release the inner hook through the upper opening.
- 2 Remove lamp by pulling it out toward the front.
- 3 Applying light pressure, turn the bulb to the left. Remove and exchange the bulb.



- 4 Insert the 2 pins on the lamp into the guides on the vehicle.
- 5 Push the lamp in. Carefully apply pressure until you hear it snap into place.



Side turn signal indicators

5 watt bulb

- 1 Use finger pressure against the rear end of the lens (arrow) to press it forward for removal.
- 2 Apply gentle pressure to the bulb while turning it to the left to remove.



Front fog lamps

HB4 bulb, 55 watts

 The bulb is pressurized. Therefore, wear safety glasses and protective gloves. Failure to comply with this precaution could lead to injury if the bulb is accidentally damaged during replacement. ◀

Please contact a BMW center in the event of a malfunction.

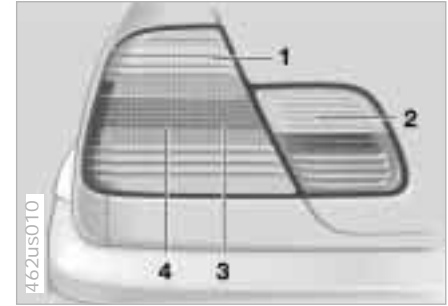

Tail lamps

Tail lamps (4): 21/4 watt bulbs
Remaining bulbs: 21 watts

- | | |
|-------------------------|--------|
| 1 Turn signal indicator | yellow |
| 2 Backup lamps | white |
| 3 Tail lamp | red |
| 4 Tail lamp/Brake lamp | red |

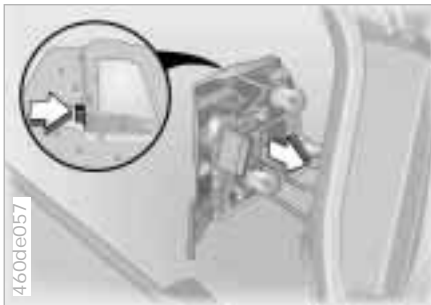

The illustration shows the right-hand luggage compartment opening.

Bulbs in the fender:

All of the bulbs are integrated in a central bulb holder.

- 1 Release the bulb holder (arrow, partial view) and remove.
- 2 Unplug the power supply receptacle. Set the bulb holder aside (on the luggage compartment floor, for example).
- 3 Applying light pressure, turn the bulb to the left. Remove and exchange the bulb.
- 4 Plug in the power supply receptacle.
- 5 Position the bulb holder for reinstallation. Apply gentle pressure on the button (arrow, partial view) until you hear it engage.



Bulbs in the luggage compartment lid:

1 Using a screwdriver, loosen the clip.



- 2 Fold the trim panel down (arrow 1). Disengage the bulb holder (arrow 2) and remove it.
- 3 Applying light pressure, turn the bulb to the left. Remove and exchange the bulb.
- 4 Press the bulb holder into position until you hear it engage.
- 5 Reinstall the trim with the clip.



Center (high-mount) brake lamp

LED light bar on the rear window.

Please contact a BMW center in the event of a malfunction.

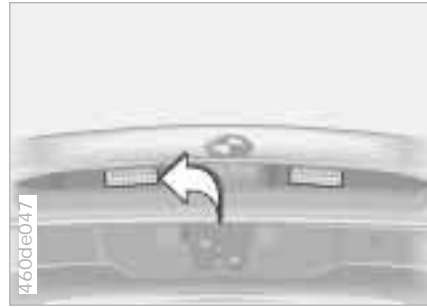

License plate lamps

5 watt bulb

- 1 Place a screwdriver in the slot and press toward the left (arrow) to release the lens.
- 2 Replace the bulb.



Interior lamps

Front:

Interior lamp (6 watt bulb)

Reading lamps (2 x 6 watt bulbs)

- 1 Using a screwdriver, press the lamp out toward the front.
- 2 Turn the bulb holder to the left and remove it.
- 3 Remove and replace the bulb.



Rear:

Interior lamp (6 watt bulb)

Reading lamp (6 watt bulb)

- 1 Press the lamp out using a screwdriver.
- 2 Turn the bulb holder to the left and remove it.
- 3 Remove and replace the bulb.

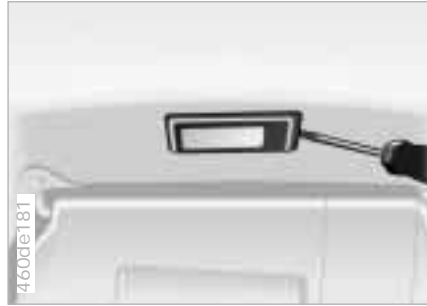

Lighted vanity mirror*

10 watt bulb

- 1 Remove the bulb housing – use a screwdriver if necessary.
- Replace the bulb.

Footwell lamps

5 watt bulb

- 1 Press the lamp out using a screwdriver.
- 2 Replace the bulb.

Glove compartment lamp

5 watt bulb

- 1 Press the lamp out using a screwdriver.
- 2 Replace the bulb.

Luggage compartment lamps

One lamp each in the bulb holder of the tail lamp assembly: 10 watt bulb.

- 1 Apply a screwdriver to the recess and remove the lens.
- 2 Replace the bulb.

Changing a wheel



Take these precautionary measures if you have either a flat tire or are changing the tire: Stop the vehicle as far as possible from passing traffic. Park on a firm, flat surface. Switch on the hazard warning flashers. Turn the steering wheel to the straight-ahead position, remove the key and engage the steering lock. Shift into 1st gear or reverse (selector lever in "Park" with automatic transmission) and engage the parking brake. All passengers should be outside the vehicle and well away from your immediate working area (behind a guardrail, for instance). If a warning triangle or portable hazard warning lamp is available, set it up on the roadside at an appropriate distance from the rear of the vehicle. Comply with all safety guidelines and regulations. Change the wheel only on a level, firm surface which is not slippery. Avoid jacking the vehicle on a soft or slippery support surface (snow, ice, loose gravel, etc.), as it could slide sideways. Position the jack on a firm support surface. Do not place wooden blocks or similar objects under the jack. If this is done, the jack might not be able to reach its full support capacity because of the limited height.

Do not lie under the vehicle or start the engine when the vehicle is supported by the jack. Failure to comply with this creates a risk of fatal injury. ◀

Your BMW has a spare tire or a space-saver spare tire for temporary use to ensure your mobility.



To remove the spare tire, lift out the floor panel in the luggage compartment completely (refer to page 41). ◀

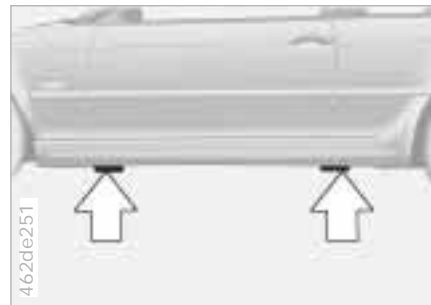
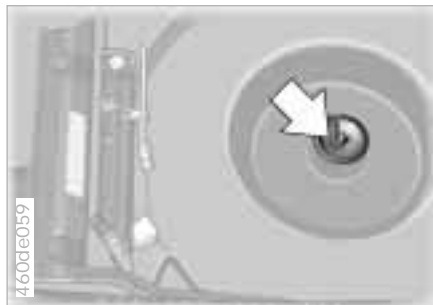
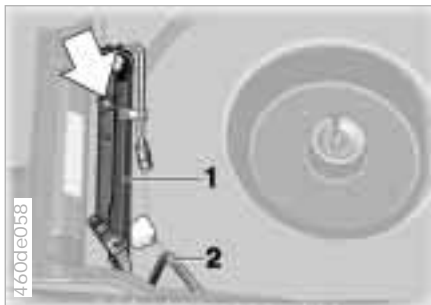

You will need the following

In order to avoid rattling noises later, note the position of the tools when you remove them and return them to their original position when you are through using them.

▷ Jack (1)

Raise the floor panel in the luggage compartment (refer to page 41) and loosen the red wing nut (arrow). When you have completed work, screw the jack all the way back down. Fold the handle back and insert it in its holder.

▷ Wedge (2)

Located behind the jack on the wall in the luggage compartment. Loosen the wing nut to remove it.

- ▷ Spare tire or space-saver spare tire
Next to the jack.
Loosen the wing nut (arrow) by hand, remove the storage shelf and take the wheel out.
- ▷ Lug wrench
In the onboard tool kit on the underside of the luggage compartment lid (refer to page 152).

Procedure

- 1 Read and comply with the safety precautions provided on the previous page.
- 2 Secure the vehicle from rolling: Place the wedge against the rear surface of the front tire on the side opposite the side being raised. If the vehicle is parked on a downward slope, place the wedge securely in front of the tire. If the wheel must be changed on a surface with a more severe slope, take additional precautions to secure the vehicle from rolling.
- 3 If your wheels are equipped with full wheel covers*: reach into the ventilation openings and pull off the cover.

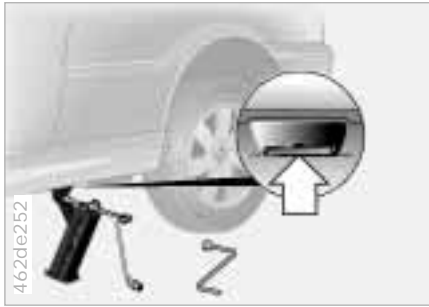

- 4 Loosen the lug bolts ½ turn.
- 5 Position the jack at the jacking point closest to the flat tire (refer to the center illustration) so that the jack base is vertically below the jacking point and the entire surface of the head of the jack will move into the square recess of the jacking point (refer to the illustration detail) when the jack is cranked.
- 6 Crank the vehicle up until the wheel in question is raised from the ground.
- 7 Unscrew the lug bolts and remove the wheel.
- 8 Remove accumulations of mud or dirt from the mounting surfaces of the wheel and hub; clean the lug bolts.

- 9 Position the new wheel or the space-saver spare tire on the hub and screw at least two lug bolts finger-tight into opposite bolt holes.
- 10 Screw in the remaining lug bolts. Tighten all the bolts securely.
- 11 Lower the jack and remove it from beneath the vehicle.
- 12 Tighten the lug bolts in a diagonal pattern.

- 13 If your wheels are equipped with full wheel covers*: position the wheel cover with the valve opening over the valve (arrow) and press it onto the wheel with both hands.
- 14 Check and correct the tire's inflation pressure at the earliest possibility. For vehicles with Tire Pressure Control (RDC): Reactivate the system after mounting the spare tire or correcting the air pressure. Refer to page 85.

 Only use original BMW full wheel covers, otherwise, the trim piece may not fit securely. The full wheel cover may not be installed on the space-saver spare tire since this could damage the cover. ◀



The vehicle jack is designed for changing wheels only. Do not attempt to raise another vehicle model with it or to raise any load of any kind. To do so could cause accidents and personal injury.

To ensure continued safety, have the tightness of the lug bolts checked with a calibrated lug wrench [torque specification: 72 lb.ft (100Nm)] at the earliest opportunity. ◀

When storing the wheel, be sure that you do not damage the retaining pin in the spare tire recess.

If light-alloy wheels other than original BMW light-alloy wheels have been mounted, it may be necessary to use different lug bolts for those wheels.

Replace the defective tire as soon as possible and have the new wheel/tire balanced.

For black-painted aluminum wheels*, use only those balancing weights approved by BMW for use with light-alloy wheels. Never attempt to balance these wheels using standard balance weights.

Driving with the space-saver spare tire

Drive cautiously and do not exceed a speed of 50 mph (80 km/h).

Be aware that vehicle handling will be altered. Slower brake response time, longer braking distances and changed steering characteristics may be anticipated when approaching limit conditions.

The changes in handling characteristics will be even more pronounced in conjunction with winter tires.



Only one space-saver spare tire may be mounted at a time. Mount a wheel and tire with the same size and specifications as the others at the earliest possible opportunity. Maintain correct tire pressures. Refer to page 28. ◀

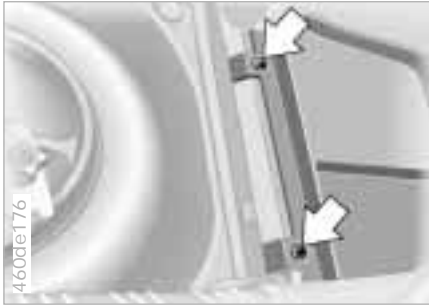

Location

The battery is located at the right-rear of the luggage compartment. Remove the luggage compartment floor panel (refer to page 41), and give a screwdriver or a coin a ¼ turn counterclockwise to release the two fasteners plus an additional fastener in the upper-center side trim panel to release and remove. In order to remove the storage tray, slide the side trim panel slightly upward.

 Battery posts, terminals, and related accessories contain lead and lead compounds. Wash hands after handling. ◀



Charge condition

You can read the charge condition of the battery with the "Magic Eye*" (a hydrometer):

- ▷ Green: adequate charge.
- ▷ Black: not adequately charged. The battery must be recharged. Please contact your BMW center for additional information.
- ▷ Yellow: replace the battery.

 The service life specified for the battery can be achieved only if it is always kept adequately charged. If the vehicle is primarily used for stop-and-go traffic, be sure to check the charge state often. ◀

Battery care

The battery is completely maintenance-free. That means that the original electrolyte will normally last for the service life of the battery under moderate climatic conditions.

 For all questions that regard the battery, please consult your BMW center. Since the battery is absolutely maintenance free, the following is for your information only. ◀

Symbols

You will find the following symbols on your vehicle battery. To avoid injury, please comply with the corresponding precautions whenever you work with or near the battery.



Before handling the battery, please read the following information.



Wear eye protection. Do not allow particles containing battery acid or lead to come into contact with your eyes, your skin, or your clothing.



Battery acid is extremely corrosive. Wear eye protection and protective gloves. Do not tip the battery. Battery acid can leak from the ventilation openings.



Do not allow children access to batteries and battery acid.



Never allow sparks or open flame in the vicinity of the battery. Avoid sparks from electrical cables or electrical equipment. Turn the key to position 0 in the ignition lock when disconnecting or connecting the battery. Do not short circuit the battery terminals. This creates a risk of injury from high-energy sparks.



A highly explosive gas is generated when the battery is charged.



If you happen to get acid in your eyes, rinse thoroughly for 15 minutes with clear water.

Consult a physician immediately. If you get acid spray on your skin or clothing, rinse with plenty of water. If electrolyte is accidentally ingested, consult a physician immediately.



In order to protect the battery case from ultraviolet radiation, do not place it in direct sunlight.

A discharged battery can freeze. Store the battery in areas where temperature remains above freezing.

Removal and installation

Do not disconnect the battery when the engine is running. If you do so, the ensuing voltage surge will damage the vehicle's onboard electronics.

Do not make any modifications in the wires to the positive terminal. If you do so, the protective function of the safety battery terminal is no longer ensured. Repair and disposal must be performed by trained technicians only. ◀

When removing the battery, disconnect the cable on the negative terminal first, then the cable on the positive terminal. Loosen the center adjusting screw on the battery retaining strap (use the screwdriver included with the onboard tool kit) and disconnect the strap.

When installing a battery, connect the positive terminal first, then connect the negative terminal.



When installing a battery, be sure that it is mounted properly and that the retaining bracket is installed with the center adjustment screw. If this is not done, the battery will not be adequately secured in case of an accident. ◀

Battery

Charging the battery

Charge the battery in the vehicle only when the engine is not running.

 Before doing any work on the electrical system, be sure to unclamp the cable from the battery's negative terminal. Failure to do so can result in short circuits, a fire or personal injury. ◀

If you plan to park the vehicle for longer than 4 weeks, disconnect the battery from the vehicle electrical system by disconnecting the cable at the negative terminal. Have the battery recharged with an appropriate battery charger.

If the vehicle is parked for more than 12 weeks, remove the battery, recharge it and store it in a cool yet frost- and dust-free area. During storage, have the battery recharged every 3 months. Also, recharge the battery before it is reinstalled. If this is not done, the battery will not be serviceable. Every time the battery is discharged, especially over extended periods, its service life is reduced.



Return used batteries to a recycling center or your BMW center. Maintain the battery in an upright position for transport and storage. Secure the battery to prevent it from tilting during transport. ◀



Storage periods during which the battery is disconnected are not taken into consideration by the Service Interval Display for changing the brake fluid. For this reason, be sure that the brake fluid is changed every two years, regardless of the information displayed. Please read the pertinent information on page [138](#). ◀



If an electrical accessory should fail, switch it off and check the fuse.

In the glove compartment

- 1 Open the glove compartment and turn the two white quick-release fasteners outward. Spare fuses and plastic tweezers are located on the fuse holder.
- 2 Use the plastic tweezers to remove the fuse for the accessory or equipment that has stopped working.
- 3 If the fuse has blown (the metal strip is melted and separated), replace it with a new fuse of the same ampere rating (color code).

A list of fuses, their respective ampere ratings and the equipment in their circuits are all indicated below the fuse holder.

To close the fuse holder, snap it into position at the top and turn the two fasteners inward.

 Do not attempt to repair a burned fuse or replace it with a fuse having a different color or ampere rating. To do this could cause a fire in the vehicle resulting from a circuit overload. ◀

If a fuse blows repeatedly, refer the problem to your BMW center for repair.

Microfilter

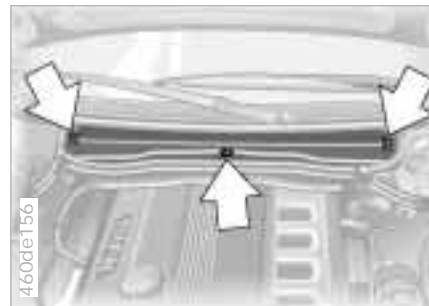

Microfilter/Activated-charcoal filter

- 1 Open the hood.
- 2 Loosen the three fasteners (arrow) with a ¼ turn.
- 3 Remove the filter cover.

Microfilter

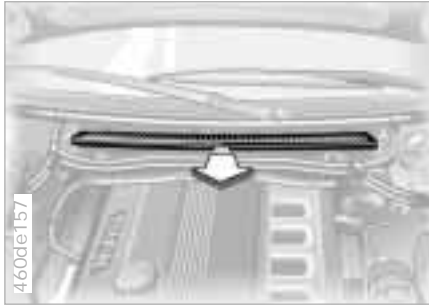

- 4 Remove the filter by pulling toward the front and installing a new one.
- 5 Position the filter cover and secure it with the three fasteners.

Fuel filler door



Manual release

Pull the knob with the fuel pump symbol (arrow) on the right trim panel of the luggage compartment.

Sliding/tilt sunroof*

167

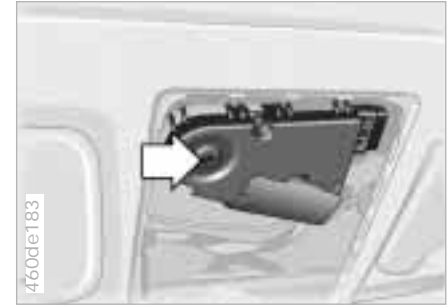

Manual operation

- 1 Remove the interior lamp (refer to page 157), reaching into the opening and pushing out the panel.
- 2 Use an Allen wrench from the onboard tool kit (refer to page 152) to turn the sunroof's steel crank in the desired direction.

Do not use spray starter fluids.

If the battery is discharged, the engine can be started with the use of two jumper cables and the battery of another vehicle. Use only jumper cables with fully insulated grips on the terminal clamps.

 Do not touch the parts conducting electrical current while the engine is running. Failure to comply with this creates a risk of fatal injury. ◀

Carefully comply with the following instructions to avoid personal injury or damage to one or both vehicles:

- 1 Be sure that the battery on the support vehicle is also rated at 12 volts, and that the capacities of the two batteries (Ah) are roughly comparable (printed on casing).
- 2 Leave your battery connected to the vehicle electrical system.
- 3 Make sure that there is no contact between the bodywork of the two vehicles – this creates a risk of short circuits.
- 4 Start by connecting the jumper cable from the positive terminal of the support vehicle to the positive terminal connector located in your BMW's engine compartment. The



cover of the positive terminal connector is marked with a "+" sign. Refer to the illustration. Remove by pulling the tab (arrow 1).

- 5 Then connect the negative terminals. Attach the cable to either the support vehicle's negative battery terminal (-), or to a suitable ground on its engine or bodywork. Then connect the other end of the cable to a ground on the engine or on the bodywork of the vehicle that is to be started. There is a special nut provided for this on the BMW (arrow 2).

 Follow the same sequence for connecting the jumper cables when helping other vehicles. If you do not, there is the risk of injury if sparks are generated at the battery. ◀

- 6 Start the support vehicle's engine and let it run.
 - 7 Start the engine on the vehicle needing the jump-start, and allow it to run as usual. If the first start attempt is not successful, wait a few minutes before another attempt in order to allow the discharged battery to recharge.
 - 8 Before disconnecting the jumper cables from your BMW, turn on the lighting, the rear window defroster and set the blower to the highest speed; allow the engine to run approx. 10 seconds. This will prevent a voltage surge from the voltage regulator to the electrical accessories.
 - 9 Then disconnect the jumper cables in reverse sequence.
- Depending on the cause of the fault, recharge the battery.

Towing the vehicle

Tow fitting

The screw-in tow fitting is stored in the onboard tool kit; be sure that it remains in the vehicle at all times. This fitting is designed for installation in the tow sockets located at the front and rear of the vehicle. It is intended for towing on paved road surfaces only. This fitting should not be used to pull a vehicle out of deep snow, mud, sand, etc. Always comply with all applicable towing laws and regulations.



Access to tow sockets

Front:

Use a screwdriver to press on the top part of the recess and pop the cover panel out.



Rear:

Press out the cover panel with a screwdriver on the top part of the recess.

 Screw the tow fittings in completely and tightly. If you do not, the threads could be damaged. Do not tow the vehicle by any components of the running gear, or lash them down in any way. If you do so, the components could be damaged, leading to possible accidents. ◀

170 Towing the vehicle

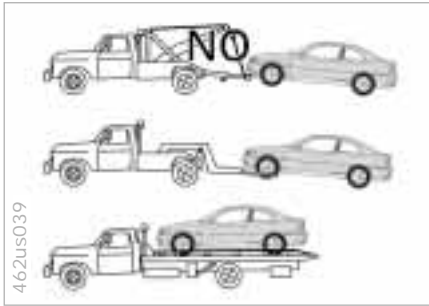

Towing with a commercial tow truck

- ▷ Do not tow with sling-type equipment.
- ▷ Use wheel lift or flat bed equipment.
- ▷ Please comply with applicable state towing laws.



Never allow passengers to ride in a towed vehicle for any reason. Never attach tie-down hooks, chains, straps, or tow hooks to tie rods, control arms, or any other part of the vehicle suspension, as severe damage to these components will occur, leading to possible accidents. ◀





Adaptive Transmission Control (ATC) [174](#)
 Airbags [175](#)
 Automatic Stability Control plus Traction (ASC+T)/Dynamic Stability Control (DSC) [175](#)
 Radio reception [176](#)
 Safety belt tensioner [176](#)
 Interior rearview mirror with automatic dimming feature [177](#)
 Rain sensor [178](#)
 Tire Pressure Control (RDC) [179](#)
 Self-diagnostics [180](#)
 Xenon lamps [181](#)

Overview

Controls and features

Operation, care and maintenance

Owner service procedures

Advanced technology

Technical data

Index



In order to include driving conditions in its calculations, ATC registers curves and both uphill and downhill gradients. For example, if you maintain speed through a curve, the transmission does not shift up. On uphill gradients, it shifts up only when the engine speed increases in order to make more efficient use of power reserves. On downhill gradients, ATC shifts down when the speed of the vehicle increases and the driver must apply the brakes.

On vehicles with automatic transmission, the ATC (Adaptive Transmission Control) uses a number of factors to calculate the maximally efficient gear. In this process, it considers your individual driving style as well as current driving conditions.

ATC recognizes your personal driving style from the positions and movements of the accelerator pedal, deceleration when braking, and lateral acceleration through curves. Based on different shift characteristics – from comfort-oriented to performance-oriented – ATC will select the appropriate gear.



Deceleration sensors continuously monitor the acceleration forces acting upon the vehicle. If, as the result of a frontal collision, a deceleration is reached at which the protection of the safety belts alone is no longer adequate, the gas generators of the driver and passenger-front airbags are ignited. However, the passenger-side airbag is only triggered if an additional sensor has recognized that the passenger seat is occupied.

In the event of a side collision, the head and side airbags in the front or rear* are triggered if necessary.

The airbags located under the marked covers inflate and unfold in a matter of a few milliseconds. In this process, they tear through the designed separation points of the upholstered covers or press them out.

Because the inflation process must be virtually instantaneous, it is accompanied by a certain amount of ignition and inflation noise, which will be drowned out by the noise from the accident itself. The gas required to inflate the airbags is not dangerous, and the associated smoke then dissipates.

The entire process is completed within fractions of a second.

Highly sensitive sensors monitor the number of revolutions of the wheels. When equipped with DSC, they also monitor steering angle, lateral acceleration, brake pressure and the movement of the vehicle around its vertical axis.

If differences in the wheel speeds occur, ASC+T counteracts the danger of wheelspin by reducing engine torque; if necessary, ASC+T will also respond by applying the brakes to the rear wheels.

In addition, DSC permanently monitors the vehicle's current operating condition and compares it with an ideal condition that is calculated from the sensor's signals. If deviations from this occur (understeering or oversteering, for instance), DSC can stabilize the vehicle in fractions of a second by reducing engine output and with the assistance of braking intervention at individual wheels. As a result, dangerous skids can be prevented even as they are just beginning. But this is only possible within the laws of physics.

You may need some time to become accustomed to this system's intervention. However, it provides optimum drive force and vehicle stability.

The braking intervention may be accompanied by sounds specific to the system.

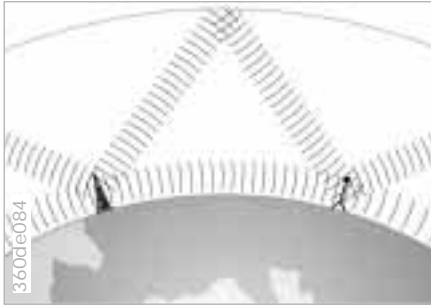

The AM frequency bands (medium-wave, long-wave and short-wave) make it possible to receive stations from a great distance, because the broadcast signals travel not only along the ground as surface waves, but also as atmospheric waves that are reflected from the ionosphere.

Frequency modulation (FM) offers substantially better sound quality than the other frequencies. However, because FM transmissions rely on line-of-sight broadcast waves, their effective reception range is limited.

The limitations inherent to radio reception in a moving vehicle have been minimized by a number of innovative system designs:

The Radio Data System (RDS) makes sure that, for broadcast stations sending on several frequencies, the radio automatically tunes to the frequency with the best reception quality.

The Antenna Diversity system employs several FM antennas integrated within the rear window to provide three separate sources for receiving broadcast waves. An integral processor automatically selects the antenna with the best FM reception quality at any given time. The selection of the antenna takes place within milliseconds, and is therefore not noticed by the radio listener.



The safety belt tensioner makes sure that the belt tightens during a head-on collision to ensure that occupants remain firmly positioned in their seats. A gas-pressure system retracts the buckle assembly to tension the shoulder and lap belts within fractions of a second. This reduces the tendency to slide under the lap belt.

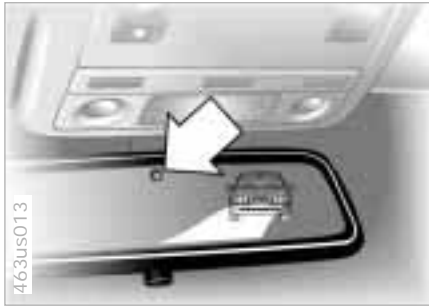

The semisolid reacts chemically to this electrical current, thus providing dimming of the mirror through an infinitely-variable range (electrochromic technology).

As a result, it is no longer necessary to dim the mirror manually, and the driver can concentrate completely on traffic conditions.

The interior rearview mirror with automatic dimming feature reduces blinding from following traffic by adapting the intensity of the reflected images to correspond to levels of light registered by the unit's sensors. The mirror reverts to its undimmed setting as soon as the light source disappears. One lamp sensor is mounted on the front of the mirror housing. This sensor, which is directed forward, measures light intensity in the area ahead of the vehicle. The second sensor is integrated within the mirror's glass. The electronic control system compares the light intensity from front and rear. The difference provides the basic parameter used to modulate an electrical current and induce chemical changes in a semisolid layer incorporated in the lens.

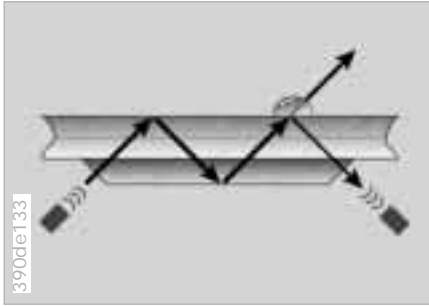

When the system is set to the "Intermittent" wiper speed, the wipers react immediately – if water is splashed onto the windshield by vehicles traveling ahead of you, for example. As a result, the rain sensor provides a contribution to driving safety and comfort.

Depending on the degree of wetness on the windshield, the rain sensor controls the operation of the windshield wipers.

Infrared light is carried along the surface of the windshield in an optical conductor in such a manner that it is reflected completely when the windshield is dry. The quantity of reflected light is measured.

If there is moisture on the glass, the amount of light reflected is reduced since the infrared light at the surface of the windshield can escape. The quantity of reflected light is thus a means of gauging the degree of wetness on the windshield.

Tire Pressure Control (RDC)*



Located near each wheel and embedded in the vehicle body is an antenna that receives signals from the wheel. A central electronics system evaluates the quadruple signals and forwards any changes. The RDC provides an important contribution to driving safety.

This system regularly checks tire pressure and monitors all four tires even while driving, so you do not have to.

Behind the valve stem in every wheel, there is an extended-life electronic chip that contains a pressure sensor, a transmitter and a battery. The pressure is measured in extremely short time intervals and then transmitted by a radio signal. If an irregularity is detected, the transmission rate is increased.

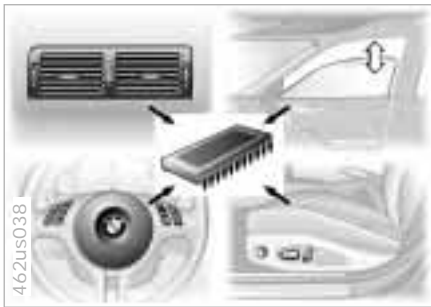

All of the important electrical and electronic systems in the vehicle are tested regularly and automatically – the driver does not have to perform any extra operations or adjustments.

The indicator lamps come on briefly after the ignition has been turned on.

While you are driving, the functional status of the actuator motors (for the windshield wipers, power windows, seats, sliding/tilt sunroof, etc.) is constantly being analyzed by electrical measurements in the relays.

In the same manner, the electrical resistance of the airbag ignition generators and all of the remaining airbag components is measured at all times. Any fault in this system would be detected immediately by a current fluctuation that would necessarily accompany it. The fault would be indicated immediately by the airbag warning lamp.

Even after you shut off the engine, the overall functional status of your vehicle is monitored. For example, all of the flaps of the heating and ventilation system travel to the nearest limit position. This way you can be assured that the defrost function is always available, even if, for example, a defect crops up in the air conditioner/automatic climate control during the night while the engine has been turned off.

A calibration cycle runs every tenth time the engine is shut off. During this cycle, the actuator motors of all the heating and ventilation flaps travel to their limit stops in both directions. The limit positions and the return travel paths are checked in this manner in order to ensure that appropriate adjustments for the operating elements can be made at any time.

You will hear the sounds of the air flaps as the air conditioner/automatic climate control carries out its self-diagnostic functions after the ignition has been shut off. All of the other self-diagnostics functions operate silently in the background.

Any possible faults detected during these self-diagnostics can be read out and corrected by your BMW center during the next regularly scheduled maintenance.

Xenon lamps*

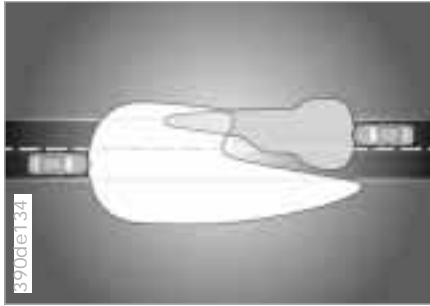

The xenon lamp provides forward illumination with significantly more brightness and uniformity than the traditional halogen lamp.

In a xenon lamp, an electric arc replaces the filament in order to generate intense illumination. A gas mixture in a quartz glass tube with metal vapor is ignited by a high electric voltage. The arc that is generated is then sustained by a lower voltage. When the lamp is turned on, there is a brief warm-up period. Maximum brightness is attained in approx. 15 seconds.

Xenon lamps provide significantly improved visibility, especially during adverse weather conditions and difficult driving situations (e. g. driving at night in heavy rain or through road repair areas where there are no lane markers).

Vehicles with xenon lamps are equipped with automatic headlamp range control. As a result, the lane ahead of you is always optimally lighted, even under varying load conditions, and drivers in oncoming traffic are not blinded.

Xenon lamps make a significant contribution to highway safety since other highway users, bicyclists and motorcyclists in the right lane, and pedestrians are more easily detected.

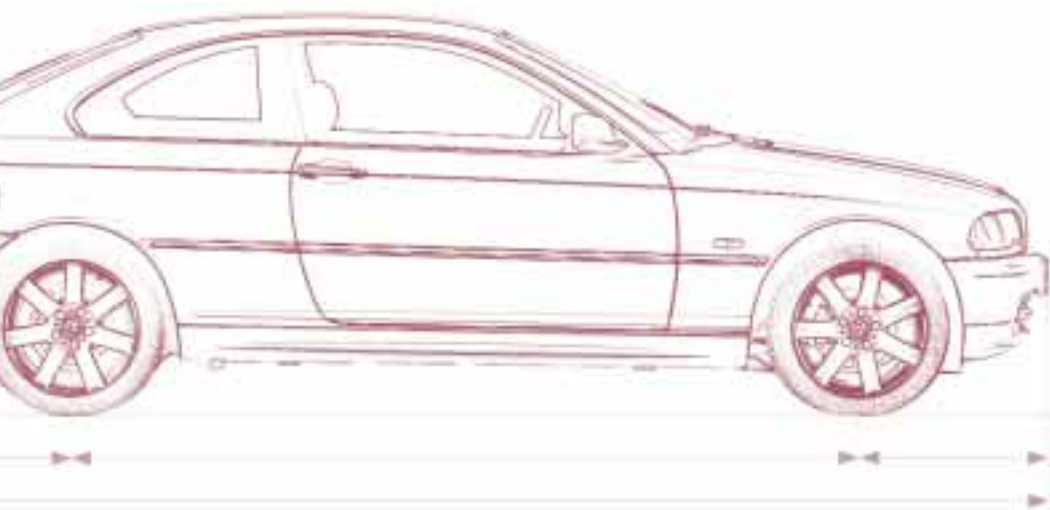

Engine data 184
Dimensions 185
Weights 186
Capacities 187
Electrical system 188
V-belts 188



Overview

Controls and features

Operation, care
and maintenance

Owner service procedures

Advanced technology

Technical data

Index

Overview

Controls

Car care

Repairs

Technology

Data

Index

184 **Engine data**

		BMW 325Ci	BMW 330Ci
Displacement	cu in (cm ³)	152.2 (2,494)	181.8 (2,979)
Number of cylinders		6	6
Maximum output at engine speed	hp (kW) rpm	184 (135) 6,000	225 (165) 5,900
Maximum torque at engine speed	lb-ft (Nm) rpm	175 (237) 3,500	214 (290) 3,500
Compression ratio	ϵ	10.5	10.2
Stroke	in (mm)	2.95 (75)	3.53 (89.6)
Bore	in (mm)	3.31 (84)	3.31 (84)
Fuel-injection system		Digital-electronic engine-management system	

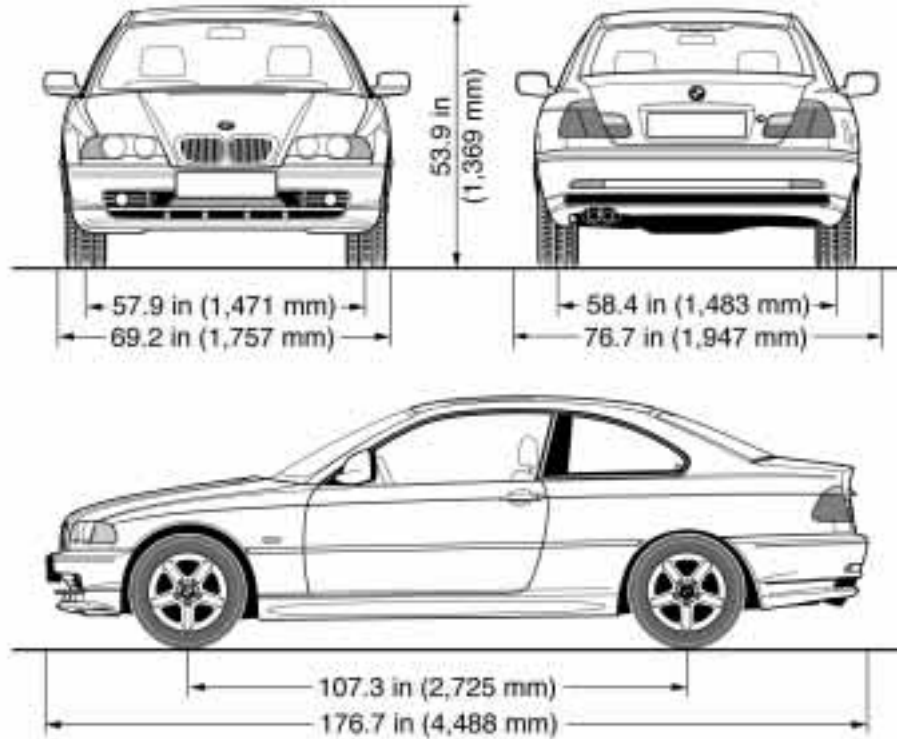

Minimum turning radius: 34.4 feet (10.5 m)

462us059

		BMW 325Ci	BMW 330Ci
Curb weight (with one person, ready for operation, full tank of fuel, options not included)			
with manual transmission	lbs. (kg)	3,252 (1,475)	3,351 (1,520)
with automatic transmission	lbs. (kg)	3,340 (1,515)	3,395 (1,540)
Approved gross vehicle weight			
with manual transmission	lbs. (kg)	4,310 (1,955)	4,409 (2,000)
with automatic transmission	lbs. (kg)	4,398 (1,995)	4,453 (2,020)
Approved front axle weight	lbs. (kg)	1,973 (895)	1,973 (895)
Approved rear axle weight	lbs. (kg)	2,447 (1,110)	2,491 (1,130)
Approved roof load capacity	lbs. (kg)	165 (75)	165 (75)
Luggage compartment capacity	cu ft (l)	14.5 (410)	14.5 (410)

Approved axle loads and approved gross vehicle weight may not be exceeded.

			Notes
Fuel tank reserve	gal. (liters) gal. (liters)	approx. 16.6 (approx. 63) approx. 2.1 (approx. 8)	Fuel specification: page 27
Windshield/Headlamp washer system	quarts (liters)	approx. 5.6 (approx. 5.3)	Specifications: page 134
Cooling system including heater circuit	quarts (liters)	approx. 8.9 (approx. 8.4)	Specifications: page 137
Engine oil filter change	quarts (liters)	approx. 6.9 (approx. 6.5)	BMW High Performance Synthetic Oil Specifications: page 136
Manual and automatic transmission, transfer box and differential		-	Lifetime fluid, no fluid change required

188 **Electrical system**

Battery

12V, 80 Ah

Spark plugs

NGK BKR 6 EQUIP

Bosch FGR 7 DQP

V-belts

Water pump – generator –
Power steering

V-belt 6 PK x 1538

A/C compressor

V-belt 5 PK x 863



You can obtain Original BMW parts and accessories, as well as professional advice from your BMW center. ◀

A B C

P Q R

Everything from A to Z 192
Owner service procedures 199

Overview

Controls and features

Operation, care
and maintenance

Owner service procedures

Advanced technology

Technical data

Index

Overview

Controls

Car care

Repairs

Technology

Data

Index

Everything from A to Z

A

ABS (Antilock Brake System) 22, 115
ABS, fault 116
Accessories 6
Activated-charcoal filter 100, 166
Adaptive Transmission Control (ATC) 67, 174
Adding
 engine oil 135
 washer fluid 134, 187
Adjusting
 backrest 48
 head restraints 48
 lumbar support 49
 steering wheel 52
 temperature 92, 98
Air conditioner 90
Air distribution 92, 98
Air nozzles 90, 96
Air outlets 90, 96
 ventilation 90, 96
Air pressure 122
Air supply 92, 99
Airbags 21, 57, 146, 175
 sitting properly 58
Alarm system 42
Antenna 121
 Diversity 176
Antifreeze 137
 radiator 119

Antilock Brake System (ABS) 22, 115
Anti-theft alarm system 42
Approved weight and load capacities 186
Approved wheel and tire specifications 127
Aquaplaning 113, 122
Armrest 102
ASC+T (Automatic Stability Control plus Traction) 22, 82, 175
Ashtray
 front 104
 rear 105
ATC (Adaptive Transmission Control) 67, 174
Attach vacuum cleaner 105
AUC (Automatic recirculated-air control) 99
Automatic car washes 141
Automatic climate control 96
 remove window condensation 99
Automatic cruise control 73
Automatic dimming, interior rearview mirror 53
Automatic recirculated-air control (AUC) 99

Automatic Stability Control plus Traction (ASC+T) 22, 82, 175
Automatic transmission with Steptronic 21, 67
Automatic windshield washer 71
Average consumption 79
Average speed 80
Avoiding unwanted alarm 43
Axle loads 186

B

Backrest, releasing 49
Backup lamps 66
 bulb replacement 155
Battery 163, 188
 capacity 188
 charge current 20
 charging 165
 discharged 168
 removal and installation 164
Battery safety terminal 164
Battery terminal 164
Belts 55
Blower 92, 99
BMW High Performance Synthetic Oil 136
BMW Maintenance System 140

BMW sports seat 49
Bore 184
Brake fluid 138
Brake hydraulic system 20
Brake lamps, bulb replacement 155
Brake pads 22
Brake system 118
Brakes 117
 malfunctions 118
Break-in procedures 112
Bulb replacement 152
Bulbs 152

C

California Proposition 65 Warning 148
Capacities 187
Car Memory 54
Car radio 121
 refer also to the separate Owner's Manual
Car radio reception 121, 176
Car vacuum cleaner 105
Car wash 141
Care
 exterior 142
 interior 144
Care of upholstery 145
Care of wool velour 145

- Cargo
 - loading [108](#)
 - securing [108](#)
 - Caring for the vehicle's
 - finish [143](#)
 - Cassette operation, refer to the Radio Owner's Manual
 - Catalytic converter [113](#)
 - CBC (Cornering Brake Control) [21](#), [116](#)
 - CD operation, refer to the Radio Owner's Manual
 - Cellular phone [104](#), [121](#)
 - refer also to the separate Owner's Manual
 - Center (high-mount) brake lamp [157](#)
 - Center 3-point-safety belt in the rear [106](#)
 - Center armrest [102](#)
 - Central locking system [34](#)
 - button [38](#)
 - Changing a wheel [159](#)
 - Changing tires [159](#)
 - Check Control [77](#)
 - Child restraint systems [56](#)
 - Child seat [56](#)
 - Child seat security [62](#)
 - Cigarette lighter [105](#)
 - Cleaning headlamps [72](#)
 - Cleaning windshield [71](#)
 - Clock [78](#)
 - Clock, refer also to the Radio or Onboard Monitor
 - Owner's Manual
 - Clothes hooks [105](#)
 - Cockpit [16](#)
 - Code, refer to the Radio
 - Owner's Manual
 - Coin box, cup holder [103](#)
 - Combination switch [70](#)
 - Compression [184](#)
 - Computer [77](#)
 - Computer, refer also to the Onboard Monitor Owner's Manual
 - Configure settings [54](#)
 - Consumption [79](#)
 - Consumption display [76](#)
 - Contents [10](#)
 - Convenience operation
 - sliding/tilt sunroof [34](#)
 - windows [34](#)
 - Coolant [119](#), [137](#), [187](#)
 - antifreeze [119](#)
 - Coolant temperature
 - gauge [76](#)
 - Cooling system [187](#)
 - Copyright [4](#)
 - Cornering Brake Control (CBC) [21](#), [116](#)
 - Cruise control [73](#)
 - Cruising range [79](#)
 - Curb weight [186](#)
 - Current, check indicator [20](#)
- ## D
- Data
 - dimensions [185](#)
 - engine [184](#)
 - technical [184](#)
 - weights [186](#)
 - Daytime-driving lamp [87](#)
 - DBC (Dynamic Brake Control) [116](#)
 - Deep water [113](#)
 - Defroster, rear
 - window [92](#), [100](#)
 - Defrosting the
 - windows [94](#), [99](#)
 - Digital clock [78](#)
 - Dimensions [185](#)
 - Dipstick [135](#)
 - Disc brakes [117](#)
 - Displacement [184](#)
 - Display lighting [87](#)
 - Displays [18](#)
 - Distance warning [81](#)
 - Diversity Antenna
 - system [176](#)
 - Divided rear backrest [106](#)
 - Door key [32](#)
 - Door locks, care [119](#)
 - Doors
 - emergency operation [34](#)
 - remote control [35](#)
 - unlocking and locking [34](#)
 - DOT Quality Grades [123](#)
- ## E
- Draft-free
 - ventilation [93](#), [100](#)
 - Drive belts [188](#)
 - Driving hints [113](#)
 - Driving in winter [119](#)
 - Driving lamps [87](#)
 - DSC (Dynamic Stability Control) [22](#), [82](#), [175](#)
 - Dynamic Brake Control (DBC) [116](#)
 - Dynamic Stability Control (DSC) [22](#), [82](#), [175](#)

Everything from A to Z

Engine oil [135](#)
adding [135](#)
capacity [187](#)
consumption [135](#)
level check [135](#)
pressure [20](#)
quality [136](#)
specifications [136](#)
viscosity [136](#)

Engine speed [184](#)

Engine, starting [63](#)

Engine, switching off [64](#)

Entry to the rear [49](#)

Exterior mirrors [52](#)

Eyelets, towing [169](#)

F

Failure messages [77](#)

Fault displays [77](#)

Fault, ABS [116](#)

Filling capacities [187](#)

Filling the washer
reservoir [187](#)

First-aid kit [25](#)

Fittings, towing and tow
starting [169](#)

Flashlight [102](#)

Flat tire [122](#), [159](#)

Floor mat [41](#)

Floor panel, lift and hook [41](#)

Fog lamps [88](#)

Folding rear backrest [106](#)

Follow-Me-Home lamps [87](#)

Footbrake [117](#)

Footwell lamps [88](#)
bulb replacement [158](#)

Front fog lamps, bulb
replacement [155](#)

Front seat, adjusting [47](#)

Frost protection,
radiator [137](#)

Fuel [27](#)

Fuel consumption [79](#)

Fuel consumption
display [76](#)

Fuel filler cap [26](#)

Fuel filler door [26](#)
unlock in case of electrical
fault [167](#)

Fuel gauge [76](#)

Fuel quality [27](#)

Fuel reserve indicator
lamp [76](#)

Fuel specifications [27](#)

Fuel tank capacity [187](#)

Fuel tank gauge [76](#)

Functional status [180](#)

Fuses [166](#)

G

Gasoline [27](#)

Gasoline gauge [76](#)

Glove compartment [102](#)

Glove compartment lamp
bulb replacement [158](#)

Gross vehicle weight [186](#)

H

Handbrake [65](#)

Handsfree system [104](#)

Hazard warning flashers [25](#)

Hazard warning triangle [25](#)

Head restraints [48](#)

Headlamp cover,
care [141](#), [153](#)

Headlamp flasher [70](#), [88](#)

Headlamp washer
system [72](#), [134](#), [187](#)

Headlamps [87](#)

Heated seats [101](#)

Heating, rapid [94](#)

Heavy loads [108](#)

Height [185](#)

HiFi system – harman
kardon [101](#)

High beams [23](#), [70](#), [88](#)
bulb replacement [153](#)

High Performance Synthetic
Oil [136](#)

High-mount brake lamp [157](#)

Hood [130](#)
release [130](#)

Horn [17](#)

Hubcap [161](#)

Hydraulic Brake assistent,
refer to DBC

I

Ice warning [79](#)

Icy roads [79](#)

Identification,
tires [125](#), [127](#)

Ignition key [32](#)

Ignition lock [63](#)

Imprint [4](#)

Indicator lamps [20](#)

Inflation
pressure [27](#), [85](#), [122](#)
monitoring [27](#), [85](#), [179](#)

INSPECTION [76](#)

Instrument cluster [18](#)

Instrument panel [16](#), [18](#)

Instrument panel lighting [87](#)

Interaxle tire rotation [124](#)

Interface socket for Onboard
Diagnostics [149](#)

Interference, cellular
phones [121](#)

Interior lamps [36](#), [88](#)
bulb replacement [157](#)
remote control [36](#)

- Interior motion
 - sensor 36, 43
- Interior rearview mirror 53
 - automatic dimming feature 53, 177
- Interlock 63
- Intermittent wipe 70

- J**
- Jack 159
- Jump-starting 168

- K**
- Key Memory 54
- Keys 32
 - with remote control 32

- L**
- Lamp switch 87
- Lamps 152
- LAMPS ON warning 87
- Lashing eyes 108
- LATCH attachment of the child seat 60
- Leather care 145
- Length 185
- License plate lamp, bulb replacement 157
- Lift the floor panel up and hook it 41
- Light switch 87
- Light-alloy wheel 127
- Lighter 105
- Loads, securing 108
- Load-securing devices 108
- Louvers 90, 96
- Low beams 87
 - bulb replacement 153
- Lug bolts 161
- Lug wrench 160
- Luggage compartment 41
 - capacity 186
 - floor mat 41
 - remote control 37
 - secure separately 39
- Luggage compartment lamps, bulb replacement 158
- Luggage compartment lid 39
 - emergency release 39
- Luggage compartment lighting 39
- Luggage rack 109
- Lumbar support 49

- M**
- M+S tires 126
- Maintenance 76
- Malfunction displays 77
- Manual transmission 66
- Manually controlled recirculated-air 99
- Memory 51
- MFL (Multi-function steering wheel) 24
- Microfilter 93, 166
- Mirror memory 51
- Mirrors 52
- Mobile phones 121
- Modifications, technical 6, 148
- Multi-function steering wheel (MFL) 24

- N**
- Navigation system, refer to the Onboard Monitor Owner's Manual
- Neckrest 48

- O**
- OBD interface socket 149
- Obstruction protection 44
- Odometer 75
- Oil
 - additives 135
 - capacity 187
 - consumption 135
 - dipstick 135
 - quality 136
 - specifications 136
 - viscosity 136
- Oil change intervals, refer to the Service and Warranty Information Booklet/ Warranty and Service Guide Booklet
- Oil filter change 187
- Oil level
 - check 135
 - indicator lamp 20
- Oil pressure, indicator lamp 20
- OILSERVICE 76
- Onboard tool kit 152
- Opening and closing
 - from the inside 38
 - from the outside 34
- Outside temperature display 78

- P**
- Paint blemishes 142
- Paint, care 142
- Paintwork
 - minor repairs 143
 - waxing 143
- Park Distance Control (PDC) 81
- Parking aid 81
- Parking brake 65
- Parking lamps 88
- Parking, winter 120

Everything from A to Z

PDC (Park Distance Control) 81
Performance 184
Pocket flashlight 102
Pollen 93, 100
Power seat 50
Power steering 121
Power windows 44
 safety feature 44
Pressure monitoring, tires 85, 179
Pressure, tires 27, 122

Q

Quality Grades 123

R

Radiator 187
Radio Data System (RDS) 176
Radio reception 121, 176
Radio, refer also to the separate Owner's Manual
Rain sensor 71, 178
RDC (Tire Pressure Control) 85, 179
RDS (Radio Data System) 176
Reading lamps 89
Rear backrest, folding 106

Rear lamps 155
Rear window defroster 72, 92, 100
Rear-entry assist 49
Rearview mirror 52
Recirculated air mode 92
Reclining seat 47
Refueling 26
Remote control 35
Removing condensation from the windows 94, 99
Replacement keys 32
Reporting safety defects 7
Restraint system 56
Reverse 17, 66
Roller blind, sun protection 101
Roof load capacity 186
Roof-mounted luggage rack 109
Rubber parts 119

S

Safety belt tensioner 176
Safety belts 55
 height adjustment 55
Safety buttons 38
Safety feature 44
Safety terminal, battery 164

Seats 47
 adjusting 47
 electric power 50
 heating 101
 mechanical 47
 memory 51
 sitting properly 58
Securing the load 108
Selector lever, automatic transmission 67
Self-defrosting mirrors 52
Self-diagnostics 180
Service and Warranty Information Booklet 140
Service Interval Display 76
Shiftlock 67
Side airbags 57
Side impact Head Protection System 57
Side lamps 87
 bulb replacement 154
Sitting properly with airbag 58
Ski bag 107
Skid control 120
Sliding/tilt sunroof 45
 closing following an electrical malfunction 167
 convenience operation 34
Slippery roads 119
Snow chains 119, 126

Socket 105
 for flashlights 105
 for power supplies 105
 for vacuum cleaner 105
Spare key 32
Spare tire 159
Spark plugs 188
Speaker 104
Specifications, fuel 27
Speed control 75
Speed display 18
Speed, average 80
Speedometer 18
Sports seat 49
Starting assistance 168
Starting problems 113, 168
Starting the engine 63
Steel rim 127
Steering 121
Steering lock 63
Steering wheel 52
 adjusting 52
Steptronic 67
Stopping the vehicle 64
Storage compartments 102
Storage facilities 102
Storing your vehicle 147
Stroke 184
Summer tires 125, 127
Sun roller blind 101
Sun visors 53

- Switching off the engine 64
 - Symbols 4, 164
 - Synthetic oils 136
- T**
- Tachometer 75
 - Tail lamp assembly, bulb replacement 155
 - Tail lamps 155
 - Tank capacity 187
 - Technical data 184
 - Technical
 - modifications 6, 148
 - Telephone hookup 104
 - Telephone, refer also to the separate Owner's Manual
 - Temperature display
 - outside temperature 78
 - Temperature gauge
 - engine coolant 76
 - Temperature
 - layering 93, 100
 - Temperature, adjusting 92, 98
 - Thigh support adjustment 49
 - Third brake lamp 157
 - Three-point-safety belt in the rear 106
 - Through-loading system 106
- Tilt sensor alarm system 36, 43
 - remote control 36
 - Tire
 - codes 125, 127
 - condition 122
 - damage 122
 - inflation
 - pressure 27, 122
 - replacement 123
 - rotation 124
 - tread 122
 - Tire pressure
 - checking 27
 - monitoring 85, 179
 - Tire Pressure Control (RDC) 85, 179
 - Tire Quality Grading 123
 - Tools 152
 - Torque 184
 - Towing eyelets 169
 - Towing the vehicle 169
 - Track 185
 - Traction Control System, refer to DSC 82
 - Transmission 66
 - Transmitter key 32
 - Transporting children safely 60
 - Tread depth, tires 122
 - Tread wear indicator 122
 - Trip odometer 75
 - Trunk lid, refer to luggage compartment lid
 - Turn signal indicator 23, 70
 - bulb replacement 154
 - Turning radius 185
 - Two-way radios 121
- U**
- Uniform Tire Quality Grading 123
 - Used batteries 165
- V**
- Vacuum cleaner 105
 - Vanity mirror, bulb replacement 158
 - V-belts 188
 - Vehicle battery 163, 188
 - Vehicle care
 - exterior 142
 - interior 144
 - Vehicle Identification Number (VIN) 139
 - Vehicle immobilizer 33
 - Vehicle painting 142
 - Vehicle starting 63
 - Vehicle storage 147
 - Vehicle vacuum cleaner, attaching 105
 - Vehicle weight 186
 - Ventilation 90, 93, 96
 - draft-free 93, 100
 - Vinyl upholstery, care 144
 - Voice recognition 24
- W**
- Warning flashers 25
 - Warning lamp "Please fasten safety belts" 21
 - Warning lamps 20
 - Warning messages 77
 - Warning triangle 25
 - Warranty and Service Guide Booklet 140
 - Washer fluids 134, 187
 - Washer nozzles, adjusting 134
 - Washer reservoir, filling 134
 - Washer system 70
 - Washing your vehicle 141
 - Water on roadways 113
 - Waxing, paintwork 143
 - Wear indicator in the tires 122
 - Weights 186
 - Wheel lug wrench 159
 - Wheel rims 125, 127
 - Wheel, changing 159
 - Wheelbase 185
 - Wheels and tires 125, 127
 - Width 185

Everything from A to Z

Windows

convenience operation [34](#)

remote control [35](#)

removing

condensation [99](#)

Windows, defrosting [94](#)

Windows, removing

condensation [94](#)

Windshield washer nozzle

adjustment [134](#)

Windshield washer reservoir,

filling [134](#), [187](#)

Windshield washer,

automatic [71](#)

Windshield wiper [70](#)

blade replacement [152](#)

Winter operation [119](#)

Winter tires [125](#), [126](#), [127](#)

Wiper blade

replacement [152](#)

Wiper system [70](#)

Work in the engine

compartment [130](#)

X

Xenon lamps [153](#), [181](#)

- A**
Adding brake fluid 138
Adding engine coolant 138
Adding engine oil 135
Avoiding unintentional alarm 43
- B**
Backup lamps, bulb replacement 155
Battery
 add distilled water 163
 charging 165
Brake fluid, adding 138
Brake lamps, bulb replacement 155
Brakes, brake faults 118
- C**
Changing the microfilter 12, 151, 166
Changing tires 159
Checking air pressure 27
Checking engine oil level 135
- D**
Defrost setting 94
Defrosting the windows 94, 99
- Difficult steering 121
Doors, emergency actuation 34
- E**
Electrical accessories, failure 166
Electrical failure
 fuel filler door 167
 sliding/tilt sunroof 167
Emergency closing
 sliding/tilt sunroof 167
Emergency release doors 34
 fuel filler door 167
 luggage compartment lid 39
Engine coolant, adding 138
Engine oil
 add 135
 level 135
 quality 136
 specifications 136
 viscosity 136
Eyelets, towing 169
- F**
First-aid kit 25
Fittings, towing and tow starting 169
Flat tire 159
- Footwell lamps, bulb replacement 158
Front fog lamps, bulb replacement 155
Fuel filler door, manual release after electrical fault 167
Fuses, replacing 166
- G**
Glove compartment lamp, bulb replacement 158
- H**
Hazard warning flashers 25
Hazard warning triangle 25
Headlamp cover, care 153
High beam headlamps, bulb replacement 153
Hood release 130
- I**
Indicator lamps 20
Inflation pressures 27, 122
Interior lamps, bulb replacement 157
- J**
Jack 159
- L**
LATCH attachment of the child seat 60
License plate lamp, bulb replacement 157
Low beam headlamps, bulb replacement 153
Luggage compartment lamps, bulb replacement 158
Luggage compartment lid emergency release 39
- M**
Maintenance 140
Microfilter, changing 12, 151, 166
- O**
Oil
 level 135
 quality 136
 specifications 136
 viscosity 136
Onboard tool kit 152

Owner service procedures

P

- Parking lamps, bulb replacement 154
- Pressure, tires 27

R

- Rear lamps 155
- Releasing the fuel filler door 167
- Releasing the hood 130
- Removing condensation from the windows 94, 99
- Replacement key 32
- Replacing bulbs 152
- Replacing windshield wiper blades 152
- Return used batteries 165
- Rotating the tires 159

S

- Sliding/tilt sunroof, closing after electrical fault 167
- Space-saver spare tire 159
- Spare key 32
- Spare tire 159
- Starting problems 64, 113
- Switching off the tilt sensor alarm system 43

T

- Tail lamp assembly, bulb replacement 155
- Tire
 - changing 159
 - checking air pressure 27
 - damage 122
- Tools 152
- Towing eyelets 169
- Towing the vehicle 169
- Turn signal indicator, bulb replacement 154

U

- Unintentional alarm, avoiding 43
- Use of antifreeze, radiator 138

V

- Vanity mirror, bulb replacement 158

W

- Warning lamps 20
- Washer fluid, adding 134
- Washer nozzles, adjusting 134
- Washer reservoir, filling 134
- Wheel lug wrench 159

- Windows, defrosting 94, 99
- Windshield washer, filling 134
- Windshield wiper blades, replacing 152
- Work in the engine compartment 130



Refueling



So that you will have important specifications available when you stop to refuel, we recommend that you supplement this table with data which apply to your vehicle.

Fuel

Designation	Premium Unleaded Gasoline
AKI: minimum	91

Engine oil

Quality	
---------	--

The oil volume between the two marks on the oil dipstick corresponds to approx. 1.1 US quarts (1 liter).

Tire inflation pressures

	Summer		Winter	
	Front	Rear	Front	Rear
4 persons				
5 persons or 4 plus luggage				

**We wish you an enjoyable
driving experience.**



The Ultimate Driving Machine

3 Coupe US-En