



M3 convertible

Thank you for deciding on a BMW M3 convertible.

Thorough familiarity with your vehicle will provide you with enhanced control and security when you drive it. Therefore, we have one request:

Read the information contained in this Owner's Manual before driving your new BMW M3 convertible for the first time. It contains important information on vehicle operation that will enable you to make full use of the advanced technical equipment of your BMW M3 convertible. In addition, you will receive information on vehicle maintenance, that help ensure operating and traffic safety, as well providing for the best possible value retention of your BMW.

For more detailed information refer to the Supplemental Manuals.

BMW M also makes decisive contribution toward greater safety in traffic through its BMW driver training.

This Owner's Manual should be considered a permanent part of this vehicle. It should stay with the vehicle when sold to provide the next owner with important operating, safety and maintenance information.

This manual is supplemented by a Service and Warranty Information Booklet (US models) or a Warranty and Service Guide Booklet (Canadian models).

We recommend that you read this publication thoroughly.

Your BMW M3 convertible is covered by the following warranties:

- New Vehicle Limited Warranty
- Limited Rust Perforation Warranty
- Federal Emissions System Defect Warranty
- Federal Emissions Performance Warranty
- California Emission Control System Limited Warranty

Detailed information about these warranties is listed in the Service and Warranty Information Booklet (US models) or in the Warranty and Service Guide Booklet (Canadian models).

We wish you an enjoyable driving experience.

BMW M

Contents

Overview

- Cockpit 14
- Instrument cluster 15
- Indicator and warning lamps 17
- Steering wheel with multifunction buttons 21
- Warning triangle 22
- First-aid kit 22
- Refueling 22
- Fuel specifications 24
- Tire inflation pressure 24

Controls and features

- Opening and closing:**
- Keys 28
- Central locking system 28
- Opening and closing – via the door lock 29
- IOpening and closing – via the remote control 30
- Opening and closing – from the inside 33
- Luggage compartment lid 34
- Luggage compartment 36
- Alarm system 37
- Electric power windows 39
- Convertible top 40

Adjustments:

- Correct sitting position 44
- Seats 44
- Head restraints 46
- Entering the rear 47
- Safety belts 48
- Seat and mirror memory 48
- Seat heating 49
- Steering wheel 50
- Mirrors 50

Passenger safety systems:

- Airbags 52
- Transporting children safely 54
- Rollover protection system 58
- Vehicle Memory, Key Memory 60

Driving:

- Steering/Ignition lock 61
- Starting the engine 61
- Switching off the engine 62
- Parking brake 63
- Manual transmission 63
- Sequential M gearbox SMG II 64
- Indicator/Headlamp flasher 70
- Washer/Wiper system/Rain sensor 71
- Cruise control 73

Everything under control:

- Odometer 75
- Tachometer 75
- Engine oil temperature gauge 75
- Fuel gauge 76
- Temperature gauge 76
- Service Interval Display 76
- Check Control 77
- Clock 77
- Computer 78

Technology for driving comfort and safety:

- Park Distance Control (PDC) 80
- Dynamic Stability Control (DSC) 81
- Flat Tire Monitor 82
- M Engine dynamics control 84

- Controls and features**
- Lamps:**
 - Parking lamps/Low beams 85
 - Instrument lighting 86
 - High beams/Standing lamps 86
 - Fog lamps 86
 - Interior lamps 87
 - Reading lamps 87
 - Controlling the climate for pleasant driving:**
 - Air conditioner 88
 - Automatic climate control 91
 - Interior conveniences:**
 - Glove compartment 95
 - Storage compartments 96
 - Cellular phone 96
 - Ashtray, front 97
 - Ashtray, rear 97
 - Loading and transporting cargo:**
 - Ski bag 98
 - Cargo loading 100
 - Roof-mounted luggage rack for the hardtop 101
- Operation, maintenance**
- Special operating instructions:**
 - Break-in procedure 104
 - Driving notes 105
 - Antilock Brake System 105
 - Brake system 105
 - Hardtop 106
 - Wheels and tires:**
 - Tire inflation pressure 109
 - Tire condition 109
 - Tire replacement 110
 - Wheel and tire combinations 111
 - Winter tires 112
 - Snow chains 112
- In the engine compartment:**
- Hood 113
 - Engine compartment essentials 114
 - Washer fluids 115
 - Engine oil 116
 - Coolant 118
 - Brake fluid 119
- Maintenance:**
- The BMW Maintenance System 120
- Laws and regulations:**
- Technical modifications 121
 - California Proposition 65 Warning 121
 - OBD interface socket 122

Contents

Owner service procedures

Replacement procedures:

- Onboard tool kit [126](#)
- Windshield wiper blades [126](#)
- Lamps and bulbs [126](#)
- Repairing a flat tire [132](#)
- Battery [136](#)
- Fuses [136](#)

Giving and receiving assistance:

- Jump-starting [137](#)
- Towing the vehicle [139](#)

Technical data

- Engine data [144](#)
- Dimensions [145](#)
- Weights [146](#)
- Capacities [147](#)

Index

- Everything from A to Z [150](#)

Notes on the Owner's Manual

We have made every effort to ensure that you are able to find what you need in this Owner's Manual as quickly as possible. The fastest way to find certain topics is by using the detailed index at the end. If you wish to gain only an initial overview of your vehicle, you will find this in the first chapter.

We hope that the detailed table of contents provided on the preceding pages will stimulate your interest and encourage you to read the manual.

Should you wish to sell your BMW at some time in the future, please remember to hand over this Owner's Manual to the new owner; it is part of the vehicle.

Should you have any further questions, your BMW center will be glad to assist at any time.

Symbols used



Indicates precautions that must be followed precisely in order to avoid the possibility of personal injury and serious damage to the vehicle. ◀



Contains information that will assist you in gaining the optimum benefit from your vehicle and enable you to care more effectively for your vehicle. ◀



Refers to measures that can be taken to help protect the environment. ◀

◀ Marks the end of a specific item of information.

* Indicates special equipment, country-specific equipment and optional extras.



Identifies index entries that refer to owner service procedures or topics on vehicle maintenance.



Identifies systems or components, which can either be activated or adapted to suit an individual driver's requirements ("Vehicle Memory", "Key Memory"). Refer to page 60. Remember that activation and adjustments on some of these systems can only be performed at your BMW center. ◀

Your individual vehicle

On purchasing your BMW, you have decided in favor of a model with individualized equipment and features. This Owner's Manual will describe all of the equipment that the BMW M3 convertible has to offer you.

We hope you will understand that equipment and features are included that you might not have chosen for your vehicle. You can easily identify any differences with the aid of the asterisk * used to identify all optional equipment and accessories.

If your BMW features equipment that is not described in this Owner's Manual (a car radio or telephone, for instance), we have enclosed Supplementary Owner's Manuals. We ask you to read these manuals as well.

Status at time of printing

BMW pursues a policy of continuous, ongoing development that is conceived to ensure that our vehicles continue to embody the highest quality and safety standards combined with advanced, state-of-the-art technology. For this reason, it is possible that the features described in this Owner's Manual could differ from those on your vehicle. Nor can errors and omissions be entirely ruled out. You are therefore asked to appreciate that no legal claims can be entertained on the basis of the data, illustrations or descriptions in this Owner's Manual.

For your own safety



Use unleaded gasoline only. Fuels containing up to and including 10% ethanol or other oxygenates with up to 2.8% oxygen by weight (i.e. 15% MTBE or 3% methanol plus an equivalent amount of co-solvent) will not void the applicable warranties respecting defects in materials or workmanship. Field experience has indicated significant differences in fuel quality (volatility, composition, additives, others) among gasolines offered for sale in the United States and Canada. The use of poor quality fuels may result in drivability, starting and stalling problems especially under certain environmental conditions, such as high ambient temperature and high altitude. Should you encounter driveability problems which you suspect could be related to the fuel you are using, we recommend that you respond by switching to a recognized high-quality brand. Failure to comply with these recommendations may result in unscheduled maintenance. Obey pertinent safety rules when you are handling gasoline. ◀



Important safety information!

For your own safety, use genuine parts and accessories approved by BMW.

When you purchase accessories tested and approved by BMW and Original BMW Parts, you simultaneously acquire the assurance that they have been thoroughly tested by BMW to ensure optimum performance when installed on your vehicle.

BMW warrants these parts to be free from defects in material and workmanship.

BMW will not accept any liability for damages resulting from installation of parts and accessories not approved by BMW.

BMW cannot test every product made by other manufacturers to verify if it can be used on a BMW safely and without risk to either the vehicle, its operation, or its occupants.

Original BMW Parts, BMW Accessories and other products approved by BMW, together with professional advice on using these items, are available from all BMW centers.

Installation and operation of non-BMW approved accessories such as alarms, radios, amplifiers, radar detectors, wheels, suspension components, brake dust shields, telephones (including operation of any portable cellular phone from within the vehicle without using an externally mounted antenna) or transceiver equipment (such as CB, walkie-talkie, ham radio or similar) may cause extensive damage to the vehicle, compromise its safety, interfere with the vehicle's electrical system or affect the validity of the BMW Limited Warranty. See your BMW center for additional information. ◀



Maintenance, replacement, or repair of the emission control devices and systems may be performed by any automotive repair establishment or individual using any certified automotive part. ◀

Symbol for vehicle parts



Indicates that you should consult the relevant section of this Owner's Manual for information on a particular part or assembly.

The following only applies to vehicles owned and operated in the US.

REPORTING SAFETY DEFECTS

If you believe that your vehicle has a defect which could cause a crash or could cause injury or death, you should immediately inform the National Highway Traffic Safety Administration (NHTSA) in addition to notifying BMW of North America, LLC, P.O. Box 1227, Westwood, New Jersey 07675-1227, Telephone (201) 307-4000.

If NHTSA receives similar complaints, it may open an investigation, and if it finds that a safety defect exists in a group of vehicles, it may order a recall and remedy campaign. However, NHTSA cannot become involved in individual problems between you, your dealer, or BMW of North America, LLC.

To contact NHTSA, you may either call the Auto Safety Hotline toll-free at 1-800-424-9393 (or 366-0123 in Washington, D.C. area) or write to: NHTSA, U.S. Department of Transportation, Washington, D.C. 20590. You can also obtain other information about engine vehicle safety from the Hotline.



Overview

Controls and features

Operation, maintenance

Owner service procedures

Technical data

Index



14 Cockpit

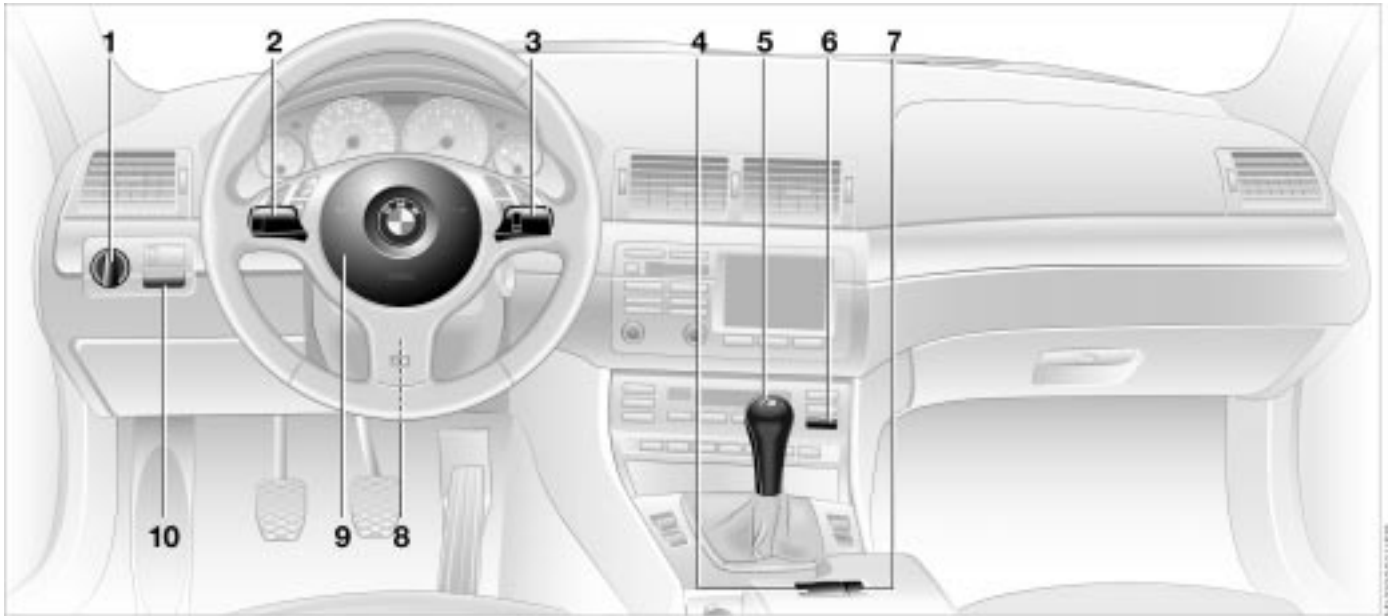

1 Parking lamps/Low beams [85](#)

2 ▷ Turn signal indicators [70](#)

▷ Standing lamps [86](#)

▷ High beams [86](#)

▷ Headlamp flasher [70](#)

▷ Computer [78](#)

3 Washer/Wiper system/Rain sensor [71](#)

4 Hazard warning flashers

5 Shift lever [63](#)

6 Rear window defroster [89, 93](#)

7 Central locking system [28](#)

8 Steering wheel [50](#)

9 Horn: the entire surface

10 Fog lamps [86](#)

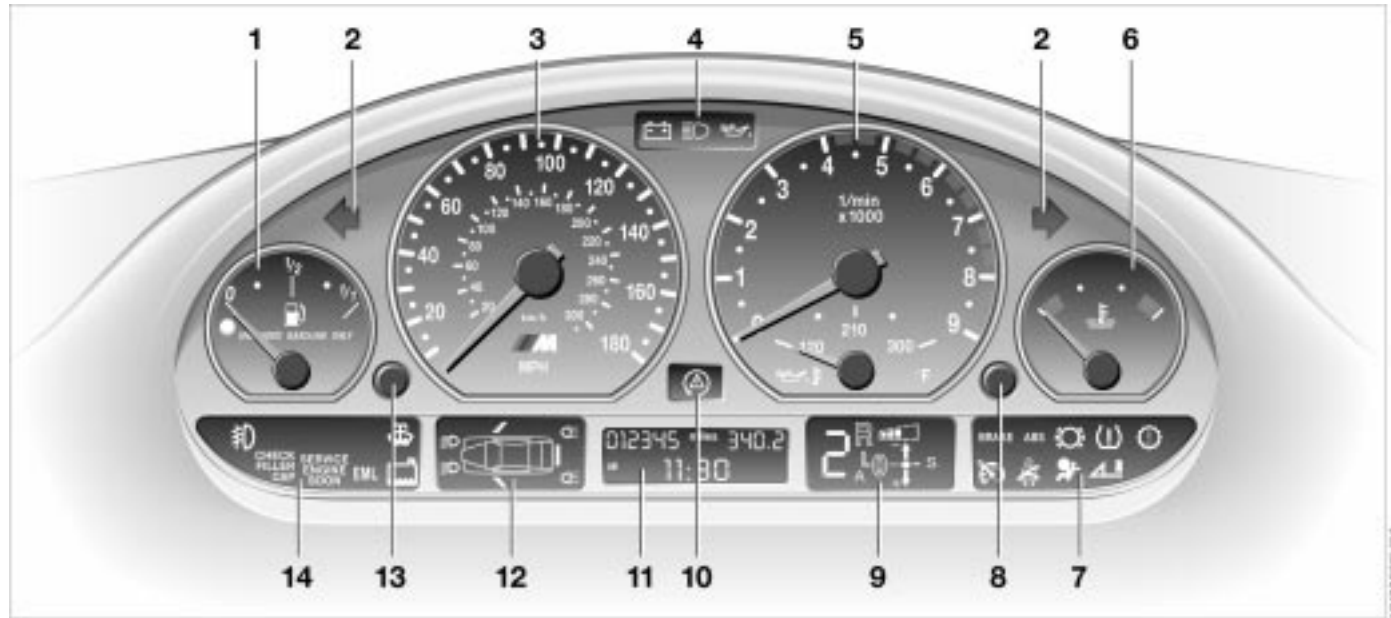

- 1 Fuel gauge [76](#)
- 2 Turn signal indicator [20](#)
- 3 Speedometer
- 4 Indicator and warning lamps [17](#) to [20](#)

- 5 Tachometer and Engine oil temperature [75](#)
- 6 Engine coolant temperature gauge [76](#)
- 7 Indicator and warning lamps [17](#) to [20](#)

- 8 Clock reset
 - ▷ Clock [77](#)
 - ▷ Unit of measure of outside temperature display [78](#)
- 9 Display for sequential M gearbox* SMG II [66](#)

16 Instrument cluster

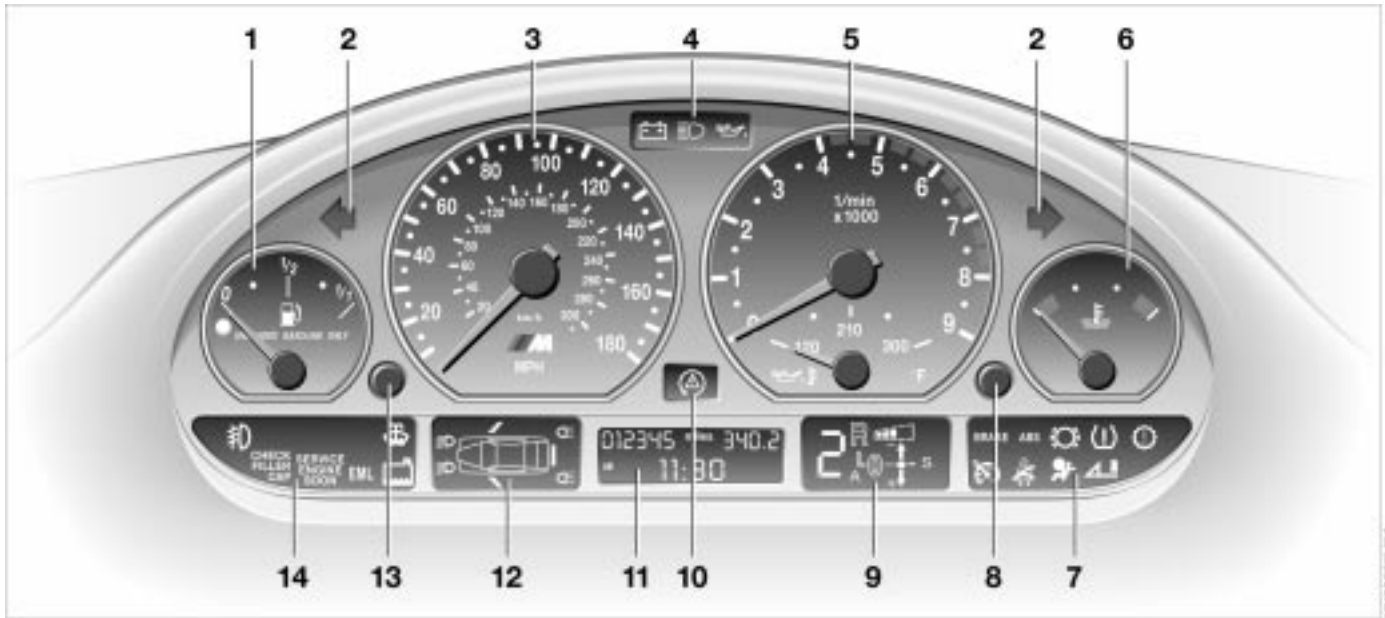

10 Indicator lamp for Dynamic Stability Control (DSC) [19](#)

- 11 Display for
- ▷ Odometer [75](#)
 - ▷ Trip odometer [75](#)
 - ▷ Clock [77](#)
 - ▷ Service Interval [76](#)

Display for computer, operation using the turn signal lever, refer to page [78](#):

- ▷ Clock
- ▷ Outside temperature
- ▷ Average fuel consumption
- ▷ Range
- ▷ Average speed

12 Display for Check Control [77](#)

13 Trip odometer, reset to zero [75](#)

14 Indicator and warning lamps [17](#) to [20](#)

Indicator and warning lamps

Technology that monitors itself

Indicator and warning lamps that are identified by "●," are tested for proper functioning whenever the ignition key is turned. They each light up once for different periods of time.

If a fault should occur in one of these systems, the corresponding lamp does not go out after the engine is started or it lights up while the vehicle is moving. You will see how to react to this below.

Red: stop immediately



Battery charge current ●
The battery is no longer being charged. There is a malfunction of the alternator drive belt or in the charging circuit of the alternator. Please contact the nearest BMW center.



▲ If the drive belt is defective, do not continue driving. The engine could be damaged due to overheating. If the drive belt is defective, increased steering effort is also required. ◀



Engine oil pressure ●
Stop vehicle immediately and switch off engine. Check the engine oil level and top up as required. Please contact the nearest BMW center.



▲ Do not continue driving, otherwise, the engine could be damaged because of inadequate lubrication. ◀



Flat Tire Monitor ●
In addition, an acoustic signal is sounded: a tire failure has occurred. To come to an immediate stop, reduce speed, while avoiding any sudden, jerky braking or steering maneuvers.

For additional information: refer to page [82](#)



Brake warning lamp ●
If the lamp comes on when the parking brake is not engaged: check the brake fluid level. Before driving further, be sure to read the notes on pages [105](#) and [119](#).



Brake warning lamp for Canadian models.

18 Indicator and warning lamps

Red: an important reminder



Parking brake ●

Comes on when the parking brake is engaged – an additional acoustic signal sounds when starting off. For additional information: refer to page [63](#)



Brake warning lamp for Canadian models.



Lock backrest/Please fasten safety belts ●

A warning signal will sound at the same time. Flashes when the backrest is not locked. Lights up when a safety belt is not fastened or until passengers fasten safety belts.

For details on locking the backrest: refer to page [47](#)

For additional information on safety belts: refer to page [48](#)



Airbags ●

Please have the system inspected immediately at your

BMW center.

For additional information: refer to page [52](#)

Red and yellow: continue to drive; drive cautiously



The red brake warning lamp lights up together with the yellow indicator lamps for ABS and DSC:



The entire ABS, CBC and DSC control system has failed.



Continue to drive; drive cautiously and defensively and avoid full brake applications. Please have the system checked by your BMW center as soon as possible.

For additional information: refer to pages [81](#), [105](#)



ABS, CBC and DSC indicator and warning lamps for Canadian models.



Orange: consult the nearest BMW center



Sequential M transmission* SMG II

If the indicator lamp fails to go out after the engine has been started, or if it comes on during normal driving: this indicates a malfunction in the system. Please consult the nearest BMW center.

Indicator lamp flashes: a system overload has occurred.

For additional information: refer to page [69](#)

Indicator and warning lamps

Yellow: check as soon as possible



ABS Antilock Brake System (ABS) ●
In addition, an acoustic signal is sounded: ABS has been deactivated in response to system malfunction. Conventional braking efficiency is available and unrestricted. Please have the system inspected at your BMW center.

For additional information: refer to page [105](#)



ABS warning lamp for Canadian models.



Engine oil level
Comes on while driving: the engine oil level has fallen to the absolute minimum; refill as soon as possible. Do not drive more than 30 miles (50 km) until you do.

For additional information: refer to page [116](#)



Engine oil level
Comes on after the engine has been switched off: add engine oil at your earliest opportunity (when you stop to refuel). For additional information: refer to page [116](#)



Brake pads ●
Have the brake pads checked. For additional information: refer to page [105](#)



Flat Tire Monitor ●
The Flat Tire Monitor has been deactivated, either at the button or in response to a system malfunction. In the event of a malfunction, have the system checked by your BMW center.

For additional information: refer to pages [24](#), [82](#)



Dynamic Stability Control (DSC) ●
The indicator lamp flashes and an acoustic signal sounds: The system is active and governs drive and braking force.

If the indicator lamp fails to go out after the engine is started, or if it comes on during normal driving and stays on: DSC has been deactivated, either at the button or in response to a system malfunction. In the event of a malfunction, have the system checked by your nearest BMW center.

For additional information: refer to page [81](#)



Dynamic Brake Control (DBC) ●
Malfunction in DBC system. Conventional braking efficiency is available and unrestricted. Have the system checked and repaired at your BMW center as soon as possible.

For additional information: refer to page [82](#)



Dynamic Brake Control (DBC) warning lamp for Canadian models.



Add washer fluid
The washer fluid is too low. Top off the fluid at the earliest opportunity.

For additional information: refer to page [115](#)



Service Engine Soon ●
If the indicator lamp comes on either continuously or intermittently, this indicates a fault in the emissions-related electronic systems. Although the vehicle remains operational, you should have the systems checked by your BMW center at the earliest possible opportunity.

For additional information: refer to page [122](#)

20 Indicator and warning lamps



Service Engine Soon warning lamp for Canadian models.



Engine electronics ●

There is a fault in the electronic engine-management system.

You can continue to drive with reduced engine output or engine speed. Please have the system inspected at your BMW center.



Add coolant

Coolant level too low, top up as soon as possible.

For additional information: refer to page [118](#)



Rollover protection system ●

The rollover protection system is deactivated due to a malfunction. Please have the system inspected immediately at your BMW center.

For additional information: refer to page [58](#)



Check Filler Cap* ●

If the indicator lamp comes on although the fuel filler cap is secured correctly; this indicates a malfunction in the fuel system. Have the system inspected at your BMW center at the earliest opportunity.

For additional information: refer to page [23](#)

Green: for your information



Turn signal indicators

Flashes when turn signals are on. Rapid flashing: indicates a system malfunction.

For additional information: refer to page [70](#)



Cruise control

Lights up when the cruise control is activated. Available for operation via the multifunction steering wheel.

For additional information: refer to page [73](#)



Front fog lamps

Lights up whenever the fog lamps are on.

For additional information: refer to page [86](#)

Blue: for your information



High beam

Comes on when the high beams are on or the headlamp flasher is actuated.

For additional information: refer to pages [70](#), [86](#)

Steering wheel with multifunction buttons

The controls integrated in the Multifunction steering wheel (MFL) are provided so that you can operate a number of accessories quickly and without being distracted from traffic conditions. You may operate:

- ▷ Selected radio functions
- ▷ the cruise control
- ▷ selected cellular phone functions
- ▷ the voice entry system*.

 The controls are active only when the corresponding systems and accessories are switched on. ◀



Press briefly:
Accept incoming call, start dialing, terminate call.
Extended pressure:
Activate and deactivate voice entry.



Switch between phone and radio, cassette, CD and MD.



Forward:

- ▷ Radio
 - Press briefly: scans for stations in FM band
 - Extended pressure: search function
- ▷ CD/MD
 - Press briefly: jump to next track
 - Extended pressure: search function in track
- ▷ Cassette
 - Press briefly: stop track scan or fast forward
 - Extended pressure: fast forward
- ▷ Phone
 - Scan personal phone book.



Rewind: functions as forward.



Volume



Cruise control: to select a stored setting.



Cruise control: store and accelerate (+) or decelerate and store (-).



Cruise control: activate/interrupt/deactivate.

22 Warning triangle*



The hazard warning triangle is stored ready to use in the luggage compartment lid inside the toolbox for the onboard tool kit.

To open the container, loosen the wing nut.

 Always observe all legal regulations requiring a warning triangle to be carried in the vehicle. ◀

First-aid kit*



The first-aid kit is located under the front passenger's seat.

To release: pull the handle and fold the cover down.

To fasten: fold the cover up

 Several of the items contained in the first-aid kit have a limited service life. For this reason, check the expiration dates of each of the items regularly, and replace any with passed dates. You can acquire replacements in any drugstore or pharmacy. Always observe all legal regulations requiring a first-aid kit to be carried in the vehicle. ◀

Refueling



Fuel filler door

 Before filling the tank, switch off the engine. If you do not, fuel cannot be filled into the tank and the Service Engine Soon lamp may come on. ◀

Press on the rear edge of the fuel filler door to open and close it.

If an electrical malfunction occurs, you can unlock the fuel filler door manually: Pull the knob with the fuel pump symbol on the right trim panel of the luggage compartment.

Refueling

 When handling fuels, comply with all of the applicable safety precautions and regulations pertaining to fuels.

Never carry spare fuel containers in your vehicle. Whether empty or full, these containers can leak, cause an explosion, or lead to fire in the event of a collision. ◀



Simple and environmentally friendly

 Open the filler cap carefully to prevent fuel from spraying out. Fuel spray may cause injury. ◀

Keep the filler cap in the bracket attached to the fuel filler door.

When refueling, insert the filler nozzle completely into the filler pipe. Pulling the nozzle out of the pipe during refueling

- ▷ results in premature pump shutoff
- ▷ and will reduce the effect of the vapor recovery system on the pump.

As long as the filler nozzle is used properly, the fuel tank is full whenever the nozzle shuts off the first time.

Fuel tank capacity

- ▷ approx. 16.6 gal. (63 liters), incl.
- ▷ a reserve capacity of approx. 2.1 gal. (8 liters).

 Refill early to avoid damaging the catalytic converter; never attempt to drive to the last drop of fuel in the tank. ◀

 Close the fuel cap carefully after refueling until a "click" is heard. While closing, be sure not to squeeze the strap which is fastened to the cap. A loose or missing cap will activate the Check Filler Cap lamp*. ◀

24 Fuel specifications

The engine uses lead-free gasoline only.

Required fuel:

- ▷ Premium Unleaded Gasoline, min. 91 AKI.
AKI = Anti Knock Index

 Never use leaded fuel, as it would cause permanent and irreversible damage to the oxygen sensor and the catalytic converter. ◀

Tire inflation pressure



Proper inflation pressures are on a sticker attached to the B-pillar and visible with the driver's door open.

Check tire pressures

All pressures are specified in the usual units of the respective country (psi; kilopascal) for tires at ambient temperature (also refer to the following tire inflation pressure table).

After correcting the tire inflation pressure, reinitialize the Flat Tire Monitor so that it can monitor the tire inflation pressure, refer to page [82](#).





Check your tire pressures on a regular basis – at least twice a month – and before every extended journey. Incorrect tire pressure can otherwise lead to driving instability, tire damage and accidents. ◀

Comply with tire approval specifications

The inflation pressures in the table apply to BMW approved tire sizes and tire manufacturers. Your BMW center is familiar with these pressures. Higher pressures may be specified for tires made by other manufacturers.

Your vehicle is equipped with tires which not only meet US standards, but also European standards. We recommend the exclusive use of BMW approved tires.

Tire inflation pressure

BMW	Tires All pressure specifications in the table are indicated in psi (kilopascal) with cold tires (cold = ambient temperature)				
225/45 ZR 18	33 (230)	-	41 (280)	-	
255/44 ZR 18	-	35 (240)	-	48 (330)	
M3 convertible	225/40 ZR 19	33 (230)	-	41 (280)	-
	255/35 ZR 19	-	35 (240)	-	48 (330)
	225/45 R 17 91 H M+S	33 (230)	38 (260)	36 (250)	46 (320)



Overview

Controls and features

Operation, maintenance

Owner service procedures

Technical data

Index

Overview

Controls

Maintenance

Repairs

Data

Index



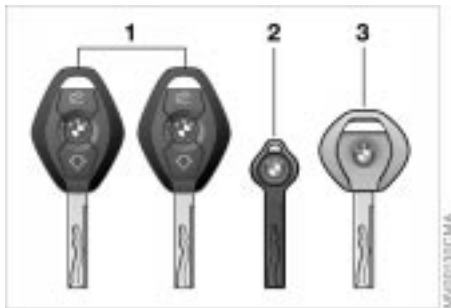

The key set

- 1 Master key with remote control
This key determines the functions of the Key Memory, refer to page 60.
You can mark individual keys for subsequent identification by applying the colored decals that you received when accepting delivery of your vehicle

▶ There is an extended-life battery in every master key with remote control that is charged automatically in the ignition lock as you drive. For this reason, if you have a master key with remote control that is otherwise not used, use that key at least once every year while driving for an extended period to charge the battery. Also refer to page 30. ◀

- 2 Spare master key for storage in a safe place, such as in your wallet.
This key is not intended for continuous use
- 3 Door and ignition key
The locks for the luggage compartment lid and the glove compartment cannot be operated with this key – this is recommended for valet parking, for instance

Central locking system

The concept

The central locking system engages and releases the locks on the

- ▶ doors
- ▶ luggage compartment lid
- ▶ fuel filler door and
- ▶ glove compartment.

The central locking system is ready for operation whenever the driver's door is closed.

The central locking system can be operated

- ▶ from outside via the door lock and using the remote control
- ▶ from inside via the central locking system button.

If it is operated from inside, the fuel filler door will not be locked, refer to page 33.

Operating it from outside simultaneously activates the anti-theft system, which prevents the doors from being unlocked via the door lock buttons or the door release handles. The alarm system is also armed or disarmed.

Information for your safety: if locked from inside, the central locking system unlocks automatically in the event of an accident. In addition, the hazard warning flashers and interior lamps come on.

Opening and closing – via the door lock



With the key

Turning the key in the door lock once unlocks the driver's door, the fuel filler door and the glove compartment. Turning the key a second time unlocks the passenger's door and the luggage compartment lid.



You can have a signal set as an acknowledgment message that the vehicle is closed correctly. ◀

Convenience operation

With the door closed you can also operate the power windows and the convertible top with the door lock.

To open: with the door closed after turning the key for the second time, hold the key in the "Unlock" position.

To close: with the door closed, turn the key to the "Lock" position and hold it.



Watch during the closing process to be sure that no one is injured. Releasing the key stops the operation. ◀

Manual operation

(in the event of electrical malfunction)

Turn the key all the way to the left or right to unlock/lock the driver's door.

30 Opening and closing – via the remote control

The concept

The remote control gives you an exceptionally convenient method for unlocking and locking your vehicle. Furthermore, it provides two additional functions which you can only execute via the remote control:

- ▷ Switch on the interior lamp, refer to page 31.

With this function, you can also "search for" your vehicle – when parked in an underground garage, for instance

- ▷ Open the luggage compartment lid, refer to page 31.

The luggage compartment lid will open slightly, regardless of whether it was locked or unlocked.

The anti-theft system is also deactivated/activated simultaneously with the unlocking or locking of the vehicle, and the alarm system* is disarmed/armed, and the interior lamps are switched on/off.



You can have a signal set as an acknowledgment message that the vehicle is closed correctly. ◀



- 1 Unlock and alarm system
- 2 Lock and secure, interior lamp activation, deactivating tilt alarm sensor and interior motion sensor
- 3 Open the luggage compartment, panic mode (trigger alarm)

Master key with remote control



Since passengers or animals remaining in the vehicle might be able to lock the doors from the inside, take the vehicle's keys with you so that the vehicle can be opened again from the outside at any time. ◀



Master keys with remote control that are used repeatedly are always ready for operation, since the battery in the key is charged automatically in the ignition lock as you drive.

If it is no longer possible to unlock the vehicle via the remote control, the battery is discharged. Use this key while driving for an extended period in order to recharge the battery. Refer also to page 28.

Guard the remote control against unauthorized use by only surrendering the spare key or the door key (refer to page 28).

In the event of a system malfunction, please contact your BMW center. You can also obtain replacement keys there. ◀

Opening and closing – via the remote control

To release



Press button to unlock the driver's door only.

Press the button twice in order to unlock the entire vehicle.



If you want, you can have this special feature set as key-dependent. ◀

To lock and secure



Press button.

To switch on the interior lamps



After locking the vehicle, press button again.

To deactivate the tilt alarm sensor* and interior motion sensor*



Press button a second time immediately after locking.

For additional information: refer to page [38](#).

To open the luggage compartment lid



Press button.

The lid will open slightly, no matter whether it was locked or unlocked.



Before and after a trip, be sure that the luggage compartment lid has not been opened unintentionally. ◀

Panic mode (trigger alarm)



By pressing button for more than 2 seconds, the alarm can be sounded in the event of danger, if it is armed.

To switch off the alarm:



Press button.

32 Opening and closing – via the remote control

External systems

Local systems or devices in the area may interfere with remote control function.

If this should occur, you can still open and close the vehicle using the master key in both the door and luggage compartment locks.

For US owners only

The transmitter and receiver units comply with part 15 of the FCC (Federal Communication Commission) regulations. Operation is governed by the following:

FCC ID: LX8EWS
LX8FZVS
LX8FZVE

Compliance statement:

This device complies with part 15 of the FCC Rules. Operation is subject to the following two conditions:

- ▷ This device may not cause harmful interference, and
- ▷ this device must accept any interference received, including interference that may cause undesired operation.



Any unauthorized modifications to these devices could void the user's authority to operate the equipment. ◀

Opening and closing – from the inside



With this button you operate the central locking system whenever the doors are closed. The doors and luggage compartment lid are unlocked or locked only. The anti-theft alarm system is not activated.

 If only the driver's door was unlocked from the outside and you press the button, then, with the driver's door still open, the passenger's door, the luggage compartment lid, the fuel filler door and the glove compartment will unlock, too. If the driver's door is closed, it will be locked. ◀



The central locking system locks automatically as soon as you begin to drive if you desire. You may also have this adjusted so that it is specific to keys. ◀

To unlock and open the doors

- ▷ Either unlock the doors together with the button for the central locking system and then pull each of the release handles above the armrests or
- ▷ pull the release handle for each door twice: the first pull unlocks the door, and the second one opens it.

To engage locks

- ▷ Either use the central locking button to lock all doors at once, or
- ▷ press the individual door lock buttons down. As an added design feature to prevent the driver from being inadvertently locked out of the vehicle, the driver's door lock button will not engage as long as the door is open.



Since passengers or animals remaining in the vehicle might be able to lock the doors from the inside, take the vehicle's keys with you so that the vehicle can be opened again from the outside at any time. ◀

34 Luggage compartment lid



The lock

Only the master keys (refer to page 28) fit in the lock of the luggage compartment lid.

Secure separately

Lock the glove compartment using the master key.

This also locks the luggage compartment lid and disconnects it from the central locking system. If you surrender only the door key (refer to page 28), this will prevent unauthorized access via the luggage compartment lid, which is an advantage for valet parking, for instance.



To open from outside

Press the button in the handle recess (arrow): the luggage compartment lid opens slightly.

The luggage compartment is lighted when the luggage compartment lid is opened.

Manual operation

(in the event of electrical malfunction)

Turn the master key to the right as far as it will go, the luggage compartment lid will open slightly.

The luggage compartment lid is locked again as soon as you close the lid.



Opening from the inside

If the luggage compartment lid has not been locked separately, you can open it with this button in the footwell on the driver's side when the vehicle is stationary.

Luggage compartment lid

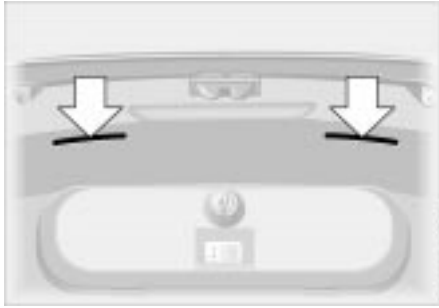

To close

The handle recesses (arrows) in the interior trim panel of the luggage compartment lid make it easier to pull the lid down.

-  To avoid injuries, be sure that the travel path of the luggage compartment lid is clear when it is closed, as with all closing procedures. Do not drive with the luggage compartment lid open, since exhaust fumes could penetrate the interior of the vehicle. Nevertheless, should it be absolutely necessary to operate the vehicle with the luggage compartment lid open (with closed convertible top):
- ▷ Close all windows
 - ▷ Increase the air supply for the air conditioner or automatic climate control to a high level, refer to pages [89](#), [92](#). ◀



Emergency release

This lever releases the luggage compartment lid from the luggage compartment's interior.

36 Luggage compartment

To secure your luggage, use the luggage nets* or flexible straps that you can attach to the fittings at the inner corners of the luggage compartment.

Refer also to "Cargo loading" on page 101.

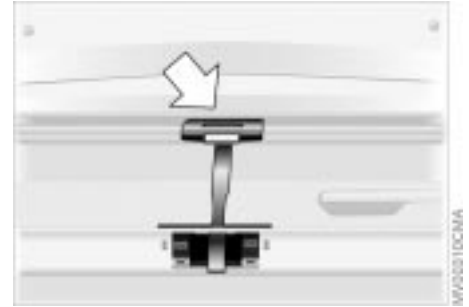

Raise floor plate and hook in

1. Grab it by the handle and pull up
2. Press the button (arrow) to release the hanger from the handle

3. Hook in the hanger on the rubber seal of the water gutter (arrow).

 Carefully replace the hanger in its holder when lowering the floor panel back into place. ◀

Luggage compartment

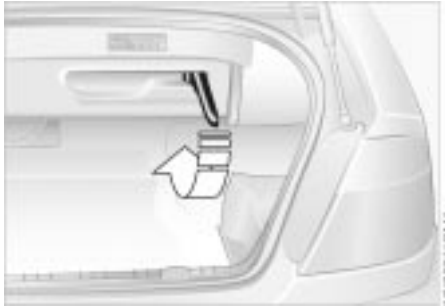

Enlarging luggage compartment

With the convertible top closed, you can enlarge the luggage compartment. To do this, flip the handle outward and press it down and toward the front of the vehicle (arrow). The convertible top compartment panel is now raised and secured.

Fold down convertible top compartment panel

To open the convertible top, the convertible top compartment panel must be lowered. To do this, fold out the handle and pull opposite the direction of travel.

 When opening the convertible top, refer to page 40, make sure that the luggage compartment is set up for this, otherwise you may damage something. ◀

Alarm system*

The concept

The vehicle alarm system responds:

- ▷ When a door, the hood or the luggage compartment lid are opened
- ▷ To movement inside the vehicle (interior motion sensor)
- ▷ Altering the vehicle tilt, e.g. as would occur while attempting to steal the wheels or tow the vehicle (Tilt alarm sensor system)
- ▷ To interruption of battery voltage.

The system responds to unauthorized vehicle entry and attempted theft by simultaneously activating the following:

- ▷ Sounding an acoustical alarm for 30 seconds
- ▷ Activating the hazard warning flashers for approx. five minutes
- ▷ Flashing the high beams on and off in rhythm with the hazard warning flashers.

To arm and disarm the alarm system

When the vehicle is locked or unlocked by using a key or with the remote control, the alarm system is also simultaneously armed or disarmed.



You can have a signal set as acknowledgment for both arming and disarming the alarm. ◀



You can also open the luggage compartment lid when the system is armed by pressing the button of the remote control (refer to page 31). When it is closed, the lid is once again secured.



Indicator lamp displays

- ▷ The indicator lamp below the interior rearview mirror flashes continuously: The system is armed
- ▷ The indicator lamp flashes when it is armed: the door(s), the hood or luggage compartment lid are not completely closed. Even if you do not close the alerted area, the remaining areas are deadlocked, and the indicator lamp flashes continuously after 10 seconds. However, the interior motion sensor is not activated
- ▷ If the indicator lamp goes out when the system is disarmed: no manipulation or attempted intrusions have been detected in the period since the system was armed

- ▷ If the indicator lamp flashes for 10 seconds when the system is disarmed: an attempted entry has been detected in the period since the system was armed.

Following triggering of an alarm, the indicator lamp will flash continuously.

Avoiding unintentional alarms

The tilt alarm sensor and interior motion sensor may be deactivated at the same time. Doing this you can prevent any unwanted alarm, e.g. in parking garages or when it is being transported on car trains:

Locking the vehicle twice (= setting the alarm). Press button 2 on the remote control twice in succession or lock the vehicle twice with the key, refer to page 31.

The indicator lamp lights up briefly and then flashes continuously. The tilt alarm sensor and the interior motion sensor are deactivated as long as the system is armed. Reset the alarm to reactivate the tilt alarm sensor and the interior motion sensor.

Interior motion sensor

Deactivate the interior motion sensor (see previous column) if children or animals are to remain in the vehicle.

For US owners only

The transmitter and receiver units comply with part 15 of the FCC (Federal Communication Commission) regulations. Operation is governed by the following:

FCC ID: LTQSDR2G5

Compliance statement:

This device complies with part 15 of the FCC Rules. Operation is subject to the following two conditions:

- ▷ This device may not cause harmful interference, and
- ▷ this device must accept any interference received, including interference that may cause undesired operation.

 Any unauthorized modifications to these devices could void the user's authority to operate the equipment. ◀



After the ignition has been switched off: You can still operate the electric power windows for up to 15 minutes, provided that no door has been opened.

 When leaving the vehicle, always remove the ignition key from the lock and remember to close the doors to prevent children from operating the power windows and injuring themselves, etc. ◀

To open and close windows

From ignition key position 1:

To open:

- ▷ Press the switch until you feel resistance: the window continues to move as long as you continue to hold the switch
- ▷ Press the switch briefly past the pressure point: the window moves automatically. Touching the switch again stops the opening cycle.

To close: you can close the windows in the same manner by pulling the switch.

For convenience closing via the door lock, refer to page [29](#).



To operate all the side windows

From ignition key position 1:

To open:

- ▷ Press the switch until you feel resistance:
All of the windows will continue to lower as long as you continue to press the switch
- ▷ Press the switch briefly past the pressure point:
All windows will move automatically. Pressing the switch again stops the opening cycle.

To close: you can close the windows in the same manner by pulling the switch.

40 Convertible top

The completely automatically operated convertible top combines assured protection against the elements together with simple and easy handling.

So that you will get the most out of enjoying your convertible, here are a few tips:

- ▷ It is advisable to close the convertible top when the vehicle is being parked. The closed convertible top not only protects the passenger compartment from unforeseeable damage from the weather, it also provides a certain degree of theft protection. In addition, keep valuables only in the locked luggage compartment, even with the convertible top closed
- ▷ Never mount a roof-mounted luggage rack on the convertible top
- ▷ At temperatures below 15 °F (-10 °C) do not operate the convertible top to prevent damage.

 Never store the convertible top while it is wet to avoid permanent damage from moisture. ◀

 Driving with the opening or closing operation not completely ended can lead to damage and/or injuries.

If possible, only operate the convertible top with the vehicle stopped, as otherwise the process may be interrupted.

Traffic laws applicable in your area take precedence when you operate the convertible top, otherwise you may be breaking the law.

Before closing the convertible top, remove any objects from the windshield frame that could keep the convertible top from closing properly.

Do not lay objects on the convertible top, since they would fall off when the convertible top is operated and cause damage or injuries.

Do not reach into the convertible top mechanism during opening and closing. Keep children away from the moving parts of the convertible top during operation. ◀

 To close the electric power windows while driving, always be sure to first close either the rear windows, or all 4 windows at the same time, otherwise, at high speed, the windows may not close tightly. ◀

 At higher speeds, the ensuing vacuum in the passenger compartment can cause the convertible top to begin fluttering. Increase the air supply via the ventilation controls so that a vacuum does not occur in the vehicle. ◀

Convertible top



- 1 To close
- 2 To open

To open and to close

From ignition key position 1, with the vehicle stationary.

If at all possible, only operate the convertible top if the engine is running. This saves unnecessary battery wear.

1. Read and comply with the preceding safety precautions
2. Before opening the convertible top, make sure that the convertible top compartment panel in the luggage compartment is lowered, refer to page 37
3. Make sure that the luggage compartment lid is closed

4. Press and hold the corresponding button for convertible top operation. The red indicator lamp will light up while the convertible top is in motion. It goes out as soon as the opening or closing operation has been completed.

If the red indicator lamp flashes after the button is released, then the opening or closing operation is not yet completed. The sequence can be continued in the desired direction by pressing this button.

If the yellow indicator lamp lights up continuously with the button pressed, then the convertible top compartment panel is raised and the convertible top cannot be moved, refer to step 2.

 The automatic sequence will be interrupted immediately if release the button that operates the top. The sequence can be continued in the desired direction by pressing this button. ◀

 During convertible top operation the rear window moves toward the passenger compartment. To prevent injuries, make sure that the closing path of the convertible top is unobstructed. ◀

When operating the convertible top, the windows will lower slightly when you press the button, and after the opening or closing operation has finished, they will go back up, if you keep holding the button down for more than 2 seconds after the indicator lamp has gone out.

The luggage compartment lid cannot be opened while the convertible top is in motion.

 Do not close the side power windows using the buttons if the convertible top operation has been interrupted. ◀

 If the convertible top has been stored in the convertible top compartment for longer periods, e.g. during the winter months while the hardtop is being used, it may be necessary to manually support the first automatic closing operation: if the convertible top should halt right before the closing phase is completed, press against the front part of the convertible top frame from the outside to help the closing process along. Keep pressing the button while doing so until the top starts up again on its own. ◀

42 Convertible top

 If the opening or closing operation is interrupted, the convertible top remains in the respective position for 15 minutes, and the sequence can be continued in the desired direction with the button. After that, the convertible top can be moved again and, if it is an emergency situation, you may have to help the top along manually. This can also be done in ignition key position 0. In certain cases, the luggage compartment lid cannot be opened if the opening or closing operation has been interrupted. ◀

Convenience operation from the driver's door lock

Refer to page [29](#).



Closing manually in the event of an electrical malfunction

- 1 Emergency operation
- 2 Allen wrench
- 3 Recess

 Only actuate the convertible top manually to close it, however never to open it, as the convertible top compartment lid cannot be locked and would open during driving. ◀

 Manual closing is best carried out with two persons from outside with the driver's door open and the driver's seat folded forward. No one is to be in the rear seat while you are doing this. ◀

1. Remove the center piece between the rear seats. Take the trim off of the guide rod and flip it forward. Press down hard on the emergency lock 1. After a brief pause, the mechanisms for the convertible top compartment will be unlocked

 If the mechanisms for the convertible top compartment lid do not unlock, then insert the Allen wrench 2 into the recess 3 and turn clockwise until the mechanisms unlock. ◀

2. If the luggage compartment lid is closed, open the convertible top compartment lid up as far as the stop will allow



3. Lift out the convertible top by holding on to the lateral guide section 1 and the front convertible top frame 2. Position the rear convertible top frame vertically and flip the convertible top compartment lid downward and lay it down. Flip the rear convertible top frame downward
4. Lift out the cover panel that is in the center of the front convertible top frame
5. Put the Allen wrench 2 (refer to page 42) into the hex slot (arrow)
6. Pull down on the front convertible top frame as far as possible. Complete the closing process by continuing to turn the wrench clockwise. Do this until the front convertible top frame has locked onto the windshield frame. The rear convertible top frame will automatically be pressed down onto the convertible top compartment lid and because of the tension, will close completely.

 The closing operation must be completed, as otherwise damage and/or injuries may result. ◀

 Please consult your BMW center to have the defect corrected. ◀

44 Correct sitting position

For relaxed and fatigue-free driving you should select a sitting position that reflects your personal requirements. Correct position combines with safety belts and airbags to enhance occupant safety in the event of an accident. To ensure that the vehicle's safety systems provide you with optimal protection, we request that you direct your careful attention to the following section.

For supplementary information on transporting children, refer to page [54](#).

Sitting correctly with airbags

 Always maintain an adequate distance between yourself and the airbags. Always hold the steering wheel by the rim to keep any chance of injury to hands or arms to an absolute minimum should the airbag be deployed. Never allow any objects, individuals or animals to obstruct the areas between passengers and airbags. Never use the front airbag's cover as a storage tray or support for objects of any kind. Never allow front passengers to rest their feet or legs on the airbag cover. ◀

For airbag locations and additional information on airbags refer to page [53](#).

Safe with safety belts

 Never allow more than one person to wear a single safety belt. Never allow infants or small children to ride in a passenger's lap. Avoid twisting the belt while routing it firmly across the pelvis and shoulder, wear it as snugly against your body as possible. Do not allow the belt to rest against hard or fragile objects in your pockets. Do not route the belt across your neck, or run it across sharp edges. Be sure that the belt does not become caught or jammed. Avoid wearing bulky clothing and pull on the lap belt periodically to retension it over your shoulders. In the event of a frontal impact, a loose lap belt could slide over the hips, leading to abdominal injury. In addition, the safety belt's restraint effectiveness is reduced if the belt is worn loosely. Expectant mothers should always wear their safety belts, taking care to position the lap belt against the lower hips, where it will not exert pressure against the abdominal area. Leave the rear safety belts in the holders, if they are not needed, to avoid unwanted movement from the safety belts at high speeds. ◀

For information on using the safety belts, refer to page [48](#).

Seats

When adjusting your seat, always observe the following precautions

 Never try to adjust your seat while operating the vehicle. The seat could respond with an unexpected movement, and the ensuing loss of vehicle control could lead to an accident. Never ride with the backrest reclined to an extreme angle (especially important for the front passenger to remember). If you do so, there is a risk that you will slide under the safety belt in an accident, thus reducing the protection provided by the safety belt. With the wind deflector in place: never push the front seats all the way back to avoid damaging the wind deflector. ◀



- 1 Tilt angle
- 2 Forward/backward adjustment
- 3 Cushion height
- 4 Backrest angle

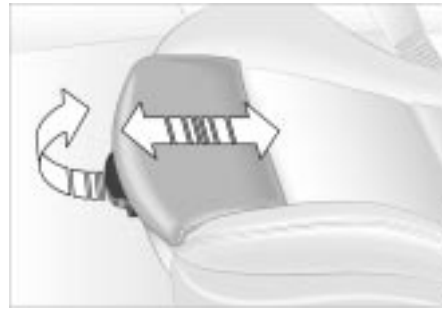

Thigh support

Pull the lever and adjust the position of the cushion for thigh support as desired.



Adjusting the lumbar support*

You can adjust the backrest's contour for additional support in the curvature of your spine's lumbar region.

The upper hips and spinal column receive supplementary support to help you maintain a relaxed, upright position.

- ▷ Press the front/rear of switch: increase/decrease curvature
- ▷ Press the upper/lower end of the switch: increase the upper/lower curvature.



Front head restraints

1 Height

 Head restraints reduce the risk of spinal injury in the event of an accident.

Adjust the head restraint so that its center is approximately at the height of your ears.

When moving the head restraints up or down, do not grab on between the head restraint and the upper edge of the backrest to avoid the possibility of injury. ◀

2 Tilt angle

Position the head restraints manually in the preferred position.

Rear head restraints

 The rear head restraints may only be lowered if there are no passengers in the rear seats. If you do so, you are in violation of the law. Raise the rear head restraints before taking on any passengers in the back. ◀

To completely lower the rear head restraints:

1. Press the button (arrow) and hold it down
2. Push the head restraint down from above.

Raising the rear head restraints: raise the head restraints until you hear them click into place.

Head restraints

 Do not remove the rear head restraints as this would damage them. ◀

For further information, please consult your BMW center.

 Do not use the rear head restraints as storage shelves. Always keep the travel path for the roll-over protection system free and clear. Under no circumstances should you put any kind of cover (antimacassar) on the head restraints (refer also to the labeling on the head restraints). ◀

Entering the rear

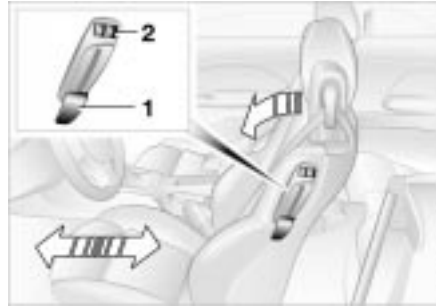

The Seat-integrated safety belt system (SGS) allows for easy access to the rear.

1. Lift the lever 1 up and tilt the backrest forward
2. Press and hold button 2 in driving direction until the seat moves to the desired position
3. After entering the rear, fold back and lock the backrest
4. Press button 2 opposite the direction of travel and hold. The seat moves back into its previous position. If the button 2 is released beforehand, the seat stops in the respective position.

 You can lock a backrest that has been tilted forward. This is practical, for example, when entering the rear seat while the vehicle is parked on a hill. To do this, press against the backrest until you hear it click into place. It does not need to be released with the lever 1 to tip it back into place again. ◀

 Lock both backrests while driving, otherwise there is a danger of an unexpected movement causing an accident. ◀

The indicator lamp in the instrument cluster flashes, when the backrest is not locked, refer to page 18.



Safety belt height adjustment

The front safety belt automatically adjusts your body size via the setting of the head restraint height, refer to page 46.



If the safety belt system has been subjected to the stresses involved in an accident or otherwise damaged: Have the entire safety belt mechanism replaced by your BMW center, including the safety belt tensioner. In addition, have your BMW center inspect the safety belt anchors. If a child-restraint system was in the vehicle during an accident, consult the manufacturer's instructions regarding replacement. ◀

Drive with your safety belt on

Even though there is an airbag, wear a safety belt every time you get in the vehicle, because airbags enhance safety by providing added protection.



Before putting your safety belts on in the rear, take them out of the holder. ◀

To close

Make sure you hear the lock engage in the belt buckle.

To open

1. Press the red button in the belt buckle
2. Hold the belt
3. Guide the belt back into its reel.

Seat and mirror memory



You can store and recall three different driver's seat and outside mirror positions.



The setting for the lumbar support is not stored in memory. ◀

To store

1. Ignition key in position 1 or 2
2. Adjust your seat and outside mirrors to the desired position.
3. Press the **MEMORY** button: the indicator lamp in the button lights up
4. Press memory button 1, 2 or 3, as desired. The indicator lamp goes out.

Seat and mirror memory

To recall a stored setting

Driver's door open after unlocking or ignition key in position 1:

- ▷ Briefly press memory button 1, 2 or 3, as desired.
Movement stops immediately when one of the seat-adjustment or memory buttons is operated during the adjustment process.

With the driver's door closed and the ignition key either removed or in position 0 or 2.

- ▷ Press and hold the desired memory button (1, 2 or 3) until the adjustment process is completed.

 If you press the **MEMORY** button accidentally: press the button again; the indicator lamp goes out. ◀

 Do not recall a memory position while the vehicle is moving. If you do so, there is a risk of accident from unexpected seat movement. ◀



Your BMW center can adjust your vehicle's systems in such a manner that your personalized settings are automatically set for the seat and outside mirror positions when you unlock the vehicle with your personal remote control. ◀



If you make use of this method of adjustment, be sure that the footwell behind the driver's seat is unobstructed before unlocking the vehicle. If you fail to do so, any persons or objects behind the seat could be injured or damaged by a rearward movement of the seat. ◀

Seat heating*



The seat cushion and backrest can be heated with the ignition key in position 2.

You can call up different heating levels by repeatedly pressing the buttons.

You can also switch the higher heating modes off directly:

Press the button and hold it slightly longer.

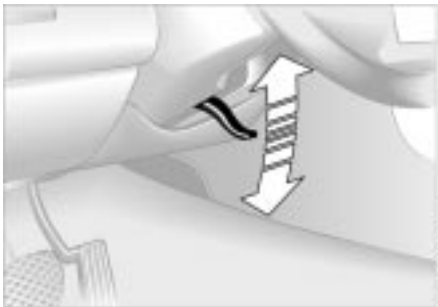

Adjustments

1. Push the locking lever downward
2. Adjusting steering column reach and rake for your selected seating position
3. Pull the lever back in.

 Do not adjust the steering wheel while the vehicle is moving, otherwise there is a risk of an accident from unexpected movement. ◀

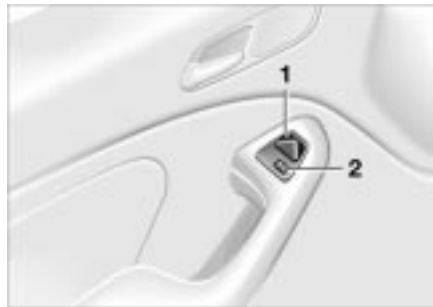

Adjusting outside mirrors

- 1 Switch for 4-way adjustment
- 2 Selection switch for changing between mirrors

Manual adjustment

The mirrors can also be adjusted manually: press the edges of the lens.

To store the mirror setting, refer to "Seat and mirror memory" on page 48.

Convex mirror

 The passenger-side mirror features a convex lens. When estimating the distance between yourself and other traffic, bear in mind that the objects reflected in the mirror are closer than they appear. This means that estimations of the distance to following traffic should not be regarded as precise. ◀

Electric defrosting*

Both mirrors are heated automatically in ignition key position 2.



Passenger-side exterior mirror tilt function

(automatic curb monitor)

- ▷ Move the mirror selector switch 1 to the "driver's mirror" position
- ▷ When the selector lever is placed in "Reverse," the passenger-side mirror tilts downward. This brings e.g. the lower area adjacent to the vehicle (curbs, etc.) into the driver's field of vision while parking.

You can deactivate this automatic feature by setting the mirror selector switch to the "passenger side" position.



Interior rearview mirror with automatic dimming feature

This mirror automatically dims through an infinitely variable range and switches automatically to its clear, undimmed mode whenever you engage reverse gear.

There are two photocells for automatic dimming. One photocell (arrow) is positioned in the mirror's frame, while the other is slightly offset on the opposite side of the mirror.

For the mirror to function perfectly, keep the photocells clean and the area between the inside rearview mirror and the windshield free of any obstruction, like stickers, etc.

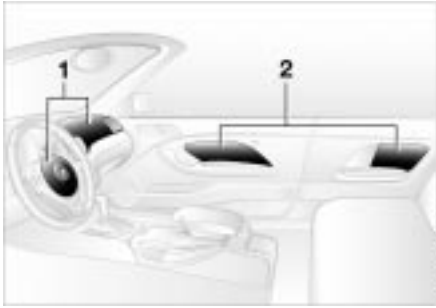

- 1 Front airbags on the driver and passenger sides
- 2 Side airbags on the driver and passenger sides (front and rear*)

Protective effect

The front airbags protect the driver and passenger in the event of a head-on collision where the protection provided by the safety belt alone would not be adequate. The side airbags help provide protection in the event of a collision from the side. Each of the side airbags is designed to help support the seat occupant's upper body.

 The side airbags in the rear passenger area* of your vehicle may already have been deactivated either at the time of manufacture or by a BMW center. You may have them activated if you desire to do so. Please contact your BMW center for additional information. ◀

For information on the correct sitting position, refer to page 44.

 The airbags will not be triggered in the event of a minor accident, a vehicle rollover, or collisions from the rear. ◀

 Do not apply adhesive materials to the cover panels of the airbags, cover them or modify them in any other way. Do not attempt to remove the airbag restraint system from the vehicle. In the event of a malfunction, deactivation, or triggered actuation (as a response to an accident) of the airbag restraint system, consult your BMW center for checking, repairs or removal. Modifications may not be made on either the wiring or the individual components in the airbag system. This includes the padded steering wheel hub, the instrument panel, the side trim panels of the front or rear doors and the roof pillars or the sides of the front headliner. Do not attempt to remove or dismantle the steering wheel. To ensure compliance with official safety regulations, entrust disposal of airbag generators to a BMW center. Unprofessional attempts to service the system could lead to failure in an emergency or undesired airbag activation, either of which could result in personal injury. Do not touch the individual components directly after the system has been triggered, as otherwise there is a danger of burns. ◀

Airbags

 At all times, occupants should sit upright and be properly restrained (infants and small children in appropriate child-restraint systems; larger children and adults using the safety belts). Never let an occupant's head rest near or on a side airbag because the inflating airbag could cause a serious or fatal injury. Please note that the word "Airbag" imprinted on the door trim panel indicates the airbag's location.

Accident research shows that the safest place for children in an automobile is in the rear seat. However, a child sitting in the rear seat and not properly restrained may place his or her head on or near the side airbag, if so equipped. For example, a child – even though belted – may fall asleep with his or her head against the side airbag. It may be difficult for a driver to ensure that children in the rear seat will remain properly positioned at all times and not place their heads on or near the side airbag. Therefore, we recommend that the rear seat side airbags, if provided, be deactivated if you plan to transport children in the rear seat.

The rear seat side airbags may already have been deactivated, either at the time of manufacture or by a BMW center. Labels in the rear door opening should indicate the status of your rear seat side airbags. If you are uncertain of their status, or wish to have the airbags activated or deactivated, please contact your BMW center. ◀

Even when all these guidelines are observed, there is still a small residual risk of injuries to the face, hands and arms occurring from airbag deployment in isolated instances. The ignition and inflation noise may provoke a mild temporary hearing loss in extremely sensitive individuals.

Airbag warning information is also provided on the sun visors.



This is the right way a child should sit in a child-restraint device when rear side airbags (arrow) are provided.



This is the right way a larger child should sit wearing the safety belt when rear side airbags (arrow) are provided.

Operational status



The indicator lamp in the instrument cluster shows the airbag system status starting in ignition key position 1.

System operational:

- ▷ The indicator lamp comes on briefly, when the ignition key is turned into position 1 or 2

System malfunction:

- ▷ The indicator lamp fails to come on, when the ignition key is turned
- ▷ The indicator lamp fails to go out after the engine has been started, or it comes on during normal driving.

Please respond to any malfunctions in the system by immediately having it inspected at your BMW center; otherwise the airbag could fail to respond to an accident in which both the angle and the severity of the impact would normally trigger airbag deployment.

Transporting children safely

Commercially available child seats complying with the legal standard are designed to be secured with a lap belt or with the lap belt portion of a combination lap/shoulder belt. Improperly or inadequately installed restraint systems can increase the risk of injury to children. Always read and follow the instructions that come with the system.

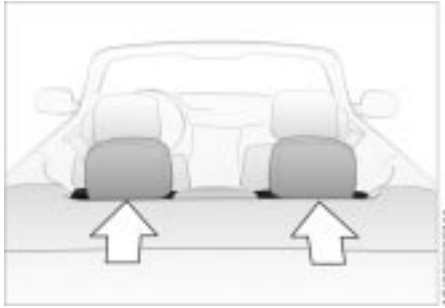

If you use a child-restraint system with a tether strap, two additional tether anchorage points (refer to the arrows in the illustration) have been provided. They are located under the convertible top compartment lid. Depending on the location selected for seating in the rear passenger area, attach the tether strap to the corresponding anchorage point to secure the child-restraint system.

Lift the respective head restraint and pass the tether strap between the head restraint and the seat back.

Adjust the tether strap according to the child restraint manufacturer's instructions.



Before installing any child-restraint device or child seat, please read the following:

Never install a rearward-facing child-restraint system in the front passenger seat of this vehicle.

Your vehicle is equipped with an airbag supplemental restraint system for the front passenger. Because the backrest on any rearward-facing child-restraint system (of the kind designed for infants under 1 year and 20-30 lbs/9-14 kg) would be within the airbag's deployment range, you should never mount such a device in the front passenger seat, as the impact of the airbag against the child restraint's backrest could lead to serious or fatal injuries. If it is necessary for a child (not an infant) to ride in the front seat, certain precautions should be taken. First, move the passenger seat as far away from the instrument panel as possible. This important precaution is intended to maximize the distance between the airbag and the child. Older children should be tightly secured with the safety belt.

Younger children should be secured in an appropriate forward-facing child-restraint system that has first been properly secured with a safety belt. Never install a rearward-facing child-restraint system in the front passenger seat. We strongly urge you to carefully read and comply with the instructions for installation and use provided by the child restraint's manufacturer whenever you use such a device. Always ensure that all occupants (of all ages) remain properly and securely restrained at all times. ◀

All rear seating positions in your vehicle meet the recommendations of SAE J1819, an industry recommended practice for securing child-restraint systems in motor vehicles.

56 Transporting children safely



Always follow all manufacturer's instructions and observe all safety precautions when installing the LATCH child-restraint system. Leave the rear safety belts in the holders, if they are not needed, to avoid unwanted movement from the safety belts at high speeds. ◀



LATCH child-restraint system installation

The anchorage points for the LATCH child-restraint system installation are located behind the upholstery at the positions indicated by the arrows.

Carefully slide the brackets through the gaps in the upholstery at the indicated locations.

To prevent damage to the upholstery, you can purchase an insertion aid* (funnel) from your BMW center.

Firmly press the insertion aid into the gap between the seat cushion and backrest, continuing until the two guides snap into place on the LATCH brackets in the seat.



Lock the safety belt

Extract the entire length of the belt from the inertia reel mechanism. Allow the reel to retract the belt somewhat and engage the buckle, then tighten the belt against the child-restraint system. The retraction mechanism is now locked.

The belt cannot be extracted further. Always observe the installation instructions provided by the manufacturer of the child-restraint system.

Child seat security

All of the rear belt retractors and the front passenger's safety belt can be locked for mounting and securing child-restraint systems.

A label with the appropriate instructions for this is located in the immediate vicinity of the buckle latch of each safety belt.

Unlock the safety belt

Release the safety belt, remove the child's seat and retract the safety belt to its end position on the belt retractor.

58 Rollover protection system

In the event of an accident or some other critical driving situation (extreme tilting in the longitudinal or transverse axis, loss of contact with the ground), the rollover protection system will be automatically activated. The protective bars located in the rear head restraints extend within fractions of a second.

In addition to the integrated rollover bar in the windshield frame, the rollover protection system affords all the vehicle occupants necessary headroom.



Always keep the travel path for the rollover protection system free and clear. Under no circumstances should you cover the head restraints. In the event of less serious accidents, the safety belt will protect you and, depending on the severity of the accident, so will the safety belt tensioner and the multi-stage airbag restraint system as well. ◀



If, after being automatically triggered, the protective function is not needed, then the rollover protection system can be lowered back into place. No special tool is needed for this.

1. Using a screwdriver from the on-board tool kit, remove the cover panel; to do this, position the screwdriver under the notch (arrow)

2. Pull up on the lever (arrow) toward the front of the vehicle and keep it in this position

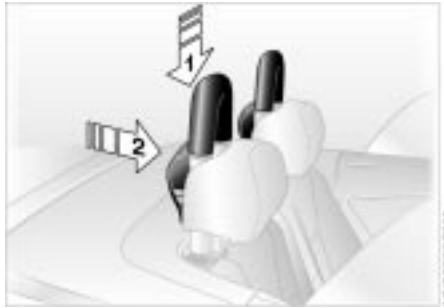

3. Keep pressing down on the protective bar 1 from on top until you hear it click into place
4. Put the cover panel back in place and press down firmly
5. Press the rear part of the head restraint 2 closed.

Do the same for the second protective bar. If you are not familiar with any of the procedures, consult your BMW center.

Have the rollover protection system checked out by your BMW center after it has been inadvertently triggered.



Do not move the convertible top under any circumstances if the rollover protection system has extended.

Do not use the rear head restraints as storage shelves.

Absolutely no modifications are to be made to any of the rollover protection system's individual components or any of its wiring.

Only your BMW center is to carry out any work on the rollover protection system.

Work done on the system that is carried out improperly could lead to failure in an emergency or accidental airbag activation.

Regarding having the system checked to ensure long-term operation: be scrupulous in adhering to the Service Interval Display for maintenance intervals. Every 2 years at the latest, the rollover protection system must be inspected by a BMW center. ◀

60 Vehicle Memory, Key Memory



How the system functions

You have probably frequently wished that you could configure individual functions of your vehicles to reflect your own personal requirements. In engineering your vehicle, BMW has included several user-defined functions in the vehicle's design. Your BMW center can make these settings for you in accordance with your wishes.

There are settings related to the vehicle ("Vehicle Memory") and settings related to individuals ("Key Memory"). You can have up to four different basic settings adjusted for four different persons. The only requirement is that each person uses his or her own remote control key.

When your vehicle is unlocked with the remote control, the vehicle recognizes the individual user by means of a data exchange with the key, and makes adjustments accordingly.

In order for you to distinguish between different keys, colored decals are supplied together with the keys.

What the system can do

Your BMW center can provide you with details on the possibilities that the Vehicle and Key Memory systems offer.

Examples for Vehicle Memory:

- ▷ Various signals that can serve as acknowledgment for locking and unlocking the vehicle, refer to pages [29](#), [30](#)
- ▷ Activating/deactivating operation of "Follow me home," refer to page [85](#).

Examples for Key Memory:

- ▷ Locking the vehicle after driving off, refer to page [33](#)
- ▷ Automatically moving the seat and outside mirror into position for that particular person when unlocking the vehicle, refer to page [49](#)
- ▷ Calling up customized settings for the automatic climate control when unlocking using the remote control, refer to page [92](#)
- ▷ After the engine is started, calling up of the last selected driving program for each shifting mode, refer to page [68](#).



You will see this symbol throughout the Owner's Manual. It is to remind you at appropriate places of the settings that are available to you. ◀



Ignition key positions

- 0 Steering locked
- 1 Steering unlocked
- 2 Ignition switched on
- 3 Starting engine

Steering locked

The key can be inserted or removed in this position only.

After removing the key, turn the steering wheel slightly to the left or right until the lock engages.

If the key is not removed, an acoustic signal is sounded after the driver's door has been opened.

Once the ignition has been switched off (ignition key in position 0 or removed), the radio functions are still available for approx. 20 minutes. Turn the radio back on to use it.

Steering unlocked

You will find that it is often easier to turn the ignition key from position 0 to position 1 when you move the steering wheel slightly to help disengage the lock.

Individual electrical accessories are ready for operation.

1. Engage the parking brake
2. Gearshift lever in idling position
3. Depress the clutch pedal
4. Turn the key to position 3 to start the engine. Do not actuate the starter for too short a time. Do not turn it for more than approx. 20 seconds. Release the ignition key immediately when the engine starts.

Do not allow the engine to warm up by leaving it running while the vehicle remains stationary. Instead, drive off immediately at a moderate engine speed.

Vehicle with sequential M gearbox* SMG II: refer to the instructions on page 64.

 Do not allow the engine to run in enclosed spaces. The exhaust gases contain carbon monoxide, an odorless and colorless, but highly toxic gas. Breathing the exhaust gases poses an extreme health risk, and can lead to unconsciousness and death. Do not leave the vehicle unattended with the engine running. An unattended vehicle with a running engine represents a potential safety hazard. ◀

62 Starting the engine

If the engine does not start on the first attempt (the engine is very hot or cold, for instance):

- ▷ Press the accelerator pedal halfway down while engaging the starter.

Cold starts at very low temperatures, starting at about 5 °F (-15 °C) and at high altitudes above 3,300 feet (1,000 m):

- ▷ For the initial start attempt, allow the starter to remain engaged somewhat longer (approx. 10 seconds).

 Extended starting attempts, characterized by excessively frequent or long periods with the starter engaged, can lead to damage to the catalytic converter. ◀

 When driving, standing at idle or when parking, take precautions to avoid contact between the hot exhaust system and easily flammable materials (grass, hay or leaves, for example). Such contact could lead to a fire, resulting in serious personal injury and property damage. ◀

Engine idle speed is controlled by the engine computer system. Increased speeds at start-up are normal and should decrease as the engine warms up. If engine speed does not decrease, service is required.

To prevent the battery from discharging, always deactivate electrical devices that are not in use. Switch the ignition off when the vehicle is not being driven.

Switching off the engine

Turn the ignition key to position 1 or 0.



Do not remove the ignition key while the vehicle is still moving. If you do so, the steering will lock, making it impossible to steer the vehicle.

When you leave the vehicle, always remove the ignition key and engage the steering lock.

While parking on a downhill road, set the parking brake, as engaging even the first or reverse gear may not be sufficient to prevent the vehicle from rolling away. ◀

Vehicle with sequential M gearbox* SMG II: refer to the instructions on page 64.

Parking brake



The parking brake is designed primarily to prevent the vehicle from rolling when it is parked. It operates against the rear wheels.

To engage

The lever engages automatically, the indicator lamp in the instrument cluster comes on when the ignition key is in position 2, refer to page 18.

To release

Pull up slightly on the lever, press the button (arrow) and lower the lever.

 If, in exceptional circumstances, it should be necessary to engage the parking brake while the vehicle is in motion, do not pull the lever with excessive pressure. Keep your thumb pressed against the release button while carefully pulling the lever up to apply moderate pressure. Excessive pressure can lead to over-braking and loss of traction (fishtailing) at the rear axle.

The brake lamps do not come on when the parking brake is engaged.

While parking on a downhill road, set the parking brake, as engaging even the first or reverse gear may not be sufficient to prevent the vehicle from rolling away. ◀

To avoid corrosion and one-sided braking, apply the parking brake lightly from time to time when coasting to a standstill (at a traffic signal, for instance), provided that it is safe to do so.

Manual transmission



Every time you shift gears, always depress the clutch pedal all the way down, pushing the gearshift lever into the desired position.

 When shifting gears in the 5th/6th-gear plane, be sure to press the gearshift lever to the right in order to prevent inadvertent selection of a gear in the 3rd/4th-gear plane. ◀

Reverse

Select only when the vehicle is stationary. Press the shift lever to the left to overcome the resistance.

As you do this, the backup lamps will turn on automatically when the ignition key is in position 2.



Do not hold the vehicle in place on slopes by slipping or "riding" the clutch. Use the parking brake instead. Riding the clutch causes the clutch assembly to wear out sooner. ◀

Sequential M gearbox* SMG II**The concept**

The sequential M gearbox SMG II is an automated manual gearbox with which clutching and shifting is assumed by an electro-hydraulic system.

The SMG II is operated via two shift paddles on the steering wheel and the selector lever in the center console.

It offers the following functions:

- ▷ Sequential and automated shifting mode
- ▷ Ability to choose between different driving programs (Drivelogic)
- ▷ Gradient assistance
- ▷ Upshift display (shift lights)
- ▷ Throttle blip
- ▷ Driving dependent functions:
 - The respective driving situation (e.g. cornering, mountain driving, braking) is detected by sensors and taken into account accordingly for shifting, e.g. to achieve optimum gear selection during deceleration and subsequent acceleration

- ▷ Slip recognition at the rear axle for increasing driving stability, e.g. during downshifting on slippery road surfaces
- ▷ Operating safety through protection against misshifting.

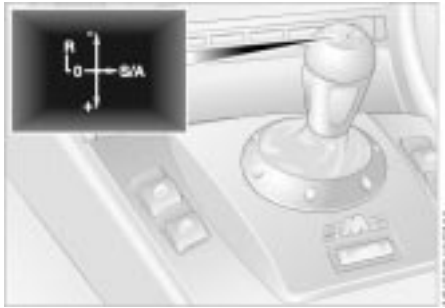

Selector lever position

R: Reverse position

0: Position 0

Forward position with one-touch mode:

▷ S: sequential mode

▷ A: automated mode

▷ +: upshifting in sequential mode

▷ -: downshifting in sequential mode.

The SMG II is ready for operation from ignition key position 2.

For your safety, it is only possible to engage a driving position with the vehicle stopped approx. 2 seconds after engaging position 0 with the footbrake depressed (shift-lock function).

It is not necessary to hold the footbrake depressed until starting off, as the vehicle does not move forward with the driving position engaged.

Starting engine and driving off

To start the engine:

1. Depress footbrake
2. Move selector lever into position 0
3. Turn the ignition key to position 3, refer to page 61.

To drive off:

1. Depress footbrake
2. Engage a driving position
3. Release footbrake and slowly depress accelerator pedal.

 With the engine running, the gear indicator in the instrument cluster flashes to indicate that a driving position is engaged with the driver's door open or if the hood is not closed properly, refer to page 66.

If none of the pedals is actuated, then the gearbox is automatically taken out of gear after approx. 4 seconds.

Then the desired direction of travel must be selected again with the selector lever in position 0. ◀

 Starting off is not possible with the hood open. ◀

 Before exiting the vehicle with the engine running, move the selector lever into position 0 and apply the parking brake. Never leave the vehicle unattended with the engine running. An unattended vehicle with a running engine represents a potential safety hazard. ◀

Switching off engine

If you turn the ignition key to position 1 or 0 with the selector lever in the forward or reverse position, a gear automatically remains engaged.

If you turn the ignition key to position 1 or 0 with the selector lever in position 0, a gong and the flashing gear indicator in the SMG display remind you that the vehicle is not secured against rolling.

66 Sequential M gearbox* SMG II

The warning stops after approx. 10 seconds. If you move the selector lever into a forward or reverse position during this time, a gear is automatically engaged.



The SMG II has no park position for securing the vehicle against rolling. The ignition key can be removed in any selector lever position. ◀



Always engage the parking brake when parking on downhill roads. Engaging a gear may not sufficiently secure the vehicle against rolling. ◀



Display in instrument cluster

The selector lever position, currently engaged gear and selected driving program are displayed in the instrument cluster.

- 1 Engaged gear
- 2 Selected driving program (corresponds to the number of illuminated fields), refer to page 68
- 3 Tapping the selector lever to the right switches over into the displayed shift mode
- 4 "A" indicates an activated automated mode.

R - Reverse position

Only engage with the vehicle stopped or at low speed, e.g. for "rocking free" in deep snow.

0 - Position 0

Always engage before starting the engine.

If the driving situation requires, e.g. when downshifting on slippery roads, the SMG II automatically disengages and reengages the clutch, i.e. it is not necessary to manually engage position 0.

S - Sequential mode

In the sequential mode all forward gears are to be shifted by the driver.

Changeover from automated to sequential mode:

- ▷ Tap the selector lever to the right toward "S" or
- ▷ Change gears with the selector lever or the shift paddles on the steering wheel.

You do not need to reduce the throttle for shifting.



Shifting gears with shift paddles on steering wheel:

- ▷ To upshift, briefly pull the right paddle "+"
- ▷ To downshift, briefly pull the left paddle "-".

 Shift paddles with various widths matched to the shape of your hand are available from your BMW center. ◀

Shifting gears with selector lever:

- ▷ To upshift, pull the selector lever backward "+"
- ▷ To downshift, push the selector lever forward "-".

No automatic upshifting is carried out in the sequential mode.

You accelerate from higher gears, e.g. during passing, by manually downshifting.

In the following situations the SMG II helps you "think" in the sequential mode:

- ▷ Upshifts and downshifts are only executed when the new gear will provide a suitable combination of vehicle and engine speed, i.e., downshifts that would cause the engine to overrev will not be executed
- ▷ During a stop the gearbox is automatically downshifted into the first gear so that, e.g. before a traffic light, it is only necessary to accelerate to continue driving
- ▷ When the speed is reduced, the gearbox is automatically downshifted shortly before a gear-dependent minimum speed is reached without you taking any action.

A - Automated mode

Each time the engine is started, the automated mode is activated as soon as you move the selector lever into the forward driving position.

In the automated mode all forward gears are automatically shifted.

Changeover from sequential to automated mode: tap the selector lever to the right toward "A". Watch the display in the instrument cluster, refer to page 66.

For rapid acceleration, e.g. during passing, depress the accelerator pedal completely (kick-down). The gearbox now downshifts in dependence on the selected driving program.

Even in the automated mode, you can help specify the shifting point: if a gear-dependent minimum speed is exceeded, you can upshift by slowly reducing pressure on the accelerator pedal. In the process, the respective driving situation is detected by sensors and taken into account.



Drivelogic

Drivelogic makes various driving programs available to you.

Press the Drivelogic repeatedly until the desired driving program is shown in the SMG display of the instrument cluster, refer to page 66.

In the automated mode you can select from five driving programs ranging from convenience mode/winter operation to sporty and highly dynamic.

In the first automatic driving program, starting off takes place in second gear, which is advisable under winter road conditions with ice and snow.

In the sequential mode you can choose from six driving programs ranging from balanced, dynamic to sporty, puristic driving. The sporty, puristic driving program can only be activated with the Dynamic Stability Control (DSC) deactivated, refer to page 82.



To maintain vehicle stability, always drive with the DSC switched on whenever possible. ◀

Following each change between the sequential and the automated mode, the last driving program selected in the respective mode is active.

Exception: instead of the last selected sequential driving program 6, program 5 is activated only after the engine has been started again.



Your vehicle is set so that when the engine is started, the last selected driving program saved in your key is activated for each shifting mode. ◀

Gradient assistance

The gradient assistance enables starting off on grades with virtually no roll-back. It can be activated in the sequential and automated mode with the vehicle stopped and can be used for both forward and reverse driving.

1. Depress footbrake with vehicle stopped
2. Activate the gradient assistance by pulling the left paddle for at least 0.5 seconds. An increase in the engine speed indicates that the gradient assistance is activated



Pulling the left paddle again briefly deactivates the gradient assistance again. ◀

3. Release the footbrake and start off within 2 seconds.

 The vehicle may roll slightly before it is held by the gradient assistance after releasing the footbrake. Two seconds after the footbrake is released, the vehicle begins to roll, as it is no longer held with the gradient assistance. ◀

The gradient assistance must be reactivated before each use.

Indicator lamp



The transmission indicator lamp in the instrument cluster goes out after the engine is started.

- ▷ If it does not go out, or if it lights up during driving, a fault has occurred. The available functions may be limited under certain circumstances. Drive carefully and with the Dynamic Stability Control (DSC) activated. Have the system checked by the nearest BMW center
- ▷ If the indicator lamp flashes while driving, the system is overloaded. Avoid high loads until the indicator lamp goes out again permanently.



Shift lights

To achieve the best possible vehicle acceleration with a sporty driving style in the sequential mode, shift lights in the instrument cluster indicate the optimum shifting point shortly before the maximum engine speed is reached.

1. When the maximum engine speed is approached, yellow indicator fields (shift lights) in the tachometer light up consecutively to indicate the approaching upshift time
2. Shift at the latest when the last indicator field lights up red.

Tire replacement, snow chains

Following a tire or wheel change and after mounting or removing snow

70 Sequential M gearbox* SMG II

chains, the slip recognition of the SMG II must "become familiar" with the changed condition.

Reinitialize the system afterwards.

1. Move the selector lever into position 0 on a straight stretch of road at a speed of over 20 mph (30 km/h)
2. Pull both shift paddles for approx. 2 seconds.

If you do not carry out the initialization, the system automatically "learns" the changed condition gradually during driving. This can become apparent due to brief opening and closing of the clutch.

Indicator/Headlamp flasher



- 1 High beams (blue indicator lamp)
- 2 Headlamp flasher (blue indicator lamp)
- 3 Turn signal indicator (green indicator accompanied by periodic clicking sound from the relay).

To signal briefly

Press the lever up to but not beyond the resistance point. It then returns to the center position when released.

 If the flashing indicator lamp and the clicking from the relay are both faster than normal, one of the turn signal indicators has failed. ◀



- 0 Wipers retracted
- 1 Intermittent operation or rain sensor
- 2 Normal wiper speed
- 3 Fast wiper speed
- 4 Brief wipe
- 5 Rotary dial for control of the wipe interval or the sensitivity of the rain sensor*

Intermittent operation

(not on vehicles with rain sensor)

You can set the wipe interval at four stages with rotary dial 5. In addition, the wipe interval is varied automatically depending on road speed.

Rain sensor

The rain sensor is positioned on the windshield, directly ahead of the interior rearview mirror.

To activate the rain sensor:

- ▷ From ignition key position 1 and up, move the lever to position 1. The wipers travel once across the windshield, regardless of the weather
- ▷ You can leave the lever permanently in position 1. It is then only necessary to activate the rain sensor from ignition key position 1 and up. Activate by briefly turning rotary dial 5.

To adjust the sensitivity of the rain sensor: turn rotary dial 5.

To deactivate the rain sensor: put lever in position 0.



Deactivate the rain sensor when passing through an automatic car wash. Failure to do so could result in damage caused by undesired wiper activation. ◀

Normal wiper speed

When the vehicle is stationary, the wipers switch automatically to intermittent wipe (not on vehicles with rain sensor).

Fast wiper speed

When the vehicle is stationary, the wipers operate at normal speed (not on vehicles with rain sensor).

72 Washer/Wiper system/Rain sensor*



- 0 Wipers retracted
- 1 Cleaning windshield

Cleaning windshield

The system sprays washer fluid against the windshield and activates the wipers for a brief period.



Do not use the washers if there is any danger that the fluid will freeze on the windshield. If you do so, your vision could be obscured. For this reason, use an antifreeze agent, refer to page [115](#).

Do not use the washers when the reservoir is empty. This could cause damage to the washer pump. ◀

Clean the headlamps*

When the vehicle's lighting system is switched on, the headlamps will also be cleaned every fifth time the automatic windshield washer is activated.

Windshield washer jets

The windshield washer jets are warmed automatically when the ignition key is in position 2.

Cruise control

Starting at about 20 mph (30 km/h), you can maintain and store any vehicle speed that you specify.

You can use cruise control, whenever the system is active while the engine is running.

To activate the system



From ignition key position 2: Press the button and the indicator lamp in the instrument cluster (refer to page 20) will come on. You can now use the cruise control.



Do not use cruise control on twisting roads, when high traffic density prevents driving at a constant speed, when the road surface is slick (snow, rain, ice), or when the road surface is loose (rocks, sand). ◀

To deactivate the system



Press button as often as you need to until the indicator lamp in the instrument cluster goes out.

Cruise control is also deactivated when the ignition key is in position 0.

The speed stored in memory is deleted.

To store and maintain speed or to accelerate



Press button (+) briefly. The system stores and maintains the current vehicle speed. Every time you tap the button, the speed increases by 0.6 mph (1 km/h).

Press and hold button (+). The vehicle accelerates without pressure on the accelerator pedal. When you release the button, the system stores and maintains the current speed.



If, on a downhill gradient, the engine braking effect is not sufficient, the controlled speed may be exceeded. Speed can drop on uphill grades if the engine output is insufficient. ◀

To decelerate

Press button (-) briefly:

When cruise control is active, every tap of the button reduces the speed by approx. 0.6 mph (1 km/h).

Press and hold button (-):

With the cruise control active, the system automatically reduces the throttle opening to slow the vehicle.

When you release the button, the system stores and maintains the current speed.

To interrupt the cruise control

When the system is activated, press the button. The indicator lamp stays on. You can use the cruise control again whenever you want by calling up the speed that was stored last.

In addition, cruise control is interrupted automatically:

- ▷ If the brakes are applied
- ▷ When pressing down the clutch pedal
- ▷ If you exceed or fall below the programmed speed for an extended period (by depressing the accelerator, for example)
- ▷ Sequential M gearbox* SMG II, refer to page 64: when shifting in the sequential mode.

Recall the stored speed

Press button:

The vehicle accelerates to and maintains the last speed stored.



- 1 Odometer
- 2 Trip odometer

Odometer

You can activate the displays shown in the illustration with the ignition key in position 0 by pressing the button in the instrument cluster (arrow).

Trip odometer

To reset the trip odometer to zero, press the button (arrow) with the ignition key in position 1 or higher.



Variable pre-warning zone

The yellow pre-warning zone displays current permissible engine speeds, depending on the engine temperature. As the engine temperature climbs, some of the sectors for this pre-warning zones will go out one after the other.

Avoid engine speeds in the early warning zone if possible.

Never allow the engine to operate with the needle in the red overspeed zone of the gauge.

To protect the engine, the fuel supply is interrupted when you approach this sector.



The general operating temperature is between 175°F (80°C) and 250°F (120°C). During performance-oriented driving, do not exceed the maximum temperature of 300°F (150°C).



Once the indicator lamp stays on continuously, there are still approx. 2 gallons (8 liters) of fuel in the fuel tank.

Fuel tank capacity:
approx. 16.6 gal. (63 liters).

If the tilt of the vehicle varies (when you are driving in mountainous areas, for example), the needle may fluctuate slightly.

 Please refuel early, since driving to the last drop of fuel can result in damage to the engine and/or catalytic converter. ◀

When you switch on the ignition, the indicator lamp lights up briefly as an operation check.



Blue

The engine is still cold. Drive at moderate engine and vehicle speeds.

Red

When you switch on the ignition, the warning lamp comes on briefly to confirm that the system is operational.

If the lamp comes on while operating the vehicle, the engine has overheated. Switch off the engine immediately and allow it to cool down.

Checking coolant level: refer to page [118](#).

Between the blue and red zones

Normal operating range. The needle may rise as far as the edge of the red sector in normal operation.



Remaining distance for service

The displays shown in the illustration appear for a few seconds when the ignition key is in position 1 or after the engine is started.

The next service due appears with the message OILSERVICE or INSPECTION, together with the distance remaining before the next scheduled service.

The computer bases its calculations of the remaining distance on the preceding driving style.

A flashing message and a "-" in front of the number mean that the service interval has already been exceeded by the distance shown on the display. Please contact your BMW center for an appointment.

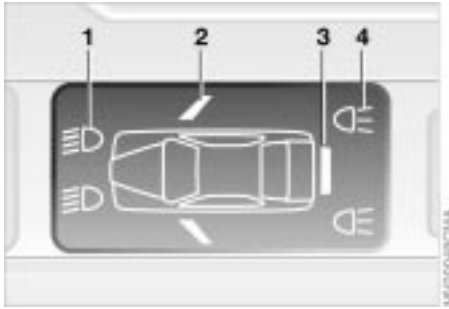

Display

The following information or conditions are displayed from ignition key position 2 on, until the cause has been corrected:

- 1 Inspect the low-beam and high-beam headlamps, as well as the parking lamps
- 2 Door open
- 3 Luggage compartment lid open
- 4 Check brake and tail lamps

After completion of a trip and upon opening the driver's door, an acoustic signal will sound yet not be displayed, as a reminder that the low-beam headlamps have not been turned off.

If you wish to have a permanent time display, you can make this adjustment in the car radio* display (refer to the Radio Owner's Manual).

You can set the time of day, and the display for the car radio*, as follows.



Adjustments

From ignition key position 1 the time of day appears in the display.

To set ahead: turn the button to the right.

To set back: turn the button to the left. The adjustment speed will increase the longer you continue to hold the button.

To change the display mode: press the knob briefly. Every time you press the knob, the clock display alternates between the 12-hour or 24-hour mode.

In ignition key position 0: the time is displayed for a few seconds after you press the left button (refer to "Odometer" on page 75).



Mode selection

With the ignition key in position 1 and higher, you can use the button in the turn signal lever to retrieve information from the computer for display in the instrument cluster. By pressing the button briefly in the direction of the steering column, you can call up a new function for display.

The displays appear in the following order:

Time of day, outside temperature, average fuel consumption, cruising range, average vehicle speed.

Starting with ignition key position 1, the last active setting is displayed.



Outside temperature

You can change the units of measure (°C/°F) for the outside temperature display by pressing the right-hand reset button in the instrument cluster while the temperature display is active.

Ice warning

If the outside temperature drops to about 37.5 °F (+3 °C), then the computer will automatically switch to show the outside temperature. In addition, a signal sounds as a warning and the display flashes for a brief period.



The ice warning does not alter the fact that surface ice can form at temperatures above 37.5 °F (+3 °C), on bridges or shaded road surfaces, for instance. ◀



Average fuel consumption

If you continue to hold the button on the turn signal lever, the average fuel consumption last displayed is recalculated from that point.

Cruising range

The computer bases its calculations of the cruising range on the preceding driving style.

Average speed

If you continue to hold the button on the turn signal lever, the average fuel consumption last displayed for that speed is recalculated from that point in time.

Any time spent when the vehicle is stationary and the engine is shut off is ignored for the calculation.

The concept

The PDC assists you when you back into a parking space. A signal warns you of the distance to an obstacle. To do this, four ultrasonic sensors in the rear bumper measure the distance to the nearest object. The range for the sensors located at both rear corners ends approx. 2 ft (60 cm) behind the bumpers. The range for the two middle sensors is slightly less than 4.9 ft (1.50 m).

The system is activated automatically about one second after you engage reverse with the ignition key in position 2. PDC is deactivated when you shift back out of reverse.

Acoustic signals

The distance to the nearest object is indicated by a tone sounding at various intervals. As the distance between vehicle and object decreases, the intervals between the tones become shorter. A continuous tone indicates the presence of an object less than 1 ft (30 cm) away.

The warning signal is canceled after approx. three seconds if the distance to the obstacle remains constant during this time (if you are moving parallel to a wall, for instance).

System malfunctions will be indicated by a continuous high-pitched tone when the system is activated the first time. Please have your BMW center resolve the problem.



The PDC does not remove the driver's personal responsibility for evaluating the distance between the vehicle and any obstacles. Even when sensors are involved, there is a blind spot in which objects cannot be detected. This applies especially in those cases where the system approaches the physical limits of ultrasonic measurement, as occurs with e. g. tow bars and trailer couplings, and in the vicinity of thin and wedge-shaped objects.

Certain sources of sound, such as a loud radio, could drown the PDC signal tone. ◀



Keep the sensors clean and free of ice or snow in order to ensure that they will continue to operate effectively.

Do not apply high pressure spray to the sensors for a prolonged period of time. Always maintain a distance of more than 4 in (10 cm). ◀

Dynamic Stability Control (DSC)

The concept

DSC maintains vehicle stability, even in critical driving situations.

The system optimizes vehicle stability during acceleration and when starting from a full stop, as well as optimizing traction. In addition, it also recognizes unstable driving conditions such as under- or oversteering on curves, and keeps the vehicle on a steady course by using the engine and brake system to intervene at the different wheels, doing only what it can within the laws of physics, of course.

The system starts up automatically each time you start the engine.



The laws of physics cannot be repealed, even with DSC. The results of driving irresponsibly rest with the driver. We therefore urge you to avoid using the additional safety margin of the system as an excuse for taking risks. Do not make any modifications to the DSC system. Allow only authorized technicians to perform service procedures on the DSC. ◀

Indicator lamp



The indicator lamp in the instrument cluster will go out shortly after the ignition has been switched on, refer to page 18.

- ▷ Indicator lamp flashes: the system is active and is controlling the drive torque based on driving conditions
- ▷ If the indicator lamp fails to go out after the engine has been started, or if it comes on during normal driving and stays on: the system has been deactivated via the button or is defective. You can continue to drive the vehicle normally, but without DSC. Please consult your BMW center for repairs.



To deactivate the system

Press the button; the indicator lamp comes on and stays on.

The vehicle does not execute the stability-enhancement and traction-control functions when DSC is deactivated.

We recommend that you deactivate the system for increased traction:

- ▷ when rocking the vehicle or starting off in deep snow or on loose surfaces
- ▷ or when driving with snow chains.

 To maintain vehicle stability, always drive with the system switched on whenever possible. ◀

To reactivate the system

Press the button again; the indicator lamp goes out.

Dynamic Brake Control (DBC)

DBC is an integral component of the DSC system.

If you apply the brakes rapidly, this system automatically generates maximum braking force boost and thus helps to achieve the shortest possible braking distance in "panic braking" situations. All of the benefits of the ABS system are exploited under these circumstances.

Do not reduce the pressure on the brake pedal for the duration of the brake application. When the brake pedal is released, the DBC is deactivated.

The concept

The Flat Tire Monitor keeps track of the inflation pressures in your tires as you drive. The system detects whenever the inflation pressure in a tire drops off significantly.

Controlling the tire pressure is based on monitoring the rpms that the tires have relative to each other. A flat tire is detected and reported because the rpms suddenly deviate drastically from one another.

Flat Tire Monitor



Initializing the system

Initializing is necessary to familiarize the system with the correct inflation pressure.

Repeat this process after any changes in tire inflation pressure, tire rotation or replacement.

1. Check the tire inflation pressure in all the tires, comparing them with the inflation pressure table (page 25), and adjusting their pressure if necessary
2. Turn the ignition key to position 2

3. Press button as long as you need to until the indicator lamp in the instrument cluster lights up. After a little while, the indicator lamp will go out by itself
4. After a few minutes, the Flat Tire Monitor will accept the current inflation pressure as the value to be measured against, and from that point on, can detect and report a flat tire.



Activating/deactivating the system

The system is automatically activated in ignition key position 2 and consequently is on whenever the vehicle is operated.

To deactivate the system: tap the button, the indicator lamp will light up yellow.

To activate the system: tap the button again; the indicator lamp goes out.

Deactivate the system when snow chains are mounted, since false warnings and undetected losses in pressure are possible under these kinds of conditions.

Flat tire



The indicator lamp in the instrument cluster will light up red in the event of a flat tire with ensuing loss in pressure. In addition, an acoustic signal is sounded. To come to an immediate stop, reduce speed, while avoiding any sudden, jerky braking or steering maneuvers.

Fix the flat tire using the M Mobility system (refer to page 132).

Resetting the indicator lamp: the red indicator lamp has to be switched off manually after putting on a new wheel. At this point, hold the Flat Tire Monitor button down until the indicator lamp goes out. Reinitialize the system afterward.

 The Flat Tire Monitor cannot alert you to severe and sudden tire damage caused by external factors. Another factor which the Flat Tire Monitor does not recognize is the balanced and very gradual pressure loss that takes place in all tires over an extended period of time. ◀



Check the tire inflation pressure on a regular basis and correct if necessary, refer to page 24.

Under certain circumstances, there may be false warnings or a delayed detection of losses in pressure when driving on snow-covered or slippery road surfaces.

Performance-oriented driving (slip at the drive wheels, high levels of lateral acceleration) can also delay the appearance of status reports in the Flat Tire Monitor's display panel. ◀

System malfunction

As long as there is still a malfunction, the indicator lamp in the instrument cluster will stay lit up yellow.

Please contact your BMW center for additional information.

M Engine dynamics control



The system (Sport mode identification) will cause the engine to respond spontaneously to the motion of the accelerator pedal.

Activating/deactivating sport-mode identification

Activating: with the key in ignition key position 2, press the sport button. The indicator lamp will light up.



The vehicle may gain speed without any additional pressure on the accelerator pedal when the system is activated. ◀

Deactivating: press the sport button again; the indicator lamp will go out.

The sport mode is deactivated every time the engine is started.

Parking lamps/Low beams



Parking lamps



With the switch in this position, the front, rear and side vehicle lighting comes on. You can use the parking lamps for parking. For lighting on one side for parking as an additional feature, refer to page [86](#).

Low beams



When you switch the ignition off with the low beam headlamps on, only the parking lamps will remain on.



"Follow me home" lamps: When you activate the headlamp flasher after parking the vehicle and switching off the lights, the low beams will come on for a brief period. You may also have this function deactivated if you wish. ◀

"LIGHTS ON" warning

Whenever you open the driver's door, after having turned the ignition key to position 0, you will hear an acoustic signal for a few seconds to remind you that the lamps have not been switched off.

Daytime driving lamps*

The headlamps are automatically switched on for daytime driving at ignition key position 2.

Automatic headlight control*



When the switch is set to this position the system automatically switches the low beams on and off in response to changes in ambient light (in tunnels, at dusk, etc.) as well as rain and snow.



The vehicle's external lamps remain on constantly when you switch on the front fog lamps after the headlamps have come on automatically. ◀



Automatic headlight control cannot serve as a substitute for the personal judgement in determining when the lamps should be switched on. The sensors cannot, for example "recognize" fog. In such situations switch on the lamp manually, as otherwise a safety hazard will result. ◀



You can have the sensitivity of your vehicle's automatic headlight control adjusted. ◀

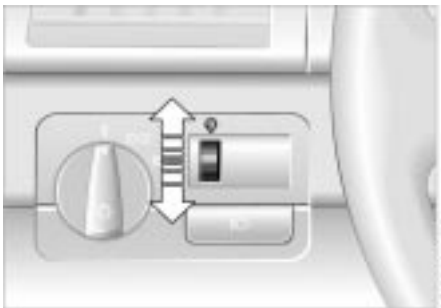

Turn the rotary dial to control the lighting when the parking or low beam lamps are on.



- 1 High beams (blue indicator lamp)
- 2 Headlamp flasher (blue indicator lamp)
- 3 Standing lamps

Standing lamps, left or right

As an additional feature, you can illuminate your vehicle on either side for parking, if you wish to do so:

With the ignition key in position 0, push the lever in the appropriate direction. The lever engages in the turn signal position.



Front fog lamps



The green indicator lamp in the instrument cluster lights up to indicate that the front fog lamps are on.



If the automatic headlight control is on, the low beams will come on automatically whenever you switch on the fog lamps. ◀



The interior lamps operate automatically.

Switching the interior lamps on and off

Press the button briefly.

If you want the interior lamps to remain off all the times, press and hold the button for approx. 3 seconds.

Press the button briefly to revert to normal operation.

Front reading lamps*

Switch on and off with the button adjacent to each lamp.

Rear reading lamps

With the hardtop* reading lamps are also located in the rear. Switch on and off with the button adjacent to each lamp.

 To avoid subjecting the battery to excessive loads, all of the lamps within the vehicle are automatically switched off approx. 15 minutes after you turn the ignition key to position 0. ◀

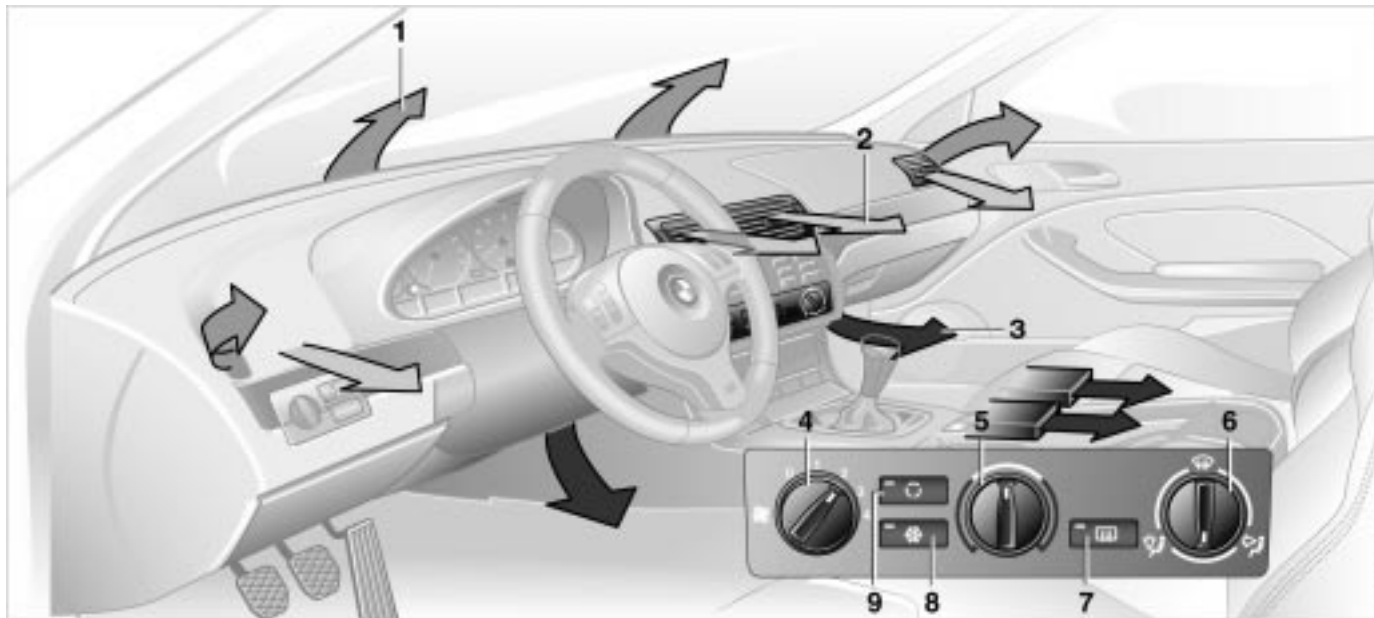

- 1 Air onto the windshield and onto the side windows
- 2 Airflow for the upper body [89](#)
- 3 Front footwell ventilation

- 4 Air supply (blower) [89](#)
- 5 Temperature [89](#)
- 6 Air distribution [89](#)

- 7 Rear window defroster [89](#)
- 8 Air conditioner [89](#)
- 9 Recirculated-air mode [89](#)

Air conditioner

Air supply (blower)



You can select blower speeds from 1 to 4. The heating and ventilation become more and more effective as the air supply settings are increased. In position 0, the blower and the heater are switched off. By using position 0, you can totally block the air supply by pressing the button for the recirculated-air mode.





Temperature



In order to increase the temperature of the passenger compartment, turn it to the right (red). Temperature regulation will keep the interior temperature you have selected constant.

Air distribution



You can direct air to flow onto the windows , toward the upper body  and into the footwell . All intermediate settings are possible. In the  setting, there is a low flow of air onto the windows to keep them free of condensation.

Rear window defroster



With the convertible top closed or with the hardtop* mounted, press the button. The indicator lamp remains on. The rear window defroster switches off automatically.



The rear defroster automatically assumes operation within 5 minutes after the engine is started at outside temperatures below 40 °F (4 °C). ◀

Air conditioner



The air is cooled and dehumidified and – depending on the temperature setting – rewarmed when the air conditioner system is switched on.

Depending on the weather, the windshield may fog over briefly when the engine is started.



Condensation forms in the air conditioner system during operation, which then exits under the vehicle. Traces of condensed water of this kind are thus normal. ◀

Recirculated-air mode



You can respond to unpleasant external odors by temporarily excluding the supply of outside air. The system then recirculates the air currently within the vehicle.



If the windows fog over in the recirculated-air mode, switch the recirculated-air mode off and increase the air supply as required. ◀

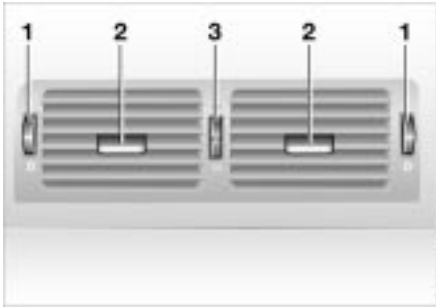

Microfilter

An microfilter, which traps incoming dust and pollen, has been installed in your vehicle. Your BMW center will replace it during routine maintenance. A substantial reduction in airflow indicates that the filter needs to be replaced early.

Draft-free ventilation

You can adjust the blower controls for the upper body area to select the optimum airflow rates and directions for your personal requirements:

- 1 Rotary dials for opening and closing the vent outlets through an infinitely variable range
- 2 Lever for adjusting airflow direction
- 3 With the rotary dial you can adjust the temperature of the outgoing air.
 - ▷ Turn toward blue – colder
 - ▷ Turn toward red – warmer.



To defrost windows and remove condensation

1. Set the blower speed control for the airflow rate to position 4
2. Turn the rotary temperature control completely to the right (red)
3. Rotary control for air distribution in position 
4. Switch on the rear window defroster to defrost the rear window.

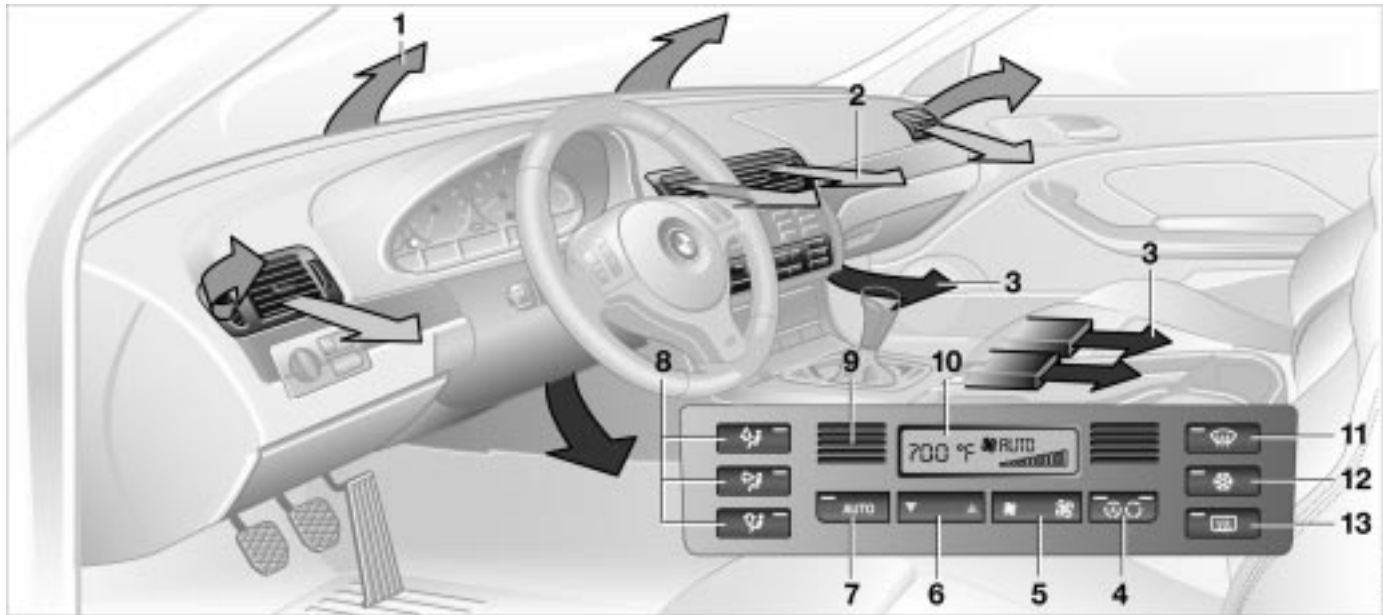

1 Air onto the windshield and onto the side windows

2 Airflow toward the upper body [92](#)

3 Front footwell ventilation

4 Recirculated-air mode/Automatic recirculated-air control (AUC) [93](#)

5 Air supply (blower) [92](#)

6 Temperature [92](#)

7 Automatic air distribution [92](#)

8 Individual air distribution [92](#)

9 Interior temperature sensor – please keep clear and unobstructed

10 Display for temperature and air supply [92](#)

11 Defrost the windshield and side windows [92](#)

12 Air conditioner [93](#)

13 Rear window defroster [93](#)

Tips for pleasant driving

Use the automatic system (switch on AUTO button 7). Select the desired interior temperature.

Detailed setting options are described for you in the following sections.



You can make the settings of your vehicle in such a manner that, when you unlock the vehicle with the remote control of your personal key, your own personalized setting for the automatic climate control is initiated. ◀



Automatic air distribution

The AUTO program assumes the adjustment of the air distribution and the air supply for you and – in addition to that – adapts the temperature to external influences (summer, winter) to meet preferences you can specify.

Individual air distribution

You also have the option of individually configuring the air distribution pattern to suit your own personal preferences.



While the AUTO program is then deactivated, the automatic airflow control remains in operation. The system directs air to the windows , the upper body  and into the footwells . You can reactivate the automatic air supply by pressing the AUTO button.

Temperature

The displayed temperatures are reference values for the interior temperature. We recommend 72 °F (+22 °C) as a comfortable setting, even if the air conditioner is on. When you start the vehicle, the system ensures that the selected temperature is reached as quickly as possible. It then maintains this temperature, regardless of the season.

Air supply (blower)

By pressing the left or right side of the button, you can vary the air supply. This deactivates the automatic air supply – the AUTO display disappears from the panel. Nevertheless, the automatic air distribution remains unchanged. You can reactivate the automatic air supply by pressing the AUTO button.

When you set the lowest blower speed by pressing the left half of the button, all of the displays are canceled: the blower, heating and air conditioner are switched off, and the air supply is stopped. You can reactivate the system by pressing any button for the automatic climate control.

To defrost windows and remove condensation

This program quickly removes ice and condensation from the windshield and side windows.

Air conditioner



The air is cooled and dehumidified and – depending on the temperature setting – rewarmed when the air conditioner system is switched on.

Depending on the weather, the windshield may fog over briefly when the engine is started.

Window mist will be reduced by switching on the air conditioner.



Condensation forms in the air conditioner system during operation, which then exits under the vehicle. Traces of condensed water of this kind are thus normal. ◀

Automatic recirculated-air control (AUC)



If there are unpleasant odors or pollutants in the outside air, you can temporarily block the airflow from the outside. The system then recirculates the air currently within the vehicle.

By repeatedly pressing the button, you can select one of three different operating modes.

- ▷ Indicator lamps off: outside air always flowing into the vehicle
- ▷ Left-hand indicator lamp on – automatic mode: the system detects pollutants in the outside air and responds by deactivating the outside airflow as required. The system then recirculates the air currently within the vehicle.
Depending on air quality requirements, the system automatically switches between outside air supply and recirculation of the air already within the vehicle
- ▷ Right-hand indicator lamp on: the flow of outside air is permanently blocked. The system recirculates the air already within the vehicle.



If the windows fog over in the recirculated-air mode, switch the recirculated air off and increase the air supply as required. ◀

Rear window defroster



With the convertible top closed or with the hardtop* mounted, press the button. The indicator lamp remains on. The rear window defroster switches off automatically.



The rear window defroster automatically assumes operation within 5 minutes after the engine is started at outside temperatures below 40 °F (4 °C). ◀

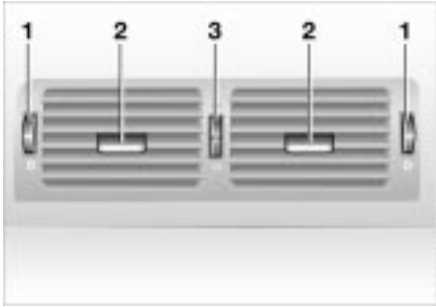

Microfilter, activated-charcoal filter

The built-in microfilter removes dust and pollen from the incoming air. The activated-charcoal filter provides additional protection by filtering gaseous pollutants from the outside air. Your BMW center will replace the combined filter as a standard part of your scheduled maintenance. A substantial reduction in airflow indicates that the filter needs to be replaced early.

Draft-free ventilation

You can adjust the blower controls for the upper body area to select the optimum airflow rates and directions for your personal requirements:

- 1 Rotary dials for opening and closing the vents at any setting desired
- 2 Selector lever for airflow direction
- 3 With the rotary dial you can adjust the temperature of the outgoing air.
 - ▷ Turn toward blue – colder
 - ▷ Turn toward red – warmer.

Glove compartment



 If you turn over only your door key for valet parking, for example (refer to page 28), access to the glove compartment and the luggage compartment lid is not possible. ◀

To open

Pull the handle. The glove compartment will light up.

To close

Fold up cover.

 To prevent injury in the event of an accident, close the glove compartment immediately after use. ◀

To lock

Lock with one of the master keys. A master key can also be used for unlocking.

96 Storage compartments



Front center armrest*

To release: press the button (arrow) and lift upward.

Other compartments and nets

You will find additional storage areas in the doors and in the center console above the ashtray. Storage nets are located on the backrests of the front seats.

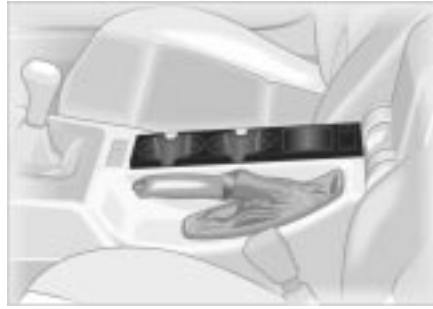

Beverage holder, coin box

A coin box and two beverage holders are provided in the center console.

Cellular phone*



Hands-free system

In vehicles with telephone preparation* the cover for the hands-free microphone is located above the interior rearview mirror on the driver side.

For further information on the cellular phone, refer to the Supplementary Owner's Manual.

Ashtray, front



To empty

Press on the edge of the open cover (arrow): you can now pull the ashtray upward for removal.

Extinguishing cigarettes

Tap off the ash and gently press the tip into the funnel.

Cigarette lighter

Press the lighter 1 in. As soon as the lighter jumps back out, it can be removed.



Hold or touch the hot cigarette lighter by the knob only. Holding or touching it in other areas could result in burns.

The cigarette lighter remains operational when the ignition key has been removed. For this reason, children should never be left in the vehicle unattended. ◀

Cigarette lighter socket

It can be used for attaching power supplies for flashlights, car vacuum cleaners and other similar appliances up to a rating of approx. 200 watts at 12 volts. Avoid damaging the socket due to inserting plugs of different shapes or sizes.

Ashtray, rear

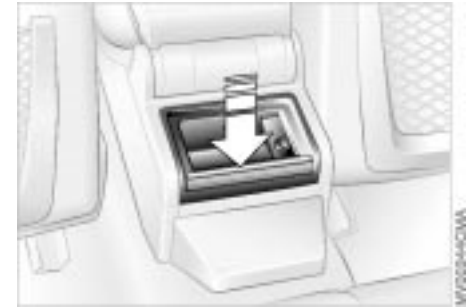

To empty

Press on the edge of the raised cover in the opening direction (arrow). You can now pull the ashtray upward for removal.

98 Ski bag*

The ski bag allows the safe and clean transport of up to 3 pairs of standard skis or up to two snowboards.

The length of the ski bag and the additional space provided in the luggage compartment make it possible to carry skis up to 6.8 ft long (2.10 meters). Because of the tapered shape of the bag, the ski bag can only accommodate two pairs of skis up to 6.8 ft long (2.10 meters).

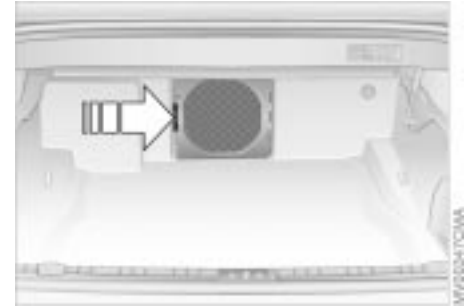

Loading

1. Release the safety belts from their holders
2. Press lever downward (arrow) and remove the center piece by pulling it forward
3. Extend the ski bag between the front seats. The zipper provides convenient access to stored items. It may be opened to allow the ski bag to dry

4. Press the release button in the luggage compartment (arrow)



5. Secure the cover panel with the magnetic retainer on the rear wall and pull out the ski bag.

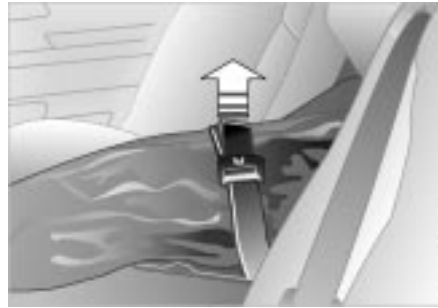

Securing the load

- ▶ Secure the bag's contents by tightening down the retaining strap at the buckle. ◀

Please be sure that the skis are clean before loading them into the bag. Be careful to avoid damage from sharp edges.



Storing the ski bag

To store the ski bag, perform the above steps in reverse sequence.

- ▶ When reattaching the center piece, guide both bars into the guide and press the center piece back into place. Secure the safety belts in their holders again. ◀



Always position and secure the load correctly. If you do not, it can endanger the passengers during braking or evasive maneuvers.

Do not exceed the permissible gross weight and the permissible axle loads (refer to page 146), otherwise the vehicle's operating safety is no longer assured and you are in violation of the law.

Do not stow heavy or hard objects in the passenger compartment without first securing them. Otherwise they would be thrown around during braking and evasive maneuvers and endanger the occupants. ◀

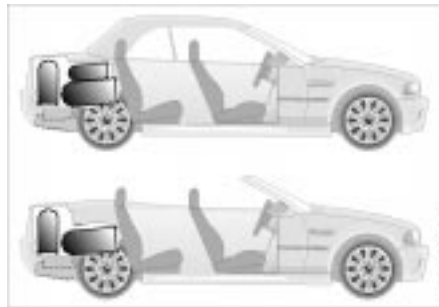

Stowing cargo

When transporting cargo in your BMW:

- ▷ Load heavy cargo as far forward as possible – directly behind the backrests or the luggage compartment partition – and as low as possible
- ▷ Cover sharp edges and corners.



You can enlarge the luggage compartment when the convertible top is closed, refer to page 37. To do this you have to fold the convertible top compartment panel up.

We recommend that you always fold the convertible top compartment panel down as soon as you have removed your cargo from the luggage compartment. This way, you can be sure that you can always operate your convertible top at any time.

Conversely, when the convertible top is closed, raise the convertible top compartment panel before stowing your cargo in the luggage compartment to avoid any damage to the convertible top compartment or your load. ◀



Securing the cargo in the luggage compartment

- ▷ Secure small, light items with a luggage compartment net* or elastic straps, refer to page [35](#)
- ▷ For large, heavy pieces, see your BMW center for load-securing devices*. Lashing eyes (arrow) are provided at the corners of the luggage compartment for attaching these load-securing devices.

Comply with the information enclosed with the load-securing devices.

A special luggage system is available as an option for your BMW. Please observe the precautions included with the installation instructions.

Mounting points

Access to the mounting points:
To fold up the cover (arrow), please use the tool which is provided with the luggage system.

Loading and driving notes

Because roof racks raise the center of gravity of the vehicle when loaded, they exercise a major effect on its handling and steering response.

When loading, be sure to remember not to exceed the approved roof weight or the approved gross vehicle weight or

the axle loads. You will find the specifications under "Technical Data" on page [146](#).

Make sure that the load is not too bulky, and attempt to distribute it evenly. Always load the heaviest pieces first (on the bottom). Make sure that no objects get in the way when the luggage compartment lid is opening or closing.

 When carrying cargo on the roof, always ensure that it is properly secured. Loose cargo can shift and even fly off, posing a serious hazard to other road users. ◀

Drive smoothly and avoid sudden acceleration or braking. Do not corner at high speeds.



Overview

Controls and features

Operation, maintenance

Owner service procedures

Technical data

Index



Overview

Controls

Maintenance

Repairs

Data

Index

To ensure that your vehicle provides maximum economy throughout a long service life, we request that you observe the following suggestions.



Because of its engineering design, the BMW M3 convertible is an especially high-quality vehicle. It is in your best interest to follow the break-in tips very closely. Doing this, you will create the basis for a long, optimum service life. ◀

Engine and differential

▷ Up to 1,200 miles (2,000 km): drive at varying engine and road speeds, but do not exceed the following engine or road speeds:
5,500 rpm or 105 mph (170 km/h)

Obey your local and state maximum speed limits.

Do not depress the accelerator pedal to the full-throttle position.

Vehicles with SMG II* (refer to page 64): refrain from using driving program 6 in the sequential mode during the break-in period.

▷ Following the break-in inspection at 1,200 miles (2,000 km), you can gradually increase engine or road speeds.

Follow the same break-in procedure if either the engine or the differential is replaced in the future.

Tires

Due to technical factors associated with their manufacture, tires do not achieve their full traction potential until an initial break-in period has elapsed. Thus drive with extra care during the initial 200 miles (300 km).

Obey your local and state maximum speed limits.



When the vehicle is operated on wet or slushy roads, a wedge of water may form between the tire and the road surface. This phenomenon is referred to as aquaplaning, or hydroplaning, and can lead to partial or complete loss of traction, vehicle control and braking effectiveness. Reduce your speed on wet roads. ◀

Brake system

Approx. 300 miles (500 km) must elapse before the brake pads and rotors achieve the optimal pad-surface and wear patterns required for trouble-free operation and long service life later on.

To break-in the separate parking brake drums, apply the parking brake lightly when coasting to a standstill (at a traffic signal, for instance), provided that traffic conditions permit to do so.

To avoid corrosion, repeat this procedure from time to time.



The brake lamps do not come on when the parking brake is engaged.

Vacuum for the brake system servo unit on your BMW is available only when the engine is running. When you move the vehicle with the engine off – when towing, for example – substantially higher levels of pedal force will be required to brake the vehicle. ◀

Clutch

The clutch will also begin to function optimally after about 300 miles (500 km). Drive cautiously during this break-in period and do not press the clutch or shift at high engine speeds.

 Brakes: do not rest your foot on the brake pedal while driving. Even light but consistent pedal pressure can lead to high temperatures, brake wear and possibly even brake failure.

Aquaplaning: when driving on wet or slushy roads, reduce road speed. If you do not, a wedge of water can form between tires and road surface. This phenomenon is referred to as aquaplaning, or hydroplaning, and can lead to partial or complete loss of traction, vehicle control and braking effectiveness.

Driving through water: do not drive through water on the road if it is deeper than 1 foot (30 cm), and then only at walking speed. Otherwise the vehicle can sustain damage to the engine, the electrical systems and the transmission. ◀

The concept

The Antilock Brake System (ABS) keeps the wheels from locking while braking, thereby enhancing active driving safety.

Braking with ABS

If you are in a situation that requires full braking, you will exploit the full benefits of the ABS system if you apply maximum brake pressure ("panic stop"). Since the vehicle maintains steering responsiveness, you can nevertheless avoid possible obstacles with a minimum of steering effort.

Pulsation at the brake pedal combines with sounds from the hydraulic circuits to indicate to the driver that ABS is in its active mode.

Cornering Brake Control (CBC)

CBC is an advanced engineering design of the ABS. When braking while cornering at high speed or braking during high lateral acceleration, or when braking during a lane change, vehicle stability is improved and steering response is enhanced.

Brake fluid level

Low brake fluid level in the reservoir combined with longer than usual pedal travel may indicate a defect in one of the brake system's hydraulic circuits.

 Proceed to the nearest BMW center. Higher brake application pressure may be necessary when stopping, and the vehicle may exhibit a slight tendency to pull to one side. Brake distances may even be longer. Please remember to adapt your driving style accordingly. ◀

Disc brakes

When the vehicle is driven only occasionally, during extended periods when the vehicle is not used at all, and in operating conditions where brake applications are less frequent, there is an increased tendency for corrosion of the rotors and accumulation of contamination on the brake pads. This occurs because the minimal pressure that must be exerted by the pads to clean the rotors by brake applications is not reached.

Corrosion on brake rotors is signaled by a running or pulsation during braking; even extended subsequent braking will not cure this phenomenon.

It is a good idea to periodically dry the brakes with a gentle application when driving in rain and on wet roads. Watch traffic conditions to ensure that this maneuver does not endanger other road users. The heat generated in this process helps dry the pads and rotors to ensure that your brake system will respond with undiminished efficiency when you need it.

Extended or steep mountain descents should be driven in the gear in which only minimal periodic brake applications are required. This helps avoid placing excessive loads on the brake system. Stay within the allowable engine speed range. For further information, refer to page 75.

 Do not coast with the clutch depressed or with the gearshift lever in idle position. Do not coast with the engine shut off. If you do so the engine provides no braking effect and there is no power assist for braking or steering when the engine is not running. ◀

Brake pads

 For your own safety: use only brake pads which BMW has approved for your specific vehicle model. BMW cannot evaluate non-approved brake pads to determine if they are suited for use, and therefore cannot ensure the operating safety of the vehicle if they are installed. ◀

Hardtop*

It is not necessary to remove the fabric top even in the winter, when the hardtop is generally in constant use. But you can also remove it at any time with no problem. Before the fabric top is stored in the convertible top compartment, it must be absolutely dry in order to avoid water spot and mildew from forming.

The hardtop offers reading lamps and clothing hooks that can be used just by pressing. In addition, a roof-rack assembly is possible. In this regard, please contact your BMW center.

 When suspending articles of clothing from the hooks, be sure that they will not obstruct the driver's vision. Do not hang heavy objects on the hooks. If you do so, they could cause personal injury during braking or evasive maneuvers. ◀

Hardtop*

Two people are required for installation or removal. Work with extreme caution in order to avoid paint damage and damage to the body or hardtop. To facilitate hardtop installation or removal, you can obtain a specially designed hardtop lift* or hardtop rack* at your BMW center.

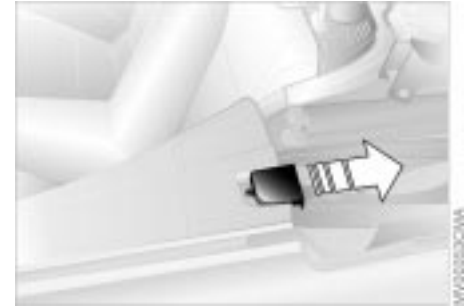

Storage

 Storing the hardtop on the floor: Shove the styrofoam block that came with the hardtop forward to its center. The arrow on top of the styrofoam block has to be pointing upward when you are doing this. ◀

Installation

1. Lower the side windows completely and flip the sun visors down. If necessary, remove the antenna rod to avoid any damage
2. Open the convertible top compartment lid slightly by pressing the button for the convertible top operation, refer to page [41](#)
3. Remove the trim pieces on both sides by pulling them off toward the back (arrow), and reclose the convertible top compartment lid

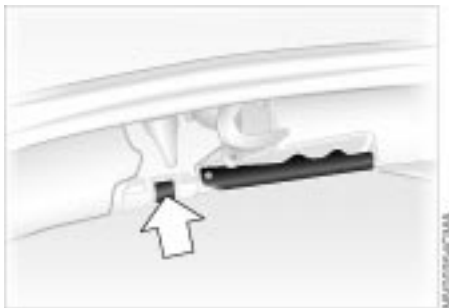

4. Open both front locking levers on the hardtop by pressing the buttons (arrow). The levers will release slightly. Raise the levers as far as the stop will allow



5. Before installing, first flip the cover panels that are located underneath the left and right interior lamps down. To do this, press on the slight bump on the cover panel. There is a holder in the cover panel to securely store the trim pieces 1 that have been removed
6. Open the red release lever as far as the stop will allow 2
7. Position the hardtop onto the supports with the help of a second person. Be sure to put the mountings exactly into the proper brackets



Lift the hardtop carefully. Be extremely careful not to shift the seals. Seals that have been shifted out of place or actually pulled out cause leaks. ◀

8. In the back, close the red locking levers by turning to the inside as far as the stop located behind the trim will allow. Flip the cover panels back into place
9. To lock the hardtop in the front, keep pressing on the front locking levers until you hear it engage.

Removal

Follow the same procedure as when installing, just reverse the steps.

Tire inflation pressure

Information for your safety

The factory-approved radial tires are matched to the vehicle and have been selected to provide optimum safety and driving comfort on your vehicle.

It is not merely the tire's service life, but also driving comfort and – above all else – driving safety that depend on the condition of the tires and the maintenance of the specified tire pressure.

Incorrect inflation pressure is a frequent cause of tire damage. It also significantly influences the roadholding ability of your BMW.

 Check tire inflation pressures on a regular basis (refer to page 24), at least every two weeks and before every long trip. If this is not done, incorrect tire pressures can cause driving instability and tire damage, ultimately resulting in accidents. ◀

Tire condition



Tire tread – tire damage

Inspect your tires frequently for tread wear, signs of damage and for foreign objects lodged in the tread. Check the tread depth.

Tread depth should not be allowed to go below 0.12 in (3 mm), even though the legally specified minimum tread depth is only 0.063 in (1.6 mm). Tread wear indicators (arrow) are embedded in the base of the tire's tread. Their locations are indicated by the legend "TWI" – Tread Wear Indicator – at various points on the tire's shoulder. When the tread reaches a depth of 0.063 in (1.6 mm), these indicators appear to signal that the tires have worn to the minimum legal level. Below 0.12 in (3 mm) tread depth, there is an increased risk of aquaplaning, even at

relatively moderate speeds and with only small amounts of water on the road.

 Do not drive on a deflated (flat) tire. A flat tire greatly impairs steering and braking response, and can lead to complete loss of control over the vehicle.

Avoid overloading the vehicle so that the permitted load on the tires is not exceeded. Overloading can lead to overheating and increases the rate at which damage develops inside the tires. You could have a blowout as a result. Unusual vibrations encountered during normal vehicle operation can indicate tire failure or some other vehicle defect. The type of problem can be caused by contact with curbs, etc. This is also true for irregularities in the vehicle's handling characteristics, such as a pronounced tendency to pull to the left or right. Should this occur, respond by immediately reducing your speed. Proceed carefully to the nearest BMW center or professional tire center, or have the vehicle towed in to have it and its wheels and tires inspected. Tire damage (up to and including blowouts) can endanger the lives of both the vehicle occupants and other road users. ◀

DOT Quality Grades

Treadwear
Traction AA A B C
Temperature A B C

 All passenger vehicle tires must conform to Federal Safety Requirements in addition to these grades. ◀

Treadwear

The treadwear grade is a comparative rating based on the wear rate of the tire when tested under controlled conditions on a specified government test course.

For example, a tire graded 150 would wear one and one-half (1 ½) times as well on the government course as a tire graded 100. The relative performance of tires depends upon the actual conditions of their use, however, and may depart significantly from the norm due to variations in driving habits, service practices and differences in road characteristics and climate.

Traction

The traction grades, from highest to lowest, are AA, A, B, and C. Those grades represent the tire's ability to stop on wet pavement as measured under controlled conditions on specified government test surfaces of asphalt and concrete. A tire marked C may have poor traction performance.

 The traction grade assigned to this tire is based on straight-ahead braking traction tests, and does not include acceleration, cornering, hydroplaning, or peak traction characteristics. ◀

Temperature

The temperature grades are A (the highest), B, and C, representing the tire's resistance to the generation of heat and its ability to dissipate heat when tested under controlled conditions on a specified indoor laboratory test wheel.

Sustained high temperature can cause the material of the tire to degenerate and reduce tire life, and excessive temperature can lead to sudden tire failure. The grade C corresponds to a level of performance which all passenger vehicle tires must meet under the Federal Motor Vehicle Safety Standard No. 109. Grades B and A represent higher levels of performance on the laboratory test wheel than the minimum required by law.

 The temperature grade for this tire is established for a tire that is properly inflated and not overloaded. Excessive speed, under-inflation, or excessive loading, either separately or in combination, can cause heat buildup and possible tire failure. ◀

Uniform Tire Quality Grading

Quality grades can be found where applicable on the tire sidewall between tread shoulder and maximum section width. For example:

Treadwear 200 Traction AA
Temperature A

Tire replacement

Tire age

BMW recommends the replacing of all tires after 6 years at the latest, even if a tire life of 10 years is possible.

The date on which the tire was manufactured is indicated by the code on the sidewall:

DOT ... 3501 indicates that the tire was manufactured in week 35 of the year 2001.

Following wheel/tire changes

Following wheel and/or tire changes you will need to reinitialize both the Flat Tire Monitor and the sequential M gearbox* SMG II, refer to pages [70](#), [83](#).

Wheel and tire combinations

The right choice



Never mount wheels and tires that have not been specifically approved by BMW for use on your particular model. Although other wheels and tires may theoretically have the same dimensions, variations in factors such as manufacturing tolerances can result in contact between tire and body-work, ultimately leading to serious accidents. If non-approved wheels and tires are used, BMW cannot evaluate their suitability, and therefore cannot be held liable for driving safety. ◀

BMW tests certain tire brands for each tire size, classifies them as road-safe and approves them. Consult your BMW center for more information. Observe any country-specific regulations, e.g. on making a corresponding entry in the vehicle documents.



The correct wheel and tire combination affects different systems such as ABS, DSC, Flat Tire Monitor. The function of these systems is impaired if improper wheel and tire combinations are used. Therefore, only use tires of the same brand and same tread configuration on the vehicle and, for example following a

tire failure, restore the approved wheel and tire combination as soon as possible. ◀



The use of rims and lug bolts that do not meet the specifications of the original factory-installed equipment will affect the safe operation of your vehicle and may cause an accident and personal injury.

Never mix tires of different design, such as steel-belted radials with radial bias-belted or bias-ply tires, etc. Mixing tire types will adversely affect roadholding and can lead to loss of vehicle control. ◀

Storage

Store wheels and tires in a cool, dry place, protecting them against light whenever possible. Protect the tires against contact with oil, grease and fuel.

Choosing the right tire

BMW recommends winter tires (M+S radial tires) for driving in adverse winter road conditions. So-called all-season tires with the M+S identification mark do indeed possess better winter traction than summer tires that have the H, V, W, Y and ZR speed ratings, they generally fail to provide the same levels of performance as snow tires.

In the interests of safe tracking and steering response, install radial tires made by the same manufacturer and with the same tread configuration on all four wheels if you elect to mount winter tires.

 When mounting winter wheels, observe the different recess on the front and rear wheels, as otherwise damage may result. ◀

Do not exceed specified maximum speeds

 Never exceed the maximum speed for which the tires are rated.

Unprofessional attempts by laymen to service tires can lead to damage and accidents.

Have this work performed by skilled professionals only. Your BMW center will be glad to assist you with both their expertise and the proper equipment for your vehicle. ◀

Tire condition, tire pressure

Once winter tires wear to a tread depth of less than 0.16 inches (4 mm), their performance under winter driving conditions deteriorates noticeably.

Worn tires should therefore be replaced for safety considerations.

Comply with the specified tire inflation pressures – and be sure to have the wheel and tire assemblies balanced every time you change the tires.

Snow chains*

The use of fine-link BMW snow chains is only permitted in pairs with the winter tires on the rear wheels. Comply with all manufacturer's safety precautions when mounting the chains. Do not exceed a maximum speed of 30 mph (50 km/h) with snow chains.

After mounting or removing snow chains, always reinitialize the sequential M gearbox* SMG II, refer to page [83](#).

 It is not possible to mount snow chains on tires with 18- and 19-inch wheels.

Deactivate the Flat Tire Monitor when using snow chains. Malfunction warnings and undetected losses in pressure are a possibility when driving with snow chains.

For further information, refer to page [82](#). ◀

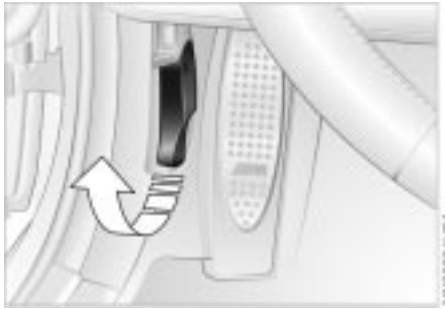

To unlock

Pull the lever located under the left-hand side of the instrument panel.

 Do not attempt to service your vehicle if you do not have the required technical background. Failure to work in an informed, professional manner when servicing components and materials constitutes a safety hazard for vehicle occupants and other road users. If you are not familiar with the guidelines, please have the operations performed by your BMW center. ◀



To open

Pull the release handle and open the hood.

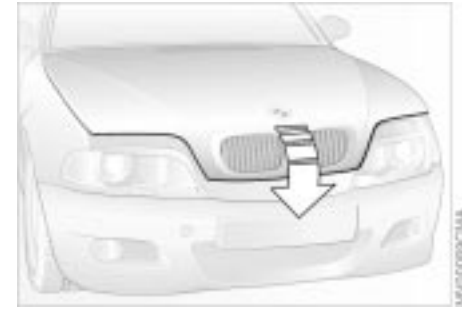

To close

Pull the hood downwards and allow the hood to fall from a minimum height of 12 in (30 cm) so that it audibly engages. Check for proper locking by pulling on the hood at the left and right above the headlamps.

 To avoid injuries, be sure that the travel path of the hood is clear when it is closed, as with all closing procedures. If it is determined that the hood is not completely closed while driving, stop immediately and close it securely. ◀

 It is not possible to accelerate from a standing stop using SMG II* when the hood is open. ◀

114 Engine compartment essentials

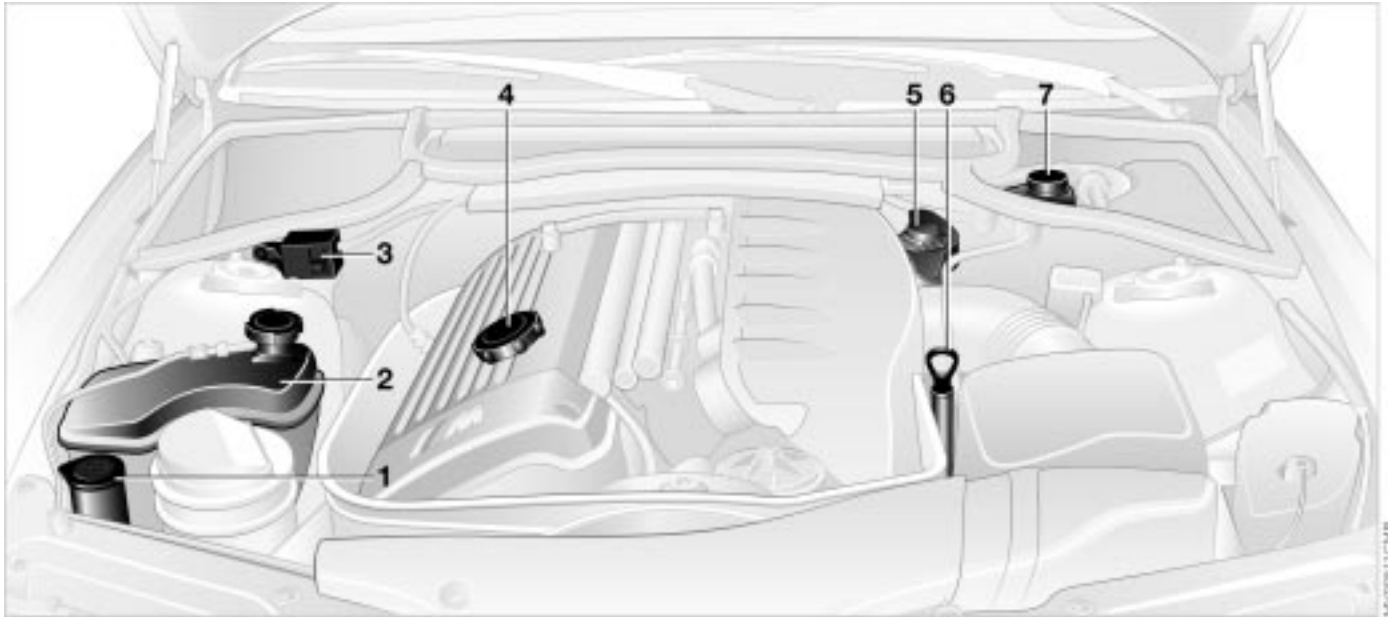

- 1 Filler neck for windshield and headlamp washer cleaning system [115](#)
- 2 Coolant expansion tank [118](#)
- 3 Positive terminal connection (for jump starting) (positive terminal) [137](#)

- 4 Engine oil filler neck [116](#)
- 5 Expansion tank for SMG* hydraulic unit (checking and possible refilling by your BMW center) [64](#)

- 6 Engine oil dipstick [116](#)
- 7 Filler neck for brake fluid [119](#)

Washer fluids



Antifreeze agent for the washer systems is inflammable. For this reason, keep it away from sources of flame and store it only in its original containers. Store it so that it is inaccessible to children. Comply with the instructions on the containers. ◀

Headlamp* and windshield washer system

Approximate capacity is 5.6 US quarts (5.3 liters).

Fill with water and – if required – with a washer antifreeze (according to manufacturer's recommendations).



We recommend that you mix the washer fluid before adding it to the reservoir. ◀



As with fuel economy, oil consumption is directly influenced by your driving style and vehicle operating conditions. The oil volume between the two marks on the dipstick corresponds to approx. 1.4 US quarts (1.3 liter).



Checking oil level

1. Park the vehicle on a level surface
2. With the engine warmed to its normal operating temperature, allow it to idle for at least 15 seconds, then switch off
3. After approx. 1 minute, pull the dipstick out and wipe it off with a clean lint-free cloth, paper towel, or similar material
4. Carefully push the dipstick all the way into the guide tube and pull it out again
5. The oil level should be between the two marks on the dipstick.

Adding engine oil

While you should wait until the level has dropped to just above the lower mark before adding oil, you should never allow the oil level to fall below this mark.

Do not fill beyond the upper mark on the dipstick. Excess oil will damage the engine.

Before checking the engine oil level after topping up, restart the engine and allow it to run to obtain a correct display. Then proceed as described under "Checking engine oil level".

Engine oil

 BMW engines are designed to operate without oil additives; the use of additives could lead to damage in some cases. This is also true for the manual transmission, the differential, and the power steering system. ◀

Recommendation: have the oil changed by your BMW center only.

 Continuous exposure to used oil has caused cancer in laboratory testing. For this reason, thoroughly wash any areas of skin that come into contact with oil using soap and water. Always store oils, grease and similar materials so that they are inaccessible to children. Comply with warning labels and information on containers. ◀

 Comply with the applicable environmental laws regulating the disposal of used oil. ◀

Prescribed engine oil

The quality of the engine oil is extremely important for the function and life of an engine. Based on extensive testing, BMW has approved only certain types of engine oils.

Use only oils approved for your vehicle model.

 Ask your BMW center for details concerning oils that have been approved. You can also call BMW of North America at 1-800-831-1117 or visit this website: www.bmwusa.com to obtain this information. ◀

Alternative oil types

Should it not be possible to purchase an oil approved by BMW, you can also use other oils for adding smaller quantities between oil changes as an exception. The following information must be specified on the package:

1. Viscosity
preferred: SAE 10W-60
or as an alternative: SAE 5W-40 or SAE 10W-40
2. Specification
preferred: API SJ/CF
or as an alternative: API SJ (also SK, SL, S etc.).

Low ambient temperatures

The oils used by BMW at the factory for your vehicle model can be used at virtually any ambient temperature.

However, if the vehicle is exposed to temperatures below -4°F (-20°C) for extended periods, please have your BMW center recommend a suitable oil.

 Do not add coolant to the cooling system when the engine is hot. If you attempt to do so, escaping coolant can cause burns.

To avoid the possibility of damage later on, never use anything other than factory-approved, nitrite and amino-free extended-duty antifreeze with corrosion inhibitor. Your BMW center is familiar with the official specifications. Antifreeze and anti-corrosion agents are hazardous to health. You should always store them in their original containers and in a location inaccessible to children. Extended-duty antifreeze with corrosion inhibitor contains ethylene glycol, a flammable substance. For this reason, do not spill extended-duty antifreeze with corrosion inhibitor on hot engine parts. It could catch fire and cause burns. ◀



Check the coolant level and add coolant

Check the coolant level when the engine is cold (approx. 68 °F or +20 °C).

1. Open the cap for the expansion tank by turning it slightly counterclockwise to allow accumulated pressure to escape. Then open
2. The coolant level is correct when the upper end of the red float is at least even with the upper edge of the filler neck (refer to the arrow in the illustration), but no more than 0.8 in (2 cm) above it – that is, up to the second mark on the float (refer also to the schematic diagram next to the filler neck)

3. If necessary, add coolant. If the coolant is low, slowly add coolant until the correct level is reached – do not overfill.

 Comply with the applicable environmental laws regulating the disposal of extended-duty antifreeze with corrosion inhibitor. ◀

Brake fluid

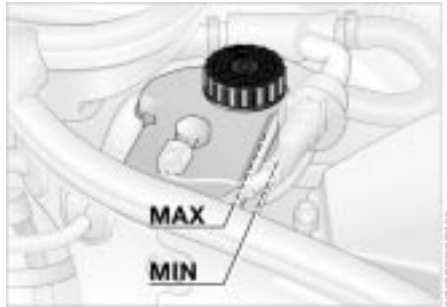

If the brake warning lamp comes on with the parking brake released: the brake fluid level is too low.



For adding brake fluid or for determining and correcting the cause of brake fluid loss, consult your BMW center. Your BMW center is familiar with the specifications for factory-approved brake fluids (DOT 4). Due to loss in brake fluid, pedal travel can lengthen and braking efficiency may be reduced. Comply with the information provided on page [105](#).



Brake fluid is hygroscopic, that is, it absorbs moisture from the air over time.

In order to ensure the safety and reliability of the brake system, have the brake fluid changed every two years by a BMW center. Refer also to the Service and Warranty Information Booklet (US models) or the Warranty and Service Guide Booklet (Canadian models).

Brake fluid is toxic and damages the vehicle's paint. You should always store it in its original container and in a location inaccessible to children.

Do not spill the fluid and do not fill the brake fluid reservoir beyond the "MAX" mark. The brake fluid could ignite upon contact with hot engine parts and cause serious burns. ◀



Comply with the applicable environmental laws regulating the disposal of brake fluid. ◀



The BMW Maintenance System has been designed as a reliable means of providing maximum driving and operating safety – and as cost-effectively as possible for you.

Please keep in mind that regular maintenance is not only necessary for the safety of your vehicle, but also plays a significant role in maintaining the resale value of the vehicle.

Service Interval Display

While conventional systems rely on distance traveled alone to determine when service is due, the BMW Maintenance System has for years considered the actual conditions under which the vehicle operates, because miles can be traveled in many different ways:

For example, 62,000 miles (100,000 km) short-distance driving are not equal to the same 62,000 miles (100,000) of long-distance travel.

The BMW Maintenance System includes the Engine Oil Service and Inspections I and II.

Determining the maintenance intervals according to the actual loads on the vehicle covers every kind of operating situation. Those who are outright "Sunday drivers," driving fewer than 6,000 miles (10,000 km) per year should, nevertheless have their oil changed every 2 years at the most, no matter what the Service Interval Display indicates, since engine oil breaks down over time, regardless of use.

Service and Warranty Information Booklet (US models)/Warranty and Service Guide Booklet (Canadian models)

For additional information on required maintenance intervals and procedures, please refer to the Service and Warranty Information Booklet (US models), or the Warranty and Service Guide Booklet (Canadian models).

As a precaution against corrosion, it is advisable to have the body checked for damage from rocks or gravel at the same time, depending upon operating conditions.

 Have your vehicle's maintenance and repairs performed at your BMW center. Be sure that all maintenance work is confirmed in the Service and Warranty Information Booklet (US models), or in the Warranty and Service Guide Booklet (Canadian models). These entries are your verification for the regular maintenance of your vehicle and are required for the performance of warranty repairs. ◀

Storing the vehicle

If the vehicle is to be stored for longer than three months, please follow the instructions in the "Caring for your vehicle" Manual.

Light-emitting diodes (LEDs)

Light-emitting diodes installed behind translucent lenses serve as the light source for many of the controls and displays in your vehicle. The concept behind their operation is related to that employed for lasers, and they are officially designated as Class 1 light-emitting diodes.

 Do not remove the protective lens and avoid staring directly at the unfiltered beam for extended periods (several hours), as inflammation of the iris could result. ◀

California laws require us to state the following warning:

 Engine exhaust, some of its constituents, and certain vehicle components contain or emit chemicals known to the State of California to cause cancer and birth defects or other reproductive harm. ◀

122 OBD interface socket



The Onboard Diagnostic (OBD) interface socket is located on the left of the driver's side at the bottom of the instrument panel and under a cover. The cover has the letters "OBD" on it.

The purpose of the OBD system is to assure proper emission-control system operation for the vehicle's lifetime by monitoring emission-related components and systems for deterioration and malfunction.



An illuminated lamp informs you of the need for service, not of the need to stop the vehicle.

However, the systems should be checked by your BMW center at the earliest possible opportunity.

If the indicator blinks or flashes, this indicates a high level of engine misfire.

Reduce speed and contact your nearest BMW center immediately. Severe engine misfiring over even a short period of time can seriously damage emission-control system components, especially the catalytic converter.



Service Engine Soon warning lamp for Canadian models.



If the fuel filler cap is not on tight enough, the OBD system can detect leaking vapor and the indicator will light up. If the fuel filler cap is then tightened, the indicator will usually go out after a short period of time. ◀





Overview

Controls and features

Operation, maintenance

Owner service procedures

Technical data

Index

Overview

Controls

Maintenance

Repairs

Data

Index



The onboard tool kit is located in the luggage compartment lid.

Loosen the wingnut to open.

Location the tow fitting, refer to page, [138](#).

Wiper blades



1. Rotate the wiper arm completely out from the windshield
2. Position the wiper blade at an angle and pull the release spring (arrow)
3. Fold the wiper blade down and unhook it toward the windshield
4. Pull the wiper blade past the wiper arm toward the top
5. Insert a new wiper blade and apply pressure until you hear it engage.

 Use only wiper blades which have been approved by BMW. ◀

Lamps and bulbs

The lamps and bulbs make essential contributions to the safety of your vehicle. Therefore, comply fully with the following instructions during bulb replacement. If you are not familiar with any of the procedures, consult your BMW center.

 Do not touch the glass portion of a new bulb with your bare hands since even small amounts of impurities burn into the surface and reduce the service life of the bulb. Use a clean cloth, paper napkin, or a similar material, or hold the bulb by its metallic base. ◀

A replacement bulb set is available from your BMW center.

 Whenever working on the electrical system, switch off the electrical accessory you are working on or disconnect the cable from the negative terminal of the battery. Failure to do this could result in short circuits.

To prevent injuries and damage when changing a bulb, be sure to comply with any instructions provided by the bulb manufacturer. ◀

Lamps and bulbs

Low and high beams

- ▷ Low beams: H7 bulb, 55 watts
- ▷ High beams: H7 bulb, 55 watts



The H7 bulb is pressurized. Therefore, wear safety glasses and protective gloves. Failure to comply with this precaution could lead to injury if the bulb is damaged during replacement. ◀

Please contact a BMW center in case of a malfunction.

Parking lamps

5 watt bulb

Please contact a BMW center in case of a malfunction.

When caring for your headlamps please observe the notes and instructions contained in the "Care for your vehicle" Manual.

Xenon lamps*

The service life of these bulbs is very long and the probability of a failure is very low, provided that they are not switched on and off an unusual number of times. If one of these bulbs should nevertheless fail, it is possible to continue driving with great caution using the fog lamps, provided traffic laws in your area do not prohibit this.



Because of the extremely high voltages involved, any work on the lighting system should be carried out by technically-qualified personnel only. Otherwise, there is a risk of fatal injury. ◀

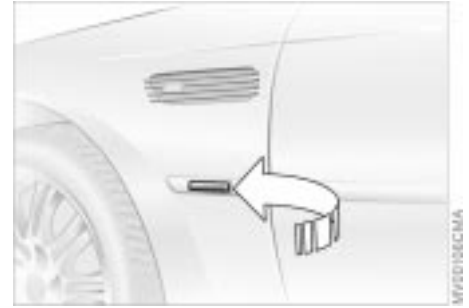

Turn signal indicator, front

21 watt bulb

1. Using a screwdriver, release the inner hook through the upper opening
2. Remove lamp by pulling it out toward the front
3. Applying light pressure, turn the bulb to the left. Remove and exchange the bulb

4. Insert the 2 pins on the lamp into the guides on the vehicle
5. Push the lamp in. Carefully apply pressure until you hear it snap into place.

Side turn signal indicators

5 watt bulb

1. Use finger pressure against the rear end of the lamp (arrow) to press it forward for removal
2. Apply gentle pressure to the bulb while turning it to the left to remove.



Front fog lamps

HB4 bulb, 51 watt

⚠ The bulb is pressurized. Therefore, wear safety glasses and protective gloves. Failure to comply with this precaution could lead to injury if the bulb is damaged during replacement. ◀

1. Pull out the cover around the headlamp toward the front
2. Loosen the screw (arrow) and swing the lamp assembly out
3. Release the spring on the back of the lamp and turn the cover to the left
4. Release the clamp, remove the contact base and replace the bulb.



Tail lamp assembly

Tail lamp 4: bulbs 21/4 watt

Remaining bulbs: 21 watt

- 1 Turn signal indicator
- 2 Backup lamp
- 3 Tail lamp
- 4 Tail lamp/brake lamp

yellow
yellow
red
red

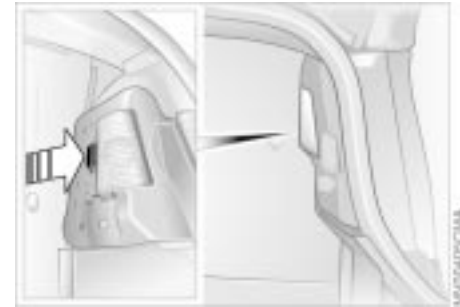

The illustration shows the right-hand luggage compartment opening.

Bulbs in the fender

All of the bulbs are integrated in a central bulb holder.

1. Release the bulb holder (arrow)

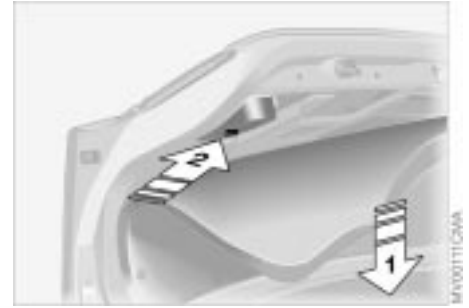
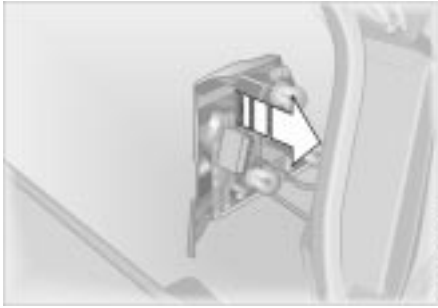

2. Take out the bulb holder
3. Unplug the power supply receptacle. Set the bulb holder aside (on the luggage compartment floor, for example)
4. Applying light pressure, turn the bulb to the left. Remove and exchange the bulb
5. Plug in the power supply receptacle
6. Reattach the bulb holder until you hear it snap into place (Illustration).

Bulbs in the luggage compartment lid

1. Using a screwdriver, loosen the clip

2. Fold the trim panel down (arrow 1). Disengage the bulb holder (arrow 2) and remove it
3. Applying light pressure, turn the bulb to the left. Remove and exchange the bulb
4. Press the bulb holder into position until you hear it engage
5. Reinstall the trim with the clip.



Center (high-mount) brake lamp

LED strip in luggage compartment lid.

Please contact a BMW center in case of a malfunction.

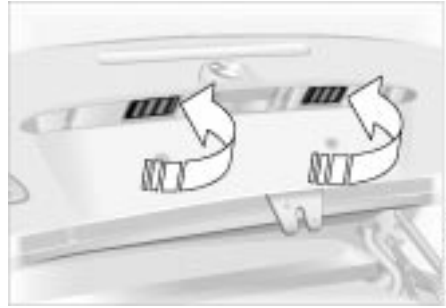

License plate lamps

5 watt bulb

1. Place a screwdriver in the slot and press toward the left (arrow) to release the lens
2. Replace the bulb.



Precautions in case of a flat tire: Stop the vehicle as far as possible from passing traffic; switch on the hazard warning flashers.

Turn the steering wheel to the straight-ahead position and engage the steering lock. Shift into 1st or reverse and engage the parking brake.

All passengers should be outside the vehicle and well away from your immediate working area (behind a guardrail, for instance).

If necessary, set up your warning triangle or portable hazard warning lamp on the roadside at an appropriate distance from the rear of the vehicle.

Comply with all safety guidelines and regulations. ◀

M Mobility system

You will find an M Mobility system in your BMW M3 convertible for repairing flat tires. With this system you can apply a sealing liquid to the inside of the tire that seals off the damaged point and then continue driving.

The M Mobility system makes transporting a spare wheel superfluous, thereby reducing the amount of weight you have to carry around.

Using the M Mobility system

To repair a flat tire using the M Mobility system, proceed as follows:

- ▷ Prepare the M Mobility system for use, refer to the next column
- ▷ This is part of the M Mobility system, refer to page [133](#)
- ▷ Filling with sealant, refer to page [133](#)
- ▷ Distributing sealant, refer to page [134](#)
- ▷ Inflating tire to correct pressure, refer to page [135](#).



Preparing the M Mobility system for use

The M Mobility system is located in the luggage compartment under the floor panel:

1. Lift the floor panel (refer to page [35](#))
2. Loosen the M Mobility system from its storage location.



Before you use the M Mobility system, read the warnings and danger notices on the device carefully. ◀

If possible, leave the foreign object in the tire.

Pull off the sticker 5 (refer to the second column on the right) for the speed limit and apply it to the steering wheel.

Repairing a flat tire

 Please note that the system's sealant container must be replaced every three years by your BMW center if the device is not used. ◀



This is part of the M Mobility system

- 1 On/Off switch
- 2 Connection hose with manometer for connecting the compressor with the sealant container or to connect the compressor to the wheel
- 3 Manometer for indicating the tire pressure
- 4 Connector hose from the sealant container to the wheel
- 5 Sticker with speed limit
- 6 Plug and cable for the cigarette lighter socket
- 7 Protective gloves (not shown)

Filling with sealant

1. Take off the round cover and take out hose 4. Unscrew the valve dust cap from the defective wheel and screw the hose to the valve. Keep the dust cap in a safe place



Distributing the sealant

Right afterward, drive at least 1.2 miles (2 km), so that the liquid sealant distributes evenly throughout the inside of the tire.

 Do not exceed a maximum speed of 40 mph (60 km/h). If possible, keep the vehicle speed above 10 mph (20 km/h). Stop in a suitable spot. ◀

2. Flip open the cover and pull out the enclosed protective gloves. Take out hose 2 with the manometer and screw it to the terminal for the sealant container as shown in the illustration
3. Make sure that the system has been switched off (position 0). Take out plug 6 and plug it into the cigarette lighter socket in the passenger compartment (refer to page 97)
4. Make sure that the screw on the rear of the pressure gauge 3 is tightened down. Turn on the M Mobility system (position I, refer to illustration) and allow minutes to elapse, to let the sealant flow in. It does not matter afterward, what the tire's inflation pressure is
5. Turn the sealant off. Disconnect the connector hose from the sealant container and the wheel valve. Stow the M Mobility system in the luggage compartment.



Inflating tire to correct pressure

1. Take out the hose with the pressure gauge and screw it onto the valve. Take the plug out and plug it into the cigarette lighter socket in the passenger compartment
2. Reset the air pressure to 29 psi (200 kilopascal), and:
 - ▷ Increase tire pressure: turn on the M Mobility system (position I). Turn the unit off while you check the current setting for the tire inflation pressure
 - ▷ Decrease tire pressure: turn the screw on the back of the manometer, a valve located there will open

▶ Even if the tire fails to hold the pressure, you should still carry out Step 3 before proceeding to drive the vehicle again, refer to "Distributing sealant" for more information. Then repeat Steps 1 through 3. The use of the M Mobility system may be ineffective if the damaged area in the tire is larger than approx. 0.16 in (4 mm). Please consult the nearest BMW center if the tire cannot be temporarily repaired with the M Mobility system. ◀

3. Unscrew the hose from the valve and stow the M Mobility system in the luggage compartment. Screw the dust cap onto the valve again.

⚠ Do not exceed the maximum speed limit described below, otherwise it could lead to accidents. ◀

When you start driving again, do not exceed the permissible maximum speed of 50 mph (80 km/h).

▶ You will find corresponding instructions for using the M Mobility system on the device. Replace the defective tire as soon as possible and have the new wheel balanced. Reinitialize the Flat Tire Monitor, and refer to page 83 for further information. Have the M Mobility system refilled. Contact your BMW center for this. ◀

Protect valve stems against dirt using screw-on dust caps. Dirty valve stems frequently lead to slow pressure loss.

 Battery posts, terminals, and related accessories contain lead and lead compounds. Wash hands after handling. ◀

Maintenance

The battery is completely maintenance-free. That means that the original battery acid will normally last for the service life of the battery under moderate climate conditions.

 For all questions that regard the battery, please consult your BMW center. Since the battery is absolutely maintenance-free, the following statements are for your information only. ◀

 Do not disconnect the battery when the engine is running. If you do so, the ensuing voltage surge will damage the vehicle's onboard electronics. ◀

Charging the battery

Charge the battery in the vehicle only when the engine is not running. Use the connections provided in the engine compartment (for correct connections, refer to "Jump-starting" on page 138).



Return used batteries to a recycling point or your BMW center. Maintain the battery in an upright position for transport and storage. Secure the battery against tilting in transit. ◀

Fuses

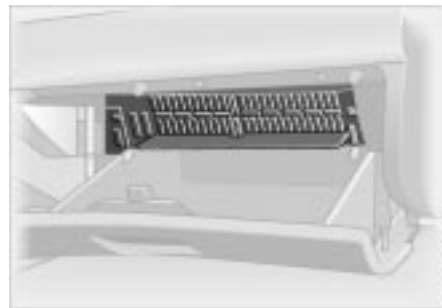

Open the glove compartment and turn the two white quick-release connections outward.

 Do not attempt to repair a burned fuse or replace it with a fuse having a different color or amperage rating. To do this could cause a fire in the vehicle resulting from a circuit overload. ◀

Jump-starting

Do not use spray starter fluids to start the engine.

When your battery is discharged you can use two jumper cables to start your vehicle with power from the battery in a second vehicle. You can also use the same method to help start another vehicle. Use only jumper cables with fully insulated handles on the terminal clamps.



Do not touch high-voltage wiring and cables on a running engine. There is a risk of fatal injury if you do this. Carefully observe the following instructions to avoid personal injury and/or damage to one or both vehicles. ◀

138 Jump-starting

1. Ensure that the battery in the support vehicle is also rated at 12 volts. This information is provided on the top of the battery casing
2. Do not disconnect your battery from your vehicle's electrical system. Switch off all electrical accessories in both vehicles
3. Make absolutely certain that there is no contact between the bodywork of the two vehicles – short circuit hazard
4. Start the engine on the support vehicle and allow it to run

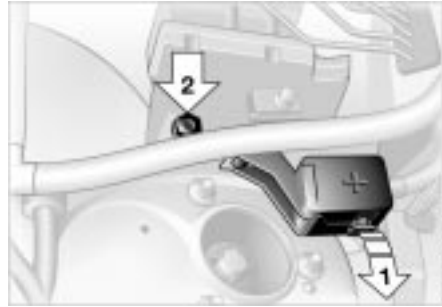

5. Use one jumper cable (+) to connect the positive terminal of the battery in the support vehicle with the auxiliary positive terminal provided in the engine compartment of your BMW specifically for jump-starting. The cover of the positive terminal connector is marked with a "+" sign. Refer to the illustration. Remove by pulling the tab (arrow 1)
6. Next, connect one end of the other jumper cable (-) to either the support vehicle's negative battery terminal or a suitable ground on its engine or bodywork. Connect the other end to the negative battery terminal or a suitable ground on the vehicle being started. There is a special nut provided for this on the BMW (arrow 2)

 Always adhere to this sequence when connecting jumper cables; failure to observe this procedure can lead to sparks at the battery terminals and pose an injury hazard. ◀

7. Allow the engine on the support vehicle to run at a fast idle for several minutes, then start the engine on the vehicle with the discharged battery in the usual manner. If the first start attempt is not successful, wait a few minutes before another attempt in order to allow the discharged battery to recharge
8. Allow the engines to run for several minutes before disconnecting the jumper cables
9. Then disconnect the jumper cables in the opposite order.

Have the battery recharged at your BMW center as required.

Towing the vehicle



Access to tow sockets

Front:

Press out the cover panel with a screwdriver above on the recess.



Rear:

Press out the cover panel with a screwdriver above on the recess.

Tow fitting

The tow fitting, which can be unscrewed, is in the luggage compartment under the floor mat and must remain in the vehicle. This fitting is designed for installation in the tow sockets located at the front and rear of the vehicle. It is intended for towing on paved road surfaces only.

It should not be used to pull a vehicle out of deep snow, mud, sand, etc. Comply with all applicable towing laws and regulations at all times.

 Screw the tow fitting in until it bottoms firmly. If this is not done, the threads could be damaged. Do not tow the vehicle by any components of the running gear, or lash them down in any way. If you do, the components could be damaged, leading to possible accidents. ◀

 Keep the vehicles in line and avoid towing at an offset angle. Ensure that the tow rope connecting the two vehicles is tight, with no slack, before starting off. ◀

140 Towing the vehicle

Use only a nylon towing strap to tow the vehicle, since the inherent resilience of this material helps protect both vehicles from sudden jerking movements.



The towed vehicle should always be the lighter of the two vehicles. If this is not the case, it will not be possible to control vehicle handling. ◀

Tow-starting

For instructions on jump-starting, refer to page [137](#).

Never attempt to use your vehicle to push another vehicle, since damage to the energy-absorbing bumpers could result.

Towing a vehicle

1. Gearshift lever in neutral
2. Towing speed:
Max. 45 mph (70 km/h)
3. Towing distance:
Max. 95 miles (150 km)
4. Leave the ignition key at position 1 to ensure that the brake lamps, turn signal indicators, horn and windshield wipers remain operative, and to prevent the steering lock detent from engaging
5. Switch on the hazard warning system (observe applicable legal regulations).

Find some means of identifying the vehicle in tow, for instance, place a sign or warning triangle in the rear window.



Make sure that the ignition key remains in position 1 even when the electrical system has failed to prevent the steering lock from engaging.

The steering and brakes are without power-assist when the engine is off. This means that increased effort is required for steering and braking. ◀

Vehicles with sequential M gearbox*
SMG II:

To push or tow, engage selector lever in position 0.



Never work on the vehicle with a driving position engaged. ◀

Towing the vehicle

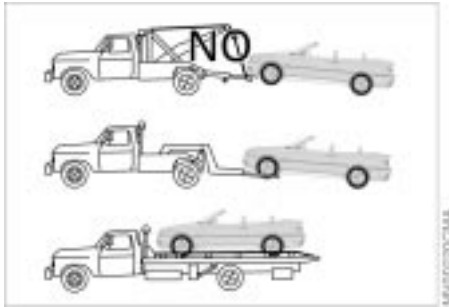

Towing with a commercial tow truck

- ▷ Do not tow with sling-type equipment
- ▷ Use wheel lift or flatbed equipment
- ▷ Please comply with applicable state towing laws



Never allow passengers to ride in a towed vehicle for any reason. Never attach tie-down hooks, chains, straps, or tow hooks to tie rods, control arms, or any other part of the vehicle suspension, as severe damage to these components will occur, leading to possible accidents. ◀



[Overview](#)[Controls and features](#)[Operation, maintenance](#)[Owner service procedures](#)[Technical data](#)[Index](#)

Overview

Controls

Maintenance

Repairs

Data

Index

144 Engine data

Displacement	cu in (cm ³)	198.1 (3,246)
Number of cylinders		6
Max. output at engine speed	hp (kW) rpm	333 (248) 7,900
Maximum torque at engine speed	lb ft (Nm) rpm	262 (355) 4,900
Compression ratio	ϵ	11.5
Stroke	in (mm)	3.58 (91)
Bore	in (mm)	3.43 (87)
Fuel-injection system	Digital electronic engine-management system	

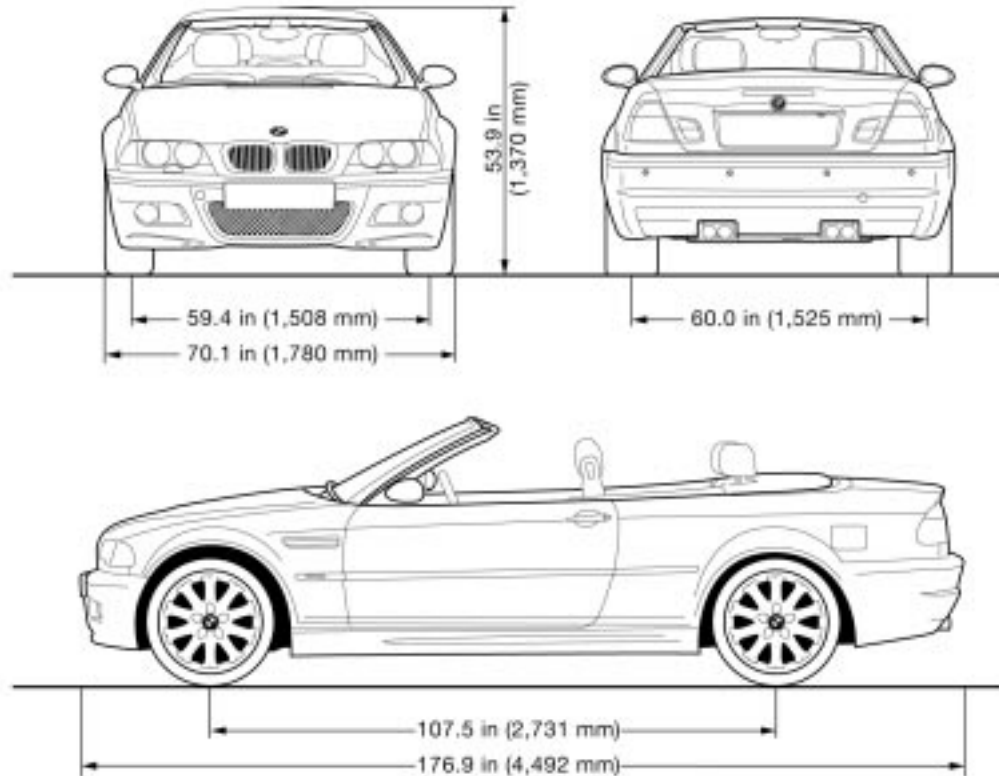

Minimum turning circle dia.: 36.1 feet (11.0 m)

146 Weights

Curb weight (with one person, ready for operation, full tank of fuel, options not included)	lbs (kg)	3,782 (1,715)
Approved gross vehicle weight	lbs (kg)	4,630 (2,100)
Approved front axle weight	lbs (kg)	2,183 (990)
Approved rear axle weight	lbs (kg)	2,579 (1,170)
Permissible roof weight for the hardtop	lbs (kg)	165 (75)
Luggage compartment capacity with the convertible top compartment raised	cu ft (l)	9.2 (260) 10.6 (300)

Approved axle weights and approved gross vehicle weight may not be exceeded.

			Notes
Fuel tank	gal. (liters)	approx. 16.6 (approx. 63)	Fuel specification: refer to page 24
Reserve	gal. (liters)	approx. 2.1 (approx. 8)	
Windshield washer system/ Headlamp washer system	quarts (liters)	approx. 5.6 (approx. 5.3)	For details: refer to page 115
Cooling system including heater circuit	quarts (liters)	approx. 9.9 (approx. 9.3)	For details: refer to page 118
Engine with oil filter change	quarts (liters)	approx. 5.3 (approx. 5.0)	For details: refer to page 117
Manual transmission	quarts (liters)	approx. 1.9 (approx. 1.8)	Oil change during running-in check and during each inspection II
Differential	quarts (liters)	approx. 1.2 (approx. 1.1)	Oil change during running-in check and during each inspection II

A B C

P Q R



Overview

Controls and features

Operation, maintenance

Owner service procedures

Technical data

Index

Overview

Controls

Maintenance

Repairs

Data

Index

Everything from A to Z

A

ABS (Antilock Brake System) [19](#), [105](#)
Accessories [10](#)
Activated-charcoal filter [94](#)
Adding
 brake fluid [119](#)
 coolant [118](#)
 engine oil [116](#)
 washer fluid [115](#)
Adjusting
 head restraints [46](#)
 lumbar support [45](#)
 mirrors [50](#)
 seats [45](#)
 steering wheel [50](#)
 temperature [89](#)
 thigh support [45](#)
Air conditioner [89](#), [93](#)
Air distribution [89](#)
 automatic [92](#)
Air outlets [88](#), [91](#)
Air pressure, tires [109](#)
Air supply [89](#), [92](#)
Airbags [52](#)
 warning lamp [18](#)

Alarm system [37](#)
 avoiding unintentional alarm [38](#)
 indicator lamp [38](#)
 interior motion sensor [37](#)
 tilt alarm sensor [37](#)
Antifreeze [118](#)
 radiator [118](#)
Antilock Brake System (ABS) [19](#), [105](#)
Anti-theft alarm system [37](#)
Anti-theft protection [28](#)
Approved weights [146](#)
Aquaplaning [105](#), [109](#)
Armrest [96](#)
Ashtray
 front [97](#)
 rear [97](#)
AUC (Automatic recirculated-air control) [93](#)
Automatic climate control [88](#), [91](#)
Automatic cruise control [73](#)
Automatic headlight control [85](#)
Automatic recirculated-air control (AUC) [93](#)

Automatic windshield washer [72](#)
Auxiliary terminal for jump-starting [114](#)
Average fuel consumption [79](#)
Average speed [79](#)
Avoiding unintentional alarm [38](#)

B





Backrest
 unlocking [47](#)
Backup lamps [64](#)
 bulb replacement [129](#)
Battery [136](#)
 add distilled water [136](#)
 charge current [17](#)
 charging [136](#)
 maintenance [136](#)
Belts [48](#)
Beverage holder [96](#)
Blower [89](#), [92](#)
BMW Maintenance System [120](#)
Bore [144](#)
Bottle holder, refer to beverage holder [96](#)

Brake fluid change [76](#)
Brake fluid level [105](#)
 indicator lamp [17](#)
Brake lamps
 bulb replacement [129](#)
 center [131](#)
Brake system
 brake fluid level [105](#)
 brake fluid level, warning lamp [105](#)
 brake pads [106](#)
 brake pads, indicator lamp [19](#)
 disc brakes [106](#)
 indicator lamp [17](#)
 malfunction [105](#)
Break-in procedure [104](#)
Bulbs and lamps [126](#)

C







California Proposition 65 Warning [121](#)
Can holder, refer to beverage holder [96](#)
Capacities [147](#)
Car care, refer to the "Caring for your vehicle" manual
Car telephone [96](#)

Everything from A to Z





- Car wash systems, refer to the "Caring for your vehicle" manual
 - Cargo loading 100
 - CBC (Cornering Brake Control) 105
 - Cellular phone 96
 - hands-free system 96
 - speaker 96
 - Center (high-mount) brake lamp 131
 - Center armrest 96
 - Central locking system 28
 - Check Control 77
 - Checking engine coolant level 118 
 - Checking engine oil level 116 
 - Child Seat Safety 57
 - Child-restraint systems 54
 - Cigarette lighter 97
 - Clean the headlamps 72
 - Cleaning windshield 72
 - Clock 77
 - also refer to the "Radio Owner's Manual" or to the "Onboard Computer Owner's Manual"
 - Cockpit 14
 - Coin box 96
 - Combination switch 70
 - Compression ratio 144
 - Computer
 - also refer to the "Onboard Computer Owner's Manual" 78
 - Configure personal settings, Vehicle Memory, Key Memory 60
 - Connecting electrical appliances 97
 - Connecting vacuum cleaner 97
 - Consumption display 76
 - Consumption, fuel 79
 - Control elements 14
 - Convertible top
 - electrical malfunction 42 
 - Coolant 118, 147
 - Coolant temperature gauge 76
 - Cooling system, capacities 147
 - Copyright 4
 - Cornering Brake Control (CBC) 105
 - Correct sitting position 44
 - Cruise control 73
 - Cruising range 79
 - Cup holder, refer to beverage holder 96
 - Curb weight 146
- ## D
- Dashboard lighting 86
 - Data
 - dimensions 145
 - engine 144
 - technical 144
 - weights 146
 - Daytime driving lamps 85
 - Deep water 105
 - Defroster, rear window 89
 - Defrosting the windows 92
 - Digital clock 77
 - also refer to the "Radio Owner's Manual"
 - Dimensions 145
 - Dimming inside rearview mirror 51
 - Dipstick, engine oil 116
 - Disc brakes 106
 - Displacement 144
 - Display lighting 86
 - Displays 15
 - Distance warning 80
 - Door key 28
 - Door mirror 50
 - Doors
 - electrical malfunction 29 
 - manual operation 29 
 - remote control 30
 - unlocking and locking 29
 - Draft-free ventilation 90, 94
 - Driving lamps 85
 - Driving notes
 - aquaplaning 105
 - brakes 105
 - disc brakes 106
 - in general 105
 - DSC (Dynamic Stability Control) 81
 - Dynamic Stability Control (DSC) 81
 - indicator lamp 19





Everything from A to Z

E

- Electric power windows 39
- Electrical accessories, failure 136 
- Electrical malfunction
 - convertible top 42 
 - doors 29 
 - fuel filler door 22 
 - luggage compartment lid 34 
- Electrical outlet 97
- Emergency release of luggage compartment lid from luggage compartment's interior 35
- Engine
 - coolant 118
 - coolant, capacity 147
 - data 144
 - displacement 144
 - output 144
 - starting 61 
 - torque 144
- Engine compartment 114
- Engine coolant, adding 118 

Engine oil

- add 116 
 - capacity 147
 - consumption 116
 - for low ambient temperatures 117
 - oil dip stick 116
 - pressure 17
 - quality 117
 - temperature 75
 - types 117
 - viscosity 117
 - Engine oil level
 - checking 114 
 - indicator lamp 19
 - Engine speed 144
 - Entering the rear of the vehicle 47
 - Entry toward rear 47
 - Eyelets, towing 139 
- ## F
- Failure messages 77
 - Filling capacities 147
 - Filling the washer reservoir 115 
 - First-aid kit 22

- Flat tire 109
 - repairing 132
- Flat Tire Monitor 82
 - indicator lamp 17, 19
- Fog lamps 86
 - bulb replacement 129 
- Follow me home lamps 85
- Footbrake, refer to brake system 106
- Front fog lamps 86
- Front head restraints 46
- Front seat adjusting 44
- Fuel 24
 - consumption display 76
 - gauge 76
 - preparation 144
- Fuel consumption 79
- Fuel filler door 22
 - electrical malfunction 22 
 - manual operation 22 
- Fuel gauge 76
- Fuel quality 24
- Fuel tank capacity 147
- Fuses, replacing 136 

G

- Gas gauge 76
- Gasoline 24
- Gearshift lever 63
- Glove compartment 95
- Grilles 88, 91
- Gross vehicle weight 146

H

- Handbrake 63
- Hardtop 106
- Hazard warning flashers 14
- Hazard warning triangle 22
- Head restraints 46
 - adjusting 46
- Headlamp cleaning system 114, 115
- Headlamp covers, care 127 
- Headlamp flasher 86
- Headlamp washer system, capacities 147
- Heated mirror 50
- Heated seats 49
- Heater and ventilation 88, 91
- Heavy loads 100

Height 145
 High beams 70, 86
 indicator lamp 20
 Holder for beverages 96
 Hood release 113 
 Horn 14





I
 Ice warning 78
 Identification mark,
 tires 111
 Ignition key 28
 Ignition key positions 61
 Ignition lock 61
 Imprint 4
 Independent ventilation
 system, refer to the
 "Onboard Computer
 Owner's Manual"
 Indicator lamps 17
 Individual settings, Vehicle
 Memory, Key Memory 60
 Inflation pressure, tires 109
 Inside rearview mirror
 automatic dimming 51
 INSPECTION 76
 Instrument cluster 15
 Instrument lighting 86
 Instrument panel 14

Interface socket
 for Onboard
 Diagnostics 122
 Interior lamps 31, 87
 remote control 31
 Interior motion
 sensor 37, 38
 deactivate 38
 Interior temperature,
 adjusting 89

J
 Jump-starting 137



K
 Key 28
 with remote control 28
 Key Memory 60

L
 Lamp switch 85
 Lamps
 daytime driving lamps 85
 fog lamps 86
 high beams 86
 interior lamps 87
 low beams 85
 parking lamps 85
 reading lamps 87
 standing lamps 86
 Lamps and bulbs 126
 Language selection, refer to
 the separate Owner's
 Manual
 Lashing eyes 101
 LATCH child-restraint
 system installation 56
 Leather care, refer to the
 "Care for your vehicle"
 manual
 Length 145
 License plate lamps, bulb
 replacement 131 
 Lighting, refer to lamps
 LIGHTS ON warning 85
 Load-securing devices 101
 Low ambient
 temperatures 117

Low beam headlamp
 bulb replacement 127 
 Low beams 85
 Lower convertible top
 compartment panel 37
 Luggage compartment 34
 bulb replacement 130 
 capacity 146
 increase volume 37
 lighting 34
 lower convertible top
 compartment panel 37
 open from inside 34
 open from outside 34
 open via remote
 control 31
 Luggage compartment
 lid 34
 electrical
 malfunction 34 
 emergency release from
 luggage compartment's
 interior 35
 manual operation 34 
 Luggage rack 101
 Lumbar support 45
 adjusting 45

Everything from A to Z

M

- M Engine dynamics
 - control [84](#)
- M Mobility system [132](#)
- M+S-tires [112](#)
- Maintenance [76](#), [120](#)
- Malfunction displays [77](#)
- Manual operation
 - convertible top [42](#) 
 - doors [29](#) 
 - fuel filler door [22](#)
 - luggage compartment lid [34](#) 
- Manual transmission [63](#)
- Master key [28](#)
- MFL (Multifunction steering wheel) [21](#)
- MFL (Multifunction steering wheel) [21](#)
- Microfilter [90](#), [94](#)
- Mirror [50](#)
 - inside rearview [51](#)
 - outside [50](#)
- Mirror memory [48](#)



Mirrors

- adjusting [50](#)
- automatic curb monitor [51](#)
- heating [50](#)
- Mobility system [132](#)
- Modifications,
 - technical [10](#), [121](#)
- Mounting the roof rack [106](#)
- Multifunction steering wheel (MFL) [21](#)

O

- OBD interface socket [122](#)
- Odometer [75](#)
- Oil
 - additives [117](#)
 - capacity [147](#)
 - consumption [116](#)
 - oil dipstick [116](#)
 - quality [117](#)
 - types [117](#)
 - viscosity [117](#)
- Oil change intervals, refer to the Service and Warranty Information Booklet (US models) or the Warranty and Service Guide Booklet (Canadian models)

Oil dipstick [116](#)







- Oil filter change [147](#)
- Oil level
 - checking [116](#) 
 - indicator lamp [19](#)
- Oil pressure, indicator lamp [17](#)
- OILSERVICE [76](#)
- Onboard Computer
 - also refer to the "Owner's Manual for Onboard Computer"
- Onboard tool kit [126](#) 
- Opening and closing
 - from inside [33](#)
 - via the door lock [29](#)
 - via the remote control [30](#)
- Operating vehicle at low ambient temperatures [117](#)
- Outlets, ventilation [88](#), [91](#)
- Output, engine [144](#)
- Outside temperature display [78](#)

P





- Paintwork, care, refer to the "Caring for your vehicle" manual
- Park Distance Control (PDC) [80](#)
- Parking brake [63](#)
- Parking help [80](#)
- Parking lamps [85](#)
 - bulb replacement [127](#) 
- PDC (Park Distance Control) [80](#)
- Pollen filter [90](#), [94](#)
- Power windows [39](#)
- Prevent accidental alarm [38](#)

R

- Radiator [147](#)
- Rain sensor [71](#)
- Reading lamps [87](#)
- Rear entry aid [47](#)
- Rear head restraints [46](#)
- Rear window
 - defroster [89](#), [93](#)
- Rearview mirror [50](#)
- Recirculated-air mode [89](#), [93](#)
- Reclining seat [44](#)

- Refueling 22
 - Releasing
 - fuel filler door following an electrical malfunction 22 
 - Remote control 30
 - Removing condensation from the windows 92
 - Replace windshield wiper blades 126 
 - Replacement key 28
 - Replacing bulbs 126 
 - Reporting safety defects 11
 - Restraint system 54
 - Rims 111
 - Rollover protection system 58
 - indicator lamp 20
 - lowering 58 
 - Roof load capacity 146
 - Roof-mounted luggage rack 101
- S**
- Safety belts 47, 48
 - Safety buttons 33
 - Seat adjustment
 - lumbar support 45
 - thigh support 45
 - Seat heating 49
 - Seat memory 48
 - Seat-integrated safety belts (SGS) 47
 - Seats
 - adjusting 44, 45
 - Secure glove compartment and luggage compartment separately 34
 - Securing cargo 100
 - Securing cargo in luggage compartment 101
 - Sequential M gearbox SMG II 64
 - Service and Warranty Information Booklet 120
 - Service Interval
 - Display 76, 120
 - Set clock 77
 - Set interior temperature 92
 - SGS (Seat-integrated safety belts) 47
- Side airbags 52**
- Side impact Head Protection System 52
 - Side turn signals
 - bulb replacement 128 
 - Ski bag 98
 - Snow chains 112
 - Spare key 28
 - Speedometer 15
 - identification 84
 - Standing lamps 86
 - Starting problems 62 
 - Steering lock 61
 - Steering wheel with multifunction buttons 21
 - Steering wheel, adjusting 50
 - Stopping the vehicle 62
 - Storage areas 96
 - Storage compartments 96
 - Stowing cargo 100
 - Stroke 144
 - Summer tires 111
 - Switching off the engine 62
 - Symbols, used 8
- T**
- Tachometer 75
 - Tail lamps 129
 - bulb replacement 129 
 - Tank capacity 147
 - Technical data 144
 - Technical
 - modifications 10, 121
 - Telephone hookup 96
 - Temperature display
 - ice warning 78
 - interior temperature 92
 - outside temperature 78
 - Temperature gauge
 - engine coolant 76
 - Temperature
 - layering 90, 94
 - Temperature, adjusting 89
 - Thigh support, adjusting 45
 - Third brake lamp 131
 - Tilt alarm sensor 38
 - deactivate 31
 - remote control 31
 - Tire inflation
 - pressures 24, 25, 109
 - Tire wear indicator 109

Everything from A to Z

Tires
 marking [111](#)
 profile [109](#)
 replacing [110](#)
Tires and wheels [111](#)
Tools [126](#)
Torque [144](#)
Towing eyelets [139](#)
Towing the vehicle [139](#)
Track [145](#)
Transmission [63](#)
Transporting children
 safely [54](#)
Tread depth, tires [109](#)
Trip odometer [75](#)
Trunk lid, refer to luggage
 compartment lid [34](#)
Turn signal indicator [70](#)
 bulb replacement [128](#)
 indicator lamp [20](#)
Turning radius [145](#)

U
Uniform Tire Quality
 Grading [110](#)
Upholstery material, refer to
 the "Caring for your
 vehicle" manual
Used batteries [136](#)

V
Vehicle battery [136](#)
Vehicle Memory [60](#)
Vehicle weight [146](#)
Ventilation [88](#), [91](#)
 draftfree [90](#), [94](#)
Ventilation while parked,
 refer to the "Onboard
 Computer Owner's
 Manual"

W
Warning lamps [17](#)
Warning messages [77](#)
Warranty and Service
 Guide [120](#)
Washing your vehicle, refer
 to the "Caring for your
 vehicle" manual
Water on roadways [105](#)
Wear indicator in the
 tires [109](#)

Weights [146](#)
Wheel and tire
 combinations [111](#)
Wheelbase [145](#)
Wheelslip control, refer to
 DSC [81](#)
Width [145](#)
Windows, convenience
 operation [29](#)
Windshield washer reservoir,
 capacities [147](#)
Windshield wiper [71](#)
Winter tires [112](#)
Wiper system [71](#)
Work in the engine
 compartment [113](#)

X
Xenon lamps [127](#)

Refueling

To ensure that you always have convenient access to all essential information when you stop for fuel, we recommend that you take the time to fill out the adjoining chart by entering the data that apply to your vehicle. Consult the index for individual specifications.

Fuel

Designation	
-------------	--

Please enter your preferred fuel here.

Engine oil

Quality	
---------	--

The oil quantity between the two marks on the dipstick is approx. 1.4 US quarts (1.3 liters).

Tire inflation pressures

	Summer tires		Winter tires	
	front	rear	front	rear
Up to 4 persons				
5 persons or 4 plus luggage				

More about BMW

bmwusa.com



The Ultimate
Driving Machine

M3 Convertible US-En