

Owner's Manual
for Vehicle



The Ultimate
Driving Machine



M6 Owner's Manual for Vehicle

Congratulations, and thank you for choosing a BMW M6.

Thorough familiarity with your vehicle will provide you with enhanced control and security when you drive it. We therefore have this request:

Please take the time to read this Owner's Manual and familiarize yourself with the information that we have compiled for you before starting off in your new vehicle. It contains important data and instructions intended to assist you in gaining maximum use and satisfaction from your BMW M6's unique range of technical features. The manual also contains information on maintenance designed to enhance operating safety and contribute to maintaining the value of your BMW M6 throughout an extended service life.

This manual is supplemented by a Service and Warranty Information Booklet for US models or a Warranty and Service Guide Booklet for Canadian models.

We wish you an enjoyable driving experience.

BMW AG

© 2006 Bayerische Motoren Werke
Aktiengesellschaft
Munich, Germany
Reprinting, including excerpts,
only with the written consent of
BMW AG, Munich.
Order No. 01 41 0 012 118
US English II/05, 06 03 500
Printed in Germany
Printed on environmentally friendly paper,
bleached without chlorine, suitable for recycling.

Contents

The fastest way to find specific topics is to use the index, refer to page [206](#).

Using this Owner's Manual

- 4 Notes
- 7 Reporting safety defects

At a glance

- 10 Cockpit
- 16 iDrive
- 22 Voice command system

Controls

- 28 Opening and closing
- 39 Adjustments
- 48 Transporting children safely
- 50 Driving
- 59 Everything under control
- 70 Technology for comfort, convenience and safety
- 80 Lamps
- 84 Climate
- 90 Practical interior accessories

Driving tips

- 98 Things to remember when driving

Navigation

- 106 Starting navigation system
- 107 Destination entry
- 118 Destination guidance
- 123 What to do if ...

Entertainment

- 126 On/off and tone
- 130 Radio
- 139 CD player and CD changer

Communications

- 148 Telephoning
- 161 TeleService, BMW Assist

Mobility

- 168 Refueling
- 170 Wheels and tires
- 175 Under the hood
- 180 Maintenance
- 182 Replacing components
- 191 Giving and receiving assistance

Reference

- 198 Technical data
- 201 Short commands of voice command system
- 206 Everything from A to Z

Notes

Using this Owner's Manual

We have made every effort to ensure that you are able to find what you need in this Owner's Manual as quickly as possible. The fastest way to find specific topics is to use the detailed index at the back of the manual. If you wish to gain an initial overview of your vehicle, you will find this in the first chapter.

Should you want to sell your BMW some day, please remember to hand over the Owner's Manual as well; it is an important component of your vehicle.

Additional sources of information

Should you have any other questions, your BMW center will be glad to advise you at any time.

You can find information on BMW, e.g. technology, on the Internet at www.bmwusa.com.

Symbols used

 Indicates precautions that must be followed precisely in order to avoid the possibility of personal injury and serious damage to the vehicle.

 Indicates information that will assist you in gaining the optimum benefit from your vehicle and enable you to care more effectively for your vehicle.

 Refers to measures that can be taken to help protect the environment.

◀ Marks the end of a specific item of information.

* Indicates special equipment, country-specific equipment and optional extras, as well as equipment and functions not yet available at the time of printing.

"..." Identifies Control Display texts used to select individual functions.

›...‹ Verbal instructions to use with the voice command system.

››...‹‹ Identifies the answers generated by the voice command system.

Symbols on vehicle components

 Indicates that you should consult the relevant section of this Owner's Manual for information on a particular part or assembly.

The individual vehicle

When purchasing your BMW, you have decided in favor of a model with individualized equipment and features. This Owner's Manual describes all equipment offered for the BMW M6.

Please bear in mind that the manual may contain information on accessories and equipment that you have not specified for your own vehicle. Sections describing options and special equipment are marked by asterisks * to assist you in identifying possible differences between the descriptions in this manual and your own vehicle's equipment.

If equipment in your BMW is not described in this Owner's Manual, please refer to the accompanying Supplementary Owner's Manuals.

Editorial notice

BMW pursues a policy of continuous, ongoing development that is conceived to ensure that our vehicles continue to embody the highest quality and safety standards combined with advanced, state-of-the-art technology. In isolated cases it is possible that the features described in this Owner's Manual could differ from those on your vehicle.

For your own safety

Maintenance and repairs

 Advanced technology, e.g. the use of modern materials and high-performance electronics, requires specially adapted maintenance and repair methods. Have corresponding work on your BMW performed only by your BMW center or a workshop that works according to BMW repair procedures with appropriately trained personnel. If this work is not carried out properly, there is a danger of subsequent damage and related safety hazards. ◀

California Proposition 65 Warning

California law requires us to issue the following warning:

 Engine exhaust and a wide variety of automobile components and parts, including components found in the interior furnishings in a vehicle, contain or emit chemicals known to the State of California to cause cancer and birth defects and reproductive harm. In addition, certain fluids contained in vehicles and certain products of component wear contain or emit chemicals known to the State of California to cause cancer and birth defects or other reproductive harm.

Battery posts, terminals and related accessories contain lead and lead compounds. Wash your hands after handling.

Used engine oil contains chemicals that have caused cancer in laboratory animals. Always protect your skin by washing thoroughly with soap and water. ◀

Parts and accessories

 For your own safety, use genuine parts and accessories approved by BMW.

When you purchase accessories tested and approved by BMW and Genuine BMW Parts, you simultaneously acquire the assurance that they have been thoroughly tested by BMW to ensure optimum performance when installed on your vehicle.

BMW warrants these parts to be free from defects in material and workmanship.

BMW will not accept any liability for damage resulting from installation of parts and accessories not approved by BMW.

BMW cannot test every product made by other manufacturers to verify if it can be used on a BMW safely and without risk to either the vehicle, its operation, or its occupants.

Genuine BMW Parts, BMW Accessories and other products approved by BMW, together with professional advice on using these items, are available from all BMW centers.

Installation and operation of non-BMW approved accessories such as alarms, radios, amplifiers, radar detectors, wheels, suspension components, brake dust shields, telephones, including operation of any mobile phone from within the vehicle without using an externally mounted antenna, or transceiver equipment, for instance, CBs, walkie-talkies, ham radios or similar accessories, may cause extensive damage to the vehicle, compromise its safety, interfere with the vehicle's electrical system or affect the validity of the BMW Limited Warranty. See your BMW center for additional information. ◀

 Maintenance, replacement, or repair of the emission control devices and systems may be performed by any automotive repair establishment or individual using any certified automotive part. ◀

Service and warranty

We recommend that you read this publication thoroughly.

Your BMW is covered by the following warranties:

- ▷ New Vehicle Limited Warranty
- ▷ Rust Perforation Limited Warranty
- ▷ Federal Emissions System Defect Warranty
- ▷ Federal Emissions Performance Warranty
- ▷ California Emission Control System Limited Warranty

Detailed information about these warranties is listed in the Service and Warranty Information Booklet for US models or in the Warranty and Service Guide Booklet for Canadian models.

Reporting safety defects

For U.S. customers

The following applies only to vehicles owned and operated in the US.

If you believe that your vehicle has a defect which could cause a crash or could cause injury or death, you should immediately inform the National Highway Traffic Safety Administration (NHTSA) in addition to notifying BMW of North America, LLC, P.O. Box 1227, Westwood, New Jersey 07675-1227, Telephone (800) 831-1117.

If NHTSA receives similar complaints, it may open an investigation, and if it finds that a safety defect exists in a group of vehicles, it may order a recall and remedy campaign. However, NHTSA cannot become involved in individual problems between you and your dealer or BMW of North America, LLC.

To contact NHTSA, you may call the Vehicle Safety Hotline toll-free at 1-800-327-4236 (TTY: 1-800-424-9153); go to <http://www.safercar.gov>; or write to: Administrator, NHTSA, 400 Seventh Street, SW., Washington, DC 20590. You can also obtain other information about motor vehicle safety from <http://www.safercar.gov>

For Canadian customers

Canadian customers who wish to report a safety-related defect to Transport Canada, Defect Investigations and Recalls, may telephone the toll free hotline 1-800-333-0510, or contact Transport Canada by mail at: Transport Canada, ASFAD, Place de Ville Tower C, 330 Sparks Street, Ottawa ON K1A 0N5.





At a glance





This overview of buttons, switches and displays is intended to familiarize you with your vehicle's operating environment. The section will also assist you in becoming acquainted with the control concepts and options available for operating the various systems.

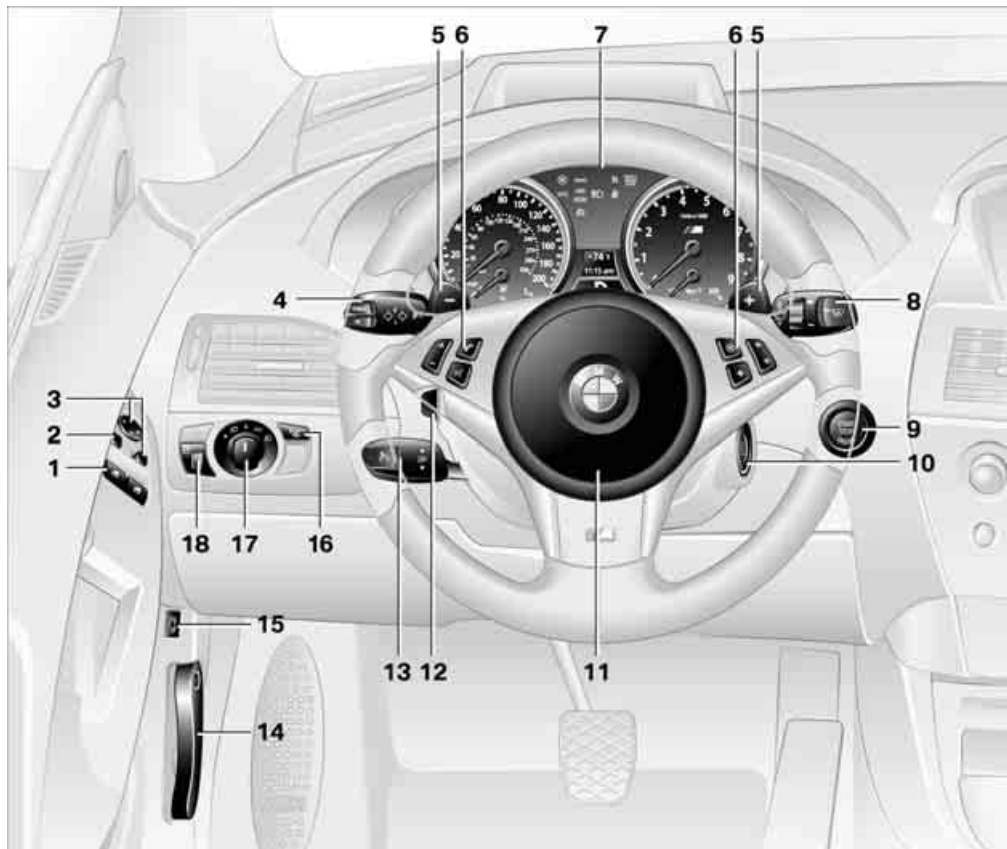







Cockpit





Around the steering wheel: controls and displays









- 1 Opening and closing windows [37](#)
- 2 Folding exterior mirrors in and out* [43](#)
- 3 Adjusting exterior mirrors [43](#)
Automatic parking function [44](#)

- 4  Turn signals [56](#)
-  High beams, headlamp flasher [81](#)
-  High-beam assistant* [81](#)
-  Roadside parking lamps [81](#)
- CHECK Check Control [64](#)
- BC Computer [60](#)

- 5 Shift paddles 54
- 6 Buttons on steering wheel
 -  Mobile phone* 148
 - ▷ Press: accepting and ending call, starting dialing* for selected phone number and redialing if no phone number is selected
 - ▷ Press longer: redialing
 -  +
Volume
 -  -
 -  Activating/deactivating voice command system* 22
 -  Changing radio station
Selecting music track
 -  Scrolling in phone book and in lists with stored phone numbers
 -  MDrive, call up individual settings 46
 -  Individually programmable 45

- 7 Instrument cluster 12
- 8  Windshield wipers 56
 -  Rain sensor 57
- 9  Starting/stopping engine and switching ignition on/off 50
- 10 Ignition lock 50
- 11 Horn: entire surface
- 12  Steering wheel adjustment 44
- 13  Cruise control 57

- 14 Releasing hood 175
- 15 Opening luggage compartment lid 33
- 16  Head-Up Display* 77
- 17  Parking lamps 80
 -  Low beams 80
 -  Automatic headlamp control 80
 -  Adaptive Head Light* 81
 -  High-beam assistant* 81
- 18  Instrument lighting 83

Instrument cluster

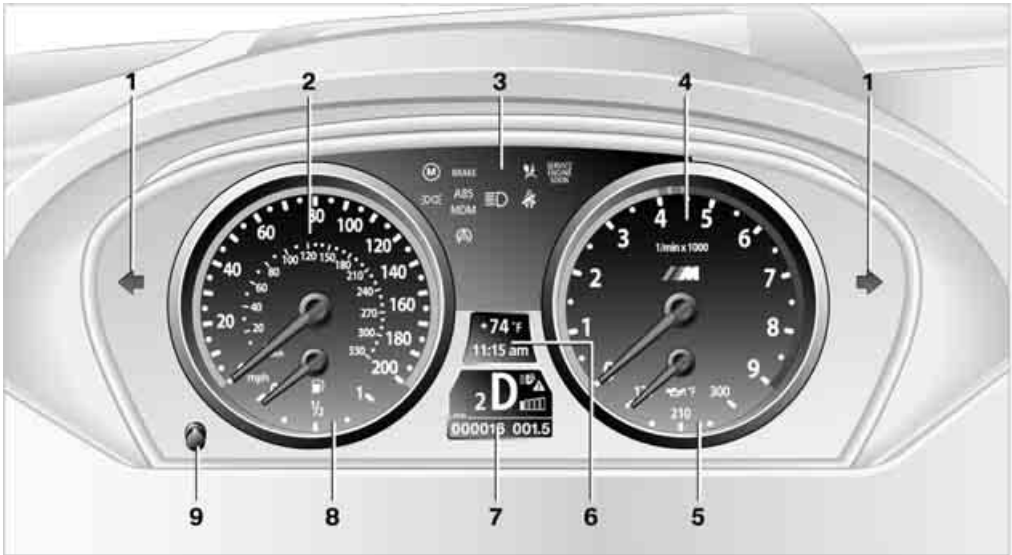

VINCENZI BORGARI

- | | |
|---|--|
| <p>1 Indicator lamps for turn signals</p> <p>2 Speedometer</p> <p>3 Indicator and warning lamps 13</p> <p>4 Tachometer 59</p> <p>5 Engine oil thermometer 60</p> <p>6 Display for</p> <ul style="list-style-type: none"> ▷ Computer 60 <li style="padding-left: 20px;">Engine oil level 176 ▷ Indicator and warning lamps 64 ▷ Speed of cruise control 58 | <p>7 Displays for</p> <ul style="list-style-type: none"> ▷ Sequential Manual Transmission with Drivelogic 53 ▷ Check Control message present 64 ▷ Odometer and trip odometer 59 ▷ Date and remaining distance to be driven for service requirements 63 ▷ High-beam assistant* 82 <p>8 Fuel gauge 60</p> <p>9 Resetting trip odometer 59</p> |
|---|--|

Indicator and warning lamps

The concept



Indicator and warning lamps can light up both in the display area **1** and in the display **2** in various combinations and colors.

When the engine is started or the ignition is switched on, some lamps are checked for proper operation and light up briefly in the process.

Explanatory text messages



Text messages at the bottom edge of the Control Display explain the meaning of the indicator and warning lamps displayed.

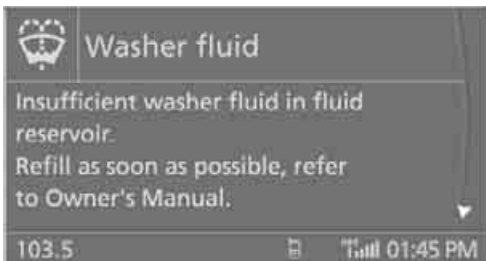

You can consult Check Control for additional information, e.g. regarding the cause of a mal-

function or the appropriate actions to take, refer to page 64.

In cases of corresponding urgency, this information is immediately displayed when the associated lamps light up.

Indicator lamps without text messages

The following indicator lamps in the display area **1** indicate that the associated functions are activated or deactivated:



MDrive 46



Handbrake set 52



Handbrake engaged for Canadian models



Parking lamps/low beams 80



M Dynamic Mode 72











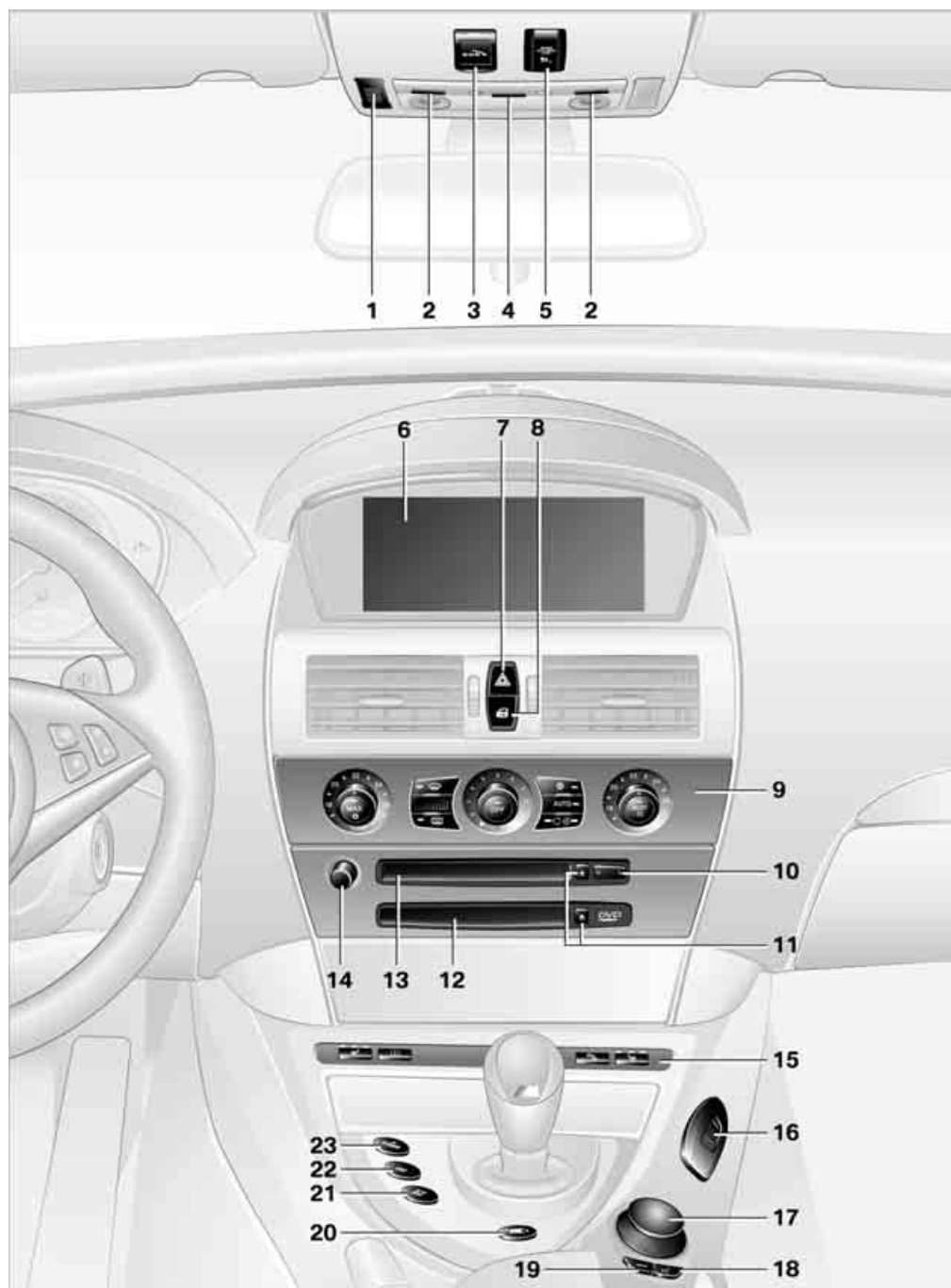



High beams/headlamp flasher 81





Lamp flashes:
DSC controls the drive and braking forces for maintaining vehicle stability 72

Around the center console: controls and displays



- 1 Microphone for handsfree mode for telephone* and for voice command system* 22
- 2 Reading lamps 83
- 3 Initiating an emergency call 191
- 4 Interior lamps 83
- 5 Indicator lamp for front passenger airbags 76
- 6 Control Display 16
- 7 Hazard warning flashers
- 8 Central locking system 32
- 9 Automatic climate control 84
 -  Temperature setting, left/right 84
 -  Automatic air distribution and volume 85
 -  Cooling function 86
 -  AUC Automatic recirculated-air control 87
 -  Recirculated-air mode 87
 -  Maximum cooling 86
 -  Residual heat mode 87
 -  Switching off automatic climate control 87
 -  Air volume 86
 -  Defrosting windows and removing condensation 86
 -  Rear window defroster 84

- 10 Changing
 - ▷ radio station 126
 - ▷ track 126
- 11 Ejecting
 - ▷ navigation DVD* 106
 - ▷ audio CD 126
- 12 Player for navigation DVD in Professional* navigation system 106

- 13 Drive for audio CDs 126
- 14 Entertainment sound output on/off and adjusting volume 126
- 15  Heated seats 43
 -  PDC Park Distance Control* 70
 -  Flat Tire Monitor 73
- 16 Bracket for cup holder 93
- 17 Controller 16
 - Turn, press or move horizontally in four directions
- 18 Activating voice command system* 22
- 19 Opening start menu on Control Display 17
- 20 Drivelogic of Sequential Manual Transmission 54
- 21 EDC Electronic Damping Control 73
- 22 DSC Dynamic Stability Control 71
- 23 M Engine Dynamic Control POWER 55

iDrive combines the functions of a multitude of switches. This allows these functions to be operated from a central position. The following section provides an introduction to basic menu

navigation. The control of individual functions is described in connection with the relevant equipment.

Controls

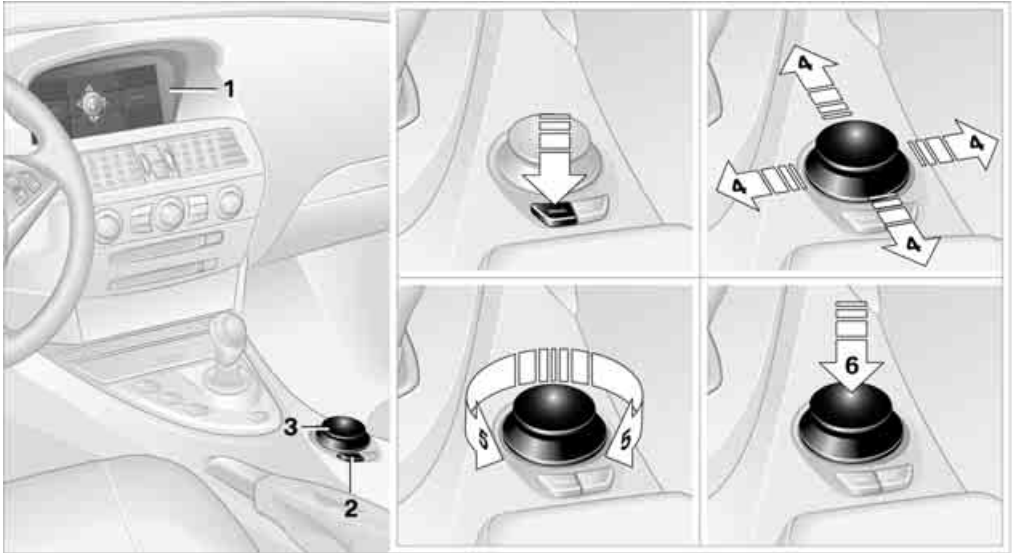

- 1 Control Display
- 2 **MENU** button
Opening the start menu
- 3 Controller
You can use the controller to select menu items and change settings by:
 - ▷ moving in four directions, arrows **4**
 - ▷ turning, arrow **5**
 - ▷ pressing, arrow **6**

⚠ To avoid becoming distracted and unnecessarily endangering both your own vehicle's occupants and other road users, never attempt to use the controls or make entries unless traffic and road conditions allow. ◀

Menu overview

Communication

- ▷ Telephone*
- ▷ BMW Assist* or TeleService*

Navigation or onboard information

- ▷ Navigation system*
- ▷ Onboard info, e.g. for displaying of the average fuel consumption

Entertainment

- ▷ Radio
- ▷ CD player and CD changer*

Climate

- ▷ Air distribution
- ▷ Automatic program
- ▷ Parked car ventilation

i menu

- ▷ Switching off the Control Display
- ▷ Tone and display settings
- ▷ Settings for your vehicle, e.g. for MDrive, or settings for the central locking system
- ▷ Display of service requirements and dates for statutory emission and vehicle inspections
- ▷ Settings for the telephone

Basic operation

From radio readiness, refer to page 50, the following message is shown on the Control Display:

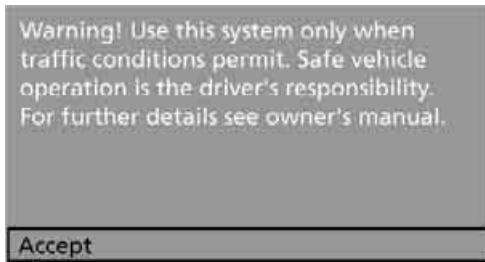

To clear the message:
Press the controller.
This displays the start menu.

On vehicles with a single drive, the message automatically disappears after approx. 10 seconds.

Start menu



You can call up all the functions of iDrive using five menu items.

Opening start menu

Press the **MENU** button.

To open the start menu from the **i** menu:

Press the **MENU** button twice.

Opening menu items of start menu

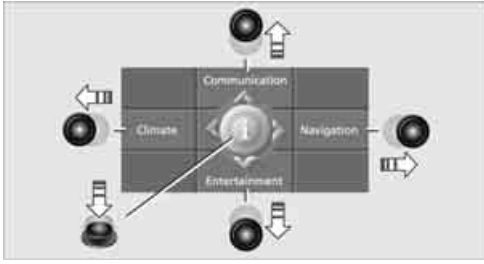

From the start menu, you can call up the four menu items Communication, Navigation, Entertainment, and Climate by moving the controller left, right, forward, or back.

You can open the **i** menu by pressing the controller.

Comfort opening of menu items

Convenience opening offers you the option of:

- ▶ Opening a menu item of the start menu in the view last selected
- ▶ Direct switching between Communication, Navigation, Entertainment and Climate without pressing the **MENU** button

To do so, move the controller in the corresponding direction and hold it for longer than approx. 2 seconds.

Displays in menu

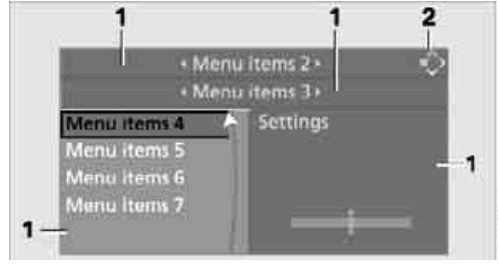

- 1 Each menu is divided into fields. The currently selected field appears brighter.
- 2 A symbol indicates the last selected menu item of the start menu:

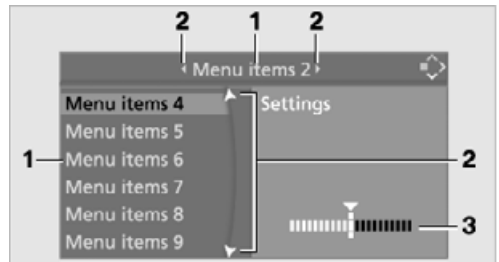
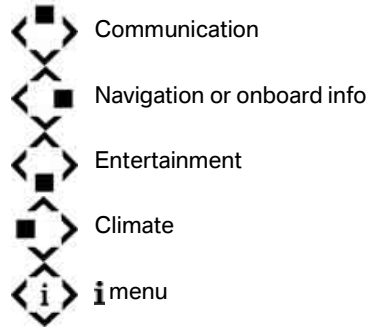

- 1 Menu items are usually grouped in horizontal or vertical lists.
- 2 Arrows indicate the possibility of accessing other menu items that are not currently visible.
- 3 Settings are displayed graphically or numerically.

Operating principle at a glance

Basic operation via iDrive is described in this view.

You can view the individual steps under Settings on Control Display, Setting time, refer to page 68.

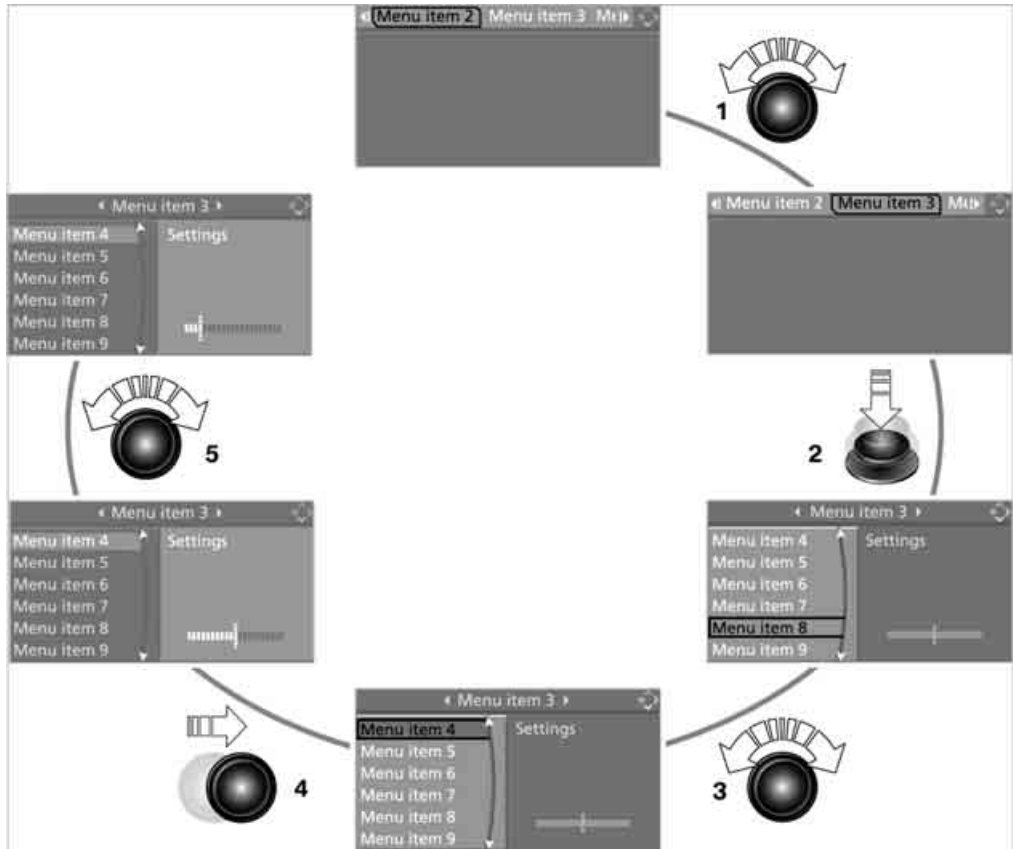

- 1 Selecting menu item:**
 - ▶ Turn controller; marking moves
 - ▶ Menu items shown in white can be selected by marking
- 2 Activating a menu item:**
 - ▶ Press controller
 - ▶ New menu items are displayed or function is carried out
- 3 Selecting a menu item: refer to 1**
- 4 Changing between fields:**
 - ▶ Briefly move controller left, right, forward or back
 - ▶ Release controller
 - ▶ Active field appears lighter
- 5 Adjusting settings:**
 - ▶ Turn controller
 - ▶ Graphic display, numerical value or text displays can be changed
 - ▶ Confirmation by changing field

Status information

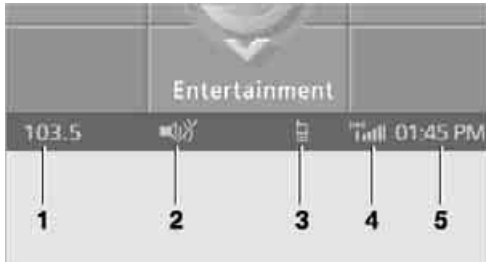

- 1 Display for:
 - ▷ Entertainment: Radio, CD
 - ▷ Telephone* in "Communication": Name of linked mobile phone, network search or no network
 - ▷ "BMW Assist"*: Existing voice connection with a service from BMW Assist
- 2 Entertainment sound output off
- 3 Display for:
 - ▷ New entries present in "Missed calls"*
 - ▷ Roaming active
- 4 Telephoning* possible if the mobile phone is logged-on in the vehicle
 Mobile phone network reception strength, display dependent on mobile phone
- 5 Time

Other displays:

When Check Control information appears or entries are made via the voice command system*, the status information is temporarily hidden.

Assistance window*



Additional information can be displayed in the assistance window:

- ▷ the computer or the trip computer
- ▷ the arrow or map view with a navigation system*
- ▷ the current position

Selecting displays

1. Move the controller to the right to switch to the assistance window and press the controller.

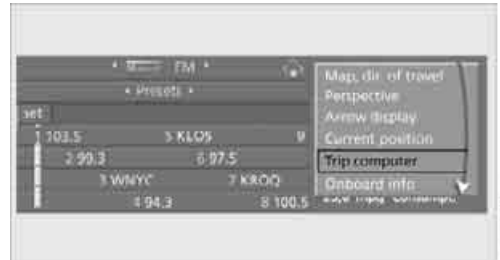

2. Select a menu item.
3. Press the controller.

Switching assistance window on/off

1. Move the controller to the right to switch to the assistance window and press the controller.
2. Select "Assist. window off" and press the controller.



To switch on, change to the assistance window and press the controller.

Switching Control Display on/off

1. Press the **MENU** button.
This opens the start menu.
2. Press the controller to open the **i** menu.
3. Select "Display off" and press the controller.



To switch on, press the controller.

Voice command system*

The concept

The voice command system allows you to control operation of various vehicle systems without ever removing your hands from the steering wheel.

Individual menu items on the Control Display can be spoken as commands. This frees you of having to use the controller.

The voice command system transforms your spoken commands into control signals for the selected systems and provides support in the form of instructions or questions.

The voice command system includes a special microphone.

The microphone is located near the interior rearview mirror, refer to page 14.

Prerequisite

In order to enable identification of the commands to be spoken, use iDrive to set the language for the voice command system. Setting iDrive language, refer to page 69.

Symbols in Owner's Manual

- ›...‹ Say the specified commands word for word.
- ››...‹‹ Indicates the responses of the voice command system.

Voice commands

Activating voice command system

1. Press the  button.

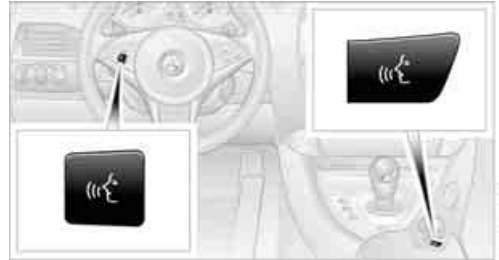

-  This symbol on the Control Display and an acoustic signal tell you that the voice command system can respond to commands.



2. Say the command.
The command is displayed on the Control Display.



-  This symbol is shown on the Control Display when you can input additional commands.

If no other commands are possible, then operate the equipment using iDrive.

Terminating or canceling voice input

Press the  button on the steering wheel or in the center console or

 ›Cancel‹

Commands

Having possible commands read aloud

You can have the system read aloud the possible commands related to the selected menu item on the Control Display.

To have the system list the possible commands:

 ›Options‹

For example, if you have selected "CD", the system will read aloud the possible commands for operating the CD player and the CD changer*.

Opening help

 ›Help‹

Using alternative commands

There are often several commands for running a function, e.g.:

 ›Radio on‹ or ›Turn radio on‹

Running functions directly with short commands

You can use short commands to carry out certain functions directly, regardless of which menu item is selected, refer to page 201.

Opening start menu

 ›Main menu‹

An example: selecting a track

1. Switch on Entertainment sound output if necessary.
2. Press the  button on the steering wheel or in the center console.

 3. ›Entertainment‹
The system says:
››Entertainment‹‹



 4. ›CD‹
The system says:
››CD player switched on‹‹



5. Press the  button on the steering wheel or in the center console.

 6. Select a track, e.g.:
›Track 1‹
The system says:
››Track 1‹‹



Notes



The mobile phone can also be operated with voice commands, refer to page 156. ◀

For voice commands, bear the following in mind:

- ▷ Say the commands and numbers smoothly and at normal volume, avoiding excessive emphasis and pauses. This also applies to spelling when entering the destination.
- ▷ Always say the commands in the language of voice command system.
- ▷ When selecting a radio station, use the usual pronunciation of the station name.
- ▷ For entries in the voice-activated phone book, only use names in the language of the voice command system and no abbreviations.
- ▷ Keep the doors and windows closed to prevent interference from ambient noise.
- ▷ Avoid background noises in the vehicle while speaking.





Controls

This chapter is intended to provide you with information for complete control of your vehicle. Its extensive array of features and accessories, both for driving and for your own safety, comfort and convenience, are described here.

Opening and closing

Keys/remote control



- 1 Remote control with integrated key
- 2 Spare key
- 3 Adapter for spare key, in glove compartment

Remote control with integrated key

Each remote control contains a battery which is automatically charged in the ignition lock while driving. Drive a longer distance with each remote control at least twice a year to keep the battery charged. For comfort access*, the remote control contains a replaceable battery, refer to page 37.

Depending on which remote control is detected by the vehicle during unlocking, different settings are called up and carried out in the vehicle, refer to Personal Profile, page 29.

Information on the required maintenance is also stored in the remote control, refer to Service data in remote control, page 180.

Integrated key



Press the button 1 to unlock the key.

The integrated key fits the following locks:

- ▷ Hotel function, refer to page 33
- ▷ Driver's door, refer to page 32
- ▷ Luggage compartment lid, refer to page 33.

New remote controls

To obtain additional or replace lost keys, new remote controls with an integrated key are available at your BMW center.

Spare key

Store the spare key in a safe place such as your wallet. This key is not intended for regular use.

The spare key and integrated key of the remote control fit the same locks.

Adapter for spare key

The adapter is required so that the vehicle can be started with the spare key or radio readiness can be switched on.



Remove the adapter from the holder in the glove compartment and slide the spare key into the adapter before use.

Personal Profile

The concept

You can set a number of functions of your BMW individually according to your preferences. Personal Profile ensures that most of these settings are stored for the remote control currently in use without you having to do anything. When the vehicle is unlocked, the corresponding remote control is detected and the settings stored for it are called up and carried out.

This means that you will always find your BMW set to your own personal settings even if another person with his/her own remote control and settings has used the vehicle since the last time you drove it. The individual settings are stored for a maximum of four remote controls.

Personal Profile settings

Details on the settings are provided on the specified pages.

- ▷ When unlocking with the remote control, either unlock only the driver's door or unlock the entire vehicle, refer to page [30](#)
- ▷ Locking the vehicle after a short time or after starting to drive, refer to page [33](#)
- ▷ Assigning the programmable button on the steering wheel, refer to page [45](#)
- ▷ Individual settings for MDrive, refer to page [46](#)

- ▷ Settings for the display on the Control Display:
 - ▷ Brightness of the Control Display, refer to page [69](#)
 - ▷ Units of measure for consumption, route/distances, temperature and pressure, refer to page [69](#)
 - ▷ Language on the Control Display, refer to page [69](#)
 - ▷ 12h/24h clock mode, refer to page [68](#)
 - ▷ Date format, refer to page [69](#)
- ▷ Drivelogic driving program in the Sequential mode, refer to page [54](#)
- ▷ Showing optical warning for PDC Park Distance Control*, refer to page [70](#)
- ▷ Selection and brightness of the display for the Head-Up Display*, refer to page [77](#)
- ▷ Air distribution, temperature in the upper body region, and intensity for the automatic climate control, refer to page [85](#)
- ▷ Adjusting the voice instructions for the destination guidance of the navigation system*, refer to page [121](#)

The most recent settings for the following are also called up during unlocking:

- ▷ Driver's seat, exterior-mirror and steering-wheel position, refer to page [40](#)
- ▷ Audio sources, setting volume and tone, refer to page [127](#)
- ▷ The display of the stored stations for the radio, refer to page [130](#)
- ▷ The volume setting for the telephone, refer to page [152](#)

Central locking system

The concept

The central locking system is ready for operation whenever the driver's door is closed.

The system either locks or unlocks all of the following:

- ▷ Doors

- ▷ Compartment in the front center console
- ▷ Luggage compartment lid
- ▷ Fuel filler door

Operating from outside

- ▷ via the remote control
- ▷ via the door lock
- ▷ with comfort access* via the door handles

These actions operate the anti-theft system at the same time. It prevents the doors from being unlocked using the lock buttons or door handles. The interior lamps and the courtesy lamps are also switched on and off with the remote control. The alarm system is armed/disarmed at the same time.

You can find more detailed information on the alarm system on page 35.

Operating from inside

Via the central locking button, refer to page 32. The fuel filler door and the compartment in the front center console are not locked, refer to page 32.

In the event of a serious accident, the central locking system unlocks automatically. The hazard warning flashers and interior lamps are also switched on.

Opening and closing: from outside

Using remote control

 Because any persons or animals left unattended in a parked vehicle could lock the doors from the inside, you should always keep the remote control with you when you leave the vehicle; this precaution ensures that you will remain able to unlock the vehicle from the outside at all times. ◀

Unlocking

Press the  button.



Use it to unlock the vehicle according to current settings.

You can set how the vehicle is unlocked. The setting is stored for the remote control currently in use.

iDrive, for explanation of principle, refer to page 16.

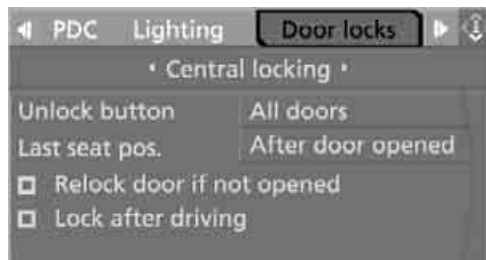
1. Press the **MENU** button.
This opens the start menu.
2. Press the controller to open the **i** menu.
3. Select "Vehicle settings" and press the controller.
4. Select "Door locks" and press the controller.



5. Select "Central locking" and press the controller.
6. Select "Unlock button" and press the controller.
7. Select a menu item:
 - ▷ "All doors"
Press the  button once to unlock the entire vehicle.
 - ▷ "Driver's door only"*
Press the  button once to unlock only the driver's door and the fuel filler door. Press the button twice to unlock the entire vehicle.



8. Press the controller.

Convenience opening mode

Press the  button longer:

The windows are opened.

Locking doors

Press the  LOCK button.

Switching on interior lamps

With vehicle locked:

Press the  LOCK button.

You can also use this function to locate your vehicle in parking garages etc.

Panic mode*

You can also trigger the alarm system in case of danger:

Press the  button for at least 3 seconds.

To switch off alarm: press any button.

Opening luggage compartment lid

Press the  button for approx. 1 second.

The luggage compartment lid opens, regardless of whether it was previously locked or unlocked.

 A previously locked luggage compartment lid is also locked again after closing. During opening, the luggage compartment lid pivots back and up. Make sure there is sufficient clearance. ◀

Setting confirmation signals

You can vary or also deactivate the confirmation signals for locking or unlocking.

1. Open the start menu.
2. Press the controller to open the  menu.
3. Select "Vehicle settings" and press the controller.
4. Select "Door locks" and press the controller.

5. Select "Confirmation" and press the controller.



6. Select the desired signal.
7. Press the controller.
 The signal is activated.

Malfunctions

The remote control may malfunction due to local radio waves. Should the remote control fail to operate owing to interference of this kind, unlock and lock the vehicle via the door lock using a key.

If it is no longer possible to lock the vehicle using the remote control, then the battery is discharged. Use this remote control during an extended drive; this will recharge the battery, refer to page 28.

For US owners only

The transmitter and receiver units comply with part 15 of the FCC/Federal Communication Commission regulations. Operation is governed by the following:

FCC ID:
LX8766S
LX8766E
LX8CAS
LX8CAS2

Compliance statement:

This device complies with part 15 of the FCC Rules. Operation is subject to the following two conditions:

- ▶ This device may not cause harmful interference, and

- ▷ this device must accept any interference received, including interference that may cause undesired operation.

 Any unauthorized modifications or changes to these devices could void the user's authority to operate this equipment. ◀

Using door lock

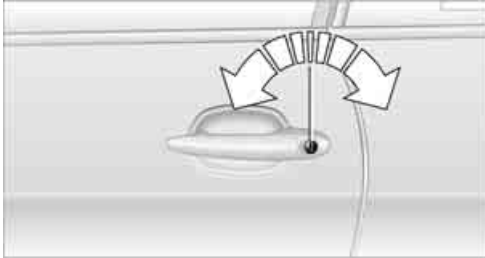

When unlocking

1. Turning the key once unlocks the driver's door and the fuel filler door.
2. A second turn of the key unlocks the passenger door and luggage compartment lid.

Convenience operation

The windows can also be operated with the door lock.

Turn and hold the key in the positions for unlocking or locking.

 Watch during the closing process to be sure that no one is injured. Releasing the key stops the operation. ◀

Manual operation

In the event of an electrical malfunction, you can turn a key all the way to the right or left in the door lock to lock or unlock the driver's door.

Opening and closing: from inside



This button serves to unlock or lock doors and the luggage compartment lid, but does not activate the anti-theft system. The fuel filler door remains unlocked.

You can also set the situations in which the vehicle is locked.

iDrive, for explanation of principle, refer to page 16.

1. Press the **MENU** button. This opens the start menu.
2. Press the controller to open the **i** menu.
3. Select "Vehicle settings" and press the controller.
4. Select "Door locks" and press the controller.
5. Select "Central locking" and press the controller.



6. Select a menu item:
 - ▷ "Relock door if not opened"

The central locking system automatically locks the vehicle after a short time when no door has been opened.

- ▷ "Lock after driving"
The central locking system automatically locks the vehicle as soon as you start to drive.

7. Press the controller.
 - ☑ The setting is selected.

The setting is stored for the remote control currently in use.

Unlocking and opening doors

- ▷ Either unlock both doors at the same time with the button for the central locking system and then pull the door handle above the armrest or
- ▷ pull the door handle for each door twice: the first pull unlocks the door, and the second one opens it.

Locking doors

- ▷ Use the central locking button to lock both of the doors simultaneously, or
- ▷ Press down the lock button of a door. To prevent you from being locked out, the open driver's door cannot be locked using the lock button.

⚠ Because any persons or animals left unattended in a parked vehicle could lock the doors from the inside, you should always keep the remote control with you when you leave the vehicle; this precaution ensures that you will remain able to unlock the vehicle from the outside at all times. ◀

Hotel function

The hotel function locks the compartment in the front center console and the luggage compartment lid separately and disconnects them from the central locking system. If you hand over the remote control without the integrated key, refer to page 28, e.g. at a hotel, then this prevents access to the luggage compartment and to the compartment in the front center console.

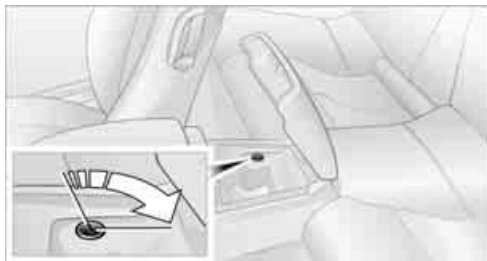

Turn the key to the right, refer to illustration, until the key slot points in the direction of travel and then remove:

The hotel function is activated after subsequent locking or unlocking of the vehicle. The system locks the luggage compartment lid and the compartment in the front center console and disconnects them from the central locking system.

Manual release

In order to manually unlock the compartment in the front center console in the event of an electrical malfunction, turn the key all the way to the right until it reaches the stop.

▷ If unlocking was manual, return the lock to the home position, i.e. all the way back to the left, before reactivating the hotel function. ◀

Doors

Automatic soft closing*

To close the doors, merely press it closed gently. The closing process will then be carried out automatically.

⚠ Make sure that the closing path of the doors is clear; as otherwise injuries may result. ◀

Luggage compartment lid

▷ During opening, the luggage compartment lid pivots back and up. Make sure there is sufficient clearance. ◀

Opening from inside

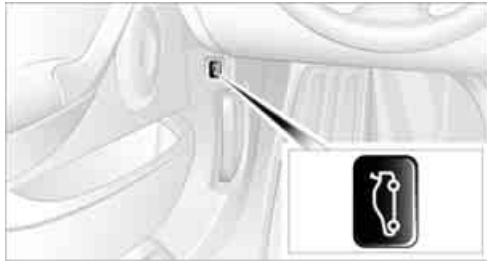

Press the button:
The luggage compartment lid opens, provided that it is not locked or the hotel function is not activated, refer to the above section.

Opening from outside

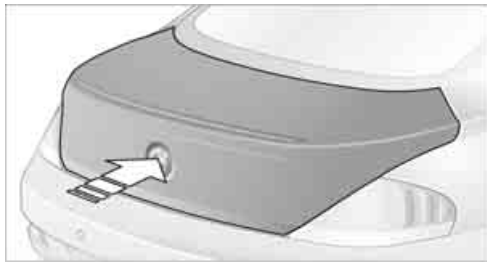

Press the upper half of the BMW emblem or press the  button on the remote control for approx. 1 second: the luggage compartment lid opens.

Manual release



The luggage compartment lid lock is located under the BMW emblem. All keys, refer to page 28, fit the luggage-compartment lid lock. Turn the key toward the right up to the stop: the luggage compartment lid opens.

 If you use the lock to open the luggage compartment lid while the alarm system is armed, the alarm will be triggered. To prevent this, you should deactivate the alarm beforehand. If the alarm has been triggered accidentally, switch off the alarm, refer to page 35. ◀

Closing

 Make sure that the closing path of the luggage compartment lid is clear; otherwise, injuries may result. ◀



The handle recesses on the interior trim of the luggage compartment lid make it easier to pull down.

Emergency release



Pull lever in luggage compartment. The luggage compartment lid is unlocked.

Luggage compartment

There are four lashing eyes on the inner corners of the luggage compartment for securing luggage nets* or securing straps to fix luggage in position. Also refer to Securing cargo, page 101.

Alarm system

The concept

The vehicle alarm system responds:

- ▷ To the opening of a door, the hood, or the luggage compartment lid
- ▷ To movements in the vehicle interior: interior motion sensor, refer to page 35
- ▷ To changes in the vehicle's tilt if someone attempts to steal the wheels or tow the vehicle
- ▷ To interruptions in battery voltage

Unauthorized operations are briefly signaled by the alarm system:

- ▷ by triggering an acoustic alarm
- ▷ by switching on the hazard warning flashers
- ▷ by flashing the high beams

Arming and disarming alarm system

When you lock or unlock the vehicle, either with the remote control or at the door lock, the alarm system is armed or disarmed at the same time.

You can open the luggage compartment lid, even with the system armed, by using the  button of the remote control, refer to page 31. When the luggage compartment lid is closed, it is once again locked and monitored.

Switching off alarm

- ▷ Unlock the vehicle using the remote control, refer to page 30, or
- ▷ insert the remote control all the way into the ignition lock.

Indicator lamp displays



- ▷ The indicator lamp below the interior rearview mirror flashes continuously: the system is armed.
- ▷ The indicator lamp flashes after locking: the doors, hood or luggage compartment lid are not properly closed. Even if you do not close the alerted area, the system begins to monitor the remaining areas, and the indicator lamp flashes continuously after approx. 10 seconds. However, the interior motion sensor is not activated.
- ▷ After the vehicle is unlocked, the indicator lamp goes out: no manipulation or attempted intrusions have been detected in the period since the system was armed.
- ▷ The indicator lamp flashes after unlocking until the remote control is inserted into the ignition lock, however for a maximum of approx. 5 minutes: an attempted entry has been detected in the period since the system was armed.

Tilt alarm sensor

Monitors the inclination of the vehicle. The alarm system reacts, for example, if someone attempts to steal the wheels or tow the vehicle.

Interior motion sensor

The condition for proper operation of the interior motion sensor is closed windows.

Avoiding unintentional alarms

The tilt alarm sensor and interior motion sensor may be switched off at the same time. This prevents unintentional alarms, e.g. in the following situations:

- ▷ In stacking garages
- ▷ When transporting on car-carrying trains
- ▷ When animals are to remain in the vehicle

Switching off tilt alarm sensor and interior motion sensor

Press the **LOCK** button on the remote control again as soon as the vehicle is locked.

The indicator lamp lights up briefly and then flashes continuously. The tilt alarm sensor and the interior motion sensor are switched off until the vehicle is unlocked and locked again.

Comfort access*

Comfort access enables you to access your vehicle without having to hold the remote control in your hand. It is sufficient to carry the remote control with you, e.g. in your jacket pocket. The vehicle automatically detects the related remote control in the immediate vicinity or in the interior.

Comfort access supports the following functions:

- ▷ Unlocking/locking vehicle
- ▷ Comfort locking
- ▷ Opening luggage compartment lid separately
- ▷ Starting engine

Functional requirement

- ▷ The vehicle or the luggage compartment lid can only be locked if the vehicle detects that the remote control you are carrying is outside the vehicle.
- ▷ The next unlocking and locking cycle is not possible until after approx. 2 seconds.
- ▷ The engine can only be started if the vehicle detects that the remote control is located in the vehicle.

Comparison with ordinary remote control

You can control the functions mentioned previously with the comfort access or by pressing the buttons on the remote control. Before doing so, please familiarize yourself with the information on opening and closing, starting on page 28.

The special features when using comfort access are described below.

- ▷ Should a short delay occur when opening or closing the windows, the system is checking whether a remote control is located in the vehicle. Please repeat opening or closing if necessary. ◀

Unlocking

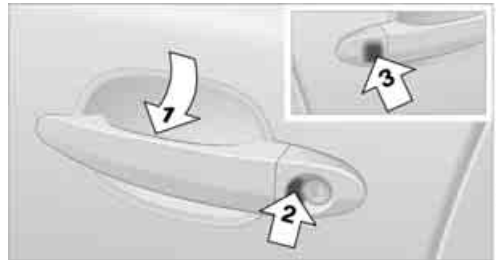

Completely grasp a door handle, arrow 1. This corresponds to pressing the **UNLOCK** button.

If a remote control is detected in the interior after unlocking, the electric steering-wheel lock disengages, refer to page 50.

Locking doors

- ▷ For the driver's door, touch the area highlighted in the picture, arrow 2, with your finger for approx. 1 second.
- ▷ For the passenger's door, touch the area highlighted in the picture, arrow 3, with your finger for approx. 1 second.

This corresponds to pressing the **LOCK** button.

- ▷ Please make sure that the ignition and all current consumers are switched off before locking to save the battery. ◀

Comfort locking

Hold a finger or the back of the hand on the surface, arrow **2** or **3**.

The windows are closed.

 Watch during the closing process to be sure that no one is injured. Removing the hand from the door handle stops the closing process immediately. ◀

Opening luggage compartment lid separately

Press the upper half of the BMW emblem. This corresponds to pressing the  button.

 If a remote control accidentally left in the luggage compartment is detected inside the locked vehicle after the luggage compartment lid has been closed, then the luggage compartment lid opens again. The hazard warning flashers flash and a signal* sounds. ◀

Switching on radio readiness

By briefly pressing the Start/Stop button, you switch on the radio readiness, refer to page 50.

 When doing so, do not depress the brake pedal, otherwise the engine will start. ◀

Starting engine

You can start the engine or switch on the ignition if a remote control is located on the interior of the vehicle. It need not be inserted in the ignition lock, refer to page 50.

If you take the remote control with you when leaving the vehicle with the engine running, a warning lamp lights up. In addition, a message appears on the Control Display. As long as no remote control is detected in the vehicle, it is only possible to restart the engine within approx. 10 seconds after it is switched off.

Malfunction

The comfort access function may malfunction due to local radio waves. If this occurs, then open or close the vehicle with the buttons on the remote control or with a key. To start the engine after this, insert the remote control in the ignition lock.

Replacing battery

The remote control for comfort access contains a battery which must be replaced occasionally.

1. Remove integrated key from remote control, refer to page 28.



2. Remove cover.
3. Insert new battery with positive side facing upward.
4. Press cover closed.

 Return used battery to a recycling collection point or to your BMW center. ◀

Windows

 To prevent injuries, exercise care when closing the windows and keep them in your field of vision until they are shut. Always take along the remote control when you leave the vehicle; otherwise, children could, for example, operate the windows and injure themselves. ◀

Opening, closing



- ▶ Press switch to resistance point: The window continues to open for as long as you hold down the switch.

- ▷ Press the switch beyond the resistance point:
The window opens automatically. Pressing the switch again stops the opening movement.

You can close the windows in the same manner by pulling the switch.

For information on using the convenience operation mode at the door lock or with the remote control, refer to page [31](#) or [32](#).

For information on comfort closing with comfort access, refer to page [37](#).

After switching off ignition

You can still operate the windows with the remote control removed or the ignition switched off for approx. 1 minute, as long as neither of the doors has been opened.

Pinch protection system

If the closing force rises beyond a predefined threshold during closing, the system will immediately stop moving the window prior to lowering it slightly.



Despite the pinch protection system, inspect the window's travel path prior to closing it, as the safety system might fail to detect certain kinds of obstructions, such as thin objects, and the window would continue closing.

Pulling the switch beyond the resistance point and holding it limits the response of the pinch protection system. In this case, the window will respond to forces beyond a defined threshold by opening only slightly.

If you pull the switch past the resistance point again within approx. 4 seconds and hold it there, the pinch protection system will be deactivated.

Do not install any accessories in the range of movement of the windows, as otherwise the pinch protection system will be impaired. ◀

Adjustments

Sitting safely

The ideal sitting position can make a vital contribution to relaxed, fatigue-free driving. In the interaction with the safety belts, the head restraints and the airbags, the seat position plays an important role in an accident. To ensure that the safety systems operate with optimal efficiency, we strongly urge you to follow the instructions contained in the following section.

For additional information on transporting children safely, refer to page 48.

Airbags

 Always maintain an adequate distance between yourself and the airbags. Always hold the steering wheel by its rim with hands at the 9 o'clock and 3 o'clock positions to minimize the risk of injuries to your hands and arms in the event of airbag deployment.

No one and nothing is to come between the airbags and the seat occupant.

Do not use the cover of the front airbag on the front passenger side as a storage area. Make sure that the front passenger is sitting correctly and does not rest feet or legs on the instrument panel, otherwise leg injuries can occur if the knee and front airbags are triggered.

Make sure that occupants do not rest their head on the side or head airbag; otherwise, injuries can occur if the airbags are triggered. ◀

Even if you adhere to all the instructions, injuries resulting from contact with airbags cannot be fully excluded, depending on the circumstances. The ignition and inflation noise may provoke a mild hearing loss in extremely sensitive individuals. This effect is usually only temporary.

For airbag locations and additional information on airbags, refer to page 75.

Head restraints

A correctly adjusted head restraint reduces the risk of injury to cervical vertebrae in an accident.

 Adjust the head restraint so that its center is approx. at ear level. Otherwise there is increased danger of injury in the event of an accident. ◀

Head restraints, refer to page 41.

Safety belt

Before every drive, make sure that safety belts are being worn at all of the occupied seats. Airbags complement the safety belt as an additional safety device, but they do not represent a substitute.

Your vehicle has four seats that are each equipped with a safety belt.

 Never allow more than one person to wear a single safety belt. Never allow infants or small children to ride in a passenger's lap. Make sure that the belt lies low around the hips in the lap area and does not press on the abdomen. The safety belt may not lie across the neck, rub on sharp edges, be routed over solid or breakable objects or be pinched. Wear the safety belt without twisting, snugly across the lap and shoulders, as close to the body as possible. Otherwise, the belt can slip over the hips in the lap area in a frontal impact and injure the abdomen. Avoid wearing clothing that prevents the belt from fitting properly and pull the shoulder belt upward periodically to readjust the tension across your lap in order to avoid a reduction in the retention effect of the safety belt. ◀

Safety belts refer to page 42.

Seats

Note before adjusting

 Never attempt to adjust your seat while operating the vehicle. The seat could respond with unexpected movement and the

ensuing loss of vehicle control could lead to an accident.

On the front passenger side as well, do not tilt the backrest too far toward the rear. Failure to observe this precaution can prevent the belt from providing effective protection against injury, as the passenger could slide under the belt in an accident. ◀

Also follow the instructions regarding damage to the safety belt on page 43.

Seat adjustment

 To ensure that the safety systems continue to provide optimized protection, please follow the adjustment instructions on page 39. ◀

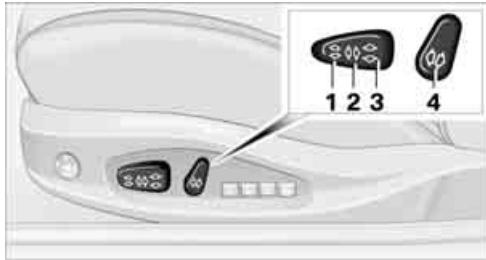

- 1 Inclination
- 2 Longitudinal direction
- 3 Height
- 4 Backrest



- 5 Backrest width
- 6 Lumbar support

Adjusting lumbar support

You can also adjust the contours of the backrest to obtain additional support in the lumbar region.

The upper hips and spinal column receive supplementary support to help you maintain a relaxed, upright sitting position.

- ▷ Increase or decrease curvature:
Press front or rear of switch.
- ▷ Move curvature up or down:
Press top or bottom of switch.

Thigh support

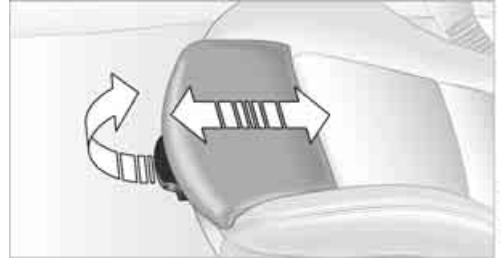

You can also adjust the thigh support manually: pull the lever and adjust the thigh support in the longitudinal direction.

Seat, mirror and steering wheel memory



You can store and select three different adjustment settings for the driver's seat, exterior mirrors and steering wheel.

The adjustments of the thigh support and the backrest width are not stored in the memory.

Storing

1. Switch on radio readiness or ignition, refer to page 50.
2. Adjust the desired seat, exterior mirror and steering-wheel positions.

3. Press the **M** button:
The LED in the button lights up.
4. Press the desired memory button **1, 2 or 3**:
The LED goes out.

Requesting

 Do not request a position from the memory while the vehicle is moving. There is a risk of accident from unexpected movement of the seat or steering wheel. ◀

Convenience mode

1. Open the driver's door after unlocking or switch on radio readiness, refer to page 50.
2. Briefly press the desired memory button **1, 2 or 3**.

The system immediately cancels the adjustment procedure when you briefly press one of the seat adjustment switches or one of the memory buttons.

The adjusting procedure for the steering wheel is immediately interrupted if you briefly press the switch for the steering wheel adjustment in any direction, refer to page 44.

Safety feature

1. Close the driver's door and switch ignition on or off, refer to page 50.
2. Press the desired memory button **1, 2 or 3** and maintain pressure until the adjustment process has been completed.

If the **M** button was pressed inadvertently: press the button again; the LED goes out.

Activating with remote control

The last positions of the driver's seat, external rearview mirrors, and steering wheel are stored for the remote key currently in use.

You can choose when the position is requested:

- ▷ Request when unlocking vehicle
- ▷ Request when opening driver's door

iDrive, for explanation of principle, refer to page 16.

1. Open the start menu.
2. Press the controller to open the **i** menu.
3. Select "Vehicle settings" and press the controller.
4. Select "Door locks" and press the controller.

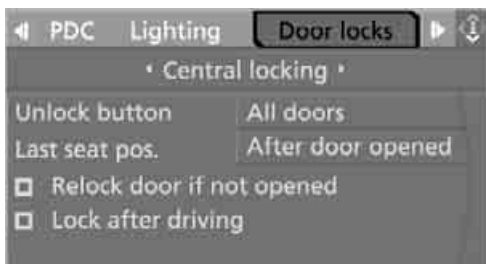

5. Select "Central locking" and press the controller.
6. Select "Last seat pos." and press the controller.
7. Select "After unlocking" or "After door opened".



8. Press the controller.

To cancel the request:
Select "Deactivated" and press the controller.

 When using this feature, always make sure that the footwell behind the driver's seat is empty and unobstructed. If you fail to do so, any persons or objects behind the seat could be injured or damaged by a rearward movement of the seat. ◀

Front head restraints

A correctly adjusted head restraint reduces the risk of injury to cervical vertebrae in an accident.

! Adjust the head restraint so that its center is approx. at ear level. Otherwise there is increased danger of injury in the event of an accident. ◀

Adjusting height



- ▷ To raise: pull the head restraint upward.
 - ▷ To lower: slide the head restraint downward.
- ▷ To reach the lowest position, press the button, refer to arrow 1. ◀

Adjusting tilt angle

Swivel the head restraints.

Removal

1. Pull the head restraint upward to the stop.
2. Press the button, arrow 1, and remove the head restraint.

▷ Only remove head restraint when no passenger is seated in the respective seat, as otherwise you will be in violation of the law. Reinstall head restraint before passengers use the respective seat. ◀

Installation

Insert head restraint into the sockets and adjust.

Getting in back

! Before starting to drive, fold backrests back, otherwise there is the danger of accident due to an unexpected movement of the seat. ◀

Releasing backrest



Pull the lever upward and fold the backrest forward.

The lever is designed so that the safety belt can be hooked onto it. This enables you to fasten the safety belt more conveniently.

Safety belts

! To ensure that the safety systems continue to provide optimized protection, please follow the adjustment instructions on page 39. ◀

Before every drive, make sure that safety belts are being worn at all of the occupied seats. Airbags complement the safety belt as an additional safety device, but they do not represent a substitute.

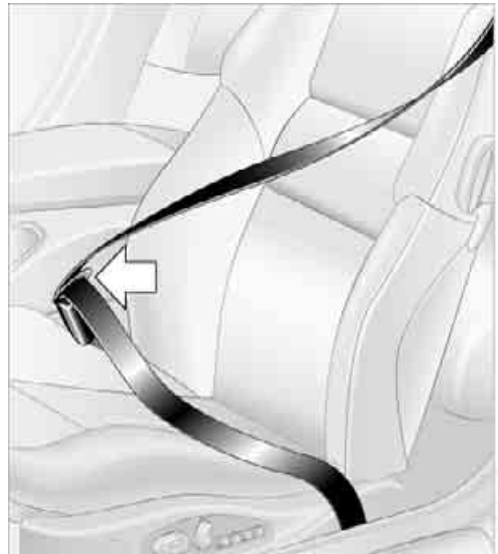

Fastening

Make sure you hear the latch plate engage in the belt buckle.

Releasing

1. Hold the belt firmly.
2. Press the red button in the belt buckle.
3. Guide the belt into its reel.

The shoulder strap's anchorage point will be in the correct position for adults of every build if the seat is correctly adjusted, refer to page 39.

Safety belt reminder for driver's seat and passenger seat*



The indicator lamp lights up and a signal sounds. At the same time, an additional message appears on the Control

Display. Please check whether safety belts are being worn correctly.

The safety belt memory is operative at speeds above approx. 5 mph/8 km/h. It can also be activated if objects are placed on the passenger seat.

Damage to safety belts



In the event of loads caused by accidents or other damage: replace the belt system including the safety belt tensioner and any child restraint systems, and have the belt anchor points checked. Have this work carried out only by a BMW center or a workshop that works according to BMW repair procedures with appropriately trained personnel. Otherwise correct operation of this safety equipment is not guaranteed. ◀

Heated seats



The temperature setting advances one step in its control sequence each time you press the button. The maximum temperature is supplied when three LEDs are lit.

To switch off:

Press the button longer.

Mirrors

Exterior mirrors



The mirror on the passenger's side is more curved than the driver's mirror. Objects reflected in the mirror are closer than they appear. Do not estimate the distance of following traffic based on what you see in the mirrors; otherwise, there is an increased accident risk. ◀



- 1 Adjustments
- 2 Switching to the other mirror or to the automatic parking function
- 3 Folding mirrors in and out*

Storing the mirror positions, refer to Seat, mirror and steering wheel memory on page 40.

Adjusting manually

You can also adjust the mirrors manually by pressing against the outer edges of their mirror glass.

Folding exterior mirrors in and out

Pressing button **3** allows you to fold mirrors in and out up to a speed of approx. 20 mph/ 30 km/h. This is advantageous, for example, in car washes, narrow streets or for bringing mirrors that have been manually folded-in back into the correct position. Folded-in mirrors automatically fold down at a speed of approx. 25 mph/ 40 km/h.

Automatic functions

- ▷ Below a certain outdoor temperature, both exterior mirrors are automatically heated when the motor is running or the ignition is switched on.
- ▷ When the vehicle is moving forward, the interior and exterior mirrors dim as a function of the incoming light.

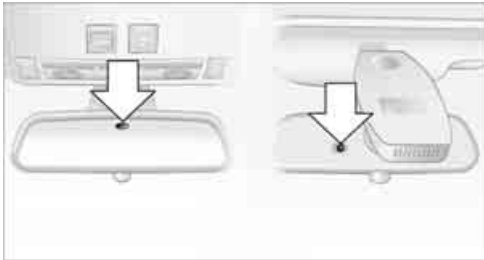

The interior mirror is provided with two photocells to control its automatic dimming function. One is integrated into the mirror glass, refer to arrow, while the other is located at a position slightly offset from this on the back of the mirror housing.

For trouble-free operation, keep the photocells clean and do not cover the area between the interior rearview mirror and the windshield. Also do not attach stickers to the windshield in front of the mirror.

Tilting down passenger-side mirror – automatic parking function

Activating

1. Slide switch into the driver's side mirror position, arrow **1**.



2. Engage reverse gear or selector lever position R.
The mirror glass tilts downward somewhat on the passenger's side. This allows the driver to see the area immediately adjacent to the vehicle – such as a curb – when parking, etc.

Deactivating

Slide switch into the passenger side mirror position, arrow **2**.

Steering wheel

Adjustments

 Do not adjust the steering wheel while the vehicle is moving. There is a risk of accident as the result of unexpected movement. ◀

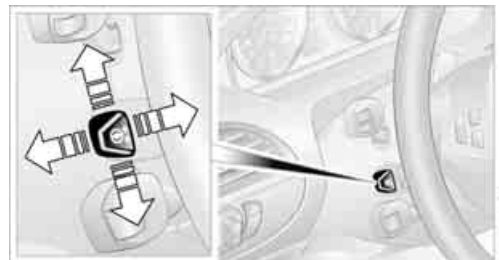

The steering wheel can be adjusted in four directions.

Storing the steering-wheel position, refer to Seat, mirror and steering wheel memory, page 40.

Electric steering wheel lock

The steering wheel locks or unlocks automatically when the remote control is removed or inserted, refer to page 50.

Easy entry/exit

To make it easier to enter and exit the vehicle, the steering wheel temporarily moves into the uppermost position.

Programmable button on steering wheel



You can program the button individually.

The setting is stored for the remote control currently in use.

iDrive, for explanation of principle, refer to page 16.

1. Press the **MENU** button.
This opens the start menu.
2. Press the controller to open the **i** menu.
3. Select "Vehicle settings" and press the controller.

4. Change to upper field if necessary. Turn the controller until "Steering wheel button" is selected and press the controller.

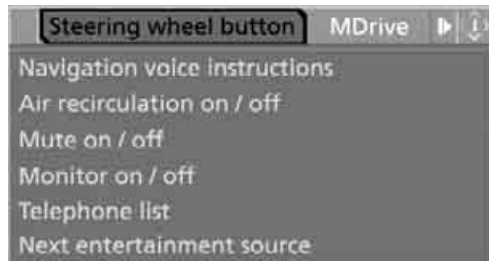

A list of different functions appears:

- ▷ "Navigation voice instructions"
Voice instructions of the navigation system*
 - ▷ "Air recirculation on / off"
Permanently shutting off outside air, refer to AUC Automatic recirculated air control on page 87
 - ▷ "Mute on / off"
Mutes the audio sources
 - ▷ "Monitor on / off"
Switches the Control Display on/off
 - ▷ "Telephone list"*
Display/hide phone book or last list of stored phone numbers displayed
 - ▷ "Next entertainment source"
Changes audio source
5. Select the desired function unit and press the controller.

Operating function

Press the button on the steering wheel.

If you have programmed "Navigation voice instructions" for the button:

- ▷ To switch voice instructions on/off:
Maintain pressure on the button for several seconds.
- ▷ To repeat the last voice instruction:
Press the button.

MDrive

With MDrive you can configure several individual settings for your vehicle on the Control Display and activate them simultaneously with the  button on the steering wheel.

Configuring settings

With the ignition switched on you can change the settings of MDrive on the Control Display. iDrive, for explanation of principle, refer to page 16.

1. Press the **MENU** button.
This opens the start menu.



2. Press the controller to open the **i** menu.
3. Select "Vehicle settings" and press the controller.
4. Move the controller forward if necessary so that the marking is located in the upper field. Turn the controller until "MDrive" is selected and press the controller.



The functions contained in MDrive are displayed:

- ▷ "SMG Drivelogic"
Sequential Manual Transmission with Drivelogic: shifting modes and Drivelogic driving programs, refer to page 54

- ▷ "EDC"
Programs of the Electronic Damping Control, refer to page 73
- ▷ "DSC"
Dynamic Stability Control and M Dynamic Mode, refer to page 71
- ▷ "POWER"
Programs of the M Engine Dynamic Control, refer to page 55
- ▷ "Head-Up Display"*
Views of the Head-Up Display, refer to page 77

You can reset all settings for MDrive to their default values:

- ▷ "Reset to default"

5. Select the desired function.

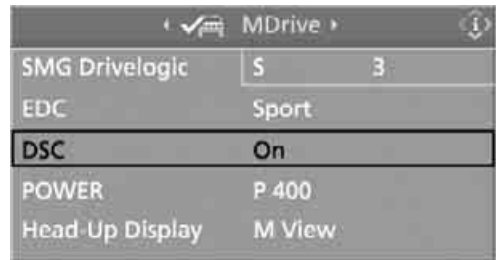

6. Press the controller.
7. Turn the controller to select the desired setting.

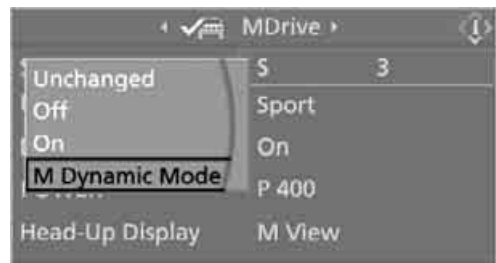

"Unchanged" retains the current setting made outside of MDrive.

8. Press the controller.

The setting is stored for the remote control currently in use.

Activating settings

Press the  button on the steering wheel.



The indicator lamp in the instrument cluster lights up. The settings made on the Control Display for the functions contained in MDrive are active.

Pressing the button again deactivates MDrive.



If the indicator lamp flashes after pressing the button, MDrive was unable to react, as the ABS Antilock Brake System or DSC Dynamic Stability Control is currently controlling the vehicle stability. Press the  button again when the indicator lamp no longer flashes. ◀

Even with MDrive activated, you can change individual settings outside MDrive, e.g. with the buttons in the center console. To reactivate all settings made for MDrive on the Control Display: press the  button twice.

Transporting children safely

The right place for children

⚠ Do not leave children unattended in the vehicle; otherwise, they could endanger themselves and other persons, e.g. by opening the doors. ◀

Children always in the rear

Accident research shows that the safest place for children is in the back.

⚠ Children younger than 13 years of age or with a height under 5 ft/150 cm may only be transported in the rear in child restraint systems which correspond to the age, weight and height of the child. Otherwise there is an increased danger of injury in an accident. ◀

Children 13 years of age or older must wear a safety belt as soon as a suitable child restraint system can no longer be used due to their age, size and weight.

With the exception of the driver's seat, all seats in your BMW comply with the recommendations of the standard SAE J1819 for the safe securing of child restraint systems in motor vehicles.

Exception for front passenger seat

⚠ Should it be necessary to use a child restraint system on the front passenger seat, the front, knee and side airbag on the passenger side must be deactivated. Otherwise, there is an increased risk of injury for the child if the airbags are triggered, even with a child restraint system. Your BMW center will be glad to advise you. ◀

For more information on automatic deactivation of the front passenger airbags, refer to page 76.

Installing child restraint systems

⚠ Follow child-restraint system manufacturer's instructions for the selection, installation and use of child restraint systems. Otherwise the degree of protection they offer may be reduced. ◀

Backrest width on front passenger seat

⚠ Before mounting a child restraint system on the front passenger seat, the backrest width adjustment must be open completely. ◀

1. Adjust the backrest width to the fully open position, refer to page 40.
2. Install child's seat.

Child seat security

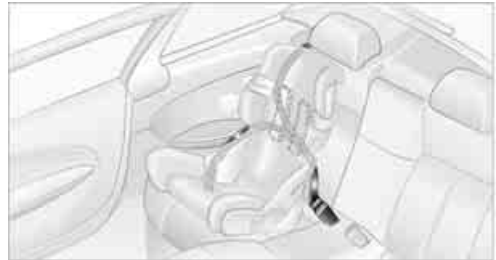

All rear safety belts and the safety belt for the front passenger can be locked against pulling out to secure child restraint systems.

Locking safety belt

1. Secure the child restraint system with the belt.
2. Pull out the belt webbing completely.
3. Allow the belt webbing to be pulled in and pull taut against the child restraint system. The safety belt is locked.

Unlocking safety belt

1. Open the belt buckle.
2. Remove the child restraint system.
3. Allow the belt webbing to be pulled in completely.

Child restraint system with tether strap

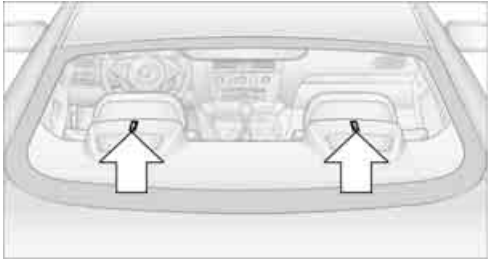

There are two additional mounting points for child restraint systems with a tether strap, refer to arrows.

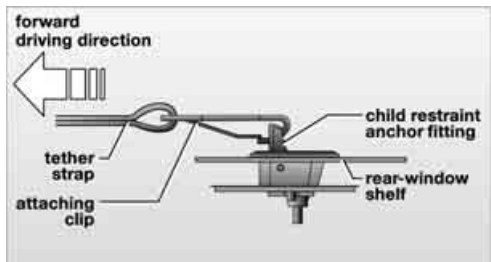

Placement of tether strap

1. Fold anchor fitting into upright position.
2. Push head restraint downward.
3. Guide tether strap over head restraint and hook onto anchor fitting.

LATCH child-restraint fixing system

LATCH: Lower Anchor and Tethers for CHildren.

 To attach a LATCH child's seat, follow the operating and safety instructions of the child's seat manufacturer. ◀

Rear seats

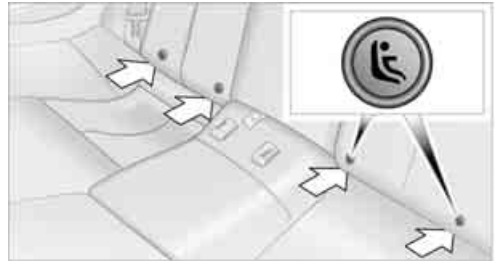

The mountings for the LATCH child-restraint fixing system are located under the points marked with the symbols. They are not visible from the outside.

Before attaching the LATCH child's seat, pull the belt away from the region of the child-restraint fixing system.

Driving

Ignition lock

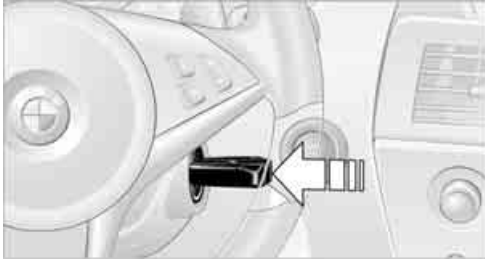

Insert the remote control as far as possible into the ignition lock.

- ▷ Radio readiness switches on. Some electrical devices are ready for operation.
- ▷ The electric steering-wheel lock audibly disengages.

⚠ Before moving the vehicle, insert the remote control into the ignition lock; otherwise, the electric steering-wheel lock will not be unlocked and the vehicle cannot be steered. ◀

Removing remote control from ignition lock

Briefly press in the remote control; it pops out slightly.

- ▷ The ignition is switched off if it was still switched on.
- ▷ The electric steering-wheel lock audibly engages.

Start/Stop button



Briefly pressing the Start/Stop button several times switches the radio readiness or the ignition on and off.

▶ Briefly pressing the Start/Stop button with the brake pedal depressed and the selector lever in position N starts the engine. ◀

Radio readiness

Some electrical devices are ready for operation. The last information of the onboard computer selected is displayed in the instrument cluster.

Radio readiness is automatically switched off:

- ▷ when the remote control is removed from the ignition lock
- ▷ with comfort access* by touching the sensitive surface on the door handle, refer to Locking doors on page 36

Ignition on

All current consumers are ready for operation. The odometer and the trip odometer are displayed in the instrument cluster, refer to page 59.

▶ Please switch off the ignition and the current consumers which are not required when the engine is not running to save the battery. ◀

Radio readiness and ignition off

All indicator and warning lamps in the instrument cluster go out.

Starting engine

⚠ Do not run the engine in closed rooms, otherwise the inhaling of toxic exhaust gases can cause unconsciousness and death. The exhaust gases contain carbon monoxide, an odorless and colorless, but highly toxic gas. Never leave an unattended vehicle with the engine running, as such a vehicle represents a potential safety hazard.

Before leaving the vehicle with the engine running, move the selector lever into the N position and set the handbrake, otherwise the vehicle can begin to roll. ◀

When starting the engine, do not press the accelerator pedal.

Do not allow the engine to warm up by leaving it running while the vehicle remains stationary. Instead, begin to drive immediately at a moderate engine speed.



▷ Do not press the brake pedal as long as you do not want to start the engine. The engine starts immediately when you briefly press the Start/Stop button with the brake pedal depressed. ◀

1. Depress brake pedal.
2. Place selector lever in position N.
3. Briefly press Start/Stop button.

The system responds by automatically engaging the starter for a certain period and automatically disengaging it as soon as the engine starts.

▷ If the engine does not start, shift back to the last selector lever position selected, refer to the instrument cluster display or the selector lever. Then select the position N. You cannot start off with the hood open.

When the engine is cold, the exhaust system has a slightly metallic undertone due to the system design. ◀

⚠ Avoid frequent starting in quick succession or repeated starting attempts in which the engine does not start. Otherwise, the fuel is not burned at all or is burned inadequately and there is a danger of overheating and damage to the catalytic converter. ◀

Special starting conditions

Depress the accelerator pedal halfway when starting the engine in the following situations:

- ▷ The engine fails to start on the first attempt, e.g. if it is very hot or cold.
- ▷ The engine is started at very low temperatures, below approx. +5 °F / -15 °C, at high altitudes, over approx. 3,300 ft / 1,000 m.

Switching engine off

⚠ Do not remove the remote control from the ignition lock while the vehicle is rolling, otherwise the steering wheel lock would engage while steering.

When leaving the vehicle, always take the remote control with you.

When parking on a downhill incline, apply the handbrake, as otherwise the vehicle could roll away. ◀

1. Apply handbrake.
2. Move selector lever into a drive position.
3. Briefly press Start/Stop button.
A signal sounds when the position N is engaged and the handbrake is not set when switching off the engine.

Handbrake

The handbrake is primarily intended to prevent the vehicle from rolling while parked; it brakes the rear wheels.

Indicator lamp



The indicator lamp lights up, and a signal also sounds when starting off. The handbrake is engaged.



Indicator lamp for Canadian models.

Engaging

The lever engages automatically.

Releasing

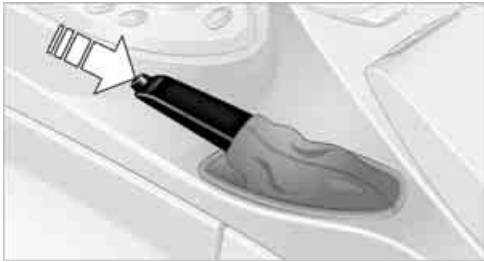

Pull slightly upwards, press the button and lower the lever.

⚠ If exceptional circumstances should make it necessary to engage the handbrake while the vehicle is in motion, do not pull it too strongly. In doing so, continuously press the button of the handbrake lever. Otherwise, excessive pressure can lead to the rear wheels locking up and loss of traction – fishtailing – at the rear axle. ◀

▶ To prevent corrosion and one-sided braking action, occasionally apply the handbrake lightly when the vehicle is slowly coming to a stop if the traffic conditions are suitable. The brake lamps do not light up when the handbrake is engaged. ◀

Sequential Manual Transmission with Drivelogic

The concept

The SMG Sequential Manual Transmission with Drivelogic is an automated manual trans-

mission in which an electrohydraulic system handles the clutching and gear changes.

The Sequential Manual Transmission is operated with the selector lever and two shift paddles on the steering wheel.

It offers the following functions:

- ▷ Choice of manual or automatic mode: Sequential mode or Drive mode
- ▷ Selection option between different driving programs, Drivelogic, refer to page 54
- ▷ Upshift display, shift lights, refer to page 55
- ▷ Automatic downshifting and prevention of incorrect shifting even in sequential operation
- ▷ Automatic double clutching

Selector lever positions



- ▷ R: Reverse gear
- ▷ N: Neutral, idle
- ▷ ●: Drive position:
 - ▷ +: manual upshifting
 - ▷ -: manual downshifting
 - ▷ D/S: switch between Drive mode and Sequential mode

Shiftlock

Press the brake pedal before shifting out of N; the shift command will not be executed unless the brake is applied.

R Reverse

Select only when the vehicle is stationary.

N Idle

Always engage before starting engine.

If the driving situation requires, e.g. when downshifting on a slippery road surface, the Sequential Manual Transmission automatically clutches and then declutches again, i.e. it is not necessary to engage idling manually.

 N is automatically engaged after just a few seconds when you open the driver's door or the hood with the engine running and do not operate either pedals, shift paddles or the selector lever. In these cases, to start off after closing the driver's door or the hood, first move the selector lever into the position N and then into the drive position. ◀

S Sequential mode

You can shift up and down using the shifting paddles or the selector-lever. You do not need to remove your foot from the accelerator to do so.

After every engine start, as soon as the selector lever is pushed to the right into the drive position ● and the brake pedal is pressed, the Sequential mode is activated.

Starting off is also possible on a level road surface in second gear, e.g. in case of ice.

In the following situations, the Sequential Manual Transmission thinks for you:

- ▶ Upshifts and downshifts are executed only when they will result in a plausible combination of engine and vehicle speed; thus, for example, the system will not execute a downshift that would cause the engine to overrev.
- ▶ When the vehicle is stationary, the transmission automatically downshifts into first gear.
- ▶ Shortly before dropping below a gear-dependent minimum speed, the transmission downshifts automatically even without your intervention.

D Drive mode

In the Drive mode, all forward gears are shifted automatically.

Shifting from Sequential mode to Drive mode: press selector lever to the right toward D/S.

To switch back into the Sequential mode: press selector lever to the right again toward D/S or shift using the shift paddles or the selector lever.

Kick-down: for rapid acceleration, e.g. passing, press the accelerator pedal as far down as it will go. You achieve maximum acceleration.

Displays in instrument cluster

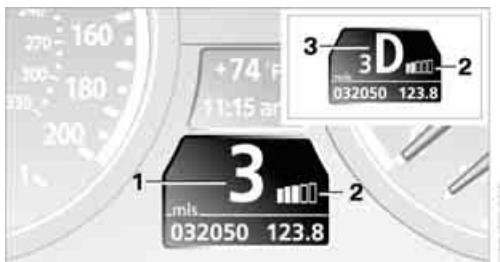

- 1 Gear 1 to 7, R, N engaged
- 2 Selected driving program, matches the number of illuminated fields, refer to DriveLogic on page 54
- 3 The currently engaged gear is displayed, followed by a D in the Drive mode.

 A flashing gear display indicates to you that the driver's door is open with the engine running.

N is automatically engaged after just a few seconds when you open the driver's door or the hood with the engine running and the vehicle stopped, and do not operate either pedals, shift paddles or the selector lever. ◀

Gear changes

Using selector-lever

- ▶ To upshift, pull the selector-lever back.
- ▶ To downshift, push the selector-lever forward.

Using shift paddles on steering wheel

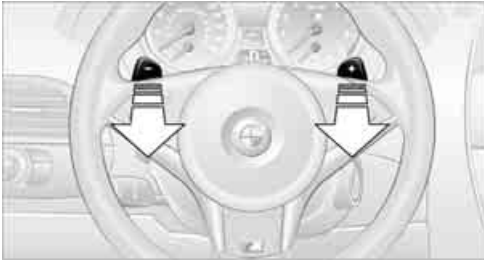

- ▷ To upshift, briefly pull the right shift paddle +.
- ▷ To downshift, briefly pull the left shift paddle -.

Drivelogic

With Drivelogic various driving programs are available to you.

Each time you change between the Sequential mode and the Drive mode, the driving program last selected in the respective mode is active. Exception: after the first change from the Sequential to the Drive mode, driving program 3 is active.

In Drive mode

Five driving programs, from relaxed 1 to sporty/highly dynamic 5 are available for selection.

In Sequential mode

You can choose from six driving program from balanced/dynamic 1 to sporty/purist 6.

Each time the engine is started, driving program 3 is activated.

The sporty/purist driving program 6 is only available with the DSC Dynamic Stability Control deactivated, refer to page 71. When DSC is activated, the system switches from driving program 6 to 5.

- ▷ To maintain vehicle stability, always drive with the DSC switched on when possible. ◀

Selecting driving program with button in center console



Press the button repeatedly until the desired driving program is displayed in the instrument cluster, refer to page 53.

Selecting driving program via button on steering wheel

You can also activate your preferred driving program with the  button on the steering wheel, refer to MDrive on page 46.

With the ignition switched on you can change the settings of MDrive on the Control Display. iDrive, for explanation of principle, refer to page 16.

1. Open the start menu.
2. Press the controller to open the  menu.
3. Select "Vehicle settings" and press the controller.
4. Select "MDrive" and press the controller.
5. Select "SMG Drivelogic" and press the controller. The first setting is selected.

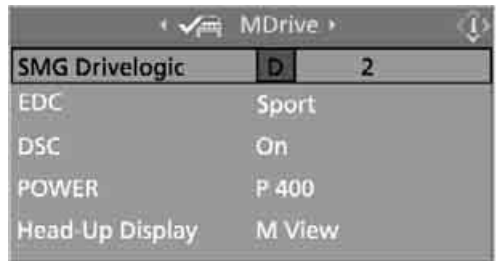

6. Turn the controller to set Drive mode or Sequential mode.

"Unchanged" retains the current settings made outside of MDrive.

7. Press the controller to select driving programs.
8. Turn the controller to set driving program.
9. Press the controller.

Shift lights

To achieve the best vehicle acceleration with a sporty driving style in the Sequential mode, shift lights in the Head-Up Display* indicate the optimum shifting point briefly before reaching the maximum rpm.

1. Switch on Head-Up Display, refer to Head-Up Display on page 77.
2. Select display "M View" on Head-Up Display, refer to Selecting displays on page 77.



The current engine speed is highlighted on the tachometer.

3. When approaching the maximum rpm, yellow illuminated fields **1** of the tachometer consecutively indicate the approaching upshift point.
4. Shift at the latest when the red indicator field lights up **2**.

When the permissible maximum rpm is reached, the entire tachometer begins to flash. When the maximum rpm is exceeded, the fuel supply is cut off to protect the engine. Always avoid engine speeds in this range.

M Engine Dynamic Control

With M Engine Dynamic Control you can influence how sporty the reaction of your vehicle to accelerator pedal movements is to be. Three programs are available for engine control.

"P 400" program

In the "P 400" program the engine reacts gently to the movement of the accelerator pedal. This is, for example, ideal for city driving or driving on snow. In the process, the fuel consumption is minimal and the engine output is reduced.

"P 500" program

The "P 500" program provides maximum performance and more spontaneous reaction of the engine to accelerator pedal movements.

"P 500 Sport" program

In the "P 500 Sport" program the engine reacts especially spontaneously and uncompromisingly sporty with maximum performance to accelerator pedal movements.

Selecting program



Each time the engine is started, the "P 400" program is activated.

Press the POWER button to activate the "P 500" program. Pressing the POWER button repeatedly switches between the programs "P 400" and "P 500".

You can also activate your preferred program with the  button on the steering wheel, refer to MDrive on page 46. You can only activate the "P 500 Sport" program with MDrive.

For the programs "P 500" and "P 500 Sport" the LED in the POWER button lights up.

Turn signals/ headlamp flasher

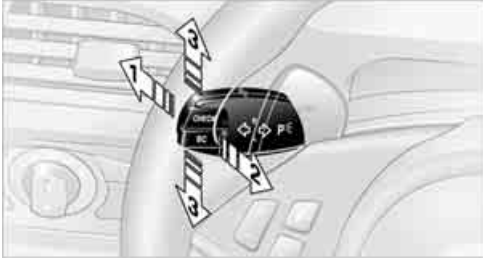

- 1 High beams
- 2 Headlamp flasher
- 3 Turn signals

Using turn signals

Move the lever beyond the resistance point.

To switch off manually, only press the lever as far as the resistance point.

 Atypically rapid flashing of the indicator lamp indicates the failure of a turn signal lamp. ◀

Signaling briefly

Press the lever to the resistance point and hold it there as long as you wish to signal.

Triple turn signal activation

Press the lever to the resistance point; the turn signals flash three times.

You can activate or deactivate this function.

iDrive, for explanation of principle, refer to page 16.

1. Open the start menu.
2. Press the controller to open the **i** menu.
3. Select "Vehicle settings" and press the controller.

4. Select "Lighting" and press the controller.



5. Select "Triple turn signal activation" and press the controller.
 Triple turn signal is activated.

Wiper system



- 1 Switching on wipers
- 2 Switching off wipers or brief wipe
- 3 Activating/deactivating rain sensor
- 4 Cleaning windshield and headlamps
- 5 Adjusting rain sensor sensitivity level

Switching on wipers

Pull the lever upward, arrow 1.

The lever automatically returns to its initial position when released.

Standard wiper speed

Press once.

The system reverts to operation in the intermittent mode whenever the vehicle is stationary.

Fast wipe

Briefly press twice or press beyond the resistance point.

The system reverts to operation at normal speed whenever the vehicle is stationary.

Rain sensor

Wiper operation is controlled automatically as a function of the rain intensity. The rain sensor is located on the windshield, directly in front of the interior rearview mirror.

Activating rain sensor

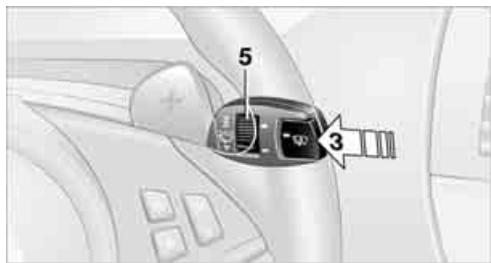

Press the button, arrow **3**. The LED in the button lights up.

Adjusting rain sensor sensitivity level

Turn the knurled wheel **5**.

Deactivating rain sensor

Press the button again, arrow **3**. The LED goes out.

 Deactivate the rain sensor when passing through an automatic car wash. Failure to do so could result in damage caused by undesired wiper activation. ◀

Cleaning windshield and headlamps

Pull the lever, arrow **4**:

The system sprays washer fluid against the windshield and activates the wipers for a brief period.

When the vehicle lighting is switched on, the headlamps are simultaneously washed at appropriate intervals.

 Do not use the washers if there is any danger that the fluid will freeze on the windshield. If you do so, your vision could be obscured. To avoid freezing, use a washer fluid antifreeze, refer to Washer fluid. Do not use

washers when the washer fluid reservoir is empty, as this will damage the washer pump. ◀

Windshield washer nozzles

Both windshield washer nozzles are automatically heated with the engine running or the ignition switched on.

Washer fluid

 Washer fluid antifreeze is flammable. Always keep it well away from sparks and open flames, and store it in tightly closed containers well out of the reach of children. Always follow the instructions for use provided on the containers. ◀

Washer fluid reservoir

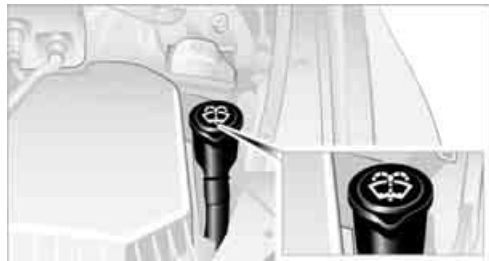

All washer jets are supplied from one reservoir. Fill with water and – if required – with a washer antifreeze, according to manufacturer's recommendations.

In order to maintain the mixture ratio, mix the washer fluid before filling. ◀

Capacity

Capacity approx. 5.3 US quarts/5 liters.

Cruise control

The concept

The cruise control is available for use at speeds of approx. 20 mph/30 km/h and higher. The vehicle stores and maintains the speed that you set using the lever mounted on the steering column.

⚠ Do not use the cruise control under driving conditions that do not permit a constant speed, e.g. when driving on winding roads, in heavy traffic or in poor road conditions such as snow, rain, ice, and loose road surface. Otherwise, you could lose control of the vehicle and cause an accident. ◀

One lever for all functions



- 1 Maintaining speed, storing speed, and accelerating
- 2 Maintaining speed, storing speed, and decelerating
- 3 Interrupting cruise control
- 4 Resuming stored speed

Maintaining speed, storing speed, and accelerating

Press lever to resistance point, arrow **1**:
The system maintains and stores the current vehicle speed. The display **1** in the speedometer, see below, indicates this regulated speed. Every time you press the lever, the vehicle's speed increases by roughly 1 mph/1 km/h.

Press the lever to the resistance point and hold it:

The vehicle accelerates without pressure on the accelerator pedal. The system maintains and stores your current speed as soon as you release the lever.

Press the lever beyond the resistance point:
Increase speed by 5 mph/10 km/h.

The vehicle may accelerate beyond the regulated speed on steep downhill stretches where the engine's braking action alone may not be sufficient to slow the vehicle. Speed can drop

on uphill grades if the engine output is insufficient.

Maintaining speed, storing speed, and decelerating

Pull the lever, arrow **2**:

Functions are the same as **1**, only the vehicle speed is reduced.

Interrupting cruise control

Press the lever up or down, arrow **3**.

Cruise control is also interrupted automatically:

- ▷ When you apply pressure to the brake pedal
- ▷ For manual shifting with the shift paddles or the selector lever
- ▷ When the DSC comes on

Resuming stored speed

Press button **4**:

The vehicle accelerates to and maintains the stored speed.

Deactivating system

When the ignition is switched off, the system is deactivated and the stored speed is deleted.

Displays in instrument cluster



- 1 Stored desired speed
- 2 Selected desired speed appears briefly
- 3**

Everything under control

Odometer, outside temperature display, clock



- 1 Time, outside temperature, refer to Computer on page 60
- 2 Odometer and trip odometer
- 3 Press button:
 - ▷ with ignition switched on, trip odometer is reset
 - ▷ with ignition switched off, briefly display odometer

Tachometer



The advance warning field, arrow 1, and the red warning field, arrow 2, change depending on the engine temperature. As the engine temperature rises, the permissible engine speed also increases.

Avoid allowing the engine speed to rise as far as the advance warning field whenever possible.

Always avoid engine speeds in the red warning field.

In this range, the fuel supply is interrupted to protect the engine.

Coolant temperature

Should the coolant and therefore the engine become too hot, a warning lamp lights up. In addition, a message appears on the Control Display.

Checking coolant level, refer to page 178.

Engine oil temperature gauge



The general operating temperature lies between 175 °F /80 °C and 250 °F /120 °C. Do not exceed a value of approx. 265 °F /130 °C. If the engine oil temperature is too high, the permissible engine speed, and with it the available engine output is reduced.

Fuel gauge



Fuel tank capacity: approx. 18.5 gallons/ 70 liters. You can find information on refueling on page 168.

If the tilt of the vehicle varies for a longer period, when you are driving in mountainous areas, for example, the indicator may fluctuate slightly.

Reserve

After the reserve quantity has been reached, a message briefly appears on the Control Display; the remaining range is shown in the computer. Below a range of approx. 30 miles/50 km, the message remains on the Control Display.

 Refuel as soon as possible once your cruising range falls below 30 miles/ 50 km, otherwise engine functions are not ensured and damage can occur. ◀

Computer

Displays in instrument cluster



To display the information, press the BC button in the turn signal lever from radio readiness.

The following information is displayed in the specified order:

- ▷ Time and outside temperature
- ▷ Cruising range
- ▷ Average fuel consumption
- ▷ Oil level, refer to Checking engine oil level on page 176

Time

To set the time, refer to page 67.

Outside temperature

If the display drops to +37 °F /+3 °C, a signal sounds and a warning lamp lights up. A message appears on the Control Display. There is an increased danger of ice.

 Ice can form even at temperatures above +37 °F /+3 °C. Drive carefully, especially on bridges and shaded roadways; otherwise, your risk of accident increases. ◀

You can set the unit of measure °F or °C on the Control Display, refer to Units of measure on page 69.

Cruising range

Displays the estimated remaining range available with the remaining fuel. The range is projected based on the driving style over the last 20 miles/30 km.



Refuel as soon as possible once your cruising range falls below 30 miles/ 50 km, otherwise engine functions are not ensured and damage can occur. ◀

Average fuel consumption

The average fuel consumption is calculated for the time during which the engine is running.

You can use the Control Display to view your fuel consumption rate over two different distances, refer to Displays on Control Display or Trip computer.

To reset the average fuel consumption: press the BC button in the turn signal lever for approx. 2 seconds.

Displays on Control Display

You can also call up the computer via iDrive, for explanation of principle, refer to page 16.

1. Press the **MENU** button.
This opens the start menu.
2. Move the controller to the right to open "Navigation".
Without navigation system*: open "Car Data".
3. Select "Car Data" and press the controller.

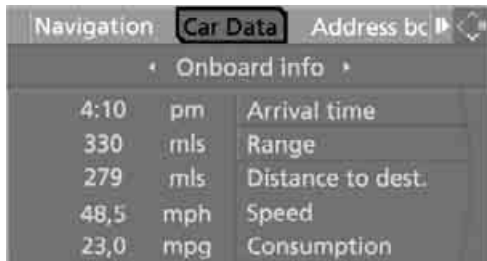

4. Select "Onboard info" and press the controller.

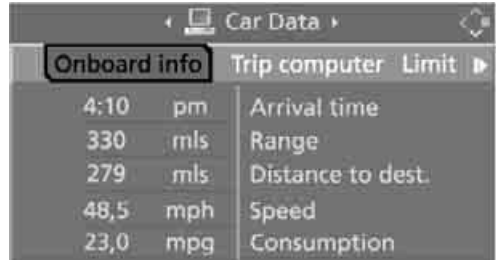

- ▶ Estimated time of arrival at destination:
 - ▶ Entering a distance manually in the computer, see below.
 - ▶ Entering a destination in the navigation system*, refer to page 107.
- ▶ Cruising range
- ▶ Distance to destination:
 - ▶ Entering a distance manually in the computer, see below.
 - ▶ Entering a destination in the navigation system*, refer to page 107.
- ▶ Average speed
- ▶ Average fuel consumption

Periods with the vehicle parked and the engine switched off are not included in the calculations of average speed.

Resetting values

You can reset the values for average speed and average fuel consumption:

1. Select the desired menu item and press the controller.
2. Press the controller again to confirm.

Entering a distance manually

1. Select "Distance to dest." and press the controller.

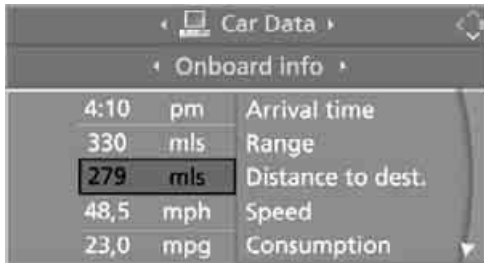

2. Turn the controller to select the distance to your destination. If necessary, hold it against a slight resistance to enter a greater difference.

3. Press the controller to apply the setting.

The distance is automatically predetermined during the destination guidance of the navigation system*.

Trip computer

The trip computer is suitable for a vacation trip, for example.

1. Open the start menu.
2. Open "Navigation".
Without navigation system*: open "Car Data".
3. Select "Car Data" and press the controller.
4. Select "Trip computer" and press the controller.



- ▷ Departure time
- ▷ Driving time
- ▷ Distance traveled

- ▷ Average speed
- ▷ Average fuel consumption

Switching trip computer on/off and resetting all values:

1. Select "Set" and press the controller.
2. Select the desired menu item and press the controller.

Display options

You can display the computer or the trip computer in the assistance window.

1. Move the controller to the right to switch to the assistance window and press the controller.

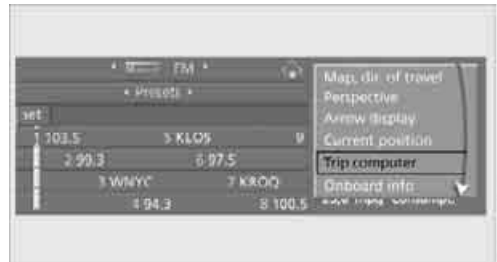

2. Select a menu item:
 - ▷ "Onboard info"
 - ▷ "Trip computer".
3. Press the controller.



Service requirements



The remaining driving distance and the date for the next maintenance are displayed briefly with the ignition switched on.

The first oil change displayed at approx. 1,200 miles/2,000 km signals that the break-in check is due.

 Your BMW Service Advisor can determine your vehicle's current service requirements by reading out the data stored in the remote control. ◀

Additional information

You can view more detailed information by using the Control Display, for explanation of principle, refer to page 16.

1. Open the start menu.
2. Press the controller to open the **i** menu.
3. Select "Service" and press the controller.
4. Select "Service requirements" and press the controller.

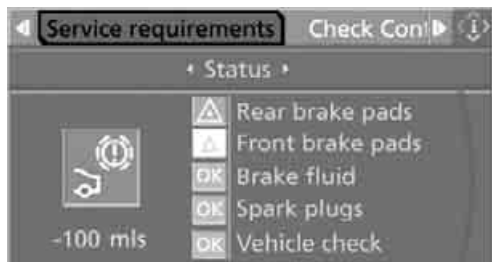

5. Select "Status" and press the controller.

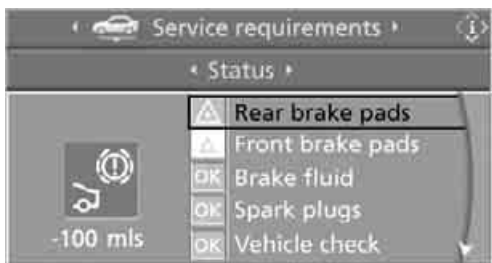

The display shows a list of selected service and maintenance procedures, as well as legally mandated official inspections.

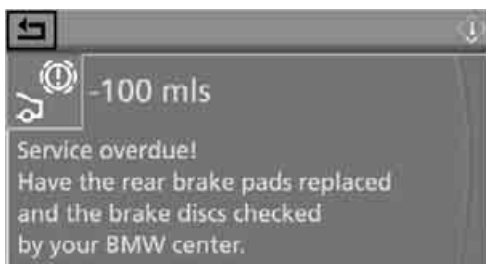

You can request more detailed information on every entry.

Select the entry and press the controller.



To exit from the menu:
Select the  arrow and press the controller.

Symbols

-  No service is currently required.
-  The deadline for service or an official inspection is approaching. Please arrange a service appointment.
-  The service deadline has already passed.

Entering dates for state emission and vehicle inspections*

Make sure the date on the Control Display is always set correctly, refer to page 68; otherwise, the effectiveness of CBS Condition Based Service is not ensured.

1. Open the start menu.
2. Press the controller to open the **i** menu.
3. Select "Service" and press the controller.
4. Select "Service requirements" and press the controller.
5. Select "Status" and press the controller.
6. Select "Emission inspect." or "State inspection" and press the controller.

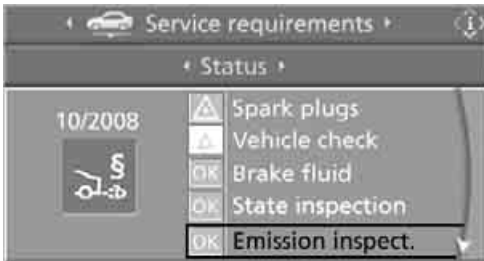

7. Select "Set service date" and press the controller. The month is highlighted.
8. Turn the controller to make the adjustment.



9. Press the controller to apply the setting. The year is highlighted.
10. Turn the controller to make the adjustment.
11. Press the controller to apply the setting. The date entry is stored.

To exit from the menu:

Select the  arrow and press the controller.

Check Control

The concept

The Check Control monitors functions in the vehicle and issues a message if there is a malfunction in the monitored systems. A Check Control message of this kind includes indicator or warning lamps in the instrument cluster, possibly an acoustic signal, and text messages at the bottom of the Control Display.

Indicator and warning lamps



Indicator and warning lamps can light up both in the display area **1** and in the display **2** in various combinations and colors.



 This symbol means that a Check Control message has been generated. The symbol remains visible even if the Check Control message has been hidden after a short time. The combinations of warning lamps and text messages are stored and can be viewed later, also refer to page [65](#).

Explanatory text messages



Text messages at the bottom edge of the Control Display explain the meaning of the indicator and warning lamps displayed.

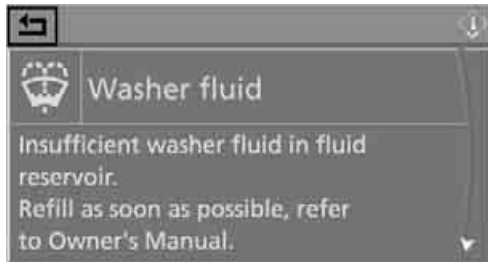

You can display supplementary information regarding most Check Control messages, e.g. as to the cause of a malfunction and corresponding actions to be taken, see below.

In cases of corresponding urgency, this information is immediately displayed when the associated lamps light up.

To exit the displayed information: Select the  arrow and press the controller.

Importance of Check Control messages

Important Check Control messages are retained until the malfunctions have been rectified. They cannot be deleted. If a number of these malfunctions occur simultaneously, they are displayed in succession.

Less important messages disappear after approx. 20 seconds, but remain in the memory.

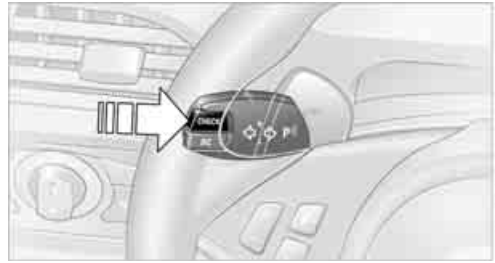

To hide these Check Control messages: Press the CHECK button on the turn signal lever.

Displaying stored Check Control messages

1. Press the button longer:
The first stored message is displayed.

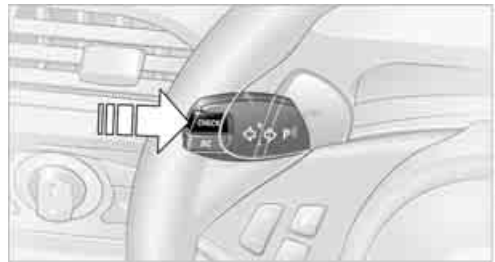

2. Press the button:
A new message appears each time you press the button.

Displaying supplementary information

iDrive, for explanation of principle, refer to page 16.

1. Press the **MENU** button.
This opens the start menu.
2. Press the controller to open the **i** menu.
3. Select "Service" and press the controller.

4. Select "Check Control messages" and press the controller.

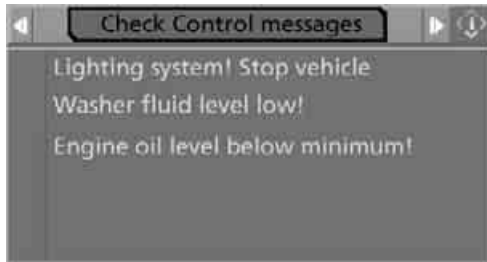

5. Select a message and press the controller.

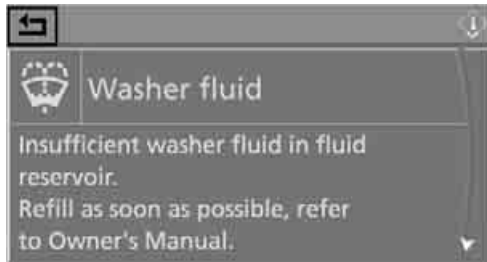

To exit from the menu immediately:
Select the arrow and press the controller.

Displaying the urgency of malfunctions

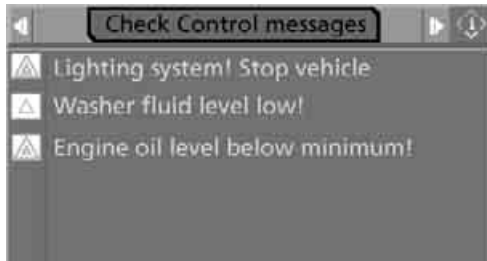

Depending on the equipment, the stored Check Control messages are also displayed with the following symbols:

- No malfunctions detected in the monitored systems.
- Malfunctions detected in the monitored systems. Depending on the malfunction, supplementary information is shown on the Control Display.

The symbols also indicate the status of the service requirements display, refer to page 63.

Displays after completion of trip

Malfunction reports generated during the trip are shown consecutively when you switch off the ignition.

Before the display disappears, you can display the messages once again. Press the CHECK button for approx. 2 seconds. If several messages are present, you can press the CHECK button repeatedly.

The display:

- ▷ turns off automatically after a brief period
- ▷ can be turned off at any time by pressing the CHECK button again for approx. 2 seconds

Speed limit

You can enter a speed and a Check Control message indicates when you have reached this speed. This enables you, for example, to receive warnings if you exceed a speed limit in an urban area.

You are only warned of reaching this speed a second time if your vehicle speed falls below it again by at least 3 mph/5 km/h.

Displaying, setting or changing limit

iDrive, for explanation of principle, refer to page 16.

1. Open the start menu.
2. Open "Navigation".
Without navigation system*: open "Car Data".
3. Select "Car Data" and press the controller.
4. Select "Limit" and press the controller.



5. Select the speed value and press the controller.
6. Turn the controller to set the limit. If necessary, hold it against a slight resistance to enter a greater difference.
7. Press the controller to apply the setting. The limit is automatically switched on.

Applying your current speed as limit

Select "Select current speed" and press the controller. The system applies your current speed as the limit.

Activating limit

Select "On" and press the controller.

 The limit is automatically switched on.

Stopwatch

iDrive, for explanation of principle, refer to page 16.

1. Open the start menu.
2. Open "Navigation".
Without navigation system*: open "Car Data".
3. Select "Car Data" and press the controller.
4. Select "Stopwatch" and press the controller.



Starting, stopping, or resetting

- ▷ Select "Start" and press the controller. The stopwatch starts at the displayed time.
- ▷ Select "Reset" and press the controller. The stopwatch is reset and it restarts if it was running beforehand.

- ▷ Select "Stop" and press the controller. This stops the timer.

Taking an intermediate time reading

Select "Interim time" and press the controller. The interim time appears below the ongoing primary stopwatch count.

 All of the remaining functions remain available at all times while the stopwatch is running. The stopwatch continues to operate in the background. ◀

Settings on Control Display

iDrive, for explanation of principle, refer to page 16.

1. Press the **MENU** button once or twice until the start menu appears.



2. Press the controller to open the **i** menu.



3. Turn the controller until "Display settings" is selected and press the controller.

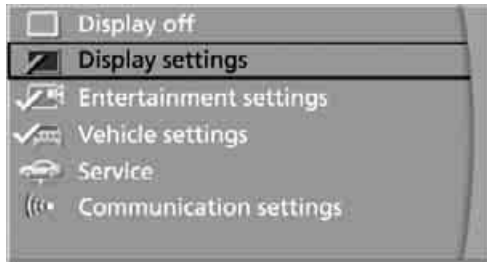

Setting time

1. Move the controller once to the front if necessary to change to the first field from the top.

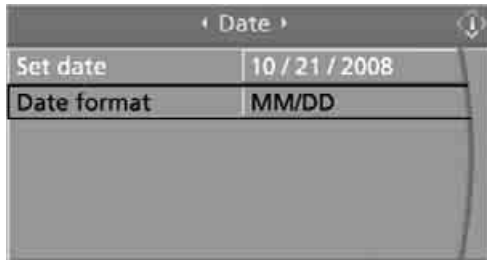

2. Turn the controller until "Time" is selected and press the controller.

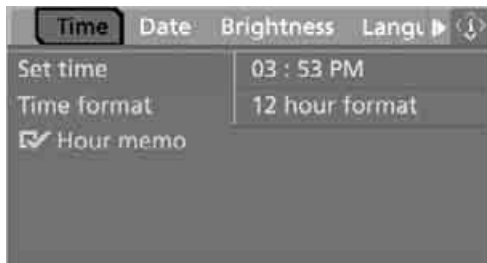

3. Turn the controller until "Set time" is selected and press the controller.

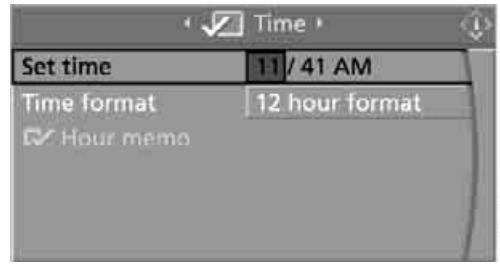

Making settings

1. Turn the controller to set the hours and press the controller.
2. Turn the controller to set the minutes and press the controller.

The changed time is stored.

Activating hour signal*

You will hear three tones just before each full hour.

Select "Hour memo" and press the controller.

- The hour signal is activated.

Setting time format

1. Select "Time format" and press the controller.
2. Select the desired format and press the controller.

The setting is stored for the remote control currently in use.

Setting date

1. Select "Date" and press the controller.



2. Select "Set date" and press the controller. The first section of the date display is highlighted, in this case the month
3. Turn the controller to make the adjustment.
4. Press the controller to apply the setting. The next adjustment is highlighted.
5. Make the remaining adjustments. After the last adjustment, the date is stored.

Changing date format

1. Select "Date format" and press the controller.
2. Select the desired format and press the controller.

The setting is stored for the remote control currently in use.

Brightness of Control Display

The brightness is automatically adapted to the ambient lighting conditions. However, you can change the base setting.

1. Select "Brightness" and press the controller.



2. If necessary, move the controller to the right to select "Display".
3. Turn the controller until the desired setting is selected.

The setting is stored for the remote control currently in use.

Units of measure

You can change the units of measure for fuel consumption, distances, temperature and pressure.

1. Select "Units" and press the controller.

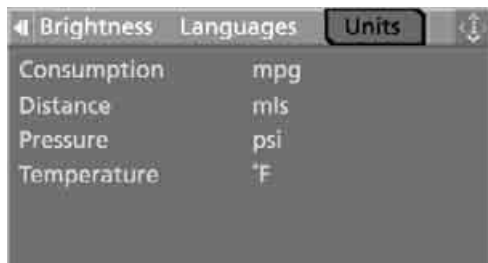

2. Select the menu item to be set.
3. Press the controller.
4. Select the desired unit of measure and press the controller.

The settings are stored for the remote control currently in use.

Language on Control Display

1. Select "Languages" and press the controller.

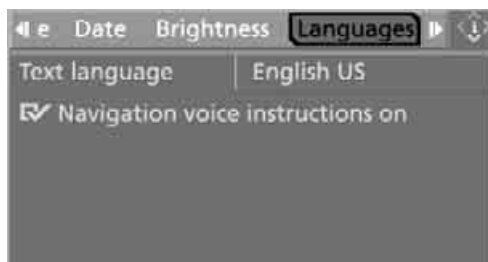

2. Select "Text language" and press the controller. You can select a different language for the text displays.
3. Select the desired language and press the controller.

The setting is stored for the remote control currently in use.

Technology for comfort, convenience and safety

PDC Park Distance Control*

The concept

The PDC assists you when you are parking. Acoustic signals and an optical display* alert you to the approach of an object from behind your vehicle. To measure the distance, there are four ultrasonic sensors in each bumper. The range of these sensors is approx. 7 ft/2 m. However, an acoustic warning first sound for the sensors at the front and at the two rear corners at approx. 24 in/60 cm, and for the center rear sensors at approx. 5 ft/1.50 m.

 PDC is a parking aid that can indicate the presence of objects when they are being approached slowly, as is usually the case when parking. Avoid approaching an object at high speed; otherwise, the physical circumstances could cause the system warning to be activated too late. ◀

Automatic switch-on

The system starts to operate automatically approx. 1 second after you move the selector lever into the R position with the engine running or the ignition switched on.

Wait this short period before driving.

Switching on manually



Press the button; the LED lights up.

Switching off manually

Press the button again; the LED goes out.

After driving approx. 165 ft/50 m or at over approx. 20 mph/30 km/h, the system is switched off and the LED goes out. You can reactivate the system manually as needed.

Signal tones

An intermittent signal indicates the distance of the vehicle from an object being approached. Thus, an object detected to the left rear of the vehicle will be indicated by a signal tone from the left rear speaker, etc. As the distance between vehicle and object decreases, the intervals between the tones become shorter. If the distance to the nearest object falls to below roughly 1 ft/30 cm, then a continuous tone sounds.

An intermittent tone is interrupted after approx. 3 seconds:

- ▷ if you remain in front of an object that was only detected by one of the corner sensors
- ▷ if you drive parallel to a wall

Malfunction

The LED in the button flashes and a message appears on the Control Display. PDC is malfunctioning. Have the system checked.

As a preventive measure, keep the sensors clean and free of ice or snow in order to ensure that they will continue to operate effectively. Do not spray the sensors with high-pressure cleaners for long periods and maintain a distance of at least 4 in/10 cm to them.

Exhaust gases near the rear sensors can cause a signal tone to sound.

PDC with visual warning*

You can also enjoy the option of having the system show the approach to an object on the Control Display. Objects that are farther away

are already shown there before a signal tone sounds. The setting is stored for the remote control currently in use.

iDrive, for explanation of principle, refer to page 16.

1. Open the start menu.
2. Press the controller to open the **i** menu.
3. Select "Vehicle settings" and press the controller.
4. Change to upper field if necessary. Turn the controller until "PDC" is selected and press the controller.



5. Select "PDC display on" and press the controller.

The PDC screen is activated.

The display appears on the Control Display as soon as PDC is activated.

System limits

⚠ Even with PDC, final responsibility for estimating the distance between the vehicle and any obstacles always remains with the driver. Even when sensors are involved, there is a blind spot in which objects cannot be detected. This applies especially in those cases where the system approaches the physical constraints of ultrasonic measurement, as occurs with tow bars and trailer couplings, and in the vicinity of thin or wedge-shaped objects. Low objects already displayed, e.g. a curb, can disappear from the detection area of the sensors again before a continuous tone sounds. Higher, protruding objects, e.g. ledges, cannot be detected. Loud noises from outside and inside the vehicle may prevent you from hearing the PDC signal tone. ◀

Driving stability control systems

Your BMW is equipped with an extended array of systems designed to enhance and maintain vehicle stability under extreme conditions.

ABS Antilock Brake System

ABS prevents the wheels from locking during braking. Safe steering response is maintained even during hard braking. This increases active driving safety.

ABS is operational every time you start the engine. For information on safe braking, refer to page 99.

CBC Cornering Brake Control

This system provides further enhancements to vehicle stability and steering response when braking while cornering or when braking during a lane change.

Electronic brake-force distribution

This system controls the brake system's application pressure at the rear wheels to ensure stable deceleration.

DBC Dynamic Brake Control

When you apply the brakes rapidly, this system automatically produces the maximum braking force boost and thus helps to achieve the shortest possible braking distance during full braking. This system exploits all of the benefits provided by ABS.

Do not reduce the pressure on the brake pedal for the duration of the full braking.

DSC Dynamic Stability Control

DSC optimizes the vehicle stability and traction. It also detects unstable driving states such as understeering and oversteering, and helps keep the vehicle on course within the physical limits by reducing the engine output and by braking at the wheels.

The DSC is operational every time you start the engine.

 The laws of physics cannot be repealed, even with DSC. An appropriate driving style always remains the responsibility of the driver. Do not reduce the additional safety margin of the system by taking risks. ◀

DSC indicator lamp

 The indicator lamp goes out shortly after the engine is started. The indicator lamp flashes: DSC is controlling the drive forces and brake forces. The indicator lamp stays lit: DSC is deactivated.

M Dynamic Mode MDM

The M Dynamic Mode is a mode of the DSC Dynamic Stability Control. It enables driving with greater longitudinal and lateral acceleration on dry road surfaces, however with limited vehicle stability. The system does not provide stabilizing intervention by reducing the engine output and braking at the wheels until the absolute driving limit is reached. Steering corrections by the driver may also be required in this driving state.

The M Dynamic Mode is deactivated each time the engine is started.

 With the M Dynamic Mode activated, stabilizing interventions are only carried out to a reduced degree. ◀

 To maintain vehicle stability, drive with DSC activated and the M Dynamic Mode deactivated whenever possible. ◀

MDM indicator lamp

 The indicator lamp goes out shortly after the engine is started. The indicator lamp stays lit: M Dynamic Mode is activated.

The indicator lamp lights up continuously and the DSC indicator lamp flashes: the M Dynamic Mode is active and controls the drive and braking forces.

Activating MDM

You activate the M Dynamic Mode with the  button on the steering wheel, refer to MDrive on page 46.

With the ignition switched on you can change the settings of MDrive on the Control Display. iDrive, for explanation of principle, refer to page 16.

1. Open the start menu.
2. Press the controller to open the  menu.
3. Select "Vehicle settings" and press the controller.
4. Select "MDrive" and press the controller.
5. Select "DSC" and press the controller.
6. Select "M Dynamic Mode" and press the controller.



Deactivating MDM again

Press the  button on the steering wheel again; the MDM indicator lamp goes out.

Switching off DSC



Press the DSC button; the DSC indicator lamp lights up continuously. DSC and MDM are deactivated.

A message appears on the Control Display. Please note any supplementary information that appears there.

When rocking free and starting off from deep snow or on loose road surfaces, it may be practical to briefly deactivate DSC.



To maintain vehicle stability, always drive with the system switched on when possible. ◀

Reactivating DSC

Press the DSC button; the indicator lamp in the instrument cluster goes out.

You can also activate and deactivate DSC with the  button on the steering wheel, refer to MDrive on page 46.

EDC Electronic Damping Control

The concept

If the influencing variables such as road surface quality or operating conditions such as steering, braking etc. change, the damping automatically adjusts to the new conditions within a fraction of a second.

You can choose from three programs.

"Comfort" program

Select the "Comfort" program if you want comfort-oriented coordination of shock absorbers and steering.

"Normal" program

The "Normal" program offers a balanced mixture of the comfort and the sport program.

"Sport" program

Select the "Sport" program if you want a consistently sporty coordination of shock absorbers and steering.

Selecting program



Press the EDC button repeatedly:

- ▷ "Comfort": no LED lights up in the button.
- ▷ "Normal": one LED lights up in the button.
- ▷ "Sport": both LEDs light up in the button.

The last selected program is active each time the engine is started.

You can also activate your preferred program with the  button on the steering wheel, refer to MDrive on page 46.

FTM Flat Tire Monitor

The concept

The Flat Tire Monitor keeps track of the inflation pressures in the tires as you drive. The system provides an alert whenever the inflation pressure drops significantly in relation to the pressure in another tire.

In the event of a pressure loss, the rolling radius and therefore the rotation speed of the wheels change. This change is detected and signaled as a flat tire.

Functional requirement

To ensure the reliable signaling of a flat tire, the system must be initialized at the correct tire inflation pressure.



The initialization must be repeated after every correction of the tire inflation pressure and after every tire or wheel change. ◀

System limits

 The Flat Tire Monitor cannot indicate sudden severe tire damage caused by outside factors and does not detect a natural, even pressure drop in all four tires. ◀

In the following situations, the system could be delayed or malfunction:

- ▷ System has not been initialized
- ▷ Driving on snow-covered or slippery roads
- ▷ Sporty driving style: slip in the drive wheels, high lateral acceleration
- ▷ Driving with snow chains*

Initializing system

 The initialization finishes during driving, which can be interrupted at any time. When driving resumes, the initialization is automatically continued. Do not initialize the system when driving with snow chains*. ◀

With the button in the center console:

1. Start the engine, but do not start driving.
2. Press the button at least 4 seconds, however not longer than 2 minutes. After releasing the button, the warning lamp in the instrument cluster lights up yellow for a few seconds. Warning lamp, refer to Indication of a flat tire. The message "Initializing FTM ..." appears on the Control Display for a few seconds.



3. Start to drive. The initialization finishes during driving without feedback.

Using iDrive, for explanation of principle, refer to page 16:

1. Press the **MENU** button. This opens the start menu.
2. Press the controller to open the **i** menu.
3. Select "Vehicle settings" and press the controller.
4. Select "FTM" and press the controller.

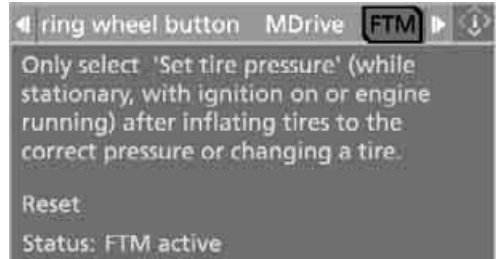

5. Start the engine, but do not start driving.
6. Select "Set tire pressure" and press the controller.
7. Select "Yes" and press the controller.

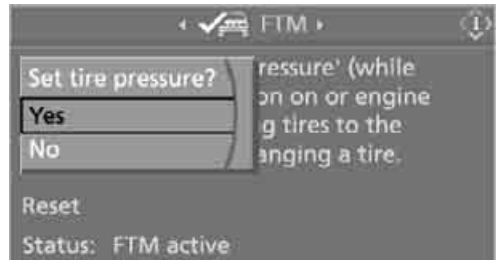

The message "Initializing..." is displayed for a few seconds. The warning lamp in the instrument cluster lights up yellow for a few seconds.

8. Start to drive. The initialization finishes during driving without feedback.

Indication of a flat tire

 The warning lamp lights up in red. A message appears on the Control Display. In addition, an acoustic signal sounds. There is a flat tire or extensive inflation pressure loss.

1. Reduce speed and stop the vehicle carefully. Avoid sudden braking and steering maneuvers.
2. Identify damaged tire. To do this, check the tire inflation pressure using the M Mobility System, refer to Producing tire inflation pressure on page 187.
3. Repair flat tire with M Mobility System, refer to page 185, or replace the damaged wheel, refer to Changing wheels on page 187.

Brake force display



- ▷ Left-hand picture: normal braking.
- ▷ Right-hand picture: heavy braking.

Airbags



The following airbags are located under the marked covers:

- 1 Front airbags
- 2 Head airbags

- 3 Side airbags
- 4 Knee airbag
- 5 Knee airbag

Protective action

⚠ To ensure that the safety systems continue to provide optimized protection, please follow the adjustment instructions on page 39. ◀

The front airbags help protect the driver and front passenger by responding to frontal impacts in which safety belts alone cannot provide adequate restraint. When needed, the head and side airbags help provide protection in the event of a side impact. The relevant side airbag supports the side upper body area. The head airbag supports the head. The knee airbag protects the legs from colliding with the cockpit.

The airbags are deliberately not triggered in every impact situation, e.g. less severe accidents or rear-end collisions.

⚠ Do not apply adhesive materials to the cover panels of the airbags, cover them or modify them in any other way. Do not attempt to remove the airbag retention system from the vehicle. Do not modify or tamper with either the wiring or the individual components in the airbag system. This category includes the upholstery in the center of the steering wheel, on the instrument panel, the doors and the roof pillars along with the sides of the headliner. Do not

attempt to remove or dismantle the steering wheel.

Do not touch the individual components directly after the system has been triggered, because there is a danger of burns.

In the event of malfunctions, deactivation, or triggering of the airbag restraint system, have the testing, repair, removal, and disposal of airbag generators carried out only by a BMW center or a workshop that works according to BMW repair procedures with appropriately trained personnel and has the required explosives licenses. Unprofessional attempts to service the system could lead to failure in an emergency or undesired airbag activation, either of which could result in personal injury. ◀

Warnings and information on the airbags is also provided on the sun visors.

Automatic deactivation of front passenger airbags

The occupation of the seat is detected by evaluating the impression on the occupied seat surface of the front passenger seat. The system correspondingly activates or deactivates the front, knee and side airbag on the front passenger side.

 The current status of the front passenger airbag, i.e. deactivated or activated, is indicated by the indicator lamp over the interior rearview mirror, refer to Operating state of front passenger airbags below. ◀

 Before transporting a child in the front passenger seat, read the safety information and follow the instructions under Transporting children safely, refer to page 48. The front, knee and side airbag on the front passenger side can be deactivated for teenagers and adults in certain seat positions; the indicator lamp for the front passenger airbags lights up when this occurs. In these cases, change the seat position so that the front passenger airbags are activated and the indicator lamp goes out. If the desired status cannot be produced by changing the seat position, transport the corresponding person in the rear seat.

Do not fit seat covers, seat cushion padding, beaded mats or other items onto the front passenger seat unless they are specifically recommended by BMW. Do not place objects under the seat which could press against the seat from below. Otherwise a correct evaluation of the occupied seat surface cannot be ensured. ◀

Operating state of front passenger airbags



The indicator lamp for the front passenger airbags indicates the operating status of the front, knee and side airbag on the front passenger side depending on whether the seat is occupied. The indicator lamp shows whether the front passenger airbags are activated or deactivated.

- ▷ The indicator lamp lights up when a child in a child restraint system intended for the purpose is properly detected on the seat. The front, knee and side airbag on the front passenger side are deactivated.
- ▷ The indicator lamp does not light up when, for example, a correctly seated person of sufficient height is detected on the seat. The front, knee and side airbag on the front passenger side are activated.
- ▷ The indicator lamp does not light up when the seat is empty. But the front, knee and side airbag on the front passenger side are still deactivated.

Operational readiness of airbag system



From radio readiness, refer to page 50, the warning lamp lights up briefly, indicating the operational readiness of the entire airbag system and the safety belt tensioners.

Airbag system malfunction

- ▶ Warning lamp does not light up as of radio readiness.
- ▶ Warning lamp lights up continuously.

 Have the airbag system checked immediately in case of a malfunction; otherwise, there is a danger that the airbag system may not respond in the expected manner in an accident despite an impact of corresponding intensity. ◀

Head-Up Display*

The concept

With the Head-Up Display, important information is projected into the driver's field of view, e.g. navigation instructions. This enables you to absorb this information without looking away from the road.



Switching on/off

With the engine running or the ignition switched on:

Press the button to activate or deactivate this system.

Selecting displays

iDrive, for explanation of principle, refer to page 16.

1. Press the **MENU** button.
This opens the start menu.
2. Press the controller to open the **i** menu.
3. Select "Display settings" and press the controller.
4. Select "Head-Up Display" and press the controller.

5. Select desired information of Head-Up Display.



6. Press the controller.
 - The information is shown on the Head-Up Display.
 - "M View": the M view is shown in the Head-Up Display. Information unavailable in the M view appears on the Control Display in gray and cannot be selected.
 - "M View": the default view is displayed.

The M view for the Head-Up Display can also be selected with the  button on the steering wheel, refer to MDrive on page 46.

The settings are stored for the remote key currently in use.

Default view



- 1 Navigation instructions
- 2 Stored desired speed of cruise control
- 3 Speed

M view

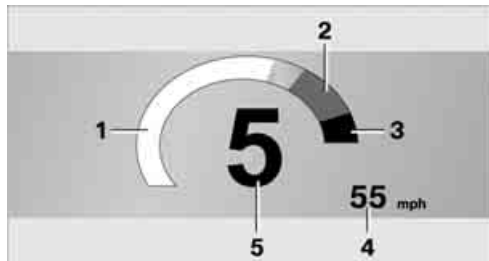

- 1 Current engine speed, highlighted
- 2 Advance warning field of tachometer
- 3 Red warning field of tachometer, also refer to Tachometer on page 59
- 4 Speed
- 5 Gear display

For information on the shift lights in the tachometer, refer to page 55.

Setting brightness

The brightness of the display is automatically adapted to the ambient lighting conditions. However, you can change the base setting. With the low beams switched on, the brightness can also be adjusted with the knurled wheel of the instrument lighting.

iDrive, for explanation of principle, refer to page 16.

1. Open the start menu.
2. Press the controller to open the **i** menu.
3. Select "Display settings" and press the controller.
4. Select "Brightness" and press the controller.



5. If necessary, move the controller to the left to select "Head-Up Display".
6. Turn the controller until the desired setting is selected.

The setting is stored for the remote control currently in use.

Notes

The visibility of the displays in the Head-Up Display is influenced by:

- ▷ Sunglasses with certain polarization filters
- ▷ Certain sitting positions
- ▷ Objects on the cover of the Head-Up Display
- ▷ Wet road surface and unfavorable lighting conditions

If the image is distorted, please have the base setting checked at a BMW center.

Specialized windshield

The windshield is a part of the system. The shape of the windshield complies with the requirements of the Head-Up Display to enable a precise display. A film in the windshield prevents double images from being displayed. Have the windshield replaced only by a BMW center or a repair shop that works in accordance with BMW guidelines and uses appropriately trained personnel.

Care instructions

You can find everything you need to know on this topic by consulting the Caring for your vehicle brochure.



Only clean the cover of the Head-Up Display with a soft, lint-free cloth or with a display cleaning cloth, otherwise damage may result. ◀

Lamps

Parking lamps/low beams

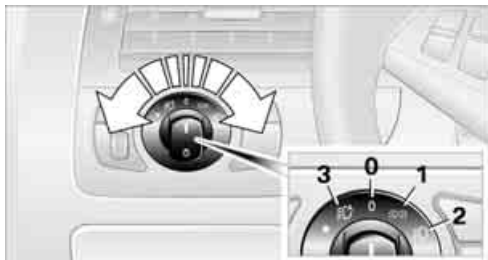

- 0 Lights off and daytime running lamps*
- 1 Parking lamps and daytime running lamps*
- 2 Low beams
- 3 Automatic headlamp control, daytime running lamps*, Adaptive Head Light* and high-beam assistant*

Parking lamps

In switch position **1**, the front, rear and side vehicle lighting is switched on. You can use the parking lamps for parking. For lighting on one side for parking as an additional feature, refer to page [81](#).

 The parking lamps drain the battery. Do not leave them switched on for long periods of time, as otherwise it may no longer be possible to start the engine. ◀

Low beams

The low beams light up in switch position **2** only with the engine running. Otherwise the parking lamps are lit.

Automatic headlamp control

In the switch position **3**, the system activates the low beams and switches them on or off in response to changes in ambient light conditions, for instance, in a tunnel, at dawn and dusk and in case of precipitation. Adaptive Head Light* is active. The LED next to the symbol is illuminated when the low beams are on.

When driving into a tunnel with bright overhead lighting, switching on of the lights may be delayed.

A blue sky with the sun low on the horizon can cause the lights to be switched on.

 If desired, the light switch can be left in the position **3**. The exterior lighting is automatically switched off after switching off the vehicle.

 The automatic headlamp control cannot serve as a substitute for your personal judgment in determining when the lamps should be switched on in response to ambient lighting conditions. For example, the system cannot detect fog. To avoid safety risks, you should always switch on the lamps manually under these conditions. ◀

Pathway lighting

When you activate the headlamp flasher after parking the vehicle and switching off the lamps, the low beams will come on for a brief period. You can set the duration or deactivate the function via iDrive.

iDrive, for explanation of principle, refer to page [16](#).

1. Press the **MENU** button.
This opens the start menu.
2. Press the controller to open the **i** menu.
3. Select "Vehicle settings" and press the controller.
4. Select "Lighting" and press the controller.



5. Select "Pathway lighting" and press the controller.
6. Turn the controller to select the desired duration.
7. Press the controller to apply the setting.

Daytime running lamps*

If desired, the light switch can remain in position **0**, **1** or **3**.

In position **0** and **3** the exterior lighting is automatically switched off after the vehicle is switched off. In position **1** the parking lamps light up after the ignition is switched off.

Switch on the parking lamps if required as described under Parking lamps.

Adaptive Head Light*

The concept

Adaptive Head Light is a variable headlamp control system that enables better illumination of the road surface. Depending on the steering angle and other parameters, the light from the headlamp follows the course of the road.

Activating Adaptive Head Light

In switch position **3**, the Adaptive Head Light is active and the automatic headlamp control is switched on, refer to page 80.

To avoid blinding oncoming traffic, the Adaptive Head Light is not active when driving in reverse and points toward the passenger side when the vehicle is stopped.

Malfunction

The LED next to the symbol for automatic headlamp control flashes. The Adaptive Head Light is malfunctioning or has failed. Have the system checked as soon as possible.

High beams/ roadside parking lamps

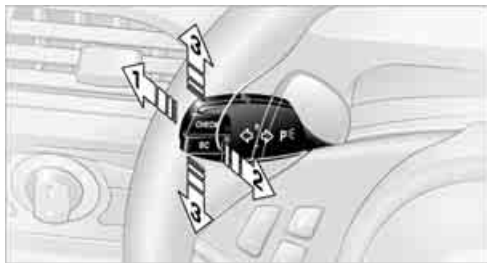

- 1 High beams
- 2 Headlamp flasher
- 3 Roadside parking lamps

Roadside parking lamps, left or right*

You also enjoy the option of lighting up just one side of your vehicle when parking. When using this function, comply with national regulations.

Switching on

After parking the vehicle, press the lever in the desired direction **3**, past the resistance point.

 The roadside parking lamps drain the battery. Do not leave them switched on for long periods of time, as otherwise it may no longer be possible to start the engine. ◀

Switching off

Briefly press the lever in the opposite direction **3** up to the resistance point.

High-beam assistant*

The concept

This system automatically switches the high beams on and off again. A sensor on the front of the interior rearview mirror controls the process. The assistant ensures that the high beams are switched on whenever the traffic situation allows. This reduces the strain on you while at the same time providing you with the best possible visibility. Of course, you can inter-

vene at any time and switch the high beams on and off in the accustomed manner.

Activating high-beam assistant

1. Turn the light switch to switch position **3**, refer to page 80.
2. Press the turn signal lever in the high beam direction with the low beams switched on.

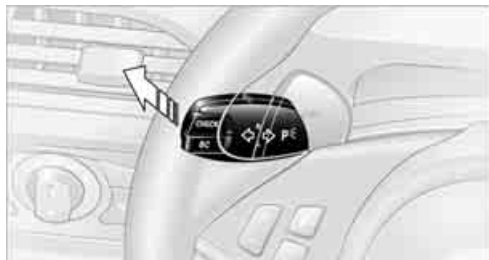

 The indicator lamp in the instrument cluster lights up when the high-beam assistant is activated. The assistant automatically switches between high and low beams, reacting to oncoming traffic and traffic ahead and to well-lit areas such as towns and cities.

Manually switching between high and low beams

You can intervene at any time if you wish or the situation requires.

- ▷ If the high-beam assistant has switched on the high beams, but you want to use the low beams, simply switch to the low beams with the turn signal lever. This also deactivates the high-beam assistant.
To reactivate the system, briefly press the turn signal lever in the high beam direction again.
- ▷ If the high-beam assistant has switched on the low beams, but you want to use the high beams, switch to the high beams in the accustomed manner. The system is deactivated in the process and you must switch to the low beams manually.
To reactivate the system, briefly press the turn signal lever in the high beam direction again.

- ▷ You use the headlamp flasher in the usual way when the low beams are on.

System limits

 The high-beam assistant cannot replace personal decisions about the benefits of using high beams. In situations that require them, you should switch to the low beams manually to avoid a safety risk. ◀

In the following sample situations, the system either does not function or functions only in a limited way and a personal reaction may be required:

- ▷ Under extremely unfavorable weather conditions, such as fog or heavy precipitation
- ▷ To make out poorly-lit road users such as pedestrians, cyclists, people on horseback, horse-drawn vehicles, train or ship traffic close to the road and wild animals crossing the road
- ▷ In tight curves, on steep hilltops or in depressions, with cross traffic or partially concealed oncoming traffic on the freeway
- ▷ In poorly lit places and with highly reflective signs
- ▷ In the low speed range
- ▷ When the windshield is fogged up, dirty or covered with stickers, decals, etc. in the area of the interior rearview mirror
- ▷ When the sensor is dirty. Clean the sensor on the front side of the inside rearview mirror with a cloth moistened with a small amount of glass cleaner

Instrument lighting



The lighting intensity can be adjusted with the knurled wheel with the parking lamps/low beams switched on.

Interior lamps

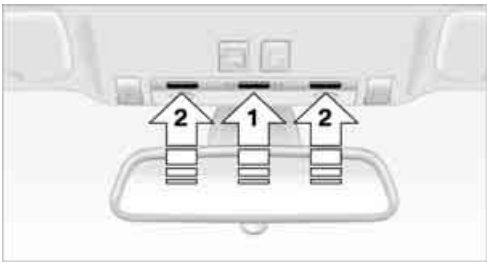

Control of the interior lamps, footwell lamps, door entry lighting, courtesy lamps* and sill panel lighting* is automatic.

With the courtesy lamps, LED lights are located in the door handles to illuminate the exterior area before the doors.

 To protect the battery, all lamps in the vehicle are switched off approx. 15 minutes after radio readiness is switched off, refer to Start/Stop button on page 50. ◀

Switching interior lamps on and off manually

Press button **1**.

If you want the interior lamps to remain off continuously, maintain pressure on the button for approx. 3 seconds.

To revert to normal operation, briefly press the button.

Reading lamps

The reading lamps are beside the interior lamp: You can turn them on and off using the buttons **2** located next to the lamps.

Climate

Automatic climate control

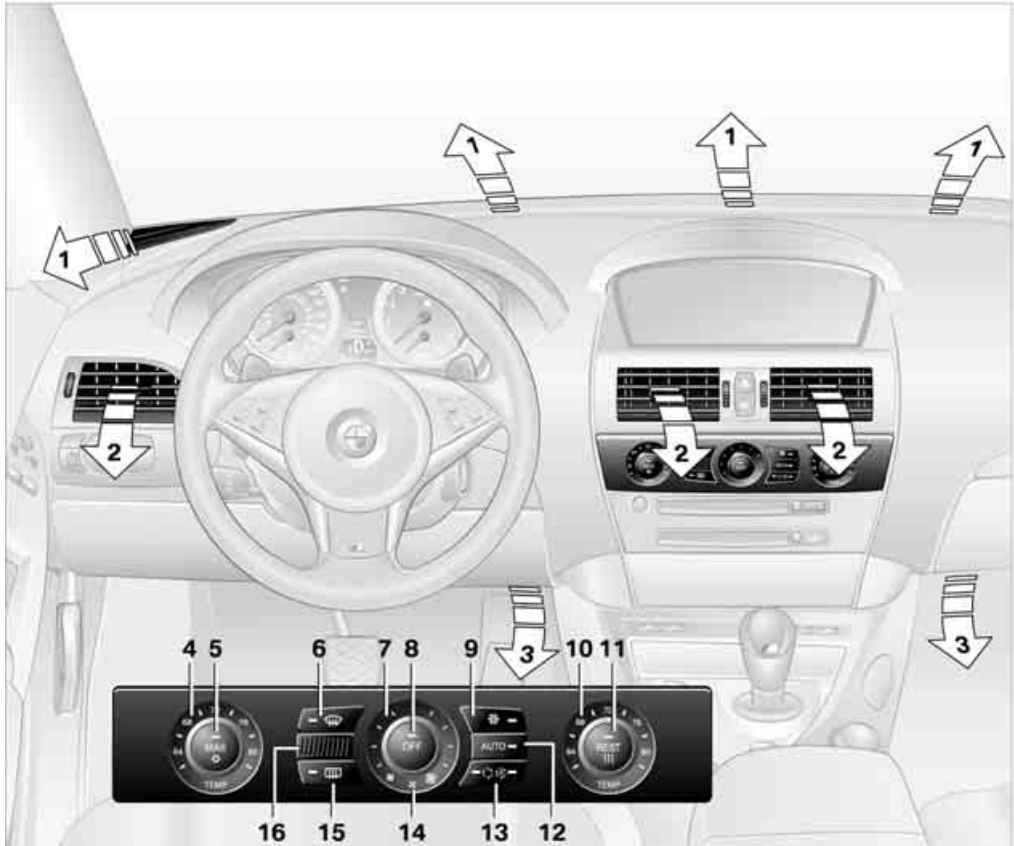

- | | |
|--|--|
| <p>1 Airflow directed toward the windshield and side windows</p> <p>2 Air for the upper body area, refer to Ventilation on page 87</p> <p>3 Air to footwell</p> <p>4 Temperature, left side of passenger compartment</p> <p>5 Maximum cooling</p> <p>6 Defrosting windows and removing condensation</p> <p>7 Air volume, manual</p> <p>8 Switching off automatic climate control</p> | <p>9 Switching cooling function on and off manually</p> <p>10 Temperature, right side of passenger compartment</p> <p>11 Residual heat mode</p> <p>12 AUTO program</p> <p>13 AUC automatic recirculated-air control/ recirculated air mode</p> <p>14 LED for parked car ventilation</p> <p>15 Rear window defroster</p> <p>16 Air grill for interior temperature sensor – please keep clear and unobstructed</p> |
|--|--|

The current setting for air distribution is displayed on the Control Display.

A congenial climate

The AUTO program offers the optimum air distribution and air volume for virtually all conditions, refer to AUTO program below. Now you only need to select an interior temperature that you find pleasant.

The following sections contain more detailed information on the available setting options.

Most settings are stored for the remote control currently in use, also refer to Personal Profile settings on page 29.

AUTO program

 The AUTO program handles the adjustment of air distribution to the windshield and side windows, in the direction of the upper body, and in the footwell, as well as the adjustment of the air volume. It also adapts your instructions for the temperature to outside influences throughout the year.

The cooling is switched on automatically with the AUTO program. At the same time, a condensation sensor controls the program in such a way that window condensation is prevented as much as possible.

Intensity of AUTO program

To meet your individual needs, you can increase or decrease the intensity of the automatic climate control.

iDrive, for explanation of principle, refer to page 16.

1. Press the **MENU** button.
This opens the start menu.
2. Move the controller to the left to open "Climate".

3. Select "Automatic programs" and press the controller.

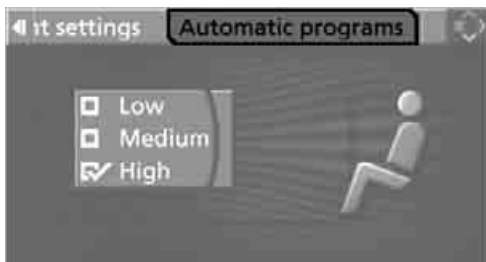

4. Select the desired intensity and press the controller.

 The marked intensity of the automatic program is switched on.

Temperature



Set the desired temperature individually on the driver's and front passenger side.

The automatic climate control achieves this temperature as quickly as possible at any time of year, if necessary with the maximum cooling or heating capacity, and then keeps it constant.

 When switching between different temperature settings in rapid succession, the automatic climate control does not have sufficient time to achieve the set temperature. ◀

Adapting temperature in upper body region

1. Open the start menu.
2. Open "Climate".
3. Select "Vent settings" and press the controller.

- Select the field by moving the controller and adjust the temperature by turning the controller.



Defrosting windows and removing condensation



Quickly remove ice and condensation from the windshield and front side windows.

Rear window defroster



The rear window defroster switches off automatically after a certain amount of time.

Air volume, manual



You can adjust the air volume by turning. You can reactivate the automatic mode for the air volume with the AUTO button.

Manual air distribution

You can specify the air distribution.

- Open the start menu.
- Open "Climate".
- Select "Vent settings" and press the controller.

The driver's and front passenger side can be adjusted separately with the fields on the right or left side.
- Select the driver's or front passenger side if necessary.

Move the controller to the right or left repeatedly until the driver's side or front passenger side is selected.
- Select the desired field by moving the controller.

- Turn the controller to adjust the air distribution.

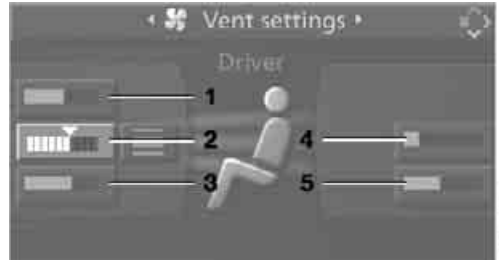

Driver's side:

- Airflow directed toward the windshield and side windows
- Airflow for the upper body
- Air to footwell

Front passenger side:

- Airflow for the upper body
- Air to footwell



Pressing the AUTO button raises and lowers the air distribution settings on the Control Display. ◀

Switching cooling function on and off



The cooling function cools and dehumidifies the incoming air before reheating it as needed according to the temperature setting. Depending on the weather, the windshield may fog over briefly when the engine is started.

The cooling function is switched on automatically with the AUTO program. The passenger compartment can only be cooled with the engine running.

Maximum cooling



Maximally cooled air is obtained as quickly as possible from an outside temperature above 32 °F / 0 °C and with the engine running.

The automatic climate control changes over to the lowest temperature and switches into the recirculated-air mode. The maximum air quantity only flows out of the vents for the upper

body. It is therefore necessary for these vents to be open for maximum cooling.

AUC Automatic recirculated-air control/recirculated-air mode



You can respond to unpleasant odors or pollutants in the immediate environment by temporarily suspending the supply of outside air. The system then recirculates the air currently within the vehicle. In AUC mode, a sensor detects pollutants in the outside air and controls the shut-off automatically.

Press the button repeatedly to run through the following control sequence:

- ▷ LED off: outside air flows into the vehicle continuously.
- ▷ Right LED on, AUC mode: the system detects pollutants in the outside air and responds by blocking the supply of outside air when required.
- ▷ Left LED on, recirculated-air mode: the supply of outside air into the vehicle is shut off continuously.

 If condensation starts to form on the inside window surfaces during operation in the recirculated-air mode, you should switch it off while also increasing the air volume as required.

The recirculated-air mode should not be used over a longer period of time, as the air quality inside the vehicle deteriorates continuously. ◀

Residual heat



The heat stored in the engine is used to heat the passenger compartment, e.g. while stopped at a school to pick up a child.

The function can be switched on when the following conditions are met:

- ▷ up to 15 minutes after switching off the engine
- ▷ engine at operating temperature
- ▷ sufficient battery voltage
- ▷ outside temperature below 77 °F /25 °C

The LED lights up when the function is switched on.

With the ignition lock at radio readiness or higher the interior temperature, the air volume and the air distribution can be set.

Switching off automatic climate control



The air volume, the heater and the cooling function are all switched off.

You can restart the automatic climate control by pressing any of its buttons except the REST button.

Ventilation

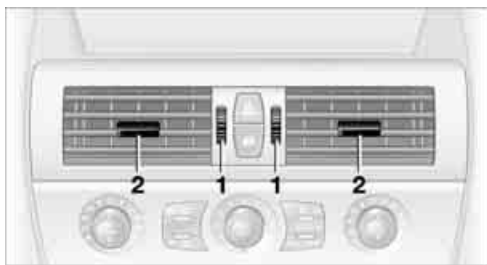

1 Knurled wheels for smoothly opening and closing air vents

2 Levers for changing the airflow direction

 Do not drop any foreign objects into the vent outlets; otherwise, they could be catapulted outwards and cause injuries. ◀

Ventilation for cooling

Adjust the vent outlets to direct the flow of cool air in your direction, for instance, if the interior has become too warm, etc.

Draft-free ventilation

Set the vent outlets so that the air flows past you and is not directed straight at you.

Microfilter/activated-charcoal filter

The microfilter removes dust and pollen from the incoming air. The activated-charcoal filter provides additional protection by filtering gaseous pollutants from the outside air. Your BMW center replaces this combined filter as a stan-

part of your scheduled maintenance. You can have more detailed information shown on the Control Display, refer to page 63.

Parked car ventilation

The concept

The parked car ventilation blows air into the passenger compartment to lower interior temperatures.

It is ready to use in the parked-car mode at any outside temperature.

You can set two different times for the system to start. The parked car ventilation can also be switched on and off directly. It remains switched on for 30 minutes.

Since the system uses a substantial amount of electrical current, you should refrain from activating it twice in succession without allowing the battery to be recharged in normal operation between uses.

The air emerges through the upper body region vent outlets in the instrument panel. These vent outlets must be open for the system to operate.

The parked car ventilation system is operated via iDrive.

Switching on and off directly

iDrive, for explanation of principle, refer to page 16.

1. Open the start menu.
2. Move the controller to the left to open "Climate".
3. Select "Parked car operation" and press the controller.
4. Select "Automatic ventilation" and press the controller.

5. Select "Parked car ventilation" and press the controller.

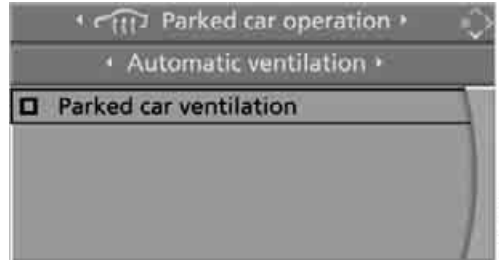

- ✓ The parked car ventilation is switched on.
- ⚙ The symbol on the display of the automatic climate control flashes.

Preselecting activation times

iDrive, for explanation of principle, refer to page 16.

1. Open the start menu.
2. Move the controller to the left to open "Climate".
3. Select "Parked car operation" and press the controller.
4. Select "Activation time" and press the controller.
5. Move the controller to the left or right to select "Timer 1" or "Timer 2".

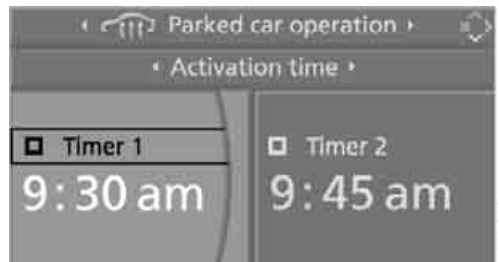

6. Select the time and press the controller.
The first time setting is highlighted.

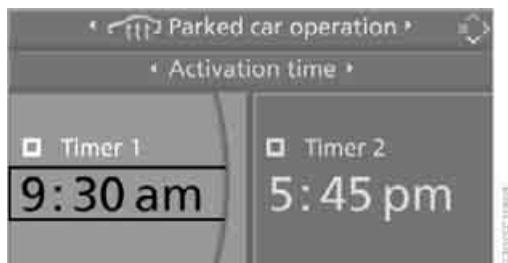

7. Turn the controller to make the adjustment.
8. Press the controller to apply the setting.
The next adjustment is highlighted.
9. Make the remaining adjustments. After the last adjustment, the time is stored.

Activating timer

Move the controller to the left or right to select "Timer 1" or "Timer 2" and then press the controller.

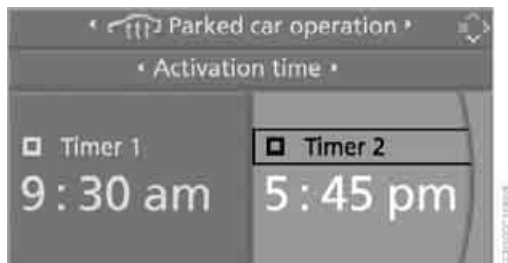

- ✔ The switch-on time is activated.
- ☞ The symbol on the display of the automatic climate control lights up.
- ☞ The symbol on the display of the automatic climate control flashes when the parked car ventilation has switched on.
- ▶ The parked car ventilation is only available for activation within the subsequent 24 hours. After that, the time must be reactivated. ◀

Practical interior accessories

Integrated universal remote control*

The concept

The integrated universal remote control replaces up to three different hand-held transmitters for various items of radio-controlled equipment such as door openers and house alarm systems. The integrated universal remote control registers and stores signals from the original hand-held transmitters.

The signal of an original hand-held transmitter can be programmed on one of the three memory buttons **1**. Then with the ignition switched on, this programmed memory button **1** can be used to operate the respective feature. The LED **2** flashes to confirm transmission of the signal.

If you sell your vehicle one day, delete the saved programs beforehand for your own security, refer to page **91**.

 To prevent possible damage or injury, before programming or using the integrated universal remote control, always inspect the immediate area to make certain that no people, animals or objects are within the travel range of the device. Also, comply with the safety precautions of the original hand-held transmitter. ◀

Checking compatibility

 If you see this symbol on the packaging or in the manual supplied with the original hand-held transmitter, it is safe to assume that it is compatible with the integrated universal remote control.

 If you have additional questions, please contact your BMW center or call: 1-800-355-3515.

Information is also provided on the Internet at: www.bmwusa.com or www.homelink.com.

HomeLink is a registered trademark of Johnson Controls, Inc. ◀

Programming

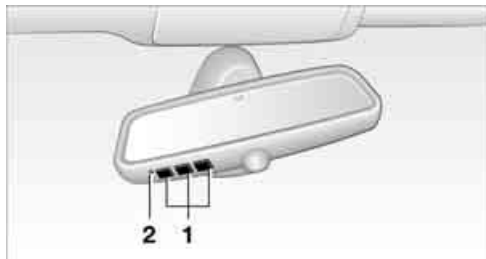

- 1** Memory buttons
- 2** LED

Fixed-code hand-held transmitters

1. Switch on ignition, refer to page **50**.
2. When using for the first time: press both outer memory buttons **1** for approx. 20 seconds until the LED **2** flashes. all stored programs are deleted.
3. Hold the original hand-held transmitter at a distance of approx. 2 in/5 cm to 8 in/20 cm from the memory buttons **1**.

 The required distance between the hand-held transmitter and the memory buttons **1** depends on the particular system of the original hand-held transmitter used. ◀

4. Simultaneously press the transmit key on the original hand-held transmitter and the desired memory button **1** on the integrated universal remote control. The LED **2** flashes slowly at first. As soon as the LED **2** flashes rapidly, release both buttons. If the LED **2** does not flash rapidly after approx. 15 seconds, alter the distance.
5. To program other original hand-held transmitters, repeat steps 3 and 4.

The corresponding memory button **1** is now programmed with the signal of the original hand-held transmitter.

You can operate the system when the engine is running or when the ignition is switched on.

 If the device can not be used after repeated programming, check whether the original hand-held transmitter uses an alternating-code system. To do so, either read the instructions for the original hand-held transmitter or hold down the programmed memory button **1** of the integrated universal remote control. If the LED **2** on the integrated universal remote control flashes rapidly for a short time and then remains lit for approx. 2 seconds, this indicates that the original hand-held transmitter uses an alternating-code system. In the case of an alternating-code system, program the memory buttons **1** as described at Alternating-code transmitters. ◀

Alternating-code hand-held transmitters

To program the integrated universal remote control, consult the operating instructions for the equipment to be set. You will find information there on the possibilities for synchronization.

When programming hand-held transmitters that employ an alternating code, please observe the following supplementary instructions:

 Programming will be easier with the aid of a second person. ◀

1. Park your vehicle within the range of the remote-controlled equipment.
2. Program the integrated universal remote control as described above in Fixed-code hand-held transmitters.
3. Locate the button on the receiver of the device to be set, e.g. on the drive unit.
4. Press the button on the receiver of the equipment to be set. After step 4, you have approx. 30 seconds for step 5.
5. Press the programmed memory button **1** of the integrated universal remote control three times.

The corresponding memory button **1** is now programmed with the signal of the original hand-held transmitter.

 If you have any additional questions, please contact your BMW center. ◀

Deleting stored programs

Press both outer buttons **1** for approx. 20 seconds, maintaining pressure until the LED **2** starts to flash: all stored programs are deleted. Programs cannot be deleted individually.

Glove compartment

Opening

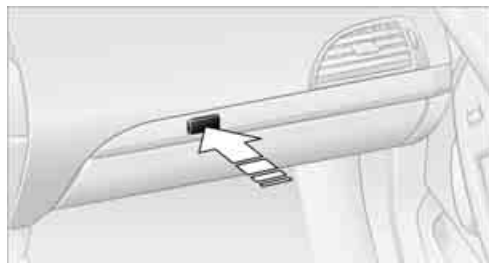

Press the button. The glove compartment opens automatically and the lamps come on.

 To prevent injury in the event of an accident while the vehicle is being driven, close the glove compartment immediately after use. ◀

Closing

Fold the cover up.

Rechargeable flashlight*

The flashlight is located on the left side of the glove compartment. The flashlight can remain there continuously.

Remove the flashlight from the socket when needed.

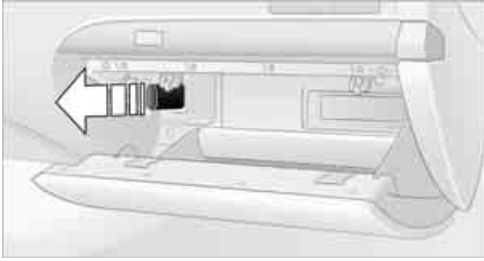

⚠ Be sure that the flashlight is switched off when it is inserted into its socket. Failure to comply with this precaution could lead to overcharging and damage. ◀

Center armrest



A storage compartment is located in the armrest between the front seats. This compartment is integrated into the central locking system and can also be locked separately using the hotel function, refer to page 33.

To open the cover:
Pull the left button. The cover opens and can be folded upward.

Depending on the version, the storage compartment can be equipped with a corresponding cradle* for the telephone or mobile phone.

Adjusting height

The center armrest can be set in two positions.



Pull the right button:
Move the armrest upward or downward and lock it in the desired position.

Storage compartments

Storage compartment behind center armrest

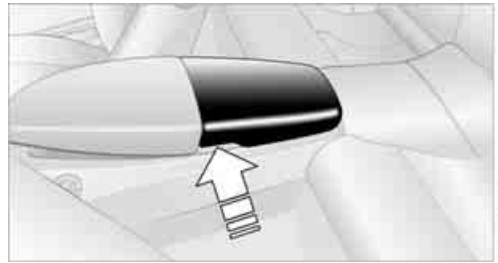

To open, raise the cover at the left or right edge. The compartment contains the cup holder and the lock for the hotel function, refer to page 33.

Other compartments and nets

Other compartments are provided in the doors as well as in the front center console*. Ticket pockets are located in the sun visors. Storage nets are located on the backrests of the front seats and in the passenger footwell*.

⚠ To prevent the risk of injury during an accident, do not stow hard or sharp-edged items in the nets. ◀

Another storage space is located in the luggage compartment in the right side panel. If you wish, this is also suitable to store the onboard documentation.

Clothes hooks

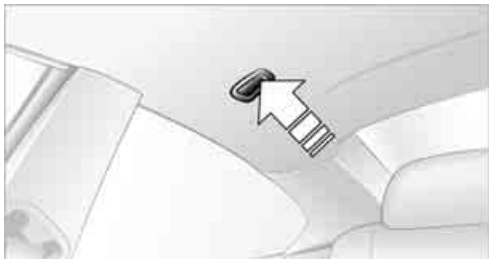

To fold down, press at the top edge.

⚠ When hanging clothing on the hooks, ensure that it will not obstruct the driver's vision. Do not hang heavy objects on the hooks. If you do so, they could cause personal injury to occupants during braking or evasive maneuvers. ◀

Cup holders*

⚠ Do not place glass containers in the cup holders. This would increase the risk of injury in the event of an accident. ◀



The compartment of the rear center console contains a built-in cup holder and a removable one.



The removable cup holder can be inserted into the side of the center console.

Ashtray

Opening

Press the trim strip of the cover.

Emptying



Press the opened cover beyond the resistance point, refer to arrow: the ashtray lifts up for removal.

Cigarette lighter



Press in the lighter with the engine running or the ignition switched on.

The lighter can be removed as soon as it pops back out.

⚠ Hold or touch the hot cigarette lighter by the knob only. Holding or touching it in other areas could result in burns. Always take along the remote control when you leave the vehicle; otherwise, children could, for example, use the lighter and burn themselves. ◀

Connecting electrical devices

Socket

With the engine running or the ignition switched on, the cigarette lighter socket can be used as a power outlet for hand flashlights, car vacuum cleaners, etc., with power ratings of up to approx. 200 W at 12 V. Avoid damaging the socket by inserting plugs of different shapes or sizes.

In front passenger footwell



Access to the socket:
Fold open the cover.

Ski bag*

It permits safe and clean transport of up to two pairs of standard skies or one snowboard.

You can use the ski bag to stow skis up to 6.9 ft/ 2.10 m long.

Loading

1. Press the button downward and pull the filler element forward.



2. Extend the ski bag between the front seats. The zipper gives you easy access to stowed items and facilitates drying of the ski bag.
3. Press the button in the luggage compartment.

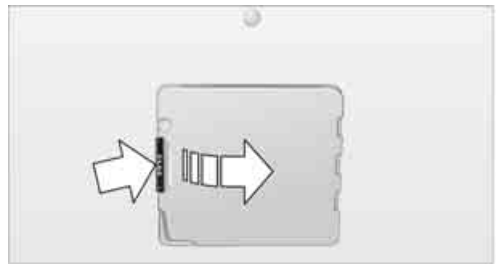

4. Open the loading flap and use the magnetic holder to secure it to the rear panel.

To stow the ski bag, perform the above steps in reverse order.

Only stow clean skis in the ski bag. Wrap sharp edges so that no damage occurs.

Securing cargo

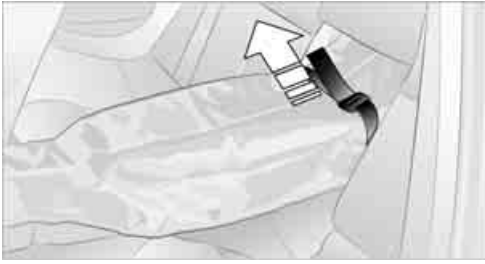

After loading, secure the ski bag and its contents. To do so, tighten the retaining belt at the buckle.

 Secure the ski bag in this way. If you fail to do so, it could move around and endanger occupants during braking or evasive maneuvers.

To refit the filler element, insert the two tabs at the bottom into the strip and press the filler element back into place. Make sure that you do not damage the rear seat upholstery. ◀



Driving tips

This section is designed to provide you with extra support by supplying information useful in dealing with specific driving and operating conditions.

Things to remember when driving

Breaking-in

Moving parts need time to adjust to one another. To ensure that your vehicle continues to provide optimized economy of operation throughout an extended service life, we request that you devote careful attention to the following section.

Do not use the driving programs 5 and 6, refer to Drivelogic on page 54, during break-in.

Engine and differential

Always obey all official speed limits.

Up to 1,200 miles/2,000 km

Drive at changing engine and driving speeds, however do not exceed 5,500 rpm or 105 mph/170 km/h.

Avoid full-throttle operation and use of the transmission's kick-down mode during these initial miles.

From 1,200 miles/2,000 km to 3,000 miles/5,000 km

The engine and driving speed can gradually be increased up to a continuous vehicle speed of 135 mph/220 km/h. Only drive at top speed briefly, e.g. when passing.

Transmission

The function of the transmission is only at its optimized level after driving a distance of approx. 300 miles/500 km. Do not exceed engine speeds of 5,500 rpm during this time.

Tires

Due to technical factors associated with their manufacture, tires do not achieve their full traction potential until after an initial break-in period. Therefore, drive reservedly during the first 200 miles/300 km.

Brake system

Brakes require an initial break-in period of approx. 300 miles/500 km to achieve optimized contact and wear patterns between brake pads and rotors. Drive in a reserved manner during this break-in period.

Clutch

The function of the clutch is only at its optimized level after a distance driven of approx. 300 miles/500 km.

Following part replacement

Observe the break-in instructions again if components mentioned above must be replaced after subsequent driving operation.

General driving notes

Closing luggage compartment lid

 Only drive with the luggage compartment lid completely closed, otherwise exhaust can penetrate into the passenger compartment. ◀

If special circumstances should make it absolutely necessary to operate the vehicle with the luggage compartment lid open:

1. Close both windows.
2. Increase the air volume of the automatic climate control to a high level, refer to page 86.

Hot exhaust system

 As in all vehicles, extremely high temperatures are generated in the exhaust system. Do not remove the heat shields installed adjacent to it, and never apply undercoating to them. When driving, standing at idle and while parking, take care to avoid possible contact between the hot exhaust system and any highly flammable materials such as hay, leaves, grass, etc. Such contact could lead to a fire, and with it

the risk of serious property damage as well as personal injury. ◀

Mobile communications devices in vehicle

 BMW advises against using mobile communications devices, e.g. mobile phones, inside the vehicle without a direct connection to an external antenna. Otherwise, the vehicle electronics and mobile communications device can interfere with each other. In addition, there is no assurance that the radiation emitted during transmission will be conveyed out of the vehicle interior. ◀

Hydroplaning

 When driving on wet or slushy roads, reduce road speed. If you do not, a wedge of water can form between tires and road surface. This phenomenon is referred to as hydroplaning, and is characterized by a partial or complete loss of contact between the tires and the road surface, ultimately undermining your ability to steer and brake the vehicle. ◀

The risk of hydroplaning increases as the tread depth of the tires decreases, also refer to Minimum tire tread on page 172.

Driving through water

 Do not drive through water on the road if it is deeper than 1 ft/30 cm, and then only at walking speed at the most. Otherwise, the vehicle's engine, the electrical systems and the transmission may be damaged. ◀

Starting off

On slopes

The starting assistant enables starting off on slopes virtually without rolling back.

1. Hold the vehicle with the footbrake.
2. Make sure that the handbrake is released.
3. Release the footbrake and immediately drive off quickly.

 The starting assistant holds the vehicle for approx. 1 second after releasing the footbrake. Depending on the load, the vehicle may also roll back slightly during this time. After releasing the footbrake, immediately start quickly, otherwise the starting assistant no longer holds the vehicle after approx. 1 second and it begins to roll back. ◀

 Start off quickly on slopes. Do not hold the vehicle on a hill by pressing the accelerator, but apply the footbrake or handbrake instead. Otherwise overheating and heavy wear can result in the area of the Sequential Manual Transmission. ◀

To protect the clutch of the Sequential Manual Transmission from overheating, the starting-off behavior is changed under heavy loading, e.g. a rapid succession of starts on slopes. This can be noticed from shaking during starting off.

On a slippery surface

1. Select program "P 400" of M Engine Dynamic Control, refer to page 55.
2. Gently press accelerator pedal to prevent wheels from spinning when starting off.

Braking safely

Your BMW is equipped with ABS as a standard feature. In situations that require it, it is best to brake with full force. Since the vehicle maintains steering responsiveness, you can still avoid possible obstacles with a minimum of steering effort.

The pulsing of the brake pedal indicates that the ABS is controlling braking.

In certain braking situations the perforated brake rotors can cause operating noises which, however, have no effect on the performance and operating safety of the brake system.

 Do not drive with your foot resting on the brake pedal. Even light but consistent pedal pressure can lead to high temperatures, brake wear and possibly even brake failure. ◀

Driving in wet conditions

When driving on wet roads or in heavy rain, it is a good idea to apply light pressure to the brake pedal every few miles. Monitor traffic conditions to ensure that this maneuver does not endanger other road users. The heat generated in this process helps dry the pads and rotors to ensure that full braking efficiency will then be available when you need it.

Hills

 To prevent overheating and thus reduced efficiency of the brake system, downshift to a gear in which only minimal brake applications are needed when descending long or steep downhill stretches. Even light but consistent pressure on the brake pedal can lead to high temperatures, brake wear and possibly even brake failure. ◀

 Do not drive in idle or with the engine switched off, otherwise there will be no engine braking action or support of the braking force and steering.

Never allow floor mats, carpets or any other objects to protrude into the area of movement of the pedals and impair their operation. ◀

Corrosion on brake rotors

When the vehicle is driven only occasionally, during extended periods when the vehicle is not used at all, and in operating conditions where brake applications are less frequent, there is an increased tendency for corrosion to form on rotors, while contaminants accumulate on the brake pads. This occurs because the minimum pressure which must be exerted by the pads during brake applications to clean the rotors is not reached.

Should corrosion form on the brake rotors, the brakes will tend to respond with a pulsating effect that even extended application will fail to cure.

When vehicle is parked

Condensation forms in the automatic climate control during operation, and then exits under

the vehicle. Traces of condensed water under the vehicle are therefore normal.

Before driving into a car wash

Fold in the exterior mirrors, refer to page 44, otherwise they could be damaged due to the width of the vehicle.

General information on the care and maintenance of your BMW is contained in the Caring for your vehicle brochure.

Ground clearance

 Ensure that sufficient ground clearance is available. To drive down curbs, select the "Sport" program of the EDC Electronic Damping Control, refer to page 73, to keep the ground clearance as uniform as possible. Otherwise, the vehicle may be damaged. ◀

Cargo loading

 To avoid loading the tires beyond their approved carrying capacity, never overload the vehicle. Overloading can lead to overheating and increases the rate at which damage develops inside the tires. The ultimate result can assume the form of a sudden blow-out. ◀

Determining loading limit



1. Locate the following statement on your vehicle's placard*:

 The combined weight of occupants and cargo should never exceed XXX lbs. or YYY kg, otherwise the vehicle may be damaged and unstable driving conditions may result. ◀

2. Determine the combined weight of the driver and passengers that will be riding in your vehicle.
3. Subtract the combined weight of the driver and passengers from XXX lbs. or YYY kg.
4. The resulting figure equals the available amount of cargo and luggage load capacity. For example, if the XXX amount equals 800 lbs. and there will be four 150-lb. passengers in your vehicle, the amount of available cargo and luggage load capacity is 200 lbs.:
800 lbs. minus 600 lbs. = 200 lbs.
5. Determine the combined weight of luggage and cargo being loaded on the vehicle. That weight may not safely exceed the available cargo and luggage load capacity calculated in step 4.
6. If your vehicle will be towing a trailer, part of the load from your trailer will be transferred to your vehicle. Consult the manual for transporting a trailer to determine how this may reduce the available cargo and luggage load capacity of your vehicle.

Load

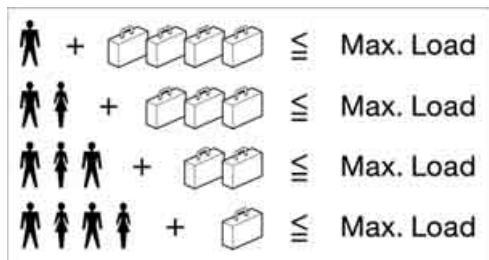

The permissible load is the total of the weight of occupants and cargo/luggage. The greater the weight of occupants, the less cargo/luggage can be transported.

Stowing cargo

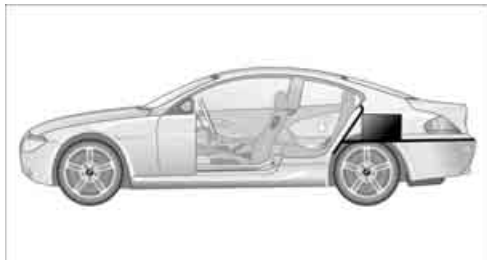

- ▷ Load heavy cargo as far forward and as low as possible, placing it directly behind the bulkhead behind the rear seats.
- ▷ Cover sharp edges and corners.

Securing cargo

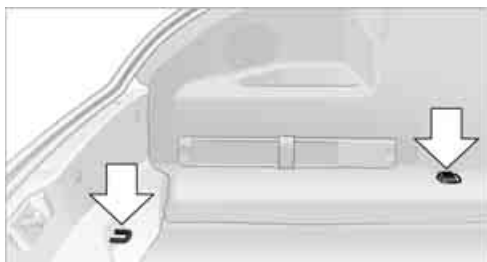

- ▷ Use the luggage net* or securing straps to hold down small and lightweight luggage and cargo.
- ▷ Heavy-duty cargo straps* for securing larger and heavier objects are available at your BMW center. Four lashing eyes mounted in the luggage compartment are used to secure these heavy-duty cargo straps, refer to arrows.
- ▷ Please observe the special instructions supplied with the heavy-duty cargo straps.

 Always position and secure the load as described above. If you do not, it can endanger the passengers during braking or evasive maneuvers. When fastening lashings, use only the lashing eyes, refer to illustration; otherwise, the lashings could come loose or you could damage the vehicle.

Never exceed the approved gross vehicle weight or either of the approved axle loads,

refer to page 200, as excessive loads can pose a safety hazard, and may also put you in violation of freeway safety laws.

You should never transport heavy or hard objects unsecured in the passenger compartment, as they could fly around and pose a safety hazard to the vehicle's occupants during abrupt braking or evasive maneuvers. ◀

Pad on bottom of luggage compartment

You can use the pad as needed, for example to transport soiled objects. The rubberized side is washable and has an anti-skid effect.





Navigation

This chapter describes how you can enter destinations and specify your route so that your navigation system guides you reliably to your destination.

Starting navigation system*

Your navigation system can use satellites to ascertain the precise position of your vehicle and guide you reliably to any destination you enter.

Navigation DVD

The navigation system requires a special navigation DVD. The latest version is available at your BMW center.

Inserting navigation DVD



1. Insert the navigation DVD with the labeled side up. The DVD is automatically pulled in.
2. Wait several seconds for the system to scan the data from the DVD.

Removing navigation DVD

1. Press **1** button. The DVD emerges slightly from the drive.
2. Remove the DVD.

If the DVD is not ejected from the drive, it is possible that it is jammed. A message appears on the Control Display.

Display in the assistance window

You can display the route or the current position in the assistance window. This display remains visible even if you switch to another application.

1. Move the controller to the right to enter the assistance window.



2. Press the controller. Other menu items are displayed.
3. Select the desired route view or "Current position".



4. Press the controller.

Destination entry

In entering your destination you can select from among the following options:

- ▷ Entering a destination manually, see below
- ▷ Entering destination via voice*, refer to page 110
- ▷ Selecting destination using information, refer to page 112
- ▷ Selecting destination from a list, refer to Destination list, page 113
- ▷ Selecting destination from address book, refer to page 114
- ▷ Selecting home address, refer to page 116

After selecting your destination you can proceed to start the destination guidance, refer to page 118.

Operating navigation system

 Enter data only when the vehicle is stationary, and always obey the traffic regulations and road signs in the event of any contradiction between traffic and road conditions and the instructions issued by the navigation system. If you do not observe this precaution, you may be in violation of the law, and can endanger vehicle occupants and other road users. ◀

iDrive, for explanation of principle, refer to page 16.

1. Press the **MENU** button.
This opens the start menu.
2. Move the controller to the right to call up "Navigation".



3. Select "Navigation" and press the controller.



Entering a destination manually

The system's word-matching principle makes it easier for you to enter the names of streets or towns, refer to page 117. This allows you to enter different spellings and completes your entry automatically so that stored names can be called up quickly.

1. Change to upper field if necessary. Turn the controller until "Navigation" is selected and press the controller.
"New destination" is selected.

2. Press the controller.



3. Select "Enter address" and press the controller.



The system also assists you with the following features:

- ▶ If you do not enter a street, the system will guide you to the downtown area of a town or city.
- ▶ You can skip the entry of country and town/city if the current entries are being retained for your new destination.

Selecting country

1. Select "State / Province" or the displayed country and press the controller.



A list of available countries appears on the display.



2. Select the country of destination and press the controller.

In order to be able to start the destination guidance, at least the town/city of the destination or its zip code must be entered.

Entering destination via town/city name

1. Select "Town / City" or the displayed town/city and press the controller.
2. Select the first letter and press the controller.
A list of all towns/cities starting with this letter appears on the Control Display.
3. To delete the letter entered if necessary:



- ▶ Delete individual numbers or letters: Move the controller toward the right to select and press the controller.
- ▶ Delete all digits or letters: Move the controller to the right to select and press the controller, holding it down.

- Enter additional letters if necessary.
The list gradually grows smaller each time you enter a new letter.
 - To enter blank space if necessary:
Select the _ symbol and press the controller.



- Change to the third field from the top if necessary. Turn the controller until the town or city name is selected from the list and press the controller.

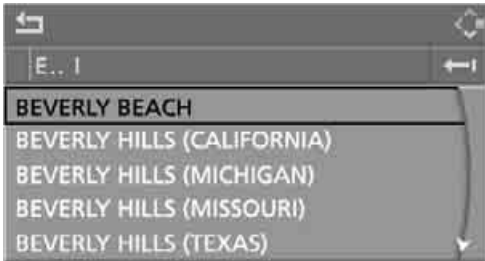

Entering town/city of destination via zip code

- Select "Town / City" and press the controller.
- Enter the zip code:
Select the individual digits and press the controller.

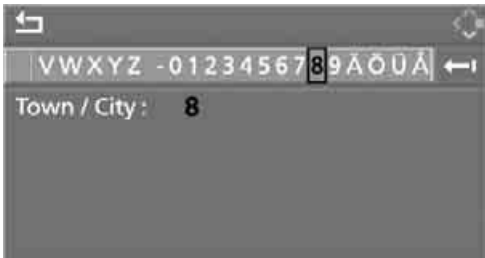

- To enter a blank space:
Select the _ symbol and press the controller.
- To delete individual digits or letters:
Move the controller toward the right to select ←| and press the controller.
- To delete all digits or letters:
Move the controller toward the right to select ←| and hold the controller down.

- Select the zip code and press the controller.
The corresponding town/city of destination is displayed.
- Change into the third field from the top.
Turn the controller until the destination is selected and press the controller.

Entering street, house number and intersection

After the street you can also enter the intersection or the house number.

Entering street and intersection

- Select "Street" or the displayed street and press the controller.
- Enter the street.
The street is entered in exactly the same way as the destination town/city.



The intersection is entered in the same way as the street.

Entering a street without entering destination

You can also enter a street without entering a destination. In this case all streets of the entered country are offered for selection.

The related town/city is displayed after the street name.

If a town/city has already been entered, you can undo this entry. This may be practical if the desired street does not exist in the entered destination, because, for example, it belongs to another part of the town/city.

1. Change to upper field.
The  arrow is selected.

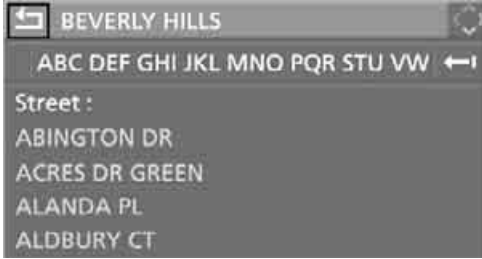

2. Turn the controller to the right until the request for the entry of a street in the country appears and press the controller.

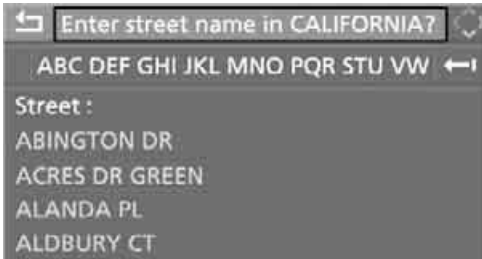

3. Change to the second field from the top and enter the street.

Entering house number

All house numbers stored for the street on the navigation DVD can be entered.

1. Select "House number" and press the controller.
2. Enter the house number:
Select the individual digits and press the controller.
3. Change into the third field from the top.
Turn the controller until the house number is selected and press the controller.

Starting destination guidance with manual destination entry

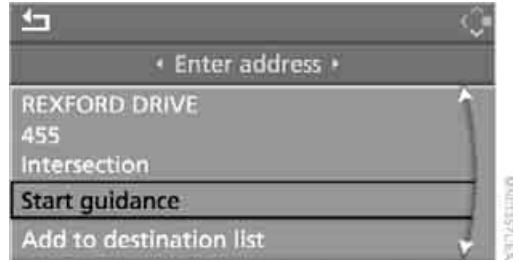

- ▷ Select "Start guidance" and press the controller.
Destination guidance starts immediately.
- ▷ If destination guidance is not to be started immediately:
Select "Add to destination list" and press the controller.
The destination is stored in the destination list, refer to page 113.

Entering destination via voice*

In conjunction with the Professional navigation system, you can enter the desired destination via the voice input system. When entering the destination, it is possible to change between speech input and iDrive at any time. Reactivate the speech input function for this purpose if necessary.

- ▷ With 'Options' you can have the system read aloud the possible commands. ◀

1. Press the  button on the steering wheel or in the center console.

2. 'Enter address'



Selecting country

 Say country of destination.

Say the name of the destination country in the language of the voice input system.

Entering destination

To enter the destination, spell it using the customary spelling of the destination country. Say the letters smoothly and at normal volume, avoiding excessive emphasis and pauses.

1. Spell town/city name:
Say at least the first three letters of the destination. The more letters you say, the more exactly the system recognizes the town/city.

The system can suggest up to 20 destinations that match your entries. Up to 6 entries are displayed at once on the Control Display.



 A destination is suggested by the system.

2. Selecting location:
Select ›Yes‹
or
Other town/city:
›No‹
Select entry, e.g. ›Entry 3‹
The following options are available:
›Next page‹: additional entries of the list are displayed.
›Repeat‹: the town/city can be respelled.

The town/city can also be selected from the list via iDrive:

Turn the controller until the destination is selected and press the controller.

Entering street and house number

The street is entered in the same way as the destination.

To enter the house number:

 Say the house number.

Up to 4-digit house numbers can be entered.

Starting destination guidance

 ›Start guidance‹

Destination guidance starts immediately.

Saving destination

The destination is added to the destination list or can be saved in the address book.

 ›Add to destination list‹ or
›Add to address book‹

Map-guided destination selection

If you only know the location of the town or street of the destination, then you can input the destination by using a map. You can use the cursor to select the destination on the map and then adopt it into the destination guidance.

1. Select "Navigation" and press the controller.
"New destination" is selected.
2. Press the controller.



3. Select "Input map" and press the controller.

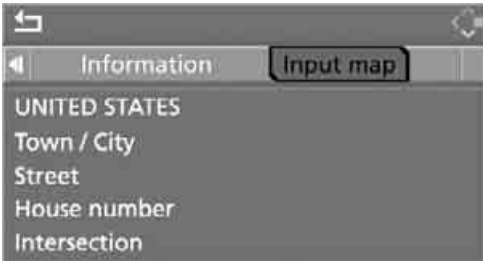

A section of a map is displayed on the Control Display:

- ▷ During destination guidance, centered around the current destination
- ▷ With the destination guidance deactivated, centered around the last destination entered



4. Select a destination with the cursor.
 - ▷ Changing scale: turn the controller.
 - ▷ Moving map: move the controller in the corresponding direction. The controller can be moved to the left, right, forward, backward and also diagonally.
5. Press the controller to accept or store the destination in the destination guidance system. The selected town/city of destination and other menu items are displayed.
6. Select the desired menu item:
 - ▷ "Start route guidance" starts destination guidance.
 - ▷ "Show current position" places the current position in the center of the map.

- ▷ "Show destination position" places the current destination in the center of the map.
- ▷ "Return to map" changes back to the "Input map".
- ▷ ↩ Exit the menu.

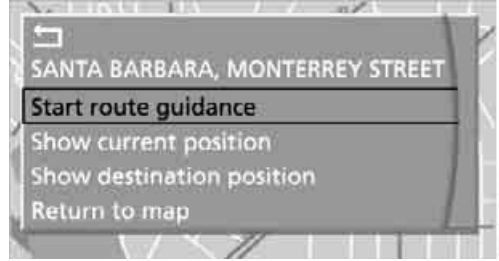

7. Press the controller.

The map for destination input can also be called up from the map view:

Select the  symbol and press the controller.

Selecting destination using information

You can obtain a display of selected destinations, e.g. hotels, sights or hospitals, and adopt them into the destination guidance.

1. Select "Navigation" and press the controller. "New destination" is selected.
2. Press the controller.
3. Select "Information" and press the controller.

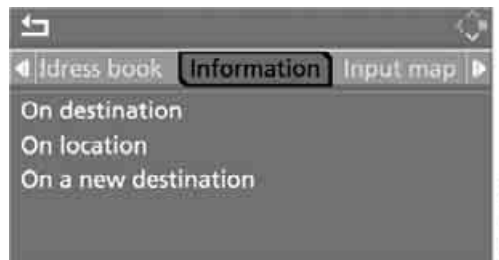

4. Select a location:
 - ▷ "On destination"
 - ▷ "On location"
 - ▷ "On a new destination"

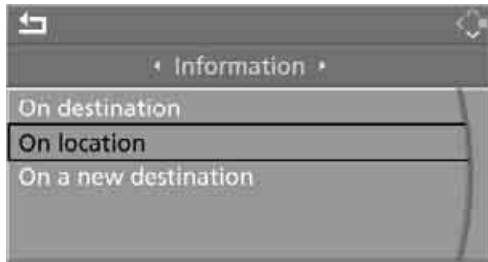

5. Press the controller.
6. Make your selection, e.g. "Hotels and restaurants", and press the controller. These destinations are displayed on the Control Display.

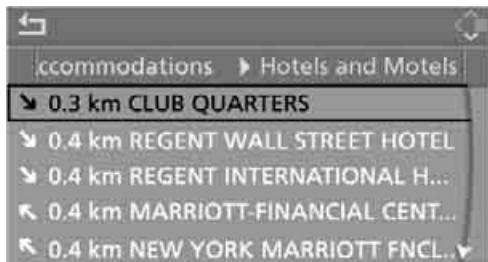

7. Select a destination and press the controller.
8. Select a menu item:
 - ▷ To adopt the address into the destination list and start the destination guidance: Select "Select as destination" and press the controller.
 - ▷ To establish a telephone connection: Select "Call" and press the controller.

To exit from the menu:
Select the  arrow and press the controller.

Destination list

The last 20 destinations entered into the destination list are displayed. You can select these destinations and adopt them into the destination guidance system.

For example, in order to plan a longer route, you can store all of the destinations you wish to visit in the destination list ahead of time, refer to Entering a destination manually on page 107.

Select "Navigation" and press the controller.



The last destination entered is the first item in the destination list.

 This symbol indicates the current destination during destination guide.

To display other destinations in the destination list:

Turn the controller.

Adopting the destination into the destination guidance system

1. Select the desired destination from the destination list and press the controller.
2. Select "Start guidance" and press the controller.

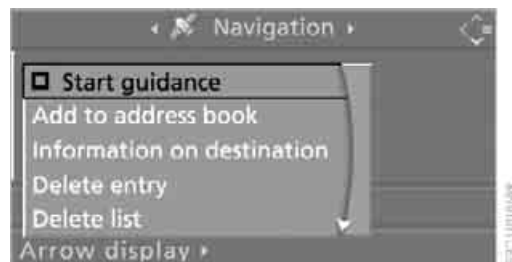

Editing the destination list

1. Select the desired destination from the destination list and press the controller.
2. The selected destination can be edited:
 - ▷ Saving entry:
Select "Add to address book".
 - ▷ Displaying information on destination:
Select "Information on destination".
 - ▷ Deleting entry:
Select "Delete entry".
 - ▷ Deleting all entries:
Select "Delete list". Destination guidance is switched off.
 - ▷ Changing entry:
Select "Edit". For operation, refer to Entering destination via town/city name, page 108.
3. Press the controller.

Address book

Opening address book

iDrive, for explanation of principle, refer to page 16.

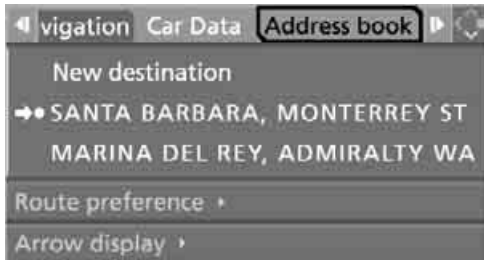

Select "Address book" and press the controller.

Storing destinations in address book

You can store approx. 100 destinations in the address book.

1. Select "Address book" and press the controller.
2. Select "New address" and press the controller.

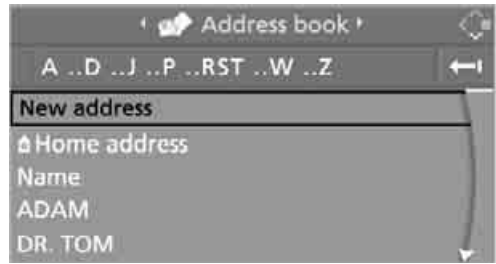

3. Select "Enter address" and press the controller.
4. Enter names and addresses.
5. Select "Store in address book" and press the controller.
The entry is stored in the address book.

You can also store a destination from the destination list in the address book, refer to page 113.

Storing current position*

The current position can be adopted into the address book.

1. Select "Address book" and press the controller.
2. Change into the third field from the top. Turn the controller until "New address" is selected and press the controller.

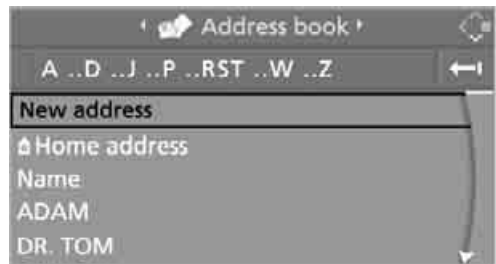

3. Select "Use current location as address" and press the controller.
The name given can be changed. For operation, refer to Entering a destination manually, page 107.
4. Select "Store in address book" and press the controller.

You can also enter your current position in the address book if you have left the sector covered by the navigation DVD. In this case, you must enter a name.

Selecting destinations from address book

1. Select "Address book" and press the controller.

The stored entries are displayed on the Control Display.



2. Select the entry and press the controller.

To start destination guidance:

Select "Start guidance" and press the controller.

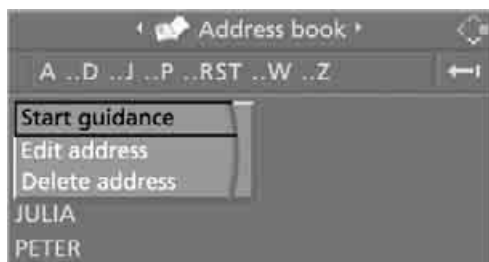

Changing destinations from address book

1. Select "Address book" and press the controller.
2. Select the entry and press the controller.

3. Select "Edit address" and press the controller.

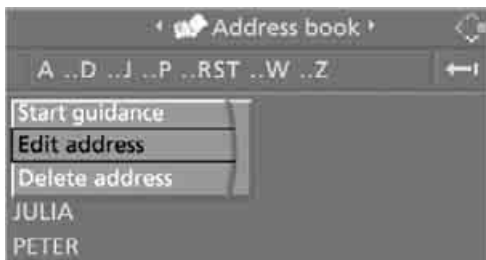

4. Change entry.

For operation, refer to Entering a destination manually, page 107.

Deleting individual destinations from address book

1. Select "Address book" and press the controller.
2. Select the entry and press the controller.
3. Select "Delete address" and press the controller.

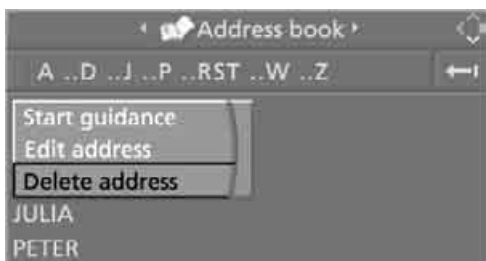

Deleting all destinations from address book

1. Open the start menu.
2. Press the controller to open the **i** menu.
3. Select "Vehicle settings" and press the controller.

4. Select "Delete data" and press the controller.



5. Select "Delete address book" and press the controller.
6. Select "Yes" and press the controller.

Storing home address

You can store your current position or the current destination as a home address in the address book. This entry is in the second position in the address book.

1. Select "Address book" and press the controller.
2. Change into the third field from the top. Turn the controller until "Home address" is selected and press the controller.

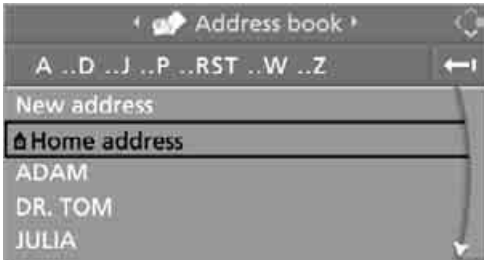

3. Select "Use current location as address", or "Save current destination" during the destination guidance, and press the controller.

To select the home address as the destination:

1. Select "Home address" and press the controller.
2. Select "Start guidance" and press the controller.

To change the entry:

1. Select "Home address" and press the controller.
2. Select "Edit address" and press the controller. For operation, refer to Entering a destination manually, page 107.

Selecting route

You can influence the calculated route by choosing certain route criteria. You can change the route criteria as often as you like when entering the destination and whenever the destination guidance is active.

The route is planned according to fixed rules, taking the road type into account, e.g. whether it involves freeways or winding roads. The road types are stored on the navigation DVD. As a result, the routes recommended by the navigation system may not always be the same ones that you would choose based on personal experience.

Changing route criteria

1. Select "Navigation" and press the controller.
2. Change into the third field from the top. Turn the controller until "Route preference" is selected and press the controller.

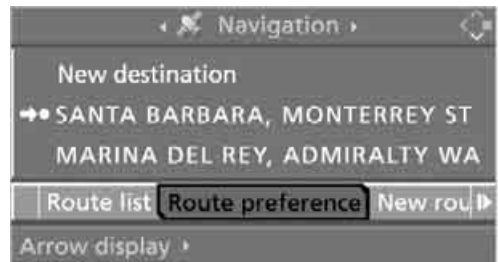

The various criteria are listed on the Control Display.

3. Select a route criterion for the route:
 - ▷ "With highways"
Freeways and major traffic arteries are given priority.
 - ▷ "Avoid highways"
Freeways are avoided where possible.
 - ▷ "Fast route"
The short traveling time, being a combination of the shortest possible route and the fastest roads
 - ▷ "Short route"
Short route, regardless of how fast or slow progress will be
4. Press the controller.



The route criterion is highlighted.

5. If necessary, select an additional route criterion and then press the controller:
 - ▷ "Avoid tollroads"
Tollroads are avoided where possible.
 - ▷ "Avoid ferries"
Ferries are avoided where possible.

To exit from the menu:

Select the  arrow and press the controller.

The route criteria can also be changed in the map view:

1. Select the symbol for the route criterion and press the controller.
2. Select a route criterion and press the controller.

Word matching principle

The system supports the word matching principle to make it easier for you to enter the names of streets or towns/cities. The system runs ongoing checks, comparing your destination entries with the data stored on the navigation DVD as the basis for instant response. The user benefits include:

- ▷ Names of specific locations can also vary from the official versions, provided that the spelling of the entry corresponds to a standard form used in another country.

Example:

Instead of "Munich", you can also enter the German spelling "München" or the Italian spelling "Monaco".

- ▷ When you are entering the names of towns/cities and streets, the system will complete them automatically as soon as enough letters are available to ensure unambiguous identification.
- ▷ The system only accepts name entries beginning with letters that are stored on the navigation DVD. The system will not accept nonexistent names and addresses.

Destination guidance

Starting destination guidance

iDrive, for explanation of principle, refer to page 16.

1. Change to upper field if necessary. Turn the controller until "Navigation" is selected and press the controller.
2. Select a destination from the destination list and press the controller or enter a new destination, refer to page 107.



3. Select "Start guidance" and press the controller.

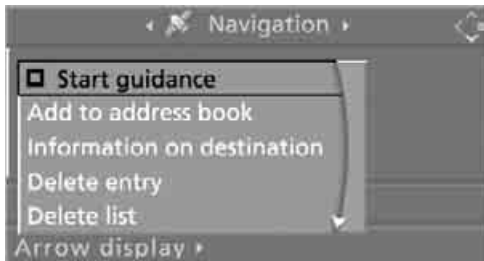

After the route has been calculated, destination guidance is indicated by arrows or a map display on the Control Display.

The destination guidance can also be started in the arrow or map display:

Select the  symbol and press the controller.

During destination guidance, you can operate other equipment via iDrive at any time. You are notified well in advance of a necessary change of direction by spoken instructions and the display of the direction arrows.

Terminating/continuing destination guidance

In arrow display or map view

Select the  symbol and press the controller.

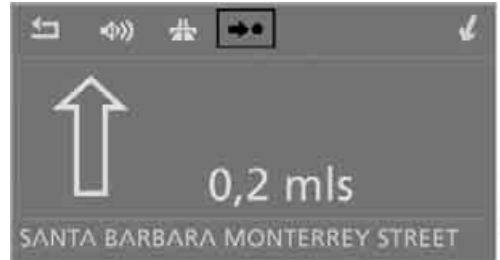

In destination list

 This symbol marks the current destination.

1. Select the current destination and press the controller.



2. Select "Start guidance" and press the controller.

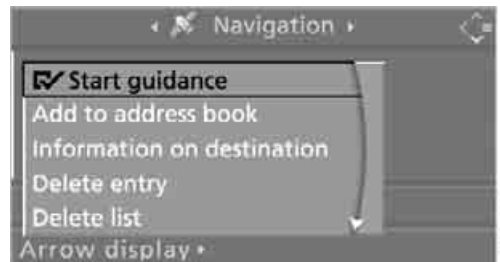

If the destination was not reached before the end of the last trip, upon restarting you will

see the question:
 "Continue guidance to destination?".
 The destination guidance starts automatically after a short time.
 To start destination guidance immediately:
 Select "Yes" and press the controller.

Route display

You have the option of displaying various views of the route during destination guidance.

 From another menu, you can switch directly to the screen last displayed, refer to Comfort opening of menu items, page 18. ◀

Displaying arrow display

1. Select "Navigation" and press the controller.
2. Change into the fourth field from the top. Turn the controller until "Arrow display" is selected and press the controller.

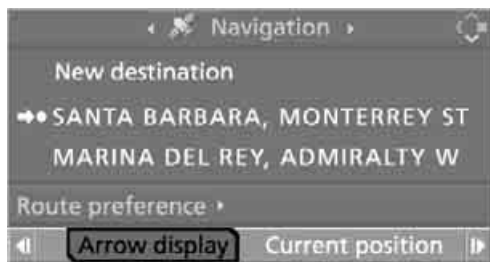

The arrow display is displayed.



- 1 Switching voice instructions on/off
- 2 Selecting route criteria

- 3 Starting/stopping destination guidance
- 4 Arrow to destination as the crow flies
- 5 Distance to the next change of direction
- 6 Current position
- 7 Direction of travel
 - ▶ Hollow arrow:
Destination guidance on the calculated route.
 - ▶ Solid arrow:
Arrow shows the route to be calculated from a bird's eye view when the vehicle is not located in an area contained on the navigation DVD, e.g. in a multilevel parking lot.

Depending on the equipment, the estimated time of arrival and the distance to the destination are displayed in the top or bottom line of the Control Display.

Before a change of direction, the appearance of the arrow changes.



- 1 Street name for change of direction
- 2 Distance to change of direction
- 3 Change of direction

To exit from the menu:
 Select the  arrow and press the controller.

Displaying map display

You can have your current position displayed on a map. After starting the destination guidance, the planned route is shown on the map.

1. Select "Navigation" and press the controller.
2. Change into the fourth field from the top. Turn the controller until the desired map view is selected:
 - ▷ "Map facing north"
 - ▷ "Map direction of travel"
 - ▷ "Perspective"



3. Press the controller.



- 1 Switching voice instructions on/off
- 2 Starting/stopping destination guidance
- 3 Selecting destination using map
- 4 Showing/hiding information last selected, refer to Selecting destination using information on page 112
- 5 Changing map view
 - ▷ "Map facing north"
 - ▷ "Map direction of travel"
 - ▷ "Perspective"
- 6 Changing route criteria
- 7 Arrow to destination as the crow flies

The estimated time of arrival and the distance to the destination are shown in the bottom line of the Control Display.

To exit from the menu:
Select the arrow and press the controller.

At scales of less than 250 miles/500 km, you have the option of deciding whether to orient the map to north, toward your current direction of travel, or show the map in perspective. At scales of 250 miles/500 km or greater, the map always points toward north.

Changing map view



Select the corresponding symbol and press the controller.

The next map view is displayed.

Changing scale

Turn the controller to change the scale.

Displaying towns/cities and streets of the route

You can have the roads and towns along the route displayed during destination guidance.

The distances remaining to be traveled on each individual road are also displayed.

1. Select "Navigation" and press the controller.
2. Change into the third field from the top. Turn the controller until "Route list" is selected and press the controller.

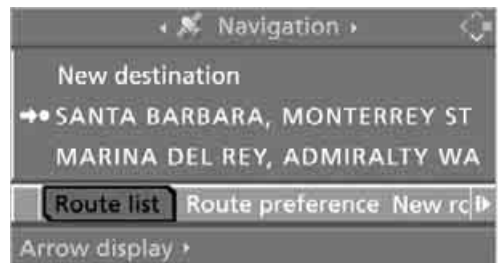

To exit the menu:
Select the arrow and press the controller.

Destination guidance through voice instructions

Switching voice instructions on/off

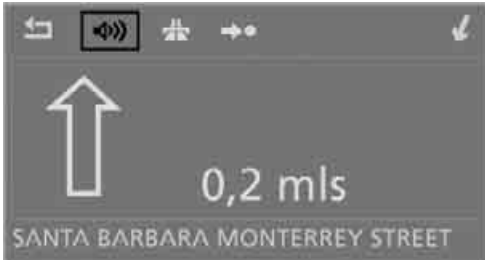

Voice instructions can be switched on or off during the destination guidance in the arrow or map view:

Select the  symbol and press the controller.

To switch the voice instructions on/off at any time:

1. Open the start menu.
2. Press the controller to open the **i** menu.
3. Turn the controller until "Display settings" is selected and press the controller.
4. Change to upper field if necessary. Turn the controller until "Languages" is selected and press the controller.

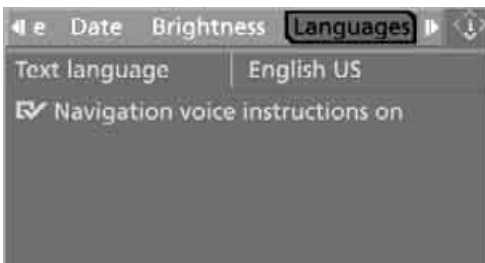

5. Select "Navigation voice instructions on" and press the controller.

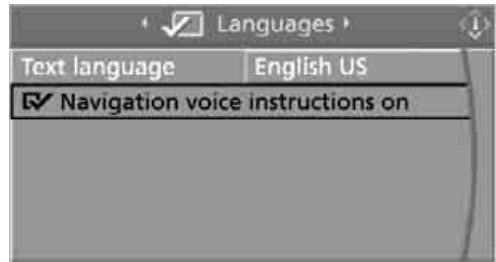

 The voice instructions are switched on.

The setting is stored for the remote control currently in use*.

Repeating and canceling voice instructions

With the programmable button on the steering wheel you can also make the following settings, refer to page 45:

- ▷ Repeat the voice instruction: Press the button.
- ▷ Switch voice instructions on/off: Maintain pressure on the button for several seconds.

Setting volume of voice instructions

The volume can only be adjusted during a voice instruction.

1. Repeat the last voice instruction, if required.
2. Turn the knob during the voice instruction to select the desired volume.



This volume is independent of the volume of the audio sources.

The setting is stored for the remote control currently in use.

Bypassing route sections

During destination guidance, you can revise the navigation system's route recommendations to avoid particular stretches of road. Enter the number of miles/kilometers that you want to travel before returning to the original route.

1. Select "Navigation" and press the controller.
2. Change into the third field from the top. Turn the controller until "New route" is selected and press the controller.

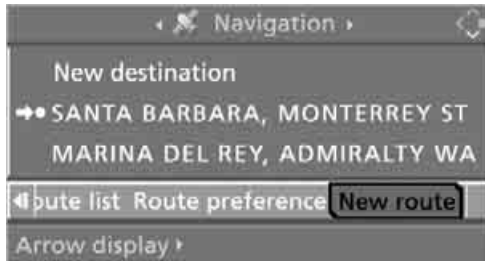

3. Turn the controller to enter the desired number and press the controller.

The route is recalculated.

To exit from the menu without changing the route:

Select the  arrow and press the controller.

Displaying current position

You can also display your current position with the destination guidance switched off.

1. Select "Navigation" and press the controller.
2. Change into the fourth field from the top. Turn the controller until "Current position" is selected and press the controller.

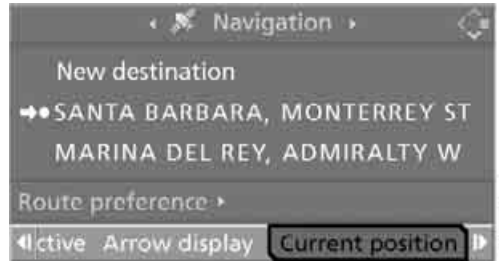

The current position of your BMW is displayed.

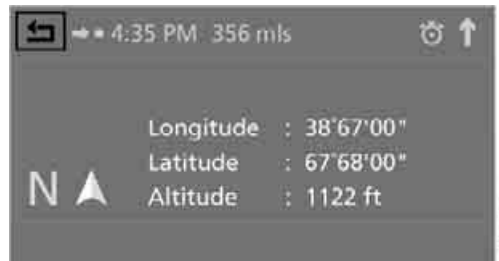

If the navigation system is unable to identify a town or city, your current map coordinates will appear.

To exit from the menu:

Select the  arrow and press the controller.

You can also have the current position displayed on a map, refer to page 119.

What to do if ...

What to do if ...

- ▷ a navigation DVD is inserted, but the request to insert the DVD is displayed on the Control Display?
The navigation DVD may not be the right DVD for the navigation system. The DVD is labeled accordingly.
- ▷ you request the current position of your vehicle, but do not receive a precise display?
The system is unable to receive enough GPS signals at your current position due to obstructions, your position is not yet available on your navigation DVD, or the system is in the process of calculating your position. As a rule, reception is guaranteed in the open air.
- ▷ the destination guidance does not accept a destination?
The data of the destination is not stored on the navigation DVD that is loaded. Select a destination that is as close as possible to the original.
- ▷ the destination guidance does not accept a destination without the street name?
On the navigation DVD, no downtown area can be determined for the city or town entered. Enter any street, or a destination such as the railway station etc., then start the destination guidance.
- ▷ you want to enter a destination for the destination guidance, but it is not possible to select the letters for your desired entry?
The data of the destination is not stored on the navigation DVD that is loaded. In this case, the system will not offer you any letters to choose from. Select a destination that is as close as possible to the original.

- ▷ the system stops furnishing directions on which way to turn as you approach intersections?
You are driving in an area that has not yet been completely recorded on the navigation DVD. Instead of an arrow indicating a turn, you will see an arrow which indicates the general direction of your planned route. Or you have left the recommended route and the system requires a few seconds to calculate a new recommended route.
- ▷ the navigation system does not react to entries?
If the battery has just been reconnected after having been disconnected, it then takes up to 10 minutes before the system is once again operational.





Entertainment

This chapter describes the operation of the radio and CD player as well as their tone settings.

On/off and tone

The following audio sources have shared controls and setting options:

- ▷ Professional* radio or Business radio
- ▷ CD player
- ▷ CD changer*

Controls

The audio sources can be operated using:

- ▷ Buttons near CD player
- ▷ iDrive
- ▷ Buttons on steering wheel, refer to page 11

Buttons near CD player

The layout of the buttons can vary depending on your vehicle's equipment.

Single drive:

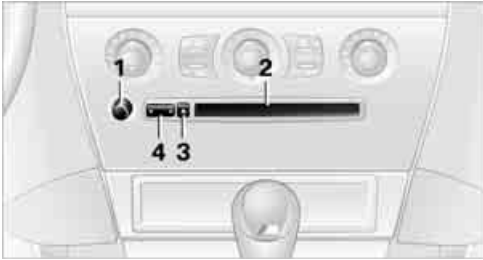

Two drives:

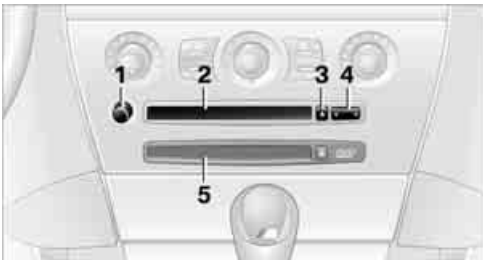

- 1 Entertainment sound output on/off, volume
 - ▷ Press: switch on/off.
When you switch on, the last set radio station or CD track is played.
 - ▷ Turn: adjust volume.
- 2 Drive for audio CDs
- 3 Eject CD
- 4 Station scan/track search
 - ▷ Change radio station.
 - ▷ Select track for CD player and CD changer.
- 5 Drive for navigation DVDs

Operation via iDrive

iDrive, for explanation of principle, refer to page 16.

1. Press the **MENU** button.
This opens the start menu.
2. Move the controller backwards to call up "Entertainment".



You have the following choices:

- ▷ "FM" and "AM": radio reception
- ▷ "WB": Weather Band station
- ▷ "SAT": satellite radio
- ▷ "CD": CD player or CD changer
- ▷ "Set": depending on the audio source, other adjustments can be made, e.g. with the radio: update station with strongest reception, store station, tone control, sample stations.



From another menu, you can switch directly to the screen last displayed, refer to Comfort opening of menu items page 18. ◀

The selected audio source is stored for the remote control currently in use.

Switching on/off

To switch the Entertainment sound output on/off:

Press knob **1** next to the CD player.

🔊 This symbol on the Control Display indicates that sound output is switched off.

For a single drive, the sound output is available for approx. 20 minutes with the ignition switched off.

To do so, switch the sound output on again.

Adjusting volume

Turn knob **1** next to the CD player until the desired volume is set.

You can also adjust the volume with buttons on the steering wheel, refer to page 11.

The setting is stored for the remote control currently in use.

Tone control

You can alter various tone settings, e.g. treble and bass, or the speed-dependent volume increase.

The sound settings are globally adjusted for all audio sources.

The settings are stored for the remote control currently in use.

Changing tone settings

1. Press the **MENU** button.
This opens the start menu.
2. Press the controller to open the **i** menu.
3. Select "Entertainment settings" and press the controller.



4. Select "Audio" and press the controller.



The tone settings can also be selected when you have opened "Entertainment" in the start menu:

Select "Set" and then "Tone", and press the controller.

Treble and bass

1. Select "Treble / Bass" and press the controller.



2. Move the controller to the left or right to select "Treble" or "Bass".



3. Turn the controller until the desired setting is selected.

Balance and fader

You can adjust the volume distribution in the same manner as "Treble / Bass".

- ▷ "Balance": left/right volume distribution
- ▷ "Fader": front/rear volume distribution

Speed-dependent volume control

The speed-dependent volume control automatically increases the volume with increasing speed. You can set various stages for the increase in volume.

1. Select "Speed volume" and press the controller.



2. Turn the controller: The adjustment is applied; the field can be changed.



Professional LOGIC7 HiFi System*

You can select a spatial sound effect that improves the spatial acoustics in all frequency ranges.

1. Select "Surround Settings" and press the controller.



2. Select "Concert hall" or "Theater".



3. Press the controller. LOGIC7 spatial sound is switched on.

To switch off spatial sound:

Select "Off" and press the controller.

LOGIC7 and the LOGIC7 logo are registered trade marks of Lexicon, Inc., a company of the Harman International Group.

Equalizer*

You can set individual sound frequency ranges:

1. Select "Equalizer" and press the controller.



2. Move the controller to the left or right to select the desired frequency range.



3. Turn the controller until the desired setting is selected.

Resetting tone settings

You can reset all tone settings to the default settings.

1. Open the start menu.
2. Press the controller to open the **i** menu.
3. Select "Entertainment settings" and press the controller.
4. Select "Audio" and press the controller.
5. Select "Reset" and press the controller.



Radio

Your radio provides reception of the FM and AM wavebands.

Listening to radio



Press the button if the sound output is switched off.

iDrive, for explanation of principle, refer to page 16.

1. Press the **MENU** button.
This opens the start menu.
2. Move the controller backwards to call up "Entertainment".
3. Change to upper field if necessary. Turn the controller until "FM" or "AM" is selected.



4. Press the controller.

Stations are shown on the Control Display on the basis of various selection criteria, e.g. "Presets".

If "Autostore" does not display any stations or if the stations displayed can no longer be received, to update the station with the strongest signal, refer to page 131.

Changing stations



Turn the controller.

In addition to the stations currently displayed, you can have stations with another selection criterion displayed.

Professional* radio

You can choose from the following selection criteria:

- ▷ "All stations":
Stations that can currently be received in the "FM" waveband.
- ▷ "Autostore":
The stations with the strongest received signals in the "AM" waveband.
- ▷ "Presets":
Stations you have stored, refer to page 132.

Business radio

You can choose from the following selection criteria:

- ▷ "Autostore":
The stations with the strongest signal, refer to page 131.
- ▷ "Presets":
Stations you have stored, refer to page 132.

Changing selection criteria

1. Change into the second field from the top.
2. Turn the controller until the desired selection criterion is selected and press the controller.



Buttons next to CD player

Press the  button for the corresponding direction. The system switches to the next displayed station.

You can also change stations with buttons on the steering wheel, refer to page 11.

Sampling stations, scan

The system automatically plays a brief sample from each of the stations on the current waveband.

1. Select "FM" or "AM" and press the controller. "Set" is selected.
2. Press the controller. Other menu items are displayed.
3. Select "Scan" and press the controller.



The stations are sampled.

To end sampling:

1. Press the controller.
2. Select "Scan" and press the controller.

This cancels sampling of the stations, and the radio remains on the current station.

Buttons next to CD player

 To sample the stations, press and hold the button for the corresponding direction. To stop scanning, press the button again.

Selecting frequency manually

With "Manual" you can select stations that are received in addition to those displayed.

1. Select "FM" or "AM" and press the controller.
2. Change into the second field from the top.
3. Select "Manual" and press the controller.



4. Turn the controller to set a certain frequency.

Updating stations with best reception

For Professional radio with "AM" and with Business radio:

If you are on a longer journey and leave the transmission range of the stations originally set, you can update the list of stations with the best reception.

1. Select "FM" or "AM" and press the controller.
2. Change into the second field from the top.

3. Select "Autostore" and press the controller. "Set" is selected.



4. Press the controller. Other menu items are displayed.
5. Select "Autostore" and press the controller.



The display of the stations with the strongest reception is updated. The frequencies of the stations are displayed.

Storing stations

1. Select "FM" or "AM" and press the controller.
2. Change into the second field from the top. Turn the controller until the desired selection criterion is selected and press the controller.

3. Select the desired frequency or station. "Set" is selected.

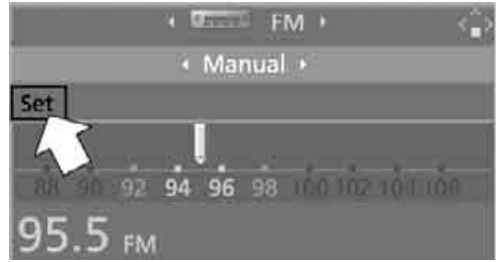

4. Press the controller. Other menu items are displayed.
5. Select "Store" and press the controller.

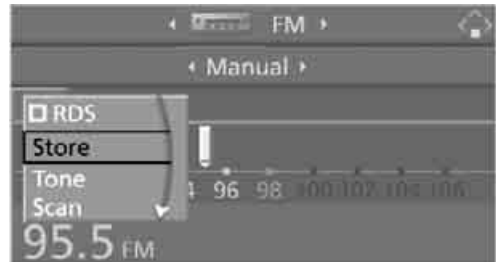

"Presets" is displayed.

6. Turn the controller until the desired memory position is selected.
7. Press the controller. The station is stored.



The channels of the last selection criterion are displayed once again after a short time.

The stations are stored for the remote control currently in use.

Changing a memory position

1. Select "Presets" and press the controller.
2. Select the desired station.
"Set" is selected.
3. Press the controller.
Other menu items are displayed.
4. Select "Store" and press the controller.



5. Turn the controller until the desired memory position is selected.
The number of the memory position appears beside the name or frequency of the station.
6. Press the controller.
The station is stored.

RDS Radio Data System

RDS transmits additional information in the FM frequency range. If the reception conditions are good, the station names are shown on the Control Display. If the reception is weak or disrupted, it can take some time before the station names are displayed.

Switching RDS on/off*

1. Select "FM" or "AM" and press the controller.
"Set" is selected.
2. Press the controller.
Other menu items are displayed.

3. Select "RDS" and press the controller.



RDS is activated.

Automatically sorting stations*

For the "All stations" selection criterion, you can set whether the most frequently used stations are displayed at the beginning.

1. Select "All stations" and press the controller.
"Set" is selected.
2. Select "Favorites" and press the controller.



The most frequently used stations are shown at the beginning.

Weather news flashes*

Weather Radio is a service of the National Oceanic and Atmospheric Administration (NOAA) of the US Department of Trade. Weather news flashes are repeated every 4 to 6 minutes and are routinely updated at intervals of 1 to 3 hours, and more often when necessary. Most stations operate 24 hours a day. In case of a storm, the National Weather Service interrupts

the routine weather news and transmits special warning messages instead. If you have a question about NOAA Weather Radio, please contact the nearest office of the National Weather Service. Details are also provided on the Internet at www.nws.noaa.gov.

Calling up weather news flashes

1. Select "WB" and press the controller.



2. Select a station.

The station for weather news flashes may be unavailable in some regions.

High Definition Radio*

Many stations transmit both analog and digital signals. You can receive these stations digitally and in improved sound quality.

Activating/deactivating digital radio reception

iDrive, for explanation of principle, refer to page 16.

1. Press the **MENU** button.
This opens the start menu.
2. Press the controller to open the **i** menu.

3. Select "Entertainment settings" and press the controller.



4. Select "HD radio" and press the controller.



5. Select "Off" and press the controller.
 The reception of digital stations is deactivated.

HD This symbol is displayed when a sender is being received digitally.



With some stations the digital signals are not transmitted simultaneously with the analog signals. If you are in an area in which the selected station is not continuously received digitally, playback switches between analog and digital reception. This can result in repetitions or interruptions. In this case it may be advisable to deactivate digital radio reception.

Updating stations offering digital reception

If you are on a longer journey and leave the transmission range of the stations originally set, you can update the list of stations with the best reception.

1. Select "FM" or "AM" and press the controller.



2. Change into the second field from the top.
3. Select "Autostore" and press the controller.



4. Press the controller.
Other menu items are displayed.
5. Select "Autostore HD" and press the controller.

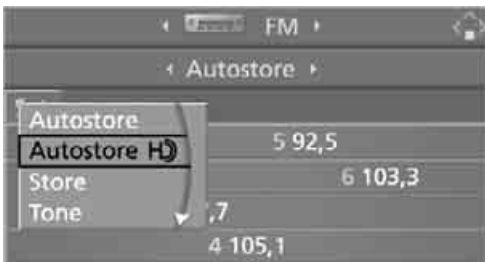

The display of the stations offering digital reception is updated. This can take up to 2 minutes.

Displaying additional information

With the digital stations, additional information on the current track is displayed, e.g. the name of the artist.

1. Select a station and press the controller.
2. Select "Details" and press the controller.



The information is displayed.



If a digital station is received again when the station is changed, the additional information will be displayed again following a brief interruption.

Satellite radio*

You can receive up to 100 different channels with high sound quality.

The channels are offered to you in predefined packages. To receive the channels of your choice, you must have this package enabled.

With this new technology the signal may fail, causing interruptions in reception. ◀

Enabling or disabling channels

iDrive, for explanation of principle, refer to page 16.

1. Press the **MENU** button.
This opens the start menu.
2. Move the controller backwards to call up "Entertainment".
3. Select "SAT".



4. Press the controller.

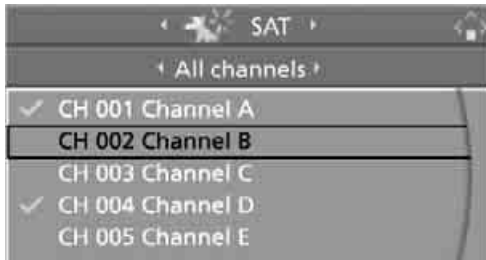

The channels are displayed.

- ✓ These channels are enabled.

Enabling

1. Select a channel that has not yet been enabled and press the controller.
A telephone number and the electronic serial number, ESN, are displayed.
 The electronic serial number is required for enabling or disabling.◀
2. To enable the channels:
Dial phone number.

Disabling

1. Select an enabled channel and press the controller.

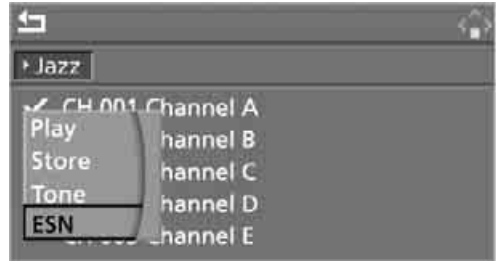

2. Select "ESN" and press the controller.
The electronic serial number, ESN, is displayed.

 The electronic serial number is required to disable.◀

3. To have the channels disabled:
Dial phone number.

Selecting and storing channel

1. Select "SAT" and press the controller.

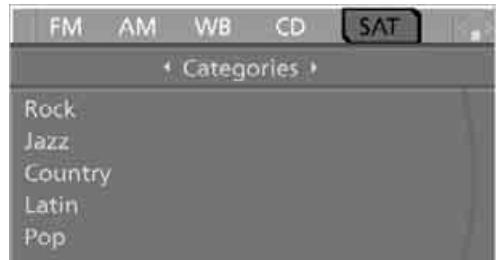

Channels are shown on the Control Display sorted on the basis of selection criteria.

2. Select a menu item:
 - ▷ "Presets":
Up to twelve channels you have stored previously.
 - ▷ "All channels":
All channels are displayed.

- ▷ "Categories":
All channels sorted by category, e.g. news, jazz.



3. Press the controller.
4. If "Categories" has been selected:
Select the desired category and press the controller.

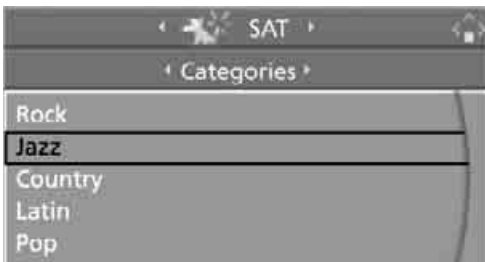

The channels of this category are displayed.

5. ✓ Select a channel marked with this symbol.

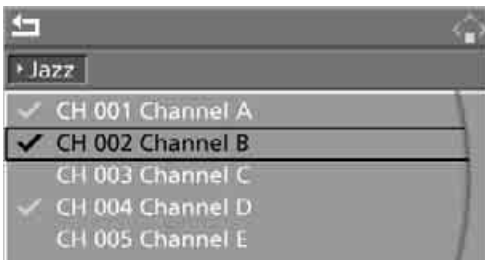

6. Press the controller.
Other menu items are displayed.

7. Select "Play" and press the controller.

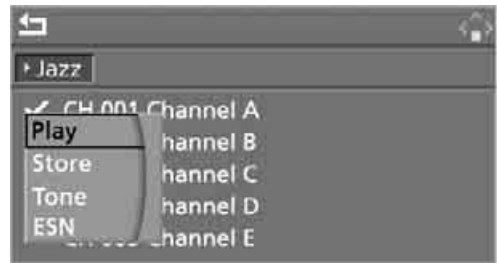

Additional information

The name of the channel and additional information on the current track are displayed, e.g. the name of the artist.

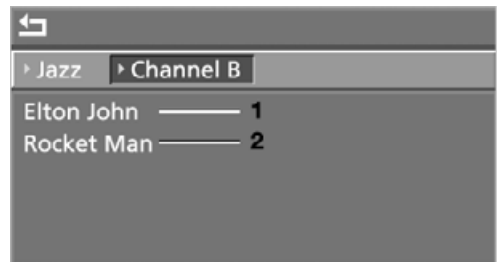

- 1 Artist
- 2 Track

Storing channel

1. Select the desired channel.
2. Press the controller.
Other menu items are displayed.
3. Select "Store" and press the controller.

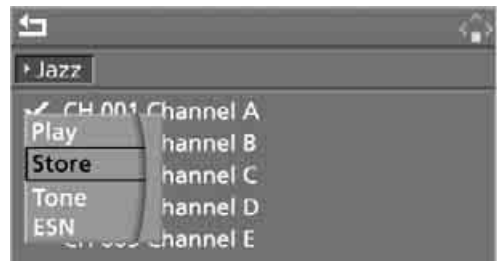

"Presets" is displayed.

- Turn the controller to select a memory position and press the controller.



The channel is stored. The stations of the last selection criterion are displayed again after a short time.

Changing channel with buttons next to CD player

Press the  button for the corresponding direction.

The system switches to the next enabled channel.

Notes

If no signal can be received for more than 4 seconds, a message is displayed on the Control Display.



Reception may not be possible for certain reasons, e.g. environmental influences or topographical conditions. The satellite radio has no influence on this.

The signal may not be available in tunnels or underground garages, next to tall buildings, near trees, mountains or other sources of radio interference.

Reception is usually possible again as soon as the signal is available again. ◀

CD player and CD changer*

Listening to CDs

Compressed audio files*

CDs with compressed audio files, i.e. MP3, can be played by the CD player, but not by the CD changer.

CD player: starting CD



Equipment with two drives:
The upper drive is for audio CDs.

Insert the CD into the drive with the labeled side up. The CD is automatically pulled in. Playback starts automatically if the sound output is on. For CDs with compressed audio files, it can take up to approx. 1 minute to read in the data depending on the directory structure.

To start playback when there is already a CD in the drive:

iDrive, for explanation of principle, refer to page 16.

1. Press the **MENU** button.
This opens the start menu.
2. Move the controller backwards to call up "Entertainment".

3. Change to upper field if necessary. Turn the controller until "CD" is selected and press the controller.



4. On vehicles with a CD changer, change to the second field from the top and turn the controller until "CD" is selected and press the controller.
The CD player is started.



Playback starts automatically if the sound output is switched on.

To eject the CD, press the  button on the CD player.
The CD emerges slightly from the drive.

CD changer: starting CD

1. Fill the CD magazine and insert, refer to page 143.
2. Press the **MENU** button.
This opens the start menu.
3. Move the controller backwards to call up "Entertainment".
4. Change to upper field if necessary. Turn the controller until "CD" is selected and press the controller.

- Change to the second field from the top if necessary. Turn the controller until the desired CD, CD 1 - 6, is selected and press the controller.

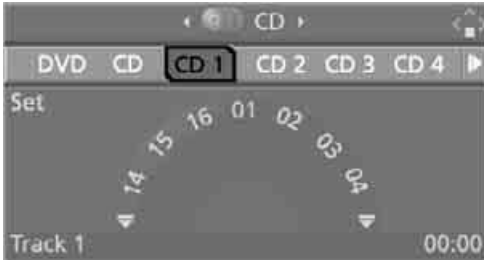

At the end of the last track, the next CD will be selected.

If new CDs have been placed in the CD magazine, playback starts with the lowest CD, e.g. CD 1, track 1.

The CD magazine's load status is indicated on the Control Display.

Selecting a track

Buttons next to CD player

Press the button for the corresponding direction repeatedly until you reach the desired track.

The CD will start to play at the start of the track. The track is displayed on the Control Display.

You can also change the track with buttons on the steering wheel, refer to page 11.

Via iDrive

Select a track by turning the controller.



Compressed audio files*

- Select the directory if necessary and press the controller.

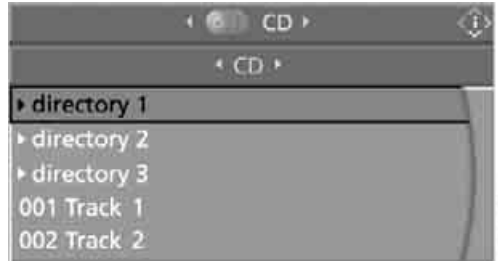

- Select the track and press the controller.

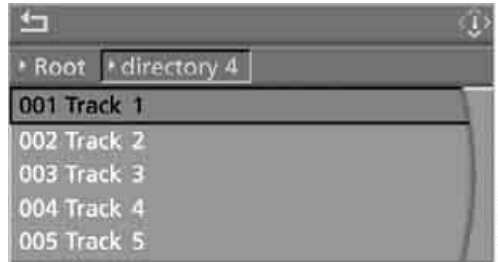

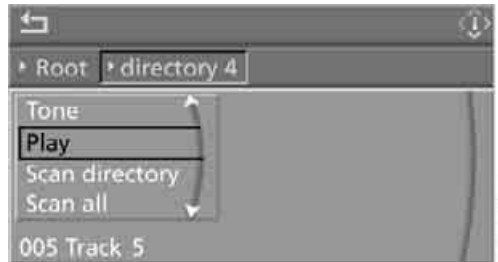

- Select "Play" and press the controller.

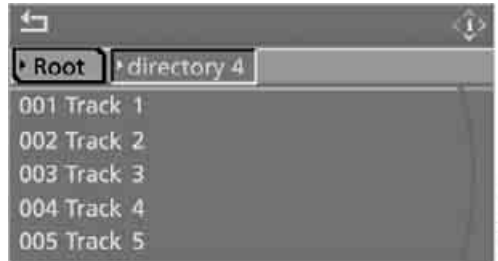

To change the directory:

Select the directory and press the controller.



To exit from the menu:
Select the  arrow and press the controller.

Displaying information on track*

With compressed audio files, you can display possibly included information about the current track, e.g. the name of the artist.

1. Press the controller.
2. Select "Details" and press the controller.

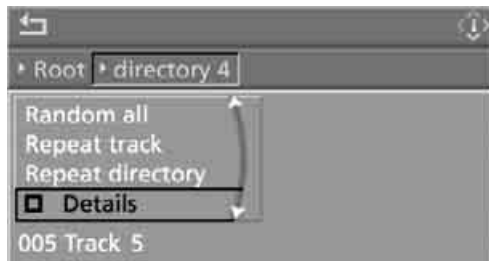

The information about the current track is displayed.

The setting is stored for the remote control currently in use.

Sampling tracks, scan

The system automatically plays a brief sample from each of the tracks on the current CD.

1. Select "Set" and press the controller.
Other menu items are displayed.



2. Select "Scan" and press the controller.



To end sampling:

1. Press the controller.
2. Select "Scan" and press the controller.

This cancels sampling of the tracks, and the player remains on the current track.

Compressed audio files*

1. Select the current track and press the controller.
2. Select the desired menu item:
 - ▶ To sample all tracks of the current directory, select "Scan directory" and press the controller.
 - ▶ To sample all tracks of the CD, select "Scan all" and press the controller.



To end scan search:

1. Press the controller.
2. Select "Scan directory" or "Scan all" and press the controller.

This cancels the scan search and the player remains on the current track.

Repeating track

1. Select "Set" and press the controller. Other menu items are displayed.



2. Select "Repeat" and press the controller.

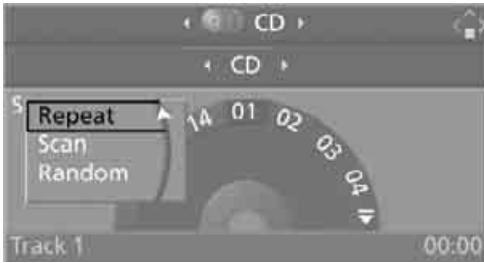

The current track on the CD is repeated.

To cancel repeat mode:

1. Press the controller again.
2. Select "Repeat" and press the controller.

Compressed audio files*

1. Select the current track and press the controller.
2. Select the desired menu item:
 - ▷ To repeat the selected track, select "Repeat track" and press the controller.
 - ▷ To repeat all tracks of the current directory, select "Repeat directory" and press the controller.

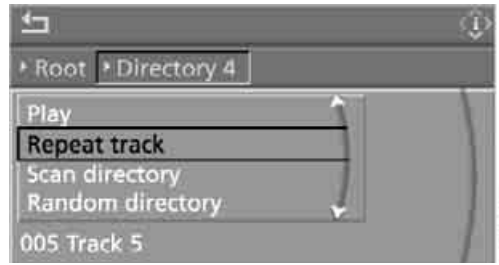

To cancel repeat mode:

1. Press the controller.
2. Select "Repeat track" or "Repeat directory" and press the controller.

Random play sequence

In this mode, the tracks on the current CD are played once in a random sequence.

1. Select "Set" and press the controller. Other menu items are displayed.
2. Select "Random" and press the controller.

To cancel random mode:

1. Press the controller.
2. Select "Random" and press the controller.

Compressed audio files*

1. Select the current track and press the controller.
2. Select the desired menu item:
 - ▷ To play all tracks of the current directory in random order, select "Random directory" and press the controller.
 - ▷ To play all tracks of the CD in random order, select "Random all" and press the controller.

To cancel random mode:

1. Press the controller.
2. Select "Random directory" or "Random all" and press the controller.

Fast forward/reverse

Buttons next to CD player:

Press and hold the  button for the corresponding direction.

CD magazine

The BMW CD changer for six CDs is installed in the glove compartment.

Removing CD magazine

To insert CDs into the CD magazine **1** or remove them from it, you must first remove the magazine from the CD changer:

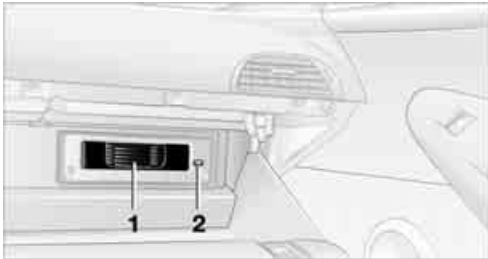

Press button **2** to eject the CD magazine **1**.

Wait at least 2 seconds before pushing in the magazine again so that the inserted CDs can be read in again.

Inserting/removing CDs into/from CD magazine

When inserting or removing CDs, remember to hold them only by their edges, taking care to avoid touching the reflective CD memory surface.

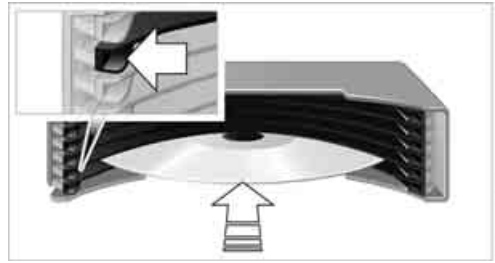

To insert:

Insert one CD into each compartment of the magazine with the labeled side up.

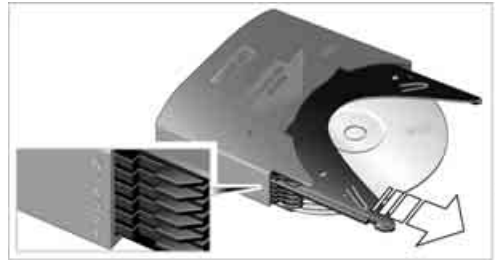

To remove:

Pull out the desired tray and remove the CD.

Inserting CD magazine

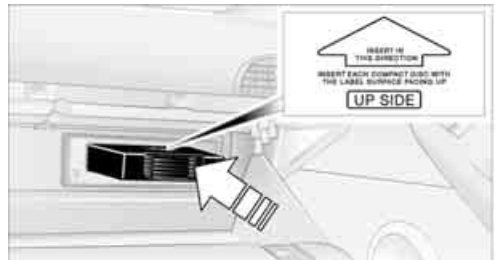

Push in the CD magazine as far as possible in the direction of the arrow.

The CD changer automatically reads in the inserted CDs and is then ready for operation.

Notes

 BMW CD/DVD players and changers are officially designated Class 1 laser products. Do not operate if the cover is damaged, otherwise severe eye damage can result. Do not use self-recorded CDs with adhesive labels as these can come loose during playback due to heat build-up and cause irreparable damage to the system.

Only use round CDs/DVDs with a standard diameter of 4.7 in/12 cm and do not play CDs/DVDs with an adapter, e.g. Single-CDs, otherwise the CDs or the adapter can jam and may no longer be ejected.

Do not use a combined CD/DVD, e.g. DVD^{Plus}, otherwise, the CD/DVD can jam and will no longer eject. ◀

General malfunctions

BMW CD/DVD changers and players have been optimized for performance in vehicles. In some instances they may be more sensitive to faulty CDs/DVDs than stationary devices would be.

If a CD/DVD cannot be played, first check if it has been inserted correctly.

Humidity

High levels of humidity can lead to condensation on the CD/DVD or the laser's scan lens and temporarily prevent playback.

Malfunctions with individual CDs/DVDs

If malfunctions only occur with individual CDs/DVDs, one of the following factors may be the cause.

Home-recorded CDs/DVDs

Possible reasons for malfunctions with self-recorded CDs/DVDs are, e.g., inconsistent data-creation or recording processes, or poor quality or advanced age of the CD/DVD blank.

Label CDs/DVDs only on the top, using a marker designed for this purpose.

Damaged CDs/DVDs

Avoid fingerprints dust, scratches, and moisture.

Keep CDs/DVDs in a sleeve.

Do not subject CDs/DVDs to temperatures over 122 °F /50 °C, high levels of humidity or direct sunlight.

CDs/DVDs with copy protection

Manufacturers often provide CDs/DVDs with copy protection. This can mean that some CDs/DVDs cannot be played or can only be played to a limited extent.

Care

If necessary, clean the reflective scanning side of the CDs/DVDs with a commercially available cleaning cloth by wiping in straight lines from the center outward.



Communications

This chapter summarizes how to operate your mobile phone using iDrive or voice control and how to use BMW Assist or TeleService.

Telephoning*

The concept

Your BMW is equipped with a full mobile phone preparation package. After a suitable mobile phone has been logged onto the vehicle once, you can operate the mobile phone via iDrive, with the buttons on the steering wheel and by voice.

A mobile phone that has been logged on once is automatically detected again as soon as it is brought back inside the vehicle, provided that the engine is running or the ignition is switched on. The logon data of up to four mobile phones can be stored simultaneously. If several mobile phones are detected simultaneously, the most recently logged-on mobile phone can be operated via the vehicle.

Using a phone in your vehicle

Using snap-in adapter*

The so-called snap-in adapter, a mobile phone cradle, enables the battery to be charged and the mobile phone to be connected to the external antenna of your vehicle. This ensures improved network reception and a consistent voice reproduction quality. Ask your BMW center which mobile phones will fit in the snap-in adapters they offer.

 BMW discourages the use of mobile phones or other mobile communications devices inside the vehicle without a direct connection to an outside antenna. Otherwise, the vehicle electronics and mobile communication device can interfere with each other. In addition, there is no assurance that the radiation that results from transmission will be dissipated from the vehicle interior. ◀

A mobile phone detected by the vehicle should not be operated by the mobile phone's keypad; otherwise malfunctions may occur.

For your safety

A car phone makes life more convenient in many ways, and can even save lives in an emergency. While you should consult your mobile phone's separate operating instructions for a detailed description of safety precautions and information, we request that you direct your particular attention to the following:

 Only make entries when the traffic situation allows you to do so. Do not hold the mobile phone in your hand while you are driving; use the handsfree system instead. If you do not observe this precaution, your being distracted can endanger vehicle occupants and other road users. ◀

Suitable mobile phones

Ask your BMW center which mobile phones with a Bluetooth interface are supported by the mobile phone preparation package or which mobile phones will fit in the snap-in adapters they offer. These mobile phones support the functions described in this Owner's Manual, provided they are running a certain software version. Malfunctions can occur with other mobile phones.

Care instructions

You can find what you need to know about caring for your mobile phone in the separate Caring for your vehicle brochure and in the mobile phone operating instructions.

Operating options

You can operate the mobile phone* using:

- ▷ The steering wheel, refer to page 11
- ▷ iDrive, refer to page 16
- ▷ Voice commands, refer to page 156

Making calls with car phone: BMW Assist calls

You can use the car phone via the handsfree system for BMW Assist calls.

When the status information "BMW Assist" or "BMW Service" is displayed in "Communication", only BMW Assist calls are possible.

It may not be possible to establish a telephone connection using the mobile phone while a connection is being established to BMW Assist or while a call to BMW Assist is already in progress. If this happens, you must unpair the mobile phone and the vehicle if you wish to place a call with the mobile phone.

Initial operation

Logging on mobile phone on vehicle

The following prerequisites must be met:

- ▶ The mobile phone is ready to operate.
- ▶ The Bluetooth links of the vehicle, refer to page 151, and the mobile phone are active.
- ▶ Depending on the mobile phone, presets in the mobile phone are required: e.g. activated via the menu item Bluetooth or the menu item Connection not with confirmation.
- ▶ To log on, specify any desired number as the Bluetooth passkey, e.g. 1. This Bluetooth passkey is no longer required following successful logon.
- ▶ The ignition is switched on.

 Only log on the mobile phone with the vehicle stopped; otherwise you may become distracted and inadvertently endanger your passengers and other road users. ◀

Switching on ignition

1. Insert the remote control as far as possible into the ignition lock.
2. Switch on the switch on ignition by pressing the Start/Stop button without depressing the brake or clutch pedal.

Preparation with iDrive

iDrive, for explanation of principle, refer to page 16.

1. Press the **MENU** button to open the start menu.



2. Open the **i** menu by pressing the controller.
3. Select "Communication settings" and press the controller.
4. Select "Bluetooth" and press the controller.



5. Select "Phone" and press the controller.



Preparation with mobile phone

6. Additional operations must be carried out on the mobile phone and differ depending on the model, refer to the operating instructions of your mobile phone, e.g. find, connect or link under Bluetooth device.

Logging on

Depending on your mobile phone, first, the display of your mobile phone and then the Control Display will ask you to enter the Bluetooth passkey you specified.

Display on the Control Display if the Bluetooth passkey can be entered with iDrive:

7. Select "Add device" and press the controller.



8. Enter the Bluetooth passkey. Depending on the mobile phone, approx. 30 seconds are available for entering the Bluetooth passkey on the mobile phone and on the Control Display.

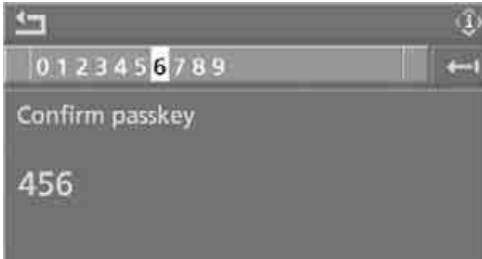

9. Select "Confirm passkey" and press the controller.
10. Wait a few seconds until the list of the logged-on mobile phones is shown on the Control Display and "Phone" is selected.

To cancel the logon of the mobile phone on the vehicle:

Select "Refuse connection" and press the controller.

The next time you use the mobile phone in the vehicle interior, it will be detected within a maximum of 2 minutes with the engine running or the ignition switched on.

As soon as a mobile phone is detected by the vehicle, the phone book entries stored on the SIM card or on your mobile phone are transferred to your vehicle, refer to the operating instructions of your mobile phone if necessary. This transfer depends on your mobile phone, refer to the operating instructions of your mobile phone if necessary, and can take several minutes.

Up to four mobile phones can be logged on consecutively. If you log on a fifth mobile phone, the logon data of the last mobile phone in the list will be deleted, refer to below.

List of logged-on mobile phones

All mobile phones for which the vehicle has stored the logon data can be displayed. If several logged-on mobile phones are detected by the vehicle simultaneously, you can operate the mobile phone highest up in the list via the vehicle.

You can change the order of the mobile phones in the list. As long as a mobile phone is selected in this list, the mobile phones cannot be operated via the vehicle.

iDrive, for explanation of principle, refer to page 16.

1. Press the **MENU** button to open the start menu.
2. Open the **i** menu by pressing the controller.
3. Select "Communication settings" and press the controller.
4. Select "Bluetooth" and press the controller.
5. Select "Phone" and press the controller.
6. Select the desired mobile phone and press the controller.



7. Select "Move device up" and press the controller. The selected mobile phone is move upward by one position.



Logging mobile phone off vehicle

If you no longer want to operate your mobile phone via the vehicle, you can delete the logon data of the mobile phone.

iDrive, for explanation of principle, refer to page 16.

1. Press the **MENU** button to open the start menu.
2. Open the **i** menu by pressing the controller.
3. Select "Communication settings" and press the controller.
4. Select "Bluetooth" and press the controller.
5. Select "Phone" and press the controller.
6. Select the desired mobile phone and press the controller.



7. Select "Delete device" and press the controller. The logged-off mobile phone is deleted from the list. The phone book entries you have trans-

ferred from your mobile phone to your vehicle are also deleted in the process.



Activating/deactivating Bluetooth link

Bluetooth technology is not approved in all countries. Observe the applicable local regulations. Temporarily disconnect the Bluetooth link between the vehicle and the mobile phone if necessary.

If the Bluetooth link is deactivated, you cannot operate your mobile phone via the vehicle and the mobile phone can use other devices with a Bluetooth interface, e.g. a laptop computer.

To temporarily deactivate the Bluetooth link between your vehicle and your mobile phone:

1. Remove the mobile phone from the snap-in adapter and switch it off.
2. Press the **MENU** button to open the start menu.
3. Select the **i** menu and press the controller.
4. Select "Communication settings" and press the controller.
5. Select "Bluetooth" and press the controller.



6. Select "Settings" and press the controller. The Bluetooth link is activated.

- Select "Bluetooth communication active" and press the controller to activate or deactivate the link.



Adjusting volume



Turn the knob during a call to select the desired volume.

This volume for the handsfree system is maintained, even if the other audio sources are set to minimum volume.

You can also adjust the volume with buttons on the steering wheel, refer to page 11.

The setting is stored for the remote control currently in use.

Operation via iDrive

You can operate the following functions via iDrive:

- ▷ Dial phone numbers.
- ▷ Dial phone numbers from the phone book.
- ▷ Dial stored phone numbers, e.g. from the list of accepted calls.
- ▷ Hang up.

With the ignition and radio readiness switched off, e.g. after removing the remote control, you

can continue an ongoing call for a maximum of 25 minutes via the handsfree system.

Requirements

The logon data of the mobile phone are stored in the vehicle and the mobile phone is ready to operate.

The engine is running or the ignition is switched on.

The mobile phone is detected by the vehicle.

iDrive, for explanation of principle, refer to page 16.

- Press the **MENU** button.



This opens the start menu.

- Move the controller forward to open "Communication".

Receiving calls

If you have the phone number of the caller stored in the phone book and the phone number has been transmitted, the name of the entry is displayed.

Accepting a call



Select "Accept" and press the controller.

Rejecting a call

Select "Reject" and press the controller. The caller is diverted to your mailbox if it has been activated.

Calling

Dialing phone numbers

1. Select "Phone" and press the controller.



2. Select "Dial" and press the controller.
3. Enter the desired phone number by dialing the individual digits and pressing the controller.

Always enter the complete phone number consisting of national dialing code, area code, and phone number.

The letters correspond to the digits on the keypad of the mobile phone.

To delete an incorrect character: Move the controller toward the right to select **←|** and press the controller.

4. Select "Dial number" and press the controller.



Ending a call

1. Select the phone number and press the controller.



2. Select "End call" and press the controller.



Dialing a phone number from phone book or a phone number stored in a list

Phone numbers you have called, incoming calls and the entries of the phone book are stored in lists when the mobile phone is connected to the vehicle via Bluetooth. If the caller is entered in the phone book, the name of the entry is displayed instead of the phone number.

You can select the desired subscriber from the list and establish the connection.

Five lists are available:

- ▷ "A - Z"
The entries of the mobile-phone phone book, consisting of the name and phone number, are sorted alphabetically.
- ▷ "Top 8"
The eight numbers called most frequently from the phone book "A - Z" are automatically stored in the Top 8 list. The list is sorted according to frequency.
- ▷ "Redial"
The last eight phone numbers you have

dialled are automatically stored. The last number dialled is at the top of the list.

- ▷ "Missed calls"
The phone numbers of the last eight calls which were not accepted are stored. This requires the telephone number of the caller to have been sent.
- ▷ "Received calls"
The phone numbers of the last eight accepted calls are stored. This requires the telephone number of the caller to have been sent.

Dialing phone numbers from phone book

The list "A - Z" is available for you phone book entries. The phone book entries appear on the Control Display.

1. Select "Phone" and press the controller.



2. Select "A - Z" and press the controller.
3. To limit the number of displayed entries, select the first letter of the desired entry and press the controller.
4. Select the desired entry and press the controller.



5. Select "Call" and press the controller. The system dials the number.

If different phone numbers are stored in the mobile phone under one name, e.g. office and home, the name is shown once for each phone number.

You can change a phone number stored in the phone book, e.g. to call a specific extension:

1. Select "Phone" and press the controller.
2. Select "A - Z" and press the controller.
3. Select the desired entry and press the controller.
4. Select "Add digits" and press the controller.
5. Change the phone number.
6. Select "Dial number" and press the controller.

Dialing phone numbers stored in a list

To select an entry and establish a connection:

1. Select "Phone" and press the controller.
2. Select list and press the controller:
 - ▷ "Top 8"
 - ▷ "Redial"
 - ▷ "Missed calls"
 - ▷ "Received calls"



3. Select the desired entry and press the controller.



4. Select "Call" and press the controller. The system dials the number.

Deleting individual entries

1. Select the desired entry from the list and press the controller.
2. Select "Delete" and press the controller. The entry is deleted.



Deleting entire list

1. Select an entry from the list and press the controller.
2. Select "Delete all numbers" and press the controller.



3. If applicable, select "Yes" and press the controller. The list is deleted.

BMW Contact*

If you are not activated for BMW Assist, you can display several service phone numbers:

- ▶ Roadside Assistance* of the BMW Group when you require breakdown assistance
- ▶ BMW center, e.g. when you want to make an appointment for service
- ▶ BMW Hotline* for information on all aspects of your vehicle

If BMW Assist is activated, refer to page 162.

You can select the displayed service phone number if your mobile phone is logged on in the vehicle:

iDrive, for explanation of principle, refer to page 16.

1. Press the **MENU** button. This opens the start menu.
2. Move the controller forwards to select "Communication".
3. Select "BMW Contact" and press the controller.



4. Select "BMW Contact Numbers" and press the controller.



5. Select one of the following menu items and press the controller:
 - ▶ "Roadside Assistance"
 - ▶ "Customer Relations"
 - ▶ "Service Request"
6. Select "Call" and press the controller. Contact is established.

Transferring phone number via tone dialing method

The tone dialing method is required for access to network services or for controlling devices, e.g. remote checking of an answering machine. This function is available when a connection has been established.

1. Establish connection.



2. Press the controller.
3. Select "Keypad" and press the controller.
4. Select the desired character and press the controller.

Each character is sent immediately and confirmed by a tone depending the mobile phone model.



Changing between mobile phone and handsfree system

From mobile phone to handsfree system

You can continue calls begun outside the Bluetooth range of the vehicle via the handsfree system when the motor is running or the ignition is switched on. Depending on your mobile phone,

the system automatically switches over to the handsfree mode.

For mobile phones that do not automatically switch over to the handsfree mode:

- ▷ You may also be able to continue the conversation via the handsfree system, depending on the mobile phone used. Follow the instructions displayed on the mobile phone display, refer to the operating instructions of your mobile phone.
- ▷ Press the  button above the storage compartment. Switching over may take several seconds.

From handsfree system to mobile phone

When you telephone via the handsfree system, you can also continue the call via the mobile phone if necessary, depending on the mobile phone model. Follow the instructions displayed on the mobile phone display, refer to the operating instructions of your mobile phone.



Operation by voice*

The concept

You can operate your mobile phone without having to remove your hands from the steering wheel. When making your entries, you will be assisted by announcements and questions in many cases.

The same prerequisites as for operation via iDrive apply, refer to page 152.

Symbols in Owner's Manual

-  >...< Say the specified commands word for word.
-  >>...<< Indicates responses of the system.

Voice commands

Activating system

1. Press the  button on the steering wheel. An acoustic signal indicates that you can say commands.
2. Say the command. The text or numbers that the voice command system has registered will appear on the Control Display.

Ending/canceling operation by voice

Press the  button on the steering wheel or

 ›Cancel‹.

In dialogs where text is spoken, not a command, e.g. a name, canceling is only possible using the button on the steering wheel.

Example: dialing phone numbers

Start the dialog:

Press the  button on the steering wheel.

Command	Response
›Dial number‹	››Please say the number‹‹
e.g. ›123 456 7890‹	Depending on equipment: ››123 456 7890. Continue?‹‹ or ››123 456 7890. And next?‹‹
›Dial‹	››Dialing number‹‹

Adjusting volume

You can adjust the volume for the instructions from the system:



Turn the button during an instruction to select the desired volume.

Having possible commands read aloud

The system understands default commands that must be spoken word for word. You can have the system read aloud the possible commands at any point:

 ›Help‹

Using alternative commands

There are often a number of commands to run a function, e.g.:

 ›Dial name‹ or ›Name‹.

The system recognizes digits from zero to nine. You can say each digit individually or group them into a sequence to accelerate the input.

This volume for the instructions is maintained, even if the other audio sources are set to minimum volume.

The setting is stored for the remote control currently in use.

Calling

Dialing phone numbers

1. ›Dial number‹.
The dialog for establishing a telephone connection is opened.
2. Say the phone number.
For telephone calls abroad, say ›Plus‹ and then the country code.
3. ›Dial‹.
The connection to the desired subscriber is established.

Correcting phone number

After the last spoken sequence of digits has been repeated by the system, you can delete this sequence of digits.

- ›Correct number‹.
The digits are deleted.

The command ›Correct number‹ can be repeated as often as you like.

Deleting input

›Delete‹ is used to delete all the digits entered so far.

Voice phone book

Operating by voice command requires a personal voice phone book.

- ▷ On vehicles with separate drives for audio CDs and navigation DVDs, the entries are automatically adopted from your mobile phone's memory.
- ▷ On vehicles with a single drive, the entries must be entered by voice and are independent of your mobile phone's memory. In this case, it is not possible to use voice command either to call phone numbers stored in the mobile phone or to store new numbers.

Creating and editing voice phone book*

Save entry:

An entry always consists of a name and phone number.

1. ›Save name‹.
The dialog for storing a name is opened.
2. Speak name and repeat entry upon request.
The spoken length of the names in the phone book must not exceed approx. 2 seconds.
3. Say the phone number when prompted.
4. To store the phone number:
›Save‹.

Delete entry:

You can delete any entry from the voice phone book.

1. ›Delete name‹.
The dialog for deleting an entry is opened.
2. Say the name when prompted.
3. Confirm the prompt with ›Yes‹.

Delete all entries:

›Delete phone book‹ deletes all entries in the phone book.

1. ›Delete phone book‹.
The dialog for deleting phone book is opened.
2. Confirm the prompt with ›Yes‹.
3. Confirm the repeated prompt with ›Yes‹.

Have entries read aloud and dial:

You can have all the entries of your voice phone book read aloud in the order of input and select a certain entry to establish a connection:

1. ›Read phone book‹.
The dialog for reading phone book is opened.
2. ›Dial number‹ when the desired entry is read aloud.

Selecting an entry

The connection to the phone number of the selected entry is established.

1. ›Dial name‹.
The dialog for selecting an entry is opened.
2. Say the name when prompted.
3. Confirm the prompt with ›Yes‹.

Redialing

The ›Redial‹ command calls up "Redial".

Notes

 The commands in English were available as of this printing. Other languages are currently not available. To operate the mobile phone via the voice command system, refer to page 22. ◀

Important for voice commands

For voice commands, keep the following in mind:

- ▷ Issue the commands smoothly and at normal volume, avoiding excessive emphasis and pauses.
- ▷ Keep the doors and windows closed to prevent interference from ambient noise.
- ▷ Avoid making other noise in the vehicle while speaking.

Mounting/removing snap-in adapter

1. Press the area 1 around the button and remove the cover.

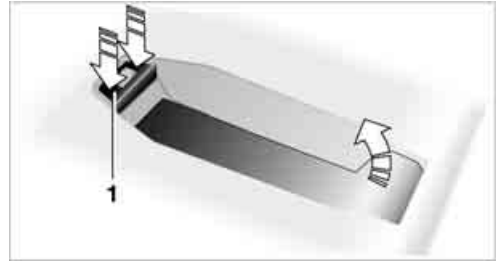

2. Insert the snap-in adapter at the front and press down until it engages.



To remove the snap-in adapter:
Press the area 1 around the button.

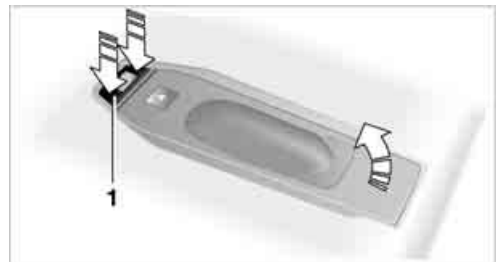

Inserting mobile phone

1. Remove the protective cap from the mobile phone's antenna connector if necessary, so that the mobile phone can engage in the snap-in adapter.
2. With the keys facing upward, press the mobile phone toward the electrical connections and press down until it engages.

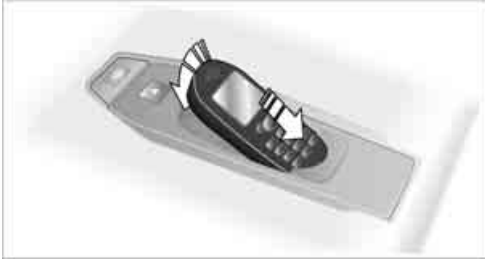

The mobile phone's battery is charged with the ignition lock at radio readiness or higher or with the steering unlocked.

 To protect the vehicle's batteries, avoid using the phone when the ignition is switched off. ◀

Removing mobile phone

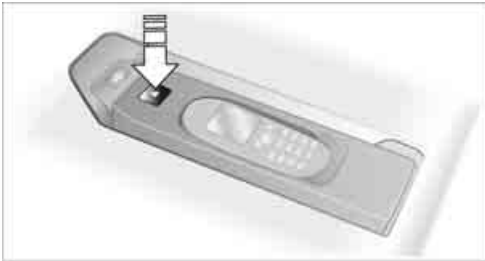

Press button.

TeleService

TeleService assists you when communicating with a BMW center. The built-in car phone can be used to transmit data regarding the service status of your vehicle or regarding legally mandated inspections directly to your BMW center. This is the same data that is also stored in the remote control for CBS Condition Based Service. Your BMW center can then contact you, and you can make an appointment that suits you while you are still on the road. Your advantage here is that your BMW center can prepare in advance for the required maintenance work. The TeleService functions are country-specific: the data regarding the service status of your vehicle or regarding legally mandated inspections is transmitted on a country-specific basis either automatically before they fall due or during your calls to the BMW center. Your BMW center will be glad to provide more detailed information.

BMW Assist

BMW Assist provides you with other services in addition to TeleService. For example, the position data of your vehicle can be transferred to the BMW Assist response center if an emergency call* has been initiated.

Many functions of BMW Assist depend on the individually agreed contract. Data transmission, e.g. of the CBS Condition Based Service, differs from country to country.

The contract of participation with BMW Assist and the activation must be completed before you can use BMW Assist.

When the contract expires, the car phone can be deactivated by a BMW center without your having to visit a BMW center. Following deactivation of the car phone, no emergency calls can be made. The car phone can be reactivated after signing a new contract with a BMW center.

You can also use the services of BMW Assist via the Internet. The range of services is continually being expanded.

Requirements

You can use TeleService or BMW Assist when the following requirements are met:

- ▷ The installed car phone is logged on to a cellular telephone network. This network must be capable of transmitting the services.
- ▷ To transmit position data, the vehicle must be able to determine the current position. This can be displayed on the Control Display.
- ▷ For TeleService or BMW Assist to be activated and updated, the GPS signal must be available.
- ▷ For BMW Assist: you have applied to your BMW center or BMW Customer Support for BMW Assist.

Enabling TeleService or BMW Assist

For you to be able to use the services of TeleService or BMW Assist, these must be enabled.

Requirements

- ▷ Make sure that the vehicle can determine its current location. Reception is best when you have an unobstructed view to the sky.
- ▷ Leave radio readiness switched on while connecting to the system.

Enabling

iDrive, for explanation of principle, refer to page 16.

1. Press the **MENU** button.
This opens the start menu.
2. Press the controller to open the **i** menu.

3. Select "Communication settings" and press the controller.
4. Select "BMW Service settings" and press the controller.



5. Select "Service Status" and press the controller.



6. Select "Enable services" and press the controller.
TeleService and, if applicable, BMW Assist are enabled; data exchange with the service center starts.

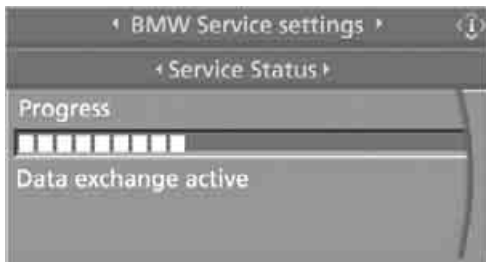

Enabling takes a few minutes. The status is displayed on the Control Display. If you open another menu, the enable process continues to run in the background.

Services offered

The following special features apply for the services of TeleService and BMW Assist:

- ▷ The services offered are country-specific.
- ▷ Voice contact is established or data are transferred, depending on the equipment and the country. In some countries, it is possible to do both.
- ▷ The data transferred can be the vehicle data, your current position or the data of the CBS Condition Based Service.

Automatic service notification*

The data on the service status of your vehicle or on legally mandated inspections is transmitted automatically directly to your BMW center prior to the due date. You can check when the BMW center was notified.

iDrive, for explanation of principle, refer to page 16.

1. Open the start menu.
2. Press the controller to open the **i** menu.
3. Select "Service" and press the controller.
4. Select "Service requirements" and press the controller.

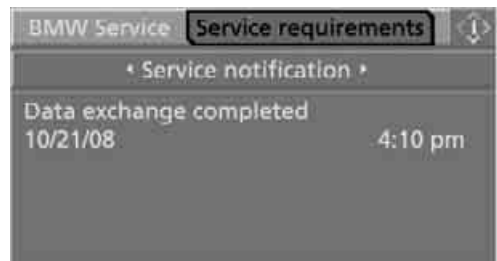

5. Select "Service notification" and press the controller.

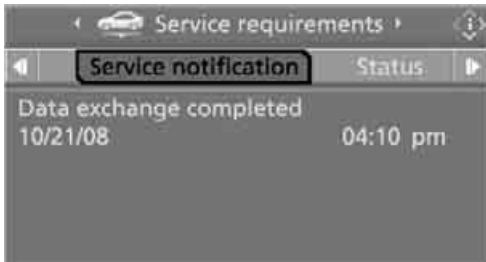

5. Select "Roadside Assistance" and press the controller.

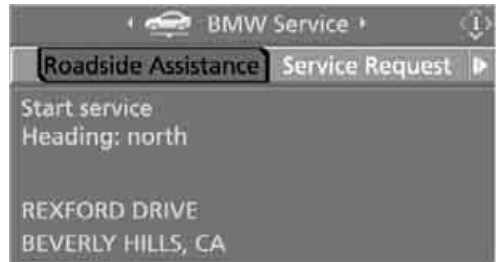

Breakdown assistance

You can call Roadside Assistance* of the BMW Group should you require help in the event of a breakdown.

iDrive, for explanation of principle, refer to page 16.

1. Press the **MENU** button.
This opens the start menu.
2. Move the controller forwards to select "Communication".
3. Select "BMW Assist" and press the controller.
4. Select "BMW Service" and press the controller.



If the current position can be determined, the current vehicle location is displayed.

6. Select "Start service" and press the controller.

Contact with Roadside Assistance will be established.

Establishing contact with your BMW center or BMW Customer Relations

You can contact your BMW center, e.g. to arrange a service appointment.

For information related to your vehicle, call the BMW Customer Relations.

This requires your mobile phone to be logged onto the vehicle.

iDrive, for explanation of principle, refer to page 16.

1. Press the **MENU** button.
This opens the start menu.
2. Press the controller to open the **i** menu.
3. Select "Service" and press the controller.
4. Select "BMW Service" and press the controller.

5. Select desired BMW service:

- ▷ "Service Request"
- ▷ "Customer Relations"



6. Press the controller.

7. Select "Start service" and press the controller.

Contact with the desired BMW service will be established.

Adapting TeleService or BMW Assist

Displaying and updating services

If the offering from TeleService or BMW Assist changes, you will be notified. In this case you should update the services.

1. Open the start menu.
2. Press the controller to open the **i** menu.
3. Select "Communication settings" and press the controller.
4. Select "BMW Service settings" and press the controller.
5. Select "Service Status" and press the controller.

The current services available from TeleService or BMW Assist are displayed.

6. If applicable, select "Options" and press the controller.

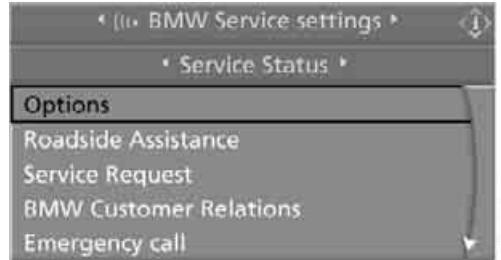

7. Select "Update services" and press the controller.

Blocking services*

If you block the services, the connection to BMW Assist is deactivated.

1. Open the start menu.
2. Press the controller to open the **i** menu.
3. Select "Communication settings" and press the controller.
4. Select "BMW Service settings" and press the controller.
5. Select "Service Status" and press the controller.
6. Select "Options" and press the controller.
7. Select "Terminate services" and press the controller.

The use of TeleService or BMW Assist is blocked, and the current vehicle position will not be transferred during an emergency call*. To deactivate the blocking function, enabling must be carried out again, refer to page 161. This does not affect the contractual agreements.

Re-enable TeleService and, if applicable, BMW Assist to log on again.

Displaying vehicle data

When TeleService or BMW Assist is activated, the license plate and the vehicle identification number of your vehicle can be displayed.

1. Open the start menu.
2. Press the controller to open the **i** menu.
3. Select "Communication settings" and press the controller.
4. Select "BMW Service settings" and press the controller.
5. Select "Profile" and press the controller.



To adjust the license plate number, please contact your BMW center.





Mobility

This section helps you maintain your mobility by supplying important information on vital topics including fuels and lubricants, wheels and tires, service, maintenance and breakdown assistance.

Refueling

! Always switch off the engine before refueling, otherwise no fuel can be filled into the tank and a message is displayed. ◀

! When handling fuel, always observe all applicable precautionary measures and regulations. Never transport reserve fuel containers in the vehicle. They can leak and cause an explosion or a fire in an accident. ◀

Fuel filler door

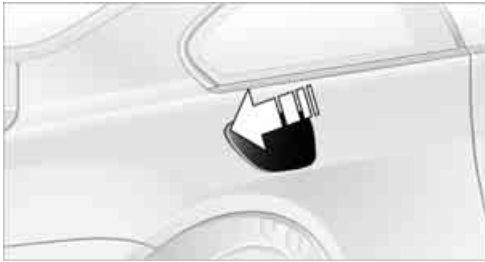

To open and close: briefly press the rear edge of the fuel filler door.

Manual release

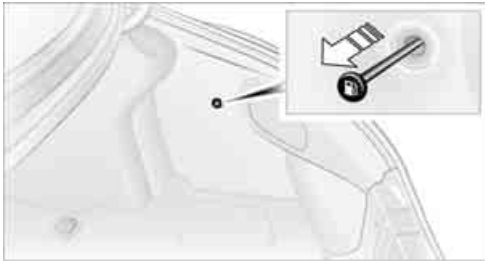

In the event of an electrical malfunction, you can release the fuel filler door manually:

In the luggage compartment, pull the knob with the gas pump symbol on the right side panel.

Observe following when refueling

! When handling fuels always follow any safety guidelines posted at the gas station. ◀

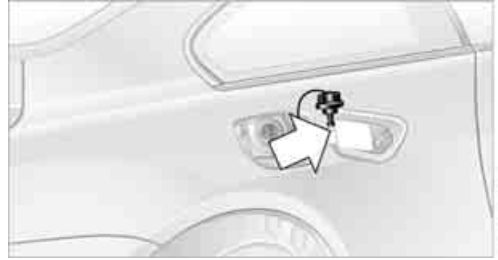

Place the fuel filler cap in the bracket attached to the fuel filler door.

When refueling, insert the filler nozzle completely into the filler pipe. Avoid raising the filler nozzle during refueling, as otherwise this

- ▷ results in premature pump shutoff
- ▷ can lead to reduced efficiency in the fuel-vapor recovery system

The fuel tank is full when the filler nozzle clicks off the first time.

Fuel tank capacity

Approx. 18.5 gallons/70 liters, including the reserve capacity of approx. 4 gallons/15 liters.

! Refuel as soon as possible once your cruising range falls below 30 miles/ 50 km, otherwise engine functions are not ensured and damage can occur. ◀

Fuel filler cap

Closing

Insert the cap and turn it clockwise until there is a clearly audible click.

! Do not jam the strap attached to the fuel filler cap between the fuel filler cap and the vehicle. A message * is displayed if the cap is loose or missing. ◀

Fuel specifications

 Never used leaded gasoline; it will permanently damage the catalytic converter. ◀

Required fuel

Super Premium Gasoline/AKI 93

Always use this premium grade fuel to obtain maximum fuel economy and performance.

The minimum approved fuel grade is AKI 91.

 Do not use gasoline below the specified minimum quality, as otherwise engine damage can result. ◀

Use high-quality brands

Field experience has demonstrated significant differences in fuel quality: volatility, composition, additives, etc., among gasolines offered for sale in the United States and Canada. Fuels containing up to and including 10% ethanol or other oxygenates with up to 2.8% oxygen by weight, that is, 15% MTBE or 3% methanol plus an equivalent amount of co-solvent, will not void the applicable warranties with respect to defects in materials or workmanship.

 The use of poor-quality fuels may result in problems relating to drivability and starting, and to a tendency to stall, especially under certain environmental conditions such as high ambient temperature and high altitude.

Should you encounter drivability problems which you suspect could be related to the fuel you are using, we recommend that you respond by switching to a recognized high-quality brand such as gasoline that is advertised as Top Tier Detergent Gasoline.

Failure to comply with these recommendations may also result in unscheduled maintenance. ◀

Wheels and tires

Tire inflation pressure

Information for your safety

The condition of the tires and the maintenance of the specified tire pressure are crucial not only to the tire's service life, but also to driving comfort and most importantly, driving safety.

Checking pressure

Only check tire inflation pressure when the tires are cold. This means after a maximum of 1.25 miles/2 km driving or when the vehicle has been parked for at least 2 hours. When tires are warm, the tire inflation pressure increases.

 Check the tire inflation pressure regularly and correct if necessary, including on the spare wheel*: at least twice a month and before starting long trips. If you fail to observe this precaution, you may be driving on tires with incorrect tire pressures, a condition that can not only compromise your vehicle's driving stability, but also lead to tire damage and the risk of an accident. ◀

 After correcting the inflation pressure(s), always reinitialize the Flat Tire Monitor, refer to page 74. ◀

Pressure specifications

The tables below provide all the correct inflation pressures for the specified tire sizes at ambient temperature.

 The inflation pressures apply to the tire sizes and tire brands respectively approved and recommended by BMW; a list of these is available from your BMW center. ◀

For correct identification of the right tire inflation pressure for your tires, observe the following:

- ▷ Tire sizes for your vehicle
- ▷ Load conditions
- ▷ Maximum allowable driving speed

Tire inflation pressures for driving up to 100 mph/160 km/h

For normal driving up to 100 mph/160 km/h, adjust pressures to the respective tire inflation pressures listed on the following pages in the column for traveling speeds up to a max. of 100 mph/160 km/h to achieve optimum driving comfort.

These pressure specifications can be found on the door post when you open the driver's door.



 The permissible top speed for these tire inflation pressures is 100 mph/160 km/h. Do not exceed this speed; otherwise, tire damage and accidents may result. ◀

Tire inflation pressures for driving above 100 mph/160 km/h

 In order to drive at maximum speeds in excess of 100 mph/160 km/h, please note the tire pressures for speeds exceeding 100 mph/160 km/h listed in the relevant column of the table on the following pages and adjust your tire inflation pressures as needed. Otherwise, tire damage and accidents could occur. ◀

Observe all national and local maximum speed limits, otherwise violations of the law could occur.

Tire size	Pressure specifications in psi/kPa					
	Traveling speeds up to max. of 100 mph/160 km/h		Traveling speeds including those exceeding 100 mph/160 km/h			
All pressure specifications in the table are indicated in psi/kilopascal with cold tires. Cold = ambient temperature						
	245/45 R 18 100 V XL M+S	35/240 38/260	35/240 38/260	41/280 46/320		
	255/40 ZR 19	33/230 -	33/230 -	41/280 -		
285/35 ZR 19	- 36/250	- 36/250	- 46/320			

More details on the permissible load and weights can be found on page [200](#).

Tire identification marks

Knowledge of the labeling on the side of the tire makes it easier to identify and choose the right tires.

Tire size

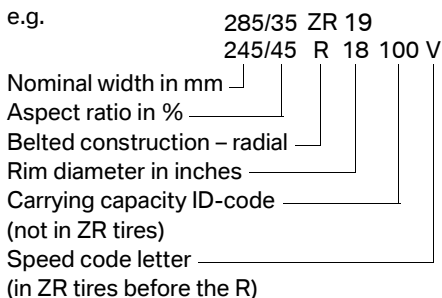

Speed letter

- T = up to 118 mph/190 km/h
- H = up to 131 mph/210 km/h
- V = up to 150 mph/240 km/h
- W = up to 167 mph/270 km/h
- Y = up to 186 mph/300 km/h
- Z = over 150 mph/240 km/h

Tire Identification Number

Tires with DOT codes meet the guidelines of the U.S. Department of Transportation.

DOT code:

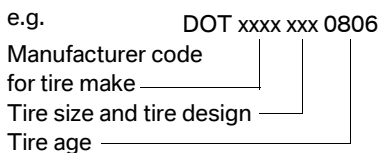

Tire age

The tire's date of manufacture is indicated on the sidewall: DOT ... 0806 indicates that a tire was manufactured in week 8 of the year 2006.

BMW recommends replacing all tires at least every 6 years, even if some tires may last for 10 years. This also concerns the tire of the spare wheel*.

Uniform Tire Quality Grading

Quality grades can be found where applicable on the tire sidewall between tread shoulder and maximum section width. For example:

Tread wear 200 Traction AA
Temperature A

DOT Quality Grades

Tread wear
Traction AA A B C
Temperature A B C

 All passenger car tires must conform to Federal Safety Requirements in addition to these grades. ◀

Tread wear

The tread wear grade is a comparative rating based on the wear rate of the tire when tested under controlled conditions on a specified government test course.

For example, a tire graded 150 would wear one and one-half, 1½, times as well on the government course as a tire graded 100. The relative performance of tires depends upon the actual conditions of their use, however, and may depart significantly from the norm due to variations in driving habits, service practices and differences in road characteristics and climate.

Traction

The traction grades, from highest to lowest, are AA, A, B, and C.

These grades represent the tire's ability to stop on wet pavement as measured under controlled conditions on specified government test surfaces of asphalt and concrete. A tire marked C may have poor traction performance.

 The traction grade assigned to this tire is based on straight-ahead braking traction tests, and does not include acceleration, cornering, hydroplaning, or peak traction characteristics. ◀

Temperature

The temperature grades are A, the highest, B, and C, representing the tire's resistance to the generation of heat and its ability to dissipate

heat when tested under controlled conditions on a specified indoor laboratory test wheel. Sustained high temperature can cause the material of the tire to degenerate and reduce tire life, and excessive temperature can lead to sudden tire failure. The grade C corresponds to a level of performance which all passenger car tires must meet under the Federal Motor Vehicle Safety Standard No. 109. Grades B and A represent higher levels of performance on the laboratory test wheel than the minimum required by law.

 The temperature grade for this tire is established for a tire that is properly inflated and not overloaded. Excessive speed, underinflation, or excessive loading, either separately or in combination, can cause heat buildup and possible tire failure. ◀

M+S

Winter and all-season tires.

These have better winter properties than summer tires.

XL

Indicates specially reinforced tires.

Tire condition

Inspect your tires frequently for tread wear, signs of damage and foreign objects lodged in the tread, and check the tread depth.

Minimum tread depth

The tread depth should not drop below 0.12 in/3 mm, although, for example, European legislation only specifies a minimum tread depth of 0.063 in/1.6 mm. At tread depths below 0.12 in/3 mm, there is an increased risk of high-speed hydroplaning, even when only small amounts of water are present on the road surface.

Winter tires noticeably lose their suitability for winter use below a tread depth of 0.16 in/4 mm. New tires should be mounted in the interest of safety.

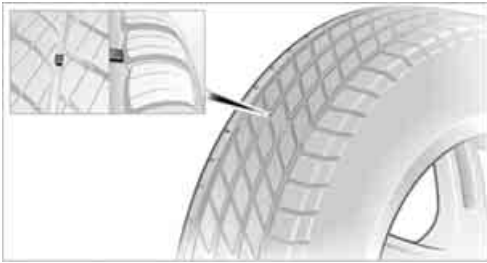

Wear indicators at the tread-groove base, refer to arrow, are distributed over the tire's circumference and are marked on the side of the tire with TWI – Tread Wear Indicator. If the tire tread has been driven down to the wear indicators, a tread depth of 0.063 in/1.6 mm has been reached.

Wheel/tire damage

Please note that low-profile tires cause wheels, tires and suspension parts to be more susceptible to road hazards and consequential damages.

Unusual vibrations encountered during normal vehicle operation can indicate tire failure or some other vehicle defect. This can, for example, be caused by driving over curbs. These kinds of problems may also be signaled by other changes in vehicle response, such as a strong tendency to pull to the left or right.

! In these cases reduce your speed immediately and have the wheels and tires inspected immediately. To do this, carefully drive to the nearest BMW center or a specialized tire dealer that works in accordance with BMW guidelines and uses appropriately trained personnel. Have the vehicle towed to the repair shop if necessary. Tire damage can be extremely dangerous to vehicle occupants and other road users. ◀

New wheels and tires

! Only have new wheels and tires mounted by a BMW center or a repair shop that works in accordance with BMW guidelines and uses appropriately trained personnel. If this work is performed inexpertly, there is a danger of damage and associated safety risks. Make sure that the new wheels are balanced. ◀

Retreaded tires

! BMW does not recommend the use of retreaded tires; otherwise, driving safety may be reduced. Potentially substantial variations in the design and the age of the carcasses can result in a reduced service life. ◀

The right wheels and tires

! BMW recommends that you use only wheel and tire combinations that BMW has tested and approved for your particular vehicle. Variations in factors such as manufacturing tolerances mean that even wheels and tires with identical official size ratings could actually have different dimensions than the approved units – these differences could lead to body contact, and with it the risk of severe accidents. When selecting the tires, also ensure that they have a sufficient load-carrying capacity. If non-approved wheels and tires are used, BMW cannot evaluate their suitability, and therefore cannot be held liable for driving safety. ◀

You can find out the right wheel-tire combination from your BMW center.

The right wheel-and-tire combination is another vital factor in ensuring reliable operation of various vehicle systems such as ABS and DSC.

To maintain good handling and vehicle response, use only tires of a single tread configuration from a single manufacturer. After a tire is damaged, always remember to have the original wheel and tire combination remounted on the vehicle as soon as possible.

Recommended tire brands

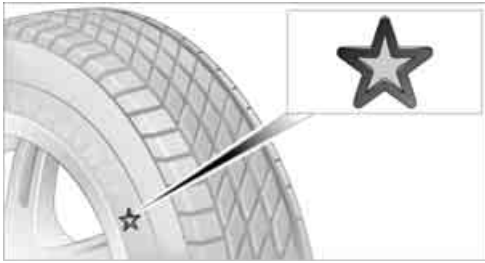

BMW recommends particular tire brands for each tire size. You can recognize these from the clearly visible BMW marking on the tire sidewall. With proper use, these tires meet the highest standards for safety and handling characteristics.

Special characteristics of winter tires

BMW recommends winter tires for use in cold winter driving conditions. Although all-season M+S tires provide better winter traction than summer tires, they generally fail to provide the same levels of cold-weather performance as winter tires.

Watch speed

 Always observe the maximum permissible speed for the winter tires, otherwise tire damage may occur, which can result in accidents. ◀

After changing wheels/tires

After changing tires or wheels, the slip detection of the Sequential Manual Transmission must become familiar with the changed state.

Reinitialize the system for this purpose:

1. Move the selector lever into the idling position N on a straight stretch of road at a speed between 20 mph/30 km/h and 90 mph/150 km/h.
2. Pull both shift paddles for approx. 2 seconds.

If you do not carry out initialization, the system will automatically learn the changed state gradually during driving. This may be noticeable from the clutch opening and closing briefly.

Storage

Always store wheels and tires in a cool, dry place with as little exposure to light as possible. Always protect tires against all contact with oil, grease and fuels. Do not exceed the maximum tire inflation pressure indicated on the side wall of the tire.

Snow chains*

BMW only tests certain fine-link snow chains, classifies them as road-safe and recommends them. Consult your BMW center for more information.

Use is only permitted in pairs, with winter tires of the size 245/45 R 18 on the rear wheels.

Observe the manufacturer's instructions when mounting snow chains. Do not exceed a speed of 30 mph/50 km/h with the chains mounted.

Make sure that the snow chains are always sufficiently tensioned. Retension in accordance with the chain manufacturer's specifications if necessary.

 Do not initialize the Flat Tire Monitor after installing snow chains as this could cause the Flat Tire Monitor to malfunction.

After mounting or removing snow chains, the slip detection of the Sequential Manual Transmission must become familiar with the altered state. To do this, reinitialize the system, refer to After changing wheels/tires. ◀

Under the hood

 Never attempt to perform any service or repair operations on your vehicle without the required professional technical training. If you are unfamiliar with the specifications to be observed, only have work carried out on your vehicle by a BMW center or a repair shop that works in accordance with BMW guidelines and uses appropriately trained personnel. Otherwise there is a danger of damage and associated safety risks if this work is performed improperly. ◀

Hood

Releasing



Pull lever.

Opening

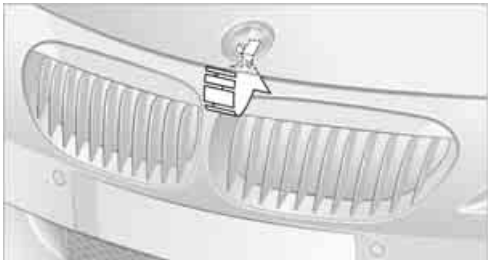

Press the release handle and open the hood.

 You cannot start off with the hood open. ◀

Closing

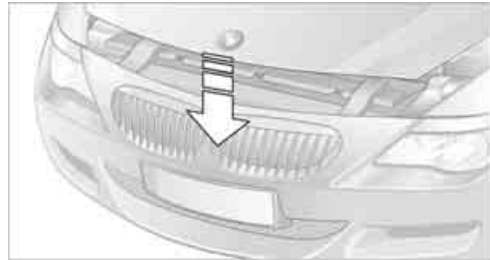

Close the hood from a height of approx. 16 in/ 40 cm with momentum. It must be clearly heard to engage.

 Make sure that the closing path of the hood is clear; otherwise, injuries may result.

If you see any signs that the hood is not completely closed while you are driving your vehicle, you should stop at once and close it securely. ◀

Engine compartment

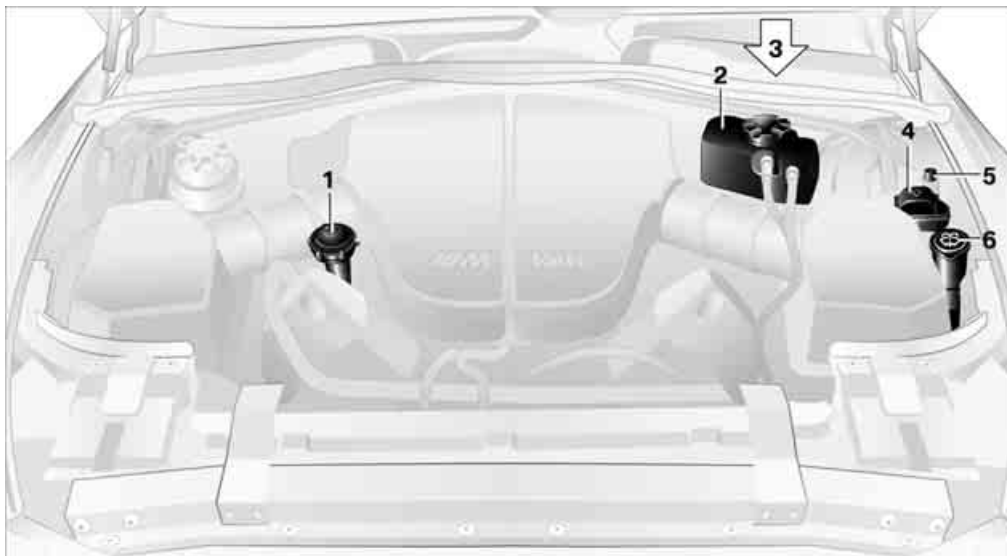

- 1 Filler neck for engine oil, refer to Adding engine oil
- 2 Expansion tank for coolant, refer to page 178
- 3 Brake fluid reservoir, located beneath the microfilter cover, refer to page 179
- 4 Jump-starting terminal, refer to page 192
- 5 Body ground/negative terminal
- 6 Washer fluid reservoir of the headlamp and windshield cleaning systems, refer to page 57

Engine oil

Engine oil consumption depends on driving style and driving conditions.

Checking engine oil level

Your vehicle is equipped with an electronic oil level check. You can display the oil level in the instrument cluster.



- 1 Oil level
- 2 Maximum marking
- 3 Minimum marking

Press the BC button in the turn signal lever repeatedly until the oil level display is shown in the instrument cluster. The displayed numeric

value indicates the current oil level in liters above Minimum.

After starting the engine, the last determined value is displayed.

The oil level must be between the two marks.

Exact measurement

The oil level is measured continuously while driving or when stopped with the engine running.

The determination of a new value can take 30 minutes or longer.

 If only dashes are shown in the display, it was not possible to determine a new value. This can, for example, be the case when driving short distances or with a sporty driving style. ◀

Fast measurement

In addition to the continuous measurement, you can also quickly determine the current oil level, e.g. after adding engine oil, however with a low measuring accuracy.

1. With the engine at operating temperature, i.e. after at least 6 miles/10 km of uninterrupted driving, park the vehicle in a horizontal position.
2. Allow the engine to run at idle.
3. Press the BC button in the turn signal lever repeatedly until the oil level display is shown in the instrument cluster.
4. Press the BC button in the turn signal lever for at least 2 seconds.

The oil level is determined. A clock symbol is displayed during the measurement.

5. After approx. 1 minute the current oil level is displayed.

 If not all measuring conditions are met, e.g. with the engine cold, "-.-" is displayed. The requested measurement is carried out as soon as possible. ◀

Possible displays



- 1 Oil level OK
- 2 Oil level at minimum:
Add a maximum of 1 US quart/1 liter of engine oil at the next opportunity, refer to Adding engine oil below
- 3 Oil level is too high
 Have the vehicle checked immediately; otherwise, engine damage may result if too much oil has been added. ◀
- 4 Oil level at maximum
- 5 Quick measurement running: oil level is being determined
- 6 No value can be determined at this time

Adding engine oil

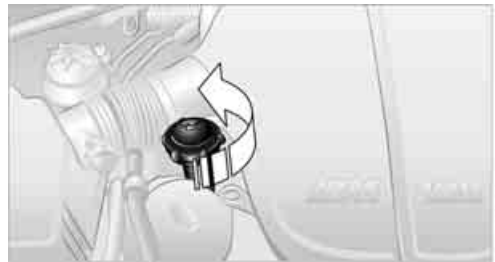

Do not add oil until a value slightly above the Minimum of 0.0 quarts/liters is displayed by the oil level measurement. In this area a message is also shown on the Control Display.

 Add oil within the next 125 miles/200 km, otherwise the engine could be damaged. Add a maximum of 1 US quart/1 liter of oil, otherwise the engine may be damaged by adding too much oil.

Add at least 0.5 US quart/0.5 liter of oil, otherwise the oil level check cannot reliably display the current oil level. ◀

 Continuous exposure to used oil has caused cancer in laboratory testing. For this reason, thoroughly wash exposed areas of skin with soap and water after such work. Keep oil, grease, etc. out of reach of children and heed warnings on containers. Failure to do so could pose health risks. ◀

 For immediate updating of the oil level display, carry out a quick measurement directly afterward. ◀

Oil change

Have oil changes carried out only by a BMW center or a repair shop that works in accordance with BMW guidelines and uses appropriately trained personnel.

Approved engine oils

The quality of the engine oil selected has critical significance for the operation and service life of an engine. BMW continuously approves specific oils after confirming their suitability for use in its vehicles with extensive testing.

 Do not use oil additives; under some circumstances, they can harm your engine. ◀

 Your BMW center will be happy to answer detailed questions on BMW High Performance Synthetic Oil or approved synthetic oils. ◀

You can also call BMW of North America at 1-800-831-1117 or visit the website at www.bmwusa.com to obtain this information.

Viscosity grades

The viscosity is a measure of the thickness of the oil and is specified in SAE grades.

 Approved oils belong to the SAE grade 10W-60. ◀

Alternative oil types

If BMW High Performance Synthetic Oil is unavailable, you can add small quantities of other synthetic oils between oil changes. Only use oils with the following specifications:

- ▷ Viscosity
preferred: SAE 10W-60;
alternative: SAE 10W-40, SAE 5W-50 or SAE 10W-50
- ▷ Specification
API SJ/CF, API SK/CF or higher

Low ambient temperatures

The oils used by BMW from the factory for your vehicle model can be used at virtually all ambient temperatures. However, if the vehicle is operated for a longer period at temperatures below -4°F / -20°C , your BMW center will be happy to recommend a suitable oil.

Coolant

 Do not open the cooling system when the engine is hot. Escaping coolant can cause burns. ◀

Coolant consists of water and coolant additive. Not all commercially available additives are suitable for your BMW. Ask your BMW center for suitable additives.

 Only use suitable additives, otherwise engine damage may result. The additives present a health hazard. ◀

 Always observe all applicable environmental laws and regulations when disposing of used coolant additives. ◀

Checking coolant level

1. The engine must be at ambient temperature.
2. Turn the cap of the expansion tank counterclockwise to allow any accumulated pressure to escape, then continue turning to open.

- The coolant level is correct when the upper end of the float rod is at the same height as the upper edge of the filler neck, also refer to the drawing next to the filler neck.



- If the coolant is low, slowly add coolant up to the specified level – do not overfill.
- Turn the cap until it clicks.
- Have the reason for the coolant loss eliminated as soon as possible.

Brake system

Malfunction

Brake fluid

 The warning lamp lights red up in spite of the handbrake being released; a message is shown on the Control Display: stop the vehicle immediately.

The brake fluid in the reservoir has fallen to below the minimum level. At the same time, a significantly longer brake pedal path may be noticeable. Have the system checked immediately by a BMW center.

 Display of the previously described malfunction on Canadian models.

 When you continue driving, an increased brake pedal path can be necessary, and significantly longer braking distances may be required. Please adapt your driving style accordingly. ◀

Brake pads

 The warning lamp lights red up in spite of the handbrake being released; a message is shown on the Control Display:

The brake pads have reached their minimum pad thickness. Have the brake pads replaced as soon as possible.

 Display of the previously described malfunction on Canadian models.

 For your own safety: use only brake pads that BMW has approved for your particular vehicle model. As BMW cannot assess the suitability of other brake pads for use on your vehicle, BMW is unable to assume continued responsibility for the vehicle's operating safety if non-approved pads are installed. ◀

Maintenance

BMW Maintenance System

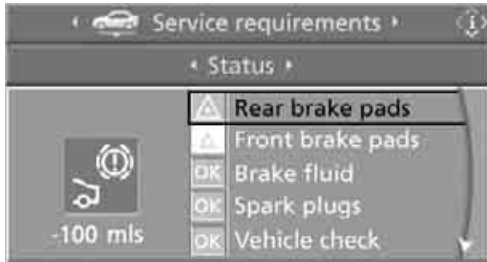

The BMW Maintenance System supports the preservation of the traffic and operating safety of your BMW. The service schedule also includes operations related to the vehicle's comfort and convenience features, such as replacement of the filters for the inside air. The ultimate objective is to ensure economical maintenance by providing the ideal service for your vehicle.

Should the day come when you decide to sell your BMW, you will find that a complete dealer service history is an asset of inestimable value.

CBS Condition Based Service

Sensors and special algorithms take the different driving conditions of your BMW into account. Condition Based Service uses this to determine the current and future service requirements. By letting you define a service and maintenance regimen that reflects your own individual requirements, the system builds the basis for trouble-free driving.

You can set the Control Display to show remaining distances and times of selected maintenance intervals and legally mandated deadlines, refer to page 63:

- ▷ Engine oil
- ▷ Brake pads, front and rear separately
- ▷ Microfilter/activated-charcoal filter
- ▷ Brake fluid
- ▷ Spark plugs

- ▷ Vehicle check
- ▷ Legally required tests depending on local regulations

Service data in remote control

Your vehicle stores the information required maintenance continuously in the remote control during driving. After accessing the data stored in the remote control, your BMW Service Advisor can suggest precisely the right array of service procedures for your own individual vehicle. For this reason, when you take your vehicle in for service, you should give the BMW Service Advisor the remote control last used to drive it.

 Make sure the date is always set correctly, refer to page 68, as otherwise the effectiveness of CBS Condition Based Service is not ensured. ◀

Service and Warranty Information Booklet for US models and Warranty and Service Guide Booklet for Canadian models

Please consult your Service and Warranty Information Booklet for US models and Warranty and Service Guide Booklet for Canadian models for additional information on service requirements.

 BMW recommends that you have service and repair operations performed at your BMW center.

Take the time to ensure that these service procedures are confirmed by entries in your vehicle's Service and Warranty Information Booklet for US models and Warranty and Service Guide Booklet for Canadian models. These entries verify that your vehicle has received the specified regular maintenance. ◀

Socket for OBD Onboard Diagnostics interface



Components which are decisive for the exhaust-gas composition can be checked via the OBD socket with a device.

This socket is located under a cover on the left side of the driver's footwell, directly under the dashboard.

Exhaust-gas values



The warning lamp lights up. The exhaust-gas values are deteriorating. Have the vehicle checked as soon as possible.



Display of the previously described malfunction on Canadian models.

The lamp flashes under certain conditions. This is a sign of excessive misfiring of the engine. In this case, you should reduce speed and drive to the nearest BMW center as soon as possible. Heavy engine misfiring causes serious damage to the emission-relevant components, especially the catalytic converter, within a short time.



If the fuel filler cap is not properly tightened, the OBD system can detect the escape of fuel vapor. This causes a display to light up. If the cap is then tightened, the display should go out within a few days. ◀

Event data recorders

Your vehicle may be equipped with one or several measuring and diagnosis modules, or with a device for recording or transmitting certain vehicle data or information. If you have also subscribed to a BMW Assist plan, then certain vehicle data can be transmitted or recorded to enable corresponding services.

Care

Important information on care and maintenance of your BMW is contained in the Caring for your vehicle brochure.

Replacing components

Onboard tool kit



The onboard tool kit is located in the luggage compartment under the floor mat.

Wiper blade replacement

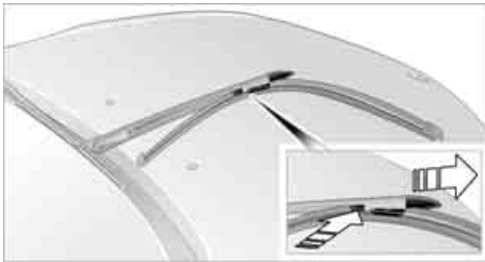

1. Fold the wiper arm out and grasp it firmly.
2. Press the locking tabs together while sliding the wiper blade toward the front to disengage it.
3. Insert the new wiper blade and slide it in until it audibly clicks into place.

Lamps and bulbs

Lamps and bulbs make an essential contribution to driving safety. You must be duly diligent in replacing them. If you are not familiar with the specified procedures, have the corresponding work carried out at your BMW center.

⚠ Never touch the glass on new bulbs with your bare fingers, as even minute amounts of contamination will burn into the bulb's surface and reduce its service life. Use a clean cloth, napkin, etc., or hold the bulb by its metal socket. ◀

A selection of replacement bulbs is available at your BMW center.

⚠ Whenever you perform any work on the electrical system, turn off the electrical devices involved to prevent short circuits from occurring. To avoid possible injury or equipment damage when replacing bulbs, follow any instructions provided by the bulb manufacturer. ◀

When performing maintenance on the headlamps, follow the instructions in the separate Caring for your vehicle brochure.

⚠ For bulbs for which changing is not described, and for checking and adjusting headlamp aim, please contact your BMW center. ◀

Light-emitting diodes LEDs

Light-emitting diodes installed behind translucent lenses serve as the light source for many of the controls and displays in your vehicle. These light-emitting diodes, which operate using a concept similar to that applied in conventional lasers, are officially designated as Class 1 light-emitting diodes.

⚠ Do not remove the covers, and never stare into the unfiltered light for several hours, as irritation of the retina could result. ◀

Xenon lamps

The service life of these lamps is very long and the probability of a failure is very low, provided that they are not switched on and off an unusual number of times.

⚠ Have work on the Xenon lighting system performed only by your BMW center or a workshop that works according to BMW repair

procedures with correspondingly trained personnel. Due to the high voltage involved, there is a danger to life and limb when work is carried out improperly. ◀

High beams, parking lamps

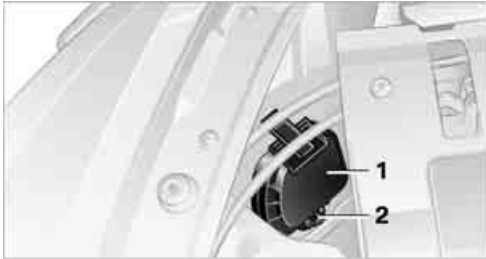

The illustration shows the front left side of the engine compartment.

High beams

Bulb 55 watts, H 7

1. Remove the cover cap **1** by pressing the tab and removing the cover cap upward.
2. Press the bulb holder from above to release it.
3. Remove the bulb holder.
4. Remove and replace the bulb.

 The lamp H7 is pressurized; wear eye protection and protective gloves. Otherwise there is a danger of injuries if the bulb is accidentally damaged during replacement. ◀

Parking lamps

Bulb 10 watts

 Bulb holder and reflector are one unit and are replaced together. ◀

1. Turn the bulb holder **2** to the right and remove.
2. Press the snap connection on the plug connector, pull off the bulb holder and replace.

Front turn signal, side marker

Your BMW is equipped with two turn signal lamps per side in the front.

Turn signal lamp 1

Bulb 21 watts, WY 21 SV

The illustration shows the front right side of the engine compartment.

1. Press the lever shown:
 - ▷ downward for the right turn signal
 - ▷ upward for the left turn signal

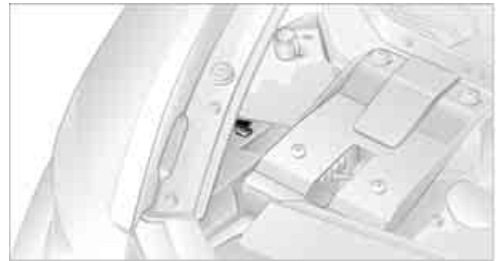

2. Remove the bulb holder towards the rear.
3. Remove and replace the bulb.

Turn signal lamp 2

Bulb 21 watts, WY 21 SV

The bulb for the turn signal lamp 2 can be replaced via the wheel well.

The illustration shows the front left side of the vehicle.

1. Steering turned all the way to the left or right.
2. Turn off the light, switch off the ignition and remove the remote control from the ignition lock.
3. Unscrew the bolt **1** with the open-ended wrench from the onboard toolkit, refer to page [182](#).

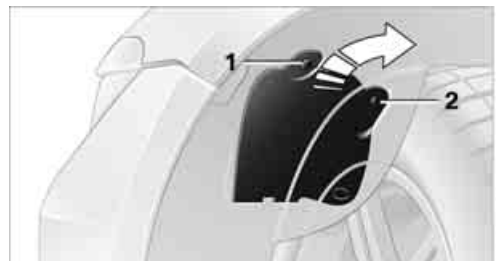

- Turn the cover around the rear securing point **2** upward while simultaneously pulling it out of the trim panel at the bottom.
- Turn the bulb holder to the left and remove, refer to arrow.



- Remove and replace the bulb.

Side markers

Bulb 5 watts, WY5W ST

The bulb can be replaced via a cover at the front of the wheel well, refer to the description for turn signal lamp 2.

- The bulb holder of the sidemarker lamp is located toward the outside of the vehicle next to the bulb holder of turn signal lamp 2.
- Turn the bulb holder to the left and remove.
- Remove and replace the bulb.

Side turn signals

Bulb 5 watts, WY 5 W

- Press against the front edge of the lamp with the tip of your finger, then push it to the rear, release the snap connection at the front and take it off the trim strip.

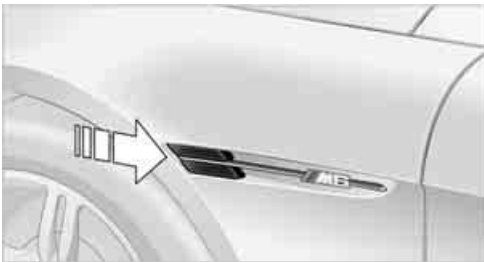

- Turn the bulb holder to the left by 90° and remove.
- Remove and replace the bulb.

Tail lamps

The roadside parking, rear and brake lamps are LEDs. The backup lamps are equipped with long-life bulbs. Please contact a BMW center in case of a malfunction.

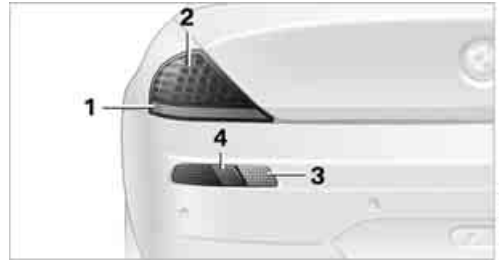

- Turn signals
- Roadside parking, rear and brake lamp
- Backup lamp
- Reflector

Rear turn signals



Bulb 21 watts, PY 21 W

The illustration shows the recess on the left side of the luggage compartment.

- Remove the cover.
- Unclip the bulb holder and remove.
- Apply gentle pressure to the bulb while turning it to the left for removal and replacement.

License plate lamps



Bulb 5 watts, WY 5 W

1. Push a screwdriver from the left under the lamp and pry out the lamp toward the right.
2. Turn the bulb holder to the left by 90° and remove.
3. Remove and replace the bulb.

Repairing flat tire with M Mobility System

To repair a flat tire, an M Mobility System is provided in the BMW M6. Using this system you can apply a sealant in the inside of the tire, seal off the damaged area, restore the tire inflation pressure and then continue driving.

 Safety measures in case of a breakdown: park the vehicle as far as possible from passing traffic and on solid ground. Switch on the hazard warning flashers.

Lock the steering wheel in straight-ahead setting of the wheels. Set the handbrake and engage the first or reverse gear. Have all vehicle occupants get out of the vehicle and ensure that they remain outside the immediate area in a safe place, such as behind a guardrail.

If a warning triangle or portable hazard warning lamp is required, set it up on the roadside at an appropriate distance from the rear of the vehicle. Comply with all safety guidelines and regulations. ◀

Preparation

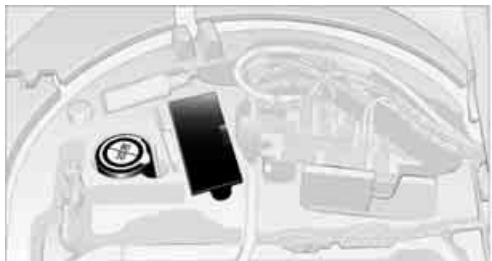

The M Mobility System is located in the luggage compartment under the floor panel flap. Do not remove foreign bodies which have penetrated the tire if possible.

 Corresponding information on using the M Mobility System are also provided on the device. ◀

 Before using the M Mobility System, observe the information on the sealant bottle. ◀

Pull the sticker for the speed limit off the sealant bottle and apply it to the steering wheel.

 Please observe the best-by date on the sealant bottle. ◀

The M Mobility System consists of



- 1 Sealant bottle and sticker with speed limit
- 2 Filling hose from sealant bottle to wheel

Model with pressure gauge on hose*

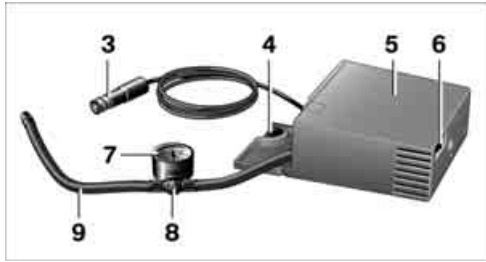

- 3 Connector and cable for lighter socket
- 4 Mounting for sealing bottle
- 5 Compressor
- 6 On/Off switch
- 7 Pressure gauge for indicating tire inflation pressure
- 8 Screw on pressure gauge for reducing tire inflation pressure
- 9 Connecting hose for connecting compressor and sealant bottle or compressor and wheel

Connector, cable and connecting hose are stored in the compressor housing.

Model with pressure gauge integrated in housing*

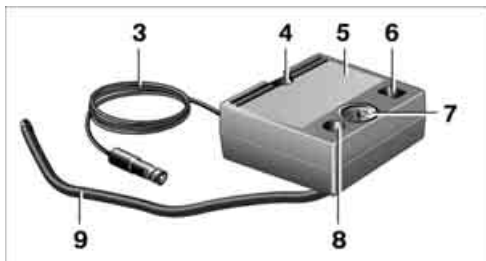

- 3 Connector and cable for lighter socket
- 4 Mounting for sealing bottle
- 5 Compressor
- 6 On/Off switch
- 7 Pressure gauge for indicating tire inflation pressure
- 8 Button for reducing tire inflation pressure

- 9 Connecting hose for connecting compressor and sealant bottle or compressor and wheel

Connector, cable and connecting hose are stored on underside of compressor.

Using M Mobility System

To repair a flat tire with the M Mobility System, proceed as follows:

- ▷ Fill sealant into wheel, refer to page 186.
- ▷ Distribute sealant, refer to page 187.
- ▷ Produce tire inflation pressure, refer to page 187.

Filling sealant into wheel

⚠ Strictly comply with the specified order, otherwise highly pressurized sealant could escape. ◀

1. Shake sealant bottle.
2. Screw hose 9 onto connection of sealant bottle.
3. For model with pressure gauge on hose: Make sure that screw 8 on pressure gauge is closed.
4. Screw dust cap off valve of defective wheel and screw filling hose 2 of sealant bottle onto valve.
5. Insert sealant bottle on compressor housing so that it is positioned upright.

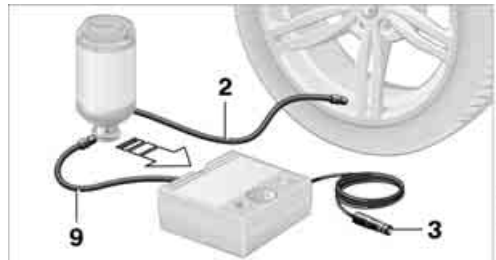

6. Make sure that device is switched off, position 0.
7. Insert connector 3 into lighter socket in vehicle interior, refer to page 93.

8. With the ignition switched on, refer to page 50:
Switch on the device and allow to run for approx. 3 minutes to fill wheel with sealant. It is not important what inflation pressure the tire has after filling.
9. Switch off device.
10. Remove connecting hose from connection of sealant bottle and tire valve.
Stow the M Mobility System in the vehicle again.

Distributing sealant

Immediately drive approx. 2 miles/3 km so that sealant is evenly distributed in tire.

-  Do not exceed a maximum speed of 35 mph/60 km/h. Do not drop below 12 mph/20 km/h if possible. ◀

Producing tire inflation pressure

1. After approx. 2 miles/3 km, stop at suitable location.
2. Screw compressor hose **9** directly onto tire valve.
3. Insert connector **3** in lighter socket in vehicle interior.
4. Correct tire inflation pressure to 29 psi/200 kPa. With the ignition switched on:
 - ▷ Increase inflation pressure: switch on device, position I. To check currently set inflation pressure, briefly switch off device.

 Do not allow compressor to run longer than 10 minutes, otherwise the device will overheat and may be damaged. ◀

- ▷ Reduce inflation pressure: press button **8** or turn screw **8** on pressure gauge.

 If the inflation pressure is not held, drive the vehicle again, refer to Distributing sealant. Then repeat steps 1 to 4 once. Using the M Mobility System can be ineffective with tire damage from a size of approx. 0.16 in/4 mm. Please contact the nearest BMW center, refer to page 192, or a workshop that works

according to BMW repair procedures with correspondingly trained personnel if the tire cannot be made ready for driving with the M Mobility System. ◀

 The tire inflation pressure must be at least 29 psi/200 kPa. Otherwise do not continue driving. ◀

Continue driving

 Do not exceed the permissible maximum speed of 50 mph/80 km/h, otherwise accidents can occur. ◀

 Reinitialize the Flat Tire Monitor. For details, refer to page 74.

Have the defective tire and the sealant bottle of the M Mobility System replaced as soon as possible. ◀

Changing wheels

 Safety precautions in the event of a flat tire or wheel change: park the vehicle as far as possible from passing traffic and on solid ground. Switch on the hazard warning flashers. Lock the steering wheel in straight-ahead setting of the wheels. Set the handbrake and engage a driving position with the selector lever.

Have all vehicle occupants get out of the vehicle and ensure that they remain outside the immediate area in a safe place, such as behind a guardrail.

If a warning triangle or portable hazard warning lamp is required, set it up on the roadside at an appropriate distance from the rear of the vehicle. Comply with all safety guidelines and regulations.

Change the wheel only on a level, firm surface which is not slippery. The vehicle or the jack could slip to the side if you attempt to raise the vehicle on a soft or slippery surface such as snow, ice, tiles, etc.

Position the jack on a firm support surface. Do not use a wooden block or similar object as a support base for the jack, as this would prevent it from extending to its full support height and reduce its load-carrying capacity.

To avoid serious or fatal injury: never lie under the vehicle, and never start the engine while it is supported by the jack. ◀

What you will need

To avoid rattling noises later on, note the positions of the tools before removing them, then return them to their initial positions after completing work.



- 1 Chock*
- 2 Vehicle jack*
- 3 Lug wrench*

The tools are located in the hollow of the spare wheel*.

Spare wheel*

1. Pull back lock 1, fold open clamp lock 2 completely and loosen the belt 3.



2. Remove the cover 4.
3. Take the tool mount out of the spare wheel.
4. Remove the spare wheel.

Preparing wheel change

1. Observe the safety precautions above.
2. Prevent the vehicle from rolling: Place the chock behind the front wheel on the other side of the vehicle, or on inclines, in front of this wheel. On a steep grade, take other steps to prevent the vehicle from rolling.
3. Loosen the lug bolts a half turn.

Jacking up vehicle

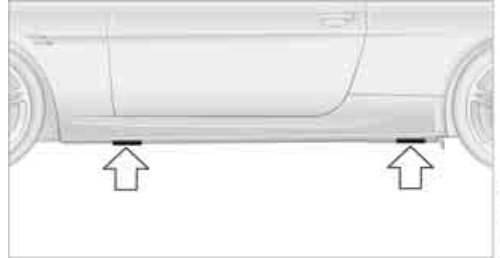

The jacking points for the car jack are located in the positions shown.

1. Position the vehicle jack at the jacking point closest to the wheel so that the entire surface of the jack base rests on the ground perpendicularly beneath the jacking point.



The vehicle jack is designed for changing wheels only. Do not attempt to raise another vehicle model with it or to raise any load of any kind. To do so could cause accidents and personal injury. ◀

2. Guide the jack head into the rectangular recess of the jacking point when cranking up, refer to illustration detail.



3. Jack the vehicle up until the wheel you are changing is raised from the ground.

Mounting a wheel

1. Unscrew the lug bolts and remove the wheel.
2. Remove accumulations of mud or dirt from the mounting surfaces of the wheel and hub. Also clean the lug bolts.
3. Position the new wheel or spare wheel. Secure the wheel by screwing at least two lug bolts into opposite bolt holes. When you mount wheels other than Genuine BMW light-alloy wheels, different lug bolts may also be required.
4. Screw in the remaining lug bolts. Tighten all the bolts securely in a diagonal pattern.
5. Lower the vehicle and remove the jack from beneath the vehicle.

After mounting

1. Tighten the lug bolts in a diagonal pattern.



To ensure safety, always have the lug bolts checked with a calibrated torque wrench as soon as possible to ensure that they are tightened to the specified torque. The tightening torque is 88.5 lb ft/120 Nm. ◀

2. Check and correct the tire inflation pressure at the earliest opportunity.



Protect valve stems and valve stem seal caps against dirt and contamination. Dirt in valve stems is a frequent source of gradual air loss. ◀

3. Initialize the Flat Tire Monitor, refer to page 74, and the Sequential Manual Transmission, refer to After changing wheels/ tires on page 174.
4. Replace the damaged tire as soon as possible and have the new wheel/tire balanced.

Stowing wheel and tools

1. Lay the wheel in the tool mounting.
2. Lay the cover on the mounting.
3. Center the wheel and cover relative to the lashing eyes 5.

4. Hook the belt into the lashing eyes.

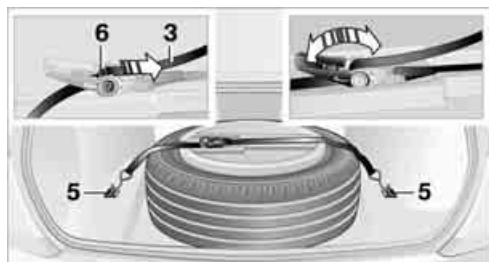

5. Completely open the tensioning lock.
6. Thread the belt 3 through the axis 6 of the tensioning lock without twisting it and tension it by hand.
7. Tighten the belt firmly with the tensioning lock by opening and closing the lock several times.
8. Fold the tensioning lock closed and stow the protruding belt end.

Driving with spare wheel



With certain wheel-and-tire combinations the size of the spare wheel differs from that of the other wheels. The spare wheel is equivalent to them in all load and speed ranges. However, to restore the original state, the normal wheel should be remounted as soon as possible. ◀

Vehicle battery

Maintenance

The battery is 100% maintenance-free, i.e., the electrolyte will last for the life of the battery when the vehicle is operated in a temperate climate.

Your BMW center will be glad to advise in all matters concerning the battery.

Charging battery

Only charge the battery in the vehicle via the terminals in the engine compartment with the engine switched off. For the connections, refer to Jump starting on page 192.

Disposal



After replacement, have old batteries disposed of by your BMW center or deposit them at a recycling center. Maintain the battery in an upright position for transport and storage. Always secure the battery to prevent it from tipping over during transport. ◀

Power failure

Following a temporary interruption of the power supply, the operation of some equipment is limited and must be reinitialized. Individual settings are also lost and must be updated:

- ▷ Seat, mirror and steering wheel memory
The position must be stored again, refer to page 40.
- ▷ Time and Date
The values must be updated, refer to page 67.
- ▷ Radio
Stations must be stored again if necessary, refer to page 132.
- ▷ Navigation system
Wait until the system starts, refer to page 123.

Fuses



Never attempt to repair a blown fuse, and do not replace a defective fuse with a substitute of another color or amperage rating, as this could lead to overloading of the wiring, ultimately resulting in a fire in the vehicle. ◀

Spare fuses and a pair of plastic tweezers are located in the compartment for the onboard tool kit, refer to page 182.

Information on fuse allocation is located below the bracket for the onboard tool kit, see below.

In glove compartment

1. Press the button on the back in the center of partition 1 and pull out the partition upward, arrow 2.

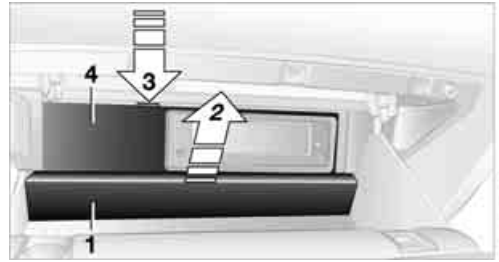

2. Press the coupling downward, arrow 3, and fold the lid 4 forward.

In luggage compartment

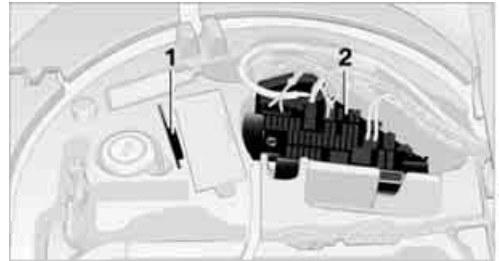

Fold the cover under the floor mat upward and remove the bracket for the onboard tool kit. Information on fuse allocation 1 and additional fuses 2 are provided there.

Giving and receiving assistance

Emergency call

Conditions for an emergency call:

- ▶ Complete preparation for mobile phone. With this equipment, an emergency call is still possible when no mobile phone is logged on in the vehicle.
- ▶ BMW Assist is activated. Activating BMW Assist, refer to page 161.
- ▶ Radio readiness is activated.
- ▶ The car phone is logged on to a mobile communications network.
- ▶ The emergency call system is operable.

When the contact of participation with BMW Assist expires, the car phone can be deactivated by a BMW center without having to visit a workshop. Following deactivation of the car phone, no emergency calls can be made. The car phone can be reactivated after signing a new contract with a BMW center.

Initiating an emergency call

1. Briefly press protective cover to open.

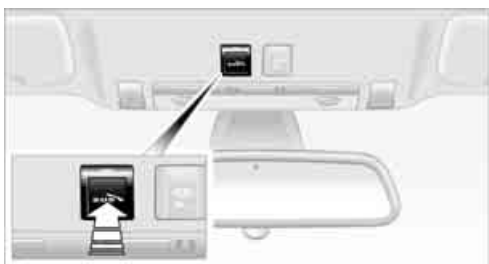

2. Press the button for at least 2 seconds.

The LED in the button lights up. As soon as the voice connection to the BMW Assist response center has been established, the LED flashes.

If conditions allow, remain in the vehicle until the connection has been established. You will then be able to provide a detailed description of the situation.

If the current location of your vehicle can be determined, it will be forwarded to the BMW Assist response center.

If the LED flashes, but you are unable to hear the BMW Assist response center through the handsfree system, this could indicate, for instance, that the handsfree system is no longer operational. But the response center is still able to hear you.

Under certain conditions, an emergency call is automatically initiated immediately after a severe accident. The automatic emergency call is not affected by the button being pressed.



For technical reasons, the emergency call cannot be guaranteed under the most unfavorable conditions. ◀

Warning triangle*



The warning triangle is located on the left-hand side in the luggage compartment.

First-aid kit*

The first-aid kit is located in the filler element of the rear seat backrest.

1. Press the button downward and pull the filler element forward.



2. Take out first-aid kit.



! To refit the filler element, insert the two bottom tabs into the strip and press the filler element back into place. Make sure that you do not damage the rear seat upholstery. ◀

Some of the articles contained in the first-aid kit have a limited service life. For this reason, check the expiration dates of each of the items regularly and replace any whose expiration dates have passed.

Roadside Assistance*

The Roadside Assistance of the BMW Group offers you assistance in the event of a breakdown around the clock, including on weekends and public holidays.

The phone numbers of the Roadside Assistance in your home country can be found in the BMW Contact directory.

With BMW Assist or TeleService, you can contact the Roadside Assistance of the BMW Group for assistance in the event of a breakdown directly via iDrive, refer to page 163.

Jump starting

When your battery is discharged, you can use two jumper cables to start your BMW with power from the battery in a second vehicle. You can also use the same method to help start another vehicle. Use only jumper cables with fully-insulated clamp handles.

! To avoid the risk of potentially fatal injury, always avoid all contact with electrical components while the engine is running. Carefully adhere to the following sequence, both to prevent damage to one or both vehicles, and to guard against possible personal injuries. ◀

Preparing

1. Check whether the battery of the other vehicle has a voltage of 12 Volts and approximately the same capacitance in Ah. This information can be found on the battery.
2. Switch off the engine of the vehicle providing assistance.
3. Switch off any electrical systems and components in both vehicles.

! There must not be any contact between the bodies of the two vehicles; otherwise, there is a danger of short circuiting. ◀

Connecting jumper cables

! To avoid personal injury from sparks, follow this sequence when connecting jumper cables. ◀

In your BMW M6, the so-called auxiliary terminal for jump starting in the engine compartment serves as a positive terminal for the battery, also refer to engine compartment overview on page 176. The cover cap is marked with a +.

1. Fold open the cover of the BMW jump-starting terminal. To do so, pull the tab.



2. Attach one end of the jumper cable plus/+ to the positive terminal of the battery or a starting-aid terminal of the vehicle providing assistance.
3. Attach the second end of the cable to the positive terminal of the battery or to a jump-starting terminal of the vehicle to be started.
4. Attach one end of the jumper cable minus/- to the negative terminal of the battery or to an engine or body ground of the vehicle providing assistance.
Your BMW M6 has a special nut as body ground or negative terminal.



5. Attach the second end of the cable to the negative terminal of the battery or to the engine or body ground of the vehicle to be started.

Starting engine

1. Start the engine on the assisting vehicle and allow it to run at idle for several minutes at slightly increased speed.
2. Start the engine on the other vehicle in the usual way.
If the first starting attempt is not successful,

wait a few minutes before another attempt in order to allow the discharged battery to recharge.

3. Let the engines run for a few minutes.
4. Disconnect the jumper cables by reversing the connection sequence.

Check the battery and recharge if necessary.

- ⚠ Never use spray fluids to start the engine. ◀

Tow-starting and towing

- ⚠ Observe applicable laws and regulations for tow-starting and towing. ◀

- ⚠ Do not transport any passengers other than the driver in a vehicle that is being towed. ◀

Using tow fitting

The threaded tow fitting is stored in the tool kit mounted on the inside of the luggage compartment under the floor mat, refer to page 182, and should always remain in the vehicle. It can be screwed in at the front or rear of the BMW M6.

- ⚠ Only use the tow fitting that comes with the vehicle and screw it in as far as possible. Use the tow fitting for towing only on roads. Avoid lateral loading of the tow fitting, e.g. do not lift the vehicle by the tow fitting. Otherwise, the tow fitting and vehicle can be damaged. ◀

Access to screw thread

Round cover in bumper:
Press the arrow symbol on the cover.

Front

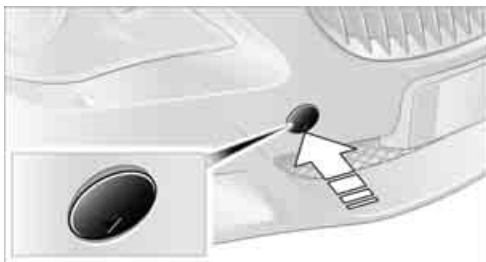

Rear

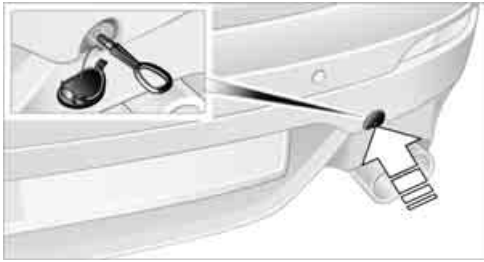

Being towed

⚠ Make sure that the ignition is switched on, refer to page 50; otherwise, the low-beam headlights, tail lights, turn signals and wind-shield wipers would not be available. If the vehicle electrical system fails, do not tow-start or tow the vehicle. The electric steering-wheel lock cannot be unlocked and the vehicle cannot be steered. For information on jump starting, refer to page 192. There is no power assistance with the engine stopped. This then requires increased effort for braking and steering. ◀

Switch on the hazard warning flashers depending on the local regulations. If the electrical system fails, mark the vehicle to be towed, e.g. with a sign or warning triangle in the rear window.

Engage selector lever position N with the ignition switched on.

Towing methods

⚠ Do not lift vehicle by tow fitting or body and chassis parts; otherwise, damage may result. ◀

In some countries, towing with tow bars or ropes in public traffic is not permitted. Familiarize yourself with the regulations on towing in the respective country.

With tow bar

⚠ The towing vehicle may not be lighter than the vehicle to be towed; otherwise, it will not be possible to reliably control vehicle response. ◀

The tow fittings used should be on the same side on both vehicles. Should it prove impossible to avoid mounting the tow bar at an offset angle, please note the following:

- ▷ Clearance and maneuvering capability will be strictly limited during cornering.
- ▷ When mounted at an angle, the tow bar will exert lateral forces, tending to push the vehicle sideways.

⚠ Attach the tow bar to the tow fittings only, as attachment to other vehicle parts can lead to damage. ◀

With tow rope

When starting off in the towing vehicle, make sure that the tow rope is taut.

⚠ To avoid jerking and the associated stresses on vehicle components when towing, always use nylon ropes or nylon straps. Attach tow ropes to the tow fittings only, as attachment to other vehicle parts can lead to damage. ◀

With tow truck

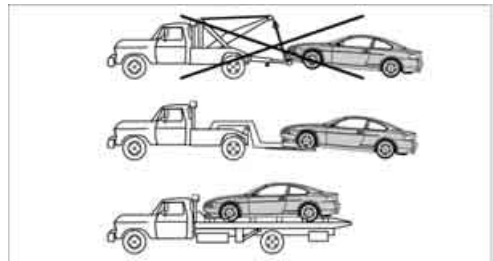

Have the BMW transported with a tow truck with a so-called lift bar or on a flat bed.

Tow-starting

Do not tow-start the vehicle if possible, but instead start the engine by means of jump starting, refer to page 192. With a catalytic converter, the vehicle should only be tow-started with the engine cold.

⚠ If the electrical system fails, do not tow-start or tow the vehicle, as otherwise the electric steering-wheel lock cannot be unlocked and the vehicle cannot be steered. ◀

1. Switch on the hazard warning flashers, comply with country-specific regulations.
2. Switch on the ignition, refer to page 50.
3. Tow-start in selector-lever position N.
4. Move the selector lever into the drive position and pull toward + within 2 seconds. The correct gear will be selected and engaged automatically.
5. Stop at a suitable location, remove the tow bar or rope and switch off the hazard warning flashers.
6. Have the vehicle checked.



Reference

This chapter contains the technical data, the short commands of the voice command system and the index, which is the quickest way to find the information you are looking for.

Technical data

Engine specifications

		M6
Displacement	cu in/cm ³	305.1/4,999
No. of cylinders		10
Maximum output	hp	500
at engine speed	rpm	7,750
Maximum torque	lb ft/Nm	383/520
at engine speed	rpm	6,100

Dimensions

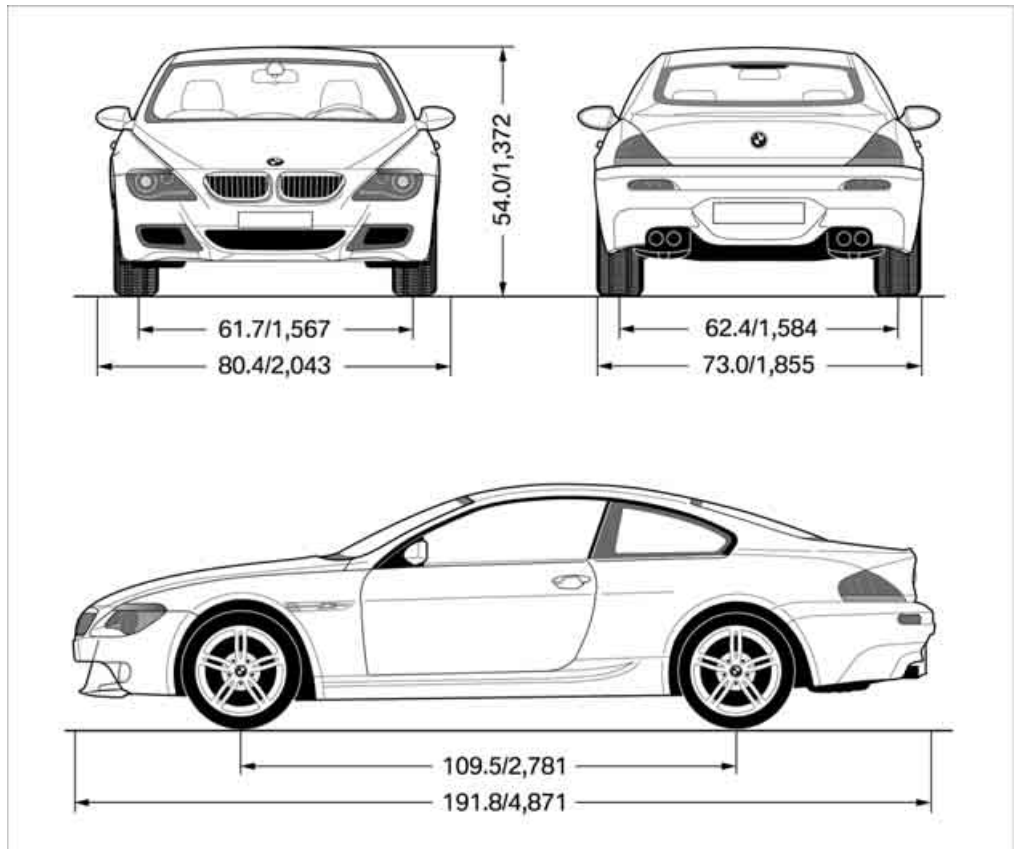

All dimensions given in inches/mm. Smallest turning circle diam.: 41.0 ft/12.5 m

Weights

			M6
Curb weight	lbs./kg		3,909/1,773
Approved gross vehicle weight	lbs./kg		4,850/2,200
Load	lbs./kg		941/427
Approved front axle load	lbs./kg		2,403/1,090
Approved rear axle load	lbs./kg		2,646/1,200
Luggage compartment capacity	cu ft/l		15.9/450

Never exceed either the approved axle loads or the gross vehicle weight.

Capacities

			Notes
Fuel tank	gal/liters	approx. 18.5/70	Fuel specification: page 169
including reserve of:	gal/liters	approx. 4/15	
Window and headlamp washer system	US quarts/liters	approx. 5.3/5	For details: page 57
Engine oil and filter change	US quarts/liters	9.8/9.25	Oil grades: page 178

Short commands of voice command system*

With short commands you can carry out certain functions directly, regardless of which menu

item is selected. Here are the important short commands for the voice command system.

Assistance window

Function	Command
To open the assistance window 20	›Assistance window‹
To select the display in the assistance window 20	›Assistance window map facing north‹, ›Assistance window map direction of travel‹, ›Assistance window arrow display‹, ›Assistance window perspective‹, ›Assistance window current position‹, ›Assistance window trip computer‹ or ›Assistance window onboard info‹
To change scale in assistance window 120	›Assistance window scale ... feet‹ or ›Assistance window scale ... miles‹

Communication

Function	Command
To activate telephone 153	›Phone‹
To dial phone number 153	›Dial number‹
To display the phone book 153	›A to Z‹
To dial from phone book 153	›Call ...‹ or ›Dial name‹
To display "Top 8" 154	›Top 8‹
To redial 154	›Redial‹
To display "Received calls" 154	›Received calls‹
To display "Missed calls" 154	›Missed calls‹
To display "Bluetooth" 149	›Bluetooth‹
To open BMW Assist 161	›BMW Assist‹
To open "BMW Service" 163	›BMW Service‹
To open "BMW Contact" 155	›BMW Contact‹
To open "BMW Contact Numbers" 163	›BMW Contact numbers‹

Navigation

Function	Command
To open navigation 107	›Navigation‹
To open "Enter address" 107	›Enter address‹
To open "New destination" 107	›New destination‹
To display "Input map" 111	›Input map‹
To display destination list 113	›Destination list‹
To display the address book 114	›Address book‹
To display the route criteria 116	›Route preference‹
To start destination guidance 118	›Start guidance‹
To end destination guidance 118	›Stop guidance‹
To display arrow display 119	›Arrow display‹
To display map view 119	›Map‹, ›Map facing north‹, ›Map direction of travel‹ or ›Perspective‹
To change scale 120	›Scale ... miles‹ or ›Scale ... feet‹
To display streets and towns/cities of the route 120	›Route list‹
To switch on voice instructions 121	›Navigation info on‹
To switch off voice instructions 121	›Navigation info off‹
To repeat voice instructions 121	›Repeat navigation info‹
To open route 116 , 120	›Route‹
To display current position 122	›Current Position‹

Onboard info

Function	Command
To open "Car Data" 61	›Car data‹
To display the computer 61	›Onboard info‹
To display the trip computer 62	›Trip computer‹
To set the speed limit 66	›Limit‹
To start the stopwatch 67	›Stopwatch‹

Entertainment

Function	Command
Tone control 127	›Audio‹
To switch on radio 130	›Radio on‹, ›FM on‹ or ›AM on‹
To open "FM" 130	›FM menu‹
To open "AM" 130	›AM menu‹
To open "All stations" 130	›FM All stations‹
To select the radio station 130	›Station ...‹ or ›Choose station‹
To open "Presets" 130	›FM presets‹ or ›AM presets‹
To select stored radio stations 130	›Choose preset‹
To open "Manual" 131	›FM manual‹, ›AM manual‹ or ›Choose frequency‹, ›Frequency ... Megahertz‹
To open the radio station with the best reception 131	›AM Autostore‹
To open "WB" 134	›Weatherband menu‹
To switch on weatherband 134	›Weatherband on‹
To select a weatherband station 134	›Choose weatherband station‹
To open "SAT" 136	›SAT radio menu‹
To switch on satellite radio 136	›SAT radio‹
To open "Presets" of satellite radio 137	›SAT radio presets‹
To open "All channels" of satellite radio 136	›SAT radio all channels‹
To open "Categories" of satellite radio 136	›SAT radio categories‹
To select CD player 139	›CD menu‹
To switch on CD player 139	›CD‹
To select CD changer 139	›CD-changer menu‹
To switch on CD changer 139	›CD-changer‹
To select a CD 139	›CD 1...6‹
To select music track 140	›CD track ...‹
To select CD and track 140	›CD 1...6 track ...‹

Climate

Function	Command
To open "Vent settings" 86	›Vent settings‹
To open "Automatic programs" 85	›Automatic programs‹
To open "Parked car ventilation" 88	›Parked car operation‹
To open "Automatic ventilation" 88	›Automatic ventilation‹
To display the activation times 88	›Activation time‹

i menu

Function	Command
To open "Door locks" 30, 32	›Door locks‹
To open "Steering wheel buttons" 45	›Steering wheel buttons‹
To open MDrive 46	›MDrive‹
To open "Lighting" 56, 80	›Lighting‹
To open "Communication settings" 161	›Communication settings‹
To open "BMW Service settings" 161	›BMW Service settings‹
To open "BMW Service" 163	›BMW service‹
To open "Service requirements" 63, 162	›Service requirements‹
To open "Service" 63, 162	›Service‹
To display "Check Control messages" 64	›Check Control messages‹
To open "Display settings" 67	›Display settings‹
To open "Head-Up Display" 77	›Head-up display‹
To activate speed limit 67	›Limit on‹
To deactivate speed limit 67	›Limit off‹
To adjust the brightness of the Control Display 69	›Brightness‹
To open "Units" 69	›Units‹
To open "Languages" 69, 121	›Language‹
To open "Time" 68	›Time‹
To open "Date" 68	›Date‹
To open "PDC" 70	›PDC‹
To open "FTM" 74	›FTM‹
To open "Entertainment settings" 127	›Entertainment settings‹

Everything from A to Z

Index

"..." Identifies Control Display texts used to select individual functions, and indicates where to find them in the text.

A

- ABS Antilock Brake System [71](#)
- Accessories [6](#)
- Activated-charcoal filter [87](#)
- Activating hour signal [68](#)
- "Activation time" for parked car ventilation [88](#)
- Adapter for spare key [28](#)
- Adaptive brake lamps, refer to Brake force display [75](#)
- Adaptive Head Light [81](#)
- "Add digits" for mobile phone [154](#)
- "Address book" for navigation [114](#)
- Address for navigation
 - deleting [115](#)
 - entering [107](#), [110](#)
 - selecting [115](#)
 - storing [114](#)
 - storing current position [114](#)
- "Add to address book" [114](#)
- "Add to destination list" [110](#)
- Adjusting confirmation signals for locking and unlocking [31](#)
- Adjusting the thigh support [40](#)
- Adjusting tone in audio mode, refer to Tone control [127](#)
- "After door opened" [41](#)
- "After unlocking" [41](#)
- Airbags [75](#)
 - deactivating, refer to Exception for front passenger seat [48](#)
 - sitting safely [39](#)
 - warning lamp [77](#)
- Air distribution
 - automatic [85](#)
 - manual [86](#)
- Airing, refer to Ventilation [87](#)
- Air recirculation, refer to AUC Automatic recirculated-air control [87](#)
- "Air recirculation on / off" [45](#)
- Air vents, refer to Ventilation [87](#)
- Air volume [86](#)
- AKI, refer to Fuel specifications [169](#)
- Alarm system [35](#)
 - avoiding unintentional alarms [35](#)
 - interior motion sensor [35](#)
 - switching off alarm [35](#)
 - switching off tilt alarm sensor and interior motion sensor [36](#)
 - tilt alarm sensor [35](#)
- "All channels" [136](#)
- "All doors" [30](#)
- All-season tires, refer to Winter tires [174](#)
- "All stations" on the radio, selecting [130](#), [133](#)
- Alterations, technical, refer to For your own safety [6](#)
- "AM", reception range [126](#), [130](#)
- Antenna for mobile phone [148](#)
- Antifreeze
 - coolant [178](#)
 - washer fluid [57](#)
- Antilock Brake System ABS [71](#)
- Anti-theft alarm system, refer to Alarm system [35](#)
- Anti-theft system, refer to Central locking system [29](#)
- Approved axle loads, refer to Weights [200](#)
- Approved engine oils [178](#)
- Approved gross vehicle weight, refer to Weights [200](#)
- Armrest, refer to Center armrest [92](#)
- Around the center console [14](#)
- Around the steering wheel [10](#)
- Arrival time
 - refer to Computer [61](#)
 - refer to Starting destination guidance [118](#)
- "Arrow display" during Navigation [119](#)
- Ashtray [93](#)
- Assist, refer to BMW Assist [161](#)
- Assistance systems, refer to Driving stability control systems [71](#)
- Assistance window [20](#)
- "Assist. window off" [21](#)
- AUC Automatic recirculated-air control [87](#)
- Audio [126](#)
 - controls [126](#)
 - switching on/off [126](#)
 - tone control [127](#)
 - volume [127](#)
- "Audio", refer to Tone control [127](#)

Automatic
– air distribution [85](#)
– air volume [85](#)
– headlamp control [80](#)
– service notification [162](#)
– steering wheel adjustment,
refer to Easy entry/exit [45](#)
– storing stations [131](#)
Automatically switching
between high beams and
low beams, refer to High-
beam assistant [81](#)
Automatic car washes [100](#)
– also refer to the Caring for
your vehicle brochure
Automatic climate control [84](#)
– automatic air distribution [85](#)
– switching off [87](#)
Automatic closing of doors,
see Automatic soft
closing [33](#)
Automatic curb monitor [44](#)
Automatic lighting
– refer to Automatic headlamp
control [80](#)
– refer to Daytime running
lamps [81](#)
– refer to High-beam
assistant [81](#)
– refer to Interior lamps [83](#)
– refer to Pathway lighting [80](#)
"Automatic programs" [85](#)
Automatic recirculated-air
control AUC [87](#)
Automatic soft closing [33](#)
Automatic station search [131](#)
"Automatic ventilation" [88](#)
AUTO program with
automatic climate control [85](#)
"Autostore" on the
radio [130](#), [132](#)
Average fuel consumption [61](#)
– setting units [69](#)
"Avoid ferries" for
navigation [117](#)
"Avoid highways" for
navigation [117](#)

Avoiding freeways for
navigation [116](#)
Avoiding unintentional
alarms [35](#)
"Avoid tollroads" for
navigation [117](#)
Axle loads, refer to
Weights [200](#)
"A - Z" [153](#), [154](#)

B

Backrest contour, refer to
Lumbar support [40](#)
Backrests, refer to Seats [39](#)
Backrest width adjustment [40](#)
Backup lamps, replacing
bulbs, refer to Tail
lamps [184](#)
"Balance", refer to Tone
control [128](#)
Balance, refer to Tone
control [128](#)
Balance adjustment in audio
mode, right/left [128](#)
Band-aids, refer to First-aid
kit [192](#)
Bass, refer to Tone
control [127](#)
"Bass", tone control [127](#)
Battery
– disposal [37](#)
– jump starting [192](#)
– refer to Vehicle battery [189](#)
Battery change [37](#)
Being towed [194](#)
Belts, refer to Safety belts [42](#)
Beverage holder, refer to Cup
holders [93](#)
Blower, refer to Air volume [86](#)
"BMW Assist" [163](#)
BMW Assist [161](#)
– enabling [161](#)
– services offered [162](#)
"BMW Contact" [155](#)
"BMW Contact
Numbers" [155](#)

BMW homepage [4](#)
BMW Maintenance
System [180](#)
"BMW Service" [163](#)
"BMW Service settings" [162](#)
BMW website [4](#)
Bottle holder, refer to Cup
holders [93](#)
Brake Assistant, refer to DBC
Dynamic Brake Control [71](#)
Brake fluid [179](#)
– level [179](#)
– warning lamp [179](#)
Brake force display [75](#)
Brake hydraulic system [179](#)
Brake lamps
– brake force display [75](#)
– replacing bulbs, refer to Tail
lamps [184](#)
Brake pads [179](#)
– breaking-in [98](#)
Brakes
– ABS Antilock Brake
System [71](#)
– brake fluid [179](#)
– brake force display [75](#)
– brake pads [179](#)
– breaking-in [98](#)
– CBC Cornering Brake
Control [71](#)
– handbrake [51](#)
Brake system [98](#)
– brake fluid level [179](#)
– brake pads [98](#), [179](#)
– brake rotors [100](#)
– breaking-in [98](#)
– warning lamp [13](#), [179](#)
Brake wear warning
– brake pads [179](#)
– warning lamp [179](#)
Braking
– electronic brake-force
distribution [71](#)
– refer to Braking safely [99](#)
Braking safely [99](#)
Breakdown, M Mobility
System [185](#)

Breakdown assistance [163](#)
 Breakdown services, refer to
 Roadside Assistance [192](#)
 Breaking-in [98](#)
 Breaking-in the clutch [98](#)
 Breaking-in the differential [98](#)
 "Brightness" [69, 78](#)
 Brightness of Control
 Display [69](#)
 Button for starting engine [50](#)
 Buttons on steering wheel [11](#)
 Bypassing route sections [122](#)

C

California Proposition 65
 Warning [6](#)
 "Call" [154](#)
 Call
 – accepting [152](#)
 – displaying accepted [154](#)
 – ending [153](#)
 – in absence [154](#)
 – starting [153](#)
 Calling
 – from phone book [153](#)
 – from Top 8 list [154](#)
 – redialing [154](#)
 Can holder, refer to Cup
 holders [93](#)
 Capacity of luggage
 compartment [200](#)
 Car battery, refer to Vehicle
 battery [189](#)
 Car care, refer to the Caring
 for your vehicle brochure
 Car-care products, refer to the
 Caring for your vehicle
 brochure
 "Car Data" [61](#)
 Care [181](#)
 – refer to the Caring for your
 vehicle brochure
 Cargo loading
 – securing cargo [101](#)
 – stowing cargo [101](#)
 – vehicle [100](#)

Caring for artificial leather,
 refer to the Caring for your
 vehicle brochure
 Caring for leather, refer to the
 Caring for your vehicle
 brochure
 Caring for light-alloy wheels,
 refer to the Caring for your
 vehicle brochure
 Caring for plastic, refer to the
 Caring for your vehicle
 brochure
 Caring for the carpet, refer to
 the Caring for your vehicle
 brochure
 Caring for the vehicle finish,
 refer to the Caring for your
 vehicle brochure
 Car key, refer to Keys/remote
 control [28](#)
 Car phone [148](#)
 – installation location, refer to
 Center armrest [92](#)
 – refer to Mobile phone [148](#)
 – refer to separate operating
 instructions
 Car radio, refer to Radio [130](#)
 Car wash [100](#)
 – refer to Before driving into a
 car wash [100](#)
 – refer to the Caring for your
 vehicle brochure
 Catalytic converter, refer to
 Hot exhaust system [98](#)
 "Categories" [137](#)
 CBC Cornering Brake
 Control [71](#)
 CBS Condition Based
 Service [180](#)
 "CD" [126, 139](#)

CD changer [139](#)
 – controls [126](#)
 – fast forward/reverse [143](#)
 – installation location [143](#)
 – playing a track [141](#)
 – random play sequence [142](#)
 – repeating a track [142](#)
 – selecting a CD [139](#)
 – selecting a track [140](#)
 – switching on/off [126](#)
 – tone control [127](#)
 – volume [127](#)
 CD player [139](#)
 – controls [126](#)
 – fast forward/reverse [143](#)
 – playing a track [141](#)
 – random play sequence [142](#)
 – repeating a track [142](#)
 – selecting a track [140](#)
 – switching on/off [126](#)
 – tone control [127](#)
 – volume [127](#)
 Center armrest, adjusting
 height [92](#)
 Center console [14](#)
 "Central locking" [30](#)
 Central locking system [29](#)
 – comfort access [36](#)
 – from inside vehicle [32](#)
 Changes, technical, refer to
 For your own safety [6](#)
 Changing a wheel [187](#)
 Changing language on
 Control Display [69](#)
 Changing units of measure on
 Control Display [69](#)
 Changing wheels [173](#)
 CHECK button [65](#)
 Check Control [64](#)
 "Check Control
 messages" [66](#)
 Check Gas Cap [168](#)
 Checking air pressure, refer to
 Tire inflation pressure [170](#)
 Children's seats, refer to Child
 restraint systems [48](#)
 Child-restraint fixing system
 LATCH [49](#)

Child restraint systems **48**
Chock **188**
Chrome parts, care, refer to the Caring for your vehicle brochure
Cigarette lighter **93**
Cigarette lighter socket, refer to Connecting electrical devices **94**
Cleaning, refer to Caring for your vehicle brochure
"Climate" **85**
Clock **60**
– 12h/24h mode **68**
– setting time and date **68**
Closing
– from inside **32**
– from outside **30**
Closing fuel filler cap **168**
Clothes hooks **93**
Cockpit **10**
Cold start, refer to Starting engine **51**
Comfort access **36**
– replacing battery **37**
Comfort closing
– windows with comfort access **37**
– with comfort access **37**
"Comfort" with EDC **73**
"Communication" **152, 163**
"Communication settings" **162**
Compact disc
– refer to CD changer **139**
– refer to CD player **139**
Compartment for remote control, refer to Ignition lock **50**
Compartments, refer to Storage compartments **92**
Compressed audio files **139**
Computer **60**
– displays on Control Display **61**
– hour signal **68**
"Concert hall", refer to Tone control **128**

Condition Based Service CBS **180**
"Confirmation" **31**
Connecting car vacuum cleaner, refer to Connecting electrical devices **94**
Consumption display, refer to Average fuel consumption **61**
Consumption statistics, refer to Average fuel consumption **61**
"Continue guidance to destination?" **118**
Control Center, refer to iDrive **16**
Control Display, refer to iDrive **16**
– setting brightness **69**
Controller, refer to iDrive **16**
Controls, refer to Cockpit **10**
Convenience operation, windows **31, 32**
Coolant **178**
– checking level **178**
– temperature **59**
Cooling, maximum **86**
Cornering Brake Control CBC **71**
Country of destination for navigation **108**
Courtesy lamps, refer to Interior lamps **83**
Cruise control **57**
Cruising range **60**
Cup holders **93**
Curb weight, refer to Weights **200**
"Current position" **122**
Current position
– displaying **122**
– entering **114**
– storing **114**
"Customer Relations" **155, 164**
Cylinders, refer to Engine data **198**

D

Dashboard, refer to Cockpit **10**
Data
– capacities **200**
– dimensions **199**
– engine **198**
– technical data **198**
– weights **200**
"Date" **68**
Date, setting **68**
"Date format" **69**
Daytime running lamps **81**
DBC Dynamic Brake Control **71**
"Deactivated" **41**
Decommissioning the vehicle
– refer to Caring for your vehicle brochure
– refer to the Caring for your vehicle brochure
Defrosting windows **86**
Defrosting windows and removing condensation **86**
Defrost position, refer to Defrosting windows **86**
"Delete address book" for navigation **116**
"Delete all numbers" on the mobile phone **155**
"Delete data" for navigation **116**
"Delete" for mobile phone **155**
Destination address
– deleting **115**
– entering **107, 110**
Destination for navigation
– destination list **113**
– entering via voice **110**
– entry **107**
– home address **116**
– selecting from address book **115**
– selecting using information **112**
– storing **114**

Destination guidance **118**

- bypassing route sections **122**
- canceling voice instructions **45**
- changing specified route **116**
- displaying routes **119**
- distance and arrival **118**
- interrupting **118**
- starting **118**
- terminating/continuing **118**
- voice instructions **121**
- volume of voice instructions **121**

Destination list for navigation **113**

Destinations recently driven to **113**

"Details" in audio mode **141**

"Dial" for mobile phone **153**

"Dial number" **153**

Digital clock **60**

Digital radio, refer to High Definition Radio **134**

Dimensions **199**

Directional indicators, refer to Turn signals **56**

Direction announcements, refer to Voice instructions **121**

Direction instructions, refer to Voice instructions **121**

Directory for navigation, refer to Address book **114**

Displacement, refer to Engine data **198**

"Display" **69**

Display, refer to iDrive **16**

Display lighting, refer to Instrument lighting **83**

"Display off" **21**

Displays, refer to Instrument cluster **12**

"Display settings" **67**

Displays on the windshield, refer to Head-Up Display **77**

Disposal

- battery of remote control with comfort access **37**
- vehicle battery **190**

Distance, refer to Computer **61**

"Distance to dest." **62**

Distance to destination, refer to Computer **61**

Distance warning, refer to PDC Park Distance Control **70**

Door entry lighting, refer to Interior lamps **83**

Door key, refer to Keys/remote control **28**

Door lock **32**

"Door locks" **30**

Doors

– manual operation **32**

– remote control **31**

DOT Quality Grades **172**

Draft-free ventilation **87**

Drivelogic **54**

"Driver's door only" **30**

Driving lamps, refer to Parking lamps/low beams **80**

Driving notes **98**

Driving programs, refer to Drivelogic **54**

Driving route, refer to Displaying the route **119**

Driving stability control systems **71**

Driving through water **99**

Driving tips, refer to Driving notes **98**

Drying the air, refer to Cooling function **86**

"DSC" **46, 72**

DSC Dynamic Stability Control **71**

– indicator lamp **13, 72**

DVD for navigation **106**

Dynamic Brake Control DBC **71**

Dynamic Stability Control DSC **71**

– M Dynamic Mode MDM **72**

E

Easy entry, refer to Entering rear **42**

Easy entry/exit **45**

EBV, refer to Electronic brake-force distribution **71**

"EDC" **46**

EDC Electronic Damping Control **73**

– "Comfort" **73**

– "Normal" **73**

– "Sport" **73**

Eject button, refer to Buttons on CD player **126**

Electrical malfunction

– door lock **32**

– driver's door **32**

– fuel filler door **168**

– luggage compartment lid **34**

– storage compartment, hotel function **33**

Electric steering wheel adjustment **44**

Electronic brake-force distribution **71**

Electronic Damping Control EDC **73**

Emergency assistance, refer to Roadside Assistance **192**

Emergency call **191**

Emergency operation, refer to Manual operation

– door lock **32**

– driver's door **32**

– fuel filler door **168**

– hotel function **33**

– luggage compartment lid **34**

Emergency release for luggage compartment lid in luggage compartment **34**

Emergency services, refer to Roadside Assistance **192**

"Emission inspect." **64**

"Enable services" **162**

"End call" **153**

Engine
– breaking-in **98**
– data **198**
– M Engine Dynamic Control **55**
– overheated, refer to Coolant temperature **59**
– speed **198**
– starting **51**
– starting, comfort access **36**
– starting difficulties **51**
– switching off **51**
Engine compartment **176**
Engine coolant **178**
Engine oil
– additives **178**
– approved oils **178**
– checking oil level **176**
– exact measurement **177**
– fast measurement **177**
– possible displays **177**
– recommended oils **178**
– temperature **60**
– temperature gauge **60**
– topping off **177**
Engine output, refer to Engine data **198**
Engine overheating, refer to Coolant temperature **59**
Engine speed, refer to Engine specifications **198**
Engine starting, refer to Starting engine **51**
"Enter address" **108, 114**
Entering address **107, 110**
Entering destination via town/city name **108**
Entering intersection **109**
Entering rear **42**
Entering town/city for navigation **108**
Entering zip code for navigation **109**
"Entertainment" **126**
"Entertainment settings" **127, 134**
Entertainment sound output on/off **127**
Entry map for destination **111**

Equalizer, refer to Tone control **129**
"Equalizer", tone control **129**
"ESN" **136**
ESP Electronic Stability Program, refer to DSC Dynamic Stability Control **71**
Event data recorders **181**
Exhaust system, refer to Hot exhaust system **98**
Exterior mirrors **43**
– automatic dimming feature **44**
– automatic heating **44**
– folding in and out **44**
– tilting down passenger-side mirror **44**
Eye for tow-starting and towing, refer to Tow fitting **193**
Eyes for lashing, refer to Securing cargo **101**

F

"Fader", refer to Tone control **128**
Fader, refer to Tone control **128**
Failure messages, refer to Check Control **64**
False alarms, refer to Avoiding unintentional alarms **35**
Fastening safety belts, refer to Safety belts **42**
Fastest route for navigation **116**
Fast forward
– CD changer **143**
– CD player **143**
"Fast route" for navigation **117**
"Favorites" calling up with radio **133**
Filling bottle, refer to M Mobility System **185**
Filling capacities **200**
First aid, refer to First-aid kit **192**
First-aid kit **192**
Flashing when locking and unlocking, refer to Setting acknowledgment signals **31**
Flashlight, refer to Rechargeable flashlight **91**
Flat tire
– M Mobility System **185**
– spare wheel **188**
Flat Tire Monitor
– false alarms **74**
– initializing system **74**
– limits of system **74**
– show chains **174**
– warning lamp **74**
"FM", reception range **126, 130**
FM, waveband **130**
Footbrake, refer to Braking safely **99**
Footwell lighting, refer to Interior lamps **83**
For specified oil grades, refer to Approved engine oils **178**
For your own safety **6**
Freeway, refer to Route criteria **116**
Front airbags **75**
Front passenger airbags deactivating **76**
"FTM" **74**
Fuel
– average consumption **61**
– display **60**
– fuel specifications **169**
– high-quality brands **169**
– quality **169**
– specifications **169**
– tank capacity **168**
Fuel display, refer to Fuel gauge **60**
Fuel filler door **168**
– releasing in the event of electrical malfunction **168**
Fuel gauge **60**
Fuses **190**

G

- Garage-door opener, refer to Integrated universal remote control [90](#)
- Gasoline
 - refer to Average fuel consumption [61](#)
 - refer to Fuel specifications [169](#)
 - refer to Required fuel [169](#)
- Gasoline display, refer to Fuel gauge [60](#)
- Gear changes [53](#)
- Gear display, refer to Displays in instrument cluster [53](#)
- General driving notes [98](#)
- Glove compartment [91](#)
 - rechargeable flashlight [91](#)
- GPS navigation, refer to Navigation system [106](#)
- Grills, refer to Ventilation [87](#)
- Gross vehicle weight, refer to Weights [200](#)
- Ground clearance [100](#)

H

- Handbrake [51](#)
 - indicator lamp [13](#), [52](#)
- Hands-free system, refer to Microphone [14](#)
- Hazard warning flashers [15](#)
- HD, refer to High Definition Radio [134](#)
- Head airbags [75](#)
- Headlamp control, automatic [80](#)
- Headlamp flasher [56](#)
- Headlamps
 - care, refer to the Caring for your vehicle brochure
 - cleaning, refer to Wiper system [57](#)
 - replacing bulbs [182](#)
- Head Light, refer to Adaptive Head Light [81](#)

- Head restraints
 - front [41](#)
 - removing [42](#)
 - sitting safely [39](#)
- "Head-Up Display" [46](#), [77](#)
- Head-Up Display [77](#)
 - default view [78](#)
 - shift lights [55](#)
- Heated
 - mirrors, refer to Automatic functions [44](#)
 - rear window [86](#)
 - seats [43](#)
- Heater [85](#)
- Heating
 - exterior mirrors [44](#)
 - interior [84](#)
 - rear window [86](#)
 - residual heat [87](#)
 - seats [43](#)
- Heating with engine switched off, refer to Residual heat [87](#)
- Heavy cargo, refer to Securing cargo [101](#)
- Height, refer to Dimensions [199](#)
- Height adjustment
 - seats [40](#)
 - steering wheel [44](#)
- High-beam assistant [81](#)
- High beams [81](#)
 - headlamp flasher [81](#)
 - indicator lamp [13](#)
 - replacing bulbs [183](#)
- High Definition Radio [134](#)
- High water, refer to Driving through water [99](#)
- Hills [100](#)
- Hold [37](#)
- Holder for cups [93](#)
- "Home address" in navigation [116](#)
- Homepage [4](#)
- Hood [175](#)
- Horn [10](#)
- Hotel function [33](#)
 - unlocking manually [33](#)
- Hot exhaust system [98](#)
- "Hour memo" [68](#)

- "House number" for destination entry [110](#)
 - Hydraulic brake assistant, refer to DBC Dynamic Brake Control [71](#)
 - Hydroplaning [99](#)
 - also refer to Minimum tread depth [172](#)
- I**
- IBOC, refer to High Definition Radio [134](#)
 - Ice, refer to Outside temperature [60](#)
 - ID3-Tag, refer to Information about track [141](#)
 - Idle [53](#)
 - iDrive [16](#)
 - adjusting brightness [69](#)
 - assistance window [20](#)
 - changing date and time [68](#)
 - changing language [69](#)
 - changing menu page [19](#)
 - changing settings [67](#)
 - changing unit of measure units and display form [69](#)
 - controller [16](#)
 - controls [16](#)
 - displaying menus [17](#)
 - selecting menu item [19](#)
 - selecting or confirming entry [19](#)
 - start menu [17](#)
 - status information [20](#)
 - symbols [18](#)
 - Ignition [50](#)
 - switched off [50](#)
 - switched on [50](#)
 - Ignition key, refer to Keys/remote control [28](#)
 - Ignition key position 1, refer to Radio readiness [50](#)
 - Ignition key position 2, refer to Ignition on [50](#)
 - Ignition lock [50](#)
 - starting engine with comfort access [37](#)

Indicator/warning lamps
– airbags [77](#)
– DSC [13, 72](#)
– Flat Tire Monitor [74](#)
– handbrake [13, 52](#)
– MDrive [13, 46](#)
– M Dynamic Mode [13, 72](#)
– parking lamps/low beams [13](#)
– safety belt warning [43](#)
Indicator and warning lamps, overview [13](#)
Individually programmable button on steering wheel [45](#)
Individual settings
– refer to MDrive [46](#)
– refer to Personal Profile [29](#)
Inflation pressure, refer to Tire inflation pressure [170](#)
Information
– on another location [112](#)
– on current position [112](#)
– on destination location [112](#)
"Information" for navigation [112](#)
"Information on destination" [114](#)
Initializing
– Flat Tire Monitor [74](#)
– radio, refer to Storing stations [132](#)
– refer to Power failure [190](#)
– seat, mirror and steering wheel memory [40](#)
– time and date [67](#)
"Input map" [111](#)
Installation location
– CD changer [143](#)
– navigation drive [106](#)
Instructions for navigation system, refer to Voice instructions [121](#)
Instrument cluster [12](#)
Instrument illumination, refer to Instrument lighting [83](#)
Instrument lighting [83](#)
Instrument panel, refer to Instrument cluster [12](#)
Integrated key [28](#)

Integrated universal remote control [90](#)
Interesting destination for navigation [112](#)
"Interim time" [67](#)
Interior lamps [83](#)
– switching on with remote control [31](#)
Interior motion sensor [35](#)
– switching off [36](#)
Interior rearview mirror [44](#)
– automatically dimming, refer to Automatic functions [44](#)
Intermittent wiper mode [56](#)

J

Jacking points [188](#)
Joystick, refer to iDrive [16](#)
Jump starting [192](#)

K

Keyless-Go, refer to Comfort access [36](#)
Keyless opening and closing, refer to Comfort access [36](#)
Key Memory, refer to Personal Profile [29](#)
"Keypad" [156](#)
Keys [28](#)
– key-related settings, refer to Personal Profile [29](#)
Kick-down, refer to Drive mode [53](#)
Knock control [169](#)

L

Lamps, refer to Parking lamps/low beams [80](#)
Lamps and bulbs [182](#)
"Languages" [69](#)
– for navigation [121](#)
Lashing eyes, refer to Securing cargo [101](#)
Last destinations, refer to Destination list [113](#)

"Last seat pos." [41](#)
LATCH child-restraint fixing system [49](#)
LEDs light-emitting diodes [182](#)
Length, refer to Dimensions [199](#)
License plate lamps, replacing bulbs [185](#)
Light-emitting diodes LEDs [182](#)
Lighter [93](#)
"Lighting" [56, 80](#)
Lighting
– instruments [83](#)
– of the vehicle, refer to Lamps [80](#)
– refer to High-beam assistant [81](#)
Light switch [80](#)
"Limit" [66](#)
Loading, refer to Cargo loading [100](#)
"Lock after driving" [32](#)
Lock buttons in the doors, refer to Locking [33](#)
Locking
– from inside [33](#)
– from outside [31](#)
– without key, refer to Comfort access [36](#)
Locking and unlocking doors
– from inside [32](#)
– from outside [30](#)
Locking out, refer to Unlocking [36](#)
Locking without key, refer to Comfort access [36](#)
Low beams [80](#)
– automatic [80](#)
– indicator lamp [13](#)
– replacing bulbs [182](#)
Lower back support, refer to Lumbar support [40](#)
Lug bolts [188](#)
– tightening torque, refer to After mounting [189](#)
– wrench [188](#)

- Luggage compartment
 - capacity [200](#)
 - emergency release [34](#)
 - hotel function [33](#)
 - opening/closing, refer to Luggage compartment lid [34](#)
 - opening from inside [34](#)
 - opening from outside [34](#)
 - opening with remote control [31](#)
- Luggage compartment lid [33](#)
 - emergency operation [34](#)
 - emergency release [34](#)
 - opening from inside [34](#)
 - opening from outside [34](#)
 - opening with remote control [31, 34](#)
 - unlocking manually [34](#)
- Lumbar support [40](#)
- LW, waveband [130](#)

M

- M Dynamic Mode MDM [72](#)
 - indicator lamp [13, 72](#)
- M Engine Dynamic Control [55](#)
 - "P 400" [55](#)
 - "P 500" [55](#)
 - "P 500 Sport" [55](#)
- M Mobility System [185](#)
- M+S tires, refer to Winter tires [174](#)
- Maintenance
 - refer to Service requirements [63](#)
 - refer to the Service and Warranty Information Booklet for US models [180](#)
 - refer to Warranty and Service Guide Booklet for Canadian models [180](#)
- Maintenance system [180](#)
- Malfunction
 - door lock [32](#)
 - fuel filler door [168](#)
 - hotel function [33](#)
 - luggage compartment lid [34](#)
- Malfunction warnings, refer to Check Control [64](#)
- Manual air distribution [86](#)
- "Manual" on the radio [131](#)
- Manual operation
 - door lock [32](#)
 - driver's door [32](#)
 - fuel filler door [168](#)
 - hotel function [33](#)
 - luggage compartment lid [34](#)
 - "Map direction of travel" [120](#)
 - "Map facing north" [120](#)
- Map for navigation
 - changing scale [120](#)
 - destination entry [111](#)
- Map view [119](#)
- Map view facing north [119](#)
- Master key, refer to Keys/remote control [28](#)
- Maximum cooling [86](#)
- Maximum speed with winter tires [174](#)
- MDM, refer to M Dynamic Mode [72](#)
- "MDrive" [46, 72](#)
- MDrive [46](#)
- "M Dynamic Mode" [72](#)
- Memory, refer to Seat, mirror and steering wheel memory [40](#)
- Menus, refer to iDrive [16](#)
- Microfilter [87](#)
- Microphone
 - for telephone [14](#)
 - for voice command system [14](#)
- Mirror dimming feature [44](#)
- Mirrors [43](#)
 - automatic curb monitor [44](#)
 - heating [44](#)
 - memory, refer to Seat, mirror and steering wheel memory [40](#)
- "Missed calls" [154](#)
- Missed calls [154](#)
- Mobile communications devices in vehicle [99](#)
- Mobile phone
 - accepted calls [154](#)
 - adjusting volume [152](#)
 - calling [153](#)
 - ending call [153](#)
 - missed calls [154](#)
 - operation via iDrive [152](#)
 - redialing [154](#)
 - refer to separate operating instructions
 - Top 8 [154](#)
 - touch tone dialing, refer to Tone dialing method [156](#)
- Mobile phones, use in vehicle, refer to Mobile communications devices in vehicle [99](#)
- Mobile Service, refer to Roadside Assistance [192](#)
- Mobility System [185](#)
- Monitor, refer to iDrive [16](#)
- "Monitor on / off" [45](#)
- Most recent mobile phone numbers [154](#)
- MP3, refer to Compressed audio files [139](#)
- Multi-function steering wheel, refer to Buttons on steering wheel [11](#)
- Multifunction switch
 - refer to Turn signals/headlamp flasher [56](#)
 - refer to Wiper/washer system [56](#)
- "Mute on / off" [45](#)
- "M View" [78](#)
- M view [78](#)
- MW, waveband [130](#)

N

- "Navigation" [61, 107](#)
- Navigation destination
 - manual entry [107](#)
 - selecting via map [111](#)
- Navigation drive, installation location [106](#)
- Navigation DVD [106](#)

Navigation instructions, refer to Switching voice instructions on/off **121**
Navigation system **106**
– address book **114**
– bypassing route sections **122**
– destination entry **107**
– destination guidance in assistance window **106**
– destination list **113**
– displaying current position **122**
– entering a destination manually **107**
– entering destination via voice **110**
– last destinations **113**
– looking for interesting destination **112**
– route display **119**
– route list **120**
– selecting destination using information **112**
– selecting destination via map **111**
– selecting route criteria **116**
– starting **107**
– starting destination guidance **118**
– switching off, refer to Terminating/continuing destination guidance **118**
– terminating/continuing destination guidance **118**
– voice instructions **121**
– volume adjustment **121**
"Navigation voice instructions" **45**
"Navigation voice instructions on" **121**
Neck support, refer to Front head restraints **41**
"New address" for navigation **114**
"New destination" **107, 111**
New remote control **28**
"New route" **122**

New wheels and tires **173**
"Next entertainment source" **45**
"Normal" with EDC **73**
Nozzles
– refer to Ventilation **87**
– refer to Windshield washer nozzles **57**
Nylon rope, refer to Tow-starting and towing **193**

O

OBD Socket **181**
Octane ratings, refer to Fuel specifications **169**
Odometer **59**
Oil
– additives **178**
– approved engine oils **178**
– capacity **200**
– consumption **176**
– level **176**
– topping off **177**
Oil change intervals
– refer to Service requirements **63**
– refer to the Service and Warranty Information Booklet for US models or to the Warranty and Service Guide Booklet for Canadian models
"On a new destination" for navigation **113**
"Onboard info" **61**
Onboard monitor, refer to iDrive **16**
Onboard tool kit **182**
"On destination" **113**
"On location" **113**
Opening and closing
– comfort access **36**
– from inside **32**
– from outside **30**
– using door lock **32**
– using the remote control **30**

Operation by voice for mobile phone **156**
– adjusting volume **157**
– canceling **157**
– commands **157**
– correcting phone number **158**
– dialing phone number **158**
– placing a call **158**
– redialing **159**
– voice phone book **158**
"Options" **164**
Orientation menu, refer to Start menu **17**
Output, refer to Engine data **198**
Outside air, refer to AUC Automatic recirculated-air control **87**
Outside temperature display **60**
– changing unit of measure **69**

P

"P 400" **55**
"P 500" **55**
"P 500 Sport" **55**
Panic mode **31**
Park Distance Control PDC **70**
"Parked car operation" **88**
"Parked car ventilation" **88**
Parked car ventilation
– activating an activation time **89**
– setting activation time **88**
– switching on and off directly **88**
Parking, vehicle **51**
Parking aid, refer to PDC Park Distance Control **70**
Parking assistant, refer to PDC Park Distance Control **70**
Parking brake, refer to Handbrake **51**
Parking lamps **80**
– indicator lamp **13**
– replacing bulbs **183**

Parts and accessories **6**
 Passenger airbags, deactivating, refer to Exception for front passenger seat **48**
 Passenger-side exterior mirror, tilting down **44**
 "Pathway lighting" **80**
 Pathway lighting **80**
 "PDC" **71**
 "PDC display on" **71**
 PDC Park Distance Control **70**
 Personal Profile **29**
 "Perspective" **120**
 "Phone" **153**
 Phone book **152**
 Phone numbers
 – deleting from phone book **155**
 – dialing **153**
 – most recent numbers **154**
 – selecting in phone book **154**
 – Top 8 **154**
 Pinch protection system of power windows **38**
 Plasters, refer to First-aid kit **192**
 "Play"
 – in audio mode **140**
 – on the radio, selecting **137**
 Plug-in unit for remote control, refer to Ignition lock **50**
 Pollen, refer to Microfilter/activated-charcoal filter **87**
 Position
 – displaying **122**
 – storing **114**
 "POWER" **46**
 POWER, refer to M Engine Dynamic Control **55**
 Power failure **190**
 Power windows, refer to Windows **37**
 "Presets" on the radio **130, 136**
 Presetting parked car ventilation activation times **88**

Pressure, tires **170**
 – producing with M Mobility System **185**
 "Profile" **165**
 Programmable button on steering wheel **45**
 Protective function, refer to Pinch protection system of windows **38**

R

Radio
 – Autostore **131**
 – controls **126**
 – High Definition Radio **134**
 – playing stations **131**
 – satellite radio **135**
 – selecting frequency manually **131**
 – selecting waveband **126, 130**
 – station search **131**
 – station selection **130**
 – station with best reception **131**
 – storing stations **132**
 – switching on/off **126**
 – tone control **127**
 – volume **127**
 – Weather Band, refer to Weather news flashes **133**
 Radio key, refer to Keys/remote control **28**
 Radio position, refer to Radio readiness **50**
 Radio readiness **50**
 – switched off **50**
 – switched on **50**
 – with comfort access **37**
 Rain sensor, windshield washer system **57**
 "Random", random play sequence, selecting **142**
 "Random all" in audio mode **142**
 "Random directory" in audio mode **142**
 Random play sequence
 – CD changer **142**
 – CD player **142**
 "RDS" **133**
 Reading lamps **83**
 Rear lamps, refer to Tail lamps **184**
 Rearview mirrors, refer to Mirrors **43**
 "Received calls" **154**
 Reception
 – quality **133**
 – radio stations **133**
 – regional station **131**
 Reception quality of mobile phone, refer to Status information **20**
 Rechargeable flashlight **91**
 Recirculated-air mode, refer to AUC Automatic recirculated-air control **87**
 Recirculation of air, refer to AUC Automatic recirculated-air control **87**
 Reclining seat, refer to Backrest **40**
 Recording times, refer to Stopwatch **67**
 "Redial" for mobile phone **153**
 Reflectors, refer to Tail lamps **184**
 Refueling **168**
 Releasing, hood **175**
 "Relock door if not opened" **32**
 Remaining distance, refer to Cruising range **60**
 Remaining distance to destination, refer to Computer **61**
 Remote control **28**
 – battery replacement **37**
 – comfort access **36**
 – garage-door opener **90**
 – luggage compartment lid **31**
 – malfunction **31, 37**
 Removing condensation from windows **86**

"Repeat directory" in audio mode [142](#)
"Repeat" in audio mode [142](#)
"Repeat track" in audio mode [142](#)
Replacement fuses [190](#)
Replacing bulbs, refer to Lamps and bulbs [182](#)
Replacing tires
– changing a wheel [187](#)
– new wheels and tires [173](#)
Reporting an accident, refer to Initiating emergency call [191](#)
Reporting safety defects [7](#)
Required fuel [169](#)
Reserve warning, refer to Fuel gauge [60](#)
Reservoir for washer systems [57](#)
"Reset"
– for stopwatch [67](#)
– tone settings [129](#)
Reset, refer to Resetting tone settings [129](#)
"Reset to default" with MDrive [46](#)
Residual heat [87](#)
Restraint systems
– for children [48](#)
– refer to Safety belts [42](#)
Retreaded tires [173](#)
Reverse, fast
– CD changer [143](#)
– CD player [143](#)
Reverse gear [52](#)
Road map [119](#)
"Roadside Assistance" [155](#), [163](#)
Roadside Assistance [192](#)
Roadside parking lamps [81](#)
– replacing bulbs, refer to Parking lamps [183](#)
Rope, refer to Tow-starting and towing [193](#)
Rotary fuel controller, refer to iDrive [16](#)

Route [116](#)
– bypassing sections [122](#)
– changing [116](#), [122](#)
– display [119](#)
– displaying arrow display [119](#)
– displaying map [119](#)
– displaying towns/cities and streets [120](#)
– list [120](#)
– selecting [116](#)
– selecting criteria [116](#)
Route map, refer to Map view [119](#)
"Route preference", changing [116](#)
Route selection [116](#)

S

Safety belts [42](#)
– damage [43](#)
– indicator lamp [43](#)
– sitting safely [39](#)
Safety belt tensioners, refer to Safety belts [42](#)
Safety systems
– ABS Antilock Brake System [71](#)
– airbags [75](#)
– DSC Dynamic Stability Control [71](#)
– safety belts [42](#)
Satellite radio [135](#)
– enabling channels [136](#)
– selecting channel [136](#)
– storing channel [136](#)
"SAT" on the radio [126](#), [136](#)
"Save current destination" [116](#)
"Scan"
– playing a music track [141](#)
– playing stations [131](#)
Scan
– CD changer [141](#)
– CD player [141](#)
– radio [131](#)
"Scan all" in audio mode [141](#)
"Scan directory" in audio mode [141](#)
Screw thread for tow fitting [193](#)
SDARS, refer to Satellite radio [135](#)
Seats [39](#)
– adjusting [40](#)
– adjusting backrest width [40](#)
– heating [43](#)
– lumbar support [40](#)
– memory, refer to Seat, mirror and steering wheel memory [40](#)
– sitting safely [39](#)
– storing the setting [40](#)
– thigh support [40](#)
Securing cargo [101](#)
– ski bag [95](#)
"Select as destination" [113](#)
"Select current speed" [67](#)
Selecting audio sources, refer to Operating via iDrive [126](#)
Selecting frequency manually [131](#)
Selecting menu items [19](#)
Selecting new scale for navigation system display [120](#)
Selecting route [116](#)
Selection options with navigation system [116](#)
Selector lever, Sequential Manual Transmission [52](#)
Selector lever lock, refer to Shiftlock [52](#)
Sequential Manual Transmission with Drivelogic [52](#)
– Drivelogic driving programs [54](#)
– Drive mode [53](#)
– idle [53](#)
– initializing system, refer to After changing wheels/tires [174](#)
– kick-down [53](#)
– reverse gear [52](#)
– Sequential mode [53](#)
– shift lights [55](#)
– shiftlock [52](#)
Sequential mode [53](#)

- "Service" [63](#), [162](#)
- Service, refer to Roadside Assistance [192](#)
- Service and Warranty Information Booklet for US models [180](#)
- Service interval display, refer to Service requirements [63](#)
- "Service notification" [163](#)
- "Service Request" [155](#), [164](#)
- "Service requirements" [63](#), [162](#)
- Service requirements [63](#)
 - also refer to CBS Condition Based Service [180](#)
- "Service Status" [162](#)
- "Set"
 - in audio mode [126](#)
 - in trip computer [62](#)
- "Set date" [68](#)
- "Set service date" [64](#)
- "Set time" [68](#)
- Settings
 - changing on Control Display [67](#)
 - clock, 12h/24h mode [68](#)
 - configuring, refer to MDrive [46](#)
 - configuring, refer to Personal Profile [29](#)
- Setting speed limit [66](#)
- Setting time, refer to Preselecting activation time [88](#)
- "Set tire pressure" [74](#)
- Shifting [53](#)
- Shifting paddles [54](#)
- Shift lights [55](#)
- Shiftlock [52](#)
- Shock absorber control, refer to EDC Electronic Damping Control [73](#)
- Short commands of voice command system [201](#)
- "Short route" for navigation [117](#)
- Short route in navigation, refer to Selecting route [116](#)
- "Show current position" [112](#)
- "Show destination position" [112](#)
- Side airbags [75](#)
- Side markers, replacing bulbs [184](#)
- Side turn signals, replacing bulbs [184](#)
- Signal horn, refer to Horn [10](#)
- Sill panel lighting, refer to Interior lamps [83](#)
- Sitting safely [39](#)
 - with airbags [39](#)
 - with head restraints [39](#)
 - with safety belts [39](#)
- Ski bag [94](#)
- Slope assistant, refer to Starting off on slopes [99](#)
- SMG, refer to Sequential Manual Transmission with Drivelogic [52](#)
- "SMG Drivelogic" [46](#), [54](#)
- Snow chains [174](#)
- Socket, refer to Connecting electrical devices [94](#)
- Socket for Onboard Diagnostics interface [181](#)
- Socket for remote control, refer to Ignition lock [50](#)
- Soft closure aid, refer to Automatic soft closing [33](#)
- Song search with CD, refer to Playing a track [141](#)
- SOS, refer to Initiating an emergency call [191](#)
- Spare fuses [190](#)
- Spare key [28](#)
 - adapter [28](#)
- Spare remote control [28](#)
- Spare wheel [188](#)
 - driving with spare wheel [189](#)
- Special oils, refer to Approved engine oils [178](#)
- Speed-dependent volume [128](#)
- Speed limit [66](#)
- Speed limit warning, refer to Speed limit [66](#)
- Speedometer [12](#)
- "Speed volume", tone control [128](#)
- Speed with winter tires [174](#)
- "Sport" with EDC [73](#)
- Stability control, refer to Driving stability control systems [71](#)
- Start/Stop button [50](#)
- "Start" for stopwatch [67](#)
- "Start guidance" [110](#), [118](#)
- Starting assistant, refer to Starting off on slopes [99](#)
- Starting difficulties
 - jump starting [192](#)
 - refer to Special starting conditions [51](#)
- Starting engine [51](#)
- Starting off
 - on a slippery surface [99](#)
 - on slopes [99](#)
- Start menu, iDrive [17](#)
- "Start route guidance" [112](#)
- "Start service" [163](#)
- "State / Province" for destination entry [108](#)
- "State inspection" [64](#)
- Station, refer to Radio [130](#)
- "Status" [63](#)
- Status information on Control Display [20](#)
- Status of this Owner's Manual at time of printing [5](#)
- Steering wheel
 - adjustment [44](#)
 - automatic adjustment, refer to Easy entry/exit [45](#)
 - buttons on steering wheel [11](#)
 - lock [50](#)
 - locking [50](#)
 - MDrive button [46](#)
 - memory [40](#)
 - programmable button [45](#)
 - "Steering wheel button" [45](#)
- Steering-wheel shift buttons, refer to Shift paddles [54](#)
- "Stop" for stopwatch [67](#)
- "Stopwatch" [67](#)
- Stopwatch [67](#)

Storage compartments [92](#)
 "Store in address book" for navigation [114](#)
 "Store" on the radio [132](#), [137](#)
 Storing current position [114](#)
 Storing radio stations [132](#)
 Storing sitting position, refer to Seat, mirror and steering wheel memory [40](#)
 Storing tires [174](#)
 Straps, refer to Loading [101](#)
 "Street" for destination entry [109](#)
 Summer tires, refer to Wheels and tires [170](#)
 "Surround Settings", adjust the sound [128](#)
 SW, waveband [130](#)
 Switches, refer to Cockpit [10](#)
 Switching between high beams and low beams, automatic, refer to High-beam assistant [81](#)
 Switching off tilt alarm sensor [36](#)
 Switching on
 – audio [126](#)
 – CD changer [126](#)
 – CD player [126](#)
 – radio [126](#)
 Switching the cooling function on and off [86](#)
 Swiveling headlamps, refer to Adaptive Head Light [81](#)
 Symbols [4](#)
 – indicator and warning lamps [13](#)

T

Tachometer [59](#)
 Tail lamps [184](#)
 – replacing bulbs [184](#)
 Tank capacity
 – also refer to Filling capacities [200](#)
 – fuel tank capacity [168](#)
 Target cursor for navigation [112](#)

Technical alterations, refer to For your own safety [6](#)
 Technical data [198](#)
 Telematic, refer to TeleService, BMW Assist [161](#)
 Telephone
 – refer to Mobile phone [148](#)
 – refer to separate operating instructions
 "Telephone list" [45](#)
 TeleService [161](#)
 – enabling [161](#)
 – services offered [162](#)
 Temperature
 – adjusting in upper body region [85](#)
 – adjusting with automatic climate control [85](#)
 – of coolant, refer to Coolant temperature [59](#)
 Temperature display
 – changing units of measure [69](#)
 – outside temperature [60](#)
 Temperature gauge, engine oil [60](#)
 Temperature warning, refer to Outside temperature [60](#)
 Tempomat, refer to Cruise control [57](#)
 "Terminate services" [164](#)
 "Text language" [69](#)
 "Theater", refer to Tone control [128](#)
 The individual vehicle [5](#)
 Tie-down points, refer to Securing cargo [101](#)
 Tightening torque of the lug bolts, refer to After mounting [189](#)
 Tilting down passenger-side exterior mirror [44](#)
 "Time" [68](#)
 "Time format" [68](#)
 Timer, refer to Preselecting activation time [88](#)
 "Timer 1" for parked car ventilation [88](#)

"Timer 2" for parked car ventilation [88](#)
 Tire inflation pressures [170](#)
 Tire Quality Grading [172](#)
 Tires
 – age [171](#)
 – air loss [74](#)
 – breaking-in [98](#)
 – condition [172](#)
 – damage [173](#)
 – inflation pressure [170](#)
 – minimum tread depth [172](#)
 – M Mobility System [185](#)
 – new wheels and tires [173](#)
 – replacing [173](#)
 – retreaded tires [173](#)
 – size, refer to The right wheels and tires [173](#)
 – wear indicators [173](#)
 – wheel/tire combination [173](#)
 – winter tires [174](#)
 "Tone" [127](#)
 Tone dialing method [156](#)
 Tone in audio mode
 – adjusting [127](#)
 – middle setting [129](#)
 Tone on locking/unlocking [31](#)
 Tools, refer to Onboard tool kit [182](#)
 "Top 8" for mobile phone [153](#)
 Torque
 – lug bolts, refer to After mounting [189](#)
 – refer to Engine specifications [198](#)
 Touch tone dialing, refer to Tone dialing method [156](#)
 Tow fitting [193](#)
 Towing [193](#)
 – tow fitting [193](#)
 "Town / City" for destination entry [108](#)
 Tow-starting [193](#), [194](#)
 Tracks
 – finding [141](#)
 – random play sequence [142](#)
 – sample, Scan [141](#)
 Track width, refer to Dimensions [199](#)

Traction control, refer to DSC Dynamic Stability Control [71](#)

Traffic congestion, refer to Bypassing route sections [122](#)

Transmission

- breaking-in [98](#)
- Drivelogic [54](#)
- Drive mode [53](#)
- idle [53](#)
- kick-down, refer to Drive mode [53](#)
- refer to Sequential Manual Transmission with Drivelogic [52](#)
- reverse gear [52](#)
- Sequential mode [53](#)
- shift lights [55](#)
- starting assistant, refer to Starting off on slopes [99](#)

Transporting children safely [48](#)

Transport securing device, refer to Securing cargo [101](#)

Tread depth, refer to Minimum tread depth [172](#)

Treble, refer to Tone control [127](#)

"Treble", tone control [127](#)

"Trip computer" [62](#)

Trip computer [62](#)

Trip-distance counter, refer to Trip odometer [59](#)

"Triple turn signal activation" [56](#)

Trip odometer [59](#)

Trunk, refer to Luggage compartment [34](#)

Trunk lid, refer to Luggage compartment lid [33](#)

Turning circle, refer to Dimensions [199](#)

Turn signals [56](#)

- replacing bulbs [183](#)

U

"Unchanged", with MDrive [46](#)

Undercarriage protection, refer to the Caring for your vehicle brochure

Uniform Tire Quality Grading/UTQR [172](#)

"Units" [69](#)

Units

- average fuel consumption [69](#)
- temperature [69](#)

Universal garage-door opener, refer to Integrated universal remote control [90](#)

Universal remote control, refer to Integrated universal remote control [90](#)

"Unlock button" [30](#)

Unlocking

- from inside [33](#)
- from outside [30](#)
- without key, refer to Comfort access [36](#)

Unlocking and locking doors, setting confirmation signals [31](#)

Unlocking without key, refer to Comfort access [36](#)

"Update services" [164](#)

Upshift display, refer to Shift lights [55](#)

"Use current location as address" [114](#), [116](#)

Used batteries

- refer to Disposal [190](#)
- refer to Replacing battery [37](#)

V

Valve screw caps, refer to After mounting [189](#)

Vehicle

- battery [189](#)
- breaking-in [98](#)
- care, refer to the Caring for your vehicle brochure
- cargo loading [100](#)
- dimensions [199](#)
- parking [51](#)
- position, refer to Displaying current position [122](#)
- washing, refer to the Caring for your vehicle brochure
- weights [200](#)

Vehicle jack [188](#)

- jacking points [188](#)

"Vehicle settings"

- when unlocking [30](#)
- with MDrive [46](#)

Ventilation [87](#)

- draft-free [87](#)
- for cooling [87](#)
- parked car ventilation [88](#)

Vent outlets of automatic climate control [84](#)

"Vent settings" [86](#)

Voice, refer to Destination guidance with voice instructions [121](#)

Voice command system [22](#)

- short commands [201](#)

Voice instructions for navigation system [121](#)

- muting [45](#)
- repeating [45](#), [121](#)
- switching on/off [45](#), [121](#)
- volume [121](#)

Voice phone book [158](#)

Volume [126](#)

- audio sources [126](#)
- mobile phone [152](#)
- setting speed-dependent [128](#)
- voice instructions [121](#)

Volume adjustment in audio mode, front-to-rear [128](#)

W

Warning lamps, refer to
Indicator and warning
lamps [13](#)

Warning messages, refer to
Check Control [64](#)

Warning triangle [191](#)

Warranty and Service Guide
Booklet for Canadian
models [180](#)

Washer fluid
– capacity of the reservoir [57](#)
– wiper system [57](#)

Washer fluid reservoir [57](#)

Water on roads, refer to
Driving through water [99](#)

Waveband for radio [130](#)

"WB" [126](#), [134](#)

Wear indicators in tires, refer
to Minimum tread depth [173](#)

Weather news flashes [133](#)

Website [4](#)

Weights [200](#)

Wheel/tire combination, refer
to New wheels and tires [173](#)

Wheel/tire damage [173](#)

Wheel/tire replacement, refer
to New wheels and tires [173](#)

Wheelbase, refer to
Dimensions [199](#)

Wheels and tires [170](#)

Width, refer to
Dimensions [199](#)

Windows [37](#)
– comfort closing with comfort
access [37](#)
– convenience
operation [31](#), [32](#)
– opening, closing [37](#)

Windshield
– cleaning, refer to Wiper
system [57](#)
– defrosting, refer to
Defrosting windows [86](#)
– displays, refer to Head-Up
Display [77](#)

Windshield washer nozzles [57](#)

Windshield washer system,
refer to Washer/wiper
system [56](#)

Windshield wiper blade
replacement [182](#)

Windshield wipers, refer to
Wiper/washer system [56](#)

Winter tires [174](#)
– setting speed limit [66](#)
– storage [174](#)

Wiper blade replacement [182](#)

Wiper system [56](#)
– rain sensor [57](#)
– washer fluid [57](#)
– windshield washer
nozzles [57](#)

"With highways" for
navigation [117](#)

Word matching principle for
navigation [117](#)

Working in the engine
compartment [175](#)

Wrenches/screwdrivers, refer
to Onboard tool kit [182](#)

X

Xenon lamps [182](#)
– replacing bulbs [182](#)

Refueling

To ensure that you always have all the essential data on hand when refueling, we recommend that you fill in the following tables with the specifications and information that apply to your vehicle. Consult the index for individual specifications.

Fuel

Designation

Please enter your preferred fuel here.

Engine oil

Quality

Tire inflation pressures

	Summer tires Front	Rear	Winter tires Front	Rear
Up to 2 persons				
4 persons or 4 persons plus luggage				

More about BMW

bmwusa.com



The Ultimate
Driving Machine

01 41 0 012 118 ue



