



Foreword

Thank you for choosing BYD F3DM. Your selection of BYD Auto is a wise investment. It will give you years of pleased driving. Reading this manual thoroughly can get familiar with the operation and enhance the enjoyment of driving your new vehicle. Keep this manual properly in your vehicle for future reference. Please also transfer this manual upon resale of your vehicle so that the next owner can still access the useful information for F3DM.

BYD F3DM adopts Dual Mode power system with power train, dual pressure controller, and power battery. As the wiring structure is complicated, please do not modify, remove or disassemble any subsystem of the hybrid vehicle without permission, such as vehicle alarm, sound system and other electronic components. Otherwise, it may affect your vehicle's performance or cause serious injuries to you or others. In addition, damage, performance problems or injuries resulting from the modification are not covered by BYD's warranty.

This manual is guidance of operating BYD F3DM properly rather than an indication about configurations of BYD F3DM. For any information about configurations, please read corresponding contract (if have), or consult your BYD authorized dealers. Illustrations in this manual are for reference only, which may vary with actual vehicles.

For the sake of product upgrades from time to time, we reserve the full right to make changes to the information on technology, features and spare parts at any time without prior notice.

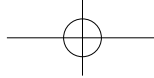

F3DM Owner's Manual

Your valuable comments and opinions will be warmly welcomed. In order to provide better service to you, please leave your contact information with your dealer. If any change of your contact, please contact BYD authorized dealers to update your information immediately.

March 2011
BYD AUTO CO. LTD.

All rights reserved. This material may not be reproduced or copied, in whole or in part, without the written permission of BYD Auto

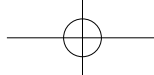

Catalog

Safety Instructions	5
Important information before driving your vehicle	6
Important information about your BYD F3DM	8
Accessories, spare parts and modification of your BYD F3DM	9
1.Operations of Instruments and Controllers	19
1)Appearance of Instrument Panel	19
2)Key and Car Door	25
3)Seats, Seat Belts, Steering Wheel and Rear-view Mirrors	43
4)Lights, Wipers, EV and HEV Switch	65
5)Instruments and Maintenance Indicators	73
6)Ignition Switch, Parking Brake and Parking Assistance System	85
7)Auto Audio System	91
8)Air-conditioning System	101
9)Charging System	111
10)Other Equipment	117

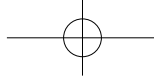

2.F3DM Auto Driving	123
3.Starting and Driving	135
4.In Case of An Emergency	145
5.Corrosion Prevention and Appearance Care	159
6.Maintenance and Care Instructions	169
7.Self-maintenance	179
1)Foreword.	179
2)Engine and Chassis	185
3)Electric Appliance	195
8.Part Specifications	207



Safety Instructions

As you read this manual, you will find some safety and vehicle damage Warnings and Notices. This information is intended to help you avoid injury to you and your passengers or damage to your vehicle. So do follow these warnings and Notices carefully.

The types of warnings, notices what they look like, and how they are used in this manual are explained as follows; besides, specific marks are stick on your vehicle. Illustrations in this manual are only for reference. Please refer to the vehicle as standard.

WARNING

This is a warning against anything which may cause serious injury to people or serious damage to the vehicle if you don't follow these instructions.

NOTICE

This is a warning against anything which may cause injury to people or damage to the vehicle or its equipments if you don't follow these instructions.

Safety Symbol



The safety symbol shown above means: "Do not..."; "Do not do this"; or "Do not let this happen".

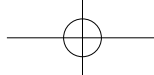

Important information before driving your vehicle

The safety is very important. To avoid unnecessary damages or injuries, please read through the operating instructions and other information on labels in this manual.

You should know that it is not practical or possible to warn all the hazards associated with operating or maintaining your vehicle, you must have your own good judgment.

You should follow the important information below before driving your vehicle.

Wear your seat belt every time when you drive

A seat belt is your best protection in

all types of collisions, Airbags are only designed to supplement seat belts and can't supersede the seat belt. So ensure that you and your passengers always wear seat belts properly.

Restrain all children

The children who are below 12 years should be restrained in back seat. Infant and little children should be restrained in child seat. Older children should use a booster seat and a shoulder belt until they can use the belt properly without a booster seat.

Beware of airbags hazard

While airbags can protect you in collisions, they also will cause serious or fatal injuries to people who do not operate properly, such as sit too close to the airbags, or who are not properly restrained. Therefore, Ensure to follow all instructions and warning in this manual.

Control your speed

Excessive speed is major factor in crash injuries and may lead up to death. Generally, the higher the speed always leads to the larger risk. Never drive faster than the speed is safe for current conditions, regardless of the maximum speed posted.

No Drunk Driving

No drunk driving, and don't let your friends drunk driving, either.

Pay attention to the task of driving safety

Engaging in mobile phone conversation or other activities that keep you from paying close attention to the road, other vehicle and pedestrians may cause a crash. Remember, situations can change quickly, and only you can decide when it is safe to divert attention away from driving.

Keep your vehicle in safe condition

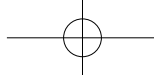

The tire blowout or mechanical failure may cause extremely accident. To reduce the possibility of such problems, check your tire pressure and condition frequently, and perform all regularly scheduled maintenance.

⚠ WARNING

- There are some parts that reach high temperatures while you drive, do not touch those components (such as engine) to avoid injury.
- Medical devices (such as cardiac pacemaker) may be interfered by radio wave, so please consult your doctor before you driving your BYD F3DM.

NOTICE

- When charging, please park your vehicle in well ventilated places.
- Power battery is installed on your vehicle, so please do not drive it throughout deep water.

- To keep your F3DM in a good performance, please drive your vehicle in the condition which temperature is above -10°C (14°F)

⚠ WARNING

The battery of BYD F3DM is placed under the guard board of trunk; if the battery needs to be replaced, please contact your BYD authorized dealer, do not replace the battery by yourself, it may cause injury to you.

NOTICE

- Because your BYD F3DM is a hybrid vehicle, which is not used widely, for you enjoy the after-sale and repair properly, do not drive your F3DM far away from the sale service areas.
- Because the structure of the hybrid vehicle is more complex, so it may take a longer time to repair your F3DM, please be more patient.

NOTICE

Battery posts, terminals and related accessories of your F3DM may contain lead and lead compounds. In order to reduce the harm to you, do wash your hands after handling.

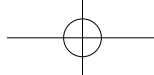

Important information about your BYD F3DM

New vehicle warranty

Your new vehicle is covered by the following BYD limited warranties:

- New vehicle warranty
- Emission control systems warranty
- Others

WARNING

Engine exhaust, some of its constituents and a wide variety of automobile components contain or emit chemicals known to the State of California to cause cancer and birth defects and other reproductive harm.

Precautions for use of hybrid vehicle
Your F3DM is a hybrid vehicle. The vehicle has both high voltage DC and AC systems as well as a 230-400volt system. DC and AC high voltage are very dangerous. It may cause death or serious injury, severe burns and electric shock.

WARNING

- Do not touch the high voltage cables (orange colored) and their connectors to avoid injury to you or others.
- Do follow the warning labels attached to the high voltage parts.
- Do not remove or replace the high voltage parts such as the inverter unit, power battery etc.

Scrapping of your BYD F3DM

The SRS airbag and seat belt devices in your BYD F3DM contain explosive. If the vehicle is scrapped with the airbags and some seat belt devices, this may cause an accident such as fire. Please remove the systems of the SRS airbag and seat belt devices by your BYD authorized dealer before disposing your F3DM

WARNING

You should consult your BYD authorized dealer when your vehicle or battery needs to be disposed of. It may cause death or serious injury if the battery is not disposed of properly. So your F3DM battery must be dismantled by BYD authorized dealers.



Accessories, spare parts and modification of your BYD F3DM

Spare parts or accessories in the market may not be genuine or authorized for BYD vehicles. BYD shall not responsible for their performance, repair, or replacement, or for any damage or adverse effect caused by them, if you use them in your F3DM.

You should not modify your BYD F3DM with non-genuine BYD products. It could affect your vehicle's performance, safety or useful life with modification with non-genuine BYD products. Besides, damage or performance problems resulting from the modification are not cover by the warranty of BYD.

NOTICE

- If an accident happen ,pull your vehicle off the road, push the “P” position switch, stop the DM system and remove the key
- Do not touch the exposed electric wires which are protruding inside or outside of your vehicle, it may cause electric shock.
- Do not touch any high voltage wirings and their connectors, and high voltage parts such as converter unit, hybrid vehicle battery, etc to avoid injury to you.
- If any suspicious fluid leaks, never touch it because it may be electrolyte from the hybrid vehicle battery. If it leaks to your skin or eyes, wash off at once with plenty of water, and get immediate medical treatment to avoid

serious injury.

- If your vehicle need to be towed, please contact your BYD authorized dealer for advice

High Voltage

Your vehicle is equipped with cables connected to parts of the vehicle subject to high voltage (about 400 V at maximum). There are some other parts that reach high temperatures while you driving. Do not touch battery cables (orange-colored) or their connectors which are under high voltage and dangerous. Observe the caution labels in the vehicle carefully.

Beware of the tires of your vehicle

Check the tire inflation pressure periodically to avoid an accident which caused by underinflated or overinflated tire inflation pressure.

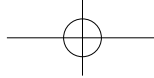

 **WARNING**

- Please do not use vehicle below -10°C (14°F).
- Orange colored cables are all high-tension lines on BYD F3DM. For your safety, please do not touch such cables.
- BYD F3DM is equipped with power battery contains high -tension electricity. If any problem happens on BYD F3DM, please contact the BYD authorized dealers. Do not repair it by yourself. It may cause an electrical shock.
- Do wear insulating gloves (the gloves can resist at least 500V) before operating the high voltage components. It must be operated by professional technicians.

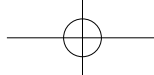

Overall Unit Parameters of BYD F3DM

Dimension	Length	4533mm	
	Width	1705mm	
	Height(No-load)	1520mm	
	Wheelbase	2600mm	
	Track	Front	1480mm
		Rear	1460mm
	Front Overhang	933mm	
	Rear Overhang	1000mm	
	Seating Capacities	5	
	Approach Angle	19.3°	
	Departure Angle	24.5°	
Weight	Curb Weight	1560kg	
	Cross Weight	1935kg	

Four -wheel Alignment Parameters	Front Camber	-0°17'±45'
	Front Wheel Toe-in	Total toe-in:-0.5~3mm(left-0.25~1.5mm,the right is equal)
	Kingpin Inclination Angle	12°±45'
	Kingpin Caster Angle	2°36'±45'
	Rear Camber	-0.6°±30'
	Rear Wheel Toe-in	(1.1±3)mm
Capacities	Engine Displacement	998ml
	Engine Maximum Power	50KW
	MG1 Maximum Power	25KW
	MG2 Maximum Power	50KW
	Maximum Speed	≥150km/h
	Maximum Gradeability (considering road condition)	≥30%
	Maximum Wheel Steering Angle	Outboard:33°04'Inside:39°12'

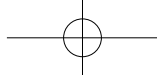

Introduction about BYD F3DM System

BYD F3DM (Dual Mode) System:

It is combined petrol engine with electric engine, BYD F3DM is able to drive by electric engine or petrol engine.

Features of BYD DM System:
Compared with common gasoline vehicle, BYD DM system has a better power performance, which can improve fuel economy in HEV mode. In EV mode, BYD F3DM will run

with low noise and zero emission, In addition, F3DM equipped with recycle electric motor assistance braking energy, which can recycle and convert the kinetic energy lost in braking to electrical energy and store it in power battery. The electrical energy can be used later.

Compared with other hybrid electrical cars, BYD F3DM has a power battery with large capacity, which can increase the driving range greatly under EV mode. F3DM can be charged with 180-240V AC, which is convenient for you to charge your vehicle. You will not rely on gasoline anymore if your F3DM can be charged in certain drive range in time.

Work Mode of BYD DM System:

1. "EV" – EV mode:

Under EV mode, power battery provides electrical energy to electric motor power 2 for driving car.

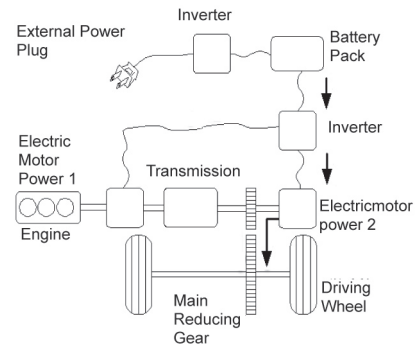

2. "HEV" – HEV mode:

(1) HEV mode A: The engine reaches its best working condition and directly drives the car, and the electric motor power 1 runs with the petrol engine to charge the power battery.

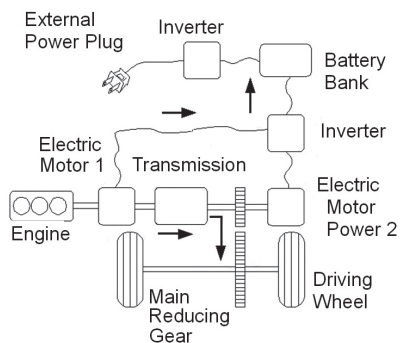
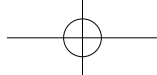

(2) HEV mode B: The petrol engine and electric motor power work together to drive the vehicle, which provides a higher output power.

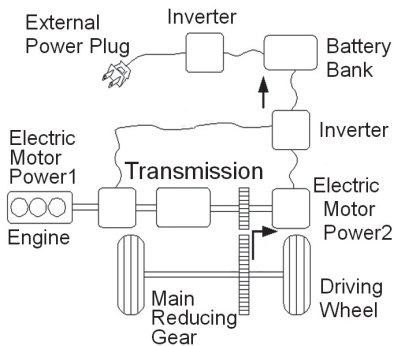

(3) HEV mode C: When a lower power output required by overall unit, turn to the HEV mode, the engine drives electric motor power 1 to generate electricity for the electric motor power 2 to drive the car and the spare electricity will be stored in the power battery.

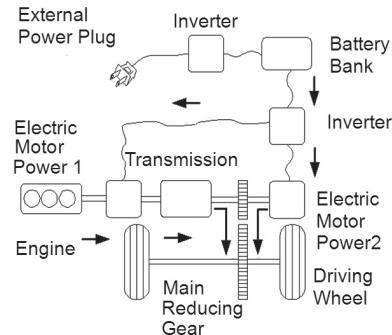

Vehicle Identification of BYD F3DM

Vehicle Identification No.

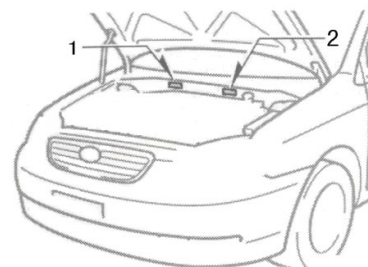

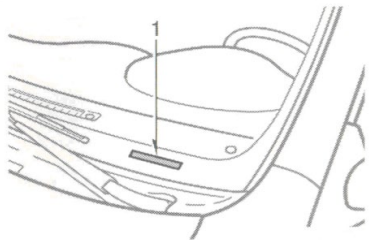
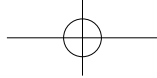

1.The vehicle identification number is attached on the cabin sheet as shown in the figure above, which is for owner registration.

2.Factory nameplate (posted where shown in the above figure) also marks the identification number.

3.The vehicle identification number (flexible mark) is posted on the left upper side of the instrument panel as shown in the figure, which is used for owner registration.

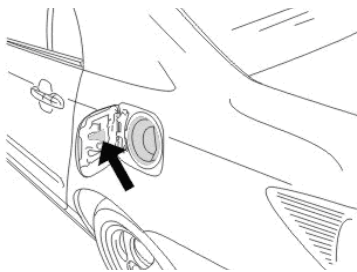
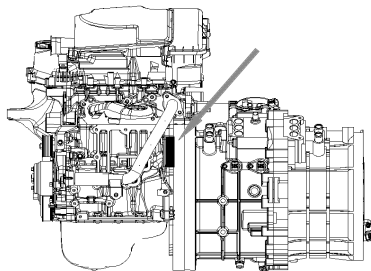

Figure above shows the fuel grade indication sign, which is posted on the inner side of the fuel lid.



Engine Number

The engine number is marked on the

cylinder block of engine, as shown in the figure.

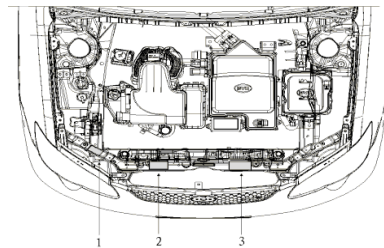

- 1.Indication sign of antifreeze
- 2.Warning sign of air-conditioning system
- 3.Warning sign of cooling fan

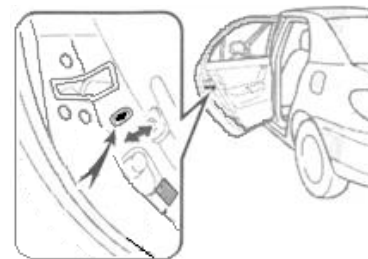

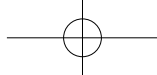

Figure above shows the indication sign of the child protection device, which is posted below the child protection lock on the inside of the rear vehicle door.

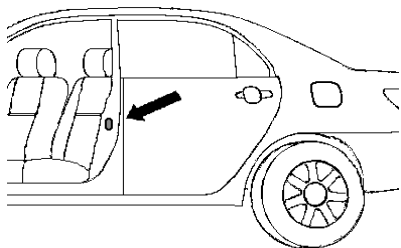
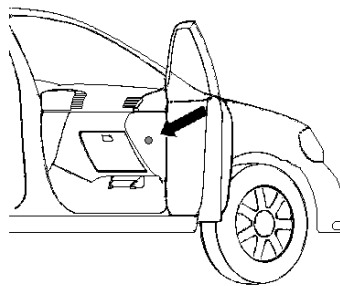

Figure above shows the indication sign of tire pressure, which is posted below lock ring of the left front door.



sign of air bag, which is posted on the driver side sun visor.

The spare parts in the figure below are all high voltage. Do not disassemble or repair your vehicle by yourself, it may cause an electric shock

Figure above shows the warning sign of auxiliary air bag, which is posted below the right side of instrument panel.

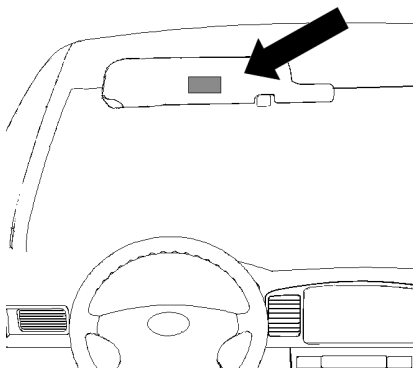
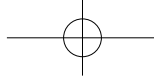
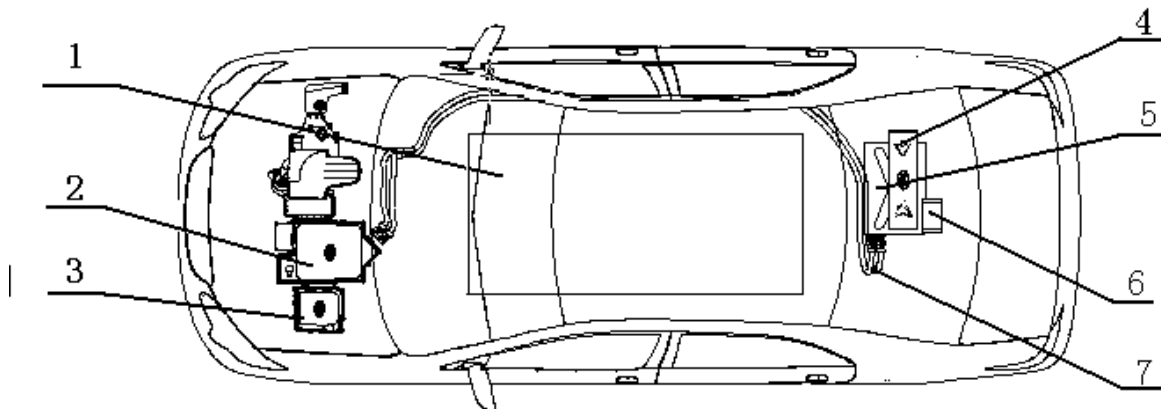

Figure above shows the warning



The high voltage spare parts of the vehicle:



1.Power Battery

4.Charger On-board

7.High Voltage Cable

2.The Main Electric Motor Power Controller

5.High Voltage Power Distributor

3.DC-DC and Air Conditioning Driver

6.Solar DC - DC controller

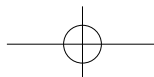

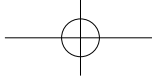

NOTICE

- Your F3DM is equipped with high voltage electric power drive equipment. Do not touch the electric components such as cables, switches, etc. To avoid electric shock.
- To avoid any injury, do not check and repair your vehicle by yourself. If your vehicle was breakdown, please contact your BYD authorized dealer.
- If your F3DM has to be repaired, it must be operated by BYD authorized dealer or professional person wearing insulation gloves(the gloves can resist at least 500 voltage).

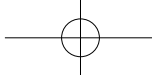

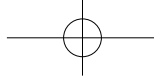

Chapter 1

Section 1-1

Operations of Instruments and Controllers Appearance of Instrument Panel

Appearance of Instrument Panel	20
Appearance of Main Instrument Panel	21
Appearance of Combination Instrument	22
Sign on Combination Instrument	23

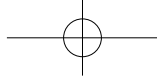

Appearance of Instrument Panel

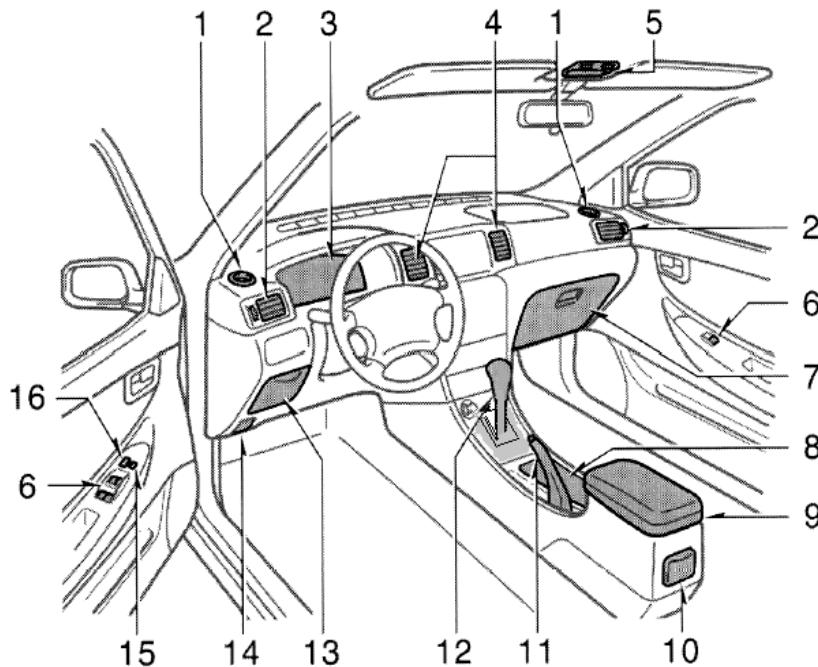

1. Side defroster outlets
2. Side vents
3. Instrument cluster
4. Center vents
5. Remote calling device (optional)
6. Power window switches
7. Right glove box
8. Cup holder
9. Central glove box
10. Rear ashtray
11. Parking break
12. Transmission gear
13. Left small glove box
14. Hood release handle
15. Door and window lock switch (contained in the power window switch of left front door)
16. Central door lock switch (contained in the power window switch of left front door)

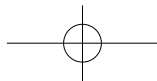



Appearance of Main Instrument Panel

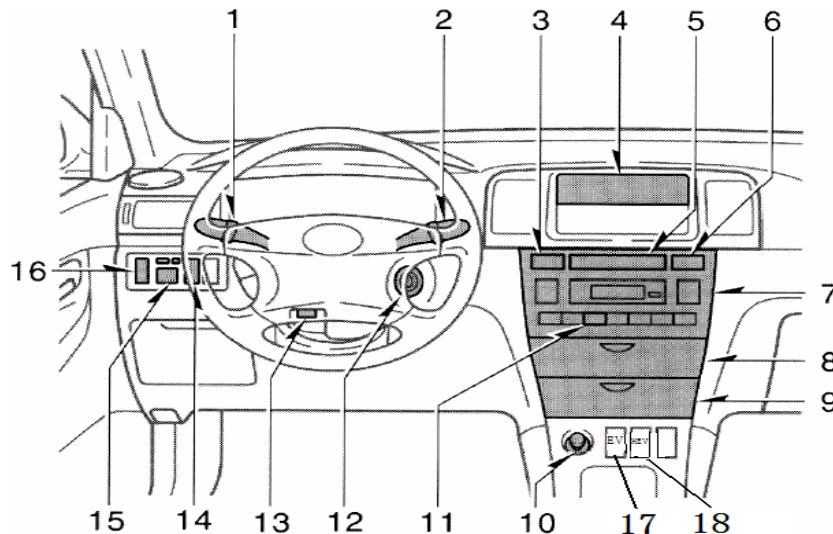

1. Headlight and turn signal switches
2. Wiper and washer switches
(windshield wiper and washer)
3. Parking assistance system
switch and indicator
4. Car audio
5. Electronic clock
6. Emergency flasher switch
7. A/C control module
8. Small glove box
9. Front ashtray
10. Cigar lighter assembly
11. Rear defrosting switch
12. Ignition switch assembly
13. Steering column regulating mechanism
14. Multi - function switches
15. Power exterior rearview mirror switch
16. Rear fog light switch
17. EV mode switch
18. HEV mode switch

Appearance of Combination Instrument

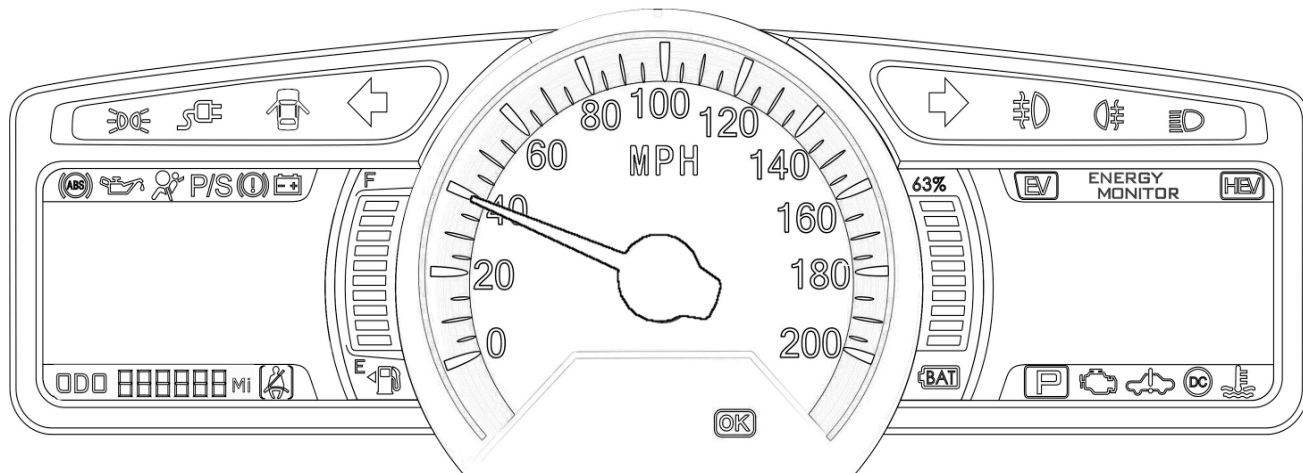

1

2

3

1. Left Display Screen

2. Speedometer

3. Right Display Screen

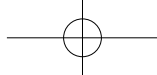



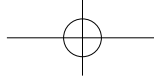

Sign on Combination Instrument

	Brake system warning lights*1 *		Anti-lock brake system warning light *		SRS Fault Warning Light *
	Driver's seat belt reminder light *		Open door warning light *		Discharge warning light *
	Low engine oil pressure warning light *		Lower Fuel Oil Warning Light* Light*		High coolant temperature warning light*
	Turn signal indicator lights		Tail light indicator light		Headlight high beam indicator light
	Malfunction indicator lamp *		Front fog light		Rear fog light
P/S	Electric power steering system warning light *		OK Indicator		DC Fault Warning Light *



F3DM Owner's Manual

	Charging Connection Indicator		Low Power Warning Light *		Power System Fault Warning Light *
	Power Battery Fault Warning Light *		Electric engine Fault Warning Light *		

Items marked with “*” are maintenance indicators. For details, please refer to “Maintenance of Indicators and Warning Buzzer” in Section 1-5.

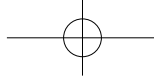

Chapter 1

Section 1-2

Operations of Instruments and Controllers Key and Car Door

Key	26
Side Car Door	27
Wireless Remote Control	29
Replace Battery of Remote Control.....	31
Power Windows	33
Luggage Compartment Lid	34
Hood	36
Anti-theft System	37
Fuel Tank Cap.....	41

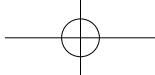

Key

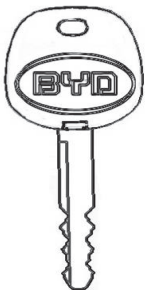

Two keys are provided for the vehicle, which can open all the doors of your car.

NOTICE

The doors may lock automatically by anti-theft system. It is recommended to keep a spare key with you, in case the doors locked with the key inside the car.

If you need additional keys, contact your BYD authorized dealer to create a duplicates.

NOTICE

To avoid the key damaged or improperly performance, observe the following instructions.

- The key should be operated with a clean hand and fingers.
- Do not insert the key forcefully.
- Do not insert any key other than genuine formal keys into the key slot.
- Do not pull out the key forcefully when it cannot be removed.
- Do not put water, oil, foreign objects, etc. into the key slot.
- Do not insert a wet, oily or damaged key into the key slot.
- Do not stick a seal on the key.

- Do not insert the key in the wrong way.

Should you find anything unusual, contact BYD authorized dealer as soon as possible.

Key Number Plate

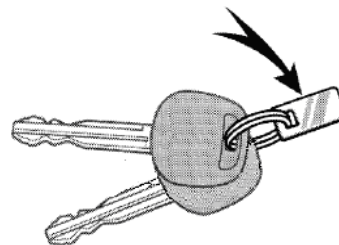

Your key number is shown on the plate. Keep the plate in a safe place, not in the vehicle.

BYD authorized dealer can create a new key with the key number. We recommend writing down the key number and storing it in a safe place in

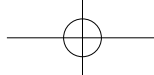

case that you need a duplicates.

If your key is locked in the car with the backup key unavailable, we strongly urges you to contact BYD authorized dealer for help. If you must get the key urgently through breaking the vehicle window, consider breaking the smallest window to reduce the repair cost to be the lowest one. Do take care of yourself to avoid an injury when breaking the vehicle window.

Side Car Door LOCKING AND UNLOCKING THE DRIVER'S DOOR WITH MECHANICAL KEY

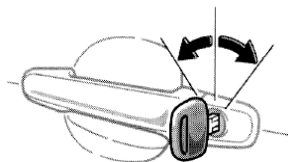

LOCKING AND UNLOCKING THE DRIVER'S DOOR WITH MECHANICAL KEY

Insert the key into the keyhole and turn it.

To unlock: turn the key clockwise.

To lock: turn the key anti-clockwise.

If the vehicle equipped with a central control door lock, all the doors will be locked or unlocked simultaneously with the driver's door.

Warning

Do not put your finger into the keyhole.
Your finger might be injured.

LOCKING AND UNLOCKING WITH INSIDE LOCK KNOB

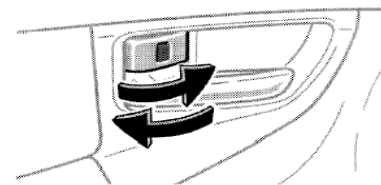

Move the lock knob as shown in the picture above.

To unlock: Pull the knob backward.

To lock: Push the knob forward.

If you need to lock the car door outside without key or wireless remote control, set the lock knob to locked position before closing the door. The exterior handle outside has to be lifted when closing the front doors.

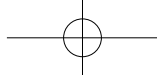

Notice: Do not to lock the key in your vehicle.

The driver's door can be opened inside by pulling the door handle even if the lock knob is depressed.

The driver's door cannot be locked if the key is in the key slot.

LOCKING AND UNLOCKING WITH POWER DOOR LOCK SWITCH

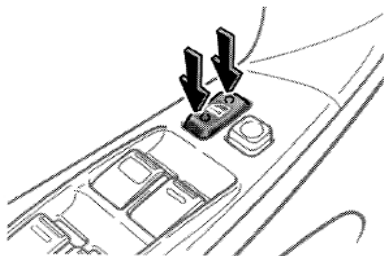

Push the switch as shown in the picture above.

To unlock: Push the switch (with a

small pit) down on the rear side.

To lock: Push the switch (with a small bump) down on the front side.

All the doors can be locked or unlock simultaneously with the central lock switch.

Auto Lock and Unlock of Car Doors

When the car speed exceeds 20km/h, all the car doors will lock automatically.

Turn the ignition key from "ON" to "ACC" or "LOCK" to unlock all the car doors.

These systems can be cancelled. Please refer to "Settings of Optional Functions" in this section for details.

Childproof door locks (on vehicles with rear doors)

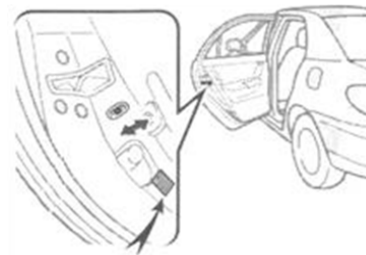

Slide the lock rod to "LOCK" position, the childproof door locks are fixed, as shown in the picture above

When these locks are set, the rear doors cannot be opened from the inside.

The rear doors can be opened from the outside when the doors are unlocked.

The childproof locks are located on rear edge of each rear door and must be set separately for each door. Setting the lock for one door will not automatically fix the lock for both doors.



Provided any children stay in the car, you'd better use this function.

WARNING

Ensure vehicle doors are locked before driving, especially when any children are in the car. Use the seat belt properly and locking all vehicle doors can prevent the driver and passengers from being thrown out in an accident. Meanwhile, it can also prevent the vehicle doors from accidental opening.

Wireless Remote Control

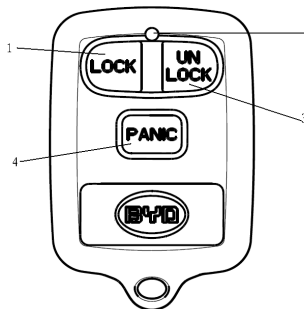

1. LOCK button
2. Indicator
3. UNLOCK button
4. Panic switch

The wireless remote control system is used to lock or unlock all doors, or activate the theft deterrent system from a distance about 2m nearby the vehicle.

The doors can be locked and unlocked by pushing the switches slowly and securely. The indicator light on the key will flash once.

WARNING

Changes or modifications not expressly approved by the party responsible for compliance could void the user's authority to operate the equipment.

Please observe the instructions below to avoid any damage when using remote control:

- Keep the key away from high temperature, such as on the dashboard.
- Do not disassemble it.
- Do not knock it or dropp it.
- Do not put it in water.

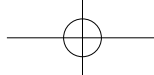

If the wireless remote control key does not perform properly, please check as below:

- Check for any radio transmitter, such as a radio station or an airport which can interfere with normal operation of the key.
- The battery may be low. Check the battery in the key. Replace the battery when necessary,

please refer to “Replace Battery of Remote Control” in this Section for detail.

If you lose your key, contact your BYD authorized dealer as soon as possible to avoid theft, or an accident.

LOCK button

Press the switch once for one action. The operation will not be repeated if the button is held for a long period of time. Release it and press it again for

another operation.

Lock Car: press LOCK button, then all doors will be locked simultaneously and the turn signal lights will flash once.

If the key is in the ignition switch, you can not lock the car doors with LOCK button.

If the key is not in the ignition switch, press LOCK button on the remote control, then all the doors will be locked once, and the buzzer will buzz once without entering anti-theft status.

When the doors are locked but the vehicle does not enter anti-theft status, press LOCK button on the remote control and then all the doors will be locked once.

Search Car: When the car is under anti-theft status, press LOCK button and the vehicle will buzz a long sound

with the turn signal lights flashing for about 15 seconds. (When you uncertain the location of your vehicle, this function is helpful to locate it.) Press LOCK button again to enter the searching status for the second time.

Warning Release: when the car is under anti-theft mode with the alarm being activated, press LOCK button, then all the doors will be locked once and the warning will be released. The vehicle will remain under anti-theft status.

UNLOCK button

Press the switch once for one action. The operation will not be repeated if the button is held for a long period of time. Release it and press it again for another operation.

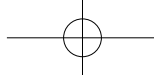

Unlock: press UNLOCK button, then all the doors are unlocked simultaneously and the turn signal lights will flash once. The turn signal lights will flash three times if the vehicle is under anti-theft status.

The vehicle can be unlocked even the key is in the ignition switch, .When the vehicle is under anti-theft mode with the alarm being activated, insert the ignition key into the ignition switch and press UNLOCK button to exit anti-theft status and unlock all the doors.

If all doors are unlocked by remote control, the rear interior light and ignition key indicator (optional) will be on for about 30 seconds. (This function is optional; for details, please refer to "Settings of Optional Functions").

After unlocking the door by remote control, all the doors will be opened

for 30 seconds. If you do not open it within the said period, all the doors will be locked again automatically.

Cancel Anti-theft Status: The anti-theft status (including that anti-theft alarm is enabled) can be cancelled by pressing UNLOCK button, then all the doors will be locked once and the turn signal lights flash three times and.

Panic Button

Press panic button at any time for 1.5 seconds or longer, the alarm sounds intermittently and the turn signal lights flash. The warning sound will last for 30 seconds, if you want to stop warning earlier, press unlocking button once or press the panic button again. (Do not press this button in driving.)

NOTICE

Do not drop or throw the Wireless Remote Control
Protect the wireless remote control from extreme temperature.
Do not immerse the wireless remote control in any liquid.

Replace Battery of Remote Control

Please use CR2016 lithium battery or equivalent to replace the battery, or contact BYD authorized dealer for replacement. Follow the steps below for replacement:

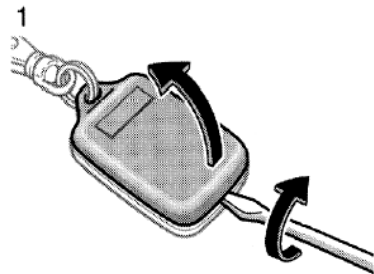
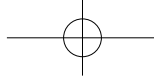

1. Open the remote control with a slotted screwdriver or a similar tool.

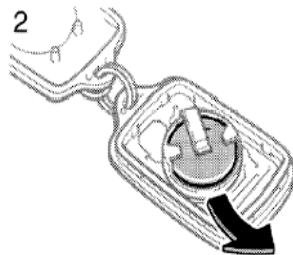

2. Remove the depleted battery of the remote control.

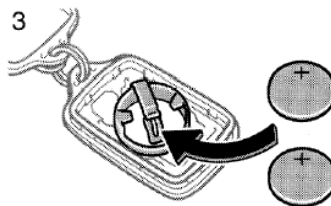

3. Install a new battery with positive (+) side up. Please get the lid on for the remote control.

After replacing the battery, please check whether the remote control can work normally. If it can not work normally, please contact BYD authorized service station for repair.

⚠ WARNING

To avoid a choking hazard, keep the battery and component away from a child.

NOTICE

Dispose of the depleted battery according to local laws or regulations.

NOTICE

- Make sure the positive side and negative side of the battery are installed correctly
- Do not replace the battery with wet hands to avoid rust.
- Do not touch or move any component of the remote control, or it may affect proper operation.
- Do not bend the electrode of the battery insertion and that dust or oils do not adhere to the case.
- Close the lid of remote control tightly.



Specifications of Remote Control

Frequency range: 314.9-315.1MHz

Transmission Power: $\leq 5500\mu\text{V/m}$ (field strength)

Spurious emission limit: $\leq 610\mu\text{V/m}$

Occupied bandwidth: $\leq 300\text{kHz}$

NOTICE

- Do not alter the emission frequency, increase the emission power (including but not limited to adding emission frequency amplifiers), equip external antenna or use other emission antennas.
- Do not interfere with wireless communication; stop using it immediately in case of any interference
- Do not use it near aircrafts or airports.

Power Windows

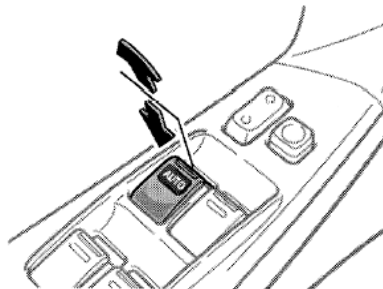

Switch on each door can control the corresponding window.

The ignition key shall be at "ON" position.

OPERATING THE DRIVER'S

WINDOW by the switch on the driver's door.

Normal Operation: The window moves as long as you hold the switch.

To open: Lightly push the switch down.

To close: Lightly pull the switch up.

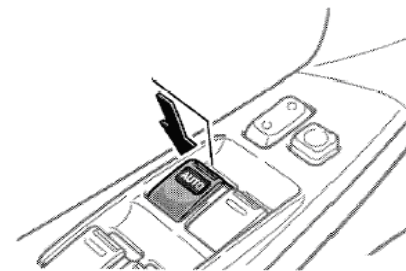

Automatic operation: Push the switch down completely or pull it up completely. The window will open or close fully. Move the switch in the opposite direction lightly and then release it, the window will be stopped.

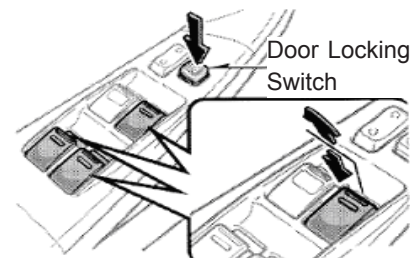

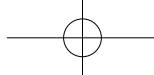

OPERATING THE PASSENGERS' WINDOWS:

The switch on each passenger's door or the switches on the driver's door can control each passengers' window.

The window moves as long as you hold the switch.

To open: Push the switch down.

To close: Pull the switch up.

The passenger's windows can be operated if the window lock switch on the driver's door is pressed.

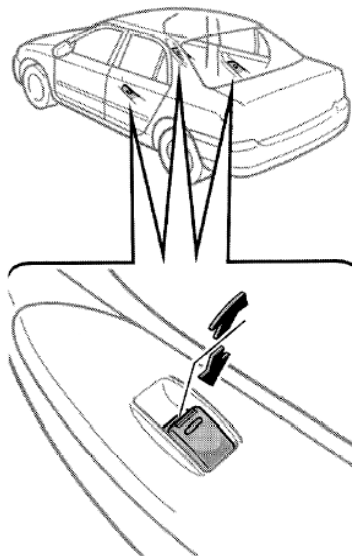

NOTICE

- As the power window does not equip with anti-pinch function. Use caution when using to avoid serious injury.

- When small children are in the vehicle, prevent them using the power window switches without supervision. Press the window lock switch to prevent them from making unexpected use of the switches.
- Make sure the ignition key is removed before leaving the car.

Luggage Compartment Lid

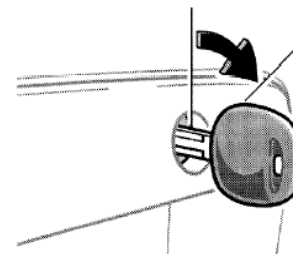

To open the luggage compartment lid outside, insert the key and turn it clockwise.

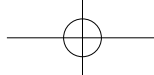

For precautions on loading luggage, please refer to “Precautions on Loading Luggage” in Chapter 2.

To close the luggage compartment lid, just pull and press it down. Check whether it is locked tightly after closing.

⚠ WARNING

Keep the back door closed while driving. This not only keeps the luggage from being thrown out, but also prevents exhaust gases from entering the vehicle.

Internal Control Handle of Luggage Compartment



To open the luggage compartment lid, pull up the internal control handle of luggage compartment under the driver seat.

Cancel the Function of Internal Control Handle of Luggage Compartment

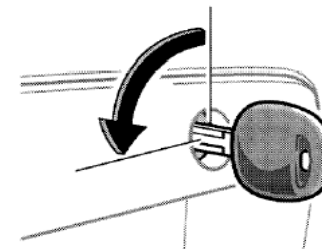

After closing the luggage compartment, insert the key and turn it anticlockwise to disable the internal control handle of luggage compartment.

Hood

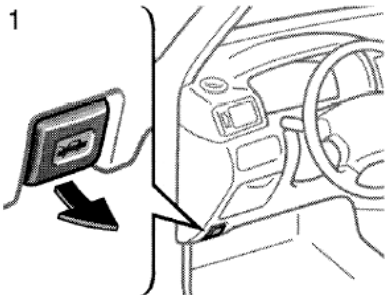
**To open the hood:**

1. Pull the hood lock release lever. The hood will pop up slightly.

⚠ WARNING

Before driving, be sure that the hood is closed and securely locked. Otherwise, the hood may open unexpectedly while driving and an accident may occur.

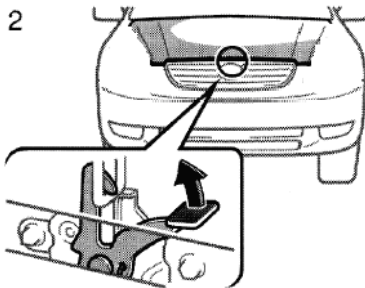

2. In front of the vehicle, pull up the auxiliary catch lever and lift up the

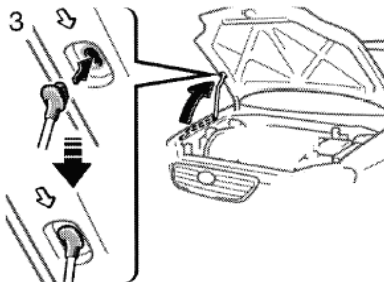

3. Hold the hood open by inserting the support rod into the slot.

Before closing the hood, ensure you have not forgotten any tools, rags, etc. and return the support rod to its clip—this prevents rattles. Then lower the hood and make sure it locks into place. If necessary, press down gently on the front edge to lock it.

⚠ WARNING

After inserting the support rod into the slot, make sure the rod supports the hood securely from falling down on to your head or body.

To deter vehicle theft, the system will sound an alarm if any of the doors or hood is forcibly unlocked or the battery terminal is reconnected when the vehicle is locked.



Anti-theft system



Under anti-theft status, the system will raise the alarm if the following conditions are detected.

- Any car door is unlocked.
- The ignition switch is turned to "ON".
- Reconnect the battery or anti-theft controller after disconnecting.
- Insert the ignition key.

If someone tries to damage you car or break in, the system will sound the alarm and the turn signal lights flash.

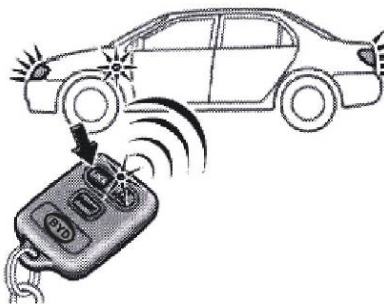

Manual Setting Functions

Set the anti-theft system manually with remote control.

Press LOCK button on the remote control to enable anti-theft function, then the turn signal lights flash once and all the doors will be locked.

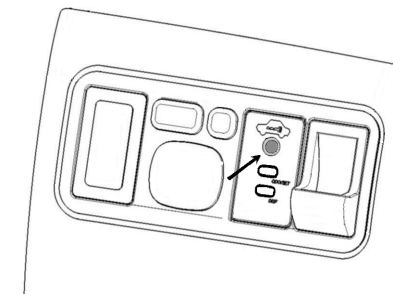

About 1 second later, anti-theft function is enabled, and then anti-theft warning light (dashed part in the picture) begins to flash slowly.

If any door is unlocked, press LOCK button, then the alarm sound a long tone and the vehicle can not enter anti-theft function; please follow the steps below:

- Close all the doors
- Reset the anti-theft system.

Automatic Setting Functions

It is optional. You need to change the

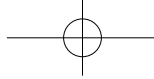

function mode; please refer to “Settings of Optional Functions”.

If no operations on the remote control within 30 seconds after remove the key and closing all the doors, the car will enable anti-theft function automatically. Under anti-theft status, insert the key into ignition switch, then the signal lights flash for caution but the alarm will not sound; when you turn the ignition key to “ON”, anti-theft function will be released (to unlock in anti-theft mode is only limited to this status); also you can press UNLOCK button to release anti-theft function.

Disable Anti-theft Function

Press UNLOCK button on the remote control, and then all the doors will be unlocked to disable anti-theft function.

The system will give a sign about the vehicle conditions as follows:

- If anti-theft function is not enabled, the turn signal lights flash twice.

- If anti-theft function is enabled, the turn signal lights flash three times and anti-theft warning light flashes rapidly; when you turn the ignition switch to “ON”, the indicator will go out.

When anti-theft function is disabled, the rear interior light and ignition key warning light (optional) will be on for about 30 seconds, even if no doors are open. (Delay time for two lights can be changed. For details, please refer to “Settings of Optional Functions”).

If anti-theft function can not be disabled by remote control, you disable it by the key; just turn the ignition switch from “ACC” to “ON” ten times within 15 seconds after opening the doors.

After anti-theft function is disabled, The doors will be unlocked for 30 seconds, all the doors will be locked

again automatically and enter anti-theft status if no door is opened.

Enable Anti-theft Function

If any abnormalities below are detected by the anti-theft system, the signal lights will flash and the alarm will sound for about 30 seconds.

- Any doors open.
- Insert the ignition key.
- Reconnect the battery or anti-theft controller.

Restart Alarming

Under the following conditions, alarm will be enabled again after it stops.

- Any door is opened.
- Insert the key into ignition switch.

The alarm sounds, the turn signal lights flash for about 30 seconds and then stop for 15 seconds, which will repeat continuously three times. The times of

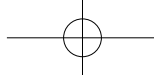

repetition can be changed. For details, please refer to “Settings of Optional Functions”.

Reset Anti-theft System

If anti-theft system is not under the status above, alarm will stop after the repetition ends. After alarm stops, the anti-theft system will be set automatically if the Auto Setting Functions is selected.

Stop Alarming

When the anti-theft alarm sounds, you can press LOCK button to stop it, but the anti-theft function is still enabled.

When anti-theft alarm sounds, you can press the UNLOCK button to stop it and the anti-theft function will be disabled.

Settings of Optional Functions

Optional Anti-theft Functions

- Automatic Setting Functions

For details, please refer to “Steps for Changing Optional Functions”.

- Auto Lock and Unlock

For details, please refer to “Steps for Changing Optional Functions”.

- Lighting System on the Car

For details, please refer “Rear Interior lights” and “Ignition Key Warning Lights (optional)” in this Chapter.

- Enable Alarm of Six Cycles

When anti-theft alarm is enabled, the alarm sounds and turn signal lights flash for about 30 seconds and then stop for about 15 seconds, which is regarded as a cycle. Default of auto setting is to enable alarm of three cycles, yet which can be changed to six cycles.

After the alarm of six cycles is set,

alarm of three cycles and nine cycles will be disabled automatically. When the alarms of 6 and 9 cycles are disabled, it will be restored to the default “alarm of 3 cycles”.

- Enable Alarm of Nine Cycles

Similarly, you can select to change it into alarm of 9 cycles. When this function is selected, the default to enable alarm of three cycles and six cycles will be disabled automatically. When the alarms of 6 and 9 cycles are disabled, it will be restored to the default setting “alarm of 3 cycles”.

- 15-Second Time Delay for Getting into the Car

When all the car doors are unlocked by remote control, the rear interior light and ignition key warning light (optional) will be on about 15 seconds (default: 30 seconds). When this function is selected, about-30-second time delay

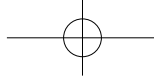

for getting into the car will be cancelled automatically.

● **30-Second Time Delay for Getting into the Car**

When all the car doors are unlocked by remote control, the rear interior light and ignition key warning light (optional) will be on about 30 seconds. It is the default selected function of the system. To select this function, be sure to cancel 15-second time delay for getting into the car. If both 15-second and 30-second time delay are selected, the system will select 15-second time delay automatically.

Steps for Changing Optional Functions

1. Check if anti-theft function is disabled.
2. Close all the doors.
3. Insert the key into ignition switch.
4. Repeat opening and closing the

driver-side door twice within 10 seconds. (Close → Open → Close → Open → Close).

5. Repeat to turn the ignition switch from "ACC" to "ON" three times. (ACC→ON→ACC→ON→ACC→ON→ACC)

Then, anti-theft indicator is on.

6. Refer to the table below, press LOCK button on the remote control and make sure the indicator flashes.

You can press LOCK button to search whether the door is open or closed.

When this function is selected, the turn signal lights flash once with a buzzing sound; to disable it, just open any door and close it; if the turn signal lights flashes twice with two buzzing sounds, it indicates this function is disabled. If unsuccessful, open the door again and then close it. Change cancelled status to set status.

Times for pressing LOCK button	Selected Functions
One	Auto setting functions
Two	Door auto lock and unlock
Three	Lighting system
Four	Enable alarm of 6 cycles
Five	Enable alarm of 9 cycles
Six	15-second time delay for getting into the car
Seven	30-second time delay for getting into the car
Eight	Vibration sensitivity settings (optional)

7. You can complete function setting by doing any items below.

- Turn the ignition switch to "ON".
- Close the driver-side door for over



30 seconds.

- Press LOCK button once more on the remote control.

For more details about this function, you can consult BYD authorized service station.

Fuel tank cap

1



1. To open the fuel filler door, pull the lever up.

Turn off the hybrid system during refueling.

WARNING

- Do not smoke, cause spark or allow open flames when refueling. The fumes are flammable.
- When opening the cap, do not remove the cap quickly. In hot weather, fuel under pressure could cause injury by spraying out the filler neck if the cap is suddenly removed.
- Insert the fuel nozzle fully, or fuel may splash out.

2

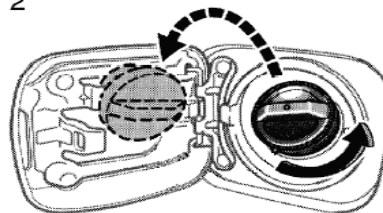

2. To remove the fuel tank cap, turn the cap counterclockwise by 90 degrees (to the pressure point 1), and then turn it a additional 30 degrees (to point 2). Pause slightly before removing it.

It is not unusual to hear a slight swoosh when the cap is opened.

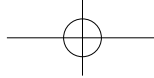

 **WARNING**

- Make sure the cap is installed securely to prevent fuel spillage in the event of an accident.
- Use only a genuine BYD fuel tank cap for replacement. It is designed to regulate fuel tank pressure.

NOTICE

To prevent damage to the cap, apply force only in the turning direction to the cap. Do not pull or pry it.

3. The removed cap can be stored on the back side of the fuel filler door. Position the cap so that the hooks point to the left and right, and set it in the receptacle on the back side of the door.

When installing the cap, turn the cap clockwise until you hear a click. And check whether the cap is tightened securely. Make sure the cap is tightened securely. If the cap is not tightened securely, the malfunction indicator lamp will come on. The indicator lamp will go off when driving. , Contact your Toyota dealer as soon as possible if the indicator lamp does not go out.

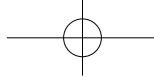

Chapter 1

Section 1-3

Operations of Instruments and Controllers Seats, Seat Belts, Steering Wheel and Rear-view Mirrors

Seats	44
Front Seats precautions	44
Rear Seats precautions	47
Middle Handrail of Rear Folding Seats	48
Seat Belts	48
SRS for Driver and SRS for Front Seat Passengers	52
Steering Wheel	62
Power Exterior Rearview Mirrors	63
Interior Rearview Mirror	64

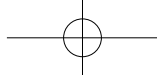

Seats

During driving, all vehicle occupants should have the seatback upright, sit well back in the seat and use seat belts provided correctly.

WARNING

- Do not drive the vehicle unless the occupants are properly seated. Never let passengers to ride in the cargo area or on top of a folded-down seatback, Persons not properly seated and/or not properly restrained by seat belts can be seriously injured in the event of emergency braking or a crash. During driving, Passengers should not stand up or change seats while the vehicle is moving. Otherwise, severe

injuries can occur in the event of emergency braking or a crash.

Front seats precautions

Driver seat

WARNING

- Sitting too close to a front driver airbag can result in serious injury or death if the front airbags inflate. The National Highway Traffic Safety Administration “NHTSA” advises: Since the risk zone for driver airbag is the first 50–75 mm (2–3 in.) of inflation, placing yourself 250 mm (10 in.) from your driver airbag provides you with a clear margin of safety. This distance is measured from the center of the steering wheel

to your breastbone. If you sit less than 250 mm (10 in.) away now, you can change your driving position in several ways: _ Move your seat to the rear as far as you can while still reaching the pedals comfortably. Slightly recline the back of the seat. Although vehicle designs vary, many drivers can achieve the 250 mm (10 in.) distance, even with the driver seat all the way forward, simply by reclining the back of the seat somewhat. If reclining the back of your seat makes it hard to see the road, raise yourself by using a firm, non-slippery cushion, or raise the seat if your vehicle has that feature.

- If your steering wheel is adjustable, tilt it downward. This



points the airbag toward your chest instead of your head and neck.

The seat should be adjusted as recommended by NHTSA above, while still maintaining control of the foot pedals, steering wheel, and your view of the instrument panel controls.

Front passenger seat

WARNING

- Sitting too close to a front passenger airbag can result in serious injury or death if the front airbags inflate. The front passenger seat should be as far from the airbag as possible with the seatback adjusted, so the front passenger sits upright.

Seat adjustment precautions

WARNING

- Once a seat is adjusted correctly , rock it back and forth to make sure it is locked in position.
- Do not adjust the seat in driving vehicle as the seat may unexpectedly move and cause the driver to lose control of the vehicle.
- Be careful that the seat does not hit a passenger or luggage.
- After adjusting the seatback, push your body back against the seat to make sure the seat is locked in position.
- Do not put objects under the seats. Otherwise, the objects may interfere with the seat-lock

mechanism or unexpectedly push up the seat position adjusting lever and the seat may suddenly move, causing the driver to lose control of the vehicle.

- While adjusting the seat, do not put your hands under the seat or near the moving parts. Otherwise, your hands or fingers may be caught and injured.

—Adjusting front seats



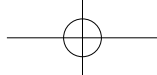

1. SEAT POSITION ADJUSTING LEVER

Pull up the handle 1, slide the seat backward and forward to the desired position. Release handle 1 and ensure the seat is securely locked in the position. (Make pedal plate, steering wheel and instrument panel within the scope of easy control for the driver).

2. SEATBACK ANGLE ADJUSTING LEVER

Lean forward and pull the lever 2 up. Then adjust the seat back to the desired angle and release the lever.

 **WARNING**

- Sitting too close to a front passenger airbag can result in serious injury or death if the front airbags inflate. The front passenger seat should be as far from the airbag as possible with the seatback adjusted, so the front passenger sits upright..

3. SEAT HEIGHT ADJUSTING KNOB

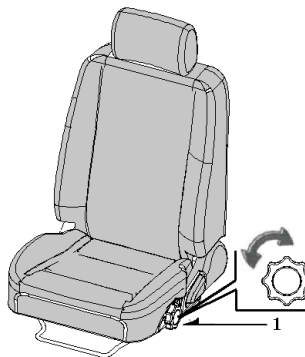

Rotate the knob 1 to adjust to the desired position.

3. WAIST-HOLDING ADJUSTING LEVER (Optional)



Turn the lever and adjust seaback lumbar support to the desired position.

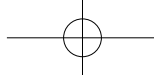

4. THE HEAD RESTRAINTS

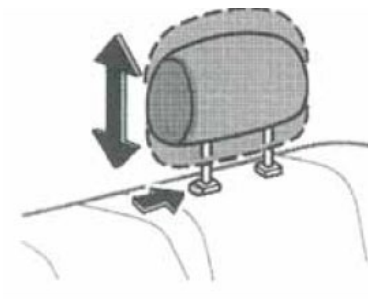

For your safety and comfort, adjust the head restraint before driving. Adjust the head restraints to the desired position while pressing the lock release button.

The head restraint is most effective when it is close to your head. Therefore, using a cushion on the seatback is not recommended

WARNING

- Adjust the center of the head restraint so that it is closest to the top of your ears.
- After adjusting the head restraint, make sure it is locked in position.
- Never remove head restraints while driving.

Rear Seats Folding down Rear Seats (optional)

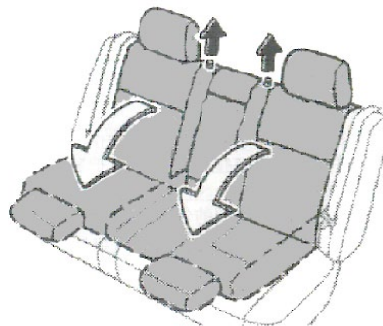

Lower the head restraints to the lowest position. Unlock release button and fold the seatback down.

Each seatback can be folded separately.

This could enlarge the luggage.

WARNING

- ◆ Never sit on the center seat because the rear center seat belt cannot be fastened correctly when the rear left seat is folded down.

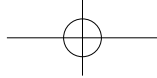
**⚠ WARNING**

- When returning the seatback to the upright position, observe the following precautions in order to prevent personal injury in a collision or sudden stop:
- Make sure seatback is securely locked by pushing forward and rearward on the top of the seatback. And make sure the red mark on the button on the top of seatback can not be seen. Failure to do so will prevent the seat belt from operating properly.
- Make sure the seat belts are not twisted or caught in the seatback and are arranged in the proper position and are ready to use.

Integral Rear Seats (optional)
It can not be folded.

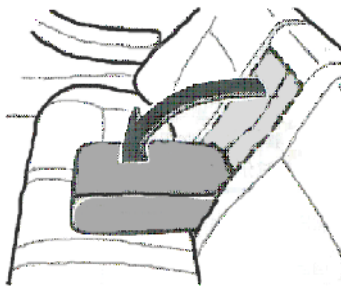
Middle Handrail of Rear Folding Seats (optional)

The middle handrail of rear seats, pull it out as shown in the figure above.

Seat belts—**—Seat belt precautions**

BYD strongly urges that the driver and passengers in the vehicle be properly

restrained at all times with the seat belts provided. Improperly positioning the seat belts can cause serious injury or death in a crash.

The seat belts provided for your vehicle are designed for people of adult size, who large enough to properly wear them.

If a child is large enough to properly wear seat belts, the child should sit in the rear seat and must be restrained using the vehicle's seat belt. According to accident statistics, the child is safer when properly restrained in the rear seat than in the front seat.

If all children can't be seated and restrained properly in a rear seating position, properly restrain the largest child in the front seat. If an accident occurs and seat belts are not worn properly, the force of the rapid inflation of the airbag may cause death or



serious injury to the child.

Do not allow any children to stand up or kneel on either rear or front seats. Otherwise child could suffer serious injury or death during emergency braking or a crash. Also, do not let the child sit on your lap. Holding a child in your arms does not provide sufficient restraint.

Pregnant woman. If you are pregnant, BYD recommends consult with your doctor for specific suggestion each time. Keep the lap belt as low as possible across the hips and not on the waist.

Injured person. BYD recommends to wear a seat belt .Depending on the injury,first check with your doctor for specific suggestion.

⚠ WARNING

The seat belts provided for your vehicle are designed for people of adult size, large enough to properly wear them If the child isn't large enough to properly wear the vehicle's seat belt, it is not safty for the child on the vehicle.

Follow the instructions below when using seat belt:

- One seat belt shall be applied to one passenger only. It's not allowed that two or more passengers share one seat belt—even for children.

- Do not over slant the seat back. The seat belt provides the maximum protection when the seat back is in the upright position.(Refer to instructions on seat adjustment).

- Do not damaging the belt or other parts of the seat belt. Keep them from being caught in the seat or the door.

- Check the seat belt regularly whether it is cut, worn or loose. Damaged parts shall be replaced with new ones. Do not disassemble or modify the system.

- Keep seat belt clean and dry. Clean it with neutral soap or lukewarm water. Bleaching agents, dyes or grinding cleaning agents are not suitable for seat belt cleaning - they may severely damage the seat belt. (refer to “Interior Cleaning” in section 5 for detail)

- The seat belt system (including bolts) should be replaced after serious crashes, even if the damage is not obvious.

—Fastening front and rear seat belts

3-point Seat Belt

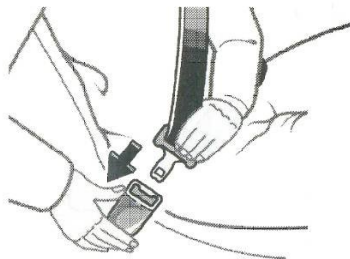

Adjust the seat to desire position and sit up straight and well back in the seat. To fasten your belt, pull it out from the retractor and insert the tab into the buckle.

Tug on the belt to make sure the belt is securely latched. Check that the belt is not twisted, A twisted belt can cause serious injuries in a crash.

The seat belt length automatically adjusts to your size and the seat position.

The retractor will lock the belt during a sudden stop or in crash. It also may lock if you lean forward too quickly. A slow, easy move will be allowed, and you can move around freely.

If the seat belt cannot be pulled out of the retractor, firmly pull the belt and release it. The seat belt will be able to pull out from the retractor.

⚠ WARNING

- After inserting the tab, make sure the belt is securely latched and that the belt is not twisted.
- Do not insert coins, clips, and other little things. In the buckle as this may prevent you from properly latching the tab and buckle.
- If the seat belt does not function normally, immediately contact your BYD authorized dealer. Do not use the seat until the seat belt is repaired, because it cannot protect an occupant from injury.

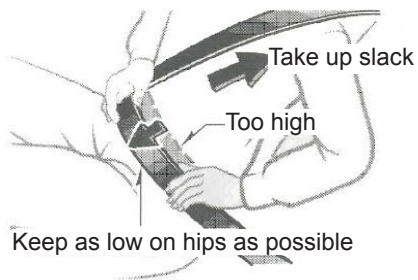
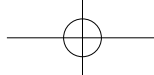

Adjust the position of the lap and shoulder belts.

Position the lap belt as low as possible across your hips—not on your waist, then pull up on the shoulder part of the belt so the lap part fits snugly. This lets your strong pelvic bones take the force of a crash and reduces the chance of internal injuries.

WARNING

- Both high-positioned lap belts and loose-fitting belts could cause serious injuries due to sliding under the lap belt during a collision or other unintended event. Keep the lap belt positioned as low on hips as possible.
- Do not place the shoulder belt under your arm
- Make sure all seat belts are properly positioned before driving.

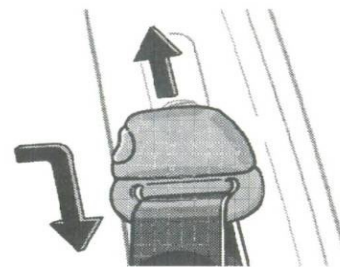

Seat belts with an adjustable shoulder anchor—

Adjust the shoulder anchor height to fit your body.

To raise: move the anchor up.

To lower: Press the lock release button and slide the anchor down.

Make sure the anchor is locked in position after adjustment.

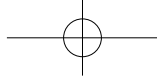

⚠ WARNING

- Always make sure the shoulder belt is positioned across the center of your shoulder. The belt should be kept away from your neck and not cross your arm instead of your shoulder. Failure to do so could reduce the amount of protection in an accident and cause serious injuries in a collision.

2-point Seat Belt

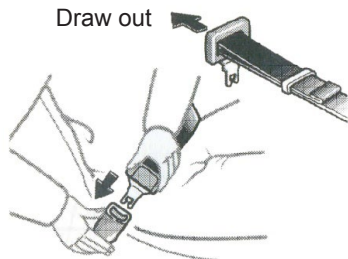

Adjust the seat as needed and sit up straight and well back in the seat. To fasten your belt, pull it out from the retractor and insert the tab into the buckle.



To release the belt, press the buckle release button and allow the belt to retract.

If the belt does not retract smoothly, pull it out and check for kinks or twists. Then make sure it remains untwisted as it retracts.

SRS driver and front passenger airbags

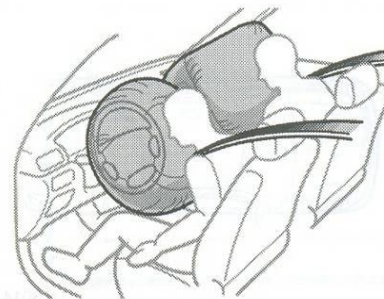

The SRS (Supplemental Restraint System) front airbags provide further protection for the driver and front passenger in addition to the primary safety protection provided by the seat belts.

In response to a severe frontal impact, the SRS front airbags work together with the seat belts to reduce



injury by inflating. The SRS front airbags reduce injuries mainly to the driver's or front passenger's head or chest caused by hitting the vehicle interior.

The front passenger airbag is activated even with no passenger in the front seat.

SRS is an auxiliary device for seat belt, which can protect passengers' head and chest from serious injury in severe front crashes.

SRS cannot supersede seat belts and is only a part of the whole passive safety protection system of the vehicle. Note that SRS has the best protection performance only when working together with fastened seat belts. For the safety of yourself and your family, please pay special attention to the "warning" and "Notice" in this section.

WARNING

- The SRS airbag system is designed only as a supplement to the primary protection of the driver side and front passenger side seat belt systems. The front seat occupants can be killed or seriously injured by the inflating airbags if they do not wear the available seat belts properly. During sudden braking just before a crash, an unrestrained driver or front passenger can fall forward into direct contact with or close proximity to the airbag which may then deploy during the collision. To ensure maximum protection in an accident, the driver and all passengers in the vehicle must wear their seat belts

properly. Wearing a seat belt during an accident reduces the chances of death or serious injury or being thrown out of the vehicle.

- Improperly seated and/or restrained infants and children can be killed or seriously injured by the deploying front airbags. An infant or child who is too small to use a seat belt should be properly secured using a child restraint system. BYD strongly recommends that all infants and children be placed in the rear seat of the vehicle and properly restrained. The rear seat is the safest for infants and children.
- Please keep sitting in correct posture so that you can get the maximum protective effect of the seat belt and SRS.

- Do not dismantle parts of SRS without permission.

The airbag SRS is designed to activate when the vehicle sustains sufficient longitudinal deceleration in severe (usually frontal) collisions where the forward deceleration of the vehicle exceeds the designed threshold level.

The airbags did not inflate in a collision does not mean that something is wrong with the system. Rather, it means the forces were not sufficient to cause activation. Airbags can inflate in frontal and near frontal collisions, but not rollover, side impact, or rear impacts.

Always wear your seat belts properly.

System Components

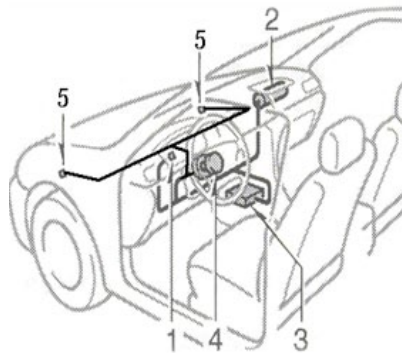

The SRS consists of the following components and their locations are shown in the illustration:

- SRS warning light
- Airbag module for front passenger (airbag and inflator)
- SRS electronic control unit (ECU)
- Airbag module for driver (airbag and inflator)
- Impact sensor

SRS ECU consists of a safing sensor and airbag sensor.

SRS Airbag Warning Indicator

SRS Airbag system is monitored by ECU and integrated self-diagnosis function. Its status is indicated by warning indicator on the instrument panel.

- Airbag warning light will be on for about 5 seconds after turning on ignition switch, which indicates that the system is normal.

This warning indicator monitors SRS airbag ECU, impact sensor, inflator, warning light, connecting wire and power supply. (For details, please refer to "Maintenance Indicator lights and Warning Buzzer" in Section 1-5)

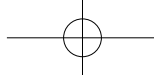
**⚠ WARNING**

If any of the following conditions, airbag system may have Malfunction troubles:

- The indicator is not on when turning on the ignition switch.
- Turn on the ignition switch, and 5 seconds later, the warning light remains on or it flashes and goes on again after going out.
- The indicator is on after turning off the ignition switch.
- The indicator comes on or flashes while driving.

⚠ WARNING

If any SRS trouble indicated by warning light, please contact your BYD authorized dealer for inspection as soon as possible. Otherwise, the airbag system can not work properly in case of accident

SRS Airbag Triggering Conditions

The airbag is triggered under the following conditions: severe frontal crashes and some special crashes.

In case of minor front collision, side collision, but it won't be triggered by rear collision or roll-over, airbag system generally won't be triggered.. In such accidents, fastening the seat belt, can protect the driver and passenger in the normal way.

The decisive factor for triggering SRS

is the result of judgment through comprehensive intelligent comparison of the deceleration curve, which is produced in a collision and acquired by the electronic control unit (ECU), with the set value. If the signals, such as deceleration, produced and detected in the collision is lower than the set reference value in the ECU, the airbag won't be triggered even though the car may have been severely deformed in the accident.

BYD SRS ECU on setting has taken various common misuse and domestic road conditions into full consideration. However, as causes and conditions of crashes are widely variable, for the sake of your safety, please strictly abide by this manual to use the vehicle correctly and avoid misuse; otherwise, the airbag may be incapacity.

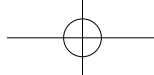

Protection Principle of SRS Airbag

If an impact results in a forward deceleration beyond the designed threshold level, the system triggers the airbag inflators. At this time a chemical reaction in the inflators very quickly fills the airbags with non-toxic gas to help restrain the forward motion of the occupants. The front airbags then quickly deflate, so that there is no obstruction of the driver's vision and it should be necessary to continue driving. When the airbags inflate, it is normal to notice a smoke-like, powdery residue or smell the burnt propellant. They produce a loud noise and release some smoke and residue along with non-toxic gas. This does not indicate a fire. This smoke may remain inside the vehicle for some time, and may cause some minor irritation to the eyes, skin or breathing. Be sure to wash off any

residue as soon as possible to prevent any potential skin irritation with soap and water. You shall exit the vehicle safely immediately if available.

While the system can reduce serious injuries, it may also cause minor abrasions, swelling or temporary hearing loss. Because airbags must inflate rapidly and with considerable force, there is the risk of death or serious injuries such as fractures, facial and eye injuries or internal injuries, particularly to occupants who are not properly restrained or are other out of position at the time of airbag deployment. Thus, it is extremely important that occupants be properly restrained as far away from the airbag cover as possible while maintaining vehicle control.

Parts of the airbag module (steering wheel hub, airbag cover and inflator)

may be hot for several minutes after deployment, so do not touch! The airbags inflate only once. The windshield may be damaged by the inflating airbag.

WARNING

Sitting too close to a front airbag can result in serious injury or death if the front airbags inflate.

BYD strongly recommends that:

- The driver sit as far back as possible from the steering wheel while still maintaining control of the vehicle.
- The front passenger sit as far back as possible from the dashboard.
- All vehicle occupants be properly restrained using the available seat belts.

**⚠ WARNING**

Do not sit on the edge of the seat or lean against the dashboard when the vehicle is in use, since the front airbags inflate with considerable speed and force. Otherwise, you may be killed or seriously injured. Sit up straight and well back in the seat, and always use your seat belt properly.

**⚠ WARNING**

Do not allow a child to stand up or to kneel on the front passenger seat, since the front airbag inflates with considerable speed and force. Otherwise, the child may be killed or seriously injured.

_ Do not hold a child on your lap or in your arms.

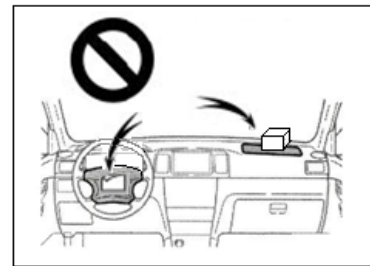
**⚠ WARNING**

Do not put anything on or over the airbag module. Placing objects on or over the airbag inflation area may cause those objects to be propelled by the airbag into your face and torso causing serious injury.

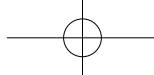

⚠ WARNING

- Do not service ,repair ,or modify any wiring.
- Do not service ,repair ,or modify any components , such as the steering wheel pad, steering wheel, column cover, front passenger airbag cover, front passenger airbag or SRS electronic control unit(ECU).

- Doing any of these may cause sudden SRS front airbag inflation or disable the system, which could result in death or serious injury.

Failure to follow these instructions can result in death or serious injury. Consult your BYD authorized dealer about any repairs and modifications.

⚠ WARNING

- Modifying or adding equipment to the front end of the vehicle (including frame,bumper ,front end body structure and tow hooks) may affect the performance of the airbag system , increasing the risk of injury .
- Do not modify the front end of the vehicle .
- Additional equipment may affect the performance of the airbag sensors increasing the risk of injury

Conditions for SRS Airbag Not to Be Deployed

Hit a cement pillar, tree or other slender objects.



Hit under a truck.



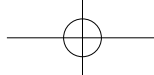

Suffer from being hit by other cars behind it.



Knock into a wall on its side.

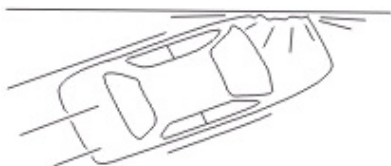

Suffer from being hit on its side by other cars.

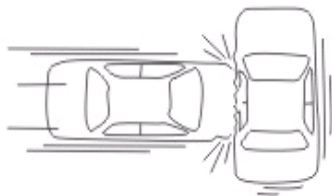

The car rolls.



In some conditions, SRS airbag may not be deployed, such as conditions in the figure above.

Conditions for SRS Airbag to Be Deployed

Hit bulges on the side of the road, safety strips or stones on the street.



Hit a deeper pit.



Hit the ground on the way down.



- In the conditions above, SRS airbag may be deployed, as shown in the figure above.
- If the car is subject to severe impact from the bottom, SRS airbag may be deployed.

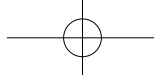

 **WARNING**

- SRS is designed to only match specified certain vehicle models, any variation in suspension, tire size, bumper, chassis and other original equipments may adversely affect the function of SRS. In addition, it is strictly prohibited to apply any airbag parts to other vehicle models; otherwise it might lead to SRS failure, resulting in personal injuries.
- During driving, please wear the seat belt properly and maintain a correct sitting posture. Otherwise, airbag deployment may increase the risk of injuries in accidents.
- It's very important for the driver to maintain a distance of at least

25cm between the chest and the steering wheel, which allows maximum protection when the airbag system is triggered. That is to say, it's necessary to adjust the front seats and the head restraint according to the figure of each occupant; in addition, the driver's arms shall only bend slightly, stretching nearly straight.

- Do not paste or cover the surface of the steering wheel lid or the surface near the airbag on the right of the instrument panel with any objects; and do not make any other decorative treatment at such places. These two places shall be cleaned only with dry or slightly wetted cloth, and it is prohibited to knock at such places violently.

- Never allow children to sit on the front seat without protection. If a collision triggers the air bag, the child passengers may get seriously injured or even killed.
- Don't leave any person, animal or object in the deployment range of driver/front seat passenger air bag. It is extremely dangerous for an adult to hold a child on the lap.
- Any accessories, such as phone holder, cup holder and ashtray, shall not be installed on airbag deployment lid or within airbag deployment range. Otherwise, risk of injury will be increased in the accident when SRS airbag is triggered.
- Don't make any modification to any part of the airbag system,



including labels.

- All operation to the airbag, including removal of airbag required for repairing other parts (such as detachment of the steering wheel), can only be made by BYD authorized dealer.
- The airbag system must be replaced in a BYD authorized dealer within 15 years as of the date of delivery (manufacture date indicated on the quality certificate and Repair Manual). If the airbag is replaced before that date, it shall be recorded in the Repair Manual.
- The airbag is disposable. Once the air bag is triggered or damaged, the system must be replaced.
- Please hand over all material

supplied with the vehicle to the next owner when transferring the car.

- When disposing the car or parts of SRS, please comply with applicable safety regulations and disposal procedures. BYD authorized dealer have a good knowledge of these regulations and the detailed disposal procedure is also available on Repair Manual.
- The air bag system has strong resistance capacity against the surrounding electromagnetic interference. However, to avoid accidents, please do not use the vehicle beyond the electromagnetic environment specified by national laws.
- SRS has taken various misuses

and road conditions into full consideration. However, avoid serious impact at the bottom of the car and do not drive roughly in poor road conditions in order to prevent accidents.

Supplemental Information

- Please read this manual carefully. If you want to transfer or dismantle the vehicle, please notify the owner or the demolition unit that the car is equipped with airbag system, and recommend them to read the manual carefully.
- After the airbag system is deployed, please don't touch any part of the airbag module to avoid burning, and ask a BYD authorized dealer to remove it. Once the air bag has been deployed, please install a new airbag system as soon as possible.

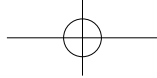

- The airbag system only functions in case of serious frontal collisions. It doesn't mean that the airbag system has problems when it doesn't respond to the collision, but improper maintenance or failure to repair may affect the normal performance of the airbag system.

- _ There is collision at the front part of the vehicle (shaded part in the illustration) which is not severe enough to trigger the deployment of the airbag. The pad section of the steering wheel or front passenger airbag cover (shaded in the illustration) is scratched, cracked, or has other damages.

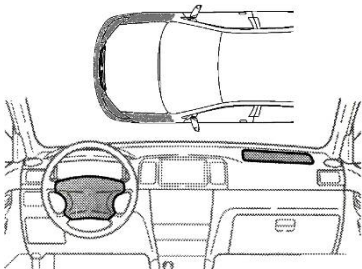

If any of the following cases, please contact your BYD authorized dealer as soon as possible:

- _ The SRS front airbags have been inflated.

Steering Wheel

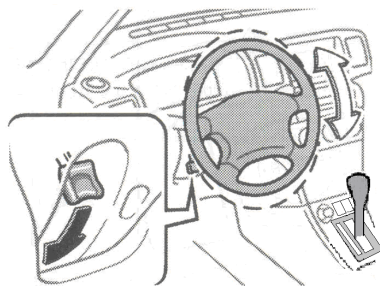

To change angle of steering wheel, hold the steering wheel and push down the lock release lever, then adjust the

steel wheel to desired angle and push the lever up to lock the steering wheel in position.

WARNING

Do not adjust the steering wheel while the vehicle is moving. Doing so may cause the driver to mishandle the vehicle and an accident may occur resulting in death or serious injuries.

- _ After adjusting the steering wheel, try moving it up and down to make sure it is locked in position.

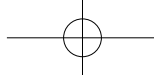

Outside Rearview Mirrors

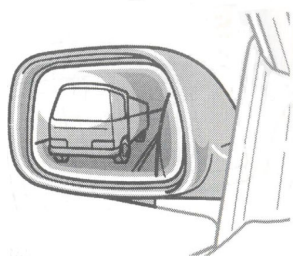

Adjust the mirror so that you can just see the side of your vehicle in the mirror.

Be careful when judging the size or distance of any object seen in the outside rear view mirror on the passenger's side because it is a convex mirror. Any object seen in a convex mirror will look smaller and farther away than when seen in a flat mirror.

WARNING

Do not adjust the mirror during driving. Doing so may cause the driver to mishandle the vehicle and an accident may occur resulting in death or serious injuries.

outside Rear-view Mirror Controller

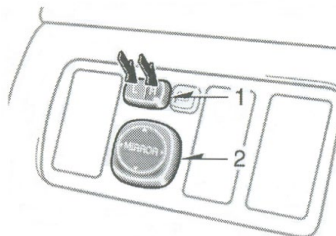

Adjust the outside rear-view mirror with this switch.

1. Selection switch – it is used to select the outside rear-view mirror which shall be adjusted.

Press the switch to select L (left) or R (right).

2. Control switch – it is used to adjust the outside rear-view mirror.

Push the switch in the desired direction.

When ignition switch is at "ACC" or "ON", you can adjust the mirror.

Notice

If ice should jam the mirror, do not operate the control or scrape the mirror face. Use a spray de-icer to free the mirror.

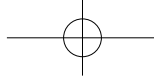

Inside Rearview Mirror

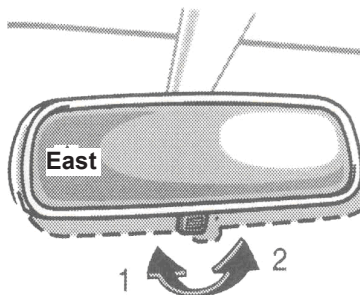

Adjust the interior rearview mirror to an angle where you can just see the rear of the vehicle inside.

During night driving, you can pull the adjusting lever on the lower edge of the mirror to weaken the glare caused by headlights of the following vehicle.

Daytime driving—the lever is at position 1.

At this position, the reflection in the rearview mirror has greater clarity.

Night driving—the lever is at position 2.

Note that the rearview clarity may be slightly reduced to weaken glare at night. Inside rearview mirror has direction indication function, which will be activated when: Ignition switch is at ACC/ON.

WARNING

Do not adjust the mirror while the vehicle is moving. Doing so may cause the driver to mishandle the vehicle and an accident may occur resulting in death or serious injuries.

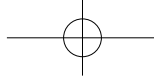

Chapter 1

Section 1-4

Operation of Instruments and Controls Lights, Wipers, EV and HEV Switch

Headlights and Turn Signals.....	66
High Mount Brake Light.....	67
Emergency Flashers	67
Front Fog Light(optional).....	68
Rear Fog Light	68
Rear Interior Light	69
Ignition Key Warning Light	69
Front Windshield Wipers and Washer.....	70
EV and HEV Switch	71
Multi-function Switch	72

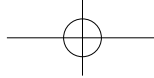

Headlights and Turn Signals

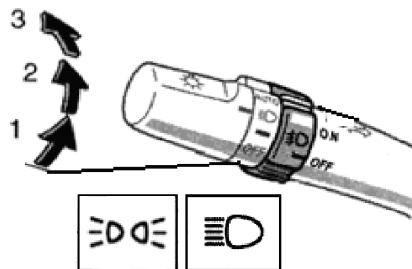

To turn on the following lights: Twist the headlight/ turn signal lever knob.

Position 1 – width-indicator lights, license plate light and instrument illumination lamps, overall unit backlight, etc.

Position 2 –headlights and all of the above.

Position 3 (“Auto”) – headlights and/or all of the above (same with position 2). They automatically turn on or off depending on the darkness of the

surroundings, When in position3, it can automatically turn on the light while driving into the dark areas.

NOTICE

To prevent the battery from being discharged, do not leave the lights on longer than necessary when the DM system is not running.

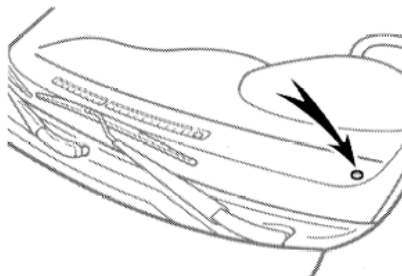

The automatic light control sensor is on the top of the driver's side instrument panel.

Do not place anything on the instrument panel, and/or do not affix anything on the windshield to block this sensor.

Light Reminder Buzzer

If you open driver-side door and remove the key when the width-indicator lights are turned on, the buzzer will sound warning tone, reminding you to turn off the lights.

NOTICE

To prevent the battery from being discharged, do not leave the switch on longer than necessary when the DM system is not running,

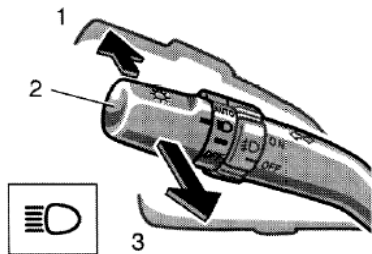
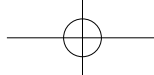

High / low beams – For high beams, turn the headlights on and push the level away from you (position 1). Pull the level toward you (position 2) for low beams.

The headlight beam indicator light (blue light) on the instrument panel will tell you that the high beams are on, Flashing the high beam headlights (position 3) -- pull the lever all the way back. The high beam headlights turn off when you release the lever, You can flash the high beam headlights

even with the knob turned to “OFF”.

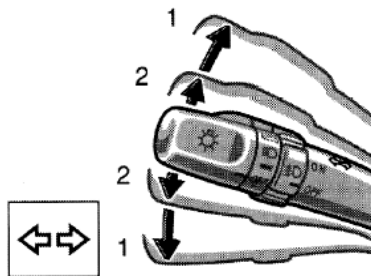

Turn Signals

To signal a right steering, push up your left handle to position1; to signal a left steering, push down your left handle to position1.

The DM system must be in the “IG-ON” mode.

The lever automatically returns after you make a turn, but you may have to return it by hand after you change lanes,

To signal a lane change, move the

lever up or down to the pressure point (position 2) and hold it.

If the turn signal indicator lights (green lights) on the instrument panel flash faster than normal, a front or rear turn signal bulb is burned out.

High Mount Brake Light

When you step on brake pedal, the light comes on together with the rear brake light, warning that the car is in braking to prevent accidents.

Emergency Flashers

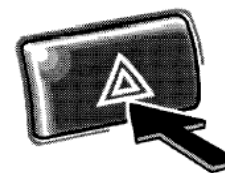

To turn on emergency flashers, just push this switch as shown on the

picture above.

All turn signal lights will flash. To turn them off, just push the switch once again.

Turn on the emergency flashers to warn other drivers if your vehicle must be stopped where it might be a traffic hazard. Always pull as far off the road as possible.

The turn signal light switch will not work when the emergency flashers are operating.

NOTICE

To prevent the battery from being discharged, do not leave the lights on longer than necessary when the DM system is not running.

Front fog lights (optional)

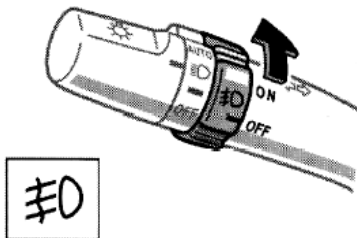

To turn on the fog lights, first twist left switch to the position of sidelight or headlight, then twist the front fog light switch to "ON".

Front fog indicator on the instrument panel indicates that the light comes on.

Rear Fog Light

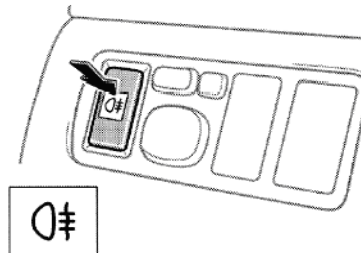

To turn on rear fog lights, push this switch. Rear fog light will go on in the following cases:

When front fog lights (optional) switch are turned on – when headlight or width-indicator lights are turned on, the rear fog lights will be turned on.

When front fog light (optional) switch is turned off – when the headlights are turned on, the rear fog lights will be turned on.

When there are no front fog lights – when headlights are turned on, press



the rear fog light switch, then the rear fog lights will be turned on.

When rear fog lights are turned on, the rear fog light switch indicator on the instrument panel will go on.

When headlights are turned off, even if you turn on the headlight switch again, the rear fog lights won't be turned on.

When all other lights are turned off, rear fog lights will go out automatically.

To turn on the rear fog lights, press the switch again under the condition mentioned above.

Rear Interior Light

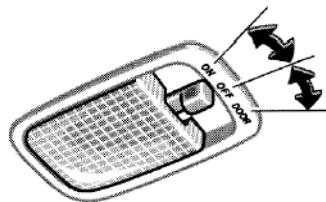

To turn on the interior light, slide the

switch.

The interior light switch has the following positions:

“ON” – Keeps the light on all the time.

“OFF” – Turns the light off.

“DOOR” – Turns the light on when any door is opened. When all doors are closed, this light will go out.

Illuminated Entry System

With the switch in the “DOOR” position, the light comes on when any of the doors is opened. When all the doors are closed, the light will remain on for 30 seconds.

However, in the following cases, the light goes off immediately:

- All the doors are closed when the DM system is in “IG-ON” mode.
- Using wireless remote control to close and lock all doors.

When all the doors are unlocked by

wireless remote control, rear interior light and ignition key warning light will remain on for 30 seconds.

You can enable or disable this function. Please refer to “Settings of Optional Functions” in Section 1-2.

Ignition Key Warning Light

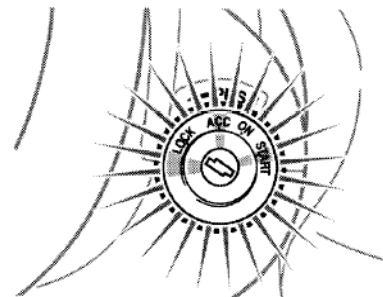

To see ignition switch easily, the ignition key warning light goes on when any doors are open.

- The light remains on for 30 seconds after all the doors are closed.

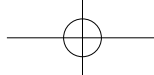

●When all doors are locked by using wireless remote control or after all doors are closed, turn the ignition switch to “ON”, then the light goes out.

●When all doors are unlocked by wireless remote control, the light will be on for about 30 seconds, even if the doors are not open.

You can enable or disable this function. Please refer to “Settings of Optional Functions” in Section 1-2.

Front Windshield Wipers and Washer

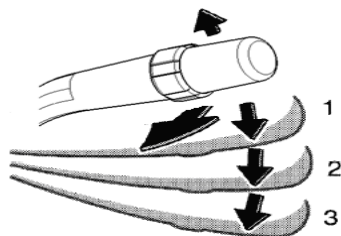

To turn on the windshield wipers, move the lever to the desired setting.

The DM system must be in the “IG-ON” mode.

Lever position	Speed Setting
Position 1	Intermittent
Position 2	Slow
Position 3	Fast

For a single sweep of the windshield, push upward the lever from OFF very quickly and then release, it will sweep once and then back to its position. It will continue sweeping if you push it longer than 0.5s. It will stop if you completely release it.

To squirt washer fluid, pull the lever backwards to yourself within 0.5s, it will squirt fluid without wiping the window; if it function for a long time,

it will continues squirt fluid with low speed wiping the window and when the windshield wipers are off, they will operate a couple of times after the washer squirts.

For instructions on adding washer fluid, see “Adding washer fluid” on Section 7-3.

In freezing weather, warm the windshield with the defroster before using the washer. This will help prevent the washer fluid from freezing on your windshield, which can block your vision.

NOTICE

Do not operate the wipers if the windshield is dry. It may scratch the glass.

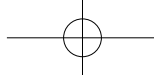

EV and HEV Switch

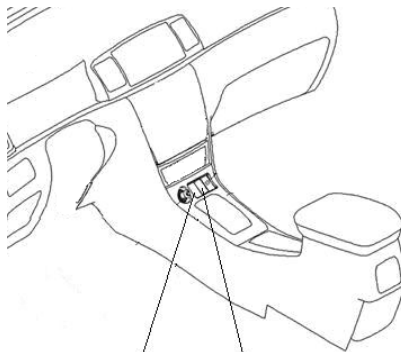

EV Switch HEV Switch

EV and HEV switches are designed to shift between EV mode and HEV mode. Indicator on the switch indicates that the vehicle runs under the corresponding mode.

EV Mode

In general conditions, push EV switch, then its indicator goes on and the vehicle runs under EV mode.

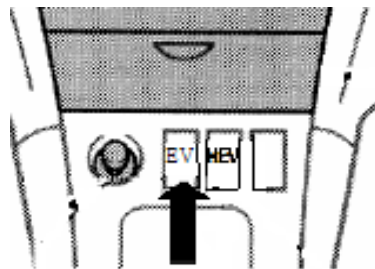

⚠ WARNING

- You are expected to make a proper choice according to the battery power, when the vehicle cannot shift to EV mode automatically.
- DM system can judge whether shift to HEV mode according to the actual situations and battery power while driving. DM system may shift to HEV mode automatically in case of rapid

acceleration or insufficient power.

- Be careful for the conditions around your vehicle when driving under pure EV mode, pedestrians may not aware your vehicle because of no noise of engine.

HEV Mode

Push HEV switch, then its indicator goes on and the vehicle runs under HEV mode.

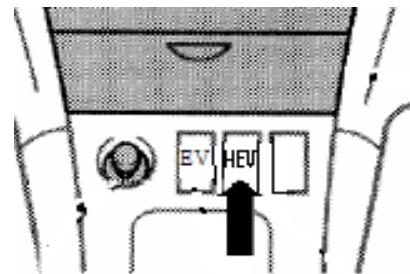

 **WARNING**

As EV and HEV have memory effect, the car will run in the mode used last time after starting.

If the power is very high, engine may not be able to start under HEV mode.

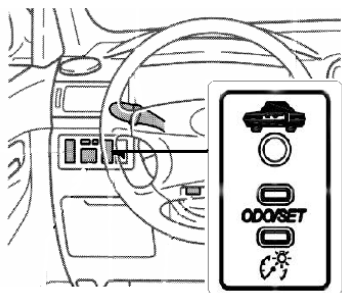

Multi-function Switch

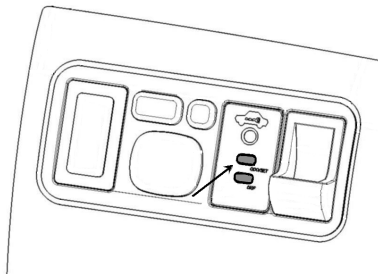

ODO/SET:

Every time you press ODO/SET button, the instrument will shift from odometer to trip odometer TRIP A, trip odometer TRIP A to trip odometer TRIP B, and trip odometer TRIP B to odometer. When readings of trip odometer TRIP A or TRIP B are displayed, long press ODO/SET button for over 2 seconds, readings of trip odometer will be cleared.

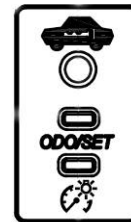

Backlight on the instrument panel

The backlight will circularly adjust five-range brightness when push the multi-function switch. (the light on instrument panel will go off when the width-indicator light comes on)



Chapter 1

Section 1-5

Operations of Instruments and Controls Instruments and Maintenance Indicators

Tachometer	74
Fuel Gauge	74
Engine Coolant Temperature Meter	74
Wattmeter	75
Battery Coulomb Meter	75
Electric motor Coolant Temperature Meter	76
Odometer and Trip Meter	76
Service Reminder Indicators & Warning Buzzers	77

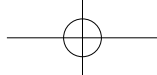

The left information display screen displays tachometer, fuel gauge, engine coolant temperature meter, electric motor coolant temperature meter, odometer, wattmeter, etc.

The right information display screen displays coulomb meter, energy conversion prompt, gears and power mode.

Tachometer



Tachometer displays the engine speed by 1000times rpm (round per minute). In pure EV mode, it is normal that

the tachometer does not indicate the rotating speed while in HEV mode the tachometer shall work and indicate the rotating speed of engine.

Fuel Gauge

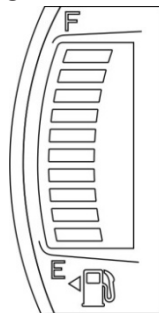

When power supply is ON, this fuel gauge indicates the approximate quantity of fuel remaining in tank.

Nearly full – Indicator at “F”.

Nearly empty – Indicator at “E”.

Generally the tank shall be kept more than 1/4 full.

When braking, accelerating or turning a corner, the meter may swing because of the fuel sloshing in the fuel tank.

If the fuel level approaches “E” or the low fuel level indicator light turn on, fill the fuel tank as soon as possible.

When driving on a slope or turning a corner, fuel in the tank may slosh, the fuel indicator may fluctuate or low fuel level warning light may often comes on earlier.

Engine Coolant Temperature Meter

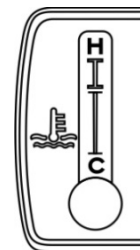

When power supply is ON, this

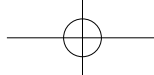

Meter indicates the engine coolant temperature when the engine is working. The engine temperature varies with climate and engine load capacity.

The light comes on, warning that the engine coolant temperature is too high. so please stop the car immediately to cool down the engine.

The engine may get overheated in the following cases:

- Driving up a long hill on a hot day. ;
- When the car is used to tow a trailer.

⚠ CAUTION

- Do not remove the thermostat in the engine cooling system, otherwise the engine may run abnormally.
- When the warning light is on, please stop the car to cool down

the engine or the electric motor, otherwise, the engine would be damaged. If the light flashes repeatedly, please contact BYD authorized dealer for help.

Wattmeter

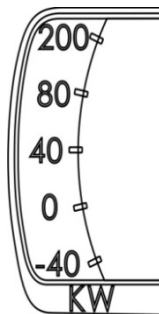

When the power supply is "ON", this meter indicates the power of the overall unit.

When the wattmeter indicates negative value, overall unit is in power feedback

rather than having any abnormalities.

Battery Coulomb Meter

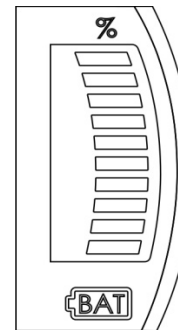

When ignition switch is turned on, this meter indicates the power of battery. If the meter points at red area, it indicates the battery power is too low. In this case, please go to charging station to charge the battery as soon as possible.

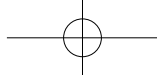

Electric motor Coolant Temperature Meter

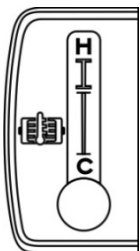

When power supply is ON, this meter indicates the electric motor coolant temperature when electric motor is working. The electric motor temperature varies with climate and load capacity.

Odometer and Trip Odometer

By pressing ODO/SET button on the central control panel, indications of odometer and trip odometer will be displayed alternately.



Information is displayed as follows:

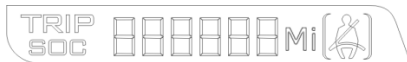
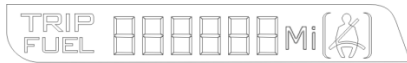

1. ODO – shows the total distance the vehicle has been driven.
2. TRIP A/TRIP B – shows the distance

driven since the trip meter was set to zero at the last time.

3. TRIP FUEL – shows the driving mileage with the engine involved.

4. TRIP SOC – shows the driving mileage without the engine involved.

To reset the Trip Meter to zero, please press ODO/SET button for over 2 seconds when display the Trip Meter reading.

Instruments Backlight Adjustment







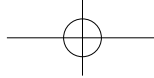

By pressing backlight adjusting button on the central control panel, you can adjust the backlight brightness circularly.







Power Conversion Indicator

The right information display screen indicates the corresponding conversion of fuel, power and the driving energy of the overall unit, according to the actual status of usage.



Service Reminder Indicators & Warning Buzzers

	If the indicator or buzzer comes on	You shall do
(a)		Parking Brake System Indicator Possible cases: low braking fluid level, braking system failure, or parking brake is not released. You shall release parking brake or stop immediately and contact BYD authorized .dealer.
(b)		Driver's Seat Belt Reminder Indicator Fasten driver's seat belt.
(c)		Auxiliary Battery Charging System Indicator Stop immediately and contact BYD authorized dealer..
(d)		Low Oil Pressure Indicator Stop immediately and contact BYD authorized dealer..
(e)		Malfunction Indicator Lamp Stop immediately and contact BYD authorized dealer..
(f)		Low Fuel level Indicator Fill up the tank.
(g)		Anti-lock Brake System(ABS) Indicator Stop immediately and contact BYD authorized dealer..
(h)		Open Door Indicator Check and make sure all doors are closed properly.

(i)		SRS Indicator Take vehicle to BYD authorized dealer immediately.
(j)		High coolant temperature Indicator Stop immediately and cool down the engine or electric motor.
(k)		Hybrid System Warning Light Stop immediately and contact BYD authorized dealer..
(l)	P/S	Electric Power Steering System Warning Indicator Stop immediately and contact BYD authorized dealer..
(m)		Low Power Indicator Charge the power battery.
(n)		Power Battery Failure Indicator Stop immediately and contact BYD authorized dealer..
(o)		Electric Motor Failure Indicator Stop immediately and contact BYD authorized dealer..
(p)		DC-DC Fault Indicator This light comes on when there is a fault in DC-DC system. Please stop your car immediately and contact BYD dealer.
(q)	Key reminder buzzer	Remove the key.
(e)	Light reminder buzzer	Turn off the light.

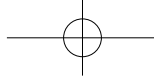
**(a) Brake System Warning Indicator**

These indicators come on in the following cases when the “IG-ON” mode is enabled.

When the brake fluid level is low.

When parking the car and the parking brake is applied.

When ABS system failure.

CAUTION

It is dangerous to continue driving when the brake fluid level is low and brake system is at fault.

Have your vehicle checked at BYD authorized dealer in the following cases:

The indicators do not come on even if the parking brake is applied when the “IG-ON” mode is enabled.

The indicator are always on even after

the parking brake is released when the “IG-ON” mode is enabled.

The parking brake system indicator remains on together with the “ABS” indicator.

(b) Seat Belt Reminder Indicator

This indicator reminds you to buckle up the driver's seat belt.

Once the “IG-ON” mode is enabled, the reminder indicator flashes if the driver's seat belt is not fastened. Unless the driver fastens the belt, the indicator keeps on flashing.

(c) Auxiliary Battery Charging System Indicator

This indicator warns that there is a problem somewhere in the auxiliary battery charging system.

If it comes on while you are driving, please contact BYD authorized dealer.

(d) Low Oil Pressure Indicator

This indicator warns that engine oil pressure is too low.

If it keeps on while you are driving, stop immediately and contact BYD authorized dealer..

When the engine is started, this indicator might flash occasionally or come on of short duration after emergency braking. It is normal that this indicator goes out when speeding up gradually.

The indicator comes on when the oil level is extremely low. The indicator is not designed to indicate the oil level, which must be checked by the dipstick.

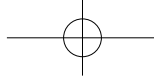
**NOTICE**

Do not drive the vehicle with the indicator on—even for one block. It may ruin the engine.

(e) Malfunction Indicator Lamp

This lamp comes on when there is a fault in engine EFI system.

When this lamp is on, please contact BYD authorized dealer for help.

(f) Low Fuel Level Indicator

This indicator flashes when the fuel tank becomes nearly empty. refuel as soon as possible.

When driving on a slope or turning a corner, shaky fuel in the tank may cause the indicator be turned on earlier.

(g) Anti-lock Brake System (ABS) Indicator

The indicator comes on when the “IG-ON” mode is enabled. If the anti-lock brake system works properly, the indicator turns off in few seconds. Thereafter if the system malfunctions, the indicator comes on again.

When the “ABS” indicator is on (the braking system indicator is off), the anti-lock brake system does not operate but the brake assist system still operates. In this case, the wheels could lock up during a sudden braking or braking on slippery road surfaces. If either of the following conditions occurs, this indicates a malfunction somewhere in the parts monitored by the warning light system, and please contact BYD authorized dealer as soon as possible.

The indicator does not come on or

keeps on when the “IG-ON” mode is enabled.

The indicator comes on while you are driving.

⚠ CAUTION

If the ABS indicator remains on together with the parking brake system indicator, immediately stop your and contact BYD authorized dealer.

In this case, not only the anti-lock brake system will fail but also the vehicle will become extremely unstable during braking.

(h) Open Door Indicator

This indicator remains on until all the doors are completely closed.

**(i) SRS Indicator**

This indicator will come on when the “IG-ON” mode is enabled. After about 5 seconds, the indicator will go off. This means the system of the airbag is operating properly.

This indicator system is intended to monitor airbag ECU, crash sensor, air charging device, warning indicator, interconnecting wiring and power sources..

If either of the following conditions occurs ,this indicates a malfunction somewhere in the parts monitored by the indicator system. Please contact BYD authorized dealer as soon as possible to service the vehicle:

- The indicator does not come on when the “IG-ON” mode is enabled or remains on.
- The indicator comes on while driving.

(j) High Coolant Temperature Indicator

The indicator operates to warn that engine and electric motor are almost overheating. Park the car immediately to cool down the engine or electric motor.

The engine or electric motor may get overheated in the following cases:

Driving up a long hill on a hot day;
lack of or leakage of the coolant fluid.

When the car is through the stop-and-go pattern in driving, the AC device is on together with the engine idle running for a long time.

When the car is used to tow a trailer

(k) Hybrid System Warning Indicator

This indicator will come on when the “IG-ON” mode is enabled. If the Dual Model system is working normally, the indicator will go off after several seconds. Later if the system

malfunctions, this indicator comes on again.

If any of the following cases occurs, this indicates a malfunction somewhere in the parts monitored by the indicator system and please contact BYD authorized dealer as soon as possible.

The indicator does not come on when the “IG-ON” mode is enabled or remains on.

The indicator comes on while driving.

NOTICE

Do not drive the vehicle with the indicator on—even for one block. It may ruin the power system.

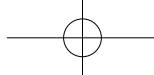

(l) Electric Power Steering System Warning Indicator

This indicator will come on when the "IG-ON" mode is enabled. If EPS system is working normally, the indicator will go off after several seconds. Later if there is a fault in the system, this indicator will come on again.

If any of the following cases occurs, this indicates a malfunction somewhere in the parts monitored by the indicator system and please contact BYD authorized dealer as soon as possible.

- The indicator does not come on when the "IG-ON" mode is enabled or remains on.
- This indicator comes on while driving.

CAUTION

If any of the following cases occurs, immediately stop your vehicle and contact BYD authorized dealer immediately. In this case, swerve would be very inflexible. You should hold the steering wheel firmly while driving.

- The indicator does not come on when the "IG-ON" mode is enabled or remains on. In this case, EPS system may not work normally, so please park your car in a safe place.
- This indicator comes on while driving.

(m) Low Power Indicator

The indicator comes on when the power is low, warning that driver shall lower the car speed and charge the battery immediately after parking.

(n) Power Battery Failure Indicator

This indicator comes on when something was wrong.

If any of the following cases occur, this indicates a malfunction somewhere in the parts monitored by the indicator system and please contact BYD authorized dealer as soon as possible.

- The indicator remains on when the "IG-ON" mode is enabled.
- The indicator comes on while driving.

(o) Electric Motor Failure Indicator

The indicator comes on when there is a failure in electric motor system.

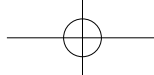

If any of the following cases occur, this indicates a malfunction somewhere in the parts monitored by the indicator system, and please contact BYD authorized dealer as soon as possible.

- The indicator does not come on when the “IG-ON” mode is enabled or remains on.
- The indicator comes on while driving.

(p) Key Reminder Buzzer

This buzzer reminds you to remove the key if you open the driver's door when the ignition key is on “ACC” or “LOCK”.

(q) Light Reminder Buzzer

This buzzer reminds you to turn off the light if you open the driver's door, with parking light or headlight on,

Check Maintenance Indicator Lights

1. Pull up the brake parking handle.
Braking system warning light will come on.

2. Open a door.

The open door indicator comes on when the door does not close completely.

3. Close all the doors.

The open door indicator goes off when all doors closed completely.

4. When the “IG-ON” mode is enabled, apart from indicator for opened door, all the maintenance indicator lights come on. Several seconds later, ABS system fault indicator and SRS fault indicator go out.

If any maintenance indicator light or buzzer does not function as per the procedure above, please have the car checked in BYD authorized dealer as soon as possible.

NOTICE

If the red warning indicators (such as auxiliary battery charging system indicator, parking brake system indicator, low oil pressure indicator, high coolant temperature indicator, Hybrid system warning indicator, Electric Power Steering System Warning indicator, power battery failure indicator, electric motor failure indicator on the instrument panel come on while driving, please park your car immediately and check for fault as per instructions in this manual. If necessary, please contact BYD authorized dealer for help

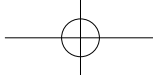

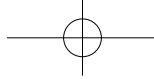

Chapter 1

Section 1-6

Operations of Instruments and Controllers Ignition Switch, Parking Brake and Parking Assistance System

Ignition Switch Equipped with Steering Wheel Auto-locking Mechanism	86
Parking Brake	86
Parking Assistance System	87

Ignition Switch Equipped with Steering Wheel Auto-locking Mechanism

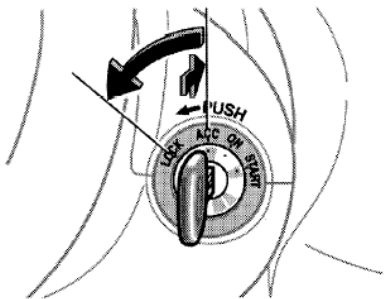

“START” – reserved gear.

“ON” – start DM system and turn on all the auxiliary equipment.

When the ignition switch is turned to “ON”, each system of the vehicle performs self-detection function.

“ACC” – only auxiliary equipment such as radio can be operated, but other

high-voltage equipment cannot be operated.

If you open the driver-side door with the key in the position “ACC” or “LOCK”, the buzzer will sound to remind the driver to remove the key.

“LOCK” – DM system stops working and steering wheel is locked. You can remove the key only in this position.

Make sure you insert the key completely before turning it from “ACC” to “LOCK”.

When you start DM system, if the key seems to be locked in the position “LOCK”, firstly you should make sure the key is inserted completely and then turn the key while turning the steering wheel gently

Parking Brake

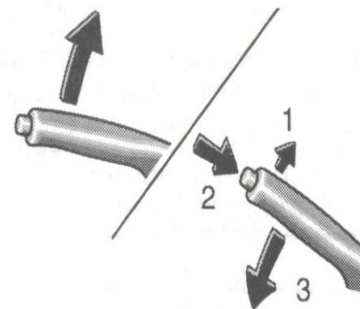

When parking your car, you must pull up the parking brake firmly to prevent the car from sliding.

To set: Pull up the parking brake handle .For better parking effect, firstly, depress the brake pedal until the vehicle completely stops, then pull up the parking brake handle firmly.

To release: pull up the parking brake handle (as shown mark 1 in picture above) gently, then press down the

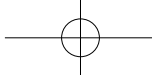

button (as shown mark 2 in the picture above) and then release it (as shown mark 3 in the picture above).

To remind you that the parking brake has been set, the parking brake indicator light in the instrument panel is on until you release the parking brake.

NOTICE

Before driving, make sure that parking brake is fully released and the parking brake indicator is off.

Parking Assistance System

WARNING

Please follow the instructions below, otherwise it may cause unsafe driving which may result in an accident:

Do not use the parking assistance system when the speed exceeds 10Km/h (6.21miles/h).

- Do not add anything to the parking assistance system within the working scope of the sensor.

NOTICE

Before washing your BYD F3DM, be sure to observe the following instruction to avoid the risk of damage to your vehicle:

Do not wash the sensor with water or steam, otherwise it may cause malfunction of the sensor.

When parking the car, the parking assistance system, which can probe barriers through a sensor, will remind the driver of the distance between the car itself and the barriers through the buzzer. Please make sure to pay attention to the area around your vehicle when using this system.

Sensor Types

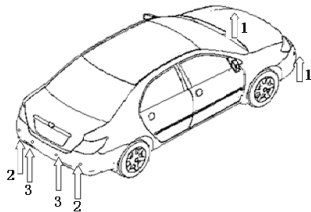



1. Front Corner Sensor
2. Rear Corner Sensor
3. Rear Central Sensor

Parking Assistance Sensor Switch

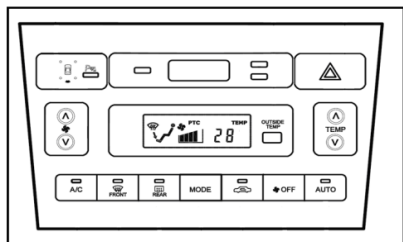
When the power supply is at “ON” and the switch turns on, the system enters working status.



When pressing the switch , the button  will light up to remind the drivers that the system is working.

Alarm

When any obstacles are detected by the sensor, the system will give off different alarms according to the shape of the obstacles and the distance between the vehicle and the obstacles,

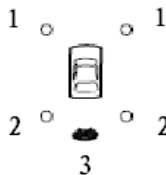

1. Front corner sensor is working
 2. Rear corner sensor is working
 3. Rear central sensor is working
- When any obstacles are detected, the indicator in corresponding position will

light up.

Distance Display and Buzzer

When any obstacles are detected by the sensor, the indicator in corresponding position will flash according to the distance between the obstacles and the vehicle with the buzzer giving off the sound for warning.

Working Example of Rear Central Sensor

Approximate Distance	Indicators	Alarm
120 to 80 cm	Flash	Slow
80 to 50cm	Flash	Fast
50cm or shorter	Always On	Last for seconds



Working Example of Front Corner Sensor

Approximate Distance	Indicators	Alarm
60 to 50cm	Flash	Fast
50cm or shorter	Always On	Last for seconds

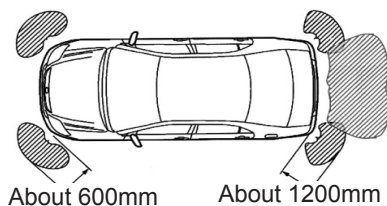

Sensor in working status

Front sensor will work when vehicle is driven forwards; and all the sensors will work when vehicle is driven backwards.

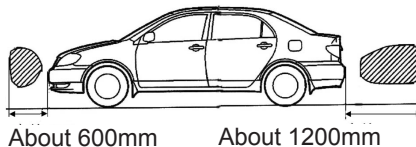

The probing range of sensor is displayed in the figure above. Please note that object extremely closed to the car may not be detected by the sensor and the probing range of sensor may vary with the shapes and materials of the obstacles.

Sensor-Detected Information

Accuracy of detection may be affected by some car conditions and surroundings. Possible causes are listed below:

- The sensor is dirty, wet or misty;
- The sensor is snowy or frozen;
- The sensor is covered;
- The car leans to one side obviously

or overloaded;

- Driving on the rugged road, slope, gravel road or grassland;
 - The sensor is repaired;
 - It is noisy around the car, due to the sound of horn, motorcycle's engine, air brake of large vehicles or other noises generating ultrasonic waves.
 - There is another car equipped with parking assistance system nearby;
 - Towing ring is installed in the car;
 - The bumper or sensor is hit strongly;
 - The car are close to a higher or zigzag road curb;
 - In very hot or cold weather;
 - Install a non-original suspension which is lower than the original one;
- Beside conditions above, the actual distance between some objects and car may not be detected by the sensor due to the shapes of the objects.
- Shapes and materials of the obstacles

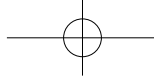

may prevent the sensor from detecting.

Pay more attention to obstacles below:

- Electric wire, fence, rope, etc;
- Cotton, snow and other materials absorbing radio wave;
- Objects with sharp edges and corners;
- Low barrier;
- High barrier with its top part extending towards your car;
- Objects under the bumper;
- Objects close to the vehicle;
- People nearby the car (depending on the type of clothing the people wear)

If the buzzer screams, any barriers may be detected by the sensor or the sensor may be interfered by the external environment. If this phenomenon continues to exist, please contact your BYD authorized dealer to have your vehicle inspected.

NOTICE

Parking assistance system can only perform an auxiliary function and cannot replace the driver to observe when driving. So please be careful when driving your vehicle.

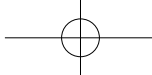

Chapter 1

Section 1-7

Operations of Instruments and Controllers Auto Sound System

Use of Vehicle CD 92

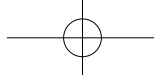

Use of Vehicle CD

Functions and Features

1. CD usable
2. Built-in AM/FM radio
3. Shock-proof mechanism
4. 25W×4 maximum output power
5. Audio input usable.

NOTICE

When vehicle is not started and there is no need to use CD system, in order not to exhausting the battery, please turn off CD system. Please do not splash drinks or other liquids on CD system. Disassembling any part of Vehicle CD is not allowed. Using mobile phone may affect the effect of CD system.

Major Technical Parameters

Items	Parameters	Unit
Working voltage	DC:11~16	V
Maximum output power	25W×4	W
Maximum working electric current	10	A
FM frequency range	87.5~108.0	MHZ
AM frequency range	522~1620	KHZ

Operation Instructions

Multimedia CD sound system, one of the Vehicle CD series products developed by BYD Auto Co., Ltd.

can not only be used to play CD/MP3 music, but also to receive AM/FM radio which can satisfy your demands. Advanced and innovative design and humanized use interface can make you a fashion leader.

Major features:

Multimedia CD sound system can play both CD and CD-R (burning CD format) disk; MP3 audio input; built-in AM/FM stereo radio; 30W×4 maximum output power.

Caution:

Caution for using disk:

1. Do not use disks of the following types, or it may damage the player or disable the function of inserting/ejecting disk.

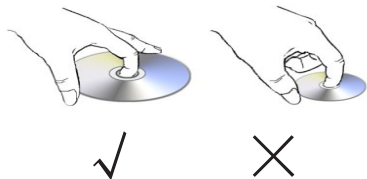

1) Only use disks with diameter of 12cm

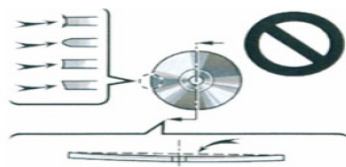

2) Inferior or deformed disks

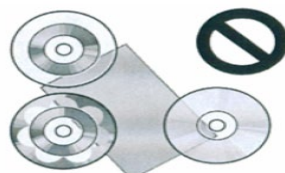

3) Disks with transparent or semi-transparent burning area

4) Disks stuck with adhesive tape and label

⚠ WARNING

In case of traffic accident, please take care when adjusting vehicle CD system.

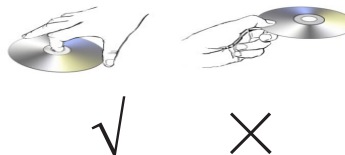

1) Do not touch the surface of disk with your hands when taking the disk

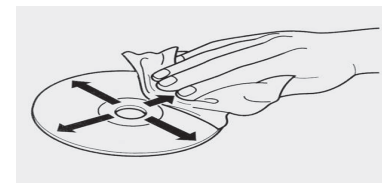

2) Wipe the disk from the inside out with soft cloth

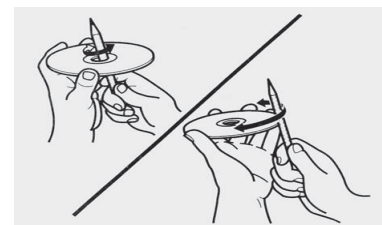

3) Rub the inner and outer edge of new disk with the side of pencil or pen to remove chippings on the edge

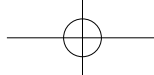

Caution for Using CD player:

1. You are not allowed to put two disks in the CD player at the same time and do not put/take anything other than CD into CD player (coin, name card, etc.);

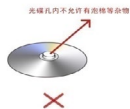

1) Disk with foam or other things



2) Do not insert other things in the disk entry, such as bank card and coin.

2. Multimedia CD sound system can play CD and CD-R (burning CD format) disk;



VCD disk



✓
CD disk



✓
Recording disk
(Only for CD music)

3. Go to service store or buy specific cleaning disk in BYD authorized service station regularly (clean it every 5,000km) for cleaning your CD player.

Trouble Shooting

1. Failure of CD Playing

1) Check if the specifications of disk are in compliance with the right status and please use 12 cm genuine CD disk;

2) Check if the disk is scratched, diaphanous or dirty; if so, replace it with a genuine disk.

2. Failure of Sound Playing

1) Check if CD player system is mute; if so, press “ · ” on the control panel to cancel mute setting;

2) Check if connection wires of speaker are disconnected; if so, reconnect them.

3) Check if the speaker is damaged; if so, replace the speaker with a new one. If these three conditions above are normal, it usually may be caused by short circuit between certain group of speakers and the car body.

3. No Sound Coming Out from Certain Speaker when Playing CD

In this case, please check if CD player system has a setup error. Solutions: enter channel shift settings, set the following modes BAS, TRE, BAL, FAD to “BAS: 0; TRE: 0; BAL: 0; FAD: 0” according to standard settings, and exit; then the sound will return to

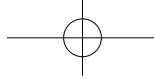

normal.

4. Poor Reception of FM/AM Radio in CD player

1) Check if the car is in an environment interfered by strong electromagnetic field or in a comparatively closed place underground.

2) Check if the radio station stops broadcasting in a specified time, which leads to no radio signal.



Function Description of Vehicle CD Player Panel

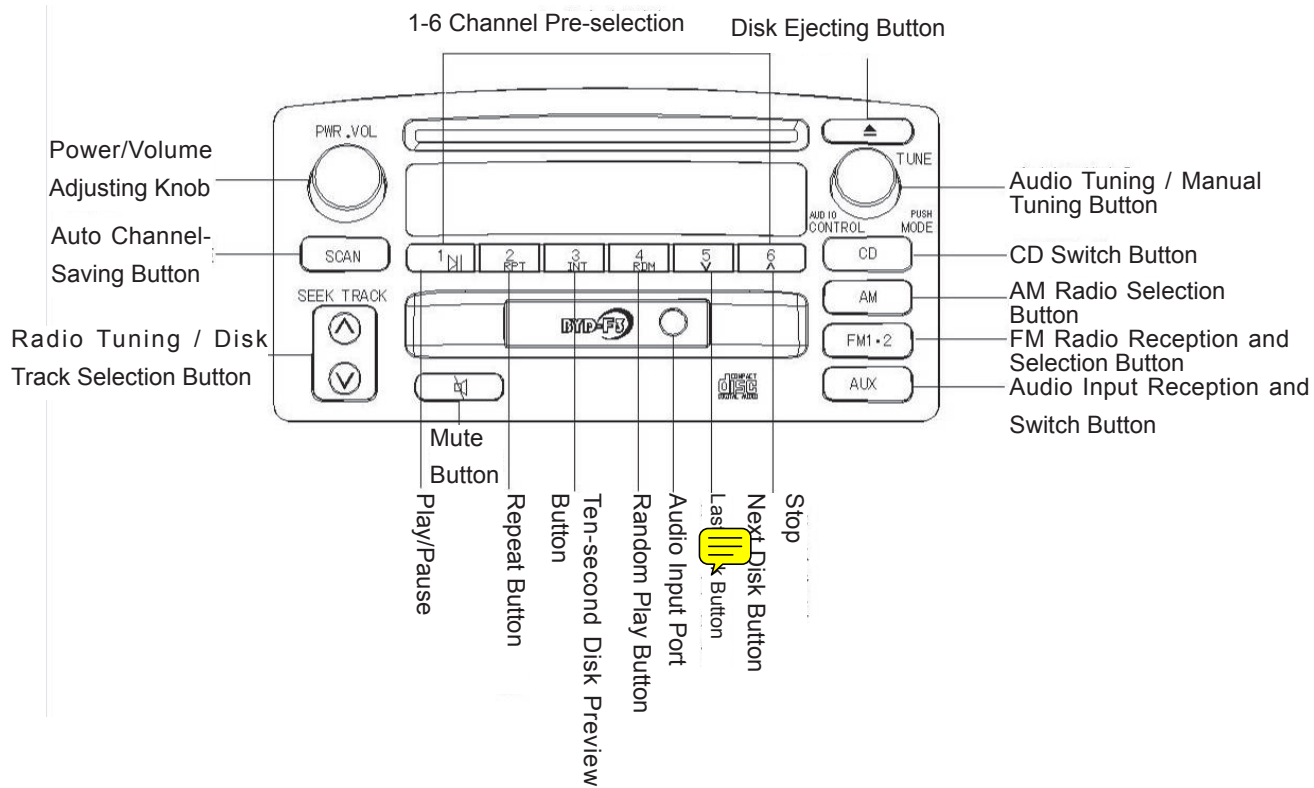



Operation Instructions for Vehicle CD Player Panel

Power/Volume Regulating Knob: you can tune the volume by turning the knob; and power on/off by pressing this knob.

Audio Adjusting/Manual Adjusting Knob: press this knob to switch the modes between “BAS – TRE – BAL - FRD” circularly; turn the knob left or right to adjust in a certain audio mode.

Auto Channel-Saving Button: in radio mode, a short press previews the saved channels, a long press searches channels and saves the searched channel automatically.

CD Switch Button: when playing in non-CD mode, press this button to switch to CD mode and play CD disk.

AM Radio Selection Button: when playing in non-AM mode, press this

button to switch to “AM” mode, and there are “AM1 and AM2” for your selection.

FM Radio Selection Button: when playing in non-FM mode, press this button to switch to “FM” mode, and there are “FM1, FM2 and FM3” for your selection.

Audio Input Switch Button: insert one end of audio wire into external audio equipment (such as MP3), and the other end into AUX input hole, turn on CD player, press AUX button and make sure the external audio equipment is turned on, and then the CD player will play music in the external audio equipment .

In other play modes, press AUX button, and then the player will switch to external audio equipment play mode automatically. If no external audio equipment at that moment, the player

will display “NO AUX” on its screen and returns to the previous play mode.

If you insert an external audio equipment when CD player is turned on, the system will switch to external audio equipment play mode automatically.

NOTICE

- CD Mode: indicates that CD player is playing CD.
- Radio Mode: indicates that CD player is in radio status.

Radio Tuning/Disk Track-selection Button:

- CD Mode: You can select last or next song by pressing this button, make a long press to perform “Fast forward or Fast Backward” and release it to return

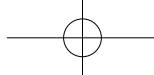

to normal playing.

- Radio Mode: Press this button for about 0.5 seconds to perform a single-step search upwards or downwards for last/next channel where signal is available.

Disk Play/Pause Button:

- CD Mode: Play/pause the disk.
- Radio Mode: Long press this button for more than 2 seconds to save the current channel; press it for about 0.5 second to listen to the saved channel.

Repeat Button:

- CD Mode: Replay the track. Repress this button to cancel the previous operation.
- Radio Mode: Long press this button for more than 2 seconds to save the current channel; press it for about 0.5 seconds to listen to the saved channel.

Ten-second Disk Preview Button:

- CD Mode: Scan all tracks and play the first ten-second contents of each song in proper order.
- Radio Mode: Long press this button for more than 2 seconds to save the current channel; press it for about 0.5 seconds to listen to the saved channel.

Random Play Button:

- CD Mode: Play tracks at random. Repress this button to cancel the previous operation.
- Radio Mode: Long press this button for more than 2 seconds to save the current channel; press it for about 0.5 seconds to listen to the saved channel.

Previous-disk Button:

- Radio Mode: Long press this button for more than 2 seconds to save the current channel; press it for about 0.5 seconds and you can listen to the saved channel.

Next-disk Button:

- CD Mode: When playing CD, press this button to stop playing and display the number and total time of tracks in the disk. Then press "Play/Pause" button again to restart playing.
 - Radio Mode: Long press this button for more than 2 seconds to save the current channel; press it for about 0.5 seconds to listen to the saved channel.
- Mute Button: press this button to mute and repress it to cancel mute settings.

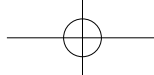

Use of Steering Wheel Sound Control Switch (optional)

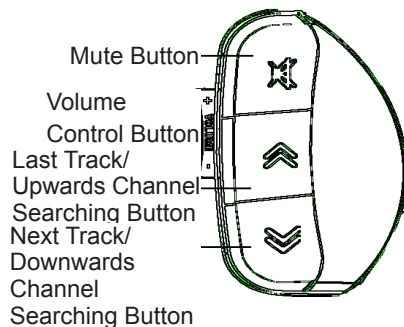

When CD player is working, you can control the playing of it through steering wheel sound control switch.

Mute Button: Press this button to mute and press it again to cancel mute settings.

Volume Control Button: Tune the volume. Press “+” to increase the

volume. Press “-” to lower the volume.

Last Track/Forward Channel Search Button:

- CD Mode: Press this button to select track upwards.
- Radio Mode: Press this button to forward search a channel where signal is available.

Next Track/Backward Channel Search Button:

- CD Mode: Press this button to select track downwards.
- Radio Mode: Press this button to backward search a channel where signal is available



Trouble Shooting Guide for Vehicle CD

	Failure	Cause Analysis	Solutions
1	No power supply or no sound	1. Ignition switch of car is not turned on. 2. Wires are not connected properly	1. Please turn the key to "ACC" or "ON" 2. Check if the wires are connected properly
2	Disk has been loaded, but there is no sound	1. Disk is placed reversely 2. Disk is dirty or seriously scratched	1. Place the disk properly 2. Clean the disk or replace it with a new disk
3	There is jumping sound due to vibration	1. Unstable installation 2. Disk is dirty or scratched	1. Fasten CD player with installation components 2. Clean or replace the disk
4	Pre-selected channels disappear and there is no memory	Battery cable is not connected properly	Connect the battery cable to an usual electriferous terminal
5	Loud noise from FM stereo and mono channel broadcasting	Radio station is too far away or signal is too weak	Select other radio stations with a higher signal frequency

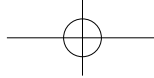

Chapter 1

Section 1-8

Operations of Instruments and Controllers Air-conditioning System

Auto Air-conditioning System – Control Panel	102
Operation Gist.....	106
Side Ventilation Opening	108
Check and Replace Air-conditioner Filter	108

Auto Air-conditioning System – Control Panel

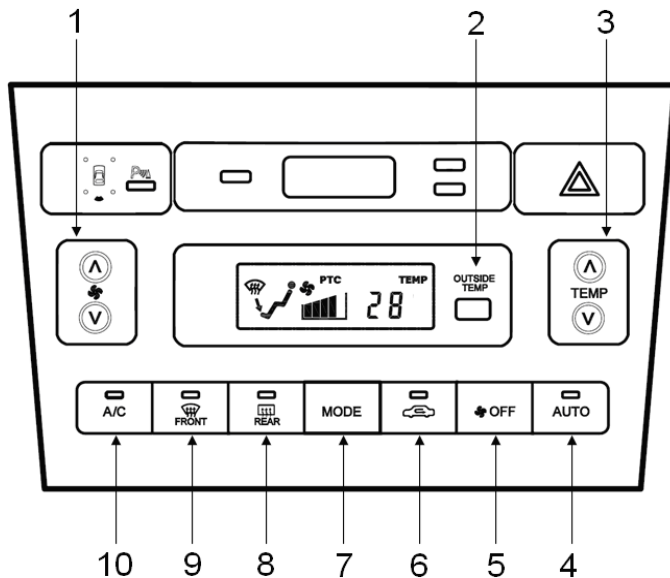

1. Blower speed-regulating button: adjusting air flow button
2. "OUTSIDE TEMP": outside temperature display button
3. "TEMP": air-conditioner temperature regulating button
4. "AUTO": auto mode button
5. "OFF": air-conditioner OFF button
6. : Internal-external recycling mode selecting button
7. "MODE": air outlet mode selecting button
8. "REAR": rear defrost switch
9. "FRONT": front defrost switch
10. "A/C": compressor on/off button

Blower speed-regulating button: adjust air volume

Press "∧" (increase) or "∨" (decrease) button to adjust the rotating speed of blower, that is, to adjust air flow volume.

In auto operation, the rotating speed of blower is not required to be adjusted, unless other speed is required.

"OUTSIDE TEMP": outside temperature display button

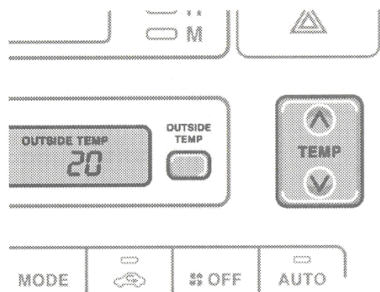
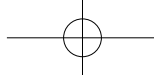

Press “OUTSIDE TEMP” button to switch the temperature display between air-conditioning temperature and outside temperature.

When pressing “OUTSIDE TEMP” button, outside temperature instrument indicates the Celsius temperature of outside air.

The key must be at “ON”.

Repress this button to turn off the display.

When air-conditioning system is turned on, press “OUTSIDE TEMP” button will

indicate the outside temperature and press “OUTSIDE TEMP” or “TEMP” button again will indicate the air-conditioning temperature.

“TEMP”: air-conditioner temperature regulating button

Press “^” to increase the temperature and press “v” to lower the temperature.

When it is adjusted to the minimum temperature, “COLD” displays; while “HOT” displays when it is adjusted to the maximum temperature.

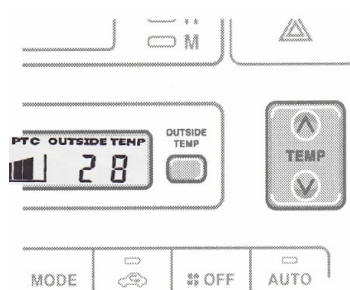

In heating mode, “PTC” appears on the display screen of air conditioner, indicating PTC heater is working.

When PTC heater stops working, “PTC” disappears from the screen.

The switch of PTC heater is controlled automatically by the system.

“AUTO”: automatic mode button

NOTICE
To prevent the battery from being discharged, do not leave the air conditioning on longer than necessary when the DM hybrid system is not operating.

For automatic operation of air conditioner, please press automatic mode button. After the button is

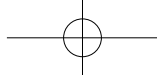

pressed, the indicator goes on indicating that automatic operation status is selected.

In automatic operation status, air-conditioning device will, according to the set temperature, select a proper rotating speed for fan and airflow direction and automatically control the rotating speed of compressor and PTC power to get the temperature in car reaching the set temperature rapidly.

To select your own setting, you can control it manually.

To exit automatic operation, press "OFF" button, blower speed-regulating button, "MODE" button or front defrosting switch.

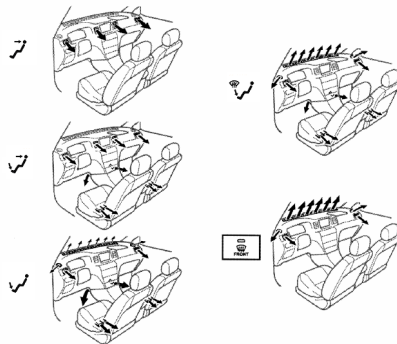

5. "OFF": air-conditioner OFF button

Press this button to turn off the air-conditioning system.

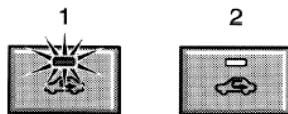

6. Internal-External recycling mode selecting button

Press this button to select airflow source of air-conditioning system.

1) Internal Recycling – press this button, the indicator will go on to enable air circulation in the car, speed up cooling or heating the inside and prevent dirty air outside from entering the car.

2) External Recycling – Repress this button, the indicator will go off to introduce fresh air outside into the car for circulation.

7. "MODE": air outlet mode selecting button

To select airflow direction, please press air outlet mode selecting button.

In automatic operation mode, the airflow is not required to be adjusted, unless other airflow modes are



required.

- 1) Instrument Panel – airflow mainly comes from the ventilation opening of instrument mounting panel.
- 2) Dual Source – airflow comes from ventilation openings of floor and instrument mounting panel.
- 3) Floor – airflow mainly comes from the ventilation opening of floor.
- 4) Floor/Windshield – airflow mainly comes from the ventilation openings of floor and windshield.

8. "REAR": rear defrost switch

Press this button, the indicator will go on and the resistance wire of rear windshield will start to heat up for defrosting and defogging. Repress this button, the indicator will go off and rear defrosting function will be off.

To avoid power waste due to long-time heating, the rear defroster has the

function of time delay for 15 minutes before shut-off. In other words, if no other operations on this button within 15 minutes after pressing it, the system will shut off rear defrosting function automatically.

NOTICE

When cleaning the inside of the rear window, pay attention not to scratch or break heating wire and connector.

Please be noted that the rear defroster is not designed to dry the raindrop and snow melt.

9. "FRONT": front defrost switch

Press this button, the indicator will go on, and airflow will mainly come from the ventilation opening of front

windshield, used for defogging or defrosting the front windshield for a clear view. Repress this button, the indicator will go off and airflow status set last time will be restored.

For settings of air outlet mode selecting button, please refer to "Settings of Air Outlet Mode Selecting Button" below.

10. "A/C" Switch

Press "A/C" switch, the air-conditioning device can be turned on and "A/C" switch indicator will go on.

Press "OFF" button to turn off the whole air-conditioning system. Repress "A/C" switch, the indicator will go off and cooling will be turned off. In this case, the system cannot guarantee that the temperature in car can be adjusted to a proper set value.

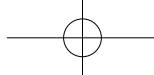

NOTICE

In wet weather with high humidity, please do not use defogging function during cooling procedure. Temperature difference between the windshield and the outside air may lead to the fog on windshield and obstruct your view.

NOTICE

To prevent the battery from being discharged, do not leave the air conditioner, vehicle CD and lighting system on longer than necessary when the indicator "OK" on the instruments is off.

Tips: Using Air Conditioner System

Operation Gist

- To quickly cool the car exposed in the hot sun, please drive for several minutes with windows opening.
- Make sure the air inlet grid in front of windshield is not blocked by things such as leaves or snow.
- In wet weather, do not let cooling air blow onto the windshield. Due to temperature difference between the outside and inside of windshield, the windshield will be fogged.
- Always keep clear under the front seat so as to make the air fully recycling in car.
- In cold weather, set the high rotating speed of blower for one minute so as to clear the snow or moisture in the air inlet channel, as it will reduce the

possibility of fogging on the windows.

- If driving behind other cars on a road which is not clean, or driving in the wind and dust, you are recommended to set internal-external recycling mode selecting button to internal recycling temporarily and set the rotating speed of blower to a proper speed.

Heating

To acquire a better effect, set the controller to:

For automatic operation

- Press automatic mode button.
- Temperature – set to the suitable temperature.
- Air admission – external recycling (outside air)
- Air conditioner - OFF

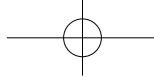

For manual operation

Rotating speed of fan – set to the suitable rotating speed.
 Temperature – point at high temperature
 Air admission – external recycling (outside air)
 Airflow – floor
 Air conditioner - OFF

- To increase temperature rapidly, select Internal Recycling for several minutes. To avoid fogging on the window, select External Recycling after heating up the inside of the car.
- Select Floor/Windshield airflow to heat up the inside of the car while defogging or defrosting the windshield.

Air Conditioner

To acquire a better effect, set the controller to:

For automatic operation

Press automatic mode button.
 Temperature – set to the suitable temperature
 Air admission – external recycling (outside air)

For manual operation

Rotating speed of fan – set to the suitable rotating speed
 Temperature – point at low temperature
 Air admission – external recycling (outside air)
 Airflow – instrument panel
 Air conditioner - ON

- To lower the temperature rapidly, set the internal-external recycling mode selecting button to Internal Recycling for several minutes' circulation.

Ventilation

To acquire a better effect, set the controller manually to:

Rotating speed of fan – set to the suitable rotating speed
 Temperature – point at low temperature
 Air a– external recycling (outside air)
 Airflow – instrument panel
 Air conditioner - OFF

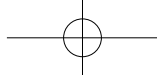

Side Ventilation Opening

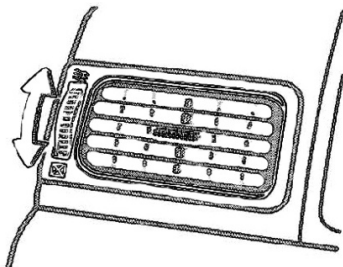

If you are not satisfied with the airflow control, check the side ventilation opening which can be opened or closed as shown in the figure.

Check and Replace Air-conditioner Filter

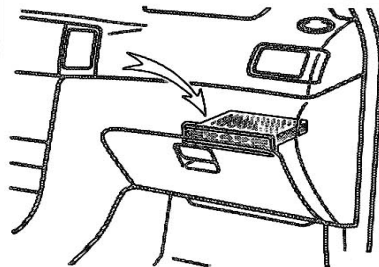

Air conditioner filter lies in the rear side of glove box as shown in the figure above.

Air conditioner filter can prevent dust from entering the car through ventilation opening.

Air conditioner filter may be blocked after being used for a long time. If you find extremely low airflow efficiency in air conditioning or heating or fogging easily on the windows, please do

replace the filter.

To maintain the efficiency of air conditioner, you must check and replace its filter according to maintenance schedule. (Please refer to Maintenance Schedule in Chapter 6)

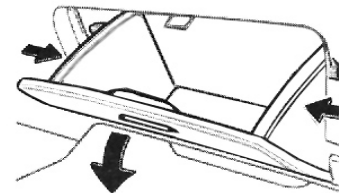

1. Press both sides of the right glove box, unfasten the pothook and take down the right glove box.

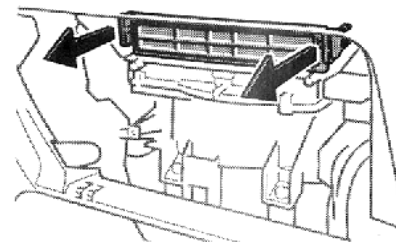



2. Remove the filter rack from the exit of filter as shown in the figure above.

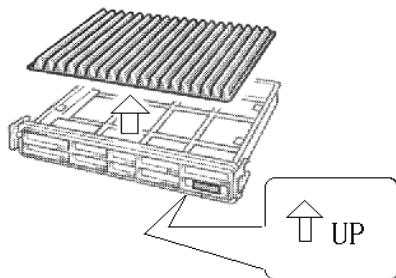

3. Take out the filter from filter rack.
4. Check the surface of filter.
If it is dirty, do replace it.
Keep the arrow upwards when installing filter and filter rack.

NOTICE

Filter of air conditioner must be installed into place properly. Using air conditioner with its filter removed will reduce its dust-proof effect and also affect its performance.

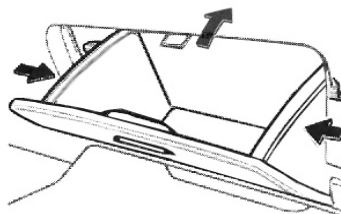

Press both sides of right glove box and close the glove box.

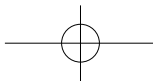
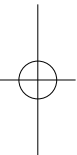
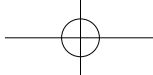

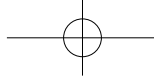

Chapter 1

Section 1-9

Operation of Instruments and Controls Charging System

Charging System	112
Power Battery	114
Solar Panel	114

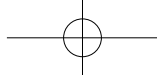

Charging System:

DM system has unique charging function, which can provide power for the vehicle by offering electrical energy.

Performance Parameters:

Input Voltage: 180~240V 50Hz

Input Current: 9~13A

Charging Time: 7 hours

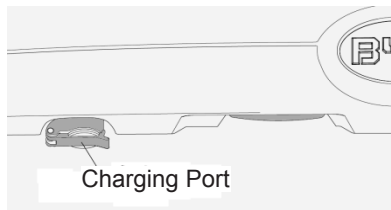

Charging Wire:

Use of Charging Device:

After parking the car properly, turn the

key to LOCK, take out the charging wire, open the lid of the charging port, insert the charging plug in the charging port, then insert the power plug in the socket of charging terminal post or specified socket, turn the power on after making sure the connection is proper, and then the car will be in charging status automatically.

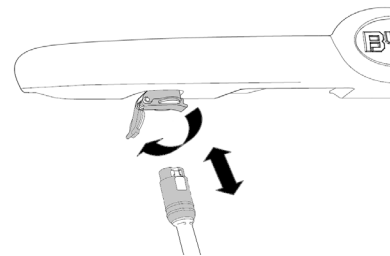
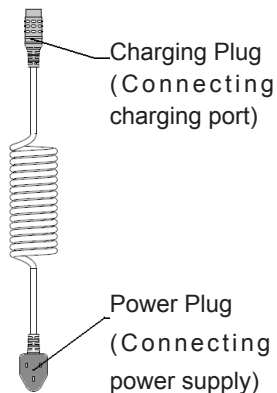

After charging begins, there will be a slight voice made by the fan of charger in the trunk; then please observe the combination instrument; if it is displayed as below, meaning it is charging now.

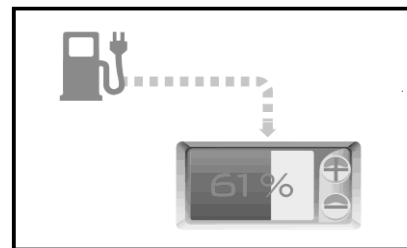

After charged, please first turn the power off, pull out the power plug, then



press the button on charging plug, pull out the plug from the charging port slowly and tidy up the charging wire.

NOTICE

- When the SOC power indicator light on the instrument is blinking, it means the power is low, please charged in time.
- F3DM is starting of motor. When the power battery is depleted, you cannot start the car, in that case please contact BYD authorized service provider.
- Please check whether there are foreign materials in the charging port and charging plug before charging.
- Suggest you should put the car in ventilated place when it's in charged,

- High-tension distribution box and vehicular charger in trunk are in working status during charging; it's normal that there will be several "click" made by relay absorption and "buzz" made by the fan of the charger.
- System will stop charging automatically when the power is full.
- Please do not charge in the open air in rainy day, to protect the power and charging port from water which may cause a damage.
- Do not spray water with high pressure gun towards charging port when washing car, to protect the charging port from water.

NOTICE

- Please charging in a relatively safe place (avoid liquid, fire etc).
- Please charge in the LOCK gear.
- In case of cannot charged or other abnormal phenomenon, please contact BYD authorized service provider. Do not examine it by yourself.
- Please use the specified charging socket and wire, do not change charging devices by yourself.
- When the car is in charging, children should not play around the charging wire.
- Please do not twist the charging wire together when it's in charging.

⚠ WARNING

If the charging wire is lost or damaged, please go to BYD authorized service provider to buy specified charging wire and do not select one by yourself.

Vehicles are installed by power battery; please do not drive your car through deep water for a long time.

Power Battery

Power battery: supply power to all the electric equipment of the vehicle.

Major charging mode for power battery: charging through charging port.

Auxiliary charging mode for power battery: charging through solar.

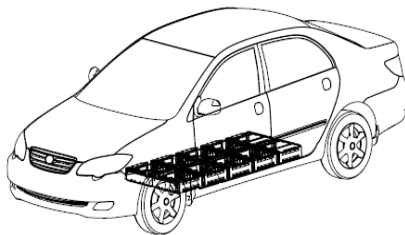
**NOTICE**

- In case of storing the car for a long time, please make sure the power battery is full of power. Otherwise, the power battery will be over discharge, which may degrade the battery performance or even damage the battery.
- Please avoid frequent rapid acceleration or high-speed driving for a long time when the battery power is low, which may degrade the battery performance or even damage the battery.

Solar Panel (if equipped)

Solar panel is installed on the car roof as shown below, which can absorb optical energy and convert it into electric energy to offer power for the power battery..

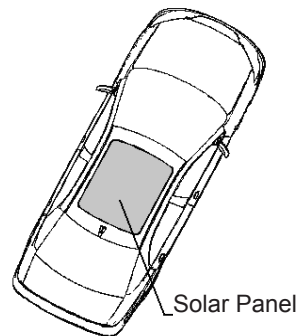

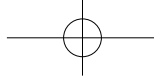

NOTICE

- Please do not wash the car roof for a long time with high-tension gun, to protect the solar panel from water.
- please clean the solar panel immediately to avoid any damage under below situations:
 1. When it is adhered with oil stain, plenty of dust, chemical substance or other dunghills.
 2. When there are scraps of paper, leaves on the roof.

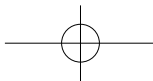
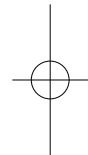
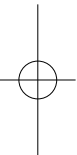
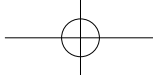

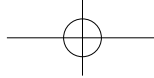

Chapter 1

Section 1-10

Operation of Instruments and Controls Other Equipment

Electronic Clock	118
Outside Temperature Display	118
Cigar Lighter and Ashtray	118
Floor Mat	122

Electronic Clock



To set the hour: Push the “H” button.

To set the minutes: Push the “M” button.

If you need to adjust integer time rapidly, press “:00” button.

For instance: if the time is between 1:01 and 1:29, press “:00” and then the time will be changed to 1:00. If the time is between 1:30 and 1:59, it will be changed to 2:00.

The key must be on “ACC” or “ON”.

If the power of the clock is cut off, the time will automatically be set at 1:00 (one o'clock).

Outside Temperature Display

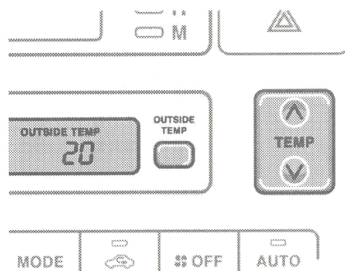

When you press “OUTSIDE TEMP” button, the temperature meter indicates the temperature of outside.

The key must be on “ON”.

Press this button again to turn off the display.

When air-conditioning system is on, press “OUTSIDE TEMP”, will

indicate the outside temperature. Press “OUTSIDE TEMP” or “TEMP” button, will return to air-conditioning temperature.

Cigar Lighter and Ashtray

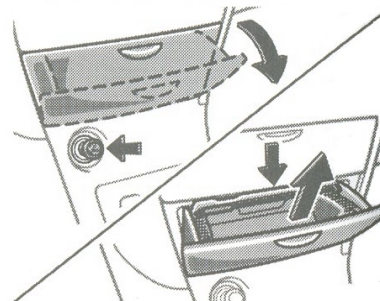

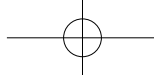

Cigar Lighter and Front Ashtray

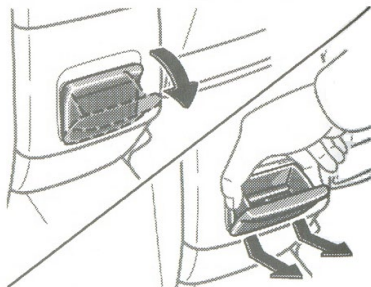

Cigar Lighter and Rear Ashtray Cigar Lighter

To use cigar lighter, just press it in. After it is lighted up, it will popup automatically for use.

When using cigar lighter, make sure the key is on "ACC" or "ON".

NOTICE

Do not press the cigar lighter without releasing it.

Ashtray

Use: To use the ashtray, pull it out.

After using the ashtray, push it back to the original position completely.

Front: to remove the ashtray, just press the locking spring strip and pull it out.

Rear: to remove the ashtray, just clamp both sides of ashtray and then pull it out.

⚠ WARNING

To reduce the possibility of human injury in case of accident or hard braking, close the ashtray after using

To prevent fire, please quench the cigarettes and matches before put them into the ashtray, and ensure the ashtray is fully closed.

To prevent fire, do not put paper or other inflammable substances into the ashtray.

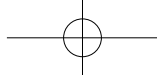

Right Glove Box

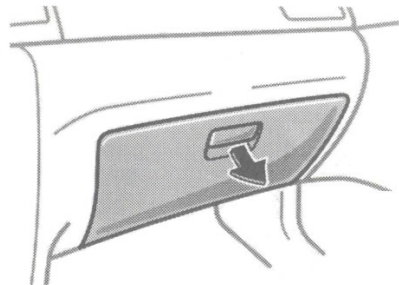

To open the right glove box, pull the handle

WARNING

To reduce the chance of injury in case of an accident or a sudden stop, always keep the glove box doors closed while driving.

Left Small Glove Box

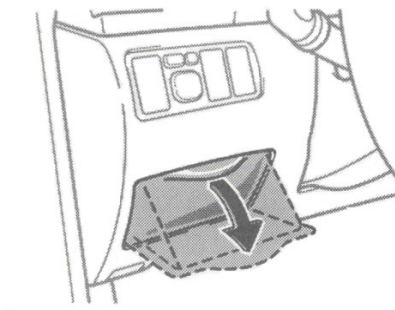

To use the left small glove box, press down the handle.

Small Box on Air-Conditioning Adjusting Panel

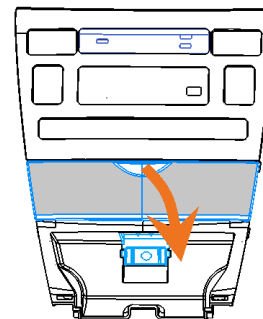

To use small box of air-conditioning adjusting panel, press down the handle

NOTICE

To reduce the possibility of human injury in case of an accident or a sudden stop, always keep the small box closed while driving

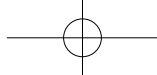

Central Glove Box

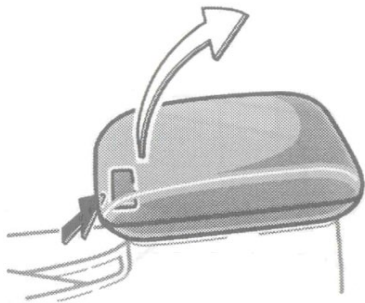

To open the central glove box, lift up the locking handle while lifting the lid of central glove box.

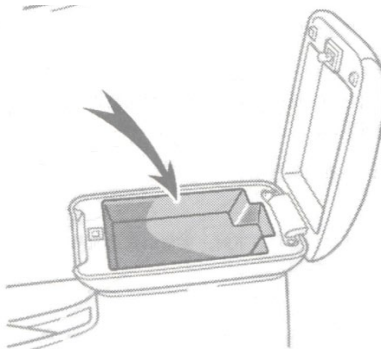
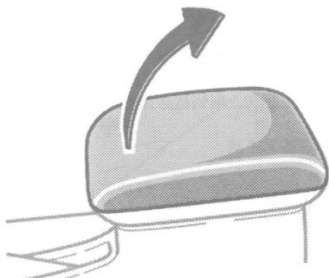

Cup Holder

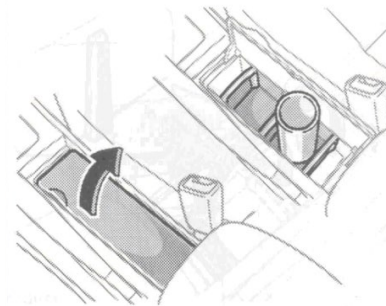

The cup holder is designed for holding cups or drink-cans securely.

To use the cup holder, open the lid.

NOTICE

- when you open the glove box, please do not clamp your fingers.
- To reduce the possibility of human injury in case of an accident or a sudden stop, always keep the central glove box closed while driving

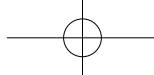

NOTICE

- Do not place anything else other than cups or drink-cans on the cup holder, as such items may be thrown about in the compartment and possibly injure people in the vehicle during sudden braking or in an accident. To reduce the chance of injury in case of an accident or a sudden stop while driving, keep the cup holder closed when not in use. Take due care not to catch your fingers when the cup holder is opened.

Floor Mat



NOTICE

Make sure the floor mat is properly placed on the floor carpet. If the floor mat slips and interferes with the movement of the pedals during driving, it may cause an accident.

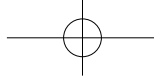

Chapter 2

F3DM Auto Driving

Break-in Period	124
Fuel	124
Fuel shut-off System	125
Three-Way Catalytic Converter	125
Engine Exhaust Warning	126
Consumption of Engine Oil	127
Gear Shifting	129
Electronic Power Steering System	130
Brake System	130
Brake Pad Wear limit indicators	133
Precautions on Luggage Loading	134
Suspension and Chassis	134

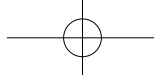

Break-in Period

Break-in is needed for engine. You are recommended to perform break-in at HEV mode in the first 2,000 km, please drive gently, avoid high-speed driving; complying with following instructions can extend the life of your car.

NOTICE

- Avoid full-throttle acceleration when starting and driving.
- Avoid driving at high speed at HEV mode when the power (SOC) is low.
- Avoid hard stops during the first 300 km.
- Avoid driving the car for a long time at the same high or low speed.
- Do not tow other car during the first 2,000 km.

Fuel

Appropriate fuel is the basis of engine performance, also the key of emission control and component maintenance. Engine damage or emission exceeded resulting from using improper fuel is not covered by BYD F3DM warranty.

Fuel Type

Select unleaded gasoline with an Octane Rating of 87 or higher. To prevent wrong operation of gas station, BYD F3DM is equipped with a small fuel tank opening which can match with the special nozzle of lead-free gasoline pump, neither can the larger standard nozzle of leaded gasoline pump.

NOTICE

Do not use leaded gasoline, which may cause the three-way catalytic converter to lose its effectiveness and the emission control system to function improperly. Also, this can increase maintenance costs.

If drivability problems are encountered (poor hot starting, vaporizing, engine knock, etc.), discontinue its use.

Take care not to spill gasohol during refueling. Gasohol may cause paint damage.

Engine Knock

When you are using fuel recommended abovementioned, in case of feeling serious engine knock, or hearing steady knocking at a steady speed on



level roads, please contact Your BYD authorized service provider.

But it's normal to hear slight knocking for a short time when the car is accelerating or driving on an uphill road, please don't worry.

Fuel Tank Capacity

38L

Fuel shut-off System

The fuel shut-off system stops supplying fuel to the engine to minimize the risk of fuel leakage when the engine stalls upon accident. To restart the DM system after the fuel shut-off system activates, press the ignition switch to "ACC" or "LOCK", and start it.

NOTICE

Inspect the ground under the car before restarting the DM system. If you found that liquid has leaked onto the ground, the fuel system has been damaged and needed repair. In this case, please contact BYD authorized service provider and do not repair it by yourself.

Three-Way Catalytic Converter

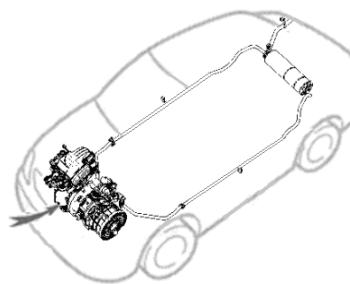

The three-way catalytic converter is an emission control device installed in the exhaust system, in order to reduce pollutants in exhaust gas.

NOTICE

- When the engine is running, keep people and combustible materials away from the exhaust pipe. The exhaust gas is very hot.
- DO not drive, park or idle your car on ground over anything that burn easily such as grass, leaves, paper.

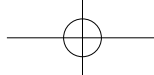

NOTICE

A large amount of unburned gases flowing into the three-way catalytic converter may cause it overheat and create a fire hazard. To prevent this and other dangers, please follow below instructions:

- Only use lead-free gasoline.
- Do not drive the car when the fuel level is extremely low; running out of fuel may cause the engine to misfire and overload on three-way catalytic converter.
- Please do not leave the car running idle.
- Avoid high-speed driving for a long time when the power is extremely low.
- Do not push or pull the car for starting.

- Do not turn off ignition while driving.
- Keep your engine in good running order. Malfunctions in the engine electrical system, electronic ignition system or fuel system could cause an extremely high temperature.
- If the engine becomes difficult to start or stalls frequently, please take your car for a check immediately.
- To ensure that the three-way catalytic converter and the entire emission control system operate properly, your car must receive the periodic inspections required by the BYD Maintenance Schedule (please refer to Maintenance Schedule in Chapter 6).

Engine Exhaust Warning

NOTICE

- Avoid inhaling the engine exhaust gas.
- Make sure the exhaust system has no leakage or loose connections. The system should be checked regularly. If you hit something or hear abnormal exhaust noise, have the exhaust system checked immediately.
- Do not run the engine at HEV mode in garage or closed space except for the time needed to drive the vehicle in or out. It's very dangerous if the exhaust gases cannot escape.
- Please lock up the trunk while driving. Open or unclosed trunk or rear door may cause exhaust

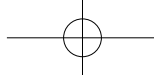

gas to be drawn into the car.

- To ensure normal operation of ventilation system, keep the inlet grilles in front of the windshield clear of snow, leaves or other stuffs.
- If you smell exhaust gas in the car, open the window immediately, figure out the place where the exhaust gas come from, and make it corrected .

WARNING

- When the exhaust pipes installed through both sides of the car are heat, it may burn your body, please keep your hands or other parts of body away from the inferior edge of the car.
- Do not get close or touch the three-way catalytic converter when the engine is running or within half an hour after it stopped.

Consumption of Engine Oil

It is normal that an engine need to consume some engine oil during normal engine operation. The causes of oil consumption in a normal engine are as follows.

- Pistons, piston rings and cylinders are lubricated by engine oil. When a piston moves downwards in a cylinder, a thin film of oil will be formed on the cylinder wall. In deceleration, the resulting high negative pressure will suck some engine oil from the film to the combustion chamber. The sucked-in engine oil will be combusted together with the oil film on the cylinder wall during the high-temperature combustion in the chamber.
- The intake valve stems are also lubricated by engine oil. Some engine oil is sucked into the combustion

Consumption of Engine Oil

Function of Engine Oil

Engine oil is used to lubricate and cool the inside of the engine and plays a major role in maintenance the engine in proper working order.

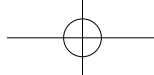

chamber together with the intake air and participates in combustion. High temperature exhaust gas may also combust the engine oil used to lubricate the exhaust valve stems.

Consumption of engine oil depends on its viscosity and quality and actual vehicle conditions.

High speed driving and frequent acceleration/deceleration at HEV mode will increase the consumption of engine oil.

A new engine may consume more engine oil as its pistons, piston rings and cylinder walls have not become conditioned.

Consumption of Engine Oil

Please be noted that the oil may become diluted and make it difficult to judge the true level accurately.

- 128 -

For example, if a vehicle is used for repeated short trips, and consumes a normal amount of oil, the dipstick may not show any drop in the oil level at all, even after 1000 km or more.

This is because the oil is gradually becoming diluted with fuel or moisture, making it appear that the oil level has not changed. The diluting ingredients evaporate out when the vehicle is then driven at high speeds, as on an expressway, making it appear that oil is excessively consumed after driving at high speeds.

Significance of Checking Engine Oil Level

One of the key points of vehicle maintenance is to keep the engine oil at optimum level, so that oil function will not be impaired. In one word, it is important to check the engine oil level

regularly. BYD recommend that the engine oil level should be checked every time you refuel the car.

NOTICE

Failure to check oil level regularly could result in serious engine trouble due to insufficient oil.

For details on checking engine oil level, please refer to “Check Engine Oil Level” in Section 7-2.



Gear Shifting

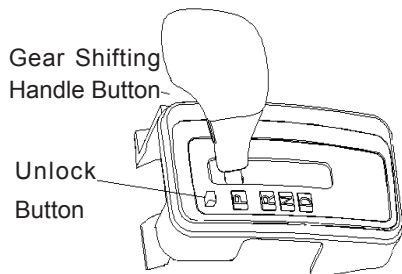

Gear Shifting Handle Position

Parking gear (P) – in this position, gear shifting mechanism has a locking function. To apply parking gear, you must press gear shifting handle button. To avoid damaging gear in the power train, you cannot apply parking gear until parking the car properly. When you have to switch parking gear to other gears, please step on brake pedal, turn the key to the ignition

switch “ON” and press down the gear shifting handle button to shift from P gear. Unlocking button can also be used for mechanical unlocking for gear shifting mechanism.

Reverse gear (R) – to apply reverse gear, you cannot do this until parking the car properly. To switch N gear to P gear, please press the gear shifting handle button.

Neutral gear (N) – when you need to stop the car temporarily and get power train started, you can shift to N gear.

Driving gear (D) – use this gear for normal driving. With your foot holding down the brake pedal, shift the selector lever to “D”. Release the parking brake and brake pedal. Depress the accelerator pedal slowly for smooth starting.

WARNING

- Gear shifting handle must be at P or N gear when starting the car.
- When you want to stop the car at D, N or R gear, you should step on brake pedal forcibly as well as move your feet from the accelerator pedal. Whatever the reason is, the driver must shift to P gear and pull up the parking brake handle as long as he leaves the car.
- Never put your foot on the accelerator pedal while shifting, unless it may cause abrupt acceleration.
- When driving forward, it is forbidden to use R or P gear and please make sure you have stopped the car properly before using P or R gear to avoid damaging the transmission.

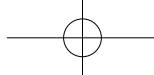

Electronic Power Steering System

The electronic power steering system, which offers steering power by electric engine in steering, can help the driver to control the steering wheel easily and accurately. When the key is turned to “ON”, warning light for power steering system turns on and the system starts to self-inspect. After 3 seconds, the warning light for power steering system will turn off if there is no fault in the system; if not, the light will not turn off. After self-inspection, if there is any trouble while driving, the warning light will also turn on.

In the following conditions, you may feel it's difficult to operate the steering wheel while the warning light for power steering system does not turn on (Because it is not a malfunction)

In case of frequently manipulating or fully turning the steering wheel for a long time, the power steering effect may be limited to avoid overheat. In this situation, you should stop turning the steering wheel or park your car and turn the switch to “ACC” or “OFF”. It takes about 10 minutes to for the system to restore power.

NOTICE

- When the auxiliary battery power is low, you may feel the steering becomes heavy. It is a malfunction, please contact BYD authorized service provider for a check.
- When turning the steering wheel, you may hear electric engine noise, made by steering electric engine. It is not a malfunction.

⚠ WARNING

If any of the following conditions about power steering system warning light, it indicates the power steering system may have a malfunction. Please contact your BYD authorized service provider for a check as soon as possible:

1. When turning the ignition switch to “ON”, the light does not turn on or is always on.
2. The indicator light is always on while driving.

In this case, it is much more difficult to turn the steering wheel and you should hold the steering wheel firmly and drive slowly.

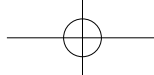

Brake System

Brake system adopts a power system with two independent vacuum sources: one is to provide vacuum negative pressure through air inflow by electric engine and the other is to provide vacuum negative pressure through vacuum-pumping by vacuum pump. If any faults occur in vacuum pump or assistance devices during driving at EV mode, the engine will start automatically and also provide vacuum source for brake system.

NOTICE

If the DM system indicator blinks with rapid clicking, system switches to HEV mode automatically, and the engine starts, these mean there is a malfunction in vacuum pump and auxiliary device, thus please park your car in a safe place and contact BYD authorized service provider.

Vacuum Booster

Vacuum booster realize boosting effect by vacuum source provided from negative pressure formed by air inflow of the electric engine or by vacuum-pumping of vacuum pump. If vacuum source is cut off in driving, you need to step on the brake pedal harder to stop the car.

NOTICE

- Do not step on the brake pedal repeatedly after you park the car, since every time you step on the brake pedal, it will consume vacuum pressure.
- If accident happens, vacuum booster may not work, but the brake can still work normally. However, you need to step on the brake harder and the braking distance will also be increased.
- It is forbidden to let your car skid before the DM system is enabled.

Anti-lock Brake System (with “ABS” warning light)

The anti-lock brake system is designed to prevent the wheels from locking in a sudden braking or driving on the

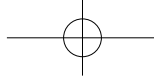

slippery road, which helps to increase the vehicle steadiness..

It is an effective way to check if ABS is working by stepping on the brake pedal: if ABS is working, the driver may feel pulsation on brake pedal and hear noises. In this case, you can let ABS work only by stepping on brake pedal forcibly. However, do not step on it repeatedly in hard braking, as it may increase the braking distance.

ABS starts working, when you accelerate the speed to over 10km/h. .ABS stops working, when you reduce the speed to 10km/h.

In rainy day, stepping on brake pedal on slippery road surfaces such as on a manhole cover, a steel plate at a construction site, joints in a bridge, etc, is easier to activate ABS.

You may hear clicking sound from front engine compartment or sound from

electric engine for several seconds when just starting the car, it indicates ABS in self-inspection rather than any malfunction.

The following conditions may occur, when ABS is working, which does not mean any malfunction in ABS.

- You may hear working sound from ABS and feel pulsation on brake pedal as well as vibration of car body and steering wheel. Even if you stop the car, you may still hear the sound of electric motor in the engine compartment.
- The brake pedal move a bit forward after ABS stops working.

NOTICE

If any of the following conditions occur, please stop your car at a safe place and contact BYD authorized service provider immediately:

- When the handbrake completely release, the parking brake warning light is still on; The parking brake fault warning light suddenly light while driving. In either case, this can indicate that the brakes do not work properly and your braking distance will be longer. Please step the brake pedal firmly and bring the car to an immediate stop.
- The “ABS” warning light turns on while driving.

In this case, not only the anti-lock brake system will fail but also the



vehicle will become extremely unstable during braking. In the event of above, please contact BYD authorized service provider.

WARNING

Do not overestimate ABS: ABS can help to control the car, but it is still very important for you to comply with all the precautions and keep proper speed as well as a safe distance with the car in front, since the function of ABS to vehicle stability and effectiveness of steering wheel operation is limited.

In case of high-speed driving in a rainy day, if anti-skidding performance of tire goes beyond its allowable capability or the car runs idle, ABS cannot help to control the

car.

Tires of specified size with proper pressure are installed in all the vehicle wheels (4 for each car); ABS measures the rotating speed of each wheel by rotating-speed sensor. If other unspecified tires are used, the rotating speed cannot be measured accurately, which may cause stopping distance increase.

In the following conditions, compared with cars without ABS, cars equipped with ABS may need a longer stopping distance:

- Driving on the rugged, cobbled or snowy road.
- Driving the car equipped with tire chains.
- Driving on such places as junction of roads.
- Driving on the bumpy or rugged

road.

Driving with the parking brake engaged can reduce braking performance.

Before driving, make sure the parking brake is fully released and the parking brake system indicator is off

Disc Brake

F3DM is equipped with disc brakes.

Brake pad wear limit Indicators

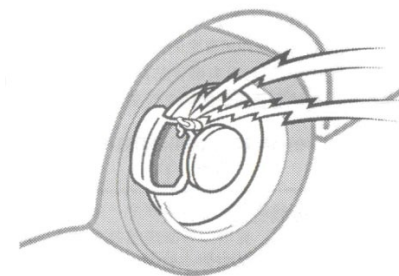

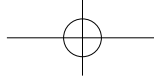

The brake pad wear limit indicators on your front disc brakes gives a warning noise when the brake pads are worn to where replacement is required

If you hear alarm sound or friction noise in driving, you should immediately contact BYD authorized service provider for check and replace pads.

Do not continue driving your car when there is alarm sound.

Precautions on Luggage Loading

When carrying luggage or goods by the car, follow the instructions below:

- It is recommended to load the luggage or goods in the Luggage storage box. Make sure all the items are fastened in proper place.
- Keep proper weight balance across the car. It is recommended to place

heavy articles in the front part to keep weight balance.

- Do not load unnecessary items to save fuel.
- Please do not place any inflammable, explosive or corrosive articles in the car.
- Please keep the luggage storage box clean and dry.
- Please keep the luggage storage box closed and locked while driving to reduce the chance of injury when there is an accident or a sudden stop.

Suspension and Chassis

NOTICE

Do not modify the suspension/ chassis with lift kits, partition panels, springs, etc. It can damage the maneuvering performance resulting in out of control.

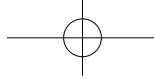

Chapter 3

Starting and Driving

Before Starting the DM system	136
Safety Check Before Driving	138
Driving Tips in Various Conditions	140
Driving Tips in Winter	141
TowTrailer	142
How to Save Fuel & Electrical Energy and Extend Auto Service Life	143

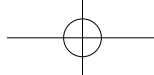

Before Starting the DM System

1. Check if the car is in charging, if so, turn off the power, take off the charging cable and keep it properly.
2. Make sure all windows mirrors ,and outside lights are clean and unobstructed .
3. Check the area around the vehicle before entering it, such as snows, puddle, space and barrier.
4. Visually check the tires. If a tire looks low, use a gauge to check its pressure.
5. Adjust seat position and height, seatback angle, waist-holding angle, head restraint height and steering wheel angle.
6. Check the steering wheel adjustment. (see section 1-3 "Steering Wheel").
7. Lock up all doors.
8. Fasten seat belts.

How to Start the Car

Please follow the procedures below:

Step 1: Lift the anti-theft system. Once you set the anti-theft system by pressing "LOCK" on the wireless remote control, you must press "UNLOCK" to cancel it before driving, or you cannot start the car.

Step 2: Turn the ignition switch to "ON" to start the car, and then the instruments will check automatically. Before starting the car, make sure the transaxle is in "P" or "N" position.

Step 3: Check if there is any warning information on instruments display, If yes, please carry out car examination refer to section 1-5.

Step 4: Adjust the inside and outside rear-view mirrors of the car.

Step 5: Make sure all doors had been lock up and seat belts were fasten.

Step6: Depress the brake pedal and shift the transaxle to D or R position. And make sure the instruments display D or R position.

Step 7: Release the parking brake.

Step 8: Release the brake pedal gradually, and rest your foot on accelerator pedal lightly to accelerate the vehicle.

NOTICE

Make sure procedure in "Before Starting the DM System" is performed before starting the DM system

**⚠ WARNING**

If the Dual Mode transaxle is in R or D, the "OK" light can't be lightened and the Dual Mode can't work. so make sure the transaxle is in "P" or "N" before turning the ignition switch to "ON".

⚠ WARNING

When starting the car on downhill slope, to avoid the vehicle creeping, please following the procedures below after performing step 6 :

1. Depress the accelerator pedal lightly;
2. Release the parking brake.

If the Car Cannot Start

Refer to "If the Car Cannot Start" in Chapter 4.

If the Car Is Overheated

Refer to "If the Car Is Overheated" in Chapter 4.

⚠ WARNING

- Do not start the DM system from outside, or an accident may occur.
- Be sure to sit on the driver seat, and fasten seat belts, then start the system when driving.

⚠ WARNING

- If the system determines that the engine should be started, but it does not start normally within 20 seconds, the system will perform automatic protection and start the engine again on its own; if the engine can not work normally after the third start-up, please contact BYD authorized dealer for repair.

NOTICE

When driving on damp road, it is necessary to avoid driving through ponding road, as if a large amount of water enters the front engine compartment, the engine and/or electrical parts may be damaged.

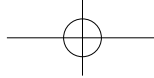

Safety Check Before Driving

Before driving, you had better conduct a safety check for the car. Several minutes' check can make for safety driving and allow you to enjoy driving. If you are unfamiliar with car system, you can ask BYD authorized dealer to check your car.

NOTICE

If you make safety check in a closed garage, make sure the garage has good ventilation.

Please pay attention to precautions below:

Vehicle Exterior Conditions

Tire: check if the tire pressure is normal and if the tire has any cut, damage or excessive wear.

Wheel Nuts: make sure there is no loose or missing nut.

Leakage: check if there is fuel oil, engine oil, antifreeze or other fluid leakage under the car after parking. (water dropping generated by air conditioner is normal).

Lighting: make sure all the headlights, width-indicator lights, turn signal lights and other lights work normally.

Vehicle Interior Conditions

Spare tire, jack and wheel nut wrench: check tire pressure and make sure the jack and wrench is in place.

Seat belt: check whether the buckle can fasten seat belt firmly. Make sure

seat belt has no wear or scratching. **Instruments and Controllers:** take special care to make sure service reminder indicator, instrument lighting I and defroster work normally.

Brake: make sure the pedal has enough free space.

Inside Front Engine Compartment

Spare Fuse: make sure all types of fuses in correspondence with the specifications of the original rating charge ones are available.

Antifreeze level: make sure the antifreeze level is between the maximum and minimum scale marks in the reservoir.

Brake Fluid Level: make sure the brake fluid level is between the maximum and minimum scale marks in the reservoir.

Clutch Fluid Level: make sure the fluid level is between the maximum and

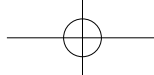

minimum scale marks in the reservoir.

Auxiliary Battery and Cables: all units of the auxiliary battery shall be added with the distilled water to the right level. Check whether there are corroded or loose terminals, and whether the battery box has cracks. Check whether the battery cables and connection are proper.

Other Cables: check whether there are damaged, loose or disconnected cables.

Fuel Pipe: check whether there is leakage or bad connection in fuel pipe.

⚠ WARNING

- Do not pile up children's toys in the car, which may post potential danger, especially in hard braking and collisions, in which case, these toys may cause personal injury.
- Please check your car in ventilated place when the engine is running ,or the engine exhaust may cause serious injury.
- Avoid burning from hot parts, let the engine and exhaust system cool down before touching any parts.
- Avoid injury from moving parts. Do not run the engine unless instructed to do so.

After Starting Engine (HEV Mode)

Exhaust System: listen to the sound to check whether there is any leakage. If any leakage, you shall have it repaired immediately. (Refer to "Engine Exhaust Warning" in Chapter 2.)

Engine Oil Level: shut down the engine and stop the car on flat ground, then check oil level with a dipstick. (Refer to description in Section 7-2.)

In Driving

Instruments: make sure the indicators and speedometer work normally.

Brake: under safe traffic conditions, make sure braking does not result in deviation of the car.

Other Abnormalities: check whether there is any leakage or loose connection, abnormal noises and other abnormalities.

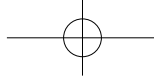

Driving Tips In Various Conditions

- Driving slowly in gusty crosswinds, which is helpful for better control.
- Driving the car slowly onto curbs at a right angle.. Avoid driving onto any high sharp-objects and other road hazards. Otherwise the tires may suffer severe damage such as burst.
- Slow down vehicle speed on bumpy or rugged roads. Otherwise the impact could cause severe damage to the tires and/or wheels.
- Washing the car or driving through deep water may get brakes wet To see whether they are wet, check that there is no traffic near you and press the brake pedal lightly. If you do not feel a normal braking force, the brakes are probably wet. To dry the brakes, slightly step on the braking pedal while driving the car carefully with parking

brake applied. If they still do not work safely, pull to the side of the road and call your BYD authorized dealer for assistance.

WARNING

- Make sure that parking brake is released fully and the parking brake indicator is off before driving.
- There is a high voltage battery pack at chassis ,please drive with caution when wading.
- Do not rest your foot on brake pedal while driving, It can cause dangerous overheating, needless wear and poor fuel economy.
- When driving down a long or steep hill at high speed, you can switch to HEV mode and brake with the motor braking.

- Please note that the brake will be overheated and function abnormally if you steps on the brake pedal too frequently.
- Be sure to operate the shift gear after the vehicle stops steadily. And to avoid accident, never put your foot on the accelerator pedal while shifting.
- In slippery road require special caution , Sudden acceleration or emergency braking could cause the vehicle to spin or skid.
- When the brake is wet, do not continue driving, as wet brake requires a longer braking distance and may cause deviation of the direction of the car. Also, in this case parking brake can not hold the vehicle securely.



- Be sure to put the DM transaxle in “P”, apply parking brake, shut off the DM system and remove the ignition key when you leave your car . Or the vehicle will creep and start abruptly with the accelerator pedal being depressed by mistake. This may cause rapid acceleration, and lead to death or serious injury.

Driving Tips in Winter

Make sure you have a proper freeze protection for engine coolant.

You are required to use the antifreeze specified by BYD and select the proper model according to the ambient temperature.

Improper use of antifreeze may damage the system components needed to be cooled, such as engine

and electric motor power.

NOTICE

Do not use plain water, which may damage the system components needed to be cooled, such as engine and electric motor power.

Checking the Auxiliary Battery

Cold temperatures may reduce the capacity of the auxiliary battery and power battery, so it must be in top shape to provide enough power for winter starting. Visually check the auxiliary battery is described in section 7-3. BYD authorized dealer can check charging level of the auxiliary battery and power battery for you.

Make sure viscosity of the engine oil is suitable for the cold weather.

Please refer to section 7-2 for information on recommended viscosity of engine oil. Leaving a large volume of summer oil in the engine in winter, may cause harder starting. If you are not sure about which oil to use, please contact BYD authorized dealer for help.

Avoid Door Lock Freezing

Spray some deicing agent or glycerin into the door lock hole to prevent the lock from freezing

Use a washer fluid containing antifreeze solution.

Such products are available in BYD authorized dealers and all auto part stores. Follow the manufacturer's direction for how much to mix with water

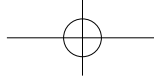

NOTICE

Don't use engine antifreeze or other substitutes as washing liquid, because it may damage the vehicle's paint.

In case the parking brake may be frozen, you'd better not drive your car immediately until the parking brake gets unfrozen.

When parking, push the "P" position switch and block the rear wheels or the wheels which may lead to sliding of the car. Do not use the parking brake, for snow or water accumulated in and around the parking brake mechanism may freeze, making it hard to release..

Prevent ice and snow from accumulating under the fenders.

Ice and snow built up under your

fenders can make steering difficult.

During extreme winter driving, stop and check under the fenders occasionally.

Depending on where you are driving, we recommend you carry some emergency equipment.

Some of the things you might put in the vehicle are tire chains, window scraper, bag of sand or salt, flares, small shovel, jumper cables, etc.

⚠ WARNING

Be careful when running on a slippery surface, because it may cause your stopping distance become longer and abrupt shifting could cause the vehicle spin or skid. Therefore, it's necessary to avoid speeding up, emergency braking and the high-speed while driving in this condition.

Tow Trailer

BYD F3DM is designed for transportation of passengers. Towing a trailer may pose bad effect to operation, performance, braking, endurance and fuel economy (fuel consumption) of the car. Safety and comfort in driving depends on the proper use of device and driver's good habit in careful driving. For your and others' safety, do not over load the car or tow a trailer. Damage or failure caused by towing a trailer for business purpose is not covered by BYD warranty.

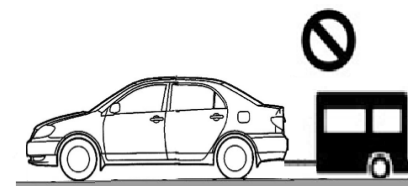

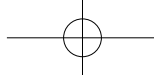
**⚠ WARNING**

- In towing a trailer, do not exceed the maximum rated load of the hook, or it may cause accident and severe personal injury.
- As towing a trailer may require a longer braking distance, you shall maintain a safe distance with other vehicles. At the speed of 10 km/h, the interval between your car and the vehicle in front of you shall be no less than the total length of your car and the trailer. Avoid hard braking to prevent the car from skidding, which may get the car out of control.

Tire

- Make sure the tire pressure is proper. Refer to description in section 7-2.

Maintenance

- For a new auto or an auto with new driving system parts (engine, electric motor power, transmission, differential mechanism, wheel bearing, driving shaft, etc.), do not tow any trailer in the first 2000 km travel.
- When towing a trailer, the increased load requires more frequent maintenance of the car.

How to Save Fuel & Electrical Energy and Extend Auto Service Life

Improving fuel and electrical energy is easy –just take it easy .It will make your vehicle last longer too. Here are some specific tips on how to save money on fuel and electrical energy as well as repairs

- Keep your tires inflate at the correct pressure. Improper inflation pressure cause tire wear and wastes fuel and electrical energy. Refer to description in section 7-2.
- Do not carry unneeded weight in your vehicle. Excess weight put a heavier load on the engine, causing greater fuel consumption.
- Accelerate slowly and smoothly. Avoid rapid acceleration when starting the vehicle.
- Avoid unnecessary stopping or braking. Maintain a steady pace. Drive according to the indication of traffic signaling lights or drive on the road free from traffic signaling lights. Keep proper distance from other vehicles. It will also reduce wear on your brakes..
- Avoid heavy traffic or traffic jams whenever possible.
- Maintain a moderate speed on

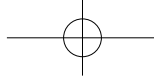

highways. The faster you drive, the greater fuel consumption. By reducing your speed, you can cut down on fuel consumption.

- Keep the Front Wheels in Proper Alignment. Improper alignment not only cause faster tire wear, but also put extra load on the engine, which in turn waste fuel.

- To increase driving comfort and safety, avoid hitting the curbstone and slow down on rough roads.

- Keep the chassis clean and free of mud etc. It helps lessen the vehicle weight and prevent corrosion.

- Adjust and Keep Vehicle at Best Performance. A dirty air cleaner, improper valve clearance, dirty plugs, dirty oil and grease, brakes not adjusted etc. all lower engine performance contribute to poor fuel economy. For longer life of all parts

and lower operation costs, keep all maintenance work on schedule, and if you often drive under severe conditions, see that your vehicle receives more frequent maintenance.

(Refer to Chapter 6)

 **WARNING**

If you do not use the vehicle for a long time (2 weeks or more), the power battery and auxiliary battery will discharge and their power will decrease. Therefore, in order to make up for the discharging, you can take either of the following methods to charge the batteries once every two weeks:

- 1.using charge device
2. Starting the DM system for about 30 minutes with all electrical components turned off.



Chapter 4

In Case of An Emergency

If the Car Cannot Start	146
If the DM system stalls in Driving.....	146
If the Car Overheats	146
If the Car Has Flat Tires	148
If the Car Gets Stuck	154
If Car-towing is Needed.....	155
Emergency Maintenance Switch	157

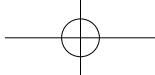

If the Car Cannot Start

(a) Simple Check

Before conducting this check, make sure the starting procedure in “How to Start the Car” in Chapter 3 is performed properly and there are sufficient fuel and power. Meanwhile, check if the car can get started by using the spare key. If it works, your key may be broken. Please contact BYD authorized dealer to check your key. If none of your keys work, the vehicle control system may have a malfunction, please contact BYD authorized dealer for help. (Refer to description “Keys” in Section 1-2.)

1. Check that the auxiliary battery connections are tight and clean.
2. Turn the ignition switch to the ON position, turn on the headlights, and check their brightness. If the headlights

are very dim or do not come on at all, the battery is discharged. Please refer to “Jump Starting” in section 7-3.

3. Check whether the power battery is discharged, if yes, charge the battery immediately.
4. Check if there is sufficient fuel in the tank. Insufficient fuel also cause the car cannot startup.

If you find nothing is wrong, but the car can't start. You will need a qualified technician to find the problem. Please contact your BYD authorized dealer.

WARNING

You cannot start your vehicle by pushing or pulling it.

If the DM system stalls in Driving

1. Turn on the emergency flashlight.
2. Please slow down the car gradually, keep moving in a straight line and run off the road to a safe place.
3. Follow “Car Starting Methods” and try to start the car again.

If the car cannot start, please see “If the Car Cannot Start Up”.

WARNING

If the DM system is off, the boosters of brake and steering device cannot work, which makes steering and braking much harder than usual.

If the Car Overheats

If the high coolant temperature warning light comes on, if there is no power

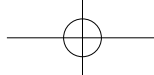

output or if there is loud knocking or ping noise, that means the power train or engine controller is overheated. Please handle it as per the procedures below...

1. Turn on the emergency flashlight, drive the car safely off the road and stop it. Put the transaxle in P position and apply the parking brake. Shut down air conditioner if it is running.

2. If there is antifreeze or steam boiling out of the tank, shut down the DM system. Wait until the steam subsides before opening the hood. If there is no antifreeze or steam boiling over, leave the DM system running and check the electric cooling fan. If electric cooling fan do not work, turn the ignition off, call your BYD authorized dealer for repair.

⚠ WARNING

Driving in the condition of car overheats can cause serious damage to your engine.

⚠ WARNING

Steam and spray from overheated engine can seriously scald you. Do not open the hood if steam is coming out.

3. Check whether there is obvious antifreeze leakage under the radiator, hose. Water draining from the air conditioning is normal if it has been used.

⚠ WARNING

Keep a proper distance between the fan and things, such as hands and clothes, to avoid a danger caused by abrupt startup of the fan.

4. If any antifreeze leakage, you shall stop the engine immediately. Please contact BYD authorized dealer for help.

5. In case of no obvious leakage, please check the antifreeze reservoir; if the level is below the MIN mark or there is no antifreeze in the reservoir, add some antifreeze to the reservoir up to the maximum scale mark with the DM system is running.

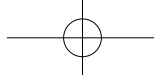

 **WARNING**

Removal of the radiator cap Under high temperature can cause the antifreeze to spray out, and serious injury may be resulted from scalding fluid and steam blown out under pressure.

Always let the engine and radiator cool down before removing the radiator cap.

6. When the antifreeze temperature be cooled to normal, check the antifreeze level in the tank again and add additional antifreeze up to the maximum scale mark if necessary. Large drop of antifreeze level means leakage in the system. Please contact BYD authorized dealer for immediate examination.

If the Car Has Flat Tires

Turn on the emergency flashlight.

Drive slowly along the shoulder until you get to an exit or an area to stop a safe place away from the traffic lanes.

Park the car on firm, level and non-slippery ground.

Put the transmission in P and apply the parking brake.

Turn the ignition switch to “LOCK” position.

All the passengers get out of the car on the side away from traffic.

Read the following instructions carefully.

 **WARNING**

To reduce the possibility of serious personal injury, please obey the instructions below when you lift the car by a jack.

- Follow the directions for changing a tire exactly, and never get under the vehicle when it is supported only by the jack
- When the car is lifted by a jack, do not start and run the DM system.
- Park the car on firm, level and non-slippery ground, apply parking brake tightly and shift the transmission to P gear. If necessary, block the wheel diagonally opposite to the one being changed.
- Make sure to set the jack properly



in the jack point. Raising the vehicle with jack improperly positioned will damage the vehicle or may allow the vehicle to fall off the jack and cause personal injury.

- When the car is supported by jack, no one is allowed to get under the car.
- Use jack only for lifting the car while tire changing.
- Do not lift up the car when someone is in it.
- Do not put anything at the top or bottom of the jack while lifting the car.
- Just lift the car to a height that allows tire removal and replacement.

WARNING

- Do not continue driving the car with a flat tire. Driving even a short distance on a deflated tire can lead to tire failure, also reduce fuel efficiency and tire life, and may affect the vehicle's handling and stopping ability.
- Use the spare tire as a temporary replacement only. Get your regular tire repaired or replaced, and put on your vehicle as soon as you can.

Tools Required and Spare Tire

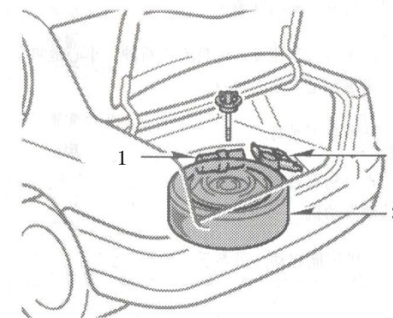

1. Take out tools required and the spare tire.

- 1.Toolkit
- 2.Jack
- 3.Spare tire

In emergency conditions, you may have to repair the car by yourself. Please well know the use method and storage location of the jack and various tools.

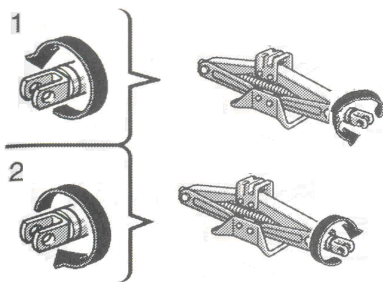
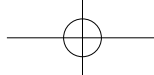

Remove: rotate the terminal in direction 1 until the jack becomes flexible.

Storage: rotate the terminal in direction 2 until the jack is fixed tightly to prevent it from being thrown forward when there is crash or emergency braking.

Loosen and remove the spare tire carrier, then take out the spare tire.

To store the tire, please put the outside of the tire downward in place, and then fasten the tire in the opposite order to prevent it from being thrown forward when there is a crash or emergency braking.

Note: when fastening the original tire of the car with methods of fastening the spare tire carrier, please put the side with higher convex plate facing upwards.

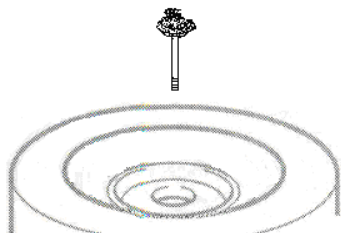

Block Wheels

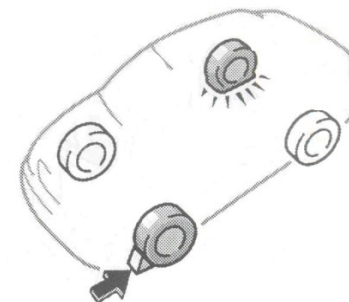

2. While lifting, please lay the block under the wheel in the diagonal direction of the flat tire to prevent the car sliding.

Put the block in front of a front wheel or behind a rear wheel.

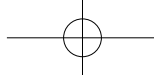

Unscrew wheel nuts

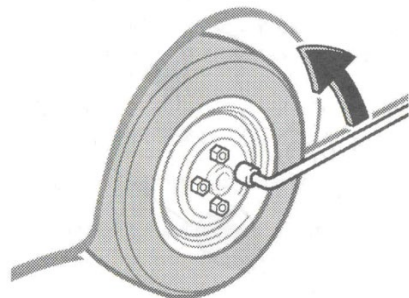

3. Unscrew all bolts on the flat tire.

Unscrew all bolts on the wheel before lifting the car.

Unscrew the bolts on the wheel anti-clockwise. For better torque, you can fit the wrench to the nut with its handle on the right side, as shown in the figure above. Grip at the end of the wrench handle and pull upwards. Please avoid the wrench slipping off the nut.

Do not remove the nuts, just loosen them.

Jack Positioning

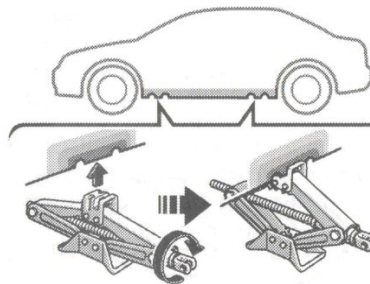

4. Place the jack under the proper lifting point, as shown in the figure.

Make sure that the jack is placed on the flat and solid ground.

Lift the Vehicle

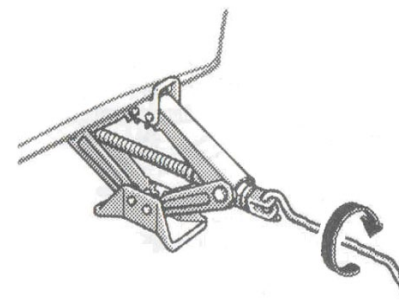

5. Make sure nobody is in the car, and lift up the car to a height that allows installation of spare tire.

Please notice that it needs larger ground clearance to install the spare tire than removing the flat tire.

To lift up the car, please insert the jack handle into the jack (loose joint) and rotate it clockwise. When the jack touches the car and starts lifting, please check again if the jack is at the right position.

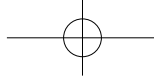

⚠ WARNING

When the car is supported only by jack, no one is allowed to get under the car.

Pay attention to the exhaust pipes on both sides of car in using jack, to avoid burns.

Replace Wheels

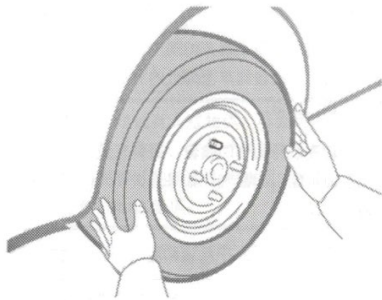

6. Remove wheel bolts and replace the tire.

Take off the flat tire and put it aside. Move the spare tire to the installation position, align the bolts to tire holes, and then raise the tire until the top bolt fits into the screw hole. Rotate the tire and push it until all bolts can fit into corresponding screw holes.

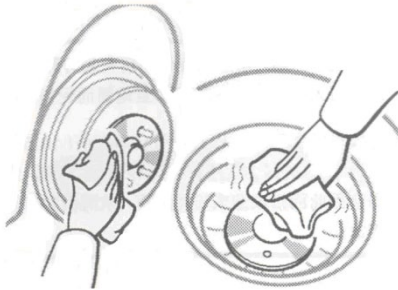

Before installation, please brush off all corrosive materials on the installation surface with a wire brush. During installation, the metal area on the installation surfaces must be in good contact with each other, or the wheel

bolts may get loose, which may cause the tire falling off while driving.

Reinstall Wheel Bolts

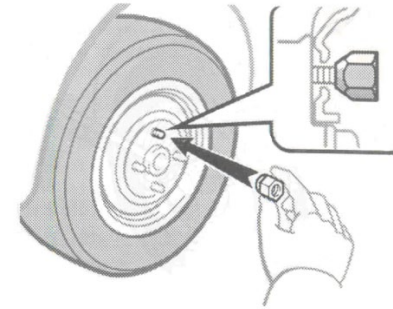

7. Put on the spare tire. Reinstall all wheel bolts (tapered end inward) and tighten them as much as you can by hand. Push the wheel backward and see if you can tighten them more..

**⚠ WARNING**

Do not apply engine oil or lubricant on the nuts, or they will get loose, which may cause the wheel detached and lead to serious accident. If there is engine oil or lubricant on the bolts or nuts, clean them immediately.

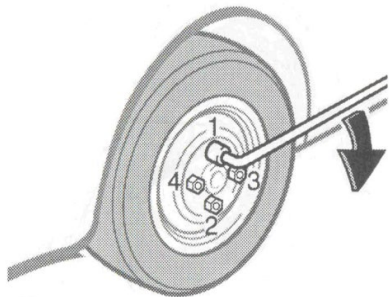
Lower Down Vehicle**8. Lower down the car to ground and tighten the wheel bolts.**

To lay down the car, please rotate the jack handle counterclockwise.

Please use a wheel wrench to tighten the wheel bolts. Do not use any other tools or lever other than your hands, like hammer, tube, or your foot. Make sure the wrench is securely engaged over the bolts.

As per the order shown in the figure above, tighten the bolts slightly one by one, repeat the procedure until all the bolts are fastened firmly.

⚠ WARNING

- Please make sure no part of your body and no one nearby will get injured while laying down the car onto the ground.
- After the tire is replaced, Have the wheel bolts tightened with torque wrench to 110N·m (11.5 kgf·m). Otherwise if the torque is insufficient, the nuts will get loose, which may cause the tire fell off and result in serious accident.

After Tire Replacement

9. The tire pressure after replacement.
Adjust the tire pressure to the specification specified in Chapter 8. If the current pressure is lower than specified, please drive the car slowly to the nearby service station for air

charging.

Do not forget to install the tire valve cap, or dust and moisture will enter the valve core to cause possible air leakage. If the tire valve cap is missing, please use a new one immediately.

10. Keep all the tools, jack and flat tire properly and fasten the flat tire in the spare tire carrier.

Flat tire shall be repaired by the professional technician. The flat tire should fasten as follow way, with higher convex plate side facing upwards. See the following illustration.

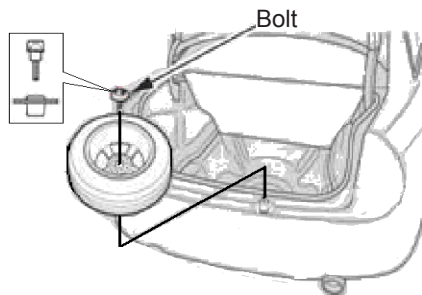
**⚠ WARNING**

- Store the jack, wheel, and tools securely before driving. Loose items can fly around the interior in a crash or sudden braking, and could seriously injure occupants.
- After tire replacement, please do not drive over 70km/h and single travel cannot exceed 100km; you shall drive slowly to the nearest BYD authorized dealer to get the tire replaced. Otherwise, serious accidents such as tire burst and failure of operation may occur.
- If you ever replaced a tire, make sure that the tire's specifications match those of the original tires.
- when the compact spare tire is installed, avoid driving over obstacles and drive slowly on rough, unpaved roads and speed bumps.

If the Car Gets Stuck

If the car gets stuck in snow, mud, or sand, please try to get it out by pushing it forward or backward. Or you can call a towing service to pull it out (see the next section If Car-towing is Needed)

⚠ WARNING

If there are persons or objects near the car, please do not try to move the car by pushing it forward and backward. If not, once the car gets out and suddenly moves forward or backward, there may be personal injury or damage to objects.

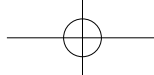

If Car-towing is Needed

Tow from the front



Tow from the back



Use flat bed truck



Proper equipment will help ensure that your vehicle is not damaged while being towed. Your vehicle can be damaged if it is towed incorrectly. Although most operators know the correct procedure, it is possible to make a mistake. To avoid damage to your vehicle, make sure the following precautions are observed.

Precautions for Towing:

Use safety chain system and abide by applicable national and local laws. If you cannot shift the transmission or start the DM system, your vehicle must be towed by a flat bed truck.

WARNING

- You are required to release P gear before towing the car, that's to say, when the engine starts, you shall shift transaxle to N gear before driving. If P gear is locked, you can only tow the car by lifting the front wheels off the ground, or it may damage the transmission box.
- Do not tow with sling type truck, either from the front or rear. This may cause body damage.
- When lifting wheels, should ensure adequate ground clearance for towing the raised vehicle. Otherwise, in the course of towing vehicle may be damaged.

Emergency Towing

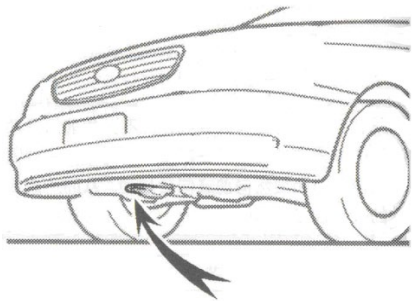

For emergency towing, we recommend you to have it done by your BYD authorized dealer.

If you cannot find a towing company under emergency situation, please tie the towing cable or chain to the emergency towing hook at the bottom of the car for temporary towing. In this case, you shall be extremely careful.

⚠ WARNING

- Please use the specified towing hook, cable or chain and tie the cable or chain to the hook tightly, or it may damage the car and cause serious injury or death.
- Do not tow the car from the rear with all four wheels on the ground, or it will seriously damage the transmission.
- You are required to release P gear before towing the car, that's to say, when the engine starts, you shall shift transaxle to N gear before driving. If P gear is locked, you can only tow the car by lifting the front wheels off the ground, or it may damage the transmission box.
- Do not tow the car farther than

10km and keep the speed below 30 KM/h.

- The DM system shall be running in towing; if not, boosters of brake and steering device cannot work, which makes steering and braking much harder than usual.

The driver must be in the vehicle to steer the car and control the brake.

Towing in this way may be done only on hard-surfaced roads for a short distance and at low speeds. Also the wheels, axles, transmission, drive train, steering, and brakes must be in good condition.

**⚠ WARNING**

Take extremely attention when towing the car. Avoid sudden starts or unstable operation which would effect great stress on the emergency towing hook and towing cable or chain. It may cause the hook and towing cable or chain break and cause serious injury or damage.

handle when using and then pull it out horizontally.

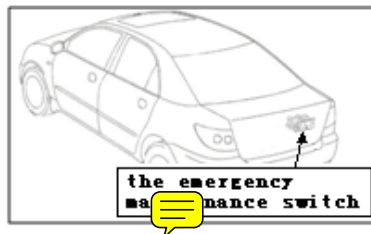
**⚠ WARNING**

- When the ignition key is at "ON", strictly prohibit from plugging/unplugging the emergency maintenance switch and connectors on the box.
- Before repair/dismantle the whole unit, do pull out the emergency maintenance switch first.
- Do not pull out the emergency maintenance switch and connectors on the box when the car is being charged

Emergency Maintenance Switch

Functions of emergency maintenance switch

In vehicle maintenance and emergency, cut off all high-voltage system in the unit.

Emergency maintenance switch is under the guard board of luggage carrier. Press the button on the

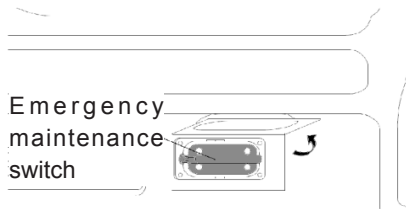

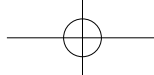

 **WARNING**

- Please check that the ignition key do turn to “LOCK” position and the emergency maintenance switch has been installed on the high-voltage distribution box before charging the battery.
- You'd better pull out the emergency maintenance switch if the car is not used for a long time.

 **WARNING**

- Do not pour any fluid or solid into high-voltage distribution box and on the connectors of box. Do not start the car when fluid and solid enter into the high-voltage distribution box.
- When there is no emergency maintenance switch, do not replace it with any other conductive metal.
- Avoid an electric shock, it's strictly forbidden to touch the high-voltage parts without security device.
- It's strictly forbidden to disconnect the high-voltage distribution box privately.
- Do not plug/unplug the connectors of battery administrator in driving and parking.

- It's strictly forbidden to compress or knock the shell of the controller. If any sunk part and crack on the shell, you shall stop the car and call your BYD authorized dealer for repair.
You shall be responsible for all consequences arising from the operations in violation of the rules

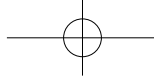

Chapter 5

Corrosion Prevention and Appearance Care

Protecting F3DM from corrosion	160
Tips on maintenance of vehicle surface	161
Washing and waxing	162
Cleaning the interior	165

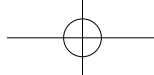

Protecting F3DM from corrosion

Proper maintenance of your car can help ensure long-term corrosion prevention.

The most common causes to corrosion to your vehicle are:

- The accumulation of road salt, dirt and moisture in hard-to-reach areas under the vehicle
- Clipping of paint, or undercoating caused by minor accident or by stones and gravel.

If you live in particular areas or operate your vehicle under certain environment condition, care is of utmost importance:

- Road salt or dust with chemicals will accelerate corrosion. Salt also exists in the air near the sea coast or in areas of industrial pollution.
- High humidity will accelerate

corrosion, especially when temperature range just above the freezing point.

- When certain parts of the car are always under circumstances with high humidity and moisture, even if the rest parts may be dry, corrosion will occur.
- High ambient temperature may cause corrosion to those components which cannot get dry quickly due to lack of proper ventilation.

Those above signifies the necessity to keep your car, especially its underside, as clean as possible and to repair any damage to paint or protective coatings as soon as possible.,

To prevent corrosion on your F3DM, please follow the guidelines below:

Washing your car regularly can keep it clean. But to prevent corrosion, please the following points should be observed:

- If you drive the car on salted roads in

winter or live near the ocean, please wash the running part of the car at least once per month to minimize corrosion.

- It is effective for cleaning chassis and wheel cover under high pressure water or steam. Pay more attention to the vehicle's underside and wheel housings as it is difficult to see all the mud and dirt. It will be much more harmful to simply wet the mud and debris without removing. Drain holes in the lower edge of doors, rocker panels and frame members should not be allowed to clog with dirt, because trapped water in these areas can cause corrosion.

- Wash the underside of your vehicle thoroughly when winter is over.

For further information, please refer to "Washing and Waxing".

Check the condition of your vehicle's



paint and decorating components;

If there are chips and scratches in the paint, please repair it immediately in order to prevent corrosion from starting at this location. If the chips and scratches have gone through the bare metal surface, please contact the BYD authorized dealer for repair.

Check the interior of your F3DM; Water and dirt will accumulate beneath the floor mats and could cause corrosion. Please check the underside of the floor mats occasionally to make sure the area is dry. Please pay particular attention when transporting chemicals, cleansers, fertilizer, salt and similar materials which should be transported in proper containers. In case of any spillage or leakage, please clean and dry the affected area immediately.

Use mudguard. When driving in salted roads or roads with gravel, mudguard

would protect your vehicle from mud. The larger the size of mudguard and lower clearance altitude are the better protection your vehicle will get. Small mudguard for wheel cover is optional for BYD F3DM, installation of which is available at BYD authorized dealer.

Park the vehicle in a well ventilated garage or a roofed place rather than in a damp or poorly ventilated place. If you wash your car in the garage or drive on a wet or snowy road, the garage may get damp and it will cause corrosion. Even though the garage is dry, the car will also get damp and suffer corrosion if the ventilation is poor.

Tips on Maintenance of Vehicle Paint

Please pay attention to the following points in using and maintaining of the

car:

- (1) Clean the dirt on the car before, during and after using your vehicle, which can minimize adhered dirt by electrostatic.
- (2) Wash your F3DM timely after rain. The rain stain on the car body will shrink in size after rain, which means acid materials in the rain will concentrate. Clean the taint as soon as possible to avoid harm to your vehicle finish caused by the taint.
- (3) Wash the car after the engine cools down. Do not wash your car in strong sunlight or under high temperature, otherwise the detergent will form taint on the paint surface after quick drying. If washing the car by yourself, please use special-purpose detergent and neutral active water. Do not use mild soap water and detergent with high alkaline, which

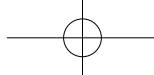

may wash away grease in the paint and speed up aging. When washing the car in car wash, you'd better prevent the staff from using grease-removing detergent, or the paint may be damaged. When driving your car in coastal areas with heavy pollution, you shall wash the car on a daily basis.

(4) Use damp, clean and soft cotton mitt to wipe the car, and make sure metal and sand article does not exist in it. Do not use dry cloth, sponge or towel to wipe it to avoid scratching the paint. When wiping, move the cloth gently along the running water, and do not move in circle or perpendicular to the running water. Do not rub or press hard in case that you may scratch the paint.

(5) Clean some special traces with very strong causticity as soon as possible (such as asphalt, bird manure and insect remains). For

such things, please clean them with special cleanser and do not scratch them with a blade or clear them up with gasoline in order to avoid causing damage to vehicle finish.

(6) Pay attention to not touching the paint with oily and dirty hands or wiping it with an oily rag; please do not stick any oily tools or put cloth with organic solvent on the car, to avoid chemical reaction.

(7) If there is no obvious scratch, do not make repainting as the new paint color may vary from the original paint.

(8) In case that the car will not be used for a long period, please park it in a well-ventilated garage or a similar place, and use a special-purposed car cover in winter. For a short period parking, please select a shade place.

(9) Prevent strong impact, knock or scratch to the paint. If the paint

is scratched, sinking or peeling off, please make repair in time, and you are recommended to go to a professional auto beauty store.

(10) Use carbon detergent to clean glossy metal parts, and apply wax regularly for protection.

(11) High qualified cleaner is needed when washing your decorative parts. Do not use excessive force when waxing to prevent the base layer from exposing when the paint is penetrated. Apply wax on the paint film and go to auto beauty store for maintenance regularly (at least once per quarter) to keep the vehicle finish glossy.

Washing and Waxing Cleaning for BYD F3DM

Clean the car in normal way.

The following cases may cause weakness to the paint or corrosion to

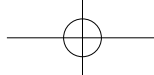

the body and parts. Please wash your vehicle as soon as possible.

- When driving in the coastal areas
- When driving on a road sprinkled with antifreeze.
- When having coal tar, tree sap, bird droppings and insects
- When driving in the areas with a lot of smoke, soot, dust, iron dust and chemical substances.
- When the vehicle becomes remarkably dirty with dust and mud.

Warning

Do not splash water on the electric components in the engine compartment in case that the malfunction of electric components occurs.

Hand-washing your BYD F3DM

Work in the shade and wait until the car body is not hot to touch.

Notice

Please be careful not to injure your hands when cleaning under floor or chassis.

1. Rinse off loose dirt with a hose. Remove any mud or road salt in the underside of your car or in the wheel wells.
2. Wash with a mild car-wash soap and mixed detergent should accord with the manufacturer's instructions. Use a soft cloth dripping the cleaner and wipe your car gently. Do not use excessive force and let soap and clean water remove the dirt.

3. Rinse thoroughly. Dried soap may cause streaking. You may need to rinse each section right after you wash it.

4. To avoid water streak, please dry the body with dried soft cotton towel. Do not rub or press hard, or the paint may be damaged.

Plastic wheel ornaments

The plastic wheel ornaments may be damaged by organic substances. If any organic substances spill on ornaments, please wash it off with clean water and check whether the ornaments are hurt.

Warning

Do not install damaged plastic wheel ornaments, or they may drop off the wheel while driving and cause an accident.

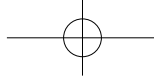

Aluminum Wheels: Wash it only with neutral soap water or neutral detergent.

Plastic bumpers: Wash carefully. Don't use soap water with abrasive cleaners because bumper face is soft.

Road tar: Remove with turpentine or cleaners marked as non-harmful to the painted surface.

Notice

Do not use organic substances (gasoline, kerosene, naphtha, and strong solvent) as they may be toxic or cause damage.

Automatic Car Washing

Your vehicle may be washed in an automatic car wash, but please notice that some types of brushes, unfiltered water, and the wash process adopted by the machine may cause the paint

scratched. Damages to the paint surface will reduce its durability and gloss, especially for dark vehicles. Staff from carwash may advise you about washing process proper for your car.

Notice

To prevent damage to the antenna, make sure to remove it before driving it though an automatic car wash.

Waxing BYD F3DM

Polishing and waxing is suggested to maintain the original beauty of your vehicle.

Waxing shall be done once per month or if the car body doesn't repel water well.

1. Please wash and dry the car body before waxing, even if you use a

combined cleaner and wax.

2. Please use polish and car wax with high quality. If the paint has been seriously weathered, please use the cleaning polish followed by a separate wax. Follow the instructions and precautions from the manufacturer carefully. Make sure that polishing and waxing is needed for the chrome as well as the paint.

3. Wax your car again when water does not bead but remains on the surface in large patches.

Warning

Always remove the plastic bumpers if your car is re-painted and placed in a high heat paint waxing booth. High temperature may cause damage to the bumpers.



Cleaning the interior

Notice

Do not wash the floor with water, or allow the water to flow onto the floor while cleaning the interior and exterior; otherwise water may enter the audio devices or other electric components above or under the carpet (or mat), which may result in fire or malfunction of the devices and corrosion of the car body.

Do not splash water or spill liquid on the floor. This may prevent the side airbags from activating correctly, which may result serious injury.

Carpets

Please use high quality foam cleaner to clean the carpet.

First use the dust collector to remove as much dust as possible. Several types of foam cleaners are applicable: some are packed in aerosol can, and others are powders or liquids which shall be mixed with water to produce foam. Rub in overlapping circles.

Do not use water so as to keep the carpet dry. Please read and follow the detergent instructions closely.

Seat Belts

The seat belt can be washed with mild soap or lukewarm water.

Use sponge or soft cloth to clean it. Check the belts for excessive wear or fraying, or cuts.

Warning

Do not use dye or bleach on the belts, or intensity of the belts may be minimized.

- Do not use the seat belts until they become dry.

Glazing

Glazing can be cleaned with any household cleaner.

Warning

When clean the internal side of the window, pay more attention to the heater wires or its connectors in order to not be damaged and scratched.

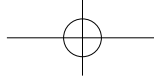

Air conditioning control panel, audio, instrument panel, console panel and switches can be cleaned with wet and soft cloth.

Soak a clean soft cloth into water or lukewarm water and then wipe off the dust gently.

Notice

- Do not use organic substances (solvent, kerosene, alcohol and gasoline) or acids or alkaline. Such chemical substances may lead to discoloring, staining or peeling-off.
- Before using detergent or polish, make sure that there is not any substances mentioned above in it.
- If you use new liquid car freshener, please do not spill the liquid with harmful substances onto the interior surface of the car. Clean any spilled liquid immediately using the method mentioned above.

Leather Trimming inside the Car

Leather interior

The leather can be cleaned with neutral detergent for wool products.

Remove the dirt with a soft cloth dipped with 5% of neutral detergent in volume fraction. Intended for woolen fabrics, and then wipe off all traces of detergent with a clean wet cloth.

Whenever any part of the leather gets wet or after cleaning, please dry with a clean soft cloth and keep it in the ventilated shade for drying.

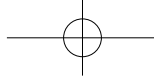

Warning

- If a stain fails to be removed by a neutral detergent, a cleaner without organic solvent is applicable.
- Never use organic substances such as ethereal oil, alcohol, gasoline or acid or alkaline solutions to clean leather, because these above may cause the leather discoloring.
- Using a nylon brush or synthetic fiber cloth may scratch the fine grained leather surface.
- Dirty leather may generate mildew, so please be careful about oil spots and keep the leather clean.
- Long exposure to direct sunlight may cause the surface of the

leather to harden and shrink. Thus, please keep your car in shade, especially in the Summer.

- Temperature in the interior may increase easily during the hot summer day. Avoid placing the items made of vinyl or plastic or containing wax as these tend to stick to the leather when hot.
- Improper washing method to the leather may cause discoloring and staining.

For more questions, please contact BYD authorized dealer for help.

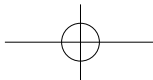
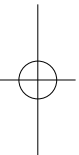
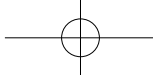

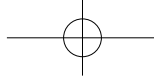

Chapter 6

Maintenance and Care Instructions

Maintenance requiriements	170
Does your car need repairing?	171
BYD F3DM Maintenance Schedule.....	172

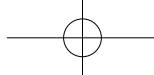

Maintenance Requirements

Regular Maintenance is Very Important.

BYD strongly recommends you to protect your new F3DM by following the maintenance program, because regular maintenance serves the purposes below:

- Save fuel
- Extend vehicle's service life
- Enjoy driving
- Driving safety
- Driving stability
- Meet maintenance requirements
- Meet governmental regulations

Notice

Please follow BYD F3DM Auto Maintenance and Repair Manual. You'd better go to BYD authorized dealer for scheduled maintenance.

BYD F3DM auto has been designed to be an economical car that is easy to be driven and maintained without too many maintenance services required before. The maintenance programs are needed, in order to keep your car running with best travel efficiency.

Where can you get maintenance service?

It is best to get your car maintained at the local BYD authorized service station.

Technicians in BYD Auto Company

are all well-trained and will get the latest service information, such as technique proceedings, maintenance gist and internal training program of special service station. They all have completed study in BYD Auto Company to better serve you before working.

BYD authorized service stations have spent a large amount of money on special tools and maintenance equipment which helps for better service as well as reducing expenses. The maintenance department of BYD authorized service station can perform all the maintenance programs for your F3DM auto—reliable and economical.

Which maintenance items can be completed by drivers?

Many maintenance items can be easily completed by driver himself, as long

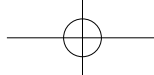

as you have some knowledge about mechanical maintenance and the methods of using basic auto tools. For easier operations, please refer to Chapter 7.

Notice

Special tools and professional skills are required for part of maintenance operation. These shall be completed by professional technicians at BYD authorized service station, even though you are a well-experienced technician, as staff in BYD authorized service station can keep a maintenance record of your car, which will do a big favor during your next maintenance service.

Does your car need repair?

Pay attention to changes of car performance and sound, as well as visualized signs for necessary repair. Some important clues are as follows:

- Engine misfire, stumbling or pinging
- Abnormal noises when starting the engine.
- Such abnormalities as coolant at a high temperature continuously, coolant not running or leakage.
- Abnormal noises in the electric engine.
- Excessive vibration during the electric engine running.
- Failure of starting the vehicle
- Leakage in power train.
- Bad smell in power train.
- Obvious reducing of power.
- Water leakage under the vehicle (however, water dripping from the air conditioning after use is normal.).
- Change in exhaust sound (it may

indicate carbon monoxide leak. Drive with the windows open and check the exhaust system immediately.)

Flat tire; excessive noises made by tires during turning a corner; uneven tire wear

The car leans to one side when driving straight on a level road
 Abnormal noises related to suspension system
 Loss of brake effectiveness; sponge feeling like brake pedal; pedal almost touches floor; vehicle pulls one side when braking

The temperature of antifreeze of engine or electric engine continues to be high.

If any condition above arises, please drive your car to BYD authorized service station as soon as possible, as your car may probably need adjustment or repair.

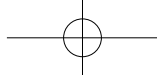

 **Warning**

Do not keep driving your vehicle before any inspection, or it may cause serious damage to your car and yourself.

BYD F3DM Maintenance Schedule

BYD F3DM maintenance schedule is designed for ensuring stable driving, reducing faults and driving safely and economically.

Refer to the schedule for intervals of maintenance, which is almost scheduled according to the reading on odometer or time interval, subject to what comes first.

For maintenance items out of the expiration date, your vehicles should be maintained at the same interval.

Maintenance intervals for each item are all recorded in the maintenance program.

Rubber hose (used for cooling and heating system, brake system and fuel system) shall be checked by qualified technicians according to the BYD F3DM maintenance schedule.

These are extremely important maintenance items. If any deterioration or damage, the hose shall be replaced immediately.

Notice

Rubber hoses will deteriorate from aging, which may cause expansion, abrasion or breakage.

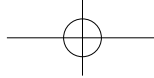

Requirements for Maintenance Program

BYD F3DM auto must be maintained according to the normal maintenance schedule (Please refer to “Maintenance Schedule”).



If the car is operated under the following one or more special clues, some maintenance items are required to be performed more frequently.

A. Road Conditions	B. Driving Conditions
Drive on the rugged, muddy or snow-melt road Drive on the dusty road	Tow a trailer with camping trailer or top clamping bracket The car runs repeatedly for a short distance below freezing point, within 5 miles. The car has idled for a long time or long run at a low speed such as police car, taxi or delivery car.



Maintenance Schedule

Maintenance Intervals	Reading on odometer or months, subject to what comes first															
	×621 miles	3	8	13	18	23	28	33	38	43	48	53	58	63	68	73
Maintenance Items	Months	Forced Maintenance	6	9	12	15	18	21	24	27	30	33	36	39	42	45
Power Train																
1. Check if there is any crack, flying chip, wear on the ribbed belt and then adjust its intensity.																
		I		I		I		I		R		I		I		I
2. Replace the timing train of engine.		371QA engine	Check it every 12,000 miles; replace it every 50,000 miles; check and replace it in advance according to the rigorous conditions.													
3. Check whether the ignition cable is damaged																
		I		I		I		I		I		I		I		I
4. Check and change the spark plug	General using conditions	Common spark plug	Replace it every 18,000 miles													
		Iridium spark plug	Replace it every 50,000 miles													
	Rigorous using conditions	Check and replace it in advance according to the conditions														
5. Check the ventilation system of crankcase (PCV valve and ventilation hose)																
		I		I		I		I		I		I		I		I
6. Check if the cooling water pipe is damaged and confirm that the pipe joint is locked tightly																
		I		I		I		I		I		I		I		I
7. Check the engine antifreeze level in the overflow tank																
		I		I		I		I		I		I		I		I

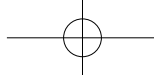

8. Replace the engine antifreeze		Replace it every two years or every 25,000 miles											
9. Replace the air cleaner cartridge	General using conditions	Clean it every 1,500 miles; replace it every 10,000 miles											
	Rigorous using conditions	Check and replace it in advance according to the conditions											
10. Replace the engine oil	General using conditions	R: every 3,000 miles or 6 months											
11. Replace the engine oil filter	General using conditions	R: change it every 3,000 miles or 6 months											
	Rigorous using conditions	R: every 2,000 miles											
12. Check the battery		I		I		I		I		I		I	
13. Check the ignition timing		I				I				I			
14. Check and adjust the valve clearance		I		I		I		I		I		I	
15. Check if the exhaust pipe connectors has air leakage		I		I		I		I		I		I	
18. Throttle Body		Clean it every 6,000 miles											
19. Injection nozzle		I				I				I			
20. Check the oxygen sensor		I		I		I		I		I		I	
21. Check the three-way catalytic converter		I		I		I		I		I		I	
22. Fuel filter		Change it every 6,000 miles or 6 months											
23. Fuel tank cover, fuel pipe and joint		I				I				I			
24. Activated carbon canister		I		I		I		I		I		I	
25. Check and replace the lubricant in gearbox	General using conditions	I		R				R		I		R	
	Rigorous using conditions	R: shorten the cycle if necessary											

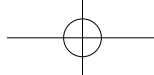

F3DM Owner's Manual

26. Check the lubricant in the electric engine and engine	General using conditions	I		R				R				I			R			I			R		I
	Rigorous using conditions	R: shorten the cycle if necessary																					
Chassis and Car Body																							
27. Check the set screws for fixing chassis	I			I			I			I			I			I			I			I	
28. Brake pedal and parking brake	I			I			I			I			I			I			I			I	
29. Brake pad and brake disc	I			I			I			I			I			I			I			I	
30. Brake fluid	I		I	I	I	I	I	I	I	R	I	I	I	I	I	I	I	I	I	I	I	I	
31. Pipeline and hose of brake system	I			I			I			I			I			I			I			I	
32. Hydraulic system oil	I		I	I	I	I	I	I	I	R	I	I	I	I	I	I	I	I	I	I	I	I	
33. Steering wheel, draw bar	I			I			I			I			I			I			I			I	
34. Transmission shaft dust cover	I			I			I			I			I			I			I			I	
35. Ball pin and dust cover	I			I			I			I			I			I			I			I	
36. Front and rear suspension device	I			I			I			I			I			I			I			I	
37. Tire and inflation pressure	I		I	I	I	I	I	I	I	I	I	I	I	I	I	I	I	I	I	I	I	I	
38. Check the front and rear wheel alignment	I			I			I			I			I			I			I			I	
39. Check if the wheel bearing has end play	I			I			I			I			I			I			I			I	
41. Cooling or heating system	I			I			I			I			I			I			I			I	
42. Air filter of air conditioner	I			R			R			R			R			R			R			R	
43. Refrigerant of air conditioner/cooling device	I			I			I			I			I			I			I			I	
44. Check the SRS system	I			I			I			I			I			I			I			I	
45. Check the car body for damage	Every year																						

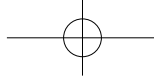

Note:

(1) Meaning of the symbols in the table

I = check, correct or replace when necessary; R = replace, change or lubricate; C = clean.

(2) Shorten the time for replacing engine oil filter according to the dirty degree of the gasoline engine.

(3) Rigorous using conditions indicate:

Often drive the car in dusty areas or expose the car long in salty air.

- Often drive the car on the rugged road, road full of water or mountain road.
 - Drive in the cold areas.
 - The engine runs idle at the same place for a long time or the car often runs for a short distance in cold seasons.
 - Use the brake frequently and often slam the brake.
 - Often use the car as a tractor-trailer. Use the car as a taxi.
 - Above 32°C, drive the car in the crowded urban area for more than 50% running time.
 - Above 30°C, drive the car at 75 m/hour or a higher speed for more than 50% running time.
- Overloaded running

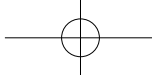

F3DM Owner's Manual

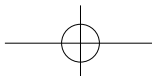
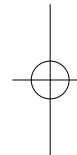
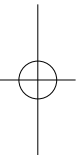

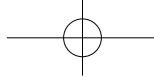

Chapter 7

Section 7-1

Self-maintenance Foreword

Fuse location	181
---------------------	-----

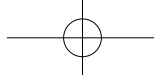

Appearance of Front Engine Compartment

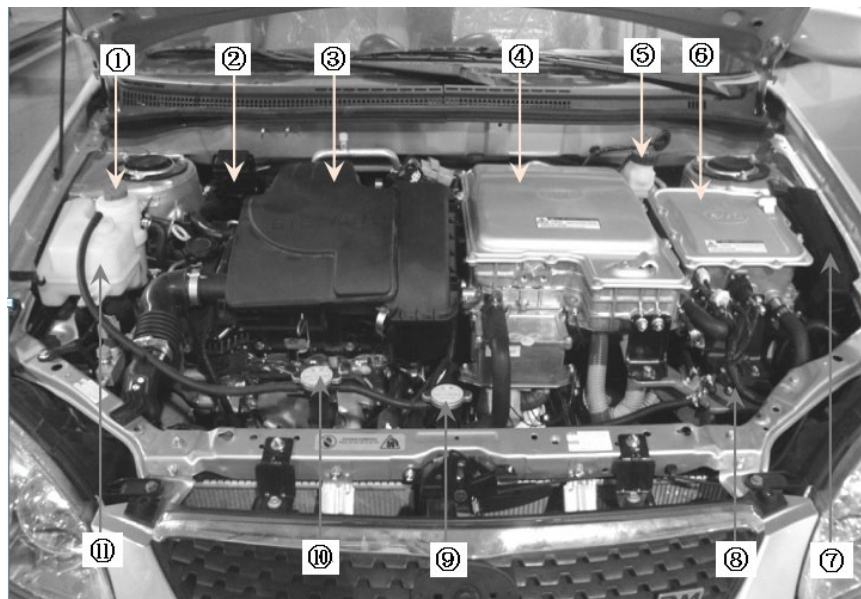

1. Clutch fluid tank
2. Power distribution box 3#
3. Gasoline engine
4. Driving electric motor controller
5. Brake fluid tank
6. DC and air conditioner controller
7. Power distribution box 1#
8. Power distribution box 2#
9. Motor cooling radiator
10. Electric motor cooling radiator
11. Overflow tank



Fuse Location

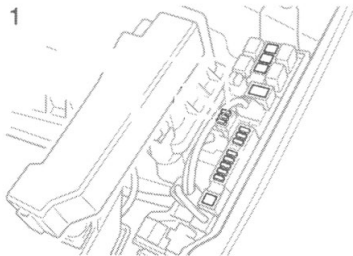

Please refer to “Fuse and Relay” in Chapter 8 for names of electrical devices protected by each fuse.

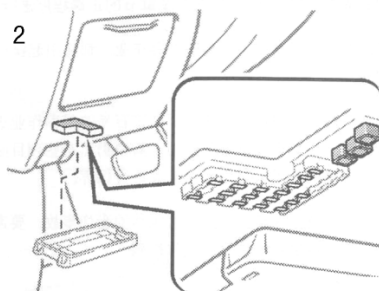

Notes of Do-it-yourself maintenance

In case of doing maintenance by yourself, be sure to follow the correct procedures in this section.

Please note that incorrect or incomplete maintenance may result in operating problems.

This section makes explanations only on maintenance operations that are relatively easy to do on your own. As said in chapter 6, there are still a number of items that must be done by a qualified technician with special tools.

Utmost attention should be paid to avoiding accidental injuries when working on your vehicle. Precautions below should be especially careful to observe.

Warning

When the DM system is operating with the “OK” indicator on, the engine is automatically started in some case. When you inspect the engine compartment, be sure to press the “POWER” switch to the “OFF” mode.

Keep your hands, clothes and tools away from the moving fans and drive belt of engine, when the engine is on.(You'd better tie up long hair and remove accessories such as finger ring, watch, necktie and so on to avoid any injury.)

- Engine compartment —engine, radiator, exhaust pipe, hold-up vessel of power steering fluid and spark plug cover— will be hot after driving. Do not touch them, as it may cause burns. The

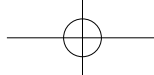

temperature of engine oil, fluid and spark plug may also be very high

- If the engine is very hot, do not remove the radiator cover or screw off the drain plug to avoid burning yourself.
- Do not leave any flammable material in the engine compartment such as paper and cloth.
- Be sure that the DM system is in the "OFF" mode if you work near the electric cooling fans or radiator grille. With the ignition on, the electric cooling fans will automatically start to run if the engine coolant temperature is high and/ or the air conditioning is on.
- Handle the storage battery with

special care, as it contains poisonous gas and corrosive sulfuric acid.

- Use eye protection whenever you work on or under your vehicle where you may be exposed to flying or falling material, fluid spray, etc.
- Used engine oil contains potentially harmful pollutants, which may cause skin disorders such as skin inflammation or skin cancer, so care should be taken to avoid prolonged and repeated contact with it. To remove used engine oil from your skin, wash thoroughly with soap and water.
- Do not leave used oil within the reach of the children.
- Dispose of used oil and filter only in a safe and acceptable manner.

Do not dispose of used oil and filter in household trash, in sewer or onto the ground. Refer to BYD authorized service station for recycling or disposing methods.

- Take care when filling the brake fluid reservoir because fluid can harm your eyes and damage painted surfaces. If fluid gets in your eyes, flush your eyes with clean water immediately. If you still feel uncomfortable with your eyes, go to the doctor.
- Basic check is needed before driving, or it may cause an accident.
- If the maintenance is not applied or properly applied, it may cause serious damage to you and your vehicle.

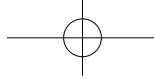

Warning

- Remember that batteries and ignition cable carry high currents or voltages. Be careful of accidentally causing a short circuit.
- If you spill the fluid, be sure to wash it with water to avoid damaging the components or paint.
- Do not allow dirt or anything else to fall through the spark plug holes.
- Do not pry the outer electrode of spark plug against the central electrode.
- Use only spark plug of special type, as using other spark plugs may cause engine damage, loss of performance or radio noise.
- If the brake fluid overflows, you

must wash it with water, to avoid damaging the components or paint finish.

- Do not drive with the air filter removed, or excessive engine wear could result. Also backfiring could cause a fire in the engine compartment
- Do not scratch the glass surface with the wiper frame.
- When closing the hood, check to make sure that you have not forgotten any tools, rags, etc.

Location of Jack

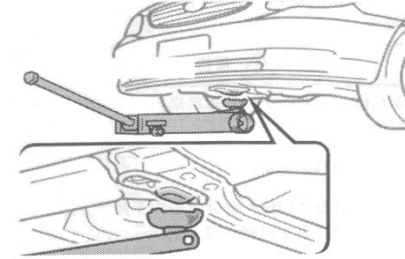

Front

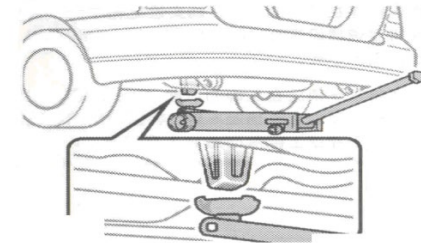

Rear

When jacking up your vehicle with the jack, position the jack correctly as shown in the illustrations.

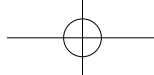

 Warning

When jacking, be sure to observe the following to reduce the possibility of personal injury:

- Avoid breathing in exhaust gas from the engine, which may contain carbon monoxide that is colorless and odorless and may cause consciousness loss and even death.
- Do not put any part of your body under the vehicle supported by the jack. Personal injury may occur.
- Do not start or run the engine while your vehicle is supported by the jack.
- Stop the vehicle on a level firm ground, firmly set the parking brake and put the transaxle in "P".

- Make sure the jack is placed on the right jack point. Raising the car with jack improperly positioned may damage the car or allow the car to fall off the jack, which may result in personal injuries.
- Do not stay under the car when it is only lifted up by a jack. Please apply a car supporting bracket.
- Do not lift the car up if there is somebody in it.
- When raising the vehicle, do not place any objects on top of or underneath the jack.

Notice

Make sure to place the jack correctly, or your vehicle may be damaged.

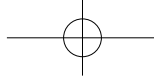

Chapter 7

Section 7-2

Self-maintenance Engine and Chassis

Check Engine Oil Level	186
Check Antifreeze Fluid Level	187
Check Radiator and Condenser	188
Check Tire Inflation Pressure	189
Check and Replace Tire	190
Replace Tires	191
Tires Rotation	191
Replace Wheels	193
Precautions on Aluminum Wheel	193

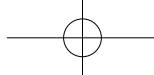

Check the Engine Oil Level

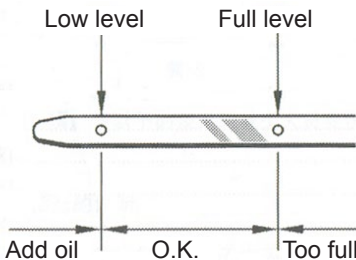

Turn off the ignition switch and check the oil level on the dipstick.

To get a true reading, make sure the vehicle is on level ground and preheat the engine. Wait several minutes after shutting down the engine.

Pull the dipstick out, place a piece of fabric at its end and wipe it clean.

Insert the dipstick again, push it in as far as it will go, or the reading will not be correct.

Pull the dipstick out and look at the oil level while holding a rag under the end.

⚠ WARNING

Be careful not to touch the hot exhaust manifold.

NOTICE

Be careful not to drop the engine oil on the vehicle components.

If the oil level is below or little higher than the lower hole, add oil of the same type as already in the engine.

Remove the engine oil fill cap and add engine oil in small quantities at a time, checking the dipstick. You are recommended to use a funnel when adding oil.

If the oil level is between the lower and upper holes, the oil level is acceptable. When the level reaches within the

correct range, install the fill cap hand-tight.

Oil quantity, L (qt., Imp. qt.):
1.5(1.6, 1.3)

NOTICE

- Be careful not to spill the engine oil on the vehicle components.
- Avoid overfilling or the engine may be damaged.
- Check the oil level with dipstick again after adding the engine oil.

Engine Oil Selection

Only use lubricating oil approved by BYD-authorized dealer or equivalents to satisfy the following grade and viscosity.

Engine Oil Grade for Gasoline Engine:
SAE Viscosity Grade:
SAE 5W—30 above -30°C

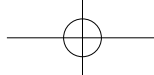

SAE 15W—40 above -15°C

API Grade: SG or above

Amount: 3L (liter)

Recommended viscosity (SAE):

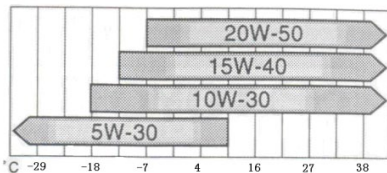

Predicted temperature range prior to next oil change

In extremely cold weather, SAE 10W-30 oil or oil with higher viscosity may cause difficulty to start, so SAE 5W-30 oil is highly recommended.

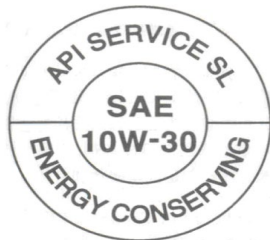

API Service Symbol



ILSAC Certification Mark

Oil Identification Mark

Either or both API registered marks are added to some oil containers to help you select the oil you should use.

The API Service Symbol is located anywhere on the outside of the container.

The top portion of the label shows the oil quality by API (American Petroleum Institute) designations such as SL. The center portion of the label shows

the SAE viscosity grade such as 10W-30. “Energy-Conserving” shown in the lower portion, indicates that the oil has the oil fuel-saving capabilities.

The ILSAC (International Lubricant Standardization and Approval Committee) Certification Mark is displayed on the front of the container.

Check Antifreeze Fluid Level

WARNING

The antifreeze fluid heat storage tank reaches high temperature inside. It is dangerous if hot antifreeze is discharged when replacing. For replacement of the antifreeze fluid, contact your BYD authorized dealer.

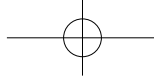

Look at the transparent antifreeze fluid tank when the engine is cold to see if it is between the “MAX” and “MIN” lines on the tank. If the level is low, add antifreeze fluid. (For the antifreeze fluid type, see “Antifreeze fluid type selection” described below.)

The antifreeze fluid level in the tank will vary with the temperature of the engine. However, if the fluid level is on or below the “MIN” line, add antifreeze fluid. Bring the level up to the “MAX” line.

If the antifreeze fluid level drops within a short time after replenishing, there may be a leak in the system. Visually check to the radiator, hoses, radiator cap, drain cock and water pump.

If you couldn't find any leak, have your BYD authorized dealer test the cap pressure and check for leaks in cooling system.

- 188 -

WARNING

To avoid personal injury, if the steam comes out from the front hatch, do not open it before the steam to be dissipated.

To prevent burning yourself, do not remove the radiator cap when engine is hot.

Antifreeze fluid type selection

Only use antifreeze authorized by BYD authorized dealer. Choose and add suitable type of antifreeze fluid into cooling system according to environment temperature.

Use of improper antifreeze fluid may damage your engine system.

NOTICE

Do not use plain water alone, which may cause damage on engine cooling system.

Please contact BYD authorized dealer for further details.

Check Radiator and Condenser

If any of the above parts are extremely dirty or you are not sure of their condition, take your vehicle to BYD authorized dealer.

**⚠ WARNING**

To prevent burning yourself, be careful not to touch radiator or condenser when the engine is hot.
Do not operate by yourself to avoid damaging the radiator or condenser.

Check Tire Inflation Pressure

Keep your tire inflation pressures at the proper level.

For information on recommended cold tire inflation pressure and tire dimension, please refer to Chapter 8.

⚠ WARNING

The tire inflation pressure is 230 kpa while the spare tire inflation pressure shall be 420 kpa.

You should check the tire inflation pressure every two weeks, or at least once a month. And do not forget the spare.

Improper tire pressure may increase gas consumption, reduce driving comfort and tire service life, and pose danger to road safety.

If the tire need air filling frequently, please contact BYD authorized dealer for a check.

⚠ WARNING

Keep your tires properly inflated. Otherwise, the following conditions may occur and cause an accident resulting in serious injuries.

Low tire pressure (under inflation)

- Excessive wear
- Uneven wear
- Poor handling
- Possibility of blowouts from overheated tire.
- Poor sealing of the tire bead
- Wheel deformation and/or tire separation
- High Tire Pressure (Over inflation)
- Poor handling Excessive wear of center of tire tread
- A greater possibility of tire damage from road hazards.

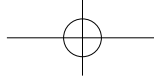

The following instructions for checking tire inflation pressure should be observed:

- Check tire pressure only when the tire is cold. If the vehicle has been parked for at least 3 hours and has not been driven for more than 1.5km or 1 mile since, you will get an accurate cold tire inflation pressure reading.
- Tire inflation pressure gauge must be used. The appearance of a tire can be misleading. In addition, a few pounds' difference may degrade ride and handling.
- Do not bleed or reduce tire inflation pressure after driving. It is normal for the tire inflation pressure to be higher after driving.
- Make sure valve cock is installed on tire. It blocks dust, damp from entering tire and prevent air leakage. Install a new one if it lost.

Check and Replace Tire



Check Tire

Check the tire tread for tire wear indicator. If the wear indicator is visible, the tire shall be replaced.

The tire on your BYD F3DM has built-in tread wear indicators to help you know when the tires need replacement. When the tread depth wears to 1.6mm (0.06in.) or less, the indicators will appear. If you can see the indicators in two or more adjacent grooves, the tire shall be replaced. The lower the tread, the higher the risk of skidding. The snow tires will be useless if the

tread wears down below 4mm (0.16 in.).

If there were tire damage such as cuts, splits, cracks deep enough to expose the fabric, or bulges indicating internal damage, the tire should be replaced.

If a tire often goes flat or cannot be properly repaired due to the size or location of a cut or other damage, it should be replaced. If you are not sure, consult with BYD authorized dealer.

If an air loss occurs while driving, do not continue driving with a deflated tire. Driving even a short distance can damage a tire beyond repair.

Any tires which are over 6 years old must be checked by a qualified technician even if damage is not obvious.

Tires deteriorate with age even if they have never or seldom been used.

This rule also applies to spare tires and

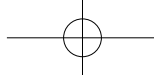

tires in storage.

Replace Tires

When replacing a tire, only use replacement tires and wheels that are of the same size, load index, speed rating and type as those originally by BYD.

Use of any tire or wheel not recommended by BYD can affect the safety and performance of your vehicle, such as operability, passenger comfort, calibration of speedometer and odometer, ground clearance between the car body and tire or tire chains.

WARNING

Please follow the instructions below, or an accident may occur resulting in serious injuries.

- Do not mix radial, bias belted, or bias-ply tires on your vehicle, as this may cause dangerous handling characteristics resulting in loss of control.
- Only use tires with size recommended by manufacturer's, or it may cause dangerous handling characteristics resulting in loss of control.

Never replace the tire on BYD F3DM with an used tire.

Unknown tire may cause great danger. You are recommended to replace four tires at one time, or at least both front

or rear tires at the same time.

See "If you have a flat tire" in Chapter 4 for change procedure.

Keep the wheels in balance when replacing tires.

An unbalanced wheel may affect vehicle handling and tire life. Wheels can get out of balance with regular use and should therefore be balanced occasionally.

Tire Rotation

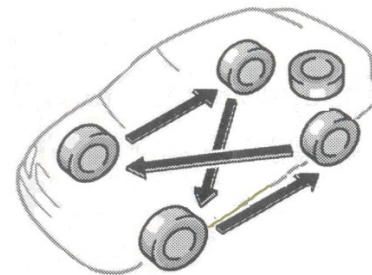

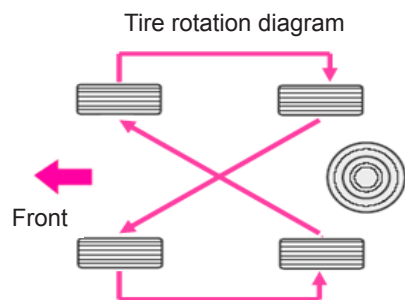
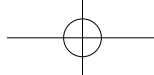

To equalize tire wear and extend its service life, you are recommended to rotate tire positions every 10,000 km. However, the most appropriate timing for tire rotation depends on driving habit and road surface conditions.

⚠ WARNING

- Do not include a spare tire when rotating the tires.

When rotating tires, check for uneven

wear and damage. Abnormal wear is usually caused by incorrect tire inflation pressure, improper wheel alignment, out-of-balance wheels, or severe braking.

Choose Tire Chain

Use the tire chains of correct size. Regulations regarding the use of tire chains vary according to location or type of road, so always check the local regulations before installing chains.

Install Tire Chain

Install the chains on the front tires as tightly as possible. Do not use tire chains on the rear tires. Retighten chains after driving 0.5-1.0 km (1/4-1/2 mile).

When installing tire chain, carefully follow the instructions of the chain manufacturer

If wheel covers are used, they will

be scratched by the chain band, so remove the covers before putting on the chains.

⚠ WARNING

- Do not exceed 50 km/h or the chain manufacturer's recommended speed limit, whichever is lower.
- Drive carefully avoiding bumps, holes, and sharp turns, which may cause the vehicle to bounce.
- Avoid sharp turns or locked-wheel braking, as use of chains may adversely affect vehicle handling.
- When driving with chains installed, be sure to drive carefully. Slow down before entering curves to avoid losing control of the vehicle. Otherwise an accident may occur.



Replace Wheels

When to Replace Wheels

When the wheel has damage such as bending, crack or severe corrosion, it shall be replaced.

If damaged wheel is not replaced timely, the tire may slip off the wheel or cause loss of handling control.

Wheel Selection

When replacing wheels, make sure that the wheels are replaced by ones with the same load capacity, diameter, rim width and offset.

Correct replacement wheels are available at BYD authorized dealer.

A wheel of a different size or type may cause serious affect on handling, wheel and bearing life, brake cooling, speedometer/odometer calibration, stopping ability, headlight aim, bumper height, vehicle ground clearance, and

tire or tire chain clearance to the body and chassis.

Do not replace the wheel on your vehicle with a used tire as they may have been subjected to rough treatment or high mileage and could fail without warning. Also, bent wheels which have been straightened may have structural damage and therefore should not be used. Never use an inner tube in a leaking wheel which is designed for a tubeless tire.

WARNING

Do not use a wheel of which the size is not recommended by the manufacturer, or the vehicle may losing control and cause serious injury or death.

Precautions on Aluminum Wheel

- You are recommended to use aluminum wheels with correct specifications; for specific parameters, please refer to chapter 8.
- When installing aluminum wheels, check that if the wheel nuts are tight after driving your vehicle the first 1600km (1000 miles).
- If you have rotated, repaired, or changed your tires, check that the wheel nuts are still tight after driving 1600 km (1000 miles).
- When using tire chains, be careful not to damage the aluminum wheels.
- Only use BYD wheel nuts and wrench designed for your aluminum wheels.
- When balancing your wheels, use only BYD balance weights or equivalent and a plastic or rubber hammer.

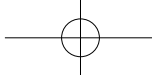

- As any wheel, periodically check your aluminum wheels for damage. If damaged, replace immediately.

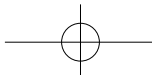
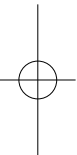

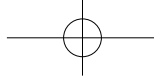

Chapter 7

Section 7-3

Self-maintenance Electric Appliance

Check Auxiliary Battery Status	196
Check and Replace Fuses	199
Add Washer Fluid	201
Replace Bulb	201

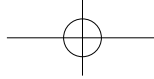

Check Auxiliary Battery Status

The auxiliary battery is located behind the rear seat backrest, when checking it, you have to cut off the emergency maintenance switch and

Open the luggage compartment shield.

Precautions

WARNING

Precautions on auxiliary battery

The auxiliary battery produces flammable and explosive hydrogen gas.

- Do not cause a spark from the battery with tools.
- Do not smoke or light a match near the battery.

The electrolyte contains poisonous and corrosive sulfuric acid.

- Avoid contact with eyes, skin or clothes.
- Do not drink electrolyte by mistake.
- Wear protective safety glasses when working near battery.
- Keep children away from battery.

EMERGENCY TREATMENT

- If electrolyte gets in your eyes, flush your eyes with clean water and get immediate medical attention. If possible, continue to apply water with a sponge or cloth on the way to hospital.
- If electrolyte gets on your skin, thoroughly wash the contact area. If there is any pain or burn, get medical attention immediately.
- If electrolyte gets on your clothes, there is a possibility of its soaking through to your skin, so immediately take off the exposed clothing and follow the procedure above, if needed.
- If you accidentally swallow electrolyte, drink a large quantity of water or milk. Follow with milk



of magnesia, beaten raw egg or vegetable oil. Then go immediately for emergency help.

Check Auxiliary Battery Appearance

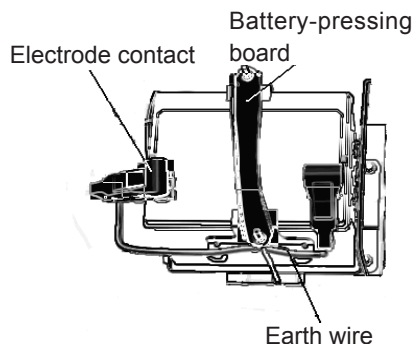

Check whether the battery and its terminal is corroded, loose, cracked or has loose hold-down clamp.

a. If the battery is corroded, wash it off with a solution of warm water and baking soda. Coat the outside of the

terminals with grease to prevent further corrosion.

b. If terminal is loose, tighten its clamp nuts; but do not overtighten.

c. Tighten the hold-down clamp only enough to keep the battery firmly in place. Overtightening may damage the battery case.

NOTICE

- Make sure the power system and all accessories are cut off before performing maintenance.
- When checking the battery, remove the ground cable from the negative terminal (“-” mark) first and reinstall it last.
- Do not cause short circuit when using tools.
- Make sure no solution gets into the battery when washing it.

Check the Internal Status of Battery

Check the internal status of the battery according to instructions on the outer shell and status indicators of the battery.

NOTICE

- Charging the battery without disconnecting the wires may cause serious damage on ECU and other electrical devices on the vehicle. Remove the battery wires first before connecting the battery to charger.
- When the engine is not running, use electrical devices for a long time may cause over discharge of the battery, which may lead to difficulty to start the car or even permanent damage to the battery.

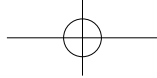

- Do not use electrical devices, such as audio system, light system, for a long time when the engine is not running.
- Before leaving the vehicle, make sure the doors are closed and all electric appliances (such as lights) are turned off.

NOTICE

Do not add electrolyte by yourself when replace a new battery for its lacking of electrolyte.

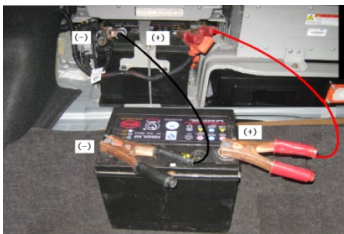

Jump start

If the auxiliary battery is run out, the DM system can be started by following procedures.

All needed tools are:

1. A set of jumper cable;
2. A vehicle with 12volt auxiliary battery or a 12volt auxiliary battery.

You are highly recommended to call BYD authorized dealer for help if you are not sure about the procedures.

Before jump start your vehicle:

Turn off all the electrical components, such as climate control, audio system, lights .est. Turn the ignition switch to OFF, and pull the parking brake;

To avoid causing spark, make sure that the jumper cable connects correctly.

Procedure:

- 1) Remove the trunk board;
- 2) In order to clamp the positive and

negative terminal easily, you should put the positive and negative plastic protective cover aside.

3).Connect the clamp of the positive jumper cable to the battery positive (+) terminal;

4).Connect the clamp at the other end of the positive jumper cable to the positive (+) terminal on the booster battery;

5).Connect the clamp of the negative jumper cable to the battery negative (-) terminal;

6).Connect the clamp at the other end of the negative jumper cable to the negative (-) terminal on the booster battery.

7).Turn on the ignition switch and starting the DM system;

8).Once your vehicle is running, disconnect the clamp of negative cable from your vehicle, then from the

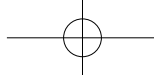

booster battery. Disconnect the clamp of the positive jumper cable from your vehicle, then from the booster battery.

WARNING

Keep the ends of the jumper cables away from each other and any metal on the vehicle until everything is disconnected.

Do not touch the clamps of the jumper cables while starting the vehicle. Otherwise, you may cause an electrical short.

Any following conditions happened, please contact your BYD authorized dealer for a check:

1. The instrument cluster display still off when power is on.
2. The battery charging system

fault warning light is on in the multi-information display when power is on.

3. The power battery fault warning light is on when power is on.

WARNING

- Make sure the clamps of the jumper cables connect the right terminal, and avoid accidentally touching anything except the right terminal.
- Do not touch the clamps of the jumper cables while starting the vehicle. Otherwise, you may cause an electrical short.
- Do not let the jumper cable connect the positive (+) terminal with the negative (-) terminal is connected.

WARNING

If the auxiliary battery is discharged with the transaxle in "P", your vehicle cannot be moved unless the front wheels are raised. This is because the front wheels are locked by means of the parking lock mechanism.

Check and Replace Fuses



Fine

A Type



Blown

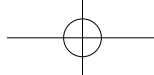

Fine



Blown

B Type

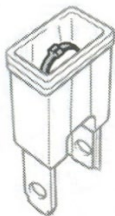

Fine

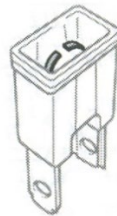

Blown

C Type

If headlight or other electric components do not work, check the fuses. Replace the fuses if necessary. See Section 7-1 "Location of Fuses"

for locations of the fuses.

Turn the ignition switch and inoperative component off. Pull a suspected fuse straight out and check it.

Find out which fuse may be causing the problem. The lid of the fuse box shows the name of the circuit for each fuse. See Chapter 8 for the functions of each circuit.

Type A fuses can be pulled out by the pull-out tool. The location of the pull-out tool is shown in the illustration "Front Engine Compartment" in Chapter 8.

If you are not sure whether the fuse is burnt out, replace it with a good one.

If the fuse has blown, push a new fuse into the socket.

Only install a fuse with the amperage rating designated on the fuse box lid.

If there is no spare fuse in emergency situation, you can pull out "Interior

light" fuse, which is not essential in driving, and substitute it for a fuse with the same amperage.

If you don't have the same amperage, use one that is lower, but as close as possible to, the rating. If the amperage is lower than that specified, the fuse might be blown again. but this does not indicate anything wrong. Be sure to get the correct fuse as soon as possible and return the substitute to its original socket.

You'd better purchase a set of spare fuses and keep them in your vehicle for emergencies.

If the new fuse immediately be blown again, there is a problem with the electrical system. Contact BYD authorized dealer for a check as soon as possible.

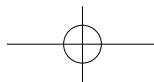

**⚠ WARNING**

- Make sure the key is turned to LOCK before replacing the fuse.
- Never use a fuse with higher amperage rating, or any other object to replace a fuse. This may cause serious damage and possibly a fire.

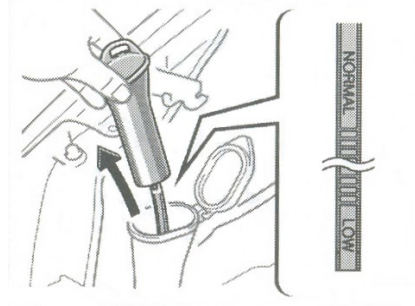
Add Washer Fluid

If the washer does not work, the

washer tank may be empty. Check the washer level on the content gauge. If the washer level is below “LOW” mark, you shall refill the washer.

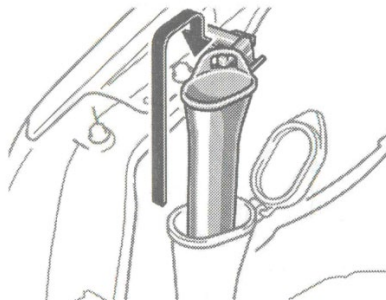
**Before Adding Washer**

Pull out Washer funnel and hang it on the brake of front engine hood support. You may use plain water as washer fluid. However, in cold areas where temperatures range below freezing point, you have to use washer fluid containing antifreeze. This product is available at your BYD authorized

dealer and most auto parts stores. Follow the manufacturer's directions for how much to mix with water. Make sure to put back the funnel in place after filling the washer tank.

NOTICE

Don't use engine antifreeze or any other substitutes for it will damage the vehicle paint.

Replace Bulb

The following illustrations show how to take off the bulbs. When replacing a bulb, make sure the ignition switch and light switch are off. Use bulbs with the wattage ratings given in the table below.

Parking light and rear parking light consists of a group of luminous diodes. When the number of burnt

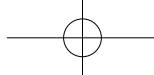

F3DM Owner's Manual

out luminous diodes affects the car's compliance with local laws, please send the car to BYD authorized dealer for replacing bulbs.

NOTICE

- To prevent burning yourself, do not replace the light bulbs when it's still hot
- Halogen bulbs have pressurized gas inside and require special handling. They can burst or shatter if scratched or dropped. Hold a bulb only by its plastic or metal case. Do not touch the glass part of a bulb with bare hands.

The inside of the lens of exterior lights such as headlights may temporarily fog up when the lens becomes wet in

the rain or in a car wash. This is not a problem because the fogging is caused by the temperature difference between the outside and inside of the lens, just like the windshield fogged up in the rain. However, if there is a large drop of water on the inside of the lens, or if there is water pooled inside the light, contact BYD authorized dealer.

Bulb	W	Type
Headlight (low beam)	55	H7
Headlight (high beam)	55	H1
Front fog light	55	H3
Parking light	5	LED
Front turn signal light	21	PY21W
Side turn signal light	5	WY5W
Rear turn signal light	21	PY21W
Backup light	21	P21W

Rear fog light	21	W21W
High mount brake light	16	W16W
Name plate light	5	W5W
Door light	5	W5W
Front interior light	5	R5W
Rear interior light	10	C10W
Luggage compartment light	5	W5W
Front parking light	5	W5W
Rear parking light	0.5	LED

NOTICE

Only use a bulb of the above listed type.

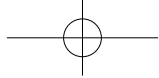

Headlight

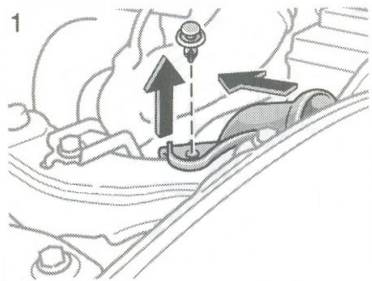

1. Left Headlight: remove clamp and take away the tube of air filter.

Remove and install the cover clamp as shown in the following illustration.

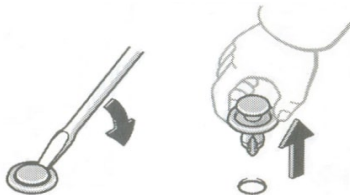

Remove Clamp

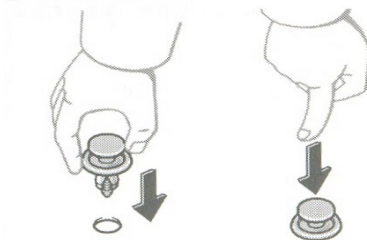

Install Clamp



2. Pull off the connector while pressing down the buckle.

If the connector is too tight, shake it first.

3

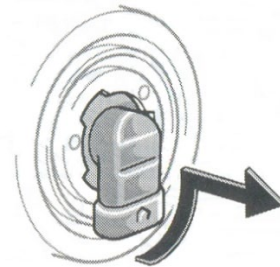

3. Remove the bulb by turning it counterclockwise, then pull it out.

4

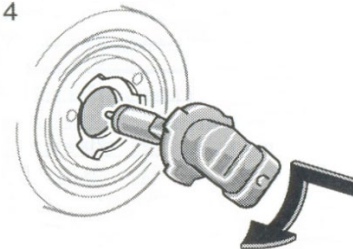

4. Install the new bulb in reverse order. You don't have to adjust the headlight after replacing the bulb. If it needed,

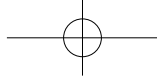

please contact BYD authorized dealer.

Front Turn Signal Light

1

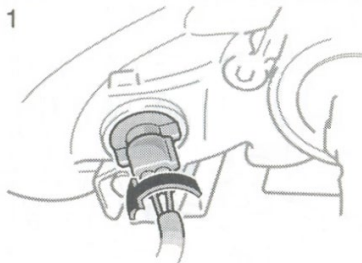

1. Remove it by turning counterclockwise

2

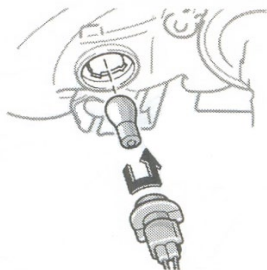

2. Remove the bulb by turning

clockwise.

The steps of installation are in reverse order.

Side Turn Signal Light

1

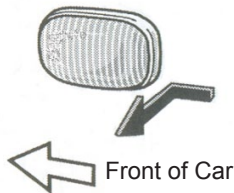

1. Push forward and remove the bulb.

2

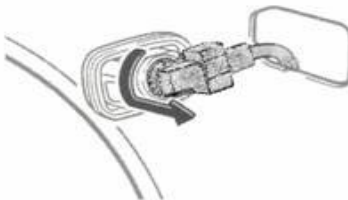

2. Remove the lamp holder by turning counterclockwise.

3

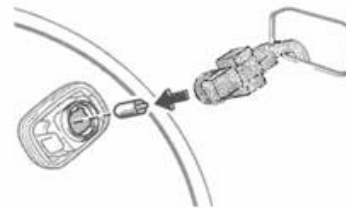

3. Remove the bulb.

The steps of installation are in reverse order.

Backup light

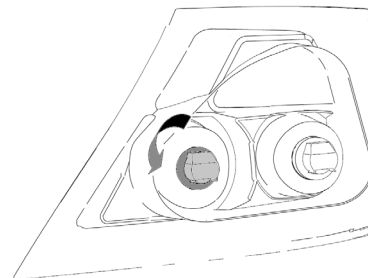



Remove the bulb and socket by turning the socket counterclockwise, and then pull out the bulb counterclockwise.

The steps of installation are in reverse order.

Rear Turn Signal Light

The steps to replace the bulb of rear turn signal light are the same with backup light.

Rear fog light (left)



1. Remove the bulb socket from the fog light by turning counterclockwise.

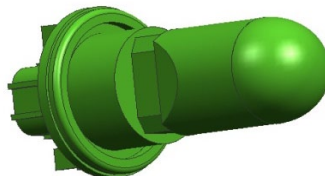

2. Pull the bulb straight out of socket.

The steps of installation are in reverse order.

High Mount Brake Light

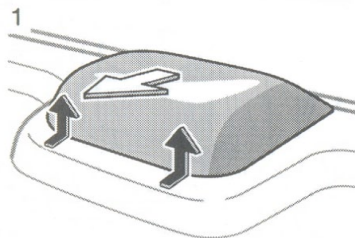

Push it forward and remove it.



2. Remove the bulb socket by turning counterclockwise.

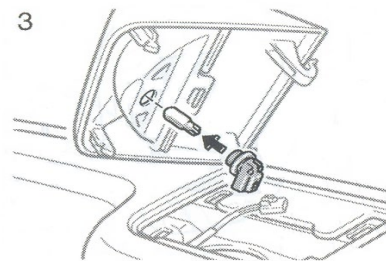

3. Remove the bulb.
The steps of installation are in reverse order.

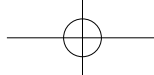

Name plate light

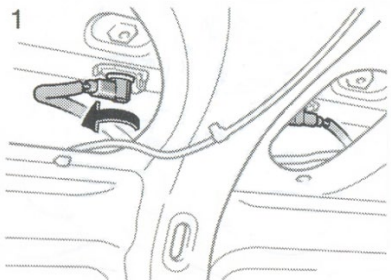

1. Remove the bulb socket by turning counterclockwise.

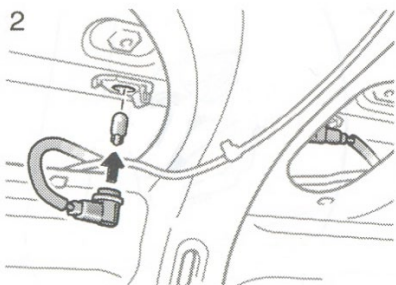

2. Remove the bulb.

The steps of installation are in reverse order.

- 206 -

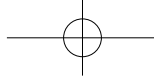

Chapter 8

Part Specifications

Maintenance Specifications	208
Fuse and Relay	209
High-voltage Cable.....	213



Maintenance Specifications

Power Train Lubricating

Electric engine Maintenance Parameters:

Items	Parameters
Amount of Transmission lubricant	3.7 L
Amount of generator oil	1.2 L
Amount of electric motor oil	1.6L
Amount of hydraulic oil	0.6L (between the upper and lower limits of hydraulic oil tank)
Lubricant type	ATF220
Electric engine oil type	ATF220
Hydraulic oil type	Shell Tellus Arctic32

Engine Maintenance Parameters:

Items	L
Using amount of engine lubricant:	3 L

Gasoline Engine Oil Level:

Items	Parameters
Apply to all the seasons for South and Spring, Summer and Autumn for North	10W-30/40
Apply to Winter for North	5W—30
Others	SG grade or above

Cooling System

Items	L
Total Capacity	8.9

Tire Specifications and Pressure

	Original Tire	Spare Tire
Tire Specifications	205/60R16	T125/90R16 98M
Tire Pressure KPa (kg/cm ²)	230	420



Aluminum Wheel Specifications

	N·m(kgf.m)
Wheel Nut Torque	110(10.5)

Battery Model

Brand	Model
Camel	12V 60AH

Fuse and Relay

Front Compartment and Instrument Panel

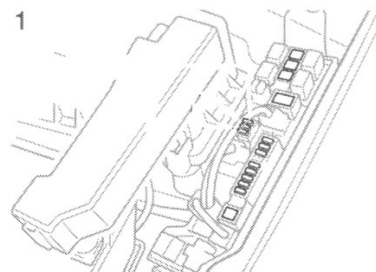
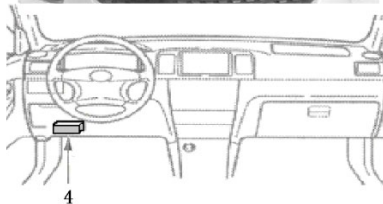
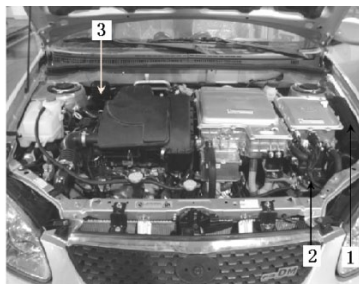

Power distribution box of front hook 1#

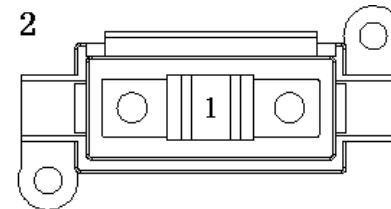

Power distribution box of front hook 2#

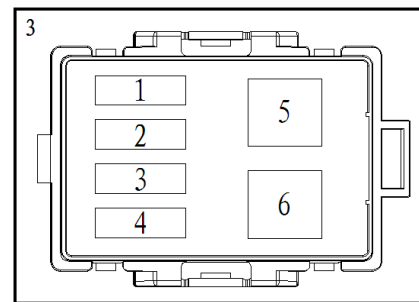

Power distribution box of front hook 2#

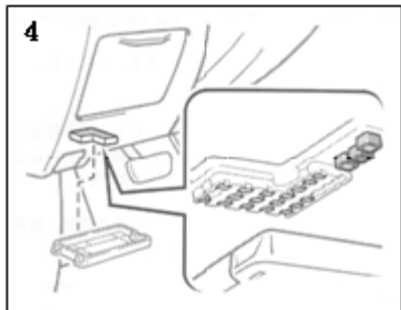

Power distribution box of front hook 4#

Front Engine Compartment Distribution Box 1#

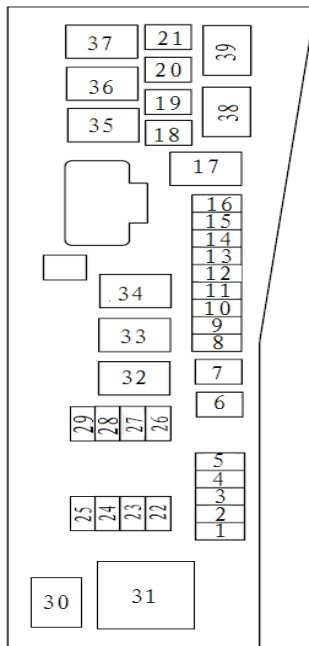

	Fuse	Amperage
1	Left front high beam	10A
2	Right front high beam	10A
3	Right front low beam	10A
4	Left front low beam	10A
5	Vacuum pump I	15A
6	IG1 power II	30A
7	Front headlight fuse protector	40A
8	Solenoid valve	5A
9	Water pump	10A
10	Interior light	15A
11	Power administrator	10A
12	Gear P electric engine	20A
13	Electronic horn	10A
14	Warning light	10A
15	EFI main relay	30A

16	Vacuum pump II	15A
17	Major power	100A
18	Hydraulic oil pump	40A
19	Electronic fan	30A
20	ABS	25A
21	ABS	40A
22	Backup fuse	5A
23	Backup fuse	7.5A
24	Backup fuse	10A
25	Backup fuse	15A
26	Backup fuse	20A
27	Backup fuse	25A
28	Backup fuse	30A
29	Backup fuse	NO

Relay	
30	Battery charging
31	Front headlight
32	Pump

33	Vacuum pump I
34	Electrical horn
35	Fan 2
36	Fan 3
37	Fan 1
38	Vacuum pump II
39	Gear P

Front Engine Compartment Distribution Box 2#

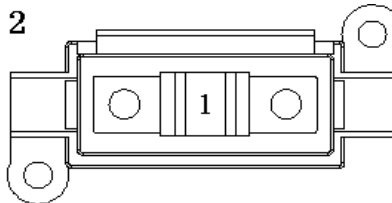

Fuse	Amperage
1	EPS insurance 80A

Fuse	Amperage
1	Major electric engine controller 15A
2	Transmission ECU 7.5A
3	Master control ECU 7.5A
4	Module second gear power 10A

Front Engine Compartment Distribution Box 3#

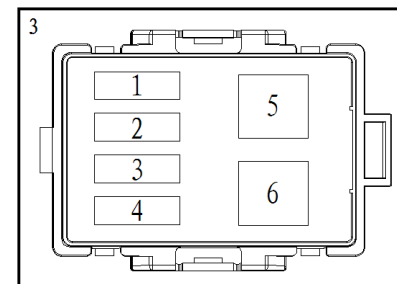



Relay	
5	IG1 relay II
6	DC relay II

Instrument Panel Connecting Box 4#

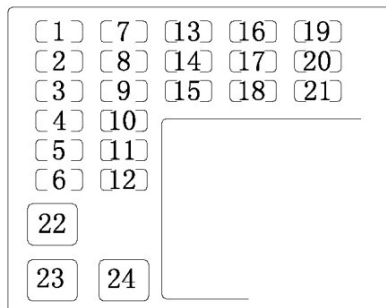

Fuse		Amperage
1	ABS-ECU	10A
2	SRS-ECU	15A
3	Instrument	10A
4	A/C control module	5A

5	Warning light	10A
6	2# ignition switch power	7.5A
7	Vehicle diagnostic system	7.5A
8	Windscreen wiper	20A
9	Width-indicator lights	15A
10	Braking light	15A
11	Car door	25A
12	2# door and window power supply	30A
13	Ignition switch power supply	25A
14	Rear fog light	15A
15	Front fog light	10A
16	Backup relay	15A

17	Air conditioner	10A
18	Fuel pump	20A
19	Defrost compensation	10A
20	Headlight control system	5A
21	Cigar lighter	15A
22	Heater	40A
23	Rear window defroster	30A
24	1# door and window power supply	30A



Instrument Panel Cable Plug-in Relay

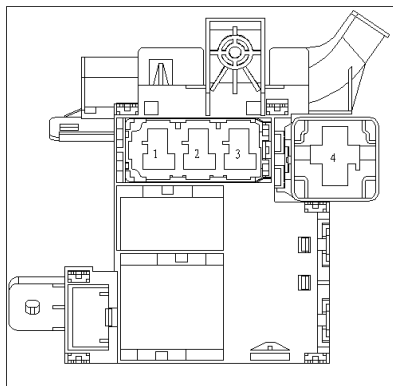

Relay	
1	Width-indicator light relay
2	Backup light relay
3	Front fog light relay
4	Blower relay

Floor Cable Plug-in Relay

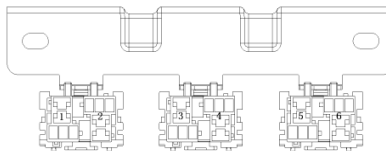

Relay	
1	Air conditioner contactor relay
2	DC contactor relay
3	Positive pole contactor relay
4	Pre-charging contactor relay
5	Negative pole contactor relay
6	Charging contactor relay

High-voltage Cable

