

# BYD F6 OWNER'S MANUAL



# Foreword

Thank you for choosing BYD F6. To help you use and maintain BYD F6, please read this manual carefully.

BYD F6 adopts EFI engine, its wiring structure is very complex. Please do not install such additional device by yourself as: anti-theft system, central control lock, power window, speakers and so on, otherwise the failure caused by it will be not covered by the “Warranty” of BYD.

You shall follow the instructions where the contents are marked with “Security Notes” or “Vehicle Damage” to avoid injury or damage. The notice types and purpose is as follows:

<b>Friendly tips</b>
<b>Precautions to avoid vehicle damage or personal injury</b>

<b>Notice</b>
<b>Precautions to be followed to facilitate maintenance easier</b>

The illustrations in this manual are only for reference.

BYD AUTO CO., LTD reserves all rights to modify technical features and contents in this manual without any restrictions and notice in advance. Thanks for choosing BYD F6, your valuable opinion and suggestion will be greatly appreciated.

## Security label



This label means “Can not do that” or “Can not make it happen”

# CONTENTS

F6 SPECIFICATION AND BRIEF INTRODUCTION. - 1 -	
F6 Specification .....	- 1 -
Brief introduction .....	- 2 -
Control panel .....	- 3 -
Driver and Passenger Safety .....	4
Safety equipment.....	5
Three-point safety belt .....	6
Safety belt tensioner (optional) .....	6
Airbag .....	7
Safety label.....	18
Instruments and Controls .....	20
Position of control switches .....	21
Indicators.....	22
Speedometer.....	26
Tachometer.....	26
Odometer.....	26
Hodometer.....	27
Coolant temperature gauge .....	27
Fuel level gauge .....	27
Control buttons around steering wheel.....	28
Headlight.....	29
Sunlight illumination sensor .....	30
Front/rear fog lamp .....	31
Turning signal .....	31
Combination instrument illumination .....	32

Windshield wiper.....	32
Danger Warning .....	33
Rear windshield defroster .....	34
Steering wheel adjustment .....	34
Adjustment: .....	34
Key .....	35
Remote control .....	35
Ignition switch .....	35
Childproof Lock.....	39
Trunk.....	40
Glove box .....	40
Seat Adjustment .....	40
Manual Adjustment of Driver Seat Height .....	41
Power Adjustment of Driver Seat (optional) ....	41
Driver Waist Support (optional).....	43
Head rest .....	44
Rear seat armrest.....	44
Seat Heating Device (optional).....	45
Power window .....	45
Power Sunroof (optional) .....	46
Backing Radar (optional).....	47
Interior Power Rearview Mirror .....	48
Parking brake.....	51
Front Seat Armrest.....	51
Sunglass box .....	52
CD Box .....	52
Central Storage Box.....	52
Accessory Power Socket.....	53

Cup Holder.....	53	Automatic transmission .....	83
Bill Box .....	54	Shift lever position indicator .....	83
Sun Visor.....	54	Position of shift lever.....	84
Vanity Mirror(optinal).....	55	Parking notice .....	85
Cigarette Lighter .....	55	CVT Transmission .....	85
Front Ashtray.....	55	Brake system.....	88
Door light .....	57	Brake system design .....	88
Interior Air Control System.....	57	ABS .....	89
Central Air Outlet.....	58	ABS indicator .....	90
Audio system (optional).....	64	Driving in atrocious weather.....	90
Audio adjustment .....	66	Trailer .....	91
Safety system .....	70	Maintenance .....	92
Cruise control system.....	71	Periodical maintenance schedule .....	93
Before driving .....	73	Owner inspection for maintenance .....	100
Running in period.....	74	Engine oil.....	101
Gasoline .....	74	Cooling system .....	105
Operation in petrol station.....	74	Windshield washer.....	108
Open engine hood .....	75	Transmission oil.....	109
Check engine oil.....	76	CVT transmission .....	111
Check engine coolant .....	77	Brake system.....	112
Fuel saving .....	78	Power steering .....	113
Luggage carrying .....	78	Air filter core .....	114
Driving .....	80	Fuel filter .....	114
Driving preparation .....	81	Engine hood lock .....	115
Start engine .....	81	Spark plug (4G69S4M model).....	115
Start in high altitude (>2400m) cold weather....	82	Battery .....	116
Manual transmission .....	82	Windshield wiper blade .....	117
Max. permissible speed.....	83	A/C system .....	119

Dust filter .....	119	Engine overheating .....	147
Driving belt .....	120	Engine oil pressure indicator .....	148
Timing belt .....	122	Battery charging indicator .....	149
Tire .....	122	Brake system indicator .....	150
Tire chains .....	125	Close power sun roof .....	151
Light .....	126	Check and replace fuses .....	152
Vehicle storage .....	134	Emergent Traction .....	157
Appearance maintenance .....	135	CVT transmission: .....	158
Washing .....	136	Technical data .....	160
Cere care .....	136	Identification No. ....	161
Alloy wheel .....	137	Specification .....	163
Painting repair .....	137		
Interior maintenance .....	137		
Carpet .....	137		
Floor cushion .....	137		
Fabric .....	137		
Nylon .....	138		
Leather (optional) .....	138		
Seat belt .....	138		
Window .....	138		
Air freshener .....	138		
Anti-rust .....	138		
Emergent malfunction solution .....	140		
Replace a flat tire .....	141		
If engine can't start .....	145		
Can't start engine or starter running slowly ....	145		
Starter running normally .....	145		
Pushing car to start engine .....	146		

# F6 SPECIFICATION AND BRIEF INTRODUCTION

## F6 Specification

Model		2.0L		2.4L
		MT	CVT	
Dimensions	Length(mm)	4846		
	Width (mm)	1822		
	Height (mm)	1465		
Wheel base (mm)		2740		
Wheeltrack	Front (mm)	1551		
	Rear (mm)	1551		
Curb weight (kg)		1435	1450	1480
Gross weight (kg)		1810	1825	1855
Tire type		205/65 R15 , 205/60 R16		
Approach angle (°)		14°		
Departure angle (°)		16°		
Front overhang (mm)		1016		
Rear overhang (mm)		1090		
Passenger		5		
Max. speed (km/h)		185	180	200
Engine Model		BYD483QB		4G69S4M
Engine type		L4/16 Valve MPI DOHC		L4/16 Valve MPI SOHC
Displacement (ml)		1991		2378
Rated Power (kW)		103		118
Gradeability (%)		35		35
* Min.fuel consumption (L/100km)		6.9		7.6

\* The actual fuel consumption depends on the vehicle condition, road condition, driving habit and so on.

## Brief introduction

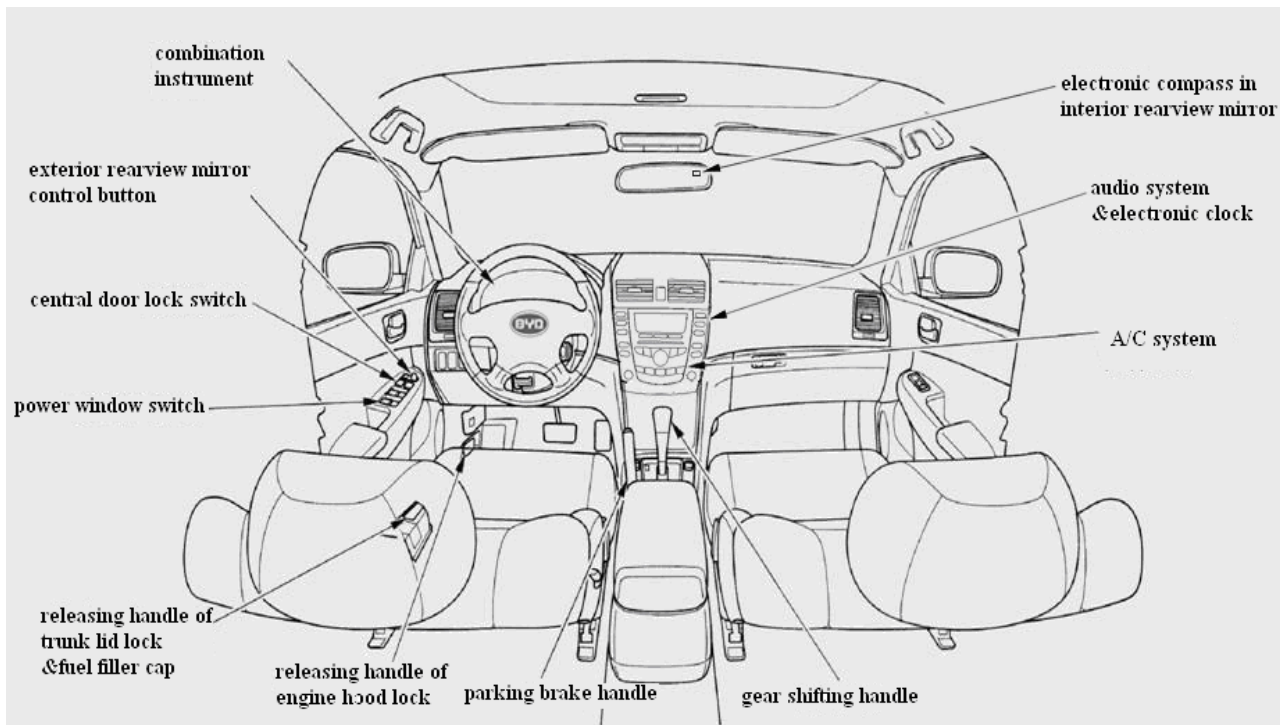

This illustration shows BYD F6 AT model

## Control panel

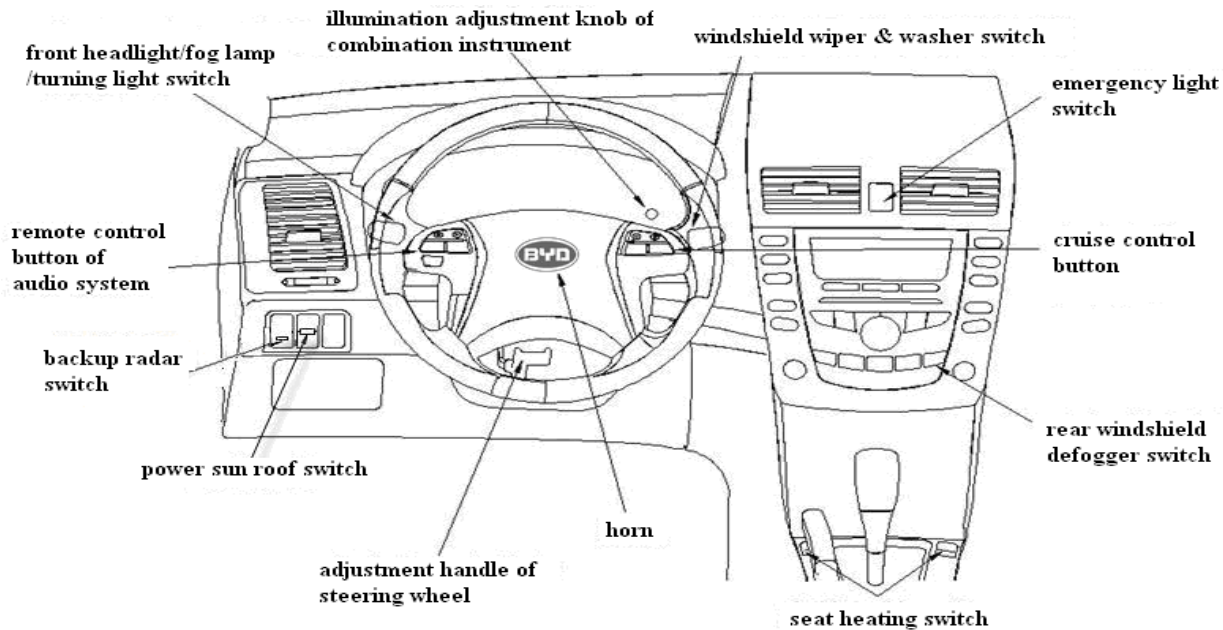

**\*If you want to use the horn, just press the pad around the “BYD” logo.**



## **Driver and Passenger Safety**

### **Important Safety Precautions**

You'll find many safety recommendations throughout this section and this manual. The following recommendations are the ones we consider to be the most important.

### **Always Wear Your Seat Belt**

A seat belt is the best protection in all types of collisions. Airbags are designed to supplement seat belts, but they are designed to inflate when the vehicle engages in a severe frontal impact. So even though your vehicle is equipped with airbags, make sure you and other passengers always wear seat belts, and wear them properly.

### **Restrain All Children**

Children should be properly restrained in a back seat, not in front seat for the best safety. Infants and small children should be restrained in a child protection device when they can not wear seat belt.

### **Be Aware of Airbag Hazards**

While airbags can save lives, they can cause serious or fatal injuries to occupants who sit too close to them or who are not properly restrained. Infants, young children, and short adults are at the greatest risk. Be sure to follow all instructions and warnings in this manual. (Refer to 7th page)

### **Don't Drink and Drive**

Alcohol and driving don't mix. Even a little drink can reduce your ability to respond to changing conditions, and your reaction gets worse with every additional drink. So don't drink and drive, and don't let your friends drink and drive, either.

### **Control Your Speed**

Excessive speed is a major cause of crash injuries and deaths. Generally, the higher the speed, the greater the risk, but serious injuries can also occur at lower speeds. Never drive faster than is safe for current conditions, regardless of the maximum speed posted.

### **Keep Your Vehicle in Safe Condition**

Tire blowout or a mechanical failure can be extremely hazardous. To reduce the possibility of such problems, check your tire pressures and condition frequently, and perform all regularly scheduled maintenance. (Refer to 112th page)

## Safety equipment

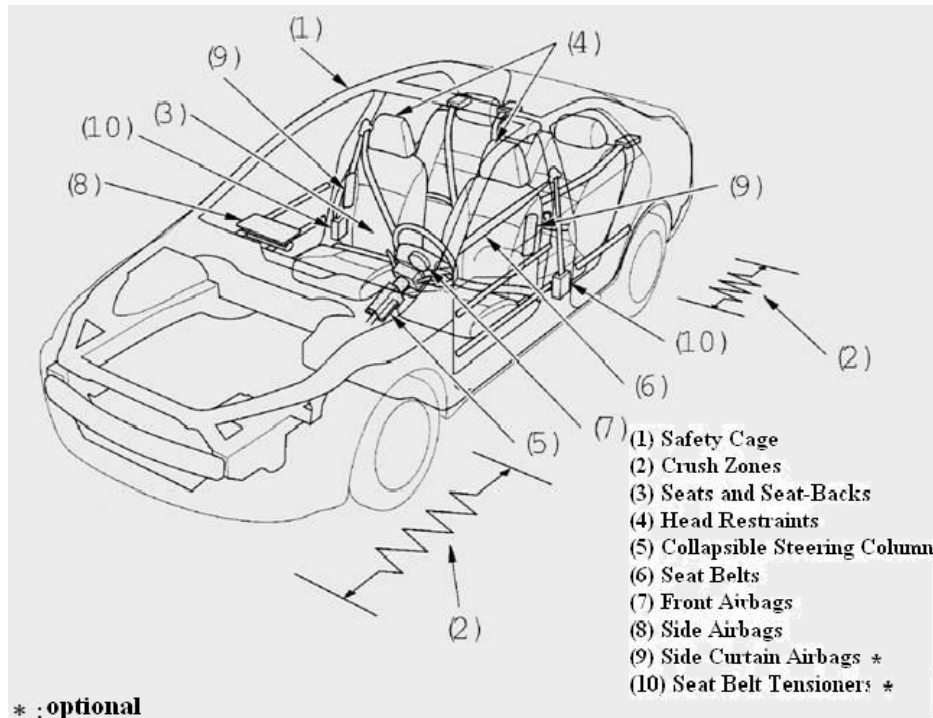

Your vehicle is equipped with many safety devices that work together to protect you and your passengers during a crash.

Some features do not require any action on your part. These include a strong steel framework that forms a safety cage around the passenger compartment; front and rear crush zones will absorb the impact energy by crumpling in a crash, a collapsible steering column, and tensioners that tighten the front seat belts in a crash.

However, you and your passengers can't take full advantage of these features unless you remain sitting in a proper position and always wear seat belts. In fact, some safety features can contribute to injuries if they are not used properly.

The following page explains how you can take an active role in protecting yourself and your passengers

### Three-point safety belt

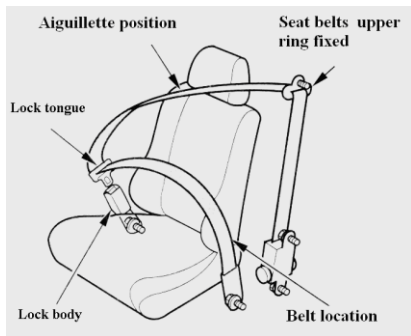

The seat belt restrains you by a belt across your shoulders, chest and hip.

To fasten your belt, pull it out of the retractor and insert the tab into the buckle. Pull the belt to make sure the tab and the buckle are locked.

To release the belt, press the red “Press” buckle-release button and allow the belt to retract.



Your seat belt system also includes an indicator on the instrument panel and a buzzer to remind you and your passengers to fasten your seat belts.

### Safety belt tensioner (optional)



Automatic tensioner is mainly designed to activate in any frontal collision. The tensioner is interlinked with airbags, in a collision severe enough to cause the airbag to deploy; the automatic tensioner also can provide help.

When the automatic tensioners are activated, seat belts will maintain tight state until they are unlocked.



The SRS light will be lit up to alerts you to a potential problem with your seat belt tensioner. (Refer to 30<sup>th</sup> page).

#### Friendly tips

- 1 Seat belts are designed to support the body's bones. So wear the seat belts across the front of the pelvis as low as possible, that is to say, the belts should across the pelvis, chest and shoulder. Please avoid belt acrossing the abdomen.
- 2 You may try to find comfortable status when wearing seat belts, but the belt shall be pulled to tension, so that the design can achieve the protective effect. Loosed seat belts will greatly reduce the protection function.
- 3 Not wear twisted seat belts.
- 4 Each seat belt can only be used by one person. Run seat belts around children in the arms are extremely dangerous.

## Airbag

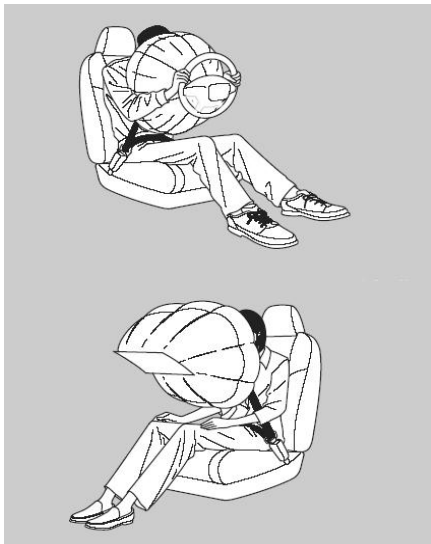

Your vehicle has a supplemental restraint system (SRS) with front airbags to help protect the heads and chests of the driver and a front seat passenger during a moderate or severe frontal collision.

## Side airbag (optional)

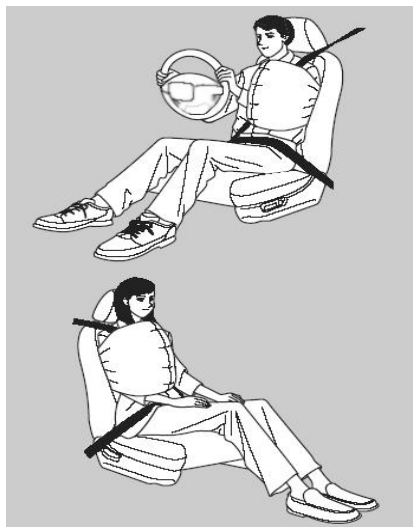

Your vehicle has side airbags to help protect the upper body of the driver or a front seat passenger during a moderate or severe side impact.

## Friendly tips

1. Airbags do not replace seat belts. They are designed to supplement the seat belts.
2. Airbags offer no protection in rear impacts, rolling or minor frontal or side collisions.
3. Airbags can pose severe hazards. To do their job, airbags must inflate with tremendous force. So while airbags help save lives, they can cause minor injuries or more serious or even fatal injuries if occupants are not properly restrained or sitting properly.

What you should do: Always wear your seat belt properly, and sit upright as far away from the steering wheel as possible while fully controlling vehicle.

**Seat and seat back**

This vehicle seat design allows you to maintain a comfortable, straighten sitting, and is able to make full use of the protection provided by the seat belts and energy absorption material of the seats.

Adjusting your seat and seat back could also affect your safety. For example, being too close to the steering wheel or dashboard will increase the possibility that you or passengers are injured by the in floatable airbag or other items inside.

If the seat backrest is too tilted, that will reduce the protective effect of the seat belts. That will increase the possibility of serious injury as felling out from seat belts.

What you should do: Try to move front belt backward, and maintain the adjustable seat back in nearly vertical state while driving.

**Headrest**

Headrest can be prevented neck sprains and other injuries. In order to get the best protective effect, adjust your head to make your occiput rest against the center of the headrest.

**Safety Checks before Driving**

To ensure that you and your passenger can be protected to maximum by the safety facilities of vehicles, please check the following matters each time before driving:

1. Be sure all adults and children with no suitable protection device always wear seat belts and wear them properly. (Refer to 6<sup>th</sup> page)
2. All infants should be placed in the child protection unit properly in the back seat. (Refer to 10<sup>th</sup> page)
3. A front passenger should sit upright and as far away from the steering wheel and dashboard as possible.
4. Seat back should remain upright.
5. Adjust headrest correctly.
6. After everyone has entered the vehicle, be sure the doors are closed and locked.



Your vehicle has a door and trunk status monitor on the instrument panel to indicate when a specific door or the trunk is not tightly closed.

7. All baggage must be properly stored and fixed good. (refer to 93<sup>rd</sup> page)

Other parts of this chapter will be more detailed on how to ensure your safety to maximum.

Remember, however, that no safety system can prevent injuries or deaths completely in a severe crash, even when seat belts are properly worn and the airbags deployed.

**Advice to pregnant women**

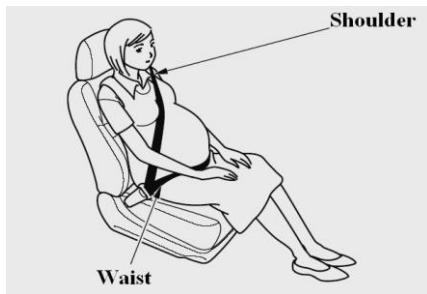

1. The best way to protect your unborn child is protecting yourself well. So when driving or riding in a vehicle, do always wear a seat belt, and keep the lap part of the belt as low as possible across the hips.

2. When driving, remember to sit upright and adjust the seat as far away from the steering wheel and dashboard as possible while allowing full control of the vehicle. This will reduce the risk of injuries to both you and your unborn child caused by a crash or an inflating front airbag.

<b>Friendly Tips</b>
Each time you have a prenatal checkup, ask doctor if it's okay for you to drive.

**Advice to Parents**



1. Never hold an infant or child on your lap. If you are not wearing a seat belt in a crash, you could be thrown forward and crush the child against the dashboard.

2. Never use a seat belt for both yourself and a child. During a crash, the belt could press deep into the child and cause serious or fatal injuries.

<b>Friendly Tips</b>
1. Never use the same seat belt for two people. If do that, they could be very seriously injured in a crash.
2. Do not add any other accessory to the seat belt.
3. Do not place any hard or sharp object between you and positive airbag.
4. Do not attach or place articles in the cover of airbag.
5. In some models equipped with side airbags, do not attach or place hard articles on or near the door.
6. Do not move hand or arm to near the cover of airbag.
7. Use childproof door locks to prevent children from opening the doors. This

can prevent children from accidentally falling out.

8. Please use the main switch power windows, preventing children from playing

with power windows, or else they might be in danger when their body are out of the car window.  
playing

9. Do not leave children alone in a vehicle. A child left alone with the key in the ignition switch can accidentally start up the vehicle, possibly injuring themselves or others.

**Extreme danger !**

Under the section 94 of E.C.E regulations:



Never place a rear-facing child protection unit when the front seat has an airbag.

**Side Airbag**

- **The driver's seat and driver's side equipped with side airbag**
- **The rear seat is best safety for children**
- **Do not rely on the door**
- **Details are set out in the owner's manual**

Side air bag inflating may result in serious injuries or even death if body tilt forward on the front door.

To remind you of danger of side airbags, your vehicle is posted with warning signs on both sides of the front door frames.

**Supplementary data for airbag**

Your SRS (supplemental restraint system) includes:

1. Two front airbags. The driver's airbag is installed in the center of the steering wheel; the front passenger's airbag is installed in the dashboard. Both are marked "SRS AIRBAG".
2. Two side airbags for driver and a passenger, one for each side of the vehicle. The airbags are installed on the outer edge of the seat backs, marked with "SRS SIDE AIRBAG". (Refer to 13rd page)
3. Automatic front seat belt tensioner. It can tension the seat belt in a moderate to severe frontal impact. (Refer to 6th page)
4. Sensors .They can detect a moderate to severe frontal impact.
5. A sophisticated electronic system that continually monitors and records information from the sensors, the control unit, the airbag modules, and seat belt in use for driver and passenger in front seat when the ignition switch is in the ON (II)

position.

6. An indicator on the instrument panel. It alerts you to a possible problem with your airbags, sensors, or seat belt tensioners and so on. (Refer to 26th page)

7. Emergency backup power in case your vehicle's electrical system is disconnected in a crash.

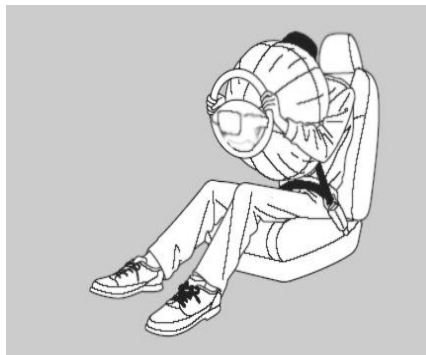
**How Front Airbag Works (if equipped)**

If you ever have a moderate to severe frontal collision, sensors will detect the vehicle's rapid deceleration. The control unit will instantly inflate the driver's and front passenger's airbags, at the same time activate automatic seat belts tensioner.

During a frontal crash, your seat belt restrains your lower body and trunk, and the front airbag helps protect your head and chest as an air cushion. The belt pretensions will tighten and lock seat belts to maintain you fixed in the position.

Although both airbags use the same sensor, so inflate at the same time, but it is also possible for only one airbag to deploy.

This can happen if the severity of a collision is at the margin, or threshold, that determines whether or not the airbags will deploy. In such cases, the seat belt will provide sufficient protection, and the supplemental protection offered by the airbag would be minimal.





After inflating, the front airbags will immediately deflate, so they won't interfere with the driver's visibility, or the ability to steer or operate other controls.

The total time for inflation and deflation is one-tenth of a second, so fast that most occupants are not aware that the airbags deployed until they see them lying in their laps.

There will be loud noise with the airbag deploying, generally it not cause the hurt (but it is possible to cause a drumming in the ears or temporary audition loss, it will be as soon recover).After a crash, you may

see what looks like smoke. This is actually powder from the airbag's surface. Although the powder is not harmful, people with respiratory problems may experience some temporary discomfort. If this occurs, get out of the vehicle as soon as it is safe.

### How Side Airbag Works (optional)



There are two side airbags for the passenger and driver. The airbags are installed on the outer edge of front seat backs and marked with "SRS SIDE AIRBAG".

### Possible Causes for Non-deployment Airbags

If you ever have a moderate to severe side impact, sensors will detect rapid deceleration and signal the control unit to instantly inflate either the driver's or the passenger's side airbag.

Only one airbag will deploy during a side impact. If the impact is on the passenger's side, the passenger's side airbag will deploy even if there is no passenger.

To get the best protection from the side airbags, front seat occupants should wear their seat belts and sit upright and lean against their seat backs.

#### Friendly tips

Using airbags unauthorized by BYD may decrease the airbag capability or cause accidental hurt to the passengers. Never place the anything between the side airbag and the passengers. Do not pose heavy stress on the seat side where side airbags are equipped.

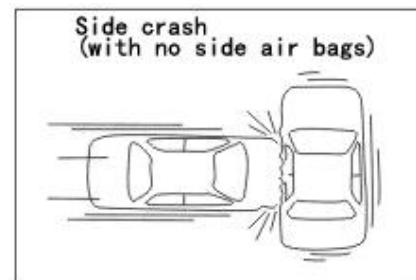
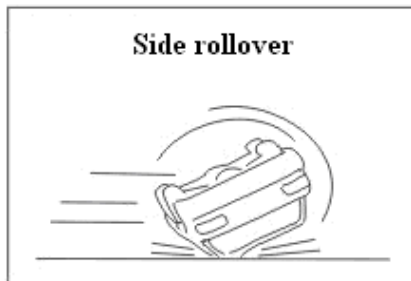
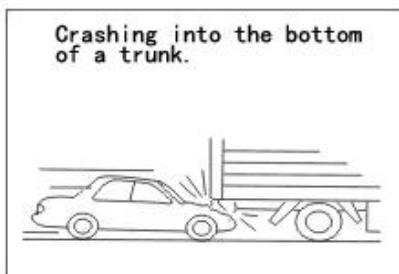
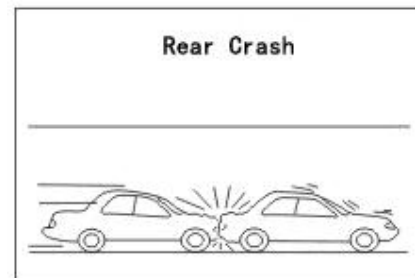
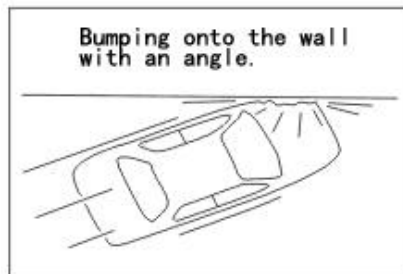
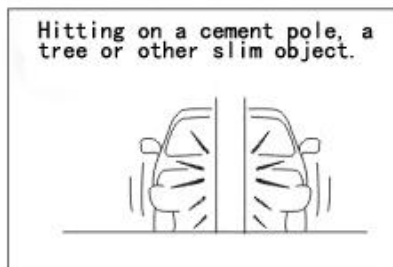

In the circumstances illustrated above, the airbags may not deploy.

## Possible Causes of Airbag Deployment

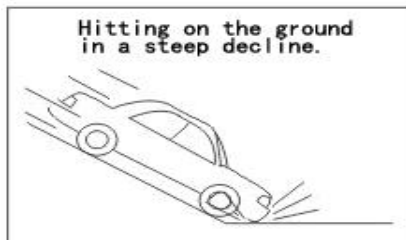
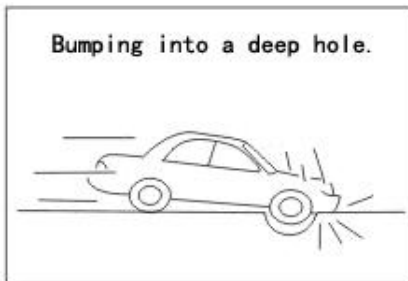

The SRS airbags may deploy if the vehicles receive severe impact on the bottom as shown in the above illustrations.

Friendly tips
<p>1. Airbag is designed to match the certain vehicle models, any changes in the tire size, bumpers, chassis and other original equipments may affect the function of the airbags. In addition, it is prohibited to use any airbag part on other vehicle model, otherwise it might lead to safety airbag system failure, resulting in personal injury.</p> <p>2. When the vehicle dashboard experience abnormality or can not display the information normally (for example, abnormal speed, seat belt</p>

wearing information, etc.), timely get maintenance from service stations, otherwise it will lead to system failures or abnormal work.

3. During driving, please wear the seat belt properly and maintain a good posture. If you do not wear seat belts or sitting in improper posture, then the deployed airbag in the accident may aggravate the risk of injury.

4. Maintaining the distance between chest and the steering wheel at least 25 cm is very important for the driver, so as to make the driver get the most effective protection when triggering the system.

5. Don't attach, cover or decorate any objects on the steering wheel surface and the front seat air bag covers. Clean these two places with dry or moist duster cloth. Strong knock at these two places is not allowed.

6. Don't let child passenger sit in the front seat without protection. If a collision triggers the air bag, the child passenger may get seriously injured or

even killed.

7. Don't stay or put any animals or objects near the driver, the front seat passenger and the air bags. It is extremely dangerous for an adult passenger to hold a child on the laps.

8. Don't install phone holder, cup, ash tray or any other attachments to the air bag cover or its function area. Otherwise, accidents triggering air bags will increase the possibility of human injuries.

9. Don't make any modifications to any components of the air bag system, including corresponding labels.

10. Any operation to the air bags, including disassembly during the repair of other parts (such as removal of the steering wheel) can only be made in the BYD dealer or franchised maintenance stores.

11. The air bag system must be replaced in the BYD dealers and franchised maintenance stores within 10 years since the manufacturing date

(indicated on pass certificate and plate on engine chamber). Please keep a record if any part of the system is replaced before the expiry date.

12. . The air bag can only provide one-time protection. Once the air bag is triggered or damaged, the system must be replaced.

13. . Please hand our materials to the next owner when selling the vehicle. Please notice that if the air bag is shut down, hand this information to the next owner as well.

14. When disposing the components of the vehicle or the air bag system, please comply with correlative safety regulations and disposal procedure. The disposal must be conducted by the BYD dealers or related qualified units.

15. The airbag system has relatively strong anti-interference ability against the surrounding electromagnetic interruption. However, please don't operate the vehicle under the electromagnetic environment that is not permitted by the government to avoid

accident.

16. BYD F6 takes full consideration of various kinds of misuses and road conditions. However, don't allow serious crashes happen in the bottom of the vehicle or drive toughly in poor road conditions in order to prevent accidents.

#### **Shut Down Air Bags**

In some occasions, shut down air bags for the driver and the front passenger in accord with regulations. These occasions include:

1. When it is impossible to keep 25cm distance between the center of the steering wheel and the chest of the driver even though the driver seat is adjusted properly.
2. When special equipment needs to be installed for the disabled within the air bag function area.
3. When the front seats cannot be maintained within the manufacturer's setting scope after adjustments due to some reasons.

The air bag system shutdown must be conducted by the BYD dealers or franchised service stores. After the shutdown, BYD dealers or franchised maintenance stores must label at the specific places and keep records.

**Friendly tips**

If the air bag system needs shutdown in some special occasions, please go to the BYD dealers or franchised service stores. Otherwise, serious injuries or death may be incurred.

In addition, please reopen the shutdown airbag as soon as possible in order to ensure the air bag recover its protecting function.

**Supplemental Information**

1. Please read this manual thoroughly. If you want to sell or demolish the vehicle, please notify the buyer or disposal departments that the car is equipped with the air bag system, and recommend them to read the manual in details.
2. After the air bag functioned, please don't touch any components of the air bag system

(or scalds or poisoning may be caused), and let the BYD dealers or franchised maintenance stores handle it. Once the air bag system functioned, please install a new air bag system.

3. The front (side) air bags only function in case of frontal (side) collisions in certain degree. It doesn't mean that the air bag system has problems when it doesn't respond to the collision. The damages or improper maintenances can influence the normal function of the system.

4. To recycle and destroy the airbag shall be performed by a qualified unit to avoid environmental pollution and harm to operator's health.

5. The company shall bear no responsibility for any direct or indirect loss caused by any improper operations.

6. Special Emphasis: you shall wear your seat belt properly any time, or the airbag may cause serious personal injury to the passengers instead of protecting effectively. If so, users shall take liability for accident

of this kind.

**How SRS Indicator Works**



The SRS indicator alerts you to a potential problem with your airbags or seat belt tensioners.

If the vehicle is equipped with side airbags, this indicator is also used to remind you of potential danger with driver side airbag or passenger airbag.

When you turn the ignition switch to the ON (II) position, this indicator is on for 5 seconds and then extinguish. This tells you the system is working properly.

If the indicator is on at any other time, or does not light up at all, you should have the system checked by the BYD AUTO dealer. For example:

1. If the SRS indicator isn't on after you turn the ignition switch to the ON (II) position.
2. If the indicator stays on after the engine starts.
3. If the indicator is on or flashes in driving.

In any of the above circumstances, the airbags and seat belt tensioners may not work properly when they are needed. You shall ask for help from the BYD AUTO dealer as soon as possible.

**Friendly tips**

Ignoring the SRS indicator can result in serious injury or death if the airbag systems or tensioners do not work properly.

Have your vehicle checked by a BYD AUTO dealer as soon as possible if the SRS indicator alerts you to a possible problem.

**Airbag Maintenance**

Your airbag systems including front airbag and side airbag (optional) are virtually maintenance free, and there are no parts you can safely service. However, you must have your vehicle serviced if:

1. An airbag ever inflates. Any airbag that has deployed must be replaced along with the control unit, seat belt tensioner and other

related parts. Do not try to remove or replace any airbag by yourself. This must be done by BYD AUTO dealer.

2. The SRS indicator alerts you to a problem. Take your vehicle to an authorized dealer as soon as possible. If you ignore this indication, your airbags may not operate properly.

Only trained personnel can do it. Prohibit removing airbag modules and seat belts tensioner from the vehicle. If the failure of engine flameout occurred or air bags inflated or seat belt tensioner worked, you shall go to a BYD AUTO dealer for repairing or troubleshooting.

**Supplementary safety notice**

1. Do not attempt to deactivate your airbags. Together, airbags and seat belts provide the best protection.

2. Do not tamper with airbag components or wiring for any reason. Tampering could cause the airbags and seat belt to deploy, possibly causing very serious injury.

**For Cars with Side Airbags**

1. Do not expose the front passenger's seat-back to liquid. If water or spraying

liquid soaks into the seatback, it can prevent the side airbag system from working properly.

2. Do not cover or replace front seatback covers without consulting your dealer. Improperly replacing or covering front seat-back covers can prevent your side airbags from inflating during a side impact.

For more information and notice on airbags, please refer to page 7.

**Avoiding Toxic of Carbon Monoxide**

Your vehicle's exhaust contains carbon monoxide gas. You should have no problem with carbon monoxide entering the vehicle in normal driving if you maintain your vehicle properly.

Have the exhaust system inspected for leaks whenever:

1. The vehicle is lifted for lubricant change.
2. You notice a change in the sound of the exhaust.
3. The vehicle was in an accident that may have damaged its underside.

**Friendly tips**

Carbon monoxide gas is toxic. Breathing it can cause unconsciousness and even death.

Avoid any enclosed conditions or activities that expose you to carbon monoxide.

High levels of carbon monoxide can concentrate rapidly in enclosed areas, such as a garage. Do not run the engine with the garage door closed. Even with the door open, run the engine only long enough to move the vehicle out of the garage.

With the trunk open, airflow can pull exhaust gas into your vehicle interior and create a hazardous condition. If you must drive with the trunk open, open all the windows and set the climate control system as shown below.

If you must sit in your parked vehicle with the engine running, even in an unconfined area, adjust the climate control system as follows:

1. Please choose Fresh Air mode.
2. Please choose  mode.
3. Turn the fan on High Speed.
4. Set the temperature control to a comfortable setting.

**Safety label**

These labels are in the locations shown in the right figure. They warn you of potential hazards that could cause serious injury. Read these labels carefully. If a label falls off or becomes hard to read, contact your dealer for a replacement

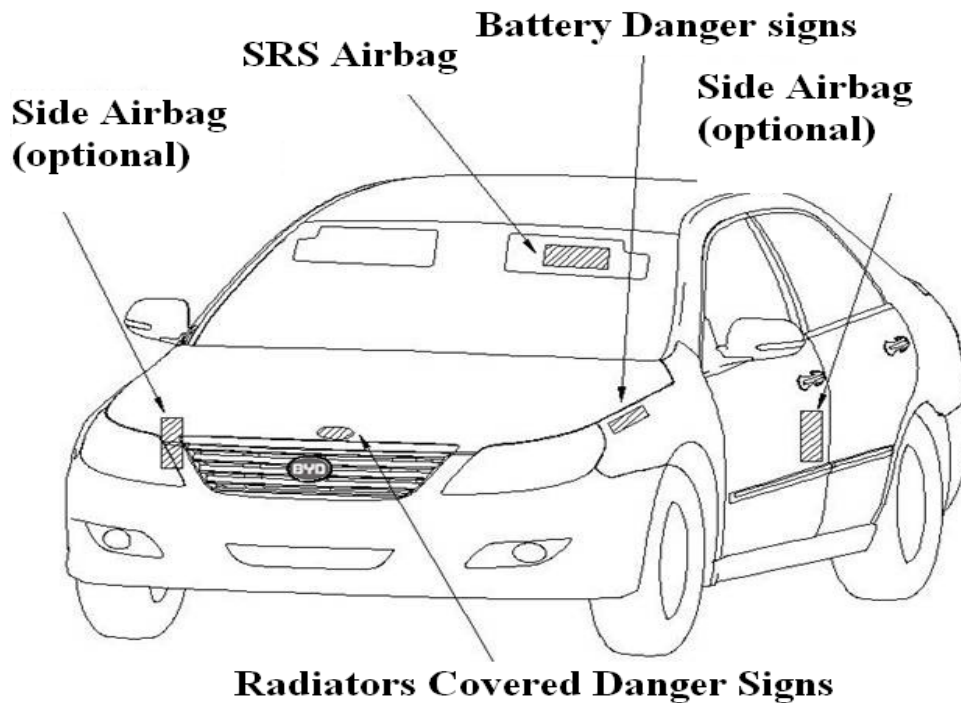



## Instruments and Controls

This chapter gives information about the controls and displays used in the daily operation of your vehicle. All the essential controls are within easy reach.

Position of control switches .....	Danger Warning .....	Mirror .....
Indicators .....	Rear windshield defroster .....	Parking brake .....
Speedometer .....	Steering wheel adjustment .....	Front Seat Armrest .....
Tachometer .....	Adjustment: .....	Sunglass box .....
Odometer .....	Key .....	CD Box .....
Hodometer .....	Remote control .....	Central Storage Box .....
Coolant temperature gauge .....	Ignition switch .....	Accessory Power Socket .....
Fuel level gauge .....	Childproof Lock .....	Cup Holder .....
Control buttons around steering wheel .....	Trunk .....	Bill Box .....
Headlight .....	Glove box .....	Sunvisor .....
Sunlight illumination sensor .....	Seat Adjustment .....	Vanity Mirror (optional) .....
Front/rear fog lamp .....	Manual Adjustment of Driver Seat .....	Cigarette Lighter .....
Turning signal .....	Height .....	Front Ashtray .....
Combination instrument illumination .....	Power Adjustment of Driver Seat (optional) .....	Door light .....
Windshield wiper .....	Driver Waist Support (optional) .....	Interior Air Control System .....
	Head rest .....	Central Air Outlet .....
	Rear seat armrest .....	Audible system (optional) .....
	Seat Heating Device (optional) .....	Audible adjustment .....
	Power windows .....	Safety system .....
	Power Sunroof (optional) .....	Cruise control system .....
	Backup Radar (optional) .....	
	Interior Power Rearview	

## Position of control switches

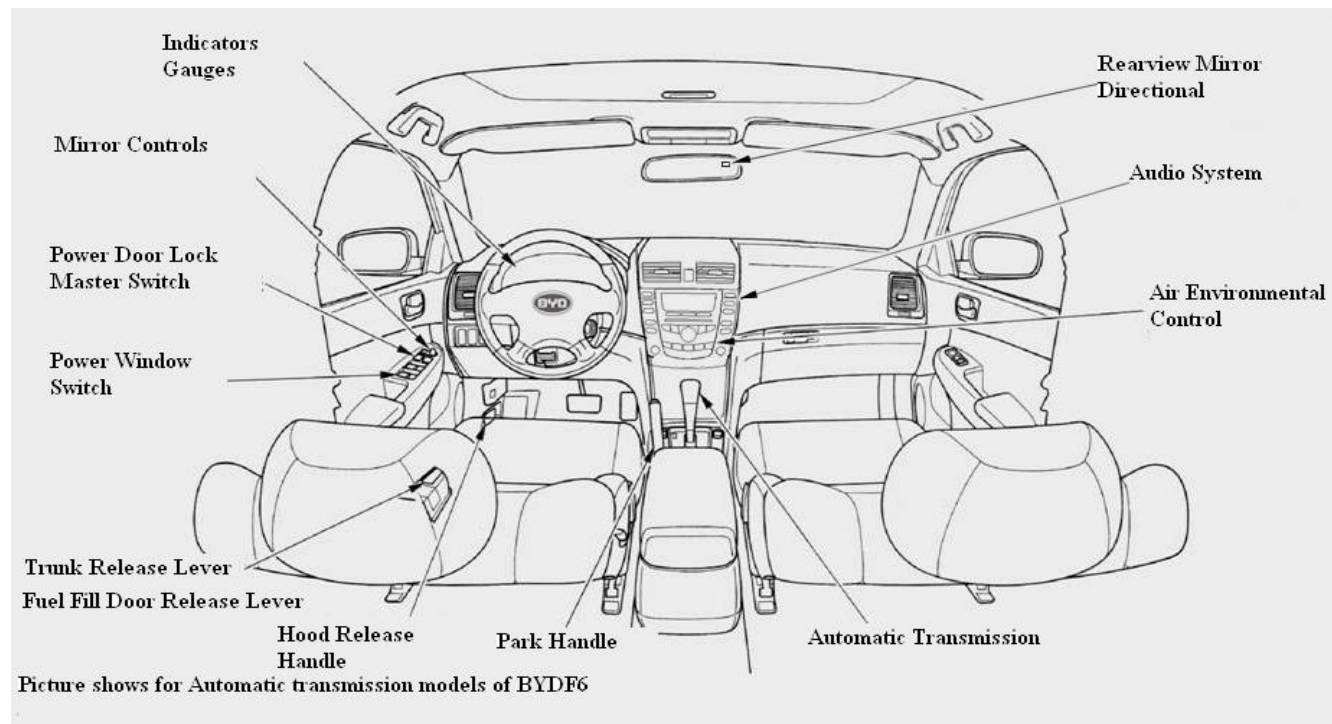

## Indicators

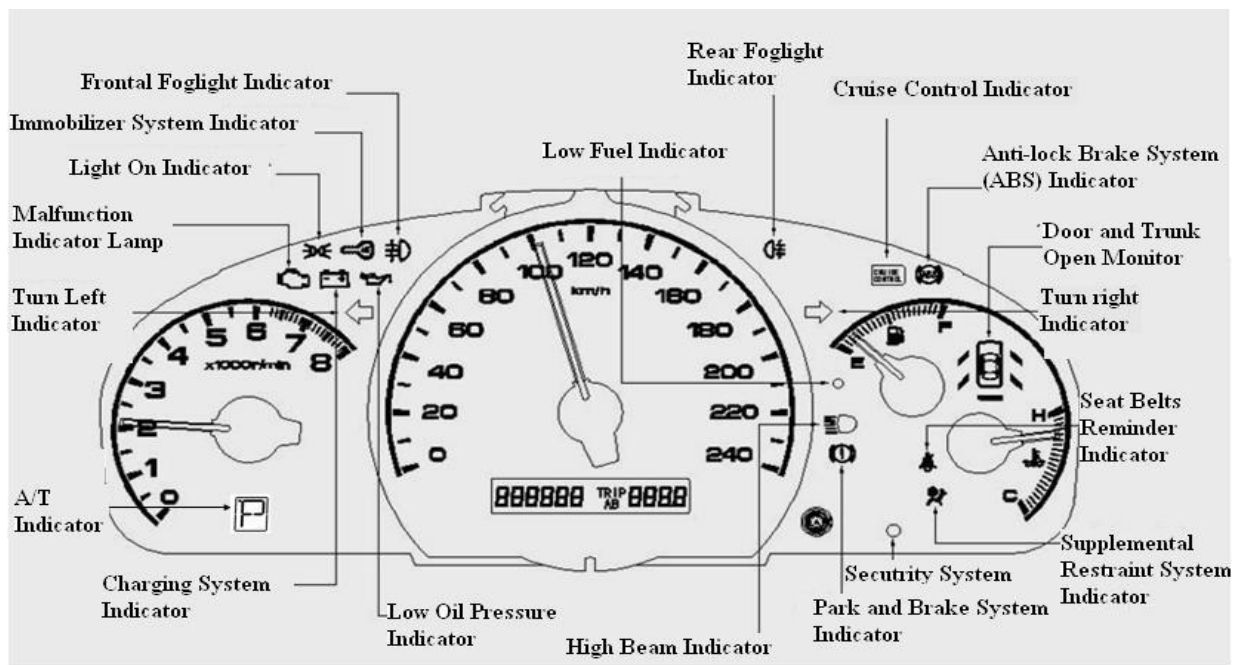

The instrument panel has many indicators to give you important information about your vehicle.



### Seat Belt Reminder Indicator

When turning the ignition switch to the ON (II) position, it reminds you and your passengers to fasten your seat belts. A buzzer also sounds if you have not fastened your seat belt.

If you turn the ignition switch to the ON (II) position before fastening your seat belt, the buzzer sounds and the indicator flashes. If you do not fasten your seat belt before the buzzer stops, the indicator stops flashing but remains on.

If you continue driving without fastening your seat belt, the buzzer sounds and the indicator flashes at regular intervals.



### Low Oil Pressure Indicator

The engine can be severely damaged if this indicator flashes or stays on when the engine is running. For more information, refer to 182<sup>nd</sup> page.



### Charging System Indicator

If this indicator comes on when the engine is running, the battery is not being charged. For more information, refer to 183<sup>rd</sup> page.

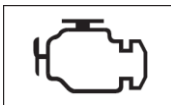

### Malfunction Indicator Lamp

Refer to 153<sup>rd</sup> page.



### Parking Brake and Brake System Indicator

This indicator has two functions:

1. It comes on when you turn the ignition switch to the ON (II) position. It is a reminder to check the parking brake. A buzzer sounds if you try to drive with the parking brake not fully released. Driving with the parking brake being not fully released can damage the brakes and tires.
2. If it remains on after you fully release the parking brake while the engine is running, or if it comes on while driving, there could be a problem with the brake system. For more information, refer to 185<sup>th</sup> page.



### Supplemental Restraint System (SRS) Indicator

This indicator comes on briefly when you turn the ignition switch to the ON (II) position. If it comes on at any other time, it indicates a potential problem with your front airbags or automatic seat belt tensioners. This indicator will also alert you to a potential problem with your side airbags. For more information, refer to 17<sup>th</sup> page.



### Anti-lock Brake System (ABS) Indicator

This indicator normally comes on for a few seconds when you turn the ignition switch to the ON (II) position. If it comes on at any other time, there is a problem with the ABS. If this happens, have your vehicle checked at a dealer. With this on, your vehicle still has normal braking ability but no anti-lock brakes. For more information, refer to 92<sup>nd</sup> page.

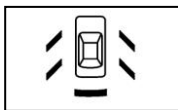

### Door and Trunk Open Monitor

If the trunk or any door is not tightly closed, the monitor reminds you to close the open trunk or door(s) before you start driving. All the indicators in the monitor come on for a few seconds when you turn the ignition switch to the ON (II) position.





### Turn Signal and Hazard Warning Indicators

The left or right turn signal indicator blinks when you signal a lane change or turn. If the indicators do not blink, or if they blink rapidly, it usually means one of the turn signal bulbs is burned out (refer to 27<sup>th</sup> page and 133<sup>th</sup> page). Replace the bulb as soon as possible, since other drivers cannot see that you are signaling.

When you press down the hazard warning button, both turn signal indicators blink and all turn signals lights on the outside of the vehicle flash at the same time.



### Light-on Indicator

This indicator reminds you that the exterior lights are on. It comes on when the light switch is in either the  or  position. If you turn the ignition switch to the ACCESSORY (I) or LOCK (0) position without turning off the light switch, this indicator will stay on. A reminder chime also sounds when you open driver's door.

The vehicle is on the alarm state after removing the key from ignition switch, automatic lighting off feature will turn off the front headlight, front lamp, then the light-on indicator will also turn off.

If you remove the key from the ignition switch with the headlight switch on, but not open the door and get out, the lights will turn off after several minutes. The lights will turn on again when you unlock or open the driver's door; if you unlock the door, but do not open it, the lights will go off.

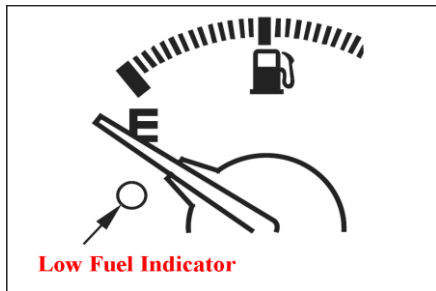
**Low Fuel Indicator**

This indicator is located on fuel gauge. This indicator comes on as a reminder that you must refuel soon for the fuel is less than 8 liters in the tank.

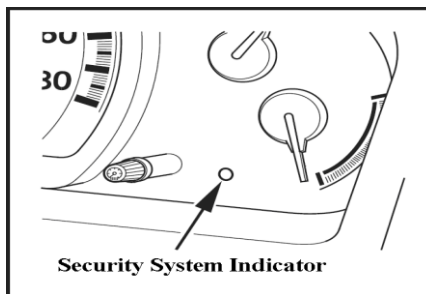
**Security System Indicator**

This indicator comes on when security system is set. Refer to 81<sup>st</sup> page for more information on the security system.

**High Beam Indicator**

This indicator comes on when you turn on the high beam headlights. For more information about head lights control device, (refer to 23<sup>nd</sup> page).

**Front Fog lamp Indicator**

This indicator comes on with the front Fog lamp. Refer to 23<sup>nd</sup> page on operating the front Fog lamp.

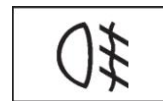
**Rear Fog lamp Indicator**

This indicator comes on with the rear fog lamp. Refer to 23<sup>nd</sup> page for more information on operating rear fog lamp.

**Cruise Control Main Indicator (optional)**

This indicator comes on when you turn on the cruise control main button (refer to 74<sup>th</sup> page).

## Combination instrument

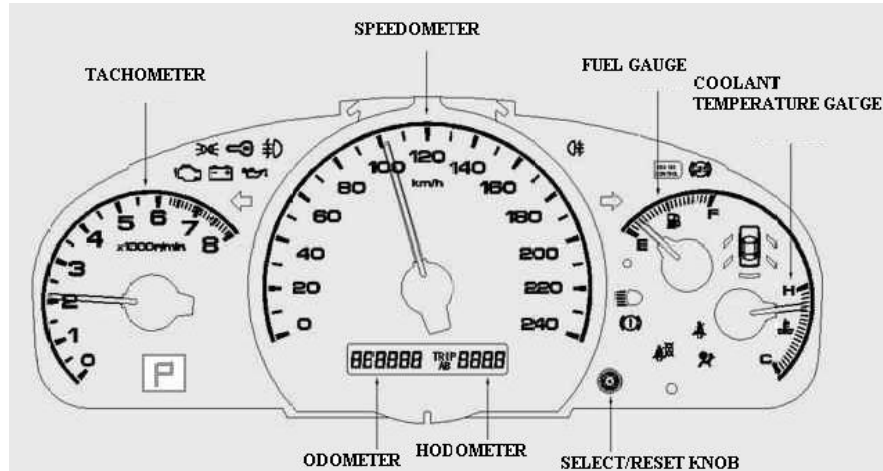
**Speedometer**

The speedometer shows the vehicle speed in kilometer per hour (km/h).

**Tachometer**

The tachometer shows the engine speed in rpm. To prevent damage to the engine; do not drive when tachometer finger is on the red area.

**Odometer**

The odometer shows the total distance your vehicle has run.

## Hodometer

This meter shows the number of kilometers driven since you last reset it.

There are two odometers: Trip A and Trip B. Switch between these displays by pressing the Select/Reset knob repeatedly. Each odometer works independently, so you can keep track of two different distances.

When you turn the ignition switch to the ON (II) position, what you last selected is displayed.

To reset a trip meter, display it, and then press and hold the Select/Reset knob until the number resets to "0.0".

## Coolant temperature gauge

This shows the temperature of the engine's coolant. During normal operation, the reading should be in the middle of the gauge. In severe driving conditions, such as very hot weather or a long period of uphill driving, the reading may reach near the red mark. If it reaches the red (Hot) mark, park safely to the side of the road. Refer to 108<sup>th</sup> page for instructions and precautions on checking the engine's cooling system.

## Fuel level gauge

This shows how much fuel you have. It is most accurate when driving on flat road; it may show slightly more or less than the actual amount when driving on winding road or rugged road.

The needle returns to the bottom after you turn off the ignition. The needle show the fuel reading when you turn the ignition switch to ON ( II )

<b>Friendly tips</b>
Avoid driving with an extremely low fuel level. Running out of fuel could cause the engine to misfire, damaging the catalytic converter.



### Information Display Screen (optional)

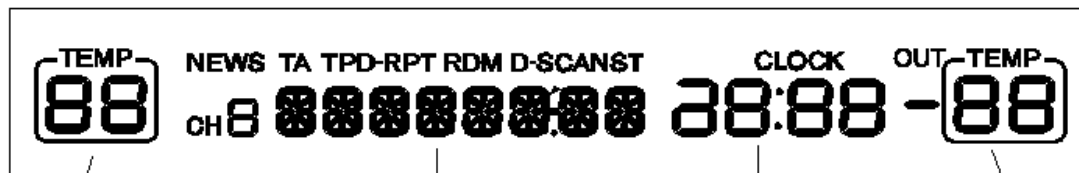

1. Driver side Temperature Information

2. DVD/FM Information

3. Clock Information

4. Passenger side/outside Temperature Information

1. **Driver side temperature information**  
It is used for displaying the set temperature (°C) in the position of driver.
2. **DVD/FM information**  
Display related information about DVD and radio
3. **Clock information**
4. **Passenger side/outside temperature information**  
Display the passenger side/outside temperature (°C)

### Control buttons around steering wheel

Two operating lever on the steering wheel include most commonly used control buttons. The left operating lever controls the turning signal lights, front headlights and fog lamps; the right operating lever control windshield wipers and washers.

The control buttons of the moonroof and the parking radar are under the left vents.

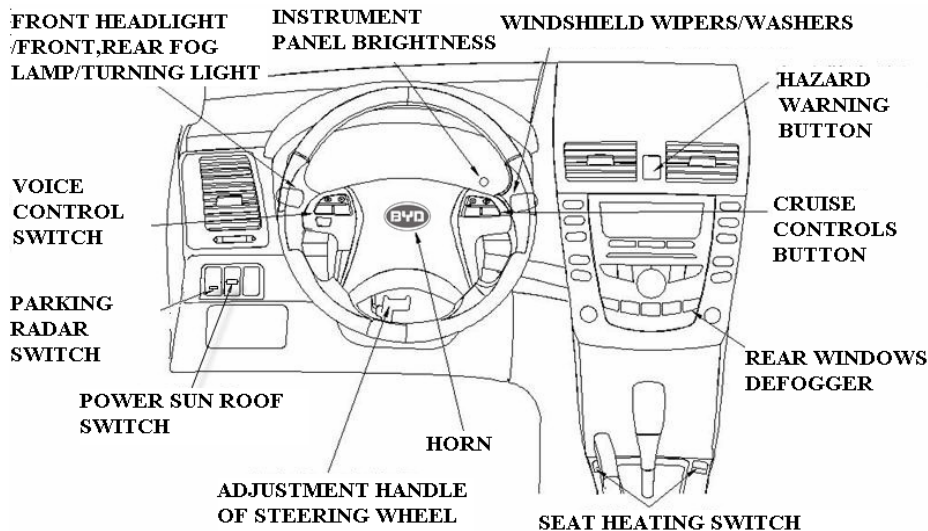

You can use the lever under the steering column to adjust the steering wheel's gradient and flex rate.

1. If you want to use the horn, press the pad around the "BYD" logo.
2. Available on certain vehicle types.

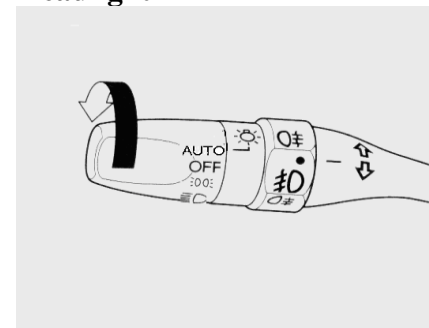

### Headlight



Rotary switch on operating lever control the lights. Turn the switch to  position to turn on the parking lights, rear license plate lights and the indicator. Turn this switch to  position to turn on the headlight. Turn the switch to AUTO position, headlight will turn on or off automatically according to the ambient illumination intensity from the sunlight illumination sensor. When the light switch is in either of these positions, the indicator is on as a reminder. (Refer to 27<sup>th</sup> page).

## Sunlight illumination sensor

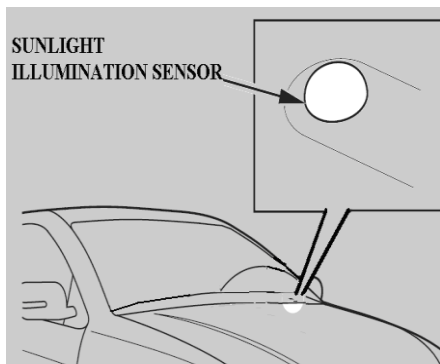

Sunlight illumination sensor is located on the top of instrument panel and beside left front treble loudspeaker. Do not cover the sensor or spatter any liquid.

If you remove the key from the ignition switch with lights turned on, you will hear a reminder chime for turning off the lights when you open the driver's door.

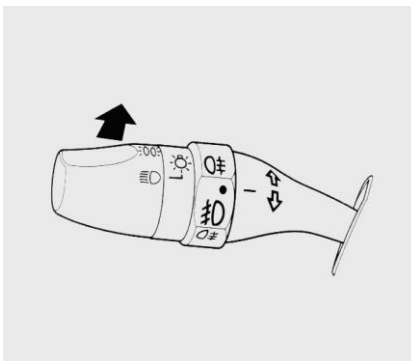

To switch dipped lights to high beams, push the lever forward until you hear a click. The high beam indicator will be on

To switch back to dipped lights, pull the lever back.

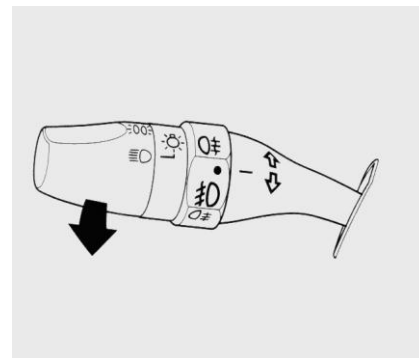







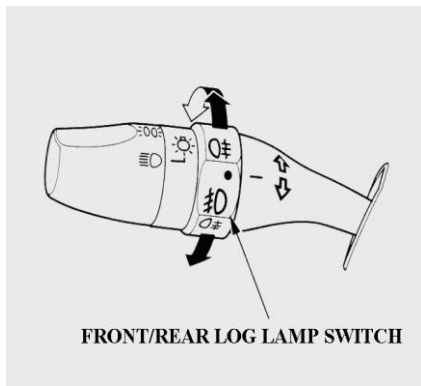

To flash the high beams, pull the lever slightly back, and then release it. The high beams will turn on then go out.



The high beams will always remain on if you pull the turning signal rod and do not release it, no matter which position the front headlight switch is in.



## Front/rear fog lamp



Front/rear fog lamp switch is at the side of lights control switch, you can turn the front fog lamp on by using this switch when the lights control switch is in the either  or  position. You also turn the rear fog lamp on using this switch when the lights switch is in the  position or the fog lamp has been on. Revolving the switch upward from OFF (  ) to  to turn the front fog lamp, then the

indicator  is on for reminding. To turn on or off the rear fog lamp with the front lamp lighting, turn upward the switch one frame from  position and release it. Then the indicator  on the instrument panel is on or off for a warning.

If only turn the rear fog lamp on, turn the switch downward from OFF (  ) to  position and release it.

The front fog lamp will comes on when you turn the rear fog lamp on, turn the lights control switch to  or  position. To turn off the fog lamp completely, turn the fog lamp switch downward to OFF (  ) position.

If you want to turn the rear fog lamp on again, you should turn the fog lamp switch when the lights control switch is on the  position.

The front/rear fog lamp will come off when you turn the light control to OFF position to close the headlights.

## Turning signal

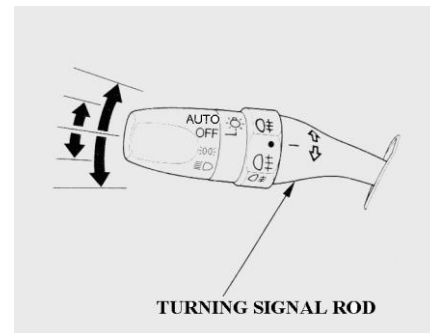

Using this operation rod can send turning signal or lane change signal. Push down on the left lever to signal a left turn and up to signal a right turn. If you push the rod to the top or the bottom, even you loose hands, the turning signal lights will continuous flash, and it will come off with a turning completed.

To signal a lane change, push lightly on the lever in the proper direction and hold it. The lever will return to center when you release it or complete a turn.

## Combination instrument illumination

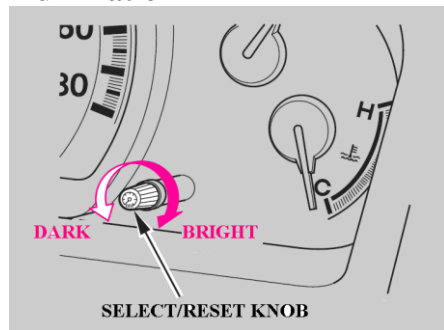



The Select/Reset knob on the instrument panel controls the brightness of the instrument panel lights and the operation buttons of central control board. Turn the knob to adjust the brightness. Counterclockwise rotation decreases brightness and clockwise rotation increases brightness, the brightness is the most dark or bright when you hear a click. This button can rotate illimitably, to protect the button, please stop rotating when you hear a click.

The instrument panel will illuminate with dim brightness when you open the driver's door. The brightness will increase slightly when you insert the key in the ignition switch, then go to normal brightness when you turn the ignition switch to the ON (II) position.

If you do not insert the key in the ignition switch after opening the driver's door, the illumination will be off scores of seconds after you close the door.

If you insert the key but do not turn the ignition switch to the ON (II) position, the illumination will be off after several seconds.

To reduce glare at night, the instrument panel illumination dims when you turn the light switch to  or . Turning the Select/Reset knob fully to the right until you hear a click will cancel the reduced brightness setting.

## Windshield wiper

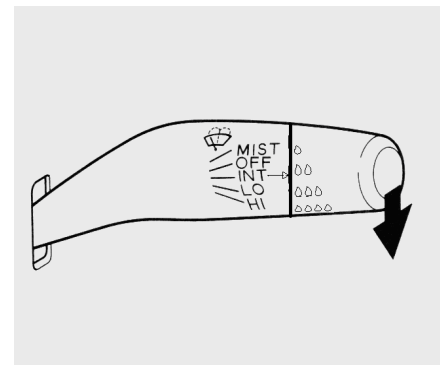

This control lever controls the windshield wiper and washers. It has 5 shifts:

- MIST: MIST
- OFF: Stop
- INT(AUTO): Intermittent
- LO: Low speed
- HI: High speed

Push the right lever up or down to select a position.

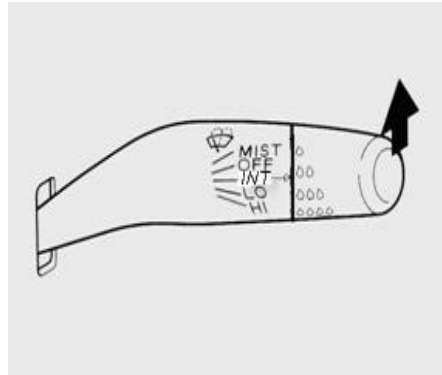

INT— the intermission adjustment knob adjust its intermission time to 7S, 5S, 3S and 1S with the raindrop number increase.

LO & HI—wiper scrape continually.

MIST—Push the control lever upwards from OFF position. The wiper will scrape high-speed until you release the control lever. So that can clean the windshield quickly.

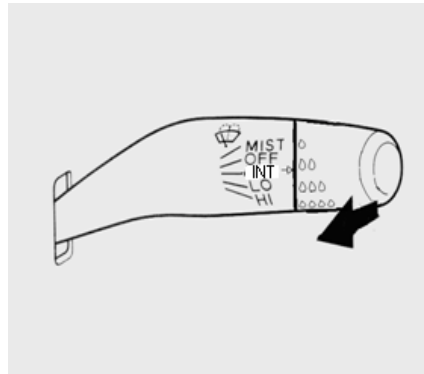

Pull the control lever of windshield wiper back to clean the windshield; the syringe will spray water and the wiper work at the same time. The syringe will stop immediately when you release the control lever and the wiper still swing three times.

## Danger Warning

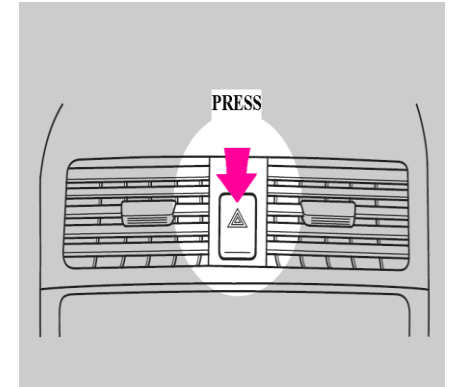

Push the button between the center vents to turn on the hazard warning lights (six-way flashers). This causes all six outside turn signal lights and both turn indicators in the instrument panel to flash. The flash light can remind the foot passenger or other vehicles that your vehicle may cause danger.

## Rear windshield defroster

The rear window defroster will clear fog, frost, and thin ice from the window. Push the defroster button to turn it on and off. The indicator in the button comes on to show the defroster is on. It shuts off when you turn off the ignition. The defroster will be turned on again when you restart the vehicle. To save battery power, when the rear windshield has good visibility you shall turn off defroster.

Make sure the rear window is clear and you have good visibility before starting to drive.

The defroster wires on the inside of the rear window can be accidentally damaged. When cleaning the glass, always wipe horizontally.

## Steering wheel adjustment

Make adjustment, if required, to steering wheel before you start driving.

### Friendly tips

Adjusting the steering wheel position while driving may cause you losing control of the vehicle and be seriously injured in a crash.

Adjust the steering wheel only when the vehicle is stopped.

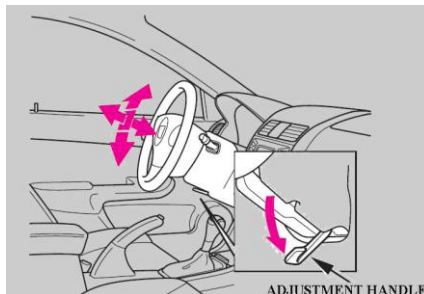

## Adjustment:

1. Push the lever under the steering column all the way down.
2. Move the steering wheel up or down, and in or out to the desired position. The steering wheel shall face your chest, not your face. Make sure you can see the instrument panel gauges and the indicator lights.
3. Push the lever up to lock the steering wheel in that position.
4. Make sure you have securely locked the steering wheel in place by trying to move it up, down, in, and out.

## Key

Your vehicle comes with a set of keys as shown in the picture.

The master key fits all the locks on your vehicle.

1. Ignition switch
2. Driver's door
3. Glove box

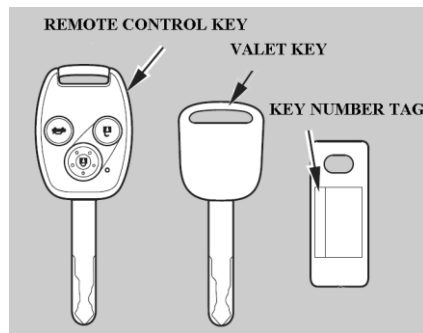

You should have received a key number tag with your keys. You will need this key number if you ever have got a lost key replaced. Use only BYD-approved key blanks.

## Remote control

Please refer to 39<sup>th</sup> page on how to use the remote control.

### Friendly tips

These keys contain electronic circuits that are used for remote control.

1. Protect the keys from direct sunlight, high temperature, and high humidity
  2. Do not drop the keys or place heavy objects on them.
  3. Keep the keys away from liquids. If they get wet, dry them immediately with a soft cloth.
- If you lose your key and cannot start the engine, contact your dealer.  
Do not try to disassemble the keys.

## Ignition switch

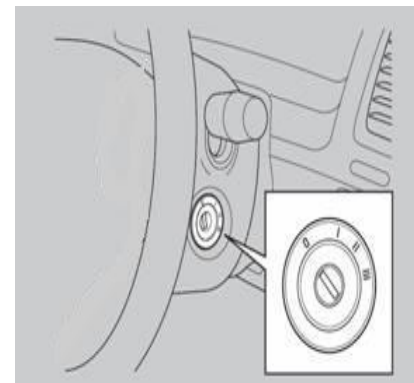

The ignition switch is located to the right for steering column. It has four positions:

1. LOCK (0)
2. ACCESSORY ( I )
3. ON ( II )
4. START ( III )



**LOCK (0)**—You can insert or remove the key only in this position. To turn the key from ACCESSORY (I) to LOCK (0), you must push the key in slightly. For a A/T vehicle, to remove the key, we suggest you put the shift lever in Park or neutral position. The parking lock will lock the steering wheel after you remove the key.

If the front wheels are turned, the anti-theft lock may make it difficult to turn the key from LOCK (0) to ACCESSORY (I). Firmly turn the steering wheel to the left or to the right as you turn the key

<b>Friendly tips</b>
<p>Do not remove the key from the ignition switch, otherwise the steering wheel will be locked and the vehicle may be out of control.</p> <p>Before removing the key from the ignition switch, make sure the car is stopped completely.</p> <p>ACCESSORY (I)—You can operate the audio system and the cigarette lighter.</p> <p>ON (II)—This is the normal key position when driving. Several of the indicators on the instrument panel come on to verify proper function when you turn the ignition switch from the ACCESSORY (I) to the ON (II) position.</p>

**START (III)**—Use this position only to start the engine. The switch returns to the ON (II) position when you let go of the key.

A reminder beeper sounds if the ignition switch is in the LOCK (0) or ACCESSORY (I) position when you open the driver's door. Remove the key from the ignition switch to turn off the beeper.

**Power door lock**

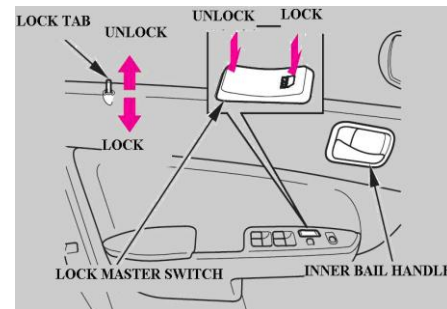

Each front door has a power door lock master switch. Either switch locks and unlocks all doors. Push the top of the switch to lock all doors; push the bottom of switch to unlock them.

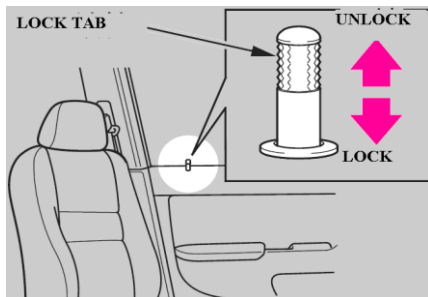

Each door has a lock tab on it. Push down the tab to lock the door and pull it up to unlock. When you push down the tab on the driver's door, all doors will be locked. While pulling the tab on the driver's door can only open the driver's door. The tab on the passenger' door only can lock or open the corresponding door.

#### Automatic locking

The lock tab of 4 doors will be locked automatically when the speed is over 20 km/h. and they will be unlocked when the engine is shut down.

To lock any passenger door, push down the tab and close the door. To lock the driver's door, remove the key from the ignition

switch, push down the tab or push the top of main switch, then close the door.

All doors can be locked from the outside by using the key in the driver's door.

Turn the key counter-clockwise and release, all doors will be locked, and the security system will also be active. All exterior turning signal lights and 2 turning signal indicators on the instrument panel will flash 3 times.

If turn the key counter-clockwise for a second time and hold over 2 seconds, glasses of the 4 doors will raise automatically until you release the key.

To unlock only the driver's door, insert the key, turn it clockwise, and release it. Turning the key clockwise for the second time can unlock all doors. If turn the key clockwise and hold over 2 seconds, 4 door glasses will drop automatically until you release the key.

Security system can be deactivated by open the driver's door using remote controller or keys.

#### Remote control

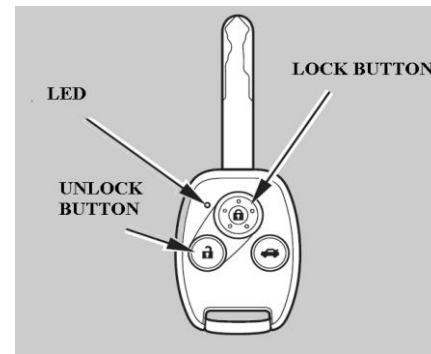

You can lock or unlock your vehicle by using the remote control transmitter. Press the Lock button once to lock all doors, and the security system will be active at the same time. The exterior turning signal lights and 2 interior turning indicators will flash 3 times.

Pressing the Unlock button once can unlock the driver's door. Pressing the button again can unlock other doors. The exterior turning signal and 2 turning indicator on the instrument panel will flash once when you press the unlock button once.

The front ceiling light (optional) and the rear ceiling light (if the ceiling light switch is in the position under door open status) will come on when you press the UNLOCK button. If you do not open any door, the light stays on for about 30 seconds, and then fades out. If you relock the doors with the remote transmitter before 30 seconds have elapsed, the light will go off immediately.

### Car searching function

After the vehicle's anti-theft function is active, if press the lock button, the enunciator will hoot once and the turning light will flash, which is helpful for you to find your vehicle.

You cannot lock the doors with the remote transmitter if they are not fully closed or the key is in the ignition switch.

If you unlock the doors with the remote transmitter, but do not open any of the doors within 30 seconds, the doors automatically relock. This function may failure because of magnetic field, vibration, foreign bodies, please do not depend on it intentionally.

Press the trunk release button for several seconds to open the trunk. You cannot open the trunk if the key is in the ignition switch.

### Replace cell

If it takes several presses on the button to lock or unlock the doors when battery runs low, replace the battery as soon as possible.

#### Battery type: CR2016

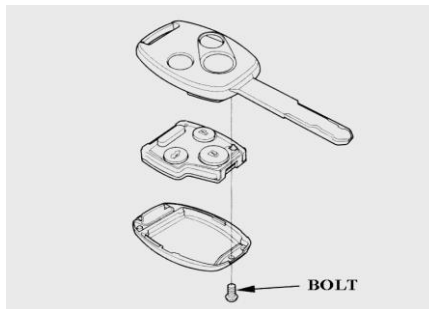

#### To replace the battery:

1. Remove the screw at the base of the transmitter with a small Phillips-head screwdriver.

2. Separate the transmitter from the middle with your fingernail.

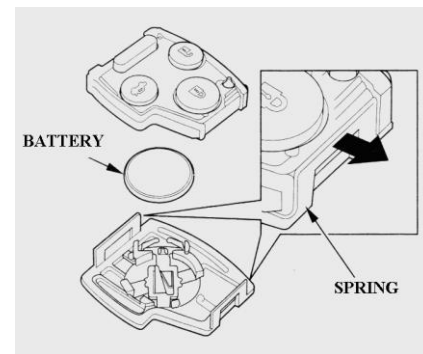

3. Separate the inner cover from the keypad by releasing the two springs on inside of the transmitter cover.

4. Remove the old battery from the back of the inner cover, and note the polarity. Make sure the polarity of the new battery is in the same position (+ side facing down), then insert it into the back of the cover.

5. Install the parts in reverse order.

## Regulations on Short Distance Transmitter

1. It is prohibited to change the emission frequency and increase the output power (do not allow install exterior amplifier).

Besides, user is not allowed to replace the transmitting antenna without approval.

2. This device can not produce interference with operating radio-communication. Once this kind interference is founded, the action of the device will be stopped until effective remedy measures are adopted

3. This ultra-low output power device must be able to stand against any interference received, including that generated by devices used in radio communication, industry, science, medical care, etc.

4. It is prohibited to use this kind radio device on airplane and around the aerodrome.

## Remote Control Maintenance

Avoid dropping or throwing the transmitter. Protect the transmitter from extreme temperature.

Wipe the remote transmitter with a soft cloth. Do not use the strong cleaning agent or impregnant, which may damage the shell of remote transmitter. Immersing the transmitter in any liquid may damage it so that its function is abnormal.

If you lose a transmitter, the replacement one needs to be reprogrammed by your dealer. Backup remote transmitters must be reprogrammed too.

## Childproof Lock

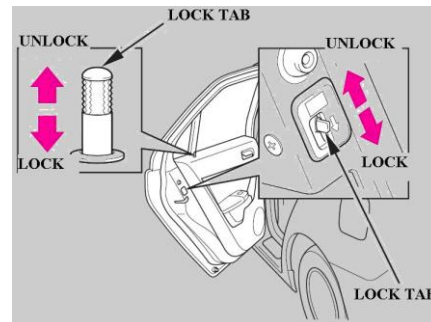

The childproof door locks are designed to prevent children in the rear seats from accidentally opening the rear doors. Each rear door has a lock lever on the flank. When the lock lever is pushed down, the door can not be opened from the inside regardless of the position of the lock tab. To open the door, pull the lock tab up, and use the outside door handle.

## Trunk

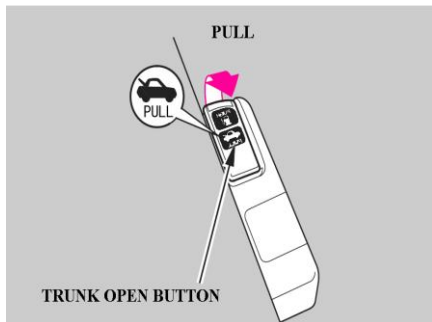

You can open the trunk in either of the follow ways:

1. Pull up the release lever of trunk on the left side of driver's seat.
2. Press and hold the trunk release button on the remote transmitter.

To close the trunk, press down the trunk lid. Refer to 82<sup>nd</sup> page for cargo loading and weight limit information. Keep the trunk lid closed at all times while driving to avoid damaging the lid, and to prevent exhaust gas from getting into the interior. See Carbon Monoxide Hazard on 19<sup>th</sup> page.

## Glove box

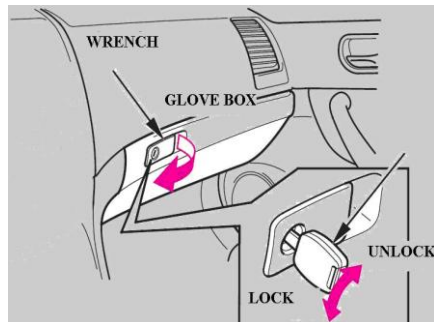

Pull the handle to left to open the glove box. Push it forcibly to close it. Also you can lock or unlock the glove box by using the ignition key.

The floodlight of glove box only comes on with the lamplet turned on.

### Friendly tips

Open glove box may bring serious hurt to the passengers in accident, even the passenger wear seat belts. Make sure to close the glove box in driving.

## Seat Adjustment

### Front Seat Manual Adjustment

You should complete all adjustment of the seats before you start driving. When the seat is adjusted to the desired position, try to move the seat backward to make sure it is locked in place.

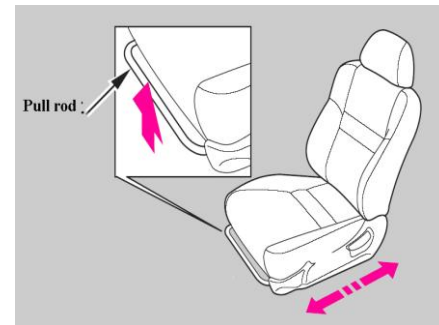

To adjust the seat forward and backward, pull up on the lever at the right bottom of the seat cushion's front edge. Move the seat to the desired position and release the lever. Try to move the seat to make sure it is locked in place.

### Manual Adjustment of Driver Seat Height

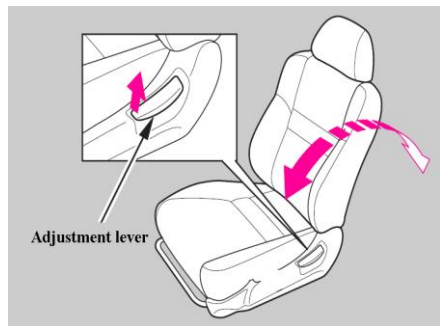

To change the seat-back angle, pull up on the lever on the outside of the seat bottom, move the seat-back to the desired position and release the lever. Make the seat-back locked in place.



Driver's seat can be adjusted, to raise or lower the seat, rotate the button forward or downward.

### Power Adjustment of Driver Seat (optional)

There are two electromotor adjustment switches. The level switch can adjust the bottom of the seat in several directions. The short vertical switch can adjust the seat-back angle.

You can adjust the position of the seats no matter the ignition switch is in which position. You should complete the adjustment of the seats before you start driving.

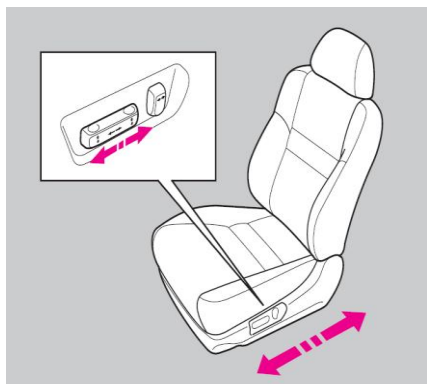

Pushing the level switch forward or backward can move the seat forward and backward.

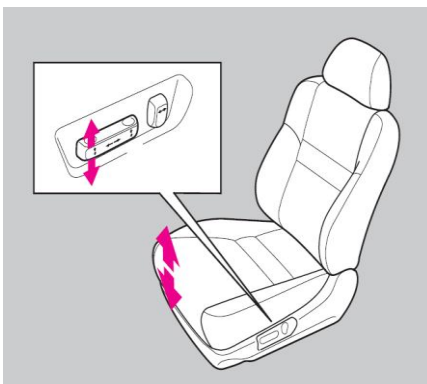

Pulling up or pressing the front of the switch can move the front part of the seat up or down.

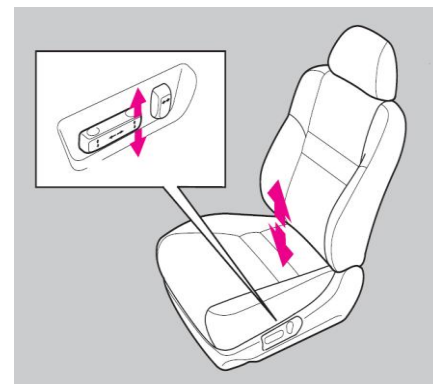

Pulling up or pressing the rear part of the switch can lift up or lower down the rear part of the seat.

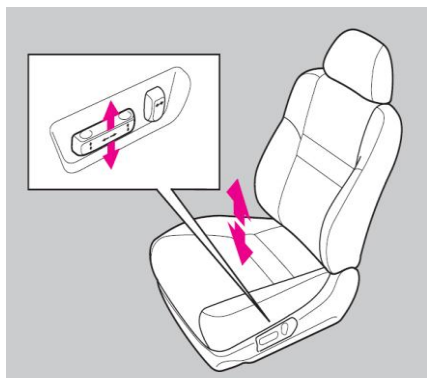
**Driver      Waist      Support  
(optional)**

Pulling up or pressing the middle of the switch can lift up or lower down the middle of the seat.

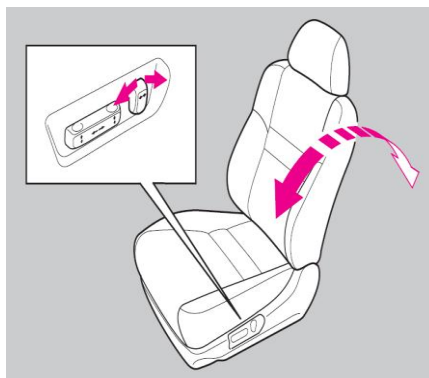

Pushing the rear switch along the direction of the seat-back can adjust the seat-back angle.

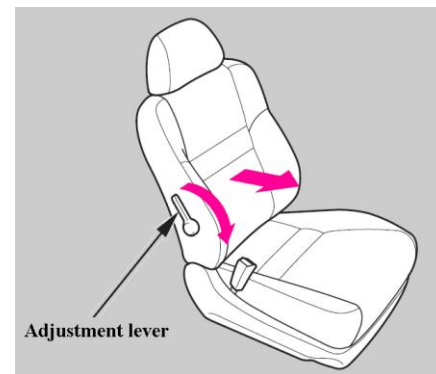

To change the waist support, move the lever on the right side of the seat-back forward or backward. Keep moving the lever forward or backward until you find a suitable position.



## Head rest

The front seats of your vehicle are equipped with adjustable headrest.

Headrest can protect you and your passengers from injuries to neck and other parts of head. They are most effective when you adjust them so the back of the occupant's head rests against the center of the rest. Tall people should adjust the headrest higher.

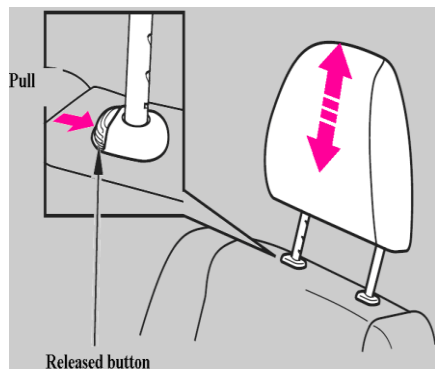

The height of front headrest is adjustable.

You need both hands to adjust it. Do not attempt to adjust it while driving. To raise it, pull upward. To lower the rest, push the release button and push the headrest down.

## Rear seat armrest

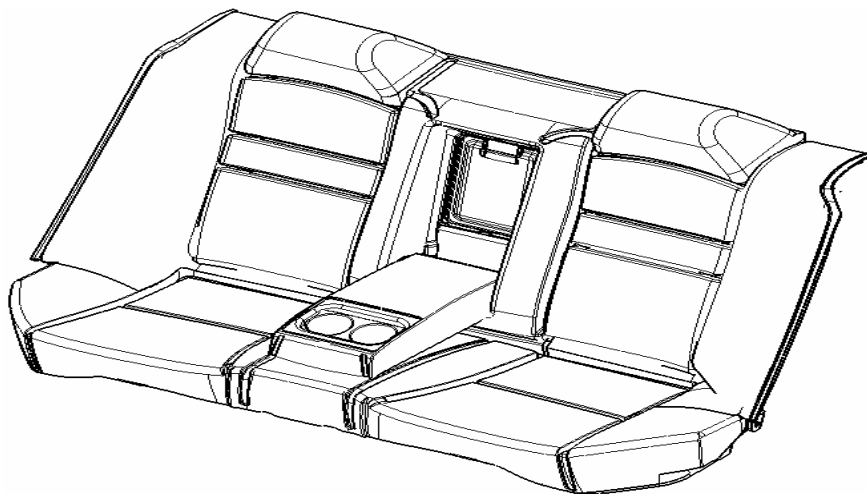

Rear seat armrest lies in the center of rear seats. When it is needed, please put it down. Open the cover of trunk from the inner of

vehicle, which is folded on the center armrest. To open it, lift it by hands and pull it.

Ensure that stuff in the trunk or the stuff which stretch from the placket to the rear seat is fixed stably.

Don't drive the car when the passage cap of trunk as well as the trunk lid is opened.

Please refer to 21<sup>st</sup> page about the danger of carbon monoxide.

## Seat Heating Device (optional)

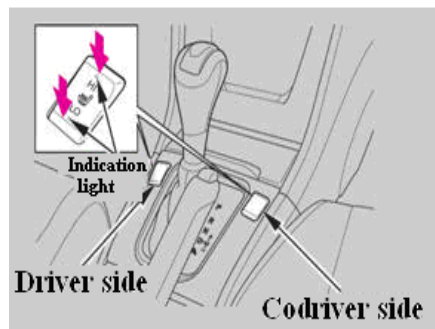

Both front seats are equipped with seat heating device. The ignition switch must be in the ON (II) position to use the seat heater. Press the top of heater switch to choose the HI and make the seat's temperature increase quickly. After the seat reaches a comfortable temperature, select the LO by pushing the bottom of the heater switch. This will keep the seat warm.

When heating, the HI or LO indicator will remain on until you press the opposite side of the switch to stop heating.

In HI, the heater will be turned off when the seat gets warm; and be turned on again after the seat temperature drops. This process will repeat if only in HI.. The HI indicator also remains on to remind you the heating device is in HI.

In LO, the heating device will continue to heat up the seat, and don't change with the temperature.

Follow these precautions whenever you use the seat heaters:

1. Use the HI heat setting only when you want to heat the seats quickly, when the seat gets warm, select the LO, Because HI consumes large amount of current from the battery.
2. If the engine is left idling for an extended period, don't use the heater even on the LO setting, as it can weaken the battery, causing failure to start up engine.

## Power window

The car is equipped with the power window. Turn the ignition switch to ON (II) position to raise or lower any window.

Each door is equipped with a control switch. To open the window, push the switch down and hold it. Release it when you want to stop the window. Pull the switch upwards and hold it to close the window.

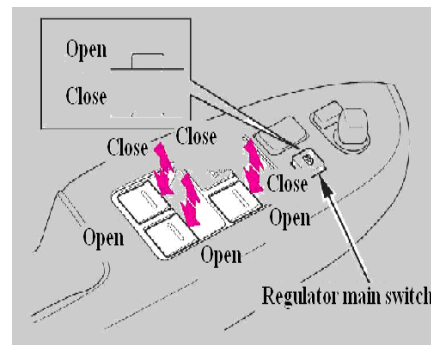

There is a main control panel of the power windows on the armrest of driver's door. There are two ways to open driver's

window: push the related switch one step downward and hold it, release it until the window gets to the desired position; or you can push the related switch two steps downwards and the window will lower down until it is fully open. To open any passenger's side window, push down the related switch and hold it, release it until the window gets to the desired position; to close the window, pull back the switch, release it until the window get to the desired position.

The main switch of glass regulator can control the window of passenger side as well as the both rear doors: push the switch, then the three windows are locked; push it again, the three windows can raise or lower freely.

The power window system has delay function. The window will still operate for up to 10 minutes after you turn off the ignition switch. Opening either front door can cancel the delay function, in which case, you must turn the ignition switch to ON (II) position before you need to raise or lower the window.

**Caution:**

When a closing power window clamps your hand or fingers, it can cause serious injury. Make sure the passengers' hands are away from the power window before closing the window.

**Caution:**

Take the ignition key with you while you or other passengers leave the car.

The light in the switch will be on while you turn the ignition switch to ON (II) position.

### Power Sunroof (optional)

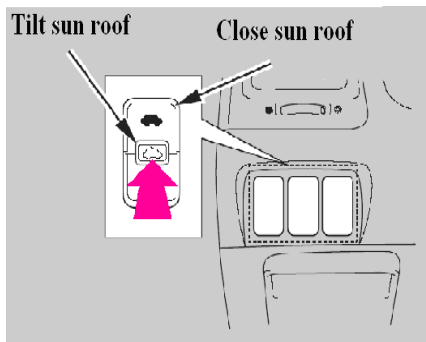

The sun roof has two positions: it can be tilted up in the back for the ventilation or it can be slid back into the roof. Use the switch under the dashboard vent to operate the sun roof. The ignition switch must be in the ON (II) position.

To tilt up the back of sun roof, press and

hold the center switch (  ); to close the sun roof, press and hold the upper

switch (  ); To open the whole sun

roof, press and hold the lower switch

(  ). Release the switch when the sun roof gets to the desired position. Make sure everyone's hands are away from the sun roof before opening or closing it.

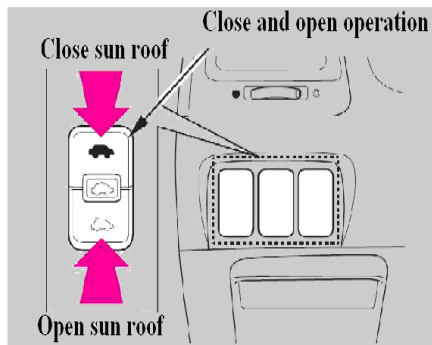
**Caution:**

Opening or closing the sun roof on the someone's hands or fingers can cause serious injury.

Make sure everyone's hands or fingers are away from the sun roof before opening or closing the sun roof.

The sun roof has the key-off delay function. The function can cancel when you open either front door. You must turn the ignition switch to the ON (II) position to operate the sun roof.

**Notice**

If you attempt to open the sun roof in the below-freezing temperature, or when it is covered with the snow or ice. The sun roof or motor may be damaged.

**Friendly tips**

Take the ignition key with you while you or other passengers leave the car. Putting the head, hands or other body parts outside the sun roof can cause serious injury or death while driving.

**Backing Radar (optional)**

When backing the car, the backup radar system reminds the driver about the distance between the car and obstacles through the indicator and buzzer. The system detects the obstacles by the sensor.

When the ignition key is in the ON position and shifting gear lever in the reverse gear position, the indicator OP is bright, buzzer sounds for  $1.0 \pm 0.3$  seconds to show system is normal and is working.

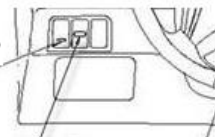
**Backup radar switch**

Open: Press in the switch.

The indicator is bright and buzzer sounds.

Close: Press switch again.

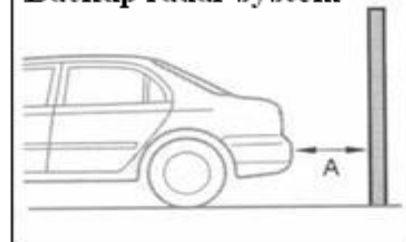
**Backup radar system**

The system prompts drivers the distance between vehicles and obstacles by indicator and buzzer.

A Distance (mm)	Indicator	Buzzer
About 1,200-800	Flash	Intermittently buzz
About 800-400	Flash	Quickly intermittently buzz
About 400 or less than 400	ON	Continuously buzz

**Detecting Range**

The detecting range of the sensor is about 1,200mm.

Notice: The detecting area is limited, so you must check the surrounding before driving and get vehicle started slowly.

Don't affix anything on the sensor. Otherwise, maybe the system doesn't work normally and cause unexpected accident.

**Hint**

In the following circumstances, the system may not work normally.

- There are something on the sensor, for example: ice, snow and mud and so on.
- The vehicle has parked in very high or low temperature for a long time.
- The vehicle is driven on road which is muddy, rugged or in deep grass.
- The vehicle is near the object which can eradiate ultrasonic. For example: horn or motor of motorcycle and so on.
- Driving the car in heavy rain or when water spatters on the vehicle.
- Dual channel wireless antenna or buffer is installed.
- The center of gravity is acclivitous.

- Shield the sensor by hands
- The vehicle is too near to the object.
- Knock the sensor badly.

The system also doesn't work normally when the vehicle is near the following objects.

- Metal lead wire, cord or very thin objects
- Cotton, snowflake or absorbent objects
- Smaller objects
- Objects with sharp edges

- High and protuberant objects.

Please contact the BYD authorized service station for a check at the following status.

- The bumpers are destroyed or sunken.
- The indicator continuously keeps ON but the buzzer doesn't buzz.

**Interior Power Rearview Mirror**

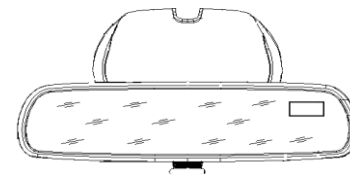

Keep the exterior and interior rearview mirror clear, and make them provide the best vision angle. Adjust them, if required, before driving.

It has two modes, day and night. It can reduce the glare from back vehicle at night. To change the mode, pull the convex tongue at the edge of rearview mirror bottom.

The methods and steps to adjust interior rearview mirror:

1. Before adjusting, pay attention for the following three points: When the direction displayed by the interior rear view mirror is the vehicle head direction, the state is called normal display status. Under adjusting, the words displayed by the interior rearview mirror is only to give you a tip, not meaning it is in the vehicle head direction, the state is called adjusting display state:

You'd better use the clip:

When adjusting, you should choose a square, closed-loop street or an annular roadway (turnplate), and confirm the east, south, west and north (as in the illustration).

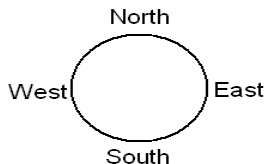

**2. Adjusting steps:**

The first step: start the vehicle, the words will be displayed in the top right corner of interior rearview mirror, the word may be

one of east, west, south, north, northwest, southwest, northeast and southeast.

The second step: Choose the start direction. It can be one of east, west, south and north.

The third step: Use clip to press the "OK" button on the back of rear view mirror to enter into adjusting state.

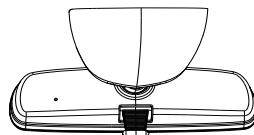

The screen will appear "north" and flash for two times, and then stop.

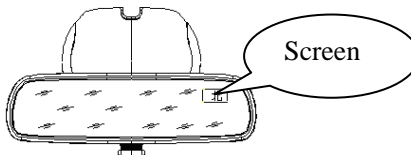

The fourth step: Drive the car for two circles at a slow speed, less than 8Km/h (notice: when driving, you can't make the car flameout).

The fifth step: Adjusting vehicle head make it point to south. Press the "OK", and the screen appear the "south", then press the "OK" again.

If "south" appears and flash for two times, then stop, the adjusting is finished. It will automatically quit the adjusting state and enter into normal state.

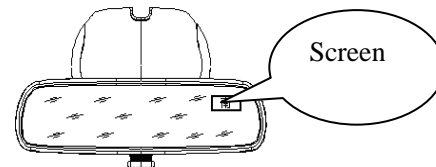

If not, the second times you press "OK" and "west" appears, you should firstly flameout, and repeat adjustment from the first step. If it displays other words, it is not necessary to flameout, you can repeat adjustment from the second step.

The sixth step: Test. After finishing the adjustment, drive the car for a circle to test whether the displayed direction is right. If it is wrong, then repeat adjustment from the first step.

### Exterior Power Rearview Mirror Adjustment

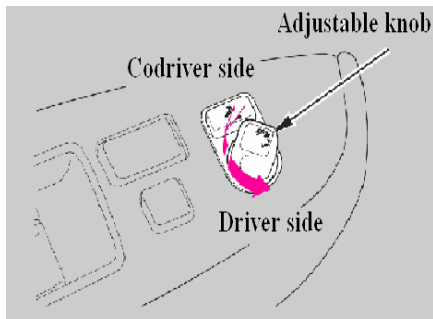

You can adjust the exterior rearview mirror through adjustable knob on the door armrest of driver side.

1. Turn the ignition switch to the ON (II) position.
2. Rotate the adjustable knob to the left (L) or right (R).

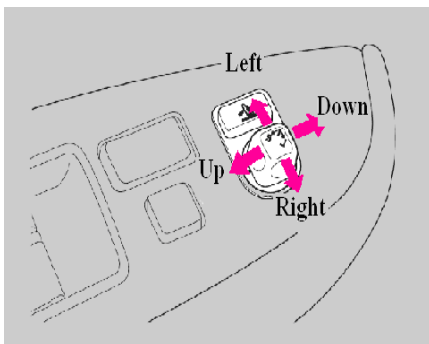

3. You can adjust the rearview mirror to the left, right, up or down by pushing the adjustable knob in the corresponding direction.
4. After finishing it, rotate the adjustable knob to the center (close) position. This can lock the adjustable knob to avoid touching the knob unconsciously and causing the angle of rearview mirror changed.

### Exterior Power Rearview Mirror Heater (optional)

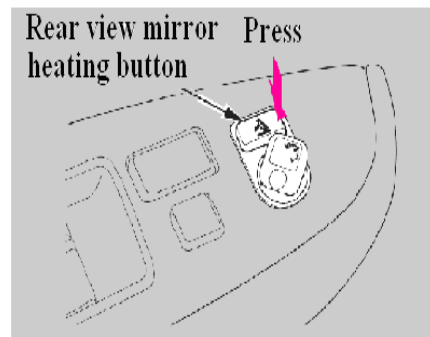

The exterior rearview mirror can be heat to eliminate the fog, ice or frost. When turning the ignition switch to the ON (II) position, press the button to turn on the heater. Here, the light on the button is on to remind. Press the button again to turn down the heater.

## Parking brake

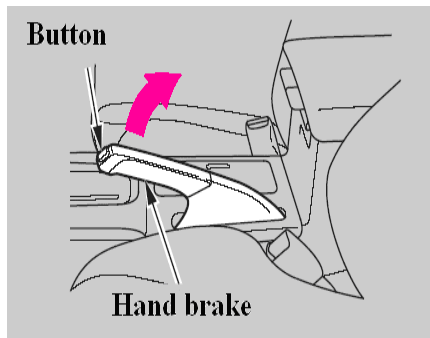

When using the hand brake, pull the lever upwards fully. When loosing it, firstly pull it upwards lightly, and then press the release button and put the hand brake down. The indicator light of braking system on the instrument panel will be automatically turned off when the hand brake is released fully.

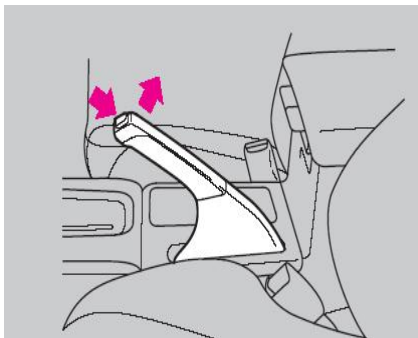

The buzzer will continuously buzz if you drive vehicle up to a speed when the hand brake is not released fully.

### Notice:

The brake, tire as well as axle will be damaged if you drive when the hand brake isn't loosed fully.

## Front Seat Armrest

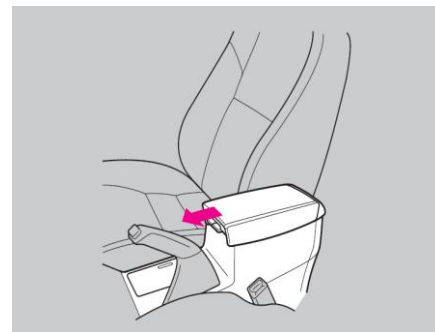

If you will take the storage box as the armrest, move it to the desired position.

Make sure the passenger's hands or fingers are safe before moving the armrest.



### Sunglass box

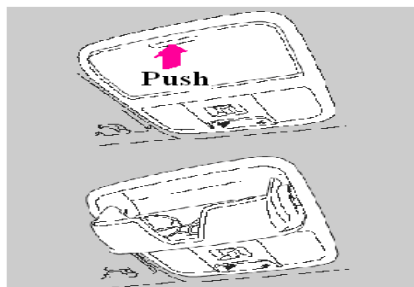

When opening the sunglasses box, press its front edge. The sunglasses box leaves the buckle and drops. When closing it, push it to the LOCK position. When driving, make sure the sunglasses box is closed tightly.

Some big size sunglasses can not be put into the box.

### CD Box

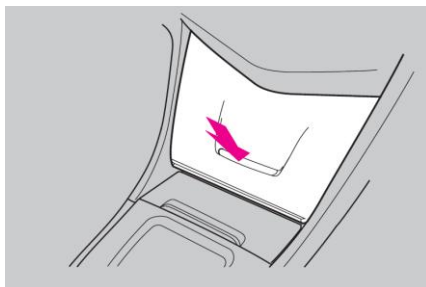

If you want to open the CD box, press the center of the box cover and make it leave the buckle, the box can be opened. When closing it, press the cover until it enters into the buckle.

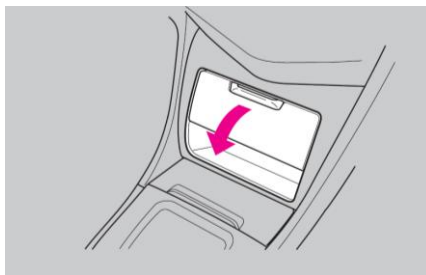

### Central Storage Box

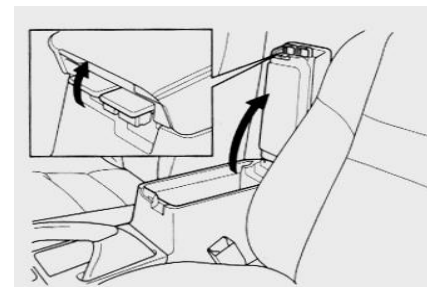

If you want to open the center storage box, lift up the right rod, and tilt up the armrest. When closing it, put it down and press it until it is locked.

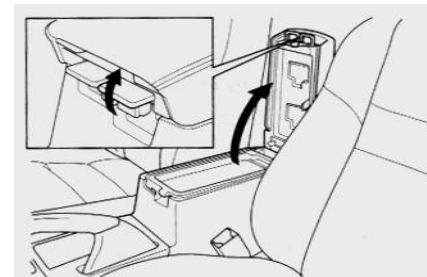

You can put some small objects into the groove of center storage box sleeve. When using the groove, pull the left rod and lift up the armrest cushion.

### Accessory Power Socket

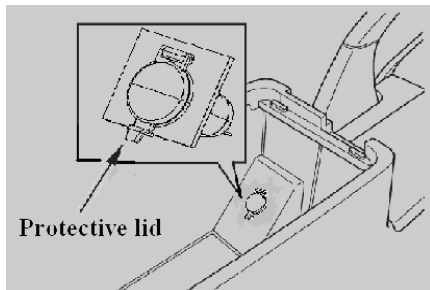

When using the accessory power socket, tilt up its cover and turn the ignition switch to the ACCESSORY ( I ) or ON ( II ) position.

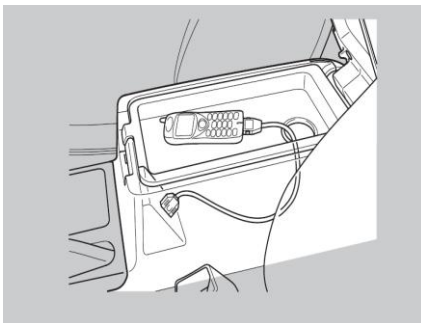

The socket is used to supply 12 volt DC power for the accessory that is rated 120 power or less. It can't supply power to the cigarette lighter.

### Cup Holder

Be careful when you are using the cup holder. A spilled liquid that is very hot may scald you or your passengers. Liquid can also spill from the door cup holder when you open or close the door. Use only closed containers in the cup holder.

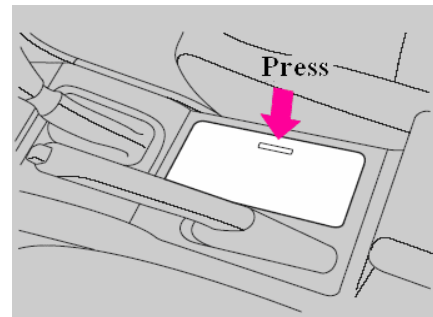

The cup holder for the front passengers lies in the center console.

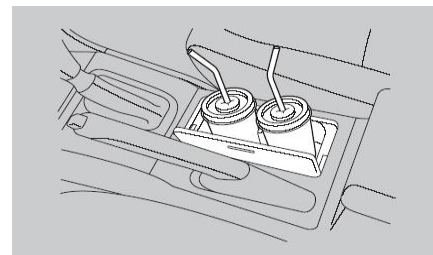

To use the front cup holder, press its cover, it will automatically open. To close it, press it until it enters the buckle.

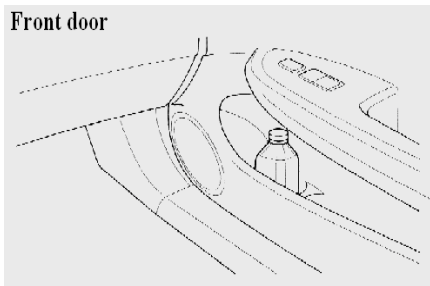
**Front door**

There are cup holders in the interior side of front and back doors.

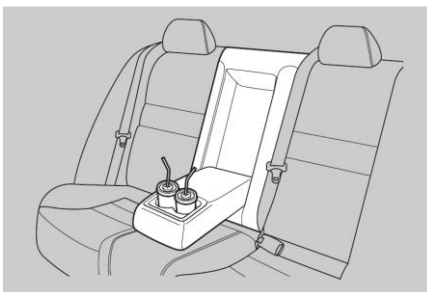
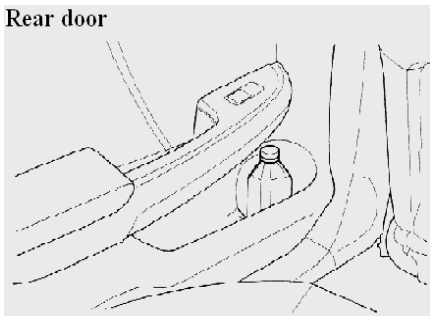
**Rear door**

There is also cup holder in the back seat. It is in the center armrest. To use it, put it down.

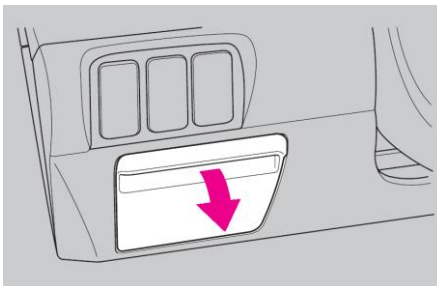
**Bill Box**

The bill box lies under of the vent. To open it, grab and pull its upper edge downwards. To close it, push it upwards.

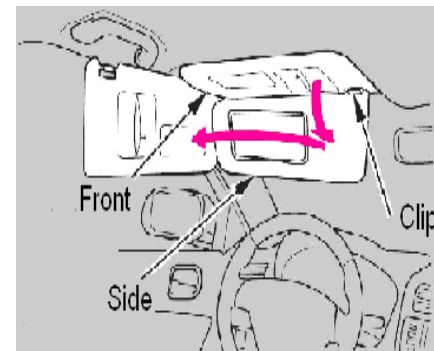
**Sun Visor**

To use a sun visor, pull it down. You can also use the sun visor for the side window: remove the support rod from the clip, and swing the sun visor toward side window. When you enter or leave the vehicle, make sure to put it back to the original place.

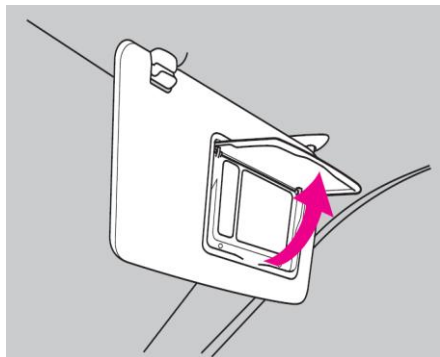
**Vanity Mirror(optional)**

To use the vanity mirror in the sun visor, open its cover.  
The vanity mirror lights will be turned on when you open its cover.

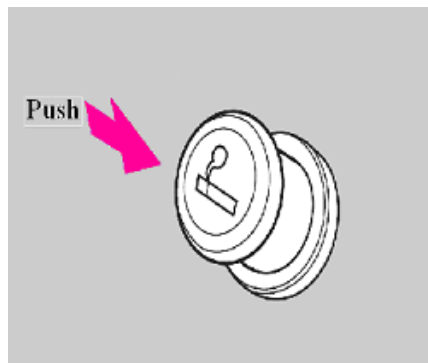
**Cigarette Lighter**

Only when turning the ignition switch to the ACCESSORY ( I ) or ON ( II ) position, the cigarette lighter can work. To heat it, push it in; it will be ejected automatically when it can be used. While heating, don't press it, or it will be overheated.

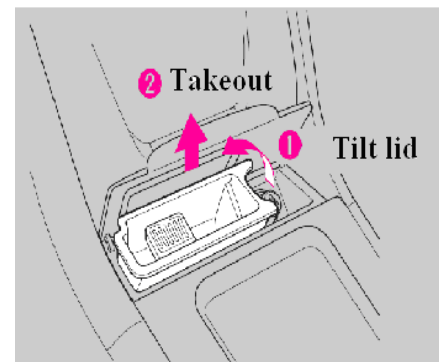
**Front Ashtray**

To open the ashtray, open its cover.  
To take out it for cleaning, firstly open its cover, then grab its right end and lift it.

## Rear Ashtray

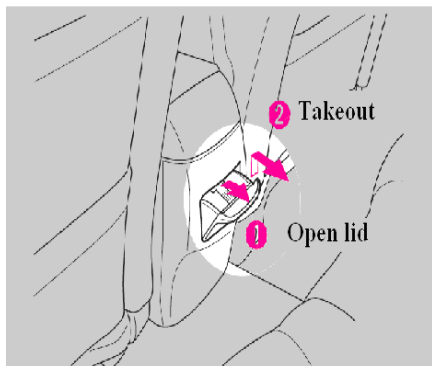

The rear ashtray lies in the back of the middle storage box. To use it, grab its top and pull down. To take out it to clean the ash, firstly open its cover, then lift.

Friendly tip
--------------

<p>The ashtray only can be used for smoking. To avoid fire that may damage the vehicle, don't put paper or burnable objects in the ashtray.</p>
---

## Interior Reading Light

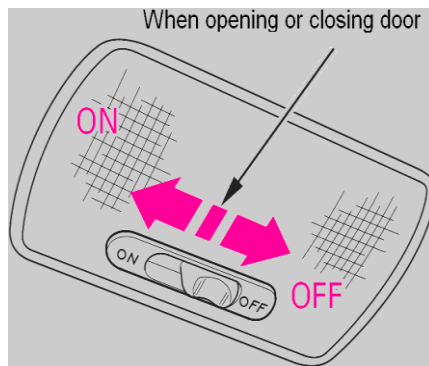

The rear interior lights have a three-position switch. In OFF, the light is not illuminated. In the middle position (that is to open a door), if opening any door, the top light is on; after closing all the door, the light will get dark gradually and go out. In ON, the top light will be always on.

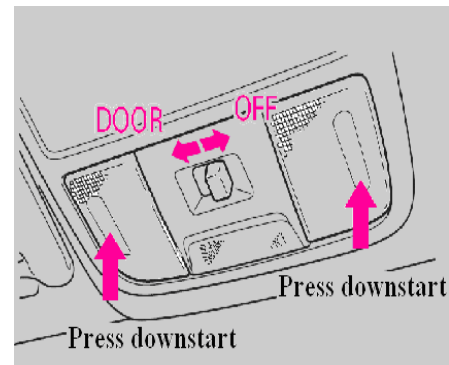

The front interior light has a two-position switch. In DOOR position, when all doors are closed, you can independently control the lights by the lens hood: push it, the light is on; push it again, the light is off. The light will remain on when you open any door. In OFF, the light is not on. You can independently control the lights by the lens hood: push it, the light is on; push it again, the light is off.

In DOOR, Pull out the key from ignition switch, the light is on. If no door is opened, it will extinguish gradually.

In DOOR, when you open the door by the key or remote transmitter (please refer to 27<sup>th</sup> page) the light will turn on. It will extinguish gradually after all doors are closed.

### **Door light**

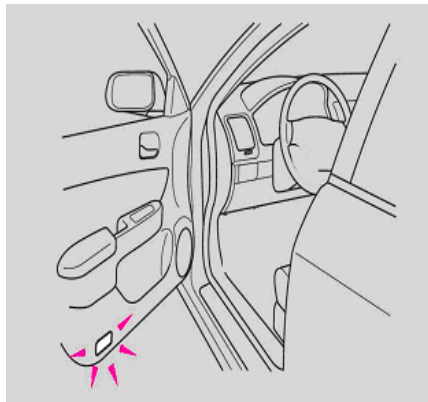

Every door has a door light, which is on when opening the door.

The ignition switch also has a spotlight. The Light will be on when opening the driver-side door. The light will extinguish gradually after closing the door.

### **Devices for Comfort and Convenience**

BYD AUTO is equipped with the interior air control system. It can supply comfortable drive condition to you in any climate.

Audio system has many features. We will introduce the performance as well as the use method in this section. (If you choose other audio system, please refer to the operation specification provided with the audio).

On vehicles equipped with the navigation system, you can operate the interior air control system and audio system by the navigation system. Please refer to the navigation system manual to get the detailed information.

### **Interior Air Control System**

The interior automatically air control system will match well with the interior temperature air conditioning, heating and ventilating settings. The system can be also used to adjust the fan rotational speed and volume of airflow.

The direction of airflow in central vent and the vents on both sides of instrument panel can be adjusted.

The interior air control system absorbs air through exterior air inlet under the windshield. You shall keep the inlet unblocked, preventing it from being blocked by the leaves and sand.

For making the interior air control system supply cooled or heated air, the engine should be running.

## Central Air Outlet

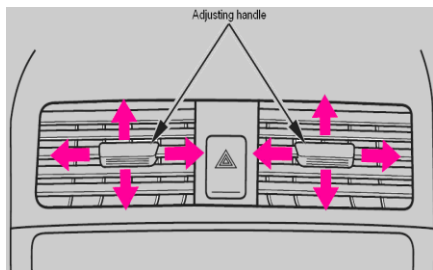

To adjust the direction of the center vent airflow, pull the adjusting handle up, down, right or left.

## Side Air Outlet (optional)

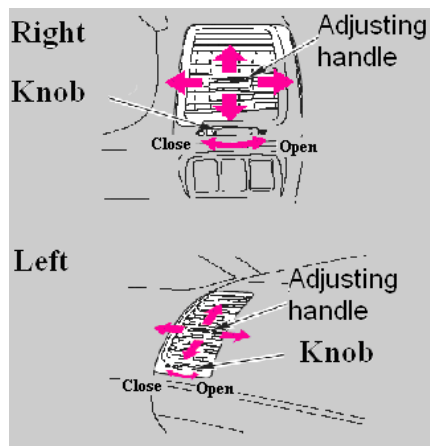

You can open or close the air outlet through the rotary knob under the side air outlet.

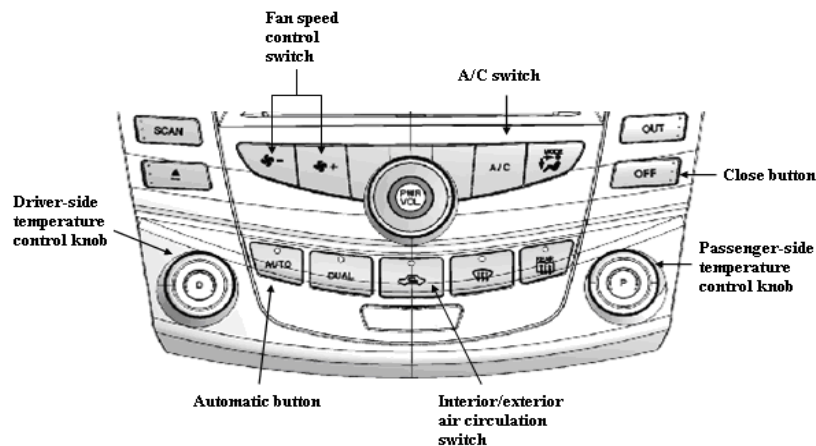

### Full-automatic mode operation

Set the interior air control to the full-automatic mode, press the AUTO button, and then rotate the temperature control knob of driver side to set it to the desired temperature.

The system display will show the "AUTO".

The system will automatically mix the adjusted or heated air properly. This can make the temperature raise or lower to the setting temperature rapidly.

When the temperature is set to (LO) or (HI), the system works only under full cooling or full heating mode, and can't control the interior temperature.

When the temperature is setted between (LO) and (HI), the temperature can be controlled to set temperature.

### OFF button

Press the (OFF) button, and the interior air control system is closed fully. For avoiding the poor and moldy air cumulation, you should often keep the fan working.

### Semi-automatic mode operation

In FULL AUTO, you can choose all function of interior air control system manually while keeping the other functions under automatic control. Any manual selection will make the "AUTO" disappear.

### A/C switch

Press the A/C button to turn the air condition on or off. The display shows "A/C ON" or "A/C OFF".

When the A/C is off, the system can't control interior temperature when you set the temperature to be below the exterior temperature by the knob, when the A/C is on, you can adjust the temperature to a comfortable setting value by the temperature control knob.



**Interior/exterior air circulation switch**

The switch controls the air headstream entering into the system. When the circulation indicator is on, the air from the interior is circulated in vehicle again (interior circulation mode). When the indicator is off, the air will be brought in from the outside of vehicle (fresh air mode, or external circulation mode).

For example, when the vehicle passes the area full of dust, you can set the system to interior circulation mode manually.

**Fan speed control button**

Press fan speed control button, you can choose the fan speed manually. Press ▲ to increase the speed; and press ▼ to lower the speed.

**DUAL zone control switch**

Press DUAL button (the button indicator is on), you can choose the dual temperature control mode (please refer to 66th page).

Press the DUAL button again (the indicator is off), adjust the temperature at both sides by rotating the temperature control knob of driver side.

**Mode button**

Choose the airflow direction by the (MODE) button. No matter under what mode, there is always air brought in from the vent at corner of instrument panel. Close it by the knob under the every air outlet. The display shows the mode chosen whenever pressing the (MODE) button. Press the button four times, all the modes will be displayed one by one.

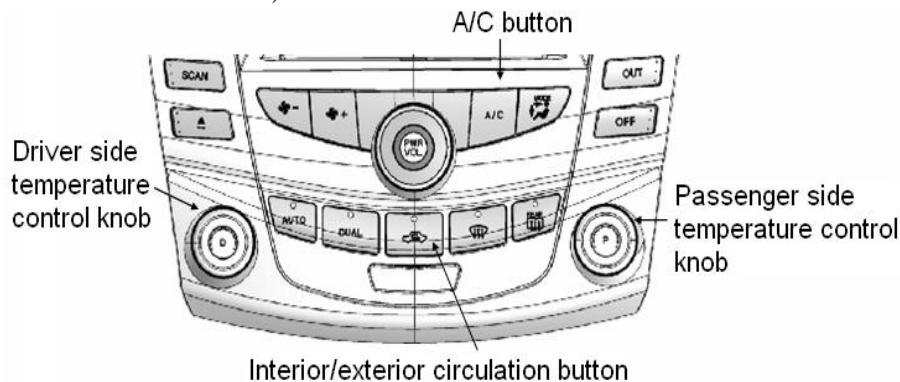

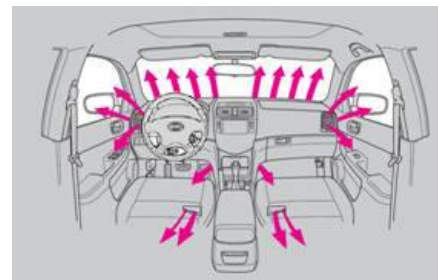
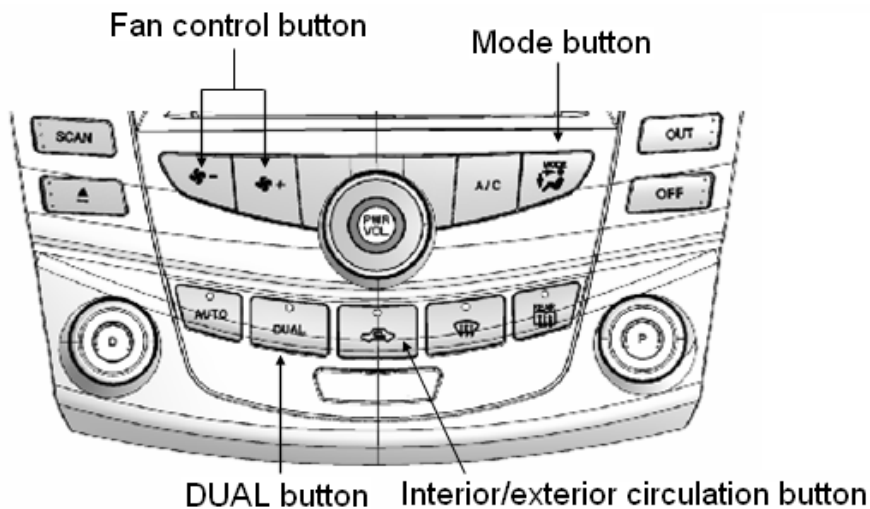

↓ Airflow from floor vents.

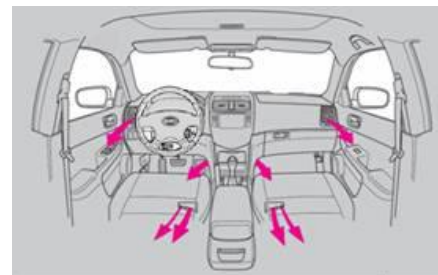

↓ Airflow is divided between the vents in the dashboard and the floor vents.

→ Airflow from the dashboard vents

Airflow is divided into the floor vents and the defroster vents at the base of windshield.

**Front windshield defroster switch**

Guide the main airflow to the windshield to defrost quickly. No matter what mode you

choose, the mode associated with  button is priority.

When choosing  mode, the air condition will automatically work, the system will choose the fresh air mode. For quick defrosting, set the fan to high speed manually. The airflow to the windshield can be increased by closing the vent by the side of instrument panel.

Press the button again to close  mode, the system will return to the original setting.

**Rear windshield defroster switch**

The button can open or close the rear windshield defroster.

**Outdoor temperature display button (OUT)**

Although the interior air control system is opened or no, press the button, and the display of passenger side will show the current outdoor temperature.

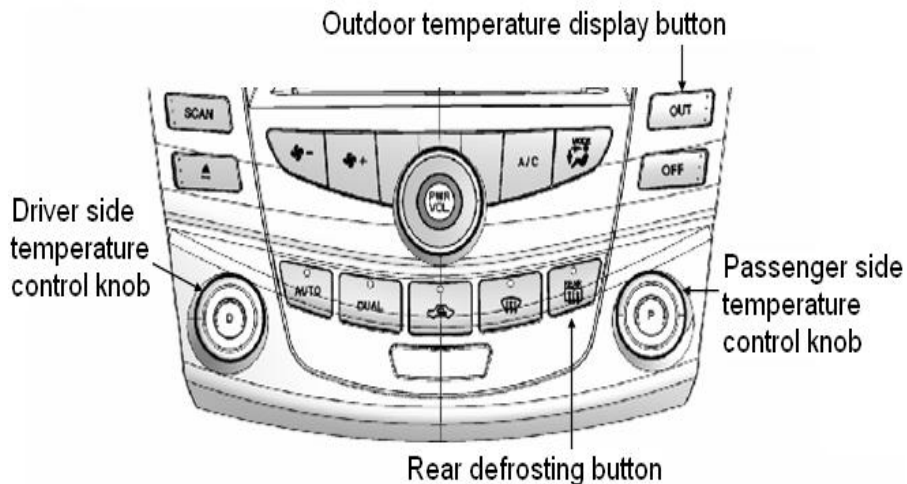

### Independent Temperature Control

There are two knobs to control temperature in the vehicle, one for the driver, the other for passengers. When the green indicator on DUAL (independent control) button is on, it is allowed to independently adjust the temperature of driver side and passenger side by rotating the related knob.

### Temperature control button

Press the fan, air condition, automatic or



button, the display will show the setting temperature. When the indicator of DUAL button is out, rotate the temperature control knob of driver side to adjust the temperature on both sides to the same level.

To make the driver side temperature different from the passenger's side temperature, press the DUAL button and rotate the control knob of the driver side. To make the passenger's side temperature different from the driver side temperature, only rotate the passenger's side knob.

Notice: The indicator of the DUAL button will be automatically on when rotating the passenger side temperature control knob.

### Sunlight illumination sensor/indoor temperature sensor

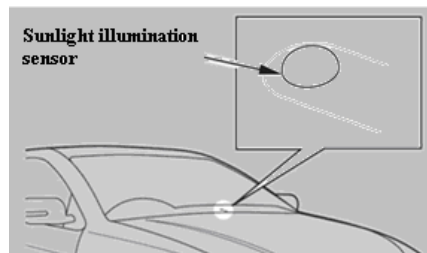

Sunlight illumination sensor lies in the top of the instrument panel. Indoor temperature sensor is beside the steering column. Don't shield the sensor, or spill any liquid on it.

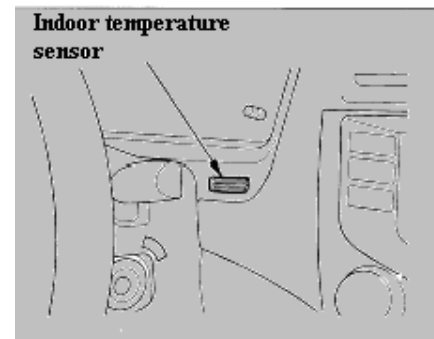

## Audio system (optional)

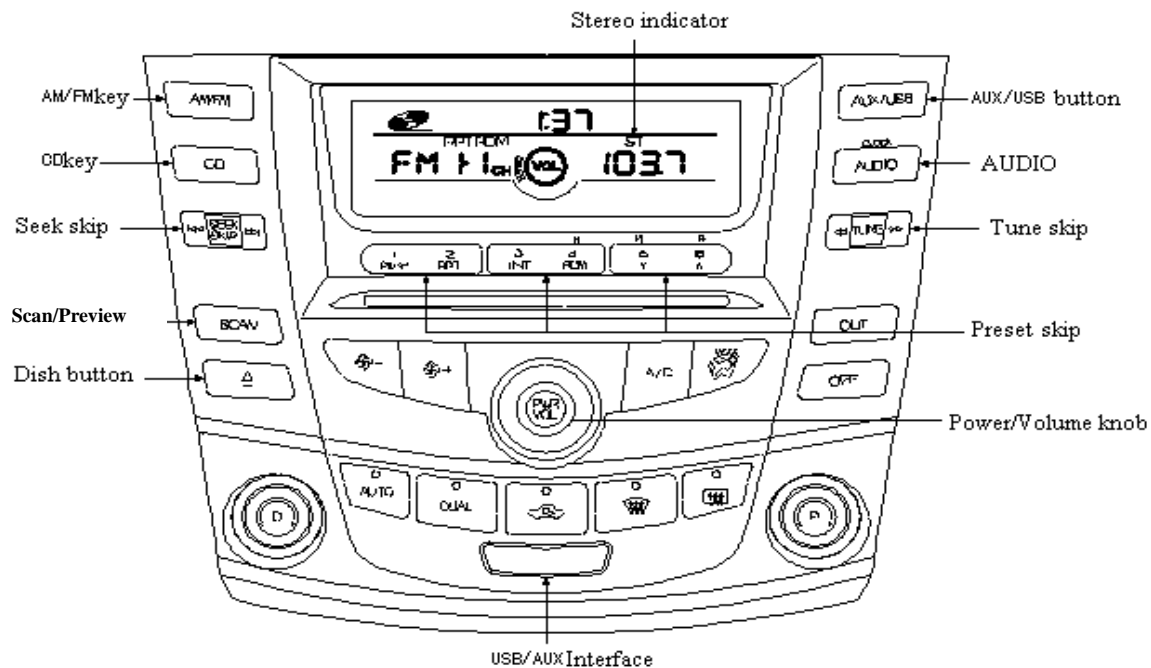

### Audio system

#### AM / FM

The audio system can receive the AM and FM radio. You can expediently choose the favorite broadcasting station through the preset bar.



### Radio operation



You can operate the radio only when the ignition switch is on the ACCESSORY ( I ) or ON ( II ) position. Turn the system on by pressing the (PWR / VOL) knob or AM / FM button, rotate the (PWR / VOL) knob to adjust the volume.

The bands and frequency that was last tuned will be displayed. To change the bands, press the AM / FM button. Press the button every time, the band will cycle from the M1 to FM2, FM3, AM1, AM2 mode. On the FM band, ST will be displayed at stereo station. The ST will flash if the car is in the area with weak signal. Stereo radio on AM is not available.

### Channel selection

You can use any of five methods to find radio station on the selected band: TUNE, SEEK, SCAN, AUTO SELECT & SAVE (long press SCAN) and the preset bar.

**TUNE**— Use the **TUNE** bar to tune the radio to the desired frequency. Press  side of TUNE bar to tune to a higher frequency, press  side of the TUNE bar to tune to a lower frequency. When tuning, the frequency reading will quickly change. Loose the bar when the desired frequency is displayed. To micro-adjusting the frequency, press the TUNE bar.

**SEEK**—The seek function searches for a station with strong signal across a band. To activate it, press the  or  side of the SEEK bar, and then release it. The system will scan up or down from the current frequency according to the pressed side. It will stop to search when finding a station with strong signal.

**SCAN**—The scan function give sample play of all saved stations on the selected band. To activate it, press the scan button, and then release it. The SCAN will be displayed. The system will play each saved stations for 5 seconds. If you don't make any operation, the next station will be played; when the station desired is played, you can press the scan button again to listen to it.

**Preset**—You can save frequency of preferred stations on theses three preset bars. Each end of bar (1-6) can save two AM frequencies (AM1, AM2), and three FM frequencies (FM1, FM2, FM3).

### Save frequency in following steps:

1. Select the desired band (AM or FM).
2. Use the TUNE, SEEK or SCAN function to tune the radio to a desired station.
3. Pick the preset number (1~6) for that station. Press the left or right side of the bar for several seconds, the station can be stored to the related number.
4. Repeat the steps 1 through 3, you can save a total of 12 AM stations and 18 FM stations.

Once the station is stored, you can press the left or right side of preset bar to listen to it.

The frequency will be lost if the battery is discharged or disconnected, or the radio fuse is taken out.

**AUTO SELECT & SAVE (Hold SCAN)**—Press SCAN for 2 seconds, the system will search the station and store it on FM1, FM2, FM3 or AM1, AM2. To activate it, long press the SCAN button. Then the SCAN is displayed in flashing. The preset bar (1~6) can store 12 stations on AM and 18 stations on FM, then you can use the preset bar (1~6) to choose the preset station.

If you don't like the frequency AUTO SELECT & SAVE has stored, you can store other frequency on the preset bars. Use the TUNE, SEEK or SCAN function to search desired frequency and store the frequency to preset bars as described above.

## Audio adjustment

The BAS, TRE, BAL and FAD can be adjusted.

Press AUDIO, choose the desired mode. Press the AUDIO repeatedly, the mode can change in the order of BAS to TRE to BAL to FAD. When changing the mode, the related mode name will be displayed.

Volume balance (L-R/F-R) — these two modes adjust the strength of the sound coming from each speaker. BALANCE adjusts the left to right strength while the FADER adjusts the front to rear strength. Press AUDIO, to choose BALANCE OR FADER mode. Rotate the volume knob, the BALANCE OR FADER can be adjusted to desired degree. The displayed number is the current setting. It will display "0" when the volume reaches the center of range.

Alt/Bass—Use these modes to choose the desired tone. Press AUDIO, to choose TRE or BAS mode. Rotate volume knob to desired mode. The displayed number is the current set.

It will display the "0" when tune level reaches the center of range. Several seconds after you stop to operate the volume knob, the system will automatically return to and display the chosen mode.

### Electronic clock

The screen of audio system usually displays time when the ignition switch is on the ACCESSORY or ON.

To set up time, press AUDIO (CLOCK) for 2 second, after hearing reminding sound, it enters clock adjusting mode. Then hold the H (preset 4) of the bar until the hour number increases to the desired hour; hold M (presetting 5) until the minute number increases to desired minute.

Use the R (presetting 6), of the bar to set the time to the starting point of the nearest hour quickly. At the clock adjusting mode, press the R. If the time is the former half hour, press R to enact the time always to former one hour... If the time is rear half hour, press R to enact the time to the beginning of next hour.

For example:

1:06 will be enacted to 1:00

1:30 will be enacted to 2:00

1:52 will be enacted to 2:00

Before don't set the time or battery is disconnected, or anew charge after power exhausted, the display of time will always twinkle to remind to set the time.

### **USB/AUX input operation**

The system can play music of MP3 format in U disk through USB interface and play music through speaker-on board, and the music is from the input audio signal through AUX interface.

When inserting the connective device of USB, the system will automatic shift into USB mode, meanwhile play the music of MP3 format in the storage device. Like the CD music, you can make the operation PLAY/PAUSE, and so on.

When the earphone jack and AUX faucet which can connect the MP3 by data wire on board is shifted to AUX mode, the MP3 player will play music which can be heard.

### **Notice:**

1. Suggest using the data wire on board to connect the U disk to avoid causing possible

damage;

2. USB interface don't support a part of mobile hart disk whose compatibility is bad and the capacity of U disk exceed 1GB;

3. USB interface only supports music file of the FAT file system MP3 format;

4. USB interface mayn't support the USM store device whose compatibility is bad.

### **CD disc play**

To play the laser disc, must turn the laser disc to ACCESSORY ( I ) or ON ( II ).

The operation of laser phonograph is same with the radio. To choose the laser phonograph, press the CD button. The screen will display the "CD" & program number which is being played. The system will play the disc until you change the mode. Insert the laser disc into player. The driver will play the music. When finish the music, the system will anew play it.

### **Notice:**

The CD player only can play the normal CD format, can't play record disc compressed such as MP3 and WMA.

Don't use the disc which has the sticky label.

The label possibly makes the disc locked in the device.

Don't play the 8 cm (3 inch) disc. Only allow to play the round standard disc. The abnormal disc may be locked in the driver or cause the malfunction.

To get the best effect of CD-R, only use the advanced disc which has the label "be used in sound system", when transcribing the CD-R disc, the transcribing should be totally close, only this, the disc can be played in the laser phonograph. The device can't play the CD-RW disc.

When playing the disc, press AM / FM button, and can shift to radio mode. Press the CD button again, and can return to CD play mode, and the disc will begin to play from the last position.

When playing, using the (PWR / VOL) knob or closing the system by closing ignition switch, the disc will stay in driver.



Open the system once more, the phonograph will play from the last position. Press the quit button, take out the disc from the driver.

If the disc has been quit, don't take out the disc at once, after 10 seconds, the system will introduce the disc automatically. To play the disc, press the CD button.

When playing, use the (SEEK / SKIP) stripkey to choose the track and change the program. To quickly move the disc in the same program, press and hold the (SEEK / SKIP). Hold the ►► to rapidly move and hold the ◀◀ to rapidly move back. When getting to the desired position, you only need loose the stripkey.

Press the ►►, the system will play the next track on the disc. Press the ◀◀, the system will replay the track in play. Press it again, the system will play the last track. When playing the disc, use the function such as (REPEAT), (RANDOM PLAY) or (SCAN) and so on.

**SCAN**— when activating the function, sample all the tracks on the selected disc in the order they are recorded. To activate the function, press the (SCAN) button, choose scan mode. The screen will display the "SCAN". The system will play the first track for 10 seconds. If don't do any operation, the system will continuously sample the each selected track for 10 seconds. When search out of the track you want to enjoy, press the SCAN button again.

**REPEAT**—to activate the function, press the (RPT) button. You will see the "RPT" in the display to remind you. The system will continuously replay the current program. Press the button again to get out of the function.

**RANDOMPLAY**— after activate the function, the system will play not the recorded order on the disc but the random order. To play randomplay function, press the (RDM) button. You will see the "RDM" in the display. And the system will choose the random track. Keep the operation until you press the randomplay button again and quit the randomplay mode.

### The maintenance of laser disc

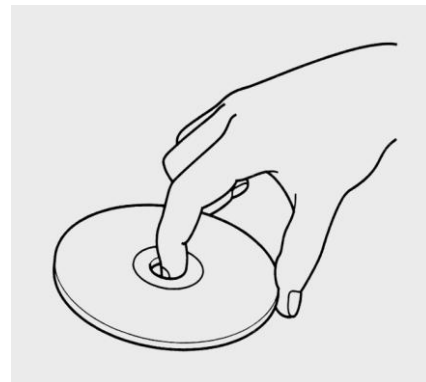

Hold its edge, and don't touch its up and down surface. Don't add the stable ring and paste the label on the disc. Don't leave the fingerprint and ink on the disc, or will not normally play the disc or the disc will be locked in the driver.

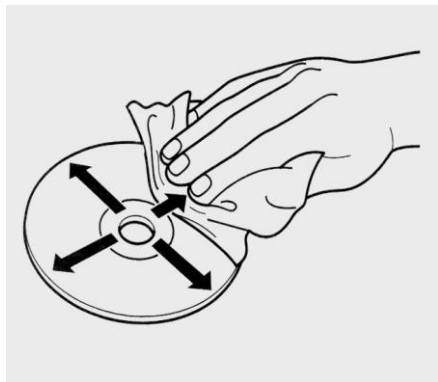

When don't use the laser disc, put it into box to avoid being polluted. To prevent distortion, should avoid the overheating and the sun directly shining.

When cleaning the disc, use the clean dishcloth from the center to edge.

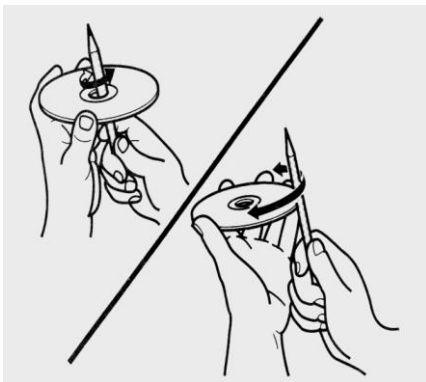

The inner and outer edge of the new laser disc is possibly some rough. The chipping of coarse edge will flake, if the chipping drop on the recorded face of disc will cause the skip or other malfunction. Use the side of pencil or pen rub the inner and outer edge to remove the chipping.

Don't insert eyewinker into the laser phonograph.

### Remote control of audio system (optional)

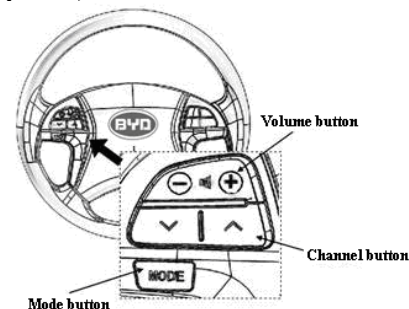

There are three buttons to set the radio system on the left side of steering wheel hub. These buttons can make you operate the radio system and your hands don't leave the steering wheel.

Volume button "+", "-" can adjust the volume. Hold the button "+", "-" and loose it until the volume get to the desired extent.

The (MODE) button can change the mode. Repeat to press the button, the system will circulate between the FM1, AM1 or disc playing (if have had the disc) or MP3 /WMV music playing (if the USB interface has been connected with the U disk) or the radio playing (if AUX interface has connected the player).

Channel button “√”“^” has the same function with “SEEK/SKIP” strip key. If you are listening to the radio, use the “^” button and can automatically search the next strong signal station; the “√” button can automatically search the last strong signal station.

If you are playing a record or contents of USB, short press the channel button “√” one time, and then the audio system will skip to the next track.

Once short press the channel button “^”,the audio system will skip to the current track. Short press again, it skips to the last track. And you will see the disc number and the track number in the display.

If it is playing the MP3 of USB, press the“^” to play the last track, press “√” to

play the next track.

If it is the AUX, the button has no effect.

## Safety system

The safety system can protect your vehicle and valuables from theft. When someone tries to enter into the vehicle, the buzzer will buzz, at the same time all buzzers will twinkle together, the buzzer will buzz for 30 seconds, and stop for 5 seconds, then buzz again. The longest time is 5 minutes. To anew set the warning system within 30 seconds, can use the remote control or key to open the side door of driver.

When locking all doors, engine hood and trunk after 15 seconds, the safety system will automatically set. Need use the key, lock bolt lock switch or remote control to start the safety system from the outer. Meanwhile the indicator light of safety system on the instrument panel will twinkle to show the safety system is self-setting.

## Indicator light of safety system

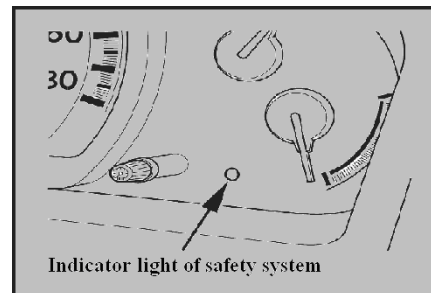

Once set the safety system, open any door (no use the remote control), engine hood or trunk, the safety system will send out the warning.

Even if the system has been set, you can still use the remote control to open the trunk, and it can't activate the warning. If the lock of trunk is unclenched or opened with the opening handle, the warning will sound.

When the engine hood, trunk or any door has not been closed, it will not be able to set the safety system. Before you leaving the vehicle, ensure the trunk, engine hood or all doors have been closed tightly.

Don't try to change the system or add other devices.

## Cruise control system

Cruise control system can keep the setting speed over 40 km/h and it isn't necessary to step the acceleration pedal. When driving on the erect and unblocked highway, you can use the function. Don't suggest using the function on the sinuous road, wet and slippery road, and rain day or at the condition of other bad climate as well as in the downtown. When encountering the condition, you should self-operate the vehicle.

### Friendly tips

Improperly using the cruise control system will be able to cause the accident.

Only use the cruise control system in the fine climate and on the unblocked highway.

## Start cruise control

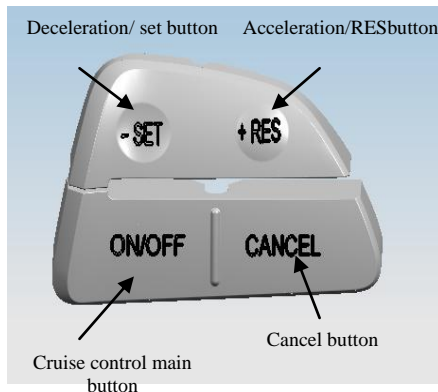

1. Press the cruise control main button (ON/OFF), the indicator light of cruise control system will be on.
2. Lift the speed to the desired speed (over 40 km/h).
3. Press the (-/SET) button, to start the cruise control system.

When you are going up and down a hill, the cruise control system can't hold the setting

speed. When the speed increase going down a hill. Use the brakes to slow down, this will cancel the cruise control. If need use the setting speed, press the (+/RES) button to automatically accelerate to set speed.

When you are going up a steep hill, automatic transmission will lower the gear to keep the setting speed.

## Change speed setting

Can increase the setting cruising speed in any of following ways:

1. Hold the (+/RES) button, vehicle will continuously accelerate, when reaching the desired speed, release the button.
2. Push the accelerator pedal, accelerate to the desired speed, press the (-/SET) button.
3. To increase the speed in very small amounts, repeat tap the (+/RES) button. Each time you do this, the vehicle will speed up about 1.6km/h.

You can decrease the setting cruising speed in any of following ways.

1. Hold the (-/SET) button, the speed will be decreased. When reaching desired speed, release the button.
2. Push the braking pedal lightly, when reaching to the desired speed (over 40km/h), press the (-/SET) button. The vehicle will keep the desired speed.
3. To decrease the speed in a small amounts, repeat tap the (-/SET) button. Each time you do this. Your vehicle will speed down about 1.6 km/h.

Even if the cruise control turned on, still use the accelerator pedal to speed up for passing. After passing, release the accelerator pedal, and the speed return to set cruising speed.

Resting your foot on the braking pedal will cancel the cruise control.

### **Cancel cruise control**

You can cancel the cruise control in any of following ways:

1. Push the braking pedal.
2. Press the (CANCEL) button on the steering wheel.
3. Press the cruise control master button (ON/OFF).
4. Shift the gear to N gear.

When press the (CANCEL) button or push braking pedal or clutch pedal, the vehicle will cancel the cruise control and begin to speed down. This time, you can use the accelerator pedal to control speed according to usual operation.

The system can store the setting cruising speed.

To return to the speed, firstly speed up to 40km/h and tap the (+/RES) button, the vehicle will speed up to set cruising speed.

Pressing the cruise control master button (ON/OFF) will totally close the system, and cancel the setting cursing speed. To use the system once more, please refer to the section of cruise control turning on.

## **Before driving**

Before you begin driving the vehicle, you should know what gasoline to use and how to check the levels of important fluids. You also need to know how to properly store luggage or packages. The information in this section will help you solve these problems. If you plan to add accessories to your vehicle, please read the information in this section first.

Running in period .....	74
Gasoline .....	74
Operation in petrol station.....	74
Open engine hood .....	75
Check engine oil .....	76
Check engine coolant.....	77
Fuel saving.....	78
Luggage carrying .....	78

## Running in period

During the first 1,000 kilometers, you should especially notice the method of driving. It's helpful to ensure the vehicle's future reliability and performance.

Notice the following proceedings during this period:

1. Avoid full-throttle starts and rapid acceleration.
2. Avoid hard braking. New braking system need running-in through properly use in the first 300 kilometers.
3. Do not change the oil until the schedule maintenance time or the driving mileage.

You should also follow these recommendations with an overhauled or exchanged engine, or when the brakes are replaced.

## Gasoline

Suggest using 93# or higher unleaded gasoline.

Using leaded gasoline will damage emission control device of vehicle and engine. At the same time it will also prick up air pollution.

## Operation in petrol station

### Fuel tank filling

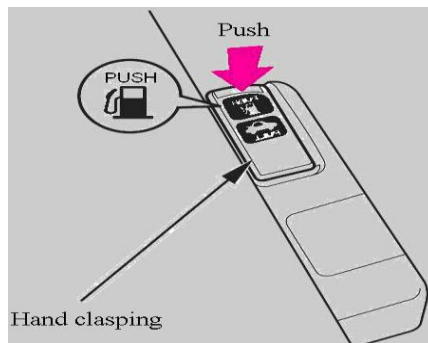

1. Because the fuel cap is located on the left side of car, please park with the left side closest to the gas pump.
2. To open the fuel cap, push down on the lever located to the left of the driver's seat.

Gasoline is highly flammable and explosive. When handling fuel, notice the following proceedings:

- 1) Stop the engine, keep heat, sparks and flames away;

- 2) Suggest handling fuel only outdoors;

- 3) Wipe up spills immediately.

3. Remove the fuel fill cap slowly. You may hear a hissing sound as pressure inside the tank escapes.

### Friendly tips

When handling fuel, notice the following proceedings:

- 1) Stop the engine, keep heat, sparks and flames away;
- 2) Suggest to handle fuel only outdoors;
- 3) Wipe up spills immediately.

## Open engine hood

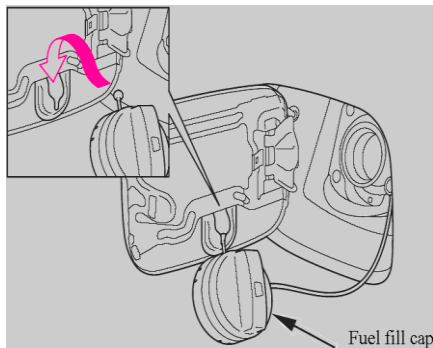

To avoid losing the fuel fill cap carelessly, the fuel fill cap is attached to the fuel filler with a tether. When handling fuel, put the fuel fill cap on the bracket of fuel fill door.

4. Stop filling fuel to the tank after the fuel nozzle automatically clicks off. Don't try to "top off" the tank. Leave some room for fuel to expand with temperature changes.
5. Screw the fuel cap back on until it clicks at least twice.
6. Push the fuel cap closed until it latches.

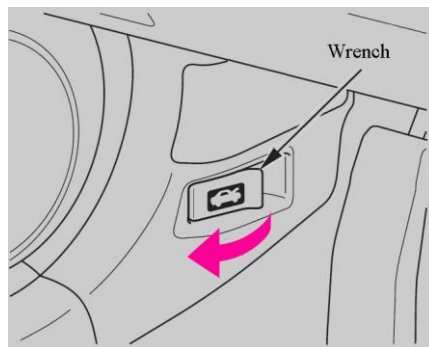

1. Shift to Park or Neutral, and set the parking brake. Pull the hood release handle located under the lower left corner of the dashboard. The hood will pop up slightly.

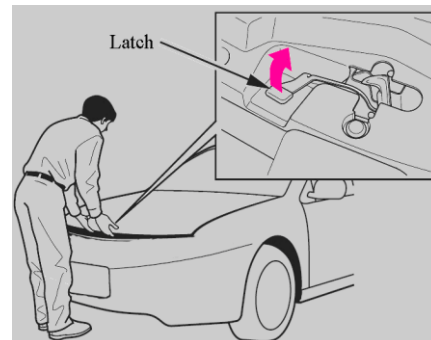

2. Stand in front of the vehicle. Put your fingers under the front edge of the hood near the center. Slide your hand to the left until you feel the hood latch handle. Push this handle up to release it. Lift up the hood.

3. Lift the hood up most of the way. The hydraulic supports will lift it up the rest of the way and hold it up.



When closing the hood, lower the hood to about 30cm above the fender, and then firmly press down on the front edge of the hood. After closing the hood, you should inspect the latch whether it is securely latched.

If you can open the hood without lifting the latch, or the hood latch handle moves stiffly or do not return back, the mechanism should be cleaned and lubricated (Please refer to 115<sup>th</sup> page ).

### Check engine oil

Engine oil is the consumable which can ensure the engine in normal working. Therefore, the oil level should be checked regularly, for example when handling fuel. You should also check the engine oil before every long-distance travel.

Engine oil consumption depends on driving status, weather condition and road condition. Engine oil consumption can reach max.1.0L/1,000km. Engine oil consumption of new engine may be higher.

Ensure the engine preheating and park on the level ground. Wait three minutes after turning the engine off, and then check the oil level.

1. Pull out the dipstick.

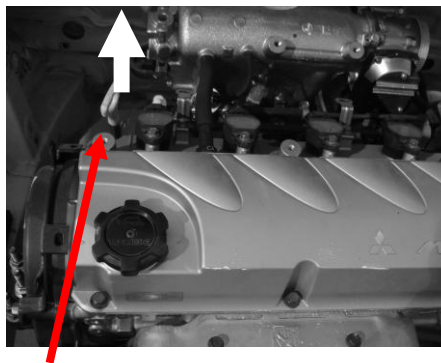

Mitsubishi 4G69S4M Engine dipstick (White ring)

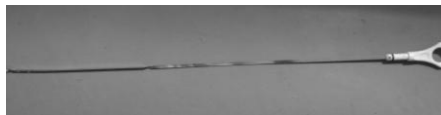

Mitsubishi 4G69S4M Engine dipstick has two holes at the upper and lower marks. The oil level should locate between two holes.

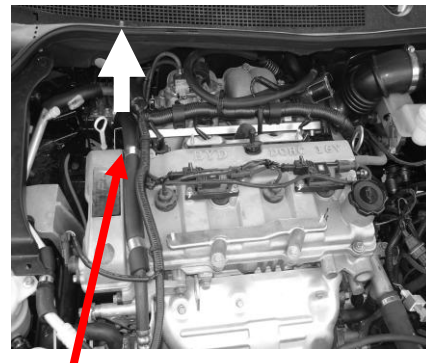

BYD483QB Engine dipstick (Yellow ring)

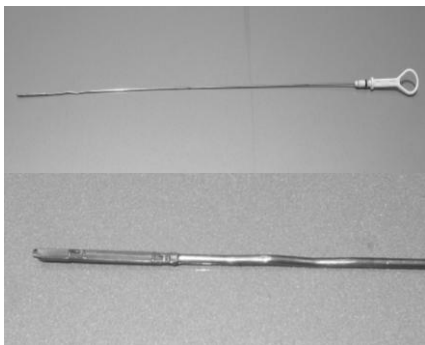

BYD483QB the upper and lower marks of dipstick are two convex lines, and mark “F””L”. The oil level should locate between the upper and lower.

2. Wipe the dipstick with a clean cloth or paper towel.
3. Insert it all the way back in its hole.
4. Remove the dipstick again, and check the level. It should be between the upper and lower marks.

If it is near or below the lower mark, refer to 103<sup>rd</sup> page on adding oil.

## Check engine coolant

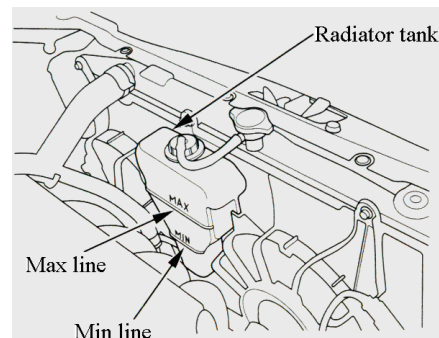

Check the coolant level in the radiator reserve tank. Make sure it is between the Max and Min lines refer to 108th page on Adding Engine Coolant for information on adding the proper coolant.

Refer to Owner's Maintenance and check on 96th page for information about checking other items on your vehicle.

## Fuel saving

### Driving custom

Moderate driving is helpful to save fuel. Rapid acceleration, abrupt cornering and hard braking use more fuel.

Always drive in the highest gear possible, it can make the engine run and accelerate more stably.

According to the traffic status, try to keep a constant speed. Every time you slow down and speed up, your vehicle uses extra fuel. Using cruise control (limit to some vehicle type) can save more fuel under appropriate driving conditions.

Cool engine uses more fuel than hot engine, but it is not necessary to make it run in idle speed for a long time to preheat. NO matter how cold outdoors, you can drive the vehicle away after one minute that you start the engine. In this way, the engine will rise in temperature more quickly, and save more fuel. To reduce times of "cool starting", you should arrange short mileage driving together.

The air conditioner puts an extra loading on the engine which makes it use more fuel. Close the air conditioner to reduce fuel consumption. Use the fresh-air ventilation when the air temperature outside the vehicle is proper.

## Luggage carrying

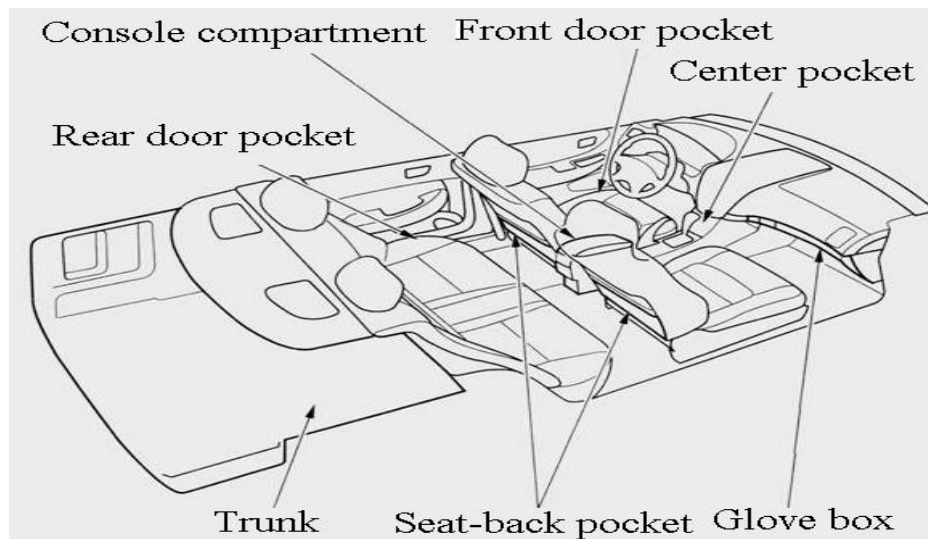

This vehicle has several convenient storage areas, it makes you carry the luggage safely.

Glove box, door pockets, seat-back pockets is designed for storing small and light cargo, and trunk is used to carry big and heavy cargo.

In addition, trunk channel port makes you carry long cargo in vehicle.

However, carrying too much cargo or improperly storing, it can affect your vehicle's handling, stability and normal running, and reduce vehicle's safety. So before carrying any type of cargo is sure to read the following pages.

### **Load limit**

When loading luggage, the total weight of vehicle, all occupants and luggage don't permit to exceed the Gross Vehicle Weight Rating. Refer to 170<sup>th</sup> page on maximum loading.

<b>Friendly tips</b>
Overloading or improper loading can affect vehicle's handling and stability, and cause a crash in which you can be hurt or killed. Follow all loading limits and other loading guide lines in this manual.

Carrying cargo in the passenger compartment:

1. Store or secure all items that could be thrown around and hurt someone during a crash.
2. Don't put any items on top of the rear shelf. Otherwise, they can block you view and be thrown around the vehicle during a crash.
3. Be sure items placed on the floor behind the front seats can not roll under the seats and interfere with the driver's ability to operate the pedals or the seat.  
Don't push the cargo over the front seat-back.
4. Keep the glove box closed while driving. If it is open, it maybe hurt the passenger's knees in a crash or a sudden stop.

Carrying cargo in the trunk or on a roof rack

1. Distribute cargo evenly on the floor of the trunk, place the heaviest items on the bottom and as far forward as possible.

2. Tie down items with rope or chain, make them not to move while driving. Do not make the cumulate items higher than the front seat-back.

3. If you carry large items that prevent you from closing the trunk lid, exhaust gas can enter the passenger area. To avoid the possibility of carbon monoxide poisoning, follow the instruction on 19<sup>th</sup> page.

4. If you carry the items on a roof rack, be sure the total weight of the luggage and items does not exceed the maximum loading. Please connect with BYD authorized service station to get more detailed data.

Please connect with BYD authorized service station about all the things of packing items and fixing device for sale in the market.

## **Driving**

This section gives you tips on starting the engine under various conditions, and how to operate the manual transmission and the automatic transmission. It also includes important information on parking your vehicle, the braking system and the vehicle's ABS.

Driving preparation .....	81
Start engine .....	81
Start in high altitude (>2400m) cold weather .....	82
Manual transmission .....	82
Max. permissible speed.....	83
Automatic transmission.....	83
Shift lever position indicator.....	83
Position of shift lever .....	84
Parking notice .....	85
CVT Transmission .....	85
Brake system.....	88
Brake system design .....	88
ABS.....	89
ABS indicator.....	90

Driving in atrocious weather.....	90
Trailer.....	91

## Driving preparation

You should do the following checks and adjustments before you drive your vehicle:

1. Make sure all windows, mirrors and outside lights are clean and unobstructed. Remove frost, snow and ice stockpiling above.
2. Check that the hood and the trunk are fully closed.
3. Visually check the status of the tires. If a tire looks slow, check its pressure using a gauge.
4. Check that any items you may be carrying are stored properly or fasten down securely.
5. Check the seat adjustment (refer to 42nd page).
6. Check the adjustment of inside and outside mirrors (refer to 86th page).
7. Check the steering wheel adjustment (refer to 35th page).
8. Make sure the doors are securely closed and locked.
9. Fasten your seat belt. Check that your passengers have fastened their seat belts (refer to 6th page).

10. Turn the ignition switch to the position of ON (II), and check the indicators in the instrument panel.

11. Start the engine (refer to 86th page).

12. Check the gauges and indicators in the instrument panel (refer to 24th page).

## Start engine

1. Apply the parking brake.

2. In cold weather, turn off all electrical accessories to reduce the consumption of the battery.

3. Manual transmission:

Make sure the shift lever is in neutral. If it isn't, press down the clutch pedal, and change the transmission shift lever to neutral, press down the brake pedal.

Automatic transmission/CVT transmission

Make sure the shift lever is in park (P) or in neutral (N), press down the brake pedal.

4. Turn the ignition key to the START (III) position at the condition of not pressing down the accelerator pedal. If the engine doesn't start right away, turn the key away from the START (III) position in 15 seconds, and pause for at least 10 seconds before try again.

5. If the engine doesn't start within 15 seconds, or starts but stalls right away, repeat step 4 with the accelerator pedal pressed halfway down. If the engine starts, leave the foot from the accelerator pedal, so the engine does not race in high speed.

6. If the engine still doesn't start, press the accelerator pedal down to the bottom and hold it there in the ignition process to clear flooding. Do as it says before, the time that the key pauses on the START (III) position doesn't exceed 15 seconds. If the engine still doesn't start, repeat step 5. After starting the engine, leave the feet from the accelerator pedal, so the engine does not race in high speed.

## Start in high altitude (>2400m) cold weather

The engine is hard to start in cold weather. Also, the engine is more hard to start in the thinner air found at altitudes above 2,400 meters.

At this time, you should take following steps:

1. Turn off all electrical accessories to reduce the consumption of the battery.
2. Press the accelerator pedal halfway down, and hold it there in the whole process. The time that the key pauses on the START (III) position do not exceed 15 seconds. After the engine starts, you should release the accelerator pedal slowly when the engine speed accelerates and engine running goes stability.
3. If the engine doesn't start after doing step 2, press the accelerator pedal down to the bottom and hold it there, try to start the engine in 15 seconds again. If the engine still doesn't start, repeat step 2.

If the temperature out of vehicle is below centigrade zero, or your vehicle has parked for several days without being driven, preheat the engine several minutes before driving.

## Manual transmission

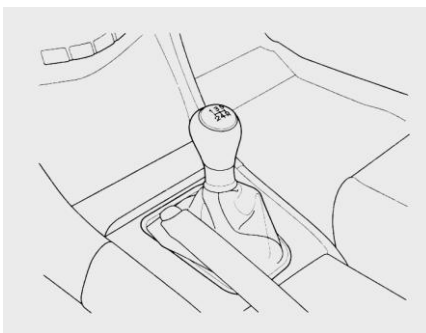

To run stably, manual transmission all has synchronizer on all of driving gear. Manual transmission has locking device, to avoid shifting gear from the fifth gear to reverse gear directly. When shifting gear, you must tread the clutch pedal down to bottom.

When not shifting gear, don't put you feet on the clutch pedal, or it can accelerate the abrasion of clutch.

Only after stopping the vehicle completely, you may shift to reverse gear. If you shift to reverse gear when the vehicle doesn't stop completely, it will damage the transmission. After treading down the clutch pedal, and before shifting to reverse gear, you should stop a few seconds, or shift to one driving gear and stop for a moment. In this way, it will make the gear stop running, and avoid "milling" each other.

When decelerating, obtain additional braking force from the engine by the way of downshifting. The additional braking force is helpful to keep one safety speed, when driving down the ramp; it can prevent the braking system overheating. Before downshifting, you need to ensure that the engine speed display doesn't enter in the red area of tachometer. Please see the max permissible speedometer.

### Friendly tips

When driving on the slippery road, rapid acceleration or rapid deceleration both can cause the vehicle out of control. Once when having a car collision accident, it will cause injury to you.

You should be more careful when driving on slippery road.

When driving at the highest gear, it can make engine run stably and accelerate. It can not only save fuel furthest, but also control exhaust emission most effectively. We commend the gear point as following:

Up shifting	The speed when shifting gear
1 gear→2 gear	25 km/h
2 gear→3 gear	40 km/h
3 gear→4 gear	65 km/h
4 gear→5 gear	80 km/h

### Max. permissible speed

These speeds correspond to max. permissible speed of every gear. If exceed these speeds, the engine speed display will enter into red area of tachometer. If this happens, you will feel the engine running intermittently, this is caused by safety governor in the ECU control device of engine. When you let the engine speed reduce below red area, the engine will recover normal running.

Before downshifting, you need to ensure the speed can not exceed the max. permissible speed of lower gear (see right table), and to avoid damaging the engine.

Gear	Max. permissible speed
First gear	46 km/h
Second gear	92 km/h
Third gear	134 km/h
Fourth gear	177 km/h

### Automatic transmission

The gearbox of your BYD F6 is manual/automatic transaxle; it has four forward gears, and electronic control system, so it can shift gear stably. It also has “lock-up type” torque converter, to save more fuel. When the torque converter is locked up, you will feel like using another gear.

### Shift lever position indicator

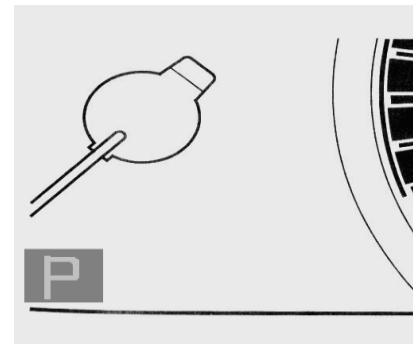



Gear indicator is located on the left lower side of tachometer, show which position the shift lever is in (P, R, N, D; when it is in manual model and has speed, it can show the current using gear 1M, 2 M, 3 M, 4.

## Position of shift lever

Shift lever includes two models, manual and automatic. The automatic model has four gears. When start the engine, shift lever must be in the position of Park (P) or Neutral (N). When you stop the vehicle in the position of D, N or R, you must press on the brake pedal hardly, and have your foot off the accelerator pedal.

**P:** Park—this position, mechanically locks the transmission. Use Park whenever you are turning off or starting the engine. To shift out of Park, the key should be in the position of ignition switch ON (II), and press on the brake pedal and have your foot off the accelerator pedal. Press the release button on the bottom of shift lever, you can shift out of it.

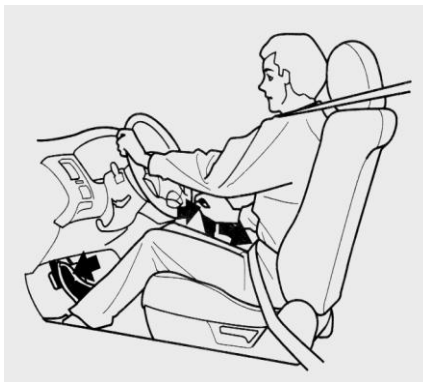

You must also press the release button to shift into Park. To avoid damaging the transmission, come to a complete stop before shifting into Park.

**R:** Reverse—about the operation method of shifting from Park to Reverse, please see the explanation of Park. When shifting from Neutral to reverse, come to a complete stop and then shift. Before shifting from Neutral to Reverse, press the release button.

**N:** Neutral—use Neutral if you need to restart a stalled engine, or if it is necessary

to stop briefly with the engine idling.

Shift to the Park position if you need to leave your vehicle. Press on the brake pedal when you are moving the shift lever from Neutral to another gear.

**D:** Drive—use this gear for your normal driving. The transmission automatically selects suitable gear according to the vehicle speed and acceleration. You may feel the transmission shifting up at higher speed when the engine is cold. This helps the engine warm up faster.

When the shift lever is in the position of Drive, move the lever to right side (assistant driver direction), so the shift lever is shifting into manual model from automatic model. You can push the shift lever to two gears, upshifting (+) and downshifting (-) under the manual model, so that you can control the transmission gear by hand.

Upshifting (+)—when normal driving and the shift lever are in the manual model, push the shift lever to this gear. After the control module of power assembly is able to judge according to the speed status, the transmission gear will correspond to

increase until the transmission is in the highest gear.

Downshifting (-)—when normal driving and the shift lever is in the manual model, push the shift lever to this gear. After the control module of power assembly is able to judge according to the speed status, the transmission gear will correspond to decrease until the transmission is in the lowest gear.

When parking, make sure to use hand brake. The indicator on instrument panel only shows that the hand brake isn't released completely, but doesn't show that the hand brake has been pulled indeed. You must make sure to pull the hand brake; otherwise, the vehicle may roll when it is parked on an incline.

If your vehicle installs automatic transmission, you should set the hand brake firmly before shifting the transmission into Park. This can avoid vehicle moving, so that press on the Park mechanism in the transmission—in this way, when you want to drive, it can make the shift lever to shift out of Park more easily.

### Parking notice

1 Make sure that the roof window (limit to some vehicle type) and windows are all closed well.

2 Turn off the lights.

3 Place any packages, valuables, etc., in the trunk or take them with you.

4 Lock the doors with the key or the remote transmitter, check the trunk whether it is locked up.

Check the indicator on the instrument panel to ensure that the security system is set.

5 Never park over dryleaves, tall grass, or other flammable materials. The hot three way catalytic could cause these materials to catch on fire.

6 When parking, if the vehicle is facing uphill, turn the front wheels away from the curb. If the vehicle installs manual transmission, shift it into the first gear.

7 When parking, if the vehicle is facing downhill, turn the front wheels toward the

curb. If the vehicle installs manual transmission, shift it into Reverse.

8 Make sure the hand brake whether it is fully released before driving away. Driving with the hand brake partially set can overheat or damage the rear brake.

### CVT Transmission

#### Gear indicator

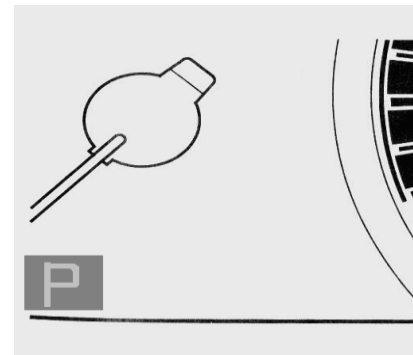

Gear indicator is located on the lower left side of tachometer, showing the mode and gear selected currently by the auto transmission:

**P: Park;**  
**R: Reverse;**  
**N: Neutral;**  
**D: Drive;**  
**S: Sport;**  
**M: Manual.**

#### Position of shift lever

It includes “park”, “reverse”, “neutral”, “drive”, “sport”, “manual”, etc.

**P : Park**—the transmission is locked mechanically in this position. It should be positioned on this gear when stopping or starting the engine. To release Park, the ignition key shall be put on the ON (II) of the ignition switch and you shall step on the brake pedal. Press the relief button on the gear shift lever; you can release Park.

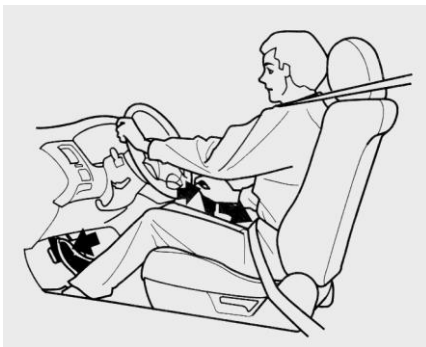

You must also press the release button to shift into Park. To avoid damaging the transmission, you must stop the car before shifting into Park.

**R: Reverse**—about the operation method of shifting from Park to Reverse, please see the explanation of Park. When shifting from Neutral to reverse, come to a complete stop and then shift. Before shifting from Neutral to Reverse, press the release button.

**N: Neutral**—use Neutral if you need to restart a stalled engine, or if it is necessary to stop briefly with the engine idling.

Shift to the Park position if you need to leave your vehicle. Press on the brake pedal when you are moving the shift lever from Neutral to another gear.

**D: Drive**—use this gear for your normal driving. The transmission automatically selects suitable gear according to the vehicle speed and acceleration. You may feel the transmission shifting up at higher speed when the engine is cold. This helps the engine warm up faster.

When the shift lever is in the position of Drive, move the lever to right side (assistant driver direction), so the shift lever is shifting into manual model from automatic model. You can push the shift lever to two gears, upshifting (+) and downshifting (-) under the manual model, so that you can control the transmission gear by hand.

**Upshifting (+)**—when normal driving and the shift lever are in the manual model, push the shift lever to this gear. After the control module of power assembly is able to judge according to the speed status, the transmission gear will increase correspondingly until the transmission is in

the highest gear (sixth).

Downshifting (-)—when normal driving and the shift lever is in the manual model, push the shift lever to this gear. After the control module of power assembly is able to judge according to the speed status, the transmission gear will correspond to decrease until the transmission is in the lowest gear.

When parking, make sure to use hand brake. The indicator on instrument panel only shows that the hand brake isn't released completely, but doesn't show that the hand brake has been pulled indeed. You must make sure to pull the hand brake; otherwise, the vehicle may roll when it is parked on an incline.

### **Sport Mode Selection**

Only when the gear shift lever is in the position of D, push it to the right directly instead of performing upshifting and downshifting operations, now you select the sport mode and the gear display screen of the combination instrument displays DS.

### **Manual Mode Selection**

When the gear shift lever is in the position of D, push it to the right at first, and then push it forward or backward, and then you select the manual mode. The gear display screen of the combination instrument displays the current gear in use: 1M, 2M, 3M, 4M, 5M, and 6M.

### **Start Car**

The gear shift lever must be placed at park gear (P) or neutral gear (N) when starting the engine.

### **Stop Car**

The gear shift lever must be placed at park gear (P) or neutral gear (N) when starting the engine.

### **Start on the slope**

To protect CVT transmission, you must start on the slope with the aid of park handle.

### **Parking notice**

1 Make sure that the roof window (limited to some vehicle type) and windows are all closed well.

2 Turn off the lights.

3 Place any packages, valuables, etc., in the trunk or take them with you.

4 Lock the doors with the key or the remote transmitter, check the trunk whether it is locked up.

5 Check the indicator on the instrument panel to ensure that the security system is set.

6 Never park over dry leaves, tall grass, or other flammable materials. The hot three way catalytic converter could cause these materials to catch on fire.

7 When parking, if the vehicle is facing uphill, turn the front wheels away from the curb. If the vehicle installs manual transmission, shift it into the first gear.

8 When parking, if the vehicle is facing downhill, turn the front wheels toward the curb. If the vehicle installs manual transmission, shift it into Reverse.

9 Make sure the hand brake whether it is fully released before driving away. Driving with the hand brake partially set can overheat or damage the rear brake.

### How to Drive Economically

Select “D” when driving on the wide road. Slowly step down the accelerator to assure the auto gear changes when the engine speed is relatively slow.

### Acceleration and Overtaking

Step down the accelerator to the bottom quickly, which will activate the low-gear shift to switch to a proper gear.

### Special Environment

If you drive on the curve or mountain road, you are suggested to use manual mode instead of auto mode.

### In Cold Weather

After starting the engine, you shall wait for a few seconds before switching the gear shift lever from position P to position D or R to avoid stopping the engine.

### Faults

If the warning light for “transmission case fault” and “service” on the instrument panel is on when driving, it indicates a fault occurs.

Contact the BYD service shops as soon as possible.

### Adaptive Update of the Clutch

In all these following cases, you must perform adaptive update for the clutch.

- 1 TCU program is refreshed
- 2 Replace with a new TCU
- 3 Replace with a new transmission box

The adaptive program of clutch is as follows:

- 1 Start the engine
- 2 Step on the brake (keep stepping down in the whole process)
- 3 Put the gear on N
- 4 Stay for 5 seconds
- 5 Put the gear on D
- 6 Stay for 5 seconds
- 7 Put the gear on N
- 8 Stay for 5 seconds
- 9 Put the gear on R
- 10 Stay for 5 seconds

Repeat the 3 to 10 steps mentioned above three times.

## Brake system Brake system design

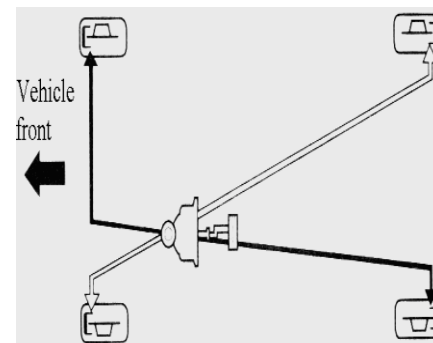

The hydraulic system of drive brake has two separate circuits. Each circuit works diagonally across the vehicle (the left-front brake is connected with the right-rear brake, etc.). If one circuit has a problem, you will still have braking at two wheels.

## **ABS**

ABS helps prevent the wheels from locking up or slipping when braking rapidly, so that make you retain steering control.

When the front wheels are slipping, you will not do steering control, in other words, although turn the steering wheel, the vehicle still runs directly. ABS helps prevent from locking up, and because rapidly pulsatile-typed brake is quicker than person's reaction, it is helpful to retain steering control.

ABS also balances the front-to-rear braking distribution according to vehicle loading.

Don't pumping press on the brake pedal, otherwise, it will let the ABS shut down. When steering away from the hazard, you should always keep firm, steady pressure on the brake pedal, in order to let the ABS activate. This is sometimes referred to as "stomp and steer".

When the ABS activates, you will feel a pulsation in the brake pedal, and hear some noise. This is normal, it is the ABS rapidly pumping braking.

The speed of ABS activating depends on the size of wheels' driving force (adhesive force). On dry pavement, you will need to press on the brake pedal very hard before the ABS activate. However, you will feel the ABS activate immediately if you are trying to stop on the snow or ice.

## **Important safety reminders**

ABS does not reduce the time or distance, which takes to stop the vehicle. This installation only helps you control steering during braking. You should always keep a safe distance away from other vehicles.

ABS will not prevent slipping those results from changing direction abruptly, such as trying to take a corner too fast or making a sudden land changing. Always drive at a safe speed for the road and weather conditions.

ABS can not prevent a loss of stability. Always steer moderately when sudden hard braking. Severe or sharp steering wheel movement can still cause your vehicle to veer into oncoming traffic or off the road.

A vehicle with ABS may require a longer distance to stop on loose or uneven surfaces (such as gravel or snow surfaces) than a vehicle without ABS. Under this condition, slow down the speed, and keep a greater distance away from other vehicles.

## ABS indicator

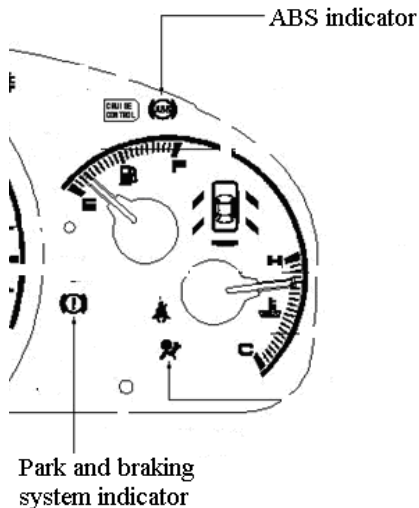

ABS has the self-diagnosis function. If malfunction happens, the ABS indicator (refer to 88<sup>th</sup> page) on instrument panel comes on. This means that the ABS function of braking system has shut down. At this time, the brakes still supply common braking ability like a conventional vehicle without ABS. You should have BYD authorized service station to inspect your vehicle as soon as possible.

If the ABS indicator and the braking system indicator come on together, and the hand brake is fully released, it means that the front-to-rear braking distribution system may also be shut down.

Inspect the brakes according to the explanation on page 91. If the brakes feel normal, you should drive slowly, and have your vehicle repaired by BYD authorized service station. At this time, avoid sudden hard braking which could cause the rear wheels to lock up and possibly lead to a loss of control.

## Driving in atrocious weather

Because the decrease of driving force (adhesive force) and visibility, different environments such as rain day, fog day and snow weather needs different driving skill. Maintain the vehicle well at any time. You need to be more careful when you have to drive in atrocious weather. You should not use the speed-fixed cruising control (limit to some vehicle type) under these conditions.

Driving skill—the speed driving in wet weather is slower than in the dry weather. Your vehicle also needs longer time to react, put stable and uniform pressure on all the control installations, even if it is under the condition which looks like a little wet. In the wet weather, sharp steering or sudden hard braking, both possibly lead to a loss of control. You must be more careful in the first a few kilometers that you adopt the changing of driving conditions, especially in the snow weather. One driving person maybe forget the driving skills on the snow surface in the several months of summer, he (she) needs to master these skills anew through practicing.

When driving in the rain weather after long-term drought, you should be more careful. The first rain after long-term drought will make the oil plants float on the pavement, and lead to pavement wet and slip.

**Visibility**—under all the weather conditions, it is very important to see far and near clearly, and be saw by other drivers. It is more difficult to do this point in the atrocious weather. To be seen more clearly, you should turn on the head light in daytime.

You should often inspect the windshield wiper and washer. Keep storing proper and enough washer fluid in fluid reserve tank of windshield washer. If the wiper does not scrape the water cleanly or leave the stripe on the windshield, replace the blade. Otherwise, use the frost removal and air-condition to make window inside without fog (refer to 35<sup>th</sup> page).

**Driving force (adhesive force)**—you should often inspect the abrasion status of tires and the pressure of tire whether it is suitable, the two items are very important to prevent the

“drafting phenomenon” (a loss of adhesive on wet pavement) of vehicle. In winter, four wheels should be installed snow tires (antiskid deep strain), to obtain best control capability.

You should look round the illusive road status. Dry leaves maybe slip like ice and snow. “Clean” pavement may have thin ice. When the temperature out of vehicle is near to zero degree, the driving condition may be very dangerous and the pavement may be covered by water and ice. So the adhesive force of vehicle may sudden change under the condition without any threaten.

When downshifting, you should take care doubling. If the adhesive force is low, the driving wheel may be locked up a moment, this may lead to slip.

#### **Friendly tips**

Don't drive on the pavement of deep water. It is easy to cause malfunction or damage to engine and electronic equipment.



When overtaking or being overtook, you should be very careful, because the water fog which is caused by heavy vehicle maybe have a influence on your sight, and air wave impact maybe lead to a loss of control.

#### **Trailer**

Towing a trailer is not designed on your vehicle. Try to install a bar on your vehicle, but it maybe damage the chassis badly.



## Maintenance

Periodical maintenance is the best method to protect vehicle, it can make you drive more safety, more economy, and no malfunction. This section will introduce the items which need periodical maintenance, and inspection method. Otherwise, it also introduces easy maintenance works in detail which you can complete by yourself. The periodical maintenance schedule will tell you when you should do these works.

Periodical maintenance schedule ....	93
Owner inspection for maintenance..	99
Engine oil .....	100
Cooling system.....	104
Windshield washer .....	107
Transmission oil .....	108
CVT transmission .....	110
Brake system.....	111
Power steering .....	112
Air filter core.....	113
Fuel filter.....	113
Engine hood lock .....	114
Spark plug (4G69S4M model).....	114

Battery .....	115
Windshield wiper blade.....	116
A/C system.....	118
Dust filter .....	118
Driving belt .....	119
Timing belt .....	121
Tire .....	121
Tire chains.....	124
Light.....	125
Vehicle storage .....	133

## Periodical maintenance schedule

The periodical maintenance schedule lists out all the maintenance items what your vehicle need to keep it being in the best driving state all the time. Maintenance works should be according to the standard and specification of BYD AUTO CO., LTD., and be performed by mechanician of accepting formal training and conversance business. BYD authorized service stations all accord with all these requirements.

The inspection items and driving time or distance listed in the periodical maintenance schedule, are made for carrying passenger and goods when you suppose your car as normal vehicle. You should follow the advice as following:

1. Avoid loading over the vehicle's loading limit. Overload will make engine, brakes and most of other parts bear additional burden.

2. On the allowable driving pavement, drive with limit speed by law.

3. Drive your vehicle periodically, and several kilometers every time.

4. Make sure to use recommended fuel (refer to 80<sup>th</sup> page).

Advise you using parts, oil or other same grade substitute of BYD AUTO company when maintaining. These goods are same to original parts on BYD new vehicle. They are both high quality products, can ensure to combine with you vehicle perfectly and drive without malfunction.

**Oil and routine maintenance**

BYD F6 maintenance schedule and content:

Maintenance interval	Odometer reading or months, whichever comes first															
	×1, 000 (km)	3		3	8	3	8	3	8	3	8	3	8	3	8	3
	months	F			2	5	8	1	4	7	0	3	6	9	2	5
<b>Engine and transmission</b>																
1. Check the drive belts and adjust the tension degree		I														
2. Replace timing belt	483QB engine	Check every 20,000km; replace every 80,000km; shorten the cycle as actual condition														
	4G69 engine	Check every 20,000km; replace every 100,000km, shorten the cycle as actual condition														
3. Check ignition cable		I														
4. Replace the spark plug	Normal condition	Common spark plug	Replace every 30,000km													
		Iridium spark plug	Replace every 80,000km													
	Serious condition	Check and replace by the concrete conditions														

5. Check the crankcase ventilation system (PVC valve and ventilation hose)		I																	
6. Check coolant pipe		I																	
7. Check the liquid level in the reservoir		I																	
8. Replace the coolant liquid		Replace every two years or 40,000km																	
9. Replace air filter core	Normal condition	Clean every 2000km; replace every 15,000km																	
	Serious condition	Check and replace by the concrete conditions																	
10. Replace oil	Normal condition	R: replace every 5,000km or 6 months																	
	Serious condition	R: Every 3,000km																	
11. Replace the oil filter	Normal condition	R: replace every 5,000km or 6 months																	
	Serious condition	R: Every 3,000km																	
12. Check the battery						I		I		I									I
13. Check idle						I													I
14. Check ignition timing						I													
15. Check the valve clearance						I													I
16. Check the connection of exhaust pipe						I													I
17. Check the transmission oil cooler hose						I													I



31. Brake pads and discs			I	I														
32. Brake fluid			I	I			I											
33. Brake pipes and hoses			I	I														
34. Power steering liquid			I	I			I			I								
35. Steering wheel, linkage			I	I			I											
36. Drive shaft dust boots			I	I														
37. Ball joints and dust covers			I	I														
38. Front and rear suspensions			I	I														
39. Tire and tire pressure			I	I			I											
40. Check the front and rear wheel alignment			I	I														
41. Check the wheel bearing			I	I														
42. Check clutch function and adjust pedal travel			I	I														
43. Clutch fluid			I	I			I											
44. Clutch pipes and hoses			I	I														
45. Warm wind equipment and A/C system			I	I														
46. A/C air filter			I	R														
47. A/C refrigerant			I	I														

48. Check SRS airbag system			I	I													
49. Check for body brakeage	Every year																

**Remarks:**

(1)Symbol meaning in the schedule

I=Check, correct or replace if necessary; R=Replace, change or lubricate; C=Clean.

(2) Shorten the replacing time of oil filter according to the smudgy degree of oil.

“Serious condition” is following:

- (1)The vehicle is driving in dusty area, or the vehicle is at salty surrounding.
- (2)The vehicle is driving at accidental road, water road or hill road.
- (3)The vehicle is driving in the cold area.
- (4)In cold whether, idle is running for a long time or the vehicle is driving for short trips frequently.
- (5)Operate the brake and parking brake frequently.
- (6)The vehicle is as daggling other vehicles.
- (7)The vehicle is as taxi or leasehold vehicle.
- (8)At 32℃ or above, the driving time in the heavy traffic is 50% of the gross time or more.
- (9)At 30℃ or above, the driving time of 120km/h or above is 50% of the gross time or more.
- (10)The vehicle is driving at overload.

**Notes: notice for CVT transmission maintenance**

**Maintenance Period**

Driving every 60,000km, you shall replace the lubricant for the transmission and replace the fuel filter, so the transmission is equipped with drain plug and roof oiling screw plug

**Lubricant Specifications**

Make sure you use ESSO EZL 799A.

To use lubricant of other specifications may damage the transmission; the damage caused by this is not within the scope of warranty.



This periodical maintenance schedule roughly lists out the lowest limit maintenance items, and you must do them to protect you vehicle driving without malfunction. Because of the different areas and weather, it maybe needs to add some maintenance content. About more detail date, please refer to your warranty manual.

### **Stated maintenance record**

Please let your BYD authorized service station fill all stated maintenance notes in the table. You should save wheel all the receipts of doing maintenance works to your vehicle.

### **Owner inspection for maintenance**

According to using condition or stated mileage, check the items as following:

1. Engine oil level—check every time you fill the fuel tank. Please refer to **81<sup>st</sup> page**.
2. Engine coolant level—check the radiator reserve tank every time you fill the fuel tank. Please refer to **81<sup>st</sup> page**.

3. Windshield washer fluid — check the washer fluid stock in reserve tank monthly. Because of the bad weather and using the washer fluid frequently, check the stock every time you fill the fuel tank. Refer to **108<sup>th</sup> page**.

4. Windshield wiper— check the wiper status monthly. If the wiper can not clean the windshield, examine for abrasion, cracking or other damage.

5. Automatic transmission — check the fluid level monthly. Refer to **109<sup>th</sup> page**.

6. Brakes and clutch—check the level monthly. Refer to **112<sup>th</sup> page**.

7. Brake pedal—examine the brake pedal for operating freely.

8. Parking brake—examine the parking brake lever for operating freely.

9. Battery — check the status of battery and corrosion status of terminal monthly. Refer to **117<sup>th</sup> page**.

10. A/C system — check the running situation of A/C weekly. Refer to **119<sup>th</sup> page**.

11. Tires—check the tire pressure monthly. Examine the tread for wear and foreign objects. Refer to **123<sup>rd</sup> page**.

12. Frost removal of windshield—use warm wind equipment and A/C monthly, check the air outlet of frost removal.

13. Lights—check the status of headlights, parking lights, taillights, high-mount braking lights, turning signal lights, front fog lights, rear fog lights, braking lights and license plate lights. Refer to **127<sup>th</sup> page**.

14. Doors—examine trunk hood and other doors (include rear row doors) for switching freely, locking up firmly.

15. Horn—check the horn.

## Engine oil

Engine oil filling

BYD483 engine oil filler cap

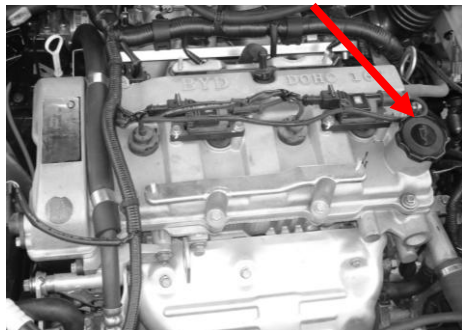

When filling the engine oil, unscrew and remove the engine oil filler cap on top of the valve cover. After filling the engine oil, replace the engine oil filler cap, and tighten. Warm the engine, and then turn off. Three minutes later, recheck the oil level. Don't fill the oil above the upper mark, you could damage the engine.

Mitsubishi 4G69S4M engine oil filler cap

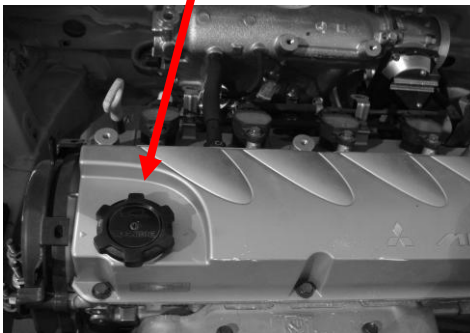

Pour in the oil slowly and carefully so you do not spill any. Clean up any spills immediately. Spilled oil could damage the components in the engine compartment.

### Recommended engine oil

Oil is a major contributor to your engine's performance and longevity. So always use a high-quality and detergent oil. For your vehicle, cordially advise you to use BYD AUTO engine oil.

According to the graph as following, choose SAE viscosity oil which suit for your vehicle.

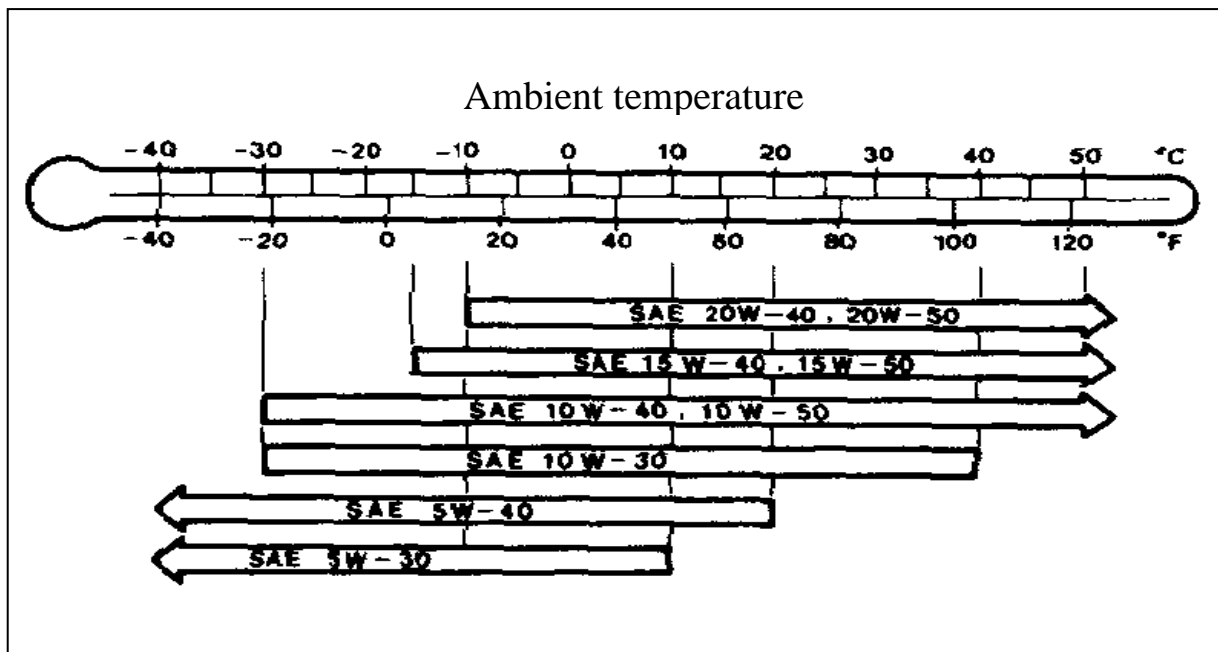

Use the oil of saving fuel type which marks “API repair grade or higher grade”. This oil’s formula is helpful to reduce fuel consumption of engine.

**Replace engine oil and oil filter**

Always replace oil and filter termly according to the recommended driving time and mileage in the periodical maintenance schedule. The oil and filter collect contaminants that can damage your engine if they are not removed regularly.

Replacing the oil and filter requires special tools and completes underneath the vehicle. The vehicle should be raised on a service station-type hydraulic lift for this work. Unless you have the knowledge and proper equipment, you should have the maintenance done by a skilled mechanic.

<b>Friendly tips</b>
Contact the used engine oil repeatedly and long-time, it may induce skin cancer.
After dealing with the used oil by hand, make sure to wash your hand with strength soap thoroughly as soon as possible.

<b>Friendly tips</b>
Oil, engine components and exhaust system are all in high temperature, they may cause scald.
When working in the engine compartment, make sure to be careful and wear protective clothing.

1. Run the engine until it reaches normal operating temperature, then shut it off.
2. Open the hood, and remove the engine oil filler cap. Remove the oil drain bolt and washer from the bottom of the engine. Drain the oil into an appropriate container.

**BYD483QB engine oil filter and oil drain bolt**

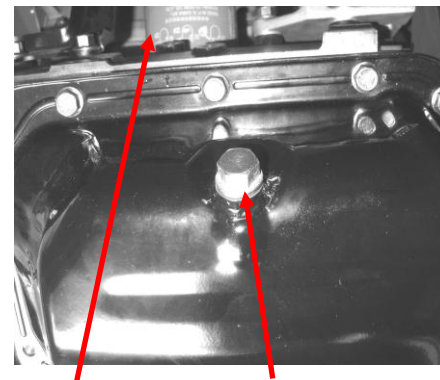

Oil filter

Oil drain bolt and gasket

Mitsubishi 4G69S4MS4M engine oil filter and oil drain plug

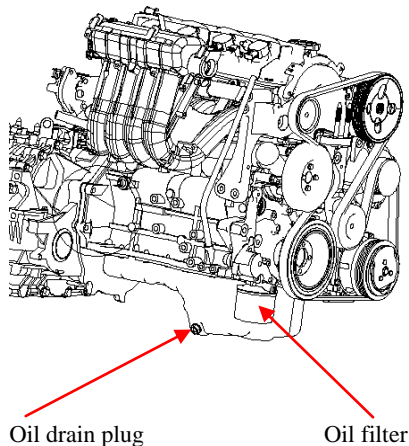

3. Remove the oil filter, and drain the remaining oil.

A special wrench (can buy it from BYD authorized service station) is required.

4. Check the oil filter to make sure its gasket did not stick to the engine block. A

stuck gasket could cause an oil leak.

5. Install a new oil filter according to the instructions that come with it.

Make sure to clean off any dirt and dust on the connecting surface of a new oil filter.

6. Put a new washer on the drain bolt, then reinstall the drain bolt and tighten it. Tighten torque:

BYD483QB engine model  
90 Nm  
Mitsubishi 4G69S4M engine model  
39 Nm (4.0kgf·m)

7. Refill the engine with recommended oil. Change capacity of engine oil (Including filter):

BYD483QB engine model  
3.5 L  
Mitsubishi 4G69S4M engine model  
4.3 L

8. Put the engine oil filler cap back on and tighten it, start the engine. The indicator of oil pressure should go out within 5 seconds.

If it does not, turn off the engine, and check your work above.

9. Let the engine run for several minutes, then check the drain oil bolt and oil filter for leaks.

10. Turn off the engine; let it stop for about 3 minutes, then check the oil level on dipstick. If necessary, add more oil to upper limit mark of dipstick.

**Friendly tips**

Improper disposal of engine oil can be harmful to the environment. If you change the oil yourself, please deal with the used oil properly. Put it in a sealed container and take it to a recycling center. Don't discard it in a trash bin or dump it on the ground.

## Cooling system

### Engine coolant filling

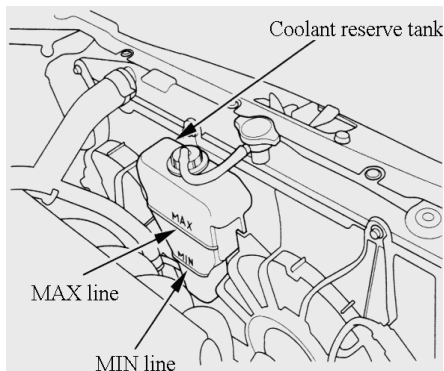

If the coolant level in the coolant reserve tank is at or below the MIN line, add coolant or water to bring it up to the MAX line. Inspect the cooling system for leaks. In the adding coolant, the proportion of coolant and water refers to local practical temperature, and choose according to the instructions of coolant adding.

Always use BYD AUTO four-season antifreeze coolant. Do not need to add any

extender. If this coolant is not available, you may use another major-brand non-silicate coolant as a temporary replacement. Make sure it is a high-quality coolant recommended for aluminum engines. Otherwise, continued use any non-BYD coolant can result in corrosion, and cause the cooling system to malfunction or fail. So empty the cooling system as soon as possible, refill the antifreeze coolant of BYD AUTO brand. Advice that coolant of different brands and types can't be mixed used.

If the reserve tank is completely empty, you should also check the coolant level in the radiator.

#### Friendly tips

Open the radiator cap while the engine doesn't cool completely, it can cause the coolant to spray out, seriously scalding you.

Before opening the radiator cap, make sure the engine and radiator both cool down.

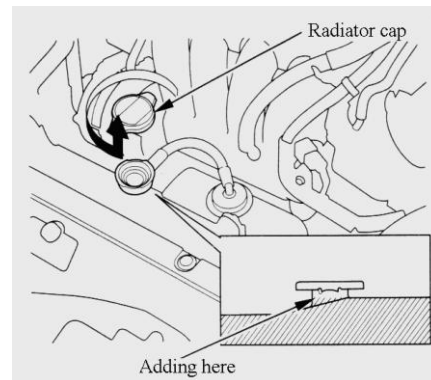

1. Be sure the engine and radiator are both cool.
2. Relieve any pressure in the cooling system by turning the radiator cap counterclockwise. (Do not press it down)
3. Remove the radiator cap by pushing down and turning counterclockwise.
4. The coolant level should be up to the bottom of the filler neck. Add if it is low.

Pour the coolant slowly and carefully, so you do not spill any. Clean up any spill immediately. The spilled coolant could damage components in the engine compartment.

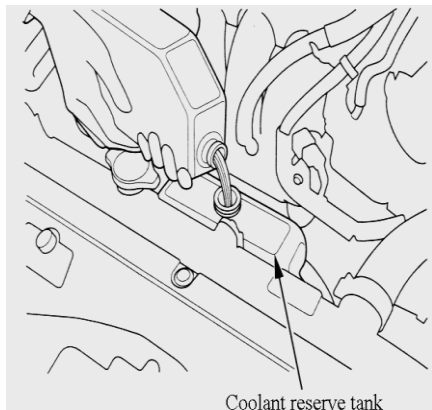

5. Put the radiator cap back on and tighten it.
6. Pour coolant into the reserve tank; make the level between the MAX and MIN marks, then put the cap back on the reserve tank.

#### Notice

Do not add any rust inhibitors or other additives to your vehicle's cooling system. They may not be compatible with the coolant or engine components.

#### Replace engine coolant

Empty the coolant completely according to the recommended driving time and mileage in the periodical maintenance schedule. Then, refill the new coolant. It can only add BYD AUTO four-season antifreeze coolant. Using any non-BYD coolant or adding water directly can cause the cooling system to corrosion and bringing precipitate.

Draining the coolant should be complete underneath the vehicle. Unless you have the enough knowledge and proper equipment, you should have the work done by a skilled mechanic.

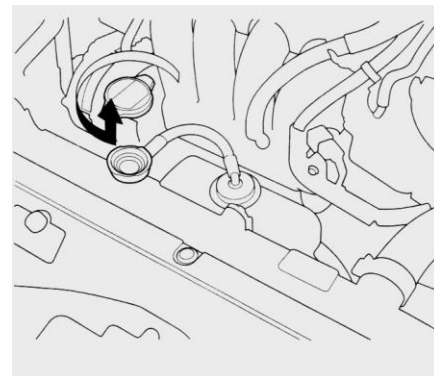

1. Turn the switch to ON (II) position. Make sure the DUAL indicator is going out. Turn the temperature control button to "Hi" on driver side. Turn off the ignition switch, and pull out the key.
2. Open the hood. Make sure engine and radiator cool down to degree that you can touch them.
3. Relieve residual pressure in the cooling system by turning the radiator cap counterclockwise. (Do not press it down)
4. Remove the radiator cap by pushing down and turning counterclockwise.

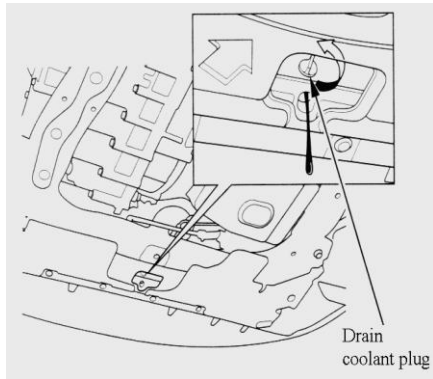

5. Unscrew the drain coolant plug on the bottom of radiator. The coolant drains from bottom. Put it in a proper container.

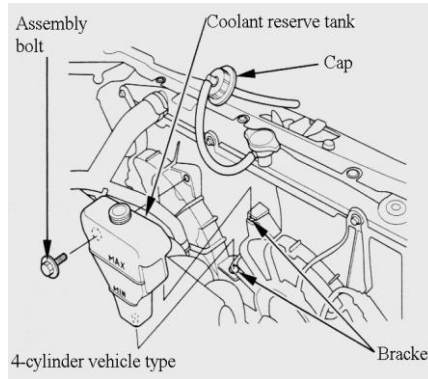

6. Demount the assembly bolt of coolant reserve tank with wrench.

7. Get the coolant reserve tank down from bracket (pull from positive above), drain out the coolant and put it back, install the assembly bolt.

8. After emptying the coolant, screw down the drain coolant plug.

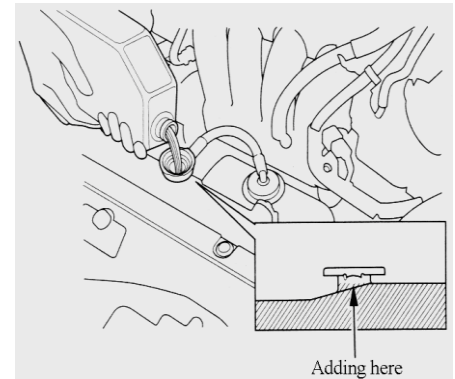

9. Pour BYD AUTO four-season antifreeze coolant glycol into radiator, until it is up to the bottom of the filler neck. Need not premix.

The capability of cooling system as following:

BYD483QB engine

Manual transmission and CVT transmission:  
6.8 L

Mitsubishi 4G69 engine

AT:

7.2 L



10. Run the engine about 30 seconds, and then turn it off.
11. Pour the coolant into radiator, till the level is up to the bottom of the filler neck.
12. Pour the coolant into coolant reserve tank to the MAX mark, cover the cap.
13. Put the radiator cap back, and tighten to first stop position.
14. Run the engine itself, till the cooling fan at least starts two times, and then turn off the engine.
15. Get down the radiator cap, then pour the coolant and make the level up to the bottom of the filler neck and MAX mark of reserve tank.
16. Start the engine and keep the speed at 1500 r/m, till the cooling fan starts, then turn off the engine. Check the coolant level in the radiator, pour the coolant if necessary.
17. Put the radiator cap back and tighten it.
18. If necessary, pour the coolant into reserve tank up to MAX mark, then cover the cap.

## Windshield washer

Check the level in the windshield washer reservoir at least monthly during normal using. In the atrocious weather, if you often use the washer, check the level in the windshield washer reservoir when adding the fuel every time.

The windshield washer reservoir is located in the engine compartment behind the right headlight.

Check the reservoir's level by removing the cap and looking at the level gauge attached to the cap.

Fill the reservoir with a good-quality windshield washer fluid. This can increase the cleaning capability, and prevent freezing in cold weather.

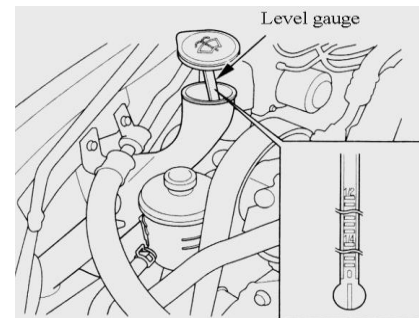

When you refill the reservoir, clean the edges of the windshield wiper blades with windshield washer fluid on a clean cloth. This will help to good condition the blade edges.

### Notice

Do not use engine antifreeze or a vinegar/water solution in the windshield washer reservoir. Anti-freeze can damage the vehicle's paint, while a vinegar/water solution can damage the windshield washer pump. Use only commercially-available windshield washer fluid.

**Transmission oil**

**Automatic transmission**

Check the oil level with the engine at normal operation temperature.

1. Drive the vehicle till the oil temperature is reaching the usual temperature (70~80°C).
2. Park the vehicle on level ground.
3. Change the shift lever to every position, make the oil inject into torque converter and hydraulic circuit, and then put the lever at N position, keep engine in normal idle speed, and must apply the park braking.
4. Remove the dipstick (yellow loop) from the transmission, and wipe it with a clean cloth.

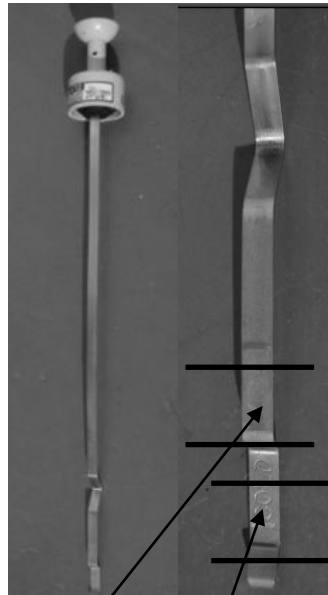

COLD upper and lower marks  
HOT upper and lower marks

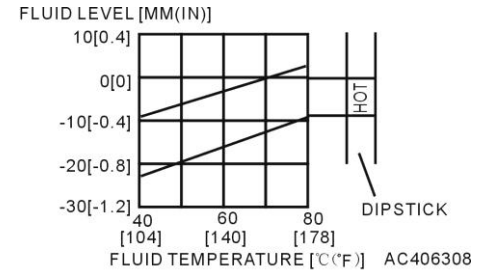

5. Insert the dipstick all the way into the transmission.
6. Remove the dipstick and check the fluid level.

7. If the oil level is below the lower mark, remove the filler plug and add oil into the tube to make the level between upper and lower marks of HOT.

Remark: status is the standard of measuring the transmission oil level, the level of cold engine is between upper and lower marks of COLD, only as reference.

Pour the oil slowly and carefully so you do not spill any. Clean up the spill immediately, it could damage components in the engine compartment.

Always use BYD AUTO automatic transmission oil (MITSUBISHI ATF SIII).

If ATF oil has the smell of coke burning, it means that the transmission oil has been polluted by burning particle and friction material, the transmission case may be necessary to be overhauled.

8. Insert the dipstick all the way back into the transmission.

The transmission should be drain and refilled with new transmission oil according to the periodical maintenance schedule.

If you are not sure how to add oil, contact with BYD authorized service station.

**Manual transmission**

Check the oil level with the engine at normal temperature 80°C and parking the vehicle on level ground. Demount the oil filler bolt, touch the oil level in the bolt hole with your finger carefully, at this time, the oil level should be up to the edge of bolt hole. Otherwise, add BYD AUTO manual transmission oil (MTF) till spill from the oil filler, then put the oil filler bolt back and tighten it.

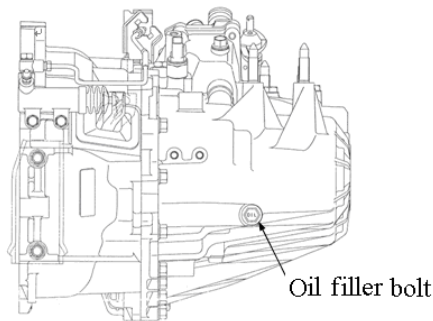

Picture 7 Oil filler bolt position

Clean up the spill immediately, it could damage components in the engine compartment.

If it is not available, you may use ARI attestation oil as temporary replacement. Specific type refers to maintenance manual, or contact with BYD authorized service station.

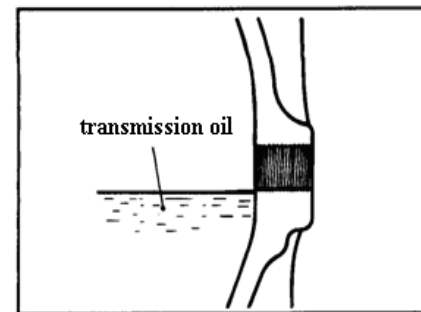

Picture 8 level position of oil

The transmission should be drain and refilled with new transmission oil according to the periodical maintenance schedule.

If you are not sure how to check oil level and add oil, contact with BYD authorized service station.

Notice: The oil can't contain water, it may rust parts in transmission.

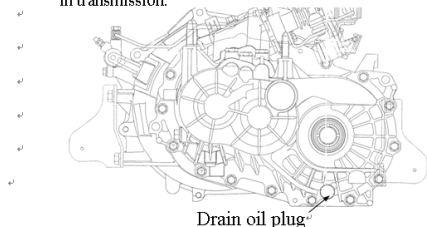

Picture 6 Drain oil plug position

## CVT transmission

The transmission used is not filled with gasoline in advance, so you shall add ESSO EZL799A gasoline of  $4.1 \pm 0.05$  liter after the transmission is installed on the car. The proper checking method for fuel level is shown as follows, after filling oil for the first time:

- Start the engine and run it at an idle speed for at least 10 seconds (notes: it is normal to hear the sound caused by air circulation in the system when starting.)
- Switch to different gears by gear shift

lever (park - reverse - neutral - driving) and stay for 5 seconds on each gear before switching to the next gear.

- Switch to "D" (Drive)
- Loosen the brake pedal
- Reduce speed to min 60 km/h (do not exceed 2500rpm)
- Loosen the accelerator until you stop the car (the noise made by air circulation when starting will disappear).
- Heat the gasoline; be careful to drive at least for 5 minutes or wait until the temperature of transmission reaches  $60^{\circ}\text{C}$ .
- Stop the car on flat ground or slope.
- Step on brake pedal.
- Wait for 2 seconds.
- Switch the gear to "R" (Neutral).
- Wait for 10 seconds.
- Switch the gear to "P" (Park).
- Run the engine at an idle speed.
- Pull out the oil level screw plug.
- Make sure you pull out the oil level screw plug and then at least 0.2 liter oil will be drained from the oil pipe. (or it indicates the initial oil is insufficient)
- Wait for a few minutes until the oil begins to drop from the oil level screw plug mouth.
- Put the lid on the oil level screw plug

again.

- stop the engine

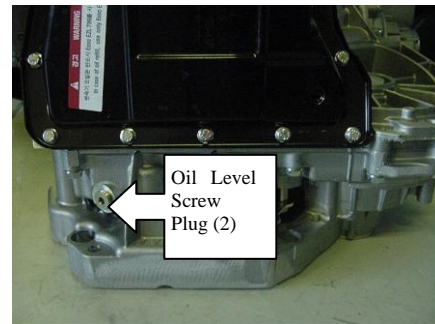
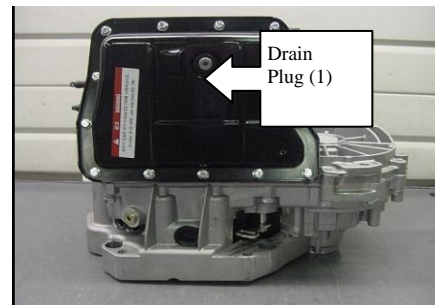

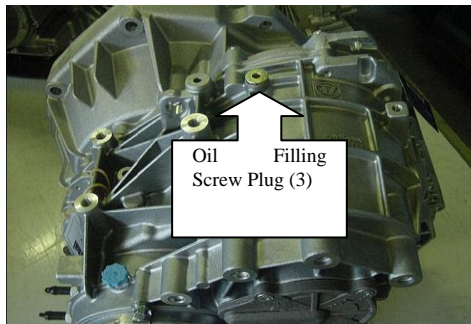

**Notes:** be careful not to overflow the oil when filling for the accelerator. If so, clear them immediately.

**Brake fluid and clutch fluid**

Check the fluid level in the brake fluid reservoir monthly. Two fluid reservoirs which distinguish according to type are respectively:

Brake fluid reservoir (all vehicle types)

Clutch fluid reservoir (limit to manual transmission).

Replace the brake fluid according to recommended driving time and mileage in

the periodical maintenance schedule. Make sure to use BYD AUTO brake fluid, or same grade product DOT3 or DOT4 from a sealed container. The brake fluid marked DOT5 is not compatible with your vehicle's braking system, and brake fluid of different types does not mixed use.

**Brake system**

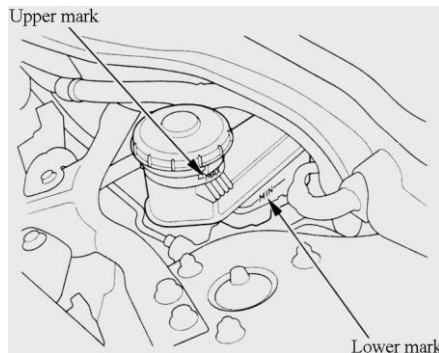

The fluid level should be between lower (MIN) and upper (MAX) marks on the wall of fluid reservoir. If the level is at or below the MIN mark, check braking system. Check braking system for leaks and brake

discs for abrasion.

**Clutch system  
(For manual transmission)**

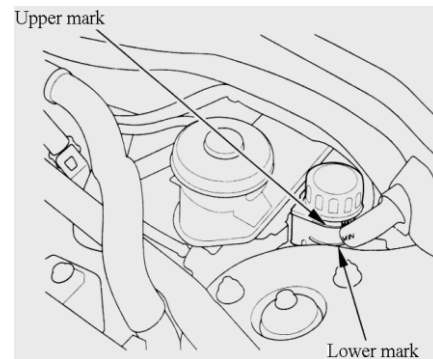

The fluid level should be between lower (MIN) and upper (MAX) marks on the wall of fluid reservoir. Otherwise, add clutch fluid to make the level up to this position. Please use the clutch fluid which is same to special fluid of braking system.

The level debasing means that the clutch system may have leak position check the clutch system as soon as possible.

## Power steering

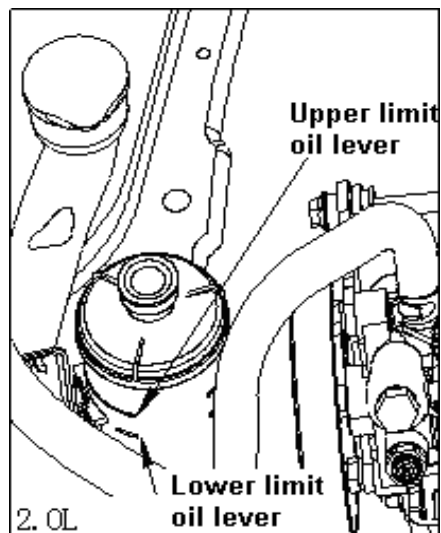

Check the fluid level in power steering fluid reservoir every one year, check the fluid level after the engine is cooling down. Look over the side of reservoir, the fluid level should be between upper level and lower level. If it is below lower level, add the

power steering fluid and make the fluid level up to the upper level.

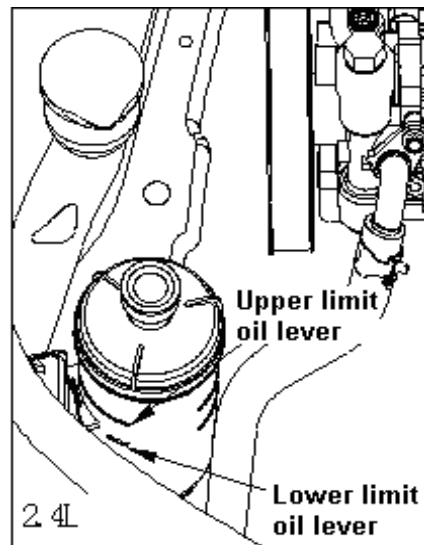

Power steering fluid level decreasing means that the power steering system may leak fluid. You should often check the fluid level position, and check the system as soon as possible.

### Notice

Make sure to only use Mobil ATF DEXRON®-III driving fluid, or ATF DEXRON-III as power steering fluid, use other type power steering fluid will damage the power steering system.

Pour the fluid slowly and carefully so you do not spill any. Clean up the spill immediately, it could damage components in the engine compartment.

If you do not know how to check the fluid level and add fluid, please contact with BYD authorized service station.

### Notice

Turn left or right the steering wheel to end, and lock it up on the position, it could damage power steering pump.

### **Air filter core**

Clean and replace the air filter core according to recommended driving time and mileage in the periodical maintenance schedule.

The air filter core installs in the air filter case on the driver side of engine compartment.

Clean inbreath compression air into air filter core through the opposite direction. If you can't obtain the compression air (as at service station), please let BYD authorized service station deal with it.

Disassemble and reinstall according to replacing working process.

### **Replacing**

1. Unscrew four bolts; disassemble the cover of air filter case.
2. Disassemble old air filter core.
3. Wipe the interior of air filter case with wet cloth carefully.

4. Install new air filter core into air filter case.

5. Reinstall the cover of air filter case, screw down four bolts.

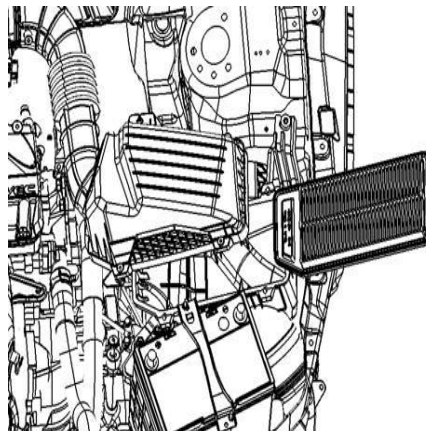

### **Fuel filter**

Replace the fuel filter according to recommended driving time and mileage in the periodical maintenance schedule.

When you find the fuel is polluting, because

the fuel filter will be plug more quickly, advise you to replace the fuel filter every 10,000 km or every 6 months.

You should invite qualified BYD AUTO mechanic to replace the fuel filter. Because there is pressure in fuel system, if all the fuel pipelines are not disposed correctly, the fuel maybe spray out, and pose a risk.

If you have used one more barrel impure fuel ever, you should replace the fuel filter more early. If you find the filter is plug with the feculence, you should invite BYD authorized service station to check or replace the fuel filter.

## Engine hood lock

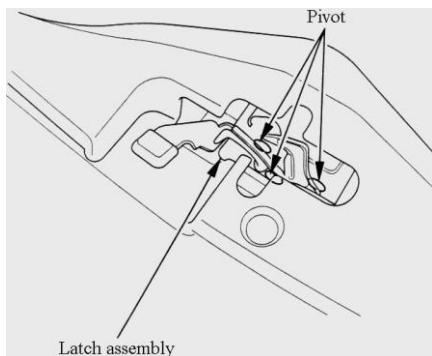

Use mellow detergent to clean the latch assembly of hood, and then wipe multipurpose lubricating oil. All active parts (showing as graph), including pivot, need to wipe lubricating oil. If you can't clean the latch and wipe lubricating oil by yourself, you should contact with BYD authorized service station.

## Spark plug (4G69S4M model)

### Replacing

Replace vehicle's spark plug according recommended driving time and mileage in the periodical maintenance schedule.

1. Clean up dunghill and oil crust aggregating around the ignition coil.

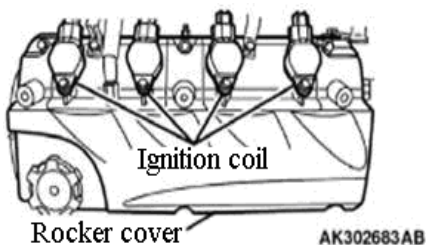

2. Press the lock plunger and nip the connector, pull off the lead connector on the ignition coil. Notice; nip the plastic end of connector, not the lead.

3. Disassemble the fixed ignition coil bolt with wrench; pull out the ignition coil lightly.

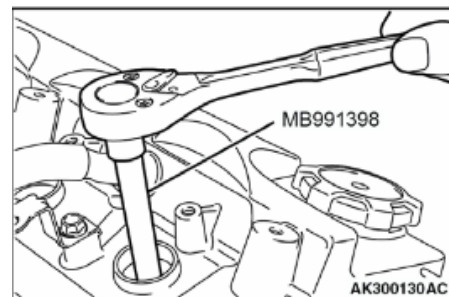

4. Get down the spark plug with spark plug sleeve.
5. Put new spark plug into spark plug sleeve, then install it into spark plug hole, screw down it by hand to avoid tripping off.
6. Screw down the spark plug with torque wrench (If you don't have torque wrench, screw down two thirds circle after spark plug is touching the head). Tighten torque: 25Nm



**Notice**

Make sure to screw down the spark plug carefully. Spark plug too loose can damage the engine because of too hot; and too tighten can damage the thread on the head.

7. Install the ignition coil into the hole and push down to the bottom, assemble the bolt.
8. Connect the lead connector with ignition coil. Make sure to lock up on the position.
9. Replace the other three spark plugs according to the steps above.

**Battery**

Check up the state of battery one time per month. You should check the color of test indicator window as well as the erodent extent of terminal.

**Friendly tip**

When work normally, the battery will produce explodable hydrogen. Spark or fire will make the battery explode, the energy of exploding can cause serious hurt even deadliness.

All spark, fire and tinder must go away from the battery.

When maintaining the battery, you must wear the protective clothing, veil or let the technician operate.

**Friendly tip**

There is the strong caustic and virulent vitriol (electrolyte) in the battery.

If the electrolyte spill into the eyes or on the skin, it will cause the serious burn. When dealing with the battery or working near the battery, you must wear protective clothing and blinkers.

When drinking the electrolyte because of mistake, if not adopt measure immediately, you maybe cause the deadly poisoning.

The battery should be located in the place to which the children can't reach.

**Emergency dealing with**

**Eye**— wash the eye at least for 15 minutes with water in cup or other container (pressure water will hurt your eyes), and cure.

**Skin**— take off the clothing polluted, wash skin with a great deal water, and cure.

Drinking because of mistake— drink the water or milk, and immediately cure.

Check up the test indicator window on the battery to inspect the state of battery. There is the mean of all the color of test indicator window on the battery label.

Check up the erodent extent of battery terminal (white or yellow powder). To remove it, should coat the saleratus on the surface of terminal, the terminal will produce the air bubble and gradually get brown, when hasn't the bubble, clean it by clean water, and make it dry with cloth or paper. Finally coat the grease on the surface of terminal to avoid eroding further.

If the terminal has a hard eroding, firstly clean it with saleratus water, then screw it with spanner and take cable out of terminal. Notice: be sure to disconnect the cathode; to fix it anew, must connect it finally. Clean it with the terminal cleaning tool or steel brush, anew connect it and fix it tightly, then coat grease on the surface of terminal.

To connect the battery with other chargers, disconnect the anode and cathode to protect the electrical system from hurting.

**Notice**

Charging but the cable is connected will damage the electrical device. Before connecting the battery with charger, firstly should disassemble the cable of battery.

If the battery is disconnected or the power is discharged, the setting of clock and channel will be canceled. Anew set them refer to the section of radio system.

**Notice:**

The battery is the device which mainly supplies power when starting the engine.

If long time to use the electrical equipment at the state the engine stops, that will make the battery discharge overly so that can't start the engine. Maybe make a serious damage to battery.

1. Don't use the electrical device at long time when the engine stops, such as radio system, navigation system (if equipped), AC blower, light system and so on.

2. If leaving the vehicle, make sure the doors and all the electrical devices (light and so on) are closed.

**Windshield wiper blade**

Check up the status of wiper blade at least one time per six months and whether the rubber has the crack or part revivification. If having these symbols, should replace the blade, or when using it, will have the stripe or unclean place.

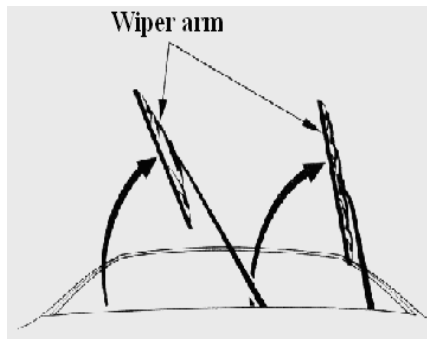
**The methods of replacing blade:**

1. Pull out the wiper arm from the windshield.

Firstly pull out the wiper arm of driver side, then the passengers'.

**Notice**

Don't open the engine hood when pulling out the wiper arm or it will damage the engine hood and wiper arm.

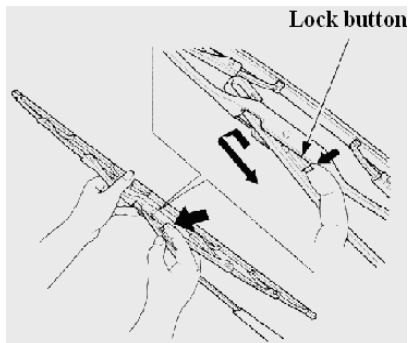

2. Press the locking button, disassemble blade assembly from the wiper arm. You should hold the blade assembly when push the blade assembly to the bottom of wiper arm.

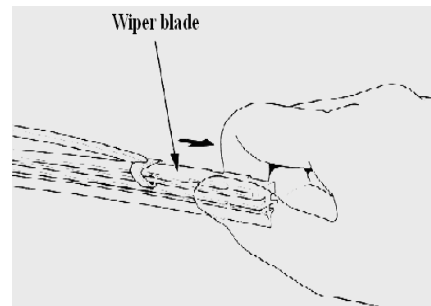

3. Hold the end which has the locking button of blade, take the blade from the holder. Pull it until the fixed button leaves off the holder.

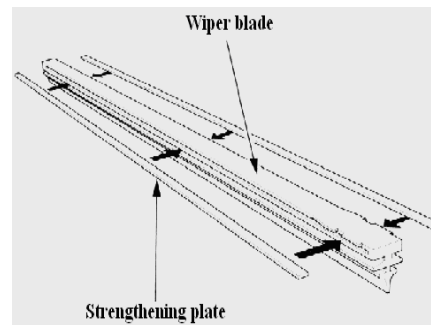

4. Check up new blader, if it hasn't the plastic which cling to rear edge or metal strengthening plate, please take out the old blades' and fix it to new blade.
5. Slide the new blade into holder until the locking button is locked.
6. Assemble the blade assembly to wiper arm and make sure to lock it to desired position.
7. Put wiper arm to windshield.  
Firstly put the wiper arm of driver side, then passengers'.

**A/C system**

AC system is a closed system; any maintenance must be made by the qualified technician. For making sure AC effectually work, you can make the following operation.

Termly check up the radiator of engine and A/C condenser. Remove the leaves, insect and dust which stay in the front surface of engine radiator and A/C condenser. They

will block the airflow so that lower the cooling effect. Clean them with the low pressure squirt gun or soft brush.

<b>Notice</b>
The condenser plate and radiator plate easily get curly. Only use the low pressure squirt gun or soft brush to wash.

When it is cold, open the A/C at least one time per week, and it is at least ten minutes each time, and make it when driving the vehicle uniformly and the temperature of engine is normal. It is the intention to circulate the lubricant in the coolant.

Compared with the former cooling effect, it is poor, maintain it in the BYD authorized service station. And add the HFC-134a (R-134a) into A/C system.

<b>Notice</b>
Whenever checking up the A/C system, you should request service shop to use circulating system of coolant. The system can recycle the coolant to avoid polluting the environment.

**Dust filter**

The dust filter can remove the dust which enters into the vehicle through the air circulation system.

Replace it according to the ruled time of termly maintaining table or driving distance. If you often drive the car in heavy smoke area, the period of replacing the dust filter should be shortened. If discharging of airflow isn't smoother than usual, you should replace the dust filter.

**Replacing**

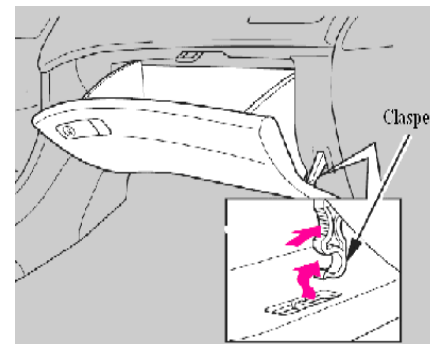

The dust filter is at back of the glove box.

1. Open the glove box.
2. Release the clasper of door side lying in glove box of front passenger.

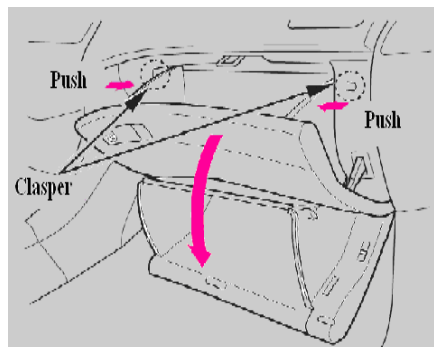

3. Push the panel of both sides of glove box, and lift the glove box.
4. Press the convex tongue on the box sleeve of dust filter, pull out the box sleeve.

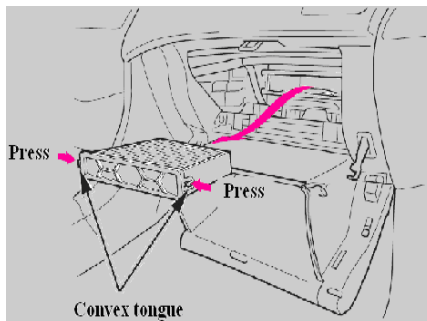

5. Disassemble the old filter from the box sleeve

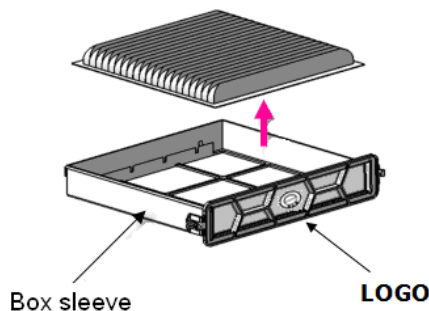

6. Assemble the new filter in the box sleeve. Make sure to properly locate BYD the "LOGO" on the box sleeve.

7. Finish the assembling of box sleeve. Make sure the both convex tongues lie in the right position.

8. Assemble the clasper of glove box, close it.

If you haven't the confidence to replace the dust filter yourself, ask for the BYD authorized service station.

### Driving belt

Check the driving belt status; check every belt's edge for cracking or abrasion. Mitsubishi 4G69S4M engine's automatic senility adjustment installation can adjust the senility of driving belt. The finger on it should be in appropriate range. Examine it according to recommended driving time and mileage in the periodical maintenance schedule.

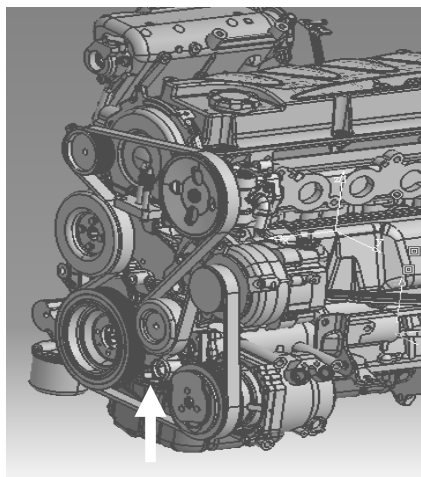

### Use tensility gauge

1. Check the tensility of driving belt.

2. Use a tensility gauge and put it in the middle of belt between belt plates to measure and confirm the belt tensility is in the standard value.

Standard value: 340-562 N

3. If it does not suit for the standard value, replace the tensioner.

If it is out of the appropriate range, or found wear evidence, you should invite BYD authorized service station to replace it.

BYD483QB engine adopts two multi-wedge belts. They are respectively used in driving generator and water pump, booster steering pump and A/C compressor. You should often check and adjust them.

Deficiency and damage of multi-wedge belt's the tensility will cause engine overheating and generated energy decreasing, and no booster for steering and refrigeration deficiency of A/C.

### 1. Adjustment method

Shut off the engine, screw down the adjustment bolt on position adjustment block of engine and on the booster steering pump.

### 2. Measure tensility

Showing position as Picture 2, press 98N to the multi-wedge belt, the press amount of it should be between 6mm~9mm.

If it isn't in this arrange, you should invite BYD authorized service station to replace driving belt.

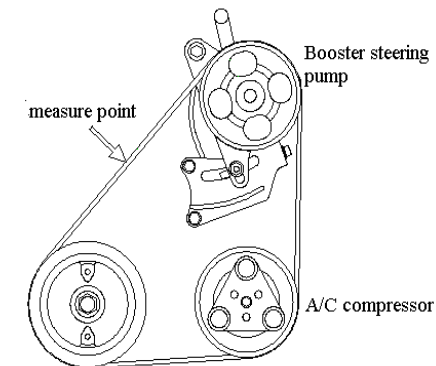
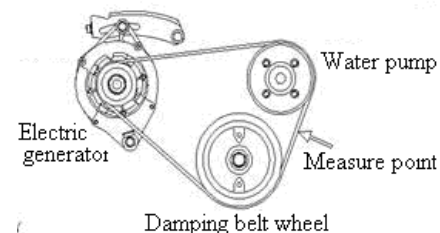

## Timing belt

Replace timing belt according to recommended driving mileage in the periodical maintenance schedule.

## Tire

To safely drive your vehicle, your tires must be the proper type and size, in good condition with adequate tread and correct tire pressure. The following pages give more detail information on how to and when check the tire pressure, and how to check the damage and abrasion of tires, and the operation method when replacing tire.

### Friendly tips

Using tires that excessive abrasion or tire pressure deficiency can cause a crash in which you may be seriously hurt or killed.

### Notice

Follow all instructions in this owner's manual regarding tire charging and maintenance.

## Tire charging

Keeping the tires properly charging provides the best combination of handling, tread life and riding comfort. Charging deficiently of tires wear unevenly, adversely affect handling and fuel economy and more likely to fail from being overheated. Charging excessively of tires can make your vehicle ride more harshly, are easier to damage from road hazard, and wear unevenly.

Advice that you visually check your vehicle every day. If you think a tire might be low, check it immediately with a tire gauge.

Use a gauge to measure the tire pressure in each tire at least once a month. Even tires that are in good condition may lose 7 to 15kPa (0.07 to 0.15kgf/cm) per month.

Remember to check all the tires at the same time including spare tire.

Check the tire pressure when the tires are cold. This means the vehicle has been parked for at least 3 hours. If you must measure it before driving, the tire can still be considered as cold as long as driven less than 1.6km.

If you check tire pressure when the tires are hot (driven for several miles), you will see readings 30 to 40kPa (0.3 to 0.4kgf/cm) higher than the cold readings. This is normal. Do not let air cut to match the recommended cold tire pressure; it will cause the tire pressure deficiency.

You should get your own tire pressure gauge and use it whenever you check your tire pressure. This will make easier for you to judge if a pressure loss is due to a tire problem and not due to a variation between gauges.

Recommended tire pressure  
Refer to the tire placard on driver's doorjamb for correct tire pressure.

When tire without inner tube is implanted, it has self-closed function. However, leakage is usually very slow. So you should look for the leakage position as long as the tire begins to decrease pressure.

**Inspection**

Every time you check tire charging condition, you should also examine the tires for damage, foreign objects, and abrasion.

You should look for:

1. Damage and bulges in the tread or side of the tire. Replace the tire if you find either of these conditions.
2. Cuts, splits or cracks in the side of tire. Replace the tire if you see fabric or cord.
3. Excessive tread wear.

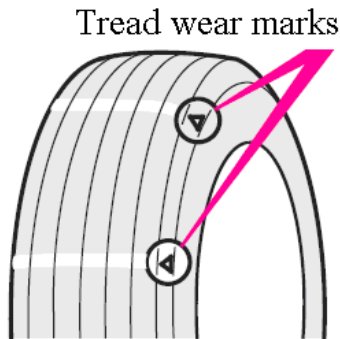

Your tires have wear marks molded into tread. When the tread wears down, you will see a band wide across the tread. This shows there is less than 1.6mm of tread left on the tire. A tire this worn gives very little adhesive force on wet road. You should replace the tire if you see three or more tread wear marks.

**Maintenance**

In addition to properly charging, correct wheel alignment helps to decrease tire wear. If you find a tire is worn unevenly, invite BYD authorized service station to check the wheel alignment condition.

The tire has been balanced before leaving factory, but before the tire is worn down, sometimes, maybe need to rebalance the tire. If you feel a consistent vibration while driving, you should invite BYD authorized service station to check the tires. If some tire ever has been repaired, make sure to rebalance the tire.

When you have new tires installed, make sure they are balanced. This increases riding comfort and tire life. Your vehicle's original tires have the dynamic balance or "idle"

balance done before leaving factory. You had better let the installer perform a dynamic balance.

**Notice**

Improper wheel balancer will damage your vehicle's aluminum alloy wheel. So use only BYD AUTO balancer to keep balance.



**Tire transposition**

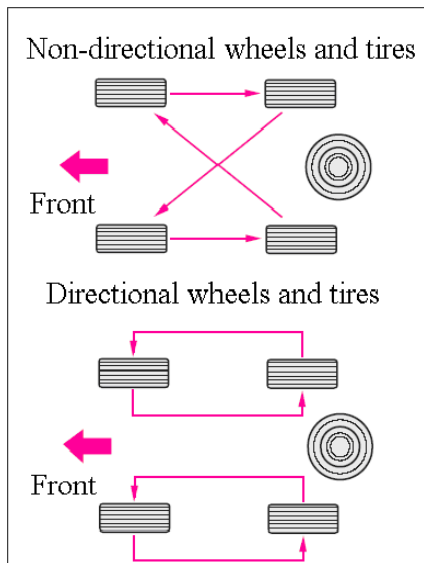

To help increase tire life and wear more evenly, change the position of tires every 10,000 km. You should move the tires to the position showing above every changing position.

The picture above shows how to change vehicle's tire position which doesn't have standard spare tires.

When you buy and replace tires, you may find some tires are "directional", this means this kind tire is designed into only one direction changing. If you use directional tires, they can only exchange front and rear wheels when changing tire position.

If you use standard spare tires when changing position, please refer to the right picture.

If the spare rim is different to the using tire rim, advice not to change the position.

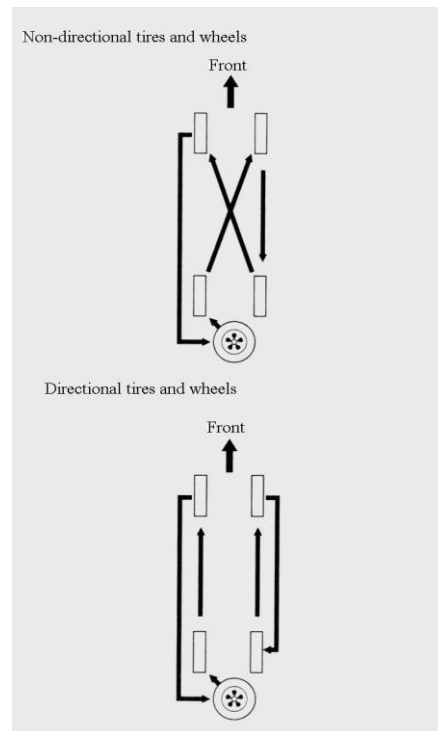

### Replace tire and wheel

The vehicle's original tires is chose to furthest play the vehicle performance, they can provide the best combination of handling, tire life and riding comfort at the same time. You should choose radial tires to exchange which have same size, load range, speed rating, and maximum cold tire pressure (marked on the side of tire). Mixing using radial and bias-ply tires can reduce braking ability, driving force (adhesive force) and steering accuracy.

Installing improper tires on your vehicle can affect your vehicle's handling agility and stability. This can cause a crash in which you can be seriously hurt or killed.

It is best to replace all four tires at the same time. If that is not possible or necessary, replace the two front tires or rear tires as a pair. Replacing just one tire can seriously affect your vehicle handling.

ABS is working by comparing wheel speed. So when replacing the tires, you should use the tire whose size is same to vehicle's original wheel. The size and structure of tire can affect the speed, and cause system's

action in coordination.

If you need to replace wheel, make sure that the wheel's specifications match those of the original wheels. Replacement new wheels are available at BYD authorized service station. Before replacing the tires, you should refer to BYD authorized service station.

Wheel and tire

Wheel size:

15\*6  $\frac{1}{2}$  JJ

16\*6  $\frac{1}{2}$  JJ

Tire size:

205/65 R15

205/60 R16

Refer to the tire placard on driver's doorjamb.

### Winter tire

Because the summer tire's applicability is limited, advice to use winter tires (M+S tire) on ice and snow pavement. If install the

M+S tires, all wheels should be installed to insure safety driving. You can only use tire with same brand and same form. When buying, you should pay attention to tire's size, load range and speed rating.

Install the winter tires according to the marks on the register card. When installing tires according to tire regulations of EEC, if vehicle original designed speed exceeds the Max. permissible speed of winter tire, you should stick a label to one position which the driver can be easy to see, writing the MAX. permissible speed of winter tire. The tire dealer can supply this kind of labels. If you have questions, please refer to BYD authorized service station.

### Tire chains

Snow tire chains are used only for emergency or in the special area where they are required by driving condition or local laws. Install them only on the front wheel. You need more careful when you drive your vehicle with snow tire chains on ice and snow pavement. Comparing with the high-grade winter tire without chains, the forecasting and handling of the tire with

chains is quite worse. Some chains may also damage vehicle's tire, wheel, suspension and body. You should choose with chains to make enough free space between tire and other parts in the wheel cowl. Look over and read parts assembly graph and other instructions of chain factory carefully. Before you want to buy chains and install them on the vehicle, you should refer to BYD authorized service station.

After installing the chains, the speed driving on the ice and snow pavement should be below 30 km/h. To furthest lighten the wear of tires and chains, you should avoid driving with the tire installed chains on the pavement without ice and snow.

## Light

### Headlight aiming

When the vehicle left the factory, the headlight aiming has been finished. If often catch heavy with the trunk, the headlight need aim anew. The headlight aiming must be finished by the BYD AUTO company or other qualified technicians.

### Replacing the bulb of headlight

There are both headlight halogen bulbs at the both sides of the vehicle. Replacing the bulb, hold its steel bottom mount, avoid the skin or hard thing touching the bulb, if you have touched bulb, clean it with metamorphic alcohol and clean dishcloth.

Notice
When the headlight is on, it will get scorching. The grease, sweat or scratch on the surface of bulb will cause the crack for overheating.

### High beam

1. Pull out the key from the ignition switch, open the engine hood. If need replace the bulb of driver side, should disassemble the battery. To replace the bulb of driver side, make the next step.



2. Press the reed; pull out the connector of electric device.



3. Pull out the sealing cover.

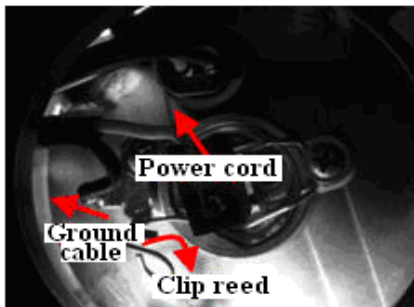

4. Pull out ground cable and power cable, press the clip reed and pull out it. Take out the bulb.

5. Replace the bulb, press the clip reed and push it into the fixed frame, and must make sure the bulb is locked.

6. Plug the power cable and ground cable, make sure they are fully connected, and don't loose.

7. Close the sealing cover.

8. Connect the connector of electric device, make sure it is well connected.

9. (Driver side)  
Install the battery.

10. Open the headlight to test the new bulb.

**Low beam**

1. Pull out the key from the ignition switch, open the engine hood. If need replace the bulb of driver side, should disassemble the battery. To replace the bulb of driver side, make the next step.

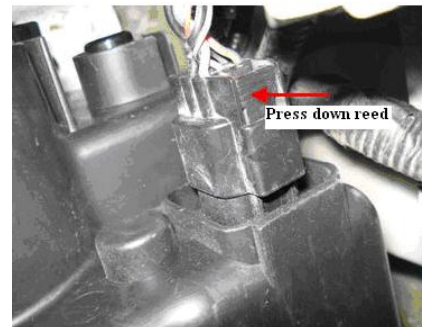

2. Press the reed, pull out the connector of electric device.

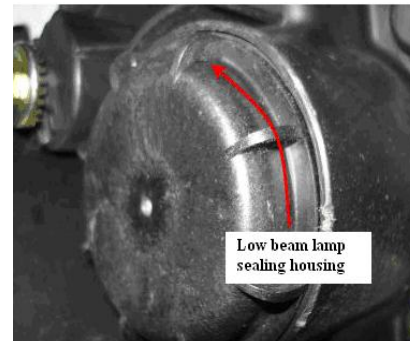

3. Rotate out the sealing cover.
4. Pull out the ground cable and power cable, then press the clip reed and pull out it, and take out the bulb.
5. Replace the bulb, press the clip reed and push it into the fixed frame, make sure the bulb is locked.
6. Plug the power cable and ground cable, make sure it is fully connected, and don't loose.
7. Rotate in the sealing cover.
8. Connect the connector of electric device; make sure it is well connected.
9. (Driver side)  
Install the battery.
10. Open the headlight to test the new bulb.

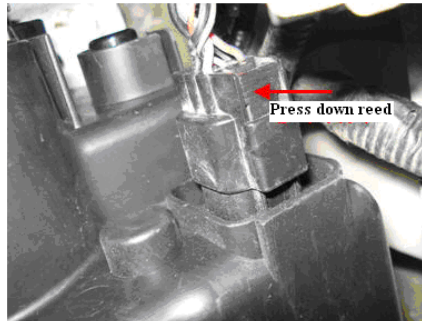
**Front position light**

1. Pull out the key from ignition switch, open the engine hood. To replace the bulb of driver side, disassemble the battery. To replace the bulb of driver side, make the next step.

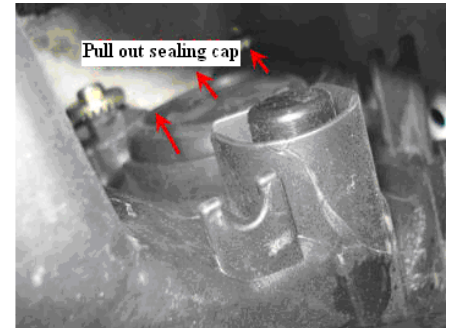

2. Press the reed, pull out the connector of electric device.

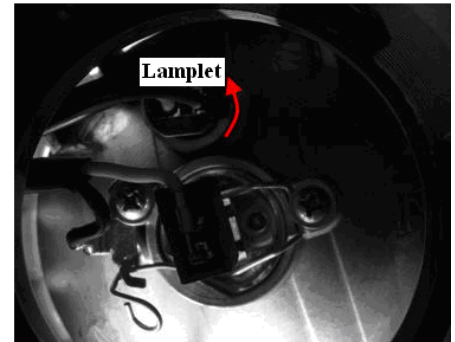

3. Pull out the sealing cover of high beam.
4. Contrarotate the mount of small light for quarter circle. Take out the small light.
5. Take out and replace the bulb of small light.
6. Rotate small light clockwise, and make it reach to proper position.
7. Close the sealing cover.
8. Connect the connector of electric device; make sure it is well connected.
9. (Driver side)  
Install the battery.
10. Open the headlight to test the new bulb.

### Front turning light

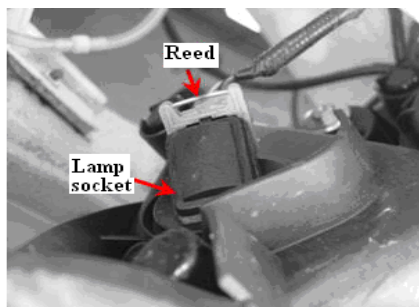

1. Pull out the key from the ignition switch, open the engine hood.
2. Press the reed and pull out the connector of electric device.
3. Contrarotate the mount for quarter circle, and disassemble it from headlight assembly.
4. Pull out the bulb from the mount directly.
5. Fix the bulb into the mount until it reaches to bottom of mount.

6. Fix the mount back to headlight assembly. Rotate it clockwise and make it locked to the proper position.

7. Test the light to make sure whether the new bulb works normally.

### Replace front fog lamp bulb

The bulb is halogen bulb. To replace bulb, hold its plastic sleeve and avoid your skin or hard thing touching the bulb. If touch the bulb, clean it with the metamorphic alcohol and clean dishcloth.

<b>Notice</b>
<p>When the halogen bulb is on, it will get scorching. The grease, sweat or scratch on the bulb will cause crack for overheating.</p>

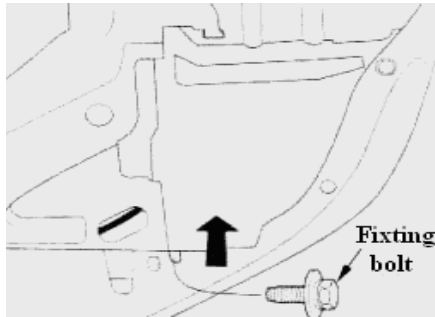

1. Disassemble the fixing bolt of bottom cover under front bumper.

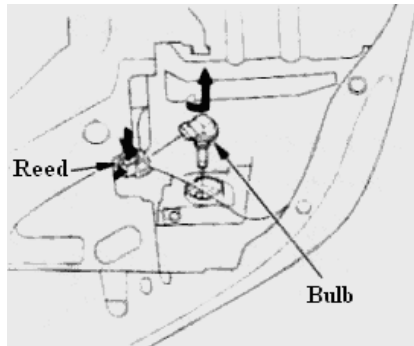

2. Push the bottom cover.
3. To disassemble the connector of electric device from the bulb, push the both sides reed of connector of electric device, and pull the connector down.
4. Contrarotate bulb for quarter circle and disassemble it from front fog lamp assembly.
5. Fix the new bulb to front fog lamp assembly. Rotate it for quarter circle clockwise, and make it locked to proper position.
6. Connect the connector of electric device to new bulb; make sure it is well connected.
7. Open front fog lamp, make sure whether the new bulb work normally or not.
8. Fix the bottom cover, and fix the fixing bolt and make it tight.

**Replace rear turning light/reversing light/fog lamp**

**Inner decoration clamp**

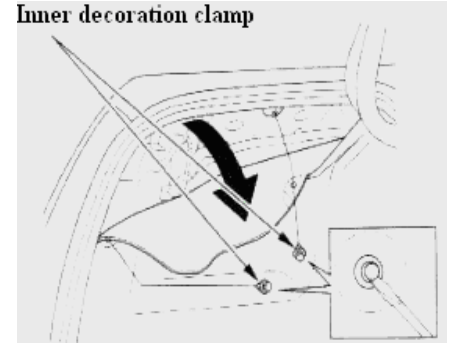

1. Open trunk.
2. Prize the interior trimming panel of trunk, and disassemble buckles of L/R corner. Carefully lift a corner of trunk, and let the light mount appear.

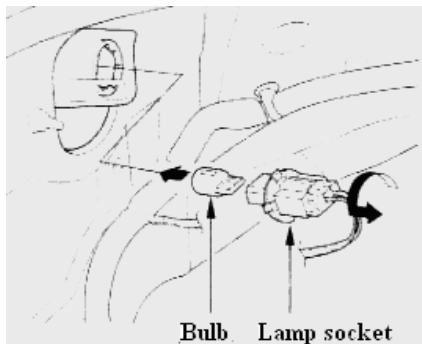

3. Contrarotate the mount for quarter circle, and disassemble it.
4. Directly pull out the bulb from the light mount. Fix new bulb.
5. Anew fix the mount back to light assembly, rotate it clockwise until it is locked to proper position.
6. Test new bulb to make sure whether the bulb work normally.
7. Fix the interior trimming panel of trunk back to original place.
8. Push the interior trimming buckle into the hole.

**Replace rear license plate light bulb**

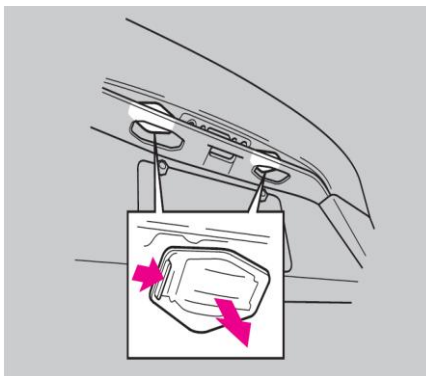

1. Open trunk
2. Prize the interior trimming panel of trunk covers carefully, and disassemble the interior trimming buckle of L/R corner.

Carefully lift a corner of interior trimming panel of trunk cover and make the mount appear.

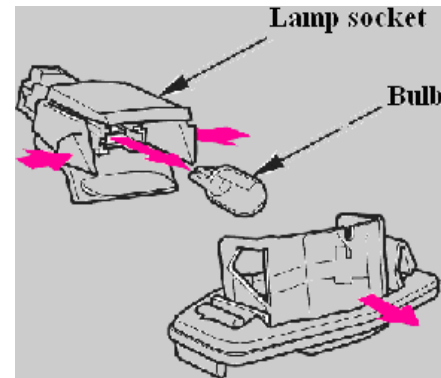

3. Pinch the lock button of light mount tightly; disassemble the mount from the light assembly.
4. Pull out the bulb. And fix well new bulb.
5. Test new bulb to make sure whether the new bulb work normally.
6. Fix the mount to original place and make it locked to proper position.
7. Fix the interior trimming panel of trunk cover to original position.



Push the interior trimming buckle into the hole.

### **Replace reading light bulb and door light bulb**

Disassemble the door light and interior light with the same method. But they are different kinds of bulbs.

1. Prize the edge of lense light shield carefully, take out the light shield. Don't prize the edge of light shield protective jacket.
2. Take out the bulb from the metal clip jacket directly.
3. Fix well the new bulb and fix the lense shield to original position.

### **Rear reading light:**



### **Prize the front of both sides lense light shield**

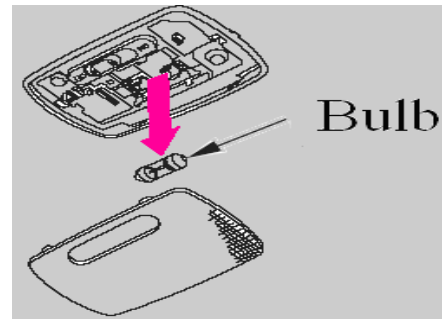

**Door light:**

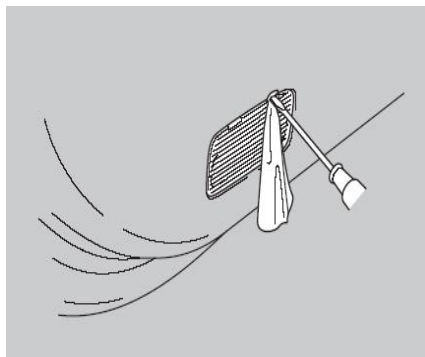

**Prize the up center of lense light shield.**

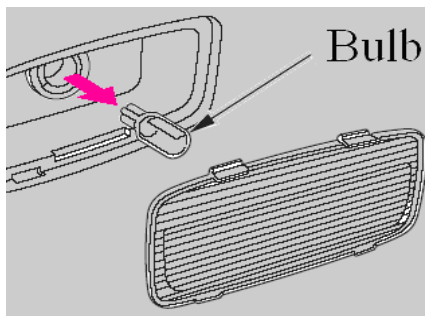

**Front reading lamp:**  
**Prize the front-edge of both sides reading lamp.**

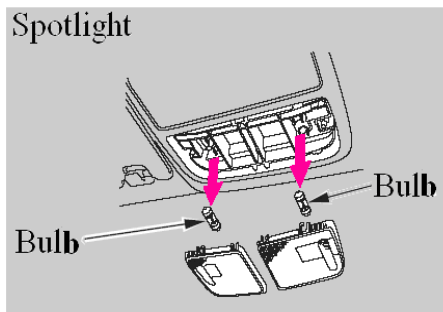

**Make-up mirror light:**

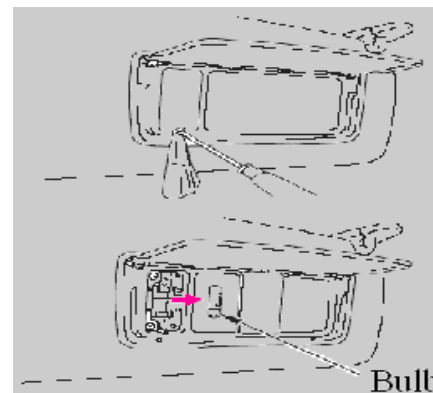

### Replace trunk light bulb

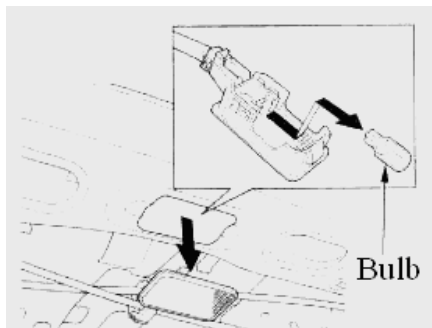

1. Open trunk.
2. Underlay a piece of cloth to left side of trunk light assembly. Prize the assembly carefully and disassemble it.
3. Pull out the bulb from its mount, and fix new bulb well.
4. Fix well the light assembly. Firstly push its right side, and push the left side until you hear a click sound.

### Vehicle storage

If park your vehicle for a long time (over one month), refer to the following step. The step is useful to prevent vehicle from deteriorating and easy to rerun it. If possible, park it indoor.

1. Add fuel.
2. Replace the engine oil as well as filter (refer to 101st page).
3. Clean and dry the body thoroughly.
4. Clear the interior to make carpet dry.
5. Release the parking handle. Set the transmission to reverse gear (manual transmission) or parking gear (automatic transmission).
6. Ward off the rear wheel.
7. To park your vehicle for a long time, should support it with jack to make it off the earth.
8. Open a window appreciably (park it indoor).

9. Disconnect the connection of battery.

10. Underlay towel or cloth to front wiper arm to avoid touching the windshield.

11. For decreasing the adhesion, spray the silicon ketene lubricant to the weather sealing position of all doors and trunk, and coat the wax on the connective position of sealing strip of door and trunk.

12. Cover the body with ventilating dress which is made of cotton cloth, and the plastic cloth will hurt the body paint because it will accumulate hydrosphere.

13. If possible, should start the engine one time per month.

If your vehicle park for a year or longer, before starting it, you should call the BYD authorized service station for a checkup of two years per 40000 kilometers (refer to 96<sup>th</sup> page). If the driving mileage or time has got to the ruled value of periodic maintenance table or it isn't necessary to replace the parts.

## Appearance maintenance

Often washing and wiping your vehicle is useful to keep its appearance brand-new. The section will introduce how to wash your vehicle as well as how to keep its appearance clean (including paint, polishing, wheel and interior). Meanwhile there are some suggestions about anti-rust.

Washing.....	135
Cere care .....	135
Alloy wheel.....	136
Painting repair.....	136
Interior maintenance .....	136
Carpet.....	136
Floor cushion .....	136
Fabric .....	136
Nylon .....	137
Leather (optional).....	137
Seat belt.....	137
Window .....	137
Air freshener .....	137
Anti-rust.....	137

## Washing

Often washing vehicle is useful to its appearance. The dust and grit can hurt the paint, leaves and dung can damage the body finish permanently.

Wash your vehicle in the cool place. Can't wash it in the sun. If park your vehicle in the sun for a long time, before washing it, drive it to the cool place, when it gets cool, wash it. Only use the solvent and cleanser which are recommended in the "owner's manual".

Notice
<p>Chymist solvent and strong cleanser will hurt the paint, metal and plastic parts. Washing the engine chamber with high pressure has bad hurt, not only hurt the engine ECU, but also hurt sensor etc.</p>

1. Wash your vehicle with cold water thoroughly to remove floating dust.
2. Fill a barrel of cold water, mix special cleanser into it.

3. Repeat wash your car with water, cleanser and rub it with soft brush, sponge or soft cloth from roof to bottom.

4. Check up whether there is ordure such as pitch or tree liquid on the body. Remove the ordure with pitch leaner or turpentine, then wash it with clean water to avoid hurting the body finish.

5. After finishing, rub it with soft cloth. Naturally drying it will make the body lose polish or form water mark.

Dry the body meanwhile checks up whether there is the symbol of dropped paint or nick. The position is easy to be eroded. If finding it, repair it with the repair paint (refer to 139<sup>th</sup> page).

## Cere care

Cering must be made after washing and drying the vehicle. For preventing the body appearance from accumulating water, should cere the body and aglet. After cereing, the accumulating water will become the drip or bead.

You should use the high quality liquid cere or mushy cere. When using, you should refer to the specification of container. There are following two kinds of products:

Protection cers—— coated on the paint to protect it from sun shining and air polluting. Should coat this cere on the new vehicle.

Polishing cere——it is the mixture of polishing cere and cleanser or paraffin that make the paint that is oxidized or lose polish anew give off reflect. Generally speaking, the cere includes soft rubbing powder and solvent, it can remove the surface layer of paint. If it can't make the paint resume original reflect after cering the protection cere, should coat the polishing cere.

With cleanser removing the ordure such as pitch and insect etc will cause dropping cere. Notice: Even if the other parts needn't cere, must anew cere on the parts which drop cere.

## Alloy wheel

When cleaning other exterior parts, meanwhile you should clean the alloy wheel. After cleaning them with the same solution, wash them thoroughly.

There is a transparent protective layer to avoid aluminum eroding and rusting. The bad chemicals or hard brush will hurt the protective layer. Only use the neuter cleanser and soft brush or sponge to wash wheel.

## Painting repair

Check up whether there is the symbol of dropping paint or nick on the body. If exist the symbol, immediately repair it to avoid metal of hurt position being eroded. The painting repair only repair a little piece of dropping paint or nick, as to the big area dropping paint, you should call for professional technician.

## Interior maintenance

### Carpet

Often vacuum the dust on the carpet. If there is too mush dust, it will increase the hurt of carpet. Periodically washing it with

detergent can keep carpet like new. You should use bubble carpet cleanser. According to its use specification, dip it with the soft brush or sponge. For keeping carpet dry as soon as possible, don't add water in the cleanser.

## Floor cushion

(Self fixing)

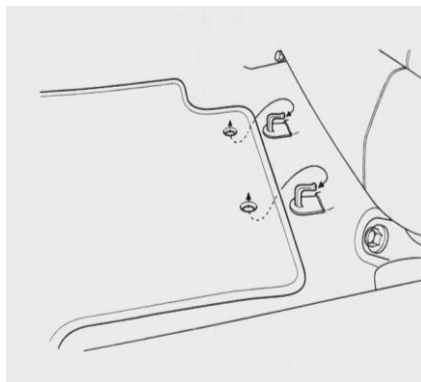

The floor cushion of driver side can be hooked by fixing bolt, it can avoid interrupting the operation of pedal for the floor cushion sliding forward. The fixing

bolt isn't standard equipment.

The fixing method of fixing bolt should refer to the fixing specification.

When assembling the floor cushion, you should make sure it is hooked tightly.

To replace it, please use the special floor cushion. The cushion can be hooked by the fixing bolt which is fixed in the vehicle.

To fix other floor cushion on the floor of driver side, you should make sure it has the proper size and can be hooked tightly by the fixing bolt. Don't add additional cushion, or will interrupt the operation of pedal for the additional cushion sliding forward.

## Fabric

Vacuum the dust and ordure on the fabric. When washing, can use the lukewarm neutral suds, then dry it in the air. To remove the hard ordure, use the fabric cleanser. Before using it, you must try out it to make sure it can't cause the fabric fading or coloration. Abide the operation of cleanser use specification.

## **Nylon**

Vacuum the dust and ordure. Wash and wipe the nylon with soft cloth with neutral suds. Remove the harder ordure with the bristle brush with the same suds, also use spray or bubble nylon cleanser.

## **Leather (optional)**

Vacuum the dust and ordure, especially the wrinkle and joint. Clean the leather with soft cloth dipping clean water, then, furbish it with dry cloth. If need further wash, use the special soap to wash, for example the leather cleaning soap. Coating the soap on the soft cloth with water to wipe the leather, and furbish it by the above method.

After wiping the leather by eradicator, wipe and dry it by soft cloth as soon as possible. Don't put the dishcloth with eradicator at the any interior parts for a long time. Some eradicator can make the rosin or fiber of fabric to fade or rupture.

## **Seat belt**

If the seat belt is dirty, wash and wipe it with soft brush with neutral warm suds. Don't use bleaching powder, dye or clean

solvent; they can lower the durability of seat belt. Before driving, should dry seat belt naturally.

If there is too much dust on the ring of seat belt, which will cause the reaction of seat belt slow. And wash and wipe the inner side of ring with clean cloth with neutral warm suds or isopropyl alcohol.

## **Window**

Clean the outside of window with glass detergent, also can using the mixture of vinegar and water, whose proportional is one to ten. The mixture can remove the mirage of window interior. Finally wipe and dry surface of all glasses and plastic with soft cloth or paper.

### **Notice:**

The heating wire of rear window defogging device and lead of antenna is fixed on the glass of rear window interior side, if wiping it strongly, make it move or rupture. So when wiping rear window, you should wipe it lightly and along the left and right side.

## **Air freshener**

To use the deodorizer or air freshener, it is better to choose the solid. Some air freshener includes chemical component which will make the interior trimming and fiber of fabric rupture or fade.

To use liquid air freshener, make sure to fix it properly to avoid air freshener spilling when driving.

## **Anti-rust**

Generally speaking, there are two reasons for vehicle eroding:

1. The moisture accumulates in the hole of body. The mud and proof-freeze salt which accumulates in the clearance of vehicle bottom easily accumulates moisture and make the parts easilier eroded.
2. Scaling off of protective layer and paint of body surface and vehicle bottom.

There are many kinds of anti-dust measures on your vehicle. Making some simple periodic maintenance is helpful to avoid vehicle eroding.

1. Immediately repair when finding the dropping of paint and nick.
2. Check up and wash door as well as osculum under the body.
3. Check up the humidity of floor dress. The carpet and floor cushion will keep the humidity for a long time, especially in winter. Moisture will make the floor eroded.
4. Wash the body bottom with high pressure squirt gun. It is important for the vehicle which running on the road with proof-freeze salt in winter. It is a good method to the area where climate is wet and often has the sea breeze. Carefully protect the ABS wheel sensors and connect them with all wheels by wire.
5. You should repair and check up the anti-dust layer of vehicle bottom periodically.



## Emergent malfunction solution

Emergent Traction.....	156
CVT transmission: .....	157

This section includes some common problems that the driver often experiences when driving. And it will tell you how to judge and dispose correctly when you meet these problems. The problem has stranded you on the side of road, you may be able to get going again according to the knowledge. If you can not still eliminate the malfunction, you will also find instructions getting your vehicle towed.

Replace a flat tire .....	140
If engine can't start .....	144
Can't start engine or starter running slowly.....	144
Starter running normally .....	144
Pushing car to start engine .....	145
Engine overheating .....	146
Engine oil pressure indicator.....	147
Battery charging indicator.....	148
Brake system indicator.....	149
Close power sun roof .....	150
Check and replace fuses.....	151

## Replace a flat tire

If you have a flat tire while driving, stop in a safe place to change it. It's dangerous to stop in the center of road or at heavy traffic shoulder.

Drive slowly along the shoulder until you get to an exit or an area that is far from the traffic lanes.

### Notice

The vehicle can easily roll off the jack, seriously injuring anyone underneath. Make sure follow the directions for changing a tire exactly. Never get under the vehicle when it is supported only by the jack.

1. Park the vehicle on firm, level and non-slippery pavement. Put the transmission in Park (AT vehicle model) or in Reverse (MT vehicle model), and apply the parking brake.

2. Turn on the hazard warning lights, and turn the ignition switch to LOCK (0) position. Have all passengers get out of the

vehicle while changing the tire.

3. Open the trunk. Raise the trunk floor by lifting up on the back edge.

4. Take the tool tray out of the trunk, and take the tools out of the tool tray.

5. Unscrew the wing bolt and take the spare tire out of trunk.

6. Put plug woods in front and back of tire which shows the diagonal line to changed tire.

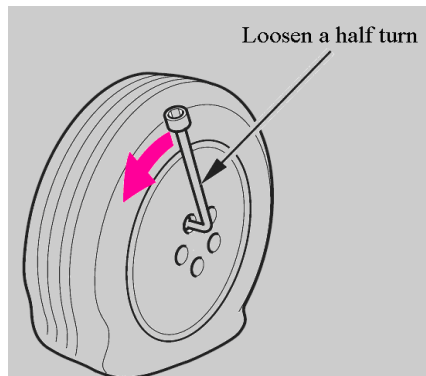

7. Loosen the wheel nuts 1/2 of a turn with the wheel wrench.

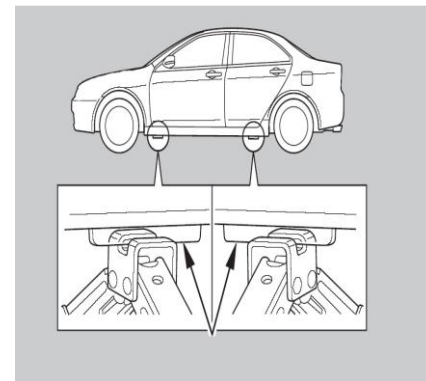

8. Find out the jacking point nearest the tire which you need to change. Place the jack under the jacking point, and turn the end bracket clockwise until the top of the jack contacts the jacking point. Make sure the jacking point tab is resting in the jack notch.

**Notice**

Use spare jack following vehicle. If you want to use the jack to lift other vehicles or use other jack to lift you vehicle, the jack or your vehicle may be damaged.

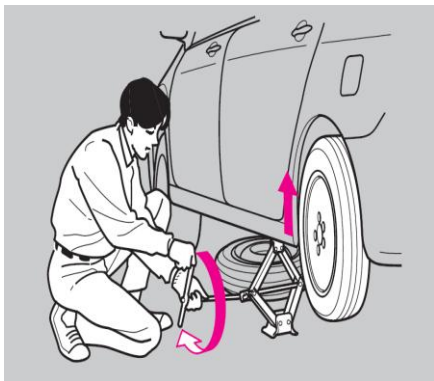

9. As shown, use the extension and wheel wrench to raise the vehicle until the flat tire is off the ground.

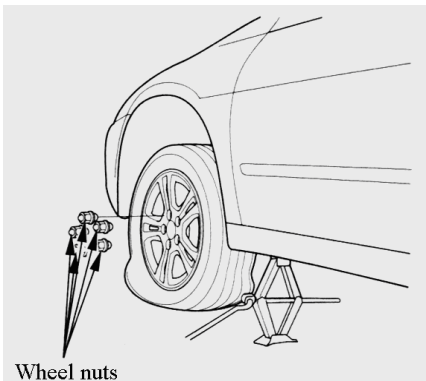

10. Remove the wheel nuts, make sure to be more careful while operating, the nuts may be hot from driving.



11. Remove the flat tire. Place the flat tire on the ground with the outside surface of the wheel facing up.

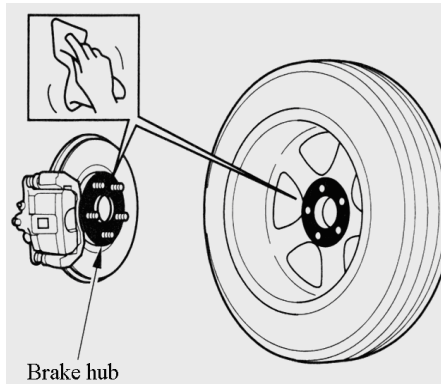

12. Before installing the spare tire, wipe any dirt off the installation surface of wheel and brake hub with a clean cloth. Wipe the hub carefully; it may be hot from driving.

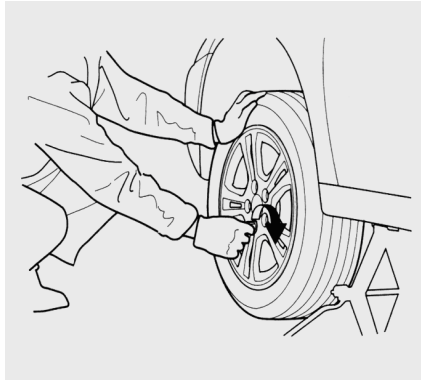

13. Put on the spare wheel. Put the wheel nuts back and screw them lightly by hand, then tighten them in a crisscross pattern with the wheel nut wrench until the wheel is firmly against the brake hub. Do not try to tighten them fully.

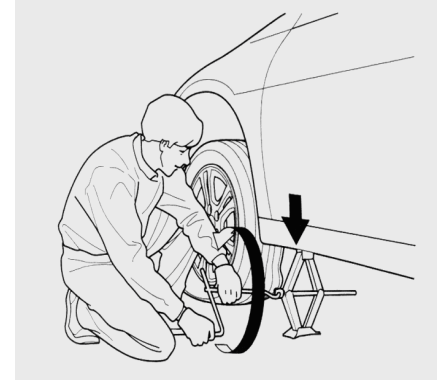

14. Lower the vehicle to the ground, and remove the jack.



15. Tighten the wheel nuts seriously in the same crisscross pattern. Have the wheel nut torque checked at the nearest authorized service station.

Tighten torque of wheel nuts: 108 Nm (11 kgf•m)

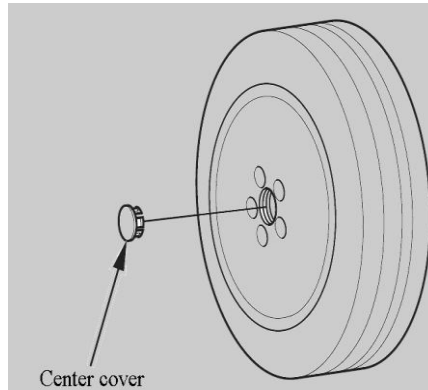

16. You need to remove the wheel's center cover before put the flat tire in the trunk.

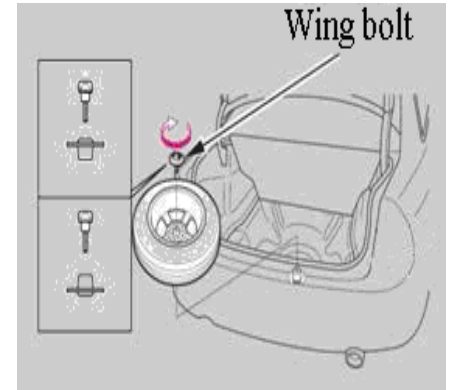

17. Place the flat tire face down in the spare tire well.

18. Screw the wing bolt back to the flat tire's screw hole, and fix it.

#### Friendly tips

Loose items can fly around the interior in crash and could seriously injure the occupants.

Store the wheel, jack and tools securely before driving.

19. Store the center cover in the trunk, make sure it does not get scratched or damaged.

20. Lower the trunk floor, and then close the trunk lid.

### **If engine can't start**

Diagnosing why the engine won't start falls into two areas depending on what you hear when you turn the ignition switch to the START (III) position:

1. You hear nothing, or almost nothing. This means that the engine's starter motor does not operate at all, or operate very slowly.

2. You can hear the starter motor operating normally or the starter motor sounds like it is spinning faster than normal, but the engine does not start up and run.

### **Can't start engine or starter running slowly**

When you turn the ignition switch to the START (III) position, you don't hear the normal sound of the engine trying to start. You may hear a clicking sound or series of clicks, or nothing at all.

Check these things:

On the vehicle installing AT  
Make sure the position of shift lever, the shift lever must be in Park or Neutral.

On the vehicle installing MT

1. The clutch pedal must be pushed all the way to the floor, or the starter will not operate, and it may damage the starter.

2. Turn the ignition switch to the ON (II) position. Turn on the headlights, and check their brightness. If the headlights are very dim or do not come on at all, the battery is discharged. At this time, see Jump Starting on 148<sup>th</sup> page.

3. Turn the ignition switch to the START (III) position. If the headlights do not dim, check the condition of the fuses. If the fuses are OK, there is probably something wrong with the electrical circuit for the ignition switch or starter motor. You will need a qualified technician to determine the problem (Emergency Towing on 159<sup>th</sup> page).

If the headlights dim noticeably or got out when you try to start the engine, either the battery is discharged or the connections are

corroded. Check the condition of the battery connections (refer to 118<sup>th</sup> page). You can then try jump starting the vehicle from a booster battery (refer to 148<sup>th</sup> page).

### **Starter running normally**

In this case, the starter motor's speed sound normal or even faster than normal, when you turn the ignition switch to the START (III) position, but the engine does not run.

1. Are you using the proper starting procedure? Refer to the starting the engine on 86<sup>th</sup> page.

2. Do you have fuel? Turn the ignition switch to ON (II) position, stop for one minute, then check the fuel gauge. The lower fuel indicator may not be working, so it does not remind you to add fuel.

3. There may be an electrical problem, such as no power to the fuel pump. Check all the fuses (refer to 158<sup>th</sup> page).

If you find nothing wrong, you will need a qualified mechanic to find out the problem. See Emergency Towing on 162<sup>nd</sup> page.

## Pushing car to start engine (for model with manual transmission)

If the vehicle's battery is discharged, maybe you can use a booster battery to start the engine. Although this seems like a simple procedure, you would take several precautions.

### Friendly tips

A battery can explode if you do not follow the correct procedure, seriously injuring anyone nearby.

Make sure to keep all sparks, open flames and smoking materials away from the battery.

If the battery is out of connecting or discharging, the setting of clock and presupposition frequency on the sound system will be cancelled. You need to reset the clock and presupposition frequency according to the explanation on sound system section.

You can not start BYD AT vehicle by pushing or pulling it.

If you want to push car to start engine, you must observe the explanation strictly as following:

1. Open the hood, and check the physical condition of the battery. (Refer to 116<sup>th</sup> page). In the very cold weather, check the condition of the electrolyte, if it seems slushy or frozen; do not to push starting until it thaws.

### Friendly tips

If the battery sits in extreme cold, the electrolyte inside can freeze. Attempt to push starting with a frozen battery can cause it to rupture.

2. Turn off all the electrical accessories (A/C, sound system, lights, ect.). Put the transmission in Neutral or Park, and set the parking brake.

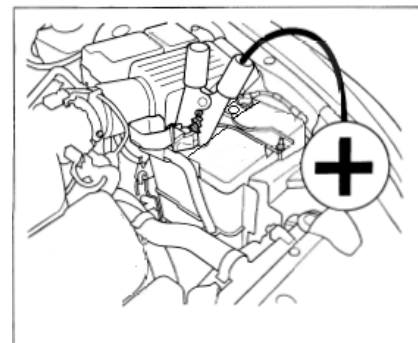

3. Connect on jumper cable to the positive (+) terminal on your battery of BYD, connect the other end to the positive (+) terminal on the booster battery.

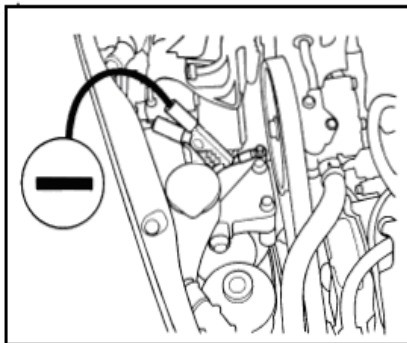

4. Connect the second jumper cable to the negative (-) terminal on the booster battery, connect the other end to the grounding strap as shown. Do not connect this jumper cable to any other part of the engine.

5. If the booster battery is in another vehicle, have an assistant start the vehicle and run it at a fast idle.

6. Start the vehicle. If the starter motor still operates slowly, check the connecting condition of the jumper cables and make sure that they have good metal-to-metal contact.

7. Once your vehicle is running, disconnect the negative cable from your vehicle, then from the booster battery. Disconnect the positive cable from your vehicle, then from the booster battery.

Keep the ends of the jumper cables away from each other. At the same time, keep the ends of the jumper cables away from any metal on the vehicle until everything is disconnected. Otherwise, you may cause an electrical short.

### Engine overheating

In the most condition, the pointer of the vehicle's temperature gauge should stay in the midrange. If you drive up a long steep hill in the hot day, the pointer may rise to the red mark, and then you should determine the reason of overheating.

#### Notice:

Driving with the temperature gauge pointer at the red mark can cause serious damage to the engine.

Several kinds of reasons can cause the vehicle overheating, as short of coolant or

mechanical failure. The only indication may be the coolant temperature gauge rising to or above the red mark. Or you may see steam or spray coming from under the hood. No matter what kind of condition appears, you must take measures at once.

#### Friendly tips

Steam and spray from an overheated engine can seriously scald you. Do not open the hood if steam is coming out.

1. Safely pull to the side of the road. Put the transmission in Neutral or Park, and set the parking brake. Turn off the A/C and all the other accessories, and turn on the hazard warning lights.

2. If you see steam and/or spray coming from under the hood, turn off the engine.

3. If you don't see steam or spray, leave the engine running, and watch the coolant temperature gauge. If the high heat is due to overloading (for example, drive up a long



steep hill with the A/C opening in the hot day), the engine should start to cool down almost immediately. At this time, wait until the coolant temperature gauge comes down to the midpoint, and then continue driving.

4. If the coolant temperature gauge stays at the red mark, turn off the engine.

5. Open the hood until you do not see any steam or spray coming out.

6. Look for any obvious coolant leaks, such as a split radiator hose. Every part is still extremely hot, so use caution. If you find a leak, it must be repaired before you continue driving (refer to Emergency Towing on 200<sup>th</sup> page).

7. If you don't find an obvious leak, check the coolant level in the radiator reserve tank (refer to 105<sup>th</sup> page). If the level is below the MIN mark, add coolant, and let the level rise between MIN and MAX marks.

8. If there was no coolant in the reserve tank, you may need to add coolant to the radiator. Let the engine cool down until the pointer

reaches the middle of the temperature gauge, or lower, before checking the radiator.

#### Friendly tips

Removing the radiator cap while the engine is hot can cause the coolant to spray out, seriously scalding you. Always make sure to let the engine and radiator cool down before removing the radiator cap.

9. Using gloves or a large heavy cloth, turn the radiator cap counterclockwise, without pushing down, to the first stop. After the pressure releases, push down on the cap, and turn it until it comes off.

10. Start the engine and set the temperature control dial to maximum (set the A/C on AUTO, "Hi"). Add coolant to the radiator up to the base of the filler neck. If you do not have the proper coolant mixture available, you can add plain water. Remember to have refilled with the proper mixture as soon as you can.

11. Put the radiator cap back and tightening it. Run the engine, and watch the temperature gauge, if the pointer rises to the red mark, the engine needs repair (see Emergency Towing on 162<sup>nd</sup> page).

12. If the temperature stays normal, check the coolant level in the radiator reserve tank. If it has gone down, add coolant to the MAX mark. Then put the cap back and tightening it.

### Engine oil pressure indicator

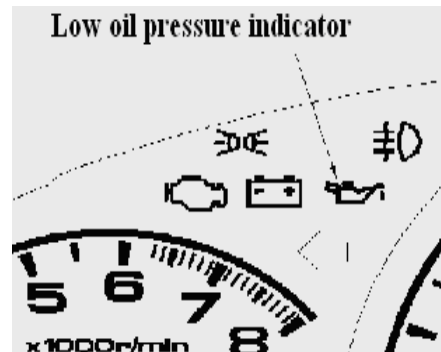

The indicator is on when turning ignitions witch to ON (II). The indicator is off after starting engine. And indicator is off within engine working. If it twinkles, show oil pressure descends too fast instantaneously, but get normal once more. If the indicator is always on within engine working, show it has hadn't oil pressure and engine may have a serious hurt. Whatever above any symbol happens, should take measures immediately.

#### Friendly tips

when engine work at low oil pressure, that will cause a serious mechanical hurt.  
Park vehicle at safe place as soon as possible, and close the engine.

1. Park vehicle at safe place, close the engine and open the dangerous warning indicator.
2. Stop vehicle for a minute. Open engine hood and check up the level of oil (refer to 120th page). Though the oil pressure hasn't direct relationship with its level, if the oil has serious shortage, when turning or other operations, the oil will lose pressure.

3. If necessary, add oil to make the level of oil get to the highest scale of oil dip rod (refer to 79th page).

4. Start engine and observe the low oil pressure indicator. If it is off within 10 seconds, close engine. This shows that engine has mechanical failure, you can drive it after repairing (refer to 162nd page about urgency draught).

#### Battery charging indicator

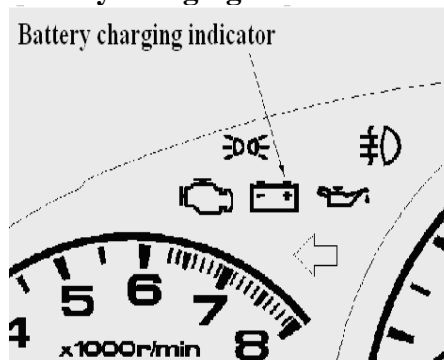

The indicator light should be on when turning ignition switch to ON (II) and misfire after starting the engine.

If it is on when the engine working, it shows that the charge system has stopped to charge battery.

So you should immediately close all electric accessories, such as radio, A/C, rear window defrosting device, and cruise control system etc. And don't use other power control device as possible as you can. Continue to keep the engine working, and notice doesn't make it misfire. Starting engine will make the battery discharged sooner.

You can drive for several mileages before the power is discharged by releasing the electric load. Drive vehicle to the gas station or repair shop to get the technique help.

### Engine malfunction indicator

#### Malfunction indicator

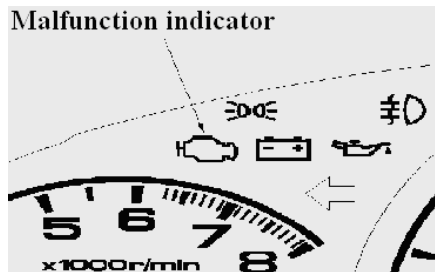

The indicator is on for several seconds when turning ignition switch to ON (II). That shows a control system of the engine or transmission may have failure. You may not feel unmoral, but the failure may lower ability of saving fuel and cause more emission. You may cause more serious hurt when go on working at the state.

If the indicator is on, park your vehicle at the road and close engine. Anew start engine and check up the indicator. If the indicator is still on, call BYD authorized service station for checking up your vehicle. Before the repairman come, carefully drive to avoid the throttle valve full opening and

drive at a high speed. If the indicator is frequently on, even if close it according to the above step, it is necessary to call BYD authorized service station for repairing.

#### Friendly tip

If go on driving vehicle when the malfunction indicator is on. That will hurt emission system and the engine. Its repair isn't included in the maintenance.

### Brake system indicator

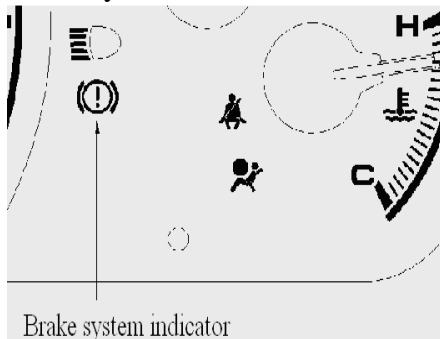

Brake system indicator

The indicator will be on when turning ignition switch to ON (II). It reminds you to check up the parking handle. If you don't fully put it down, the indicator will be always on.

Whenever the indicator is on, it shows that brake system has failure. The problem is mainly that the level of brake liquid is too low.

Step the brake pedal lightly to test whether it is normal. If normal, you should check up the level of brake liquid (refer to 112nd page) in the next fuel station. If there is a low level, you should drive to BYD authorized service station to check up whether the brake system has symbol of brake system leakage and the wearing extent of brake disc.

But, if the brake pedal is unmoral, you should take measures immediately, because the design of brake system is dual loop. Even if a part of system has failure, other both wheels are still broken. The time you must step pedal deeply, the vehicle can decelerate and the brake distance also is longer.

Shift to low gear to decelerate, and park your vehicle at the road. Because of the long brake distance, drive is dangerous. Trail the vehicle and repair it as soon as possible. (Refer to 162nd page about urgent draught).

If you have to drive for a short distance at the state, be sure to carefully drive at a low speed.

If the ABS indicator and it is on together, should immediately send your vehicle to BYD authorized service station to repair.

**Close power sun roof**

If you can't close the sun roof by power motor, please take the following operation:

1. Check up the fuse of power motor (refer to 187th page), if the fuse is burned, replace the fuse whose aph value is the same or low.
2. Try to close sun roof, if the new fuse is burned immediately or the motor doesn't work, you can close sun roof with your hands.
3. Take out the sun roof wrench from the combination tool in the trunk.

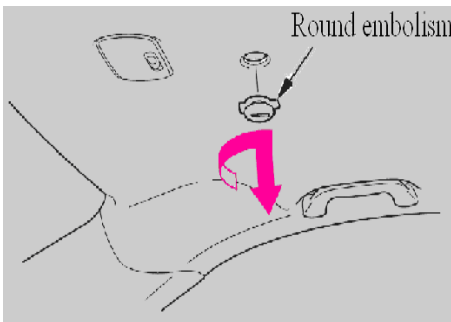

4. Disassemble the round embolism by screwdriver or coin.

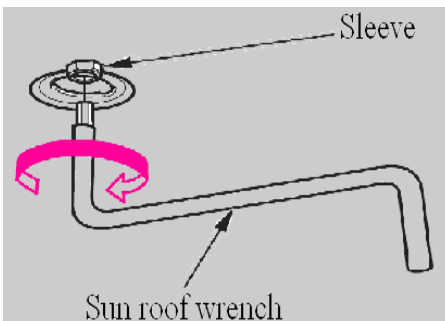

5. Insert the wrench into sleeve of embolism, rotate wrench until the sun roof is fully closed.

6. Pull out wrench, fix the round embolism anew.

If you need close the sun roof by hands, it shows that the closing and opening function of sun roof has failure. Call BYD authorized service station to repair.

**Fuses**

All circuitry has itself fuse on your vehicle to avoid short circuitry or overtaking load. The fuses are fixed in both fuse boxes.

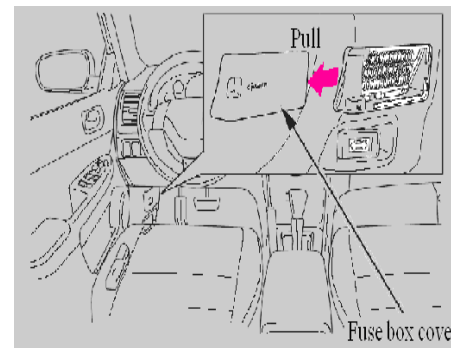

The interior fuse box is under the driver side. To disassemble it, pull and take out it from hinge.

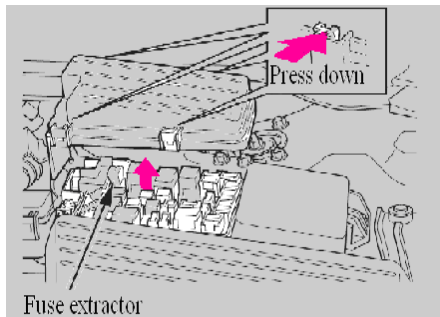

Fuse box under engine hood lies in left rearside of engine chamber. To open it, press button as the picture shows.

### Check and replace fuses

If an electric device doesn't work, firstly find out burned fuse. According to diagram from 158th page to 159th page or the position picture on the fuse box cover, make sure which a fuse or several fuse control the device. Firstly check up above fuses, but before making sure burned fuse isn't the

reason for malfunction, should check up all fuses. Replace all burned fuses and check up the work state of all electric devices.

1. Turn ignition switch to LOCK (0), make sure the headlight as well as other accessory have been closed.

2. Open the fuse box.

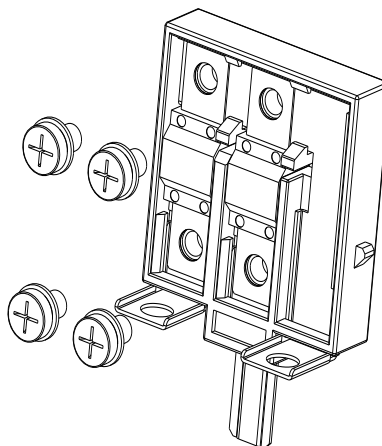

3. Measure both ends of fuse with the lead gear of multimeter. Make sure whether it is burned; check up every thick fuse in the fuse box under engine hood.

To disassemble these fuses, you must use the cross screwdriver.

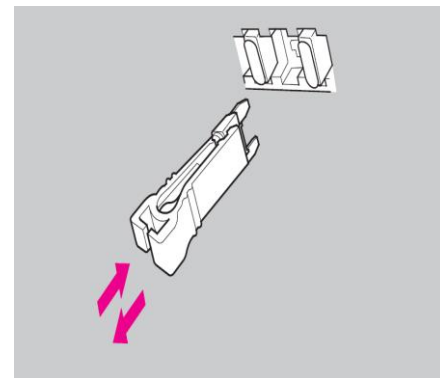

4. Use the fuse extractor attached in the fuse box under engine hood, pull out the thinner fuse in the fuse box under engine hood and all fuses in the interior fuse box. Check up them one by one.

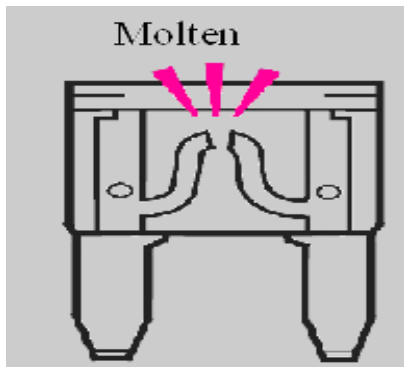

5. Find out the burned fuses, if burned, you should replace them with spare fuse which has a same amp value or lower.

When you can't drive vehicle for still

having malfunction and hasn't the spare fuse to replace, pull out the fuse, it has a same amp value or lower from other circuitry, instead of it. But firstly you must make sure the circuitry (cigar lighter or radio) has no influence on drive.

The replaced spare fuse may be burned once more.

Though it doesn't show that there is malfunction, also you should use the fuse which has right rating value to replace as soon as possible.

Notice
Replacing the burned fuse with the fuse which has a higher amp value will increase the possibility of electric system hurting. If there isn't the fuse

which matches with the circuitry, you should use the fuse whose amp value is low.
---

6. If the substitute fuses which has the same rating is burned in a short time, which shows the vehicle has a serious malfunction in the electric system. Call the qualified technician for checking up your vehicle.

If the fuse of radio system is taken out, the setting of clock and frequency will be cancelled. Anew set them according to the chapter of radio system.

Use box under engineer hood

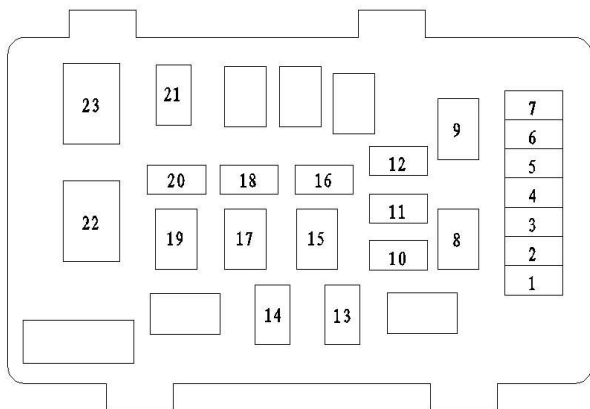

Label of fuse box

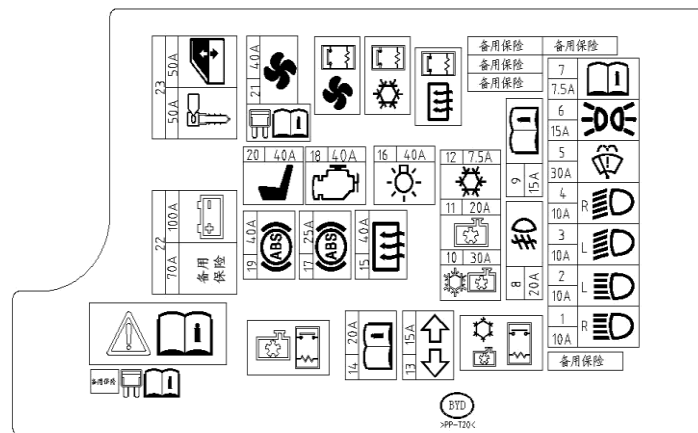

The position of fuse is marked on the fuse label by the number. Refer to the page about the fuse on your vehicle.

Number	AMP	Device or circuitry protected
1	10A	R headlight ( high beam)
2	10A	L headlight ( high beam)
3	10A	L headlight ( low beam)
4	10A	R headlight ( low beam)
5	30A	Power wiper system
6	15A	Ash box light, Radio-HVAC-Display module light, Automatic transmission case control light, Front sign light, Glove box light, Dangerous warning switch light, Foot part light, License plate light, Sun roof switch light, Relay control module, Seat heater switch light, Trailing light
7	7.5A	Relay control module
8	20A	Front fog light
9	15A	ECM power, A/T control relay power
10	30A	Condenser fan motor (low speed), radiator fan motor ( low and high speed)
11	20A	Condenser fan motor ( high speed)
12	7.5A	A / C compressor clutch ( through relay of A / C compressor clutch)
13	15A	Turning signal / dangerous warning relay.

Number	Amp	Device or circuitry protected
14	20A	Brake light, High brake light, ignition switch key light, (MICU) Speaker, Warning device relay ( through relay module)
15	40A	Rear window defogging ( through its relay)
16	40A	Cigar lighter, Spare power on-board, Doorlock motor, Rear fog light, interior light, radio system, all CAN module power
17	25A	ABS modulator — control device
18	40A	Electric injection system
19	40A	ABS modulator — control device (RFP MOTOR)
20	40A	Power seat adjusting system, seat heating system
21	40A	Blower motor ( through blower motor relay)
22_1	100A	Battery, distribution
22_2	70A	Spare
23_1	50A	Power window system
23_2	50A	Ignition switch (BAT)



Interior fuse box

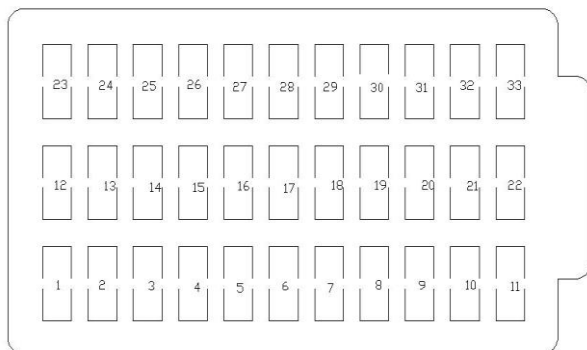

Label of fuse box

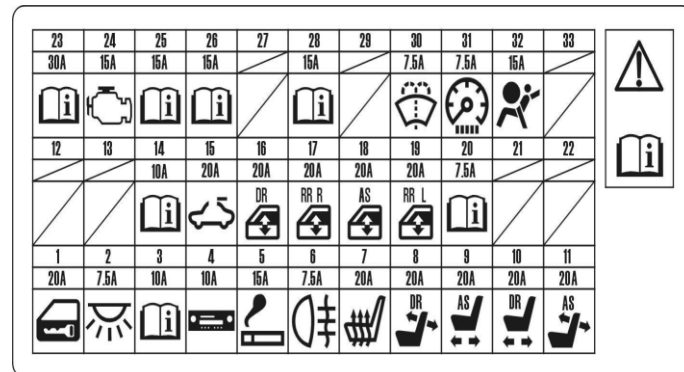

The position of fuse is marked on the fuse label by the number. Refer to the page about the fuse on your vehicle.

Number	Amp	Device or circuitry protected
1	20A	Door lock, trunk lock motor power
2	7.5A	Door light, environment light, roof light, map light, trunk light, dresser light
3	10A	Instrument control module, combination switch control device, door multi roads control, (MICU)
4	10A	Radio system power
5	15A	Cigar lighter, spare power
6	7.5A	Rear fog light
7	20A	Seat heater and heater switch indicator
8	20A	Driver power seat angle adjusting motor and rear up and down adjusting motor (8 direction)
9	20A	Front passenger F/R sliding motor
10	20A	Driver power seat F/R sliding motor and front up and dower adjusting motor (8 direction)
11	20A	Front passenger power seat angle adjusting motor
12	....	Spare
13	....	Spare

14	10A	Seat heater relay loop power, power Rear view mirror, A/C control power
15	20A	Sun roof motor and ON/OFF relay
16	20A	Regulator motor of driver side
17	20A	Regulator motor of front passenger
Number	AMP	Device or circuitry protected
18	20A	Regulator motor of L-R door
19	20A	Regulator motor of R-R door
20	7.5A	Cigar lighter, spare power relay, radio device, interior rear view mirror direction display
21	.....	Spare
22	.....	Spare
23	30A	Engine ECU, injector, camshaft position sensor, vacuum solenoid, oxygen sensor, carbon jar control valve
24	15A	Diagnostic tester power, fuel pump motor
25	15A	ETV relay
26	15A	Engine ECU
27	.....	Spare
28	15A	4G69S4M ECU 2nd gear power, ABS control 2nd gear power, relay control module
29	....	Spare
30	7.5A	Rain amount sensor, wiper

		relay
31	7.5A	Combination instrument, combination switch, door multi-road control, relay control module, back radar ECU, multi-road control device IG1 power
32	10A	Air bag control module
33	.....	spare

### Emergent Traction

If your vehicle needs to be towed, call a professional towing service or an organization. Never tow your vehicle with just a rope or chain. It is very dangerous.

There are three ways to tow your vehicle.

1. **Flat-bed Equipment** — The operator loads your vehicle on the back of a truck. This is the best way to transport your BYD vehicle.

2. **Wheel-lift Equipment** — The tow truck uses two pivoting arms that go under the tires (front or rear) and lift them off the ground. The other two tires remain on the ground. This is an acceptable way to tow your BYD vehicle.

**Notice**

If your BYD vehicle can not use Flat-bed Equipment to transport, you should use Wheel-lift Equipment to transport. If, due to damage, your vehicle must be towed with the front wheels on the ground, do the following:

**Manual transmission:**

- 1 Release the parking brake.
- 2 put the transmission in Neutral.
- 3 Leave the ignition switch in the ACCESSORY ( I ) position, so the steering wheel does not lock.

**Automatic transmission:**

- 1 Release the parking brake.
- 2 Start the engine.
- 3 Shift to Drive, then to Neutral.
- 4 turn off the engine.
- 5 Leave the ignition switch in the ACCESSORY ( I ) position, so the steering wheel does not lock.

**CVT transmission:**

The model with VT2-040 transmission cannot haul, because only when the engine runs, can the cone pulley produce oil pressure, and then the drive belt can run. Thus, the front wheel must be raised to begin hauling (hanging hauling)

3. If you can not find trailer company while occurring emergency faults, you can use towing hook to tow the vehicle. There is a decoration cover on the bumper under the right front headlight. Remove the cover, and take out the towing hook from vehicle tools and screw into the towing hook bracket and tightening it, use the special trailer cable. You must be careful while towing the vehicle. **For CVT vehicle, the gear must be put on "N" and the engine must run in case of emergent traction. Only if the engine runs, can the oil pump of the transmission provide oil pressure and the drive belt can run, or it will damage the drive belt.**

The driver must sit in the towed vehicle; operate the vehicle and the brakes

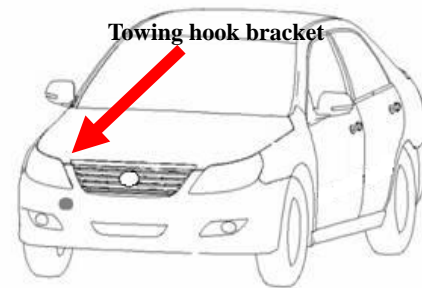
**Notice**

We do not recommend to use towing hook to tow the vehicle with four-wheel on the ground, it is best to call a professional towing service or an organization.

You can only use the towing hook on the vehicle, or you will damage your vehicle. Do not tow the vehicle from the backside of vehicle with four-wheel on the ground, or it can damage your vehicle.

**Notice**

Improper towing preparation will damage the transmission. So follow the above procedure exactly. If you can not shift the transmission or start the engine (AT), your vehicle must be transported with the front wheels off the ground.

With the front wheels on the ground, it is best to tow the vehicle no farther than 80 km, and keep the speed below 55 km/h.

If you decide to tow with four-wheel on the ground, you must use special trailer cable with reasonable design and towing hook on the vehicle. Follow the above procedure, and do the preparation work for the vehicle. Leave the ignition switch in the ACCESSORY ( I ) position, so the steering wheel does not lock. Make sure that the radio and all electrical accessories both turn off, to avoid discharging the battery.

**Notice**

The steering system can be damaged if the steering wheel is locked. Leave the ignition switch in the ACCESSORY ( I ) position, and make sure the steering wheel turns freely before you begin towing.

**Notice**

Trying to lift or tow your vehicle by the hampers will cause serious damage. The hampers are not designed to support the vehicle's weight.

## **Technical data**

Diagram of the chapter shows the dimension and capacity as well as the position of identification no.

Identification No. .... 160

Specification ..... 162

**Identification No.**

There are several identification no. at different positions on your vehicle.

1. The engine model no. is stamped in the Engine group.
2. The transmission no. is in the name plate at the top of the transmission.

Don't confuse the transmission no. and engine no..

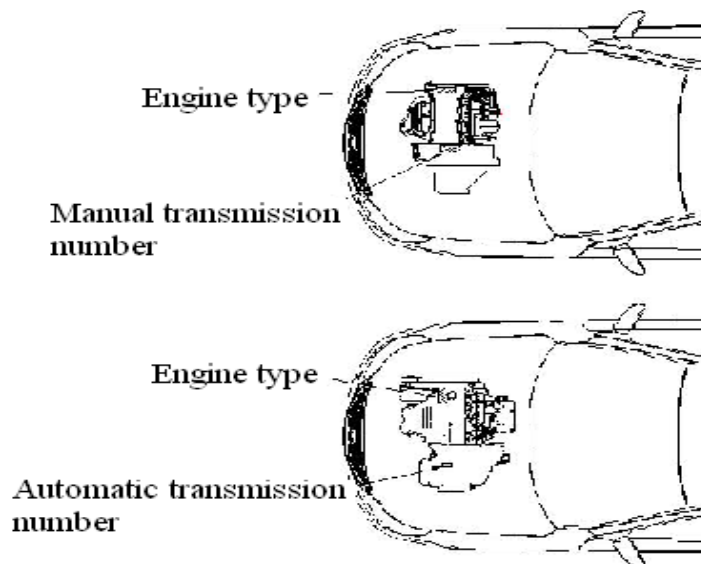

Engine Model

CVT Transmission No.

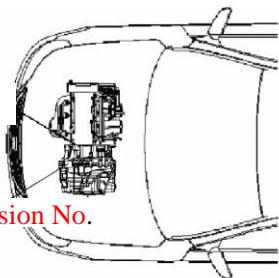

3. Vehicle identification no. (VIN) marked on the rear clapboard of engine chamber and the label on the instrument of left-down position of front windshield.

4. Product label is nailed on the left damper mounting. There are (VIN), engine no., vehicle no., displacement, the main designer and the date of producer etc.

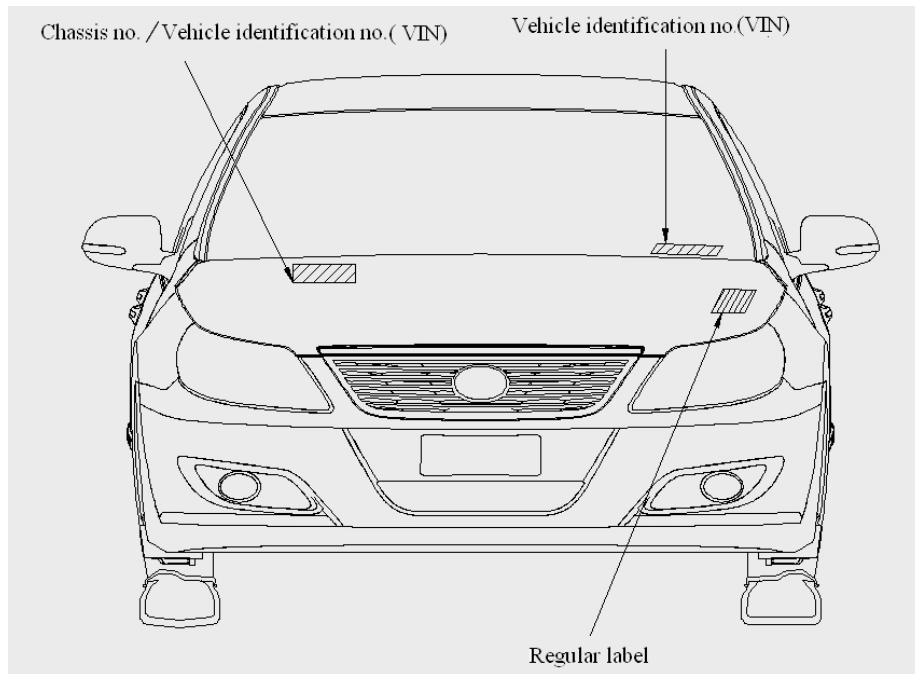

**Specification  
Dimension**

Length		4846mm	
Width		1822mm	
Height	2.0	1465mm	
	2.4		
Wheelbase	2.0	2740mm	
	2.4		
Track	Front	1551mm	
	Rear	1551mm	

**Quality**

Unladen Mass	2.0L	MT	1435kg
		CVT	1450kg
2.4L		1480kg	
Max Permitted Mass	2.0L	MT	1810kg
		CVT	1825kg
2.4L		1855kg	

**Engine**

Type	2.0	L4/16-valve, water cooling, MPI fuel injection, DOHC
	2.4	L4/16-valve, MPI fuel injection, SOHC

Diameter×Stroke	2.0	83×92mm
	2.4	87×100mm
Displacement	2.0	1.991
	2.4	2.378
Compression ratio	2.0	9.6: 1
	2.4	9.5: 1
Spark plug	Refer to section about maintenance of spark plug on 98th and 118th page.	

**Capacity**

<b>Capacity</b>			
<b>Fuel tank</b>		65L	
Engine coolant	BYD 483QB engine	Replace	MT 4.9L
			CVT 4.9L
		Total	MT 6.8L
		CVT 6.8L	
	Mitsu bishi 4G69 engine	Replace	4.9L
	Total	7.2L	

\*: Include coolant in liquid storage tank and remanded coolant in engine.

<b>Engine oil</b>		
BYD483BQ engine	Replace	3.3L
	Total	3.5L
Mitsubishi 4G69 engine	Replace	3.8L
	Total	4.3L
<b>Transmission gear oil</b>		
Manual transmission	Replace	2.0L
	Total	2.1L
Auto transmission	Replace	6.5L
	Total	7.7L
CVT transmission	Replace	4.1L
	Total	4.1L



**Tire**

Dimension/tire pressure	Please look at the data label on the driver side door case or refer it from BYD AUTO authorized service station.
-------------------------	--

**Positioning**

Toe-in	Front wheel	0±2mm
	Rear wheel	2±2mm
Camber angle	Front wheel	0°00'±45'
	Rear wheel	-1°00'±30'
Caster angle	Front wheel	3°05'±45'

**Suspension**

Suspension	Front	Double-wishbone independent suspension
	Rear	5-link independent suspension

**Steering**

Type	Rack and pinion, booster steering type
------	--

**Clutch**

Type	Dry, Single plate diaphragm
------	-----------------------------

**Brake**

Type	Booster braking
Front wheel	Ventilated disc
Rear wheel	Solid disc
Parking brake	Mechanical

**Battery**

Capability	12V—70AH/80D26LBYD
------------	--------------------

**Fuse**

Vehicle interior	Refer to 163rd page of the manual or label in the fuse box sticked under dashboard.
Under hood	Refer to 161st page of the manual or the fuse box's cover.

**Light**

Headlight	High beam	H1/12V55W
	Low beam	H1/12V55W
	Front turning signal light	PY21W/21W
	Front position light	W5W/5W
Front fog light		H11/55 W
Rear turning light		PY21W/21W
Backup light		W16W/16W
Rear fog light		P21W/21W
License plate light		W5W/5W
Spotlight ( front interior light, L/R)		12V8W/8W
Rear interior light		12V8W/8W
High brake light		2.0W (LED)
Trunk light		W5W/5W
Door light		T10/3.4W
Dressing glass light		12V3W/3W

\*: Optional

Note: You should call BYD authorized service station for replacing the lights.

**Three-way catalytic converter**

Meet the following displacement standard:

•GB18352.2-2001

Light vehicle displacement limited value & measure method (II)

•GB18352.3-2005

Light vehicle displacement limited value & measure method (III)

Three-way catalytic converter includes precious metals which is a catalyze and accelerate the chemical reaction to purify exhaust gas, but the metal hasn't been affect. Why the catalytic converter is called three-way is it has a positive effect on the HC, CO and Ox. To replace it, must use the BYD AUTO original parts.

For cause the chemical reaction, the three-way catalytic must work at high temperature, it may fire the tinder around. So park your vehicle at the place far away from combustible objects such as litter and dry leaves.

If three-way catalytic converter has failure, which will cause the air pollution, and lower the ability of engine. Protecting it should be according to the following.

1. Keep using the unleaded gasoline. Even if including a little lead, also pollute the catalytic metal and cause the failure to catalyze.
2. Keep the normal work of engine.
3. If appear the ignition miss, backfire, misfire or other unmoral work symbol, and send to check up and repair it immediately.