



# L3 Owner's Manual

**BYD AUTO CO., Ltd**

(European & African Countries) Ver.2014

ECE / Reg.



## Preface

Thank you for choosing BYD L3. For better use and maintenance of your BYD L3.AUTO, please do read this Manual carefully.

**Special Warning: BYD Auto Industry Company Limited assumes NO liability for any vehicle damage or failure and collateral damage caused by re-moulding, retrofitting or parts change of BYD L3.**

Thank you for choosing BYD L3, and your comments and suggestions will be welcomed. To allow us to provide better service to you our esteemed customer, please make sure to provide us with your accurate contact information. In the case of any change to your contact details, please contact BYD sales service center to update it in our system. Meanwhile, we would suggest you to check your national laws and regulations as well as your local policies and obtain a license plates as soon as possible, thus to avoid any possible legal risk that could arise thereof.

Please strictly follow “Safety tips” and “Notice” in this Manual to avoid possible injury or damage.

Designation and usage of prompt type are described below:

NOTICE
Precautions to be followed to make maintenance easier

FRIENDLY TIPS
Precautions to avoid the vehicle damage or personal injury

Safety sign



The safety sign shown in the figure above indicates “Do NOT do so” or “Do NOT behave this way”.

This Manual is provided ONLY to help you use this auto properly, and shall not be construed as any specification of the product



configuration. For the product configuration, please refer to the contract (if any) related to this product or contact your distributor.

The illustrations provided in this Manual are for reference only. Actual auto may differ in appearance. For detailed user instruction, please check <http://www.bydauto.com.cn/service/manual/index.php>.

BYD Auto Industry Company Limited reserves its right to change the technical characteristics, contents and spare parts status in this Manual, and may update software at any time without any restriction or prior notice.

To join our online vehicle community, please log into the BYD “The vehicle Forum” at <http://www.byd-auto.net/owner/service.php>



## Contents

Whole-The Vehicle Parameters and the Vehicle Identification of BYD L3 .....	V
Chapter 1 Operation of Instruments and Controllers .....	1-1
Section 1 Instrument Panel Exterior .....	1-1
Section 2 Keys and Doors .....	1-7
Section 3 Seats, Seat Belts, Steering Wheels, the Child Seat and Rearview Mirrors .....	1-33
Section 4 Lighting, Wipers, Defrosters and Travel Speed Projector .....	1-65
Section 5 Instrument and Maintenance Indicators .....	1-75
Section 6 Parking Brake Assembly .....	1-89
Section 7 Auto Audio System .....	1-91
Section 8 Air Conditioning System .....	1-101
Section 9 Other Devices .....	1-111
Chapter 2 Driving Tips .....	2-1
Chapter 3 Starting and Driving .....	3-1
Chapter 4 Emergency Handling .....	4-1
Chapter 5 Anti-Corrosion and Automobile Exterior Maintenance .....	5-1
Chapter 6 Maintenance Knowledge .....	6-1
Chapter 7 Self-Maintenance .....	7-1
Section 1 Preface .....	7-1
Section 2 Engine and Chassis .....	7-7
Section 3 Electrical Appliance Parts .....	7-17
Chapter 8 Specification of Parts .....	8-1

**Complete Vehicle Parameter of BYD L3 (The actual fuel consumption is subject to the vehicle conditions, road conditions and driving habits etc.)**

Product Model and Name		QCJ7153 A	QCJ7153 A3	QCJ7153 A5	QCJ7153 A6	QCJ7153 A7	BYD7153 A	QCJ7183 A3	QCJ7183 A4
Dimension	Length mm (millimeter)	4568							
	width mm (millimeter)	1716							
	Height mm (millimeter)	1480							
Wheelbase		2615							
Tread	front mm (millimeter)	1486							
	rear mm (millimeter)	1466							
Axle load	front kg (kilogram)	830	830				885		
	rear kg (kilogram)	725	755				695		
Curb weight (kg)		1180	1210				1205		
Gross weight (kg)		1555	1585				1580		
Tire size		195/60 R15 88H							
Approach angle (degree)		17.6°							
Departure angle (degree)		18.6°							
The front overhang (mm)		943							
Rear overhang (mm)		1010							



Passenger capacity	5						
Maximum speed (km/h)	170				175		
Engine model	BYD473QB		BYD473QE			BYD483QA	
Pattern	In-line transverse position, SOHC					In-line 4-cylinder engine, water cooled, double overhead camshaft	
Displacement (L)	1.488		1.497			1.839	
Emission level	Euro IV	Euro III	Euro IV			Euro III	Euro IV
Maximum output power (rated power) kw (kilowatts)	79		80			90	
Speed corresponding to engine rated power r/min	5800		5800			6000	
Maximum torque (Nm/rpm)	144		145			160	
speed at maximum torque r/min	4800		4800			3700~4200	
Maximum gradeability %	≥30					≥35	
Fuel consumption (urban conditions)	8.5	7.9	8.2	7.9	7.9	10.4	
Fuel consumption (suburban conditions)	5.3	5.1	5.5	5.1	5.1	6.9	
Combined fuel consumption	6.5	6.2	6.5	6.2	6.2	7.9	

## The Vehicle Identification of BYD L3

The vehicle Identification number

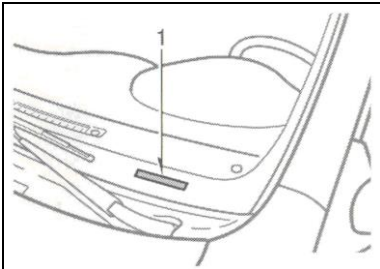
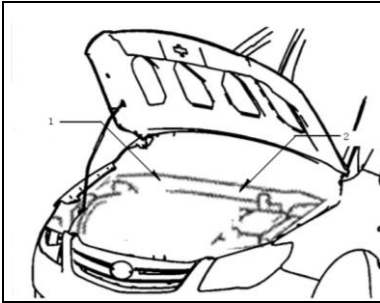

The vehicle Identification numbers are marked inside the engine compartment and on the top left of the instrument panel as shown in the figure. This is the vehicle identification number of BYD L3. It is used for registration of the car owner. The vehicle identification number is also marked on the manufacturer nameplate.

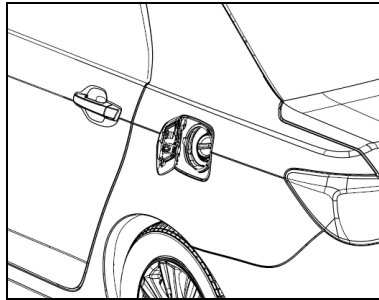

The indication sign of oil standard is attached inside oil filler lid as shown in the above figure.

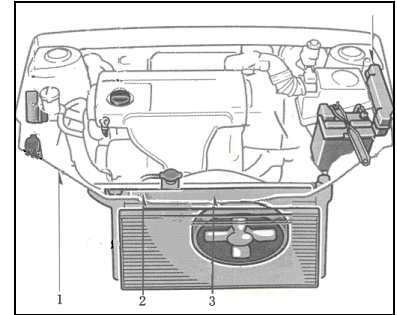

1. The indication sign of the engine coolant
2. The warning sign of the air conditioning system
3. The warning sign of the cooling fan

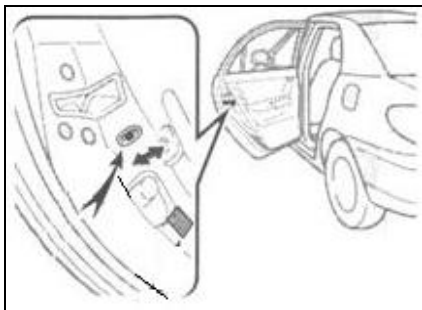

The indication sign of the child protection device is attached inside the rear door below the child protection lock.



The indication sign of the tire air pressure is attached to the downside of the front left door lock as shown in the above figure.

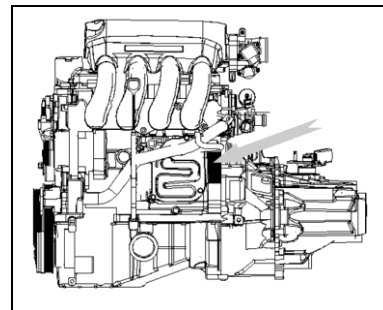

Engine Number (BYD473Q series engine)

Engine Number

Engine Number is marked on the engine cylinder as shown in the figure.





# Chapter 1

## Section 1

---

### Operation of Instruments and Controllers

#### Instrument Panel Exterior

Instrument Panel Exterior ..... 1-2

Combined Meter Exterior ..... 1-4

The Indication Sign on the Combined Meter..... 1-5

## Instrument Panel Exterior

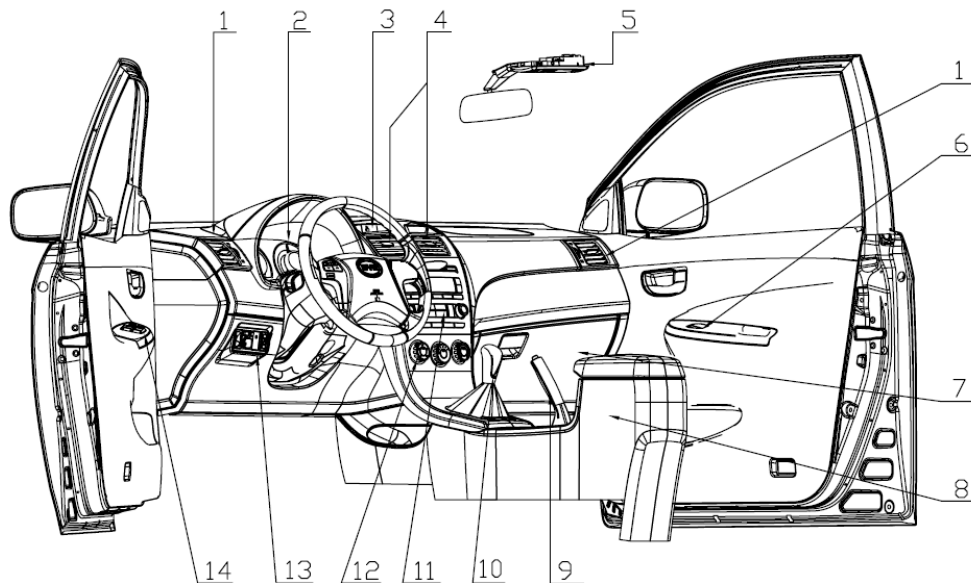

1. Left/right assembly on the instrument panel
2. Combined meter assembly
3. Reversing radar switch and co-driver safety-belt the indication
4. Central airduct
5. Lighting and switch assembly in the front cabinet
6. Window regulator switch
7. Glove box
8. Auxiliary instrument panel
9. Parking brake mechanism assembly
10. Gear shift handle (manual transmission)
11. Multi-media system
12. Air-conditioner panel
13. 2#Switch block
14. Central control switch

## Switch Button Inside Car

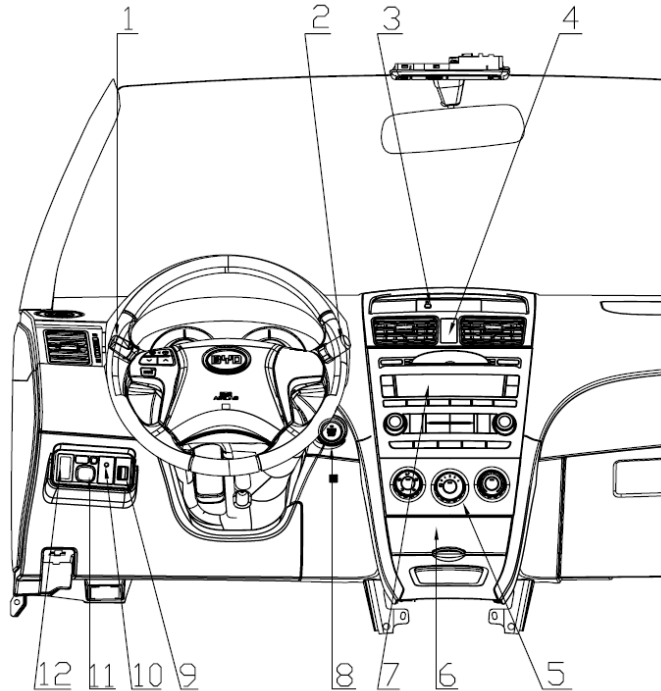

1. Left combined switch (light)
2. Right combined switch (wiping, washing)
3. Reversing radar switch
4. Emergency warning light switch
5. Air-conditioner controller
6. Storage compartment
7. Multi-media system
8. Startup button
9. Headlight adjustment switch
10. Anti-theft warning light
11. Electric exterior rearview mirror switch
12. Rear foglight switch

Combined Meter Exterior

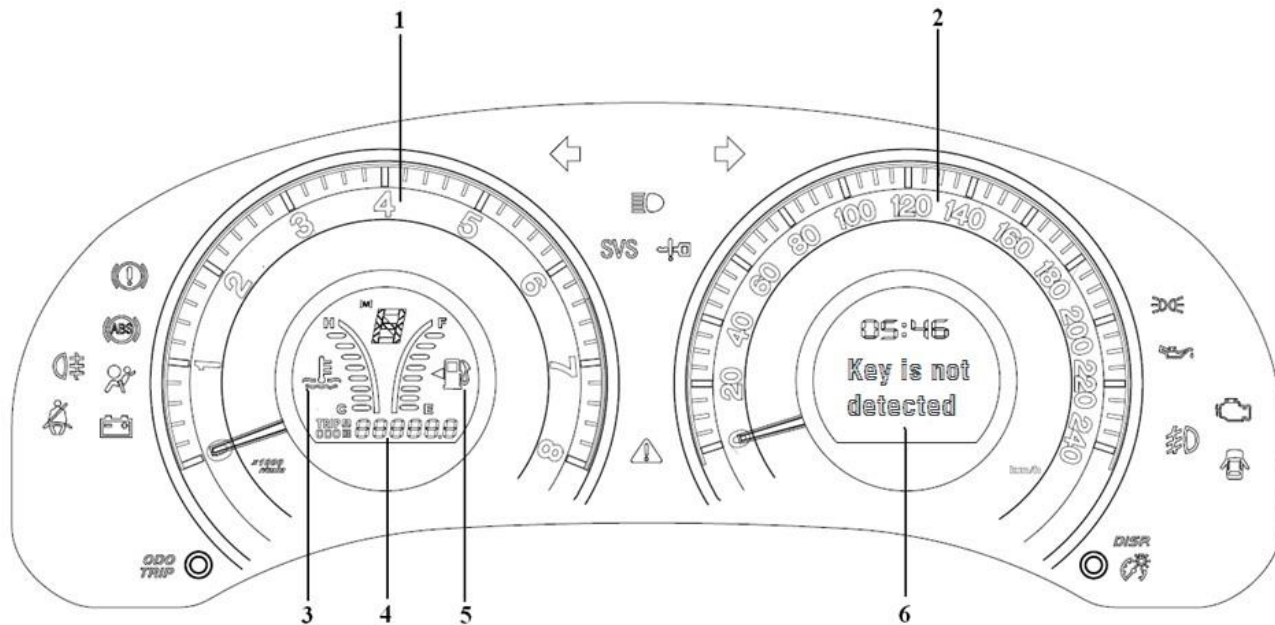



















- 1. Tachometer
- 4. Odometer

- 2. Speedometer
- 5. Fuel gauge

- 3. Water thermometer
- 6. Information display

### The Indication Sign on the Combined Meter

	Braking system warning light*		Door-open warning light*
	Indicator light of the driver seat belt*		SRS Warning light*
	Battery discharge indicator*		Clearance lamp indicator
	Low engine oil pressure indicator*		High beam indicator
	Engine fault indicator*		Turn signal light indicator
	Smart key system warning light*		Front fog light indicator
	ABS system warning light*		Rear fog light indicator
	SVS Warning light*		Major warning indicator*
	Low fuel warning lamp		High coolant temperature warning lamp

Maintenance reminder is marked with “\*”. Refer to Chapter 1-5 “Maintenance Reminder and warning buzzer”.





# Chapter 1

## Section 2

### Operation of Instruments and Controllers

#### Keys and Doors

Key.....	1-8
The Smart Entry and Starting System.....	1-15
The Front Door .....	1-20
Electric Door Windows.....	1-22
The Trunk Cover .....	1-24
Engine Hood .....	1-25
Anti-Theft System .....	1-26
The Fuel Tank Cap.....	1-27
Starting the Engine.....	1-28



## Key

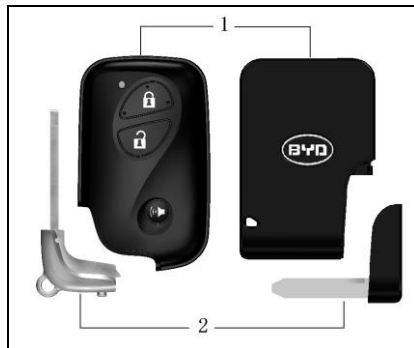

### Key includes the smart Key and the mechanical Key

1. The smart key—the smart key, which includes the electronic smart key and the card smart key, is used for unlocking and locking of all side doors. Remote control button on the electronic smart key can be used to lock and unlock doors, send out emergency alert and locate car in a remote way.

2. The mechanical key (inside the electronic smart key and the card smart key) — It is used to lock or unlock the driver's door and the trunk.

### FRIENDLY TIPS

- People who wear cardiac pacemaker or defibrillator should keep away from the antenna of the smart entry and starting system, as electromagnetic wave could affect normal use of these appliances. Refer to “Antenna position” in the chapter for antenna position.
- Besides those who wear cardiac pacemaker or defibrillator, users of other electronic medical appliances should also consult with manufacture about electro the mechanical effect on these appliances. Electromagnetic waves can cause unpredictable consequences to the use of such medical devices.

### NOTICE

- Please observe the following notes in use of the smart key.
- Do not attach objects which might cut off electromagnetic wave to the smart key (for example metal sealing element).
- Do not knock at other objects with the smart key.
- Do not leave the smart key in high temperature for long time, for example, on the instrument panel or the engine hood under direct sunshine.
- Do not dip the smart key into water or wash it in ultra-sonic wave washer.
- Do not put the smart key together with an appliance which emits electromagnetic wave, for example, mobile phone.



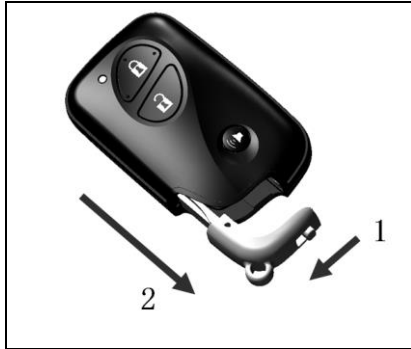

How to use the mechanical key in the electronic smart key

To use the mechanical key in the electronic smart key, please pull down release switch and take out the mechanical key as shown in the figure. After using it, please put it back.

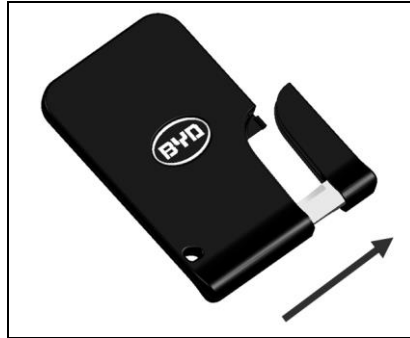

How to use the mechanical key in the card smart key

To use the mechanical key in the card smart key, please pull out the mechanical key in the direction as indicated in above figure. After using it, please insert it back.



The key number plate

The key number is indicated on the key number plate, which should be stored in safe place, such as travel bag, instead of leaving it in the car.

If the key is lost or a spare key is needed, please contact BYD authorized service station to prepare a key with the key number.

It is recommended to remember the key number and store it in a safe place.

## Wireless Remote Control



The electronic smart key

1. Locking switch
2. Unlocking switch
3. (🔊) Switch
4. The mechanical key
5. Indicator light

Wireless remote system is designed to lock or unlock all side doors at a distance about 1m from the car and

Keys and Doors 1-10

perform some other functions. It applies to the electronic smart key only.

To operate a switch, please push it in a slow and steady way.

The electronic smart key is an electronic component. Please observe the following description in order not to damage it.

- Do not leave it in a high temperature place, for example, on the instrument panel.
- Do not disassemble it.
- Do not knock at other objects with it or drop it on land.
- Do not dip it into water.

It is allowed to register the spare key for a car. For detailed description, please contact BYD authorized service station.

In the case that the electronic key fails to operate within normal distance or the indicator light on the key dims or turns off.

- Check whether there is a radio station or radio transmitter of airport

in vicinity which has interfered the normal operation of the electronic smart key.

- Battery power might have run off. Check the battery in the electronic smart key. For battery replacement, please refer to “replacement of the electronic smart key battery”.

If the electronic smart key is lost, please contact BYD authorized service station as soon as possible to avoid car theft or accident.

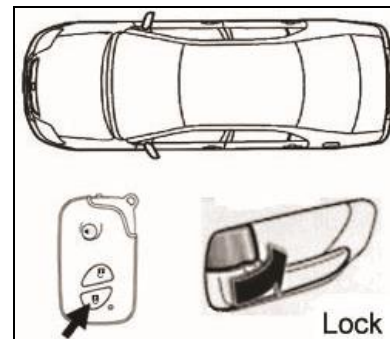

### Locking operation

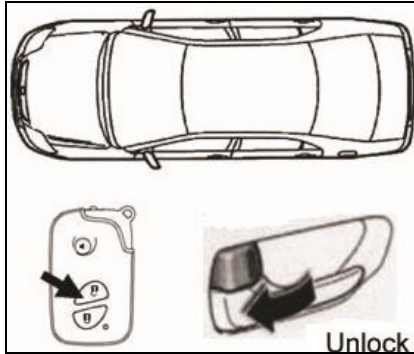

### Unlocking operation

While locking or unlocking car doors, please press the switch on key in a slow and steady way.

**Lock:** Press locking switch to lock all car doors at the same time. At this time, the turn signal light blinks once.

Check whether all car doors are locked.

If one car door is not locked, all the

vehicle doors are locked at the same time, the turn signal light does not blink and alarm rings once.

**Unlock:** Press unlocking switch to unlock all car doors at the same time. The turn signal light blinks twice.

If power position is at ACC or ON, unlocking switch or locking switch cannot unlock or lock car doors.

When unlocking all car doors with the electronic smart keys at the same time, even if car door is not unlocked, lamp inside the vehicle will remain on for 15 seconds and then will be turned off.

After unlocking with the electronic smart key, please open a car door within 30 seconds. Otherwise, all car doors will be locked again.

If you press and holding locking or unlocking switch, locking or unlocking function will not recover. You have to release switch and press it again.

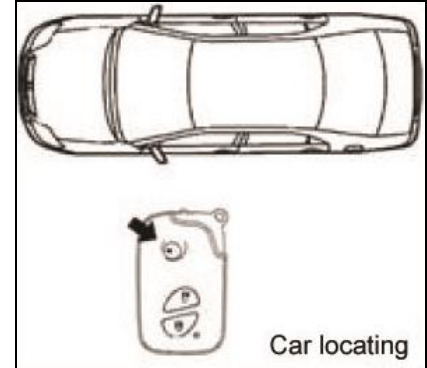

### Car locating operation

If you press locking switch when a car is under anti-theft condition, the car will give a long ring and the turn signal light will blink for 15 seconds. When you cannot find your car, please use the function to locate your car.

If you press locking switch again when a car is under location condition, a new round of car location will start.



## Switch

Press and hold for about 2 seconds to give off intermittent alarm and blink the turn signal light. Alarm may last 30 seconds. If you want to stop it,  please press unlocking switch once or hold it for a while. (Do not press the switch during drive.)

### Replace the card smart key battery

Replacement of the card smart key battery is simple and you can do it by yourself. Please replace it with CR2025 lithium battery or equivalent.

#### FRIENDLY TIPS

Please pay specific attention to avoid replaced the card smart key battery or component being swallowed by the children.

#### NOTICE

- Only same or similar type of battery, recommended by the BYD authorized service station, can be used.
- Please observe local laws when disposing used battery.

Replace the card smart key battery in accordance with the following steps.

1. Pull out the mechanical key in the direction of arrow.



2. Take out the battery.



3. Insert a new battery into the smart key and then insert the mechanical key into the card smart key.

#### NOTICE

- Please install a battery with its anode terminal and cathode terminal in correct position.
- Do not replace battery with wet hands. Water might cause rust.
- As the card smart key is not water-tight, please do not splash water into key.



After replacing battery, please check whether the card smart key works normally. If the card smart key does not work well, please contact BYD authorized service station.

Specification of the card smart key

Frequency range: 433.050-434.790MHZ

Emission power  $\leq 5500 \mu\text{V/m}$  (field strength)

Spray emission limit:  $\leq 610 \mu\text{V/m}$

Nominal frequency: 433.92MHZ

**NOTICE**

- Do not change emission frequency or increase emission power (including adding emission frequency amplifier). Do not connect to external antenna or use other emission antenna.
- Do not interfere with legal radio communication services. Once it occurs, please stop using it and take measures to eliminate

**interference before use it again.**

- When using micropower radio equipment, please be aware of interference of various radio businesses - or - radiated interference - of - industrial, scientific or medical appliances.
- It shall not be used at or near airport.

**Replace the electronic smart Key battery**

The electronic smart key is subject to damage during battery replacement. It is recommended to replace battery in BYD authorized service station. If you replace battery by yourself, ensure to use CR1632 lithium battery or equivalent and a flat head screwdriver.

**FRIENDLY TIPS**

Please pay specific attention to avoid replaced the electronic smart key battery or component being swallowed by the children.

**NOTICE**

- Do not touch electric circuit. Otherwise, static electricity might cause damage to the electronic smart key.
- Do not leave out any component when replacing the electronic smart key battery.
- Only same or similar type of battery, recommended by the BYD authorized service station, can be used.
- Please observe local laws when disposing used battery.

Replace the electronic smart key battery in accordance with the following steps.

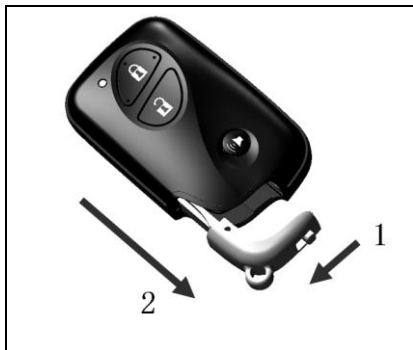

1. Pull down the release switch and take out the mechanical key.
2. Open the electronic smart key cover with a flat head screw driver or similar tools.

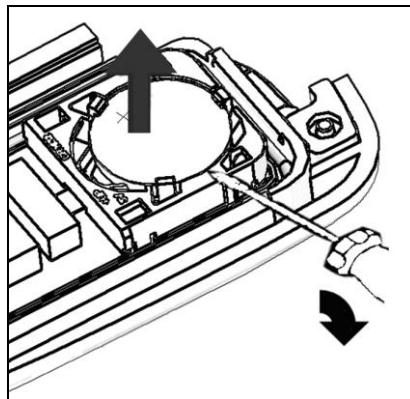

3. Remove the electronic smart key battery which has run out of power with a flat head screw driver or a similar tool. Insert the tool into guide slot and inflict force in the direction as shown in the figure above to get out the battery.

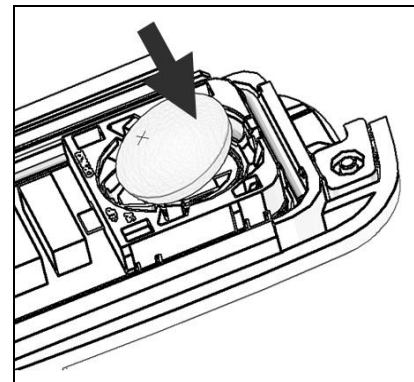

4. Put the new battery inside the box with its cathode (+) upward.

Close the electronic smart key cover tightly.

After closing the battery cover, insert the mechanical key into the electronic smart key.

**NOTICE**

**Do not refit the battery cover to avoid fault.**

### NOTICE

- Please install a battery with its anode terminal and cathode terminal in correct position.
- Do not replace battery with wet hands. Water might cause rust.
- Do not touch or move any part inside the smart key. Otherwise, it might affect the normal operation.
- Do not bend electrode when inserting the electronic smart key battery. There should be no dust or greasy dirt in the battery box.
- Close the electronic smart key cover tightly.

Check whether the electronic smart key is operating normally after replacing its battery. If the electronic smart key still cannot operate properly, you can contact with BYD Auto authorized service shop.

Specification of the electronic smart key

Frequency range: 433.050-434.790MHZ  
Emission power  $\leq 5500\mu\text{V/m}$  (field strength)

Spray emission limit:  $\leq 610\mu\text{V/m}$

Nominal frequency: 433.92MHZ

### NOTICE

- Do not change emission frequency or increase emission power (including adding emission frequency amplifier). Do not connect to external antenna or use other emission antenna.
- Do not interfere with legal radio communication services. Once it occurs, please stop using it and take measures to eliminate interference before use it again.
- When using micropower radio equipment, please be aware of interference of various radio businesses or radiated interference of industrial, scientific or medical appliances.
- It shall not be used at or near airport.

### The Smart Entry and Starting System

The smart entry and starting system mainly exerts the following functions.

- Wireless remote control function (refer to “Wireless Remote Control” in this section for details)
- Access function and startup function (refer to “Access Function and Startup Function” in this section)
- Steering locking function (refer to “Steering Locking Function” in this section)
- Button startup function (refer to “Engine Startup Method” in this section)

### FRIENDLY TIPS

- Those who are implanted with cardiac pacemaker or cardiac defibrillator shall keep away from antenna of intelligent access and keyless startup system, as electromagnetic wave may affect normal use of these appliances. Refer to “Antenna position” in the chapter for antenna position.
- Besides those who wear cardiac pacemaker or defibrillator, users

of other electronic medical appliances should also consult with manufacture about electro the mechanical effect on these appliances. Electromagnetic wave might cause unpredicted consequence on use of these medical appliances.

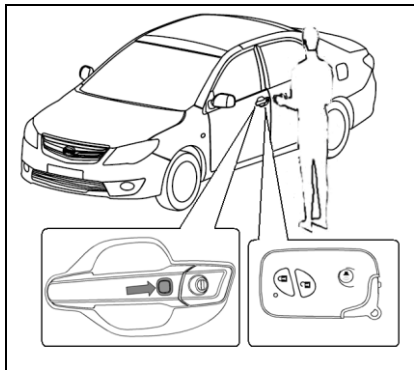

Access function

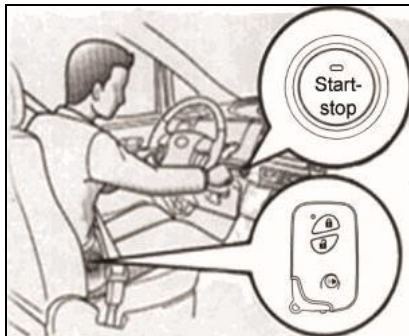

Startup function

### Access Function and Startup Function

**The smart key (the electronic smart key or the card smart key) might unlock or lock car door and start up the engine.**

**Access function**—Lock or unlock car door. Refer to “The Front Door” in this section for details.

**Startup function**—The smart key inside the car can switch power mode and start the engine. Refer to “How to start the

engine” in this section for details.

### Steering Locking Function

When you use wireless remote control and micro switch to lock car door, the steering wheel will be locked.

When the key is inside the car, press “start/stop” switch to unlock steering lock. If the green indicator on “start/stop” switch blinks, it indicates that the steering function is locked. To unlock it, please slightly sway the steering wheel while pressing “start/stop”. If the green indicator still blinks, it indicates that there is a fault in steering function. Please contact BYD authorized service station for car examination. Refer to “start the engine” in this section for details.



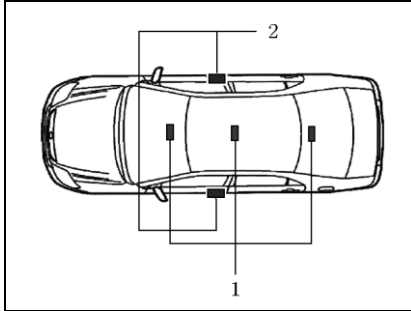

#### Antenna position

1. Antenna located outside car.
2. Antenna located inside car.

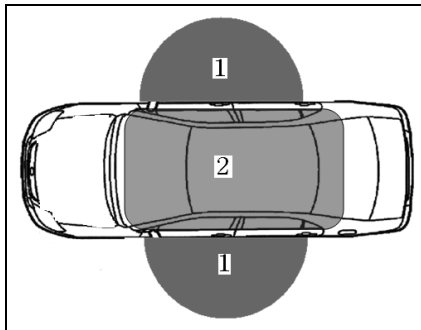

#### Activation zone

When a registered the smart key enters activation zone, access function and startup function will be activated.

1. Activation zone of access function — within 0.7 m from micro switch of the front outside car door handle. If the smart key is too close to car door handle or car window, it might not activate access function.
2. Activation zone of startup function — within the car.

If the smart key is on the instrument panel or in the trunk, glove box or on the floor, it might not activate startup function.

In the following cases, the smart entry and starting system might not work normally.

- When there is a facility which emits strong electromagnetic wave, such as a television tower, power station or broadcast station.

- When the smart key is carried together with some communication devices, such as two-way radio communication device or mobile phone.
- When the smart key is contacted or covered by metal objects.
- When the car door handle is operated rapidly.
- When the smart key approaches the car door handle.
- When other people use wireless remote control function in a nearby car.
- When battery runs out of power. Please refer to “Replace the card smart key battery” and “Replace the electronic smart key battery” in this section when replacing battery.
- When the smart key is nearby high pressure equipment or equipment generating noise.



- When the smart key is carried together with the smart entry and starting system key of other cars or other devices emitting radio wave.
- Even if within activation zone, the smart key might not work normally due to position of the smart key or shape of car body.

**If you cannot enter the car due to the intelligent access and keyless startup system which do not work normally, use wireless remote control function to unlock and lock all car doors.**

When the smart key of another car approaches the smart key of this car, the time spent on unlocking car door might be longer than usual, which is not a malfunction.

#### **If the smart key battery runs out of power**

If the indicator of the electronic smart key does not blink and startup function fails to start the engine, the reason might be that the battery has run out of power. Please replace battery as soon as

possible. (Please refer to “Replace the electronic smart key battery” in the chapter.)

Now, you can use the card smart key to start the engine.

If the card smart key or electronic key also runs out of power, please start the engine in the following steps.

1. Step on braking pedal or press “start/stop” switch and the key position indicator of the smart key system on the instrument panel will be turned on.
2. Draw the electronic smart key or the card smart key up to “start/stop” switch within 30 seconds after the buzzer beeps.
3. In 5 seconds after the smart key approached, press the “start/stop” switch to start the engine.

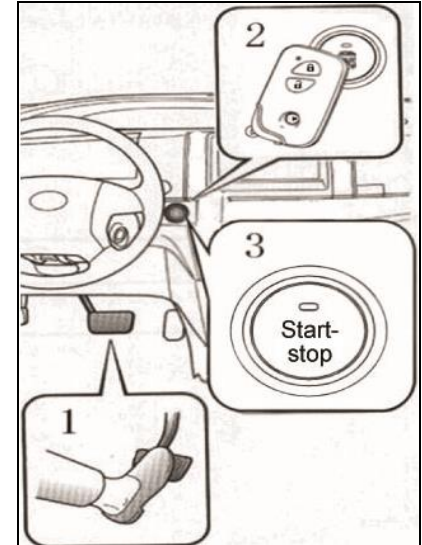

**If you cannot enter your car or cannot start the engine with the smart key, it is possible that the battery has run out. Be sure to replace the battery as soon as possible. (Please refer to “Replace the card smart key battery” and “Replace the electronic smart key battery” in this section)**

## Save Battery Power

Even if the car is not driven, the key and the car communicate with each other. Therefore, stop leaving the key near the car (within 2 m).

If the car has been not in use for a long time, the storage battery might run out of power. Please disconnect cathode terminal of the storage battery to prevent running out of power.

**In order to activate the smart entry and starting system again, please use any of the following operation method:**

1.1. Press the micro switch of external car door handle while carrying a smart key.

1.2. Perform wireless remote control operation.

If the smart key receives strong electromagnetic wave for a long time, battery power might run out rapidly. The smart key must be kept at a minimum distance of 1 m from the following appliances.

- Television
- Personal computer
- Wireless phone charger
- Electrolier
- Fluorescent lamp

### FRIENDLY TIPS

**Alteration and refitting without consent by authorized organization might cause some equipment out of normal work.**

**If the smart entry and starting system fails to operate normally due to fault, please contact BYD service station. Be sure to take all the smart keys with you. They might be necessary for system repair.**

**Specification of the smart entry and starting system Key**

Frequency range: 433.050-434.790MHZ

Emission power  $\leq 5500 \mu\text{V/m}$  (field strength)

Spray emission limit:  $\leq 610 \mu\text{V/m}$

Nominal frequency: 433.92MHZ

**Internal and external specification of the smart entry and starting system transmitter**

Emission magnetic field strength: 72dBuA/m (10 meters away, quasi-peak value)

Spray emission limit:: 27dBuA/m (10meters away, quasi-peak value)

### NOTICE

- **Do not change emission frequency or increase emission power (including adding emission frequency amplifier). Do not connect to external antenna or use other emission antenna.**
- **Do not interfere with legal radio communication services. Once it occurs, please stop using it and**

take measures to eliminate interference before use it again.

- When using micropower radio equipment, please be aware of interference of various radio businesses or radiated interference of industrial, scientific or medical appliances.
- It shall not be used at or near airport.

### The Front Door

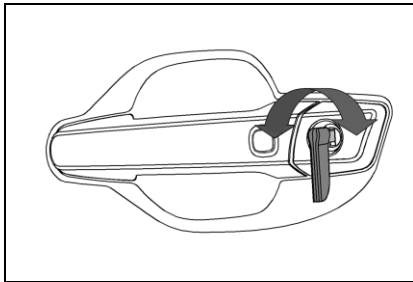

Lock and unlock with a mechanical key

**Insert the Key into Keyhole and Revolve it.**

Lock: revolve the key counterclockwise

at left the front door;

Revolve the key clockwise at right the front door.

Unlock: revolve the key clockwise at left the front door;

Revolve the key counterclockwise at right the front door.

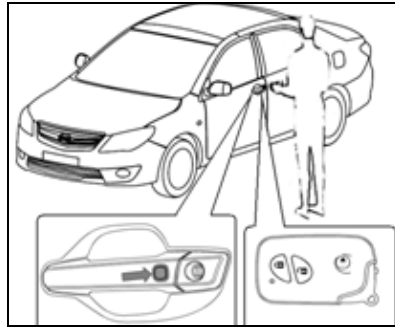

Lock and unlock

When you carry a registered the smart entry and starting system key (the electronic smart key or the card smart key; only the electronic smart key is

shown in the figure) into an activation zone, you can lock or unlock all car doors without using the key.

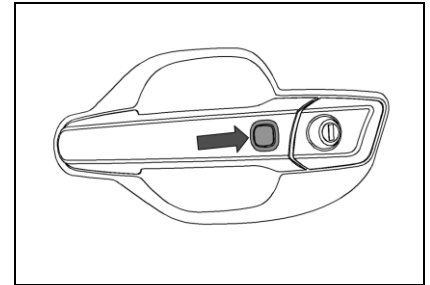

Locking operation

**Press the micro switch button of external car door handle in a slow and steady way. All car doors are locked at the same time. At this time, the turn signal light blinks once.**

Pressing micro switch button in the following cases will not perform the locking function.

- When a door is not closed well.
- When you press the locking button

while opening or closing car door.

- When the engine is not turned off.
- When the power position is at "ACC" or "ON".

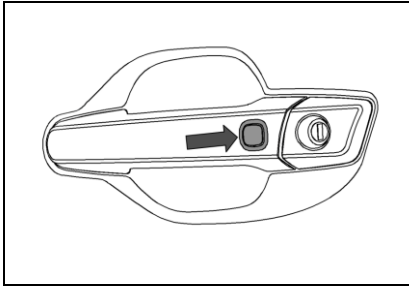

Unlocking operation

**Press the micro switch button of external car door handle in a slow and steady way. All car doors are unlocked at the same time. At this time, the turn signal light blinks twice.**

Please open the car door within 30 seconds after using unlocking function.

Otherwise, all car doors will be locked again.

When locking a car door with the smart entry and starting system, please check whether the car door is unlocked before pulling at car door handle.

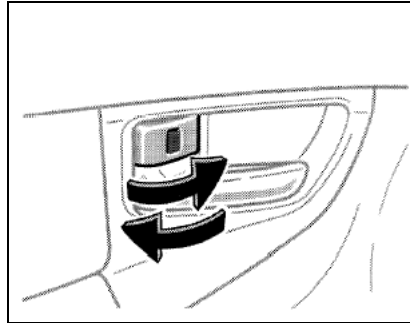

Use internal wedging block to lock and block

#### Turn Lock Button.

Unlock: pull the lock button backward.

Lock: push the lock button forward.  
When the internal wedging block button

is at locking position, you can also open the driver side door from inside.

#### FRIENDLY TIPS

**Do not pull the internal button of the driver side door during driving. Otherwise opened door might cause accident and severe injury.**

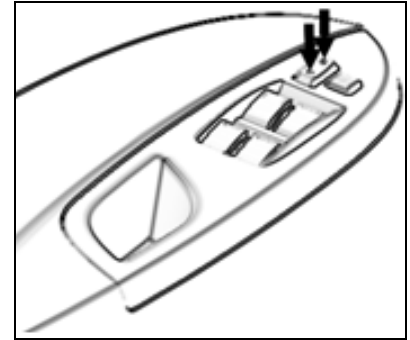

Use the central control lock switch to lock and unlock

**Press the Switch.**



Unlock: press down the rear side of the switch.

Lock: press down the front side of the switch.

All car doors are unlocked and locked at the same time.

### Automatic locking and unlocking of car door

When the car speed exceeds 20 km/h, all car doors will be locked automatically.

When you press “start/stop” switch to turn the power position from ON to OFF, all car doors will be opened automatically.

### Electric Door Windows

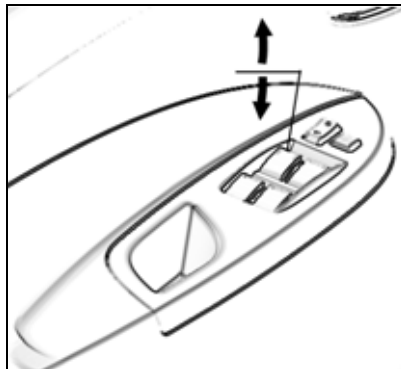

The switch on each door car can operate door window.

Power position must be at “ON” position.

### Operation of the driver side door window

Use the switch on the driver side door.

**The normal operation:** Press the switch downward slightly/press the

switch downward to the end/press the switch upward.

**Open:** Press the switch downward slightly, but not to the end, and then release the button.

**Close:** Pull the switch upward slightly and hold it until it is closed. If you want to stop it, just press the switch downward.

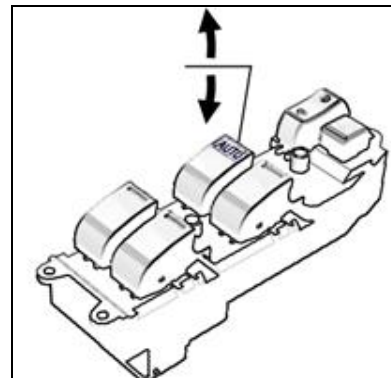

**Automatic drop of the driver side door window (AUTO) operation:** Press the switch downward to the full and then

release it until the window is opened to the full. If you want the window to be opened halfway, please pull the switch upward slightly and then release it.

### Operation of passenger door window

Switch of any passenger door or the driver door can be used to control passenger door window.

The normal operation: Press the switch to raise or drop the door window.

Open: Press the switch downward.

Close: Pull the switch upward.

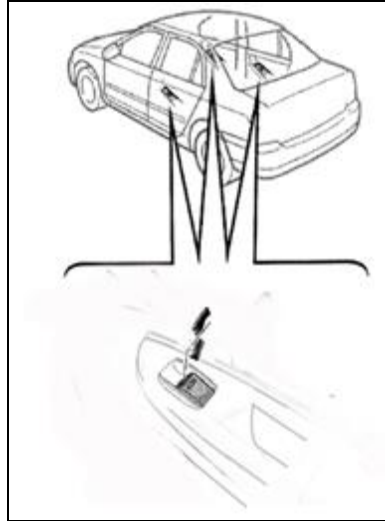

If you press the locking switch of the driver side door window, passenger side door window cannot move but the driver side door window can be operated.

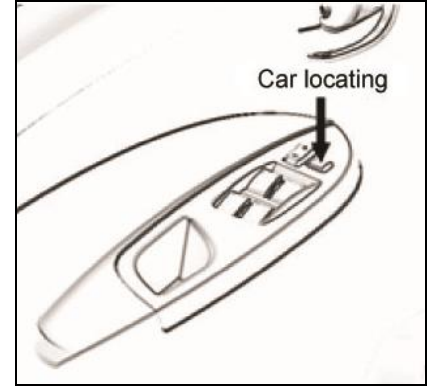

### FRIENDLY TIPS

- The electric door window does not provide anti-clamping function. Please pay attention to your safety when operating.
- When a child is in the car, please use door window locking switch to prevent him (her) from tampering with electric door window switch.
- When you leave the car, be sure to take the smart key with you.

## The Trunk Cover

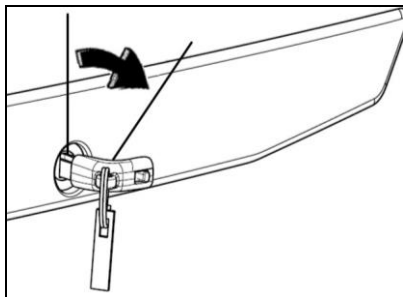

To open the trunk cover from outside, please insert the main key and rotate it clockwise.

For notes on loading luggage, refer to “notes on luggage loading” in section 2.

To close the trunk cover, please pull and press it downward. After closing the trunk cover, please try to pull it upward to check whether it has been closed tightly.

### FRIENDLY TIPS

During driving, please keep the trunk cover closed tightly. This not only prevents luggage from getting out but also prevents waste gas from getting into the car.

### Electric switch of the trunk cover (if installed)

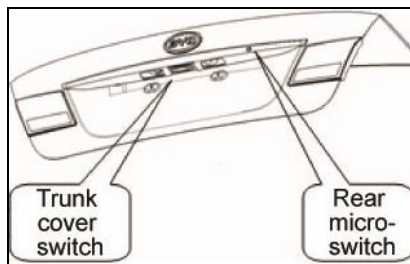

In the case of whole-the vehicle locking, press the trunk micro switch in a slow and steady way to unlock all car doors at the same time. At this time, the turn signal light blinks twice.

In the case of whole-the vehicle unlocking, press the trunk micro switch

in a slow and steady way to lock all car doors at the same time. At this time, the turn signal light blinks once.

In the case of whole-the vehicle unlocking, press the trunk cover to open the trunk.

After performing locking with central control, pressing the trunk cover will not open the trunk.

When using the electronic smart key or micro switch to lock the car when four doors or the trunk is not closed, the car alarm will ring once and the turn signal light does not blink.



### Internal Wedging Block of the Trunk



To open the trunk cover from the driver's seat, please pull internal wedging block of the trunk upward.

### Engine Hood

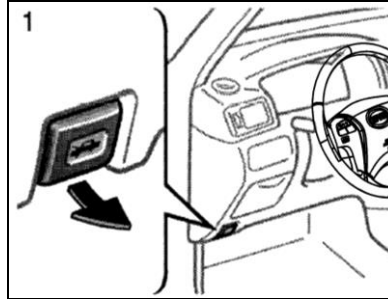

#### Open the Engine Hood

1. Pull internal wedging block of the engine hood upward to pop up the engine hood slightly.

#### FRIENDLY TIPS

**Before driving, please confirm that the engine hood has been closed and locked tightly. Otherwise, the engine hood might be opened suddenly during driving to cause accident.**

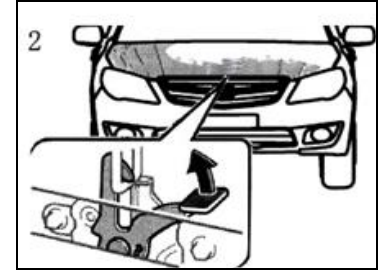

2. Pull up the auxiliary handle of the engine hood lock and lift the engine hood in the front of the car.

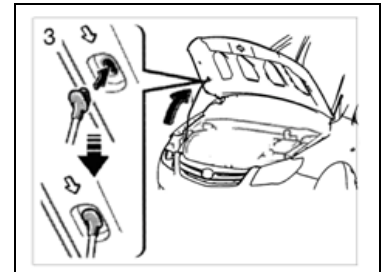

3. Insert the engine jackstay into the slot to keep the engine hood open.

Before closing the engine hood, please check whether any tool or rag is lost inside the engine hood before moving the engine hood jackstay back to its former position. Then, lower the engine hood and check whether it is locked in place. If necessary, please press the front edge slightly to lock it.

#### FRIENDLY TIPS

After inserting the engine hood jackstay into the slot, please check whether the engine hood jackstay is supporting the engine hood firmly in order to prevent the engine hood from dropping to prevent the engine hood from falling down and causing injury.

### Anti-Theft System



In order to prevent car theft, when any car door is opened when the car is under anti-theft condition, the system will give out alert.

The alarm rings and the steering lamp blink.

#### Setting System

1. Turn off the engine.
2. Get off all passengers.
3. Lock all car doors.

When all car doors are locked, the anti-theft indicator will remain on. 10 seconds later, the anti-theft system will be set automatically. When the system is set, the anti-theft indicator will begin to blink.



4. After confirming that the indicator blinks, you may leave the car.

As unlocking the car door from inside the car activates the system, nobody should stay inside the car when setting the system.

## Activating System

In the following cases, the system will give out alert.

- When unlock a car door without using the access function of the smart key.
- When powering up the car without using the startup function of the smart key.

## Cancelling System

Stop alert in the following way:

- Unlock car door with wireless remote control.
- Unlock car door with micro switch.

## The Fuel Tank Cap

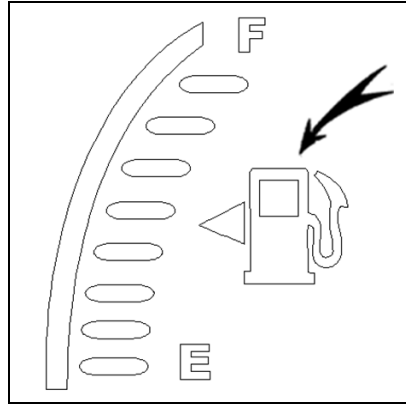

It indicates that the fuel filler lid is on the left side of the car.

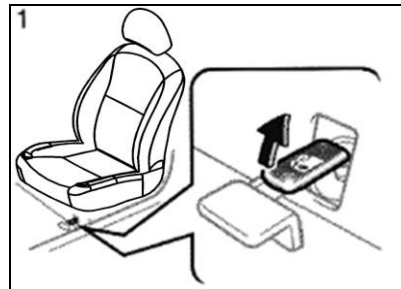

1. Pull up the internal wedging block of the fuel filler lid to open the fuel filler lid.

In fuel injection, the engine should be kept turned off.

### FRIENDLY TIPS

- Do not smoke in fuel injection. Sparks or flames will lead to fires.
- For opening the fuel tank, the cap should not be taken off suddenly. In hot weather, if the fuel tank cap is taken off suddenly, pressurized fuel may spurt out from the filling port and cause human damage.

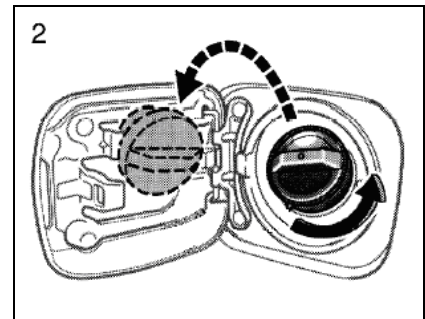



2. To remove the fuel tank cap, rotate the cap counterclockwise slowly and take it out after a while. After removing the cap, please hang it on cap supporter.

When the fuel tank cap is taken out, a slight noise can be heard. It's normal. When mounting the cap, rotate the cover clockwise until a click is heard.

#### FRIENDLY TIPS

- In order to prevent fuel spilling in an unexpected accident, please make sure to tighten the fuel tank cap.
- When replacing the fuel tank cap, please use an original The fuel tank cap of BYD L3 car. It can adjust the pressure of the fuel tank.

### Starting the Engine

#### Before Starting the Engine

1. Please check surrounding of the car before getting into the car.

2. Adjust seat position, seat back angle, seat cushion height, head protection device height and steering wheel angle and height.
3. Adjust internal and external rearview mirror.
4. Lock all car doors.
5. Fasten seat belt.

### Engine Starting Methods

#### (a) Before Starting

1. Perform parking brake to the full.
2. Turn off all unnecessary car light and accessories.
3. Automatic transmission: Place the shift at position P or N.  
Manual transmission: place the shift at neutral position.
4. Press the braking pedal or the clutch pedal to the full until the car moves.

#### NOTICE

- Starting procedure should not exceed 20 seconds to avoid overheating of starter and wiring system.
- Do not operate the engine refrigerator in a high speed.
- If it is hard to start the engine or the engine shuts down frequently, please check the engine immediately.

#### (b) Starting the Engine

#### Starting function of button

When the smart key is inside the car, press "start/stop" switch to start the engine.

Before starting the engine, be sure to follow the description in "(a) Before starting".

#### Normal starting procedure

Only when the smart key is inside the car (held by someone) can engine be started.



When pressing the brake or the clutch pedal with force, the indicator on “start/stop” switch will become green. Press “start/stop” switch to start the engine.

Press “start/stop” switch in a slow but forceful way.

#### **If the engine shuts off**

Restart the engine in accordance with correct starting procedure.

<b>NOTICE</b>
<b>Do not touch the “start/stop” switch with oil stained hands.</b>

<b>FRIENDLY TIPS</b>
<ul style="list-style-type: none"><li>• If operating “start/stop” switch fails, please stop using “start/stop” switch and contact BYD authorized service station immediately.</li></ul>

### If the engine fails to start

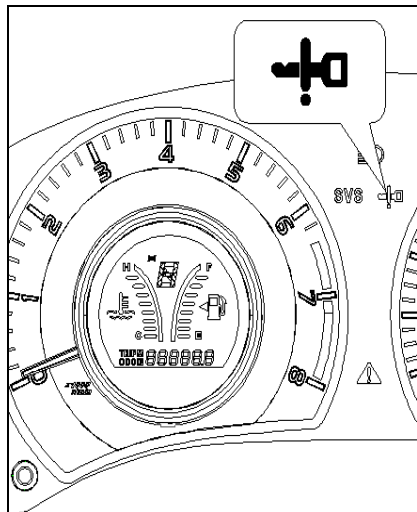

In the following cases, the engine will not start.

- When pressing “start/stop” switch, if the key position indicator lamp of the smart key system is turned on, buzzer in the car rings and “key isn’t detected” is shown on information

display on the right side of combined meter, it indicates that the intelligent key is not in the car.

- Even if the smart key is inside the car (for example on the floor, in the cup shelf, in the trunk or in the glove box), the engine cannot be started.

#### **Pressing “start/stop” switch does not perform startup function normally, possibly due to the following reasons.**

- If the smart key does not work, and the key position indicator of the smart key system on the combined meter and the prompt message “key battery voltage is low” is shown on information display on the right side of combined meter, the key battery might have run out of power.

Draw the smart key up to “start/stop” switch to start the engine. (Please refer to “the smart entry and starting system” for details.)

Please replace the smart key battery as soon as possible. (Please refer to

“Replace the card smart key battery” and “Replace the electronic smart key battery” in this section.)

- The engine is started repeatedly in a short period.

Start the engine 10 seconds later.

If startup fails, the orange indicator on “start/stop” switch will blink.

- If the green indicator on “start/stop” switch blinks, it indicates that the steering function fails.

Please contact BYD service station for examination of the car and all keys.

Intelligent access and keyless startup system cannot work normally in some conditions other than above stated ones due to application environment. (Please refer to “the smart entry and starting system” for details.)

#### **Use the smart entry and starting system to drive and park**

## Main Points on the Smart Entry and Starting System

You can start the engine with your own when using the smart entry and starting system.

Due to this, the driver might not become aware that someone else has taken the key away from the car. In this situation, the engine turned off cannot be started again. Or the driver is not aware that power position is not at OFF when he left the car.

The driver should confirm whether he is carrying the smart key when driving, getting on car or getting off car.

### NOTICE

**Do not touch “start/stop” switch while driving.**

If it is necessary to turn off the engine in emergency during driving, please hold “start/stop” switch for more than 3 seconds.

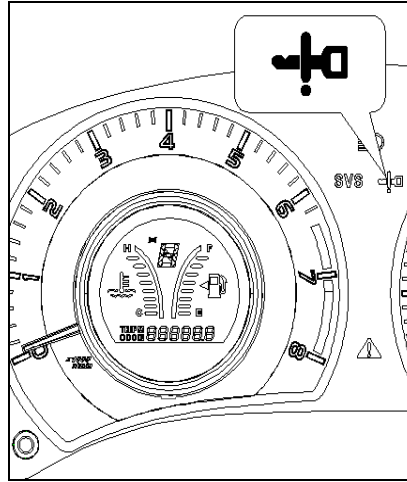

**Key position indicator lamp of the smart key system**

### System Function Prompter

In the case of the following warning, please follow corresponding description:

- 1.1 When pressing “start/stop” switch to power up, instrument warning buzzer beeps once and “key isn’t detected” is shown on information display on the right side of instrument.**

It indicates that the driver doesn't carry the smart key into the car. Key position indicator lamp of the smart key system on the instrument panel remains on for up to 8 seconds while “key isn't detected” is shown on information display is shown on information display. Do not operate “start/stop” switch until you confirm that the smart key is inside the car.

- 1.2 When pressing “start/stop” switch to power off, instrument set warning buzzer beeps once and warning light blinks while “key battery voltage is low” is shown on the Information Display on the Right Side of instrument.**

It indicates low level of the smart key battery. Please replace the smart key battery earlier to ensure normal work of the smart entry and starting system.



**1.3 When pressing “start/stop” switch to power up, the green indicator lamp of “start/stop” switch blinks.**

It indicates that the steering lock is stuck. To unlock it, please slightly sway the steering wheel while pressing “start/stop”.





# Chapter 1

## Section 3

### **Operation of Instruments and Controllers** **Seats, Seat Belts, Steering Wheels, the Child Seat and** **Rearview Mirrors**

Seat .....	1-34
The Front Seat.....	1-34
Seat Belt .....	1-35
The Children Seat.....	1-40
Airbag Restraint System .....	1-48
Steering Wheel .....	1-58
Power-Driven External Rearview Mirror .....	1-59
Internal Rearview Mirror .....	1-60
Sunroof .....	1-61

## Seat

During driving, all passengers in the car should make the seatbacks be in an upright position. They should sit upright against the seatbacks and fasten the seat belts properly.

### FRIENDLY TIPS

- Do not move the car before passengers sit in place. Do not sit on the upper side of folded seat back, among luggage or on stuff. Otherwise, passengers who are not sitting in place or wearing seat belt might be injured severely in the case of emergency braking or bumping.
- Passengers should not stand up or move between seats during driving. Otherwise, they might be injured severely in the case of emergency braking or bumping.

## The Front Seat

### Notes on Seat adjustment

Please adjust the driver seat to put pedal, steering wheel and the

instrument panel controller under control of the driver.

### FRIENDLY TIPS

- Do not make adjustment during driving, as seat movement might cause the car out of control of the driver.
- When adjusting the seat, be sure not to damage any passenger or luggage.
- After adjusting the seat, please try to slide it back and forth to confirm the seat is locked in place.
- After adjusting seat back, please lean your back backward to confirm that the seat back is locked in place.
- Do not place anything under the seat. Otherwise, it might affect seat locking mechanism or accidentally push the seat position lever upward and cause a sudden move so that the driver might lose control of the car.
- When adjusting the seat, do not put your hand under the seat or near any parts in operation to avoid injury of your hand or finger.

## Adjusting the Front Seat

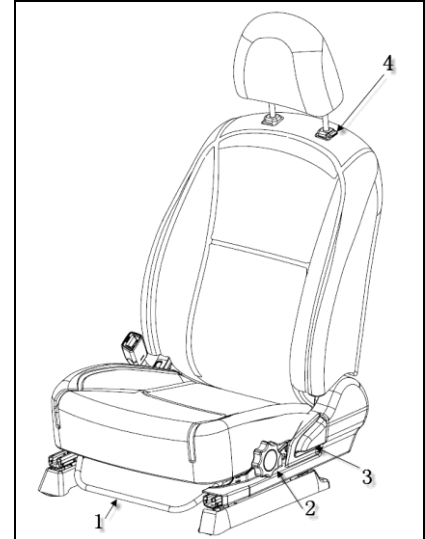

### 1. Front and back adjustment rod

Hold the middle part of the rod and pull it upward. Then, slide the seat to desired position by using body pressure and release the lever.

## 2. Hand wheel of cushion adjustment

Rotate the cushion adjustment hand wheel to adjust the seat to a desired height. (Notes: adjustment mechanism is not available for practical type, standard type and co-driver seat)

## 3. Adjustment rod of seat back angle

Tilt the rod forward and pull it upward, then tilt it backward to a desired angle and release the lever.

## 4. Headrest height adjustment button

### Raising Headrest

Slide the headrest upward to an appropriate height and release it.

### Lowering Headrest

Hold the button A to lower the headrest to an appropriate height and release it.

### Removing Headrest

Holding the button A to raise the headrest and remove it.

### Resetting Headrest

Insert the headrest connecting rod into the bush and keep the groove forward. Hold the button A to lower the headrest to an appropriate height and release it.

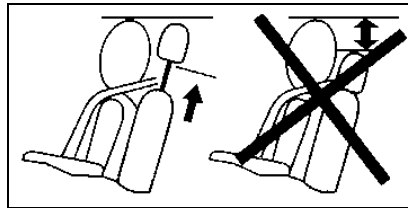

### FRIENDLY TIPS

**In order to reduce the risk that the seat belt comes off in a bumping accident, please avoid excessive tilting of seat back. When the driver and passengers sit straight with their back against seat back, seat belt will provide the maximum protection in an accident of the front or back bumping. If someone leans against the seat in an oblique way, the seat**

**belt at the waist might slide down the hip and inflict pressure on the bosom. In the case of an accident of the front bumping, excessive tilting of a seat might increase injury risk.**

### Seat Belt

#### Notes on Seat Belt:

It is strongly recommended that the driver and passengers should wear seat belt at any time. Otherwise, it might increase the risk of injury/ severe injury in an accident.

As seat belt is designed for adults, only those who have reached a certain age can wear seat belt properly.

The children must sit on back seat and wear seat belt properly for protection. In accordance with accident statistics, it is safer for the children to seat in a back seat under proper protection than in a front seat.

If a child has to sit in a front seat, he (she) must wear seat belt properly. If seat belt is not used properly, the air bag



system which rapidly in an accident might cause injury or even death to a child.

Whether in a front seat or a back seat, do not have a child stand or kneel on it. Emergency braking or bumping might cause severe injury or death to an unprotected the child. Do not have a child sit on an adult's thigh to avoid any risk.

**FRIENDLY TIPS**

**Passengers must seat in place and wear seat belt properly during driving. Otherwise, emergency braking or bumping might cause severe injury or death to them.**

**Please follow the description below when using seat belt:**

- One seat belt can only be used by one people at a time. It is prohibited for two or more people (including the children) to share one seat belt.

**FRIENDLY TIPS**

- **After inserting the seat belt into the buckle, please check whether the seat belt is locked by the buckle firmly and whether the seat belt is twisted.**
- **Do not insert coin, paper clip or other objects into the buckle to ensure correct connection between the seat belt and the buckle.**
- **If seat belt does not work normally, please contact BYD sales service station immediately. Before the seat belt is repaired, do not use the corresponding seat, as it cannot protect the passenger who uses it.**

- Avoid excessive tilting of seat back. When the seat back is in a straight-up position, seat belt exerts the maximum protection role. (Refer to description of seat adjustment.)
- Do not damage seat belt or its hardware. Do not stick or clamp seat belt between seats or in a door car.
- Examine seat belt regularly. Examine whether there is scratch, wearing or

loose parts. Replace damaged parts if necessary. Do not remove or refit the system.

- Keep the seat belt clean and dry. If cleaning is necessary, please use neutral soap water or slightly warm water. Never use bleach, dye fluid or grinding detergent, which might severely undermine seat belt. (Please refer to "inside cleaning" in the instruction.)
- In the case of a severe crash accident, please replace seat belt set (including bolt). Even if the damage condition is not obvious, it is necessary to replace the whole set.

**FRIENDLY TIPS**

**Seat belt is designed for adults and does not fit the children's body size. It is recommended that a child should sit in the back row.**

### 3. Point-type Seat Belt

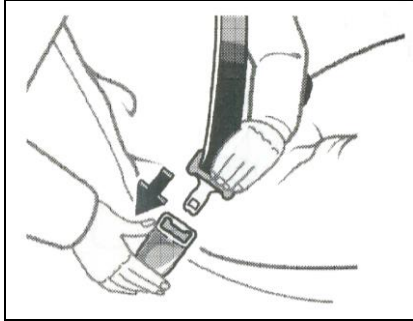

**Adjust the seat as desired and sit straight up in the seat with your back against seat back. When fastening seat belt, pull out seat belt from the retractor and insert it into the buckle.**

After inserting it into the buckle, a click will be heard.

The length of seat belt can be adjusted automatically in accordance with passenger's body size and seat position.

In the case of emergency braking or

bumping, the retractor will lock the seat belt. If you move your body forward very quickly, the seat belt will also be locked. Slow and steady body movement will extend seat belt free movement.

If the seat belt cannot be pulled out from the retractor, please fasten the seat belt once and then release it. In this way, you can pull out seat belt from the retractor smoothly.

When the seat belt on the shoulder a passenger in a back seat extends to the full, retract it slightly to lock the seat belt at the position. To release the seat belt again, please retract it to the full and then pull it out again.

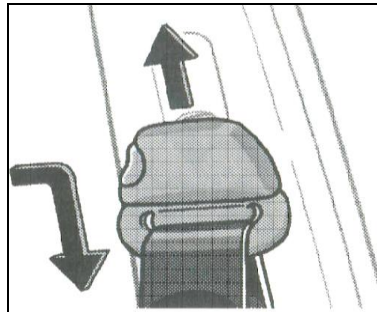

#### FRIENDLY TIPS

- **A waist seat belt fastened at a higher a position or a loosened seat belt might slide down your waist to cause severe injury In the case of bumping or other accident. Please keep the waist seat belt down as low as your hip.**
- **For safety sake, do not put the shoulder seat belt under your arm.**

#### Seat belt with height adjustment device

Adjust the seat belt to a position suitable for body size with the height adjustment device.

**Raise:** Slide the height adjustment device upward.

**Lower:** Press the adjustment button of the height adjustment device and slide the height adjustment device downward.

After completing adjustment, check whether the height adjustment device is locked in place.

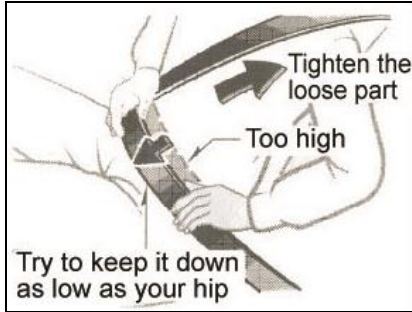

**Adjusting the positions of the waist and shoulder seat belts.**

Please keep the waist seat belt as low as your hip. Do not fasten it in the position of your waist. Then pull the shoulder part upward through the latch board and adjust the seat belt to a proper position.

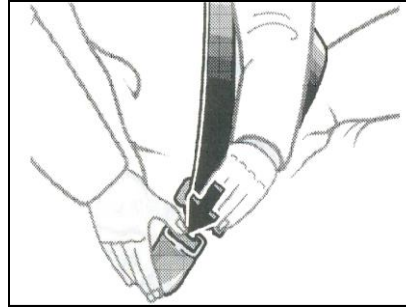

**To release seat belt, please release button on the seat belt and the seat belt will be retracted automatically.**

If the seat belt cannot be retracted properly, please pull it out and examine whether there is a knot or a twist. Make sure that there is no twist when retracting the seat belt.

**FRIENDLY TIPS**

**Please make sure that the shoulder seat belt cross the middle of your shoulder. Seat belt should be away from your neck to an extent that it will not come off from your shoulder. Otherwise, it will undermine**

**protection function of the seat belt in the case of unexpected accident and cause severe injury in the case of a bumping accident.**

**2. Point-type Seat Belt**

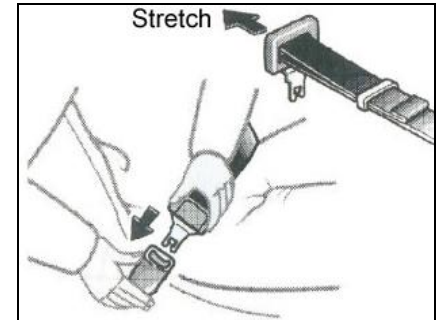

Please keep it down as low as your hip.

**Sit straight in your seat with your back against seat back. To buckle the seat belt, please insert it into the buckle.**

After inserting it into the buckle, a click will be heard.

If the **seat belt** is not long enough, please pull the belt head while maintaining a right angle between the belt head and the **seat belt**.

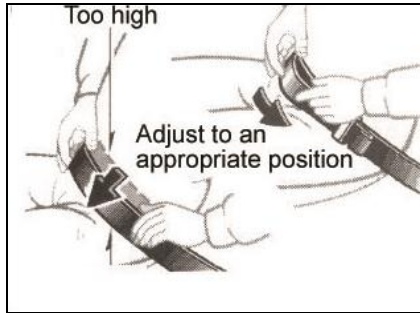

**Retract the extra part of the seat belt and adjust the seat belt position.**

When retracting the seat belt, please pull at the unfixed end of the seat belt. Please keep the waist seat belt in a position as low as your hip instead of your waist, and then adjust the seat belt to a proper position.

#### FRIENDLY TIPS

**A waist seat belt fastened at a higher a position or a loosened seat belt might slide down your waist to cause severe injury In the case of bumping or other accident. Please keep the waist seat belt down as low as your hip.**

#### FRIENDLY TIPS

- After inserting the seat belt into the buckle, please check whether the seat belt is locked by the buckle firmly and whether the seat belt is twisted.
- Do not insert coin, paper clip or other objects into the buckle to ensure correct connection between the seat belt and the buckle.
- If seat belt does not work normally, please contact BYD authorized service station immediately. Before repairing the seat belt, do not use the corresponding seat. It cannot provide protection for the passenger who uses it and might cause injury.

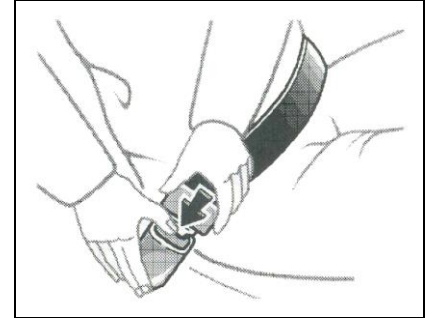

**To release the seat belt, please press the releasing button on the buckle.**

## The Children Seat

It is strongly recommended to use the children protection device.

### FRIENDLY TIPS

- According to a research, it is safer to install a child protection device on a back seat than on a front seat.
- Please select a child protection device in accordance with age and body size of your child.
- For related installation details, please refer to the instruction attached to the child protection device.

The manual provides a common installation instruction.

### Type of the Child Protection Device

The child protection device falls into the following 3 types in accordance with age and body size of the children.

### 1. Baby Seat (infant seat)



### 2. The Child Seat (convertible seat)

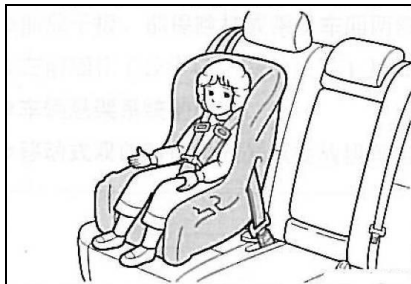

### 3. Youth Seat (auxiliary seat)



### Select a Suitable Child Protection Device

Please select a suitable child protection device. If your child cannot use a child protection device due to large body size, please use seat belt on the back seat.



### Notes on the child protection device

- Please use seat belt or the child protection device in accordance with age and body size of a child to provide effective restriction and protection in order to protect the children. In the case of emergent accident or emergent braking. Embracing a child cannot substitute a child protection device. In the case of accident, a child might be bumped onto shield glass or squeezed between you and car body.
- Never install a back seat the child protection device on the front seat. Otherwise, impacting strength caused by rapidly inflating air bag might cause severe damage or death to a child.
- Install a child protection device on a front seat only when there is no other choice. As air bag in the front of the front seat might inflate in quite a rapid speed and generates quite a great impact, please move the seat backward as much as possible to avoid risk of the child injury or death.
- For a car equipped with a side airbag or a curtain type air bag, even if you

have place a child in the child protection device, do not let his (her) head or any body part rest on the car door, the seat, front/rear pole or side roof beam (inflation range of side air bag or curtain type air bag). Otherwise, the strong impact of inflating side air bag or curtain type air bag might cause severe damage or even death to a child.

- Be sure to follow installation instruction provided by the child protection device the manufacturer to install the child protection device correctly. Otherwise, it might cause severe damage or even death to a child. In the case of emergency braking or accident.

### Installing the Child Protection Device

**Please follow the installation instruction provided by the child protection device the manufacturer. Use the seat belt or the fastening device to fix the child protection device to the outside seat of the back row. Please fix the top belt when installing the child protection device.**



Seat belt equipped with the child protection device

(ALR/ELR seat belt on back row seat)

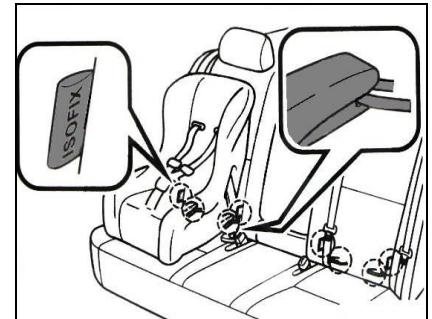

ISOFIX rigid fixing anchor (ISOFIX the child protection device)

A dedicated fixing lever is provided on the outside seat in the back row. (The tag indicating anchoring position is attached to the seat.)

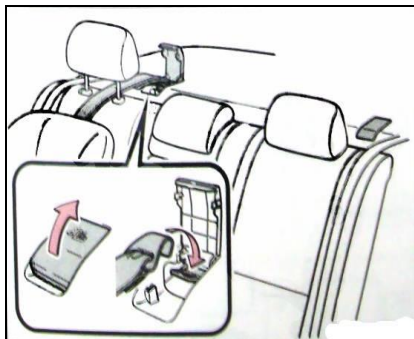

Fixing anchor support (used for top belt)

Fixed anchor support is provided on outside seat of the back row.

**The child protection device using Seat belt (the child protection device locking seat belt)**

1. The child seat facing behind — baby seat (infant seat)/the child seat (convertible seat)

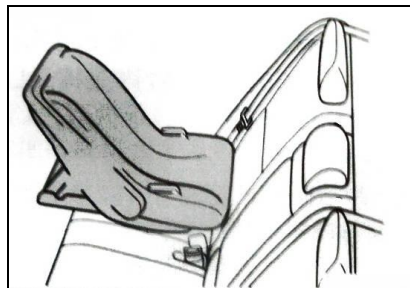

Put the child seat on the back row seat and face it to the back.

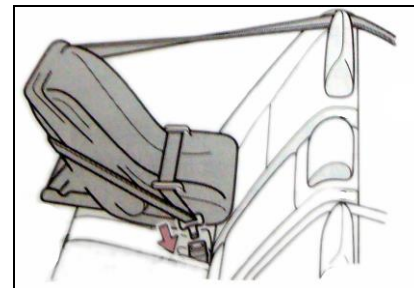

Pass the seat belt through the child seat and insert the belt head into the buckle. Ensure that the seat belt is not twisted.

2. The child seat facing forward (convertible seat)

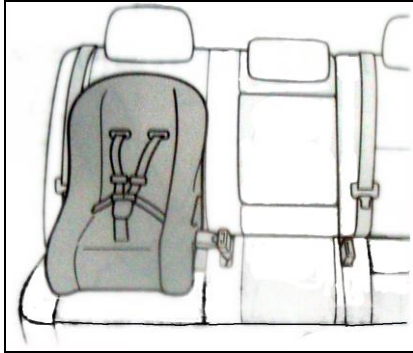

Install the child seat on the seat and make it face forward.

Pass the seat belt through the child seat and insert the belt head into the buckle.

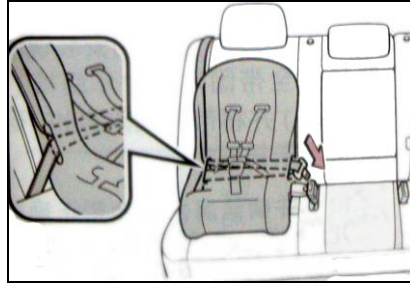

Ensure that the seat belt is not twisted.

Pull out the shoulder seat belt to the full and then retract it slightly to enter ALR locking mode.

It is not allowed to retract seat belt in locking mode.

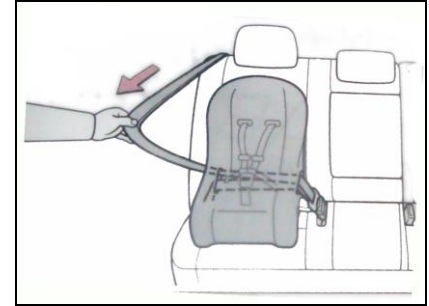

Place the child seat on the back row seat closely and retract the shoulder seat belt to the full until the child seat belt is fixed in place.

Retract shoulder seat belt to the full and then confirm that it cannot be pulled out by trying to pull it.

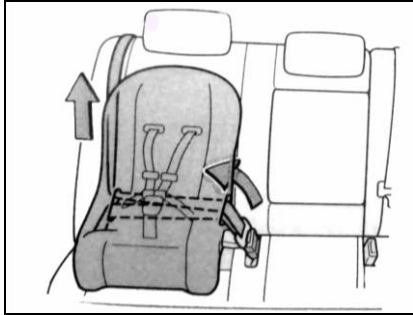

### Youth Seat (auxiliary seat)

Install the child seat on the seat and make it face forward.

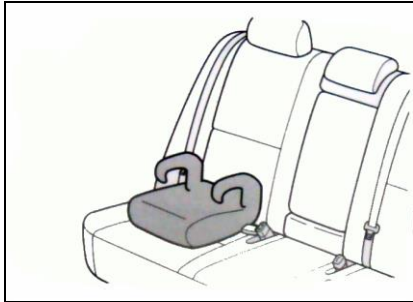

The child should use the child seat. Fix the child seat with seat belt and insert the belt head into the buckle in accordance with installation instruction provided by the manufacturer. Ensure that the seat belt is not twisted.

Check and confirm that the shoulder seat belt crosses a child's shoulder properly and lower the waist seat belt as much as possible.

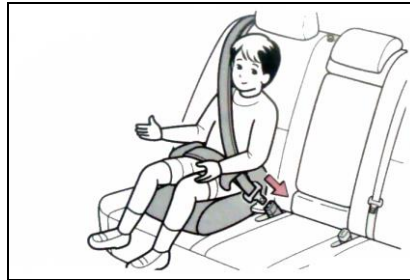

Remove the child protection device fixed with seat belt and press buckle releasing button to retract the seat belt to the full.

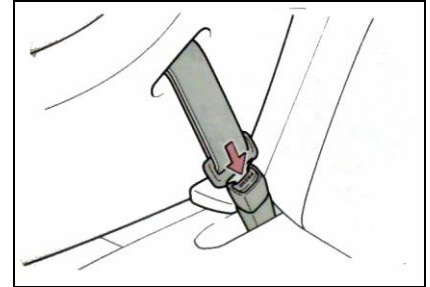

### Install the child protection device with ISOFIX rigid fixing anchor (ISOFIX the child protection device)

Check the position of dedicated fixing lever and install the child protection device to the seat.

Install fixing lever between cushion and seat back.

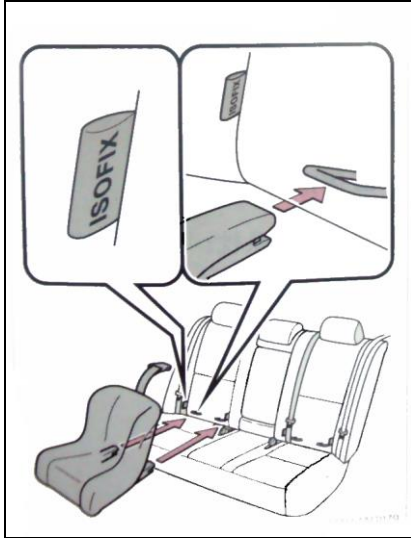

If the child protection device is equipped with top belt, please fix top belt to anchoring device.

### The child protection device with top belt

Fix the child protection device with seat belt or ISOFIX rigid fixing anchor and remove the headrest.

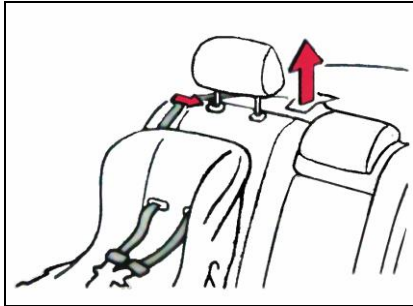

Open the fixing anchor support cover, fasten the hook to fixing anchor support and fix the top belt firmly.

Be sure to fasten top belt.

1. Hook
2. Top belt

### 3. Fixing anchor support

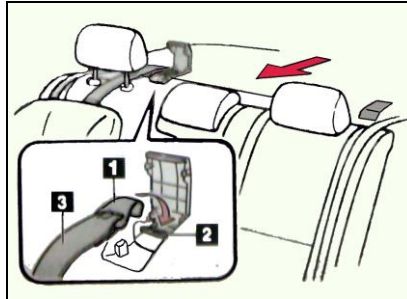

Reinstall the headrest

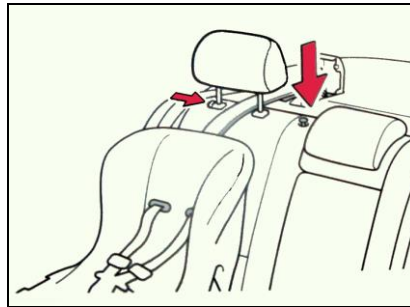

### When installing the child protection device in the front row seats

To install the child protection device on the front row chair on the front row seat with locking buckle, please follow installation instruction provided by the child protection device the manufacturer.

#### Notes on the child protection device

- Never stretch the shoulder seat belt to the full to prevent seat belt from entering into ALR locking model.
  - In ALR mode, seat belt can only be retracted, which will injure or discomfort a child.
  - The children should never tamper with seat belt, otherwise it might cause severe injury or even death to them.
- When installing the child protection device
 

Please follow the instruction in the child protection device installation manual to fix the child protection device firmly. If the child protection device is not fixed properly, emergent braking or accident might cause severe injury or death to a child.

### When Installing Youth Seat (auxiliary)

1 If the driver's seat impedes proper installation of the child protection device, please install the child protection device on the right side seat in the back row.

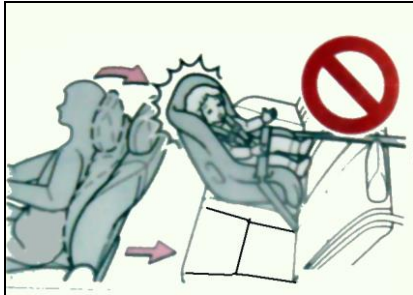

2 Do not install the child seat or youth (auxiliary) seat facing forward on the front row seat unless there is no other choice. When installing, move the seat backward as far as possible. Otherwise, inflating air bag might cause severe injury or even death.



### When installing the child protection device

Never install a back seat the child protection device on the front seat.

Otherwise, impacting strength caused by rapidly inflating airbag might cause severe damage or death to a child.

The warning tag on the instrument panel on the passenger side reminds you not to install backward-facing the child protection device on the front row seat.

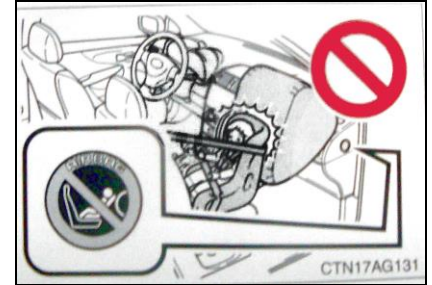

1. When installing youth (auxiliary) seat, please make sure that shoulder seat belt crosses the middle of a child's shoulder. seat belt should be kept away from a child's neck but should not come off easily. Otherwise, it might cause severe damage or even death to a child In the case of emergency braking or accident.
2. Ensure that seat belt and belt head are locked and seat belt is not twisted.
3. Push and pull the child seat in different directions to ensure that it is secured.



4. Please follow the installation instruction provided by the child protection device the manufacturer.
2. Please fix the child seat to anchoring device correctly

When using a lower anchoring device, please ensure there is no foreign object around the anchoring device and the seat belt is not stuck behind the child seat. Ensure that the child protection device is fixed firmly. Otherwise, emergency braking or accident might cause severe injury or even death to a child.

### **Airbag Restraint System (if installed)**

**Airbag restraint system, which belongs to Supplemental Restraint System (SRS), is a supplementary device to seat belt. The airbag restraint system provides additional protection for the head and the chest of the drivers and passengers to reduce injury or death in an accident of head-on collision.**

The airbag restraint system, which is a component of the whole passive safety protection system of a car, cannot substitute the seat belt. Please note that only when working together with the seat belt, the airbag restraint system can provide the maximum protection. Therefore, for the safety of you and your family, please pay attention to “notes” and “friend tips” in this section.

#### **FRIENDLY TIPS**

- **Always wear seat belt while driving!**
- **Please maintain correct sitting position so that the seat belt and safety and the airbag restraint system may provide the maximum protection!**
- **For a child, the back row seat is a safety position!**
- **Never try to remove or install safety bag components by yourself!**

#### **Triggering condition of airbag restraint**

Triggering condition of airbag restraint is as follows: In the case of a severe accident of head-on collision, the safety

air bag system will be triggered. In the case of a special collision accident, the air bag system might also be triggered.

In the case of slight head-on collision, side-on collision, rear-end collision or turnover, the air bag system will not be triggered usually. In these cases, the drivers and passengers are protected by seat belt.

A crucial factor to trigger the airbag restraint system is as follows: Deceleration curve generated by collision and obtained by ECU and set value are compared and judged in an all-around way. If the car deceleration signal generated and detected by collision is lower than reference value preset in ECU, the safety air bag will not be triggered, although the car might have been deformed severely in an accident.

ECU of BYD airbag restraint system is set in full consideration of misuse and road condition in China which is often experienced. However, considering that collision accidents are caused by various factors, please strictly comply with the instruction to use the car in a correct way



and avoid misuse. Otherwise, the expected effect of the airbag restraint system may not be achieved.

### Safety air bag system components

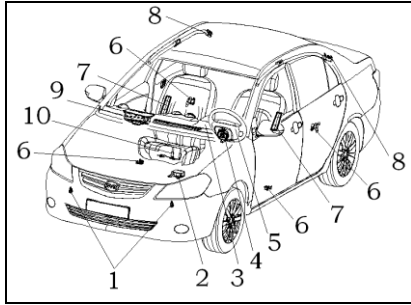

L3 car air bag safety system mainly includes the following components as shown in the above figure.

1. Front-end collision sensor
2. SRS ECU
3. SRS warning light
4. Clock spring

5. The driver's air bag module (if installed)
6. Side-on collision sensor (if installed)
7. The front row seat side air bag module (if installed)
8. Curtain type air bag module (if installed)
9. The front row passenger air bag module (if installed)
10. Seat belt warning sensor (if installed)

### The driver's air bag and the front row passenger air bag (if installed)

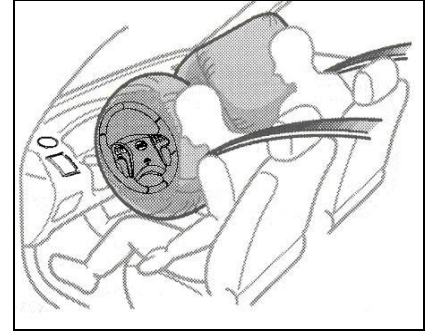

If your car is equipped with the front side supplemental restraint system (SRS AIRBAG), including the driver's safety air bag and the front row passenger air bag, air bag will be inflated to help protect the head and the chest of you and the front row passenger to reduce injury. In the case of a medium or severe head-on collision during driving.

### How the front side air bag works

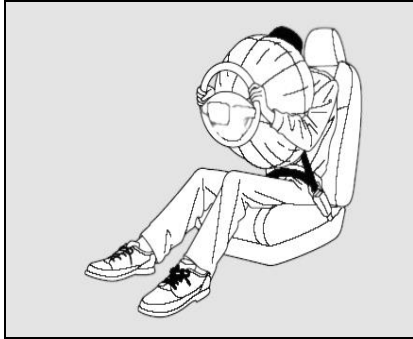

In the case of a medium or severe head-on collision accident, the sensor will detect dramatic deceleration of the car and send signal to the control device to inflate the front air bag immediately.

In the case of head-on collision, the seat belt may help fix the lower part of your body and your main body to keep you where you are. That is, the air bag provides an air cushion to stable and protect your head and chest.

As both air bags use the same sensor, they are usually inflated at the same time. However, only one air bag is inflated sometimes.

The reason might be that collision extension is an edge value or a critical value which causes air bag inflation. At this time, the seat belt will provide main protection function while the air bag only provides very limited auxiliary protection. At this time, the seat belt will provide main protection function while the air bag only provides very limited auxiliary protection.

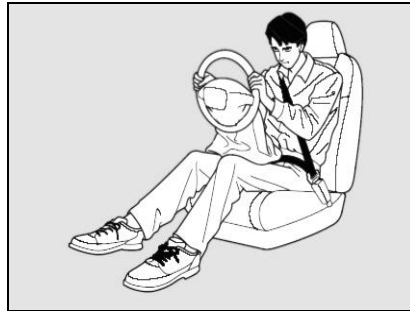

The front air bag will be discharged immediately after being inflated. In this way, it will not affect the driver's vision or ability to control the steering wheel or other control devices.

The air bag can be inflated within fractions of a second to provide additional protection for the driver and the passengers in an accident.

The air bag gives out a big sound when being inflated but does not cause injury usually (tinnitus or temporary deafness might be caused, which, however, will recover soon). After collision, you might see fog-like objects, which are actually powder on the surface of the air bag. Although the powder is non-toxic, passengers contracted with respiratory diseases might feel a temporary discomfort. In this case, please leave the car as soon as possible if it is allowed by traffic safety.

### Notes on Repair of the Front Air Bag

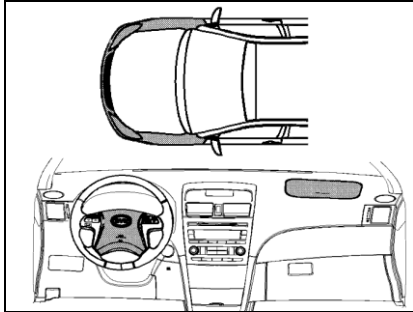

In the following cases, please contact BYD authorized service station immediately.

- All air bag modules of SRS airbag restraint system are inflated.
- An accident which occurs at the front side of the car (as shown in the shade of the figure) is not enough to inflate SRS air bag.
- The cross section of steering wheel liner or the cover of the front row passenger air bag (as shown in the shade in the figure) is scratched, cracked or damaged.

### The Front Row Seat Side Air Bag (if installed)

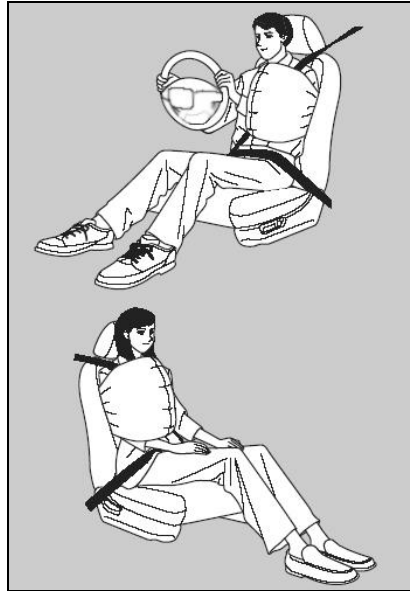

If your car is equipped with the front row seat side air bag, the air bag will be inflated to protect the upper body of the driver and the front seat passenger to

reduce injury In the case of medium or severe side collision.

### Curtain Type Air Bag (if installed)



If your car is equipped with curtain type air bag, the air bag will be inflated to protect the upper body of the driver and the front seat passenger to reduce injury In the case of medium or severe side collision.

### Notes on Repair of Side Air Bag

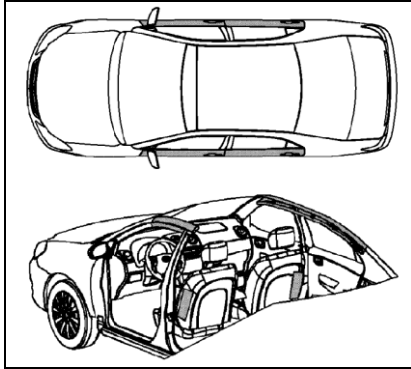

In the following cases, please contact BYD authorized service station immediately.

- SRS side air bag and air curtain have been inflated.
- An accident which occurs at car door (as shown in the shade of the figure) is not enough to inflate SRS air bag.

- The surface of the seat which is equipped with side air bag (as shown in the shade in the figure) is scratched, cracked or damaged.
- Decoration (lining) part of pole A, roof longitudinal beam and pole C which are equipped with curtain type air bag (as shown in the shade in the figure) is scratched, cracked or damaged.

### Safety air bag warning light (if installed)

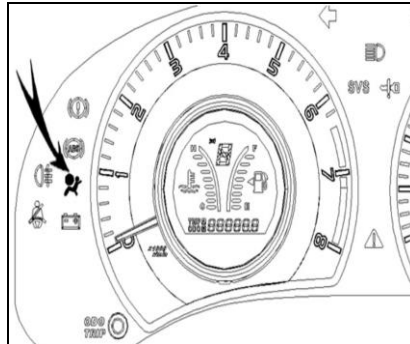

The air bag system is controlled by ECU and has self-diagnosis function, which indicates system status through warning light on the instrument panel.

- When “start/stop” switch is in IGNITION ON mode, the air bag lamp will be lighted for about 5 seconds and then turned off for about 5 seconds to indicate normal system.
- If the air bag has been turned off by BYD authorized service station, the warning light will react as above but will not have protection function.

The warning light system is used to monitor air bag ECU, bumping sensor, charging device, warning light, connecting line and power. (Refer to Chapter 1-5 “Maintenance Reminder and warning buzzer”.)

### NOTICE

The following cases indicate that fault exists in the airbag restraint system:

- When “start/stop” switch is in IGNITION ON mode, the warning light is not lighted.
- When “start/stop” switch is in IGNITION ON mode, the warning light will not turn off or will be lighted again after being turned off after 5 seconds.
- When “start/stop” switch is in OFF mode, the warning light will be lighted.
- The warning light will be lighted or blink while the car travels.

### FRIENDLY TIPS

If fault occurs, please contact BYD authorized service station for examination of the air bag system. Otherwise, the airbag restraint system might not work normally in the case of an accident!

### Indicator lamp for unfastening of co-driver seat belt (if installed)

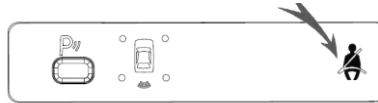

If your L3 car is equipped with seat belt warning sensor, you will see an indicator lamp for unfastening of co-driver seat belt on the No.1 switch set on the central control panel of the instrument panel (as shown in the black shade in the above figure). It is used together with seat belt. When a passenger who sits on the co-driver seat does not wear seat belt, the lamp will be lighted and give out alarm sound to remind him. After the passenger buckles up the seat belt, the lamp will turned off. If no passenger sits on the co-driver seat, the lamp will remain turned off.

### When air bag might not be triggered

Collision with concrete column, tree or other long and thin objects

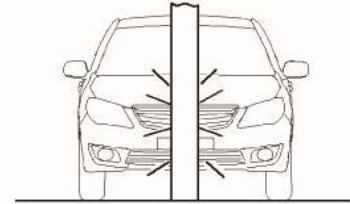

Non-head-on collision with wall

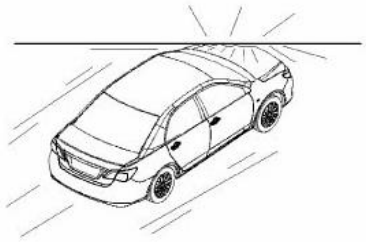

Rear end collision

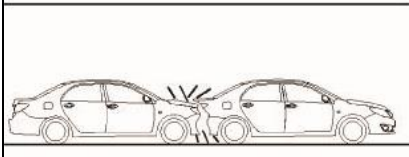

Bump into the lower part of rear end of large truck

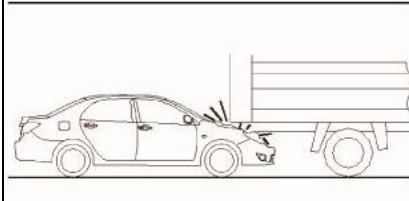

Rollover

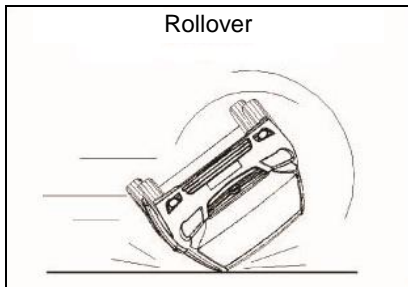

In the above stated cases, air bag might not be triggered. The figure above is an example.

In the following cases, the front air bag might not be triggered. If your car is equipped with the front row seat side air bag and curtain type air bag module, the front air bag might not be triggered. However, the front row seat side air bag and curtain type air bag might be triggered.

Lateral collision

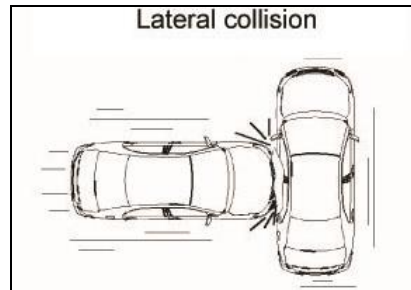

When air bag might be triggered

Bump into protruding objects on road side, safety island or kerb.



Car head touches ground  
when going downslope

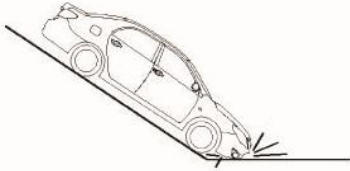

Car head touches ground  
when crossing a deep cavity



In the above stated cases, air bag might be triggered. The figure above is an example.

#### NOTES

- As air bag is designed to match a specified car type, any modification to suspension, tire size, bumper, chassis and OEM equipment will cause unfavorable effect on safety air bag. Do not use any part of the airbag restraint system on other types of cars. Otherwise, it might cause invalidation of airbag restraint system and injury.
- Please wear seat belt and maintain correct sitting position while the car is traveling. If you do not wear a seat belt or maintain an incorrect sitting position while the car is driving, an accident which triggers airbag restraint system might increase your injury risk.
- It is important for a driver to keep his chest away from the steering wheel for at least 25 cm, which will provide the most effective protection for the driver when the system is triggered. That is, the front seat and the head rest should be adjusted in accordance with body size of a driver. The driver should slightly bend his arms to an

extent reaching almost straight condition.

- Do not paste or place and objects or decoration on the surface of the steering wheel cover and the surface near the safety air bag on the right side of the instrument panel. The two places can only be cleaned with dry or slightly wet cloth. Do not strike the two places with force.
- The children are prohibited to sit on the front row seat without any protection. Otherwise, air bag triggered in an accident might cause severe injury.
- There should be no other persons, animals or objects between the driver/the front seat passenger and the safety air bag. It is very dangerous for a child who is embraced by an adult sitting in the front row.
- For example, telephone support, cup, ash tray and any other fixture are prohibited to be installed on the cover of the safety air bag or within its function scope. Otherwise, the air bag triggered in an accident might increase injury risk.



- It is prohibited to alter any component of the airbag restraint system, including corresponding labels.
- Only BYD authorized service station can operate on the safety air bag, including removing it for repair or other parts (for example, removal of the steering wheel).
- Please replace the airbag restraint system within 15 years since manufacture date of the car (as shown on automobile certificate and maintenance manual). Replacement must be conducted by BYD authorized service station. If you have replaced a part of the air bag system before the date, please make records on the service manual.
- The safety air bag can provide accident protection function once only. Once the air bag is triggered or damaged, the system must be replaced.
- When selling the car, please hand over all related document to the new owner. If the safety bag is turned off, please hand over related document to the new owner.

- When disposing any part of the car or the airbag restraint system, please observe related safety procedure and disposal procedure. BYD authorized service station is familiar with these regulations. Maintenance manual gives a detailed description of disposal procedure.
- The airbag restraint system provides strong interference resisting and disturbance resisting capability against surrounding electromagnetic interference and electromagnetic disturbance. However, in order to avoid an accident, please use the car in accordance with national regulation on electromagnetic environment.
- BYD L3 airbag restraint system has fully considered various misuses and road conditions which are often experienced in China. However, in order to prevent an accident. Please avoid strong impact on chassis or drive in bad road condition.

### Turn off Safety Air Bag

The driver/the front seat passenger safety air bag can only be turned off in the following cases.

- Although the driver seat position is adjusted properly, the distance between the steering wheel center and the driver's chest is less than 25 cm.
- It is necessary to install special equipment for the disabled within the working scope of the steering wheel.
- The position of the front row passenger seat is adjusted due to some reason, which is not within the position scope set in factory.

To turn off the airbag restraint system, please contact BYD authorized service station. After turning off a safety air bag, BYD authorized service station will attach label and make records on maintenance manual accordingly.





### FRIENDLY TIPS

**If it is necessary to turn off safety bag in a special case, please make sure to contact BYD authorized service station. Otherwise, there might be a risk of severe injury or death!**  
**In order to resume protection function of the air bag, please turn on the air bag which has been turned off!**

#### Others

- Please read the manual carefully. If you want to sell your car or dispose it, please tell the new owner or the disposing company that your car is equipped with airbag restraint system and advise them to read the manual carefully.
- After the airbag restraint system comes into effect, do not directly touch the safety air bag module component (otherwise you might be scalded or discomforted). Please contact BYD authorized service station for treatment. Once the airbag restraint system comes into

effect, please replace it with a new air bag system.

- The airbag restraint system only comes into effect In the case of severe head-on collision.

### FRIENDLY TIPS

**If turning on/off of indicator lamp of SRS is ignored, once the air bag does not work normally, it might cause severe injury or death.**  
**If SRS indicator lamp reminds you of a potential risk, please contact BYD authorized service station for car examination immediately.**

#### Maintenance of Air Bag

Your airbag restraint system actually requires no maintenance. There is no parts requiring your maintenance. In the following cases, please have your car examined and repaired.

1. If the air bag has experienced inflation. If the air bag has experienced inflation, the air bag and its controller as well as related parts have to be replaced. Never

try to remove or replace any air bag by yourself. Please leave the work to BYD authorized service station.

2. If SRS indicator lamp reminds you of device problem. Please contact BYD authorized service station for car examination immediately. If you ignore the reminding from the indicator lamp, the air bag might not be inflated when necessary.

Only trained personnel can deal with it. It is prohibited to remove any air bag component off the car. For repair or trouble-shooting of the airbag restraint system, please contact BYD authorized service station.

#### Supplementary Safety Notes

1. Never try to remove the air bag. Only the air bag in the normal operation can provide the best protection.
2. Never tamper with air bag component or wiring. Tampering might trigger the air bag accidentally and cause severe injury.



## Steering Wheel



To change the angle of the steering wheel, please hold the steering wheel and press steering column adjustment handle, tilt the steering wheel to a desired angle and then recover the handle to its original position.

### FRIENDLY TIPS

- Do not turn steering wheel while the car is travelling. Otherwise, the driver might operate the car incorrectly and cause an accident.
- After adjusting the steering wheel, please try to move it upward and downward to check whether it has been locked firmly.

## Control switch of steering wheel audio (if installed)

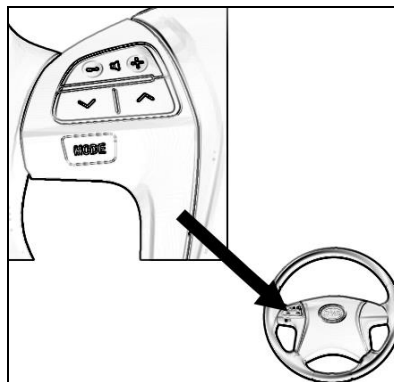

Press (hold) “+”/“-” to increase volume/reduce

Press (hold) “+”/“-” to increase volume/reduce volume (consecutively); Repeat pressing “^”/“v” key rapidly more than once to search for previous/next strong signal radio station automatically; Press “^”/“v” key to enter next/previous strong signal radio station automatically in radio mode;

Increase/decrease frequency in DVD/USB mode to fast forward/fast reverse; Press MODE key shortly to switch mode in the sequence of FM→AM→DVD (if MODE interface is filled by USB, content in USB device will be played, If it is empty, multimedia file in audio device will be played).

Press MODE key for 3 seconds to enter audio OFF status. Press MODE to turn on the audio.

## Power-Driven External Rearview Mirror

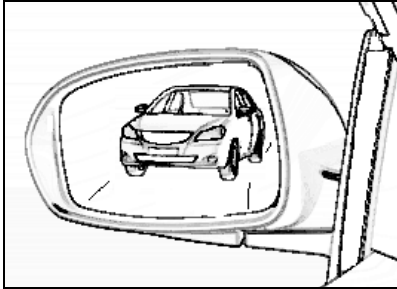

The driver can use mirror direction conversion button on the power-driven external rearview mirror to adjust the powered-driven external rearview mirror to a position where you can see the car side.

Foot lamp of external rearview mirror (if installed)

1. When the car turns from anti-theft condition to non-anti-theft condition, the foot lamp of external rearview mirror will remain on for 15 seconds; When the car turns from non-anti-theft condition to

anti-theft condition, the foot lamp will turn off.

2. In the anti-theft condition, when the key enters detection scope, the foot lamp will remain on for 15 seconds; In the anti-theft condition, when the key does not enter detection scope, the lamp will remain off.

Folding of external rearview mirror (if installed)

When the car goes through a narrow space, the driver might operate the folding button on power-driven external rearview mirror switch to fold the external rearview mirror in order to pass the space successfully. Press the folding switch again after passing the space to resume the rearview mirror to normal condition.

### FRIENDLY TIPS

**Do not adjust rearview mirror while the car is travelling. Otherwise, the driver might operate the car incorrectly and cause an accident.**

## Power-driven external rearview mirror controller

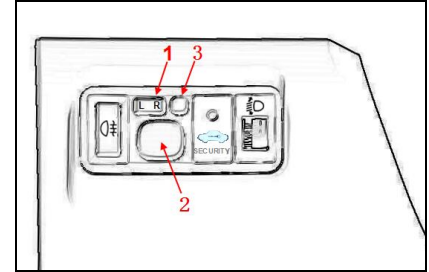

**Use the switch to adjust external rearview mirror.**

1. Selection switch — to select the external rearview mirror to be adjusted. Press the switch to L (left) or R (right).
2. Control switch — to adjust the external rearview mirror. Press the switch in the desired direction.
3. Folding button (if installed) — Press the button to fold the external rearview mirror. Press it again to unfold the external rearview mirror.

When the whole car is powered up, please adjust the mirror.

**NOTES**

**If the rearview mirror is frozen, do not operate the controller or wipe the surface of the external rearview mirror. Please use spray type ice scraper to remove ice of the surface.**

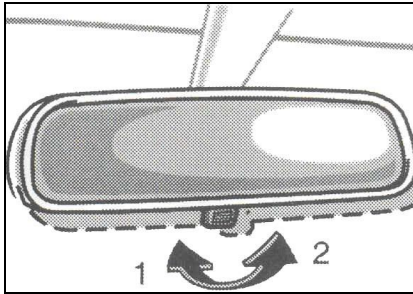
**Internal Rearview Mirror**

**Adjust the rearview mirror to a position where you can see the rear part of the car.**

When driving the car at night, please pull the lever towards you to reduce

reflection of headlight from following the vehicles.

Driving in day—the lever remains at position 1

In this position, reflection from the rearview mirror provides good sharpness.

Driving at night—the lever remains at position 2.

Please remember, in order to reduce glare, please reduce sharpness of the rearview mirror to some extent.

Starting condition of internal rearview mirror with direction the indication function (if installed):

Ignition switch is at “ACC” or “ON” position.

## Sunroof

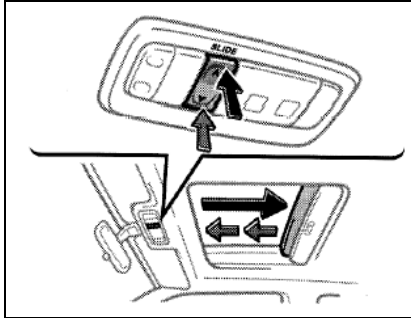

## Schematic diagram of sliding operation

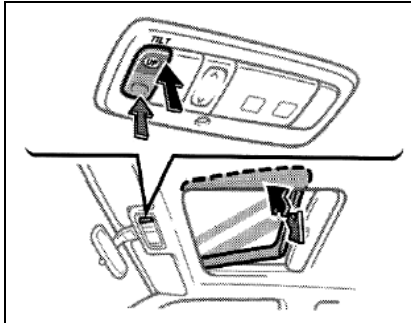

## Schematic diagram of tilting operation

**When operating the sunroof, please use the switch beside the front in-car lamp.**

The key must be at "ON" position.

Sunroof guard may be opened or closed manually.

## Sliding operation

Open: Press "SLIDE" side of the switch.

Sunroof guard and car roof will be opened together.

Close: Press the switch on the opposite side of "SLIDE".

As a precaution against closing, the car roof will stop at a half-closing position before totally closed. Therefore, you have to release the switch and press it again to close the car roof totally.

## Tilting operation

Tilting upward: Press "UP" side of the switch.

Lowering: Press the switch on the opposite side of "UP".

Please stop power-driven sunroof at any desired position. Press the button to move the car roof. Release the button to stop moving.

## Power-driven Sunroof (if installed)

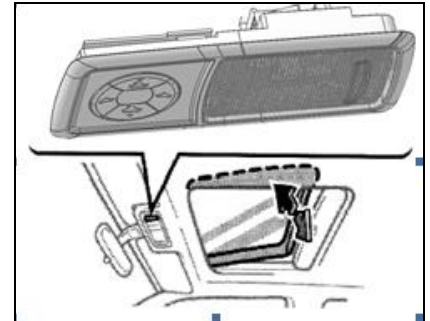

### Schematic diagram of sliding operation

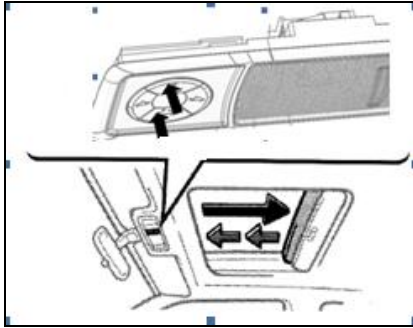

### Schematic diagram of tilting operation

**When operating the sunroof, please use the sunroof switch beside the front in-car lamp.**

Power position must be at "ON" position.

Sunroof guard may be opened or closed manually.

### Sliding operation

Press the switch bearing the following mark to move the sunroof accordingly as

shown in Figure 1.



: Press the switch to open the sunroof and move it towards the end of the car.



: Press the button to close the sunroof.

The operation is reverse to former action.

As a precaution against closing, the sunroof will stop at a half-closing position before totally closed. Therefore, you have to release the switch and press it again to close the sunroof totally.

### Tilting operation



: Press the button to tilt the sunroof. An angle is formed at the rear side of the sunroof.



: Press the button to close the sunroof tilted at rear end.

The operation is reverse to former operation.

Please stop power-driven sunroof at any desired position. Press the button to move the sunroof. Release the button to stop moving.

### FRIENDLY TIPS

- While the car is travelling, all passengers should keep their heads, hands other parts of their bodies away from opened car roof. Otherwise, emergent braking or unexpected accident might cause severe injury.
- Before closing the sunroof, please make sure it will not clamp passengers' neck, head or hand to avoid severe injury.
- When the vehicle is not powered off, please do not leave any passenger alone in the car (especially a child). Otherwise, he/she might be stuck by sunroof. Severe accident might occur to a passenger (especially a child) who is not cared.

**FRIENDLY TIPS**

- Do not turn on the sunroof where there is large quantity of dust or bad road condition to avoid pollution of sunroof slide grease, which might cause excessive wearing of mechanism parts and blocking of water outlet. Opening sunroof on bumpy road will shorten its life and damage it.
- Regularly examine whether sunroof works normally and whether water outlet is unobstructed. Often wash the car.
- When the car is parked for a long time, please pull the sun shading board to closing status. If condition allows, please park your car in a garage to avoid damage of internal decoration due to high internal temperature caused by long time sunshine.
- When washing the car, please close the sunroof totally. Do not wash sunroof sealing strip with high pressure gun to avoid unnecessary damage caused by sunroof leak due to excessively

high pressure.

- The sunroof sealing strip cannot contact with oil, acid, alkali or other corrosive objects to avoid undermining sealing performance of sunroof caused by its ageing.







# Chapter 1

## Section 4

### Operation of Instruments and Controllers

#### Lighting, Wipers, Defrosters

Head Light and the Turn Signal Light.....	1-66
High-Mount Stop Light .....	1-68
Emergency Light.....	1-68
The Front Fog Light .....	1-68
In-Car Regulation of Rear Fog Light and Head Lamp.....	1-69
Rear in-Car Lamp .....	1-69
The Front in-Car Lamp.....	1-70
Wiper and Cleaner of Windshield .....	1-71



## Head Light and the Turn Signal Light

(Without automatic light control)

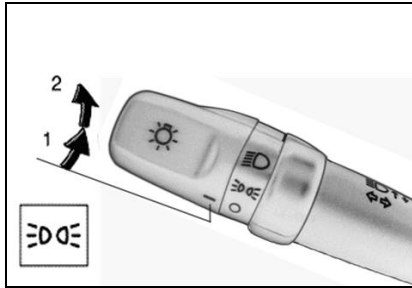

### Head light

Turn on the following lamps: rotate lever button of head lamp/ the turn signal light.

Position 1—the front position lamp, rear position lamp, LOGO assembly behind LED, number plate lamp, combined meter backlight and combined meter position indicator lamp (green) are all in ON status.

Position 2—Headlight and all lamps stated above.

### Light reminding buzzer

If the clearance lamp switch is turned on and power shift position is “OFF”, when opening the driver door, the alarm will remind you to turn off the light.

#### NOTICE

In order to prevent unnecessary discharge of the storage battery, do not turn on light while the engine is not running.

In order to prevent excessive consumption of the storage battery, when the power shift is at OFF and the combined switch is at clearance lamp, the clearance lamp on car door will remain on for 10 seconds before turning off. After opening the car door, the clearance lamp will remain on for 10 minutes before turning off.

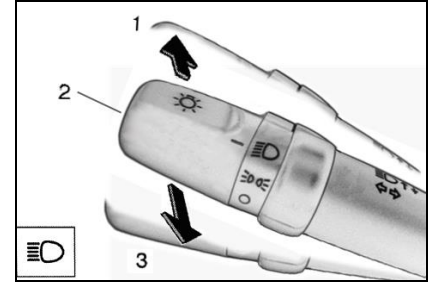

**High beam and low beam lights**—Rotate light adjustment button on the top of left combined switch to the front lamp position. When using low beam lights, please move the switch handle to position 2. When using distance light, Please turn switch handle to position 1. At this time, distance light and low beam lights are on. High beam light indicator (blue) on the Combined Meter remains in turn-on status.

**High beam light blinks**—Move the left combined switch handle to position 3 to turn on the distance light. Release the left combined switch handle to turn off the distance light.

When the headlight distance light indicator on combined instrument (blue) blinks, it indicates that distance light remain in work condition.

Rotating the knob to “OFF” will also blink the headlight distance light.

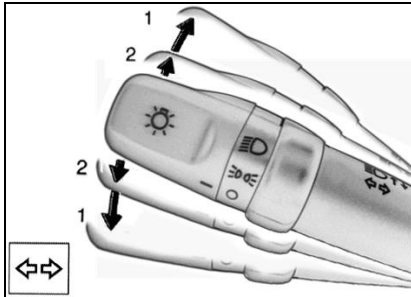

### The turn signal lights

To send direction signal, please rotate the light handle forward or backward to position 1.

Power position must be at “ON” position.

After the car turns, the lever will resume its original position. However, before

changing lane, it is necessary to resume the lever position.

To send a lane converting signal, move the level upward or downward to a pressure point (position 2) and maintain it.

If the turn signal light on the Combined Meter (green) blinks more frequently than usual, it indicates that the front or the rear the turn signal light has its bulb burned.

### Automatic light control system (if installed)

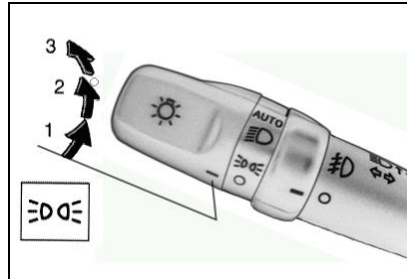

### Head lamp

**Turn on the following light: Rotate light regulating button.**

**Position1**—the front position lamp, rear position lamp, LED rear LOGO assembly, number plate lamp, combined meter backlight and combined meter position indicator lamp (green) are all in ON status.

**Position 2**—Headlight and all lamps stated above

**Position 3 (“AUTO”)**—Headlight and/or all lamps (position 2)

These lamps will be turned on or off automatically in accordance with surrounding brightness.

When it is necessary to turn on light immediately, for example, when entering a dark tunnel or a garage, please rotate light adjustment button to former position 2 to turn on the headlight.

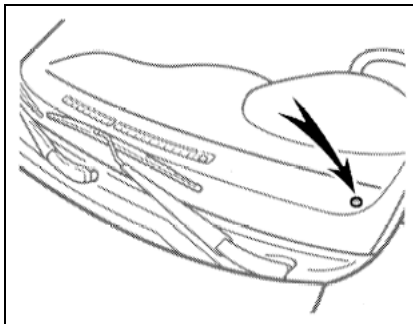

Illumination intensity sensor is located on the top of the instrument panel on the driver side.

Do not place and objects on the above stated area of the instrument panel or paste any objects on the above stated area of shield glass to obstruct the sensor.

**NOTICE**

**In order to prevent unnecessary discharge of the storage battery, do not turn on light while the engine is not running.**

**High-Mount Stop Light**

When pressing the **braking pedal**, the light and rear stop light will be turned on at the same time. It indicates that the car is in braking status to prevent accident.

**Emergency Light**

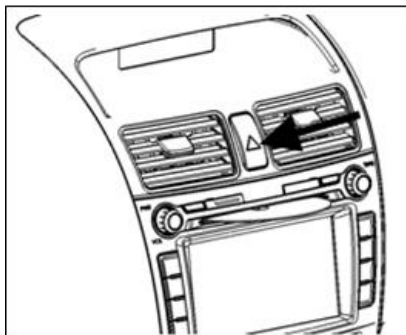

**To turn on an emergency light, please press the button.**

All direction the indication lamps blink. To turn them off, just press the button again.

When you have to park your car where it

is likely to cause traffic accident, please turn on the emergency light to warn other the drivers.

Please park the car far away from the road.

When the emergency light is turned on, the turn signal light does not work.

**NOTICE**

**In order to prevent unnecessary discharge of the storage battery, do not turn on light while the engine is not running.**

**The Front Fog Light (if installed)**

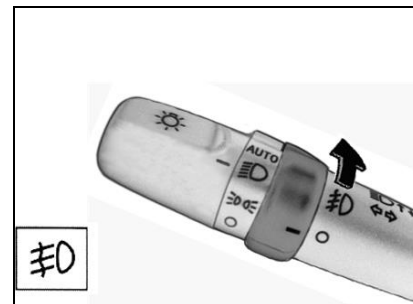

To turn on the front fog light, please rotate the light adjustment knob of the left combined switch to the position of a position lamp or a headlight, then rotate the front fog light switch knob (as shown in the figure) to position ON.

The front fog light indicator on the combined meter indicates that the front fog light remain On.

### In-Car Regulation of Rear Fog Light and Head Lamp

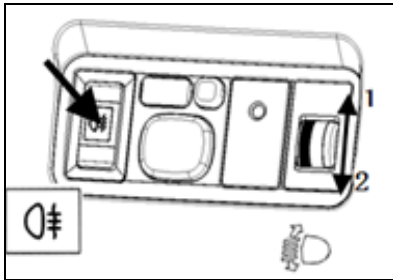

To turn on the rear fog light, please press the button. The rear fog light will be tuned on in the following cases:

When the front fog light is turned on—when the clearance lamp or headlight is turned on, the rear fog light will be turned on.

When the front fog light is turned off—when the headlight is turned on, the rear fog light will be turned on.

When the rear fog light is turned on, the rear fog light backlight will be turned on.

After the headlight is turned off, even if the headlight is turned on again, the rear fog light will not be turned on.

When all the other lamps are turned off, the rear fog light will be turned off automatically. To switch on the rear fog light, please press the switch again in above stated condition.

The adjustment knob of headlight beam direction is used to adjust headlight and beam direction in accordance with passenger number and car load.

By rotating the headlight adjustment switch, you can select the adjustment switch between 1 and 5.

Passengers and in-car load		Knob position
Occupancy	The trunk load	
The driver	No	0
The driver + the front row passenger	No	0
Full occupancy	No	1.5
Full occupancy	Maximum load	3
The driver	Maximum load	4

### Rear in-Car Lamp

(if installed)

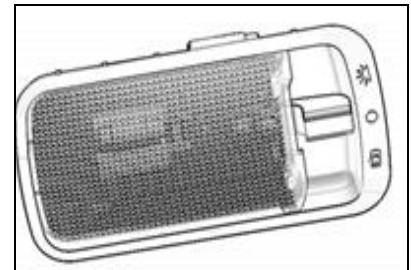

**If it is necessary to turn on the rear in-car lamp, please rotate the switch.**

The rear in-car lamp switch has the following positions:

“☀️”—In any time, keep the lamp on.

“○”—Turn off the lamp.

“🚪”—When any car door is opened, the lamp will be turned on. After all car doors are closed, the lamp will be turned off gradually.

**Rear in-Car Lamp (if installed)**

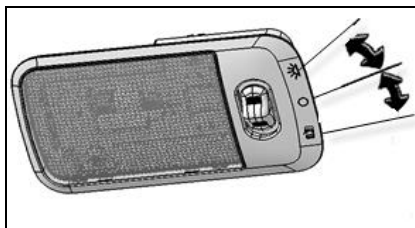

**If it is necessary to turn on the rear in-car lamp, please slide the switch.**

The rear in-car lamp switch has the following positions:

“☀️”—In any time, keep the lamp on.

“○”—Turn off the lamp.

“🚪”—When any car door is opened, the lamp will be turned on. After all car doors are closed, the lamp will be turned off gradually.

**The Front in-Car Lamp (a car type with power driven sunroof, if installed)**

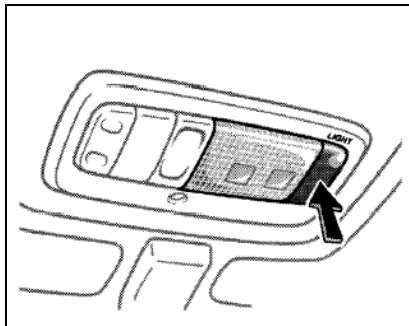

**To turn on the front fog light, please press the button. To turn off the front in-car lamp, please press the switch again.**

**The Front in-Car Lamp (a car type with power driven sunroof, if installed)**

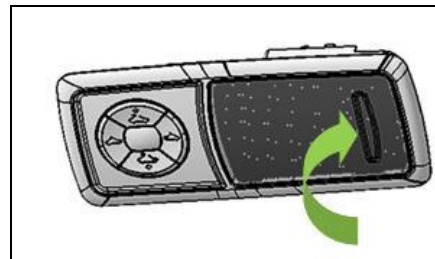

To turn on the front in-car lamp, please press the transparent mask on the right side of the front -in-car lamp as shown in the figure above. To turn off the front in-car lamp, please press the mask again and the lamp will be turned off.

## Wiper and Cleaner of Windshield

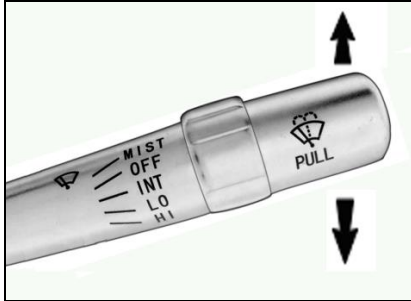

The switch is used to control the front windshield wiper and washer and is divided into five shifts.

MIST: Spot wiping mode

OFF: Turned off

INT: Interval shift

LO: Low speed shift

HI: High speed shift

To select a shift, please push upward or press downward the control lever.

In low speed shift and high speed shift, the wiper continuously works.

To have the wiper work in spot wiping mode, please push the control lever upward from OFF position and the wiper will scrape in high speed until the control lever is released. In this way, the windshield can be cleaned soon.

At interval shift, the wiper works for a cycle every 3 to 4 seconds. The shift position is suitable for small rain.

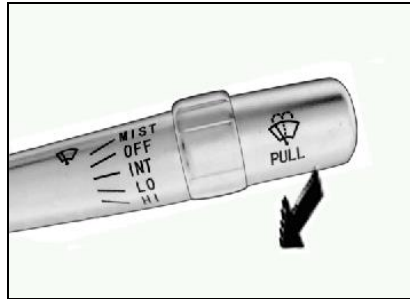

To spray cleanser, please move the right combined switch upward and then release it. After spraying cleanser, the wiper will work for twice.

For details of adding cleanser, please refer to Chapter 7-3 “Adding cleanser”. To use cleanser in freezing weather, please warm up and defrost the windshield glass before applying it. This will prevent the cleanser from being frozen on windshield to obstruct vision.

### 【Add cleanser】

If the cleaner does not work, the reason might be that the cleanser has run out. Please check liquid level scale for cleanser level. If the cleanser level is “LOW”, please add cleanser.

### NOTICE

**Do not use pure water as cleanser in cold area or in cold season. Otherwise, the cleaner inside, cleaner nozzle or cleaning tube inside might freeze and the cleaner motor might be damaged.**

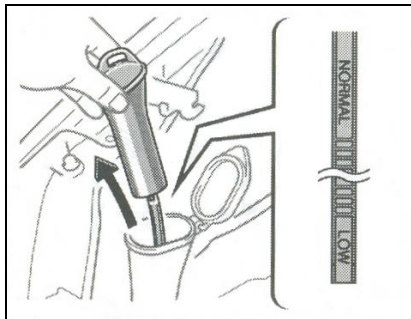

Remove the cover of cleanser container and then check the liquid level scale for liquid level. If the liquid level approaches LOW, please add cleanser until it reaches HI on the liquid level scale.

#### NOTICE

- When the front windshield glass is dry, do not use wiper. Otherwise, it would damage the glass.
- In a cold season, if the wiper blade is frozen or covered by snow, please clear snow or ice. Otherwise, the wiper motor might be damaged due to excessive resistance born by the wiper blade.

- If the front windshield is very dirty, please clean it manually before using the wiper. Otherwise, it will greatly shorten service life of the wiper blade.

If the windshield glass cleanser is not available, please use clean water. However, please use anti-freezing windshield glass cleanser in a cold area or in a cold season. The product is available in BYD authorized service station and most automobile parts shop. Refer to the manufacturer instruction for mixture ratio of water.

#### NOTICE

Please adjust cleanser concentration in accordance with temperature outside the car. If the concentration is not appropriate, sprayed cleanser might freeze on the windshield glass to obstruct your vision and cleaning mixture in the container may also freeze. Do not use the engine coolant as cleanser. Otherwise, painting might be damaged.

#### Use and maintenance of wiper blade

##### Notes on use of wiper blade

Please pay attention to the following cases. Otherwise, it might damage wiper blade sealing strip and cause abnormal work of wiper. For example, vibration, harsh noise and bad performance of wiper.

- Do not use wiper blade to remove ice on the windshield glass. Otherwise, the wiper blade sealing strip might be damaged to cause bad performance.
- Do not use the wiper on dirty, oily or waxed windshield glass.
- Keep the windshield glass clean (there is no a large quantity of dust, sand, insects or other hard objects on the windshield glass). Using the wiper on dirty windshield glass might damage the windshield glass and the wiper blade sealing strip, which causes bad performance.
- When the windshield glass surface is dry and dusty, please use the wiper together with windshield cleaner which sprays



water. Otherwise, the wiper blade might be worn to cause bad performance.

- When washing the car and maintaining car paint, do not wax the windshield glass. The wax layer will reflect light where it is not bright enough to affect vision and driving safety. After washing the car, please use clean water to rinse the wiper blade and use dedicated glass wax cleanser to remove the wax layer on the windshield glass.
- Do not use hydraulic gun to wash the wiper blade for fear that excessive water pressure might damage the wiper blade.

#### How to clean windshield glass and wiper blade

1. Turn off automobile power; Lift the wiper beam before cleaning the windshield glass (※ it is prohibited to hold the wiper blade with hand), For detailed operation method, refer to the following figure, (Note: Wiper beams for different series of car

types have different structures, Wiper beam of some car types may not be lifted):

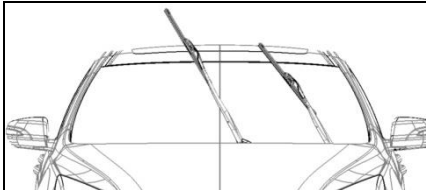

2. Use wet nanometer cloth to clean wiper blade sealing strip; Please hold the wiper blade frame or the plastic crust when cleaning so as not to cause wiper blade deforming. Please remove the wiper blade to wash it, After cleaning, reinstall it onto the wiper beam, A click sound

indicates that the wiper blade has been installed in place.

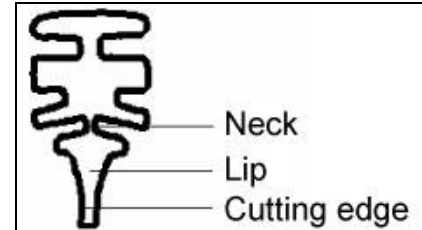

3. Remove and clean dust, sand and other objects accumulated on the windshield glass.
  - When the wiper beam is lifted, do not open the engine hood. Otherwise, the engine hood and the wiper beam might be damaged.
  - When putting the wiper blade back after car washing, do not hit windshield glasses with the wiper beam.
  - Do not bend the wiper blade. Do not obstruct wiper blade while the wiper is in operation.





# Chapter 1

## Section 5

---

### Operation of Instruments and Controllers Instrument and Maintenance Indicators

Information Display on the Left Side .....	1-76
Tachometer .....	1-78
Information Display on the Right Side.....	1-78
Maintenance Prompt Indicator and Warning Buzzers .....	1-82

## Information Display on the Left Side

- **Fuel Gauge**

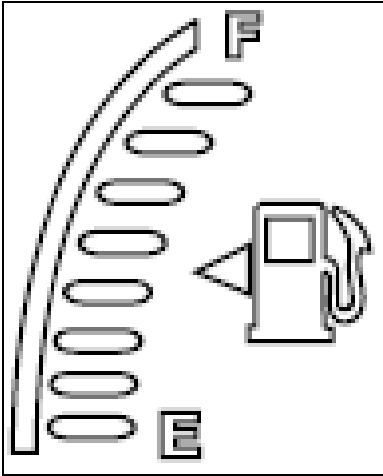

When the power is at ON position, the fuel meter shows left oil quantity.

Almost full — All the eight cells are lighted.

Almost empty — Only the lowest cell is lighted.

It is normal to keep fuel above 1/4 capacity of the fuel tank.

The indicator might blink frequently at the time of braking, accelerating or turning. It might be caused by swaying oil in the fuel tank.

If the fuel level approaches “E” or the low fuel level indicator lamp illuminates, while the main warning lamp illuminates and the right information display indicates “Please add fuel”, be sure to refill fuel as soon as possible.

Oil in the fuel tank might sway when the car travels on a slope or turns. Indicating cell on the fuel meter might blink frequently or the reminding message “please refuel” might occur earlier.

- **Thermometer of the engine coolant**

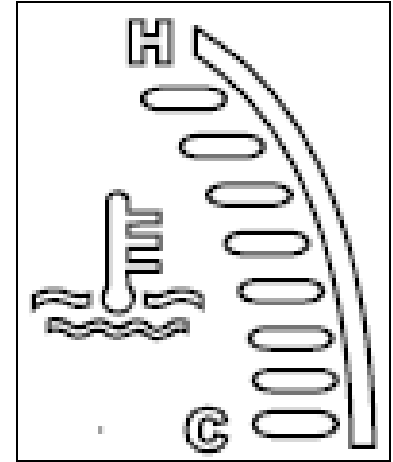

When the power is at ON position, thermometer indicates temperature of the engine coolant. Working temperature of the engine varies with weather and the engine load.

When the main warning light is lighted and “coolant at a very high temperature” is shown on the information display, it indicates that the engine coolant is at a very high temperature. If the car is too hot, please stop the car and decrease the engine temperature.

In the following work conditions, the engine might be overheated:

- The car goes up a slope in a hot day.
- The engine idles and the air conditioner runs while the car moves and stops frequently.
- The car has a trailer.

#### NOTICE

- Do not remove thermostat in the engine cooling system. Otherwise, it might cause abnormal work of the engine.
  - The car with an overheated engine should not continue travelling.
- Gear indicator (if available)

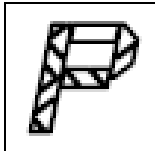

**It is displayed only when automatic gearbox is equipped. It indicates corresponding shift position when the gear lever is at a position.**

- **Odometer and double short distance odometer**

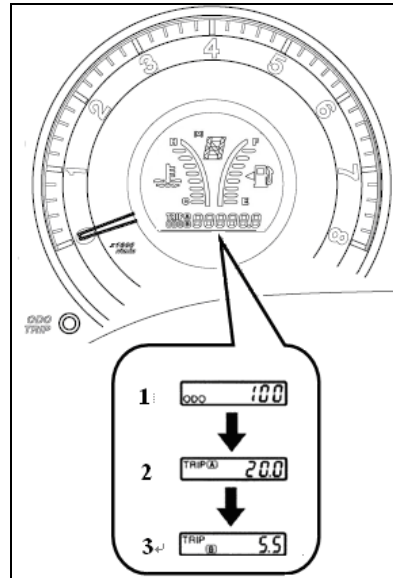

**The display shows the following information.**

1. Odometer—Indicates total mileage the car has travelled.
2. Double short distance odometer — Indicates mileage the car has travelled since the two short-distance odometers are cleared to zero.

You can use one short distance odometer to measure fuel (TRIP A) and use another one to measure mileage of each trip (TRIP B).

3. Trip / Reset button (on the left, ODO TRIP button) —

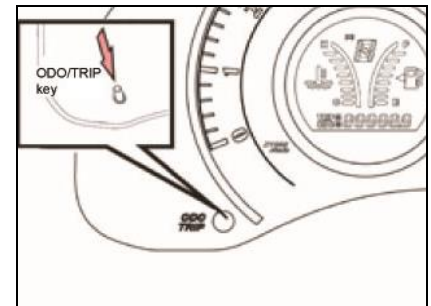



Clear the two short distance odometers to zero and change odometer display.

To change instrument display, please press and release ODO TRIP key immediately. Every time you press the key, the instrument will show odometer — short distance odometer (TRIP A) — short distance odometer (TRIP B) — Odometer (ODO) in sequence.

To reset a short distance odometer, please press and hold TRIP key for more than 2 seconds after it shows reading of the short distance odometer (TRIP A/TRIP B) until the instrument is reset to zero.

### Tachometer

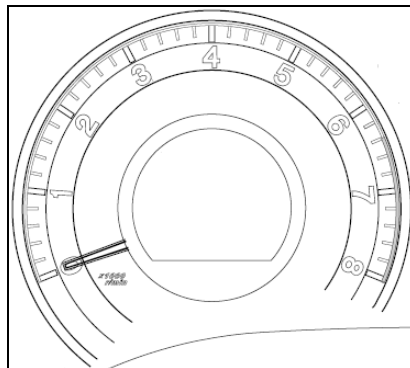

**The tachometer uses 1000 times of rpm (rotation per minute) to indicate rotation speed of the engine. Please select proper shifting time while driving the car in accordance with tachometer to avoid load deceleration and over-fast running of the engine.**

Driving a car whose engine runs over-fast might wear the engine excessively and waste fuel.

### NOTICE

**Do not let the pointer enters the red zone, which might severely damage the engine.**

### Information Display on the Right Side

Information switching button (right side, DISP key) — switch and set in-car information.

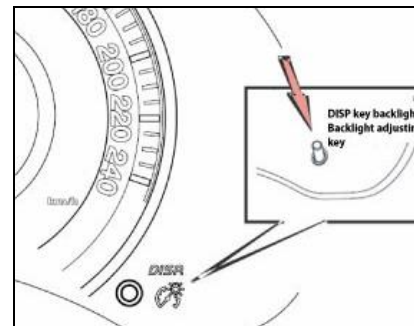

- **Time Adjustment**

Use the right side DISP key and the left side ODO TRIP key together to set a clock.

1. Firstly, use DISP key to access the time displaying interface in information display. Then press ODO TRIP key on the combined meter to access time setting interface. When “hour” on the screen blinks, press DISP key. Every time you press it, the number will increase by 1. Hold DISP key to increase the number continuously. The number is changed in a cycle from 00 to 23.

2. Press ODO TRIP key again, “hour” stops blinking and “minute” begins to blink. Then press DISP. Every time you press it, the number increases by 1. Hold DISP to increase number continuously. The number is displayed in a cycle from 00 to 59.

3. Press ODO TRIP key again, “minute” stops blinking and the second digit and the first digit of “year” begin to blink. Then press DISP. Every time you press it, the number increases by 1. Hold DISP to increase number continuously. The number is displayed in a cycle from 09 to 49.

4. Adjust time in the following sequence: hour-minute-the second digit and the first digit of year-month-date-hour.

5. After adjusting “date”, press and hold ODO TRIP key for 2 seconds to finish time setting and access time display. Or press ODO TRIP key to skip to step 1.

6. Press and hold ODO TRIP for 2 seconds during operation to access display interface automatically to finish setting.

During adjustment, if operation is stopped before adjustment is completed, the current value will be taken as default value 10 seconds later and the system will access time displaying interface to complete setting.

- **Gear indicator (DCT model)**

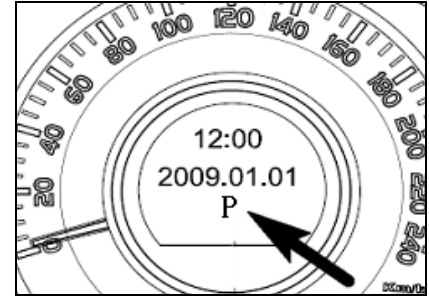

**The gear indicator is functioning only if equipped with DCT. When the gear selector lever at a certain position, display the corresponding gear indicator.**

- **Traveling information display**

Travelling information can be switched through TRIP key. Refer to the following table for displayed content and switching sequence.



Displayed content	Detailed description
Clock	The clock always appears When the power is at ON position.
Date	Default display date When the power is at ON position.
Backlight adjustment	Instrument backlight position which is set when clearance lamp is turned on or turned off last time. Press and hold DISP key for 2 seconds to switch backlight position in cycle.
Fuel consumption	Total fuel consumption since it is reset last time until now. Press DISP key for 2 seconds to reset the information.
The average fuel consumption	The average consumption per hundred kilometers since it is reset last time until now. Press DISP key for 2 seconds to reset the information.
Instant fuel consumption	The message shows instant fuel consumption.
Driving range	It displays the driving distance which the car can travel with currently left fuel. Calculation result of the distance in combination with the average fuel consumption and instant fuel consumption may be different from actually covered distance.
Average speed	The average speed since it is reset last time until now. Press DISP key for 2 seconds to reset the information.
Driving period	Driving period since the engine is started or it is reset last time. Press DISP key for 2 seconds to clear the information.
Time setting	Clock and date are adjusted in an increasing cycle.









- **Prompt Message Display**







Content is displayed or buzzer beeps	Detailed description
No key is detected	If a key is not detected in detection zone, press the start switch and the message will be shown.
Key battery voltage is low	The message indicates that key battery is low. Please replace battery.
Parking brake is not released	When car speed exceeds 5km/h, the parking brake switch will not be disconnected totally and alarm rings.
Please refuel	The message is shown when fuel is low and alarm rings.

- **Display of Fault Message**

Content is displayed or buzzer beeps	Detailed description
Please examine car network system	The message is often seen when the vehicle network system is abnormal. Please park your car and contact BYD authorized service station immediately.
Coolant at a very high temperature	The message is often seen when the coolant is at a very high temperature. Please park your car and contact BYD authorized service station immediately.
Insufficient pressure of the engine oil	When the engine oil is insufficient, please park your car immediately and contact BYD authorized service station.
Please examine electricity charging system	The message indicates that fault occurs in electricity system. Please park your car and contact BYD authorized service station immediately.
Please examine braking system	The message indicates that braking fluid level is very low or fault occurs in braking system. Please park your car and contact BYD authorized service station immediately.
Please examine ABS system	The message will appear In the case of ABS failure or braking system failure. Please contact BYD authorized service station for examination.

**Maintenance Prompt Indicator and Warning Buzzers**

If the indicator is turned on, something is shown on right side information display or buzzer beeps		Measures
(a)		Braking system warning light Possible causes: low braking fluid, braking system failure, and unreleased parking brake. Be sure to stop your car immediately and contact with the BYD sales and service shop.
(b)		Indicator light of the driver seat belt A driver should wear seat belt.
(c)		Battery discharge indicator Be sure to stop your car immediately and contact with the BYD sales and service shop.
(d)		Low engine oil pressure indicator Be sure to stop your car immediately and contact with the BYD sales and service shop.
(e)		Engine fault indicator Be sure to deliver your car to the BYD sales and service shop to have it checked.
(f)		Low fuel warning lamp Add fuel to the tank as soon as possible.
(g)		ABS system warning light Be sure to deliver your car to the BYD sales and service shop to have it checked. If the parking brake fault warning lamp also illuminates, be sure to stop your car immediately and contact with the BYD sales and service shop.

(h)		Door-open warning light Check and confirm that all car doors are closed.
(i)		SRS failure warning light Be sure to deliver your car to the BYD sales and service shop to have it checked.
(j)		Major warning indicator Please pay attention to prompt information on the right side information display.
(k)		Smart key system warning light
(l)		High coolant temperature warning lamp Stop your car immediately for inspection. Be sure to deliver your car to the BYD sales and service shop to have it checked.
(m)		SVS Warning light Be sure to deliver your car to the BYD sales and service shop to have it checked.
(n)	Light reminding buzzer	Turn off the lamplight.



## 1. Braking System Warning Light

When the power is at ON position, the lamp will be lighted in the following cases.

- **When Braking Fluid is Low.**

### FRIENDLY TIPS

**It is very dangerous to drive while braking fluid is low.**

**Please contact BYD authorized service station for car examination in the following cases.**

- When the power is at "ON" position, the lamp will remain off even if parking control mechanism is used.
- When the parking control mechanism is released, the lamp will remain on even if power is at ON position.

The warning light might become on for a short while during operation. It does not mean problems.

### FRIENDLY TIPS

**In the case of the following cases, please park your car in a safe place and contact BYD authorized service station.**

- **When the engine is running, the lamp remains on even if the parking control mechanism is released.**  
**In the case, the brake might not work normally and causes longer stopping distance. Please press braking pedal with force to park the car in emergency.**
- **While ABS warning light is on, the braking system warning light is still on.**  
**In this case, braking does not activate ABS system and the car becomes very unsteady.**

## 2. The Driver's Seat Belt Indicator Lamp

The indicator reminds the driver to fasten his safety seat belt.

Once power is switched to ON position, if the driver does not fasten his seat belt,

the indicator will turn on. The indicator will remain on until the driver fastens his seat belt.

## 3. Charging System Failure Warning Lamp

This lamp is used to indicate that the storage battery is in discharging status.

If the lamp is turned on while the car is travelling, it indicates that something is wrong with electricity charging system.

The engine can be started until the storage battery is thoroughly discharged. Turn off the air conditioner, fan and radio and drive your car to the nearest BYD authorized service station for repair.

## 4. Low Oil Pressure Warning Lamp

This lamp is used to warn that the engine oil pressure is very low.

While the car is travelling, if the lamp blinks or remains on, please pull off your car at a safe place and turn off the engine immediately. Contact BYD authorized service station for help.

When the engine is idling, this lamp can occasionally flicker and illuminate or illuminate for a short time after emergency brake. If the lamp is turned off while the engine is gradually accelerated, it indicates OK.

When the engine oil level is very low, the lamp will also turn on. The lamp is not used to indicate low engine oil level. The engine oil level must be measured with oil dip rod.

#### NOTICE

**Do not drive a car while the warning light is on, even if it is a short distance. Otherwise, the engine might be damaged.**

### 5. Engine fault indicator

The indicator will be turned on while the engine electronic injection system fails.

If the indicator turns on, please contact BYD authorized service station for examination/repair immediately.

### 6. Low fuel warning lamp

The lamp will be turned on when fuel in the fuel tank almost runs out. Please fill the fuel tank as soon as possible.

When the car travels up a slope or turns, the low fuel level warning light might be turned on earlier due to swaying fuel in the fuel tank.

### 7. "ABS" fault warning lamp

When the power is switched to ON position, the lamp will be turned on. If ABS system works normally, the lamp will be turned off a few seconds later. If the system fails later, the lamp will be turned on again.

When ABS warning light is turned on (braking system warning light is turned off), ABS system does not work but braking system will work normally.

When ABS warning light is turned on (braking system warning light is turned off), emergent braking or braking on slippery road will lock the wheel because ABS system doesn't work.

**In the following cases, fault occurs in parts monitored by indicator system. Please contact BYD authorized service station for examination.**

- When the power is switched to ON position, the lamp remains off or remains on.
- While the car is travelling, the lamp will be turned on.

The warning light might become on for a short while during operation. It does not mean problems.

#### FRIENDLY TIPS

**If ABS warning light remains on while braking system warning light is on, please park your car at a safe place and contact BYD authorized service station immediately. In this case, braking does not activate ABS system and the car becomes very unsteady.**

### 8. Door status indicator lamp

The car remains on until all car doors are closed.



## 10. SRS fault warning lamp

When the power is switched to ON position, the lamp will be turned on. About 5 seconds later, the lamp will be turned off. It indicates that airbag restraint system works normally.

The warning light system is used to monitor safety air bag ECU, bumping sensor, charging device, warning light, connecting line and power.

Any of the following cases indicates that fault occurs in parts monitored by warning light system. Please contact BYD authorized service station immediately for examination.

- When the power is switched to ON position, the lamp remains off or remains on.
- While the car is travelling, the lamp is turned on or blinks.

## 11. Major warning indicator

If the fault/prompt message presents on the right-side LCD, this lamp will be illuminated.

## 12. Smart Key system warning light

Push down the starting button, if no key is available at the moment, this indicator lamp will be illuminated for several seconds and buzz together with the buzzer. As a result, the LCD will display ""No key is detected.""

If pushing down the starting button when the key is available, this indicator lamp will not be illuminated. In this case, you can power on your car to start.

If you bring the key into your car within several seconds after this indicator lamp has been illuminated, this indicator lamp will go out and the steering shaft will be unlocked. In this case, you can power on your car to start.

If this indicator lamp is flashing after pushing down the starting button, it is an indication that your magnetic card is short of electric quantity.

## 13. High coolant temperature-warning lamp

When this lamp is illuminated, it is an

indication that the engine coolant temperature is too high. In this case, be sure to immediately stop your car for inspection, and ask the BYD Auto authorized sales and service shop to check/repair it as soon as possible.

## 14. SVS warning lamp

Push down the starting button and turn the power switch to the ON position, and this lamp will be illuminated for several seconds and then go out.

If this indicator lamp is illuminated or flashing at other moment it is an indication that there is a trouble in the automatic transmission or the engine management system.

In this case, be sure to deliver your car to the BYD Auto authorized sales and service shop for inspection.

## 15. Lamp reminding buzzer

When you switch power to OFF position and open the driver door while the clearance lamp or headlight is on, the buzzer will ring.



### Examination/maintenance reminding lamp

1. Parking control mechanism.
2. Open one car door.

The door status indicator lamp will be illuminated.

3. Turn off the door.

The door status indicator lamp will go out.

4. Switch power to "On" position but do not start the engine.

Except the status indicator lamp, all servicing prompt indicator lamps will be illuminated. After several seconds, ABS system fault indicator lamp (if available), SRS fault indicator lamp (if available), SVS warning lamp, engine fault indicator lamp and ESP fault warning lamp (if available) will go out.

If a maintenance reminding lamp or warning buzzers does not work as stated above, please contact BYD authorized service station for examination.

#### NOTES

**If red warning light (such as electricity discharging, braking, the engine oil and temperature) is turned on while the car is driving, please park your car and examine your car in compliance with instruction in the manual or contact BYD authorized service station.**







**Chapter 1**  
**Section 6**

---

**Operation of Instruments and Controllers**  
**Parking Brake Assembly**

Parking Control Mechanism ..... 1-90

## Parking control mechanism

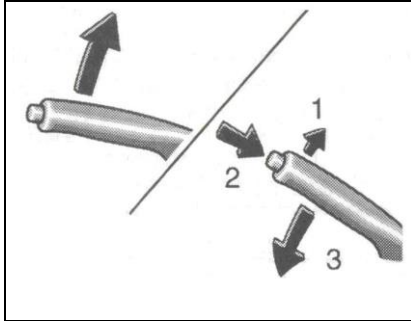

**Pull up the parking control mechanism tightly to avoid unexpected sliding while parking.**

**Setting:** Pull up the parking brake handle. For a better holding power, please press the braking pedal until your pull up the parking control mechanism.

**Release:** Slightly pull up the parking brake handle 1., press locking release button (2) and then put it down (3).

The parking control mechanism on the instrument panel remains on until the parking control mechanism is released to remind you that the parking control mechanism has been set.

### FRIENDLY TIPS

**Before driving, please confirm that the parking control mechanism is fully released and the braking system indicator is turned off.**



# Chapter 1

## Section 7

---

### Operation of Instruments and Controllers

#### Auto Audio System

How to Use in-Car CD .....	1-92
How to Use Multi-media Player .....	1-100



## How to Use in-Car CD

### Function and Characteristics

1. Playable CD
2. Integrated AM/FM radio
3. Anti-vibration mechanism
4. 25W x 4 maximum output power

### Major Technical Parameters

Item	Parameter	Unit
Working voltage	DC: 11~16	V
Maximum output power	25W×4	W
Maximum working current	10	A
FM frequency range	87.5~108.0	MHZ
AM frequency range	522~1620	KHZ

## In-Car CD Panel Function Description

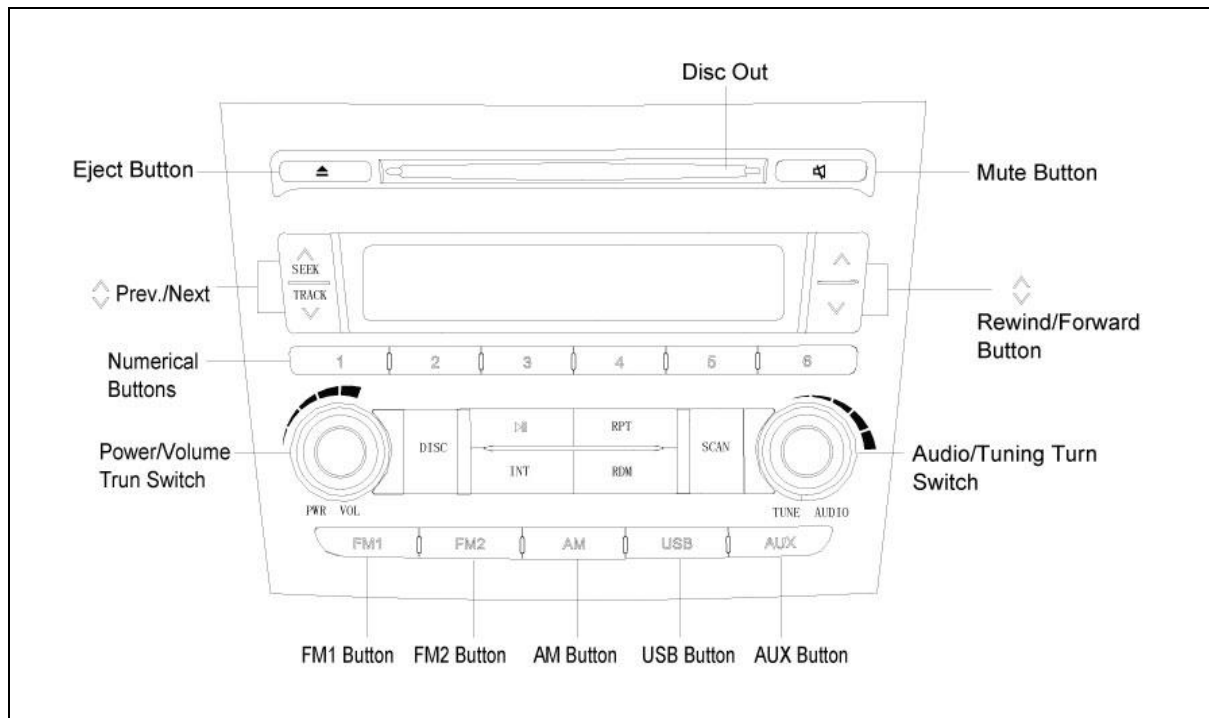

L3 CD panel button description

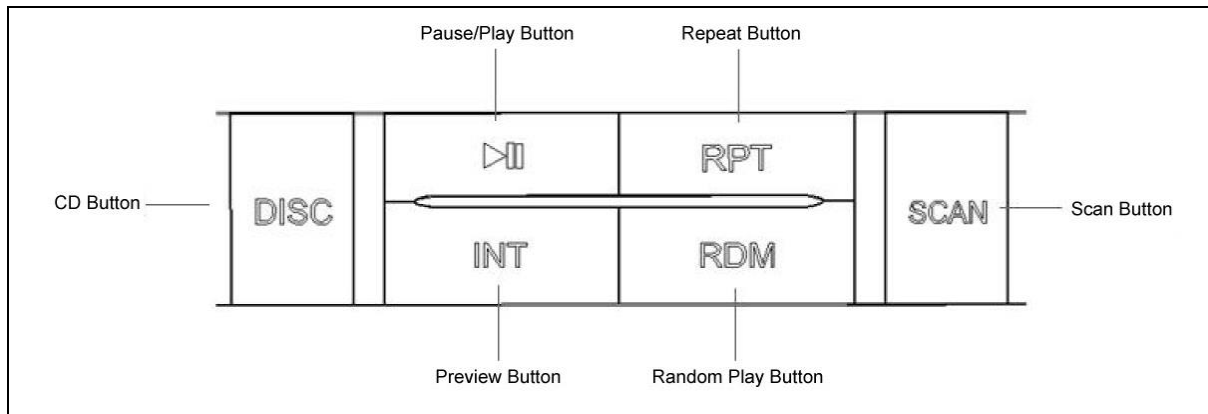

L3 CD panel button supplementary description

**Schematic diagram of in-car CD display**

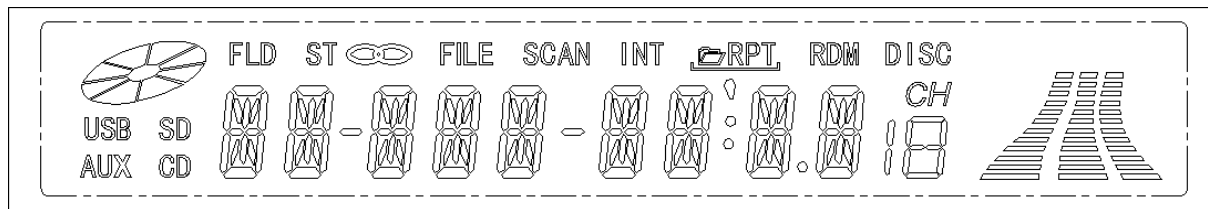



L3 CD initial sketch of display

### In-Car CD Panel Usage Description



**“Power switch/volume” knob:** Rotate the knob to adjust volume or switch on/off CD. At the time of volume adjustment, the display shows corresponding volume.

**“Tuning/sound effect” button knob:** Rotate the knob to tune manually. Rotate counterclockwise to reduce frequency and rotate clockwise to increase frequency; Press the button in a cycle of “bass (BAS) - treble (TRE) - balance (BAL) - fader (FAD) - automatic noise control (ANC)”. Rotate the knob to adjust between different modes. When the mode changes, the corresponding mode name will be shown on the display.

**“ ” key:** In RADIO mode: press it to automatically search for a strong signal station +/-, start play or stop searching.

Press and hold it to search for high/low frequency radio station quickly.

Release the button to stop. In CD and USB mode, press it to go to next/previous track. Press and hold it to fast forward or fast reverse single track time and to fast forward or fast reverse a track in USB mode.

**“   ” button:** file folder operation button: increase/reduce file folder. The key is available in USB mode only in order to switch between different U disk file folders quickly.

**“1-6” number key:** In RADIO mode, press it to select a radio station to store the current channel in a corresponding number key.

**“FM1”, “FM2” and “AM” keys:** Press the keys in any mode to switch to FM1, FM2 or AM radio functions respectively. The display shows FM1, FM2 and AM respectively.

**“CD”, “USB” and “AUX” keys:** Press these keys to enter CD, USB and AUX modes respectively. The display shows CD, USB and AUX respectively.

**“SEEK” key:** Press and hold it to

automatically search and store a radio station.

Press it to preview all stored radio stations in the current mode. The display shows SCAN.

**“PAUS” key:**

CD mode: disk play/pause. The display shows PAUS.

**“RPT” key:**

In CD mode: Press it to repeat playing a track.

In USB mode: Press it to repeat the current file. Press and hold it to play the current file folder in a cycle.

The display shows “RPT”.

**“INT” key:** In CD and USB modes, press it to preview play. The display shows “INT”.

**“RDM” key:** In CD and USB modes, press it to perform random play. The display shows “RDM”.

**“MUTE” key:** Press the key to enter the mute status. The display shows “MUTE ON”.

**“EJECT” key:** disc ejection key: eject the disc. At ACC or above position, in POWER OFF, press and hold for 2 seconds to eject the disk. The display shows “CD EJE”.

**Audio System Operation Prompt**

NOTICE
<p><b>CD mode:</b> indicates that the machine is in CD play status.</p> <p><b>Radio mode:</b> indicates that the machine is in radio status.</p> <p><b>CD disk ejection key:</b> Disk ejection key is located on the host machine. Only one disk can be inserted. Disk ejection key is used to eject the disk.</p>

NOTICE
<p><b>To protect correct operation of audio system:</b></p> <ol style="list-style-type: none"> <li>1. Do not splash drink onto audio system.</li> <li>2. Do not insert anything other than</li> </ol>

**CD into disk mouth.**  
**3. Mobile phone might affect speaker in operation. As a normal phenomenon, it will not affect use.**

Audio/video remote control (if installed)

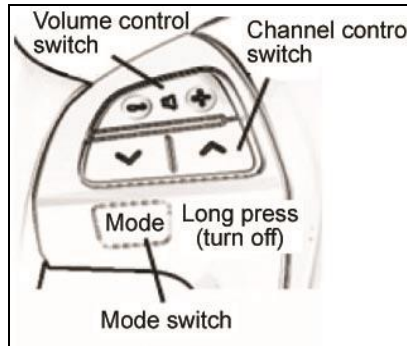

Use the switch on steering disc to adjust audio system (if installed).

These dedicated switch, control and function are described as below.

1. Volume control switch
2. “∨” and “∧” switch

3. “Mode” switch

Volume control switch

Press “+” to increase volume. Press and hold it to continuously increase volume.

Press “-” to reduce volume. Press and hold it to continuously reduce volume.

Channel control switch

Radio

Select preset radio stations:

Press and release “∨” or “∧” switch quickly. Repeat once or more times to select the next preset radio station.

Search for radio station

Press and hold “∨” or “∧” switch to search for a radio station nearest to current frequency and stop there. Repeat once or more times to search for the next radio station. If you press “∨” or “∧” in search mode, search mode will be cancelled.



### Mode switch

Every time you press “mode” switch, the system will change audio mode.

If you want to turn on audio system, press “mode” switch.

If you want to turn off audio system, press and hold “mode” switch.

### Protect Your CD Player

- Only 12 cm CD is applicable for CD player.
- Excessively high temperature will cause abnormal work of CD. In summer, please turn on air-conditioner when playing CD.
- Bumpy road might cause sound vibration of CD player.
- Wet air might lead to the fact that CD does not sound although it seems to play normally.

### WARNING

**As a laser related product, CD head generates radiation. Please correctly operate CD player.**



- Please use the CD shown in above figure only. The following CD might not be played. In order to achieve optimum sound quality, please use high quality CD bearing audio system mark.

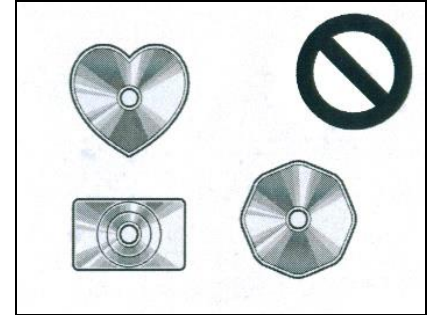

Discs with special shapes

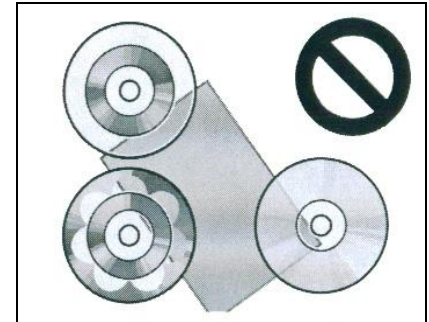

Transparent and translucent discs

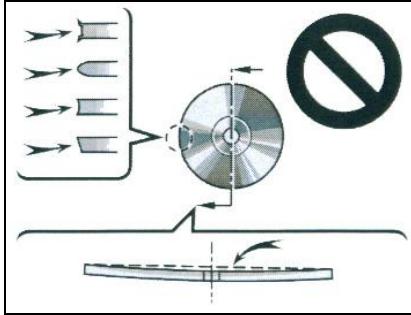

Discs of poor quality

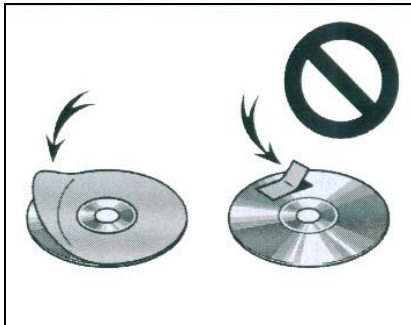

Discs with labels

### NOTES

**As shown in the above four pictures, please do not use disc in special shape, transparent or translucent disc, bad quality disc or labeled disc. These discs might damage CD player or might be ejected by CD player.**

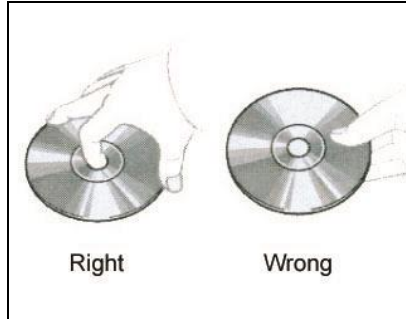

- Deal with CD with care, especially when inserting CD into CD player. Hold CD at its edge. Avoid leaving finger print on it, especially on its data storage side.

- If disc is dirty, damaged or has other fault, it might cause sound vibration or segment repeat when playing it.
- When you do not use CD, please take it out from CD player. Store CD in a CD box and keep it away from greasy dirt, heat source and direct sunshine.

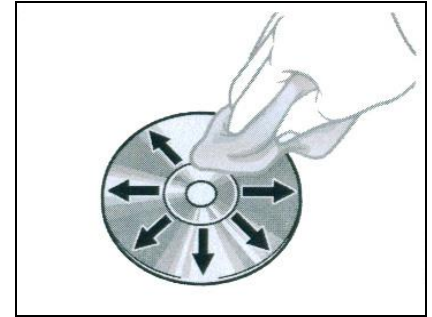

To clean CD, use soft cloth wetted by clean water to wipe CD surface carefully. Then, use other dry soft cloth to wipe it again. Do not use alcohol or other detergent.



### MP3 and WMA file

- MP3 (MPEG Audio LAYER 3) is a standard audio compression format. A file in MP3 compression format is 1/10 of its original size or even smaller.
- WMA (Windows Media TM Audio) is an audio compression format provided by Microsoft. Audio data in the format is smaller than that in MP3 format.
- The audio system sets a limit on MP3 and WMA file standard and medium/format recorded in compliance with the standard.

### MP3 file compatibility

- Compatibility standard  
MP3 (MPEG-1, MPEG-2, MPEG-2.5)
- Compatible sampling frequency  
MPEG-1: 32, 44.1, 48 (kHz)  
MPEG-2: 16, 22.05 (kHz)  
MPEG-2.5: 11 (kHz)

- Compatibility bit rate  
MPEG-1: 64, 80, 96, 112, 128, 160, 192, 224, 256, 320(kbps)  
MPEG-2: 40, 48, 56, 64, 80, 96, 112, 128, 160(kbps)  
MPEG-2.5: 32, 40, 48, 56, 64(kbps)
- Compatible sound track: double track and single track

### MP3 file compatibility

- Compatibility standard  
WMA Ver.2, 7, 8
- Compatible sampling frequency  
44.1, 48 (kHz)
- Compatibility bit rate  
64, 80, 96, 128, 160, 192 (kbps)
- Compatible track mode:  
compatible with double track play only.

### NOTES

**To have your USB device read more quickly, please store in USB device songs in MP3 and WMA format only.**

**In-Car CD Trouble-shooting Guide**

	Fault	Fault cause analysis	Solution
1	No power or no sound	1. Ignition switch is not turned on 2. Electric wire is not connected correctly.	1. Please turn key to ACC or ON 2. Examine whether connection line is correct
2	Inserted CD has no sound	1. CD is placed upside down 2. CD gets dirty or severely scratched	1. Place CD in proper direction 2. Clean CD or replace new CD
3	Sound vibration caused by vibration	1. Installation is unsteady 2. CD gets dirty or scratched	1. Use installation part to install the machine 2. Clean or replace CD
4	Preset radio station disappears and is not remembered	Battery cable is not connected properly	Battery cable is connected to a usually charged terminal
5	Much noise from FM stereo and single track radio	Radio station is very distant and signal is very weak	Select other radio station with stronger signal

**How to Use Multi-media Player**

Refer to "User's manual for L3 multi-media system"



# Chapter 1

## Section 8

---

### Operation of Instruments and Controllers

#### Air Conditioning System

Manual Controller of Air Conditioning System.....	1-102
Setting of Air Outlet Mode Selection Knob .....	1-103
Operating Essentials .....	1-104
Left/Right Air Duct on the Instrument Panel .....	1-106
Examine and Change Air Filter .....	1-106
Rear Window Defrosting .....	1-108

### Manual Controller of Air Conditioning System

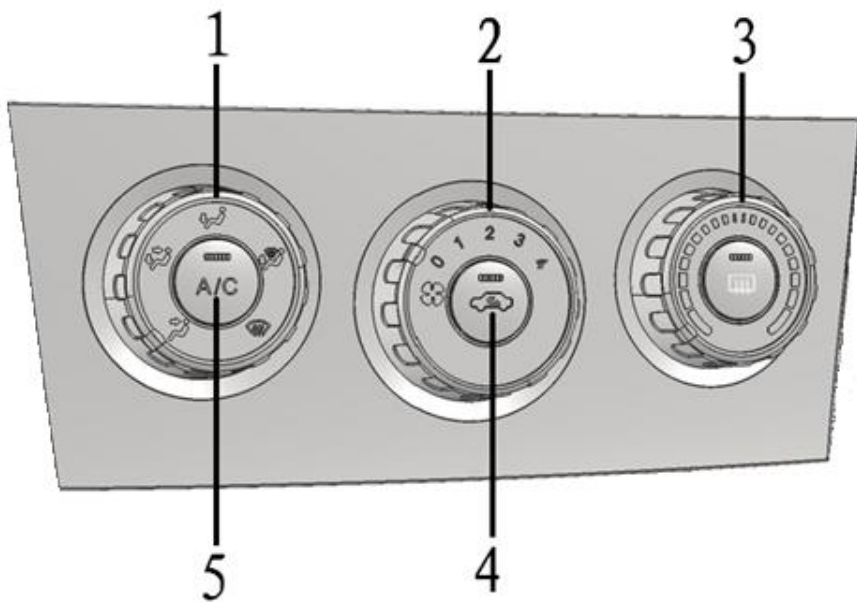

1. Air supply mode selection knob
2. Fan rotation control knob
3. Temperature control knob
4. Air supply mode selection button
5. "A/C" button

## Setting of Air Outlet Mode Selection Knob

### Fan rotation control knob

Rotate the knob to adjust fan speed — Rotate clockwise to increase wind speed. Rotate counterclockwise to reduce wind speed.

Rotate the knob to 0 to turn off fan.

### Temperature control knob

Rotate the knob to adjust temperature — Rotate clockwise increase air supply temperature. Rotate counterclockwise to reduce air supply temperature.

If “A/C” button is not pressed, system air supply will be room temperature wind or hot wind.

### Air supply selection knob

Turn the air supply selection knob to a proper position.

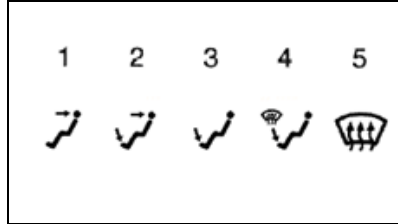

Or adjust in detail in accordance with the following air supply scheme.

1. Turn the knob to and air flow will come to your upper body.

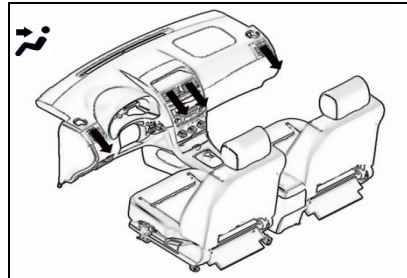

2. Turn the knob to and air flow will come to your upper body and feet.

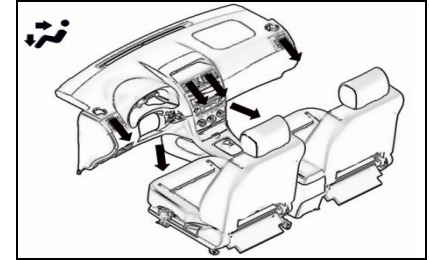

3. Turn the knob to and air flow will mainly come to your feet.

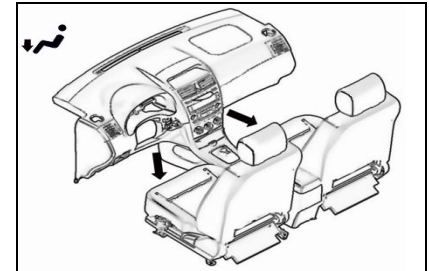

4. Turn the knob to and air flow will come to your feet and windshield glass defroster will work.

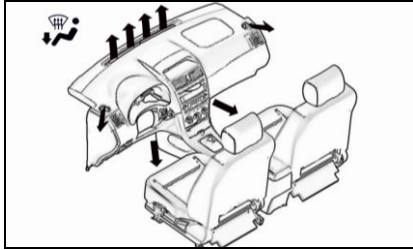

5. Turn the knob to and air flow will come to windshield glass and side window.

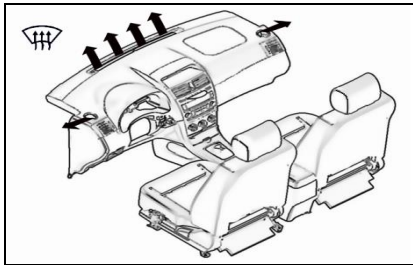

Air supply mode is of external circulation mode.

Press “A/C” button to turn on air conditioner to clean windshield glass and side window quickly.

Air Conditioning System 1-104

### Air Supply Mode Selection Button

1. **Internal cycle**—Recycle air in the car.
2. **External cycle**—Introduce external air into the system.

When pressing internal/external cycle button, the indicator (green) is turned on and air supply mode is internal cycle; Press it again, the indicator is turned off and air supply mode is external cycle.

### “A/C” button

To turn on air conditioner system requires that firstly turn the fan rotation speed control knob to non-“0”, Then press “A/C” button. At this time, indicator on the button (green) is turned on. Press “A/C” button again or rotate fan rotation speed control knob to 0, the indicator is turned off and air conditioner system is turned off.

### Operation Essentials

- In order to cool a car parked under hot sunshine, please lower car door

glass and drive for a few minutes. Lift the glass after hot air is discharged. In this way, hot air can be discharged. Air conditioner will cool the car soon.

- Make sure that air inlet grid in the front of the windshield glass is not blocked (for example, by leaves or snow).
- In a damp day, do not blow cold air onto windshield glass. Due to temperature difference inside and outside windshield glass, windshield glass might get foggy.
- Please keep downside of the front seat ventilated to fully cycle air in the car.
- In a cold day, please keep rotation speed of the air blower at high rotation speed for one minute to clear snow or dampness in air inlet. In this way, car window fog will be reduced.
- When driving the car following other the vehicles on a dusty road or



driving in wind or dust, please set the air supply mode as internal cycle to shut off external air inlet and prevent external air and dust from entering the car.

## Heating

For the optimistic effect, please set the air conditioner to:

**Air blower rotation speed**—non-0 shift  
**Temperature**—set a high temperature (red zone)  
**Air supply**—external cycle (external air)  
**Air flow**—   
**Air conditioner**—turn off

- To increase temperature rapidly, please use internal cycle for a few minutes. To avoid fog on car window, please select external cycle air supply after temperature in car rises.
- For heating, please press “A/C” button to decrease dampness in air flow.

- To defrost the windshield glass, please select “” air supply mode to increase in-car temperature.

## Air Conditioner

For the optimistic effect, please set the air conditioner to:

**Air blower rotation speed**—non-0 shift  
**Temperature**—set a low temperature (blue zone)  
**Air supply**—external cycle (external air)  
**Air flow**—   
**Air conditioner**—turn on

- To decrease temperature rapidly, please rotate the temperature knob to the coldest level and keep the air supply mode in internal cycle for a few minutes.

## Ventilation

For the optimistic effect, please set the air conditioner to:

**Air blower rotation speed**—Air speed  
**Temperature**—set a low temperature (blue zone)  
**Air supply**—external cycle (external air)  
**Air flow**—   
**Air conditioner**—turn off

## Defogging

—Internal side of windshield glass

For the optimistic effect, please set the air conditioner to:

**Air blower rotation speed**—non-0 shift  
**Temperature**—set a high temperature (red zone) for heating  
 Set a low temperature (blue zone) for cooling  
**Air supply**—external cycle (external air)  
**Air flow**— 

To keep a clear the front view requires to rotate the air supply knob to “” or “” to turn on defogging function.

Please press “A/C” button for cooling or heating. This will clear the front view more quickly.



- In a damp day, do not blow cold air onto windshield glass. Due to temperature difference inside and outside windshield glass, windshield glass might get more foggy.

### Defrosting

#### —External side of windshield glass

For the optimistic effect, please set the air conditioner to:

- Air blower rotation speed**—non-0 shift
- Temperature**—set a high temperature (red zone)
- Air supply**—**external cycle** (external air)
- Air flow**—

To keep a clear the front view requires to rotate the air supply knob to “” or “” to turn on defrosting function.

For heating, please press “A/C” button to decrease dampness in air flow. This will clear the front view more quickly.

- To defrost the windshield glass, please select “” air supply mode to increase in-car temperature.

### Left/Right Air Duct on the Instrument Panel

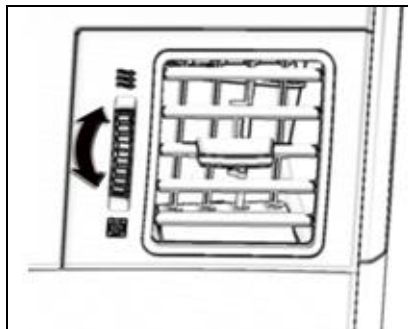

If air flow control is not enough, please check left/right air duct, which might have been opened or closed as shown in the figure.

### Examine and Change Air Filter

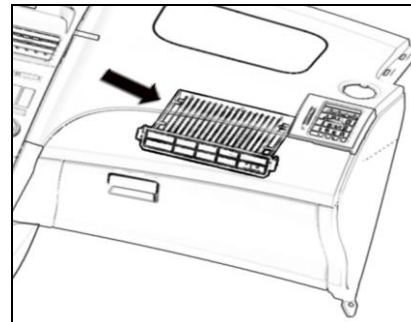

The information label for air filter is attached inside illustrated glove box to indicate that a filter has been installed. (This part and filter label picture to be deleted)



Air filter may prevent dust from entering the car through air conditioner air duct.

The air filter is located behind the glove box.

The air filter which has been used for a long time might be blocked. If air flow of air conditioner drops dramatically, or glass tends to generate fog in external air supply mode, the air filter needs to be changed.

To maintain air conditioner efficiency, please examine and replace air filter in accordance with maintenance plan.

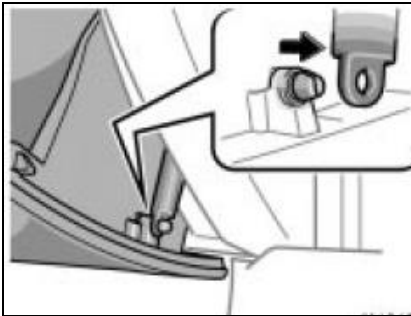

1. Open the glove box and remove one side of damper from below the instrument panel.

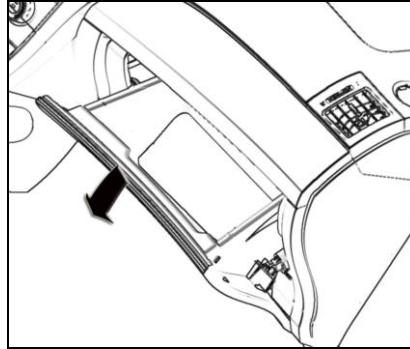

2. Pull both sides of the glove box upward in an oblique direction to release bottom clip and remove the glove box.

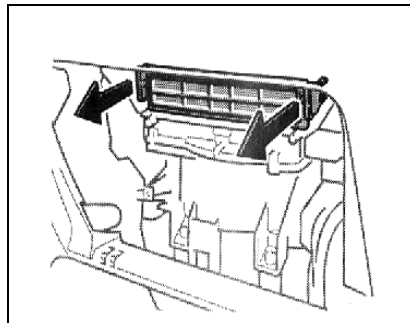

3. Remove the filter box off the filter as shown in the figure.

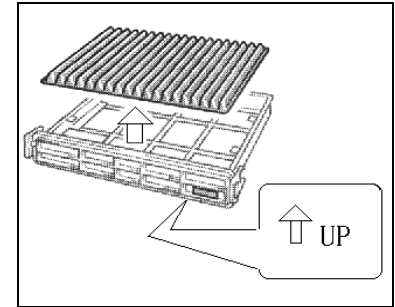

4. Take out filter net from filter box.

5. Examine filter net surface.

If it becomes dirty, please replace it.

When installing the filter and the filter box, please keep the arrow upward.

#### TIPS

The air filter should be installed in place correctly. If you turn on the air conditioner with air filter removed, it will reduce dustproof function and air conditioner performance.

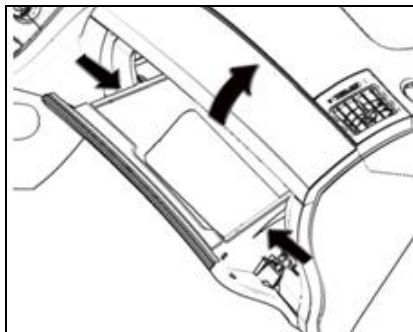

### Reinstalling Glove Box

1. Press the glove box towards inside and prepare the hook as shown in the figure.

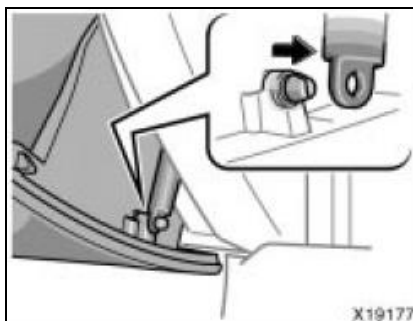

2. Insert the latch into the damper hole.

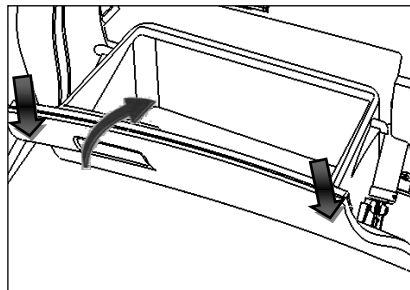

3. Align the clip on both sides of the glove box bottom with installation axle, fix the clip to the installation axle downward in an oblique way with force and lock the buckle to close the glove box.

### Rear Window Defrosting

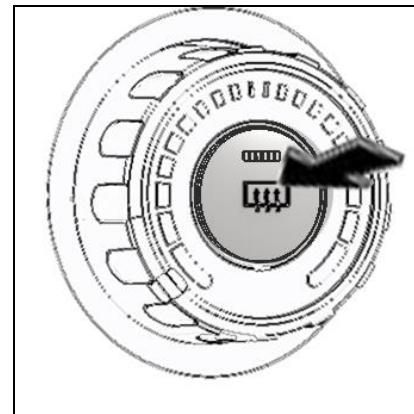

**To defrost the rear window, please press the button.**

Power position must be at "ON" position.

The thin heater strip in the rear window will clear glass surface quickly. While the defroster works, the indicator will be turned on.

Press the button again to turn off rear window defroster.



After the rear window surface becomes clear, be sure to turn off the defroster. Keeping the defrost function on for a long time will run out the storage battery, especially while the car moves and stops frequently. The defroster is not designed to dry rain drip or melt snow.

#### NOTICE

- **When cleaning the inside of rear window, take care not to scrape or damage the heater strip or the connector.**
- **To prevent the storage battery from discharging, please turn off the defroster while the engine is turned off.**





# Chapter 1

## Section 9

---

### Operation of Instruments and Controllers

#### Other Devices

Cigarette Lighter .....	1-112
Glove Compartment.....	1-112
Central Storage Cabinet.....	1-112
Parking Auxiliary System .....	1-113
Reversing Image System.....	1-117

### Cigarette Lighter

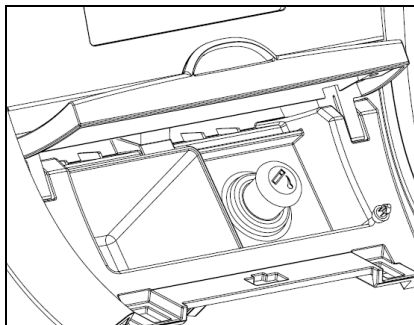

### Cigarette Lighter

To use a cigarette lighter, please press it down. After the cigarette lighter is lighted, it will pop up automatically for use.

Power position must be at “ACC” or “ON” position.

Do not press down and hold the cigarette lighter.

**Notes:** It is recommended not to use cigarette lighter as external electric appliance in order to avoid cigarette lighter or unexpected accident. If service stations, sales terminals or users use a non-BYD cigarette lighter, BYD Company would not assume any liability for any loss or damage caused thereof for any reason.

### Glove Compartment

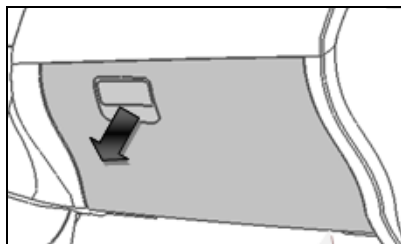

To open the glove box, please pull the handle.

### Central Storage Cabinet

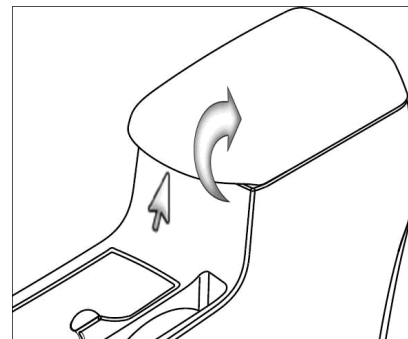

### Central Storage Cabinet

To open the central storage cabinet, please pull the locking buckle upward while lifting the central storage cabinet cover.



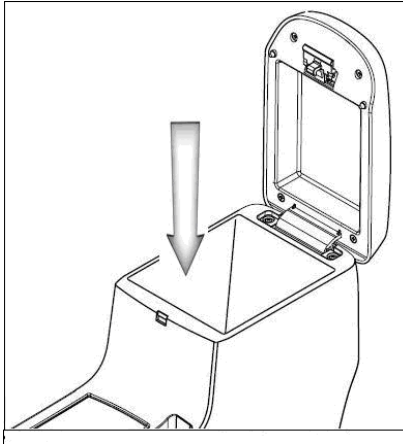

#### FRIENDLY TIPS

In order to reduce injury risk in the case of unexpected accident or emergent braking, please keep the central storage box closed while driving.

#### Cup Shelf

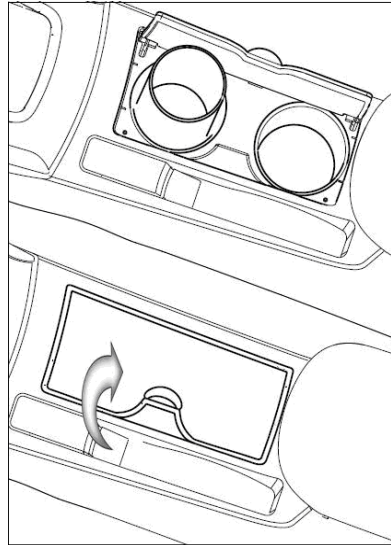

The cup shelf is used to hold a cup or drink can firmly.

#### Parking Auxiliary System (if installed)

##### FRIENDLY TIPS

Please observe the following items, otherwise the car might not drive safely and cause accident.

- Do not place any other articles within working range of the sensor.

##### NOTICE

- Do wash the sensor with water or steam. Otherwise, fault might occur to the sensor.

When parking the car, the parking auxiliary system will remind the driver of the distance between the car and an obstacle through indicator lamp, icons on a touch screen and buzzer alarm. The system uses the sensor to detect an obstacle.

The parking auxiliary system is a method to help parking. When reversing the car, please look out for obstacles behind and surrounding the car.

## Sensor Type

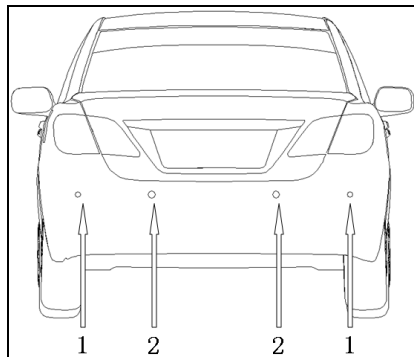

1. Clearance angle sensor
2. Rear central sensor

### Parking auxiliary switch

The parking auxiliary switch is located on No.1 switch set, which is located at the uppermost part of the central console.



When the starting button is at ON position and the shift lever is at R position, the system will work.

**Turn on: press the switch.**



The indicator on switch set display is turned on and the buzzer beeps once.

**Turn off: press the switch again.**

### Display

When the sensor detects an obstacle, corresponding indicator will be shown on No.1 switch set and corresponding icon will be displayed on the touch screen (if installed) in accordance with obstacle position and the distance between the obstacle and the car.

1. Clearance angle sensor works
2. Rear central sensor works

### Indicator display on switch set

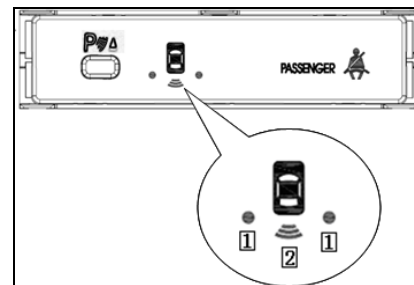

### Icon display on touch screen (if installed)

When using the reverse gear, the screen will show car reversing video. In the case of an obstacle, the top right corner will display the warning sign of reversing radar.

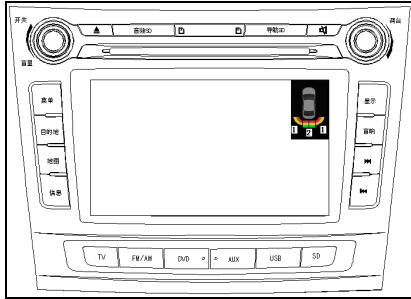

### Distance display and the buzzer

When the sensor detects an obstacle, obstacle position and the distance between the obstacle and the obstacle will be displayed and the buzzer beeps while corresponding indicator blinks in the same frequency.

### Example of a working rear central sensor

Rough distance (mm)	Display example	Alarm sound
About		Slow speed
about 800 to 500		Fast speed
About 500 or less		Long ringing sound

### Example of a working clearance angle sensor

Rough distance (mm)	Display example	Alarm sound
about 600 to 500		Fast speed

About 500 or less		Long ringing sound
-------------------	--	--------------------

### Working sensor

When the car reverses, all sensors work.

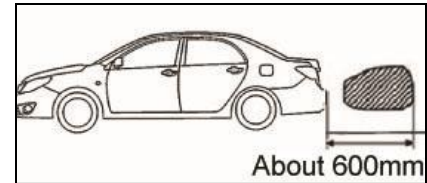
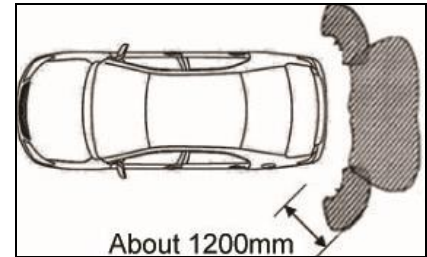

The figure shows detection range of sensors. As the detection range stated



above is limited, please reverse the car slowly while looking out for the surrounding.

#### FRIENDLY TIPS

- **The parking auxiliary system is used to help the driver park and shall not substitute your personal judgment. Please operate your car while looking out for the surrounding.**
- **Do not place any fixture or other articles within the sensor range. Otherwise, it might affect normal work of the system.**
- **In some cases, the system does not work normally and cannot detect some objects which the car is approaching. Therefore, please look out for the surrounding of the car instead of relying on the system only.**

#### Sensor Detection Information

Car conditions and surrounding conditions might affect sensor performance to detect an obstacle accurately.

Specific possible cases are exemplified as below:

- There is dirt, water or fog on the sensor;
- There is snow on the sensor or the sensor is frozen;
- The sensor is covered in any way;
- The car is obviously skew or is overloaded;
- The car travels on very bumpy road, slope, gravel road or grassland;
- The sensor is sprayed again;
- There is noise which generates ultrasonic wave, such as car honk, motorcycle the engine sound, air brake sound of heavy-duty the vehicle or it is very noisy near the car;
- There is another car equipped with parking auxiliary system nearby;
- The car is equipped with a tow lug;

- The bumper or the sensor experiences strong impact;
- The car is approaching a high or curved curb;
- The car is under scorching sunshine or in a very cold day;
- A non-OEM suspension is installed which is lower than OEM suspension.

Except the cases stated above, the sensor might not determine the actual distance from some objects which has a special shape;

Shape and material of an obstacle might affect sensor detection. Please notes the following obstacles;

- Electric wire, rail guard, rope;
- Cotton, snow or other materials which absorb radio wave;
- Objects with a sharp angle;
- A low obstacle;

- A high obstacle whose upper part extends to your car;
- An object below the buffer;
- An object near the car;
- Persons near the car (depending on their clothes)

If the parking auxiliary switch indicator is turned on, the DVD touch screen icon is displayed or the buzzer beeps, it might be that the sensor has detected an obstacle or that the surrounding generates interference to the sensor.

If the phenomenon continues existing, please contact BYD authorized service station for examination.

When parking the car, the parking auxiliary system will remind the driver of the distance between the car and an obstacle through indicator lamp and the beeping buzzer. The system uses the sensor to detect an obstacle.

### Reversing Image System (if installed)

The reversing image system helps the driver to reverse the car by displaying object image behind the car and serves as an aiding method to reverse the car.

#### FRIENDLY TIPS

- **Please use the system together with parking auxiliary system and internal/external rearview mirror. Do not rely on it too much. If the surrounding space is narrow, please ask someone outside to help you to avoid bumping into an obstacle if necessary.**
- **Never park your car by watching the screen only. The image on the screen might be different from actual situation. The distance between an object and a plane shown on the screen might be different from the actual distance. If you park the car by watching the screen only, the car might bump into other the vehicles, pedestrians or obstacles. Please look out of the surrounding before parking with the help of the parking image system.**
- **If the rear the trunk is not closed totally, do not use the system.**

- **If the car is bumped from behind or bumps into an obstacle, position and installation angle of the camera will be changed. Please contact BYD authorized service station for position and installation angle of the camera.**
- **As the camera has a dustproof and waterproof structure, do not disassemble or refit it. Otherwise, it might not be operated.**
- **If the temperature changes quickly, for example, when you spread hot water on the car in a cold day, the system might not work normally.**
- **If the camera lens is stained by water, snow or soil, please wash it with water and wipe it with soft cloth. For substance which is not easy to wipe off, such as oil dirt or rubber, please wash it with soft detergent and water and wipe it with soft cloth.**
- **Do not splash organic solvent, car wax, car window detergent or glass film on the camera lens. If you have done so, please remove it immediately.**

- Please identify surrounding objects with your eyes, as the displayed image might be fuzzy. Especially when external temperature is very low, moving image might be distorted and even invisible. When parking your car, please look out for the surrounding by using the rearview mirror.
- When turning on the turn signal light or the emergency warning light, please do not use the parking image system. If there are blinking light nearby, please turn off the parking image system. Blinking light might cause blinking image on the display and you may not be able to look out for the surrounding or park the car.

**NOTICE**

In the following cases, even if the system works normally, you may not see an image on the screen.

- In darkness (such as at night)
- The temperature near the camera is very high or very low.
- Water drip sticks to the camera or humidity is very high (for example in a rainy day).
- Foreign substance (snow or soil) sticks to the camera.
- The camera lens is scraped or stained.
- The camera lens is exposed to intense direct light.

If the camera catches an intense light source, a light spot will be displayed on the screen, which will interfere with surrounding image and generates unclear image.

**Reversing Image System**

When the starting button is set at ON, please adjust the gear lever to R position to start parking video mode.

The reversing camera is installed on the backdoor.

View range of the camera is limited.

The reversing image doesn't show objects near both sides of the bumper or below the bumper. Please refer to the following figure:

Objects near both sides of the bumper.

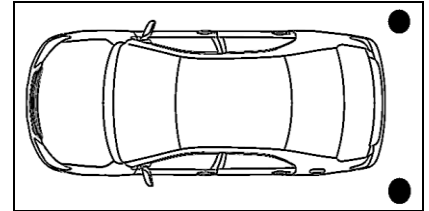

Objects below the bumper.

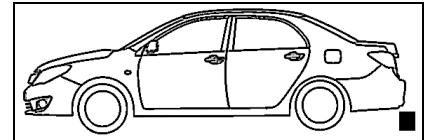

## Reversing Operation

Please start reversing image system when reversing the car.

When shifting to the reverse position, the rear view images will be displayed on the touch screen of the multimedia host in order.

to observe in real-time the places where cannot be observed actually to help back your car.

### FRIENDLY TIPS

- **Reversing safety line is only used only to provide distance reference when the car is empty.**

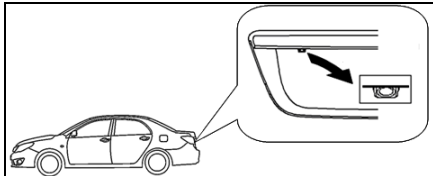

The reversing camera is installed on the backdoor.

### Example of touch screen display

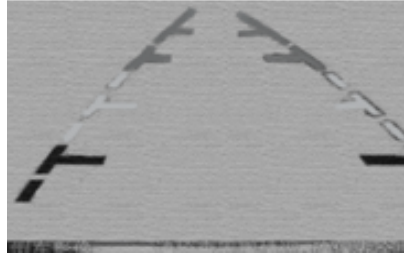

The two lines shown in the figure are reversing safety line.

Red: about 0-0.5 m

Yellow: about 0.5-2 m

Green: Above 2 m

The displayed zone varies with car direction and road condition.

The system only plays an auxiliary role, which cannot be relied on only.

Please be aware of this before using the parking image system. Please confirm enough space before reversing the car.







## Chapter 2

### Driving Instruction for BYD L3 Driving Tips

Running-in Period .....	2-2
Fuel .....	2-2
Fuel Cut-off System .....	2-2
Three-way Catalytic Converter .....	2-3
Engine Exhaust Warning .....	2-4
Engine Oil Consumption .....	2-5
Gear Shifting.....	2-5
Brake System .....	2-9
Brake Lining Warning Piece.....	2-14



## Running-in Period

### Drive steadily and avoid high-speed driving.

The vehicle doesn't need complicated running-in. However, within the first 2000 km, please follow the simple instructions below to save fuel and lengthen service life of the car.

- Do not press the accelerator to the full while starting and driving.
- Avoid running the engine over-fast.
- Do not use emergent braking within the first 300 km.
- Do not drive slow or fast at the same speed.
- Do not pull a tow within the first 2000 km.

## Fuel

**Please select proper fuel to fully exert the engine performance. It will also essential to control exhaust and**

### maintain related components.

Use of improper fuel might cause damage to the engine or exceed exhaust standard. It is not within the guarantee scope of BYD L3 car.

### Fuel type

**Please use lead-free gasoline of No.93 or above.**

To avoid any mishandling in the gas station, a small fuel tank mouth is prepared. Only the nozzle dedicated for lead-free oil pump matches it. Larger nozzles of leaded oil pump do not match it.

### NOTICE

**Do not use leaded gasoline. Use of leaded gasoline will invalidate the three-way catalytic converter and cause abnormal work of exhaust pollution control device. Additionally, it also increases maintenance fee.**

### NOTICE

**The in-car exhaust system can only use lead-free gasoline of No.93 or above.**

### If the engine knocks

If you feel severe knock when using the recommended fuel or you hear regular knock sound when driving at a steady speed, please contact BYD service station.

However, you will also hear short and weak knock sound when accelerating or going up a slope. Don't worry as it is a normal phenomenon.

### Rated capacity of the fuel tank

50L

### Fuel Cut-off System

If the engine stops running in an accident, the engine control system will stop providing fuel to the engine to stop providing fuel to the engine to reduce fuel leaking risk to the minimum. When you want to restart the engine after the fuel pump stops work, please

rotate the ignition switch to ACC or LOCK before restarting the engine.

#### FRIENDLY TIPS

Before restarting the engine, please examine the ground under the car. If leaked fluid is found on the ground, it indicates that the fuel system is damaged and requires repair. In this case, do not restart the engine.

#### Three-way Catalytic Converter

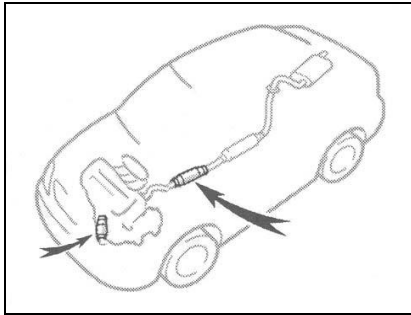

Three-way catalytic converter is an exhaust pollution purifying device which is installed in the exhaust system.

It is used to reduce pollution substance in exhaust.

#### NOTICE

- When the engine is under operation, persons and inflammable material should be away from exhaust pipe. The exhaust pipe gives off gas in very high temperature.
- Do not drive the car, idle the car or park the car on grass, tree leaves, paper or rag (especially wheat straw in summer) which is easy to be burned.

#### NOTICE

Large quantity of unburnt gas mixture which enters the three-way catalytic converter will overheat the three-way catalytic converter and cause fire. To prevent the risk, please take the following precautions.

- Please use lead free gasoline only.
- Do not drive the car when fuel level is very low; Car operation with less fuel might affect the engine and add excessive load to

the three-way catalytic converter.

- Do not run the engine at a high idling speed more than 10 minutes or at a low idling speed for more than 20 minutes.
- Avoid running the engine over-fast.
- Do not start the engine by pushing or pulling the car.
- Do not turn off ignition switch while the car is travelling.
- Please maintain good operation status of the engine. If electric system, electronic ignition system or fuel system of the engine does not work normally, it will cause abnormally high temperature on the three-way catalytic converter.
- If the engine is hard to start or often stops running, please examine the car immediately.
- To ensure normal work of the three-way catalytic converter and the whole pollution control device, please conduct regular car examination in accordance with BYD L3 car maintenance schedule. (Refer to Chapter 6)



## Engine Exhaust Warning

### FRIENDLY TIPS

- Do not inhale waste gas exhausted from the engine.
- Please confirm that the exhausting system has no leaking hole or loosened connector. Please examine exhausting system frequently. If your car bumps into something or exhausting sound changes, please examine the car immediately.
- Do not run the engine in a garage or at a closed place unless the car comes into or go out of a garage. Exhaust which can not be dissipated might cause severe risk.
- Do not park your car for a long time while the engine runs. If you have to do so, please park your car at an open place and adjust heating or cooling system to exchange air with outside.
- Please close the trunk cover while driving. The trunk cover which remains open or is not closed

**tightly might draw exhaust into the car.**

- To ensure normal work of car ventilation system, please ensure that there is no snow, tree leaves or other obstacles in the air inlet grid in the front of the windshield glass.
- If you smell waste gas in the car, please open the window and examine incoming position of waste gas to take measures.

## Engine Oil Consumption

### Engine oil function

Engine oil is used to lubricate and cool the engine inside and plays a major role in keeping the engine in normal working condition.

### Engine Oil Consumption

The engine in normal working condition consumes some engine oil. In normal condition, the engine consumes the engine oil due to the following causes.

- Engine oil is used to lubricate piston, piston ring and cylinder. When the piston moves up and down in the cylinder, a thick layer of oil film will be left on the cylinder wall. When the car decelerates, high negative pressure will inhale the engine oil into the combustion chamber. The engine oil and some of oil film left on the cylinder wall will be burnt by high temperature gas during burning.
- The engine oil is also used to lubricate intake valve lever. Some engine oil and intake air will be drawn into the combustion chamber and burnt together with fuel. High temperature waste gas also consumes the engine oil used to lubricate exhaust valve lever.

**Engine oil consumption is related to viscosity and quality of the engine oil and car condition.**

Driving at a high speed or accelerating and decelerating frequently will increase consumption of the engine oil.

Piston, piston ring and cylinder wall of a new the engine consumes more the engine oil as they have not experienced run-in period.

### Engine Oil Consumption

**When determining the engine oil consumption, please note that it might be difficult to determine an actual oil level due to diluted the engine oil.**

For example, if the car travels 1000km in repeated short-distance trip and consumes normal quantity of the engine oil, oil dipstick shows no drop. As the engine oil is diluted by fuel and steam, oil level does not drop.

While the car is traveling in high speed, for example on a highway, the diluted the engine oil will be vaporized. Therefore, you will find excessive consumption of the engine oil after driving at a high speed.

**Importance of the engine oil level check**

It is an important point in car maintenance to keep the engine oil level at the optimistic position so as not to weaken the engine oil function. Therefore, regular examination of the engine oil level is very important. It is recommended to check the engine oil level every time you refuel the car.

#### NOTICE

**If the engine oil level is not checked regularly, insufficient the engine oil might cause severe engine fault.**

For details of the engine oil level check, please refer to “engine oil level check” in Chapter 7-2.

### Gear Shifting

#### NOTICE

**Do not shift to the reverse gear until the car is totally stopped. Shifting to the reverse gear before the car is totally stopped would damage the transmission.**

### Manual transmission

To run the car in a steady way, manual transmissions in all forward gears are synchronous. Manual transmission is equipped with locking device to avoid direct gear shifting from the fifth gear to the reverse gear. When shifting gear, please press the clutch to the full. When not shifting gear, do not put your foot on the clutch pedal. Otherwise, it will speed up clutch wearing.

Wait for a few seconds after pressing the clutch pedal and before shifting to the reverse gear. Or wait for a moment after shifting to a forward gear. This will stop gear running and avoid mutual “grinding”.

When decelerating, the decreasing gear will receive extra braking force from the engine. The additional braking power helps keep a safe speed. When travelling down a slope, it will prevent brake overheating.

**FRIENDLY TIPS**

**When travelling on a slippery road, dramatic acceleration or dramatic deceleration might cause the car out of control. Consequent collision accident might cause harm on you. When driving on slippery road, please take extra care.**

**DCT transmission**

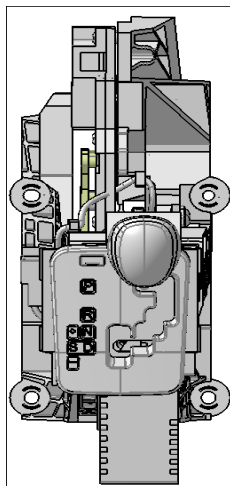

The gear indicator is located on the lower left side of the tachometer. This display shows you the mode and position of the shift lever of the automatic transmission.

P: Park position

R: Reverse position

N: Neutral position

D: Drive (mode of fuel economy)

S: Sport mode

M: Manual mode.

**Position of gear shifting lever**

The shift lever has Park (P), Reverse (R), Neutral (N), Drive (D), Sport (S) and Manual (M) and other positions

P: Park—This position mechanically locks the transmission and the shift lever. Please use this gear position when turning off or turning on the engine. To shift out of Park, you must power on the

starting switch and press on the brake pedal. In this case, you can move the lever out of Park.

Note: To shift into Park, to avoid damage to transmission, come to a complete stop before shifting into Park.

Reverse gear (R) — Refer to instruction on parking gear for operation method of switching from parking gear to reverse gear.

Neutral gear (N) — If you want to restart the engine which has been turned off or to idle the engine for temporary parking, please use the neutral gear. No matter what the reason is, as long as you get off the car, please shift to the parking gear.

D: Drive—Use this position for your normal driving. the transmission automatically selects a suitable gear based on your speed and acceleration. This position allows your car to be in the mode of fuel economy to achieve its optimum fuel economy.

**S: Sport**—This position allows your vehicle dynamic performance to be better than that in the mode of fuel economy.

**M: Manual**—Use this position to push the shift lever into upshifting(+) or downshifting(-), thereby you can control the gear positions of the transmission manually.

**Upshifting (+)**—For your normal driving with the shift lever in M position, push the shift lever into this position. Subject to the judgement of the transmission control unit (TCU) based on the current vehicle speed conditions, the transmission upshifts to a higher gear until the transmission is in the highest gear (6th gear) position.

**Downshifting (+)**—For your normal driving with the shift lever in M position, push the shift lever into this position. Subject to the judgement of the transmission control unit (TCU) based on the current vehicle speed conditions, the transmission downshifts to a lower gear until the transmission is in the lowest gear (1st gear) position.

### Selection of sport mode (S)

#### WARNING

- 1. If your car is still allowed to move after shutting off the engine and shifting into N, the transmission can be badly damaged due to lack of effective lubricating.**
- 2. If the engine operating and shifting into R/D/S already, be sure to press on the brake pedal and hold it there to stop your car. Because even if the engine is idling, the power train can still transfer power so that your car can drive forward slowly.**
- 3. When driving, if needed to change gears, to avoid accident, doesn't press on the accelerator pedal.**
- 4. During driving, don't shift the shift lever into R or P in order to avoid accident.**
- 5. Don't let your car go down hills with the shift lever in N or P even if the engine stops running.**
- 6. To prevent your car from moving accidentally, after parking your car on level ground, be sure to pull up the parking brake lever and shift the shift**

#### lever into P.

With the shift lever in D position, push the shift lever to the left side directly instead of performing operation of upshifting/downshifting. In this case, you can select the sport mode. The gear display on the combination instrument panel shows you D1, D2, D3, D4, D5 or D6.

### Selection of manual mode (M)

With the shift lever in D position, push the shift lever to the left side firstly, and then, push the shift lever forward or backward. In this case, you can select the manual mode. The gear display on the combination instrument panel shows you the current gear position of M1, M2, M3, M4, M5 or M6.

Explanation:

1 The shift lever is in the same position under sport mode and manual mode.

2 If it is necessary to shift from M to S again, you must shift the shift lever into D and then into S.



3 Under the sport mode, the first operation of upshifting/downshifting is defaulted as the switch signal of entering the manual mode so that the transmission will not operate accordingly.

### Starting out your car

When start the engine, you must shift the shift lever into P or N.

### Parking

If you need to park your car, you must release the accelerator pedal and press on the brake pedal. After a complete stop, you must pull up the parking brake lever, and finally shift the shift lever into P.

### NOTES

- When parking your car on a slope, make sure to press on the brake pedal and hold it there and pull up the parking brake lever. Don't use the method for pressing on the accelerator pedal with the shift lever in D position to stop your car

from going down hills, which can cause overheating or bad wear to the transmission clutch.

- When parking, before shifting the shift lever into P, make sure to pull up the parking brake lever. Because when parking your car on a slope, releasing the brake pedal can cause your car to go down slightly. Before shifting the transmission into P, pulling up the parking brake lever can avoid applying a pressure to the parking device inside the transmission when your car moving. As a result, when you want to drive your car away, you can shift the shift lever out of P more easily.

### Starting on hills

To protect the DCT transmission, be sure to apply the parking brake to assist in starting your car on steep hills.

### Special environment

If you encounter downhills, corners, or mountain roads, it is recommended to

use the manual mode and shift into a lower gear in order to make full use of engine braking.

### FRIENDLY TIPS

**Prolonged frequent starting, or prolonged slow driving or prolonged stop-and-go driving with traffic can cause overheating to the DCT transmission clutch.**

**If the DCT transmission clutch is overheated, the instrument panel will show a warning signal. In this case, to protect the clutch from being damaged, the transmission control module will disengage the clutch so that your car cannot drive. If this occurs, be sure to press on the brake pedal and hold it there to park for several minutes. Let the transmission cool down for a period of time before driving again.**

### Parking control mechanism

Pull up the parking control mechanism tightly to avoid unexpected sliding while parking. To avoid accidental slide of the car, it is recommended to use position 1



when parking the car on a horizontal road. It is recommended to use position 1 when parking the car on the upward slope. It is recommended to use reverse position when parking the car on a downward slope.

Before driving, please confirm that the parking control mechanism is fully released and the braking control mechanism indicator is turned off.

To avoid unexpected car sliding, please pull the parking control mechanism tightly after parking the car. Additionally, it is recommended to use non-neutral position, preferentially position 1 (on horizontal road or upward slope) or reverse (on downward slope).

Pull up the parking control mechanism and set the transmission at a non-neutral gear, preferentially position 1.

Please park your car on flat and solid ground. Then pull up the parking control mechanism tightly and shift the transmission to a non-neutral position, preferentially position 1.

### Notes on traction

Traction requirement	Transmission configuration	
	Manual transmission	DCT transmission
Traction gear	Neutral gear	Not allowed
Traction with the front wheel raised	Allowed	Allowed
Traction with rear wheel raised	Allowed	Not allowed
Traction with four wheels on ground	Allowed	Not allowed
Transport with dedicated the vehicle	Allowed	Allowed

### Selection of transmission oil

1. Specification of gear oil used for

manual transmission:

75W—90 North China in winter

80W—90 North China in summer

80W—90 or 85W—140 South China in the whole year

API class, GL-4 level or above

Quantity: (DABS15-41 series): 2.1 L  
(BYD5T-14 series): 1.6 L

### Braking System

#### Design of braking system

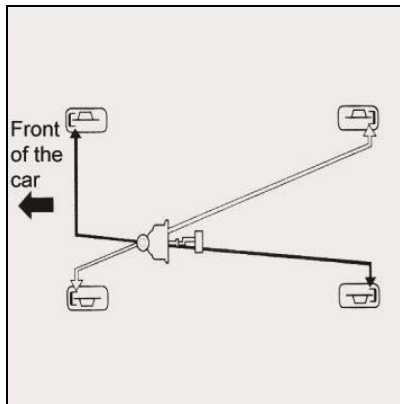

There are two independent circuits for hydraulic system of the brake. Each circuit acts by crossing the car in diagonal direction (the front left wheel brake connected with rear right wheel brake). In the case that one circuit fails, the other two wheels can be braked.

### Disc-and-drum brake

The car is equipped with disc-and-drum brake. For this type of braking system, brake shoe should be run in regularly or after replacing brake shoe or braking drum.

Driving Instruction for BYD L3 2-10

BYE authorized service station will perform running-in.

### ABS braking device

ABS helps prevent wheel skid In the case of emergent braking to help your control steering.

When the front wheel skids, you cannot control steering. That is, even if you operate the steering wheel, the car still travels forward straightly. ABS helps prevent skid and pulse braking is much faster than human reaction. Therefore, it helps maintain steering control.

ABS balances distribution of front/rear wheel braking power in accordance with car load.

Do not press the braking pedal in a pulse way. Otherwise, ABS will lose control. When operating the steering wheel to avoid danger, please inflict a powerful and steady pressure on the braking pedal to help ABS function. As it is often said, "press steadily, and turn accurately".

When ABS starts, you will feel that braking pedal vibrates and might hear noise. This is a normal phenomenon, as ABS is performing fast braking in a pulse way.

Fast/slow function of ABS depends on driving force (adhesive force) of the tire. On dry and paved road, please step the braking pedal with force to activate ABS. However, if you want to park your car on snowy or icy road, you can feel ABS function immediately.

Important safety tips ABS (anti-lock brake system) cannot shorten the time and distance required for braking your car. The device is designed to help you control steering while braking only. You should always keep safe distance from other the vehicles.

ABS cannot prevent skid caused by sudden change of direction, for example when you turn the car sharply or change a lane suddenly. Whatever the road condition or weather condition is, you should always carefully drive your car at a safe speed.

ABS cannot prevent reduction of steadiness either. When you brake your car suddenly, please turn your car appropriately. Large turn or sharp turn during driving might leave the car turn to vehicle flow on the opposite side or get out of the road.

Compared with a car without ABS, a car with ABS might require more braking distance while driving on soft or bumpy road (such as gravel road or snowy road). In such a case, please decrease car speed and keep quite a distance from other the vehicles.

### ABS indicator

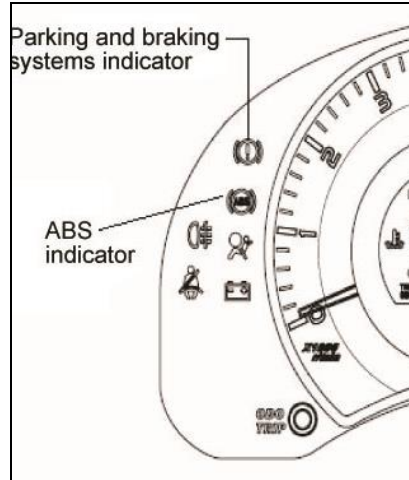

ABS has self-examination function. In the case of any fault, the ABS indicator on the instrument panel will be turned on (please refer to combined meter). It means that ABS function of braking system doesn't work. At this time, the brake only provides ordinary braking function as that of an ordinary car without ABS. Please contact BYD

authorized service station for examination.

If the ABS indicator and braking system indicator are turned on at the same time while the hand brake is released to the full, it indicates that front/rear wheel braking distribution system does not work.

Press the braking pedal slightly to feel whether it is normal. If it is normal, please check braking fluid level next time you pull off at a oil station (refer to the section about braking fluid check). If the fluid level is low, please contact BYD authorized service station to check leakage of braking system and wearing of brake block.

However, if the braking pedal doesn't feel normal, please take measures immediately. As the braking system is of two-circuit design, even if part of the system fails, you can still brake the other two wheels. At this time, you must press the braking pedal more deeply to decelerate the car and braking distance become longer.



Shift to a low position to decelerate the car and pull the car off the road safely. As a long parking distance is required, it is dangerous to drive the car. Please have the car towed away and repaired as soon as possible.

If you have to drive for a short distance in the situation, you must drive the car very carefully.

### **Drive in Bad Weather**

Due to reduced driving force (adhesion force) and visibility in a rainy, foggy or snowy day, different environment requires different driving skills. You should maintain your car. If you have to drive in bad weather, please take extra care. In these cases, do not use cruise control (limited to a type).

Driving skill —Traveling speed should be slower than in dry weather. Even if in a seemingly damp condition, your car requires a long time to react and inflict steady and balanced pressure on all control devices. Sharp turn or sharp brake in damp weather might cause the car out of control. Please take care of

driving before you are accustomed to changed driving condition, especially in a snowy day. A driver might forget about driving skill on snowy road after the few summer months and has to practice to recollect the skills.

Take great care when driving in a rainy day after a long dry season. The first rain after continuous dryness might cause oil to float on the road, which therefore becomes slippery.

Visibility — In all weather conditions, it is very important to see surrounding and be seen by other the drivers. It is difficult to do so in bad weather. Therefore, please turn on the headlight even if in daytime.

Please examine windshield wiper and washer regularly. Make sure that windshield washer container is stored with sufficient cleanser. If the wiper doesn't work thoroughly or leave a stripe on the windshield, please change the wiper. Additionally, defroster and air conditioner are used to avoid fog in the car.

Driving force (adhesive force) - Always check whether tire wear conditions are modest and tire pressures are proper.

These items are very important to prevent your car from aquaplaning (loss of adhesive force on a slippery surface). In winter, four wheels should be equipped with snow tire (with anti-skid tread) to achieve optimistic operation performance.

Please carefully observe constantly changing road conditions. Damp tree leaves might be as slippery as snow and ice. "Clean" road might be dotted with thin ice. When external temperature approaches zero degree centigrade, driving condition is very dangerous as road might be covered with interwoven water and ice. Therefore, adhesion force of a car might change suddenly without any sign.

When you decrease shift, please take great care. If adhesion force is weak, driving wheel might be locked for a moment, which might also cause skid.



When overtaking other the vehicles or being overtaken by others, make sure you will take great care. Water mist caused by heavy-duty the vehicles might baffle your vision and air billow might cause your car out of control.

Note: Please do not drive on road where there is deep water. Car driving in water might cause failure or damage of the engine and electric devices.

### Engine Fault Indicator

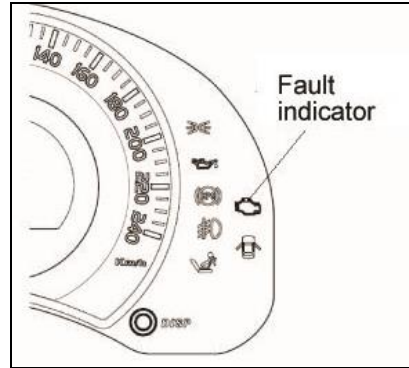

The indicator will remain on for a few seconds after you turn the ignition switch to ON (II). If it is turned on at any time, it indicates that fault might occur to discharging control system of the engine. Even if you do not feel abnormal condition of the car, the fault might reduce oil saving performance and discharge more exhaust. The engine which continues running in the condition might result in severe damage.

If the indicator is turned on, please pull your car off the road safely and turn off the engine. Restart the engine and check the indicator. If the indicator remains on, please contact BYD authorized service station for examination. Before the fault is determined in BYD authorized service station, please take care while driving and avoid wide open of accelerator and high-speed travel.

In the case that the indicator turns on frequently, even if it is turned off after handling in accordance with above stated procedure, please contact BYD authorized service station for car examination.

#### FRIENDLY TIPS

**If you keep on driving while the fault indicator is on, it would damage discharging system and the engine itself. This kind of repair is not included in warranty range.**

### Brake Lining Warning Piece

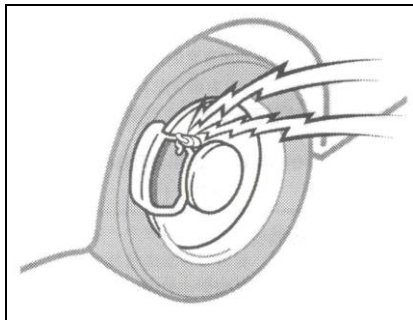

**The Brake lining piece on disc brake will send out alarm when the piece is worn and requires replacement.**

If you hear sharp sound or friction sound, please contact a nearby BYD authorized service station for examination and piece replacement.

Do not continue driving the car while the alarm rings.

### Notes on Luggage Loading

When the car is loaded with luggage or goods, please observe the following instructions.

- Place your luggage and goods in the trunk. Please confirm that all goods are fixed in place.
- Please keep balance of the car. Please place weight in the front to keep balance.
- In order to save fuel, do not load unnecessary weight.

### Suspension and Chassis

#### FRIENDLY TIPS

**Do not use lifting tool, spacer or spring to refit suspension/ chassis. This will cause damage to control performance and cause the car out of control.**



## Chapter 3

### Starting and Driving

Before Starting the Engine .....	3-2
Engine Starting Method .....	3-2
Safety Examination before Driving .....	3-3
After Starting the Engine .....	3-4
Driving Trips in Winter .....	3-5
Trailer Towing.....	3-6
How to Save Fuel and Lengthen Service Life of the Car .....	3-7



## Before Starting the Engine

1. Before coming inside the car, please check surrounding of the car.
2. Please adjust seat position, seat height, seat back angle, head protection device height and steering wheel angle.
3. Adjust internal and external rearview mirror.
4. Lock all car doors.
5. Fasten seat belt.

Once you set anti-theft system by pressing LOCK on wireless remote control, you must press UNLOCK before starting the engine. Otherwise, you cannot start the engine.

## Engine Starting Methods

### (a) Before starting

Manual transmission:

1. Check parking control mechanism.
2. Turn off all unnecessary car light and accessories.
3. Set the gear shifting lever at neutral position.
4. Press the clutch pedal to the end and hold until the car moves.
5. Release anti-theft system.

### (b) The engine starting

Before starting the engine, please confirm the steps in “(a) before starting” have been performed.

### Normal starting procedures

The multi-point fuel injection system in the engine controls proper mixture of air and fuel used for starting. Perform the following procedure to start the engine in cold or warm condition.

Start the engine in accordance with instruction in the section of the smart key system access function and starting

function.

The engine may be warmed through driving instead of through idle driving. Operate the engine in a steady way to warm up the car until the engine coolant temperature rises to a normal scope.

### If the engine stalls

Start the engine again in correct procedure.

### If the engine cannot start

Refer to Chapter 4 “if the car fails to start”.

### NOTICE

- **Starting operation of the engine shall not exceed 30 seconds each time. Otherwise, it might cause overheating of the starter or the circuit system.**
- **Avoid running the engine at overspeed.**
- **If it is difficult to start the engine or the engine often stalls, please examine the engine immediately.**





## Safety Examination before Driving

Before starting by driving, please conduct a safety examination on the car. Examination for a few minutes contributes to safety driving and helps you enjoy driving.

### FRIENDLY TIPS

**If the examination is performed in a closed garage, make sure that the garage is well ventilated. Exhaust from the engine is toxic.**

### Checking before Starting the Engine

#### Exterior

**Tires:** Use a gauge to measure the air pressure and also examine the tires for cuts, damage or excessive wear.

**Wheel nuts:** Make sure that no nut is loosened or lost.

**Leakage:** Park your car for a period of time, and check the vehicle bottom for fuel, oil, water or other fluid leakage. (Water drip generated by air conditioner is normal.)

**Lighting:** Confirm that headlight, parking lamp, clearance lamp, the turn signal light and other lamps all work well. Examine light intensity of the headlight.

#### Interior

**The vehicle exterior Spare tires, jack and wheel wrench:** Examine tire pressure and confirm that lifting jack and wheel wrench are available.

**Seat belt:** Examine whether the belt buckle is locked well. Confirm that the seat belt is not abraded or scraped.

**Instruments and controllers:** Confirm that maintenance indicator, instrument illumination and defroster work well.

**Brake:** Confirm that the pedal has enough free space.

#### Engine compartment interior

**Spare fuses:** Confirm that various fuses are prepared. Please prepare fuses with various rated electric charge in the fuse box.

**Coolant level:** Confirm that the coolant fluid level is proper. (Refer to description in chapter 7-2.)

**Battery and cable:** All units in the storage battery should be filled with proper level of steam water. Check whether the connector is corroded or loosened and whether there is crack on the box. Check whether the cable and connection are good.

**Wires:** Check whether the cable it is damaged, loosened or comes off.

**Fuel pipe:** Examine whether there is oil leak and loosened connection in the fuel pipe.

### FRIENDLY TIPS

**Do not pile the car with various the children toys. It is convenient for the children to play but leaves safety risk, especially In the case of emergent braking or collision. These toys might not only affect driving safety but also cause damage to the children.**



### After Starting the Engine

Exhaust system: Hear whether there is air leakage. If there is any air leakage, please repair it immediately. (Refer to "engine exhaust warning" in Chapter II.)

Engine oil level: Turn off the engine and stop the car on the flat ground. Measure the fuel level with oil dip rod. (Refer to description in chapter 7-2.)

### In driving

**Instruments:** Confirm that the maintenance indicator and the speedometer work normally.

**Brake:** In a safe place, please confirm that the brake deviate to neither side while working.

**Examination of other abnormalities:** Check whether there is loosened part or leakage. Hear whether there is abnormal noise.

If everything is normal, please relax and enjoy your driving.

### Driving Tips under Different Conditions

- Please drive slowly in dead wind. It is convenient to control the car.
- Please drive slowly maintain correct angle on pedestrian road. Avoid driving on high or sharp objects or other road obstacles. Otherwise, the tire might be burst or severely damaged.
- Please slow down car speed while driving on bumpy road. Otherwise, it might severely damage tires and/or wheels.
- The brake might be wetted when washing the car or driving the car in deep water. Before checking whether they are wetted, please check whether surrounding is safe firstly and press the braking pedal gently then. If you do not feel normal braking force, the brake might have been wetted. To dry it, please take care to press the braking pedal gently while using parking control mechanism.

### FRIENDLY TIPS

- Before driving, please confirm that the parking control mechanism is fully released and the braking system indicator is turned off.
- Do not leave the car while the engine is running.
- Do not place your feet on the braking pedal while driving. This might cause dangerous overheating, abrading and fuel wasting.
- While driving down a long steep slope, please reduce speed and change to a low speed position. Please note that if you press the brake too frequently, overheating brake might not work normally.
- While accelerating, changing to a higher or lower gear or braking on slippery road, please take care. Dramatic acceleration or braking might cause car slid or revolution.
- While the brake is wet, do not continue driving. If the brake is wet, the car needs a longer braking distance. While using the brake, the car might be thrown to



one side. Likely, the parking control mechanism cannot brake the car firmly.

- While the car is travelling, do not place your head or hand out of the window to avoid traffic accident and death risk, especially when a child stays in the car.

#### NOTICE

While the car is travelling on wet road, please avoid driving on road with much accumulated water. If a large quantity of water enters the engine chamber, it would damage the engine and/ or electric parts.

#### Driving Trips in Winter

**Confirm that coolant works well as anti-freezing protection.**

Please use coolant specified by BYD authorized service station only. Please select proper coolant type to inject into cooling system in accordance with environment temperature.

Use of improper coolant might damage cooling system of the engine.

#### NOTICE

**Do not use excessive quantity of water, as excessive quantity of water might damage cooling system of the engine in winter.**

**Examine the storage battery and cable condition.**

Cold weather will reduce the storage battery. Therefore, the storage battery should keep sufficient capacity in winter. Chapter 7-3 describes the method to examine the storage battery with eyes. BYD authorized service station will help you to check charging level of the storage battery.

**Confirm that the engine oil viscosity suits for driving in winter.**

For recommended the engine oil viscosity, please refer to chapter 7-2. In winter, as a quantity of the engine oil used in summer

remains in the engine, the engine might not be started easily. If you are not sure which type of the engine oil should be used, please contact BYD authorized service station for help.

**Prevent car door lock from being frozen by snow and ice.**

Please inject some deicing agent or glycerol to prevent freezing.

**Please use cleaning mixture containing anti-freezing agent.**

These products are available in BYD authorized service station and all automobile parts shop. Please determine mixture ratio of water and anti-freezing agent in accordance with the manufacturer's instruction.

#### NOTICE

**Do not use the engine anti-freezing agent or other substitutes as cleanser, as it might damage car paint.**

**If the parking control mechanism**



**might be frozen, do not use it.**

While parking, please set the transmission lever at neutral position and baffle the rear wheel. Do not use the parking control mechanism. Otherwise, surrounding of the parking control mechanism might be frozen by accumulated water or snow and, as a result, it is difficult to release the parking control mechanism.

**Avoid accumulated ice and snow under splash guard.**

If there is accumulated ice and snow under the splash guard, it might be difficult to steer. While driving in a cold winter, please often stop your car and check whether there is accumulated ice or snow under the splash guard.

**Please carry some necessary emergency tools in accordance with recommendation for different driving conditions.**

It is better to prepare a tire chain, a car window scraper, a bag of sand or salt, a signal flashing device, a small spade

Starting and Driving 3-6

and connecting cable in the car.

### Trailer Towing

BYD L3 is mainly designed to carry passengers. Towing a trailer can have adverse effects on the manipulation, performance, braking, durability, economic driving (fuel consumption) and other aspect. Safety and comfort of driving totally depends on correct use of equipment and careful driving habit. For the safety of you and other people, please do not overload the car or tow a trailer. BYD is not liable for damage or fault caused by towing a trailer for a commercial purpose.

### Weight limit

Before towing a car, please confirm towing capability of the car. Please contact local BYD authorized service station and confirm that towing capability of the car is within specified scope.

Towing capability is measured on horizontal road. If the car is traveling in mountainous area, its engine power and towing capability will be reduced.

### FRIENDLY TIPS

**The weight of the trailer to be towed should not exceed the maximum rated weight of the tow hook. Otherwise, this can cause accidents, resulting in serious personal injuries. Due to possible increase of braking distance, be sure to increase the distance between your car and the trailer when towing a trailer. The distance between the car and a car in the front of it should be at least the sum of the car and its trailer at a speed of 10 km/h. Please avoid emergent braking to prevent car folding and control loss caused by skid.**

### Tires

- Ensure that the tire has proper air pressure. (Refer to description in chapter 7-2).
- Please keep the tire pressure at the level specified by trailer the manufacturer in accordance with the trailer's gross weight.

### Running-in procedures

- BYD recommends that a car with new transmission system (engine, transmission, differential mechanism, wheel bearing, transmission shaft) should not tow a trailer within its initial 2000 km.

### Maintenance

- When the car tows a trailer, the car has more load capacity. Therefore, it requires more frequent maintenance.

### How to Save Fuel and Lengthen Service Life of the Car

It is easy and convenient to save fuel. It also helps lengthen service life of the car. Refer to the following tips to save fuel fee and repair fee.

- **Maintain proper tire pressure.** Insufficient tire pressure might cause tire wearing and fuel wasting. (Refer to description in chapter 7-2).

- **Do not place unnecessary load on the vehicle.** Overweight might increase the engine load and consume large quantity of fuel.
- **Avoid long-time warning up idling.** Once the engine operates steadily, please drive steadily. Preheating time in a cold day might be longer.
- **Accelerate slowly and steadily.** Avoid fast starting. Please use high speed gear while driving.
- **Avoid long-time engine idling.** If you have to wait for someone in a area which is not busy, please turn off the engine.
- **Avoid lugging down or over-speeding the engine.** Please select a proper speed gear in accordance with road condition.
- **Avoid frequent acceleration and deceleration.** Frequent stop and move wastes fuel.
- **Avoid unnecessary parking or**

**braking.** Keep a steady speed.

Drive in accordance with traffic signal lamps to reduce stopping times to the minimum extent or drive on a highway without traffic light. Keep a proper distance from cars in the front of you to avoid emergent braking. It will also reduce brake wearing.

- **Avoid areas with busy traffic or congestion as far as possible.**
- **Do not place your foot on the clutch pedal or the brake pedal.** Otherwise, it might cause premature wearing, overheating or consumption of large quantity of fuel.
- **Please maintain a proper speed on a highway.** The higher the speed is, the more fuel the car consumes. Slow the car speed to save fuel.
- **Please maintain correct position of the front wheel.** Please avoid bumping into road kerb. Drive



slowly on bumpy road. If the front wheel is not positioned accurately, it will not only cause early wearing of tire but also increase the engine load. In another word, it will increase oil consumption.

- **The chassis should be kept clean and free of mud.** It will not only reduce car weight but also prevent corrosion.
- **Adjust the car and keep it in the optimistic working condition.** Dirty air filter, improper air valve gap, dirty spark plug, dirty the engine oil or lubricant, unadjusted brake might affect the engine performance and waste fuel. In order to maintain a long service life of all parts and reduce operation cost, please provide regular maintenance. If the car often travels in bad condition, it requires more frequent maintenance (refer to chapter 6).

**vacuum booster will not work. Likewise, only when the engine is in operation, exhaust pollution control device can work normally.**

**FRIENDLY TIPS**

**When going down the slope, never shut down the engine. If you turn off the engine, power steering and**



# Chapter 4

## Emergency Handling

- The Car Can Not Start Up ..... 4-2
- The Engine Shut Down While Driving ..... 4-4
- If the Car is Overheated ..... 4-5
- The Car Has Flat Tires ..... 4-6
- If the Car Gets Stuck ..... 4-11
- The Car Needs Towing ..... 4-11



## The Car Can Not Start Up

### 1. Simple check

Before conduct checking, please start the car as described in chapter 3 “how to start the engine” and check whether fuel is sufficient.

#### **If the engine can not run or run too slowly,**

1. Check whether the connector of the storage battery is tightened and cleaned.
2. If the connector of the storage battery is OK, please turn on the rear in-car lamp. If the in-car lamp isn't turned on or gives out weak light or the starter runs out while starting, please try bridging start. Please refer to “(c) bridging start”.

If the in-car lamp is turned on but the engine fails to start, please make repair or adjustment. Please contact BYD authorized service station.

### NOTICE

**Do not start the car by pulling or pushing it. Otherwise, when the engine starts, it might damage the car or causes collision. It might also overheat the three-way catalytic converter and cause fire.**

#### **If the starter motor of the engine runs at the normal speed but can not start the engine.**

1. Switch power position to OFF or ACC, then restart the engine.
2. If the engine fails to start, the reason might be oil overflow of the engine due to repeated starting. For related details, please refer to *(b).starting an engine with overflow oil.*
3. If the engine still refuses to start, please make repair or adjustment. Please contact BYD authorized service station.

## 2. Fuel Spill in the engine Starting

**If the engine fails to start, the reason might be flooding of the engine due to repeated starting.**

In this case please press the accelerating pedal with full force while switching the power position to START. Release after keeping the power position and accelerating pedal at the position for 15 seconds. Then, restart the engine while keeping your foot off the accelerating pedal.

If the engine still fails to start after trying for 15 seconds, please power off and retry after a few minutes.

If the engine still fails to start, please make repair or adjustment. Contact BYD authorized service station for help.

### NOTICE

**Every time you try to start the engine, do not exceed 30 seconds. Otherwise, it might cause overheating of starter or circuit.**



### (c) Jump Start

In order to avoid severe injury and damage of car or electric accessories caused by battery burst, sulfuric acid corrosion, electric burning, please strictly comply with the following instruction.

If you do not know how to perform in accordance with procedure, please contact BYD authorized service station for help.

#### FRIENDLY TIPS

- The storage battery contains corrosive and toxic sulfuric acid liquid. Therefore, please wear safety goggle at the time of bridging start to avoid spraying of sulfuric liquid on skin, coat or the vehicle.
- If you carelessly spray sulfuric acid onto your body or into your eyes, please take off your coat immediately and wash the stained part. Then go to see a doctor immediately. If it is possible, please wash the stained part with

sponge or clean cloth wetted with clean water while going to hospital.

- If there is open flame or spark nearby, the gas emitted by the storage battery might burst. To jump start your car, be sure to use standard jumper cables. No smoking or lighting a match is permitted.

#### NOTICE

The storage battery must be of 12 V. Before confirming that the storage battery is OK, do not conduct bridging start.

#### Procedures of Jump Start

1. If another car is equipped with the storage battery, please make sure that both car do not contact each other. Turn off all unnecessary car light and accessories.
2. If it is necessary, please remove all orifice plugs of the storage battery for charging and discharged the storage battery and cover a piece of cloth on

opened the storage battery orifice. (It helps reduce explosion risk, injury or scorching.)

3. If a car equipped with the storage battery for charging does not work, please start it and operate for a few minutes. During bridging start, please press the accelerating pedal gently and run the engine at 2000 rpm.

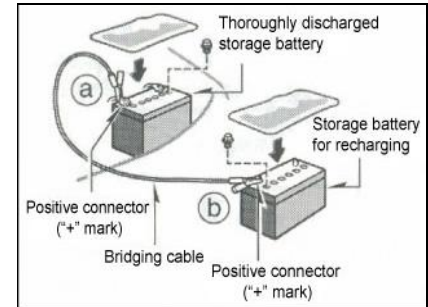

4. Connect the cable in the sequence of a, b, c.

4.1 Connect the positive (red) bridging cable clip to the positive connector (+) of discharged the storage battery.

4.2. Connect the positive (red) bridging cable clip to the positive connector (+) of the storage battery to be charged.

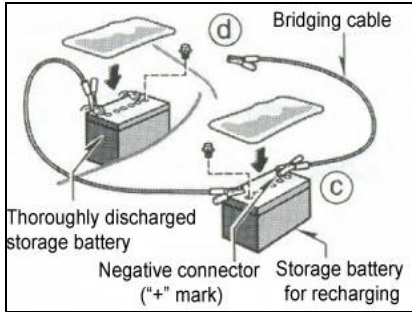

4.3. Connect the negative (black) bridging cable clip to the negative connector (-) of discharged the storage battery.

4.4. Connect the clip on the other end of the negative (black) jump cable to the unpainted fixed metal point of the car with discharged the storage battery.

The connection point is shown in the following figure.

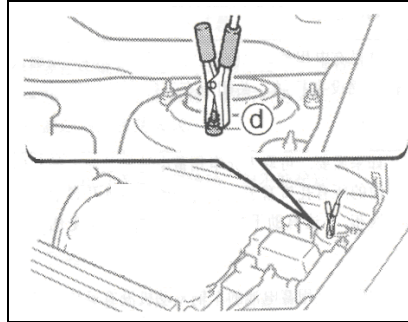

### Connection to jump-start the engine.

While you jump-start an engine, do not keep the connection cable near any operating part of the engine.

#### FRIENDLY TIPS

**While conducting connection, do not keep your body near the storage battery or carelessly contact the jump cable or clip with any object other than correct the storage battery connector or point in order to avoid severe injury.**

5. Start the engine in a normal way. After starting the engine, please press the

accelerating pedal gently and keep the engine running at 2000 rpm for a few minutes.

6. In a totally opposite procedure, carefully remove the cable: Firstly remove negative cable and then remove positive cable.

7. Take off the cloth covered on the storage battery. The cloth might be stained with sulfuric acid.

8. If you want to move, please recover all the storage battery orifices.

If the reason of the storage battery discharging is not clear (for example, the lamp remains on), please contact BYD authorized service station for examination.

### The Engine Shut Down While Driving

The engine shut down while driving.

1. Please reduce car speed gradually and keep a straight line while driving. Please pull your car off the road to a safe place.



2. Turn on the emergency flash.
3. Switch power position to OFF or ACC, then restart the engine.

If the engine fails to start, please refer to "The car can not start up".

#### FRIENDLY TIPS

**If the engine doesn't run, power assisting device of the brake and the steering gear does not work. Therefore, it is more difficult to change direction and brake than usual.**

#### If the Car is Overheated

**If the engine coolant indicator shows overheating or there is power loss or great burst or bang is heard, it indicates that the engine might be overheated. Please handle in accordance with the following procedure.....**

1. Pull the car off the road safely and turn on the emergency light. Set the transmission at neutral position and pull

up the parking control mechanism. If the air conditioner is in operation, please turn it off.

2. If the coolant or steam spurts out from the heater or the expansion kettle, please stop the engine. Open the engine hood after the steam disappears. If no coolant or steam spurts out, please keep the engine in operation status and confirm that the cooling fan is in working status. If no, please turn off ignition switch.

#### FRIENDLY TIPS

**In order to avoid injury, please keep the engine hood closed until steam vanishes. Spurt of steam or coolant indicates very high pressure.**

3. Check whether there is obvious coolant leakage at the heater, the hose and the car bottom. However, if the air conditioner in operation generates water drop, it is a normal phenomenon.

#### FRIENDLY TIPS

**While the engine is in operation, please keep your hand and clothe away from the fan and the engine conveying belt for a certain distance.**

4. If the coolant leaks, please turn off the engine immediately. Notify BYD car authorized service station for help.

5. If there is no obvious leakage, please check the storage box of coolant. If it is dry, please add coolant into the storage box until reaching between two scale lines while the engine is in operation.

#### FRIENDLY TIPS

**While the engine and the heater are in high temperature, do not take off the heater cover. Otherwise, steam or fluid in high temperature spurting out due to pressure.**

6. Check the coolant level in storage box again after the engine coolant temperature drops to normal level. Increase it to appropriate scale if necessary. Much drainage of coolant indicates leakage in the system. Please



contact BYD authorized service station for examination as soon as possible.

### The Car Has Flat Tires

1. Please reduce car speed gradually and keep a straight line while driving. Pull the car off the road and stop at a safe place away from busy traffic. Do not stop at the central divergence on a highway. Please stop the car on a solid and flat ground.
2. Turn off the engine and turn on the emergency flash.
3. Pull up the parking control mechanism and set the transmission at neutral position.
4. All passengers on the car should get off the car and go to a place away from traffic.
5. Please read the following instruction carefully.

#### FRIENDLY TIPS

**When lifting the car with a jack, please follow the instruction below to reduce severe injury risk.**

- Observe the regulation on lifting a car with a jack.
- Do not place any part of your body under the car lifted by the jack. Otherwise, it might cause injury.
- While the car is lifted by a lifting jack, do not start or operate the engine.
- Stop the car on flat and solid ground, pull up the parking control mechanism tightly and set the transmission at neutral position.  
If necessary, be sure to put a stopper under the tire in the diagonal direction of the tire to be replaced.
- Be sure to set the jack at a proper lifting point. Improper position of the lifting jack might damage the car. If the car falls off the jack, it might cause injury.
- When the car is supported by the jack only, people should not get

under it.

- You cannot lift the car with a jack unless you replace a tire.
- If someone stays in the car, do not lift the car.
- While raising the car, do not place anything on or under the jack.
- Lift the car to keep a height enough to remove and replace a tire.

#### NOTICE

**Stop driving the car if a tire leaks. Even if you drive for a short distance on a leaking air, the tire might be damaged to an extent that cannot be repaired.**

## Required tools and spare tire

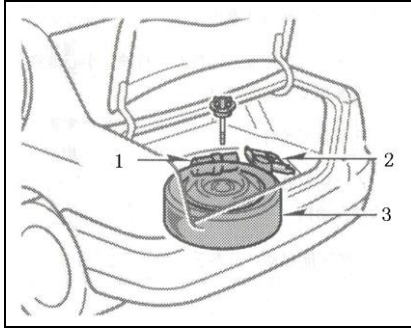

### 1. Take out required tools and spare tire

1. Tool bag
2. Spare tire
3. Triangular the warning sign

In order to repair the car by yourself in an emergency, you have to know how to use the lifting jack and various tools as well as their storage place.

### How to use triangular the warning sign:

#### FRIENDLY TIPS

**While you repair the car on a public road, make sure to place the triangular the warning sign 100-200 m behind your car to warn coming the vehicles and avoid risk. After finishing repair, please take back the triangular the warning sign for future use.**

### Triangular the Warning Sign

The triangular the warning sign is used to warn coming cars and avoid risk such as collision with the car which is parked or repaired due to very fast speed and late braking.

How to use:

1. Take the triangular the warning sign out from its box.
2. Combine components into a closed triangular.

3. Release the supporting back of the triangular the warning sign as shown in the following figure.

Notes: Face the red side of the triangular the warning sign to coming the vehicles and place it 100-200 m behind the car.



To remove the spare tire, use the notch at the end of the wheel wrench grip to unscrew the bolts and remove them. Then, take out the spare tire from the car.

While storing a spare tire, please place the external wheel on its position downward. Then, fix the tire in a opposite way of above stated procedure to prevent the tire flying forward in a collision accident or emergent braking.

### Baffle the wheel

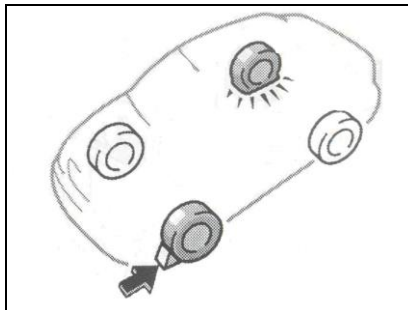

2. While lifting the car with a jack, please place a blocking piece under the tire in the diagonal direction or the leaking tire to prevent the car from sliding.

While baffling the wheel, please place the blocking piece in the front of a front wheel or behind a rear wheel.

### Loosen the wheel nut

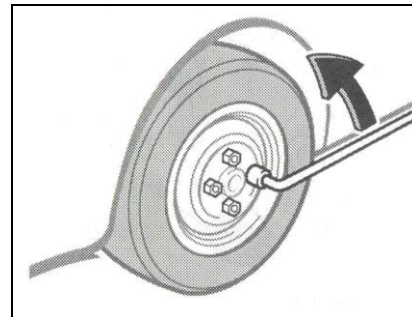

3. Loosen all wheel nuts of the wheel.

Before lifting the car, please loosen the wheel nut firstly.

Rotate the wheel nut counterclockwise and loosen it. To obtain the maximum torque, please set the spanner on the nut and place the spanner handle on the right side as shown in the figure. Hold the end of the spanner handle and pull it upward. Take care not to slide the spanner off the nut.

Do not remove the nut.—Please loosen it halfway.

### FRIENDLY TIPS

Do not apply lubricant or the engine oil on the bolt or the nut. Otherwise, the nut might be loosened and the wheel might come off to cause severe accident.

#### Locate the jack (jack figure modified)

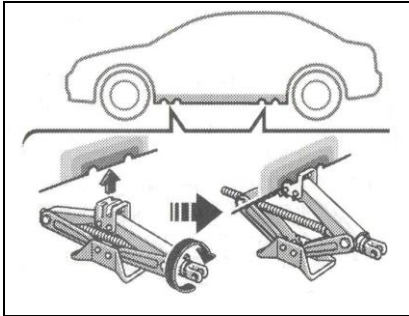

#### 4. Please place the jack at a proper supporting point.

Make sure that the jack is set on flat and solid ground.

#### Lift the car (jack figure modified)

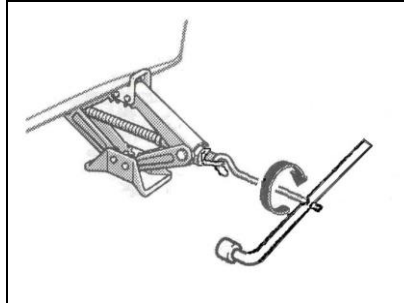

#### 5. Lift the car to a height that is enough to install a spare tire after confirming that no people are in the car.

Remember, installation of a spare tire requires more distance from the ground than removing a leaking tire.

When lifting the car, please insert the jack handle into the jack (loose joint) and rotate it clockwise. When the jack touches the car and starts to rise, please check whether the jack is located properly.

### FRIENDLY TIPS

When the car is supported by the jack only, people should not get under it.

#### Exchange tire

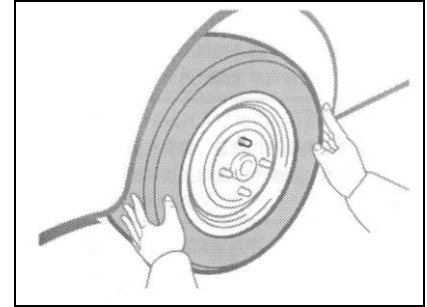

#### 6. Remove the wheel nut and replace the tire.

Remove the leaking tire immediately and put it aside.

Roll the spare tire to the installation place and align the bolt with wheel orifice. Lift the wheel until the upmost bolt enters the wheel orifice. Rotate the wheel and push it backward until all the other bolts enter the wheel orifice.

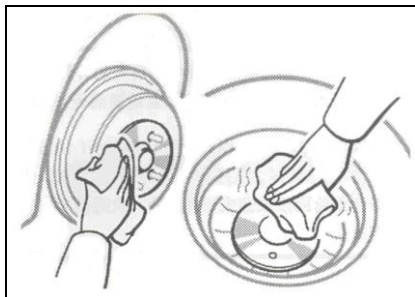

Before installing the wheel, please clear all corrosive substance off the installation surface with a wire brush. While installing a wheel, if the metal sides on the installation surface do not contact well, the wheel nut might be loosened and the wheel might come off while driving.

### Reinstall wheel nut

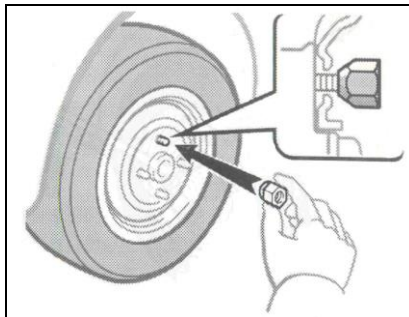

### 7. Reinstall all wheel nuts

Reinstall wheel nut (wedge-shaped end), tighten the wheel nut manually. Try to push the wheel backward to see whether it can be tightened further.

#### FRIENDLY TIPS

**Do not apply lubricant or the engine oil on the bolt or the nut. This will tighten the nut excessively and damage it. Otherwise, the nut might be loosened and the wheel might come off to cause severe accident. If there is oil the engine or lubricant on the bolt or the nut, please clear them.**

### Lower the car

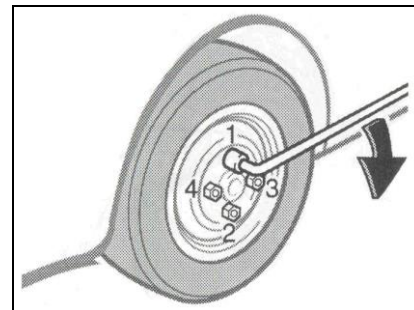

### 8. Lower the car to the ground and tighten the wheel nut.

To lower the car, please rotate the jack counterclockwise.

Please use the wheel spanner only to tighten the nut. Do not use other tools or any lever tools except your hand, such as a hammer, a hose or your foot. Confirm that the spanner surrounds the bolt tightly.

Tighten the bolt little by little in the shown sequence. Repeat the procedure until all nuts are tightened.



#### FRIENDLY TIPS

- When lowering the car, please make sure that all parts of your body and other people nearby would not be damaged.
- Please use a spanner with 103N·m (10.5kgf·m) torque force to tighten the wheel nut immediately after replacing the wheel. Otherwise, the nut might be loosened and the wheel might come off to cause severe accident.

#### FRIENDLY TIPS

- In accordance with installation technique requirement, single side unbalance of wheel assembly should be less than or equal to 5g·cm.

#### After replacing wheel

#### 9. Examine air pressure of replaced tire.

Adjust tire pressure to the value specified in chapter 8. If the air pressure value is lower than specified value, please drive your car slowly to a nearby

service station for inflation to reach a proper air pressure value. Remember to install the tire air valve cover. Otherwise, dust and damp air might enter the air valve to cause air leakage. If you the air valve cover is lost, please use a new one.

#### 10. Put away all tools, jack and leaking tire.

After replacing the wheel, please using a torque spanner to tighten the wheel nut to a torque value specified in chapter 8, have the leaking tire repaired by technicians.

#### FRIENDLY TIPS

**Before driving, please make sure that all tools, jack and leaking tire are stored in place firmly to reduce injury risk in the case of collision or emergent braking.**

#### If the Car Gets Stuck

**If the car gets stuck in snow, mud or sand, please try to push the car forward and backward to get out of it.**

#### FRIENDLY TIPS

**If there are people or objects near the car, do not push the car. The car might suddenly move forward or backward after getting out of trouble and cause injury or damage to other people or objects.**

#### The Car Needs Towing

Tow from front end



Tow from rear end



Use platform truck

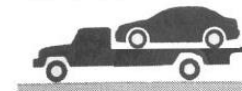



While towing the car, please use proper towing equipment to avoid damaging the car.

Improper towing method would damage the car. Although most towing personnel are familiar with a correct towing method, there is always mistake. In order to avoid damage to the car, please take the following precautions.

### Precautions for Towing:

Use safety chain system when towing the car and observe national, provincial and local laws. Wheel and car axle which contact the ground should be in good status. If they are damaged, please use towing trolley.

### Emergency Towing

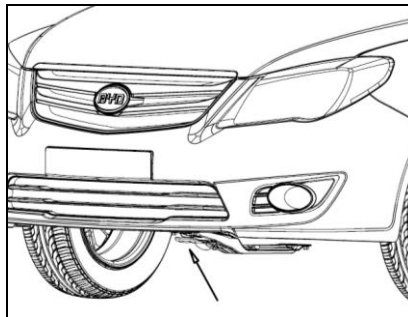

**If you need a towing the vehicle, it is recommended to contact BYD authorized service station.**

**If you cannot contact a towing company, please connect the towing cable to an emergent towing hook under the car and tow the car temporarily. Take great care when towing the car.**

#### NOTICE

- Use specified towing hook only. Otherwise, it might damage the car.

- Do not tow the car from behind while its four wheels are on ground. Otherwise, it might cause severe damage to the transmission.

The driver must sit in the car to drive the car and control the brake.

Maybe, a short distance can be towed at a low vehicle speed only on a hard surface by using such a towing method.

At the same time, wheel, car axle, transmission system, steering wheel and brake must be in good status.

#### FRIENDLY TIPS

Please take great care while towing a car. Avoid dramatic starting or unsteady driving. Otherwise, it might cause great stress on emergency towing hook and towing cable/chain. The towing hook and towing cable/chain might be broken and cause severe injury or car damage.

**NOTICE**

**Only use dedicated towing cable/chain. Tie the cable/chain on the towing hook tightly.**

Release the parking control mechanism and set the transmission at neutral position before towing. Switch the ignition switch to ACC (turn off the engine) or ON (turn on the engine).

**FRIENDLY TIPS**

**If the engine doesn't run, power assisting device of the brake and the steering gear does not work. Therefore, it is more difficult to change direction and brake than usual.**





---

## Chapter 5

### **Anti-Corrosion and Automobile Exterior Maintenance**

Anti-Corrosion of BYD L3 Car .....	5-2
Instruction on Lacquer Surface Maintenance .....	5-3
Car Washing and Waxing .....	5-4
Inside Cleaning .....	5-6



### Anti-Corrosion of BYD L3 Car

Proper car maintenance prevents the car from corrosion for a long time.

#### Car corrosion is most often caused by:

- Alkaline substance, dust and damp air are accumulated below the car where it is hard to reach.
- Paint layer or bottom layer is damaged by slight collision or stone or gravel.

**If you live in a special area or drive the car in a special environment, be sure to take care.**

- Alkaline substance or chemical substance on the road might accelerate corrosion. Air in coastal area or industrial pollution area also contains alkaline substance.
- High humidity might accelerate corrosion, especially when the environment temperature is just above zero.

- When some parts of the car is wet or damp for a long time, even if other parts remain dry, it will also cause corrosion.
- High temperature might cause corrosion to car components which are not dried due to lack of proper ventilation.

The items stated above represents that it is important to keep the car clean, especially car bottom, and recover damaged paint layer and protection layer as soon as possible.

**To prevent corrosion of BYD L3 car, please observe the following rules:**

**Wash the car regularly.** Regular washing keeps the car clean. However, in order to prevent corrosion, please observe the following points.

- If you drive the car on a road containing alkaline substance or at seaside, please wash the travelling part of the car once a month at least to reduce corrosion.
- High pressure or steam is very

effective to car chassis and wheel cover washing. As it is difficult to see mud and dirt at these places, please take great care. If you only dampen mud or debris instead of removing them, it might cause greater harm. Do not block the lower edge and threshold board of car doors and water outlets of the car frame with dust. Otherwise water accumulated at these places will cause corrosion.

- After winter, please wash the car chassis thoroughly.

For more tips, please refer to “car washing and waxing”.

**Examine paint and decoration parts.** If you find any fragment or flaw on the paint layer, please make repair immediately to prevent corrosion. If the fragment or the flaw comes off the metal surface, please contact BYD authorized service station for repair.

**Examine car inside.** Moisture and dust are accumulated under the floor mat and cause corrosion. Please examine the

mat and ensure that it is dry. When transporting chemical substance, detergent, chemical fertilizer and salt, please take extra care and use proper container. If the liquid splashes out or leaks, please clean it immediately and keep dryness.

**Use a splash guard.** For example, when driving on saline alkali area or gravel road, the splash guard can protect the car. A splash guard with larger size which approaches the ground is preferred. The small splash guard for the wheel cover of BYD L3 is an optional part. BYD authorized service station will install splash guard for your car.

**Park the car at a well ventilated garage or roofed place. Do not stop the car in a damp and badly ventilated garage.** If you wash the car in a garage or drive the car on watery or snowy road, the garage will become damp and cause corrosion. Even if the garage is dry, bad ventilation will still corrode damp car.

### Instruction on Lacquer Surface Maintenance

Pay attention to the following points in car maintenance.

1. Please clear dust on the car before, while and after you drive the car to reduce absorption of dust by static electricity on the car.
2. Wash after rain. Water stain will shrink gradually after rain, which increases acid substance concentration. If you do not wash it off, it would damage paint surface.
3. Be sure to let the engine cool down before washing your car. Don't clean your car in the hot sun or at a high temperature in order to avoid any mark resulting from the dried detergent. While washing the car by yourself, please use dedicated detergent and fresh neutral water. Do not use washing powder, soap water or detergent with strong alkali, which might wash off oil in the paint surface and accelerate paint surface ageing. When washing in the garage, do not use dewaxing detergent to avoid

damage to the paint surface. Especially when driving in coastal area or severely polluted area, please wash the car once a day.

4. Use clean and soft cloth or sponge to clean car and avoid mixture of metal chip and sand. Do not use dry cloth, dry towel or dry sponge to clean car to avoid scratching. Wipe the car in the direction of flowing water, do not draw circles or wipe horizontally.

5. For some special and very corrosive trace (such as asphalt, bird shit or insect), please clean it immediately. In this case, please use dedicated detergent. Do not use blade to scratch it or use gasoline to eliminate it, which might damage the paint surface.

6. Do not touch the car paint surface with oily hand or wipe the paint surface with oily cloth. Do not place oily tool or cloth stained with organic solvent on the car to avoid chemical reaction.

7. If there is no obvious scratch on the paint surface, do not paint the car for a second time to avoid un-matching paint color or bad bonding.



8. If the car isn't in use for a long time, please park it in a garage or well ventilated place. Cover it with dedicated car cover in winter. Please select a shady place to park your car.

9. Avoid intense impact, bump and scratch on paint film. If there is scar, dent or coming off on the paint surface, please make repair immediately. A professional automobile beauty shop is preferred.

10. To wash a plated metalware, please use carbon detergent and regularly wash it to protect it.

11. To wash decoration parts of the car, please use quality detergent. While waxing the car, do not use too much force to avoid penetrating the painting layer and expose the base.

Irregularly wax the paint surface and regularly (once per quarter) to receive maintenance in a professional automobile shop and recover gloss of the paint surface in time.

## Car Washing and Waxing

### How to wash a BYD L3 car

#### Wash the car with a normal method.

In the following cases, paint layer might come off and parts might be corroded, please wash the car immediately.

- Drive in coastal area.
- Drive on road surface spread with anti-freezing agent.
- The car is stained with coal tar, resin, bird shit or dead insect.
- Drive in an area where there is large amount of fume, coal ash, dust, scrap iron or chemical substance.
- The car is stained by dust or mud.

#### How to wash BYD L3 car manually

**Wash the car in a shady place after the car body cools down.**

### FRIENDLY TIPS

**When washing the mat bottom or chassis, take care not to hurt your hand.**

1. Use water to wash off loosened dirt and all mud or alkaline under the car and dent on the wheel.

2. Use neutral detergent to wash the car. Follow the instruction of the manufacturer for detergent mixture ratio. Use the soft cloth with detergent. Do not wipe with force. Use soap water and clean water to remove dirt.

3. Wash it thoroughly. Dried soap water might leave a trace. Please use clean water to wash off the car thoroughly after washing the car in a hot day.

4. In order to avoid water trace, please use a clean soft towel to dry the car body. Do not wipe or press with force. Otherwise, it will scratch the paint surface.

Plastic decoration part of the wheel:  
Plastic wheel decoration part is subject





to damage caused by organic substance. If any organic substance sprays on the decoration part, be sure to use water to wash it off and check whether the decoration part is damaged.

#### FRIENDLY TIPS

**Do not install plastic wheel decoration part which is severely damaged. Otherwise the decoration part might come off the wheel and cause an accident while the car is travelling.**

Aluminum wheel: Only use neutral soap water or neutral detergent.

Plastic bumper: Take care while washing it. Do not use detergent containing grinding material to clean as the front side of the bumper is soft.

Asphalt from the road: Use turpentine or detergent which does not damage paint surface to perform cleaning.

#### NOTICE

**Do not use organic goods (gasoline, kerosene, volatile oil or strong solvent), which might cause toxicity or damage.**

#### Automatic Car Washing Station

You may wash your car in an automatic car washing station. However, please note that some brushes, unfiltered water or machine-defined washing procedure might damage the paint surface. Scraped paint surface might reduce endurance and gloss of paint surface, especially for a dark color car. Staff of the car washing station will recommend a preferred washing procedure which is safer to the car paint surface.

#### Waxing for BYD L3 Car

**In order to maintain surface gloss, it is recommended to polish and wax the car body.**

Please wax your car once a month or when the car surface fails to resist water.

1. Before waxing the car, please wash the car and dry the car body, even if combination of detergent and car wax is used.

2. Use quality polishing agent and car wax. If polishing condition of the car is severely weathered, please use car polishing agent which is separated from car wax. Strictly follow the manufacturer's description and precautions. Chromeplate surface and paint surface should also be polished and waxed.

3. On a large contact surface, if water forms droplet and stays on the surface, please wax the car again.

#### NOTICE

**If the car is painted again and parked in a high-temperature painting/waxing workshop, please remove the plastic bumper, which is vulnerable to high temperature.**



### Inside Cleaning

#### FRIENDLY TIPS

Do not wash the car floor with clean water or cause water to flow into the floor while washing outside/inside of the car, as water might enter audio components or other electric components on or under the carpet (mat) and cause malfunction or cause corrosion of the car.

#### Carpet

Use quality foam-type detergent to clean carpet.

Firstly, use a vacuum cleaner to absorb all dust. Several types of foam detergent are applicable. Some are packed in spray can. Some are powder or liquid, which generates foam when mixed with water. Use sponge with foam or brush to clean carpet. Clean it in a circular way.

Do not use water in order to keep the carpet dry. Read carefully and follow strictly instruction on detergent use.

### Seat Belt

Use neutral soap water or slightly warm water to clean a seat belt.

Use sponge or soft cloth and check whether the seat belt buckle is excessively worn, damaged or cut during cleaning.

#### NOTES

- Do not use dye or bleacher to clean seat belt buckle. Otherwise, it might weaken the strength of seat belt.
- Do not use seat belt until they are dried.

### Doors and windows

Doors and windows may be cleaned with any family detergent.

#### NOTES

When cleaning the inside of rear window, take care not to scrape or damage the heater strip or the connector.

Air conditioner control panel, automobile audio, the instrument panel, control panel and switch should be cleaned with damp soft cloth.

Dip a clean soft cloth in water or slightly warm water, and then wipe off dust gently.

#### NOTES

- Do not use organic substance (solvent, kerosene, alcohol, gasoline) or acid/alkali solvent. Such kind of chemical substance might fade stain or strip the car surface.
- To use detergent or polishing agent, please confirm that it does not contain substance stated above.
- When using a new type of liquid washing agent, do not splash it onto internal surface of the car. The liquid might contain above stated composition. Clean splashed liquid quickly with the above stated method.

**Leather ornament inside the car**

**Leather ornament may be cleaned with neutral detergent applicable for woolen fabric.**

Use soft cloth with 5% neutral detergent applicable for woolen fabric to wipe off dust. Then, use a clean wet cloth to clean all detergent left.

Use a clean soft cloth to dry it after washing it or if any leather part gets wet. Dry the leather in a well ventilated shady place.

**NOTES**

- If neutral detergent cannot wash dirt off, you can use detergent without organic solvent.
- Never use volatile oil, alcohol, gasoline, acid/alkali fluid or other organic substance to clean leather. They might fade the leather.
- Use of nylon brush or artificial fiber cloth might damage pattern on the leather surface.
- Dirty leather decoration parts might generate mould. Take care to avoid oil stain and always keep decoration parts clean.
- Exposure to sunshine for a long time might harden or shrunken leather surface. Therefore, please park your car at a shady place, especially in summer.
- As temperature inside the car tends to rise in hot summer, do not place articles made of ethylene, plastic or wax on decoration parts. These articles might be adhered to the leather in high temperature.

- Improper washing of leather parts might cause fade or generate speckle.

**In the case of any doubt about car washing, please contact local BYD authorized service station.**





# Chapter 6

## Maintenance Knowledge

Maintenance .....6-2  
Signs for Repair Arrangement .....6-3  
Maintenance Schedule for BYD L3 Sedan.....6-4



## Maintenance

### Regular Maintenance is Important

BYD strongly recommends you to maintain a BYD L3 car in accordance with maintenance schedule in the following page to protect a new car. Regular maintenance helps in the following way.

- Fuel saving
- Extension of service life
- Joy of driving
- Safety driving
- Steadiness driving
- Warranty compliance
- Compliance with government rules

#### NOTES

Receive car maintenance in BYD authorized service station in accordance with “BYD L3 car maintenance manual”.

BYD L3 is designed to be a car with economic driving and economic maintenance. Many maintenance items are unnecessary any more. To ensure that the car travels in the optimistic efficiency, please maintain it in accordance with maintenance schedule.

### Where to maintain your car?

Local BYD authorized service station is a preferable place for maintenance.

BYD technicians are well trained professional personnel. They will receive related technical proceedings, maintenance essentials, internal training plan for authorized service station and updated service data.

BYD authorized service station has invested large amount of fund to provide tools and maintenance equipment dedicated for BYD cars. It helps complete work and reduce cost.

Maintenance department of BYD authorized service station provides reliable and economic maintenance schedule for your car.

### What a driver himself can do for maintenance?

As long as a driver is aware of some basic mechanical common knowledge and basic automobile tools, many maintenance items can be performed by the driver himself. For a simple description, please refer to Chapter 7.

Please note that some maintenance work requires professional tools and technique. Please leave these items to a qualified technician. Even if you are an experienced technician, it is recommended that you should leave repair and maintenance work to BYD authorized service station, which will make maintenance record. The record is useful for maintenance service.



## Signs for Repair Arrangement

Pay attention to performance, sound change and visual omen for repair of the car. Some important situations are as follows:

- The engine stalls, is unsteady or bangs.
- Driving force drops obviously.
- Abnormal the engine noise.
- Water leakage on car bottom (if air conditioner in operation drips water, it is normal.)
- Abnormal exhaust noise (This can be an indication that there is leakage of dangerous carbon monoxide. It is necessary to drive your car with its windows open and immediately check its exhaust system.)
- Air leakage of tire; excessive tire noise while turning; uneven tire wearing.

- While driving on a flat ground in a straight line, the car inclines to one side.
- Abnormal noise related to suspension device movement.
- Loss of braking effect; Sponge-like feeling of braking pedal or clutch pedal; pedal almost touches the floor; the car inclines to one side while braking.
- Temperature of the engine coolant continues rising.

In the following cases, please contact BYD authorized service station immediately for adjustment or repair.

### FRIENDLY TIPS

**Do not continue driving a car which has not been examined. Otherwise, it might cause severe car damage and personnel injury.**



**Maintenance schedule for BYD L3 car**

**Maintenance schedule for BYD L3 car ensures steady, safe and economic driving.**

**For maintenance interval, please refer to the schedule depending on travelled distance or time interval. The earlier one governs.**

**Maintenance items which have expired should be performed in the same time interval.**

Maintenance interval of each item is recorded in the maintenance schedule.

**Rubber hose (used for cooling and heating system, braking system and fuel system) should be examined by a qualified technician in accordance with BYD L3 maintenance schedule.**

These are very important maintenance items. A hose with degradation or damage should be replaced immediately. Please note that rubber hose degrades as time goes on and causes expansion, wearing or rupture.

**Requirement of maintenance**

**schedule**

BYD L3 car should be maintained in accordance with normal maintenance schedule (refer to maintenance schedule).

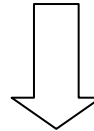

When driving a car in one or more of the following special conditions, some maintenance schedule items require more frequent performance.

<b>A. Road condition</b>	<b>B. Driving condition</b>
1. Drive on bumpy, muddy or melted snow road	1. Tow a trailer, use camp trailer or top bracket
2. Drive on dusty road	2. Within 8 km, repeated short-distance trip, surrounding temperature below 0 degree of centigrade.
	3. Long-term idling and/or low speed long-distance driving, such as police car, taxi or delivery car.



## Maintenance Schedule

Maintenance Operations: I=to examine, repair, or replace if necessary; R=to replace, change, or lubricate; C=to clean.

Maintenance interval	Milometer readings or months, whichever comes earlier															
	× 1,000 km (kilometers)	3	8	13	18	23	28	33	38	43	48	53	58	63	68	73
Maintenance items	Month number	Compulsory insurance	3	6	9	12	15	18	21	24	27	30	33	36	39	42
<b>Basic parts of the engine</b>																
1 Check whether there is flaw, flying scrap or wearing condition on conveying belt and adjust its tension		I		I		I		I		I		I		I		I
2 Check the ignition cable for damage						I				I				I		
3 Replace the engine timing belt	Ordinary service condition					I				I				I		R
	Harsh service condition	R: every 70,000 km														
4 Check whether control system of crank case works normally						I				I				I		
5 Check and replacing the spark plugs				I		I		R		I		I		R		I
6 Check whether cooling water pipe is damaged and confirm whether connection part is locked				I		I				I				I		
7 Examine the engine coolant level inside water overflowing kettle		I		I		I		I		I		I		I		I
8 Replace the engine coolant						R				R				R		
9 Check whether air filter cartridge is blocked or damaged	Ordinary service condition		I	I	I	I	I	I	I	I	I	I	I	I	I	I
	Harsh service condition	I: Reduce cycle if necessary														
10 Replace the air cleaner element	Ordinary service condition			R		R		R		R		R		R		R
	Harsh service condition	R: Reduce cycle if necessary														



Maintenance interval  Maintenance items	Milometer readings or months, whichever comes earlier															
	× 1,000 km (kilometers)	3	8	13	18	23	28	33	38	43	48	53	58	63	68	73
	Month number	Compulsory insurance	3	6	9	12	15	18	21	24	27	30	33	36	39	42
11 Check the oil level of the manual transmission		I		I		I		I		I		I		I		I
12 Replace the manual transmission oil	Ordinary service condition	I	R			R				R				R		
	Harsh service condition	R: Reduce cycle if necessary														
13 Check and replace the DCT transmission oil	Ordinary service condition	After initial 55000km/, check oil every 60000km. If necessary, replace oil														
	Harsh service condition	R: Reduce cycle if necessary														
14 Replace engine oil	Ordinary service condition	To be replaced every 6 months or every 5,000 km														
	Harsh service condition	Every 3,000 km														
15 Replace oil filter element	Ordinary service condition	To be replaced every 6 months or every 5,000 km														
	Harsh service condition	Every 3,000 km														
16 Check battery electrolyte		I	I	I	I	I	I	I	I	I	I	I	I	I	I	I
17 Check idle speed		I		I		I		I		I		I		I		I
18 Check ignition timing		I			I			I			I			I		
19 Check the crankcase ventilation hose			I		I		I		I		I		I		I	
20 Check valve clearance		I			I			I			I			I		I



21 Check exhaust pipe connection for leakage			I		I		I		I		I		I
22 Throttle body			C		C		C		C		C		C
23 Injection nozzle			C		C		C		C		C		C
24 Check oxygen sensor			I		I		I		I		I		I
25 Check three-way catalytic converters			I		I		I		I		I		I
<b>Fuel and exhaust purification control system</b>													
26 Check fuel filter			R		R		R		R		R		R
27 Fuel tank cap, fuel pipes and connections	I				I				I				I



Maintenance items	Maintenance interval	Milometer readings or months, whichever comes earlier															
		× 1,000 km (kilometers)	3	8	13	18	23	28	33	38	43	48	53	58	63	68	73
		Month number	Compulsory insurance	3	6	9	12	15	18	21	24	27	30	33	36	39	42
28 Active carbon canister																	
<b>Chassis and car body</b>																	
29 Brake pedal and parking control mechanism																	
30 Brake lining and brake disc																	
31 Brake fluid					R				R				R				
32 Brake system pipes and hoses																	
33 Power steering fluid					R				R				R				
34 Steering wheel, tie rod																	
35 Drive shaft boots																	
36 Ball pins and boots																	
37 Front/rear suspension components																	
38 Tires and air pressure																	
39 Check front wheel alignment and rear wheel alignment																	
40 Check wheel bearings for play																	
41 Air-conditioning or heating system																	
42 Air conditioning filter				R		R		R		R		R		R	R		
43 Coolant for air conditioner/cooling device																	
44 Check airbags system																	
45 Check the vehicle body for damage			Every year														

**Notes:**

**Specification for “harsh service condition” only applies to a car used in a harsh service condition. Severe usage condition includes the following items:**

1. Drive in dusty area or coastal area or the car is often exposed to salty air;
2. Drive on bumpy, watery or mountainous road;
3. Drive in a cold area;
4. Drive in a cold season or the engine idles for a long time or the car often travels for a short-distance trip;
5. Frequently use brake and slam the brake;
6. Serve as towing the vehicle;
7. Serve as taxi or commercial the vehicle;
8. Driving time in crowded traffic exceeds 50% of total driving time at a temperature above 32 °C;
9. Driving time at a speed of 120 km/h or more exceeds 50% of total driving time at a temperature above 30 °C;
10. Overload driving.





# Chapter 7

## Section 1

---

### Self-Maintenance

#### Preface

Appearance of the Engine Compartment.....	7-2
Fuse Layout .....	7-3
Precautions for Self-Maintenance.....	7-3
Positioning of the Jack .....	7-5

### Appearance of the Engine Compartment

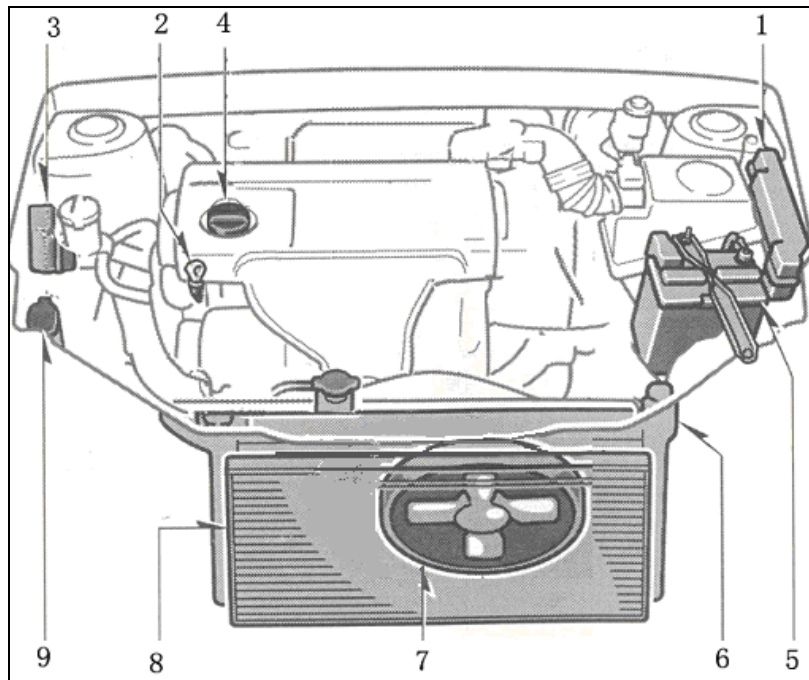

1. Assembly of distribution box
2. Oil Dipstick for the engine oil level
3. Overflowing kettle of the engine cooling fluid
4. Engine oil filler cap
5. The storage battery
6. Radiator
7. Electric the cooling fan
8. Condenser
9. Windshield glass cleaner reservoir



## Fuse Layout

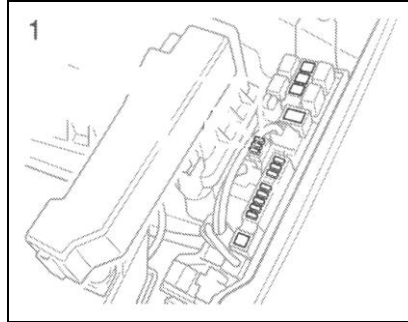
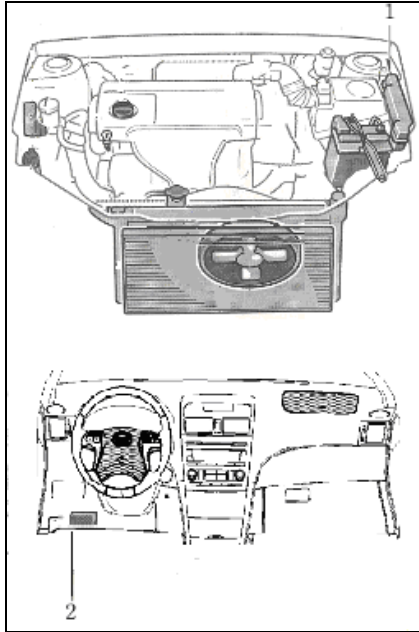

For electric components protected by various fuses, please refer to Chapter 8 “fuse and relay”.

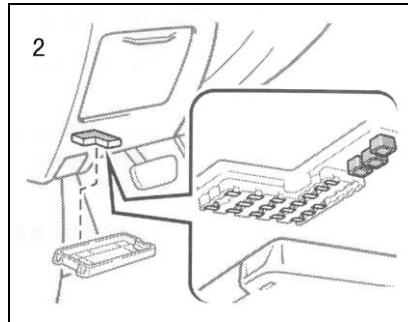

## Precautions for Self-Maintenance

**If you perform maintenance by yourself, please follow the procedure specified in this chapter.**

Please note that incorrect or incomplete maintenance will cause operation problem.

This chapter only gives a description for simple maintenance which you can perform by yourself. As stated in Chapter 6, some maintenance item must be performed by a qualified technician with dedicated tools.

Please take extra care when performing in order to prevent injury accident. Please follow these precautions which require extra attention.



### FRIENDLY TIPS

- While the engine is running, please keep your hands, clothes and tools away from fan and transmission belt of the engine in operation. (It is better to take off your ring, watch or necktie.)
- When a car has just completed travelling, the temperature of its engine compartment is very high, including the engine, radiator, exhaust pipe, power steering fluid reservoir and spark plug cover. Please take care and do not touch it. The temperature of the engine oil, liquid and spark plug is also very high.
- If the engine temperature is high, do not remove radiator cap or loosen discharging plug to avoid scorching.
- Do not leave paper, cloth or anything inflammable in the engine compartment.
- Before working on electric the cooling fan or radiator guard, please confirm that the ignition switch is turned off. When turning on the ignition switch, if

- the engine cooling fluid temperature rises and/or the air conditioner is turned on, the electric the cooling fan of the engine will start running automatically.
- Do not smoke a cigarette near the fuel tank or the storage battery in order to avoid spark or flame, which might cause fire.
  - When handling the battery, be sure to be particularly careful because the battery contains sulfuric acid (electrolyte) which is highly poisonous and corrosive.
  - When the car is jacked up only by the body jack, no people is permitted to stay under the car. Be sure to support the car with a motorcar jack or other firm strut.
  - Whether you work on or under a car, be sure to wear a pair of goggle to prevent yourself from the dropping or falling objects and splashing liquid.
  - Used the engine oil contains potential pollutant, which might cause skin inflammation or skin cancer. Please take care not to

- contact these types of the engine oil for a long time or frequently. Please use soap and clean water to clean used the engine oil stained on your skin.
- Do not put away the engine oil in a place which is within the reach of a child.
  - Use - a - safe - and environment-friendly method to handle used the engine oil and filter. Do not dispose used the engine oil and filter together with household garbage, into sewer or onto ground. For recycle or disposal method, please consult BYD authorized service station.
  - As braking fluid might damage your eye and paint surface, please take care when filling braking fluid. If the fluid splashes into your eyes, please wash your eyes with clean water immediately. If your eyes still feel uncomfortable, please go to the hospital for examination.

### NOTES

- Please note that the storage battery and ignition oil have strong current or high voltage. Please take care of short circuit caused by an accident.
- If cooling fluid flows over, please wash it off with water in order not to damage parts or paint surface.
- Do not have dirty objects or other objects fall into spark plug orifice.
- Do not lift the external electrode of spark plug on the central electrode side.
- You can only use spark plug of specified type. Other types of spark plug might damage the engine, lose performance or generate radio interference.
- Do not fill too much power steering fluid. The power steering fluid level should be between MIN and MAX.
- If braking fluid flows over, please wash it off with water in order not to damage parts or paint surface.
- Do not drive the car while the air filter is removed. Otherwise, the

engine might be worn excessively and backfire might cause fire in the engine compartment.

- Please take care not to scrape glass surface with the wiper.
- When closing the engine hood, check whether there is any tool, cloth or other object left in the engine compartment.

### Positioning of the Jack

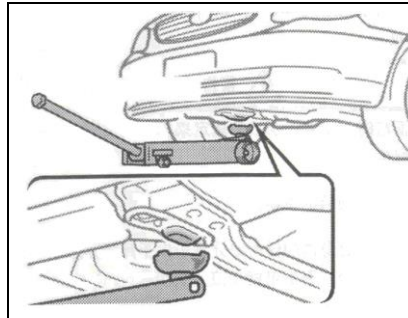

### Front

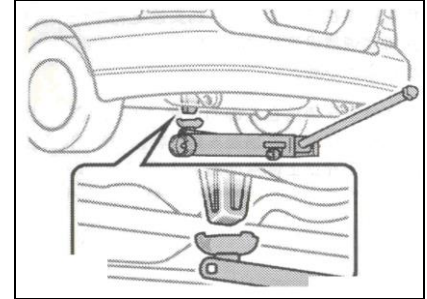

### Rear

To lift a car with jack, please place the jack at a proper position.

### FRIENDLY TIPS

While lifting it up, please observe the following regulation to reduce injury risk.

- Do not inhale waste gas exhausted from the engine. Waste gas contains carbon monoxide, which is a colorless and odorless gas. It might cause consciousness loss and even death.



- Do not place any part of your body under the car lifted by the jack. Otherwise, it might cause injury.
- While the car is lifted by a jack, do not start or operate the engine.
- Please park the car on a flat ground and confirm that the parking control mechanism is pulled up. If necessary, please baffle the wheel on the opposite side of the lifting point.
- Be sure to place the jack at a proper lifting point. Improper position of the jack might damage the car. If the car falls off the jack, it might cause injury.
- When the car is supported by jack only, do not crawl under the car. Please use car supporting bracket.
- Do not lift the car while someone stays in the car.
- While raising the car, do not place anything on or under the jack.

**NOTES**

**Be sure to place the jack properly. Otherwise, it might damage the car.**



## Chapter 7

### Section 2

#### Self-Maintenance Engine and Chassis

Check the Engine Oil Level.....	7-8
Check the Fluid Level of the Transmission .....	7-10
Check the Engine Coolant Level.....	7-11
Check Radiator and Condenser.....	7-12
Check Tire Pressure .....	7-12
Check and Replace Tire.....	7-13
Replace Tire.....	7-14
Exchange Tire.....	7-15
Notes on Aluminum Tire.....	7-16

### Check the Engine Oil Level

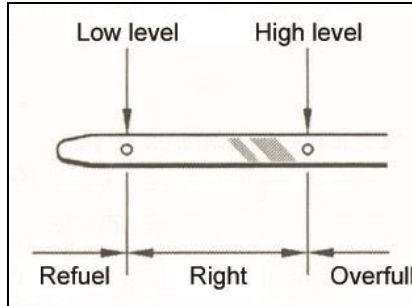

**While the engine is in working temperature, please turn off the engine and check oil level with oil dip rod.**

1. In order to obtain a correct reading, please park your car on flat ground. Please wait for a few minutes after turning off the engine until the engine oil collects at the bottom of the engine.
2. Pull out oil Dipstick and place a piece of cloth at its end and clean it.
3. Insert Oil Dipstick again. Please insert it to the end. Otherwise, the indication is not accurate.

4. Pull out oil Dipstick and place a piece of cloth at its end and check oil level.

#### NOTES

**Do not dip the engine oil onto the vehicle parts.**

**If oil level is lower or slightly higher than low oil level, please fill the engine oil of the same type into the engine.**

Remove the engine oil cap, fill small quantity of the engine oil every time and check oil dip rod. It is recommended that you use funnel to fill the engine oil.

The appropriate quantity of required the engine oil is between low level and high level for reference.

When oil level reaches normal scope, please install filling cap and fasten it manually.

#### NOTES

- Do not dip the engine oil onto the vehicle parts.
- Do not add too much fuel. Otherwise, the engine might be damaged.
- After adding fuel, please check oil level on oil Dipstick again.

#### Selection of the engine oil

Please use lubricant approved by BYD authorized service station or the equivalent in compliance with the following class and viscosity.

Class of gasoline the engine oil:

SAE 5W—30 above -30 °C

SAE 15W—40 above -15 °C

API class, SG level or above.

Quantity: 3L

**Recommended the engine oil viscosity (SAE):**

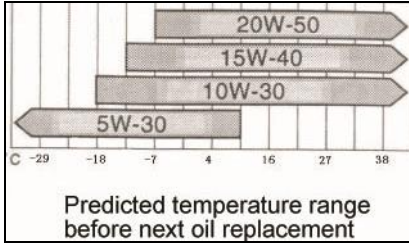

If the engine oil of SAE 10W-30 or higher viscosity in very cold weather, it is difficult to start the engine. Therefore, it is recommended to use SAE 5W-30 the engine oil.

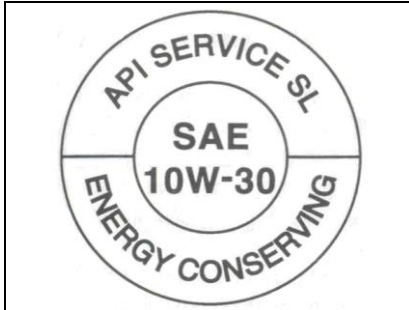

### API classification mark



### ILSAC certificate mark

### Engine oil identification mark

There is one or two API registration marks on some oil containers for reference of oil selection.

API classification mark might be attached at any place of the container.

The upper part of the label shows the engine oil quality specified by API (American Petroleum Institute), such as

SL. The middle part of the label is SAE viscosity class, such as SAE 10W-30." Energy-Conserving" shown at the lower part indicates that the engine oil saves oil.

Certificate mark of ILSAC (International Lubricant Standardization and Approval Committee) is attached in the front of the container.



## Check the Fluid Level of the Transmission

### Manual transmission

How to check BYD5T-14 transmission oil level

When the transmission is at 80 °C which is a normal operation temperature, park your car on horizontal ground and check transmission oil level. Remove the bolt at the filling inlet of transmission oil (filling orifice and oil level examination orifice in the following figure) and touch oil level in the bolt orifice with your finger. At this time, oil level should reach the edge of bolt orifice. Otherwise, please add BYD manufactured manual transmission fuel (MTF) until it flows over the filling inlet. Then, put the filling inlet bolt back and tighten it.

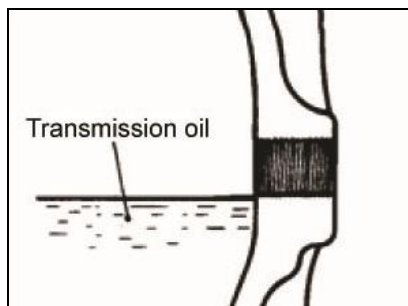
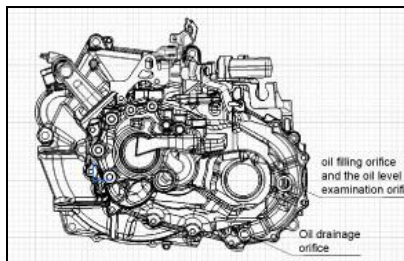

Gear oil level

If BYD manufactured MTF (manual transmission fuel) is not available, API approved gear oil is recommended as a substitute. For a specific type, please refer to maintenance manual or contact BYD authorized service station.

Please replace transmission fuel in accordance with driving time and distance specified in the maintenance table. Now, discharge all fuel in the transmission and add new transmission fuel again.

If you are not aware how to check oil level and add oil, please contact BYD authorized service station.

Please note that gear oil should not contain water. Otherwise, it might rust transmission parts.

### Check the Engine Coolant Level

**While the engine is cooled, check the transparent coolant overflow kettle. If the coolant level in the overflow kettle is between “MAX” and “MIN” mark lines, it meets requirement. If the fluid level is low, please add coolant. (For coolant type, please refer to the following “coolant type selection”).**

Coolant level in the overflow kettle varies with the engine temperature.



However, if the fluid level is at or below “**MIN**”, please add coolant. Make the liquid fluid to reach “**MAX**” line.

If the coolant level drops within a short time after adding coolant, the system might leak. Please check radiator, hose, radiator cap, discharging plug and pump visually.

If no leakage is found, please contact BYD authorized service station to test cap pressure and check whether there is leakage in the cooling system.

#### FRIENDLY TIPS

**In order to prevent scorching injury, do not try to remove the radiator cap while the engine is hot.**

#### Selection of coolant type

Please use coolant specified by BYD authorized service station only. Please select proper coolant type to inject into cooling system in accordance with environment temperature.

Use of improper coolant might damage cooling system of the engine.

#### NOTES

**Do not use excessive quantity of water, as excessive quantity of water might damage cooling system of the engine in winter.**

For detailed description, please contact BYD authorized service station.

#### Check Radiator and Condenser

If any of the above stated parts is dirty or its condition is unclear, please contact BYD authorized service station.

#### FRIENDLY TIPS

**In order to prevent scorching injury, do not touch radiator or condenser while the engine is hot.**

#### NOTES

**In order to prevent damage of radiator and condenser, do not operate by yourself.**

#### Check Tire Pressure

**Keep proper tire pressure.**

For recommended cold tire pressure and tire size, please refer to Chapter 8.

Check tire pressure once every two weeks or every month. Please remember to check air pressure of spare tire.

Improper tire pressure will consume oil, reduce driving comfort, shorten service life of tire and affect driving safety.

If a tire requires frequent inflation, please contact BYD authorized service station for examination.

### FRIENDLY TIPS

Keep proper tire pressure. Otherwise, it might cause the following cases and severe injury.

Low tire pressure (insufficient inflation)

- Excessive wearing
- Improper wearing
- Difficult to control
- Air leakage caused by overheating tire
- Weakened sealing performance of tire edge
- Tire deformation and/ or tire separation

High tire pressure (excessive inflation)

- Difficult to control
- Excessive wearing of tire pattern center
- Hard part of road is likely to cause tire damage

When examining tire pressure, please observe the following instruction.

- **Check Tire Pressure Only When the Tire is Cold.** If the car has remained still for three hours or has

travelled for less than 1.5 km, you can get correct cold tire pressure the indication.

- **Please Use Tire Pressure Gauge.** Judgment of tire pressure in accordance with experience might be incorrect. Additionally, even difference of a few pounds might affect comfort and control.
- **Do Not Discharge the Tire or Reduce Tire Pressure after Driving.** It is normal that tire pressure is high after driving.
- **Confirm that the Tire Air Valve Cap is Installed.** If air valve cap is not installed, dust or dampness might enter the air valve core and cause leakage. If the air valve cap is lost, please use a new one.

### Check and Replace Tire

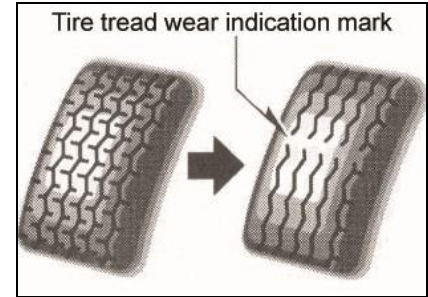

### Check Tire

**Check tire tread with tire wearing the indication mark. If the indicator mark is visible, please replace the tire.**

BYD L3 tire is has a tire tread wearing the indication mark inside to show when it is necessary to replace tire. When tire tread depth is worn to 1.6 mm or less, the wearing the indication mark will appear. When wearing the indication mark appears on two or more neighboring pattern grooves, please replace the tire. The thinner a tire tread is, the higher the skid risk is.



**If the tire tread is worn to less than 4 mm, the snow tire function will be lost.**

**In the case of tire damage such as cutting, rupture, deep crackle or expansion which exposes cord fabric, it indicates inside damage of the tire. Please replace the tire.**

If a tire often leaks air or cannot be repaired due to size and position of cutting or other damage, please replace the tire. If it cannot be determined, please contact BYD authorized service station.

If air leakage occurs, do not continue driving. Even a short distance of travel might cause un-repairable damage to the tire.

**Any tire of six years old or above should be checked by a qualified technician, even if there is no obvious damage.**

Even if a tire is not used or not frequently used, ageing might cause degradation.

It is also suitable for spare tire and stored tire.

### Replace Tire

**To replace a tire, please use another one with same size and structure, which has bearing capability equal to or more than old one.**

Any tire of different size or type might severely affect setting of driving, riding, speedometer/odometer, distance from ground and distance between car body and tire or tire chain.

#### FRIENDLY TIPS

**Please observe the following instructions. Otherwise, it might cause severe injury.**

- **Do not use radial tire, belt oblique line tire or oblique pattern cord fabric tire together. Otherwise, it might cause typical operation risk and cause the car out of control.**
- **Do not use tire other than that is recommended by the manufacturer. Otherwise, it might**

**cause typical operation risk and cause the car out of control.**

**Never Use an Old Tire on a BYD L3 Car.**

It is dangerous to use a tire with unclear history.

**It is recommended to replace four wheels at the same time or at least the two the front wheels or the two rear wheels.**

For tire replacement procedure, please refer to Chapter 4 "if tire leaks".

**After replacing a tire, please keep the tire balanced.**

Unbalanced tire might affect car operation and service life of a tire. Wheel in the normal operation might also lose balance. Please conduct irregular examination to keep the wheel balanced.

## Exchange Tire

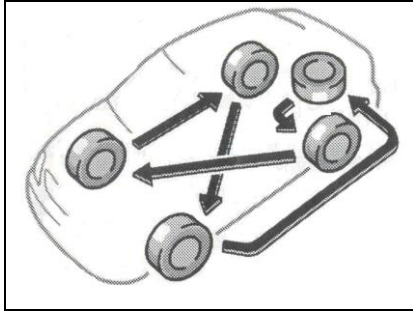

In order to keep tire wearing to the same extent and lengthen service life of a tire, it is recommended to replace tire every 10,000 km. However, the most appropriate time for tire replacement depends on a driver's daily driving habit and road condition.

When replacing a tire, please check whether there is unbalanced wearing or damage. Incorrect tire pressure, improper tire alignment, unbalanced wheel or frequent braking might cause abnormal wearing of a tire.

## Selection of Tire Chain

Use tire chain with correct size.

Application rule of tire chain varies with driving place or road type. Therefore, please confirm local rules before installing wheel chain.

### Installation of tire chain

Install tire chain on the front wheel very tightly. Do not use the tire chain on rear wheel. Please tighten tire chain again after driving for 0.5-1.0 km.

When installing tire chain on wheel, please follow instruction provided by the tire chain the manufacturer.

If wheel cover is in use, it might be scraped by tire chain. Therefore, please remove wheel cover before installing tire chain.

## FRIENDLY TIPS

- Travel speed should not exceed 50 km/h or the lower speed in limit speed scope specified by the tire chain the manufacturer.
- Please drive carefully and look out for protruding object, cavity and sharp turn, which might cause the car to jump.
- When using tire chain, please avoid sharp turn or wheel skid braking. Otherwise, it might inflict unfavorable effect on the car.
- While driving a car equipped with tire chain, please take care. Before turning, please decelerate to avoid losing control of the car. Otherwise, it might cause an accident.

## Exchange Tire

### When replacing a tire

If a tire bends, cracks or is damaged by severe corrosion, it must be replaced.

If you do not replace a damaged tire, the tire might come off the wheel and the car might get out of control.

Wheel selection

**When replacing wheel, please use a new wheel with same load capacity, diameter, wheel width and offset as the older one.**

BYD authorized service station can replace wheel correctly.

A wheel with different size or type might inflict unfavorable effect on operation, service life of wheel and bearing, cooling of brake, speedometer/odometer setting, braking performance, headlight accuracy, bumper height, distance from the ground, distance between tire or tire chain and car body or chassis.

Do not replace with an old tire. The old tire might have been disposed or have run for a long way and fault might occur without any sign. Likewise, the aligned bent wheel has damaged structure. Therefore, do not use it. Do not use an inner tube designed for a tubeless tire in

a leaking wheel.

#### FRIENDLY TIPS

**As it might cause a typical operation risk and the car out of control, please do not use a tire other than that with size recommended by the manufacturer. Otherwise, it might cause death or severe injury.**

#### Notes on Aluminum Tire

- For a car equipped with aluminum wheel, please check to make sure the wheel nut is tightened within the initial 1600 km.
- If a tire is exchanged, repaired or replaced, please check to make sure the wheel nut is tightened after driving for 1600 km.
- While using tire chain, take care not to damage the aluminum wheel.
- Please use BYD wheel bolt and spanner designed for aluminum wheel only.

- When adjusting wheel balance with tire chain, please use BYD balance block and plastic hammer or rubber hammer only.
- Just as with any other the vehicles, please check to make sure the aluminum wheel is not damaged. In the case of damage, please replace immediately.





# Chapter 7

## Section 3

---

### Self-Maintenance

#### Electrical Appliance Parts

Check the Battery Status .....	7-18
Check and Replace Fuse.....	7-19
Add Cleanser .....	7-21
Replace Bulb .....	7-21

## Check the Battery Status

### Notes

#### FRIENDLY TIPS

##### Notes on the storage battery

The storage battery generates inflammable and explosive hydrogen.

- While using a tool, do not produce spark on the storage battery.
- Do not smoke a cigarette or light a match near the storage battery.

Electrolyte contains toxic and corrosive sulfuric acid.

- Do not contact your eyes skin or clothe with electrolyte.
- Do not drink electrolyte by accident.
- When working near the storage battery, please wear safety goggle.
- Please keep the children away from the storage battery.

#### EMERGENT MEASURES

- If electrolyte enters eyes by accident, please wash it with clean water immediately and go to hospital. If it is possible, please wash the stained part with sponge or clean cloth wetted with clean water while going to hospital.
- If electrolyte splashes on skin, please wash it off thoroughly. If you feel ache or scorched, please receive medical treatment immediately.
- If electrolyte splashes on clothes, it might penetrate clothes to skin. Therefore, please take off your clothes immediately. Please handle the situation as stated above if necessary.
- If someone drinks electrolyte by accident, he should drink large quantity of clean water or milk. He should also drink milk containing magnesium oxide, stirred raw egg or plant oil. Then he should seek medical treatment immediately.

## Check the storage battery outside

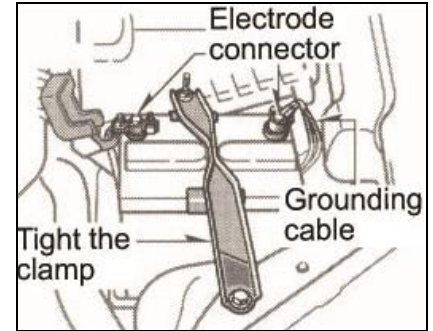

**Check whether there is corrosion, loosened connector, flaw or loosened pressing tool.**

1. If the storage battery has been corroded, please use mixture of warm water and baking soda to clean it. Apply lubricant on connector outside to prevent further corrosion.
2. If the connector is loosened, please tighten clamp bolt. However, do not tighten it excessively.



c. Tighten the pressing tool to an extent where the storage battery can be fixed. Excessive tightening might damage the storage battery box.

#### NOTES

- Before maintenance, please confirm that the engine and accessory equipment are turned off.
- When examining the storage battery, please remove grounding cable off negative connector (with “-” mark) and reinstall it again at last.
- Take care not to cause short circuit when using a tool.
- When washing the storage battery, do not have the fluid enter the storage battery.

#### Check the storage battery inside

Understand inside status of the storage battery in accordance with description on the crust of the storage battery and the storage battery indicator.

#### NOTES

- **Charging the storage battery without disconnecting cable might severely damage electronic control unit and electric device of the car. Please remove the storage battery cable before connecting the storage battery to charger.**
- If electric device of the car is used for a long time while the engine is off, the storage battery might discharge excessive electricity. Consequently, the car might not be able to start and the storage battery might be damaged permanently.
- Do not use electric device for a long time while the engine is off, for example audio system, light system.
- When you leave the car, please make sure that the car door is locked and all electric devices are turned off (such as light).

#### FRIENDLY TIPS

When electrolyte of the storage battery is not enough, please replace the storage battery instead of adding electrolyte by yourself.

#### Check and Replace Fuse

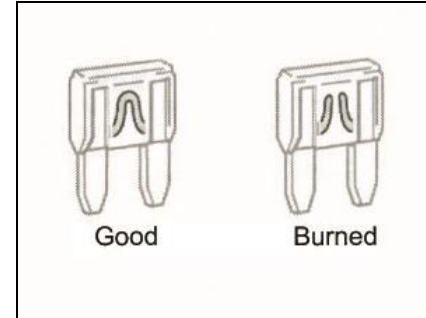

### A type

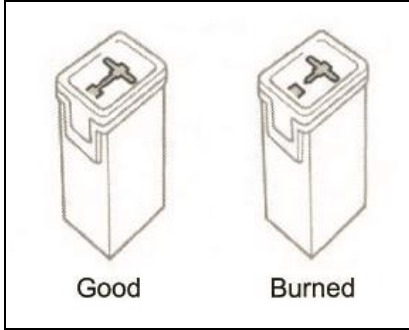

### B type

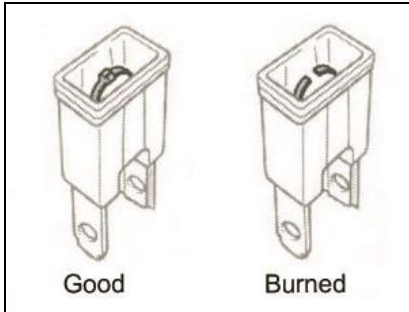

### C type

**If headlight or other electric parts do not work, please check fuse. If fuse is burned, please replace it.**

Fuse layout, Refer to Chapter 7-1 "Fuse layout".

**Turn off ignition switch and parts that do not work. Pull out the fuse in question vertically for examination.**

Determine which fuse is out of order. Circuit name of each fuse is marked on fuse box cover. For control function of each circuit, please refer to chapter 8 in the manual.

Use a pulling tool to pull out the fuse of type A. For position of pulling tool, refer to 19 "piece puller" in figure "engine compartment" in Chapter 8.

If it can not be determined whether fuse has been burned, please replace the fuse in question with a better fuse.

**If fuse has been burned, please insert new fuse into the socket.**

Please install the fuse with amperage specified on fuse box cover.

If no spare fuse is available, In the case of emergency, please pull out the fuse of "29. In-car lamp" which is dispensable during ordinary driving and replace with it, if it has the same rated amperage.

If no fuse with the same amperage is available, please use fuse with lower amperage and try to reach the rated amperage. If a fuse with amperage lower than specified value is used, it might be burned again, but this does not mean any problem. Please replace with correct fuse as soon as possible and insert it into the socket.

It is recommended to purchase a set of spare fuse and store it in the car for use in emergency.

If newly replaced fuse is burned soon, it indicates that electric system might have a trouble. Please contact BYD authorized service station for examination and repair.

### FRIENDLY TIPS

Never use fuse whose amperage is higher than rated value or anything else. Otherwise, it might cause severe damage and cause fire.

#### Add Cleanser

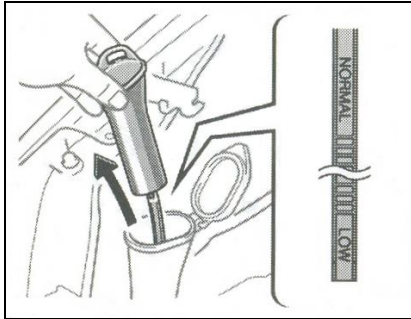

If a cleaner does not work, it could be because that the cleaner overflow kettle might have become empty. Please check cleaning mixture level on level gauge. If cleanser level is lower than “LOW”, please add cleanser.

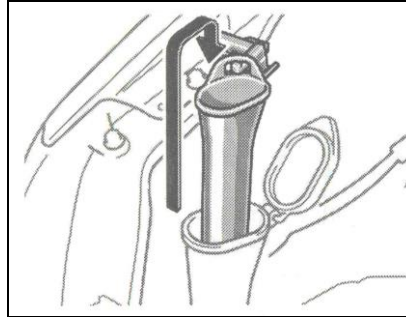

#### Before adding cleanser

**Pull out the cleanser funnel and hang it on support holder of the engine hood.**

Clean water may serve as cleanser. However, in a cold area, when temperature is below 0 degree of centigrade, please use cleanser containing anti-freezing agent. The product is available in BYD authorized service station and most automobile parts shop. Refer to the manufacturer instruction for mixture ratio of water.

After adding cleanser into overflow kettle, please put funnel back to its original position.

### NOTES

**Do not use the engine anti-freezing agent or other substitute. Otherwise, it might damage paint layer of the car.**

#### Replace Bulb

The following diagram shows how to remove a bulb. When replacing a bulb, please confirm that ignition switch and lamp switch are in OFF status. Use a bulb with the same rated power as that in the following table.

### NOTES

**Only the bulbs specified in the following table can be used.**

Top-mount stop light, tail stop light and rear lamp are using LED. If the number of burned LED goes against related local regulation, please contact BYD authorized service station for bulb replacement.

**FRIENDLY TIPS**

- In order to prevent scald, do not replace a bulb while it is hot.
- As halogen lamp has pressurized gas inside, please take great care. If a bulb is scraped or falls down, it might explode or crack. Please hold plastic part or metal box of the bulb. Do not touch glass part of the bulb.

When the car travels in a rainy day or its rear lamp cover is dampened after washing the car, lamp shade of headlight or other external lamps might fog temporarily. Just as a windshield glass fogs in a rainy day, the fogging phenomenon is caused by temperature difference between inside and outside of lampshade, which is not a malfunction. However, if there is large water drops inside the lampshade or there is accumulated inside the lamp, please contact BYD authorized service station.

Voltage: 12V

Bulb	W	Type	Over-current (A)
Headlight (high beam)	55	H7	4.58
Headlight (low beam)	60	HB3	5
The front fog light	55	H11	4.58
The front the turn signal light	21	PY21 W	1.75
Side the turn signal light	5	W5W	0.41
Rear the turn signal light	21	PY21 W	1.75
Backup light	16	W16W	1.3
Rear fog light	21	W21W	1.75
Top-mount stop light	16	W16W	1.3
Number plate lamp	5	W5W	0.41
Door lamp	5	W5W	0.41
The front in-car lamp	5	R5W	0.41

Rear in-car lamp	10	C10W	0.83
The trunk lamp	5	W5W	0.41
The front position lamp	5	W5W	0.41
Rear position lamp	0.4	LED	0.03
Stop light	4	LED	0.33

**Head Light**

(Low beam — high beam)

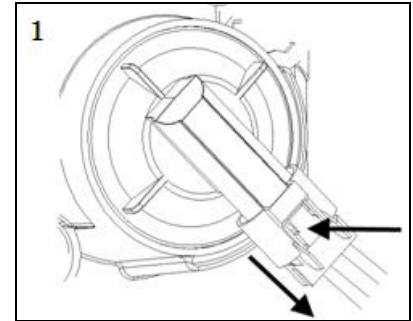

1. Press the tongue reed and pull off the Headlight connector as shown in the figure.

If the connector is tight, please shake it.

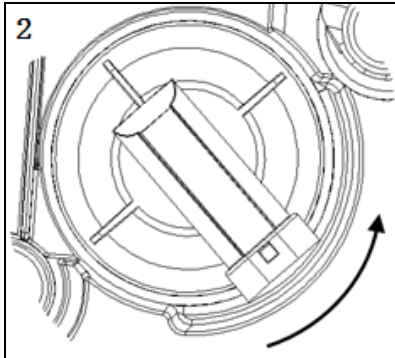

2. Rotate dust cover clockwise and remove it.

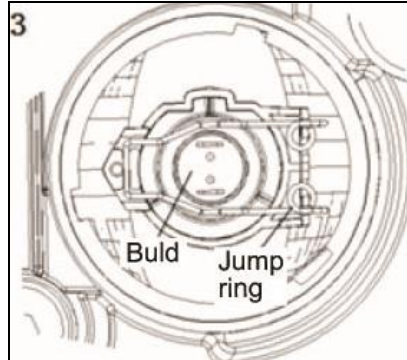

3. Pull out ground wire and power line (if they are fixed tightly, please shake them). Then, press and pull out the jump ring and take out the bulb.

4. Replace the bulb.

Installation procedure is reverse to removal procedure.

After replacing a bulb, it is unnecessary to modulate light again. If it is necessary to modulate light again, please contact BYD authorized service station.

### Higher Beam Headlight

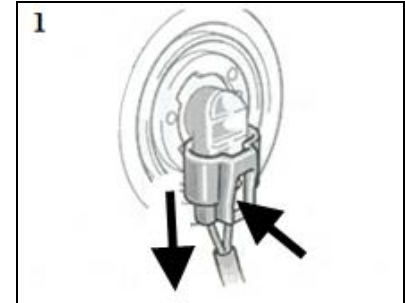

1. Press the tongue reed and pull off the Headlight connector as shown in the figure.

If the connector is tight, please shake it.

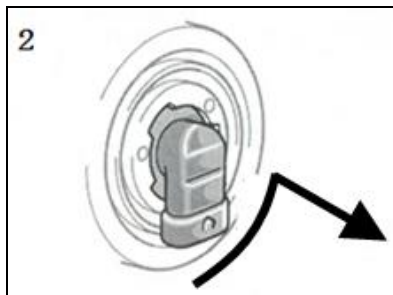

2. Rotate the bulb counterclockwise and remove it.
3. Replace the bulb.

Installation procedure is reverse to removal procedure.

After replacing a bulb, it is unnecessary to modulate light again. If it is necessary to modulate light again, please contact BYD authorized service station.

### The Front the Turn Signal Light

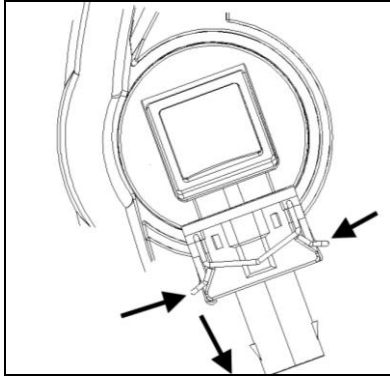

1. Please press clips on both sides while removing direction indicator connector as shown in the figure.

If the connector is tight, please shake it.

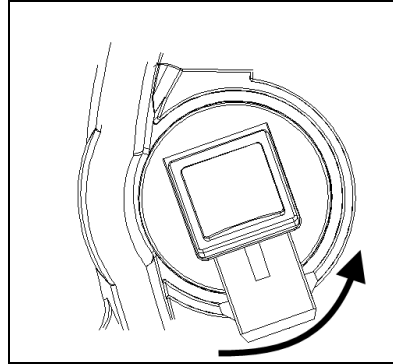

2. Rotate the lamp stand counterclockwise and remove it.

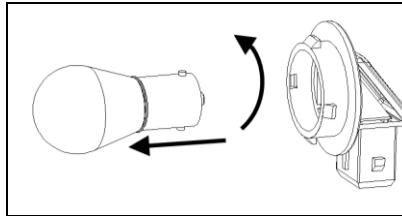

Press the bulb inward and rotate it clockwise to remove it from lamp stand and replace bulb.

### The Front Fog Light

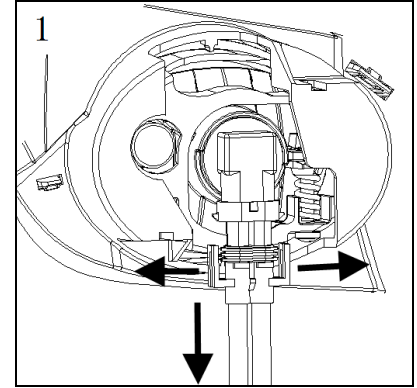

1. Pull the clips on both sides wards and pull down the fog lamp connector.

If the connector is tight, please shake it.

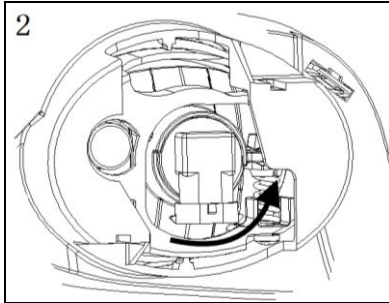

2. Rotate the bulb counterclockwise and remove it.

3. Replace the bulb.

Installation procedure is reverse to removal procedure.

After replacing a bulb, it is unnecessary to modulate light again. If it is necessary to modulate light again, please contact BYD authorized service station.

### Side the Turn Signal Light

The side the turn signal light is of integrated type. If it is necessary to replace bulb, please replace the side the turn signal light as a whole.

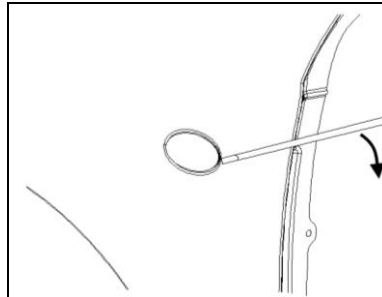

1. Use a straight screw the driver to lift one side of the side the turn signal light.

Please wrap a layer of cotton cloth around the straight screw the driver so as not to scrape object surface.

### Rear Fog Light

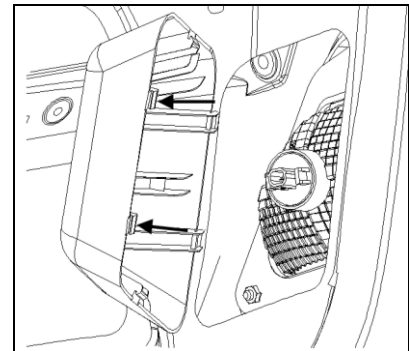
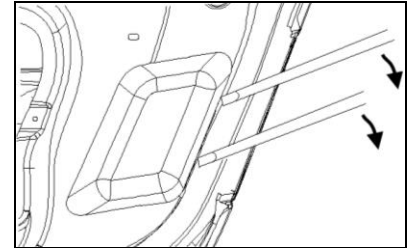

1. Use a straight screw the driver to lift the cover.



Please wrap a layer of cotton cloth around the straight screw the driver so as not to scrape object surface.

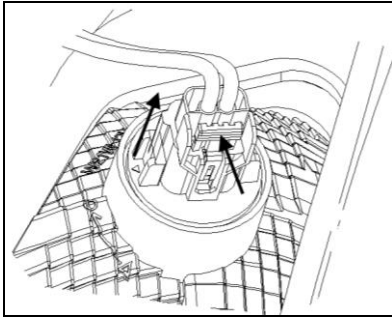

2. Press the tongue reed and pull down the Headlight connector.

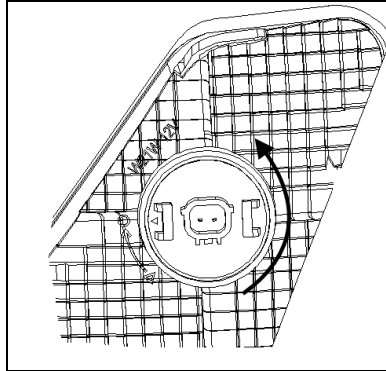

3. Rotate the lamp stand and pull it outward to remove the lamp stand.

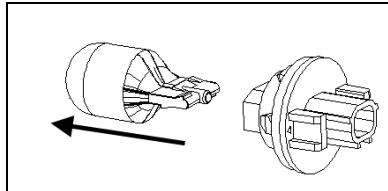

4. Rotate the bulb and pull it outward to remove the bulb.

Installation procedure is reverse to removal procedure.

### Assemble Rear Lamp

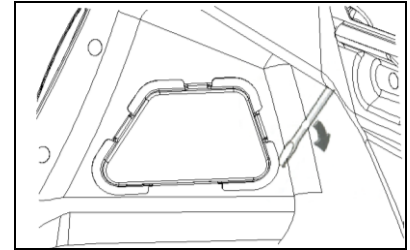

Rear the turn signal light and fog lamp bulb are replaced in the same procedure as backup light.

Installation procedure is reverse to removal procedure.

### Top-mount Stop Light

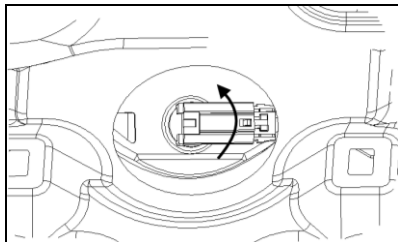

1. Rotate the lamp stand of top-mount stop light counterclockwise and pull it out through the round hole on rear rack.

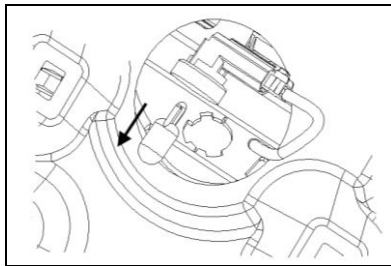

2. Pull the bulb out of the bulb stand to replace it. If it is inconvenient, please pull off the connector too.

### Number Plate Lamp

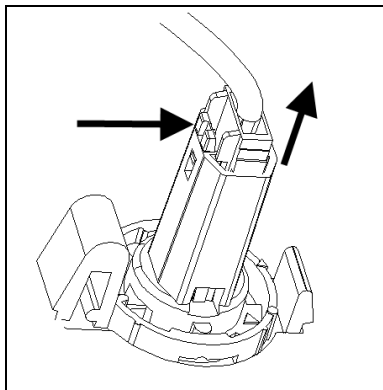

1. Press the tongue reed and pull off the number plate connector as shown in the figure.

If the connector is tight, please shake it.

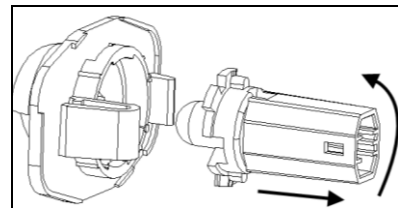

2. Rotate the lamp stand counterclockwise and pull out the lamp stand backward.

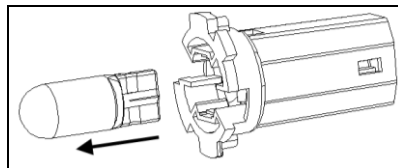

3. Pull the bulb out of the bulb stand to replace it.

## The Trunk Lamp

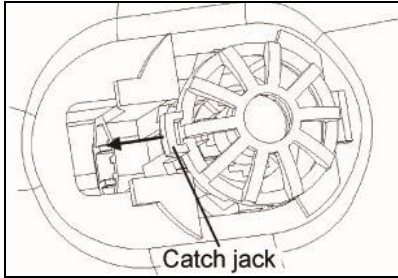

1. Pull the jack catch in the direction shown in the figure to open the lampshade.

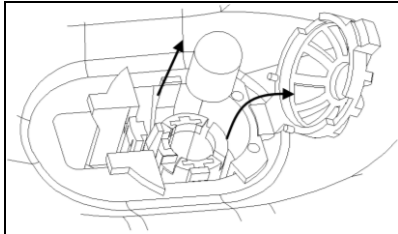

2. Pull the bulb out of the bulb stand to replace it as shown in the figure.





---

## Chapter 8

### Specification of Parts

Maintenance Specification .....	8-2
Fuse and Relay.....	8-3



## Maintenance Specification

### Engine lubrication

Class of gasoline the engine oil:

SAE 5W—30      above -30 °C

SAE 15W—40    above -15 °C

API class, SG level or above.

Quantity: 3L

Specification of gear oil used for manual transmission:

75W—90       $\geq -30^{\circ}\text{C}$

80W—90       $\geq -15^{\circ}\text{C}$

API class, GL-4 level or above

Quantity: (DABS15-41 series): 2.1 L

(BYD5T-14 series): 1.6 L

Specifications of DCT transmission oil:

MTF 95+EP+FM/ Castrol G 052 171

Volume: 1.7L

### Cooling system

Total capacity: L

6.8L

Tire size

195/60 R15

Tire pressure, KPa (kg/cm<sup>2</sup>)

210(2.1)

Wheel bolt torque, N·m (kgf·m)

103(10.5)

## Fuse and Relay

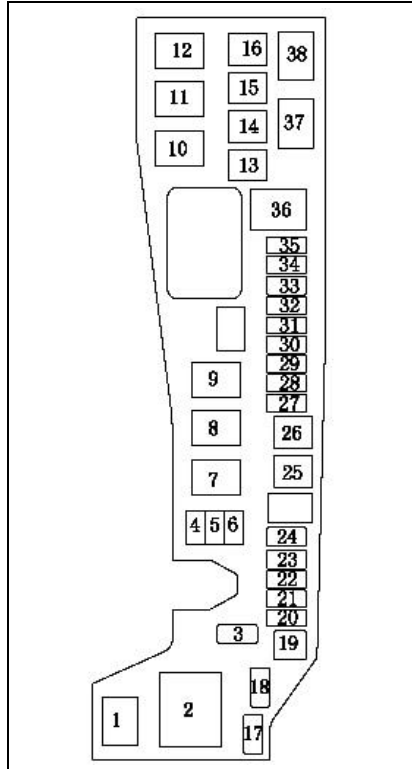

## Engine compartment

### Relay:

1. A/C electromagnetic clutch
2. Headlight
7. No.3 fan
8. IG2 relay
9. Claxon
10. No.3 fan
11. ACC relay
12. No.3 fan
37. Stop light
38. Main relay of electronic ejection

### Fuse:

3. Spare fuse (10A)
4. Spare fuse (15A)

5. Spare fuse (20A)
6. Spare fuse (25A)
13. Void space
14. Electronic fan (30A)
15. ABS (25A)
16. ABS(60A)
- 16.ABS(40A)
17. Spare fuse (30A)
18. Spare fuse (7.5A)
19. Piece puller
20. The front left higher beam (10A)
21. The front right higher beam (10A)
22. The front right low beam (10A)
23. The front left low beam (10A)
24. Blank
25. Void space



- 26. Headlight fuse (40A)
- 27. BCM(25A)
- 28. Electronic injection (15A)-MT20U/2 or (30A)-M7.9.7.1
- 29. In-car lamp (15A)
- 30. Ignition switch No.2 power supply (30A)
- 31. Keyless(5A)
- 32. Claxon (10A)
- 33. Warning lamp (10A)
- 34. Transmission motor power-supply module TCU (30A)
- 35. Generator (5A)
- 36. Main power supply (100A)

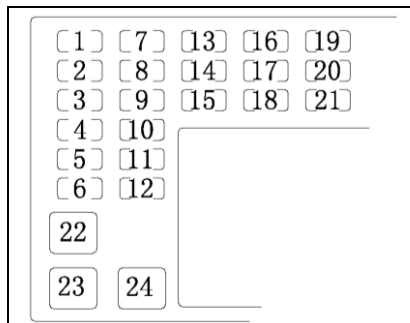

**Instrument panel**

Fuse

- 1. ABS system (10A)
- 2. SRS system (15A)
- 3. Instrument (10A)
- 4. EFI constant current(15A)
- 5. Fuel pump (15A)
- 6. Luggage compartment lock (10A)
- 7. In-car diagnosis system (7.5A)
- 8. Windscreen wiper (20A)

- 9. Clearance lamp (15A)
- 10. Stop light (15A)
- 11. Car door (25A)
- 12. No.2 door window power supply (30A)
- 13. No.1 ignition switch power supply (25A)
- 14. The front fog light (15A)
- 15. Rear fog light (10A)
- 16. Starting power (7.5A)
- 17. Air conditioner (10A)
- 18. EFI System (15A)
- 19. Void space
- 20. Headlight control system (5A)
- 21. Cigarette lighter (15A)
- 22. Warm wind (40A)
- 23. Rear window defroster (30A)
- 24. No.2 door window power supply (30A)