



Roadtrek™®

The Motorhome that...
Drives like an SUV!™®



210 Chevrolet Models Owner's Manual

Including
Limited Warranty Information



WARNINGS AND CAUTIONS

This manual contains **WARNINGS** against operating procedures which could result in an accident or bodily injury.

The manual also contains **CAUTIONS** against procedures which could result in damage to your vehicle.

If you do not read the entire manual you may miss important information. Observe all Warnings & Cautions.

WARNINGS:

SEAT BELTS:

Only forward facing seats equipped with factory installed seat belts are to be occupied while the vehicle is in motion. All passengers must be seated in these seats only, with the seat belts fastened while the vehicle is in motion.

TV:

The flat screen TV should not be stored inside the Roadtrek in temperatures below -4°F (-20°C) to reduce the chance of damage from the cold. The operating temperature of the monitor is recommended between 50°F and 104°F (10°C and 40°C) with a humidity range of 10% to 80%, non condensing.

If your vehicle is equipped with an optional flat screen TV, the TV must be off and in the stored position during travel.

LPG:

L.P.G. tanks shall not be placed or stored inside your vehicle. L.P.G. tanks are equipped with safety devices which relieve excessive pressure by discharging gas to the atmosphere.

To reduce the danger of fire or explosion do not store gasoline or other flammable liquids inside your vehicle. Ensure you purchase L.P.G. From a reputable L.P.G. facility. Contaminated L.P.G. is common cause of system failure.

Do not refuel the L.P.G. tank to more than 80% of its capacity.

The L.P.G. tank valve must be closed and ALL PILOT LIGHTS, APPLIANCES, AND THEIR IGNITERS (see Operating Instructions) SHALL BE TURNED OFF during refueling of motor fuel tank and/or the L.P.G. tank. Only qualified personnel should refuel your L.P.G. tank.

APPLIANCES:

It is not safe to use cooking appliances for space heating purposes due to the danger of asphyxiation.

The L.P.G. Stove needs fresh air for its safe operation.

Portable fuel burning equipment, including wood or charcoal grills and stoves, should not be used inside your vehicle. Use of this type of equipment inside your vehicle may cause fire or asphyxiation.

L.P.G. LEAK DETECTOR:

Do not block air circulation in the area where the L.P.G. Leak Detector is located.

Battery disconnect switch must be in the "ON" position for the L.P.G. detector to function.

CARBON MONOXIDE LEAK DETECTOR:

Do not block air circulation in the area where the carbon monoxide leak detector is located.

Battery disconnect switch must be in the "ON" position for the Carbon Monoxide Leak Detector to function.

110 VOLT ELECTRICAL SERVICING:

Prior to servicing the 110 volt Galley GFCI & Audio/Video cabinet interior receptacles, unplug the output lead from the power inverter.

EXTERIOR ACCESS DOORS:

Ensure power cord and city water line are disconnected and in their stored positions before vehicle is put in motion.

CAUTIONS:

CLOVERLEAF DINING TABLE:

Cloverleaf dining table is heavy, lift while bending knees.

EXTRA COUNTER SPACE:

Make sure the stove is off and has cooled prior to lowering the stove cover.

TV:

When the vehicle is in motion it is recommended that the TV be "OFF" and in the stored position. The thumb tab should be in place to secure the TV in the stored position.

The flat screen TV (option TF) should not be stored inside the Roadtrek in temperatures below -4°F (-20°C). The operating temperature of the monitor is recommended between 50°F & 104°F (10°C – 40°C) with a humidity range of 10%-80%, non condensing.

To remove the T/V, remove the four mounting bolts on the back of the T/V mounting bracket and remove the RCA cables, power supply cable and antenna cable.

AUXILIARY BATTERY:

Battery acid can burn skin and clothing. Protective eye wear and gloves should be worn when handling batteries.

REPLACING THE AUXILIARY BATTERY:

Ensure that the inverter is disconnected prior to disconnecting the auxiliary battery.

GENERATOR:

When launching a boat, using your Roadtrek, it is important to know that the generator must not be submerged in water.

WASTE WATER STORAGE AND DUMPING SYSTEM:

Ensure that both the black and gray water gate valves are closed (inward position) before using the waste water system.

Under moderate subfreezing conditions, antifreeze is required in the exterior fresh water tank, black and gray waste water tanks. Antifreeze should be used at a 50% water and 50% antifreeze ratio.

THE WARNINGS AND CAUTIONS IN THE QUICK REFERENCE ARE AN OVERVIEW AND THERE ARE MORE NOTES AND INSTRUCTIONS WITHIN THIS MANUAL.

OBTAINING MOTORHOME SERVICE

The solution to all your Roadtrek concerns starts with your Roadtrek Dealer

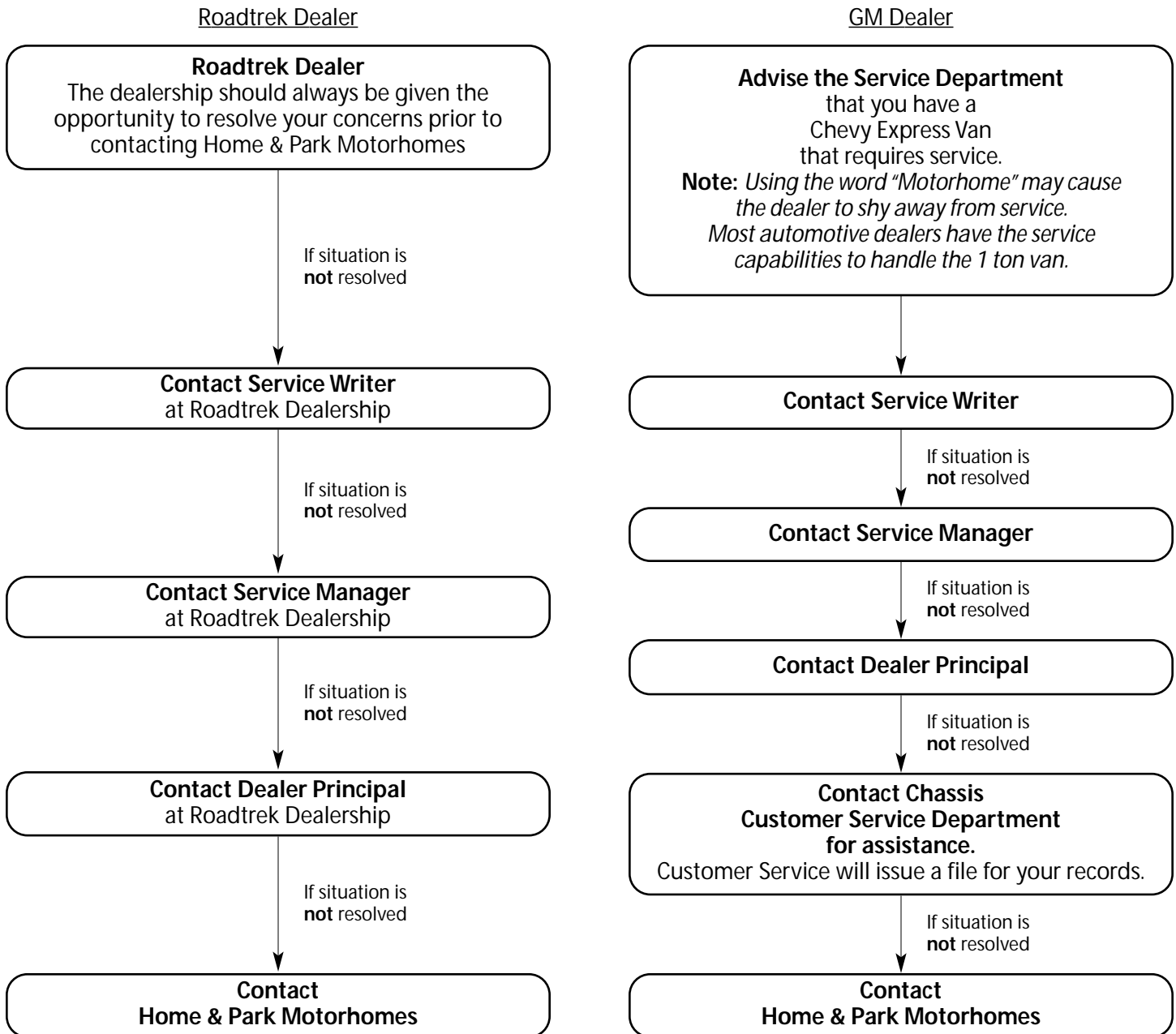

Introduction	A-0
Weight Ratings	A-1
Specifications (Automotive/Motorhome)	A-2
Appliance Log	A-3
Manufacturer Contact Information	A-4
Daily Living	B-1
Captain's Seats	B-1
Seat Belt Usage	B-1
Cloverleaf Dining Table	B-2
Dinette Table	B-3
Sleeping Facilities	B-4
Rear Twin Beds	B-4
Rear King Bed / Rear Queen Bed	B-5
Front Lounge Seats	B-6
Washroom and Privacy Area	B-7
Rear Privacy Doors	B-7
Front Privacy Doors	B-7
Washroom Facilities	B-8
Toilet	B-8
Stand-up Aisle Shower	B-8
Extra Counter Space	B-9
TV	B-9
Exterior Access Doors	B-10
Driver Side Access Doors	B-10
L.P.G. (Liquid Propane Gas) Access Door	B-11
Passenger Side Access Doors	B-11
Auxiliary Battery	B-12
Replacing the Auxiliary Battery	B-12
Spare Tire Storage	B-13
Continental Spare Tire Kit	B-13
Caution Note (Mineralling)	B-13
Floor Plan & Appliance Location	C-1
Fresh Water System	C-1
Elevation (210-Popular Chevrolet)	C-2
Floor Plan with Appliance Location (210-Popular Chevrolet)	C-3
Elevation (210-Versatile Chevrolet)	C-4
Floor Plan with Appliance Location (210-Versatile Chevrolet)	C-5
Electrical System	E-1
Inverter	E-1
10V Inverter/Charger Shut Down	E-1
Inverter/Charger Start up After Automatic Safety Shut Down	E-1
Dry Camping Battery Conservation	E-1
Receptacle Functionality	E-1
120 / 12V Inverter/Charger/Distribution Panel	E-2
External Electrical Source Connection	E-2
Generator	E-2
Built-in 110 V Heat Pump - Air Conditioner	E-2
Monitor Panel	E-3
Auxiliary Battery and Isolator	E-4
Automotive Battery	E-4
Interior Cab Light	E-4
Range Hood Exhaust Fan	E-4
Water Heater	E-4
Rear Storage Light	E-4
Electrical System Legend	E-5
Electrical System Schematics	E-6 - E-7
L.P.G. (Liquid Propane Gas) & Safety System	F-1
L.P.G. Tank	F-2
Appliances	F-2
Refueling Procedures	F-2
Regulator	F-2
L.P.G. Leak Detector	F-3

Carbon Monoxide Leak Detector _____	F-3
Smoke Detector _____	F-3
L.P.G. System Schematic (210-Popular Chevrolet) _____	F-4
L.P.G. System Schematic (210-Versatile Chevrolet) _____	F-5
Water Systems _____	G-1
Winter Mode Valve Position _____	G-1
Winter Use _____	G-1
Summer Use Valve Position _____	G-1
Water Systems (Summer & Winter mode) _____	G-2
To De-Winterize _____	G-3
Fresh Water Tanks _____	G-4
Filling the Interior Fresh Water Tank _____	G-4
Filling the Exterior Fresh Water Tank _____	G-4
City Water Connection _____	G-5
Waste Water Storage and Dumping System _____	G-6
Waste Water Tank Preparation _____	G-6
Waste Water Tank Dumping _____	G-7
Waste Water Tank Flushing _____	G-8
Outside Shower _____	G-8
Potable Water System Draining _____	G-8
Potable Water System Sanitizing _____	G-9
Water System Winterizing _____	G-9
Water System Schematic (210-Popular Chevrolet) _____	G-10
Water System Schematic (210-Versatile Chevrolet) _____	G-11
Owner Maintenance _____	H-1
Fiberglass Maintenance _____	H-1
Exterior Washing _____	H-1
Other Maintenance _____	H-1
Winter Storage _____	H-1
Inside Your Vehicle _____	H-1
Outside Your Vehicle _____	H-1
Spring Start-Up _____	H-2
Tires _____	H-2
Cargo Carrying Capacity _____	H-2
Owner Maintenance Checks _____	H-2
When You Stop for Fuel _____	H-2
At Least Monthly _____	H-2
At Least Once Every Three Months _____	H-2
At Least Twice A Year _____	H-3
At Least Once A Year _____	H-3
Auxiliary Battery _____	H-3
Aluminum Wheel Maintenance _____	H-4
Limited Warranty Information _____	I-0
Limited Warranty Definitions _____	I-1
Home & Park Limited Warranty Registration Card _____	I-1
Automotive Warranty - General Motors (Chevrolet Chassis) _____	I-1 - I-2
Limited Warranty Information _____	I-2
Automotive Customer Service & Roadside Assistance Numbers _____	I-2
Appliance Warranty _____	I-2
Home & Park Limited Motorhome Warranty _____	I-3 - I-4
Customer Assistance _____	J-1
Reporting Safety Defects (U.S. Only) _____	J-1
Roadtrek Ambassador Potential Customer Referral Program for Roadtrek Owners _____	J-1
Roadtrek Club International _____	J-2
Address, Phone & Facsimile Numbers, and E-mail _____	J-2
Website _____	J-2
Obtaining Motorhome Service _____	K-1
Roadtrek International Chapter FMCA / A Roadtrek Owners' Club Membership Forms _____	L-1
Change of Owner Name or Address Form _____	L-2
Potential Customer Referral Card _____	L-4

A WORD TO ROADTREK OWNERS...

This manual has been prepared to acquaint you with the operation, maintenance and warranties of your new **Roadtrek Motorhome Van**. Your vehicle has been designed, engineered and manufactured to provide you with the utmost in pleasure, dependability and quality. It is important that you read the contents of this manual, that of the Chevrolet chassis and those of other components, and follow the instructions and recommendations contained in each to help assure the most enjoyable and trouble free operation of your vehicle.

We would like to take this opportunity to thank you for selecting a **Roadtrek** product and assure you of our continuing commitment to your recreational vehicle pleasure, safety and satisfaction.

INTRODUCTION

This manual has been written to provide you with the information required to properly operate and maintain your new Roadtrek. After reading this manual, be sure to keep it in your vehicle as a reference. Your **Roadtrek** dealer will be glad to answer any further questions about the operation of your vehicle.

IMPORTANT

Every reasonable precaution has been undertaken in the preparation of this manual resulting in the utmost accuracy possible at the time of publication. However, due to the continuing improvement and refinement of our products and normal changes in information and procedures, Home & Park shall assume no responsibility whatsoever for errors or omissions in the manual's contents.

Further, Home & Park shall not be held liable or assume any obligations or responsibilities whatsoever for any loss, damage or injury directly or indirectly caused by, arising or resulting from, or as a consequence of the use or nonuse of the information contained herein or the operation or non-operation of any items mentioned herein. And finally, Home & Park shall be indemnified and saved harmless from all losses, expenses, claims and demands whatsoever.

Weight Ratings

Gross Vehicle Weight Rating (GVWR): is the maximum permissible weight of this vehicle when fully loaded. It includes all weight at the vehicle axle(s).

Unloaded Vehicle Weight (UVW): is the weight of this motorhome as manufactured at the factory. It includes all weight at the vehicle axle(s). If applicable, it also includes full generator fluids, including fuel, engine oil and coolants.

Cargo Carrying Capacity (CCC): is equal to GVWR minus each of the following: UVW, full fresh (potable) water weight (including water heater), and full LP-Gas weight and SCWR.

Gross Combined Weight Rating (GCWR): means the maximum allowable loaded weight of this motorhome and any towed trailer or towed vehicle.

Canadian Models - Seating Capacity Weight Rating (SCWR)

US Models - Sleeping Capacity Weight Rating (SCWR): is the manufacturer's designated number of sleeping positions multiplied by 154 pounds (70 kilograms).

Gross Axle Weight Rating (GAWR): is the value specified as the load carrying capacity of a single axle system, as measured at the tire-ground interfaces.

Towing Guidelines: Consult Chevrolet Owners Manual(s) for specific weighing instructions and towing guidelines including auxiliary brake requirements for any towed trailer or towed vehicle.

Weighing Procedure: Prior to weighing each unit, the fuel tank must be full, as well as the fresh water tank. All tires must be of equal pressure, and any snow must be removed.

Note the weighing must be done on level ground!

Equipment: 2 Portable Scales (including electrical power source), 2 wooden ramps, lift and pressure gauge.

Alternate: D.O.T. approved customer scales

Note: Wooden ramps must be equal to or less than 1/8" of the height of the scales being used.

Procedure:

- 1) Fill Fuel Tank
- 2) Fill Fresh Water Tank
- 3) Measure all tire pressures and equalize if necessary
- 4) Place wooden ramps below rear wheels (using lift or driving onto ramps for levelling vehicle; N/A if commercial scales used)
- 5) Place scales under front wheels
- 6) Record scale readings
- 7) Repeat for rear wheels

VIN: 1GBHG31U1 31205833		MANUFACTURED BY:	
MOTORHOME WEIGHT INFORMATION			
GVWR(GROSS COMBINED WT RATING): THE MAX. ALLOWABLE LOADED WT OF THIS MOTORHOME & ANY TOWED TRAILER OR TOWED VEHICLE			
UVW (UNLOADED VEHICLE WT): THE WT OF MOTORHOME AS MANUFACTURED AT THE FACTORY WITH FULL FUEL, ENGINE OIL & COOLANTS			
SCWR (SLEEPING CAPACITY WT RATING): THE MANUFACTURER'S DESIGNATED NO. OF SLEEPING POSITIONS X 154 POUNDS (70 KILOGRAMS)			
CCC (CARGO CARRYING CAPACITY) = GVWR - (UVW + FULL FRESH(POTABLE) WATER W/INCLUDING HOT WATER) + FULL LP-GAS WT + SCWR			
WEIGHING: (CONSULT OWNER MANUAL) FOR SPECIFIC WEIGHING INSTRUCTIONS & TOWING GUIDELINES	GVWR	9600	4,354
MINUS UVW		7570	3,434
MINUS FRESH & HW WT (32 + 6) GALLONS @ 8.3 lb/gal		317	144
MINUS LP-GAS WT OF 9.8 GALLONS @ 4.5 lb/gal		42	19
MINUS SCWR OF 3 PERSONS @ 154 lb/person		462	210
MINUS TOTAL FACTORY SUPPLIED OPTION WT		271	123
DEALER INSTALLED EQUIPMENT AND TOWED VEHICLE TONGUE WEIGHT WILL REDUCE CCC			
CCC FOR THIS MOTORHOME		938	426
GAWR	TIRES	RIMS	COLD INFL. PRESS. SINGLE DUAL
FRONT 4100 lb (1860 kg)	LT245/75R16-E	16 x 6.5J	50 PSI (340 kPa) X
REAR 6084 lb (2760 kg)	LT245/75R16-E	16 x 6.5J	80 PSI (550 kPa) X
TYPE OF VEHICLE: MPV CLASS B MOTORHOME SO 63145			
THIS VEHICLE CONFORMS TO ALL APPLICABLE U.S. FEDERAL MOTOR VEHICLE SAFETY STANDARDS IN EFFECT AS OF: 16-Oct-03			
Paint Identification: Chassis Paint Code: 50UWAU8624 Deluxe Paint Code: MM203.50			

Sample of US Weight label:

MANUFACTURED BY / FABRIQUE PAR: HOME & PARK MOTORHOMES		Date: 23 Jul 03	
INCOMPLETE VEHICLE MANUFACTURED BY/VEHICULE INCOMPLÉTEMENT CONSTRUIT PAR: GENERAL MOTORS CORPORATION		Date: 01-Jan-03	
GVWR/PNBV: 4355 Kg		VIN/NIV: 1GBHG31U2 31163155	
SEATING CAPACITY / NOMBRE DÉSIGNÉ DE PLACES ASSISSES: (3 x 70) = 210 Kg			
GAWR/PMBE (KG)	TIRE/PNEU	RIM/JANTE	COLD INFL. PRESS. / PRESS. DE GONFL. À FROID PSIL/PC KPA
FRONT 1860	LT245/75R16-E	16 x 6.5J	50 340
REAR 2760	LT245/75R16-E	16 x 6.5J	80 550
CARGO CAPACITY	500 (kg)	CAPACITÉ DE CHARGEMENT	500 (kg)
CALCULATED WITH FRESH WATER TANKS FULL:		CALCULÉE AVEC LES RÉSERVOIRS D'EAU DOUCE PLEINS:	
(COLD)	121 (kg)	(FROID)	121 (kg)
(HOT)	23 (kg)	(CHAUD)	23 (kg)
AND THE WASTE WATER TANKS EMPTY		ET LES RÉSERVOIRS D'EAUX USÉES VIDES	
WASTE WATER TANKS CAPACITY	182 (kg)	CAP. DES RÉSERVOIRS D'EAUX USÉES	182 (kg)
Paint Identification: Chassis Paint Code: 50UWAU8624 Deluxe Paint Code: B.M.W.442			

Sample of Canadian Weight label:

2005 STANDARD AND OPTIONAL AUTOMOTIVE FEATURES

2005 STANDARD AND OPTIONAL AUTOMOTIVE FEATURES	Roadtrek 210 models on Chevrolet 3500 Extended Van
Air bag - driver & passenger	standard with passenger on/off switch
Alternator	145 amp.
Axle - rear - standard	4.10 ratio (w/locking diff., trans. cooler)
Battery	600 amp.
Brakes - anti lock	four wheel disc
Cooling - transmission oil	standard - internal
Defroster - rear window	standard
Door locks	power - all doors
Doors & exits	wide side & 50/50 rear
Engine - standard	6.0 L SFI gas V8
Fuel capacity	117 L/31 US gal.
Ground effects package	optional
Mirror - interior	compass & exterior temperature
Mirrors - exterior	power - 7 1/2" x 8"
Power - standard	223 kW/300 HP
Receiver - Class IV frame mounted	standard
Running boards	aerodynamic with storage
Seats - Captain's	swiveling, reclining, power lumbar supports & dual armrests
Seats - leather	optional - Captain's & lounge seats
Sound system	premium AM/FM & CD
Tire storage - spare	rear storage area or optional Continental kit
Tires	LT245/75R16E black wall
Torque - standard engine	490 N-m/360 ft. lbs.
Towing - GCWR * - standard	7258 Kg/16000 lbs. *
Towing - tow weight ** - standard	3450 Kg/7600 lbs. **
Towing - tongue weight ***	454 Kg/1000 lbs. ***
Wheels - standard	steel - 16" - with trim
Wheels - optional	aluminum - 16" - with steel spare
Window operation	power - front doors only
Window tint	tinted - all
Wiring harness for towing - 4 way	standard
Wiring harness for towing - 7 way	optional (in addition to 4 way)

* Gross Combination Weight Rating (GCWR) includes total weight of vehicle, equipment, fuel, water, LP gas, cargo, driver and passengers.

** Maximum towable weight with driver and minimal fuel only. This weight reduced by weight of optional equipment, fuel, water, LP gas, cargo and/or passengers.

*** A weight distributing hitch is required for tongue weights over 200 Kg/400 lbs.

2005 EXTERIOR DIMENSIONS

Length	6680 mm/21' 11" *
Height - overall	2590 mm/8' 6"
Width - overall (w/o mirrors)	2240 mm/7' 4"
Wheel base	3940 mm/155"
Unloaded vehicle weight ** (no opt.)	3750 Kg/8200 lbs.
Gross vehicle weight rating	4355 Kg/9600 lbs.

* Add 250 mm/10" if equipped with optional Continental spare tire kit.

** Includes weight of base vehicle and fuel only. Does not include weight of optional equipment, water, LP gas, cargo and/or passengers.

2005 INTERIOR DIMENSIONS

Standing height	1880 mm/74"
Queen bed length	2030 mm/80"
Queen bed width	1520 mm/60"
Single bed length - front	1660 mm/65" right
Single bed width - front	560 mm/22" (maximum)
King bed length	1930 mm/76" (maximum)
King bed width	2030 mm/80" (maximum)
Twin bed length - rear	1930 mm/76" left, 1830 mm/72" right
Twin bed width - rear	760 mm/30"
Water tank - fresh	10 US gal interior/20 US gal exterior
Water tank - grey	85 L/23 US gal.
Water tank - black	40 L/10 US gal.

2005 STANDARD MOTORHOME FEATURES

2005 STANDARD MOTORHOME FEATURES	Roadtrek 210 models on Chevrolet 3500 Extended Van
Air conditioner	110V recessed, 12000 BTU
Aisle	32"/810 mm wide
Battery - auxiliary - 12V	lead acid deep cycle, 95 amp-hrs.
Battery storage - auxiliary	slide-out tray below floor
Beds - dual density foam	130 mm/5"
Cabinet - audio/video & storage	standard
Carpet	40 oz. 100% Dupont nylon
Connection - auxiliary	LPG for BBQ w/quick disconnect
Connection - external - 110V	standard w/detachable power cord
Connection - external - TV cable	standard
Connection - external - water	standard with quick disconnect
Counter top	molded fiberglass w/solid surface
Detectors	smoke, LP gas & CO
Faucet - galley	single lever
Floor - lowered	2025 mm x 890 mm x 50 mm 80" x 35" x 2", no step over frame
Furnace - 'Suburban'	LP gas automatic, 16000 BTU
Generator ready package	for 'Onan'
Heat pump (A/C & heater)	'Dometic' with ducts to rear bed
Microwave oven - 110V	toast & bake, 28L/1.0 cu. ft., 1800 W
Monitor panel	water & LP gas levels, battery charge & battery disconnect
Distribution panel	110/12V electronic with all 12V outputs filtered, 45 amp.
Power inverter with charger	12/110V, 600 W
Privacy area	with trifold doors, patented
Range hood - 12V	with exhaust fan & light
Refrigerator - 'Dometic'	12V/110V/LP gas, 4.0 cu.ft.
Roof vent - 'FanTastic' - 12V	low profile power w/thermostat
Sewage disposal system	12V macerator sewage pump
Shower	stand-up in aisle
Sink	molded into counter w/flush cover
Storage area	across the rear with trunk
Storage compartments - exterior	3 drawers below floor
Storage capacity - standard	68 cu.ft., 86 w/options
Stove - two burner	LP gas recessed w/flush cover
Table - dining - cloverleaf	32" x 32" open, 20" x 20" closed
Tank - LP gas	38 L/10 US gal./45 lbs.
Toilet - 'Thetford'	marine with foot pedal flush
TV antenna - 'Hide-A-Tenna'	built-in
Water fill - fresh - location	front & rear door posts to reduce clutter & prevent tampering w/supply
Water heater - 'Suburban'	110V/LP gas with bypass, 23L/6 US gal., 12000 BTU
Water system - on demand	12V with 'Shurflo' water pump
Water tank capacities	(see Interior Dimensions)
Windows	frameless awning type
Windows - roof	3 frameless with removable shades

2005 MOTORHOME OPTIONS

Armoire - with removable & adjustable shelves & drawers	optional, permanently replaces right lounge seat
Awning - box	optional, 3500 mm/11'6"
Battery - second auxiliary	optional, two lead acid deep cycle 6V, 220 total amp-hrs. (repl. 12V)
DVD player	optional, with remote
Generator - 'Onan MicroLite'	optional, remote-start, 2.8 kW
Lounge - L-shaped at rear	optional
Satellite receiver	optional
Screen package	optional for side van door windows and side & rear door openings
Seat belts for 2 in rear	optional
TV - flat screen	optional, 15" (600 W inverter std.)
Video cassette recorder	optional

APPLIANCE & ACCESSORY MANUFACTURER'S LOG

Appliance	Manufacturer	Model
Awning	Fiamma	F45
Battery - Auxiliary	Trojan	27TM
Battery - Auxiliary -Optional Dual	Trojan	T-605
Battery Isolator	Hehr-Powerline	33-22
CO Detector	MTI Industries	60-541
Coffee Maker	Black & Decker	ODC425
Distribution Panel	Progressive Dynamics	PD50K3Q2GP
DVD Player	Diamond Vision	DVDV805-05
Fire Extinguisher	Company Kidde	Elite 10
Furnace	Suburban	NT 16SE
Generator	Onan	Microlite
Heat Pump	Dometic	41001.61
Inverter	Tripp-Lite	RV612ULH
LP Gas Detector	Electro Systems	GS/3
LP Gas Tank	Manchester	68001
Macerator Pump	Shur-Flo	3200-200
Microwave oven	Dometic	CDMW07W
Monitor Panel	Kib	K46RT
Power Roof Vent	Fantastic	4000BT
Range Hood	Elmec	04032001
Refrigerator	Dometic	RM2454L
Refrigerator	Dometic	if so equipped RM2333R
Running Board Lock	Briggs & Stratton	702852 AB1
Smoke Detector	Fire Sentry	0914CA
Stove	Elmel	SD2 Proprietary
Toilet	Thetford	Aqua Magic IV Lo
Transfer Switch	Progressive Dynamics	PD5110610
TV	Samsung (Flat Screen)	510MP
Water Heater	Suburban	SW6DE
Water Pump	Shurflo	2088-403-144

Appliance manufacturers and model numbers subject to change without notice

MANUFACTURER CONTACT INFORMATION:

Component	Manufacturer	Location	Phone Number
Awning	Fiamma	Orlando, FL	407-672-0091
Detector-carbon monoxide	MTI Industries	Wauconda, IL	800-383-0269, 847-487-4940
Detector - LP gas	MTI Industries	Wauconda, IL	800-383-0269, 487-487-4940
DVD Player	AVS Technologies	Mississuga, ON	800-303-0287
Flat LCD T.V.	Aralex Acoustics Ltd	Coquitlam BC	306-221-7610
Furnace (U.S.)	Suburban Mfg.	Elkhart, IN	423-775-2131
Furnace (Canada)	Suburban c/o GL Products	Oakville, ON	905-845-7558
Generator (U.S.)	Onan Corporation	Minneapolis, MN	800-888-6626
Generator (Canada)	Onan Corporation	Oakville, ON	905-795-0050
Heat Pump	Dometic	Elkart, IN	800-544-4881
Inverter/Charger	Tripp-Lite	Chicago, IL	773-869-1234
LP Gas Tank	Manchester		1-800-640-6327
Microwave (U.S.)	Dometic Corporation	Elkhart, IN	800-544-4881, 219-463-4858
Microwave (Canada)	Dometic Distribution	Cambridge, ON	519-653-4390
Oven-Microwave (210)	Camco Inc.	Hamilton	800-361-3400
Refrigerator (U.S.)	Dometic Corporation	Elkhart, IN	800-544-4881, 219-463-4858
Refrigerator (Canada)	Dometic Distribution	Cambridge, ON	519-653-4390
Roof Vent - Power	FanTastic Vent	Capac, MI	810-724-3818
Satellite	MotoSat	Salt Lake City, UT	800-247-7486
Screens (for van doors)	Bug Barrier	Medina, OH	800-548-0214, 216-723-2551
Toilet (U.S.)	Thetford Corporation	Ann Arbor, MI	800-521-3032
Toilet (Canada)	Thetford Sanitation	Mississauga, ON	905-671-0255
Water Heater (U.S.)	Suburban Mfg.	Elkhart, IN	423-775-2131
Water Heater (Canada)	Suburban c/o GL Products	Oakville, ON	905-845-7558
Water Pump (U.S.)	Shurflo	Santa Ana, CA	800-854-3218
Water Pump (Canada)	Shurflo	Belmont, ON	519-727-6752
Wheels - Aluminum(SE)	Prime Wheel	Gardena, CA	310-516-9126
Wheels - Aluminum	American Racing	Mississauga, ON	800-959-1969

CAPTAIN'S SEATS:

To recline, pull up the recline control lever below the inboard armrest and lean back.

To slide, pull up on the slide bar located on the front of the seat and slide the seat either forward or back, (see Picture B-P1a).

To swivel the seats from a forward facing position to a rearward facing position pull the swivel lever up, (see Picture B-P1).

Important Note: Before swiveling the seat, you must be aware of the following:

1. Ensure that the back of the seat is reclined forward, as far as the recline control allows.
2. Slide the seat forward but not so far as to lose clearance of the engine cover. Pull up on slide bar, (see Picture B-P1A).
3. Put the tilt steering wheel in the most downward position.
4. The swivel lever is located on the door side of the seat and locks the seat in a forward facing position. To release pull the swivel lever up and the seat freely swivels, (see location on Picture B-P1).
5. Swivel the seat to the desired position, (see Picture B-P2).

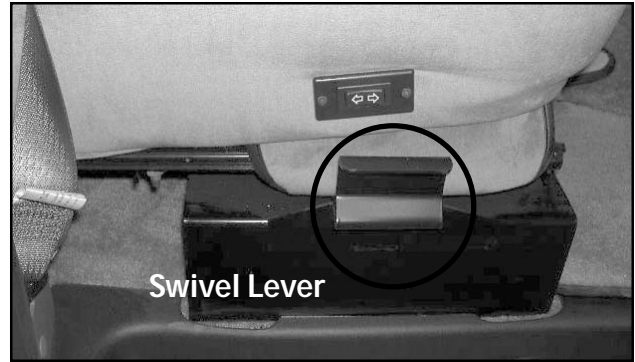

Picture B-P1: View of front captain's seat showing the location of the swivel lever.



Picture B-P1A: View of the front of the Captain's seat, showing the location of the slide bar.



Picture B-P2: Captain seats swiveled towards the rear of the Motorhome.

SEAT BELT USAGE:

Only forward facing seats equipped with factory installed seat belts are to be occupied while the vehicle is in motion. All passengers must be seated in these seats only with the seat belts fastened while the vehicle is in motion.

CLOVERLEAF DINING TABLE:**210 Popular:**

The cloverleaf dining table is stored in the lower galley cabinet, (see Picture B-P3). Remove table leg from wardrobe, (see Picture B-P4) and place it in the floor base receptacle located in front of the lower galley cabinet. Place table top on top of table leg.

To use the table "leaves":

1. Pivot the table into the desired position.
2. In the seated position, with one hand on the top of the table, use the other hand to unfold the desired leaf to the upright position.

To return the "leaf" to its original position, use the following steps:

1. Hold the leaf with one hand.
2. With the other hand reach under the table and carefully press on the center of the downward facing part of the spring hinge.
3. Fold the leaf back into the stored position.

Caution: Cloverleaf dining table is heavy, lift while bending knees.

210 Versatile:

The cloverleaf dining table is stored in the wardrobe, (see Picture B-P4A). Remove table leg from wardrobe, (see Picture B-P4) and place it in the floor base receptacle located beside the lounge seats. Place table top on top of table leg.

Follow steps listed above.

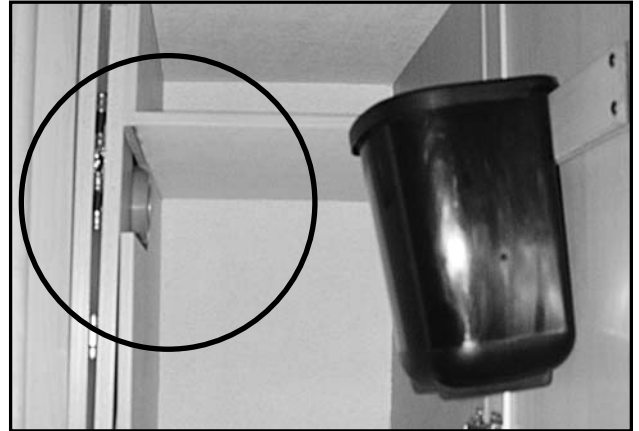

Picture B-P3: Lower galley cabinet showing location of cloverleaf table, (Popular model).



Picture B-P4: Cloverleaf and dinette table legs are stored in the wardrobe closet.



Picture B-P4A: Cloverleaf, dinette table legs and clover leaf table are stored in the wardrobe closet.

DINETTE TABLE:

The table leg is stored in the rear wardrobe closet, Popular model, (see Picture B-P4) Versatile model, (see Picture B-P4A). Remove the table leg and place in the floor base receptacle located at the rear on the floor.

The table top is stored under the driver side rear bed cushion, (see Picture B-P6). Place table top on table leg, (see Picture B-P5).

When returning table top to the storage position ensure the table base is placed correctly in the table base receptacle located on top of the rear driver side bench, (see Picture B-P6). Return table leg to rear wardrobe closet and clip into place for proper storage.



Picture B-P5: Location of assembled dinette table, (Popular model).



Picture B-P6: Storage location of dinette table, showing placement of the table base receptacle.



Picture B-P5A: Location of assembled dinette table, (Versatile model).

SLEEPING FACILITIES:

REAR TWIN BEDS (210-Popular Model):

To convert the dinette into twin beds:

1. Remove the table and leg from its receptacle and place the table under the driver side seat cushion and store table leg.
2. Place both back rest cushions on the floor vertically up against the seat base boxes or store if desired.
3. Pull each seat cushion 3" (8 cm) from the wall to provide additional elbow room while sleeping.
4. Night table can be removed, (see Picture B-P7) and stored if desired.

To convert back to a dinette, perform these steps in reverse order.

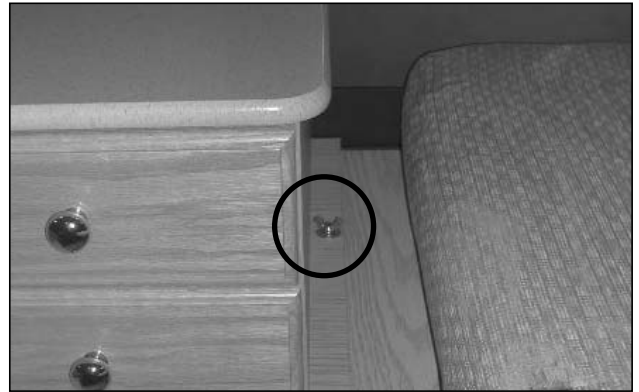

Picture B-P7: Wing nuts attaching the night table, are accessed from the sides of the night table as pictured above, (Popular model).



Picture B-P8: Placement of the cushions for Twin beds, (Popular model).

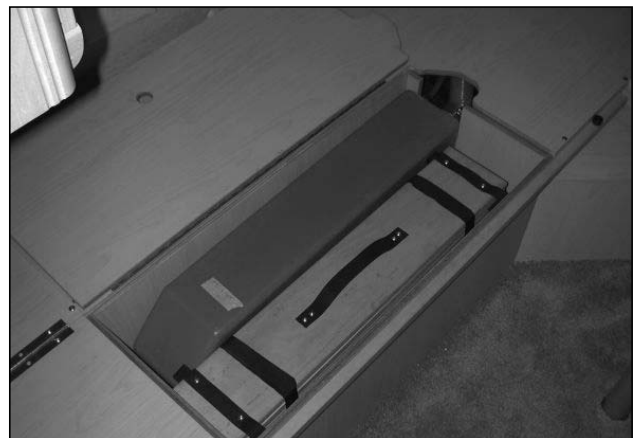

Picture B-P9: Storage of bed support for King size and Queen size bed.

REAR KING BED / REAR QUEEN BED
**REAR KING SIZE BED (Popular Model)/
 REAR QUEEN SIZE BED (Versatile Model):**

To convert the dinette into a King size bed or Queen size bed :

1. Remove the table and leg from its receptacle.
2. Remove night table and store. In order to remove, unscrew the wing nut found on each side of the night table, (see Picture B-P7). Store wing nut in the night tables drawer when not in use.
3. Place table top in storage, (see Picture B-P6).
4. Remove bed support from storage located under bed base on passenger side, (see Picture B-P9).
5. Install bed support, (see Picture B-P10).
6. Slide both bottom cushions together so that they meet in the middle, (see Picture BP-11).
7. Place both back rest cushions on sides, (see Picture B-P12). **NOTE:** The longer back rest cushion must be placed on the driver side to provide clearance for the bathroom door.
8. Push down the back rest cushions so they lay flat to create the King size or Queen size bed.
9. Install filler cushions, (see Pictures B-P12 & 13).

To convert back to a dinette, perform these steps in reverse order.

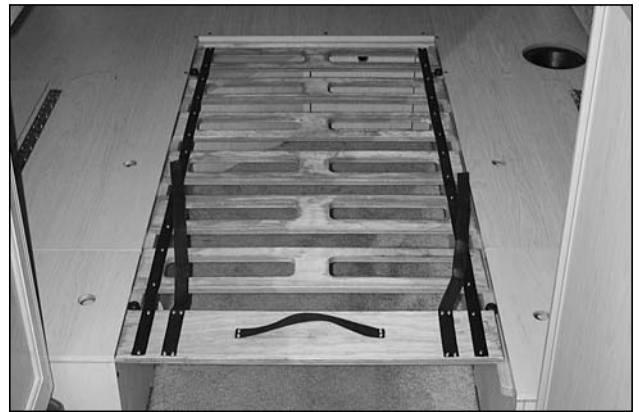

Picture B-P10: Placement of support for bed.



Picture B-P11: Lay cushions flat.

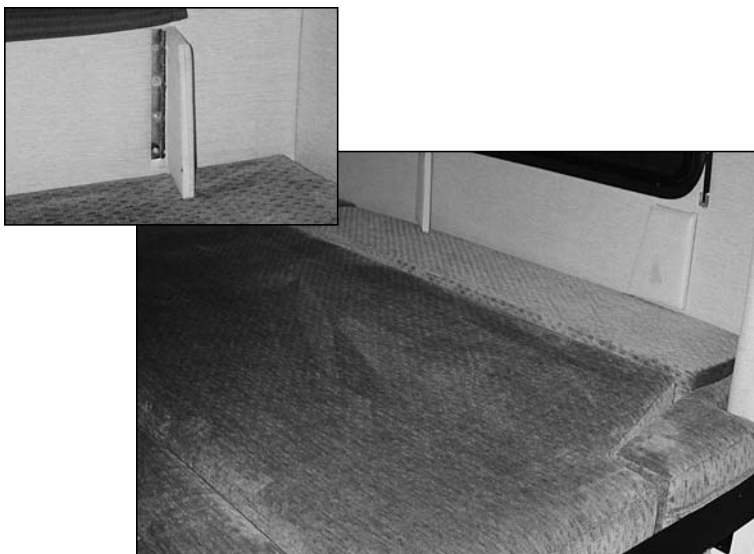

Picture B-P12: Placement of back rest cushions.

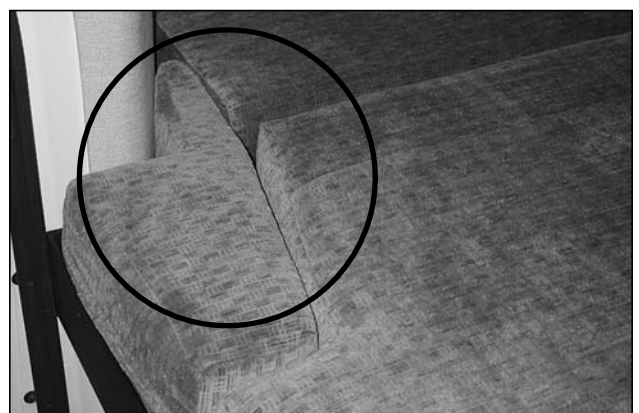

Picture B-P13: Placement of filler cushion.

FRONT LOUNGE SEATS:

To convert the lounge seat into a single bed:

1. Swivel the passenger captain's seat 90 degrees clockwise so that the backrest is toward the center aisle. Be sure all armrests are in an upright position, (see Picture B-P15).
2. Slide out the drawer under the passenger lounge seat and fully extend the drawer forward until it touches the raised platform, (see Picture B-P15). Raise the support block located at the front of the drawer, (see Picture B-P16).
3. Lift the lounge seat back rest cushion upward. Remove from its metal support and place it flat on top of the drawer, with the tapered end forward, (see Picture B-P17).



Picture B-P14: Swiveled front captain seat.



Picture B-P15: Extended drawer.

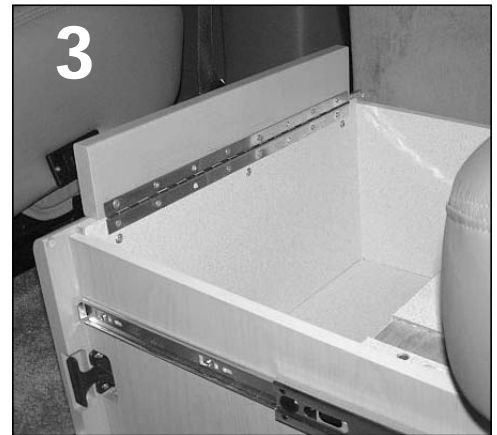

Picture B-P16: Raised support.



Picture B-P17: Front lounge bed.

To convert back to a lounge seat, perform these steps in reverse order.

The lounge and optional 2 rear passenger seats are designed to carry passengers while your vehicle is in motion and are equipped with seat belts installed for their protection. All passengers must be seated in the front captain's seats, lounge seats and optional 2 rear passenger seats, facing forward with seat belts fastened while vehicle is in motion. All other seats are not to be occupied while vehicle is in motion. The lap belts must be worn across the hips and not across the abdomen. Passengers must sit well back in the seat and in an upright position.

WASHROOM AND PRIVACY AREA:

FRONT AND REAR PRIVACY DOORS

When privacy is required:

Rear privacy doors:

1. Open the door on the rear wardrobe by pressing the push latch.
2. Release the plastic turn tab that secures the inner door found near the top inside door, (see Picture B-P18A). Extend this door until privacy is achieved, (see Picture B-P18 & B-P19A).
3. Secure door in place by latching the center hook, (see Picture B-P18B).



Picture B-P18: Rear privacy door in place, (Popular model).



Picture B-P19A: Rear privacy door in place, (Versatile model).

Front privacy doors:

1. Open the water closet door by pressing the push latch.
2. Release the plastic turn tab that secures the inner door found near the middle and top of the inside door, (see Picture B-P18A).
3. Extend this door until privacy is achieved, (see Picture B-P19 & B-P19B).
4. Secure door in place by latching the center hook, (see Picture B-P18B).
5. To close the privacy doors perform these steps in a reverse order.



Picture B-P18A: Plastic turn tab.

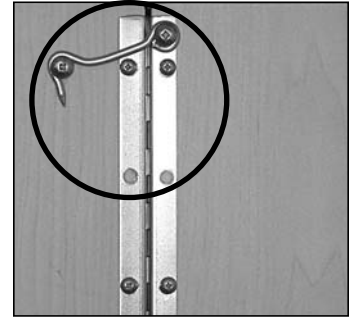

Picture B-P18B: Center hook.



Picture B-P19: Front privacy door in place, (Popular model).



Picture B-P19B: Front privacy door in place, (Versatile model).

WASHROOM FACILITIES:

TOILET:

1. Privacy is achieved by extending all privacy doors and closing the galley curtain.
2. The washroom is equipped with an automatic light that will illuminate when the door is in the open position, (see Picture B-P20).

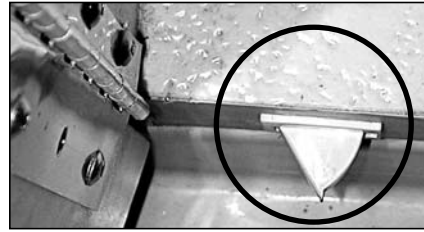

Picture B-P20: Light activation switch located at floor level.

STAND-UP AISLE SHOWER:

To set up the stand-up aisle shower:

1. Remove floor drain cover and drain plug from floor, (see Picture P-B21).
2. Privacy is achieved by extending all privacy doors and closing the galley curtain.
3. Release the Velcro retention straps and move the hand held shower from its storage position to shower position, (see Picture B-P22).
4. Draw the shower curtain until you are completely surrounded.
5. Using the Velcro connectors, secure the edges of the curtain together allowing the shower hose to hang within the shower area to retain any dripping water.
6. When adjusting the water temperature, be sure to allow enough time for the temperature adjusted water to exit the shower head before making further adjustments.
7. Roof vent may be used on **low speed** to remove steam and moisture.

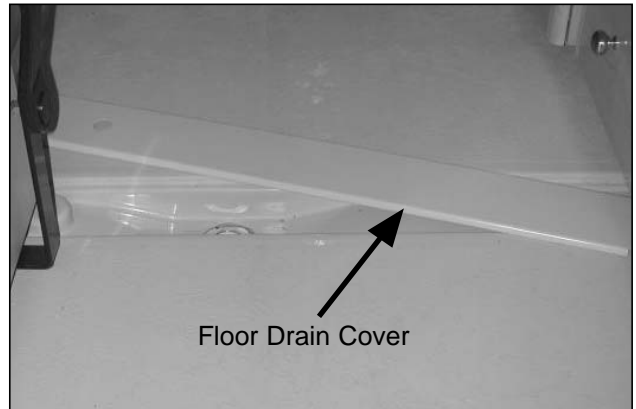

Picture B-P21: Floor drain, remove floor drain cover using the access holes provided in the cover.

Note: To conserve water, **discontinue the water flow at the shower head between wetting and rinsing.**

To put away the stand-up shower:

1. Rinse and dry the shower curtain thoroughly, (this function is most easily performed before leaving the shower area after use).
2. Allow the curtain to air dry completely, (this function can be expedited using the power roof vent).
3. Replace drain plug and floor drain cover when finished.



Picture B-P22: Hand held shower head in its shower position.

To prevent grey water tank contents from spilling onto the floor while driving, keep the drain plug secured when not in use.

EXTRA COUNTER SPACE:

In order to provide additional counter space, your motorhome has the following three features:

1. stove cover.
2. sink cover, (cutting board).
3. slide out shelf above the cutlery drawer.

To raise the stove cover do the following:

1. The stove cover is fit so you just need to lift and secure using the thumb tab (see Picture B-P23).
2. Raise cover while cooking, when finished lower stove cover.

CAUTION: Make sure the stove is off and has cooled prior to lowering stove cover.

To access slide out shelf above cutlery drawer, do the following:

1. Open cutlery drawer.
2. Reach under and slide the shelf forward, (see Pictures B-P24 and B-P25, Popular model see Pictures B-P24A and B-P25A, Versatile model). When shelf is no longer in use wipe down and close cutlery drawer.

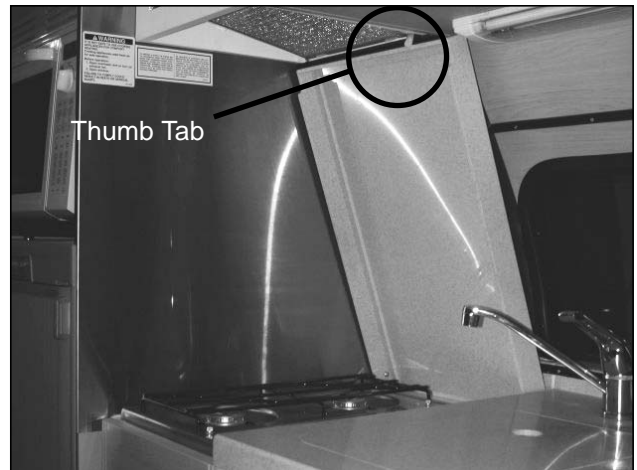

Picture B-P23: Lifting stove counter top.



Picture B-P24: Counter top drawer partially open, (Popular model).



Picture B-P25: Counter top drawer fully open, (Popular model).

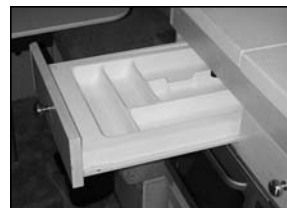

Picture B-P24A: Cutlery drawer, (Versatile model).

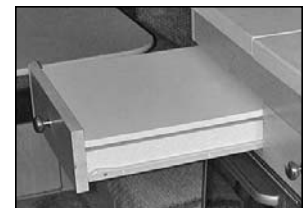

Picture B-P25A: Counter top drawer fully open, (Versatile model).

TV:

To view the flat screen display, loosen the thumb tab and swing the screen on its arm to the position you desire, (see Picture B-P26).

CAUTION: When vehicle is in motion it is recommended that the TV be "OFF" and in the stored position. The thumb tab should be in place to secure the TV in the stored position.



Picture B-P26: Flat screen thumbtab.

EXTERIOR ACCESS DOORS:
DRIVER SIDE ACCESS DOORS:

Behind the lockable middle access door, (see Pictures B-P27, 28 and 29) the following are found:

1. Sewage hose.
2. Grey water gate valve handle.
3. Black water gate valve handle.
4. Storage compartment.
5. Exterior fresh water drain valve.

Behind the driver side lockable rear access door, (see Picture B-P30) the following are found:

1. City water connection, (integrated at the side behind the rear access door).
2. City water by-pass valve.
3. Exterior shower faucet's.
4. Cable TV connection.
5. External 110V power connection.

Warning: Before driving ensure the shore power cord and city water line are disconnected.



Picture B-P27: Black water, grey water valves and sewage hose locations.



Picture B-P28: Front access door showing storage.

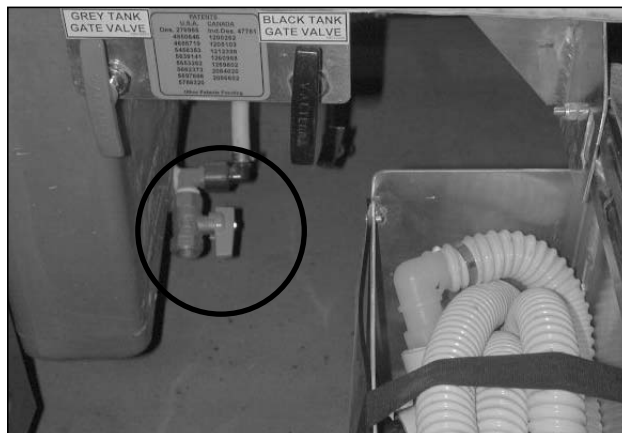

Picture B-P29: Exterior fresh water tank drain valve.

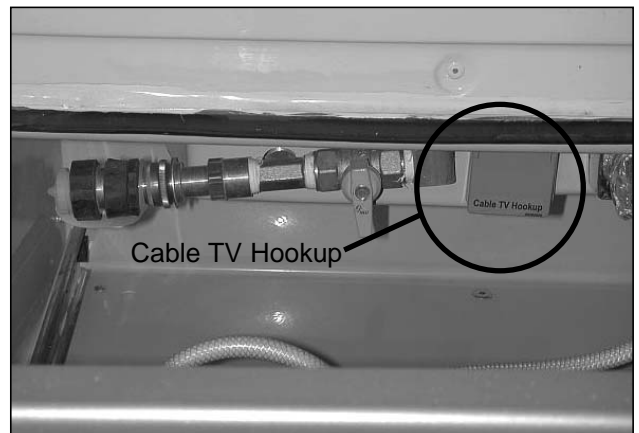

Picture B-P30: External connections.

L.P.G. (Liquid Propane Gas) ACCESS DOOR:

Behind the **L.P.G. access door**, (integrated into the rear bumper, covered with a black plate, see Picture B-P31), the following are found:

1. L.P.G. fill valve.
2. L.P.G. tank shut off valve.
3. Portable barbecue connection.

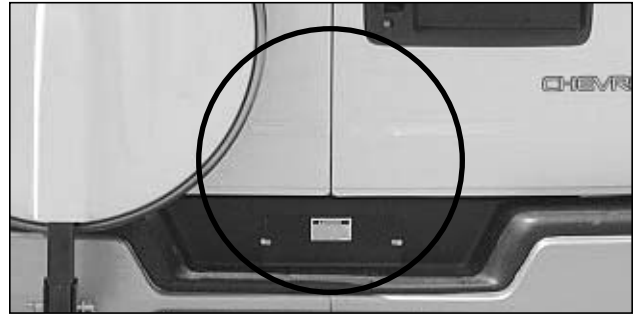

Picture B-P31: L.P.G. access door.

PASSENGER SIDE ACCESS DOORS:

Behind the access door in front of the rear passenger tire, (see Picture B-P32) the slide out tray with auxiliary battery(s) is found.

Behind the passenger side rear lockable access door, (see Picture B-P33), a slide out storage area is found.

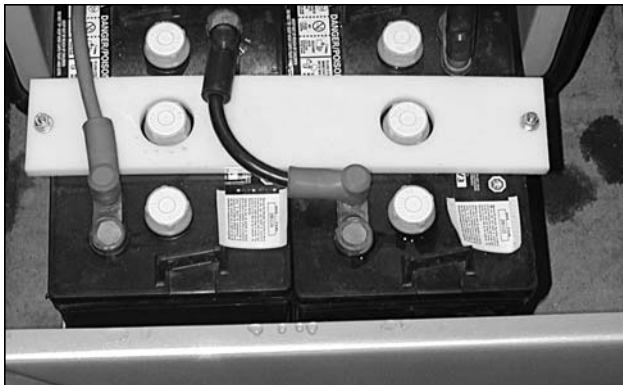

Picture B-P32: Slide out battery drawer, dual battery option shown.



Picture B-P33: Slide out storage tray.

REAR STORAGE UNDER THE BED:

Awning crank/support storage, (see Picture B-P32A).

Rear storage trunk, (see Picture B-P33A).

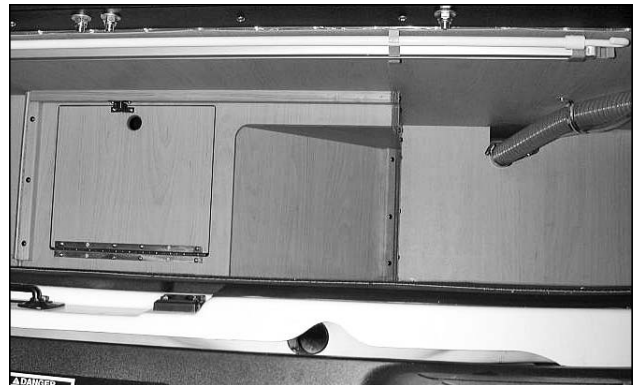

Picture B-P32A: Awning crank and support storage.



Picture B-P33A: Rear storage trunk.

AUXILIARY BATTERY:

The auxiliary battery(s) is located behind the access door in front of the rear passenger tire, (see Picture B-P34). It is recommended to check once a month, (see maintenance section).

In order to access the auxiliary battery one must do the following:

1. Unlock battery access compartment.
2. Open battery access compartment.
3. Slide out tray.

To reinstall reverse steps above.

CAUTION: BATTERY ACID CAN BURN SKIN AND CLOTHING. PROTECTIVE EYE WEAR AND GLOVES SHOULD BE WORN WHEN HANDLING.

Observe all battery warnings and caution labels.

NOTE: Your vehicle is equipped with a group 27 lead acid auxiliary battery. It is recommended that acid levels be checked at least once every month. See battery manufacturers maintenance recommendations.

If your vehicle is equipped with the dual battery option, your batteries are 6V lead acid. See battery manufacturers maintenance recommendations.



Picture B-P34: Auxiliary battery compartment.

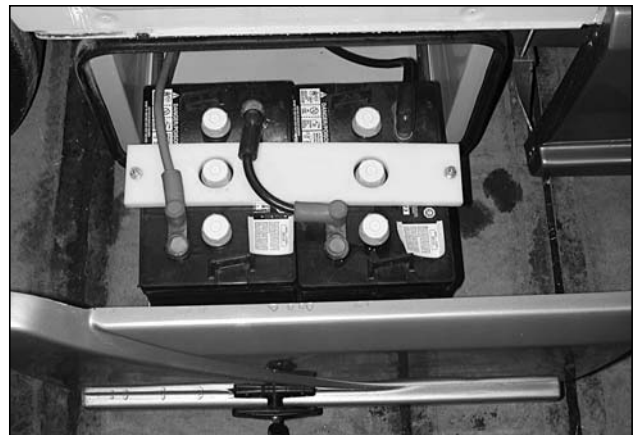

Picture B-P35: Dual battery option shown.

REPLACING THE AUXILIARY BATTERY:

Replacement battery must be a group 27 deep cycle lead acid or equivalent.

Dual battery option if so equipped uses two 6 Volt deep cycle batteries.

Ensure that the battery cable hex nuts are tightened to 10 ft-lbs, (see Picture B-P35).

Ensure that the inverter is disconnected prior to disconnecting the auxiliary battery.

SPARE TIRE STORAGE:

The spare tire is located in the storage area found under the passenger side rear bed, (see Picture B-P36A).

Unless equipped with optional Continental Spare Tire Kit, (see Picture B-P37).

Brace yourself for the weight of the tire, (40 kg / 80 lbs).

The jack is located in the storage area found under the passenger side rear bed mounted on the outside wall, (see Picture B-P36).

Interior storage light switch, (see Picture B-P36).

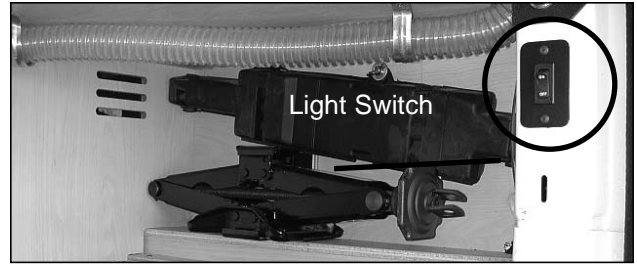

Picture B-P36: Location of jack, handle and light switch.

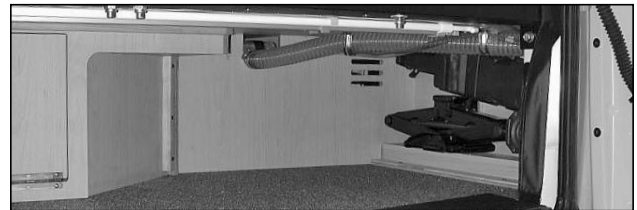

Picture B-P36A: Storage area for spare tire.

CONTINENTAL SPARE TIRE KIT (Optional):

To access full size spare tire:

1. Unlock and remove chrome ring and fiberglass disc, (see picture B-P38).
2. While holding the spare tire, in the upright position, remove catch pin on the elbow of the receiver.
3. Slowly lower the spare tire to the flat position, (see Picture B-P39). Brace yourself for the weight of the tire, (40 kg / 80 lbs).
4. Remove lug nuts on spare tire to remove from carrier.

To store tire, repeat these steps in reverse.

Note: To open driver side rear door, the spare tire kit must be lowered.



Picture B-P37: Spare tire kit.



Picture B-P38: Remove chrome ring and fiberglass disc.



Picture B-P39: Remove catch pin and lower carrier to remove tire.

Mineraling:

Due to the properties of natural Maple wood, Home & Park makes no warranty against the mineraling of wood components, (see Picture B-P40).

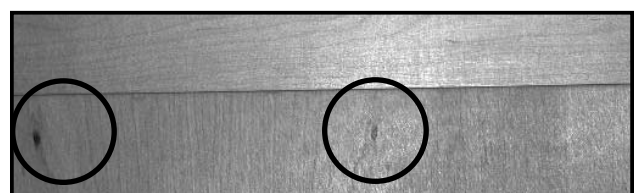

Picture B-P40: Maple cabinet showing mineraling.

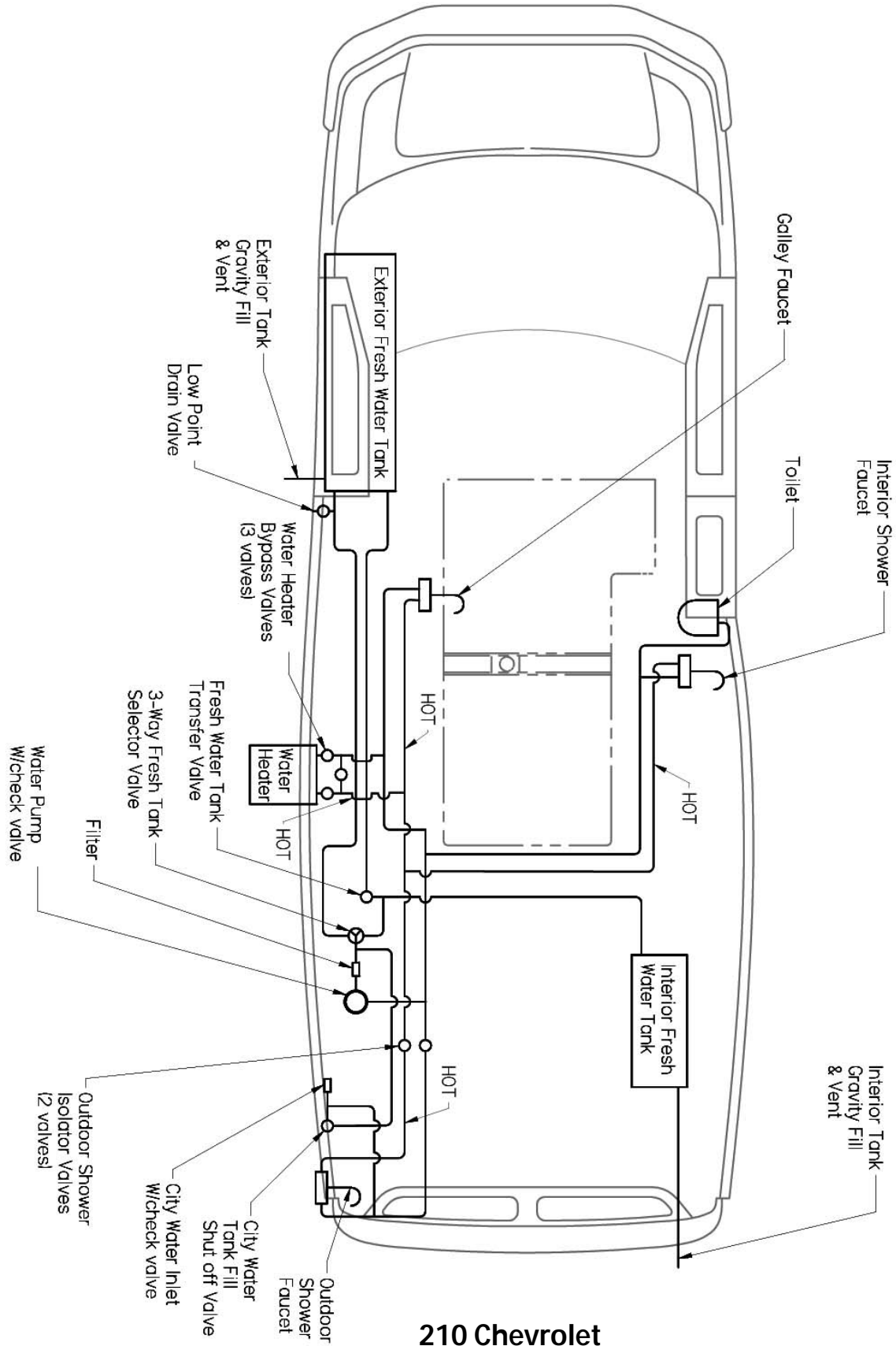

210 Chevrolet

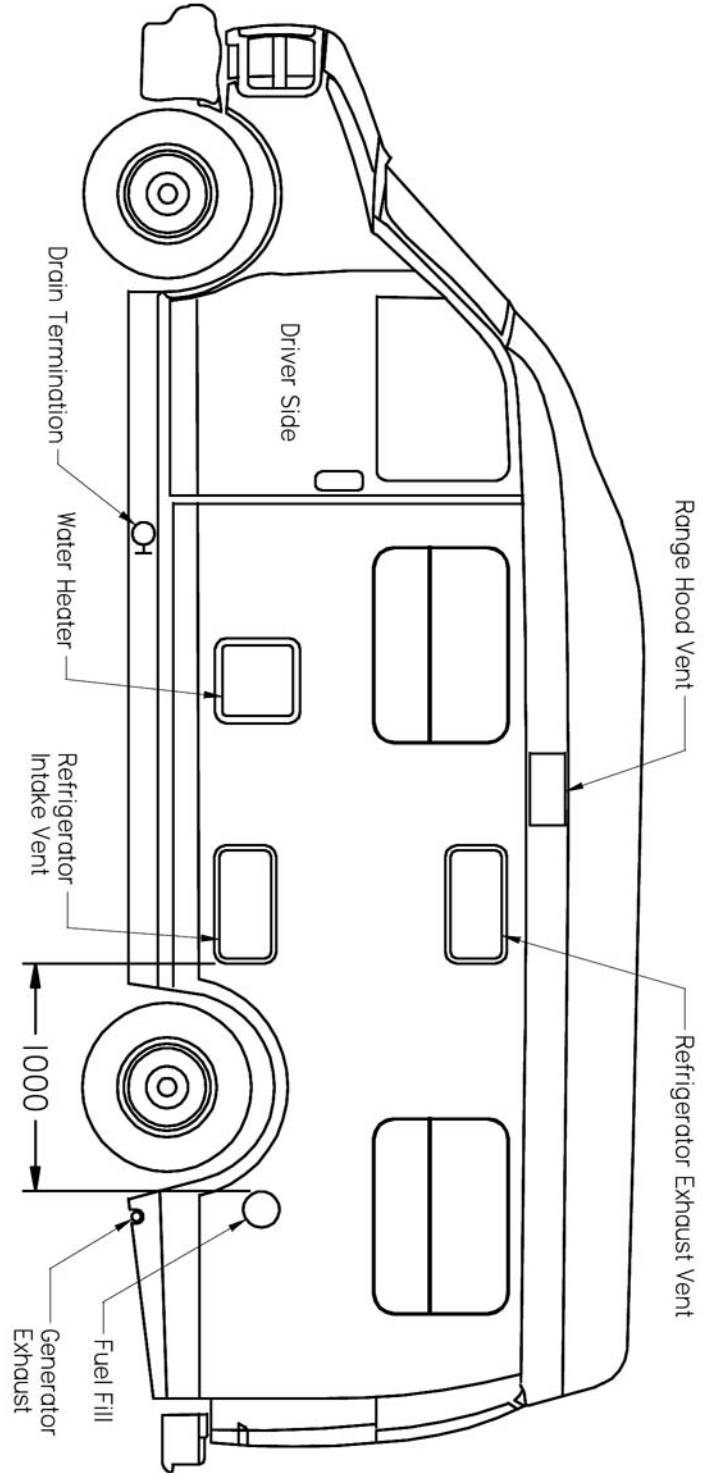
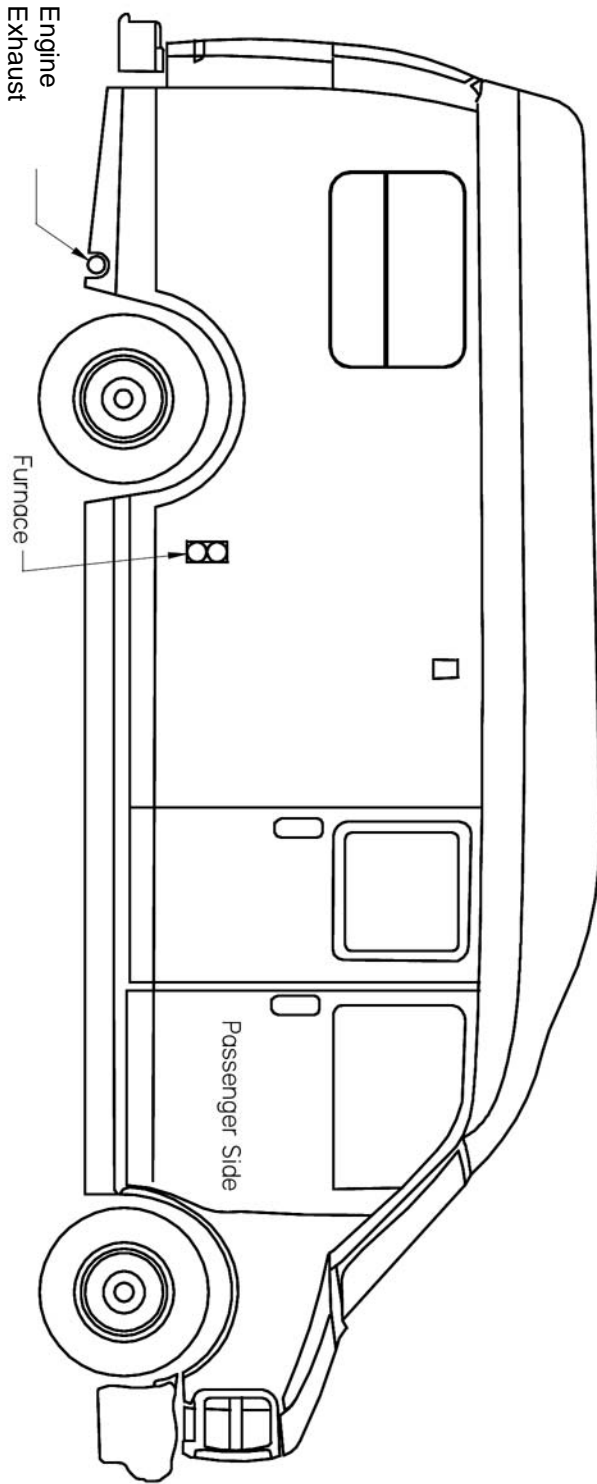

210-Popular Chevrolet

-INTERIOR FINISH MATERIALS HAVE A FLAME SPREAD RATING OF LESS THAN 200
 -INTERIOR TEXTILE MATERIALS COMPLY WITH FMVSS 302
 -INTERIOR DOORS/PARTITIONS ARE NON-LOCKING

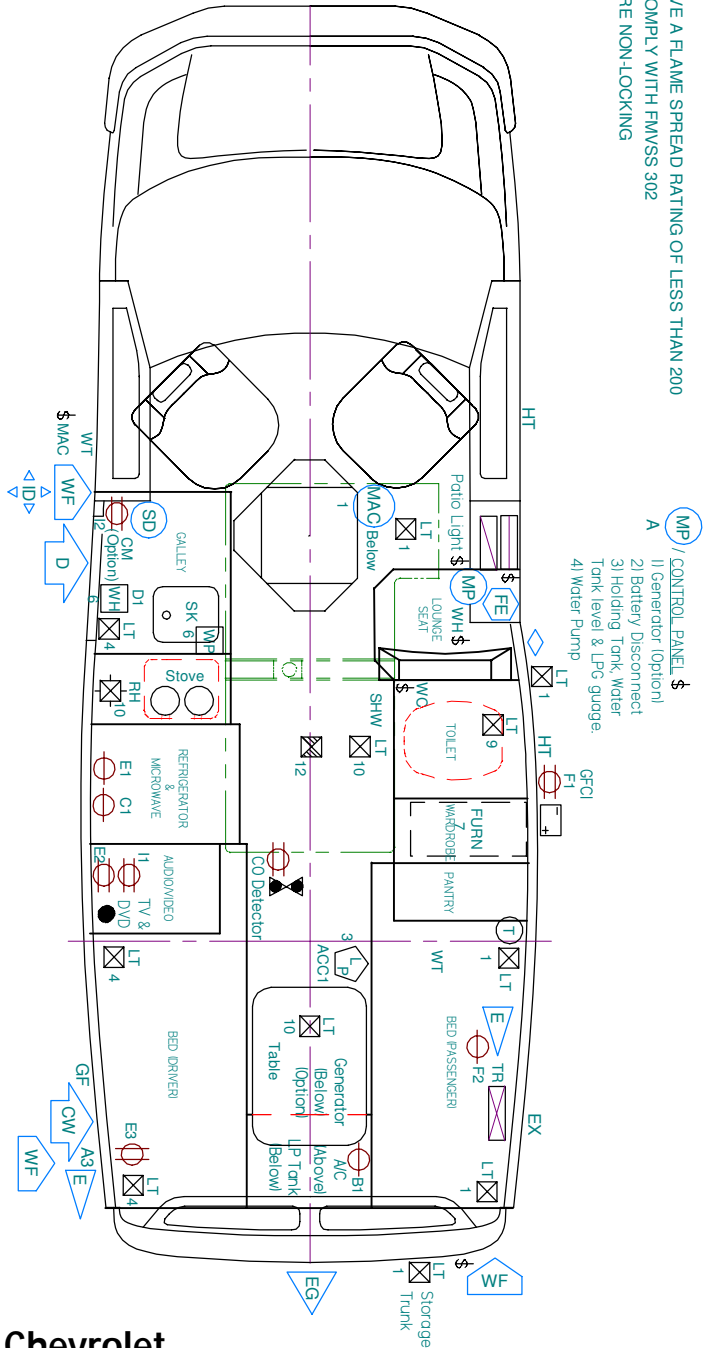

Circuit	VOLTS	AMPS	WIRE SIZE	LOADING
12	120	10	14AWG STANDARD CU	Roof Vent
10	120	15	14AWG STANDARD CU	Passenger side lights, Range hood, Rear center light
9	120	15	14AWG STANDARD CU	TV - Audio / Video
7	120	15	14AWG STANDARD CU	Furnace
6	120	15	14AWG STANDARD CU	Water Heater
5	120	20	10AWG STANDARD CU	Refrigerator
4	120	1	18AWG STANDARD CU	CO Detector & Driver side lights
3	120	1	18AWG STANDARD CU	LP Gas Detector
2	120	10	14AWG STANDARD CU	Water Pump Switch
1	120	20	10AWG STANDARD CU	Macerator, Patio light & Rear passenger side lights
12	120	15	14AWG 2CU W/GROUND	Galley Receptacle
11	120	15	14AWG 2CU W/GROUND	Audio / Video (AV) cabinet Receptacle
F2	120	15	14AWG 2CU W/GROUND	Inverter / Charger Receptacle
F1	120	15	14AWG 2CU W/GROUND	Outdoor Receptacle - passenger side
E3	120	15	14AWG 2CU W/GROUND	Rear wall Receptacle
E2	120	15	14AWG 2CU W/GROUND	Lower A/V Receptacle
E1	120	15	14AWG 2CU W/GROUND	Fridge Receptacle
D1	120	15	14AWG 2CU W/GROUND	Water heater
C1	120	15	14AWG 2CU W/GROUND	Microwave oven Receptacle
B1	120	20	12AWG 2CU W/GROUND	AC / Heatpump Receptacle
A3	120	30	10AWG 2CU W/GROUND	Outdoor Receptacle
A	120	30	10AWG 2CU W/GROUND	Main Power Switch

CIRCUIT SCHEDULE

210-Popular Chevrolet

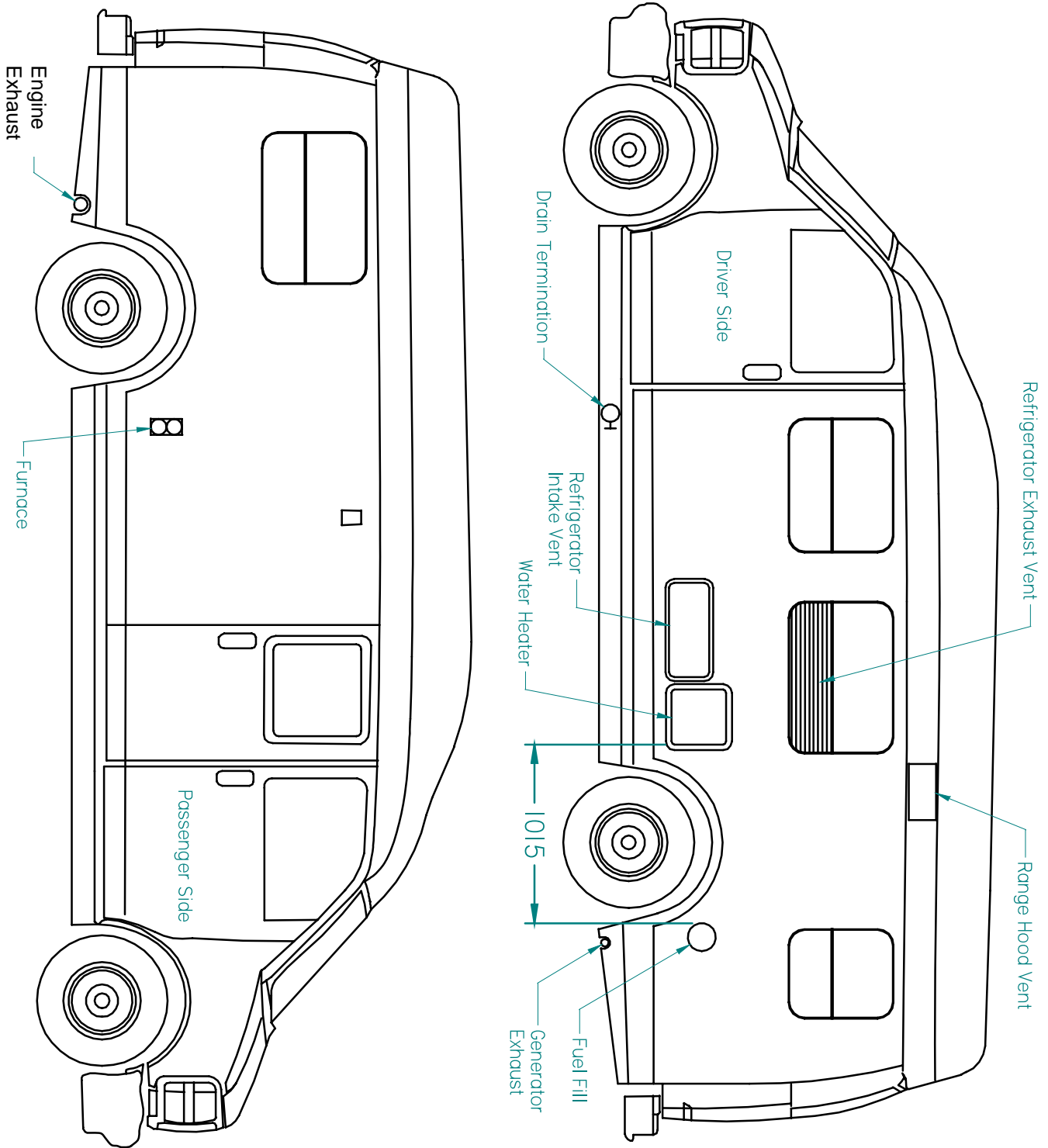

210-Versatile Chevrolet

-INTERIOR FINISH MATERIALS HAVE A FLAME SPREAD RATING OF LESS THAN 200
 -INTERIOR TEXTILE MATERIALS COMPLY WITH FMVSS 302
 -INTERIOR DOORS/PARTITIONS ARE NON-LOCKING

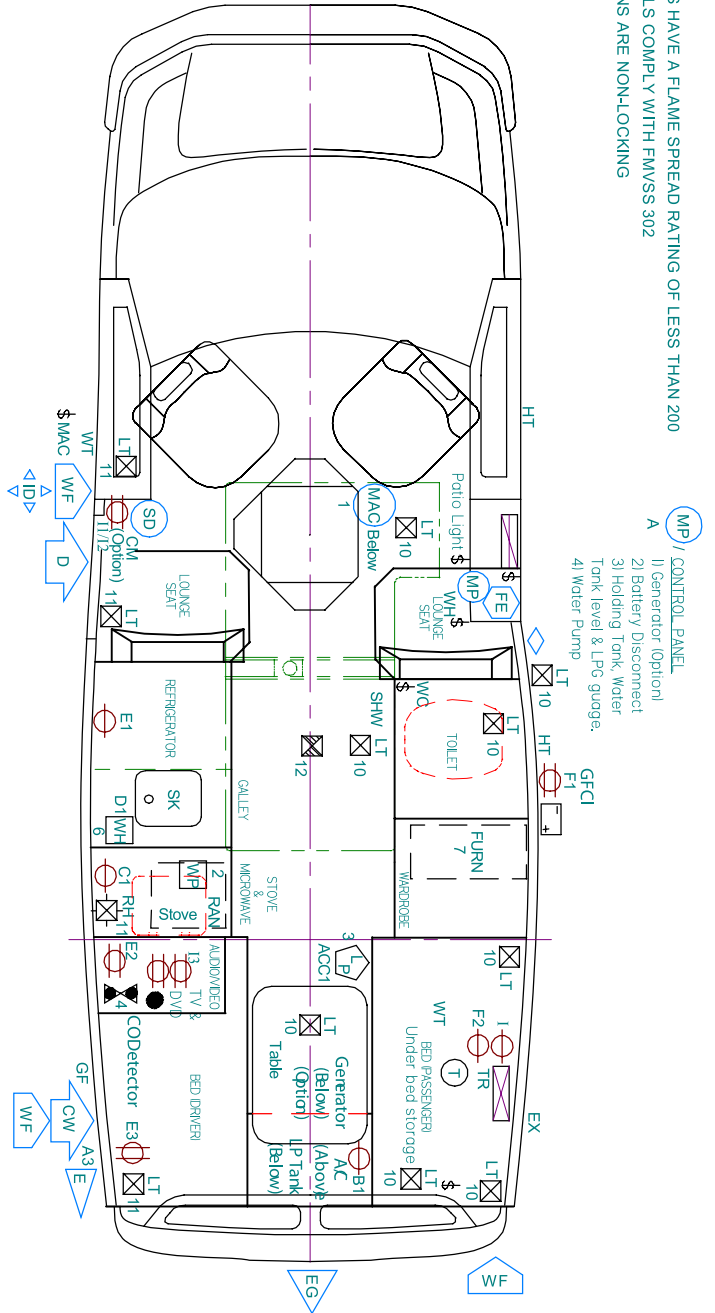

Circuit	VOLTS	AMPS	WIRE SIZE	LOADING
12	12	15	14AWG STANDARD CU	Roof/Vent Fan, Roof lights
11	12	15	14AWG STANDARD CU	Driver side lights, Cab light, Range hood vent fan
10	12	10	14AWG STANDARD CU	Passenger side lights, Patio light
9	12	15	14AWG STANDARD CU	Audio / Video Cabinet
8	12	10	16AWG STANDARD CU	Heat Pump
7	12	10	14AWG STANDARD CU	Furnace
6	12	10	14AWG STANDARD CU	Water Heater
5	12	20	10AWG STANDARD CU	Refrigerator
4	12	1	18AWG STANDARD CU	CO Detector
3	12	1	18AWG STANDARD CU	LP Gas Detector
2	12	10	14AWG STANDARD CU	Water Pump
1	12	20	10AWG STANDARD CU	Macerator
1	110	6	14AWG 2CU W/GROUND	Inverter output
11 / 12	110	15	14AWG 2CU W/GROUND	Galley Receiptacle
13	110	15	14AWG 2CU W/GROUND	Audio / Video (AV) cabinet Receiptacle
F2	110	15	14AWG 2CU W/GROUND	Inverter / Charger Receiptacle
F1	110	15	14AWG 2CU W/GROUND	Outdoor Receiptacle - passenger side
E3	110	15	14AWG 2CU W/GROUND	Rear wall Receiptacle
E2	110	15	14AWG 2CU W/GROUND	Lower AV Receiptacle
E1	110	15	14AWG 2CU W/GROUND	Fridge Receiptacle
D1	110	15	14AWG 2CU W/GROUND	Water heater
C1	110	15	14AWG 2CU W/GROUND	Microwave oven Receiptacle
B1	110	20	12AWG 2CU W/GROUND	AC / Heatpump Receiptacle
A3	110	30	10AWG 2CU W/GROUND	Outdoor Receiptacle
A	110	30	10AWG 2CU W/GROUND	Main Power Switch

CIRCUIT SCHEDULE 21VC

210-Versatile Chevrolet

NOTE: INVERTER

Your Owner's Manual for RV612ULHW contains most of the essential information you need to enjoy the electrical conveniences of home while at RV parks or dry camping. However, we wish to highlight for you exactly how the charging portion of the inverter/charger works, in order to help avoid possible confusion:

Supplying shore power or (optional) generator power enables RV612ULHW to charge the auxiliary battery (ies). Operation of your vehicle engine and alternator will also charge the auxiliary battery (ies). When your motorhome is not plugged-in to shore power or (optional) AC generator power, all electricity you use draws power from your motorhome's auxiliary battery bank, with the inverter allowing you to enjoy quiet DC-to-AC (12 volt to 120 volt) power in the absence of shore or generator power.

10V inverter/charger shut down

As a safety feature, the inverter component of the RV612ULHW inverter/charger (which changes DC battery power to AC electricity) will shut itself down when your auxiliary battery bank drops below 10 volts DC. This occurs in order to avoid excessive discharging and potential damage to the battery (ies), as well as to preserve sufficient battery voltage to maintain the functionality and readiness of the battery charger component of the RV612ULHW. It is possible, however, for the battery (ies) to become discharged below 10 volts DC as a function of activity other than using the inverter. For example, while dry camping, in the absence of shore or generator power, if a 12 volt appliance such as the fridge, furnace or lights are left on for an extended period of time. In that event, the battery charger component of the RV612ULHW will become inoperative. Therefore, after plugging into shore power or supply of (optional) generator power, it is possible that the battery (ies) may not be recharging. The indicators of this situation will be either completely dark LED lights on the monitor panel of the RV612ULHW inverter/charger, and a continuously blinking red LED light on the battery voltage readout, or all three LED lights continuously blinking on the battery voltage readout on the RV612ULHW.

Inverter/charger start up after automatic safety shut down

To remedy this situation, start the automotive engine, to allow the charger to sense a voltage of higher than 10 volts. The indicator of success will be a transition on the monitor panel from yellow inverted power LED light to the green line power illuminated LED light. This may take up to 60 seconds. At this point the engine can be turned off, because the charger has been activated and "takes over" the function of charging the battery (ies). Once battery voltage has risen sufficiently for your purposes (e.g., to the yellow, yellow-green, or green "full charge" level), shore power or (optional) generator power can be disconnected, although disconnection is not required; the charger will automatically reduce the rate of charge to prevent the battery (ies) from becoming overcharged.

Dry camping battery conservation

While dry camping (no 110 VAC power available) to conserve battery power, it is recommended to switch the inverter to the off or charge position, if the inverter is left in the ON position, it will continue to draw 1.25 amps. To ease in switching of the inverter, we recommend installation of the optional remote switch and harness. (Part # APSRM4)

Receptacle functionality

When using your motorhome and connected to shore power or optional generator, the receptacles in the audio/video cabinet and in the galley will function to the 15 amp capacity supplied from the distribution panel. However when no shore power or option generator power is available, these receptacles are limited to the 600 watts (6 amps) output from the inverter.

If an overload occurs, the inverter will shut down, and will need to be reset manually, by turning of the inverter off for 1 minute, removing the load, and then turn the inverter back on.

Your vehicle's electrical system should not be subjected to changes and / or additions to circuitry, appliances, etc. without consulting your dealer or Home & Park for proper installation procedures.

Failure to do this could result in serious safety issues or component damage. Changes to the electrical system run the risk of voiding the warranty.

120 / 12V INVERTER / CHARGER / DISTRIBUTION PANEL:

For your convenience when camping in parks with hookups for 110V power, all our models have in the electrical system a 110/12 volt distribution panel / inverter / charger. The inverter/charger provides 12 volt power for the 12 volt appliances and the inverter provides 110 volt power for the galley receptacle and the audio/video receptacle. The inverter charger also charges auxiliary batteries present in the system.

See "Floor Plan & Appliance Location" for the distribution/inverter/charger location. To open the distribution panel simply pull the access door until the cover is released. All the 110 volt breakers and 12 volt fused circuits are identified inside the distribution panel, behind the distribution panel access door.

EXTERNAL ELECTRICAL SOURCE CONNECTION:

Your vehicle is equipped with a heavy duty 30 amp. power cord so that you can connect your electrical system to an outside 110V power source.

The power cord is stored in the storage compartment, (see picture G-P19) located behind the driver side rear tire.

NOTICE: Do not place heavy or sharp objects on the power cord.

A 30 to 15 amp. adapter is not included with your vehicle.

NOTICE: When connecting your system to an external power source, ensure that a properly equipped (three pronged) and functioning receptacle is used. If any type of spark or shock is detected, disconnect from the source immediately and do not reconnect until the problem is corrected.

GENERATOR:

All service requirements are listed in the Onan Owner's Manual.

The generator is located and accessed on the underside behind the rear axle of your vehicle.

CAUTION: When launching a boat, using your Roadtrek, it is important to know that a generator must not be submerged in water. This will permanently damage the generator. If you cannot launch without submerging the generator, an alternate method would be to use a boat launching service.

Notice: To prevent carburetor damage, add an approved fuel stabilizer to our fuel tank, then run your generator for a minimum of 20 minutes under load monthly.

BUILT-IN 110V HEAT PUMP - AIR CONDITIONER:

In addition to the operating instructions contained in the Manufacturer's Owner's Manual, the air conditioner - heat pump should be started as follows when the optional generator is used:

1. Set the battery disconnect switch on the monitor panel to the "ON" position.
2. Start the generator and run for several minutes until warm.
3. Set thermostat setting above ambient temperature.
4. Turn thermostat control to the "low cool" position.
5. Turn fan to the ON position.
6. Adjust the thermostat cooler until the compressor starts.
7. Once compressor is running adjust the thermostat to desired setting. Your vehicle should be parked as close to level as possible to maximize the air conditioner's efficiency.

NOTE: The heat pump may be used to warm the motorhome on cool nights. For colder temperatures, below 40°F (4°C), it is suggested that the furnace be used for heat.

MONITOR PANEL:

The monitor panel is located on the shelf above the passenger lounge seat, (see Picture E-P1). For location of porch light switch with optional armoire, (see Picture E-P1B).

The monitor panel is used to provide the approximate fluid levels in the fresh, grey and black (holding) water tanks, the L.P.G. (Liquid Propane Gas) tank, and the charge level of the auxiliary battery(s).

The monitor panel has a series of L.E.D. lights that mark the fluid levels at set increments of F (full), 2/3, 1/3 and E (empty). Therefore with respect to the water tank levels, you must be aware that the panel does not always reflect the actual fluid levels. For example, when the 1/3 level light is on, the tank may be anywhere from 1/3 to just under 2/3 full. When the panel reads empty, the tank may be anywhere from empty to just under 1/3 full.

The black and grey water tanks must be flushed regularly with sanitation fluid, to prevent the accumulation of solids on the probes to maintain accurate black and grey water level readings. Required tank flushing will vary depending on usage.

To flush: Refer to the instructions on the Waste Tank Dumping found in the Water Systems Section.

NOTE: When the water system is operating in the winter mode, only the interior fresh water tank is to be used.

The auxiliary battery charge level indicator is marked "C", "G", "F", and "L".

1. "C" indicates the battery is fully charged.
2. "G" indicates the battery charge is "good".
3. "F" indicates "fair".
4. "L" indicates "low".

The battery condition is indicated by the uppermost light that is on. For example, if the "G", "F", and "L" lights are on, the battery charge is "good".

The panel also provides the switch for the water pump and a disconnect switch for the auxiliary battery.

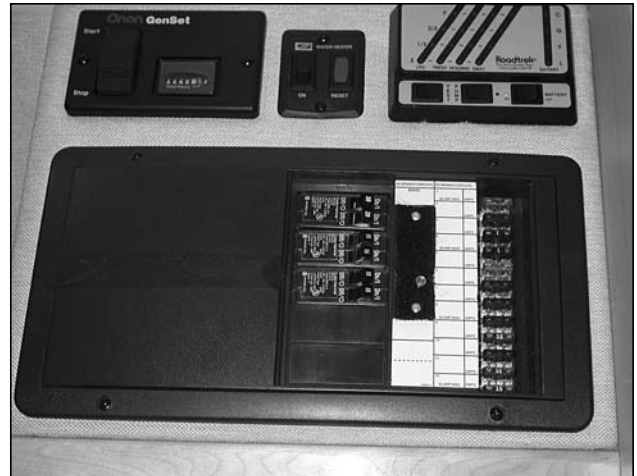

Picture E-P1: Monitor panel, water heater switch, 110/12V distribution panel and optional generator control switch.



Picture E-P1A: Location of porch light switch.



Picture E-P1B: Location of porch light switch with optional armoire.

AUXILIARY BATTERY AND ISOLATOR:

The auxiliary battery is a group 27 lead acid battery. The auxiliary battery is located behind the passenger side access door found ahead of the rear wheel, (see section on Auxiliary Battery). To access the battery refer to the auxiliary battery section found in the Daily Living section.

The auxiliary battery is automatically charged through the isolator by the engine's alternator while the engine is running. This battery is also automatically charged by the inverter / charger when:

1. The battery disconnect switch on the monitor panel is set to the "ON" position prior to connection to an outside electrical power source.
2. The breakers in the inverter/charger are in the "ON" position.
3. Or while the generator is in operation, (if so equipped).

A disconnect switch, located on the monitor panel, provides a disconnect for the auxiliary battery from the 12V system while your vehicle is not in use.

Since the auxiliary battery is a deep-cycle type, it may be discharged completely and recharged without damage, (whereas the automotive battery is designed to be kept fully charged by the alternator and may undergo damage if fully discharged). However, a battery should never remain in a discharged state and should be recharged immediately to prevent damage. When not in use, the auxiliary battery will slowly discharge on its own.

Accordingly, if the battery is not being used, it should be recharged monthly by connecting to an outside electrical power source, by operating the generator, (if equipped) for at least 12 hours, or by running your vehicle's engine for a minimum of 2 hours.

The **isolator** is located under the hood in the engine compartment. The isolator allows the alternator to charge both the automotive and auxiliary batteries when the engine is running, and it will prevent your vehicle's 12V motorhome equipment, (interior lights, water pump, exhaust fans, furnace blower, etc.) from drawing on the automotive battery.

AUTOMOTIVE BATTERY:

The automotive radio in your vehicle will exert a small draw on the automotive battery to maintain the time and preset stations.

To prevent the battery from being completely discharged, the radio should be disconnected from the automotive battery when your vehicle will be out of service for 2 months or more. Failure to do this may risk voiding the warranty.

The radio can be disconnected by removing the 10 amp. radio fuse from the automotive fuse block, located at the left underside of the dash, or by disconnecting the negative automotive battery cable. See Automotive Owners Manual for full radio operating instructions.

INTERIOR CAB LIGHT :

The interior 12V cab light located on the underside of the cab ceiling panel has a multipurpose switching system. This switching system utilizes the switch on the light itself and the dash mounted headlight switch, located to the left of the steering wheel.

Refer to the Chevrolet's Owner's Manual for complete operation instructions.

RANGE HOOD EXHAUST FAN:

The range hood exhaust fan should be on while the L.P.G. stove is in operation.

The operation switches for the fan and light are located on the face of the fan.

WATER HEATER :

The Roadtrek is equipped with a dual mode water heater. The water heater may be operated by 110V power or L.P.G. Please refer to the Suburban Owner's Manual for complete operation instructions.

REAR STORAGE LIGHT :

The inside rear storage light is powered by the auxiliary battery. The switch is located on the passenger side rear door post, (see Picture B-P36).

	POTABLE WATER FILL	A/C	AIR CONDITIONER	BAT	BATTERY CHARGE LEVEL INDICATOR
	CITY WATER INLET	TR	TRANSFER SWITCH	GFI	GROUND FAULT INTERRUPT
	POTABLE WATER PUMP		INSIGNIA LOCATION	GFC	GROUND FAULT INTERRUPT CIRCUIT
	DRAIN OUTLET		FIRE EXTINGUISHER (MIN. 10B.C.)		
WH	WATER HEATER		EMERGENCY EGRESS (17"x24" min.)		
WT	WATER TANK	EX	ENGINE EXHAUST		
HT	HOLDING TANK	GF	GASOLINE FILL		
WC	WATER CLOSET		MFG. ID LABEL		
LAV	LAVATORY		SMOKE DETECTOR		
SHW	SHOWER	LPG	LPG STORAGE TANKS		
SK	KITCHEN SINK	FURN	COMFORT HEATING APPL.		
	120V DISTRIBUTION PANEL	RAN	COOKING APPLIANCE		
	INVERTER / CHARGER	REF	REFRIGERATOR		
	12V FUSE BLOCK	GEN	GENERATOR SET		
	120V SINGLE RECEPTACLE		THERMOSTAT		
	120V DUPLEX RECEPTACLE	CM	COFFEE MAKER		
	120V SPLIT DUPLEX RECEPTACLE	MP	MONITOR PANEL		
	SINGLE POLE SWITCH	MAC	MACERATOR		
	2 POLE DBL THROW SWITCH		T.V. JACKS		
	12V LIGHT FIXTURE		CARBON MONOXIDE DETECTOR		
	12V EXHAUST FAN		L.P. DETECTOR		
	COMB. 12V FAN/LIGHT FIXTURE	MIC	MICROWAVE		
	120V ELECTRICAL INLET		BATTERY STORAGE		

LEGEND

ROADTREK MOTORHOMES
ELECTRICAL DIAGRAMS LEGEND

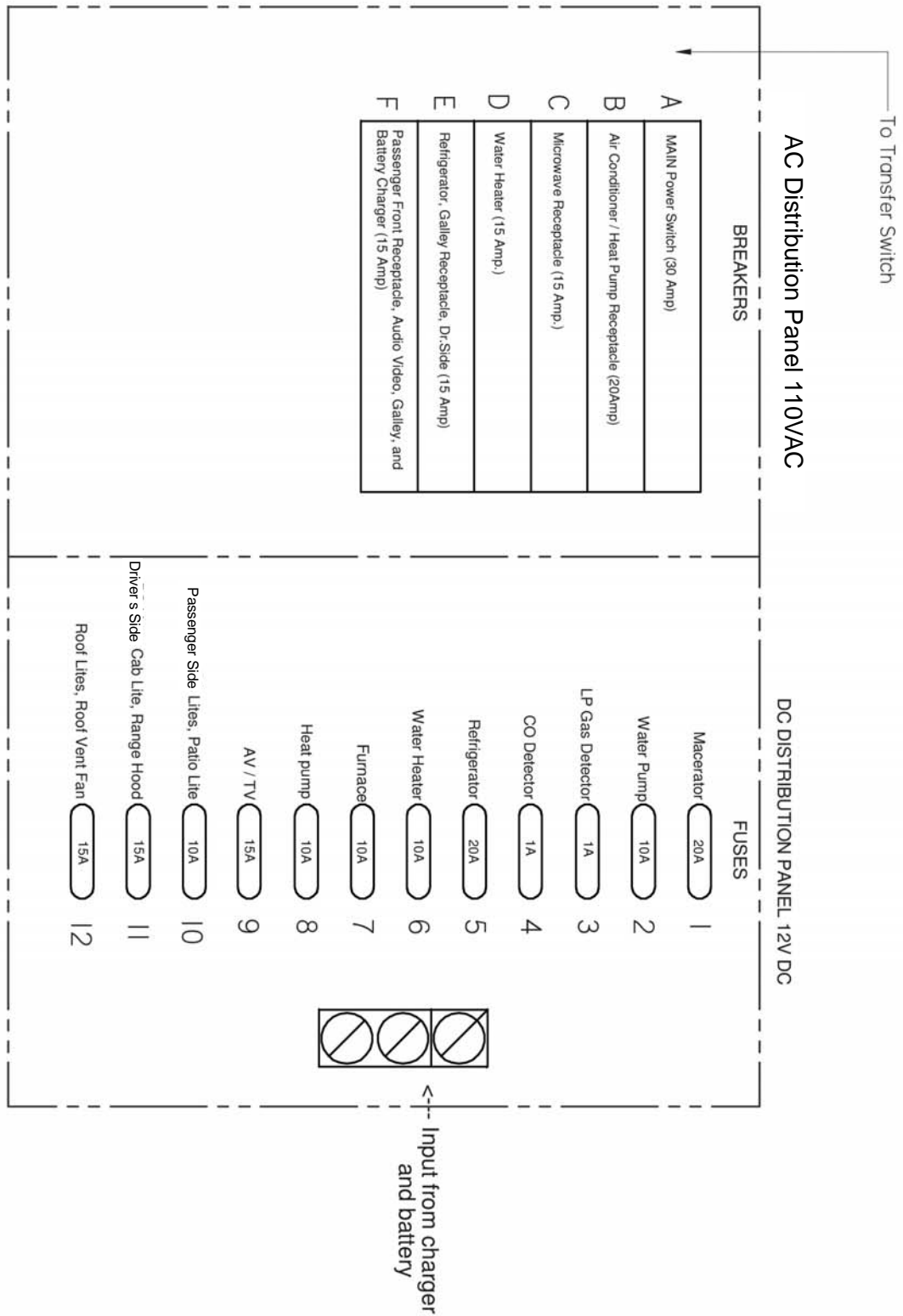

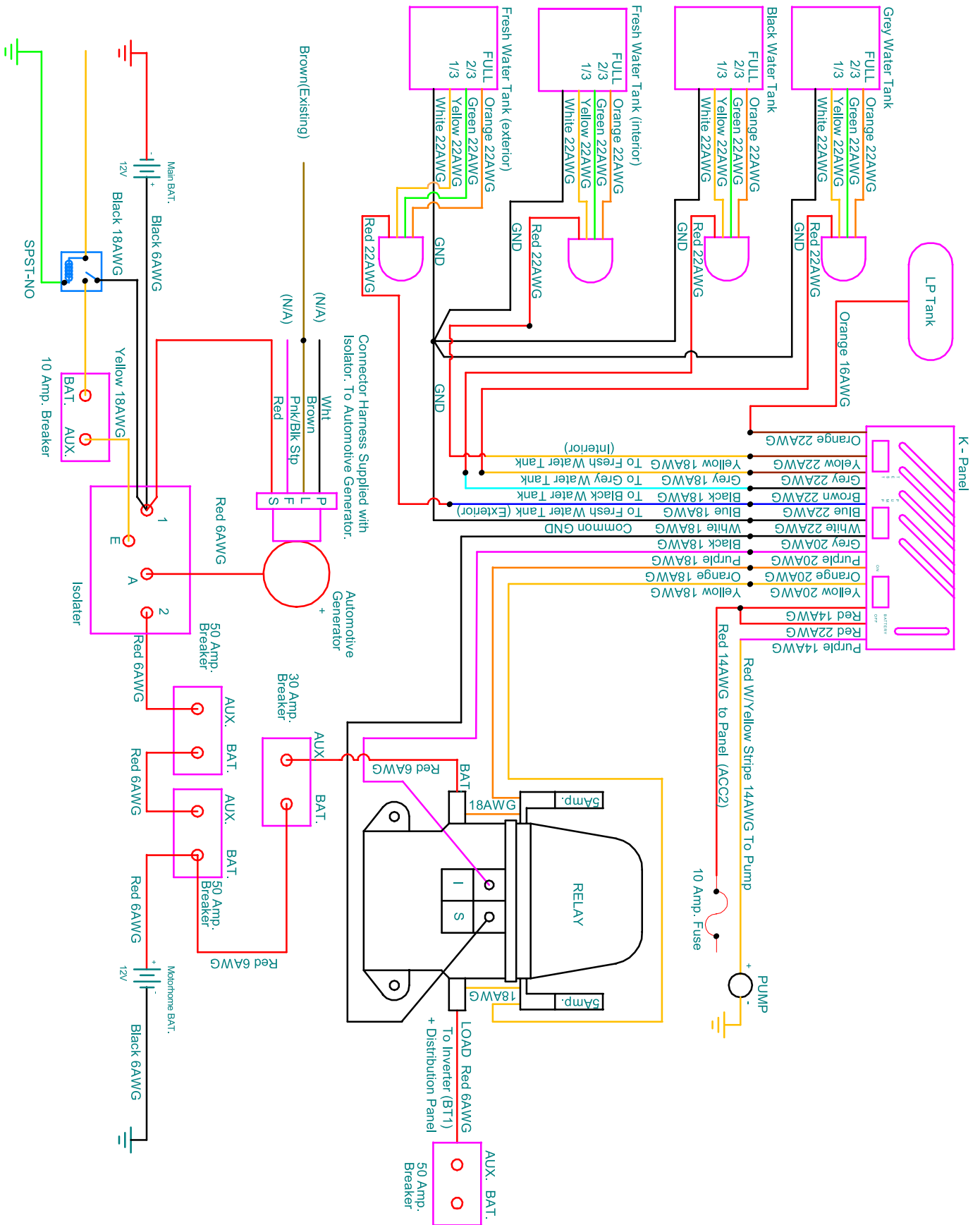

Your vehicle is equipped with an L.P.G. (Liquid Propane Gas) system which, when properly handled and maintained, will provide trouble and worry free operation of your L.P.G fueled appliances.

L.P.G. fuel is stored in a liquid state under extremely high pressure. As fuel is used, L.P.G. passes from the top of the tank through the regulator into the gas lines and eventually to the appliances.

Although the entire system has undergone extensive factory and dealer testing for leaks, the system's connections and fittings are subjected to road vibrations and therefore **should be checked annually for possible leaks.**

L.P.G. fuel is extremely flammable, colourless, heavier than air and smells like garlic or rotten eggs.

IF YOU SMELL GAS, extinguish any open flames, pilot lights and smoking materials immediately. Do not touch any electrical switches. Leave vehicle, shut off the gas supply at the tank valve and open doors and windows to provide maximum ventilation. Leave the area until the odor clears. Have the system checked and the leak corrected before use.

L.P.G. fuel tank valve must be open to operate gas fueled appliances.

WARNING: L.P.G. tanks shall not be placed or stored inside your vehicle. L.P.G. tanks are equipped with safety devices which relieve excessive pressure by discharging gas to the atmosphere.

WARNING: To reduce the danger of fire or explosion do not store gasoline or other flammable liquids inside your vehicle.

WARNING: Ensure you purchase L.P.G. from a reputable L.P.G. facility. Contaminated L.P.G. is a common cause of system failure.

WARNING: Follow all recommended maintenance schedules.

L.P.G. TANK:

To open and close the tank use the manual tank shutoff valve located on the tank, accessible from behind the rear bumper.

It is recommended to close the tank shutoff valve when the vehicle is not in daily use. Further, it is recommended to close the shutoff valve when the vehicle is in travel.

The refrigerator should be operated on 12 volt when the vehicle is in travel. See refrigerator Manufacturers Owner Manual for proper 12 volt operation.

APPLIANCES:

WARNING: It is not safe to use cooking appliances for space heating purposes due to the danger of asphyxiation.

WARNING: The L.P.G. stove needs fresh air for its safe operation.

Because the amount of air supply is limited by the size of your vehicle, before operating the L.P.G. stove, open the overhead vent or a window and then turn on the range hood for increased air circulation, (see Floor Plan & Appliance Location). Proper ventilation when using the L.P.G. stove will reduce the dangers of asphyxiation.

WARNING: Portable fuel burning equipment, including wood and charcoal grills and stoves, should not be used inside your vehicle. Use of this equipment inside your vehicle may cause fire or asphyxiation.

See appropriate component Manufacturer's Owner's Manuals for operating instructions.

REFUELING PROCEDURES:

WARNING: Do not refuel the L.P.G. tank to more than 80% of its capacity.

A properly refueled L.P.G. tank will hold approximately 80% of its volume in a liquid state. Over fueling of the L.P.G. tank can result in uncontrolled gas flow which can cause fire or explosion.

WARNING: The tank valve must be closed and **ALL PILOT LIGHTS, APPLIANCES, AND THEIR IGNITERS, (see Operating Instructions) SHALL BE TURNED OFF** during refueling of motor fuel tank and / or the L.P.G. tank. Only qualified personnel should refuel your L.P.G. tank.

REGULATOR:

The L.P.G. regulator is located adjacent to the L.P.G. tank.

This regulator has been installed under a protective cover to keep out debris, with the vent facing downward.

L.P.G. LEAK DETECTOR:

Your vehicle has been equipped with a L.P.G. leak detection device for your protection, (see Picture F-P1, Popular model, see Picture F-P1A, Versatile model).

See "Floor Plan & Appliance Location" for location of the L.P.G. leak detector location.

Be sure the detector is operating while using your vehicle. **Do not block air circulation in the area where the L.P.G. leak detector is located.**

See Manufacturer's Owner's Manual for other operating instructions.

WARNING: Battery disconnect switch must be in the "ON" position for detector operation.



Picture F-P1:
L.P.G. leak detector,
Popular model.



Picture F-P1A:
L.P.G. leak detector,
Versatile model.

CARBON MONOXIDE LEAK DETECTOR:

Your vehicle is equipped with a carbon monoxide (CO) leak detection device for your protection, (see Picture F-P2).

See "Floor Plan & Appliance Location" for location of the carbon monoxide gas leak detector location.

Be sure the detector is operating while using your vehicle. Do not block air circulation in the area where the carbon monoxide leak detector is located.

See Manufacturer's Owner's Manual for other operating instructions.

WARNING: Battery disconnect switch must be in the "ON" position for detector operation.



Picture F-P2: Carbon monoxide leak detector.

SMOKE DETECTOR:

Your vehicle is equipped with a smoke detection device for your protection, (see Picture F-P3, Popular model, see Picture F-P3A, Versatile model).

See "Floor Plan & Appliance Location" for the smoke detector location.

This device should be tested after each time your vehicle has been in storage, before each use, and at least once each week during your vehicle's use.

NOTE: Upon delivery of your vehicle from the factory, the detector is inoperative because the battery is reversed to prevent drainage. Before operation, reverse the battery to the proper position and test the operation of the detector.

Be sure the detector is operating while using your vehicle. Do not block air circulation in the area where the smoke detector is located.

See Manufacturer's Owner's Manual for operating instructions.

NOTE: Cleaning products may contaminate safety detectors. Detectors should be covered when using cleaning chemicals on the vehicles interior.



Picture F-P3:
Smoke detector,
Popular model.



Picture F-P3A:
Smoke detector,
Versatile model.

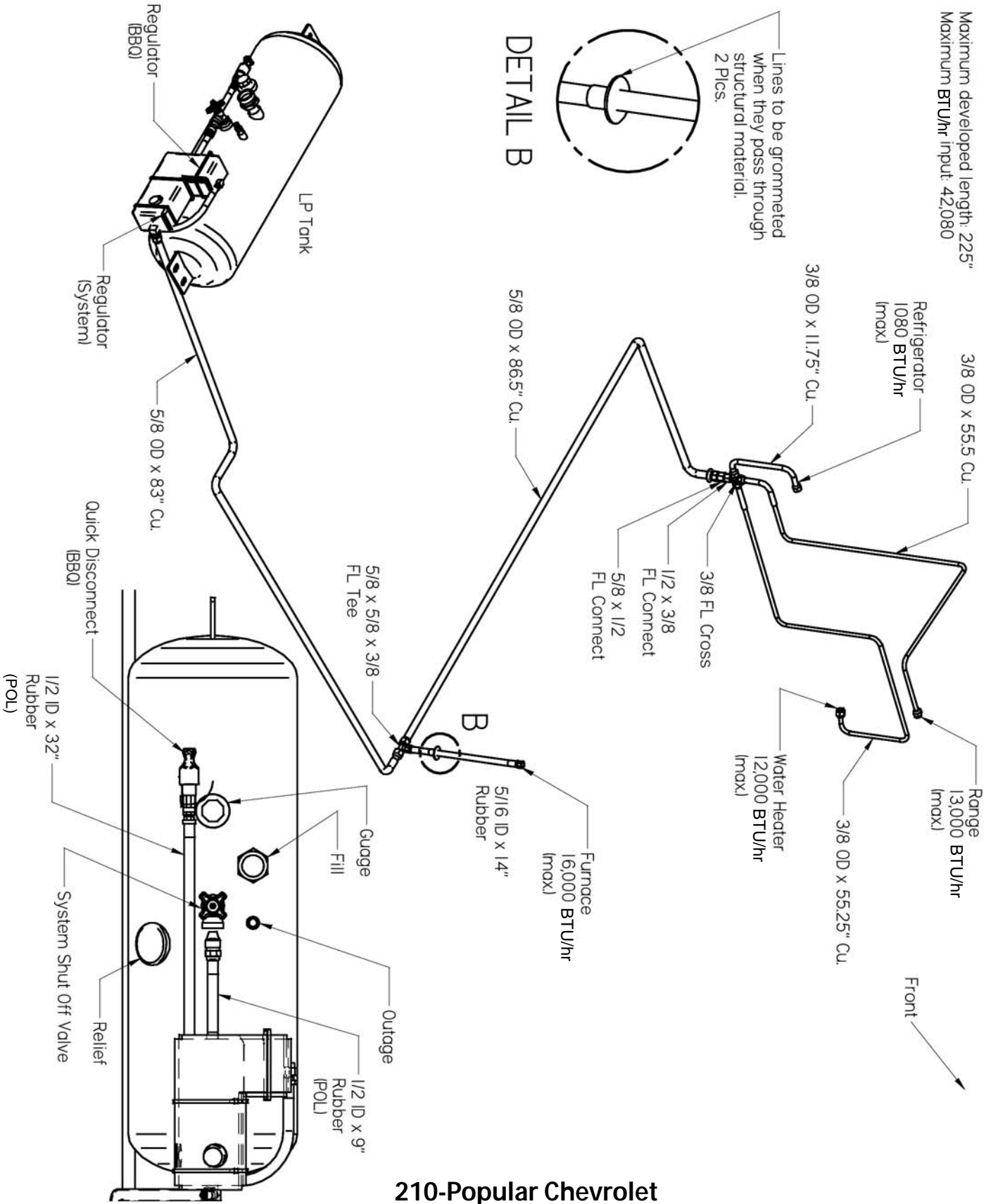

Maximum developed length: 272.3"
Maximum Btu/hr input: 42,080

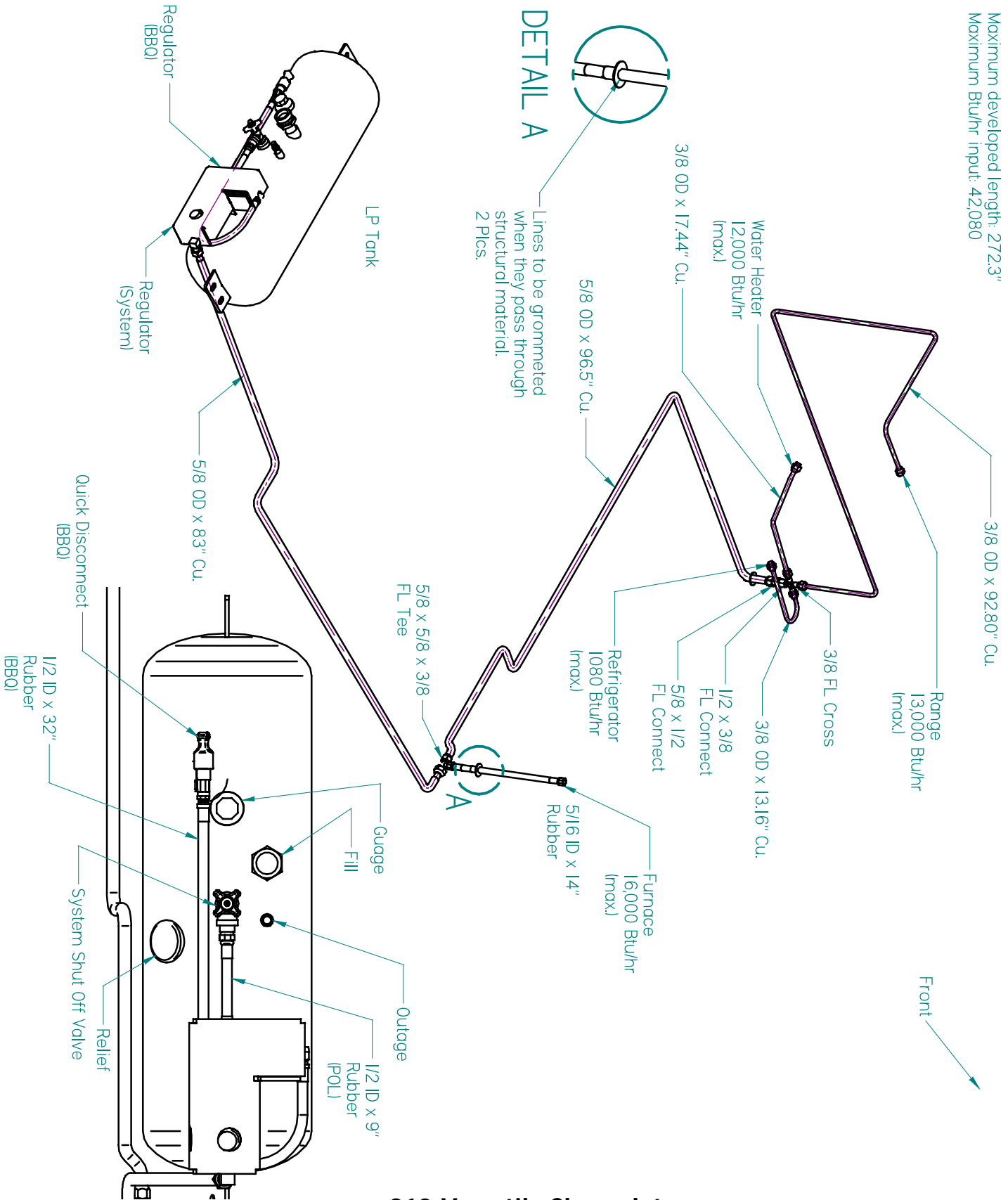

210-Versatile Chevrolet

WINTER MODE VALVE POSITIONS:

Tank selector valve must be in the interior tank position, (see Picture G-P1).

WINTER USE: (Moderate Subfreezing Conditions, -10°C (14°F)):

The dual tank system allows you to use the fresh water system under moderate subfreezing conditions by allowing you to isolate and drain the exterior fresh water tank.

- During winter use
- Use gravity fill for interior tank only.
 - No outdoor shower.
 - Waste water tanks are unprotected from freezing unless charged with antifreeze.
 - Interior temp must be maintained above 65°F(18°C) .
 - Fridge must be turned ON.
 - Exterior fresh tank must be drained.
 - Exterior shower and city fill must be drained.

To prepare your motorhomes fresh water system for winter use you must do the following:

1. Ensure you first turn off the water pump, (switch is found on the monitor panel) before isolating and draining the exterior fresh water tank.
2. Switch tank selector valve to interior tank position, (see Picture G-P1).
3. Drain exterior fresh water tank by opening exterior drain valve, (see Picture B-P30A on page B-10).

SUMMER USE VALVE POSITION:

1. Tank selector valve must be in the exterior tank position, (see Picture G-P2).

SUMMER USE:

1. The dual tank system requires you to switch from the interior tank to the exterior tank position. This will allow you to utilize the full capacity of both fresh water holding tanks.
2. To utilize the interior tank and the exterior tank at the same time, you must open the interior fresh water tank drain and position the supply selector valve to the exterior or summer position, (see Picture G-P6 on page G3).



Picture G-P1: Selector valve position for supply from the interior fresh water tank.



Picture G-P2: Selector valve position for supply from the exterior fresh water tank.

Your Roadtrek is equipped with a water heater by-pass valve. When it is in summer mode, all three valves will face the aisle, (see Picture G-P3). In winter mode, the water line valve is open and the valves at the water heater are closed, (see Picture G-P4).

NOTE: When the water system is operating in the winter mode, only the interior fresh water tank is to be used.

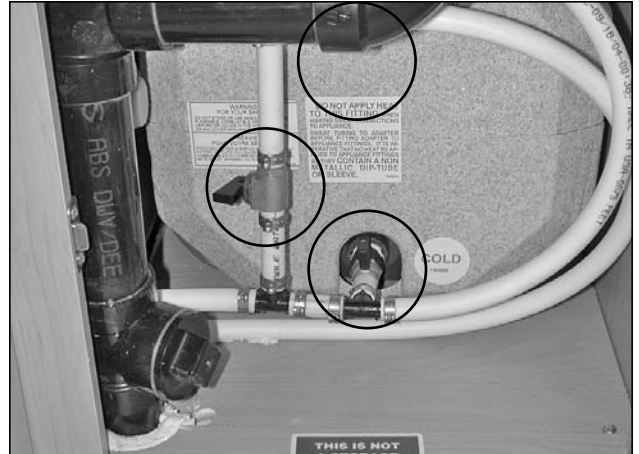

Picture G-P3: Summer mode valve positions.

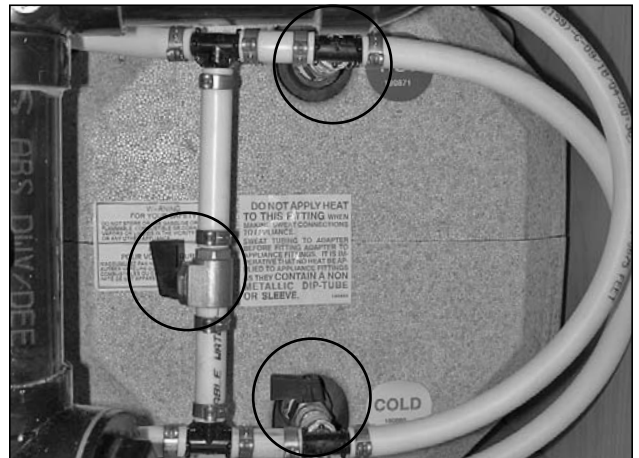

Picture G-P4: Winter mode valve positions.

To drain the exterior fresh water tank you must open exterior drain valve at the low point drain located below the drivers side front storage drawer compartment, (see Picture G-P5).

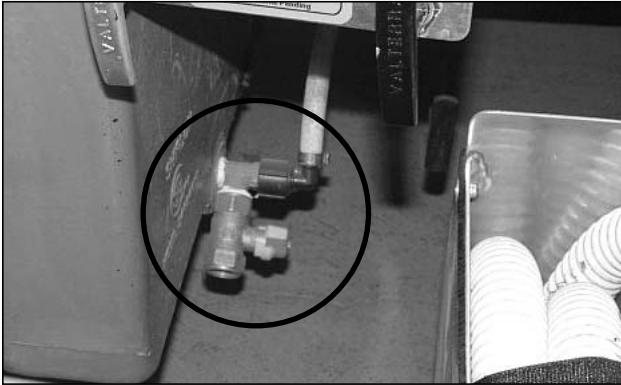

Picture G-P5: Location of the exterior freshwater tank drain.



Picture G-P6: Interior tank drain valve in open position.



Picture G-P7: Interior tank drain valve in closed position.

TO DE-WINTERIZE:

Repeat the steps in reverse order.

NOTE: By using antifreeze in the black and grey waste water tanks, the waste water system can be used in moderate subfreezing conditions.

Although the waste and fresh water systems have been designed for use in moderate subfreezing conditions, Home & Park Motorhomes makes no warranty what so ever for damage to the water systems as a result of freezing.

To prevent interior water lines from freezing, it is recommended that the interior temperature be maintained at +65°F (18°C) and the refrigerator left running.

FRESH WATER TANKS:

One tank is located in the vehicle's interior, the other tank is located on the vehicle's exterior. The purpose of the dual tank system is to provide a separate fresh water system that can be used in moderate sub freezing conditions.

The system can only function properly in either one of two modes. Summer use or winter use. All procedures to change operation modes must be followed for proper operation.

Your vehicle is equipped with a water system for either completely self contained or fully dependent use. It is not equipped with a pressure regulator to compensate for varying water pressure levels.

During self contained use, caution should be taken so as to minimize water consumption. For example, water consumption can be reduced while showering if you turn off the shower between wetting down and rinsing off.

To avoid damage due to road vibrations, be sure not to store heavy or sharp objects where they may come into contact with either the water lines or water pump. Also, allow sufficient room around the pump for proper operation.

FILLING THE INTERIOR FRESH WATER TANK:

The interior fresh water tank can be filled through the gravity fill located on the passenger side of the rear door opening, (see Picture G-P8). To fill the interior tank:

1. Open the rear passenger door.
2. Open the gravity fill cover by removing the orange plug, (see Picture G-P8).
3. Insert the hose and fill the tank using moderate pressure, (excessive pressure will result in a back flow of water).
4. When the tank is full, water will overflow back through the gravity fill hole.
5. Overfilled tanks will spill out through tank vents. This is evidenced by water dripping from the rear passenger side corner of van.



Picture G-P8 : The gravity fill for the interior fresh water tank, (located on passenger side rear door post).

FILLING THE EXTERIOR FRESH WATER TANK (All Models):

1. Open the front driver side door.
2. Open the gravity fill cover by removing the orange plug, (see Picture G-P9).
3. Insert the hose and fill the tank using moderate pressure, (excessive pressure will result in a back flow of water).
4. When the tank is full, water will overflow back through the gravity fill hole.
5. Overfilled tanks will spill out through tank vents. This is evidenced by water dripping from the underside of the van.



Picture G-P9 : The water fill for the external fresh water tank, (located at driver's side front door post).

The fresh water tanks can also be filled through the city water inlet located behind the rear lockable driver side access drawer, for location, see the Daily Living section. The use of the city fill is not possible when in the winter operation mode.

To fill the tank:

1. Prior to using city fill, ensure water system is in summer use mode, (see Picture G-P2 on page G-1). Connect a hose to the city water inlet connection, (see Picture G-P10).
2. To fill the exterior fresh water tank, open the city water tank fill shut off valve, (see Picture G-P11).
3. Open the water source moderately.
4. When the tank is full, water will overflow in the same manner as when using the gravity fill, (see previous page).
5. To fill the interior fresh water tank, ensure the water system is in winter mode, (see Picture G-P1 on page G-1). Repeat steps 2-4.
6. Close the city water tank fill shut off valve, (see Picture G-P5).

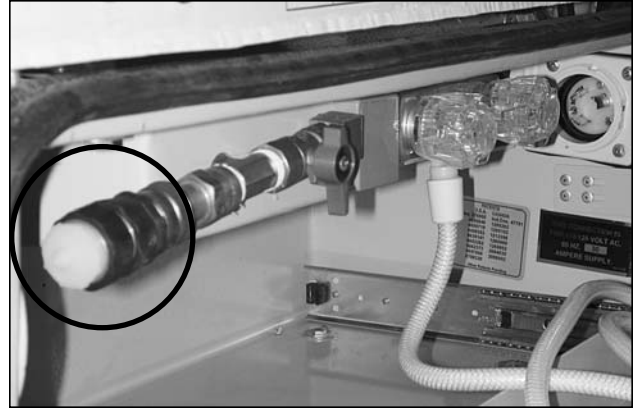

Picture G-P10: Location of the city water inlet connection.

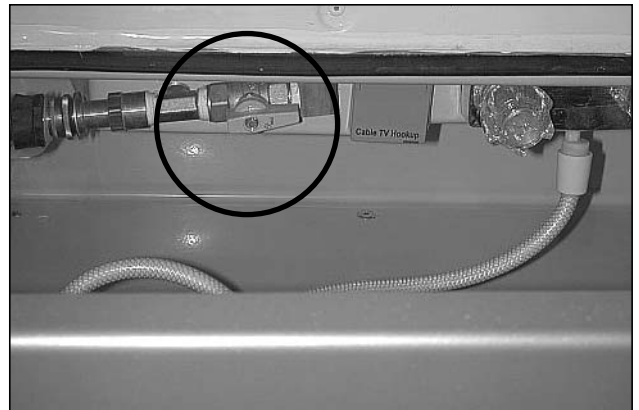

Picture G-P11: Open position of the city water tank fill valve.



Picture G-P12: Closed position of the city water tank fill valve.

CITY WATER CONNECTION:

NOTE: City water connection can only be used in summer operation mode.

The city water inlet connection is located in the small compartment behind the large lockable driver side storage compartment, (see Picture G-P10). To connect the water system to an outside source:

1. Ensure that the water pump is turned off.
2. Close the city water tank fill valve by turning the handle to the vertical position, (see Picture G-P12).
3. Be sure that all interior faucet's are closed to prevent spillage.
4. Open the city water source slowly to prevent excessive water force inside your vehicle. To protect your system from excessive pressure from water supply systems encountered in some areas, a water pressure regulator should be used. Such a regulator is not supplied with your vehicle.
5. Note that this connection by-passes the water pump and fresh water tank. Therefore, the use of these items is not necessary when connected directly to an external water source.

To disconnect the city water connection:

1. Turn off the external water source.
2. Open the sink faucet to relieve the pressure in the system, (failure to do so may result in an unexpected shower).
3. Ensure that the city water tank fill valve is closed, (see Picture G-P12).
4. Remove the hose from the city water connection, replace the cap on fill connection.

WASTE WATER STORAGE AND DUMPING SYSTEM:

Your vehicle is equipped with a waste water storage and dumping system that will provide adequate and effective storage and dumping of waste water. Your vehicle should be as level as possible to allow optimal operation of the system.

CAUTION: Ensure that both the black and grey water gate valves are closed, (inward position) before using the waste water system. This applies especially after extensive driving. Black and grey water dump valves are accessed through the driver side storage door, (see Picture G-P13).

Waste Water Tank Preparation:

Your vehicle is equipped with two waste water tanks; the grey waste water tank is for waste water from the sink and aisle shower. The black waste water tank is for sewage from the toilet. Both tanks are equipped with separate dump valves so that each may be dumped independently. Before use of either waste tank, be sure to read instructions provided by the toilet manufacturer regarding waste water chemicals. We suggest that such chemicals be used every time to minimize odours and build up of solids on water level sensors inside the tanks.

CAUTION: During winter use under moderate subfreezing conditions, (refer to page G.1-G.3) antifreeze is required in the exterior black and grey waste water tank. Antifreeze should be used at a 50-50 ratio.

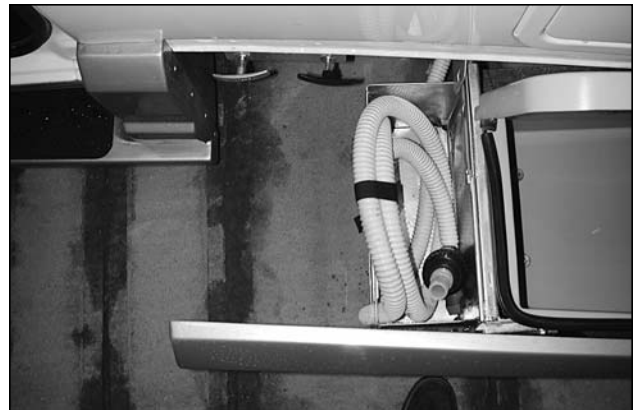

Picture G-P13: Driver side storage door.



Picture G-P14: Access to sewer discharge assembly, black and grey gate valve handles.

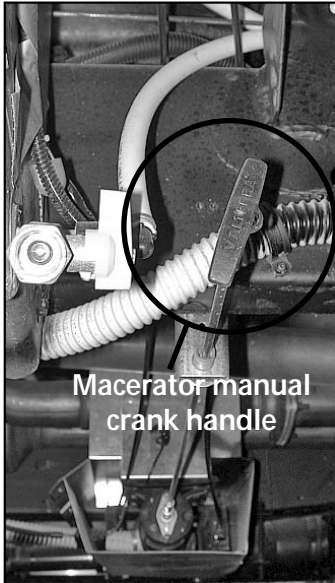

Picture G-P15: Macerator pump located under center of vehicle.



Picture G-P16: Macerator pump switch located on driver's door post.



Picture G-P17: Sewage discharge hose storage located in driver's side storage drawer.

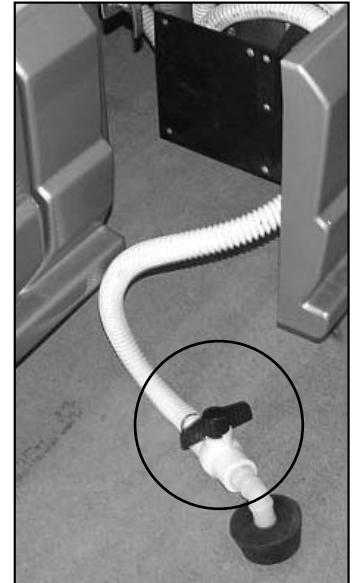

Picture G-P18: Sewage hose discharge valve.

Waste Water Tank Dumping:

To dump the exterior black waste water tank:

1. Turn the battery disconnect switch to the "ON" position, if not already on, (located on the monitor panel).
2. Remove sewage discharge hose from storage, (see Picture G-P17).
3. Insert the discharge outlet into the waste receptacle.
4. Open the valve on the sewage hose, (see Picture G-P18).
5. Open the black water tank valve, (see Picture G-P14).
6. Open the driver's door, press and hold the macerator pump switch until the tank is empty, (see Picture G-P16).

To dump the grey waste water tank:

1. Open grey water tank valve.
2. Repeat step 6.
3. Close all valves.
4. Return sewage hose to its storage compartment.
5. Turn battery disconnect to the "OFF" position.

NOTICE: It is recommended to always dump the black water tank first, then the grey water tank.

NOTE: If macerator should get clogged you will have to push and turn the manual macerator crank "T" handle to dislodge any debris that might be blocking the macerator, (see picture G-P15).

Waste Water Tank Flushing:

To flush the waste water tanks:

1. Ensure that both tanks are empty by checking the monitor panel.
2. Fill the black waste water tank by inserting a hose into the toilet, **(be sure to step on the flush pedal, so the flapper door stays open to prevent toilet overflow)** and the grey waste water tank using the sink.
3. Dump both tanks using the procedure outlined above.

Both waste water tanks can also be flushed using a similar procedure, but rather than filling each tank using the potable water system, they can be filled by inserting a hose directly into the sink and toilet.

OUTSIDE SHOWER:

NOTE: Outside shower can only be used in summer operation mode.

The outside shower faucet is found in the storage compartment behind the driver side rear wheel. Remove the shower hose from the storage compartment and attach to the faucet spout, (see Picture G-P19). The shower hose must be returned to the storage compartment before travel as to prevent damage to the unit.



Picture G-P19: Outside shower and shore power connection. Shower hose storage when Motorhome is parked.

POTABLE WATER SYSTEM DRAINING:

NOTE: Water system must be in summer operation mode.

To completely drain the fresh water system of all water:

1. Ensure that the water pump is off and that your vehicle is level.
2. Ensure that the interior tank valve is in the open position.
3. Drain the fresh water tank and the hot and cold fresh water system by opening the exterior fresh water drain valve at the low point drain, (see Picture G-P5 on page G-3).
4. Open all water outlets including the sink faucet, aisle shower faucet, external shower faucet, and toilet flushing pedal. The latter can be propped open or opened manually several times. This procedure allows gravity to draw any remaining water out through the tank drains.
5. Your vehicle is equipped with a water heater, follow the manufacturer's instructions for draining.
6. Open the sink faucet and turn on the water pump until water is no longer pumped.
7. Turn off the water pump.

If this procedure is followed, it is unnecessary to blow out the water system. Once the system is drained, be sure to close all taps before driving.

NOTE: Do not allow water to sit in tanks when vehicle is not in use.

POTABLE WATER SYSTEM SANITIZING:

NOTE: Water system must be in summer operation mode.

Your potable water system should be sanitized if it is new, has not been used for a period of time, or may have become contaminated.

To sanitize your system:

1. Prepare a chlorine solution using 4 L (1 gallon) of water and 60 ml (1/4 cup) of household bleach, (5% sodium hypo chlorite solution).
2. With the fresh water tank empty, (see section on Waste Water Tank Flushing), pour, (see section on Filling Fresh Water Tank) 4 L (1 gallon) of solution into the fresh water tank for each 60 L (15 gallon) of tank capacity. As an alternative, several commercial solutions are available and should be used as directed on the package.
3. Complete filling of the tank with fresh water.
4. Turn on the water pump and slowly open all faucet's to release trapped air.
5. Close faucet's and allow to stand for 3 hours then drain and flush with fresh potable water.
6. To remove excessive chlorine taste or odor which may remain, prepare a solution of 1 L (1 quart) vinegar to 20 L (5 gallons) water and pour into tank and allow solution to agitate in tank by vehicle motion, (several days if possible).
7. Drain tank and flush with fresh potable water.

WATER SYSTEM WINTERIZING:

NOTE: Water system must be in summer operation mode and repeat operations 5 and 6 with water system in winter operation mode.

To winterize your potable water system:

1. Drain the entire system including water heater, (refer to water heater manual for instructions on draining).
2. Place water heater by-pass in the by-pass position to prevent water heater from filling with antifreeze.
3. Add 8 L (2 gallons) of approved nontoxic recreational vehicle antifreeze to the interior and exterior fresh water tanks using both gravity fills.
4. Turn on the water pump.
5. Open all three faucet's until antifreeze is visible.
6. Open the toilet valve until antifreeze is visible. Refer to the water system winterizing **NOTE** above.
7. Turn off pump.
8. Remove the plug for the aisle shower drain and fill P-Trap with antifreeze

To prepare your potable water system for use:

1. Drain the antifreeze from the system.
2. Sanitize the system if desired.

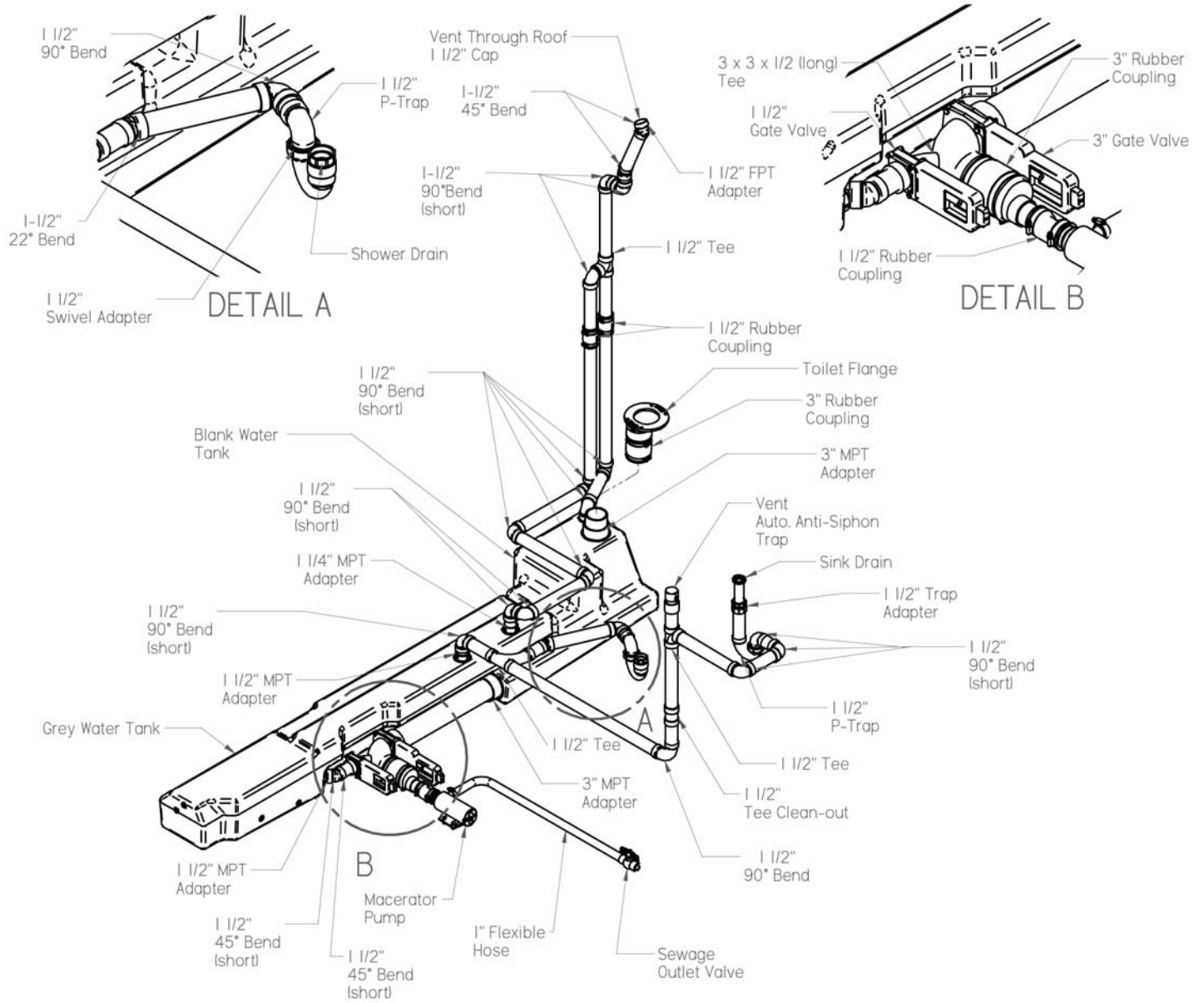

210-Popular Chevrolet

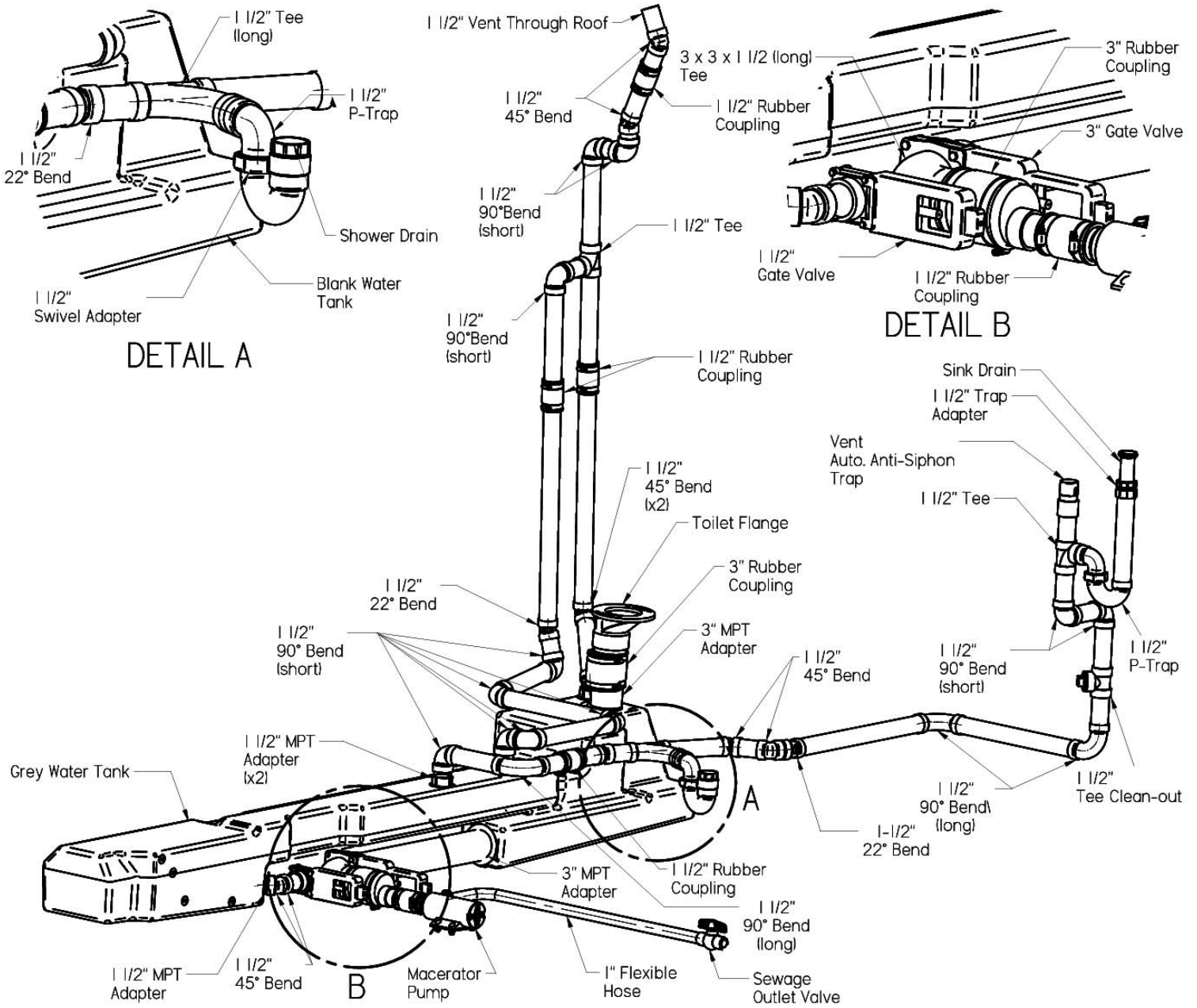

210-Versatile Chevrolet

FIBERGLASS MAINTENANCE:

To maintain the original appearance and finish, your vehicle's fiberglass running boards, roof and/or body must be waxed at least annually. If deterioration, such as tarnishing or chalking, should occur, apply a mild rubbing compound and wax to restore the original appearance.

EXTERIOR WASHING:

To prevent water from entering your vehicle, avoid spraying water directly into exterior vents or grills. Use care and caution when using a power washer to prevent water leaks. Do not point power washer directly towards any door openings, body seams, vent or automotive striping.

OTHER MAINTENANCE:

For necessary maintenance of other components and appliances, see their respective manufacturer's owner's manuals for instructions.

WINTER STORAGE:

INSIDE YOUR VEHICLE:

Before winter storage:

1. Be sure to clean your vehicle thoroughly. Special emphasis should be given to the appliances, such as the refrigerator.
2. Once cleaned, leave the refrigerator door propped open with the cutting board in the freezer compartment to prevent the development of odors, (insert a box of baking soda if desired).
3. Open a window slightly allowing sufficient air circulation to avoid the development of odors, condensation and mildew.
4. To prevent sun rays from deteriorating and fading interior fabrics, cover all upholstered seats and cushions. As a further precaution, close all drapes tightly.
5. Disconnect the auxiliary battery using the disconnect switch located in the monitor panel.

OUTSIDE YOUR VEHICLE:

Before winter storage:

1. Ensure that all waste water tanks have been dumped and flushed and that the entire potable water system has been properly drained, refer to sections on Potable Water System Draining and Potable Water System Winterizing.
2. Be sure to cover the external vents to the refrigerator, exhaust fan, furnace and air conditioner with heavy plastic sheeting to prevent entry by rodents and insects.
3. To improve tire life and maintain performance, put your vehicle up on blocks. Also, cover all tires exposed to sun light to prevent deterioration from ultraviolet rays.
4. Consult your automotive owner's manual or local automotive dealer regarding steps necessary to prevent engine and chassis damage during long periods of storage in your particular region.
5. Vehicle should be parked level so that all vents and water drains can operate properly.

SPRING START UP:

After storage, reactivate your vehicle for use by reversing all the procedures that you performed to prepare it for winter storage. In addition, L.P.G. (liquid propane gas) system's connections and fittings should be checked for possible leaks and all other systems and appliances should be operated to ensure satisfactory performance.

TIRES:

See the automotive chassis manufacturer's owner's manual and documents for tire warranty and recommended inflation pressures.

CARGO CARRYING CAPACITY:

See the information labels attached to the driver door post, inside of lower galley cabinet door, and insert at the front of this manual.

OWNER MAINTENANCE CHECKS:

Listed below are vehicle maintenance checks and inspections that should be performed by the owner or qualified service technician at the indicated intervals.

Any adverse conditions should be brought to the attention of your dealer or qualified service technician for expert service advice as soon as possible.

The owner maintenance checks are generally not covered by warranties and you may be charged for labor, parts and supplies used.

WHEN YOU STOP FOR FUEL:

Extinguish all pilot lights, (e.g. refrigerator, furnace).

Check engine oil level.

Look for low or under inflated tires, the tires should be 50 P.S.I. in the front tires and 80 P.S.I. in the rear tires.

AT LEAST MONTHLY:

Check coolant level in the coolant recovery reservoir.

Check operation of all exterior lamps, including brake lamps, turn signals and hazard warning flashers.

Check tire pressure.

Run generator for 20 minutes under load to prevent carburetor damage.

AT LEAST ONCE EVERY THREE MONTHS:

Flush black water holding tank.

Flush grey water holding tank.

Add fuel stabilizer to the fuel tank.

Flush and sanitize fresh water tank.

Grease external drawer slides.

AT LEAST TWICE A YEAR:

- Check power steering fluid level.
- Check windshield washer level and wiper operation. Clean wiper blades with clean cloth dampened with washer fluid.
- Check radiator, heater and air-conditioning hose for leaks or damage.
- Check for worn tires and loose wheel lug nuts.
- Check parking brake system.
- Check head lamp alignment.
- Check lap and shoulder belts for wear and function.
- Check air pressure in spare tire.
- Inspect appliance vents to ensure they are free from dirt, insects, spider webs and/or nests.
- Inspect black and grey water tank vents.
- Clean air conditioner filter.
- Thoroughly clean and wax the roof of the van.

AT LEAST ONCE A YEAR:

- Lubricate all door hinges, locks and latches.
- Clean battery terminals, (automotive and coach).
- Have L.P.G. test completed by certified gas technician.
- Have appliances tested and cleaned.
- Wax & polish and protect exterior surfaces.

The above maintenance schedule is a recommendation only. Please refer to your Chevrolet Manual for details on the Chevrolet required maintenance schedule.

Efficient economical vehicle performance will be enhanced by utilizing this recommended maintenance. It is strongly recommended that no repairs be made without appropriate training, tools and safety equipment. This could cause bodily injury, damage to the vehicle or cause the vehicle to operate improperly.

Home & Park shall not be held liable or assume any obligations or responsibilities whatsoever for any loss, damage or injury directly or indirectly caused by, arising or resulting from, or as a consequence of the use or nonuse of the information contained herein or the operation or non-operation of any items mentioned herein. Home & Park shall be indemnified and saved from all losses, expenses, claims and demands whatsoever.

AUXILIARY BATTERY:

Your vehicle is equipped with a group 27 lead acid auxiliary battery. Dual battery option is equipped with two 6 volt deep cycle batteries. It is recommended that acid levels be checked at least once every 3 months, every 1 month under heavy usage.

See battery manufacturers maintenance recommendations.

In order to maintain the function of the slide out battery tray you must lubricate the slides and compartment bottom. Use of a general automotive grease is recommended. It is recommended that this be done every 3 months when you are checking the acid levels.

ALUMINUM WHEEL MAINTENANCE:

Never clean your wheels when they are hot either from free standing in the sun, or from normal road use.

Always clean wheels when they are cool to the touch of your hand. If you spray any type of cleaning agent, corrosive or not, they will stain a polished and chrome wheel and even some clear coated wheels. Period. No matter how expensive they are.

Clean your wheels either early in summer mornings or dusk on summer evenings. A good practice is not to clean them in direct sunlight. We are experiencing different UV and ambient temperatures, from a result of a changing ozone. This also plays havoc on tires as well.

Clean rims using mild soap and water. Some strong cleaning agents will spot polished wheels every time.

Avoid car washes if possible when your wheels are hot. This could stain the wheel.

In time, due to brake and regional temperatures in North America, the wheel's lustre will fade, so from time to time, use a premium polish wheel cleaner/polish to keep the natural polished finish.

Never use steel wool or coarse abrasive pads to clean ANY wheel. This will cause permanent damage, and will not be warranted by the wheel manufacture.

It is recommended to place Vaseline, or some type of oil based cooking grease and coat the wheels during the harsh winter and touch them up from time to time or have a set of winter wheels and tires.

LIMITED WARRANTY DEFINITIONS

Home & Park Home & Park Motorhomes (A Division of HANMAR MOTOR CORPORATION).

Dealer	Dealer or any wholesale buyer of recreational vehicles, authorized by Home & Park .
Vehicle	Any recreational vehicle manufactured by Home & Park Motorhomes .
Purchaser	Registered owner of the Vehicle and/or purchaser of the Vehicle .
Warranty Card	Home & Park Limited Warranty Registration Card specifying Purchaser of Vehicle .

All vehicles are covered by a three part limited warranty: Automotive Warranty, Appliance Warranty, and Home & Park Limited Motorhome Warranty.

HOME & PARK LIMITED WARRANTY REGISTRATION CARD

It is very important that the Dealer complete the Home & Park Limited Warranty Registration, (at the bottom of the "QualityCare" Pre-Delivery Report) on each Vehicle and fax it to Home & Park within 48 hours from the date of retail delivery. Home & Park uses the information on the Limited Warranty Registration to:

1. Notify General Motors to start the automotive (chassis) warranty in the Purchaser's name as of the date of retail delivery.
2. Maintain records for the Home & Park Limited Motorhome Warranty and for any recall notifications.

If Home & Park does not receive this information, when the Purchaser tries to have automotive warranty work done, the Purchaser, the Dealer and Home & Park will be severely inconvenienced until this information is received and processed by General Motors.

AUTOMOTIVE WARRANTY - GENERAL MOTORS (CHEVROLET CHASSIS)

The warranty currently offered by General Motors covers the manufacture of the Chevrolet chassis. See the General Motors Warranty Information booklet for details.

For Chevrolet chassis sold through **RV dealers**, Home & Park uses the information on the completed Warranty Card to notify General Motors to **restart the automotive (chassis) warranty** in the Purchaser's name as of the date of retail delivery. Upon receipt of the Warranty Card, Home & Park completes and mails the appropriate forms to General Motors who in turn enter this information into their computer systems. This process can take up to 6 weeks from when the Dealer mails the Warranty Card. If warranty work is required before this process is completed and the Vehicle's V.I.N. appears on the computer, the Purchaser should ask the Chevrolet dealer to enter the Purchaser's name and address and date of retail delivery into the computer. To prove the vehicle is still under warranty, the Purchaser should show a copy of the bill of sale to the Chevrolet dealer.

If Home & Park does not receive the completed Warranty Card, when the Purchaser tries to have automotive warranty work done, the Purchaser, the Dealer and Home & Park will be inconvenienced until this information is received and processed by General Motors.

AUTOMOTIVE WARRANTY - GENERAL MOTORS (CHEVROLET CHASSIS)

For Chevrolet chassis sold through **Chevrolet dealers**, the Dealer will enter the appropriate information directly into General Motors' computer system to **restart the automotive (chassis) warranty** in the Purchaser's name as of the date of retail delivery.

All automotive service, maintenance and repairs are to be performed by any Chevrolet dealer. See the General Motors Warranty Information booklet for details. Such items are not warranted by Home & Park. **Home & Park will pay for the removal and reinstallation of motorhome components necessary to perform automotive recalls and warranty** for 36 months or 36,000 miles (in US) or 60,000 Km (in Canada), which ever occurs first, from date of purchase by the first Purchaser. After this period such costs are considered to be inherent in the ownership of such a vehicle. **Home & Park will not pay for the removal and reinstallation of motorhome components necessary to perform automotive service or maintenance.** Such costs are considered to be inherent in the ownership of such a vehicle.

LIMITED WARRANTY INFORMATION

The following information must be provided when contacting the factory for warranty:

Selling Home & Park Dealer: _____

Address: _____ Phone: (____) _____

City, State/Prov: _____ Zip/Postal Code: _____

V.I.N.(last 8 digits): _____ Sales order #(Located On The Driver Door Post Label): _____

Date Of Delivery To Owner (Retail Purchaser): _____

AUTOMOTIVE CUSTOMER SERVICE & ROADSIDE ASSISTANCE NUMBERS

Chevrolet (US) customer service	800-222-1020
Chevrolet (US) roadside assistance	800-CHEV-USA (243-8872)
GM Canada customer service	800-263-3777
GM Canada roadside assistance	800-268-6800

APPLIANCE WARRANTY

The following are not warranted by Home & Park, but are covered by individual warranties offered by their respective manufacturers to which terms both Purchaser and Dealer must comply: air conditioner, electrical inverter/charger, furnace, generator, microwave oven, range hood exhaust fan, refrigerator, stove, toilet, water pump, water heater, and macerator. Home & Park makes no warranty whatsoever, regarding these items and/or such like components manufactured by others. However, Home & Park will pay for the removal and reinstallation of such components that it determines at its sole discretion are installed by Home & Park in a manner unusual to the industry. **Purchaser and/or Dealer are required to deal directly with the nearest service center for such manufactured components** and abide by the warranty policy as allowed by such component manufacturers. The name, location and phone number of some such component manufacturer's are as follows:

HOME & PARK LIMITED MOTORHOME WARRANTY:

Home & Park warrants to the Purchaser that the Vehicle is free from defects in material and workmanship on the portion manufactured by Home & Park, under normal use and service, for **four (4) years or 48,000 miles (U.S.) or 80,000 (Canadian)** whichever occurs first, from date of purchase by the first Purchaser or the date the Vehicle was first put into service (for example, as a demo or rental), whichever is earlier.

This warranty shall be fulfilled at a Home & Park Dealer or authorized Roadtrek repair facility. For in transit emergency repairs, you may choose to deal with a non-authorized RV service facility. However **all warranty repairs at non-authorized RV service facilities** must be preauthorized by Home & Park. Home & Park will, at its option, replace or repair free of charge (including related labor) any defective part, about which the Purchaser shall notify their Roadtrek Dealer within the warranty period. The obligation of Home & Park under this warranty, is expressly limited to such replacement or repair.

The provisions of this limited warranty shall not apply to the following:

1. Accident.
2. Unauthorized repairs or alterations.
3. Normal maintenance.
4. Changes made to other units manufactured after this Vehicle was manufactured.
5. Incidental damages connected with the failure of the Vehicle such as lost time, inconvenience, loss of use of the Vehicle, cost of rental cars, gasoline, telephone, travel or lodging.
6. Damages caused by environmental factors including, but not limited to, hailstorms, tornadoes, sandstorms, lightning, floods, earthquakes, airborne fallout, chemicals, tree sap, ocean spray, road hazards.
7. Vehicle that has been declared a total loss by an insurance company (demolished) or a Vehicle whose title indicates that it is designated as "salvage," "junk," or "rebuilt" or words of similar impact.
8. Exterior side storage compartments may not be moisture free. It is advised that you store items accordingly. Home & Park is not responsible for goods damaged while stored in exterior storage compartments.
9. There will be no allowance for emergency road repair, towing, labor, meals accommodations, etc. Such will not be accepted if claimed under warranty.
10. After the "QualityCare" Pre-Delivery Report is completed by the dealer, appliance adjustments, door latch adjustments, light bulbs, fuses, battery in the smoke detector and window screens are warranted for 90 days.
11. Aluminum wheels are not warranted against corrosion that is a result of road salt, sea salt, cleaning chemicals or harsh driving conditions.

HOME & PARK LIMITED MOTORHOME WARRANTY:

The provisions of this limited warranty shall not apply to deterioration due to wear and exposure beyond the following limitations:

1. For **one (1) year** or 12,000 miles (in US) or 20,000 Km (in Canada), which ever occurs first, from date of purchase by the first Purchaser for sewage hose, curtain fabric, seating fabric, carpet, cup holders, exterior stripes and decals, running board trim, and black and grey water tank valves.
2. For **two (2) years** or 24,000 miles (in US) or 40,000 Km (in Canada), which ever occurs first, from the date of purchase by the first Purchaser for leather seats.
3. For **three (3) years** or 36,000 miles (in US) or 60,000 Km (in Canada), which ever occurs first, from date of purchase by the first Purchaser for exterior painted surfaces.

Home & Park Limited Motorhome Warranty is void unless the following conditions are adhered to:

1. Warranty Card on Vehicle must be completed by the Dealer and faxed to Home & Park within 48 hours of date of retail delivery. When warranty applications are made and Warranty Card is not on file at Home & Park, reimbursement of claim will be delayed until proof of original purchase is submitted to Home & Park.
2. All warranty claims must be submitted on a Home & Park Motorhomes Warranty Claim form and properly completed including Vehicle Identification Number (V.I.N.), odometer reading and Home & Park Limited Motorhome Warranty start date (date of retail delivery).
3. **Warranty work that will exceed \$200 must first be authorized by Home & Park** before proceeding with such work. The authorization number issued by Home & Park must be noted on the warranty claim.
4. Home & Park reserves the right to inspect defective parts that have been replaced under warranty. Dealer is expected to hold selected parts for a period of not to exceed 60 days.
5. Only parts and accessories and other material, available through Home & Park are to be used in the performance of warranty service.
6. Warranty repairs performed a second time by a Dealer (due to incorrect or inadequate diagnosis, improper assembly or repair, or lack of proper testing when the original warranty repair was performed) are considered as shop comebacks and are not reimbursable. Costs of such repairs must be adsorbed by the Dealer.
7. All claims must be submitted within 30 days of the date of repair.
8. Purchasers are responsible for presenting their vehicle to a Roadtrek Dealer as soon as a problem exists. The warranty repairs should be completed in a reasonable amount of time from date of authorization.

This limited warranty is expressly in lieu of any other expressed or implied warranty, including any implied warranty of merchantability or fitness for a particular purpose and of any other obligations or liabilities on Home & Park which neither assumes nor authorizes any other person to assume for it any other liability in connection with Vehicle manufactured by it.

REPORTING SAFETY DEFECTS (U.S. ONLY)

If you believe that your vehicle has a defect which could cause a crash or could cause injury or death, you should immediately inform the National Highway Traffic Safety Administration (NHTSA) in addition to notifying Home & Park.

If NHTSA receives similar complaints, it may open an investigation, and if it finds that a safety defect exists in a group of vehicles, it may order a recall and remedy campaign. However, NHTSA cannot become involved in individual problems between you, your dealer, or Home & Park.

To contact NHTSA, you may call the Auto Safety Hot line toll-free at 1-800-424-9393 (or 366-0123 in Washington, DC area) or write to:

NHTSA
U.S. Department of Transportation
Washington, DC 20590

You can also obtain other information about motor vehicle safety from the Hot line.

ROADTREK AMBASSADOR POTENTIAL CUSTOMER REFERRAL PROGRAM FOR ROADTREK OWNERS:

Most Roadtrek owners spend a lot of their valuable time giving tours of their Roadtreks to numerous inquisitive people. Many of these potential customers become Roadtrek owners. To reward their efforts and encourage more "tours" by these very convincing "sales people," we will pay a \$100.00 commission and provide incentive rewards to any Roadtrek owner who refers a potential customer to us who eventually purchases a new Roadtrek.

To participate in this program, the Roadtrek owner must sign up for the Roadtrek Ambassador program by visiting www.roadtrek.com/ambassador or calling 1-888-ROADTREK (762-3873). For every potential customer that you show your Roadtrek, complete a "Potential Customer Referral Card". You will receive \$100.00 for each referral that purchases a new Roadtrek. In addition, we have these complimentary gifts:

1. For your 1st purchasing customer we will send you Two Roadtrek Ambassador Golf Shirts.
2. For your 2nd purchasing customer we will send you Two Roadtrek Ambassador Windbreakers.
3. For your 5th purchasing customer we will send you Two Roadtrek Ambassador Leather & Melton jackets.
4. For your 10th purchasing customer we will provide an all expense paid trip to the Roadtrek factory.

If these incentives weren't enough, all Roadtrek Ambassadors referring more than 2 purchasing customers in a given year will be eligible for a draw to win the use of a new Roadtrek for a full year (mileage restrictions will apply).

This program is subject to the following conditions:

1. Home & Park receives a "Potential Customer Referral Card" (supplies available upon request) completed and mailed by the potential customer and/or Roadtrek owner.
2. The potential customer purchases a new Roadtrek within 3 years from the date the "Potential Customer Referral Card" is received by Home & Park.
3. The potential customer purchases a new Roadtrek and has the dealer complete the "Home & Park Warranty Registration" in the same name and address that was inserted on the "Potential Customer Referral Card".
4. If more than one Roadtrek owner refers the same potential customer, the \$100.00 commission will be split equally among all of the referring Roadtrek owners.

Home & Park Motorhomes reserves the right to cancel this program based upon 90 days notice to Roadtrek owners.

ROADTREK CLUB INTERNATIONAL

As a new Roadtrek owner, you are cordially invited to join our family of Roadtrek owners as members of the "Roadtrek Club International". An owners' club offers its members an opportunity to meet other people with common interests, attend enjoyable gatherings (such as group outings, sight seeing, camping, suppers, factory tours, and more!), share travel experiences, keep current on the latest information and products from the factory, and exchange ideas for improvements or solutions to problems. Annual membership dues are only US\$10. Their common bond is the that they are all Roadtrek owners. As a group, they promote fellowship and enrich their way of life.

Roadtrek Club International is an active Chapter of the Family Motor Coach Association. FMCA, the foremost organization in the world composed exclusively for motorhome owners, was founded in 1963 for the express purpose of promoting fellowship and the use of motor coaching for pleasure. Many of its 130,000 members meet and form fast friendships with fellow motorhomers and join together in Association sponsored activities that are interesting and fun.

FMCA offers benefits and services specially designed to meet the needs of motorhome owners that you can't get anywhere else. Although space does not permit listing everything available, member benefits include: free monthly subscription to the full color Family Motor Coaching magazine, minimum cost motorhome insurance, accidental death coverage, emergency road service, trip routing service, toll free 800 number message service, mail forwarding, identification emblems for your motorhome, free membership directory, anti-theft program, discount programs, national and regional conventions, caravans and tours, and year-round activities in nearly 300 chapters of FMCA for fun, fellowship and entertainment... plus much more. FMCA dues are \$35 per year plus a one time \$10 initiation fee in the first year.

Just complete the applications on the next page and mail them with your checks to the addresses shown. You'll be glad you did!

ADDRESS, PHONE & FACSIMILE NUMBERS, AND E-MAIL

Address all inquiries to: Home & Park Motorhomes
Warranty & Service Department
100 Shirley Avenue
Kitchener, Ontario, Canada, N2B 2E1
Telephone: toll free 888-ROADTREK (762-3873) or 519-745-1169
Facsimile: 519-745-1160
E-mail: service@roadtrek.com

All inquiries must include: Owner's name, address, home and work phone numbers
Selling Home & Park dealer's name and contact
Servicing Chevrolet dealer's name, contact and phone number
(if applicable)
Last 8 digits of Vehicle Identification Number (V.I.N.)
Vehicle mileage
Date of Retail Delivery

WEBSITE

Checkout the Roadtrek website at WWW.roadtrek.com



CHANGE OF OWNER NAME OR ADDRESS FORM

*IMPORTANT - To owner with New Address or Used-Vehicle Buyer -
complete and mail for accuracy of recall mailing records.*

PLEASE TYPE OR PRINT LEGIBLY:

1. VEHICLE IDENTIFICATION NUMBER (17 character number found on top left of instrument panel)										
2. PRINT Last Name (including Jr., Sr., etc.)										
3. PRINT First Name (or Initial) and Middle Name (or Initial)										
4. PRINT NEW mailing Address: House/Building Number and Street Name (including St., Ave., Rd., Ct., etc.)										
Apt./Suite No.		or	P.O. Box No.			or	<input type="checkbox"/> RRR/ <input type="checkbox"/> HCR (check one)		<input type="checkbox"/> RR/ <input type="checkbox"/> HCR Box No.	
City				State		ZIP Code		ZIP + 4		
Area Code			Prov.			Postal Code				
Phone No.		Month	Day	Year		Email Address				
Current Date		Month	Day	Year		Email Address				



M190204



**AFFIX
STAMP**

 **Roadtrek**TM
100 SHIRLEY AVENUE
KITCHENER, ONTARIO
N2B 2E1



POTENTIAL CUSTOMER REFERRAL CARD

PLEASE TYPE OR PRINT LEGIBLY:

PRINT **Potential Customer Name** (including Jr., Sr., etc.)

PRINT **Mailing Address:** House/Building Number and Street Name (including St., Ave., Rd., Ct., etc.)

City State/Prov. ZIP/P.C.

Country Email

Please send me a brochure and the name and address of my nearest dealer

REFERRED BY: Area Code

Roadtrek Vehicle Identification Number (last 8 digits only) Phone No. | | - | |

PRINT **Roadtrek Owner's Name** (including Jr., Sr., etc.)

Optional

PRINT **Mailing Address:** House/Building Number and Street Name (including St., Ave., Rd., Ct., etc.)

City State/Prov. ZIP/P.C.

Email

Please send me more of these referral cards

Please send me more brochures



Roadtrek™ by Home & Park Motorhomes

M300404



POTENTIAL CUSTOMER REFERRAL CARD

PLEASE TYPE OR PRINT LEGIBLY:

PRINT **Potential Customer Name** (including Jr., Sr., etc.)

PRINT **Mailing Address:** House/Building Number and Street Name (including St., Ave., Rd., Ct., etc.)

City State/Prov. ZIP/P.C.

Country Email

Please send me a brochure and the name and address of my nearest dealer

REFERRED BY: Area Code

Roadtrek Vehicle Identification Number (last 8 digits only) Phone No. | | - | |

PRINT **Roadtrek Owner's Name** (including Jr., Sr., etc.)

Optional

PRINT **Mailing Address:** House/Building Number and Street Name (including St., Ave., Rd., Ct., etc.)

City State/Prov. ZIP/P.C.

Email

Please send me more of these referral cards

Please send me more brochures



Roadtrek™ by Home & Park Motorhomes

M300404



**AFFIX
STAMP**

 **Roadtrek™**
100 SHIRLEY AVENUE
KITCHENER, ONTARIO
N2B 2E1



**AFFIX
STAMP**

 **Roadtrek™**
100 SHIRLEY AVENUE
KITCHENER, ONTARIO
N2B 2E1

Please contact Home & Park Motorhomes should you require additional customer referral cards.



Division of HANMAR MOTOR CORPORATION
100 Shirley Avenue, Kitchener, Ontario,
Canada, N2B 2E1
Telephone: 519-745-1169
or Toll Free 1-888-ROADTREK (1-888-762-3873)
Telefacsimile: 519-745-1160
Email: service@roadtrek.com
WebSite: <http://www.roadtrek.com/LIT>