

DODGE

2010

OWNER'S MANUAL

Nitro

TABLE OF CONTENTS

SECTION		PAGE
1	INTRODUCTION	3
2	THINGS TO KNOW BEFORE STARTING YOUR VEHICLE	9
3	UNDERSTANDING THE FEATURES OF YOUR VEHICLE	85
4	UNDERSTANDING YOUR INSTRUMENT PANEL	179
5	STARTING AND OPERATING	275
6	WHAT TO DO IN EMERGENCIES	375
7	MAINTAINING YOUR VEHICLE	391
8	MAINTENANCE SCHEDULES	439
9	IF YOU NEED CONSUMER ASSISTANCE	459
10	INDEX	469

INTRODUCTION

CONTENTS

■ Introduction	4	■ Warnings And Cautions	7
■ Rollover Warning	4	■ Vehicle Identification Number	7
■ How To Use This Manual	5	■ Vehicle Modifications/Alterations	8

INTRODUCTION

Congratulations on selecting your new Chrysler Group LLC vehicle. Be assured that it represents precision workmanship, distinctive styling, and high quality - all essentials that are traditional to our vehicles.

This Owner's Manual has been prepared with the assistance of service and engineering specialists to acquaint you with the operation and maintenance of your vehicle. It is supplemented by a Warranty Information Booklet, located on the DVD, and various customer-oriented documents. Please take the time to read these publications carefully. Following the instructions and recommendations in this manual will help assure safe and enjoyable operation of your vehicle.

NOTE: After you read the manual, it should be stored in the vehicle for convenient referencing and remain with the vehicle when sold, so that the new owner will be aware of all safety warnings.

When it comes to service, remember that your authorized dealer knows your vehicle best, has factory-trained technicians and genuine MOPAR® parts, and cares about your satisfaction.

ROLLOVER WARNING

Utility vehicles have a significantly higher rollover rate than other types of vehicles. This vehicle has a higher ground clearance and a higher center of gravity than many passenger cars. It is capable of performing better in a wide variety of off-road applications. Driven in an unsafe manner, all vehicles can go out of control. Because of the higher center of gravity, if this vehicle is out of control it may roll over when some other vehicles may not.

Do not attempt sharp turns, abrupt maneuvers, or other unsafe driving actions that can cause loss of vehicle

control. Failure to operate this vehicle safely may result in an accident, rollover of the vehicle, and severe or fatal injury. Drive carefully.

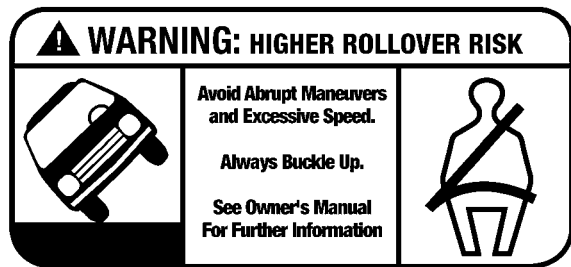

80bfe0f0

Rollover Warning Label

Failure to use driver and passenger seat belts provided is a major cause of severe or fatal injury. In fact, the U.S. government notes that the universal use of existing seat

belts could cut the highway death toll by 10,000 or more each year and could reduce disabling injuries by two million annually. In a rollover crash, an unbelted person is significantly more likely to die than a person wearing a seat belt. Always buckle up.

HOW TO USE THIS MANUAL

Consult the Table of Contents to determine which section contains the information you desire.

Since the specification of your vehicle depends on the items of equipment ordered, certain descriptions and illustrations may differ from your vehicle's equipment

The detailed index at the back of this Owner's Manual contains a complete listing of all subjects.

Consult the following table for a description of the symbols that may be used on your vehicle or throughout this Owner's Manual:



WARNINGS AND CAUTIONS

This Owner's Manual contains **WARNINGS** against operating procedures that could result in an accident or bodily injury. It also contains **CAUTIONS** against procedures that could result in damage to your vehicle. If you do not read this entire manual, you may miss important information. Observe all Warnings and Cautions.

VEHICLE IDENTIFICATION NUMBER

The Vehicle Identification Number (VIN) is found on the left front corner of the instrument panel. The VIN is visible from outside of the vehicle through the windshield. This number also is stamped into the right front door sill (under the molding) and appears on the Automobile Information Disclosure Label affixed to a window on your vehicle, the vehicle registration, and the title.

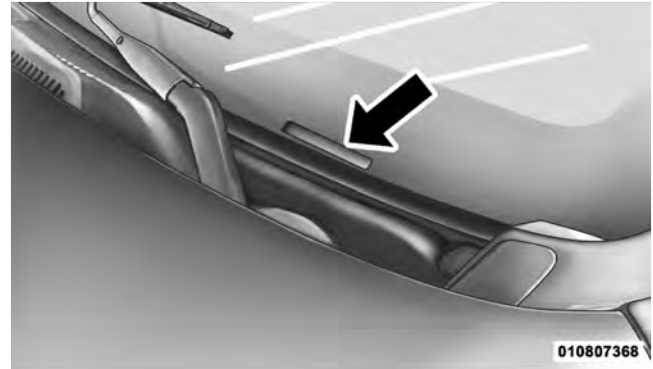

Vehicle Identification Number

NOTE: It is illegal to remove or alter the VIN.

VEHICLE MODIFICATIONS/ALTERATIONS

WARNING!

Any modifications or alterations to this vehicle could seriously affect its roadworthiness and safety and may lead to an accident resulting in serious injury or death.

THINGS TO KNOW BEFORE STARTING YOUR VEHICLE

CONTENTS

■ A Word About Your Keys	12	□ General Information	17
□ Ignition Key Removal	12	■ Vehicle Security Alarm — If Equipped	17
□ Key-In-Ignition Reminder	13	□ To Arm The System	18
■ Steering Wheel Lock — If Equipped	14	□ To Disarm The System	18
□ To Manually Lock The Steering Wheel	14	■ Illuminated Entry	19
□ To Release The Steering Wheel Lock	14	■ Remote Keyless Entry (RKE)	19
■ Sentry Key®	14	□ To Unlock The Doors And Liftgate	20
□ Replacement Keys	15	□ To Lock The Doors And Liftgate	21
□ Customer Key Programming	16		

10 THINGS TO KNOW BEFORE STARTING YOUR VEHICLE

- Remote Open Window Feature —
If Equipped 22
- Using The Panic Alarm 23
- Programming Additional Transmitters 23
- Battery Replacement 23
- General Information 24
- Remote Starting System — If Equipped 25
 - How To Use Remote Start 25
- Door Locks 27
 - Manual Door Locks 27
 - Power Door Locks 28
 - Automatic Door Locks 29
 - Automatic Unlock Doors On Exit 30
- Child-Protection Door Lock System
(Rear Doors) 31
- Windows 32
 - Power Windows 32
 - Wind Buffeting 36
- Liftgate 36
- Occupant Restraints 37
 - Lap/Shoulder Belts 38
 - Lap/Shoulder Belt Operating Instructions 39
 - Lap/Shoulder Belt Untwisting Procedure 43
 - Seat Belt Pretensioner — If Equipped 43
 - Adjustable Upper Shoulder Belt Anchorage 43
 - Automatic Locking Retractors (ALR) Mode
— If Equipped 44

□ Energy Management Feature	45
□ Supplemental Rear Impact Active Head Restraints (AHR)	45
□ Enhanced Seat Belt Use Reminder System (BeltAlert®)	49
□ Seat Belts And Pregnant Women	50
□ Seat Belt Extender	50
□ Supplemental Restraint Systems (SRS) — Airbags	51
□ Event Data Recorder (EDR)	69

THINGS TO KNOW BEFORE STARTING YOUR VEHICLE 11

□ Child Restraint	71
■ Engine Break-In Recommendations	81
■ Safety Tips	81
□ Transporting Passengers	81
□ Exhaust Gas	82
□ Safety Checks You Should Make Inside The Vehicle	83
□ Periodic Safety Checks You Should Make Outside The Vehicle	84

A WORD ABOUT YOUR KEYS

The keys for your vehicle are double-sided. You can insert the keys into the locks with either side up.

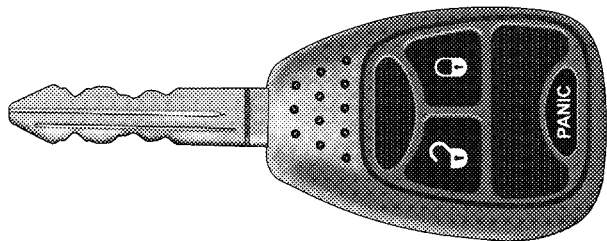

8163e6a8

Vehicle Key

The keys for your new vehicle are enclosed in a plastic bag with the key code number on it. If you received your keys without the bag, ask your authorized dealer to give you the number. The key code can also be obtained by an authorized dealer from your vehicle invoice.

Ignition Key Removal

Automatic Transmission

- Place the shift lever in PARK.
- Push the key and cylinder inward slightly and rotate the key to the LOCK position.
- Remove the key.

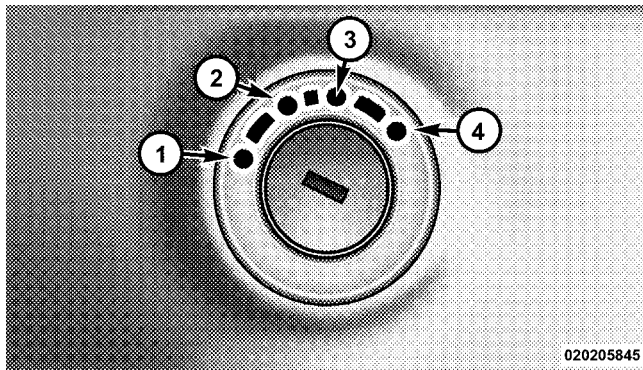

020205845

Ignition Switch Positions

1 — Lock
2 — Acc

3 — On
4 — Start

WARNING!

Never leave children alone in a vehicle. Leaving unattended children in a vehicle is dangerous for a number of reasons. A child or others could be seriously or fatally injured. Don't leave the key in the ignition. A child could operate power windows, other controls, or move the vehicle.

CAUTION!

An unlocked vehicle is an invitation to thieves. Always remove the key from the ignition and lock all doors when leaving the vehicle unattended.

Key-In-Ignition Reminder

If you open the driver's door and the key is in the ignition, a chime will sound to remind you to remove the key.

NOTE: The Key-In-Ignition reminder only sounds when the ignition key is placed in the LOCK or ACC position.

STEERING WHEEL LOCK — IF EQUIPPED

Your vehicle may be equipped with a passive steering wheel lock. This lock prevents steering the vehicle without the ignition key. If the steering wheel is moved approximately a half turn in either direction and the key is not in the ignition, the steering wheel will lock.

To Manually Lock the Steering Wheel

With the engine running, rotate the steering wheel one-half revolution from the straight ahead position, turn OFF the engine, and remove the key. Rotate the steering wheel slightly in both directions, until the lock engages.

To Release the Steering Wheel Lock

Insert the key in the ignition and turn the wheel slightly to the right or left to disengage the lock.

NOTE: If you turned the wheel to the right to engage the lock, you must turn the wheel slightly to the right to disengage it. If you turned the wheel to the left to engage the lock, turn the wheel slightly to the left to disengage it.

SENTRY KEY®

The Sentry Key® Immobilizer System prevents unauthorized vehicle operation by disabling the engine. The system does not need to be armed or activated. Operation is automatic, regardless of whether the vehicle is locked or unlocked.

The system uses ignition keys that have an embedded electronic chip (transponder) to prevent unauthorized vehicle operation. Therefore, only keys that are programmed to the vehicle can be used to start and operate the vehicle. The system will shut the engine off in two seconds if someone uses an invalid key to try to start the engine.

NOTE: A key that has not been programmed is also considered an invalid key, even if it is cut to fit the ignition switch lock cylinder for that vehicle.

During normal operation, after turning on the ignition switch, the Vehicle Security Light will turn on for three seconds for a bulb check. If the light remains on after the bulb check, it indicates that there is a problem with the electronics. In addition, if the Vehicle Security Light begins to flash after the bulb check, it indicates that someone used an invalid key to try to start the engine. Either of these conditions will result in the engine being shut off after two seconds.

If the Vehicle Security Light turns on during normal vehicle operation (vehicle running for longer than 10 seconds), it indicates that there is a fault in the electronics. Should this occur, have the vehicle serviced as soon as possible by an authorized dealer.

NOTE: The Sentry Key® Immobilizer System is not compatible with some aftermarket remote starting systems. Use of these systems may result in vehicle starting problems and loss of security protection.

All of the keys provided with your new vehicle have been programmed to the vehicle electronics.

Replacement Keys

NOTE: Only keys that are programmed to the vehicle electronics can be used to start and operate the vehicle. Once a Sentry Key® is programmed to a vehicle, it cannot be programmed to any other vehicle.

CAUTION!

Always remove the Sentry Keys® from the vehicle and lock all doors when leaving the vehicle unattended.

At the time of purchase, the original owner is provided with a four-digit Personal Identification Number (PIN). Keep the PIN in a secure location. This number is required for authorized dealer replacement of keys. Duplication of keys may be performed at an authorized dealer or by following the customer key programming procedure. This procedure consists of programming a blank key to the vehicle electronics. A blank key is one that has never been programmed.

NOTE: When having the Sentry Key® Immobilizer System serviced, bring all vehicle keys with you to an authorized dealer.

Customer Key Programming

If you have two valid Sentry Keys®, you can program new Sentry Keys® to the system by performing the following procedure:

1. Cut the additional Sentry Key® Transponder blank(s) to match the ignition switch lock cylinder key code.

2. Insert the first valid key into the ignition switch. Turn the ignition switch to the ON position for at least three seconds, but no longer than 15 seconds. Then, turn the ignition switch to the LOCK position and remove the first key.

3. Insert the second valid key into the ignition switch. Turn the ignition switch to the ON position within 15 seconds. After 10 seconds, a chime will sound. In addition, the Vehicle Security Light will begin to flash. Turn the ignition switch to the LOCK position and remove the second key.

4. Insert a blank Sentry Key® into the ignition switch. Turn the ignition switch to the ON position within 60 seconds. After 10 seconds, a single chime will sound. In addition, the Vehicle Security Light will stop flashing. To indicate that programming is complete, the Vehicle Security Light will turn on again for three seconds and then turn off.

The new Sentry Key® is programmed. **The Remote Keyless Entry (RKE) transmitter will also be programmed during this procedure.**

Repeat this procedure to program up to eight keys. If you do not have a programmed Sentry Key®, contact your authorized dealer for details.

NOTE: If a programmed key is lost, see your authorized dealer to have all remaining keys erased from the system's memory. This will prevent the lost key from starting your vehicle. The remaining keys must then be reprogrammed. All vehicle keys must be taken to an authorized dealer at the time of service to be reprogrammed.

General Information

The Sentry Key® system complies with FCC rules Part 15 and with RSS-210 of Industry Canada. Operation is subject to the following conditions:

- This device may not cause harmful interference.
- This device must accept any interference that may be received, including interference that may cause undesired operation.

VEHICLE SECURITY ALARM — IF EQUIPPED

The Vehicle Security Alarm monitors the vehicle doors, liftgate, and ignition for unauthorized operation. When the Vehicle Security Alarm is activated, the alarm provides both audible and visual signals. The horn will sound repeatedly for three minutes, while the headlights, park lamps and/or turn signals will flash for an additional 15 minutes.

NOTE: The Panic and Security alarms are quite different. Please take a moment to activate the Panic and Security modes to hear the differences in the horn. In case one should go off in the future, you will need to know which mode has been activated in order to deactivate it.

To Arm the System

Remove the keys from the ignition switch and exit the vehicle. Lock the doors and liftgate by pressing the power door LOCK switch or the LOCK button on the Remote Keyless Entry (RKE) transmitter. Close all the doors.

The Vehicle Security Light (located in the instrument cluster) will flash rapidly for about 16 seconds to signal that the Vehicle Security Alarm is arming. During this 16 second pre-arm period, opening any door or the liftgate will cancel the arming process. If the Vehicle Security Alarm arms successfully, the Vehicle Security Light will flash at a slower rate to indicate the alarm is set. Manually locking the doors with the door lock plunger (located on the inside of the doors) or the driver's door key lock cylinder will not arm the Vehicle Security Alarm.

To Disarm the System

Either press the UNLOCK button on the RKE transmitter or insert a valid Sentry Key® into the ignition lock cylinder and turn the key to the ON position.

The Vehicle Security Alarm is designed to protect your vehicle; however, you can create conditions where the Vehicle Security Alarm will give you a false alarm. If the previously described arming sequence has occurred, the Vehicle Security Alarm will arm regardless of whether you are inside or outside the vehicle. If you remain inside the vehicle and open a door, the alarm will sound. If this occurs, disarm the Vehicle Security Alarm. Manually unlocking the doors with the door lock plunger (located on the inside of the doors) or the driver's door key lock cylinder will not disarm the Vehicle Security Alarm.

Tamper Alert

If something has triggered the Vehicle Security Alarm in your absence, the horn will sound three times when you unlock the doors. Check the vehicle for tampering.

ILLUMINATED ENTRY

The interior lights come on when you open any door or use the Remote Keyless Entry (RKE) transmitter to unlock any door. They will remain on for approximately 30 seconds after all doors are closed then fade to off.

The lights also will fade to off if you turn on the ignition after you close all the doors.

REMOTE KEYLESS ENTRY (RKE)

This system allows you to lock or unlock the doors and liftgate or activate the Panic Alarm from distances up to approximately 66 ft (20 m) using your Remote Keyless Entry (RKE) transmitter. The RKE transmitter does not need to be pointed at the vehicle to activate the system.

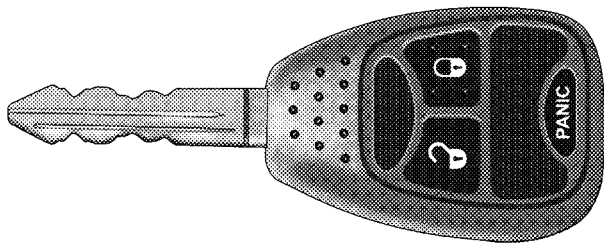

818e937a

Three Button RKE transmitter

NOTE:

- For the remote starting feature (if equipped), refer to "Remote Starting System" for further information.
- Your vehicle's RKE transmitter may have three or four buttons depending on the optional features purchased with your vehicle.

To Unlock the Doors and Liftgate

Press and release the UNLOCK button on the RKE transmitter once to unlock the driver's door or twice to unlock all doors and the liftgate. The parking lights will flash to acknowledge the unlock signal. The illuminated entry system will also turn on.

Remote Key Unlock, Driver Door/All Doors First

This feature lets you program the system to unlock either the driver's door or all doors and the liftgate on the first press of the UNLOCK button on the RKE transmitter. To change the current setting, proceed as follows:

On Electronic Vehicle Information Center (EVIC) equipped vehicles, refer to "Electronic Vehicle Information Center (EVIC)/Personal Settings (Customer-Programmable Features)" in "Understanding Your Instrument Panel" for further information.

On non-EVIC equipped vehicles, perform the following steps:

1. Press and hold the LOCK button on a programmed (i.e., functional) RKE transmitter for at least four seconds, but not longer than 10 seconds. Then, press and hold the UNLOCK button while still holding the LOCK button.
2. Release both buttons at the same time.
3. Test the feature from outside the vehicle by pressing the LOCK and UNLOCK buttons on the RKE transmitter.
4. Repeat these steps if you want to return this feature to its previous setting.

NOTE: Pressing the LOCK button on the RKE transmitter while you are inside the vehicle will activate the Vehicle Security Alarm. Opening a door with the Vehicle Security Alarm activated will cause the alarm to sound. Press the UNLOCK button to deactivate the Vehicle Security Alarm.

To Lock the Doors and Liftgate

Press and release the LOCK button on the RKE transmitter to lock all doors and the liftgate. If the ignition is OFF when the doors are locked, the parking lights will flash once and the horn will sound a single chirp.

Sound Horn with Lock

This feature will cause the horn to chirp when the doors are locked with the RKE transmitter. This feature can be turned on or off. To change the current setting, proceed as follows:

- On Electronic Vehicle Information Center (EVIC) equipped vehicles, refer to “Electronic Vehicle Information Center (EVIC)/Personal Settings (Customer-Programmable Features)” in “Understanding Your Instrument Panel” for further information.
- On non-EVIC equipped vehicles, perform the following steps:

1. Press the LOCK button on a programmed (i.e., functional) RKE transmitter for at least four seconds, but not longer than 10 seconds. Then, press the PANIC button while still holding the LOCK button.

2. Release both buttons at the same time.

3. Test the feature from outside the vehicle by pressing the LOCK button on the RKE transmitter.

4. Repeat these steps if you want to return this feature to its previous setting.

NOTE: Pressing the LOCK button on the RKE transmitter while you are inside the vehicle will activate the Vehicle Security Alarm. Opening a door with the Vehicle Security Alarm activated will cause the alarm to sound. Press the UNLOCK button to deactivate the Vehicle Security Alarm.

Flash Lights with Lock

The feature will cause the parking lights to flash when the doors are locked or unlocked with the RKE transmitter. This feature can be turned on or off. To change the current setting, proceed as follows:

- On Electronic Vehicle Information Center (EVIC) equipped vehicles, refer to “Electronic Vehicle Information Center (EVIC)/Personal Settings (Customer-Programmable Features)” in “Understanding Your Instrument Panel” for further information.
- On non-EVIC equipped vehicles, perform the following steps:
 1. Press and hold the UNLOCK button on a programmed (i.e., functional) RKE transmitter for at least four seconds, but not longer than 10 seconds. Then, press and hold the LOCK button while still holding the UNLOCK button.
 2. Release both buttons at the same time.

3. Test the feature from outside the vehicle by pressing the LOCK and UNLOCK buttons on the RKE transmitter.

4. Repeat these steps if you want to return this feature to its previous setting.

NOTE: Pressing the LOCK button on the RKE transmitter while you are inside the vehicle will activate the Vehicle Security Alarm. Opening a door with the Vehicle Security Alarm activated will cause the alarm to sound. Press the UNLOCK button to deactivate the Vehicle Security Alarm.

Remote Open Window Feature — If Equipped

This feature allows you to remotely lower both front door windows at the same time. To use this feature, press and release the UNLOCK button on the RKE transmitter and then immediately press and hold the UNLOCK button until the windows lower to the level desired or until they lower completely.

Using the Panic Alarm

NOTE: The PANIC and SECURITY alarms are quite different. Please take a moment to activate the PANIC and SECURITY modes to hear the differences in the horn. If one should sound in the future, you will need to know which mode has been activated in order to deactivate it.

To turn the PANIC alarm feature on or off, press and hold the PANIC button on the RKE transmitter for at least one second and release. When the PANIC alarm is on, the headlights and parking lights will flash, the horn will pulse on and off, and the illuminated entry system will turn on.

The PANIC alarm will stay on for three minutes unless you turn it off by pressing the PANIC button a second time or if the vehicle speed is 5 mph (8 km/h) or greater.

During the PANIC mode, the door locks and RKE systems will function normally. PANIC mode will not disarm the Vehicle Security Alarm system on vehicles so equipped.

Programming Additional Transmitters

Refer to Sentry Key® “Customer Key Programming.”

If you do not have a programmed RKE transmitter, contact your authorized dealer for details.

Battery Replacement

The recommended replacement battery is CR2032.

NOTE: Perchlorate Material – special handling may apply. See www.dtsc.ca.gov/hazardouswaste/perchlorate

1. If the RKE transmitter is equipped with a screw, remove the screw.

24 THINGS TO KNOW BEFORE STARTING YOUR VEHICLE

2. With the RKE transmitter buttons facing down, use a flat blade to pry the two halves of the RKE transmitter case apart. Make sure not to damage the seal during removal.

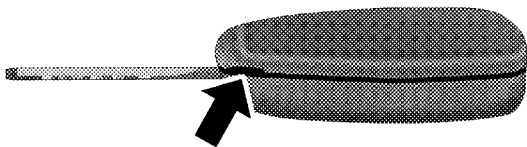

Separating Case Halves

81182c72

3. Remove and replace the battery. Avoid touching the new battery with your fingers. Skin oils may cause battery deterioration. If you touch a battery, clean it with rubbing alcohol.

4. To reassemble the RKE transmitter case, snap the two halves together.

5. If the RKE transmitter is equipped with a screw, reinstall and tighten until snug.

General Information

This device complies with part 15 of FCC rules and with RS-210 of Industry Canada. Operation is subject to the following conditions:

1. This device may not cause harmful interference.
2. This device must accept any interference that may be received, including interference that may cause undesired operation.

NOTE: Changes or modifications not expressly approved by the party responsible for compliance could void the user's authority to operate the equipment.

If your RKE transmitter fails to operate from a normal distance, check for these two conditions:

1. Weak battery in RKE transmitter. The expected life of the battery is from one to two years.
2. Closeness to a radio transmitter such as a radio station tower, airport transmitter, and some mobile or CB radios.

REMOTE STARTING SYSTEM — IF EQUIPPED

 This system uses the Remote Keyless Entry (RKE) transmitter to start the engine conveniently from outside the vehicle while still maintaining security. The system has a range of approximately 328 ft (100 m).

NOTE: The vehicle must be equipped with an automatic transmission to be equipped with Remote Start.

How to Use Remote Start

All of the following conditions must be met before the engine will remote start:

- Shift lever in PARK
- Doors closed
- Hood closed
- Hazard switch off
- Brake switch inactive (brake pedal not pressed)
- Ignition key removed from ignition switch
- Battery at an acceptable charge level
- RKE PANIC button not pressed

WARNING!

- Do not start or run an engine in a closed garage or confined area. Exhaust gas contains Carbon Monoxide (CO) which is odorless and colorless. Carbon Monoxide is poisonous and can cause serious injury or death when inhaled.
- Keep Remote Keyless Entry (RKE) transmitters away from children. Operation of the Remote Start System, windows, door locks or other controls could cause serious injury or death.

To Enter Remote Start

 Press and release the REMOTE START button on the RKE transmitter twice, within five seconds. The parking lights will flash and the horn will chirp twice (if programmed). Then, the engine will start and the vehicle will remain in the Remote Start mode for a 15-minute cycle.

NOTE:

- The park lamps will turn on and remain on during Remote Start mode.
- For security, power window and power sunroof operation (if equipped) are disabled when the vehicle is in the Remote Start mode.
- The engine can be started two consecutive times (two 15-minute cycles) with the RKE transmitter. However, the ignition switch must be cycled to the ON position before you can repeat the start sequence for a third cycle.

Remote start will also cancel if any of the following occur:

- The engine stalls or RPM exceeds 2500
- Any engine warning lamps come on
- The hood is opened
- The hazard switch is pressed
- The transmission is moved out of PARK
- The brake pedal is pressed

To Exit Remote Start Mode without Driving the Vehicle

Press and release the REMOTE START button one time, or allow the engine to run for the entire 15-minute cycle.

NOTE: To avoid unintentional shut downs, the system will disable the one time press of the REMOTE START button for two seconds after receiving a valid Remote Start request.

To Exit Remote Start Mode and Drive the Vehicle

Before the end of the 15-minute cycle, press and release the UNLOCK button on the RKE transmitter to unlock the doors and disarm the Vehicle Security Alarm (if equipped). Then, prior to the end of the 15-minute cycle, insert the key into the ignition switch and turn the switch to the ON position.

NOTE: The ignition switch must be in the ON position in order to drive the vehicle.

DOOR LOCKS

Manual Door Locks

Use the manual door lock plunger to lock the doors from inside the vehicle. If the plunger is down when the door is closed, the door will lock. Make sure the keys are not inside the vehicle before closing the door.

2



Manual Lock Plunger

WARNING!

- For personal security and safety in the event of an accident, lock the vehicle doors when you drive as well as when you park and leave the vehicle.
- When leaving the vehicle, always remove the key from the ignition lock, and lock your vehicle. Do not leave unattended children in the vehicle, or with access to an unlocked vehicle. Unsupervised use of vehicle equipment may cause severe personal injuries and death.

Power Door Locks

A door lock switch is located on each of the front door panels. Press this switch to lock or unlock the doors.

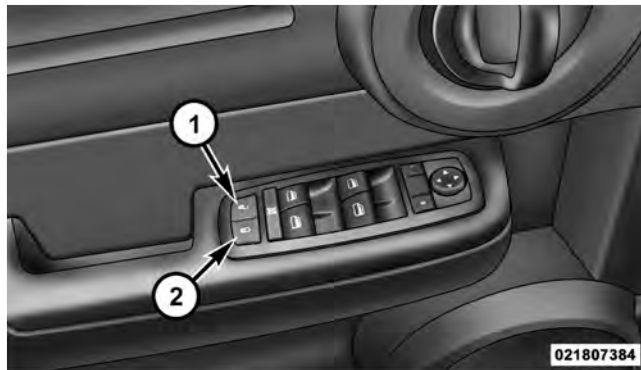
**Power Door Lock Switch**

1 - Unlock

2 - Lock

If you press the power door LOCK switch while the key is in the ignition and either of the front doors is open, the power locks will not operate. This prevents you from accidentally locking your keys in the vehicle. Removing the key or closing the door will allow the locks to operate.

A chime will sound if the key is in the ignition switch and a door is open as a reminder to remove the key.

Automatic Door Locks

The doors will lock automatically on vehicles with power door locks if all of the following conditions are met:

1. The automatic door locks feature is enabled.
2. The transmission is in gear.
3. All doors are closed.
4. The throttle is pressed.
5. The vehicle speed is above 15 mph (24 km/h).
6. The doors were not previously locked using the power door lock switch or Remote Keyless Entry (RKE) transmitter.

Automatic Door Locks Programming

The automatic door locks feature can be enabled or disabled as follows:

For vehicles equipped with an Electronic Vehicle Information Center (EVIC), refer to “Electronic Vehicle Information Center (EVIC)/Personal Settings (Customer-Programmable Features)” in “Understanding Your Instrument Panel” for further information.

For vehicles not equipped with the EVIC, perform the following procedure:

1. Close all doors and place the key in the ignition.
2. Cycle the ignition switch between LOCK and ON and then back to LOCK four times, ending up in the LOCK position.
3. Press the power door LOCK switch to lock the doors.

30 THINGS TO KNOW BEFORE STARTING YOUR VEHICLE

4. A single chime will indicate the completion of the programming.

5. Repeat these steps if you want to return this feature to its previous setting.

NOTE: Use the automatic door locks feature in accordance with local laws.

Automatic Unlock Doors on Exit

The doors will unlock automatically on vehicles with power door locks if:

1. The automatic unlock doors on exit feature is enabled.
2. The transmission was in gear and the vehicle speed returned to 0 mph (0 km/h).
3. The transmission is in NEUTRAL or PARK.
4. The driver door is opened.
5. The doors were not previously unlocked.

6. The vehicle speed is 0 mph (0 km/h).

Automatic Unlock Doors on Exit Programming

The automatic unlock doors on exit feature can be enabled or disabled as follows:

For vehicles equipped with an Electronic Vehicle Information Center (EVIC), refer to “Electronic Vehicle Information Center (EVIC)/Personal Settings (Customer-Programmable Features)” in “Understanding Your Instrument Panel” for further information.

For vehicles not equipped with the EVIC, perform the following procedure:

1. Close all doors and place the key in the ignition.
2. Cycle the ignition switch between LOCK and ON and then back to LOCK four times, ending up in the LOCK position.

3. Press the power door UNLOCK switch to unlock the doors.
4. A single chime will indicate the completion of the programming.
5. Repeat these steps if you want to return this feature to its previous setting.

NOTE: Use the automatic unlock doors on exit feature in accordance with local laws.

Child-Protection Door Lock System (Rear Doors)

Insert the tip of the ignition key into the lock and rotate it to either the LOCK or UNLOCK positions.



Child Protection Door Lock

WARNING!

Avoid trapping anyone in a vehicle in a collision. Remember that the rear doors can only be opened from the outside when the child protection locks are engaged.

32 THINGS TO KNOW BEFORE STARTING YOUR VEHICLE

NOTE: For emergency exit with the system engaged, move the lock plunger up (unlocked position), roll down the window, and open the door with the outside door handle.

WINDOWS

Power Windows

The power window controls are located on the driver's door trim panel. There is a single switch on the front passenger/rear passenger doors which operates the front passenger/rear passenger door windows. The window controls will operate only when the ignition switch is in the ON or ACC position.

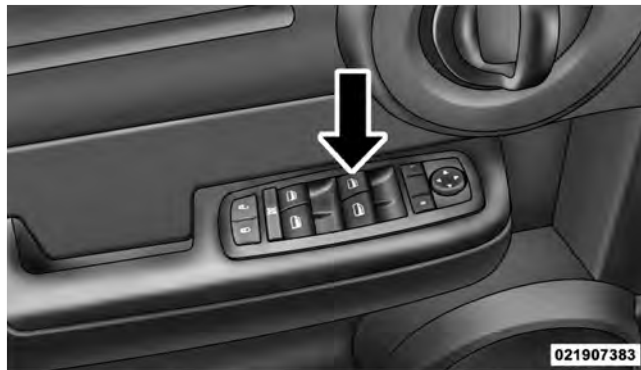

Power Window Switches

The power window switches remain active for up to 10 minutes after the ignition switch has been turned OFF. For vehicles equipped with an Electronic Vehicle Information Center (EVIC), this feature is programmable. Refer to “Electronic Vehicle Information Center (EVIC)/

Personal Settings (Customer-Programmable Features)” in “Understanding Your Instrument Panel” for further information.

WARNING!

Never leave children in a vehicle with the keys in the ignition switch. Occupants, particularly unattended children, can become entrapped by the windows while operating the power window switches. Such entrapment may result in serious injury or death.

Auto-Down Feature

The driver’s and front passenger’s (if equipped for passenger side) power window switches have an “Auto-Down” feature. Press the window switch past the first detent, release, and the window will go down automatically.

To open the window part way, press the window switch to the first detent and release it when you want the window to stop.

To stop the window from going all the way down during the Auto-Down operation, pull up on the switch briefly.

For vehicles not equipped with the Electronic Vehicle Information Center (EVIC), the power window switches will remain active for 45 seconds after the ignition switch is turned to the LOCK position. Opening either front door will cancel this feature.

For vehicles equipped with the EVIC, the power window switches will remain active for up to 10 minutes after the ignition switch is turned to the LOCK position. Opening either front door will cancel this feature. The time is programmable. Refer to “Electronic Vehicle Information Center (EVIC)/Personal Settings (Customer-Programmable Features)” in “Understanding Your Instrument Panel” for further information.

Auto Up Feature with Anti-Pinch Protection — If Equipped

On some models, the driver's and front passenger's (if equipped for passenger side) power window switches have an "Auto Up" feature. Pull the window switch up to the second detent, release, and the window will go up automatically.

To stop the window from going all the way up during the auto-up operation, push down on the switch briefly.

To close the window part way, pull the window switch up to the first detent and release when you want the window to stop.

For vehicles not equipped with the Electronic Vehicle Information Center (EVIC), the power window switches will remain active for 45 seconds after the ignition switch is turned to the LOCK position. Opening either front door will cancel this feature.

For vehicles equipped with the EVIC, the power window switches will remain active for up to 10 minutes after the ignition switch is turned to the LOCK position. Opening either front door will cancel this feature. The time is programmable. Refer to "Electronic Vehicle Information Center (EVIC)/Personal Settings (Customer-Programmable Features)" in "Understanding Your Instrument Panel" for further information.

NOTE:

- If the window runs into any obstacle during auto-closure, it will reverse direction and then go back down. Remove the obstacle and use the window switch again to close the window.
- Any impact due to rough road conditions may trigger the auto-reverse function unexpectedly during auto-closure. If this happens, pull the switch lightly to the first detent and hold to close window manually.

WARNING!

There is no anti-pinch protection when the window is almost closed. Be sure to clear all objects from the window before closing.

Reset

At some point in time, it may be necessary to reactivate the auto-up feature. To do so, perform the following procedure:

1. Pull the window switch up to close window completely and continue to hold the switch up for an additional two seconds after the window is closed.
2. Push the window switch down firmly to the second detent to open the window completely and continue to hold the switch down for an additional two seconds after the window is fully open.

Window Lockout Button

The window lockout button on the driver's door (below the power window switches) allows you to disable the window control on the other doors. To disable the window controls on the other doors, press the window LOCKOUT button. To enable the window controls, press the window LOCKOUT button a second time.

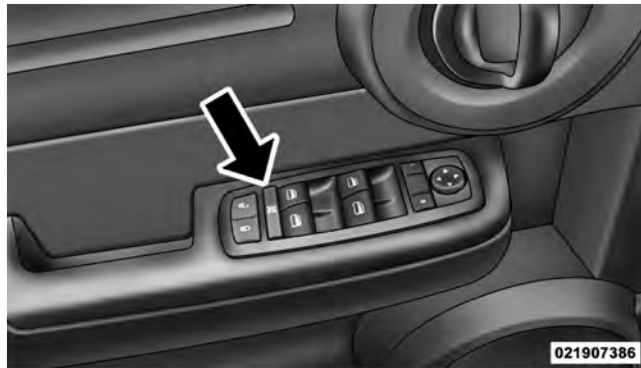

Window Lockout Button

Wind Buffeting

Wind buffeting can be described as the perception of pressure on the ears or a helicopter-type sound in the ears. Your vehicle may exhibit wind buffeting with the windows down, or the sunroof (if equipped) in certain open or partially open positions. This is a normal occurrence and can be minimized. If the buffeting occurs with the sunroof open, adjust the sunroof opening to minimize the buffeting.

LIFTGATE

To open the liftgate, pull up (squeeze) on the handle and lift. Manually unlocking the vehicle doors with the plunger or a key in the lock cylinder will not unlock the liftgate.

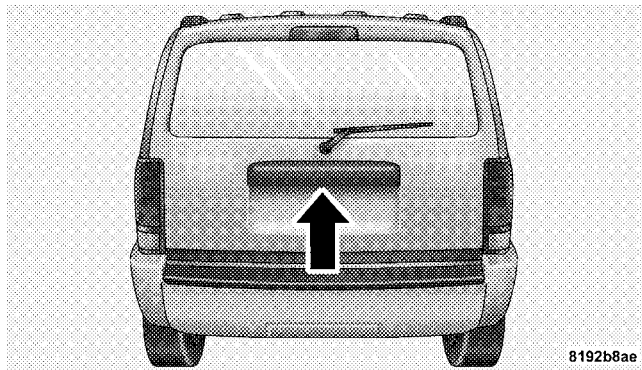

8192b8ae

Liftgate Release

WARNING!

Driving with the liftgate open can allow poisonous exhaust gases into your vehicle. You and your passengers could be injured by these fumes. Keep the liftgate closed when you are operating the vehicle.

OCCUPANT RESTRAINTS

Some of the most important safety features in your vehicle are the restraint systems:

- Three-point lap and shoulder belts for all seating positions
- Advanced Front Airbags for driver and front passenger
- Supplemental Rear Impact Active Head Restraints (AHR) located on top of the front seats (integrated into the head restraint)
- Supplemental Side Airbag Inflatable Curtains (SABIC) for the driver and passengers seated next to a window
- An energy-absorbing steering column and steering wheel
- Knee bolsters/blockers for front seat occupants

- Front seat belts incorporate pretensioners to enhance occupant protection by managing occupant energy during an impact event — if equipped
- All seat belt systems (except the driver's) include Automatic Locking Retractors (ALRs), which lock the seat belt webbing into position by extending the belt all the way out and then adjusting the belt to the desired length to restrain a child seat or secure a large item in a seat — if equipped

If you will be carrying children too small for adult-sized seat belts, the seat belts or the Lower Anchors and Tether for CHildren (LATCH) feature also can be used to hold infant and child restraint systems. For more information on LATCH, see Lower Anchors and Tether for CHildren (LATCH).

NOTE: The Advanced Front Airbags have a multistage inflator design. This allows the airbag to have different rates of inflation based on severity and type of collision.

Please pay close attention to the information in this section. It tells you how to use your restraint system properly, to keep you and your passengers as safe as possible.

WARNING!

In a collision, you and your passengers can suffer much greater injuries if you are not properly buckled up. You can strike the interior of your vehicle or other passengers, or you can be thrown out of the vehicle. Always be sure you and others in your vehicle are buckled up properly.

Buckle up even though you are an excellent driver, even on short trips. Someone on the road may be a poor driver and cause a collision that includes you. This can happen far away from home or on your own street.

Research has shown that seat belts save lives, and they can reduce the seriousness of injuries in a collision. Some of the worst injuries happen when people are thrown from the vehicle. Seat belts reduce the possibility of ejection and the risk of injury caused by striking the inside of the vehicle. **Everyone in a motor vehicle should be belted at all times.**

Lap/Shoulder Belts

All seating positions in your vehicle have combination lap/shoulder belts. The belt webbing retractor is designed to lock during very sudden stops or collisions. This feature allows the shoulder part of the belt to move freely with you under normal conditions. But in a collision, the belt will lock and reduce the risk of you striking the inside of the vehicle or being thrown out.

WARNING!

- Wearing a seat belt incorrectly is dangerous. Seat belts are designed to go around the large bones of your body. These are the strongest parts of your body and can take the forces of a collision the best. Wearing your belt in the wrong place could make your injuries in a collision much worse. You might suffer internal injuries, or you could even slide out of part of the belt. Follow these instructions to wear your seat belt safely and to keep your passengers safe also.
- Two people should never be belted into a single seat belt. People belted together can crash into one another in an accident, hurting one another badly. Never use a lap/shoulder belt or a lap belt for more than one person, no matter what their size.

Lap/Shoulder Belt Operating Instructions

1. Enter the vehicle and close the door. Sit back and adjust the seat.
2. The seat belt latch plate is along the outboard side and rear of the seat cushion. Grasp the latch plate and pull out the belt. Slide the latch plate up the webbing as far as necessary to make the belt go around your lap.

2

Latch Plate

40 THINGS TO KNOW BEFORE STARTING YOUR VEHICLE

3. When the belt is long enough to fit, insert the latch plate into the buckle until you hear a “click.”



Latch Plate To Buckle

WARNING!

A belt that is buckled into the wrong buckle will not protect you properly. The lap portion could ride too high on your body, possibly causing internal injuries. Always buckle your belt into the buckle nearest you.

A belt that is too loose will not protect you as well. In a sudden stop you could move too far forward, increasing the possibility of injury. Wear your seat belt snugly.

A belt that is worn under your arm is very dangerous. Your body could strike the inside surfaces of the vehicle in a collision, increasing head and neck injury. A belt worn under the arm can cause internal injuries. Ribs aren't as strong as shoulder bones. Wear the belt over your shoulder so that your strongest bones will take the force in a collision.

(Continued)

WARNING! (Continued)

A shoulder belt placed behind will not protect you from injury during a collision. You are more likely to hit your head in a collision if you do not wear your shoulder belt. The lap and shoulder belt are meant to be used together.

4. Position the lap belt across your thighs, below your abdomen. To remove slack in the lap portion, pull up a bit on the shoulder belt. To loosen the lap belt if it is too tight, tilt the latch plate and pull on the lap belt. A snug belt reduces the risk of sliding under the belt in a collision.

WARNING!

A lap belt worn too high can increase the risk of injury in a collision. The belt forces won't be at the strong hip and pelvic bones, but across your abdomen. Always wear the lap part of your seat belt as low as possible and keep it snug.

A twisted belt can't do its job as well. In a collision, it could even cut into you. Be sure the belt is straight. If you can't straighten a belt in your vehicle, take it to your authorized dealer and have it fixed.

42 THINGS TO KNOW BEFORE STARTING YOUR VEHICLE

5. Position the shoulder belt on your chest so that it is comfortable and not resting on your neck. The retractor will withdraw any slack in the belt.



Removing Slack From Belt

6. To release the belt, push the red button marked PRESS on the buckle. The belt will automatically retract to its stowed position. If necessary, slide the latch plate down the webbing to allow it to retract fully.

WARNING!

A frayed or torn belt could rip apart in a collision and leave you with no protection. Inspect the belt system periodically, checking for cuts, frays, or loose parts. Damaged parts must be replaced immediately. Do not disassemble or modify the system. Seat belt assemblies must be replaced after an accident if they have been damaged (bent retractor, torn webbing, etc.).

Lap/Shoulder Belt Untwisting Procedure

Use the following procedure to untwist a twisted lap/shoulder belt.

1. Position the latch plate as close as possible to the anchor point.
2. At about 6 to 12 in (15 to 30 cm) above the latch plate, grasp and twist the belt webbing 180 degrees to create a fold that begins immediately above the latch plate.
3. Slide the latch plate upward over the folded webbing. The folded webbing must enter the slot at the top of the latch plate.
4. Continue to slide the latch plate up until it clears the folded webbing.

Seat Belt Pretensioner — If Equipped

The front passenger seat belt is equipped with a pretensioning device that is designed to remove any slack from the seat belt systems in the event of a collision. These

devices improve the performance of the seat belt by assuring that the belt is tight around the occupant early in a collision. Pretensioners work for all size occupants, including those in child restraints.

NOTE: These devices are not a substitute for proper seat belt placement by the occupant. The seat belt must still be worn snugly and positioned properly

The pretensioner is triggered by the Occupant Restraint Controller (ORC). Like the airbags, the pretensioners are single use items. After a collision that is severe enough to deploy the airbags and/or pretensioners, both must be replaced.

Adjustable Upper Shoulder Belt Anchorage

In the front seating positions, the shoulder belt can be adjusted upward or downward to position the belt away from your neck. Press the release button to release the anchorage, and then move it up or down to the position that fits you best.

NOTE: The adjustable upper shoulder belt anchorage is equipped with an Easy Up feature. This feature allows the shoulder belt anchorage to be adjusted in the upward position without pressing the release button. To verify the shoulder belt anchorage is latched, pull downward on the shoulder belt anchorage until it is locked into position.



Adjusting Upper Shoulder Belt

As a guide, if you are shorter than average, you will prefer a lower position, and if you are taller than average, you will prefer a higher position.

Automatic Locking Retractors (ALR) Mode — If Equipped

In this mode, the shoulder belt is automatically pre-locked. The belt will still retract to remove any slack in the shoulder belt. The Automatic Locking Mode is available on all passenger-seating positions with a combination lap/shoulder belt.

When To Use The Automatic Locking Mode

Use the Automatic Locking Mode anytime a child safety seat is installed in the rear outboard seating position. Children 12 years old and younger should always be properly restrained in the rear seat.

How To Use The Automatic Locking Mode

1. Buckle the combination lap and shoulder belt.
2. Grasp the shoulder portion and pull downward until the entire belt is extracted.
3. Allow the belt to retract. As the belt retracts, you will hear a clicking sound. This indicates the safety belt is now in the Automatic Locking Mode.

How to Disengage The Automatic Locking Mode

Disconnect the combination lap/shoulder belt from the buckle and allow it to retract completely to disengage the Automatic Locking Mode and activate the vehicle sensitive (emergency) locking mode.

Energy Management Feature

This vehicle has a safety belt system with an energy management feature in the front seating positions to help further reduce the risk of injury in the event of a head-on collision.

This safety belt system has a retractor assembly that is designed to release webbing in a controlled manner. This feature is designed to help reduce the belt force acting on the occupant's chest.

WARNING!

- The belt and retractor assembly must be replaced if the seat belt assembly "automatic locking retractor" feature or any other seat belt function is not working properly when checked according to the procedures in the Service Manual.
- Failure to replace the belt and retractor assembly could increase the risk of injury in collisions.

Supplemental Rear Impact Active Head Restraints (AHR)

These head restraints are passive, deployable components, and vehicles with this equipment can not be readily identified by any markings, only through visual

inspection of the head restraint. The head restraint will be split in two halves, with the front half being soft foam and trim, the back half being decorative plastic.

How the Active Head Restraints (AHR) Work

The Occupant Restraint Controller (ORC) determines whether the severity or type of rear impact require the Active Head Restraints (AHR) to deploy. In case of AHR deployment both driver and front passenger seat AHR's will be deployed.

When AHR's deploy during a rear impact, the head restraint front half extends forward to minimize the gap between the back of the head and the AHR. This system is designed to help prevent or reduce the extent of injuries the driver and front passenger in certain types of rear end impacts.

NOTE: The Active Head Restraints (AHR) may or may not deploy in the event of a front or side impact.

However if during a front impact, a secondary rear impact occurs, the AHR may deploy based on the severity and type of the impact.

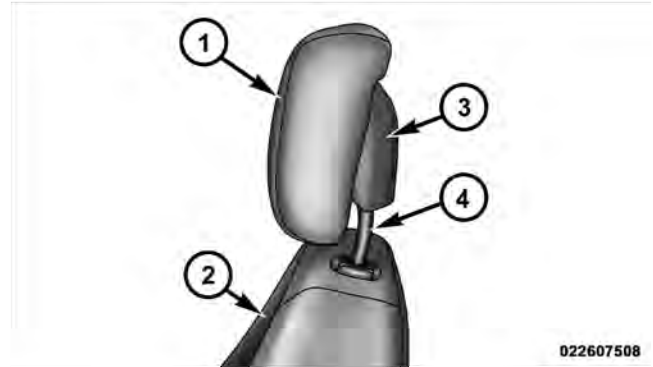

Active Head Restraint (AHR) Components

- | | |
|--|--|
| 1 — Head Restraint Front Half (Soft Foam and Trim) | 3 — Head Restraint Back Half (Decorative Plastic Rear Cover) |
| 2 — Seatback | 4 — Head Restraint Guide Tubes |

CAUTION!

All occupants, including the driver, should not operate a vehicle or sit in a vehicle's seat until the head restraints are placed in their proper positions in order to minimize the risk of neck injury in the event of an accident.

NOTE: For more information on properly adjusting and positioning the head restraint, refer to "Adjusting Active Head Restraints" in "Understanding The Features Of Your Vehicle".

Resetting Active Head Restraints (AHR)

If the Active Head Restraints are triggered in an accident, you must reset the head restraint on the driver's and front passenger seat. You can recognize when the Active Head Restraint has been triggered by the fact that they have moved forward (as shown in step three of the resetting procedure).

1. Grasp the deployed AHR from the rear seat.

**Hand Positioning Points On AHR**

2. Position the hands on the top of the deployed AHR at a comfortable position.

48 THINGS TO KNOW BEFORE STARTING YOUR VEHICLE

3. Pull **down** then **rearward** towards the rear of the vehicle then **down** to engage the locking mechanism.

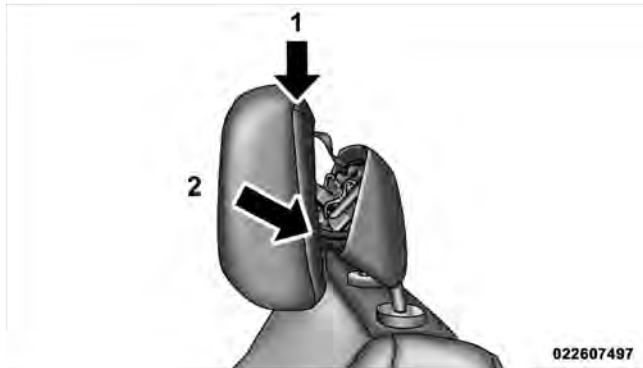

- 1 — Downward Movement
- 2 — Rearward Movement

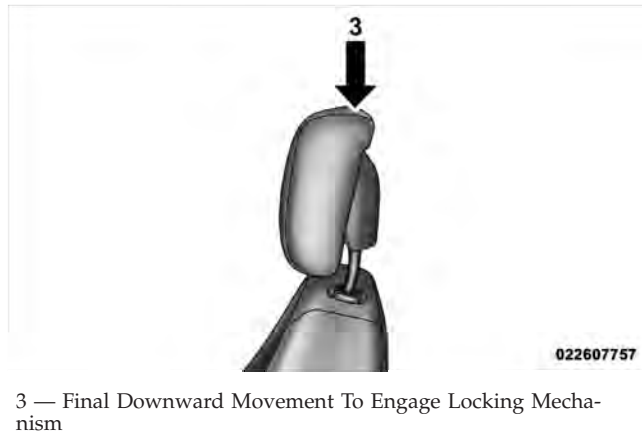

- 3 — Final Downward Movement To Engage Locking Mechanism

4. The AHR front soft foam and trim half should lock into the back decorative plastic half.



AHR In Reset Position

022607494

NOTE:

- If you have difficulties or problems resetting the head restraints, see an authorized dealer.

- For safety reasons, have the Active Head Restraints checked by a qualified specialist at an authorized dealer.

Enhanced Seat Belt Use Reminder System (BeltAlert®)

If the driver's seat belt has not been buckled within 60 seconds of starting the vehicle and if the vehicle speed is greater than 5 mph (8 km/h), the BeltAlert® will alert the driver to buckle the seat belt. The driver should also instruct all other occupants to buckle their seat belts. Once the warning is triggered, the BeltAlert® will continue to chime and flash the Seat Belt Reminder Light for 96 seconds or until the driver's seat belt is buckled. The BeltAlert® will be reactivated if the driver's seat belt is unbuckled for more than 10 seconds and the vehicle speed is greater than 5 mph (8 km/h).

BeltAlert® can be enabled or disabled by your authorized dealer or by following these steps:

NOTE: The following steps must occur within the first 60 seconds of the ignition switch being turned to the ON or START position. The manufacturer does not recommend deactivating BeltAlert®.

1. Turn the ignition switch to the OFF position, and fasten the driver seat belt.
2. Start the engine, and wait for the Seat Belt Reminder Light to turn off.
3. Within 60 seconds of starting the vehicle, unbuckle and then re-buckle the driver seat belt at least three times, ending with the seat belt buckled.
4. Turn OFF the engine. A single chime will sound to signify that you have successfully completed the programming.

BeltAlert® can be reactivated by repeating this procedure.

NOTE: Although BeltAlert® has been deactivated, the Seat Belt Reminder Light will continue to illuminate while the driver seat belt remains unfastened.

Seat Belts and Pregnant Women

We recommend that pregnant women use the seat belts throughout their pregnancy. Keeping the mother safe is the best way to keep the baby safe.

Pregnant women should wear the lap part of the belt across the thighs and as snug across the hips as possible. Keep the belt low so that it does not come across the abdomen. That way the strong bones of the hips will take the force if there is a collision.

Seat Belt Extender

If a seat belt is too short even when fully extended and when the adjustable upper shoulder belt anchorage (if equipped) is in its lowest position, your authorized dealer can provide you with a seat belt extender. This

extender should be used only if the existing belt is not long enough. When it is not required, remove the extender and store it.

WARNING!

Using a seat belt extender when not needed can increase the risk of injury in a collision. Only use when the lap belt is not long enough when it is worn low and snug, and in the recommended seating positions. Remove and store the extender when not needed.

Supplemental Restraint Systems (SRS) — Airbags

This vehicle has airbags for both the driver and front passenger as a supplement to the seat belt restraint systems. The driver's front airbag is mounted in the steering wheel. The passenger's front airbag is mounted in the instrument panel, above the glove compartment. The words SRS/AIRBAG are embossed on the airbag covers.

NOTE: These airbags are certified to the new Federal regulations for Advanced Airbags.

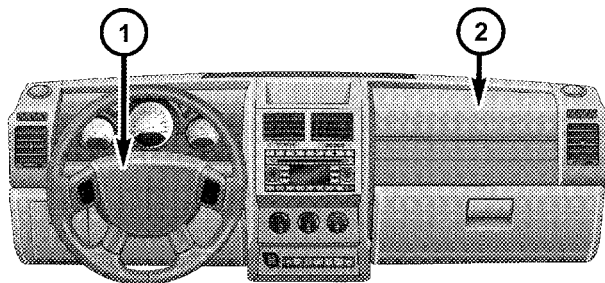

022606181

Front Airbag Components

- 1 — Driver Airbag
- 2 — Passenger Airbag

52 THINGS TO KNOW BEFORE STARTING YOUR VEHICLE

The Advanced Front Airbags have a multistage inflator design. This allows the airbag to have different rates of inflation that are based on the severity and type of collision.

This vehicle may also be equipped with Supplemental Side Airbag Inflatable Curtains (SABIC) that run the entire length of the headliner to protect the driver, front, and rear passengers sitting next to a window.



Supplemental Side Airbag Inflatable Curtains (SABIC) Label Location

NOTE: Airbag covers may not be obvious in the interior trim, but they will open during airbag deployment.

Airbag System Components

The airbag system consists of the following:

- Occupant Restraint Controller (ORC)
- Airbag Warning Light
- Driver Front Airbag
- Front Passenger Airbag
- Supplemental Rear Impact Active Head Restraint for Driver and Front Passenger
- Supplemental Side Airbag Inflatable Curtains (SABIC) — if equipped
- Steering Wheel and Column
- Instrument Panel
- Knee Impact Bolsters
- Front and Side Impact Sensors
- Front Seat Belt Pretensioners — if equipped

- Occupant Classification System (OCS) — Front Passenger Seat Only
 - Occupant Classification Module
 - Passenger Airbag Disable (PAD) Indicator Light
 - Weight Sensors

Advanced Front Airbag Features

The Advanced Front Airbag system has multistage driver and front passenger airbags. This system provides output appropriate to the severity and type of collision as determined by the Occupant Restraint Controller (ORC), which may receive information from the impact sensors at the front of the car.

The first stage inflator is triggered immediately during an impact that requires airbag deployment. The timing of the second stage determines whether the output force is low, medium, or high. If a low output is sufficient to meet the need, the remaining gas in the inflator is expended.

NOTE: The passenger front airbag may not deploy even when the driver front airbag has if the Occupant Classification System (refer to "Occupant Classification System") has determined the passenger seat is empty or is occupied by someone that is classified in the "child" size category. This could be a child, teenager, or even an adult.

WARNING!

- No objects should be placed over or near the airbag on the instrument panel, because any such objects could cause harm if the vehicle is in a crash severe enough to cause the airbag to inflate.

(Continued)

WARNING! (Continued)

- Do not put anything on or around the front airbag covers or attempt to manually open them. You may damage the airbags and you could be injured because the airbags may no longer be functional. These protective covers for the airbag cushions are designed to open only when the airbags are inflating.
- Do not use accessory seat covers or place objects between you and the side airbags; the performance could be adversely affected and/or objects could be pushed into you, causing serious injury.
- Do not drill, cut or tamper with the knee bolster in any way.
- Do not mount any accessories to the knee bolster such as alarm lights, stereos, citizen band radios, etc.

(Continued)

WARNING! (Continued)

- Do not have any accessory items installed which will alter the roof, including adding a sunroof to your vehicle. Do not add roof racks that require permanent attachments (bolts or screws) for installation on the vehicle roof. Do not drill into the roof of the vehicle for any reason.

Supplemental Side Airbag Inflatable Curtain (SABIC)

SABIC airbags offer side-impact and vehicle rollover protection to front and rear seat outboard occupants in addition to that provided by the body structure. Each airbag features inflated chambers placed adjacent to the head of each outboard occupant that reduce the potential for side-impact head injuries. The SABIC airbags deploy downward, covering both windows on the impact side.

NOTE:

- Should a vehicle rollover occur, the pretensioners and/or SABIC airbags on both sides of the vehicle may deploy.
- Airbag covers may not be obvious in the interior trim; but they will open during airbag deployment.

The system includes sensors adjacent to both front and rear seat occupants that are calibrated to deploy the SABIC airbags during impacts that require airbag occupant protection.

WARNING!

If your vehicle is equipped with left and right Side Airbag Inflatable Curtain (SABIC), do not stack luggage or other cargo up high enough to block the location of the SABIC. The area where the side curtain airbag is located should remain free from any obstructions.

Knee Impact Bolsters

The Knee Impact Bolsters help protect the knees of the driver and the front passenger, and position everyone for the best interaction with the front airbag.

Along with seat belts and pretensioners, Advanced Front Airbags work with the knee bolsters to provide improved protection for the driver and front passenger. Side airbags also work with seat belts to improve occupant protection.

Here are some simple steps you can take to minimize the risk of harm from a deploying airbag:

1. Children 12 years and younger should always ride buckled up in a rear seat.

Infants in rear facing child restraints should **NEVER** ride in the front seat of a vehicle with a passenger airbag. An airbag deployment could cause severe injury or death to infants in that position.

Children that are not big enough to properly wear the vehicle seat belt should be secured in the rear seat, in a child restraint or belt-positioning booster seat. Older children who do not use child restraints or belt-positioning booster seats should ride properly buckled up in the rear seat. Never allow children to slide the shoulder belt behind them or under their arm.

If a child from 1 to 12 years old (not in a rear facing child seat) must ride in the front passenger seat, move the seat as far back as possible and use the proper child restraint. (Refer to “Child Restraints”)

You should read the instructions provided with your child restraint to make sure that you are using it properly.

2. All occupants should ALWAYS wear their lap and shoulder belts properly.
3. The driver and front passenger seats should be moved back as far as practical to allow the Advanced Front Airbags room to inflate.
4. Do not lean against the door. If your vehicle has side airbags, and deployment occurs, the side airbags will inflate forcefully into the space between you and the door.

5. If the airbag system in this vehicle needs to be modified to accommodate a disabled person, contact the customer center. Phone numbers are provided under “If You Need Assistance”.

WARNING!

- Relying on the airbags alone could lead to more severe injuries in a collision. The airbags work with your seat belt to restrain you properly. In some collisions, the airbags won't deploy at all. Always wear your seat belts even though you have airbags.
- Being too close to the steering wheel or instrument panel during airbag deployment could cause serious injury, including death. Airbags need room to inflate. Sit back, comfortably extending your arms to reach the steering wheel or instrument panel.

(Continued)

WARNING! (Continued)

- **The side curtain airbags need room to inflate. Do not lean against the door or window. Sit upright in the center of the seat.**

Airbag Deployment Sensors and Controls***Occupant Restraint Controller (ORC)***

The **ORC** is part of a Federally regulated safety system required for this vehicle.

Based on the impact sensors signals, a central electronic ORC deploys the Advanced Front Airbags, side airbags — if equipped, and front seat belt pretensioners — if equipped, as required, depending on each type of impact.

Advanced Front Airbags are designed to provide additional protection by supplementing the seat belts in certain frontal collisions depending on the severity and

type of collision. Advanced Front Airbags are not expected to reduce the risk of injury in rear, side, or rollover collisions.

The Advanced Front Airbags will not deploy in all frontal collisions, including some that may produce substantial vehicle damage — for example, some pole collisions, truck underrides, and angle offset collisions. On the other hand, depending on the type and location of impact, Advanced Front Airbags may deploy in crashes with little vehicle front-end damage but that produce a severe initial deceleration.

The side airbags will not deploy in all side collisions. Side airbag deployment will depend on the severity and type of collision.

Because airbag sensors measure vehicle deceleration over time, vehicle speed and damage by themselves are not good indicators of whether or not an airbag should have deployed.

Seat belts are necessary for your protection in all crashes, and also are needed to help keep you in position, away from an inflating airbag.

The ORC also monitors the readiness of the electronic parts of the system whenever the ignition switch is in the START or ON positions. If the key is in the LOCK position, in the ACC position, or not in the ignition, the airbags are not on and will not inflate.

The ORC contains a backup power supply system that may deploy the airbags even if the battery loses power or it becomes disconnected prior to deployment.



- Also, the ORC turns on the “Airbag Warning Light” for six to eight seconds for a self-check when the ignition is first turned ON. After the self-check, the “Airbag Warning Light” will turn off. If the ORC detects a malfunction in any part of the system, it turns on the “Airbag

Warning Light” either momentarily or continuously. A single chime will sound if the light comes on again after initial startup.

WARNING!

Ignoring the “Airbag Warning Light” in your instrument panel could mean you won’t have the airbags to protect you in a collision. If the light does not come on, stays on after you start the vehicle, or if it comes on as you drive, have the airbag system checked right away.

- The **Occupant Classification System (OCS)** is part of a Federally regulated safety system required for this vehicle. It is designed to turn off the front passenger airbag for an empty seat and for occupants classified in a category other than an adult. This could be a child, teenager, or even an adult.

NOTE: Children 12 years and younger should always ride buckled up in a rear seat in an appropriate child restraint.

- The **Passenger Airbag Disable (PAD) Indicator Light** (an amber light located in the center of the instrument panel) tells the driver and front passenger when the front passenger airbag is turned off. The “PAD Indicator Light” illuminates the words “PASS AIR BAG OFF” to show that the passenger airbag will not inflate during a collision requiring airbags. When the right front passenger seat is empty or when very light objects are placed on the seat, the passenger airbag will not inflate even though the “PAD Indicator Light” is not illuminated.

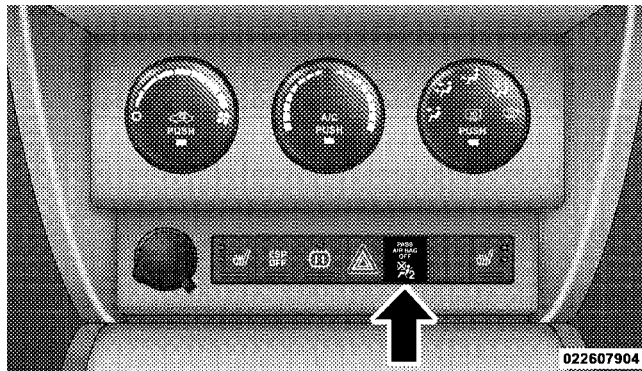

Indicator Light Location

The “PAD Indicator Light” should not be illuminated when an adult passenger is properly seated in the front passenger seat. In this case, the airbag is ready to be inflated if a collision requiring an airbag occurs.

For occupants classified in the “child” size category, the “PAD Indicator Light” will be illuminated, indicating that the front passenger airbag is turned off and will not inflate. If the “PAD Indicator Light” is not illuminated, **DO NOT** assume the airbag is turned off. Move the child restraint to the rear seat. A deploying passenger airbag can cause death or serious injury to a child in a rear facing infant seat.

NOTE: Even though this vehicle is equipped with an Occupant Classification System, children 12 years and younger should always ride buckled up in a rear seat in an appropriate child restraint.

Front Passenger Seat Occupant	Passenger Airbag Disable (PAD) Indicator Light	Airbag Status
Adult	OFF	ON
Grocery Bags, Heavy Briefcases and Other Relatively Light Objects	ON	OFF
Empty or Very Small Objects	OFF*	OFF
* Since the system senses weight, some small objects will turn the PAD Indicator Light on.		

The OCS classifies an occupant using weight sensors mounted in the base of the front passenger seat. Any weight on the seat will be sensed by the system. Objects hanging on the seat or other passengers pushing down on the seat will also be sensed. The weight of an adult will cause the system to turn the airbag on. In this case,

the OCS has classified the occupant of the seat as an adult. An adult occupant needs to sit in a normal position (with their feet on or near the floor) in order to be properly classified. Reclining the seat back too far may change how an occupant is classified by the OCS.

Drivers and adult passengers should verify that the "PAD Indicator Light" is not illuminated when an adult is riding in the front passenger seat. If an adult occupant's weight is transferred to another part of the vehicle (like the door or instrument panel), the weight sensors in the seat may not properly classify the occupant. Objects lodged under the seat or between the seat and the center console can prevent the occupant's weight from being measured properly and may result in the occupant being improperly classified. Ensure that the front passenger seatback does not touch anything placed on the back seat because this can also affect occupant classification. Also, if you fold down the rear seat, check to be sure it doesn't touch the front passenger seat.

If the front passenger seat is damaged in any way, it should only be serviced by an authorized dealer. If the seat is removed (or even if the seat attachment bolts are loosened or tightened in any way), take the vehicle to an authorized dealer.

If there is a fault present in the OCS, the "Airbag Warning Light" (a red light located in the center of the instrument cluster directly in front of the driver) will be turned on. This indicates that you should take the vehicle to an authorized dealer. The "Airbag Warning Light" is turned on whenever there is a fault that can affect the operation of the airbag system. If there is a fault present in the OCS, both the "PAD Indicator Light" and the "Airbag Warning Light" are illuminated to show that the passenger airbag is turned off until the fault is cleared. If an object is lodged under the seat and interferes with operation of the weight sensors, a fault will occur which turns on both the "PAD Indicator Light" and the "Airbag Warning

Light.” Once the lodged object is removed, the fault will be automatically cleared after a short period of time.

- The **Driver and Passenger Airbag/Inflator Units** are located in the center of the steering wheel and the right side of the instrument panel. When the ORC detects a collision requiring the airbags, it signals the inflator units. A large quantity of non-toxic gas is generated to inflate the Advanced Front Airbags. Different airbag inflation rates are possible based on collision severity and type. The steering wheel hub trim cover and the upper right side of the instrument panel separate and fold out of the way as the bags inflate to their full size. The bags fully inflate in about 50 to 70 milliseconds. This is about half of the time it takes to blink your eyes. The bags then quickly deflate while helping to restrain the driver and front passenger.

The driver front airbag gas is vented through the vent holes in the sides of the airbag. The passenger front

airbag gas is vented through the vent holes in the sides of the airbag. In this way, the airbags do not interfere with your control of the vehicle.

Along with seat belts and pretensioners, Advanced Front Airbags work with the knee bolsters to provide improved protection for the driver and front passenger. Side airbags also work with seat belts to improve occupant protection.

- The **Occupant Classification Module (OCM)** is located beneath the front passenger seat. The OCM classifies the occupant into categories based on the measurements made by the seat weight sensors. The OCM communicates with the Occupant Restraint Control (ORC) module. The ORC uses the occupant category to determine whether the front passenger airbag should be turned off. It also determines the rate of airbag inflation during a collision.

- Your vehicle has four **weight sensors** located between the seat and the floor pan. The weight sensors measure applied weight and transfers that information to the OCM.
- The **Supplemental Side Airbag Inflatable Curtains (SABIC)** may deploy during collisions where the impact is confined to a particular area of the side of the vehicle, depending on the severity and type of collision. In these events, the ORC will deploy the SABIC only on the impact side of the vehicle. Because airbag sensors estimate deceleration over time, vehicle speed and damage by themselves are not good indicators of whether or not an airbag should have deployed.

A quantity of non-toxic gas is generated to inflate the side curtain airbag. The inflating side curtain airbag pushes the outside edge of the headliner out of the way and covers the window. The airbag inflates in about 30 milliseconds (about one quarter of the time it

takes to blink your eyes) with enough force to injure you if you are not belted and seated properly, or if items are positioned in the area where the side curtain airbag inflates. This especially applies to children. The side curtain airbag is only about 3½ inches (9 cm) thick when it is inflated.

The system includes sensors adjacent to both front and rear seat occupants that are calibrated to deploy the SABIC airbags during impacts that require airbag occupant protection.

WARNING!

If your vehicle is equipped with left and right Side Airbag Inflatable Curtain (SABIC), do not stack luggage or other cargo up high enough to block the location of the SABIC. The area where the side curtain airbag is located should remain free from any obstructions.

The front passenger seat assembly contains critical components that affect the front passenger airbag deployment. Correctly functioning front passenger seat components are critical for the Occupant Classification System (OCS) to properly classify the front passenger and calculate the proper airbag deployment. Do not make any modifications to the front passenger seat components, assembly, or to the seat cover.

The following requirements must be strictly adhered to:

- Do not modify the front passenger seat assembly or components in any way.
- Do not use prior or future model year seat covers not designated for the specific model being repaired. Always use the correct seat cover specified for the vehicle.
- Do not replace the seat cover with an aftermarket seat cover.
- Do not add a secondary seat cover other than those approved by Chrysler Group LLC/Mopar®.
- At no time should any Supplemental Restraint System (SRS) component or SRS related component or fastener be modified or replaced with any part except those which are approved by Chrysler Group LLC/Mopar®.

WARNING!

Unapproved modifications or service procedures to the front passenger seat assembly, its related components or seat cover may inadvertently change the airbag deployment in case of a frontal crash. This could result in death or serious injury to the front seat passenger if the vehicle is involved in an accident. A modified vehicle may not comply with required Federal Motor Vehicle Safety Standards (FMVSS) and/or Canadian Motor Vehicle Safety Standards (CMVSS).

If a Deployment Occurs

The airbags are designed to deflate immediately after deployment.

NOTE: Front and/or side airbags will not deploy in all collisions. This does not mean something is wrong with the airbag system.

If you do have a collision which deploys the airbags, any or all of the following may occur:

- The nylon airbag material may sometimes cause abrasions and/or skin reddening to the driver and front passenger as the airbags deploy and unfold. The abrasions are similar to friction rope burns or those you might get sliding along a carpet or gymnasium floor. They are not caused by contact with chemicals. They are not permanent and normally heal quickly. However, if you haven't healed significantly within a few days, or if you have any blistering, see your doctor immediately.
- As the airbags deflate you may see some smoke-like particles. The particles are a normal by-product of the process that generates the non-toxic gas used for airbag inflation. These airborne particles may irritate the skin, eyes, nose, or throat. If you have skin or eye irritation, rinse the area with cool water. For nose or

throat irritation, move to fresh air. If the irritation continues, see your doctor. If these particles settle on your clothing, follow the garment manufacturer's instructions for cleaning.

Do not drive your vehicle after the airbags have deployed. If you are involved in another collision, the airbags will not be in place to protect you.

WARNING!

Deployed airbags cannot protect you in another collision. Have the airbags, and seat belt retractor assembly replaced by an authorized dealer as soon as possible.

Enhanced Accident Response System

In the event of an impact causing airbag deployment, if the communication network remains intact, and the power remains intact, depending on the nature of the event the ORC will determine whether to have the Enhanced Accident Response System perform the following functions:

- Cut off fuel to the engine.
- Flash hazard lights as long as the battery has power or until the ignition key is turned off.
- Turn on the interior lights, which remain on as long as the battery has power or until the ignition key is removed.
- Unlock the doors automatically.

Maintaining Your Airbag System

WARNING!

- Modifications to any part of the airbag system could cause it to fail when you need it. You could be injured if the airbag system is not there to protect you. Do not modify the components or wiring, including adding any kind of badges or stickers to the steering wheel hub trim cover or the upper right side of the instrument panel or the headliner along the side rails. Do not modify the front bumper or vehicle body structure.

(Continued)

WARNING! (Continued)

- Do not attempt to modify any part of your advanced airbag system. The airbag may inflate accidentally or may not function properly if modifications are made. Take your vehicle to an authorized dealer for any advanced airbag system service. If it is necessary to modify an advanced airbag system for persons with disabilities, contact your authorized dealer.
- It is dangerous to try to repair any part of the airbag system yourself. Be sure to tell anyone who works on your vehicle that it has an airbag system.

Airbag Warning Light

You will want to have the airbag system ready to inflate for your protection in an impact. The airbag system is designed to be maintenance free. If any of the following occurs, have an authorized dealer service the system promptly:

- Does not come on during the six to eight seconds after the ignition switch is first turned ON.
- Remains on after the six to eight second interval.
- Comes on for any period of time while driving.

Event Data Recorder (EDR)

In the event of an accident, your vehicle is designed to record up to five seconds of specific vehicle data parameters (see list below) in an event data recorder prior to the moment of airbag deployment, or near deployment (if applicable), and up to a quarter second of either high-speed deceleration data or change in velocity during

and/or after airbag deployment or near-deployment. EDR data is ONLY recorded if an airbag deploys, or nearly deploys, and is otherwise unavailable.

NOTE:

1. A near-deployment event occurs when the airbag sensor detects severe vehicle deceleration usually indicative of a crash, but not severe enough to warrant airbag deployment.
2. Under certain circumstances, EDR data may not be recorded (e.g., loss of battery power).

In conjunction with other data gathered during a complete accident investigation, the electronic data may be used by Chrysler Group LLC and others to learn more about the possible causes of crashes and associated injuries in order to assess and improve vehicle performance. In addition to crash investigations initiated by Chrysler Group LLC, such investigations may be requested by customers, insurance carriers, government

officials, and professional crash researchers, such as those associated with universities, and with hospital and insurance organizations.

In the event that an investigation is undertaken by Chrysler Group LLC (regardless of initiative), the company or its designated representative will first obtain permission of the appropriate custodial entity for the vehicle (usually the vehicle owner or lessee) before accessing the electronic data stored, unless ordered to download data by a court with legal jurisdiction (i.e., pursuant to a warrant). A copy of the data will be provided to the custodial entity upon request. General data that does not identify particular vehicles or crashes may be released for incorporation in aggregate crash databases, such as those maintained by the U.S. government and various states. Data of a potentially sensitive

nature, such as would identify a particular driver, vehicle, or crash, will be treated confidentially. Confidential data will not be disclosed by Chrysler Group LLC to any third party except when:

1. Used for research purposes, such as to match data with a particular crash record in an aggregate database, provided confidentiality of personal data is thereafter preserved.
2. Used in defense of litigation involving a Chrysler Group LLC product.
3. Requested by police under a legal warrant.
4. Otherwise required by law.

Data parameters that are recorded:

- Diagnostic trouble code(s) and warning light status for electronically-controlled safety systems, including the airbag system

- Vehicle speed
- Engine RPM
- Brake switch status
- Pedal position
- And other parameters depending on vehicle configuration

Child Restraint

Everyone in your vehicle needs to be buckled up all the time including babies and children. Every state in the United States and all Canadian provinces require that small children ride in proper restraint systems. This is the law, and you can be prosecuted for ignoring it.

Children 12 years and younger should ride properly buckled up in a rear seat, if available. According to crash statistics, children are safer when properly restrained in the rear seats rather than in the front.

There are different sizes and types of restraints for children from newborn size to the child almost large enough for an adult safety belt. Always check the child seat Owner's Manual to ensure you have the right seat for your child. Use the restraint that is correct for your child.

WARNING!

In a collision, an unrestrained child, even a tiny baby, can become a projectile inside the vehicle. The force required to hold even an infant on your lap can become so great that you could not hold the child, no matter how strong you are. The child and others could be badly injured. Any child riding in your vehicle should be in a proper restraint for the child's size.

Infants and Child Restraints

- Safety experts recommend that children ride rearward-facing in the vehicle until they are at least one year old **and** weigh at least 20 lbs (9 kg). Two types of child restraints can be used: rearward-facing infant carriers and “convertible” child seats.
- The infant carrier is only used rearward-facing in the vehicle. It is recommended for children who weigh up to about 20 lbs (9 kg). “Convertible” child seats often have a higher weight limit in the rearward-facing direction than infant carriers do, so they can be used rearward-facing by children who weigh more than 20 lbs (9 kg) but are less than one year old. Both types of child restraints are held in the vehicle by the lap/shoulder belt or the LATCH child restraint anchorage system (Refer to LATCH — Child Seat Anchorage System.)

- Rearward-facing child seats must **NEVER** be used in the front seat of a vehicle with the front passenger airbag unless the airbag is turned off. An airbag deployment could cause severe injury or death to infants in this position.

WARNING!

- **Improper installation can lead to failure of an infant or child restraint. It could come loose in a collision. The child could be badly injured or killed. Follow the manufacturer’s directions exactly when installing an infant or child restraint.**
- **A rearward-facing infant restraint should only be used in a rear seat. A rearward-facing infant restraint in the front seat may be struck by a deploying passenger airbag which may cause severe or fatal injury to the infant.**

Here are some tips for getting the most out of your child restraint:

- Before buying any restraint system, make sure that it has a label certifying that it meets all applicable safety standards. The manufacturer also recommends that you try a child restraint in the vehicle seats where you will use it before you buy it.
- The restraint must be appropriate for your child's weight and height. Check the label on the restraint for weight and height limits.
- Carefully follow the instructions that come with the restraint. If you install the restraint improperly, it may not work when you need it.
- Except for the second row center seating position, all passenger seat belts are equipped with "automatic locking retractors." The second row center position has a cinching latch plate. Both types of seat belts are

designed to keep the lap portion tight around the child restraint so that it is not necessary to use a locking clip. If the seat belt has a cinching latch plate, pulling up on the shoulder portion of the lap/shoulder belt will tighten the belt (the cinching latch plate will keep the belt tight). However, any seat belt system may loosen with time, so check the belt occasionally and pull it tight if necessary. For the second row seat belts with the automatic locking retractors, pull the belt from the retractor until there is enough to allow it to pass through the child restraint and slide the latch plate into the buckle. Then, pull the belt until it is fully extracted from the retractor. Allow the belt to return to the retractor, pulling on the excess webbing to tighten the lap portion around the child restraint. For additional information, refer to "Automatic Locking Mode".

- In the rear seat, you may have trouble tightening the lap/shoulder belt on the child restraint because the

buckle or latch plate is too close to the belt path opening on the restraint. Disconnect the latch plate from the buckle and twist the short buckle-end belt several times to shorten it. Insert the latch plate into the buckle with the release button facing out.

- If the belt still cannot be tightened, or if pulling and pushing on the restraint loosens the belt, disconnect the latch plate from the buckle, turn the buckle around, and insert the latch plate into the buckle again. If you still cannot make the child restraint secure, try a different seating position.
- Buckle the child into the restraint exactly as the manufacturer's instructions tell you.
- When your child restraint is not in use, secure it in the vehicle with the seat belt or remove it from the vehicle. Do not leave it loose in the vehicle. In a sudden stop or collision, it could strike the occupants or seatbacks and cause serious personal injury.

NOTE: For additional information, refer to www.seatcheck.org or call 1-866-SEATCHECK. Canadian residents, should refer to Transport Canada's website for additional information. <http://www.tc.gc.ca/roadsafety/safedrivers/childsafety/index.htm>

Older Children and Child Restraints

Children who weigh more than 20 lbs (9 kg) and who are older than one year can ride forward-facing in the vehicle. Forward-facing child seats and convertible child seats used in the forward-facing direction are for children who weigh 20 to 40 lbs (9 to 18 kg), and who are older than one year. These child seats are also held in the vehicle by the lap/shoulder belt or the LATCH child restraint anchorage system (refer to LATCH — Child Seat Anchorage System.)

The belt-positioning booster seat is for children weighing more than 40 lbs (18 kg), but who are still too small to fit the vehicle's seat belts properly. If the child cannot sit

with knees bent over the vehicle's seat cushion while the child's back is against the seatback, they should use a belt-positioning booster seat. The child and belt-positioning booster seat are held in the vehicle by the lap/shoulder belt.

Children Too Large for Booster Seats

Children who are large enough to wear the shoulder belt comfortably and whose legs are long enough to bend over the front of the seat when their back is against the seatback, should use the lap/shoulder belt in a rear seat.

- Make sure that the child is upright in the seat.
- The lap portion should be low on the hips and as snug as possible.
- Check belt fit periodically. A child's squirming or slouching can move the belt out of position.

- If the shoulder belt contacts the face or neck, move the child closer to the center of the vehicle. Never allow a child to put the shoulder belt under an arm or behind their back.

LATCH — Child Seat Anchorage System (Lower Anchors and Tether for Children)

Your vehicle's rear seat is equipped with the child restraint anchorage system called LATCH. The LATCH system provides for the installation of the child restraint without using the vehicle's seat belts, instead securing the child restraint using lower anchorages and upper tether straps from the child restraint to the vehicle structure.

LATCH-compatible child restraint systems are now available. However, because the lower anchorages are to be introduced over a period of years, child restraint systems having attachments for those anchorages will continue to also have features for installation using the vehicle's seat

belts. Child restraints having tether straps and hooks for connection to the top tether anchorages, have been available for some time. For some older child restraints, many child restraint manufacturers offer add-on tether strap kits or retro-fit kits. You are urged to take advantage of all the available attachments provided with your child restraint in any vehicle.

All three rear seating positions have lower anchorages that are capable of accommodating LATCH-compatible child seats having fixed lower attachments or flexible webbing-mounted lower attachments. Child seats with fixed lower attachments must be installed in the outboard seating positions only. The center seating position will accommodate LATCH-compatible lower anchorages with flexible webbing mounted attachments only. Regardless of the specific type of lower attachment, **NEVER** install LATCH-compatible child seats so that two seats share a common lower anchorage.

If you are installing LATCH-compatible child restraints in adjacent rear seating positions, you can use the LATCH anchors or the vehicle's seat belt for the outboard position, but you must use the vehicle's seat belt at the center position. If your child restraints are not LATCH-compatible, you can only install the child restraints using the vehicle's seat belts. Please refer to "Installing the LATCH-Compatible Child Restraint System" for typical installation instructions.

Installing the LATCH-Compatible Child Restraint System

We urge you to carefully follow the directions of the manufacturer when installing your child restraint. Not all child restraint systems will be installed as described here. Again, carefully follow the installation instructions that were provided with the child restraint system.

The rear seat lower anchorages are round bars located at the rear of the seat cushion where it meets the seatback, and are just visible when you lean into the rear seat to install the child restraint. You will easily feel them if you run your finger along the intersection of the seatback and seat cushion surfaces.

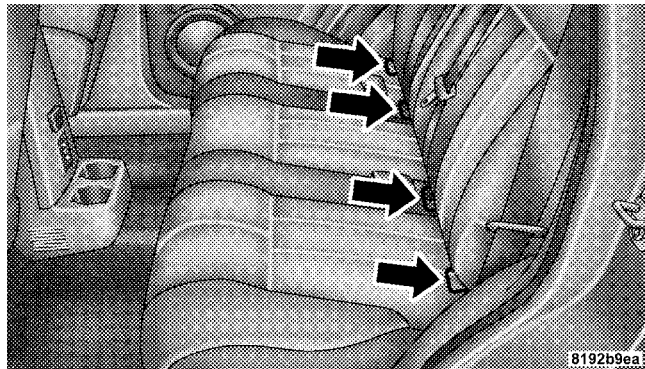

Latch Anchorages

In addition, there are tether strap anchorages behind each rear seating position located on the back of the seat.

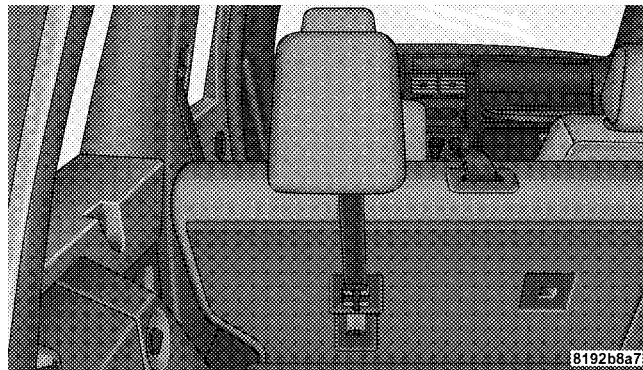

Tether Strap Mounting

Many, but not all restraint systems will be equipped with separate straps on each side, with each having a hook or connector for attachment to the lower anchorage and a means of adjusting the tension in the strap. Forward-facing toddler restraints and some rear-facing infant restraints will also be equipped with a tether strap, a hook for attachment to the tether strap anchorage and a means of adjusting the tension of the strap.

You will first loosen the adjusters on the lower straps and on the tether strap so that you can more easily attach the hooks or connectors to the vehicle anchorages. Next, attach the lower hooks or connectors over the top of the anchorage bars, pushing aside the seat cover material. Then, locate the tether anchorage directly behind the seat where you are placing the child restraint and attach the tether strap to the anchorage, being careful to route the

tether strap to provide the most direct path between the anchor and the child restraint. For the outboard seating positions, route the tether underneath the head rest and attach the hook to the tether anchor located on the back of the seat. Finally, tighten all three straps as you push the child restraint rearward and downward into the seat, removing slack in the straps according to the child restraint manufacturer's instructions.

WARNING!

Improper installation of a child restraint to the LATCH anchorages can lead to failure of an infant or child restraint. The child could be badly injured or killed. Follow the manufacturer's directions exactly when installing an infant or child restraint.

Installing Child Restraints Using the Vehicle Seat Belt

The passenger seat belts are equipped with either cinching latch plates or automatic locking retractors, which are designed to keep the lap portion tight around the child restraint so that it is not necessary to use a locking clip. If the seat belt has a cinching latch plate, pulling up on the shoulder portion of the lap/shoulder belt will tighten the belt. However, any seat belt system may loosen with time, so check the belt occasionally and pull it tight if necessary.

Pull the belt from the retractor until there is enough to allow it to pass through the child restraint and slide the latch plate into the buckle. Then, pull the belt until it is completely extracted from the retractor. Allow the belt to return to the retractor, pulling on the excess webbing to tighten the lap portion around the child restraint. Refer to “Automatic Locking Mode”.

In the rear seat, you may have trouble tightening the lap/shoulder belt on the child restraint because the buckle or latch plate is too close to the belt path opening on the restraint. Disconnect the latch plate from the buckle and twist the short buckle-end belt several times to shorten it. Insert the latch plate into the buckle with the release button facing out.

If the belt still can't be tightened, or if pulling and pushing on the restraint loosens the belt, you may need to do something more. Disconnect the latch plate from the buckle, turn the buckle around, and insert the latch plate into the buckle again. If you still can't make the child restraint secure, try a different seating position.

To attach a child restraint tether strap:

Route the tether strap over the seatback and attach the hook to the tether anchor located on the back of the seat. For the outboard seating positions, route the tether under the head rests, and attach the hook to the tether anchor located on the back of the seat.

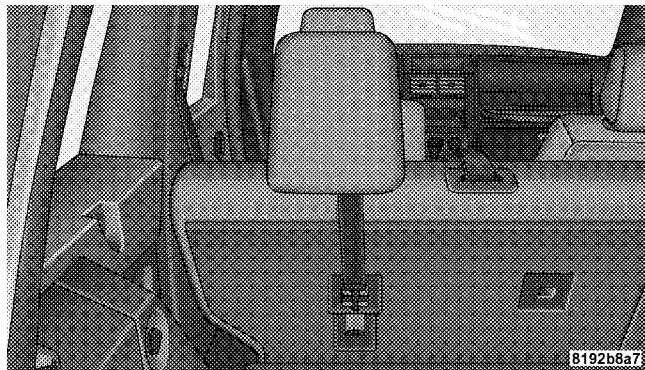

Tether Strap Mounting

WARNING!

An incorrectly anchored tether strap could lead to increased head motion and possible injury to the child. Use only the anchor positions directly behind the child seat to secure a child restraint top tether strap.

Transporting Pets

Airbags deploying in the front seat could harm your pet. An unrestrained pet will be thrown about and possibly injured, or injure a passenger during panic braking or in a collision. Pets should be restrained in the rear seat in pet harnesses or pet carriers that are secured by seat belts.

ENGINE BREAK-IN RECOMMENDATIONS

A long break-in period is not required for the engine and drivetrain (transmission and axle) in your vehicle.

Drive moderately during the first 300 miles (500 km). After the initial 60 miles (100 km), speeds up to 50 or 55 mph (80 or 90 km/h) are desirable.

While cruising, brief full-throttle acceleration within the limits of local traffic laws, contributes to a good break-in. Wide-open throttle acceleration in low gear can be detrimental and should be avoided.

The engine oil installed in the engine at the factory is a high-quality energy conserving type lubricant. Oil changes should be consistent with anticipated climate conditions under which vehicle operations will occur. For the recommended viscosity and quality grades refer to “Maintenance Procedures” in “Maintaining Your Vehicle”. NON-DETERGENT OR STRAIGHT MINERAL OILS MUST NEVER BE USED.

A new engine may consume some oil during its first few thousand miles (kilometers) of operation. This should be considered a normal part of the break-in and not interpreted as an indication of difficulty.

SAFETY TIPS

Transporting Passengers

NEVER TRANSPORT PASSENGERS IN THE CARGO AREA.

WARNING!

- It is extremely dangerous to ride in a cargo area, inside or outside of a vehicle. In a collision, people riding in these areas are more likely to be seriously injured or killed.

(Continued)

WARNING! (Continued)

- Do not allow people to ride in any area of your vehicle that is not equipped with seats and seat belts.
- Be sure everyone in your vehicle is in a seat and using a seat belt properly.

Exhaust Gas**WARNING!**

Exhaust gases can injure or kill. They contain carbon monoxide (CO), which is colorless and odorless. Breathing it can make you unconscious and can eventually poison you. To avoid breathing (CO) follow these safety tips:

Do not run the engine in a closed garage or in confined areas any longer than needed to move your vehicle in or out of the area.

If it is necessary to sit in a parked vehicle with the engine running, adjust your heating or cooling controls to force outside air into the vehicle. Set the blower at high speed.

If you are required to drive with the trunk/liftgate open, make sure that all windows are closed and the climate control BLOWER switch is set at high speed. DO NOT use the recirculation mode.

The best protection against carbon monoxide entry into the vehicle body is a properly maintained engine exhaust system.

Whenever a change is noticed in the sound of the exhaust system, when exhaust fumes can be detected inside the vehicle, or when the underside or rear of the vehicle is damaged, have a competent mechanic inspect the complete exhaust system and adjacent body areas for broken, damaged, deteriorated, or mispositioned parts. Open seams or loose connections could permit exhaust fumes to seep into the passenger compartment. In addition, inspect the exhaust system each time the vehicle is raised for lubrication or oil change. Replace as required.

Safety Checks You Should Make Inside the Vehicle

Seat Belts

Inspect the belt system periodically, checking for cuts, frays, and loose parts. Damaged parts must be replaced immediately. Do not disassemble or modify the system.

Front seat belt assemblies must be replaced after a collision. Rear seat belt assemblies must be replaced after

a collision if they have been damaged (i.e., bent retractor, torn webbing, etc.). If there is any question regarding belt or retractor condition, replace the belt.

Airbag Warning Light

The light should come on and remain on for six to eight seconds as a bulb check when the ignition switch is first turned ON. If the light is not lit during starting, see your authorized dealer. If the light stays on, flickers, or comes on while driving, have the system checked by an authorized dealer.

Defroster

Check operation by selecting the defrost mode and place the blower control on high speed. You should be able to feel the air directed against the windshield. See your authorized dealer for service if your defroster is inoperable.

Periodic Safety Checks You Should Make Outside the Vehicle

Tires

Examine tires for excessive tread wear and uneven wear patterns. Check for stones, nails, glass, or other objects lodged in the tread. Inspect the tread and sidewall for cuts and cracks. Check the wheel nuts for tightness. Check the tires (including spare) for proper pressure.

Lights

Have someone observe the operation of exterior lights while you work the controls. Check turn signal and high beam indicator lights on the instrument panel.

Door Latches

Check for positive closing, latching, and locking.

Fluid Leaks

Check area under vehicle after overnight parking for fuel, engine coolant, oil, or other fluid leaks. Also, if gasoline fumes are detected or if fuel, power steering fluid, or brake fluid leaks are suspected, the cause should be located and corrected immediately.

UNDERSTANDING THE FEATURES OF YOUR VEHICLE

CONTENTS

■ Mirrors	89	□ Phone Call Features	102
□ Inside Day/Night Mirror	89	□ Uconnect™ phone Features	105
□ Automatic Dimming Mirror — If Equipped . . .	90	□ Advanced Phone Connectivity	110
□ Outside Mirrors	90	□ Things You Should Know About Your Uconnect™ phone	112
□ Power Mirrors	91	□ General Information	121
□ Illuminated Vanity Mirrors — If Equipped . . .	92	■ Voice Command — If Equipped	121
□ Sun Visor “Slide-On-Rod” Feature	92	□ Voice Command System Operation	121
■ Uconnect™ phone — If Equipped	92	□ Commands	123
□ Operation	94		

86 UNDERSTANDING THE FEATURES OF YOUR VEHICLE

- Voice Training 126
- Seats 126
 - Front Manual Seat Adjustment 127
 - Front Seat Adjustment — Recline 128
 - Six-Way Driver’s Power Seat With Manual Recliner 128
 - Fold-Flat Front Passenger Seat 130
 - Adjusting Active Head Restraints 130
 - Heated Seats — If Equipped 133
 - 60/40 Split Folding Rear Seat With Fold-Flat Feature 134
- To Open And Close The Hood 137
- Lights 139
 - Multifunction Lever 139
 - Headlights And Parking Lights 139
 - Instrument Panel Dimmer 140
 - Lights-On Reminder 140
 - High/Low Beam Switch 141
 - Flash-To-Pass 141
 - Front Fog Lights — If Equipped 141
 - Turn Signals 142
 - Lane Change Assist 142
 - Daytime Running Lights — If Equipped 142
 - Interior Lights 143
- Windshield Wipers And Washers 143
 - Windshield Wiper Operation 144
 - Intermittent Wiper System 145

□ Windshield Washers	146	□ Parksense® Operation	154
□ Mist Feature	146	□ Service Parksense® Rear Park Assist	157
■ Tilt Steering Column	147	■ Garage Door Opener — If Equipped	157
■ Electronic Speed Control — If Equipped	148	□ Programming HomeLink®	159
□ To Activate	149	□ Gate Operator/Canadian Programming	161
□ To Set a Desired Speed	149	□ Using HomeLink®	162
□ To Deactivate	149	□ Reprogramming A Single HomeLink® Button	162
□ To Resume Speed	149	□ Security	162
□ To Vary The Speed Setting	150	□ Troubleshooting Tips	163
□ To Accelerate For Passing	150	□ General Information	163
■ Parksense® Rear Park Assist — If Equipped	151	■ Power Sunroof — If Equipped	164
□ System Usage Precautions	151	□ Opening Sunroof — Express	165
□ Enabling And Disabling Parksense®	154		

88 UNDERSTANDING THE FEATURES OF YOUR VEHICLE

□ Opening Sunroof — Manual Mode	165	■ Storage	171
□ Closing Sunroof — Express	165	□ Front Storage Compartment	171
□ Closing Sunroof — Manual Mode	165	□ Console Storage Compartment	171
□ Pinch Protect Feature	165	■ Cargo Area Features	172
□ Pinch Protect Override	166	□ Cargo Light	172
□ Venting Sunroof — Express	166	□ Cargo Tie-Down Hooks	172
□ Sunshade Operation	166	□ Cargo Load Floor — If Equipped	173
□ Wind Buffeting	166	■ Rear Window Features	174
□ Sunroof Maintenance	166	□ Rear Window Wiper/Washer	174
□ Ignition Off Operation	167	□ Rear Window Defroster	175
■ Electrical Power Outlet	167	■ Roof Trim Applique — Non Functional	176
■ Cupholders	170		

MIRRORS

Inside Day/Night Mirror

A two-point pivot system allows for horizontal and vertical adjustment of the mirror. The mirror should be adjusted to center on the view through the rear window.

Headlight glare can be reduced by moving the small control under the mirror to the night position (toward the rear of the vehicle). The mirror should be adjusted while set in the day position (toward the windshield).

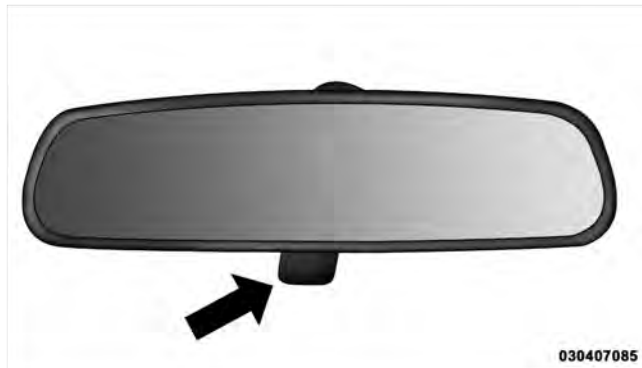

3

030407085

Adjusting Rearview Mirror

Automatic Dimming Mirror — If Equipped

This mirror will automatically adjust for headlight glare from vehicles behind you. You can turn the feature on or off by pressing the button at the base of the mirror. A light next to the button will illuminate indicate when the dimming feature is activated.



Automatic Dimming Mirror

CAUTION!

To avoid damage to the mirror during cleaning, never spray any cleaning solution directly onto the mirror. Apply the solution onto a clean cloth and wipe the mirror clean.

Outside Mirrors

To receive maximum benefit, adjust the outside mirror(s) to center on the adjacent lane of traffic with a slight overlap of the view obtained on the inside mirror.

WARNING!

Vehicles and other objects seen in the passenger side convex mirror will look smaller and farther away than they really are. Relying too much on your passenger side mirror could cause you to collide with another vehicle or other object. Use your inside mirror when judging the size or distance of a vehicle seen in the passenger side mirror.

Power Mirrors

The power mirror switch is located on the driver's door trim panel.

**Power Mirror Switch**

Press the switch to the L (left) or R (right) to select a mirror. Using one of the four arrows, move the mirror to the desired position.

Illuminated Vanity Mirrors — If Equipped

An illuminated vanity mirror is on each sun visor. To use the mirror, rotate the sun visor down and swing the mirror cover upward. The lights will turn on automatically. Closing the mirror cover will turn off the light.

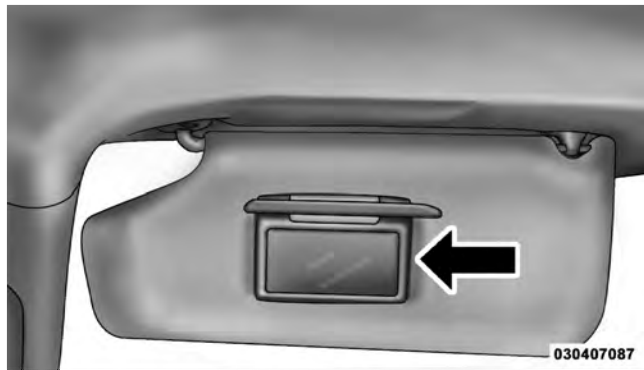

Illuminated Vanity Mirror

Sun Visor “Slide-On-Rod” Feature

The sun visor “Slide-On-Rod” feature allows for additional flexibility in positioning the visor to block out the sun.

1. Fold down the sun visor.
2. Unclip the visor from center clip.
3. Pull the sun visor toward the inside rearview mirror to extend.

Uconnect™ Phone — IF EQUIPPED

Uconnect™ Phone is a voice-activated, hands-free, in-vehicle communications system. Uconnect™ Phone allows you to dial a phone number with your cellular phone using simple voice commands (e.g., “Call” ... “Mike” ... “Work” or “Dial” ... “248-555-1212”). Your cellular phone’s audio is transmitted through your vehicle’s audio system; the system will automatically mute your radio when using the Uconnect™ Phone.

NOTE: The Uconnect™ Phone requires a cellular phone equipped with the Bluetooth® "Hands-Free Profile," Version 0.96 or higher. See the Uconnect™ website for supported phones.

For Uconnect™ customer support, visit the following websites:

- www.chrysler.com/uconnect
- www.dodge.com/uconnect
- www.jeep.com/uconnect
- or call 1-877-855-8400

Uconnect™ Phone allows you to transfer calls between the system and your cellular phone as you enter or exit your vehicle and enables you to mute the system's microphone for private conversation.

The Uconnect™ Phone is driven through your Bluetooth® "Hands-Free Profile" cellular phone.



Uconnect™ features Bluetooth® technology - the global standard that enables different electronic devices to connect to each other without wires or a docking station, so Uconnect™ Phone works no matter where you stow your cellular phone (be it your purse, pocket, or briefcase), as long as your phone is turned on and has been paired to the vehicle's Uconnect™ Phone. The Uconnect™ Phone allows up to seven cellular phones to be linked to the system. Only one linked (or paired) cellular phone can be used with the system at a time. The system is available in English, Spanish, or French languages.

WARNING!

Any voice commanded system should be used only in safe driving conditions following local laws and phone use. All attention should be kept on the roadway ahead. Failure to do so may result in an accident causing serious injury or death.

Uconnect™ Phone Button



Depending on the vehicle options, either the radio or the mirror will contain the two control buttons  (Uconnect™ Phone button) and  (Voice Command button) that will enable you to access the system.

Voice Command Button

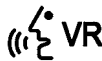

Actual button location may vary with the radio. The individual buttons are described in the “Operation” section.

The Uconnect™ Phone can be used with any Hands-Free Profile certified Bluetooth® cellular phone. See the Uconnect™ website for supported phones. If your cellular phone supports a different profile (e.g., Headset Profile) you may not be able to use any Uconnect™ Phone features. Refer to your cellular service provider or the phone manufacturer for details.

The Uconnect™ Phone is fully integrated with the vehicle’s audio system. The volume of the Uconnect™ Phone can be adjusted either from the radio volume control knob or from the steering wheel radio control (right switch), if so equipped.

The radio display will be used for visual prompts from the Uconnect™ Phone such as “CELL” or caller ID on certain radios.

Operation

Voice commands can be used to operate the Uconnect™ Phone and to navigate through the Uconnect™ Phone menu structure. Voice commands are required after most Uconnect™ Phone prompts. You will be prompted for a specific command and then guided through the available options.

- Prior to giving a voice command, one must wait for the beep, which follows the “Ready” prompt or another prompt.



- For certain operations, compound commands can be used. For example, instead of saying "Setup" and then "Phone Pairing," the following compound command can be said: "Setup Phone Pairing."
- For each feature explanation in this section, only the combined form of the voice command is given. You can also break the commands into parts and say each part of the command when you are asked for it. For example, you can use the combined form voice command "Phonebook New Entry," or you can break the combined form command into two voice commands: "Phonebook" and "New Entry." Please remember, the Uconnect™ Phone works best when you talk in a normal conversational tone, as if speaking to someone sitting a few feet/meters away from you.

Voice Command Tree

Refer to "Voice Tree" in this section.

Help Command

If you need assistance at any prompt, or if you want to know your options at any prompt, say "Help" following the beep. The Uconnect™ Phone will play all the options at any prompt if you ask for help.

To activate the Uconnect™ Phone from idle, simply press the  button and follow the audible prompts for directions. All Uconnect™ Phone sessions begin with a press of the  button on the radio control head.

Cancel Command

At any prompt, after the beep, you can say "Cancel" and you will be returned to the main menu. However, in a few instances the system will take you back to the previous menu.

Pair (Link) Uconnect™ Phone to a Cellular Phone

To begin using your Uconnect™ Phone, you must pair your compatible Bluetooth® enabled cellular phone.

To complete the pairing process, you will need to reference your cellular phone Owner's Manual. The Uconnect™ website may also provide detailed instructions for pairing.

The following are general phone to Uconnect™ Phone pairing instructions:

- Press the  button to begin.
- After the "Ready" prompt and the following beep, say "Setup Phone Pairing."
- When prompted, after the beep, say "Pair a Phone" and follow the audible prompts.
- You will be asked to say a four-digit Personal Identification Number (PIN), which you will later need to enter into your cellular phone. You can enter any four-digit PIN. You will not need to remember this PIN after the initial pairing process.
- For identification purposes, you will be prompted to give the Uconnect™ Phone a name for your cellular phone. Each cellular phone that is paired should be given a unique phone name.
- You will then be asked to give your cellular phone a priority level between one and seven, with one being the highest priority. You can pair up to seven cellular phones to your Uconnect™ Phone. However, at any given time, only one cellular phone can be in use, connected to your Uconnect™ Phone. The priority allows the Uconnect™ Phone to know which cellular phone to use if multiple cellular phones are in the vehicle at the same time. For example, if priority three and priority five phones are present in the vehicle, the Uconnect™ Phone will use the priority three cellular phone when you make a call. You can select to use a lower priority cellular phone at any time (refer to "Advanced Phone Connectivity" in this section).

Dial by Saying a Number

- Press the  button to begin.
- After the "Ready" prompt and the following beep, say "Dial."
- The system will prompt you to say the number you want to call.
- For example, you can say "234-567-8901".
- The Uconnect™ Phone will confirm the phone number and then dial. The number will appear in the display of certain radios.

Call by Saying a Name

- Press the  button to begin.
- After the "Ready" prompt and the following beep, say "Call."

- The system will prompt you to say the name of the person you want to call.
- After the "Ready" prompt and the following beep, say the name of the person you want to call. For example, you can say "John Doe," where John Doe is a previously stored name entry in the Uconnect™ phonebook or downloaded phonebook. To learn how to store a name in the phonebook, refer to "Add Names to Your Uconnect™ Phonebook," in the phonebook.
- The Uconnect™ system will confirm the name and then dial the corresponding phone number, which may appear in the display of certain radios.

Add Names to Your Uconnect™ Phonebook

NOTE: Adding names to the Uconnect™ Phonebook is recommended when the vehicle is not in motion.

- Press the  button to begin.

- After the "Ready" prompt and the following beep, say "Phonebook New Entry."
- When prompted, say the name of the new entry. Use of long names helps the Voice Command and it is recommended. For example, say "Robert Smith" or "Robert" instead of "Bob."
- When prompted, enter the number designation (e.g., "Home," "Work," "Mobile," or "Pager"). This will allow you to store multiple numbers for each phonebook entry, if desired.
- When prompted, recite the phone number for the phonebook entry that you are adding.

After you are finished adding an entry into the phonebook, you will be given the opportunity to add more phone numbers to the current entry or to return to the main menu.

The Uconnect™ Phone will allow you to enter up to 32 names in the phonebook with each name having up to four associated phone numbers and designations. Each language has a separate 32-name phonebook accessible only in that language. In addition, if equipped and supported by your phone, Uconnect™ Phone automatically downloads your cellular phone's phonebook.

Phonebook Download – Automatic Phonebook Transfer From Cellular Phone

If equipped and specifically supported by your phone, Uconnect™ Phone automatically downloads names (text names) and number entries from the cellular phone's phonebook. Specific Bluetooth® Phones with Phone Book Access Profile may support this feature. See Uconnect™ website for supported phones.

- To call a name from downloaded (or Uconnect™) Phonebook, follow the procedure in "Call by Saying a Name" section.

- Automatic download and update, if supported, begins as soon as the Bluetooth® wireless phone connection is made to the Uconnect™ Phone, for example, after you start the vehicle.
- A maximum of 1000 entries per phone will be downloaded and updated every time a phone is connected to the Uconnect™ Phone.
- Depending on the maximum number of entries downloaded, there may be a short delay before the latest downloaded names can be used. Until then, if available, the previous downloaded phonebook is available for use.
- Only the phonebook of the currently connected cellular phone is accessible.
- Only the cellular phone's phonebook is downloaded. SIM card phonebook is not part of the Mobile phonebook.
- This downloaded phonebook cannot be edited or deleted on the Uconnect™ Phone. These can only be edited on the cellular phone. The changes are transferred and updated to Uconnect™ Phone on the next phone connection.

Phonebook Download — Single Entry

If equipped and supported by your phone, Uconnect™ Phone allows the user to download entries from their phone via Bluetooth®. To use this feature, press the  button and say “Phonebook Download.” The system prompts, “Ready to accept “V” card entry via Bluetooth®...” The system is now ready to accept phonebook entries from your phone using the Bluetooth® Object Exchange Profile (OBEX). Please see your phone Owner's Manual for specific instructions on how to send these entries from your phone.

NOTE:

- The phone handset must support Bluetooth® OBEX transfers of phonebook entries to use this feature.
- Some phones cannot send phonebook entries if they are already connected to any system via Bluetooth®, and you may see a message on the phone display that the Bluetooth® link is busy. In this case, the user must first disconnect or drop the Bluetooth® connection to the Uconnect™ Phone, and then send the address book entry via Bluetooth®. Please see your phone Owner's Manual for specific instructions on how to drop the Bluetooth® connection.
- If the phonebook entry is longer than 24 characters, it will only use the first 24 characters.

Edit Uconnect™ Phonebook Entries**NOTE:**



- Editing names in the phonebook is recommended when the vehicle is not in motion.
- Automatic downloaded phonebook entries cannot be deleted or edited.
- Press the  button to begin.
- After the "Ready" prompt and the following beep, say "Phonebook Edit."
- You will then be asked for the name of the phonebook entry that you wish to edit.
- Next, choose the number designation (home, work, cellular, or pager) that you wish to edit.
- When prompted, recite the new phone number for the phonebook entry that you are editing.

After you are finished editing an entry in the phonebook, you will be given the opportunity to edit another entry in the phonebook, call the number you just edited, or return to the main menu.

"Phonebook Edit" can be used to add another phone number to a name entry that already exists in the phonebook. For example, the entry John Doe may have a cellular and a home number, but you can add "John Doe's" work number later using the "Phonebook Edit" feature.

Delete Uconnect™ Phonebook Entry

NOTE: Editing phonebook entries is recommended when the vehicle is not in motion.

- Press the  button to begin.
- After the "Ready" prompt and the following beep, say "Phonebook Delete."
- After you enter the Phonebook Delete menu, you will then be asked for the name of the entry that you wish to delete. You can either say the name of a phonebook entry that you wish to delete or you can say "List Names" to hear a list of the entries in the phonebook from which you choose. To select one of the entries from the list, press the  button while the Uconnect™ Phone is playing the desired entry and say "Delete."
- After you enter the name, the Uconnect™ Phone will ask you which designation you wish to delete: home, work, cellular, pager, or all. Say the designation you wish to delete.
- Note that only the phonebook entry in the current language is deleted.
- Automatic downloaded phonebook entries cannot be deleted or edited.

Delete/Erase "All" Uconnect™ Phonebook Entries

- Press the  button to begin.
- After the "Ready" prompt and the following beep, say "Phonebook Erase All."
- The Uconnect™ Phone will ask you to verify that you wish to delete all the entries from the phonebook.
- After confirmation, the phonebook entries will be deleted.
- Note that only the phonebook in the current language is deleted.
- Automatic downloaded phonebook entries cannot be deleted or edited.

List All Names in the Uconnect™ Phonebook

- Press the  button to begin.

- After the "Ready" prompt and the following beep, say "Phonebook List Names."
- The Uconnect™ Phone will play the names of all the phonebook entries, including the downloaded phonebook entries, if available.
- To call one of the names in the list, press the  button during the playing of the desired name, and say "Call."

NOTE: The user can also exercise "Edit" or "Delete" operations at this point.



- The Uconnect™ Phone will then prompt you as to the number designation you wish to call.
- The selected number will be dialed.

Phone Call Features

The following features can be accessed through the Uconnect™ Phone if the feature(s) are available on your

cellular service plan. For example, if your cellular service plan provides three-way calling, this feature can be accessed through the Uconnect™ Phone. Check with your cellular service provider for the features that you have.

Answer or Reject an Incoming Call - No Call Currently in Progress

When you receive a call on your cellular phone, the Uconnect™ Phone will interrupt the vehicle audio system, if on, and will ask if you would like to answer the call. Press the  button to accept the call. To reject the call, press and hold the  button until you hear a single beep, indicating that the incoming call was rejected.

Answer or Reject an Incoming Call - Call Currently in Progress

If a call is currently in progress and you have another incoming call, you will hear the same network tones for



call waiting that you normally hear when using your cellular phone. Press the  button to place the current call on hold and answer the incoming call.

NOTE: The Uconnect™ Phone compatible phones in the market today do not support rejecting an incoming call when another call is in progress. Therefore, the user can only answer an incoming call or ignore it.

Making a Second Call While Current Call is in Progress

To make a second call while you are currently on a call, press the  button and say "Dial" or "Call" followed by the phone number or phonebook entry you wish to call. The first call will be on hold while the second call is in progress. To go back to the first call, refer to "Toggling Between Calls" in this section. To combine two calls, refer to "Conference Call" in this section.

Place/Retrieve a Call From Hold

To put a call on hold, press the  button until you hear a single beep. This indicates that the call is on hold. To bring the call back from hold, press and hold the  button until you hear a single beep.



Toggling Between Calls

If two calls are in progress (one active and one on hold), press the  button until you hear a single beep, indicating that the active and hold status of the two calls have switched. Only one call can be placed on hold at a time.



Conference Call

When two calls are in progress (one active and one on hold), press and hold the  button until you hear a double beep indicating that the two calls have been joined into one conference call.

Three-Way Calling

To initiate three-way calling, press the  button while a call is in progress, and make a second phone call, as described under "Making a Second Call While Current Call is in Progress." After the second call has established, press and hold the  button until you hear a double beep, indicating that the two calls have been joined into one conference call.

Call Termination

To end a call in progress, momentarily press the  button. Only the active call(s) will be terminated and if there is a call on hold, it will become the new active call. If the active call is terminated by the phone far end, a call on hold may not become active automatically. This is cell phone-dependent. To bring the call back from hold, press and hold the  button until you hear a single beep.

Redial

- Press the  button to begin.

- After the "Ready" prompt and the following beep, say "Redial."
- The Uconnect™ Phone will call the last number that was dialed from your cellular phone.

NOTE: This may not be the last number dialed from the Uconnect™ Phone.

Call Continuation

Call continuation is the progression of a phone call on the Uconnect™ Phone after the vehicle ignition key has been switched to OFF. Call continuation functionality available on the vehicle can be any one of three types:

- After the ignition key is switched to OFF, a call can continue on the Uconnect™ Phone either until the call ends, or until the vehicle battery condition dictates cessation of the call on the Uconnect™ Phone and transfer of the call to the cellular phone.
- After the ignition key is switched to OFF, a call can continue on the Uconnect™ Phone for a certain duration, after which the call is automatically transferred from the Uconnect™ Phone to the cellular phone.
- An active call is automatically transferred to the cellular phone after the ignition key is switched to OFF.

Uconnect™ Phone Features

Language Selection

To change the language that the Uconnect™ Phone is using:

- Press the  button to begin.
- After the "Ready" prompt and the following beep, say the name of the language you wish to switch to English, Espanol, or Francais.

- Continue to follow the system prompts to complete the language selection.

After selecting one of the languages, all prompts and voice commands will be in that language.

NOTE: After every Uconnect™ Phone language change operation, only the language-specific 32-name phonebook is usable. The paired phone name is not language-specific and usable across all languages.

Emergency Assistance

If you are in an emergency and the cellular phone is reachable:

- Pick up the phone and manually dial the emergency number for your area.

If the phone is not reachable and the Uconnect™ Phone is operational, you may reach the emergency number as follows:

- Press the  button to begin.
- After the "Ready" prompt and the following beep, say "Emergency" and the Uconnect™ Phone will instruct the paired cellular phone to call the emergency number. This feature is supported in the U.S., Canada, and Mexico.

NOTE:

- The emergency number dialed is based on the country where the vehicle is purchased (911 for the U.S. and Canada and 060 for Mexico). The number dialed may not be applicable with the available cellular service and area.
- If supported, this number may be programmable on some systems. To do this, press the  button and say 'Setup', followed by 'Emergency'.

- The Uconnect™ Phone does slightly lower your chances of successfully making a phone call as to that for the cellular phone directly.

WARNING!

Your phone must be turned on and paired to the Uconnect™ Phone to allow use of this vehicle feature in emergency situations, when the cellular phone has network coverage and stays paired to the Uconnect™ Phone.

Towing Assistance

If you need towing assistance:

- Press the  button to begin.
- After the "Ready" prompt and the following beep, say "Towing Assistance."

NOTE:

- The towing assistance number dialed is based on the country where the vehicle is purchased (1-800-528-2069 for the U.S., 1-877-213-4525 for Canada, 55-14-3454 for Mexico City and 1-800-712-3040 for outside Mexico City in Mexico). Please refer to the 24-Hour "Towing Assistance" coverage details on the DVD in the Warranty Information Booklet and the 24-Hour Towing Assistance references.
- If supported, this number may be programmable on some systems. To do this, press the  button and say "Setup", followed by "Towing Assistance".

Paging

To learn how to page, refer to "Working with Automated Systems." Paging works properly except for pagers of certain companies, which time out a little too soon to work properly with the Uconnect™ Phone.

Voice Mail Calling

To learn how to access your voice mail, refer to "Working with Automated Systems."

Working with Automated Systems

This method is used in instances where one generally has to press numbers on the cellular phone keypad while navigating through an automated telephone system.

You can use your Uconnect™ Phone to access a voice mail system or an automated service, such as a paging service or automated customer service line. Some services require immediate response selection. In some instances, that may be too quick for use of the Uconnect™ Phone.

When calling a number with your Uconnect™ Phone that normally requires you to enter in a touch-tone sequence on your cellular phone keypad, you can press the  button and say the sequence you wish to enter, followed by the word "Send." For example, if required to enter

your PIN followed with a pound, (3 7 4 6 #), you can press the  button and say, "3 7 4 6 # Send." Saying a number, or sequence of numbers, followed by "Send," is also to be used for navigating through an automated customer service center menu structure, and to leave a number on a pager.

You can also send stored Uconnect™ phonebook entries as tones for fast and easy access to voice mail and pager entries. To use this feature, dial the number you wish to call and then press the  button and say, "Send." The system will prompt you to enter the name or number and say the name of the phonebook entry you wish to send. The Uconnect™ Phone will then send the corresponding phone number associated with the phonebook entry, as tones over the phone.

NOTE:

- You may not hear all of the tones due to cellular phone network configurations. This is normal.

- Some paging and voice mail systems have system time out settings that are too short and may not allow the use of this feature.
- After the "Ready" prompt and the following beep, say "Setup Confirmations." The Uconnect™ Phone will play the current confirmation prompt status and you will be given the choice to change it.

Barge In - Overriding Prompts

The "Voice Command" button can be used when you wish to skip part of a prompt and issue your voice command immediately. For example, if a prompt is asking "Would you like to pair a phone, clear a...", you could press the  button and say, "Pair a Phone" to select that option without having to listen to the rest of the voice prompt.

Turning Confirmation Prompts ON/OFF

Turning confirmation prompts off will stop the system from confirming your choices (e.g., the Uconnect™ Phone will not repeat a phone number before you dial it).

- Press the  button to begin.

Phone and Network Status Indicators

If available on the radio and/or on a premium display such as the instrument panel cluster, and supported by your cellular phone, the Uconnect™ Phone will provide notification to inform you of your phone and network status when you are attempting to make a phone call using Uconnect™ Phone. The status is given for roaming, network signal strength, phone battery strength, etc.

Dialing Using the Cellular Phone Keypad

You can dial a phone number with your cellular phone keypad and still use the Uconnect™ Phone (while dialing via the cellular phone keypad, the user must exercise caution and take precautionary safety measures). By dialing a number with your paired Bluetooth® cellular

phone, the audio will be played through your vehicle's audio system. The Uconnect™ Phone will work the same as if you dial the number using Voice Command.

NOTE: Certain brands of cellular phones do not send the dial ring to the Uconnect™ Phone to play it on the vehicle audio system, so you will not hear it. Under this situation, after successfully dialing a number the user may feel that the call did not go through even though the call is in progress. Once your call is answered, you will hear the audio.

Mute/Un-Mute (Mute OFF)

When you mute the Uconnect™ Phone, you will still be able to hear the conversation coming from the other party, but the other party will not be able to hear you. In order to mute the Uconnect™ Phone:

- Press the  button.
- Following the beep, say "Mute."

In order to un-mute the Uconnect™ Phone:

- Press the  button.
- Following the beep, say "Mute off."

Advanced Phone Connectivity

Transfer Call to and from Cellular Phone



The Uconnect™ Phone allows ongoing calls to be transferred from your cellular phone to the Uconnect™ Phone without terminating the call. To transfer an ongoing call from your Uconnect™ Phone paired cellular phone to the Uconnect™ Phone or vice versa, press the  button and say "Transfer Call."

Connect or Disconnect Link Between the Uconnect™ Phone and Cellular Phone

Your cellular phone can be paired with many different electronic devices, but can only be actively "connected" with one electronic device at a time.



If you would like to connect or disconnect the Bluetooth® connection between a Uconnect™ Phone paired cellular phone and the Uconnect™ Phone, follow the instructions described in your cellular phone User's Manual.

List Paired Cellular Phone Names



- Press the  button to begin.
- After the "Ready" prompt and the following beep, say "Setup Phone Pairing."
- When prompted, say "List Phones."
- The Uconnect™ Phone will play the phone names of all paired cellular phones in order from the highest to the lowest priority. To "select" or "delete" a paired phone being announced, press the  button and say "Select" or "Delete." Also, see the next two sections for an alternate way to "select" or "delete" a paired phone.

Select Another Cellular Phone

This feature allows you to select and start using another phone paired with the Uconnect™ Phone.

- Press the  button to begin.
- After the "Ready" prompt and the following beep, say "Setup Select Phone" and follow the prompts.
- You can also press the  button at any time while the list is being played, and then choose the phone that you wish to select.
- The selected phone will be used for the next phone call. If the selected phone is not available, the Uconnect™ Phone will return to using the highest priority phone present in or near (approximately within 30 ft (9 m)) the vehicle.

Delete Uconnect™ Phone Paired Cellular Phones

- Press the  button to begin.
- After the "Ready" prompt and the following beep, say "Setup Phone Pairing."
- At the next prompt, say "Delete" and follow the prompts.
- You can also press the  button at any time while the list is being played, and then choose the phone you wish to delete.

Things You Should Know About Your Uconnect™ Phone



Uconnect™ Phone Tutorial

To hear a brief tutorial of the system features, press the  button and say "Uconnect™ Tutorial."

Voice Training

For users experiencing difficulty with the system recognizing their voice commands or numbers, the Uconnect™ Phone Voice Training feature may be used. To enter this training mode, follow one of the two following procedures:

From outside the Uconnect™ Phone mode (e.g., from radio mode):

- Press and hold the  button for five seconds until the session begins, or,
- Press the  button and say the "Setup, Voice Training" command.

Repeat the words and phrases when prompted by the Uconnect™ Phone. For best results, the Voice Training session should be completed when the vehicle is parked with the engine running, all windows closed, and the blower fan switched off.

This procedure may be repeated with a new user. The system will adapt to the last trained voice only.

To restore the Voice Command system to factory default settings, enter the Voice Training session via the above procedure and follow the prompts.

Voice Command

- For best performance, adjust the rearview mirror to provide at least $\frac{1}{2}$ in (1 cm) gap between the overhead console (if equipped) and the mirror.
- Always wait for the beep before speaking.
- Speak normally, without pausing, just as you would speak to a person sitting a few feet/meters away from you.
- Make sure that no one other than you is speaking during a Voice Command period.

- Performance is maximized under:
 - low-to-medium blower setting,
 - low-to-medium vehicle speed,
 - low road noise,
 - smooth road surface,
 - fully closed windows,
 - dry weather condition.
- Even though the system is designed for users speaking in North American English, French, and Spanish accents, the system may not always work for some.
- When navigating through an automated system such as voice mail, or when sending a page, at the end of speaking the digit string, make sure to say "Send."
- Storing names in the phonebook when the vehicle is not in motion is recommended.

- It is not recommended to store similar sounding names in the Uconnect™ Phonebook.
- Phonebook (Downloaded and Uconnect™ Phone Local) name recognition rate is optimized when the entries are not similar.
- Numbers must be spoken in single digits. “800” must be spoken “eight-zero-zero” not “eight hundred”.
- You can say “O” (letter “O”) for “0” (zero).
- Even though international dialing for most number combinations is supported, some shortcut dialing number combinations may not be supported.
- In a convertible vehicle, system performance may be compromised with the convertible top down.

Phone Far End Audio Performance

- Audio quality is maximized under:
 - low-to-medium blower setting,
 - low-to-medium vehicle speed,
 - low road noise,
 - smooth road surface,
 - fully closed windows,
 - dry weather conditions, and
 - operation from the driver’s seat.
- Performance, such as audio clarity, echo, and loudness to a large degree rely on the phone and network, and not the Uconnect™ Phone.

- Echo at the phone far end can sometimes be reduced by lowering the in-vehicle audio volume.
- In a convertible vehicle, system performance may be compromised with the convertible top down.

Bluetooth® Communication Link

Cellular phones have been found to lose connection to the Uconnect™ Phone. When this happens, the connection can generally be reestablished by switching the phone off/on. Your cellular phone is recommended to remain in Bluetooth® ON mode.

Power-Up

After switching the ignition key from OFF to either the ON or ACC position, or after a language change, you must wait at least five seconds prior to using the system.

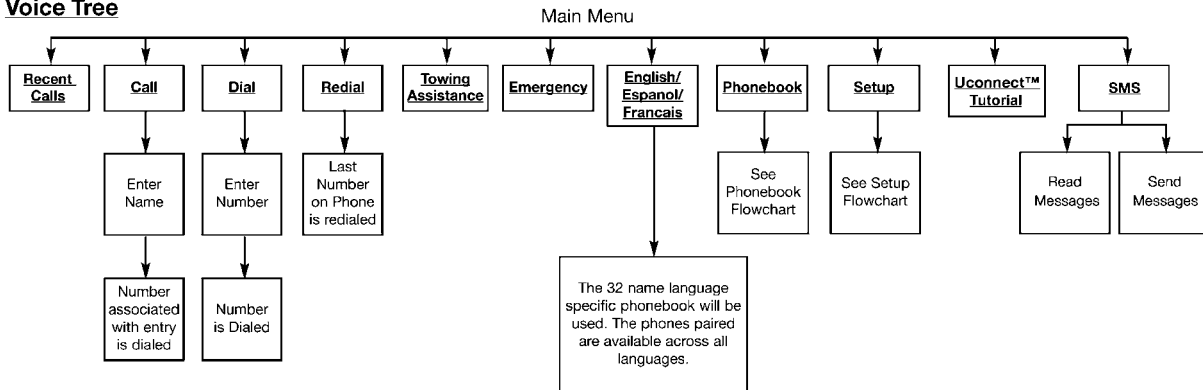
Voice Tree

Note: Available Voice commands are shown in bold face and are underlined.

Voice Tree – Phonebook

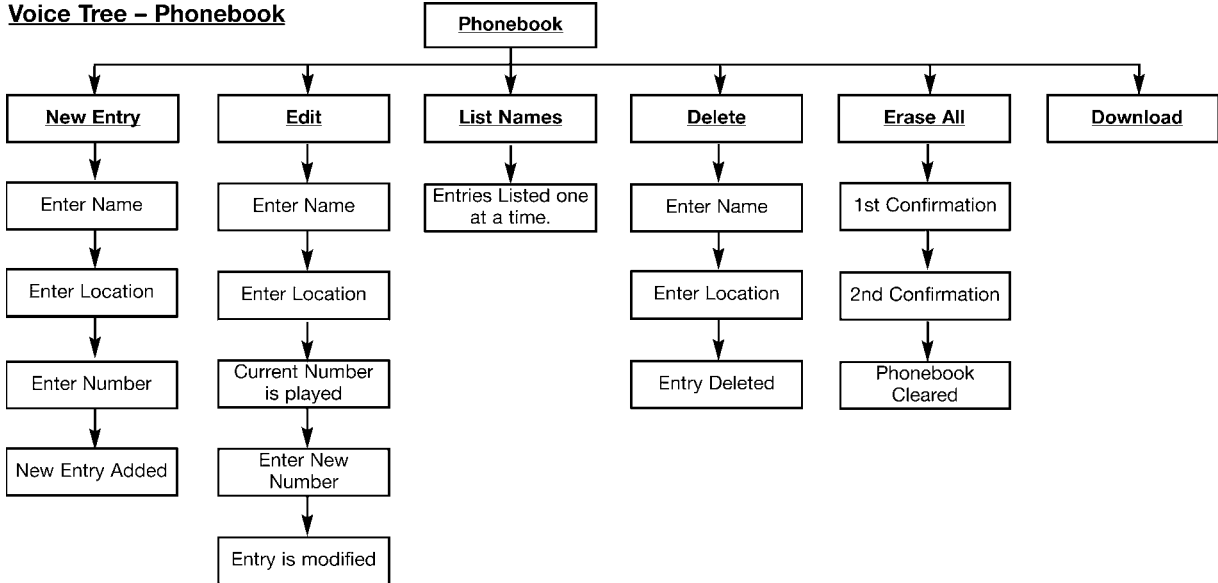

Note: Available Voice commands are shown in bold face and are underlined.

Voice Tree – Setup

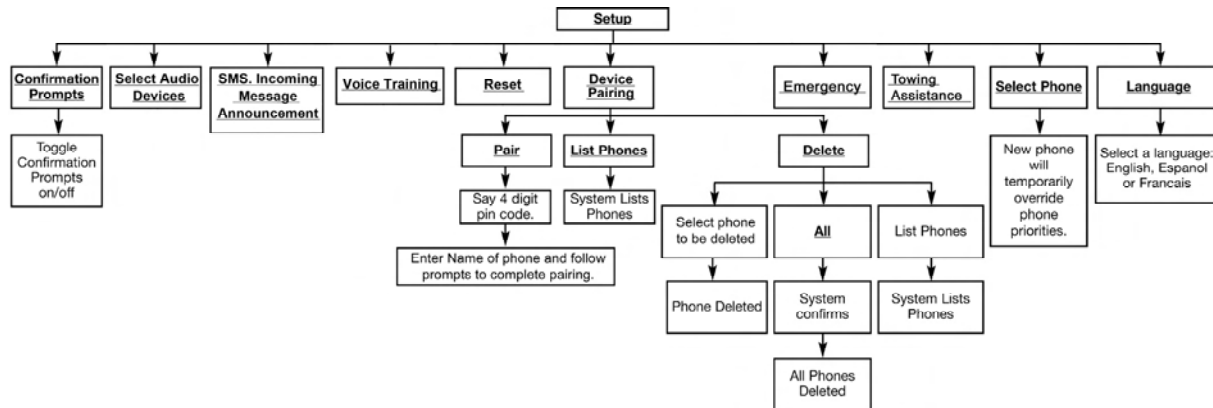

Note: Available Voice commands are shown in bold face and are underlined.

030605540

Voice Commands	
Primary	Alternate(s)
zero	
one	
two	
three	
four	
five	
six	
seven	
eight	
nine	
star (*)	
plus (+)	
pound (#)	
add location	
all	

Voice Commands	
Primary	Alternate(s)
call	
cancel	
confirmation prompts	
continue	
delete	
dial	
download	
edit	
emergency	
English	
erase all	
Espanol	
Francais	
help	
home	

Voice Commands	
Primary	Alternate(s)
language	
list names	
list phones	
mobile	
mute	
mute off	
new entry	
no	
pager	
pair a phone	
phone pairing	pairing
phonebook	phone book
previous	
record again	
redial	

Voice Commands	
Primary	Alternate(s)
return to main menu	return or main menu
select phone	select
send	
set up	phone settings or phone set up
towing assistance	
transfer call	
Uconnect™ Tutorial	
try again	
voice training	
work	
yes	

General Information

This device complies with Part 15 of the FCC rules and RSS 210 of Industry Canada. Operation is subject to the following conditions:

- Changes or modifications not expressly approved by the party responsible for compliance could void the user's authority to operate the equipment.
- This device may not cause harmful interference.
- This device must accept any interference received, including interference that may cause undesired operation.

VOICE COMMAND — IF EQUIPPED

Voice Command System Operation

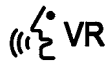

This Voice Command system allows you to control your AM, FM radio, satellite radio, disc player, and a memo recorder.

NOTE: Take care to speak into the Voice Interface System as calmly and normally as possible. The ability of the Voice Interface System to recognize user voice commands may be negatively affected by rapid speaking or a raised voice level.

WARNING!

Any voice commanded system should be used only in safe driving conditions following local laws and phone use. All attention should be kept on the roadway ahead. Failure to do so may result in an accident causing serious injury or death.

When you press the Voice Command  button, you will hear a beep. The beep is your signal to give a command.

NOTE: If you do not say a command within a few seconds, the system will present you with a list of options.

If you ever wish to interrupt the system while it lists options, press the Voice Command  button, listen for the beep, and say your command.

Pressing the Voice Command  button while the system is speaking is known as “barging in.” The system will be interrupted, and after the beep, you can add or change commands. This will become helpful once you start to learn the options.

NOTE: At any time, you can say the words “Cancel”, “Help” or “Main Menu”.

These commands are universal and can be used from any menu. All other commands can be used depending upon the active application.

For example, if you are in the disc menu and you are listening to FM radio, you can speak commands from the disc menu or from the FM radio menu.

When using this system, you should speak clearly and at a normal speaking volume.

The system will best recognize your speech if the windows are closed, and the heater/air conditioning fan is set to low.

At any point, if the system does not recognize one of your commands, you will be prompted to repeat it.

To hear the first available Menu, press the Voice Command  button and say “Help” or “Main Menu”.

Commands

The Voice Command system understands two types of commands. Universal commands are available at all times. Local commands are available if the supported radio mode is active.

Changing the Volume

1. Start a dialogue by pressing the Voice Command  button.
2. Say a command (e.g., “Help”).
3. Use the ON/OFF VOLUME rotary knob to adjust the volume to a comfortable level while the Voice Command system is speaking. Please note the volume setting for Voice Command is different than the audio system.

Main Menu

Start a dialogue by pressing the Voice Command  button. You may say “Main Menu” to switch to the main menu.

In this mode, you can say the following commands:

- “Radio” (to switch to the radio mode)
- “Disc” (to switch to the disc mode)
- “Memo” (to switch to the memo recorder)
- “System Setup” (to switch to system setup)

Radio AM (or Radio Long Wave or Radio Medium Wave — If Equipped)

To switch to the AM band, say “AM” or “Radio AM”. In this mode, you may say the following commands:

- “Frequency” (to change the frequency)
- “Next Station” (to select the next station)
- “Previous Station” (to select the previous station)
- “Radio Menu” (to switch to the radio menu)
- “Main Menu” (to switch to the main menu)

Radio FM

To switch to the FM band, say “FM” or “Radio FM”. In this mode, you may say the following commands:

- “Frequency” (to change the frequency)
- “Next Station” (to select the next station)
- “Previous Station” (to select the previous station)
- “Radio Menu” (to switch to the radio menu)
- “Main Menu” (to switch to the main menu)

Satellite Radio

To switch to satellite radio mode, say “Sat” or “Satellite Radio”. In this mode, you may say the following commands:

- “Channel Number” (to change the channel by its spoken number)
- “Next Channel” (to select the next channel)

- “Previous Channel” (to select the previous channel)
- “List Channel” (to hear a list of available channels)
- “Select Name” (to say the name of a channel)
- “Radio Menu” (to switch to the radio menu)
- “Main Menu” (to switch to the main menu)



Disc

To switch to the disc mode, say “Disc”. In this mode, you may say the following commands:

- “Track” (#) (to change the track)
- “Next Track” (to play the next track)
- “Previous Track” (to play the previous track)
- “Main Menu” (to switch to the main menu)

Memo

To switch to the voice recorder mode, say “Memo”. In this mode, you may say the following commands:

- “New Memo” (to record a new memo) — During the recording, you may press the Voice Command  button to stop recording. You proceed by saying one of the following commands:
 - “Save” (to save the memo)
 - “Continue” (to continue recording)
 - “Delete” (to delete the recording)
- “Play Memos” (to play previously recorded memos) — During the playback you may press the Voice Command  button to stop playing memos. You proceed by saying one of the following commands:
 - “Repeat” (to repeat a memo)
 - “Next” (to play the next memo)

- “Previous” (to play the previous memo)
- “Delete” (to delete a memo)
- “Delete All” (to delete all memos)

System Setup

To switch to system setup, say “Setup”. In this mode, you may say the following commands:

- “Language German”
- “Language Dutch”
- “Language Italian”
- “Language English”
- “Language French”
- “Language Spanish”
- “Tutorial”
- “Voice Training”

NOTE: Keep in mind that you have to press the Voice Command  button first and wait for the beep before speaking the “Barge In” commands.

Voice Training

For users experiencing difficulty with the system recognizing their voice commands or numbers the Uconnect™ Voice “Voice Training” feature may be used.

1. Press the Voice Command  button, say “System Setup” and once you are in that menu then say “Voice Training.” This will train your own voice to the system and will improve recognition.

2. Repeat the words and phrases when prompted by Uconnect™ Voice. For best results, the “Voice Training” session should be completed when the vehicle is parked, engine running, all windows closed, and the blower fan switched off. This procedure may be repeated with a new user. The system will adapt to the last trained voice only.

SEATS

Seats are a primary part of the Occupant Restraint System of the vehicle. They need to be used properly for safe operation of the vehicle.

WARNING!

- **DO NOT allow people to ride in any area of your vehicle that is not equipped with seats and seat belts. In a collision, people riding in these areas are more likely to be seriously injured or killed.**
- **Be sure everyone in your vehicle is in a seat and using a seat belt properly.**

Front Manual Seat Adjustment

Move the seat forward or rearward using the adjustment bar. Lift up on the bar located on the front of the seat near the floor. Position the seat and release the bar, making sure the latch engages fully.

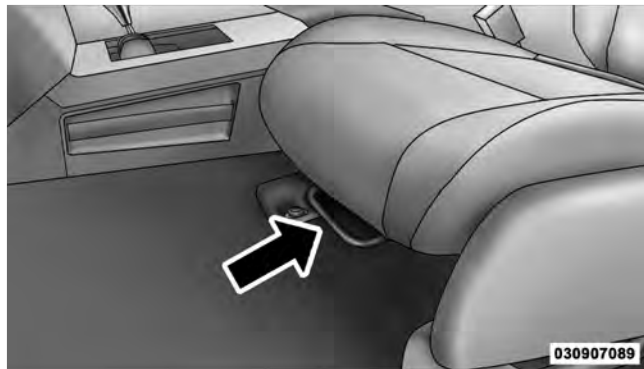

Manual Seat Adjustment

Using body pressure, move forward and rearward on the seat to be sure the seat adjusters have latched.

WARNING!

Adjusting a seat while the vehicle is moving is dangerous. The sudden movement of the seat could cause you to lose control. The seat belt might not be properly adjusted and you could be injured. Adjust any seat only while the vehicle is parked.

Front Seat Adjustment — Recline

To adjust the seatback, lift the lever located on the outboard side of the seat, lean back, and release the lever at the desired position. To return the seatback, lift the lever, lean forward and release the lever.

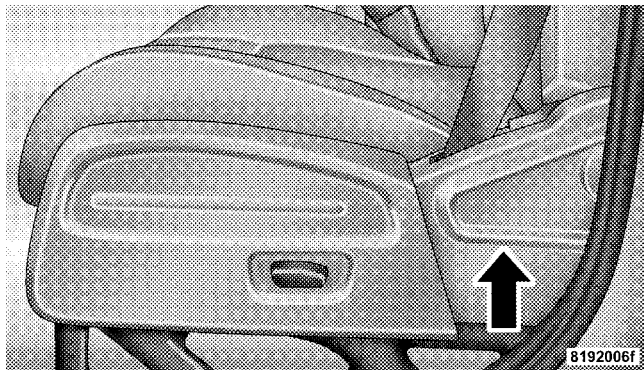

Seatback Release Lever

WARNING!

Do not ride with the seatback reclined so that the seat belt is no longer resting against your chest. In a collision you could slide under the seat belt and be seriously or even fatally injured. Use the recliner only when the vehicle is parked.

Six-Way Driver's Power Seat with Manual Recliner

The power seat switch is located on the outboard side of the seat near the floor. Use this switch to move the seat up or down, forward or rearward or to tilt the seat.

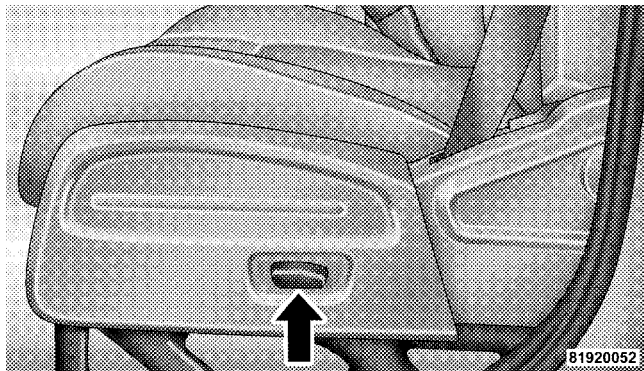

Power Seat Switches

This seat also has a manual recline lever located just to the rear of the power seat switch. Pull up on the lever to recline the seatback.

WARNING!

Adjusting a seat while the vehicle is moving is dangerous. The sudden movement of the seat could cause you to lose control. The seat belt might not be properly adjusted and you could be injured. Adjust any seat only while the vehicle is parked.

CAUTION!

DO NOT place any article under a power seat or impede its ability to move as it may cause damage to the seat controls. Seat travel may become limited if movement is stopped by an obstruction in the seat's path.

Fold-Flat Front Passenger Seat

The front passenger seatback can be folded flat to allow for extended cargo space. Pull up on the lever to fold down the seatback.

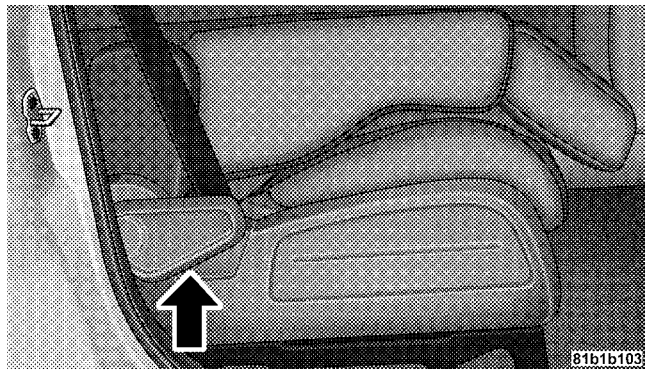

Fold Flat Passenger Seat

Adjusting Active Head Restraints

Active Head Restraints can reduce the risk of injury in the event of a rear impact. The Active Head Restraint should be adjusted so the top of the head restraint is located above the top of your ear.



Adjusted Head Restraint

To raise the head restraint, pull upward on the head restraint (on some models, you may need to press the push button). To lower the head restraint, press the push button, located at the base of the head restraint, and push downward on the head restraint.

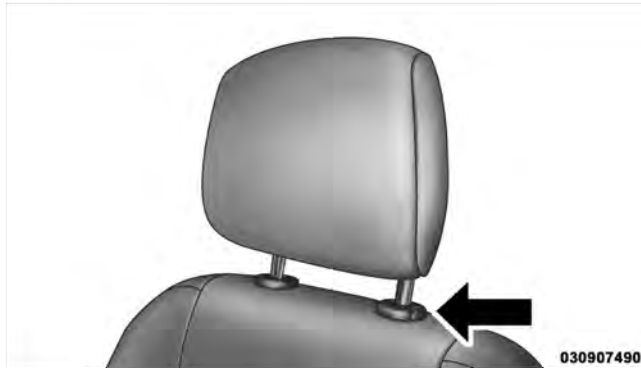

Push Button

For comfort the Active Head Restraints can be tilted forward and backward. To tilt the head restraint closer to the back of your head, pull outward on the bottom of the head restraint. Push rearward on the bottom of the head restraint to move the head restraint away from your head.



Active Head Restraint (Normal Position)



030907533

Active Head Restraint (Tilted)

NOTE:

- The head restraints should only be removed by qualified technicians, for service purposes only. If either of the head restraints require removal, see your authorized dealer.

- In the event of deployment of an Active Head Restraint, refer to “Occupant Restraints/Resetting Active Head Restraints (AHR)” in “Things to Know Before Starting Your Vehicle” for further information.

WARNING!

- Driving a vehicle with the head restraints removed or improperly adjusted could cause serious injury or death in the event of a collision. The head restraints should always be checked prior to operating the vehicle and never adjusted while the vehicle is in motion. Always adjust the head restraints when the vehicle is in PARK.

(Continued)

WARNING! (Continued)

- Do not place items over the top of the Active Head Restraint, such as coats, seat covers or portable DVD players. These items may interfere with the operation of the Active Head Restraint in the event of an accident and could result in serious injury or death.
- Active Head Restraints may be deployed if they are struck by an object such as a hand, foot or loose cargo. To avoid accidental deployment of the Active Head Restraint ensure that all cargo is secured, as loose cargo could contact the Active Head Restraint during sudden stops. Failure to follow this warning could cause personal injury if the Active Head Restraint is deployed.

Heated Seats — If Equipped

This feature heats the front driver and passenger seats. The controls for each seat are located on a switch bank near the bottom center of the instrument panel.

After turning the ignition ON, you can choose from High, Low or Off heat settings. Amber indicator lights in each switch indicate the level of heat in use. Two indicator lights will illuminate for High, one for Low and none for Off.



Press the switch once to select High-level heating. Press the switch a second time to select Low-level heating. Press the switch a third time to shut the heating elements Off.

When High-level is selected, the heaters provide a boosted heat level during the first four minutes of operation after heating is activated. The heat output then drops to the normal High-level setting. If High-level is

selected, the system will automatically switch to Low-level after approximately 30 minutes of continuous operation. At that time, the number of illuminated LEDs changes from two to one, indicating the change. Operation on Low-level also turns Off automatically after approximately 30 minutes.

NOTE: Once a heat setting is selected, heat will be felt within two to five minutes.

WARNING!

- Persons who are unable to feel pain to the skin because of advanced age, chronic illness, diabetes, spinal cord injury, medication, alcohol use, exhaustion or other physical condition must exercise care when using the seat heater. It may cause burns even at low temperatures, especially if used for long periods of time.

(Continued)

WARNING! (Continued)

- Do not place anything on the seat that insulates against heat, such as a blanket or cushion. This may cause the seat heater to overheat. Sitting in a seat that has been overheated could cause serious burns due to the increased surface temperature of the seat.

CAUTION!

Repeated overheating of the seat could damage the heating element and/or degrade the material of the seat.

60/40 Split Folding Rear Seat with Fold-Flat Feature

To provide additional storage area, each rear seat can be folded flat to allow for extended cargo space and still maintain some rear seating room.

The rear seatback also reclines for additional passenger comfort. Pull the release strap while sitting in the rear seat to recline the seatback.

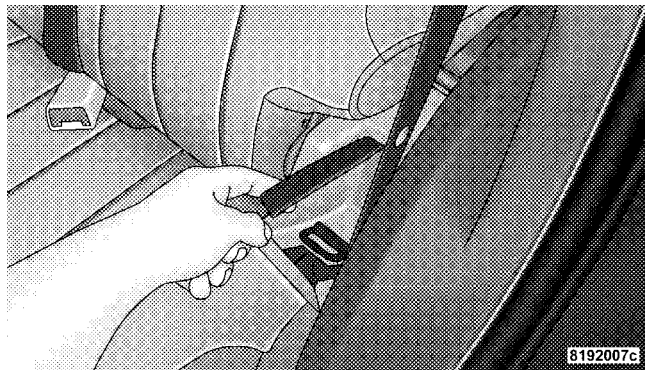

Rear Seat Release Strap

NOTE:

- Prior to folding the rear seat, it may be necessary to reposition the front seat to its mid-track position.

- Be sure that the front seats are fully upright and positioned forward. This will allow the rear seat to fold down easily.

WARNING!

- It is extremely dangerous to ride in a cargo area, inside or outside of a vehicle. In a collision, people riding in these areas are more likely to be seriously injured or killed.
- Do not allow people to ride in any area of your vehicle that is not equipped with seats and seat belts.
- Be sure everyone in your vehicle is in a seat and using a seat belt properly.

3

To Lower Rear Seat

1. Locate the release strap on the lower outboard side of each rear seatback.

2. Pull the release strap (toward the front of the vehicle).

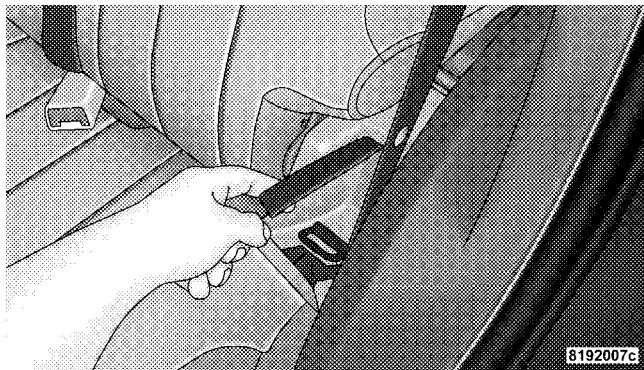

Rear Seat Release Strap

3. Fold the rear seat completely forward.
4. Push down on the seatback to lock it in the folded position.

To Raise Rear Seat

If locked in the folded position, pull the release strap (toward the front of the vehicle).

Raise the seatback and lock it into place. If interference from the cargo area prevents the seatback from fully locking, you will have difficulty returning the seat to its proper position.

WARNING!

Be certain that the seatback is securely locked into position. If the seatback is not securely locked into position, the seat will not provide the proper stability for child seats and/or passengers. An improperly latched seat could cause serious injury.

TO OPEN AND CLOSE THE HOOD

To open the hood, there are two latches that must be released.

1. Pull the hood release lever located under the left side of the instrument panel.

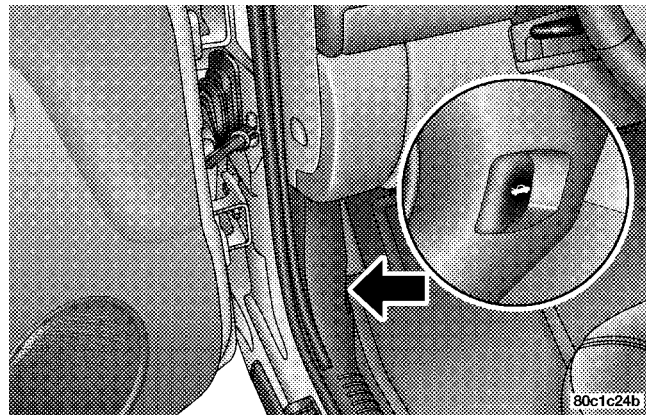

Hood Release Lever

2. Push the safety latch lever to the right. It is located between the grille and hood opening left of the center.

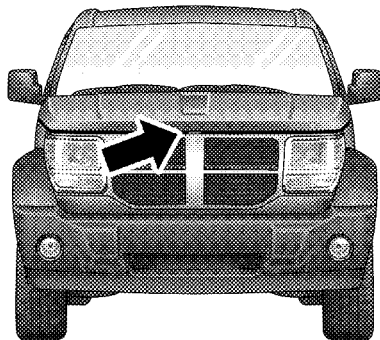

Safety Latch

CAUTION!

To prevent possible damage:

- Do not slam the hood to close it.
- Lower the hood to approximately 6 in (15.2 cm) above the closed position and drop the hood to latch it.
- Never drive your vehicle unless the hood is fully closed, with both latches engaged.

NOTE: Ensure hood prop rod is fully seated into clip before closing hood to prevent damage to grille.

WARNING!

Be sure the hood is fully latched before driving your vehicle. If the hood is not fully latched, it could open when the vehicle is in motion and block your vision. Failure to follow this warning could result in serious injury or death.

LIGHTS

Multifunction Lever

The multifunction lever controls the operation of the parking lights, headlights, headlight beam selection, passing light, fog lights, instrument panel light dimming and turn signals. The multifunction lever is located on the left side of the steering column.



031407547

Multifunction Lever

Headlights and Parking Lights

Turn the end of the multifunction lever to the first detent for parking lights and instrument panel lights. Turn to the second detent for headlight operation.



031407548

Headlight Switch

To change the brightness of the instrument panel lights, rotate the center portion of the multifunction lever up or down.

NOTE: If the driver's door is left open, and the headlights or parking lights are left on, a chime will sound.

Instrument Panel Dimmer

Rotate the center portion of the lever to the extreme bottom position to fully dim the instrument panel lights and prevent the interior lights from illuminating when a door is opened.

Rotate the center portion of the lever up to increase the brightness of the instrument panel lights when the parking lights or headlights are on.

Rotate the center portion of the lever upward to the next detent position to brighten the odometer and radio when the parking lights or headlights are on.

Rotate the center portion of the lever upward to the last detent to turn on the interior lighting.



Dimmer Control

Lights-On Reminder

If the headlights or parking lights are on after the ignition is turned OFF, a chime will sound when the driver's door is opened.

High/Low Beam Switch

Push the multifunction lever away from you to switch the headlights to high beams. Pull the lever toward you to switch the headlights back to low beams.

Flash-to-Pass

You can signal another vehicle with your headlights by lightly pulling the multifunction lever toward the steering wheel. This will turn on the high beam headlights until the lever is released.

Front Fog Lights — If Equipped

 The front fog light switch is in the multifunction lever. To activate the front fog lights, turn on the parking or low beam headlights and pull out the end of the lever.



Fog Light Operation

NOTE: The fog lights will only operate with the parking lights or the headlights on low beam. Selecting high beam headlights will turn off the fog lights.

Turn Signals

Move the multifunction lever up or down and the arrows on each side of the instrument cluster flash to show proper operation of the front and rear turn signal lights.

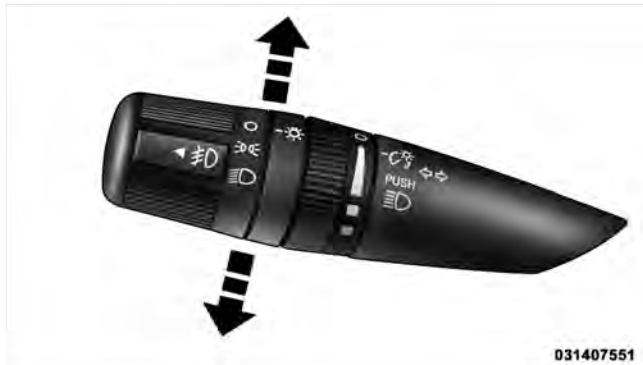

031407551

Turn Signal Operation

NOTE:

- If either light remains on and does not flash, or there is a very fast flash rate, check for a defective outside light bulb. If an indicator fails to light when the lever is moved, it would suggest that the indicator bulb is defective.
- A tone will chime if the turn signals are left on for more than 1 mile (2 km).

Lane Change Assist

Tap the lever up or down once, without moving beyond the detent, and the turn signal (right or left) will flash three times then automatically turn off.

Daytime Running Lights — If Equipped

The high beam headlights will turn on as Daytime Running Lights (DRL) and operate at lower intensity whenever the ignition is ON, the engine is running, the headlight switch is off, the parking brake is released and the shift lever is in any position except PARK.

NOTE: The Daytime Running Lights will turn off automatically when a turn signal is in operation and turn on again when the turn signal is not operating.

Interior Lights

The overhead light comes on when a door is opened. It may also be turned on by rotating the control for the dimmer switch on the multifunction lever fully upward. The overhead light will automatically turn off in approximately 10 minutes if a door is left open or the dimmer control is left in the dome light position and the key is not in the ignition. Turn the ignition switch ON to restore the overhead light operation.

Daytime Brightness Feature

Certain instrument panel components (odometer, radio display) can be illuminated at full brightness during the daytime. This can be helpful when driving with your headlights on during the daytime, such as in a parade or a funeral procession. To activate this feature, rotate the left stalk one detent lower than the dome light.

WINDSHIELD WIPERS AND WASHERS

The windshield wiper/washer control lever is located on the right side of the steering column. The front wipers are operated by rotating a switch, located at the end of the lever. For information on using the rear window wiper/washer, refer to “Rear Window Features” in “Understanding the Features of Your Vehicle”.

3



036407502

Wiper/Washer Lever

Windshield Wiper Operation

Rotate the end of the lever upward to the LO position for low-speed wiper operation.

Rotate the end of the lever upward to the HI position for high-speed wiper operation.



031507503

Front Wiper Control

NOTE: The wipers will automatically return to the “park” position if you turn OFF the ignition switch while they are operating. The wipers will resume operation when you turn the ignition switch back to the ON position.

CAUTION!

- Turn the windshield wipers off when driving through an automatic car wash. Damage to the windshield wipers may result if the wiper control is left in any position other than off.
- In cold weather, always turn off the wiper switch and allow the wipers to return to the “Park” position before turning off the engine. If the wiper switch is left on and the wipers freeze to the windshield, damage to the wiper motor may occur when the vehicle is restarted.

(Continued)

CAUTION! (Continued)

- Always remove any buildup of snow that prevents the windshield wiper blades from returning to the off position. If the windshield wiper control is turned off and the blades cannot return to the off position, damage to the wiper motor may occur.

Intermittent Wiper System

Use the intermittent wiper system when weather conditions make a single wiping cycle with a variable pause between cycles desirable. Rotate the end of the windshield wiper/washer control lever to the first detent, and then turn the end of the lever to select the desired delay interval.



031507503

Front Wiper Control

There are five delay settings, which allow you to regulate the wipe interval from a minimum of two cycles every second to a maximum of approximately 36 seconds between cycles or from a minimum of one cycle every second to a maximum of approximately 18 seconds between cycles at vehicle speeds greater than 10 mph (16 km/h).

NOTE: The wiper delay times depend on vehicle speed. If the vehicle is moving less than 10 mph (16 km/h), delay times will be doubled.

Windshield Washers

To use the washer, pull the windshield wiper/washer control lever toward you and hold it for as long as washer spray is desired.

If you activate the washer while the wiper control is in the delay range, the wipers will operate in low-speed for two or three wipe cycles after releasing the lever and then resume the intermittent interval previously selected.

If you activate the washer while the wiper control is in the off position, the wipers will operate for two or three wipe cycles and then turn off.

WARNING!

Sudden loss of visibility through the windshield could lead to an accident. You might not see other vehicles or other obstacles. To avoid sudden icing of the windshield during freezing weather, warm the windshield with defroster before and during windshield washer use.

Mist Feature

Push downward on the windshield wiper/washer control lever to activate a single wipe cycle to clear the windshield of road mist or spray from a passing vehicle. The wipers will continue to operate until you release the lever.



Mist Control

TILT STEERING COLUMN

This feature allows you to tilt the steering column upward or downward. The tilt lever is located on the steering column, below the turn signal lever.

Push the lever down to unlock the steering column. With one hand firmly on the steering wheel, move the steering column up or down, as desired. Pull the lever up to lock the column firmly in place.

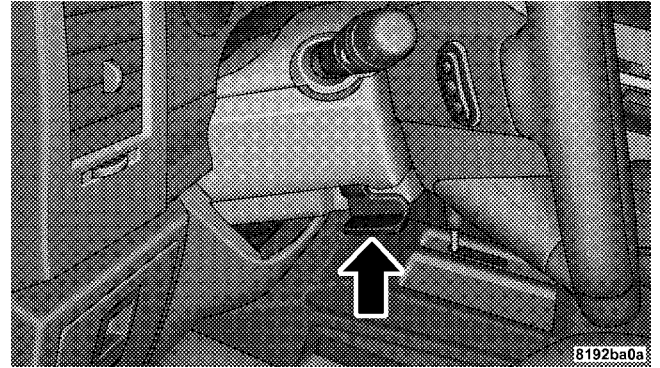

Tilt Steering Control Handle

WARNING!

Do not adjust the steering column while driving. Adjusting the steering column while driving or driving with the steering column unlocked, could cause the driver to lose control of the vehicle. Be sure the steering column is locked before driving your vehicle. Failure to follow this warning may result in serious injury or death.

ELECTRONIC SPEED CONTROL — IF EQUIPPED

When engaged, the Electronic Speed Control takes over the accelerator operation at speeds greater than 25 mph (40 km/h).

The Electronic Speed Control lever is located on the right side of the steering wheel.



81bc4c2c

Electronic Speed Control Lever

NOTE: In order to ensure proper operation, the Electronic Speed Control System has been designed to shut down if multiple Speed Control functions are operated

simultaneously. If this occurs, the Electronic Speed Control System can be reactivated by pushing the Electronic Speed Control ON/OFF button and resetting the desired vehicle set speed.

To Activate

Push the ON/OFF button. The CRUISE indicator in the instrument cluster will illuminate. To turn the system off, push the ON/OFF button a second time. The CRUISE indicator will turn off. The system should be turned off when not in use.

WARNING!

Leaving the Electronic Speed Control system on when not in use is dangerous. You could accidentally set the system or cause it to go faster than you want. You could lose control and have an accident. Always leave the system off when you are not using it.

To Set a Desired Speed

When the vehicle has reached the desired speed, press down on the lever and release. Release the accelerator and the vehicle will operate at the selected speed.

NOTE: The vehicle should be traveling at a steady speed and on level ground before pressing the SET lever.

To Deactivate

A soft tap on the brake pedal, pulling the Electronic Speed Control lever toward you, "CANCEL", or normal brake or clutch pressure while slowing the vehicle will deactivate speed control without erasing the set speed memory. Pressing the ON/OFF button or turning off the ignition switch erases the set speed memory.

To Resume Speed

To resume a previously set speed, push the RESUME ACCEL lever up and release. Resume can be used at any speed above 25 mph (40 km/h).

To Vary the Speed Setting

When the Electronic Speed Control is set, you can increase speed by pushing up and holding the RESUME ACCEL lever. If the lever is continually held in the RESUME ACCEL position, the set speed will continue to increase until the lever is released, then the new set speed will be established.

Tapping RESUME ACCEL once will result in a 1 mph (2 km/h) speed increase. Each time the lever is tapped, speed increases so that tapping the lever three times will increase speed by 3 mph (6 km/h), etc.

To decrease speed while the Electronic Speed Control is set, push down and hold the SET DECEL lever. If the lever is continually held in the SET DECEL position, the set speed will continue to decrease until the lever is released. Release the lever when the desired speed is reached, and the new set speed will be established.

Tapping the SET DECEL lever once will result in a 1 mph (2 km/h) speed decrease. Each time the lever is tapped, speed decreases.

To Accelerate for Passing

Press the accelerator as you would normally. When the pedal is released, the vehicle will return to the set speed.

Using Electronic Speed Control On Hills

NOTE: The Electronic Speed Control system maintains speed up and down hills. A slight speed change on moderate hills is normal.

On steep hills a greater speed loss or gain may occur so it may be preferable to drive without Electronic Speed Control.

WARNING!

Electronic Speed Control can be dangerous where the system cannot maintain a constant speed. Your vehicle could go too fast for the conditions, and you could lose control. An accident could be the result. Do not use Electronic Speed Control in heavy traffic or on roads that are winding, icy, snow-covered, or slippery.

PARKSENSE® REAR PARK ASSIST — IF EQUIPPED

ParkSense® Rear Park Assist is a driver aid that senses for obstacles behind the vehicle and provides both visible and audible warnings to indicate the range of the object.

System Usage Precautions**NOTE:**

- Ensure that the rear bumper is free of snow, ice, mud, dirt and debris to keep ParkSense® operating properly.
- Jackhammers, large trucks, and other vibrations could affect the performance of ParkSense®.
- When you turn ParkSense® off, the instrument cluster will display “PARK ASSIST DISABLED.” Furthermore, once you turn ParkSense® off, it remains off until you turn it on again, even if you cycle the ignition key.
- When you move the shift lever to the REVERSE position and ParkSense® is turned off, a single chime will sound once per ignition cycle and the instrument cluster will display “PARK ASSIST DISABLED.”
- ParkSense®, when on, will MUTE the radio when it is sounding a tone.

- If a ParkSense® system malfunction occurs, a single chime will sound once per ignition cycle. In addition, the Electronic Vehicle Information Center (EVIC) will display “SERVICE PARK ASSIST SYSTEM” and the LED in the ParkSense® Rear Park Assist switch will illuminate. If this occurs after making sure the rear bumper is free of snow, ice, mud, dirt and debris, see your authorized dealer for service.

CAUTION!

- ParkSense® is only a parking aid and it is unable to recognize every obstacle, including small obstacles. Parking curbs might be temporarily detected or not detected at all. Obstacles located above or below the sensors will not be detected when they are in close proximity.

(Continued)

CAUTION! (Continued)

- The vehicle must be driven slowly when using ParkSense® to be able to stop in time when the obstacle is detected. It is recommended that the driver looks over his/her shoulder when using ParkSense®.
- Clean the ParkSense® sensors with water, car wash soap, and a soft cloth. Do not use rough or hard cloths. Do not scratch or poke the sensors. Otherwise, you could damage the sensors.

WARNING!

- Drivers must be careful when backing up even when using the ParkSense® Rear Park Assist System. Always check carefully behind your vehicle, look behind you, and be sure to check for pedestrians, animals, other vehicles, obstructions, and blind spots before backing up. You are responsible for safety and must continue to pay attention to your surroundings. Failure to do so can result in serious injury or death.

(Continued)

WARNING! (Continued)

- Before using the ParkSense® Rear Park Assist System, it is strongly recommended that the ball mount and hitch ball assembly is disconnected from the vehicle when the vehicle is not used for towing. Failure to do so can result in injury or damage to vehicles or obstacles because the hitch ball will be much closer to the obstacle than the rear fascia when the warning display turns the red LEDs ON. Also, the sensors could detect the ball mount and hitch ball assembly, depending on its size and shape, giving a false indication that an obstacle is behind the vehicle.

Enabling and Disabling ParkSense®

There are times when you may want to disable ParkSense®, such as when towing a trailer.

Vehicles Equipped With the Electronic Vehicle Information Center (EVIC)

You can turn ParkSense® on or off through the EVIC. Refer to “Electronic Vehicle Information Center (EVIC)/ Personal Settings (Customer-Programmable Features)” in “Understanding Your Instrument Panel” for further information.

Vehicles Equipped with ParkSense® Rear Park Assist Switch



You can turn ParkSense® on or off by pressing the ParkSense® Rear Park Assist switch located on the lower switch bank below the climate controls.

ParkSense® Operation

ParkSense® uses four sensors located in the rear bumper fascia to scan for obstacles up to 79 in (200 cm) away from the rear bumper fascia. The warning display located above the rear window provides both visible and audible warnings to indicate the range of the object.



032805242

ParkSense® LED Display

The warning display contains two sets of yellow and red LEDs, one set to warn of obstacles behind the left rear of the vehicle and the other set to warn of obstacles behind the right rear of the vehicle. The driver can view the LEDs either through the rear view mirror or by looking at the display above the rear window.

When the ignition is turned to the ON position, and the system is enabled, the warning display will turn on all of its LEDs for approximately one second. Then, the system dimly illuminates the two inner most LEDs when it is detecting no obstacles.

ParkSense® is active when the ignition is in the ON position, and the system is enabled, and the driver shifts the transmission into the REVERSE position, and the vehicle speed is less than 11 mph (18 km/h). The following chart shows the warning display operation when the system is detecting an obstacle:

WARNING DISPLAY DISTANCES

DISPLAY LED	OBSTACLE DISTANCE FROM:		LED COLOR	AUDIBLE SIGNAL
	REAR CORNERS	REAR CENTER		
Inner LED		79 in (200 cm)	Yellow	Sounds for ½ second
1st LED		51 in (130 cm)	Yellow	None
2nd LED		45 in (115 cm)	Yellow	None
3rd LED	31.5 in (80 cm)	39 in (100 cm)	Yellow	None
4th LED	25.5 in (65 cm)	33.5 in (85 cm)	Yellow	None
5th LED	20 in (50 cm)	28 in (70 cm)	Yellow	None
6th LED	16 in (40 cm)	20 in (50 cm)	Red	Intermittent
7th LED	6 in (15 cm)	12 in (30 cm)	Red	Continuous

Service ParkSense® Rear Park Assist

When the ParkSense® Rear Park Assist System is defective, the instrument cluster will actuate a single chime, once per ignition cycle, and it will display the “SERVICE PARK ASSIST SYSTEM” message. Refer to “Electronic Vehicle Information Center (EVIC)” in “Understanding Your Instrument Panel” for further information. When the shift lever is moved to REVERSE and the system has detected a faulted condition, the EVIC will display the “SERVICE PARK ASSIST SYSTEM” message for as long as the vehicle is in REVERSE. Under this condition ParkSense® will not operate.

If “SERVICE PARK ASSIST SYSTEM” appears in the Electronic Vehicle Information Center (EVIC) after making sure the rear fascia/bumper is clean and clear of snow, ice, mud, dirt, or other obstruction, see your authorized dealer.

ParkSense® Rear Park Assist uses four sensors located in the rear bumper fascia to scan for obstacles up to 79 in (200 cm) away from the rear bumper fascia. The warning display located above the rear window provides both visible and audible warnings to indicate the range of the object.

GARAGE DOOR OPENER — IF EQUIPPED

HomeLink® replaces up to three remote controls (hand-held transmitters) that operate devices such as garage door openers, motorized gates, lighting or home security systems. The HomeLink® unit operates off your vehicle’s battery.

The HomeLink® buttons that are located in the headliner or sun visor designate the three different HomeLink® channels.

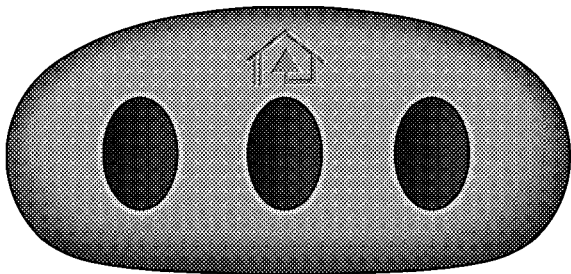

81cb44fe

HomeLink® Buttons

NOTE: HomeLink® is disabled when the Vehicle Security Alarm is active.

WARNING!

- Your motorized door or gate will open and close while you are training the Universal Transceiver. Do not train the transceiver if people, pets or other objects are in the path of the door or gate. Only use this transceiver with a garage door opener that has a “stop and reverse” feature as required by Federal safety standards. This includes most garage door opener models manufactured after 1982. Do not use a garage door opener without these safety features. Call toll-free 1-800-355-3515 or, on the Internet at www.HomeLink.com for safety information or assistance.
- Vehicle exhaust contains carbon monoxide, a dangerous gas. Do not run your vehicle in the garage while training the transceiver. Exhaust gas can cause serious injury or death.

Programming HomeLink®

Before You Begin

If you have not trained any of the HomeLink® buttons, erase all channels before you begin training.

To do this, press and hold the two outside buttons for 20 seconds until the red indicator flashes.

It is recommended that a new battery be placed in the handheld transmitter of the device that is being copied to HomeLink® for more efficient training and accurate transmission of the radio-frequency signal.

Your vehicle should be parked outside of the garage when programming.

1. Turn the ignition switch to the ON/RUN position.
2. Hold the battery side of the handheld transmitter away from the HomeLink® button you wish to program.

Place the handheld transmitter 1–3 in (3-8 cm) away from the HomeLink® button you wish to program while keeping the indicator light in view.

3. Simultaneously press and hold both the chosen HomeLink® button and the handheld transmitter button until the HomeLink® indicator changes from a slow to a rapidly blinking light, then release both the HomeLink® and handheld transmitter buttons.

Watch for the HomeLink® indicator to change flash rates. When it changes, it is programmed. It may take up to 30 seconds or longer in rare cases. The garage door may open and close while you train.

NOTE:

- Some gate operators and garage door openers may require you to replace Step 3 with procedures noted in the “Gate Operator/Canadian Programming” section.

- After training a HomeLink® channel, if the garage door does not operate with HomeLink® and the garage door opener was manufactured after 1995, the garage door opener may have a rolling code. If so, proceed to the heading “Programming A Rolling Code System.”

4. Press and hold the just-trained HomeLink® button and observe the indicator light.

If the indicator light stays on constantly, programming is complete and the garage door (or device) should activate when the HomeLink® button is pressed.

If the indicator light blinks rapidly for two seconds, and then turns to a constant light, continue with programming for a Rolling Code.

5. PROGRAMMING A ROLLING CODE SYSTEM

At the garage door opener motor (in the garage), locate the “Learn” or “Training” button.

This can usually be found where the hanging antenna wire is attached to the garage door opener motor (it is NOT the button normally used to open and close the door).

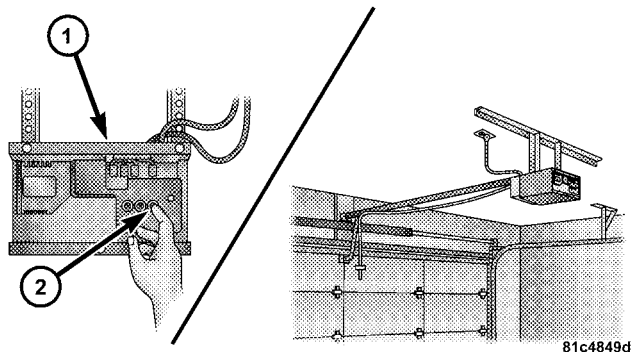

1 — Garage Door Opener
2 — Training Button

81c4849d

6. Firmly press and release the LEARN or TRAINING button. The name and color of the button may vary by manufacturer.

NOTE: You have 30 seconds in which to initiate the next step after the LEARN button has been pressed.

7. Return to the vehicle and press the programmed HomeLink® button twice (holding the button for two seconds each time). If the device is plugged in and activates, programming is complete.

If the device does not activate, press the button a third time (for two seconds) to complete the training.

If you have any problems, or require assistance, please call toll-free 1-800-355-3515 or, on the Internet at www.HomeLink.com for information or assistance.

To program the remaining two HomeLink® buttons, repeat each step for each remaining button. DO NOT erase the channels.

Gate Operator/Canadian Programming

Canadian radio-frequency laws require transmitter signals to “time-out” (or quit) after several seconds of transmission – which may not be long enough for HomeLink® to pick up the signal during programming. Similar to this Canadian law, some U.S. gate operators are designed to “time-out” in the same manner.

It may be helpful to unplug the device during the cycling process to prevent possible overheating of the garage door or gate motor.

If you are having difficulties programming a garage door opener or a gate operator, replace “Programming HomeLink®” Step 3 with the following:

3. Continue to press and hold the HomeLink® button, while you press and release (“cycle”), your handheld transmitter every two seconds until HomeLink® has successfully accepted the frequency signal. The indicator light will flash slowly and then rapidly when fully trained.

If you unplugged the device for training, plug it back in at this time.

Then proceed with Step 4 under “Programming HomeLink®” earlier in this section.

Using HomeLink®

To operate, press and release the programmed HomeLink® button. Activation will now occur for the trained device (i.e., garage door opener, gate operator, Security system, entry door lock, home/office lighting, etc.,). The handheld transmitter of the device may also be used at any time.

Reprogramming A Single HomeLink® Button

To reprogram a channel that has been previously trained, follow these steps:

1. Turn the ignition switch to the ON/RUN position.

2. Press and hold the desired HomeLink® button until the indicator light begins to flash after 20 seconds. **Do not release the button.**

3. **Without releasing the button**, proceed with Programming HomeLink® Step 2 and follow all remaining steps.

Security

It is advised to erase all channels before you sell or turn in your vehicle.

To do this, press and hold the two outside buttons for 20 seconds until the red indicator flashes. Note that all channels will be erased. Individual channels cannot be erased.

The HomeLink® Universal Transceiver is disabled when the Vehicle Security Alarm is active.

Troubleshooting Tips

If you are having trouble programming HomeLink®, here are some of the most common solutions:

- Replace the battery in the original transmitter.
- Press the LEARN button on the Garage Door Opener to complete the training for a Rolling Code.
- Did you unplug the device for training, and remember to plug it back in?

If you have any problems, or require assistance, please call toll-free 1-800-355-3515 or, on the Internet at www.HomeLink.com for information or assistance.

General Information

This device complies with FCC rules Part 15 and Industry Canada RSS-210. Operation is subject to the following two conditions:

1. This device may not cause harmful interference.
2. This device must accept any interference that may be received including interference that may cause undesired operation.

NOTE: The transmitter has been tested and it complies with FCC and IC rules. Changes or modifications not expressly approved by the party responsible for compliance could void the user's authority to operate the device.

The term IC before the certification/registration number only signifies that Industry Canada technical specifications were met.

POWER SUNROOF — IF EQUIPPED

The power sunroof switch is located between the sun visors on the overhead console.



Power Sunroof Switch

WARNING!

- Never leave unattended children in a vehicle with the key in the ignition switch. Occupants, particularly unattended children, can become entrapped by the power sunroof while operating the power sunroof switch. Such entrapment may result in serious injury or death.
- In an accident, there is a greater risk of being thrown from a vehicle with an open sunroof. You could also be seriously injured or killed. Always fasten your seat belt properly and make sure all passengers are properly secured too.
- Do not allow small children to operate the sunroof. Never allow your fingers, other body parts, or any object to project through the sunroof opening. Injury may result.

Opening Sunroof — Express

Press the switch rearward and release it within one-half second and the sunroof will open automatically from any position. The sunroof will open fully and stop automatically. This is called “Express Open”. During Express Open operation, any movement of the sunroof switch will stop the sunroof.

Opening Sunroof — Manual Mode

To open the sunroof, press and hold the switch rearward to full open. Any release of the switch will stop the movement and the sunroof will remain in a partially opened condition until the switch is pushed and held rearward again.

Closing Sunroof — Express

Press the switch forward and release it within one-half second and the sunroof will close automatically from any

position. The sunroof will close fully and stop automatically. This is called “Express Close”. During Express Close operation, any movement of the switch will stop the sunroof.

Closing Sunroof — Manual Mode

To close the sunroof, press and hold the switch in the forward position. Any release of the switch will stop the movement and the sunroof will remain in a partially closed condition until the switch is pushed and held forward again.

Pinch Protect Feature

This feature will detect an obstruction in the opening of the sunroof during Express Close operation. If an obstruction in the path of the sunroof is detected, the sunroof will automatically retract. Remove the obstruction if this occurs. Next, press the switch forward and release to Express Close.

Pinch Protect Override

If a known obstruction (ice, debris, etc.) prevents closing and moves the sunroof in the opposite direction, press the switch forward and hold. This allows the sunroof to move towards the closed position.

NOTE: Pinch protection is disabled while the switch is pressed.

Venting Sunroof — Express

Press and release the "Vent" button within one-half second and the sunroof will open to the vent position. This is called "Express Vent", and it will occur regardless of sunroof position. During Express Vent operation, any movement of the switch will stop the sunroof.

Sunshade Operation

The sunshade can be opened manually. However, the sunshade will open automatically as the sunroof opens.

NOTE: The sunshade cannot be closed if the sunroof is open.

Wind Buffeting

Wind buffeting can be described as the perception of pressure on the ears or a helicopter-type sound in the ears. Your vehicle may exhibit wind buffeting with the windows down, or the sunroof (if equipped) in certain open or partially open positions. This is a normal occurrence and can be minimized. If the buffeting occurs with the rear windows open, then open the front and rear windows together to minimize the buffeting. If the buffeting occurs with the sunroof open, adjust the sunroof opening to minimize the buffeting or open any window.

Sunroof Maintenance

Use only a non-abrasive cleaner and a soft cloth to clean the glass panel.

Ignition Off Operation

For vehicles not equipped with the Electronic Vehicle Information Center (EVIC), the power sunroof switch will remain active for 45 seconds after the ignition switch is turned to the LOCK position. Opening either front door will cancel this feature.

For vehicles equipped with the EVIC, the power sunroof switch will remain active for up to approximately ten minutes after the ignition switch is turned to the LOCK position. Opening either front door will cancel this feature. The time is programmable. Refer to “Electronic Vehicle Information Center (EVIC)/Personal Settings (Customer-Programmable Features)” in “Understanding Your Instrument Panel” for further information.

ELECTRICAL POWER OUTLET

Your vehicle is equipped with a fused 12 Volt (13 Amp) power outlet. This power outlet is located on the instrument panel, below the climate controls. It has power available when the ignition switch is in the ON or ACC position. Insert the cigar lighter or accessory plug into the outlet for use to ensure proper operation. **To preserve the heating element, do not hold the lighter in the heating position.**

NOTE:

- To ensure proper operation a MOPAR® knob and element must be used.
- Do not exceed the maximum power of 160 Watts (13 Amps) at 12 Volts. If the 160 Watt (13 Amp) power rating is exceeded the fuse protecting the system will need to be replaced.

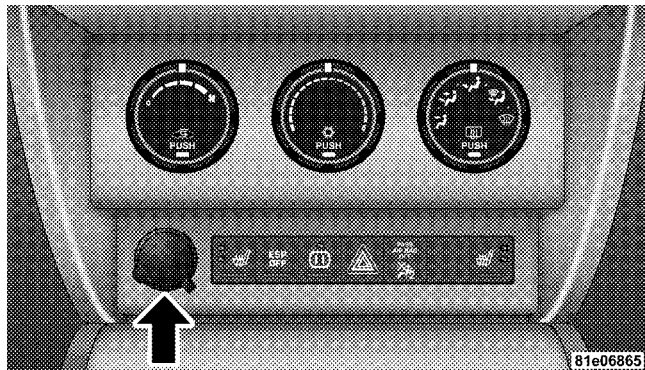
**Front Power Outlet****WARNING!**

To avoid serious injury or death:

- Only devices designed for use in this type of outlet should be inserted into any 12 Volt outlet.
- Do not touch with wet hands.
- Close the lid when not in use and while driving the vehicle.
- If this outlet is mishandled, it may cause an electric shock and failure.

CAUTION!

- Many accessories that can be plugged in draw power from the vehicle's battery, even when not in use (i.e., cellular phones, etc.). Eventually, if plugged in long enough, the vehicle's battery will discharge sufficiently to degrade battery life and/or prevent the engine from starting.
- Accessories that draw higher power (i.e., coolers, vacuum cleaners, lights, etc.) will degrade the battery even more quickly. Only use these intermittently and with greater caution.
- After the use of high power draw accessories, or long periods of the vehicle not being started (with accessories still plugged in), the vehicle must be driven a sufficient length of time to allow the alternator to recharge the vehicle's battery.

(Continued)

CAUTION! (Continued)

- Power outlets are designed for accessory plugs only. Do not hang any type of accessory or accessory bracket from the plug.

CUPHOLDERS

There are two cupholders for the front seat passengers, located in the center console.

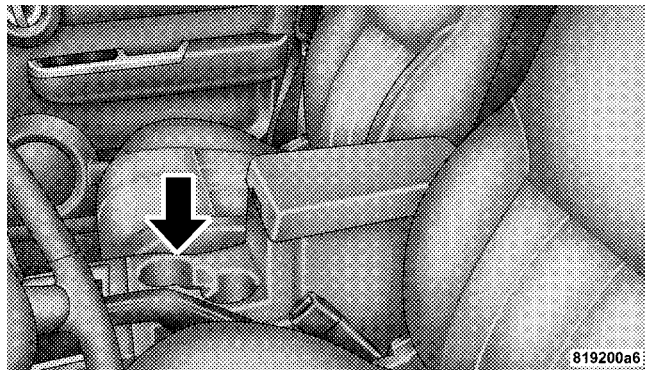

Front Cupholders

The rear passengers have cupholders at the rear of the center console.

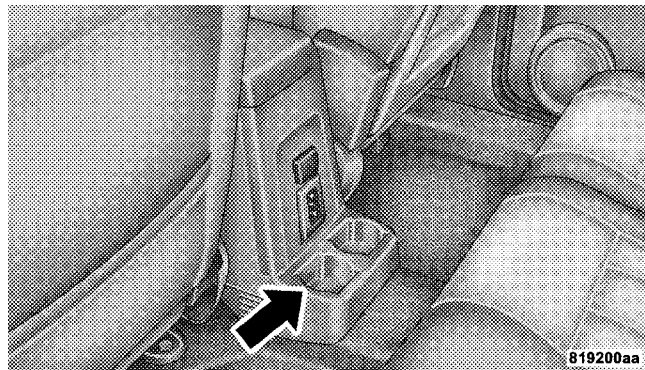

Rear Cupholders

STORAGE

Front Storage Compartment

The front storage compartment (located on the left side of the instrument panel) can hold cell phones, PDAs, and other small items.

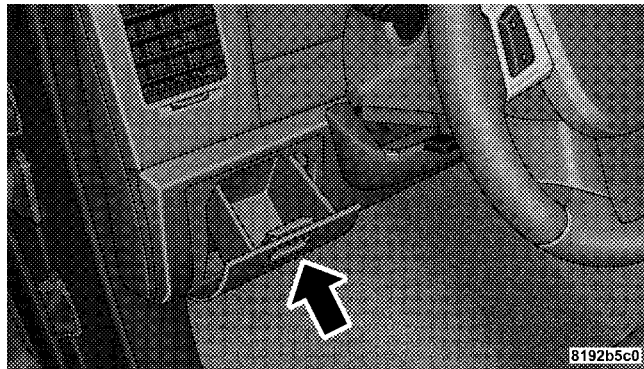

Front Storage Compartment

Console Storage Compartment

To open, press the latch and lift the cover.

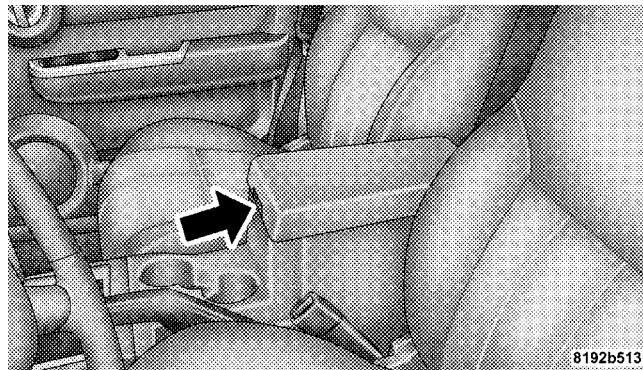

Center Console

The center console has a removable storage tray which can hold cell phones, PDAs, and other small items.

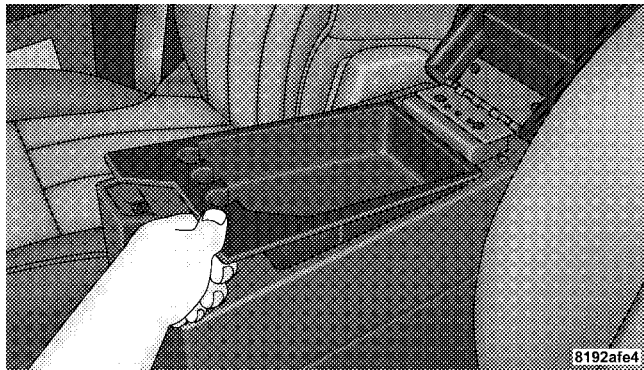

Removable Storage Tray

CARGO AREA FEATURES

Cargo Light

The cargo area light is activated by opening the liftgate, opening any door, or by rotating the dimmer control on the multifunction lever to the extreme top position.

Cargo Tie-Down Hooks

The tie-downs located on the cargo area floor should be used to safely secure loads when the vehicle is moving.

WARNING!

Cargo tie-down hooks are not safe anchors for a child seat tether strap. In a sudden stop or collision a hook could pull loose and allow the child seat to come loose. A child could be badly injured. Use only the anchors provided for child seat tethers.

WARNING!

The weight and position of cargo and passengers can change the vehicle center of gravity and vehicle handling. To avoid loss of control resulting in personal injury, follow these guidelines for loading your vehicle:

- Do not carry loads which exceed the load limits described on the label attached to the left door or left door center pillar.
- Always place cargo evenly on the cargo floor. Put heavier objects as low and as far forward as possible.
- Place as much cargo as possible in front of the rear axle. Too much weight or improperly placed weight over or behind the rear axle can cause the vehicle to sway.

(Continued)

WARNING! (Continued)

- Do not pile luggage or cargo higher than the top of the seatback. This could impair visibility or become a dangerous projectile in a sudden stop or collision.
- To help protect against personal injury, passengers should not be seated in the rear cargo area. The rear cargo space is intended for load carrying purposes only, not for passengers, who should sit in seats and use seat belts.

Cargo Load Floor — If Equipped

The panel in the load floor is reversible for added utility. One side features a plastic lined tray which can hold a variety of items. The maximum load capacity of the load floor is 400 lbs (181 kg).

174 UNDERSTANDING THE FEATURES OF YOUR VEHICLE

The cargo load floor is held by spring loaded latches. In order to use the cargo load floor, use the following procedure:

1. Push both side mounted release handles (toward the center of the vehicle) at the same time to release cover.

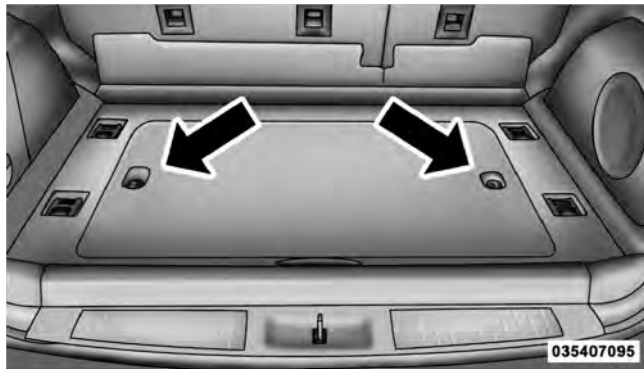

Floor Panel

2. Lift the cover.

3. Flip the cover over, and lock panel back into position.

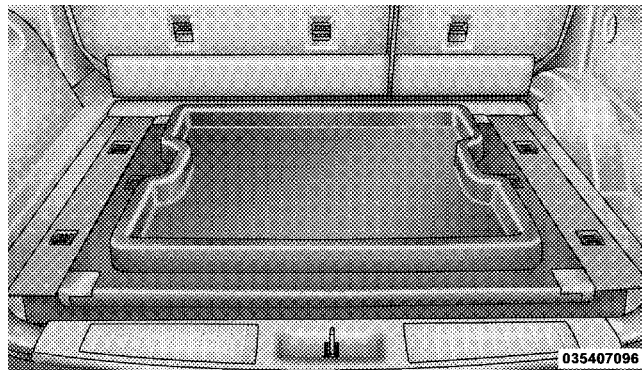

Load Floor

REAR WINDOW FEATURES

Rear Window Wiper/Washer

The rear wiper/washer is controlled by a rotary switch located on the control lever. The control lever is located on the right side of the steering column.



031507505

Rear Wiper/Washer Control

 Rotate the switch upward to the “On” position to activate the rear wiper.

NOTE: The rear wiper operates in an intermittent mode only.

 Rotate the switch upward to the “washer” position to activate that rear washer. The washer pump will continue to operate as long as the lever or ring is engaged. Upon release, the wipers will cycle two times before returning to the set position.

If the rear wiper is operating when the ignition is turned OFF, the wiper will automatically return to the “park” position. When the vehicle is restarted, the wiper will resume function at whichever position the switch is set.

Rear Window Defroster

 The rear window defroster button is located on the climate control (Mode) knob. Press this button to turn on the rear window defroster and the heated outside mirrors. An indicator in the button will illuminate when the rear window defroster is on. The rear window defroster automatically turns off after approximately 10 minutes. For an additional five minutes of operation, press the button a second time.

NOTE: To prevent excessive battery drain, use the rear window defroster only when the engine is operating.

CAUTION!

Failure to follow these cautions can cause damage to the heating elements:

- Use care when washing the inside of the rear window. Do not use abrasive window cleaners on the interior surface of the window. Use a soft cloth and a mild washing solution, wiping parallel to the heating elements. Labels can be peeled off after soaking with warm water.
- Do not use scrapers, sharp instruments, or abrasive window cleaners on the interior surface of the window.
- Keep all objects a safe distance from the window.

ROOF TRIM APPLIQUE — NON FUNCTIONAL

The Roof Trim Applique as provided on the vehicle is non functional. Metal side rails and crossbars can be purchased from MOPAR® accessories to provide a functional roof rack system.

The load carried on the roof, when equipped with a luggage rack, must not exceed 150 lbs (68 kg), and it should be uniformly distributed over the cargo area. Check the straps frequently to be sure that the load remains securely attached.

NOTE: Metal rails/crossbars are offered by MOPAR® accessories. See your authorized dealer.

External racks do not increase the total load carrying capacity of the vehicle. Be sure that the total occupant and luggage load inside the vehicle, plus the load on the luggage rack, do not exceed the maximum vehicle load capacity.

CAUTION!

- To avoid damage to the roof rack and vehicle, do not exceed the maximum roof rack load capacity. Always distribute heavy loads as evenly as possible and secure the load appropriately.
- Long loads, which extend over the windshield, such as wood panels or surfboards, should be secured to both the front and rear of the vehicle.
- Place a blanket or other protection between the surface of the roof and the load.
- Travel at reduced speeds and turn corners carefully when carrying large or heavy loads on the roof rack. Wind forces, due to natural causes or nearby truck traffic, can add sudden upward loads. This is especially true on large flat loads and may result in damage to the cargo or your vehicle.

WARNING!

Cargo must be securely tied before driving your vehicle. Improperly secured loads can fly off the vehicle, particularly at high speeds, resulting in personal injury or property damage. Follow the roof rack Cautions when carrying cargo on your roof rack.

UNDERSTANDING YOUR INSTRUMENT PANEL

CONTENTS

■ Instrument Panel Features	182	□ Electronic Vehicle Information Center (EVIC) Displays	205
■ Instrument Cluster	183	□ Oil Change Required	206
■ Instrument Cluster Descriptions	184	□ Trip Functions	207
■ Compass And Trip Computer — If Equipped . .	199	□ Compass Display / ECO (Fuel Saver Mode) — If Equipped	208
□ Control Buttons	200	□ Personal Settings (Customer-Programmable Features)	211
□ Trip Conditions	201	■ Media Center 230 (REQ) — AM/FM Stereo Radio And 6-Disc CD/DVD Changer (MP3/WMA AUX Jack)	214
□ Compass/Temperature Display	201		
■ Electronic Vehicle Information Center (EVIC) — If Equipped	203		

- Operating Instructions - Radio Mode 214
- Operation Instructions - (Disc Mode For CD And MP3/WMA Audio Play, DVD-Video) . . . 222
- Notes On Playing MP3/WMA Files 224
- List Button (Disc Mode For MP3/WMA Play) 227
- Info Button (Disc Mode For MP3/WMA Play) 227
- Media Center 730N/430 (RER/REN/RBZ) — AM/FM Stereo Radio And CD/DVD/HDD/Nav — If Equipped. 229
 - Operating Instructions — Voice Command System — If Equipped 230
 - Operating Instructions — Uconnect™ phone — If Equipped 230
 - Clock Setting Procedure — RBZ Radio 230
- Clock Setting Procedure — RER/REN Radio 231
- Media Center 130 (RES) — AM/FM Stereo Radio With CD Player (MP3 AUX Jack). 234
 - Operating Instructions — Radio Mode 234
 - Operation Instructions — CD Mode For CD And MP3 Audio Play 237
 - Notes On Playing MP3 Files 239
 - Operation Instructions - Auxiliary Mode 242
- Media Center 130 (RES/RSC) — AM/FM Stereo Radio With CD Player (MP3 AUX Jack) And Sirius Radio 242
 - Operating Instructions — Radio Mode 243
 - Operation Instructions — CD Mode For CD And MP3 Audio Play 248

□ Notes On Playing MP3 Files	250	□ Operating Instructions - Uconnect™ phone (If Equipped)	258
□ List Button (CD Mode For MP3 Play)	253	■ Remote Sound System Controls — If Equipped	259
□ Info Button (CD Mode For MP3 Play)	253	□ Radio Operation	259
■ Uconnect™ Multimedia (Satellite Radio) — If Equipped (REN/REQ/RER/RES Radios Only).	254	□ CD Player	260
□ System Activation	255	■ CD/DVD Disc Maintenance	260
□ Electronic Serial Number/Sirius Identification Number (ESN/SID)	255	■ Radio Operation And Cellular Phones	261
□ Selecting Uconnect™ Multimedia (Satellite) Mode	256	■ Climate Controls	261
□ Satellite Antenna	256	□ Manual Heating And Air Conditioning	261
□ Reception Quality	256	□ Automatic Temperature Control (ATC) — If Equipped	265
□ Operating Instructions - Uconnect™ Multimedia (Satellite) Mode	256	□ Operating Tips	271

INSTRUMENT PANEL FEATURES

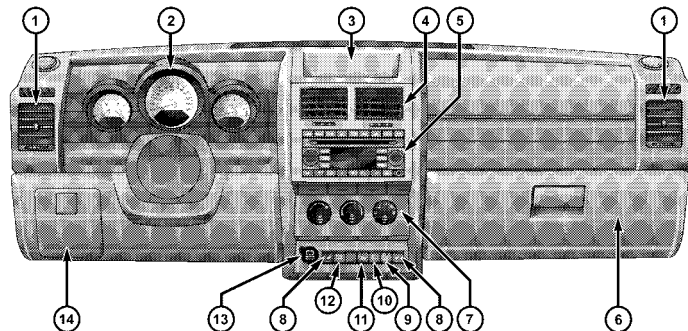

81c8724e

- 1 — Air Outlet
- 2 — Instrument Cluster
- 3 — Storage Tray
- 4 — Center Air Outlet
- 5 — Radio

- 6 — Glove Compartment
- 7 — Climate Control
- 8 — Heated Seat Switch *
- 9 — Rear Park Assist Switch *
- 10 — Passenger Airbag Disable Light

- 11 — Hazard Warning Flasher
 - 12 — Electronic Stability Program / Traction Control Switch *
 - 13 — Cigar Lighter / Power Outlet
 - 14 — Storage Bin
- * If Equipped

INSTRUMENT CLUSTER

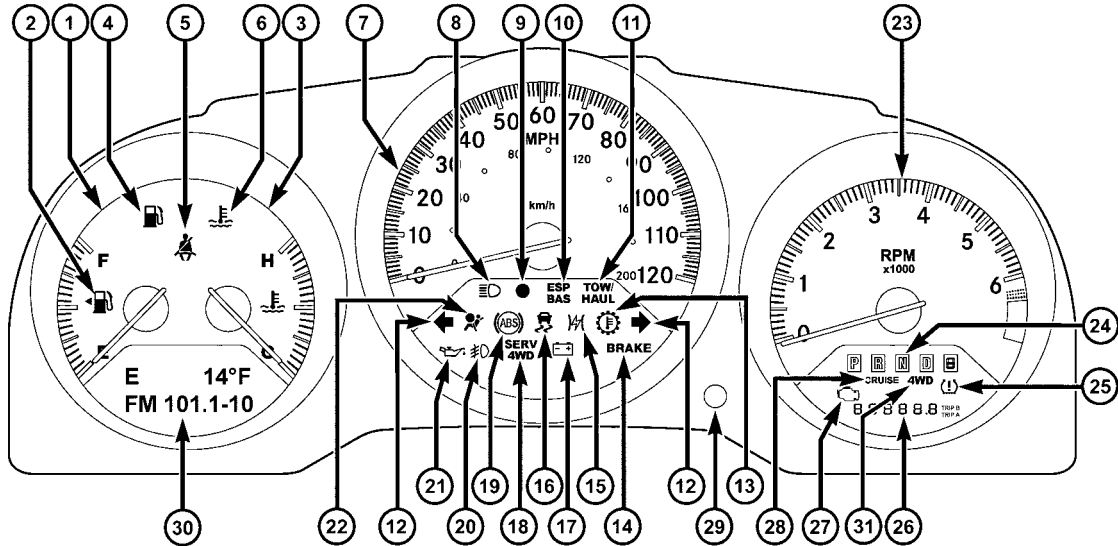

INSTRUMENT CLUSTER DESCRIPTIONS

1. *Fuel Gauge*

The fuel gauge shows level of fuel in tank when ignition switch is in the ON position.

2. *Fuel Door Reminder*



This symbol indicates the side of the vehicle where the fuel cap is located.

3. *Temperature Gauge*

The temperature gauge shows engine coolant temperature. Any reading within the normal range indicates that the engine cooling system is operating satisfactorily.

The gauge pointer will likely indicate a higher temperature when driving in hot weather, up mountain grades, or when towing a trailer. It should not be allowed to exceed the upper limits of the normal operating range.

CAUTION!

Driving with a hot engine cooling system could damage your vehicle. If temperature gauge reads "H" pull over and stop the vehicle. Idle the vehicle with the air conditioner turned off until the pointer drops back into the normal range. If the pointer remains on the "H" and you hear continuous chimes, turn the engine off immediately, and call an authorized dealership for service.

WARNING!

A hot engine cooling system is dangerous. You or others could be badly burned by steam or boiling coolant. You may want to call an authorized dealership for service if your vehicle overheats. If you decide to look under the hood yourself, see “Maintaining Your Vehicle”. Follow the warnings under the Cooling System Pressure Cap paragraph.

4. Low Fuel Light

When the fuel level reaches approximately 2.0 gal (7.8 L) this light will turn on, and remain on until fuel is added.

5. Seat Belt Reminder Light

When the ignition switch is first turned ON, this light will turn on for five to eight seconds as a bulb check. During the bulb check, if the driver’s seat belt is unbuckled, a chime will sound. After the bulb

check or when driving, if the driver’s seat belt remains unbuckled, the Seat Belt Reminder Light will illuminate and the chime will sound. Refer to “Occupant Restraints” in “Things To Know Before Starting Your Vehicle” for further information.

6. Engine Temperature Warning Light

This light warns of an overheated engine condition. As temperatures rise and the gauge approaches **H**, this indicator will illuminate and a single chime will sound after reaching a set threshold. Further overheating will cause the temperature gauge to pass **H**, the indicator will continuously flash and a continuous chime will occur until the engine is allowed to cool.

If the light turns on while driving, safely pull over and stop the vehicle. If the A/C system is on, turn it off. Also, shift the transmission into NEUTRAL and idle the vehicle. If the temperature reading does not return to

normal, turn the engine off immediately and call for service. Refer to “If Your Engine Overheats” in “What To Do In Emergencies” for further information.

7. *Speedometer*

Shows the vehicles speed.

8. *High Beam Indicator*

 This indicator shows that the high beam headlights are on. Push the multifunction lever forward to switch the headlights to high beam, and pull toward yourself (normal position) to return to low beam.

9. *Vehicle Security Light — If Equipped*



This light will flash at a fast rate for approximately 15 seconds, when the vehicle security alarm is arming, and then will flash slowly until the vehicle is disarmed.

10. *Electronic Stability Program (ESP) Warning Light / Brake Assist System (BAS) Warning Light – If Equipped*

**ESP
BAS**

The malfunction light for the Electronic Stability Program (ESP) is combined with Brake Assist System (BAS). The yellow “ESP/BAS Warning Light” comes on when the ignition switch is turned to the “ON” position. They should go out with the engine running. If the “ESP/BAS Warning Light” comes on continuously with the engine running, a malfunction has been detected in either the ESP or the BAS system. If this light remains on after several ignition cycles, and the vehicle has been driven several miles (kilometers) at speeds greater than 30 mph (48 km/h), see an authorized dealer as soon as possible.

NOTE: The ESP Control System will make buzzing or clicking sounds when it is actively operating.

WARNING!

If a warning light remains on the system may not be working and you will not have the benefit of ESP or BAS. Under certain driving conditions, where ESP or BAS would be beneficial, you - if you have not adjusted your driving speeds and stopping in or to account for the lack of the feature, may be in accident.

11. TOW/HAUL Indicator — If Equipped**TOW/
HAUL**

The TOW/HAUL button is located on the gear shift bezel. This light will illuminate when the TOW/HAUL button has been selected.

12. Turn Signal Indicators

The arrow will flash with the exterior turn signal when the turn signal lever is operated.

If the vehicle electronics sense that the vehicle has traveled about 1 mile (1.6 km) with the turn signals on, a continuous chime will sound to alert you to turn the signals off. If either indicator flashes at a rapid rate, check for a defective outside light bulb.

13. Transmission Temperature Warning Light — If Equipped

This light indicates that there is excessive transmission fluid temperature that might occur with severe usage such as trailer towing. If this light comes on, stop the vehicle and run the engine at idle or faster, with the transmission in NEUTRAL until the light goes off.

CAUTION!

Continuous driving with the Transmission Temperature Warning Light illuminated will eventually cause severe transmission damage or transmission failure.

WARNING!

In some circumstances a Transmission Temperature Warning Light, under continued operation, could cause the fluid to boil over, come in contact with hot engine or exhaust components and cause a fire.

14. Brake Warning Light

This light monitors various brake functions, including brake fluid level and parking brake application. If the brake light turns on, it may indicate that the parking brake is applied, that the brake fluid level is low, or that there is a problem with the anti-lock brake system reservoir.

If the light remains on when the parking brake has been disengaged, and the fluid level is at the full mark on the master cylinder reservoir, it indicates a possible brake hydraulic system malfunction or that a problem with the Brake Booster has been detected by the Anti-Lock Brake

System (ABS) / Electronic Stability Program (ESP) system. In this case, the light will remain on until the condition has been corrected. If the problem is related to the brake booster, the ABS pump will run when applying the brake and a brake pedal pulsation may be felt during each stop.

The dual brake system provides a reserve braking capacity in the event of a failure to a portion of the hydraulic system. A leak in either half of the dual brake system is indicated by the Brake Warning Light, which will turn on when the brake fluid level in the master cylinder has dropped below a specified level.

The light will remain on until the cause is corrected.

NOTE: The light may flash momentarily during sharp cornering maneuvers, which change fluid level conditions. The vehicle should have service performed, and the brake fluid level checked.

If brake failure is indicated, immediate repair is necessary.

WARNING!

Driving a vehicle with the red brake light on is dangerous. Part of the brake system may have failed. It will take longer to stop the vehicle. You could have an accident. Have the vehicle checked immediately.

Vehicles equipped with the Anti-Lock Brake System (ABS), are also equipped with Electronic Brake Force Distribution (EBD). In the event of an EBD failure, the Brake Warning Light will turn on along with the ABS Light. Immediate repair to the ABS system is required.

Operation of the Brake Warning Light can be checked by turning the ignition switch from the OFF position to the ON position. The light should illuminate for approximately two seconds. The light should then turn off unless

the parking brake is applied or a brake fault is detected. If the light does not illuminate, have the light inspected by an authorized dealer.

The light also will turn on when the parking brake is applied with the ignition switch in the ON position.

NOTE: This light shows only that the parking brake is applied. It does not show the degree of brake application.

15. *Electronic Throttle Control (ETC) Light*



This light informs you of a problem with the Electronic Throttle Control (ETC) system. If a problem is detected, the light will come on while the engine is running. Cycle the ignition key when the vehicle has completely stopped and the shift lever is placed in the PARK position. The light should turn off. If the light remains lit with the engine running, your vehicle will usually be drivable; however, see an authorized dealer for service as soon as possible. If

the light is flashing when the engine is running, immediate service is required and you may experience reduced performance, an elevated/rough idle or engine stall and your vehicle may require towing. The light will come on when the ignition is first turned ON and remain on briefly as a bulb check. If the light does not come on during starting, have the system checked by an authorized dealer.

16. *Electronic Stability Program (ESP) Indicator Light / Traction Control System (TCS) Indicator Light*



The yellow Electronic Stability Program (ESP) / Traction Control System (TCS) indicator light in the speedometer area illuminates with the key in the ignition switch turned to the ON/RUN position. It should go out with the engine running. The "ESP/TCS Indicator Light" starts to flash as soon as the tires lose traction and the ESP system becomes active. The "ESP/TCS Indicator Light" also flashes when TCS is active. If the "ESP/TCS Indicator Light" begins to flash

during acceleration, ease up on the accelerator and apply as little throttle as possible. Be sure to adapt your speed and driving to the prevailing road conditions. The "ESP/TCS Indicator Light" becomes illuminated when the ESP Off button has been pressed or ESP is only partially available, caused by lack of engine management or brake thermal model.

17. *Charging System Light*



This light shows the status of the electrical charging system. The light should come on when the ignition switch is first turned ON and remain on briefly as a bulb check. If the light stays on or comes on while driving, turn off some of the vehicle's non-essential electrical devices or increase engine speed (if at idle). If the charging system light remains on, it means that the vehicle is experiencing a problem with the charging system. Obtain SERVICE IMMEDIATELY. See an authorized dealer.

If jump starting is required, refer to “Jump Starting Procedures” in “What To Do In Emergencies”.

18. *SERV (Service) 4WD Indicator — If Equipped*

**SERV
4WD**

The “SERV 4WD Indicator Light” will come on when the ignition key is turned to the ON position and will stay on for two seconds. If the light stays on or comes on during driving, it means that the 4WD system is not functioning properly and that service is required.

19. *Anti-Lock Brake (ABS) Light*



This light monitors the Anti-Lock Brake System (ABS). The light will turn on when the ignition switch is turned to the ON position and may stay on for as long as four seconds.

If the ABS light remains on or turns on while driving, it indicates that the Anti-Lock portion of the brake system is not functioning and that service is required. However,

the conventional brake system will continue to operate normally if the BRAKE warning light is not on.

If the ABS light is on, the brake system should be serviced as soon as possible to restore the benefits of Anti-Lock brakes. If the ABS light does not turn on when the Ignition switch is turned to the ON position, have the light inspected by an authorized dealer.

20. *Front Fog Light Indicator — If Equipped*



This indicator will illuminate when the fog lights are On.

21. *Oil Pressure Warning Light*



This light indicates low engine oil pressure. The light should turn on momentarily when the engine is started. If the light turns on while driving, stop the vehicle and shut off the engine as soon as possible. A chime will sound for four minutes when this light turns on.

Do not operate the vehicle until the cause is corrected. This light does not indicate how much oil is in the engine. The engine oil level must be checked under the hood.

22. *Airbag Warning Light*



This light turns on and remains on for seven seconds as a bulb check when the ignition switch is first turned ON. If the light is not on during starting, stays on, or turns on while driving, have the system inspected by an authorized dealer as soon as possible. Refer to “Occupant Restraints” in “Things To Know Before Starting Your Vehicle” for further information.

23. *Tachometer*

This gauge measures engine revolutions-per-minute (RPM x 1000).

24. *Shift Lever Indicator*

The Shift Lever Indicator is self-contained within the instrument cluster. It displays the gear position of the automatic transmission.

25. *Tire Pressure Monitoring Telltale Light*



Each tire, including the spare (if provided), should be checked monthly, when cold and inflated to the inflation pressure recommended by the vehicle manufacturer on the vehicle placard or tire inflation pressure label. (If your vehicle has tires of a different size than the size indicated on the vehicle placard or tire inflation pressure label, you should determine the proper tire inflation pressure for those tires.)

As an added safety feature, your vehicle has been equipped with a Tire Pressure Monitoring System (TPMS) that illuminates a low tire pressure telltale when one or more of your tires is significantly under-inflated.

Accordingly, when the low tire pressure telltale illuminates, you should stop and check your tires as soon as possible, and inflate them to the proper pressure. Driving on a significantly under-inflated tire causes the tire to overheat and can lead to tire failure. Under-inflation also reduces fuel efficiency and tire tread life, and may affect the vehicle's handling and stopping ability.

Please note that the TPMS is not a substitute for proper tire maintenance, and it is the driver's responsibility to maintain correct tire pressure, even if under-inflation has not reached the level to trigger illumination of the TPMS low tire pressure telltale.

Your vehicle has also been equipped with a TPMS malfunction indicator to indicate when the system is not operating properly. The TPMS malfunction indicator is

combined with the low tire pressure telltale. When the system detects a malfunction, the telltale will flash for approximately one minute and then remain continuously illuminated. This sequence will continue upon subsequent vehicle start-ups as long as the malfunction exists. When the malfunction indicator is illuminated, the system may not be able to detect or signal low tire pressure as intended. TPMS malfunctions may occur for a variety of reasons, including the installation of replacement or alternate tires or wheels on the vehicle that prevent the TPMS from functioning properly. Always check the TPMS malfunction telltale after replacing one or more tires or wheels on your vehicle, to ensure that the replacement or alternate tires and wheels allow the TPMS to continue to function properly.

CAUTION!

The TPMS has been optimized for the original equipment tires and wheels. TPMS pressures and warning have been established for the tire size equipped on your vehicle. Undesirable system operation or sensor damage may result when using replacement equipment that is not of the same size, type, and/or style. Aftermarket wheels can cause sensor damage. Do not use tire sealant from a can, or balance beads if your vehicle is equipped with a TPMS, as damage to the sensors may result.

26. Odometer / Trip Odometer Display Area

The odometer shows the total distance the vehicle has been driven. The trip odometer shows individual trip mileage. Refer to “Trip Odometer Button” for additional information.

NOTE: U.S. Federal regulations require that upon transfer of vehicle ownership, the seller certify to the purchaser the correct mileage that the vehicle has been driven. If your odometer needs to be repaired or serviced, the repair technician should leave the odometer reading the same as it was before the repair or service. If s/he cannot do so, then the odometer must be set at zero, and a sticker must be placed in the door jamb stating what the mileage was before the repair or service. It is a good idea for you to make a record of the odometer reading before the repair/service, so that you can be sure that it is properly reset, or that the door jamb sticker is accurate if the odometer must be reset at zero.

Vehicle Odometer Messages

When the appropriate conditions exist, the following messages will display in the odometer:

- ECO Fuel Saver Indicator Off
- ECO-ON Fuel Saver Indicator On
- door Door Ajar
- gATE Liftgate Ajar
- gASCAP Fuel Cap Fault
- noFUSE Fuse Fault
- CHAnge OIL Oil Change Required
- LoWASH Low Washer Fluid

On vehicles equipped with a Premium Instrument Cluster, this display shows the Electronic Vehicle Information Center (EVIC) messages when the appropriate conditions exist. Refer to Electronic Vehicle Information Center (EVIC) for further information.

ECO / ECO-ON (Fuel Saver Indicator) — If Equipped

The ECO-ON indicator will illuminate when you are driving in a fuel efficient manner and can be used to modify driving habits in order to increase fuel economy. The ECO display will toggle between ECO and ECO-ON depending on driving habits and vehicle usage. Press the Odometer / Trip Odometer / ECO (Fuel Saver Indicator) button to change the display from odometer to either of the two trip odometer settings or the “ECO” display.

gASCAP Message

If the vehicle diagnostic system determines that the fuel filler cap is loose, improperly installed, or damaged, “gASCAP” will be displayed in the odometer display area. Tighten the fuel filler cap properly and press the odometer reset button to turn the gASCAP message off. If the problem continues, the message will appear the next time the vehicle is started.

A loose, improperly installed, or damaged fuel filler cap may also turn on the Malfunction Indicator Light (MIL).

noFUSE

If the vehicle diagnostic system determines that the Ignition Off Draw (IOD) fuse is improperly installed, or damaged, a “noFUSE” message will display in the odometer display area. For further information on fuses and fuse locations refer to “Fuses” in “Maintaining Your Vehicle”.

CHAngE OIL Message

Your vehicle is equipped with an engine oil change indicator system. The “CHAngE OIL” message will flash in the instrument cluster odometer for approximately 12 seconds after a single chime has sounded to indicate the next scheduled oil change interval. The engine oil change indicator system is duty cycle based, which means the engine oil change interval may fluctuate dependent upon your personal driving style. Unless

reset, this message will continue to display each time you turn the ignition switch to the ON/RUN position. To turn off the message temporarily, press and release the TRIP ODOMETER button on the instrument cluster. To reset the oil change indicator system (after performing the scheduled maintenance), refer to the following procedure:

1. Turn the ignition switch to the ON position. **Do not start the engine.**
2. Fully depress the accelerator pedal slowly three times within 10 seconds.
3. Turn the ignition switch to the OFF/LOCK position.

NOTE: If the indicator message illuminates when you start the vehicle, the oil change indicator system did not reset. If necessary, repeat this procedure.

27. Malfunction Indicator Light (MIL)



The Malfunction Indicator Light (MIL) is part of an onboard diagnostic system, called OBD, that monitors engine and automatic transmission control systems. The light will illuminate when the key is in the ON position, before engine start. If the bulb does not come on when turning the key from OFF to ON, have the condition checked promptly.

Certain conditions such as a loose or missing gas cap, poor fuel quality, etc., may illuminate the MIL after engine start. The vehicle should be serviced if the light stays on through several of your typical driving cycles. In most situations, the vehicle will drive normally and will not require towing.

CAUTION!

Prolonged driving with the MIL on could cause damage to the engine control system. It also could affect fuel economy and drivability. If the MIL is flashing, severe catalytic converter damage and power loss will soon occur. Immediate service is required.

WARNING!

A malfunctioning catalytic converter, as referenced above, can reach higher temperatures than in normal operating conditions. This can cause a fire if you drive slowly or park over flammable substances such as dry plants or wood or cardboard, etc. This could result in death or serious injury to the driver, occupants or others.

28. Cruise Indicator — If Equipped

This indicator lights when the electronic speed control system is turned on.

29. Odometer / Trip Odometer / ECO (Fuel Saver Indicator) Button

Changing the Display

Press this button to change the display from odometer to either of the two trip odometer settings or the “ECO” display. Trip A or Trip B will appear when in the trip odometer mode. On vehicles equipped with a Base Cluster, press and release it once again to display the outside temperature. On vehicles equipped with a Mid Line Cluster, press and release it once again to display the outside temperature and compass heading in the screen below the speedometer. Refer to “Compass/Trip Computer” for details.

Resetting the Trip Odometer

Display the trip mileage that you want to reset, “Trip A” or “Trip B.” Then push and hold the button (approximately two seconds) until the display resets to 0. The odometer must be in Trip Mode to reset the trip odometer.

30. Compass/Trip Computer or Electronic Vehicle Information Center (EVIC) Display — If Equipped

When the appropriate conditions exist, this display shows the Compass/Trip Computer or Electronic Vehicle Information Center (EVIC) messages.

For further information refer to “Compass/Trip Computer” or “Electronic Vehicle Information Center (EVIC)”.

31. 4WD Indicator — *If Equipped*

4WD This light indicates the vehicle is in four-wheel drive and 4LOCK. 4WD allows all four wheels to receive torque from the engine simultaneously.

COMPASS AND TRIP COMPUTER — IF EQUIPPED

The Compass/Trip Computer features a driver-interactive display (displays information on outside temperature, compass direction, and trip information). It is located on the lower left part of the cluster below the fuel and engine temperature gauge, and the tachometer.

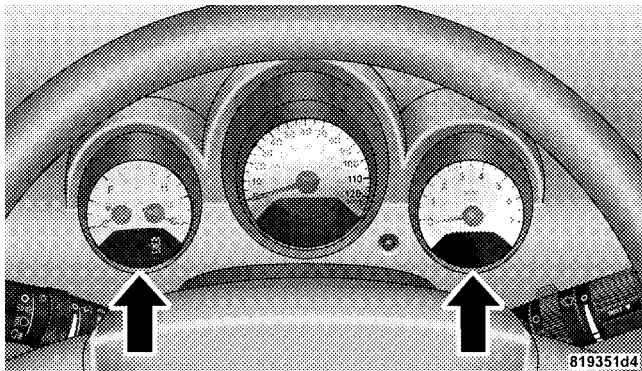

Compass/Trip Computer Display

The compass/trip computer, when the appropriate conditions exist, will show the following messages in the odometer display:

- Door Ajar (door)
- Lift Gate Ajar (gATE)

- Loose Fuel Cap (gASCAP)

These messages can be manually turned off by pressing the right button (on the instrument cluster).

Control Buttons

Press and release the odometer/trip odometer reset button (right side of the instrument cluster) to access the compass/trip computer displays.

NOTE: The system will display the last known outside temperature when starting the vehicle and may need to be driven several minutes before the updated temperature is displayed. Engine temperature can also affect the displayed temperature, therefore temperature readings are not updated when the vehicle is not moving.

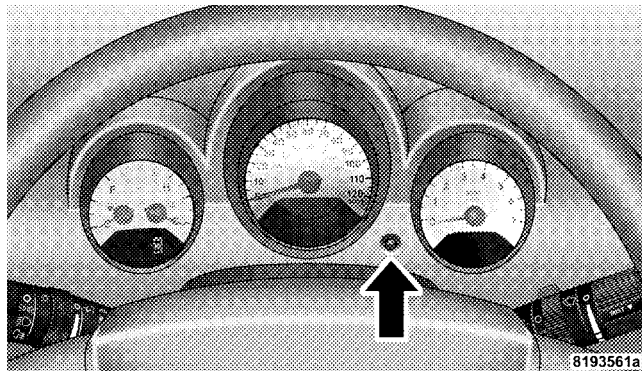

Display Button

Trip Conditions

Trip Odometer (ODO) / ECO (Fuel Saver Indicator) — If Equipped

This display shows the distance traveled since the last reset. Press and release the right button (on the instrument cluster) to switch from odometer, to Trip A or Trip B, or to ECO. Press and hold the right button while the odometer/trip odometer is displayed to reset.

Trip A

Shows the total distance traveled for trip A since the last reset.

Trip B

Shows the total distance traveled for trip B since the last reset.

ECO (Fuel Saver Indicator) — If Equipped

The ECO-ON indicator will illuminate when you are driving in a fuel efficient manner and can be used to

modify driving habits in order to increase fuel economy. The ECO display will toggle between ECO and ECO-ON depending on driving habits and vehicle usage.

Compass/Temperature Display

Compass Variance

Compass Variance is the difference between Magnetic North and Geographic North. To compensate for the differences, the variance should be set for the zone where the vehicle is driven, per the zone map. Once properly set, the compass will automatically compensate for the differences and provide the most accurate compass heading.

NOTE:

- A good calibration requires a level surface and an environment free from large metallic objects such as buildings, bridges, underground cables, railroad tracks, etc.

- Magnetic materials should be kept away from the top of the right rear quarter window. This is where the compass sensor is located.

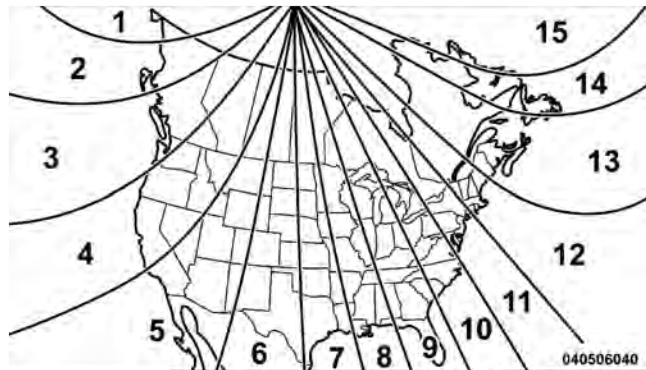

Compass Variance Map

To Set the Variance

Start the engine and leave the transmission gear selector lever in the PARK position. Press and hold the CMTC

reset button (for approximately ten seconds) until the current variance zone number is displayed. To change the zone, press and release the CMTC reset button to increase the variance one step. Repeat as necessary until the desired variance is achieved.

NOTE: The factory default zone is 8. During programming, the zone value will wrap around from zone 15 to zone 1.

Manual Compass Calibration

If the compass appears erratic inaccurate or abnormal, you may wish to calibrate the compass. Prior to calibrating the compass, make sure the proper zone is selected.

1. Start the engine and leave the transmission in the PARK position.
2. Press and hold the CMTC reset button (for approximately 10 seconds) until the current variance zone number is displayed.

3. Release the CMTC reset button, then press and hold again for approximately 10 seconds, until the direction is displayed, with the CAL indicator on continuously in the display.

4. To complete the compass calibration, drive the vehicle in one or more complete 360-degree circles, under 5 mph (8 km/h) in an area free from power lines and large metallic objects, until the CAL indicator turns off. The compass will now function normally.

ELECTRONIC VEHICLE INFORMATION CENTER (EVIC) — IF EQUIPPED

The Electronic Vehicle Information Center (EVIC) features a driver-interactive display that is located in the instrument cluster.

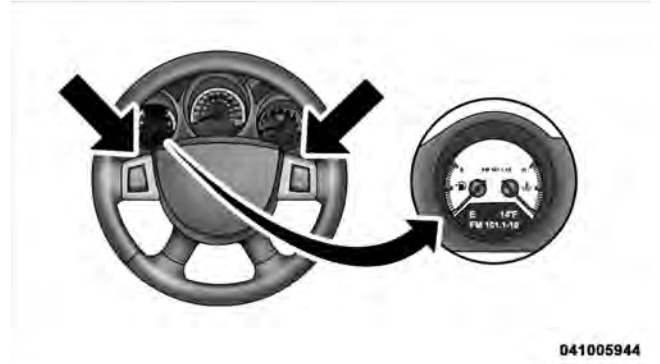

041005944

Electronic Vehicle Information Center (EVIC)

This system conveniently allows the driver to select a variety of useful information by pressing the switches mounted on the steering wheel. The EVIC consists of the following:

- System Status
- Vehicle information warning message displays
- Tire Pressure Monitor System (if equipped)
- Personal Settings (Customer-Programmable Features)
- Compass display
- Outside temperature display
- Trip computer functions
- Uconnect™ gps system screens (if equipped)
- Audio mode display

The system allows the driver to select information by pressing the following buttons mounted on the steering wheel:

MENU Button



Press and release the MENU button and the mode displayed will change between Trip Functions, Uconnect™ gps (if equipped), System Status, and Personal Settings.



Press the FUNCTION SELECT button to accept a selection. Also, the FUNCTION SELECT button changes the current CD track being played (if equipped) when the EVIC is in the Compass/Temp/Audio screen.



Press the SCROLL button to scroll through Navigation (if equipped), System Status Messages, and Personal Settings (Customer-Programmable Features).



Press and release the COMPASS/TEMPERATURE button to display one of eight compass readings and the outside temperature.

Electronic Vehicle Information Center (EVIC)

Displays

When the appropriate conditions exist, the EVIC displays the following messages.

- Turn signal on (with a continuous warning chime)
- Left front turn signal light out (with a single chime)
- Left rear turn signal light out (with a single chime)
- Right front turn signal light out (with a single chime)
- Right rear turn signal light out (with a single chime)
- RKE Battery Low (with a single chime)
- Personal settings not available – vehicle not in PARK
- Left/right front door ajar (one or more, with a single chime if speed is above 1 mph/1 km/h)
- Left/right rear door ajar (one or more, with a single chime if speed is above 1 mph/1 km/h)
- Door(s) ajar (with a single chime if vehicle is in motion)
- Liftgate ajar (with a single chime)
- Left front low pressure (with a single chime). Refer to “Tire Pressure Monitoring System” in “Starting And Operating”.
- Left rear low pressure (with a single chime). Refer to “Tire Pressure Monitoring System” in “Starting And Operating”.
- Right front low pressure (with a single chime). Refer to “Tire Pressure Monitoring System” in “Starting And Operating”.

- Right rear low pressure (with a single chime). Refer to “Tire Pressure Monitoring System” in “Starting And Operating”.
- Check TPM System (with a single chime). Refer to “Tire Pressure Monitoring System” in “Starting And Operating”.
- Check Gascap (refer to “Adding Fuel” in “Starting And Operating”).
- Oil change required (with a single chime).
- ECO (Fuel Saver Indicator) — if equipped

Oil Change Required

Your vehicle is equipped with an engine oil change indicator system. The “Oil Change Required” message will flash in the EVIC display for approximately 10 seconds after a single chime has sounded to indicate the next scheduled oil change interval. The engine oil change indicator system is duty cycle based, which means the

engine oil change interval may fluctuate dependent upon your personal driving style. Unless reset, this message will continue to display each time you turn the ignition switch to the ON/RUN position. To turn off the message temporarily, press and release the MENU button. To reset the oil change indicator system (after performing the scheduled maintenance) refer to the following procedure.

1. Turn the ignition switch to the ON position. (Do not start the engine).
2. Fully depress the accelerator pedal slowly three times within 10 seconds.
3. Turn the ignition switch to the OFF/LOCK position.

NOTE: If the indicator message illuminates when you start the engine, the oil change indicator system did not reset. If necessary, repeat this procedure.

Trip Functions

Press and release the MENU button until one of the following trip functions displays in the EVIC:

- Average Fuel Economy
- Distance To Empty
- Elapsed Time
- Display Units of Measure in

Press the SCROLL button to cycle through all the trip computer functions.

The Trip Functions mode displays the following information:

- *Average Fuel Economy*

Shows the average fuel economy since the last reset. When the fuel economy is reset, the display will read "RESET" or show dashes for two seconds. Then, the history information will be erased, and the averaging will continue from the last fuel average reading before the reset.

- *Distance To Empty (DTE)*

Shows the estimated distance that can be traveled with the fuel remaining in the tank. This estimated distance is determined by a weighted average of the instantaneous and average fuel economy, according to the current fuel tank level. DTE cannot be reset through the FUNCTION SELECT button.

NOTE: Significant changes in driving style or vehicle loading will greatly affect the actual drivable distance of the vehicle, regardless of the DTE displayed value.

When the DTE value is less than 30 miles (48 km) estimated driving distance, the DTE display will change to a text display of LOW FUEL. This display will continue until the vehicle runs out of fuel. Adding a significant amount of fuel to the vehicle will turn off the LOW FUEL text and a new DTE value will display.

- *Elapsed Time*

Shows the total elapsed time of travel since the last reset when the ignition switch is in the ACC position. Elapsed time will increment when the ignition switch is in the ON or START position.

- *Display Units of Measure in:*

To make your selection, press and release the FUNCTION SELECT button until “ENGLISH” or “METRIC” appears.

To Reset The Display

Reset will only occur while a resettable function is being displayed. Press and release the FUNCTION SELECT button once to clear the resettable function being displayed. To reset all resettable functions, press and release the FUNCTION SELECT button a second time within three seconds of resetting the currently displayed function. (Reset ALL will display during this three-second window).

Compass Display / ECO (Fuel Saver Mode) — If Equipped



The compass readings indicate the direction the vehicle is facing. Press and release the compass button to display one of eight compass readings and the outside temperature.

COMPASS Button

NOTE: The system will display the last known outside temperature when starting the vehicle and may need to be driven several minutes before the updated temperature is displayed. Engine temperature can also affect the displayed temperature, therefore temperature readings are not updated when the vehicle is not moving.

ECO (Fuel Saver Mode) — If Equipped

The ECO message will display below the outside temperature in the EVIC display. This message will appear whenever you are driving in a fuel efficient manner.

This feature allows you to monitor when you are driving in a fuel efficient manner, and it can be used to modify driving habits in order to increase fuel economy.

Automatic Compass Calibration

This compass is self-calibrating, which eliminates the need to manually reset the compass. When the vehicle is new, the compass may appear erratic and the EVIC will display CAL until the compass is calibrated. You may also calibrate the compass by completing one or more 360-degree turns (in an area free from large metal or metallic objects) until the CAL indicator displayed in the EVIC turns off. The compass will now function normally.

NOTE: A good calibration requires a level surface and an environment free from large metallic objects such as buildings, bridges, underground cables, railroad tracks, etc.

Manual Compass Calibration

If the compass appears erratic and the CAL indicator does not appear in the EVIC display, you must put the compass into the calibration mode manually as follows:

1. Turn the ignition switch ON.
2. Press the MENU button until Personal Settings (Customer-Programmable Features) menu is reached.
3. Press the SCROLL button until “Calibrate Compass” is displayed in the EVIC.
4. Press and release the FUNCTION SELECT button to start the calibration. The CAL indicator will be displayed in the EVIC.
5. Complete one or more 360-degree turns (in an area free from large metal or metallic objects) until the CAL indicator turns off. The compass will now function normally.

Compass Variance

Compass Variance is the difference between Magnetic North and Geographic North. To compensate for the differences, the variance should be set for the zone where the vehicle is driven, per the zone map. Once properly set, the compass will automatically compensate for the differences and provide the most accurate compass heading.

NOTE: Magnetic materials should be kept away from the top of the right rear quarter window. This is where the compass sensor is located.

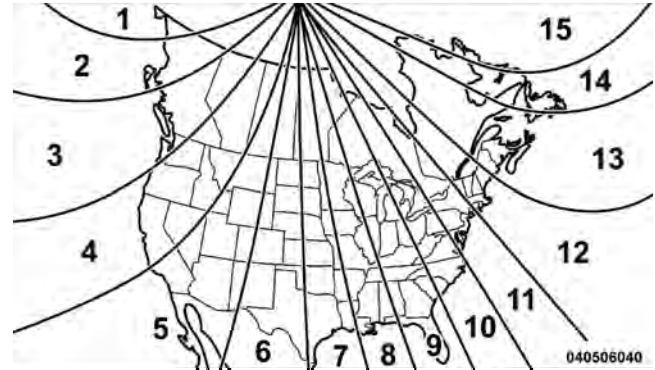

Compass Variance Map

1. Turn the ignition switch ON.
2. Press and hold the COMPASS button for approximately two seconds.

3. Press the SCROLL button until the “Compass Variance” message and the last variance zone number displays in the EVIC.
4. Press and release the FUNCTION SELECT button until the proper variance zone is selected according to the map.
5. Press and release the COMPASS button to exit.

Personal Settings (Customer-Programmable Features)

Personal Settings allows the driver to set and recall features when the transmission is in PARK.

Press and release the MENU button until Personal Settings displays in the EVIC.

Use the SCROLL button to display one of the following choices:

Language

When in this display you may select one of five languages for all display nomenclature, including the trip functions and the navigation system (if equipped). Press the FUNCTION SELECT button while in this display to select English, Espanol, or Francais. As you continue, the information will display in the selected language.

Lock Doors Automatically at 15 mph (24 km/h)

When ON is selected, all doors will lock automatically when the vehicle reaches a speed of 15 mph (24 km/h). To make your selection, press and release the FUNCTION SELECT button until ON or OFF appears.

Unlock Doors Automatically on Exit

When ON is selected, all doors will unlock when the vehicle is stopped and the transmission is in the PARK or NEUTRAL position and the driver's door is opened. To make your selection, press and release the FUNCTION SELECT button until ON or OFF appears.

Remote Key Unlock

When **Driver Door 1st Press** is selected, only the driver's door will unlock on the first press of the Remote Keyless Entry (RKE) transmitter UNLOCK button. When **Driver Door 1st Press** is selected, you must press the RKE transmitter UNLOCK button twice to unlock the passengers' doors. When **All Doors 1st Press** is selected, all of the doors will unlock on the first press of the RKE transmitter UNLOCK button. To make your selection, press and release the FUNCTION SELECT button until "Driver Door 1st Press" or "All Doors 1st Press" appears.

Sound Horn with Remote Key Lock

When ON is selected, a short horn sound will occur when the RKE transmitter LOCK button is pressed. This feature may be selected with or without the Flash Lights with Remote Key Lock feature. To make your selection, press and release the FUNCTION SELECT button until ON or OFF appears.

Flash Lights with Remote Key Lock

When ON is selected, the front and rear turn signals will flash when the doors are locked or unlocked with the RKE transmitter. This feature may be selected with or without the sound horn on lock feature selected. To make your selection, press and release the FUNCTION SELECT button until ON or OFF appears.

Delay Turning Headlights Off

When this feature is selected, the driver can choose to have the headlights remain on for 0, 30, 60, or 90 seconds when exiting the vehicle. To make your selection, press and release the FUNCTION SELECT button until "0," "30," "60," or "90" appears.

Turn Headlights On with Remote Key Unlock

When this feature is selected, the headlights will activate and remain on for up to 90 seconds when the doors are unlocked with the RKE transmitter. To make your selection, press and release the FUNCTION SELECT button until “OFF,” “30 sec.,” “60 sec.,” or “90 sec.” appears.

Delay Power Off to Accessories Until Exit

When this feature is selected, the power window switches, radio, Uconnect Phone™ (if equipped), DVD video system (if equipped), power sunroof (if equipped), and power outlets will remain active for up to 10 minutes after the ignition switch is turned off. Opening a vehicle door will cancel this feature. To make your selection, press and release the FUNCTION SELECT button until “Off,” “45 sec,” “5 min,” or “10 min” appears.

Display ECO — If Equipped

The “ECO” message is located in the Compass/Temperature display, this message can be turned on or off. To make your selection, press and release the FUNCTION SELECT button until “ON” or “OFF” appears.

Display Units of Measure in

The EVIC, odometer, and navigation system (if equipped) can be changed between English and Metric units of measure. To make your selection, press and release the FUNCTION SELECT button until ENGLISH or METRIC appears.

MEDIA CENTER 230 (REQ) — AM/FM STEREO RADIO AND 6-DISC CD/DVD CHANGER (MP3/WMA AUX JACK)

NOTE: The radio sales code is located on the lower right side of the radio faceplate.

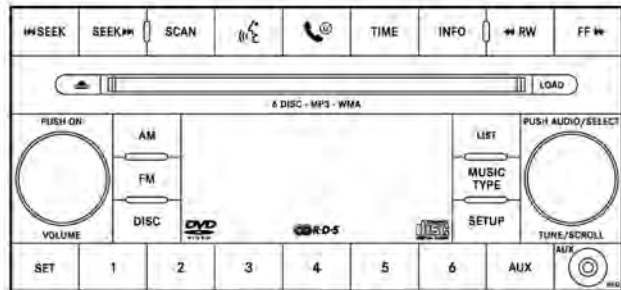

042005200

REQ Radio

Operating Instructions - Radio Mode

NOTE: The ignition switch must be in the ON or ACC position to operate the radio.

Power Switch/Volume Control (Rotary)

Push the ON/VOLUME control knob to turn on the radio. Press the ON/VOLUME control knob a second time to turn off the radio.

Electronic Volume Control

The electronic volume control turns continuously (360 degrees) in either direction without stopping. Turning the ON/VOLUME control knob to the right increases the volume and to the left decreases it.

When the audio system is turned ON, the sound will be set at the same volume level as last played.

SEEK Buttons

Press and release the SEEK buttons to search for the next listenable station in AM/FM mode. Press the right switch to seek up and the left switch to seek down. The radio will remain tuned to the new station until you make another selection. Holding either button will bypass stations without stopping until you release it.

SCAN Button

Pressing the SCAN button causes the tuner to search for the next listenable station in AM, FM or Satellite (if equipped) frequencies, pausing for five seconds at each listenable station before continuing to the next. To stop the search, press the SCAN button a second time.

Voice Command Button Uconnect™ Phone — If Equipped

Press this button to operate the Uconnect™ Phone feature (if equipped). Refer to “Uconnect™ Phone” in “Understanding The Features Of Your Vehicle”.

If your vehicle is not equipped with or this feature is not available on your vehicle, a “Not Equipped With Uconnect” message will display on the radio screen.

Phone Button Uconnect™ Phone — If Equipped

Press this button to operate the Uconnect™ Phone feature (if equipped). Refer to “Uconnect™ Phone” in “Understanding The Features Of Your Vehicle”.

If your vehicle is not equipped with or this feature is not available on your vehicle, a “Not Equipped With Uconnect” message will display on the radio screen.

TIME Button

Press the TIME button to alternate locations of the time and frequency display.

Clock Setting Procedure

1. Press and hold the TIME button until the hours blink.

2. Adjust the hours by turning the right side TUNE/SCROLL control knob.
3. After adjusting the hours, press the right side TUNE/SCROLL control knob to set the minutes. The minutes will begin to blink.
4. Adjust the minutes using the right side TUNE/SCROLL control knob. Press the TUNE/SCROLL control knob to save the time change.
5. To exit, press any button/knob or wait five seconds.

The clock can also be set by pressing the SETUP button and selecting the "SET HOME CLOCK" entry. Once in this display follow the above procedure, starting at step 2.

INFO Button

Press the INFO button for an RDS station (one with call letters displayed). The radio will return a Radio Text message broadcast from an FM station (FM mode only).

RW/FF

Pressing the RW (Rewind) or FF (Fast Forward) buttons causes the tuner to search for the next frequency in the direction of the arrows. This feature operates in AM, FM or Satellite (if equipped) frequencies.

TUNE Control

Turn the rotary TUNE/SCROLL control knob clockwise to increase or counterclockwise to decrease the frequency.

Setting the Tone, Balance, and Fade

Push the rotary TUNE/SCROLL control knob and BASS will display. Turn the TUNE/SCROLL control knob to the right or left to increase or decrease the bass tones.

Push the rotary TUNE/SCROLL control knob a second time and MID will display. Turn the TUNE/SCROLL control knob to the right or left to increase or decrease the mid-range tones.

Push the rotary TUNE/SCROLL control knob a third time and TREBLE will display. Turn the TUNE/SCROLL control knob to the right or left to increase or decrease the treble tones.

Push the rotary TUNE/SCROLL control knob a fourth time and BALANCE will display. Turn the TUNE/SCROLL control knob to the right or left to adjust the sound level from the right or left side speakers.

Push the rotary TUNE/SCROLL control knob a fifth time and FADE will display. Turn the TUNE/SCROLL control knob to the left or right to adjust the sound level between the front and rear speakers.

Push the rotary TUNE/SCROLL control knob again to exit setting tone, balance, and fade.

MUSIC TYPE Button

Pressing this button once will turn on the Music Type mode for five seconds. Pressing the MUSIC TYPE button

or turning the TUNE/SCROLL control knob within five seconds will allow the program format type to be selected. Many radio stations do not currently broadcast Music Type information.

Toggle the MUSIC TYPE button to select the following format types:

Program Type	16-Digit Character Display
No program type or undefined	None
Adult Hits	Adlt Hit
Classical	Classicl
Classic Rock	Cls Rock
College	College
Country	Country
Foreign Language	Language
Information	Inform

Program Type	16-Digit Character Display
Jazz	Jazz
News	News
Nostalgia	Nostalgia
Oldies	Oldies
Personality	Persnlty
Public	Public
Rhythm and Blues	R & B
Religious Music	Rel Musc
Religious Talk	Rel Talk
Rock	Rock
Soft	Soft
Soft Rock	Soft Rck
Soft Rhythm and Blues	Soft R & B
Sports	Sports
Talk	Talk

Program Type	16-Digit Character Display
Top 40	Top 40
Weather	Weather

By pressing the SEEK button when the Music Type icon is displayed, the radio will be tuned to the next frequency station with the same selected Music Type name. The Music Type function only operates when in the FM mode.

If a preset button is activated while in the Music Type (Program Type) mode, the Music Type mode will be exited and the radio will tune to the preset station.

SETUP Button

Pressing the SETUP button allows you to select between the following items:

NOTE: Turn the TUNE/SCROLL control knob to scroll through the entries. Push the AUDIO/SELECT button to select an entry and make changes.

- **DVD Enter** - When the disc is in DVD Menu mode, selecting DVD Enter will allow you to play the current highlighted selection. Use the remote control to scroll up and down the menu (if equipped).



- **DISC Play/Pause** - You can toggle between playing the DVD and pausing the DVD by pushing the SELECT button (if equipped).
- **DVD Play Options** - Selecting the DVD Play Options will display the following:
 - **Subtitle** – Repeatedly pressing SELECT will switch subtitles to different subtitle languages that are available on the disc (if equipped).

- **Audio Stream** – Repeatedly pressing SELECT will switch to different audio languages (if supported on the disc) (if equipped).
- **Angle** – Repeatedly pressing SELECT will change the viewing angle if supported by the DVD disc (if equipped).

NOTE:

- The available selections for each of the above entries varies depending upon the disc.
- These selections can only be made while playing a DVD.
- **VES™ Power** - Allows you to turn VES™ ON and OFF (if equipped).
- **VES™ Lock** - Locks out rear VES™ remote controls (if equipped).

- **VES™ CH1/CH2** - Allows the user to change the mode of either the IR1 or IR2 wireless headphones by pressing the AUDIO/SELECT button (if equipped).
- **Set Home Clock** - Pressing the SELECT button allows you to set the clock. Turn the TUNE/SCROLL control knob to adjust the hours and then press and turn the TUNE/SCROLL control knob to adjust the minutes. Press the TUNE/SCROLL control knob again to save changes.
- **Player Defaults** - Selecting this item will allow the user to scroll through the following items and set defaults according to customer preference.

Menu Language — If Equipped

Selecting this item will allow the user to choose the default startup DVD menu language (effective only if language supported by disc). If you want to select a language not listed, then scroll down and select "other."

Enter the four-digit country code using the TUNE/SCROLL control knob to scroll up and down to select the number and then push to select.

Audio Language — If Equipped

Selecting this item allows you to choose a default audio language (effective only if the language is supported by the disc). You can select a language not listed by scrolling down and selecting "other." Enter the country code using the TUNE/SCROLL control knob to scroll up and down to select the number and then push to select.

Subtitle Language — If Equipped

Selecting this item allows you to choose a default subtitle language (effective only if the language is supported by the disc). You can select a language not listed by scrolling down and selecting "other." Enter the country code using the TUNE/SCROLL control knob to scroll up and down to select the number and then push to select.

Subtitles — If Equipped

Selecting this item allows you to choose between subtitle Off or On.

Audio DRC — If Equipped

Selecting this item allows you to limit maximum audio dynamic range. The default is set to "High," and under this setting, dialogues will play at 11 db higher than if the setting is "Normal."

Aspect Ratio — If Equipped

Selecting this item allows you to choose between wide screen, pan scan, and letter box.

AutoPlay — If Equipped

When this is set to On and a DVD video is inserted, it will bypass the DVD menu screen and automatically play the movie. In some rare cases, the DVD player may not auto-play the main title. In such cases, use the MENU button on the remote control to select desired title to play.

NOTE: The user will have to set these defaults before loading a disc. If changes are made to these settings after a disc is loaded, changes will not be effective. Also, the defaults are effective only if the disc supports the customer-preferred settings.

AM and FM Buttons

Press the buttons to select AM or FM mode.

SET Button — To Set the Pushbutton Memory

When you are receiving a station that you wish to commit to pushbutton memory, press the SET button. The symbol SET 1 will now show in the display window. Select the button (1-6) you wish to lock onto this station and press and release that button. If a button is not selected within five seconds after pressing the SET button, the station will continue to play but will not be stored into pushbutton memory.

You may add a second station to each pushbutton by repeating the above procedure with this exception: Press the SET button twice and SET 2 will show in the display window. Each button can be set for SET 1 and SET 2 in both AM and FM. This allows a total of 12 AM, 12 FM, and 12 Satellite (if equipped) stations to be stored into pushbutton memory. The stations stored in SET 2 memory can be selected by pressing the pushbutton twice.

Every time a preset button is used, a corresponding button number will display.

Buttons 1 - 6

These buttons tune the radio to the stations that you commit to pushbutton memory {12 AM, 12 FM, and 12 Satellite (if equipped) stations}.

DISC Button

Pressing the DISC button will allow you to switch from AM/FM modes to Disc modes.

Operation Instructions - (DISC MODE for CD and MP3/WMA Audio Play, DVD-VIDEO)

The radio DVD player and many DVD discs are coded by geographic region. These region codes must match in order for the disc to play. If the region code for the DVD disc does not match the region code for the radio DVD player, it will not play the disc. Customers may take their vehicle to an authorized dealer to change the region code of the player a maximum of five times.

CAUTION!

The radio may shut down during extremely hot conditions. When this occurs, the radio will indicate "Disc Hot" and shut off until a safe temperature is reached. This shutdown is necessary to protect the optics of the DVD player and other radio internal components.

NOTE: The ignition switch must be in the ON or ACC position to operate the radio.

LOAD Button — Loading Compact Disc(s)

Press the LOAD button and the pushbutton with the corresponding number (1-6) where the CD is being loaded. The radio will display PLEASE WAIT and prompt when to INSERT DISC. After the radio displays "INSERT DISC," insert the CD into the player.

Radio display will show "LOADING DISC" when the disc is loading and "READING DISC" when the radio is reading the disc.

CAUTION!

This CD player will accept 4-3/4 in (12 cm) discs only. The use of other sized discs may damage the CD player mechanism.

Eject Button — Ejecting Compact Disc(s)



Press the EJECT button and the pushbutton with the corresponding number (1-6) where the CD was loaded and the disc will unload and move to the entrance for easy removal. Radio display will show "EJECTING DISC" when the disc is being ejected and prompt the user to remove the disc.

Press and hold the EJECT button for five seconds and all CDs will be ejected from the radio.

The disc can be ejected with the radio and ignition OFF.

SEEK Button (CD MODE)

Press the right SEEK button for the next selection on the CD. Press the left SEEK button to return to the beginning of the current selection, or return to the beginning of the previous selection if the CD is within the first second of the current selection. Pressing and holding the SEEK button will allow you to scroll through the tracks faster in CD and MP3/MWA modes.

SCAN Button (CD MODE)

Press the SCAN button to scan through each track on the CD currently playing.

TIME Button (CD MODE)

Press this button to change the display from a large CD playing time display to a small CD playing time display.

RW/FF (CD MODE)

Press and hold FF (Fast Forward) and the CD player will begin to fast forward until FF is released, or RW or another CD button is pressed. The RW (Rewind) button works in a similar manner.

AM or FM Button (CD MODE)

Switches the radio into the AM or FM radio mode.

Notes On Playing MP3/WMA Files

The radio can play MP3/WMA files; however, acceptable MP3/WMA file recording media and formats are limited. When writing MP3/WMA files, pay attention to the following restrictions.

Supported Media (Disc Types)

The MP3/WMA file recording media supported by the radio are CDDA, CD-R, CD-RW, MP3, WMA, DVD Video, DVD-R, DVD-RW, DVD+R, DVD+RW, and CDDA+MP3.

Supported Medium Formats (File Systems)

The medium formats supported by the radio are ISO 9660 Level 1 and Level 2 and includes the Joliet extension. When reading discs recorded using formats other than ISO 9660 Level 1 and Level 2, the radio may fail to read files properly and may be unable to play the file normally. UDF and Apple HFS formats are not supported.

The radio uses the following limits for file systems:

- Maximum number of directory levels: 8
- Maximum number of files: 255
- Maximum number of folders: 100
- Maximum number of characters in file/folder names:
 - Level 1: 12 (including a separator "." and a three-character extension)
 - Level 2: 31 (including a separator "." and a three-character extension)

Multisession disc formats are supported by the radio. Multisession discs may contain combinations of normal CD audio tracks and computer files (including MP3/WMA files). Discs created with an option such as "keep disc open after writing" are most likely multisession discs. The use of multisession for CD audio or MP3/WMA playback may result in longer disc loading times.

If a disc contains multi-formats, such as CD audio and MP3/WMA tracks, the radio will only play the MP3/WMA tracks on that disc.

Supported MP3/WMA File Formats

The radio will recognize only files with the *.MP3/WMA extension as MP3/WMA files. Non-MP3/WMA files named with the *.MP3/WMA extension may cause playback problems. The radio is designed to recognize the file as an invalid MP3/WMA and will not play the file.

When using the MP3/WMA encoder to compress audio data to an MP3/WMA file, the bit rate and sampling frequencies in the following table are supported. In addition, variable bit rates (VBR) are also supported. The majority of MP3/WMA files use a 44.1 kHz sampling rate and a 192, 160, 128, 96 or VBR bit rates.

MPEG Specification	Sampling Frequency (kHz)	Bit Rate (kbps)
MPEG-1 Audio Layer 3	48, 44.1, 32	320, 256, 224, 192, 160, 128, 112, 96, 80, 64, 56, 48
MPEG-2 Audio Layer 3	24, 22.05, 16	160, 128, 144, 112, 96, 80, 64, 56, 48

WMA Specification	Sampling Frequency (kHz)	Bit Rate (kbps)
WMA	44.1 and 48	48, 64, 96, 128, 160, 192 VBR

ID3 Tag information for artist, song title, and album title are supported for ID3 version 1 tags. ID3 version 2 is not supported by the radios.

Playlist files are not supported. MP3 Pro files are not supported.

Playback of MP3/WMA Files

When a medium containing MP3/WMA data is loaded, the radio checks all files on the medium. If the medium contains a lot of folders or files, the radio will take more time to start playing the MP3/WMA files.

Loading times for playback of MP3/WMA files may be affected by the following:

- Media - CD-RW media may take longer to load than CD-R media
- Medium formats - Multisession discs may take longer to load than non-multisession discs
- Number of files and folders - Loading times will increase with more files and folders

To increase the speed of disc loading, it is recommended to use CD-R media and single-session discs. To create a single-session disc, enable the “Disc at Once” option before writing to the disc.

LIST Button (DISC Mode for MP3/WMA Play)

Pressing the LIST button will bring up a list of all folders on the disc. Scrolling up or down the list is done by turning the TUNE/SCROLL control knob. Selecting a folder by pressing the TUNE/SCROLL control knob will begin playing the files contained in that folder (or the next folder in sequence if the selection does not contain playable files).

The folder list will time out after five seconds.

INFO Button (DISC Mode for MP3/WMA Play)

Pressing the INFO button repeatedly will scroll through the following TAG information: Song Title, Artist, File Name, and Folder Name (if available).

Press the INFO button once more to return to “elapsed time” priority mode.

Press and hold the INFO button for three seconds or more and radio will display song titles for each file.

Press and hold the INFO button again for three seconds to return to “elapsed time” display.

Operation Instructions - Auxiliary Mode

The auxiliary (AUX) jack is an audio input jack which allows the user to plug in a portable device such as an MP3/WMA player, cassette player, or microphone and utilize the vehicle’s audio system to amplify the source and play through the vehicle speakers.

Pressing the AUX button will change the mode to auxiliary device if the AUX jack is connected.

NOTE: The AUX device must be turned on and the device’s volume set to the proper level. If the AUX audio

is not loud enough, turn the device's volume up. If the AUX audio sounds distorted, turn the device's volume down.

SEEK Button (Auxiliary Mode)

No function.

SCAN Button (Auxiliary Mode)

No function.

EJECT Button (Auxiliary Mode)

No function.

**TIME Button (Auxiliary Mode)**

Press the TIME button to change the display from elapsed playing time to time of day. The time of day will display for five seconds.

RW/FF (Auxiliary Mode)

No function.

SET Button (Auxiliary Mode)

No function.

Operating Instructions — Voice Command System (If Equipped)

For the radio, refer to "Voice Command" in "Understanding The Features Of Your Vehicle".

For Uconnect™ "Voice Command," refer to "Uconnect™ Phone" in "Understanding The Features Of Your Vehicle".

Operating Instructions - Uconnect™ Phone (If Equipped)

Refer to "Uconnect™ Phone" in "Understanding The Features Of Your Vehicle".

Operating Instructions - Uconnect™ Multimedia (Satellite Radio) (If Equipped)

Refer to “Uconnect™ Multimedia (Satellite Radio)”.

Operating Instructions - Video Entertainment System (VES)™ (If Equipped)

Refer to separate “Video Entertainment System (VES)™ Guide.”

Dolby®

Manufactured under license from Dolby® Laboratories. “Dolby®” and the double-D symbol are trademarks of Dolby® Laboratories.

Macrovision

This product incorporates copyright protection technology that is protected by U.S. patents and other intellectual property rights. Use of this copyright protection technology must be authorized by Macrovision, and is

intended for home and other limited viewing uses only, unless otherwise authorized by Macrovision. Reverse engineering or disassembly is prohibited.

DTS™

“DTS™” and “DTS™ 2.0” are trademarks of Digital Theater Systems, Inc.

MEDIA CENTER 730N/430 (RER/REN/RBZ) — AM/FM STEREO RADIO AND CD/DVD/HDD/NAV — IF EQUIPPED

NOTE: The sales code is located on the lower right side of the unit’s faceplate.

The REN, RER and RBZ radios contain a CD/DVD player, USB port, and a 30-gigabyte hard drive (HDD). Sirius Satellite Radio is optional. The 6.5 in (16.5 cm) touch screen allows for easy menu selection.

The RER radio also contains a Global Positioning System (GPS)-based Navigation system.

Refer to your Uconnect™ Multimedia REN, RER or RBZ user's manual for detailed operating instructions.

Operating Instructions — Voice Command System — If Equipped

For the radio, refer to "Voice Command" in "Understanding The Features Of Your Vehicle".

Operating Instructions — Uconnect™ Phone — If Equipped

Refer to "Uconnect™ Phone" in "Understanding The Features Of Your Vehicle".

Clock Setting Procedure — RBZ Radio

To Manually Set the Clock

1. Turn on the radio.
2. Touch the screen where the time is displayed, the clock setting menu will appear on the screen.

3. To move the hour forward, touch the screen where the word "Hour" with the arrow pointing upward is displayed. To move the hour backward, touch the screen where the word "Hour" with the arrow pointing downward is displayed.

4. To move the minute forward, touch the screen where the word "Min" with the arrow pointing upward is displayed. To move the minute backward, touch the screen where the word "Min" with the arrow pointing downward is displayed.

5. To save the new time setting, touch the screen where the word "Save" is displayed.

Changing Daylight Savings Time

When selected, this feature will display the time of day in daylight savings time. Proceed as follows to change the current setting:

1. Turn on the radio.

2. Touch the screen where the time is displayed. The clock setting menu will appear on the screen.
3. When this feature is on, a check mark will appear in the box next to the words “Daylight Savings.” Touch the screen where the words “Daylight Savings” are displayed to change the current setting.

Show Time if Radio is Off

When selected, this feature will display the time of day on the touch screen when the radio is turned off. Proceed as follows to change the current setting:

1. Turn on the radio.
2. Touch the screen where the time is displayed. The clock setting menu will appear on the screen.
3. When this feature is on, a check mark will appear in the box next to the words “Show Time if Radio is Off.” Touch the screen where the words “Show Time if Radio is Off” are displayed to change the current setting.

Changing the Time Zone

1. Turn on the radio.
2. Touch the screen where the time is displayed. The clock setting menu will appear on the screen.
3. Touch the screen where the words “Set Time Zone” are displayed. The time zone selection menu will appear on the screen.
4. Select a time zone by touching the screen where your selection appears. If you do not see a time zone that you want to select, touch the screen where the word “Page” is displayed to view additional time zones in the menu.
5. Touch the screen where the word “Save” is displayed.

Clock Setting Procedure — RER/REN Radio

Uconnect® gps — RER Only

The GPS receiver used in this system is synchronized to the time data being transmitted by the GPS satellite. The

satellite clock is Greenwich Mean Time (GMT). This is the worldwide standard for time. This makes the system's clock very accurate once the appropriate time zone and daylight savings information is set.

To Manually Set the Clock — RER/REN

1. Turn on the radio.
2. Touch the screen where the time is displayed.
3. Touch the screen where "User Clock" is displayed, the clock setting menu will appear on the screen.
4. To move the hour forward, touch the screen where the word "Hour" with the arrow pointing upward is displayed. To move the hour backward, touch the screen where the word "Hour" with the arrow pointing downward is displayed.
5. To move the minute forward, touch the screen where the word "Min" with the arrow pointing upward is

displayed. To move the minute backward, touch the screen where the word "Min" with the arrow pointing downward is displayed.

6. To save the new time setting, touch the screen where the word "Save" is displayed.

Changing Daylight Savings Time

When selected, this feature will display the time of day in daylight savings time. Proceed as follows to change the current setting:

1. Turn on the radio.
2. Touch the screen where "User Clock" is displayed, the clock setting menu will appear on the screen.
3. When this feature is on, a check mark will appear in the box next to the words "Daylight Savings." Touch the screen where the words "Daylight Savings" are displayed to change the current setting.

Show Time if Radio is Off

When selected, this feature will display the time of day on the touch screen when the radio is turned off. Proceed as follows to change the current setting:

1. Turn on the radio.
2. Touch the screen where the time is displayed.
3. Touch the screen where “User Clock” is displayed, the clock setting menu will appear on the screen.
4. When this feature is on, a check mark will appear in the box next to the words “Show Time if Radio is Off.” Touch the screen where the words “Show Time if Radio is Off” are displayed to change the current setting.

Changing the Time Zone

1. Turn on the radio.
2. Touch the screen where the time is displayed.
3. Touch the screen where “User Clock” is displayed, the clock setting menu will appear on the screen.
4. Touch the screen where the words “Set Time Zone” are displayed. The time zone selection menu will appear on the screen.
5. Select a time zone by touching the screen where your selection appears. If you do not see a time zone that you want to select, touch the screen where the word “Page” is displayed to view additional time zones in the menu.
6. Touch the screen where the word “Save” is displayed.

MEDIA CENTER 130 (RES) — AM/FM STEREO RADIO WITH CD PLAYER (MP3 AUX JACK)

NOTE: The radio sales code is located on the lower right side of the radio faceplate.

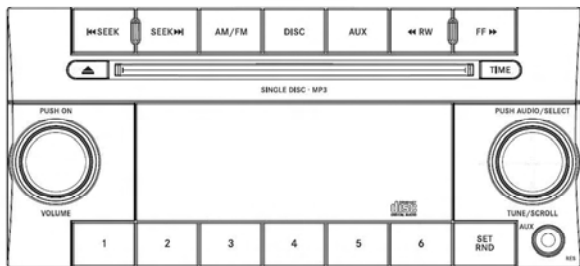

042305232

RES Radio

Operating Instructions — Radio Mode

NOTE: The ignition switch must be in the ON or ACC position to operate the radio.

Power Switch/Volume Control (Rotary)

Push the ON/VOLUME control knob to turn on the radio. Push the ON/VOLUME control knob a second time to turn off the radio.

Electronic Volume Control

The electronic volume control turns continuously (360 degrees) in either direction, without stopping. Turning the ON/VOLUME control knob to the right increases the volume, and to the left decreases it.

When the audio system is turned on, the sound will be set at the same volume level as last played.

SEEK Buttons

Press and release the SEEK buttons to search for the next listenable station in AM/FM mode. Press the right switch to seek up and the left switch to seek down. The radio will remain tuned to the new station until you make another selection. Holding either button will bypass stations without stopping, until you release it.

TIME Button

Press the TIME button to alternate display of the time and radio frequency.

Clock Setting Procedure

1. Press and hold the TIME button until the hours blink.
2. Adjust the hours by turning the right side TUNE/SCROLL control knob.
3. After adjusting the hours, press the right side TUNE/SCROLL control knob to set the minutes. The minutes will begin to blink.

4. Adjust the minutes using the right side TUNE/SCROLL control knob. Press the TUNE/SCROLL control knob to save time change.

5. To exit, press any button/knob, or wait five seconds.

RW/FF

Pressing the RW (Rewind) or FF (Fast Forward) buttons causes the tuner to search for the next frequency in the direction of the arrows. This feature operates in either AM or FM frequencies.

TUNE Control

Turn the rotary TUNE/SCROLL control knob clockwise to increase or counterclockwise to decrease the frequency.

Setting the Tone, Balance, and Fade

Push the rotary TUNE/SCROLL control knob and BASS will display. Turn the TUNE/SCROLL control knob to the right or left to increase or decrease the bass tones.

Push the rotary TUNE/SCROLL control knob a second time and MID will display. Turn the TUNE/SCROLL control knob to the right or left to increase or decrease the mid-range tones.

Push the rotary TUNE/SCROLL control knob a third time and TREBLE will display. Turn the TUNE/SCROLL control knob to the right or left to increase or decrease the treble tones.

Push the rotary TUNE/SCROLL control knob a fourth time and BALANCE will display. Turn the TUNE/SCROLL control knob to the right or left to adjust the sound level from the right or left side speakers.

Push the rotary TUNE/SCROLL control knob a fifth time and FADE will display. Turn the TUNE/SCROLL control knob to the left or right to adjust the sound level between the front and rear speakers.

Push the rotary TUNE/SCROLL control knob again to exit setting tone, balance, and fade.

AM/FM Button

Press the buttons to select either AM or FM mode.

SET/RND Button — To Set the Pushbutton Memory

When you are receiving a station that you wish to commit to pushbutton memory, press the SET/RND button. The symbol SET 1 will now show in the display window. Select the button (1 to 6) you wish to lock onto this station and press and release that button. If a button is not selected within five seconds after pressing the SET/RND button, the station will continue to play but will not be stored into pushbutton memory.

You may add a second station to each pushbutton by repeating the above procedure with this exception: Press the SET/RND button twice and SET 2 will show in the display window. Each button can be set for SET 1 and

SET 2 in both AM and FM. This allows a total of 12 AM and 12 FM stations to be stored into pushbutton memory. The stations stored in SET 2 memory can be selected by pressing the pushbutton twice.

Every time a preset button is used, a corresponding button number will display.

Buttons 1 - 6

These buttons tune the radio to the stations that you commit to pushbutton memory (12 AM and 12 FM stations).

DISC Button

Pressing the DISC button will allow you to switch from AM/FM modes to Disc modes.

Operation Instructions — CD MODE For CD And MP3 Audio Play

NOTE:

- The ignition switch must be in the ON or ACC position to operate the radio.
- This radio is capable of playing compact discs (CD), recordable compact discs (CD-R), rewritable compact discs (CD-RW), compact discs with MP3 tracks and multisession compact discs with CD and MP3 tracks.

Inserting Compact Disc(s)

Gently insert one CD into the CD player with the CD label facing up. The CD will automatically be pulled into the CD player and the CD icon will illuminate on the radio display. If a CD does not go into the slot more than 1.0 in (2.5 cm), a disc may already be loaded and must be ejected before a new disc can be loaded.

If you insert a disc with the ignition ON and the radio ON, the unit will switch from radio to CD mode and begin to play when you insert the disc. The display will show the track number, and index time in minutes and seconds. Play will begin at the start of track 1.

CAUTION!

- **This CD player will accept 4-3/4 in (12 cm) discs only. The use of other sized discs may damage the CD player mechanism.**
- **Do not use adhesive labels. These labels can peel away and jam the player mechanism.**
- **RES is a single CD player. Do not attempt to insert a second CD if one is already loaded.**
- **Dual-media disc types (one side is a DVD, the other side is a CD) should not be used, and they can cause damage to the player.**

EJECT Button - Ejecting a CD

Press the EJECT button to eject the CD.



If you have ejected a disc and have not removed it within 10 seconds, it will be reloaded. If the CD is not removed, the radio will reinsert the CD but will not play it.

A disc can be ejected with the radio and ignition OFF.

NOTE: Ejecting with the ignition OFF is not allowed on convertible or soft-top models (if equipped).

SEEK Button

Press the right SEEK button for the next selection on the CD. Press the left SEEK button to return to the beginning of the current selection, or return to the beginning of the previous selection if the CD is within the first second of the current selection. Pressing and holding the SEEK button will allow faster scrolling through the tracks in CD and MP3 modes.

TIME Button

Press this button to change the display from a large CD playing time display to a small CD playing time display.

RW/FF

Press and hold the FF (Fast Forward) button and the CD player will begin to fast forward until FF is released, or RW or another CD button is pressed. The RW (Reverse) button works in a similar manner.

AM/FM Button

Press the button to select either AM or FM mode.

SET/RND Button (Random Play Button)

Press this button while the CD is playing to activate Random Play. This feature plays the selections on the compact disc in random order to provide an interesting change of pace.

Press the right SEEK button to move to the next randomly selected track.

Press the RND button a second time to stop Random Play.

Notes on Playing MP3 Files

The radio can play MP3 files; however, acceptable MP3 file recording media and formats are limited. When writing MP3 files, pay attention to the following restrictions.

Supported Media (Disc Types)

The MP3 file recording media supported by the radio are CDDA, CD-R, CD-RW, MP3, and CDDA+MP3.

Supported Medium Formats (File Systems)

The medium formats supported by the radio are ISO 9660 Level 1 and Level 2 and includes the Joliet extension. When reading discs recorded using formats other than ISO 9660 Level 1 and Level 2, the radio may fail to read files properly and may be unable to play the file normally. UDF and Apple HFS formats are not supported.

The radio uses the following limits for file systems:

- Maximum number of folder levels: 8
- Maximum number of files: 255
- Maximum number of folders. (The radio display of file names and folder names is limited. For large numbers of files and/or folders, the radio may be unable to display the file name and folder name, and will assign a number instead. With a maximum number of files, exceeding 20 folders will result in this display. With 200 files, exceeding 50 folders will result in this display.)
- Maximum number of characters in file/folder names:
 - Level 1: 12 (including a separator "." and a three-character extension)
 - Level 2: 31 (including a separator "." and a three-character extension)

Multisession disc formats are supported by the radio. Multisession discs may contain combinations of normal CD audio tracks and computer files (including MP3 files). Discs created with an option such as "keep disc open after writing" are most likely multisession discs. The use of multisession for CD audio or MP3 playback may result in longer disc loading times.

Supported MP3 File Formats

The radio will recognize only files with the *.MP3 extension as MP3 files. Non-MP3 files named with the *.MP3 extension may cause playback problems. The radio is designed to recognize the file as an invalid MP3 and will not play the file.

When using the MP3 encoder to compress audio data to an MP3 file, the bit rate and sampling frequencies in the following table are supported. In addition, variable bit

rates (VBR) are also supported. The majority of MP3 files use a 44.1 kHz sampling rate and a 192, 160, 128, 96 or VBR bit rate.

MPEG Specification	Sampling Frequency (kHz)	Bit Rate (kbps)
MPEG-1 Audio Layer 3	48, 44.1, 32	320, 256, 224, 192, 160, 128, 112, 96, 80, 64, 56, 48, 40, 32
MPEG-2 Audio Layer 3	24, 22.05, 16	160, 128, 144, 112, 96, 80, 64, 56, 48, 40, 32, 24, 16, 8

ID3 Tag information for artist, song title, and album title are supported for version 1 ID3 tags. ID3 version 2 is not supported by the radios.

Playlist files are not supported. MP3 Pro files are not supported.

Playback of MP3 Files

When a medium containing MP3 data is loaded, the radio checks all files on the medium. If the medium contains a lot of folders or files, the radio will take more time to start playing the MP3 files.

Loading times for playback of MP3 files may be affected by the following:

- Media - CD-RW media may take longer to load than CD-R media
- Medium formats - Multisession discs may take longer to load than non-multisession discs
- Number of files and folders - Loading times will increase with more files and folders

To increase the speed of disc loading, it is recommended to use CD-R media and single-session discs. To create a single-session disc, enable the “Disc at Once” option before writing to the disc.

Operation Instructions - Auxiliary Mode

The auxiliary (AUX) jack is an audio input jack, which allows the user to plug in a portable device, such as an MP3 player, or cassette player, and utilize the vehicle's audio system to amplify the source and play through the vehicle speakers.

Pressing the DISC/AUX button will change the mode to auxiliary device if the AUX jack is connected.

NOTE: The AUX device must be turned on and the device's volume set to proper level. If the AUX audio is not loud enough, turn the device's volume up. If the AUX audio sounds distorted, turn the device's volume down.

TIME Button (Auxiliary Mode)

Press this button to change the display to time of day. The time of day will display for five seconds (when ignition is OFF).

MEDIA CENTER 130 (RES/RSC) — AM/FM STEREO RADIO WITH CD PLAYER (MP3 AUX JACK) AND SIRIUS RADIO

NOTE: The radio sales code is located on the lower right side of the radio faceplate.

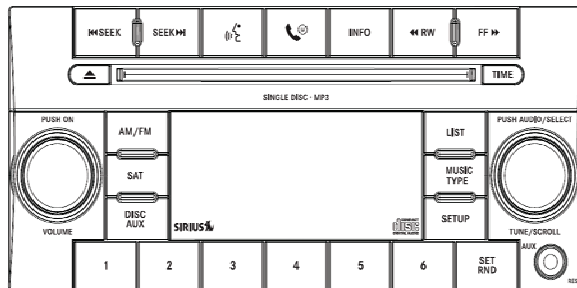

042305233

RES/RSC Radio

Operating Instructions — Radio Mode

NOTE: The ignition switch must be in the ON or ACC position to operate the radio.

Power Switch/Volume Control (Rotary)

Push the ON/VOLUME control knob to turn on the radio. Push the ON/VOLUME control knob a second time to turn off the radio.

Electronic Volume Control

The electronic volume control turns continuously (360 degrees) in either direction without stopping. Turning the ON/VOLUME control knob to the right increases the volume and to the left decreases it.

When the audio system is turned on, the sound will be set at the same volume level as last played.

SEEK Buttons

Press and release the SEEK buttons to search for the next listenable station in AM/FM mode. Press the right switch

to seek up and the left switch to seek down. The radio will remain tuned to the new station until you make another selection. Holding either button will bypass stations without stopping until you release it.

Voice Command System (Radio) — If Equipped

Refer to “Voice Command” in “Understanding The Features If Your Vehicle”.

Voice Command Button Uconnect™ Phone — If Equipped

Press this button to operate the Uconnect™ Phone feature (if equipped). Refer to “Uconnect™ Phone” in “Understanding The Features If Your Vehicle”.

If your vehicle is not equipped with or this feature is not available on your vehicle, a “Not Equipped With Uconnect” message will display on the radio screen.

Phone Button Uconnect™ Phone — If Equipped

Press this button to operate the Uconnect™ Phone feature (if equipped). Refer to “Uconnect™ Phone” in “Understanding The Features If Your Vehicle”.

If your vehicle is not equipped with or this feature is not available on your vehicle, a “Not Equipped With Uconnect” message will display on the radio screen.

TIME Button

Press the TIME button to alternate display of the time and radio frequency.

Clock Setting Procedure

1. Press and hold the TIME button until the hours blink.
2. Adjust the hours by turning the right side TUNE/SCROLL control knob.

3. After adjusting the hours, press the right side TUNE/SCROLL control knob to set the minutes. The minutes will begin to blink.

4. Adjust the minutes using the right side TUNE/SCROLL control knob. Press the TUNE/SCROLL control knob to save time change.

5. To exit, press any button/knob or wait five seconds.

The clock can also be set by pressing the SETUP button. For vehicles equipped with satellite radio, press the SETUP button, use the TUNE/SCROLL control to select SET CLOCK, and then follow the above procedure, starting at Step 2. For vehicles not equipped with satellite radio, press the SETUP button and then follow the above procedure, starting at Step 2.

INFO Button

Press the INFO button for an RDS station (one with call letters displayed). The radio will return a Radio Text message broadcast from an FM station (FM mode only).

RW/FF

Pressing the RW (Rewind) or FF (Fast Forward) buttons causes the tuner to search for the next frequency in the direction of the arrows. This feature operates in either AM or FM frequencies.

TUNE Control

Turn the rotary TUNE/SCROLL control knob clockwise to increase or counterclockwise to decrease the frequency.

Setting the Tone, Balance, and Fade

Push the rotary TUNE/SCROLL control knob and BASS will display. Turn the TUNE/SCROLL control knob to the right or left to increase or decrease the bass tones.

Push the rotary TUNE/SCROLL control knob a second time and MID will display. Turn the TUNE/SCROLL control knob to the right or left to increase or decrease the mid-range tones.

Push the rotary TUNE/SCROLL control knob a third time and TREBLE will display. Turn the TUNE/SCROLL control knob to the right or left to increase or decrease the treble tones.

Push the rotary TUNE/SCROLL control knob a fourth time and BALANCE will display. Turn the TUNE/SCROLL control knob to the right or left to adjust the sound level from the right or left side speakers.

Push the rotary TUNE/SCROLL control knob a fifth time and FADE will display. Turn the TUNE/SCROLL control knob to the left or right to adjust the sound level between the front and rear speakers.

Push the rotary TUNE/SCROLL control knob again to exit setting tone, balance, and fade.

MUSIC TYPE Button

Pressing this button once will turn on the Music Type mode for five seconds. Pressing the MUSIC TYPE button or turning the TUNE/SCROLL control knob within five seconds will allow the program format type to be selected. Many radio stations do not currently broadcast Music Type information.

Toggle the MUSIC TYPE button to select the following format types:

Program Type	16-Digit Character Display
No program type or undefined	None
Adult Hits	Adlt Hit
Classical	Classicl
Classic Rock	Cls Rock

Program Type	16-Digit Character Display
College	College
Country	Country
Foreign Language	Language
Information	Inform
Jazz	Jazz
News	News
Nostalgia	Nostalga
Oldies	Oldies
Personality	Persnlty
Public	Public
Rhythm and Blues	R & B
Religious Music	Rel Musc
Religious Talk	Rel Talk
Rock	Rock
Soft	Soft
Soft Rock	Soft Rck

Program Type	16-Digit Character Display
Soft Rhythm and Blues	Soft R&B
Sports	Sports
Talk	Talk
Top 40	Top 40
Weather	Weather

By pressing the SEEK button when the Music Type icon is displayed, the radio will be tuned to the next frequency station with the same selected Music Type name. The Music Type function only operates when in the FM mode.

If a preset button is activated while in the Music Type (Program Type) mode, the Music Type mode will be exited and the radio will tune to the preset station.

SETUP Button

Pressing the SETUP button allows you to select between the following items:

- **Set Clock** — Pressing the SELECT button will allow you to set the clock. Adjust the hours by turning the TUNE/SCROLL control knob. After adjusting the hours, press the TUNE/SCROLL control knob to set the minutes. The minutes will begin to blink. Adjust the minutes using the right side TUNE/SCROLL control knob. Press the TUNE/SCROLL control knob to save time change.

AM/FM Button

Press the button to select either AM or FM mode.

SET/RND Button — To Set the Pushbutton Memory

When you are receiving a station that you wish to commit to pushbutton memory, press the SET/RND button. The symbol SET 1 will now show in the display window. Select the button (1–6) you wish to lock onto this station and press and release that button. If a button is

not selected within five seconds after pressing the SET/RND button, the station will continue to play but will not be stored into pushbutton memory.

You may add a second station to each pushbutton by repeating the above procedure with this exception: Press the SET/RND button twice and SET 2 will show in the display window. Each button can be set for SET 1 and SET 2 in both AM and FM. This allows a total of 12 AM and 12 FM stations to be stored into pushbutton memory. The stations stored in SET 2 memory can be selected by pressing the pushbutton twice.

Every time a preset button is used, a corresponding button number will display.

Buttons 1 - 6

These buttons tune the radio to the stations that you commit to pushbutton memory (12 AM and 12 FM stations).

DISC/AUX Button

Pressing the DISC/AUX button will allow you to switch from AM/FM modes to DISC/AUX mode.

Operation Instructions — CD MODE for CD and MP3 Audio Play

NOTE:

- The ignition switch must be in the ON or ACC position to operate the radio.
- This radio is capable of playing compact discs (CD), recordable compact discs (CD-R), rewritable compact discs (CD-RW), compact discs with MP3 tracks and multisession compact discs with CD and MP3 tracks.

Inserting Compact Disc(s)

Gently insert one CD into the CD player with the CD label facing up. The CD will automatically be pulled into the CD player and the CD icon will illuminate on the

radio display. If a CD does not go into the slot more than 1.0 in (2.5 cm), a disc may already be loaded and must be ejected before a new disc can be loaded.

If you insert a disc with the ignition ON and the radio ON, the unit will switch from radio to CD mode and begin to play when you insert the disc. The display will show the track number, and index time in minutes and seconds. Play will begin at the start of track 1.

CAUTION!

- **This CD player will accept 4-3/4 in (12 cm) discs only. The use of other sized discs may damage the CD player mechanism.**
- **Do not use adhesive labels. These labels can peel away and jam the player mechanism.**
- **RES is a single CD player. Do not attempt to insert a second CD if one is already loaded.**

(Continued)

CAUTION! (Continued)

- **Dual-media disc types (one side is a DVD, the other side is a CD) should not be used, and they can cause damage to the player.**

EJECT Button - Ejecting a CD

Press the EJECT button to eject the CD.



If you have ejected a disc and have not removed it within 10 seconds, it will be reloaded. If the CD is not removed, the radio will reinsert the CD but will not play it.

A disc can be ejected with the radio and ignition OFF.

NOTE: Ejecting with the ignition OFF is not allowed on convertible or soft-top models (if equipped).

SEEK Button

Press the right SEEK button for the next selection on the CD. Press the left SEEK button to return to the beginning of the current selection, or return to the beginning of the previous selection if the CD is within the first second of the current selection. Pressing and holding the SEEK button will allow faster scrolling through the tracks in CD and MP3 modes.

TIME Button

Press this button to change the display from a large CD playing time display to a small CD playing time display.

RW/FF

Press and hold FF (Fast Forward) and the CD player will begin to fast forward until FF is released or RW or another CD button is pressed. The RW (Reverse) button works in a similar manner.

AM/FM Button

Press the button to select either AM or FM mode.

SET/RND Button (Random Play Button)

Press this button while the CD is playing to activate Random Play. This feature plays the selections on the compact disc in random order to provide an interesting change of pace.

Press the right SEEK button to move to the next randomly selected track.

Press the SET/RND button a second time to stop Random Play.

Notes On Playing MP3 Files

The radio can play MP3 files; however, acceptable MP3 file recording media and formats are limited. When writing MP3 files, pay attention to the following restrictions.

Supported Media (Disc Types)

The MP3 file recording media supported by the radio are CDDA, CD-R, CD-RW, MP3, and CDDA+MP3.

Supported Medium Formats (File Systems)

The medium formats supported by the radio are ISO 9660 Level 1 and Level 2 and includes the Joliet extension. When reading discs recorded using formats other than ISO 9660 Level 1 and Level 2, the radio may fail to read files properly and may be unable to play the file normally. UDF and Apple HFS formats are not supported.

The radio uses the following limits for file systems:

- Maximum number of folder levels: 8
- Maximum number of files: 255
- Maximum number of folders. (The radio display of file names and folder names is limited. For large numbers of files and/or folders, the radio may be unable to display the file name and folder name and will assign a number instead. With a maximum number of files,

exceeding 20 folders will result in this display. With 200 files, exceeding 50 folders will result in this display.)

- Maximum number of characters in file/folder names:
 - Level 1: 12 (including a separator "." and a three-character extension)
 - Level 2: 31 (including a separator "." and a three-character extension)

Multisession disc formats are supported by the radio. Multisession discs may contain combinations of normal CD audio tracks and computer files (including MP3 files). Discs created with an option such as "keep disc open after writing" are most likely multisession discs. The use of multisession for CD audio or MP3 playback may result in longer disc loading times.

Supported MP3 File Formats

The radio will recognize only files with the *.MP3 extension as MP3 files. Non-MP3 files named with the *.MP3 extension may cause playback problems. The radio is designed to recognize the file as an invalid MP3 and will not play the file.

When using the MP3 encoder to compress audio data to an MP3 file, the bit rate and sampling frequencies in the following table are supported. In addition, variable bit rates (VBR) are also supported. The majority of MP3 files use a 44.1 kHz sampling rate and a 192, 160, 128, 96 or VBR bit rates.

MPEG Specification	Sampling Frequency (kHz)	Bit Rate (kbps)
MPEG-1 Audio Layer 3	48, 44.1, 32	320, 256, 224, 192, 160, 128, 112, 96, 80, 64, 56, 48, 40, 32

MPEG Specification	Sampling Frequency (kHz)	Bit Rate (kbps)
MPEG-2 Audio Layer 3	24, 22.05, 16	160, 128, 144, 112, 96, 80, 64, 56, 48, 40, 32, 24, 16, 8

ID3 Tag information for artist, song title, and album title are supported for version 1 ID3 tags. ID3 version 2 is not supported by the radios.

Playlist files are not supported. MP3 Pro files are not supported.

Playback of MP3 Files

When a medium containing MP3 data is loaded, the radio checks all files on the medium. If the medium contains a lot of folders or files, the radio will take more time to start playing the MP3 files.

Loading times for playback of MP3 files may be affected by the following:

- Media - CD-RW media may take longer to load than CD-R media
- Medium formats - Multisession discs may take longer to load than non-multisession discs
- Number of files and folders - Loading times will increase with more files and folders

To increase the speed of disc loading, it is recommended to use CD-R media and single-session discs. To create a single-session disc, enable the "Disc at Once" option before writing to the disc.

LIST Button (CD Mode for MP3 Play)

Pressing the LIST button will bring up a list of all folders on the disc. Scrolling up or down the list is done by turning the TUNE/SCROLL control knob. Selecting a folder by pressing the TUNE/SCROLL control knob will

begin playing the files contained in that folder (or the next folder in sequence if the selection does not contain playable files).

The folder list will time out after five seconds.

INFO Button (CD Mode for MP3 Play)

Pressing the INFO button repeatedly will scroll through the following TAG information: Song Title, Artist, File Name, and Folder Name (if available).

Press the INFO button once more to return to "elapsed time" priority mode.

Press and hold the INFO button for three seconds or more and the radio will display song titles for each file.

Press and hold the INFO button again for three seconds to return to "elapsed time" display.

Operation Instructions - Auxiliary Mode

The auxiliary (AUX) jack is an audio input jack which allows the user to plug in a portable device such as an MP3 player or cassette player and utilize the vehicle's audio system to amplify the source and play through the vehicle speakers.

Pressing the AUX button will change the mode to auxiliary device if the AUX jack is connected.

NOTE: The AUX device must be turned on and the device's volume set to the proper level. If the AUX audio is not loud enough, turn the device's volume up. If the AUX audio sounds distorted, turn the device's volume down.

TIME Button (Auxiliary Mode)

Press this button to change the display to time of day. The time of day will display for five seconds (when the ignition is OFF).

Operating Instructions - Uconnect™ Phone (If Equipped)

Refer to "Uconnect™ Phone" in "Understanding The Features If Your Vehicle".

Operating Instructions - Uconnect™ Multimedia (Satellite Radio) (If Equipped)

Refer to "Uconnect™ Multimedia (Satellite Radio)".

Uconnect™ Multimedia (SATELLITE RADIO) — IF EQUIPPED (REN/REQ/RER/RES RADIOS ONLY)

Satellite radio uses direct satellite-to-receiver broadcasting technology to provide clear digital sound, coast to coast. The subscription service provider is Sirius Satellite Radio. This service offers over 130 channels of music, sports, news, entertainment, and programming for children, directly from its satellites and broadcasting studios.

NOTE: Sirius service is not available in Hawaii and has limited coverage in Alaska.

System Activation

Sirius Satellite Radio service is pre-activated, and you may begin listening immediately to the one year of audio service that is included with the factory-installed satellite radio system in your vehicle. Sirius will supply a welcome kit that contains general information, including how to setup your on-line listening account. For further information, call the toll-free number 888-539-7474, or visit the Sirius web site at www.sirius.com, or at www.siriuscanada.ca for Canadian residents.

Electronic Serial Number/Sirius Identification Number (ESN/SID)

Please have the following information available when calling:

1. The Electronic Serial Number/Sirius Identification Number (ESN/SID).
2. Your Vehicle Identification Number.

To access the ESN/SID, refer to the following steps:

ESN/SID Access With REQ/RES Radios

With the ignition switch in the ON/RUN or ACC position and the radio on, press the SETUP button and scroll using the TUNE/SCROLL control knob until Sirius ID is selected. Press the TUNE/SCROLL control knob and the Sirius ID number will display. The Sirius ID number display will time out in two minutes. Press any button on the radio to exit this screen.

ESN/SID Access With REN/RER Radios

While in SAT mode, press the MENU button on the radio faceplate.

Next, touch the SUBSCRIPTION tab on the touch screen. All the ESNs that apply to your vehicle will display.

Selecting Uconnect™ Multimedia (Satellite) Mode

Press the SAT button until "SAT" appears in the display. A CD may remain in the radio while in the Satellite radio mode.

Satellite Antenna

To ensure optimum reception, do not place items on the roof around the rooftop antenna location. Metal objects placed within the line of sight of the antenna will cause decreased performance. Larger luggage items such as bikes should be placed as far rearward as possible, within the loading design of the rack. Do not place items directly on or above the antenna.

Reception Quality

Satellite reception may be interrupted due to one of the following reasons:

- The vehicle is parked in an underground parking structure or under a physical obstacle.

- Dense tree coverage may interrupt reception in the form of short audio mutes.
- Driving under wide bridges or along tall buildings can cause intermittent reception.
- Placing objects over or too close to the antenna can cause signal blockage.

Operating Instructions - Uconnect™ Multimedia (Satellite) Mode

NOTE: The ignition switch must be in the ON or ACC position to operate the radio.

SEEK Buttons

Press and release the SEEK buttons to search for the next channel in Satellite mode. Press the right switch to seek up and the left switch to seek down. The radio will remain tuned to the new channel until you make another selection. Holding either button will bypass channels without stopping until you release it.

SCAN Button

Pressing the SCAN button causes the tuner to search for the next channel, pausing for eight seconds before continuing to the next. To stop the search, press the SCAN button a second time.

INFO Button

Pressing the INFO button will cycle the display information between Artist, Song Title, and Composer (if available). Also, pressing and holding the INFO button for an additional three seconds will make the radio display the Song Title all of the time (press and hold again to return to normal display).

RW/FF

Pressing the RW (Rewind) or FF (Fast Forward) buttons causes the tuner to search for the next channel in the direction of the arrows.

TUNE Control (Rotary)

Turn the rotary TUNE/SCROLL control knob clockwise to increase or counterclockwise to decrease the channel.

MUSIC TYPE Button

Pressing this button once will turn on the Music Type mode for five seconds. Pressing the MUSIC TYPE button or turning the TUNE/SCROLL control knob within five seconds will allow the program format type to be selected.

Toggle the MUSIC TYPE button again to select the music type.

By pressing the SEEK button when the Music Type function is active, the radio will be tuned to the next channel with the same selected Music Type name.

If a preset button is activated while in the Music Type (Program Type) mode, the Music Type mode will be exited and the radio will tune to the preset channel.

SETUP Button

Pressing the SETUP button allows you to select the following items:

- Display Sirius ID number — Press the AUDIO/SELECT button to display the Sirius ID number. This number is used to activate, deactivate, or change the Sirius subscription.

SET Button – To Set the Pushbutton Memory

When you are receiving a channel that you wish to commit to pushbutton memory, press the SET button. The symbol SET 1 will now show in the display window. Select the button (1-6) you wish to lock onto this channel and press and release that button. If a button is not selected within five seconds after pressing the SET button, the channel will continue to play but will not be stored into pushbutton memory.

You may add a second channel to each pushbutton by repeating the above procedure with this exception: Press the SET button twice and SET 2 will show in the display window. Each button can be set for SET 1 and SET 2. This allows a total of 12 Satellite channels to be stored into pushbutton memory. The channels stored in SET 2 memory can be selected by pressing the pushbutton twice.

Every time a preset button is used, a corresponding button number will display.

Buttons 1 - 6

These buttons tune the radio to the channels that you commit to pushbutton memory (12 Satellite stations).

Operating Instructions - Uconnect™ Phone (If Equipped)

Refer to “Uconnect™ Phone” in “Understanding The Features Of Your Vehicle”.

REMOTE SOUND SYSTEM CONTROLS — IF EQUIPPED

The remote sound system controls are located on the rear surface of the steering wheel. Reach behind the wheel to access the switches.

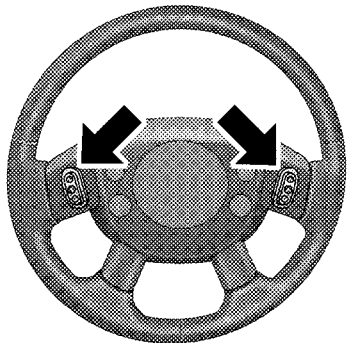

045003761

Remote Sound System Controls (Back View Of Steering Wheel)

The right-hand control is a rocker type switch with a pushbutton in the center. Pressing the top of the switch will increase the volume, and pressing the bottom of the switch will decrease the volume.

The button located in the center of the right-hand control will switch modes to Radio or CD.

The left-hand control is a rocker type switch with a pushbutton in the center. The function of the left-hand control is different depending on which mode you are in.

Radio Operation

Press the top of the switch to SEEK up for the next listenable station. Press the bottom of the switch to SEEK down for the next listenable station.

The button located in the center of the left-hand control will tune to the next preset station that you have programmed in the radio preset pushbuttons.

CD Player

Press the top of the switch once to go to the next track on the CD. Press the bottom of the switch once to go to the beginning of the current track or to the beginning of the previous track, if it is within one second after the current track begins to play.

If you press the switch up or down twice it plays the second track, three times, it will play the third, etc.

The button in the center of the left-hand switch changes CDs on the 6-Disc in-dash CD changer radio. This button does not function for all other radios.

CD/DVD DISC MAINTENANCE

To keep a CD/DVD in good condition, take the following precautions:

1. Handle the disc by its edge; avoid touching the surface.

2. If the disc is stained, clean the surface with a soft cloth, wiping from center to edge.

3. Do not apply paper or tape to the disc; avoid scratching the disc.

4. Do not use solvents such as benzene, thinner, cleaners, or anti-static sprays.

5. Store the disc in its case after playing.

6. Do not expose the disc to direct sunlight.

7. Do not store the disc where temperatures may become too high.

NOTE: If you experience difficulty in playing a particular disc, it may be damaged (i.e., scratched, reflective coating removed, a hair, moisture or dew on the disc) oversized, or have protection encoding. Try a known good disc before considering disc player service.

RADIO OPERATION AND CELLULAR PHONES

Under certain conditions, the cellular phone being on in your vehicle can cause erratic or noisy performance from your radio. This condition may be lessened or eliminated by relocating the cellular phone antenna. This condition is not harmful to the radio. If your radio performance does not satisfactorily “clear” by the repositioning of the antenna, it is recommended that the radio volume be turned down or off during cellular phone operation.

CLIMATE CONTROLS

The Air Conditioning and Heating System is designed to make you comfortable in all types of weather.

Manual Heating and Air Conditioning



The Manual Temperature Controls consist of a series of outer rotary dials and inner push knobs.

Blower Control



045607539

Rotate this control to regulate the amount of air forced through the ventilation system in any mode. The blower speed increases as you move the control to the right from the “O” (OFF) position. There are seven blower speeds.

Temperature Control



045607540

Rotate this control to regulate the temperature of the air inside the passenger compartment. Rotating the dial left into the blue area of the scale indicates cooler temperatures while rotating right into the red area indicates warmer temperatures.

NOTE: If your air conditioning performance seems lower than expected, check the front of the A/C condenser located in front of the radiator for an accumulation of dirt or insects. Clean with a gentle water spray from behind the radiator and through the condenser. Fabric front fascia protectors may reduce airflow to the condenser, reducing air conditioning performance.

Mode Control (Air Direction)



045607541

Rotate this control to choose from several patterns of air distribution. You can select either a primary mode as identified by the symbols on the control, or a blend of two of these modes. The closer the setting is to a particular symbol, the more air distribution you

receive from that mode.

Panel

 Air is directed through the outlets in the instrument panel. These outlets can be adjusted to direct airflow.

NOTE: The center instrument panel outlets can be aimed so that they are directed toward the rear seat passengers for maximum airflow to the rear.

Bi-Level

 Air is directed through the panel and floor outlets.

NOTE: For all settings except full cold or full hot, there is a difference in temperature between the upper and lower outlets. The warmer air flows to the floor outlets. This feature gives improved comfort during sunny but cool conditions.

Floor

 Air is directed through the floor outlets with a small amount flowing through the defrost and side window demist outlets.

Mix

 Air is directed through the floor, defrost, and side window demist outlets. This setting works best in cold or snowy conditions that require extra heat to the windshield. This setting is good for maintaining comfort while reducing moisture on the windshield.

Defrost

 Air is directed through the windshield and side window demist outlets. Use this mode with maximum blower and temperature settings for best windshield and side window defrosting.

NOTE: The air conditioning compressor operates in Mix, Defrost, or a blend of these modes, even if the Air Conditioning (A/C) button is not pressed. This dehumidifies the air to help dry the windshield. To improve fuel economy, use these modes only when necessary.

Recirculation Control



Pressing the Recirculation Control button will put the system in recirculation mode. This can be used when outside conditions such as smoke, odors, dust, or high humidity are present. Activating recirculation will cause the LED in the control button to illuminate. After ten minutes, the system will return to normal mode function and the LED will turn off.

NOTE:

- Continuous use of the recirculation mode may make the inside air stuffy and window fogging may occur. Extended use of this mode is not recommended.
- The use of the recirculation mode in cold or damp weather will cause windows to fog on the inside, because of moisture buildup inside the vehicle. Select the Outside Air position for maximum defogging.
- The A/C will engage automatically to prevent fogging when the recirculation button is pressed and the mode control is set to panel or panel / floor.
- The A/C can be deselected manually without disturbing the mode control selection.
- When the ignition switch is turned to the LOCK position, the recirculation feature will be cancelled.

Air Conditioning Control



045607557

Press this button to engage the Air Conditioning. A light will illuminate when the Air Conditioning System is engaged. Rotating the dial left into the blue area of the scale indicates cooler temperatures while rotating right into the red area indicates warmer temperatures.

peratures.

NOTE: The air conditioning compressor will not engage until the engine has been running for about 10 seconds.

- **MAX A/C**

For maximum cooling use the A/C and recirculation buttons at the same time.

- **ECONOMY MODE**

If economy mode is desired, press the A/C button to turn OFF the indicator light and the A/C compressor. Then, move the temperature control to the desired temperature.

Automatic Temperature Control (ATC) — If Equipped



045607534

Automatic Temperature Control

Automatic Operation

The Automatic Temperature Control system automatically maintains the climate in the cabin of the vehicle at the comfort levels desired by the driver and passenger.

Operation of the system is quite simple.

1. Turn the Mode Control knob (on the right) and the Blower Control knob (on the left) to AUTO.

NOTE: The AUTO position performs best for front seat occupants only.



045607537

2. Dial in the temperature you would like the system to maintain by rotating the Temperature Control knob. Once the comfort level is selected, the system will maintain that level automatically using the heating system. Should the desired comfort level require air conditioning, the system will automatically make the adjustment.

You will experience the greatest efficiency by simply allowing the system to function automatically. Selecting the "O" (OFF) position on the blower control stops the system completely and closes the outside air intake.

The recommended setting for maximum comfort is 72°F (22°C) for the average person; however, this may vary.

NOTE:

- The temperature setting can be adjusted at anytime without affecting automatic operation.
- Pressing the Air Conditioning Control button while in AUTO mode will cause the LED in the control button to flash three times and then turn off. This indicates that the system is in AUTO mode and requesting the air conditioning is not necessary.

- If your air conditioning performance seems lower than expected, check the front of the A/C condenser located in front of the radiator for an accumulation of dirt or insects. Clean with a gentle water spray from behind the radiator and through the condenser. Fabric front fascia protectors may reduce airflow to the condenser, reducing air conditioning performance.

Blower Control



045607536

For full automatic operation or for automatic blower operation turn the knob to AUTO position. In manual mode there are seven blower speeds that can be individual selected. In off position the blower will shut off.

Manual Operation

This system offers a full complement of manual override features, which consist of Blower Preferred Automatic, Mode Preferred Automatic, or Blower and Mode Preferred Automatic. This means the operator can override the blower, the mode, or both. There is a manual blower range for times when the AUTO setting is not desired. The blower can be set to any fixed blower speed by rotating the Blower Control knob (on the left).

NOTE: Please read the Automatic Temperature Control Operation Chart that follows for details.

Automatic Temperature Control Operation		The system will...				
Operation	How	Blower Control	Mode Control	Air Temperature Control	Air Recirculation Control	A/C Operation
Full Automatic Operation	Set blower knob to Auto. Set mode knob to Auto. Set temperature knobs for comfort.	Automatic	Automatic	Automatic	Automatic but can be overridden for 10 minutes at a time.	Automatic
Blower Preferred Automatic	Set blower knob to any desired airflow level other than Auto. Set mode knob to Auto. Set temperature knobs for comfort.	User selectable to any speed.	Automatic	Automatic	Automatic but can be overridden for 10 minutes at a time.	Automatic
Mode Preferred Automatic	Set mode knob to any desired air delivery point other than Auto. Set blower knob to Auto. Set temperature knobs for comfort.	Automatic	User selectable to any air delivery point.	Automatic	User selectable outside or recirculated.	User selectable A/C on or off.
Blower and Mode Preferred Automatic	Set blower knob to any desired airflow level other than Auto. Set mode knob to any desired air delivery point other than Auto. Set temperature knobs for comfort.	User selectable to any speed.	User selectable to any air delivery point.	Automatic	User selectable outside or recirculated.	User selectable A/C on or off.

The operator can override the AUTO mode setting to change airflow distribution by rotating the Mode Control knob (on the right) to one of the following positions.

- *Panel*

 Air is directed through the outlets in the instrument panel. These outlets can be adjusted to direct airflow.

NOTE: The center instrument panel outlets can be aimed so that they are directed toward the rear seat passengers for maximum airflow to the rear.

- *Bi-Level*

 Air is directed through the panel and floor outlets.

NOTE: For all settings except full cold or full hot, there is a difference in temperature between the upper and lower outlets. The warmer air flows to the floor outlets. This feature gives improved comfort during sunny but cool conditions.

- *Floor*

 Air is directed through the floor outlets with a small amount flowing through the defrost and side window demist outlets.

- *Mix*

 Air is directed through the floor, defrost, and side window demist outlets. This setting works best in cold or snowy conditions that require extra heat to the windshield. This setting is good for maintaining comfort while reducing moisture on the windshield.

- *Defrost*

 Air is directed through the windshield and side window demist outlets. Use this mode with maximum blower and temperature settings for best windshield and side window defrosting.

- *Air Conditioner Control*



045607559

Press this button to turn on the air conditioning during manual operation only. When the air conditioning is turned on, cool dehumidified air will flow through the outlets selected with the Mode control dial. Press this button a second time to turn OFF the air conditioning. An LED in the button illuminates when manual compressor operation is selected.

- *Recirculation Control*



The system will automatically control recirculation. However, pressing the Recirculation Control button will temporarily put the system in recirculation mode (ten minutes). This can be used when outside conditions such as smoke, odors,

dust, or high humidity are present. Activating recirculation will cause the LED in the control button to illuminate. After ten minutes, the system will return to normal AUTO mode function and the LED will turn off.

NOTE:

- When the ignition switch is turned to the LOCK position, the recirculation feature will be cancelled.
- In cold weather, use of the Recirculation mode may lead to excessive window fogging. The Recirculation mode is not allowed in the floor, defrost, or defrost/floor mode in order to improve window clearing. Recirculation will be disabled automatically if these modes are selected.
- Extended use of recirculation may cause the windows to fog. If the interior of the windows begins to fog, press the Recirculation button to return to outside air. Some temp/humidity conditions will cause captured interior air to condense on windows and hamper

visibility. For this reason, the system will not allow Recirculation to be selected while in floor, defrost, or defrost/floor mode. Attempting to use the recirculation while in these modes will cause the LED in the control button to blink and then turn off.

- Most of the time, when in Automatic Operation, you can temporarily put the system into Recirculation Mode by pressing the Recirculation button. However, under certain conditions, while in Automatic Mode, the system is blowing air out the defrost vents. When these conditions are present, and the Recirculation button is pressed, the indicator will flash and then turn off. This tells you that you are unable to go into Recirculation Mode at this time. If you would like the system to go into Recirculation Mode, you must first move the Mode knob to Panel, Panel/Floor and then press the Recirculation button. This feature reduces the possibility of window fogging.

Operating Tips

NOTE: Refer to the chart at the end of this section for suggested control settings for various weather conditions.

Summer Operation

The engine cooling system in air-conditioned vehicles must be protected with a high-quality antifreeze coolant to provide proper corrosion protection and to protect against engine overheating. A solution of 50% ethylene glycol antifreeze coolant and 50% water is recommended. Refer to “Maintenance Procedures” in “Maintaining Your Vehicle” for proper coolant selection.

Winter Operation

Use of the air Recirculation Mode during winter months is not recommended because it may cause window fogging.

Vacation Storage

Anytime you store your vehicle, or keep it out of service (i.e., vacation) for two weeks or more, run the air conditioning system at idle for about five minutes in the fresh air and high blower settings. This will ensure adequate system lubrication to minimize the possibility of compressor damage when the system is started again.

Window Fogging

Interior fogging on the windshield can be quickly removed by turning the mode selector to Defrost. The Defrost/Floor mode can be used to maintain a clear windshield and provide sufficient heating. If side window fogging becomes a problem, increase blower speed. Vehicle windows tend to fog on the inside in mild but rainy or humid weather.

NOTE: Recirculate without A/C should not be used for long periods as fogging may occur.

Side Window Demisters

A side window demister outlet is located at each end of the instrument panel. These non-adjustable outlets direct air toward the side windows when the system is in the FLOOR, MIX, or DEFROST mode. The air is directed at the area of the windows through which you view the outside mirrors.











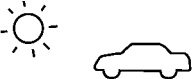









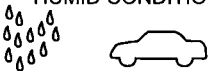

Outside Air Intake

Make sure the air intake, located directly in front of the windshield, is free of obstructions such as leaves. Leaves collected in the air intake may reduce airflow, and if they enter the plenum, they could plug the water drains. In winter months, make sure the air intake is clear of ice, slush, and snow.

A/C Air Filter — If Equipped

The A/C Filter prevents most dust and pollen from entering the cabin. The filter acts on air coming from outside the vehicle and recirculated air within the passenger compartment. Refer to “Maintenance Procedures” in “Maintaining Your Vehicle” for A/C Air Filter service information or see your authorized dealer for service. Refer to “Maintenance Schedules” for filter service intervals.

Control Setting Suggestions for Various Weather Conditions

WEATHER	CONTROL SETTINGS
<p>HOT WEATHER AND VEHICLE INTERIOR IS VERY HOT</p> 	<p>Open the windows, start the vehicle, press the  button to turn recirculate off. Set the Fan control to the high position (full clockwise). Press the A/C button. Set the Mode control at or between  and . Set the temperature control to full cool. After the hot air is pushed from the vehicle press the  button to turn recirculate on and roll up the windows. Once you are comfortable, press the  button to turn recirculate off and adjust the temperature control for comfort.</p>
<p>WARM WEATHER</p> 	<p>Press the  button to turn recirculate off. If it's sunny, set the Mode control at or near  and turn the air conditioning on. If it's cloudy or dark, set the Mode control at or near .</p>
<p>COOL OR COLD HUMID CONDITIONS</p> 	<p>Press the  button to turn recirculate off. If it's sunny, set the Mode control at or between  and  then turn the air conditioning on. If it's cloudy or dark, set the Mode control at or near  and turn the air conditioning on. If the windows begin to fog, set Mode control at or between  and .</p>
<p>COLD DRY CONDITIONS</p> 	<p>Set the Mode control at or near . If it is sunny, you may want more upper air. In this case, set the Mode control at or between  and . In very cold weather, if you need extra heat at the windshield, set the Mode control at or near the .</p>

STARTING AND OPERATING

CONTENTS

■ Starting Procedures	279	□ Brake/Transmission Interlock System	284
□ Normal Starting	279	□ Brake/Transmission Interlock Manual Override	284
□ Extreme Cold Weather (Below -20°F Or -29°C)	279	□ Four-Speed Automatic Transmission – 3.7L Engine	285
□ If Engine Fails To Start	280	□ Gear Ranges	286
□ After Starting	281	□ Five-Speed Automatic Transmission – 4.0L Engine	290
■ Engine Block Heater — If Equipped	282	□ Gear Ranges	290
■ Automatic Transmission	282		
□ Key Ignition Park Interlock	284		

- Four-Wheel Drive Operation — If Equipped . . . 295
 - MP 143 Single-Speed Part-Time Transfer Case 295
 - Shifting Procedure – Electronically Shifted Transfer Case 296
- On-Road Driving Tips 297
- Off-Road Driving Tips 298
 - When To Use 4L Or 4LO (Low) Range 298
 - Driving Through Water 298
 - Driving In Snow, Mud And Sand 299
 - Hill Climbing 300
 - Traction Downhill 301
 - After Driving Off-Road 301
- Power Steering 302
 - Power Steering Fluid Check 303
- Parking Brake 304
- Anti-Lock Brake System 306
- Electronic Brake Control System 309
 - Anti-Lock Brake System (ABS) 309
 - Traction Control System (TCS) 309
 - Brake Assist System (BAS) 310
 - Electronic Roll Mitigation (ERM) 311
 - Electronic Stability Program (ESP) 312
 - ESP/BAS Warning Lamp 314
- Tire Safety Information 315
 - Tire Markings 315

□ Tire Identification Number (TIN)	319	■ Tire Chains	335
□ Tire Terminology And Definitions	320	■ Tire Rotation Recommendations	336
□ Tire Loading And Tire Pressure	323	■ Tire Pressure Monitor System (TPMS)	337
■ Tires — General Information	327	□ Base System	340
□ Tire Pressure	327	□ Premium System – If Equipped	343
□ Tire Inflation Pressures	328	□ General Information	347
□ Tire Pressures For High Speed Operation	329	■ Fuel Requirements	347
□ Radial-Ply Tires	330	□ 3.7L Engine	347
□ Compact Spare Tire – If Equipped	330	□ 4.0L Engine	348
□ Tire Spinning	331	□ Reformulated Gasoline	348
□ Tread Wear Indicators	332	□ Gasoline/Oxygenate Blends	349
□ Life Of Tire	333	□ E-85 Usage In Non-Flex Fuel Vehicles	349
□ Replacement Tires	333	□ MMT In Gasoline	350

278 STARTING AND OPERATING

- Materials Added To Fuel 350
- Fuel System Cautions 351
- Carbon Monoxide Warnings 352
- Adding Fuel 353
 - Fuel Filler Cap (Gas Cap) 353
 - Loose Fuel Filler Cap Message 354
- Vehicle Loading 355
 - Certification Label 355
- Trailer Towing 357
 - Common Towing Definitions 357
 - Trailer Hitch Classification 362
 - Trailer Towing Weights
(Maximum Trailer Weight Ratings) 363
 - Trailer And Tongue Weight 365
 - Towing Requirements 366
 - Towing Tips 371
- Recreational Towing
(Behind Motorhome, Etc.) 372
 - Two-Wheel Drive Models 372
 - Four-Wheel Drive Or All-Wheel Drive
Models 373

STARTING PROCEDURES

Before starting your vehicle, adjust your seat, adjust both inside and outside mirrors, and fasten your seat belts.

WARNING!

Do not leave children or animals inside parked vehicles in hot weather. Interior heat build up may cause serious injury or death.

Start the engine with the shift lever in the NEUTRAL or PARK position. Apply the brake before shifting to any driving range.

Normal Starting

NOTE: Normal starting of either a cold or a warm engine is obtained without pumping or pressing the accelerator pedal.

Turn the ignition switch to the START position and release when the engine starts. If the engine fails to start within 10 seconds, turn the ignition switch to the LOCK position, wait 10 to 15 seconds, then repeat the “Normal Starting” procedure.

Tip Start Feature

Turn the ignition switch to START position and release it as soon as the starter engages. The starter motor will continue to run, but will automatically disengage itself when the engine is running. If the engine fails to start, the starter will disengage automatically in 10 seconds. If this occurs, turn the ignition switch to the LOCK position, wait 10 to 15 seconds, then repeat the “Normal Starting” procedure.

Extreme Cold Weather (below -20°F or -29°C)

To ensure reliable starting at these temperatures, the use of an externally powered electric engine block heater (available from your authorized dealer) is recommended.

If Engine Fails to Start**WARNING!**

- Never pour fuel or other flammable liquids into the throttle body air inlet opening in an attempt to start the vehicle. This could result in a flash fire causing serious personal injury.

(Continued)

WARNING! (Continued)

- Do not attempt to push or tow your vehicle to get it started. Vehicles equipped with an automatic transmission cannot be started this way. Unburned fuel could enter the catalytic converter and once the engine has started, ignite and damage the converter and vehicle. If the vehicle has a discharged battery, booster cables may be used to obtain a start from a booster battery or the battery in another vehicle. This type of start can be dangerous if done improperly. Refer to "Jump Starting" in "What To Do In Emergencies" for further information.

CAUTION!

To prevent damage to the starter, do not crank the engine for more than 15 seconds at a time. Wait 10 to 15 seconds before trying again.

If the engine has been flooded, it may start to run, but not have enough power to continue running when the key is released. If this occurs, continue cranking with the accelerator pedal pressed all the way to the floor. Release the accelerator pedal and the key once the engine is running smoothly.

If the engine shows no sign of starting after two 15 second periods of cranking with the accelerator pedal held to the floor, repeat the “Normal Starting” or “Extreme Cold Weather” procedures.

With Tip Start

If the engine fails to start after you have followed the “Normal Starting” or “Extreme Cold Weather” procedures, it may be flooded. To clear any excess fuel, press the accelerator pedal all the way to the floor and hold it. Then, turn the ignition switch to the START position and release it as soon as the starter engages. The starter motor will disengage automatically in 10 seconds. Once this occurs, release the accelerator pedal, turn the ignition switch to the LOCK position, wait 10 to 15 seconds, then repeat the “Normal Starting” procedure.

CAUTION!

To prevent damage to the starter, wait 10 to 15 seconds before trying again.

After Starting

The idle speed will automatically decrease as the engine warms up.

WARNING!

Do not leave children or animals inside parked vehicles in hot weather. Interior heat buildup may cause serious injury or death.

ENGINE BLOCK HEATER — IF EQUIPPED

The engine block heater warms the engine, and permits quicker starts in cold weather. Connect the cord to a standard 110-115 Volt AC electrical outlet with a grounded three-wire extension cord.

- The engine block heater cord is found under the hood clipped to the heater line on the left side of the engine.

WARNING!

Remember to disconnect the cord before driving. Damage to the 110-115 Volt AC electrical cord could cause electrocution.

Use the heater when temperatures below 0 °F (-18 °C) are expected to last for several days.

AUTOMATIC TRANSMISSION**CAUTION!**

Damage to the transmission may occur if the following precautions are not observed:

- Shift into PARK only after the vehicle has come to a complete stop.

(Continued)

CAUTION! (Continued)

- Shift into or out of REVERSE only after the vehicle has come to a complete stop and the engine is at idle speed.
- Do not shift from REVERSE, PARK, or NEUTRAL into any forward gear when the engine is above idle speed.
- Before shifting into any gear, make sure your foot is firmly on the brake pedal.

WARNING!

- It is dangerous to move the shift lever out of PARK or NEUTRAL if the engine speed is higher than idle speed. If your foot is not firmly on the brake pedal, the vehicle could accelerate quickly forward or in REVERSE. You could lose control of the vehicle and hit someone or something. Only shift into gear when the engine is idling normally and when your foot is firmly on the brake pedal.
- Never leave children alone in a vehicle. Leaving unattended in a vehicle is dangerous for a number of reasons. A child or others could be seriously or fatally injured. A child could operate power windows, other controls or move the vehicle.

Key Ignition Park Interlock

This vehicle is equipped with a Key Ignition Park Interlock which requires the shift lever to be placed in PARK prior to rotating the key to the LOCK position. The key can only be removed from the ignition when the ignition is in the LOCK position and once removed the shift lever is locked in PARK.

Brake/Transmission Interlock System

This vehicle is equipped with a Brake Transmission Shift Interlock System (BTSI) that holds the shift lever in the PARK position when the ignition switch is in the LOCK position. To move the shift lever out of the PARK position, the ignition switch must be turned to the ON or START position (engine running or not) and the brake pedal must be pressed.

Brake/Transmission Interlock Manual Override

Your vehicle may be equipped with a shift lock manual override. The manual override may be used in the event that the shift lever should fail to move from PARK with the key in the ON position and the brake pedal pressed. To operate the shift lock manual override, perform the following steps:

1. Turn the key to the ON position but do not start the engine.
2. Firmly set the parking brake.
3. Using a flat blade screwdriver, carefully remove the shift lock manual override cover which is located on the PRNDL bezel.
4. Press and maintain firm pressure on the brake pedal.

5. Using the screwdriver, reach into the manual override opening. Press and hold the shift lock lever down.

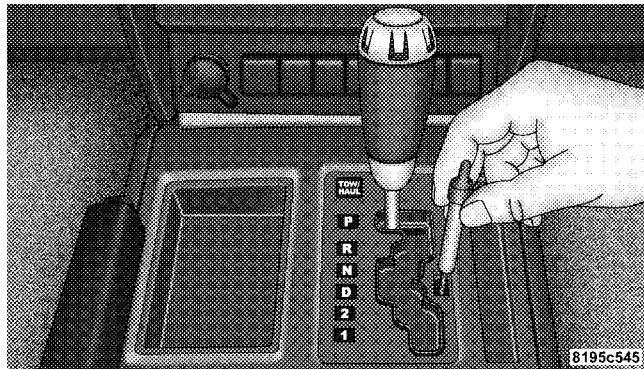

Interlock Manual Override

6. Move the shift lever into the NEUTRAL position.

7. The vehicle may then be started in NEUTRAL.

Have your vehicle inspected by your local authorized dealer if the shift lock manual override has been used.

Four-Speed Automatic Transmission – 3.7L Engine

NOTE: Under extreme cold temperatures (-10°F (-23°C) and when in DRIVE, transmission operation may be briefly limited to only second gear operation. Normal operation will resume once the transmission temperature has risen to a suitable level.

Shifting from DRIVE to PARK or REVERSE should be done only after the accelerator pedal is released and the vehicle is stopped. Be sure to keep your foot on the brake when moving the shift lever between these gears.

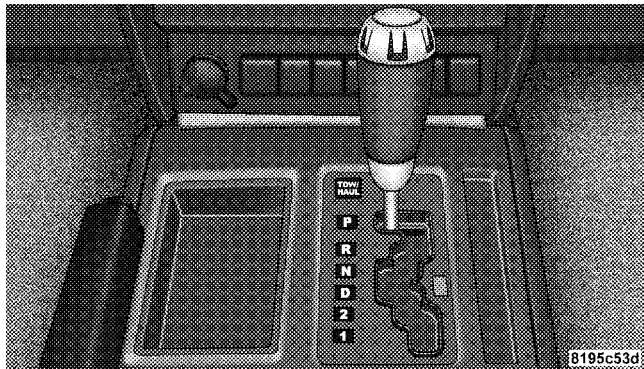

Shift Lever

Gear Ranges

DO NOT race the engine when shifting from PARK or NEUTRAL position into another gear range.

PARK

This range supplements the parking brake by locking the transmission. The engine can be started in this range.

Never use PARK while the vehicle is in motion. Apply the parking brake when leaving the vehicle in this range. Always apply the parking brake first, then place the shift lever in the PARK position.

WARNING!

- Never use the PARK position as a substitute for the parking brake. Always apply the parking brake fully when parked to guard against vehicle movement and possible injury or damage.
- It is dangerous to move the shift lever out of PARK or NEUTRAL if the engine speed is higher than idle speed. If your foot is not firmly on the brake pedal, the vehicle could accelerate quickly forward or in REVERSE. You could lose control of the vehicle and hit someone or something. Only shift into gear when the engine is idling normally and when your right foot is firmly on the brake pedal.

REVERSE

This range is for moving the vehicle backward. Use only after the vehicle has come to a complete stop.

NEUTRAL

This range is used when vehicle is standing for prolonged periods with engine running. Engine may be started in this range. Set the parking brake if you must leave the vehicle.

NOTE: Towing the vehicle, coasting, or driving for any other reason with shift lever in NEUTRAL can result in severe transmission damage. Refer to “Recreational Towing” in “Starting and Operating” and “Towing a Disabled Vehicle” in “What To Do In Emergencies” for further information.

DRIVE

This range is used for most city and highway driving.

2 (Second)

This range is used for moderate grades and to assist braking on dry pavement or in mud and snow. Begins at a stop in low gear with automatic upshift to second gear. Will not shift into third gear.

1 (First)

This range is used for hard pulling at low speeds in mud, sand, snow, or on steep grades. Begins and stays in low gear with no upshift. Provides engine compression braking at low speeds.

Overdrive Operation

The overdrive automatic transmission contains an electronically controlled fourth gear (OVERDRIVE). The transmission will automatically shift from third gear into OVERDRIVE if the following conditions are present:

- the shift lever is in DRIVE

- vehicle speed is above approximately 30 mph (48 km/h)
- the TOW/HAUL button has not been activated

The transmission will downshift from OVERDRIVE to DRIVE if the accelerator pedal is fully pressed at vehicle speeds above approximately 35 mph (56 km/h).

When To Use TOW/HAUL Mode

When driving in hilly areas, towing a trailer, carrying a heavy load, etc., and frequent transmission shifting occurs, press the TOW/HAUL button. This will improve performance and reduce the potential for transmission overheating or failure due to excessive shifting. When operating in TOW/HAUL mode, the transmission will shift into third gear.

NOTE: The TOW/HAUL mode locks out Overdrive.

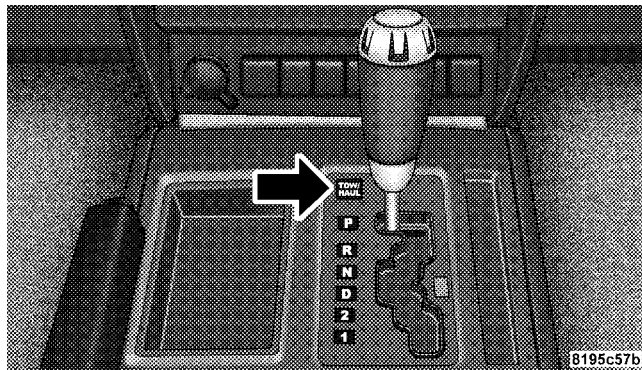

Tow/Haul Button

The “TOW/HAUL Indicator Light” will illuminate in the instrument cluster to indicate when the switch has been activated. Pressing the switch a second time restores normal operation. If the TOW/HAUL mode is desired, the switch must be pressed each time the engine is started.

Transmission Limp Home Mode

Transmission function is monitored for abnormal conditions. If a condition is detected that could result in transmission damage, the Transmission Limp Home Mode will be engaged. In this mode, the transmission will remain in second gear in any forward driving range.

To reset the transmission, use the following procedure:

1. Stop the vehicle.
2. Move the shift lever to the PARK position.
3. Turn the engine off and turn the key to the LOCK position.
4. Wait approximately 10 seconds, then restart the engine.
5. Move the shift lever to the desired gear range.

If the problem is no longer detected, the transmission will return to normal operation. If the problem persists, PARK, REVERSE, and NEUTRAL will continue to operate. Only second gear range will operate in the DRIVE position. Have the transmission checked at your authorized dealer as soon as possible.

Torque Converter Clutch

A feature designed to improve fuel economy has been added to the automatic transmission of this vehicle. A clutch within the torque converter engages automatically at calibrated speeds. This may result in a slightly different feeling or response during normal operation in high gear. When the vehicle speed drops or during acceleration, the clutch automatically and smoothly disengages.

Five-Speed Automatic Transmission – 4.0L Engine

The electronically controlled transmission provides a precise shift schedule. The transmission electronics are self-calibrating; therefore, the first few shifts on a new vehicle may be somewhat abrupt. This is a normal condition and precision shifts will develop within a few hundred miles/kilometers.

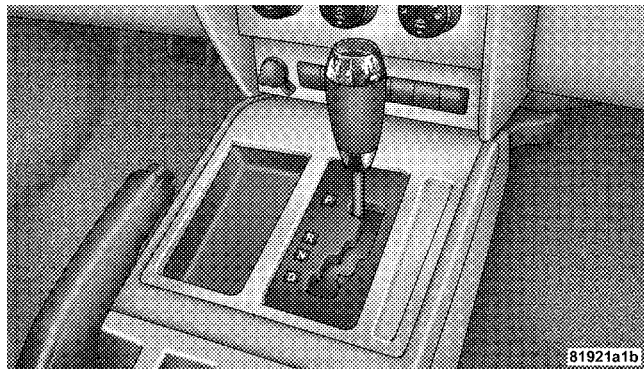

Shift Lever

Gear Ranges

NOTE: After selecting any gear range, wait a moment to allow the selected gear to engage before accelerating. This is especially important when the engine is cold. If there is a need to restart the engine, be sure to cycle the key to the LOCK position before restarting. Transmission gear engagement may be delayed after restarting the engine if the key is not cycled to the LOCK position first.

PARK

This range supplements the parking brake by locking the transmission. The engine can be started in this range. Never use PARK while the vehicle is in motion. Apply the parking brake when leaving the vehicle in this range. Always apply the parking brake first, then place the shift lever in the PARK position.

WARNING!

- Never use the **PARK** position as a substitute for the parking brake. Always apply the parking brake fully when parked to guard against vehicle movement and possible injury or damage.
- It is dangerous to move the shift lever out of **PARK** or **NEUTRAL** if the engine speed is higher than idle speed. If your foot is not firmly on the brake pedal, the vehicle could accelerate quickly forward or in **REVERSE**. You could lose control of the vehicle and hit someone or something. Only shift into gear when the engine is idling normally and when your right foot is firmly on the brake pedal.

REVERSE

This range is for moving the vehicle backward. Use this range only after the vehicle has come to a complete stop.

NEUTRAL

This range is used when vehicle is standing for prolonged periods with engine running. Engine may be started in this range. Set the parking brake if you must leave the vehicle.

NOTE: Towing the vehicle, coasting, or driving for any other reason with the shift lever in **NEUTRAL** can result in severe transmission damage. Refer to “Recreational Towing” in “Starting and Operating” and “Towing a Disabled Vehicle” in “What To Do In Emergencies” for further information.

DRIVE

This range is used for most city and highway driving.

Electronic Range Select (ERS) Operation

The Electronic Range Select (ERS) shift control allows you to move the shift lever left (-) or right (+) when the shift lever is in the DRIVE position, allowing the selection of the desired top gear. For example, if the driver shifts the transmission into third gear, the transmission will never shift above third gear, but can shift down into second gear or first gear, when needed.

WARNING!

Do not downshift for additional engine braking on a slippery surface. The drive wheels could lose their grip and the vehicle could skid.

Screen Display	1	2	3	4	D
Actual Gear(s) Allowed	1	1-2	1-3	1-4	1-5

NOTE: To select the proper gear position for maximum deceleration (engine braking), move the shift lever to the left “D (-)” and hold it there. The transmission will shift to the range from which the vehicle can best be slowed down.

Overdrive Operation

The overdrive automatic transmission contains an electronically controlled fifth gear (OVERDRIVE). The transmission will automatically shift from fourth gear to OVERDRIVE if the following conditions are present:

- the shift lever is in DRIVE
- the engine coolant has reached normal operating temperature
- the vehicle speed is above approximately 30 mph (48 km/h)
- the transmission has reached normal operating temperature

NOTE: If the vehicle is started in extremely cold temperatures, the transmission may not shift into OVERDRIVE and will automatically select the most desirable gear for operation at this temperature. Normal operation will resume when the transmission fluid temperature has risen to a suitable level. Refer to the “Note” under “Torque Converter Clutch” later in this section.

During cold temperature operation, you may notice delayed upshifts depending on engine and transmission temperature. This feature improves the warm up time of the engine and transmission.

During cold temperature operation, the transmission may not downshift from second gear into first gear after the initial first to second gear upshift.

Transmission Limp Home Mode

Transmission function is monitored for abnormal conditions. If a condition is detected that could result in transmission damage, the Transmission Limp Home Mode will be engaged. In this mode, the transmission will remain in the current gear until the vehicle is brought to a stop.

To reset the transmission, use the following procedure:

1. Stop the vehicle.
2. Move the shift lever to the PARK position.
3. Turn the engine off and turn the key to the LOCK position.
4. Wait approximately 10 seconds, then restart the engine.
5. Move the shift lever to the desired gear range.

If the problem is no longer detected, the transmission will return to normal operation. If the problem persists, PARK, REVERSE, and NEUTRAL will continue to operate. Only second gear will operate in the DRIVE position. Have the transmission checked at your authorized dealer as soon as possible.

Torque Converter Clutch

A feature designed to improve fuel economy has been included in the automatic transmission on your vehicle. A clutch within the torque converter engages automatically at a calibrated speed at light throttle. It engages at higher speeds under heavier acceleration. This may result in a slightly different feeling or response during normal operation in high gear. When the vehicle speed drops below a calibrated speed, or during acceleration, the clutch automatically and smoothly disengages. The feature is operational in OVERDRIVE and in DRIVE.

NOTE:

- The torque converter clutch will not engage until the transmission fluid and engine coolant are warm (usually after 1 to 3 miles (1.6 - 4.8 km) of driving). Because the engine speed is higher when the torque converter clutch is not engaged, it may seem as if the transmission is not shifting into OVERDRIVE when cold. This is normal.
- If the vehicle has not been driven in several days, the first few seconds of operation after shifting the transmission into gear may seem sluggish. This is due to the fluid partially draining from the torque converter into the transmission. This condition is normal and will not cause damage to the transmission. The torque converter will refill within five seconds of shifting from PARK into any other gear position.

FOUR-WHEEL DRIVE OPERATION — IF EQUIPPED

MP 143 Single-Speed Part-Time Transfer Case

Operating Information/Precautions

The transfer case is operated by the transfer case switch (located on the center console).

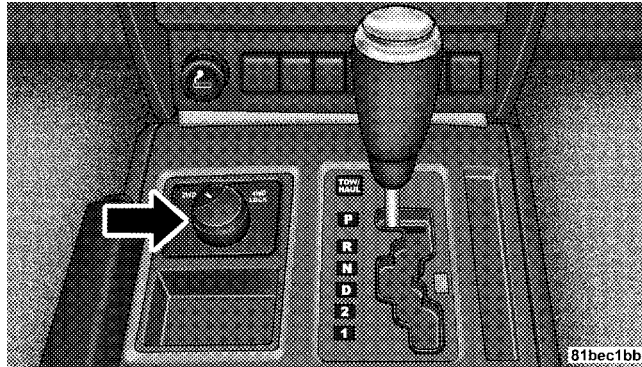

Transfer Case Switch

The electronically shifted transfer case provides two mode positions:

- Two-wheel drive high range (2WD)
- Four-wheel drive high range (4WD LOCK)

The electronically shifted transfer case is designed to be driven in the two-wheel drive position (2WD) for normal street and highway conditions (dry hard surfaced roads).

When additional traction is required, the transfer case 4WD LOCK position can be used to lock the front and rear driveshafts together and force the front and rear wheels to rotate at the same speed. This is accomplished by rotating the transfer case switch to the desired position. Refer to “Shifting Procedure” for specific shifting instructions. The 4WD LOCK position is designed for loose, slippery road surfaces only.

CAUTION!

- Driving in the 4WD LOCK position on dry hard surfaced roads may cause increased tire wear and damage to the driveline components.
- Do not attempt to make a shift while only the front or rear wheels are spinning. Shifting while only the front or rear wheels are spinning can cause damage to the transfer case.

Proper operation of four-wheel drive vehicles depends on tires of equal size, type and circumference on each wheel. Any difference in tire size can cause damage to the transfer case. Tire rotation schedule should be followed to balance tire wear.

Since four-wheel drive provides improved traction, there is a tendency to exceed safe turning and stopping speeds. Do not go faster than road conditions permit.

Shifting Procedure – Electronically Shifted Transfer Case

NOTE: If any of the requirements to select a new transfer case position have not been met, the transfer case will not shift. The “4WD Indicator Light” (located in the display under the tachometer) will flash until all the requirements for the selected position have been met. To retry a shift, return the control knob back to the original position, make certain all shift requirements have been met, wait five seconds and try the shift again.

2WD ⇔ 4WD LOCK

Rotate the transfer case switch to the desired position. Shifts between 2WD and 4WD LOCK can be done with the vehicle stopped or in motion. With the vehicle in motion, the transfer case will engage/disengage faster if you momentarily release the accelerator pedal after turning the switch. If the vehicle is stopped, the ignition key

must be in the ON position with the engine either RUNNING or OFF. This shift cannot be completed if the key is in the ACC position.

NOTE:

- The four-wheel drive system will not allow shifts between 2WD/4WD LOCK if the front and/or rear wheels are spinning (no traction). In this situation, the “4WD Indicator Light” (located in the display under the tachometer) will flash. At this time, reduce speed and stop spinning the wheels to complete the shift.
- Delayed shifting out of 4WD LOCK may be experienced due to uneven tire wear, low tire pressure, or excessive loading.

ON-ROAD DRIVING TIPS

Utility vehicles have higher ground clearance and a narrower track to make them capable of performing in a wide variety of off-road applications. Specific design characteristics give them a higher center of gravity than ordinary cars.

An advantage of the higher ground clearance is a better view of the road, allowing you to anticipate problems. They are not designed for cornering at the same speeds as conventional two-wheel drive vehicles any more than low-slung sports cars are designed to perform satisfactorily in off-road conditions. If at all possible, avoid sharp turns or abrupt maneuvers. As with other vehicles of this type, failure to operate this vehicle correctly may result in loss of control or vehicle rollover.

OFF-ROAD DRIVING TIPS

When To Use 4L or 4LO (Low) Range

When off-road driving, shift to 4L or 4LO for additional traction and control on slippery or difficult terrain, ascending or descending steep hills, and to increase low-speed pulling power. This range should be limited to extreme situations such as deep snow, mud, or sand where additional low speed pulling power is needed. Vehicle speeds in excess of 25 mph (40 km/h) should be avoided when in 4L or 4LO range.

Driving Through Water

Although your vehicle is capable of driving through water, there are a number of precautions that must be considered before entering the water:

CAUTION!

When driving through water, do not exceed 5 mph (8 km/h). Always check water depth before entering as a precaution, and check all fluids afterward. Driving through water may cause damage that may not be covered by the new vehicle limited warranty.

Driving through water more than a few inches/centimeters deep will require extra caution to ensure safety and prevent damage to your vehicle. If you must drive through water, try to determine the depth and the bottom condition (and location of any obstacles) prior to entering. Proceed with caution and maintain a steady controlled speed less than 5 mph (8 km/h) in deep water to minimize wave effects.

Flowing Water

If the water is swift flowing and rising (as in storm run-off) avoid crossing until the water level recedes and/or the flow rate is reduced. If you must cross flowing water, avoid depths in excess of 9 in (23 cm). The flowing water can erode the streambed causing your vehicle to sink into deeper water. Determine exit point(s) that are downstream of your entry point to allow for drifting.

Standing Water

Avoid driving in standing water deeper than 20 in (50 cm) and reduce speed appropriately to minimize wave effects. Maximum speed in 20 in (50 cm) of water is less than 5 mph (8 km/h).

Maintenance

After driving through deep water, inspect your vehicle fluids and lubricants (engine, transmission, axle, transfer

case) to assure they have not been contaminated. Contaminated fluids and lubricants (milky, foamy in appearance) should be flushed/changed as soon as possible to prevent component damage.

Driving In Snow, Mud and Sand

In heavy snow, when pulling a load, or for additional control at slower speeds, shift the transmission to a low gear and shift the transfer case to 4L or 4LO if necessary. Refer to "Four-Wheel Drive Operation" in "Starting and Operating" for further information. Do not shift to a lower gear than necessary to maintain headway. Over-revving the engine can spin the wheels and traction will be lost.

Avoid abrupt downshifts on icy or slippery roads, because engine braking may cause skidding and loss of control.

Hill Climbing

NOTE: Before attempting to climb a hill, determine the conditions at the crest and/or on the other side.

Before climbing a steep hill, shift the transmission to a lower gear and shift the transfer case to 4L or 4LO. Use first gear and 4L or 4LO for very steep hills.

If you stall or begin to lose headway while climbing a steep hill, allow your vehicle to come to a stop and immediately apply the brakes. Restart the engine and shift to REVERSE. Back slowly down the hill allowing the compression braking of the engine to help regulate your speed. If the brakes are required to control vehicle speed, apply them lightly and avoid locking or skidding the tires.

WARNING!

If the engine stalls or you lose headway or cannot make it to the top of a steep hill or grade, never attempt to turn around. To do so may result in tipping and rolling the vehicle. Always back straight down a hill in REVERSE gear carefully. Never back down a hill in NEUTRAL using only the brake.

Remember, never drive diagonally across a hill; always drive straight up or down.

If the wheels start to slip as you approach the crest of a hill, ease off the accelerator and maintain headway by turning the front wheels slowly left and right. This may provide a fresh “bite” into the surface and will usually provide traction to complete the climb.

Traction Downhill

Shift the transmission into a low gear and the transfer case to 4L or 4LO range. Let the vehicle go slowly down the hill with all four wheels turning against engine compression drag. This will permit you to control the vehicle speed and direction.

When descending mountains or hills, repeated braking can cause brake fade with loss of braking control. Avoid repeated heavy braking by downshifting the transmission whenever possible.

After Driving Off-Road

Off-road operation puts more stress on your vehicle than most on-road driving. After going off-road, it is always a good idea to check for damage. That way you can get any problems taken care of right away and have your vehicle ready when you need it.

- Completely inspect the underbody of your vehicle. Check tires, body structure, steering, suspension, and exhaust system for damage.
- Check threaded fasteners for looseness, particularly on the chassis, drivetrain components, steering, and suspension. Retighten them if required and torque to the values specified in the Service Manual.
- Check for accumulations of plants or brush. These things could be a fire hazard. They might hide damage to fuel lines, brake hoses, axle pinion seals, and propeller shafts.
- After extended operation in mud, sand, water, or similar dirty conditions, have brake rotors, wheels, brake linings, and axle yokes inspected and cleaned as soon as possible.

WARNING!

Abrasive material in any part of the brakes may cause excessive wear or unpredictable braking. You might not have full braking power when you need it to prevent an accident. If you have been operating your vehicle in dirty conditions, get your brakes checked and cleaned as necessary.

- If you experience unusual vibration after driving in mud, slush, or similar conditions, check the wheels for impacted material. Impacted material can cause a wheel imbalance and freeing the wheels of it will correct the situation.

POWER STEERING

The standard power steering system will give you good vehicle response and increased ease of maneuverability in tight spaces. The system will provide mechanical steering capability if power assist is lost.

If for some reason the power assist is interrupted, it will still be possible to steer your vehicle. Under these conditions, you will observe a substantial increase in steering effort, especially at very low vehicle speeds and during parking maneuvers.

NOTE:

- Increased noise levels at the end of the steering wheel travel are considered normal and do not indicate that there is a problem with the power steering system.
- Upon initial start-up in cold weather, the power steering pump may make noise for a short amount of time. This is due to the cold, thick fluid in the steering system. This noise should be considered normal, and it does not in any way damage the steering system.

WARNING!

Continued operation with reduced power steering assist could pose a safety risk to yourself and others. Service should be obtained as soon as possible.

CAUTION!

Prolonged operation of the steering system at the end of the steering wheel travel will increase the steering fluid temperature and it should be avoided when possible. Damage to the power steering pump may occur.

Power Steering Fluid Check

Checking the power steering fluid level at a defined service interval is not required. The fluid should only be checked if a leak is suspected, abnormal noises are

apparent, and/or the system is not functioning as anticipated. Coordinate inspection efforts through an authorized dealer.

CAUTION!

Do not use chemical flushes in your power steering system as the chemicals can damage your power steering components. Such damage is not covered by the New Vehicle Limited Warranty.

WARNING!

Fluid level should be checked on a level surface and with the engine off to prevent injury from moving parts and to ensure accurate fluid level reading. Do not overfill. Use only manufacturer's recommended power steering fluid.

If necessary, add fluid to restore to the proper indicated level. With a clean cloth, wipe any spilled fluid from all surfaces. Refer to “Fluids, Lubricants, and Genuine Parts” in “Maintaining Your Vehicle” for further information.

PARKING BRAKE

Before leaving the vehicle, make sure that the parking brake is fully applied. Also, be certain to leave the transmission in PARK.

The parking brake lever is located in the center console. To apply the parking brake, pull the lever up as firmly as possible. To release the parking brake, pull the lever up slightly, press the center button, then lower the lever completely.

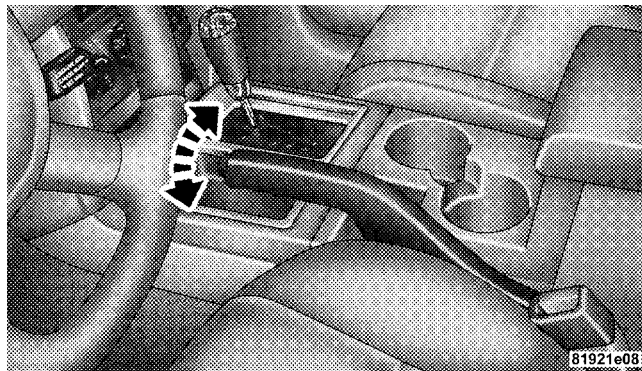

Parking Brake

When the parking brake is applied with the ignition switch ON, the “Brake Warning Light” in the instrument cluster will illuminate.

NOTE:

- When the parking brake is applied and the transmission is placed in gear, the “Brake Warning Light” will flash. If vehicle speed is detected, a chime will sound to alert the driver. Fully release the parking brake before attempting to move the vehicle.
- This light only shows that the parking brake is applied. It does not show the degree of brake application.

When parking on a hill, it is important to turn the front wheels toward the curb on a downhill grade and away from the curb on an uphill grade. Apply the parking brake before placing the shift lever in PARK, otherwise the load on the transmission locking mechanism may make it difficult to move the shift lever out of PARK. The parking brake should always be applied whenever the driver is not in the vehicle.

WARNING!

- **Never use the PARK position as a substitute for the parking brake. Always apply the parking brake fully when parked to guard against vehicle movement and possible injury or damage.**
- **Never leave children alone in a vehicle. Leaving unattended children in a vehicle is dangerous for a number of reasons. A child or others could be seriously or fatally injured.**
- **Do not leave the key in the ignition. A child could operate power windows, other controls, or move the vehicle.**
- **Be sure the parking brake is fully disengaged before driving; failure to do so can lead to brake failure and an accident.**

(Continued)

WARNING! (Continued)

- Always fully apply the parking brake when leaving your vehicle or it may roll and cause damage or injury. Also, be certain to leave the transmission in PARK. Failure to do so may cause the vehicle to roll and cause damage or injury.

CAUTION!

If the "Brake Warning Light" remains on with the parking brake released, a brake system malfunction is indicated. Have the brake system serviced by an authorized dealer immediately.

ANTI-LOCK BRAKE SYSTEM

The Anti-Lock Brake System (ABS) is designed to aid the driver in maintaining vehicle control under adverse braking conditions. The system operates with a separate

computer to modulate hydraulic pressure, to prevent wheel lock-up and help avoid skidding on slippery surfaces.

All vehicle wheels and tires must be the same size and type, and tires must be properly inflated, to produce accurate signals for the computer.

WARNING!

Significant over or under-inflation of tires or mixing sizes of tires or wheels on the vehicle can lead to loss of braking effectiveness.

The ABS conducts a low-speed self-test at about 12 mph (20 km/h). If you have your foot lightly on the brake while this test is occurring, you may feel slight pedal movement. The movement can be more apparent on ice and snow. This is normal.

The ABS pump motor runs during the self-test at 12 mph (20 km/h) and during an ABS stop. The pump motor makes a low humming noise during operation, which is normal.

WARNING!

- Pumping of the Anti-Lock Brakes will diminish their effectiveness and may lead to an accident. Pumping makes the stopping distance longer. Just press firmly on your brake pedal when you need to slow down or stop.
- The ABS cannot prevent the natural laws of physics from acting on the vehicle, nor can it increase braking or steering efficiency beyond that afforded by the condition of the vehicle brakes and tires or the traction afforded.

(Continued)

WARNING! (Continued)

- The ABS cannot prevent accidents, including those resulting from excessive speed in turns, following another vehicle too closely, or hydroplaning. Only a safe, attentive, and skillful driver can prevent accidents.
- The capabilities of an ABS equipped vehicle must never be exploited in a reckless or dangerous manner, which could jeopardize the user's safety or the safety of others.

CAUTION!

The ABS is subject to possible detrimental effects of electronic interference caused by improperly installed aftermarket radios or telephones.

NOTE: During severe braking conditions, a pulsing sensation may occur and a clicking noise will be heard. This is normal, indicating that the ABS is functioning.

- Do not “ride” the brakes by resting your foot on the pedal. This could overheat the brakes and result in unpredictable braking action, longer stopping distances, or brake damage.
- When descending mountains or hills, repeated braking can cause brake fade with loss of braking control. Avoid repeated heavy braking by downshifting the transmission or locking out overdrive whenever possible.
- Engines may idle at higher speeds during warm-up, which could cause rear wheels to spin and result in loss of vehicle control. Be especially careful while driving on slippery roads, in close-quarter maneuvering, parking, or stopping.
- Do not drive too fast for road conditions, especially when roads are wet or slushy. A wedge of water can build up between the tire tread and the road. This hydroplaning action can cause loss of traction, braking ability, and control.
- After going through deep water or a car wash, brakes may become wet, resulting in decreased performance and unpredictable braking action. Dry the brakes by gentle, intermittent pedal action while driving at very slow speeds.

ELECTRONIC BRAKE CONTROL SYSTEM

Your vehicle is equipped with an advanced electronic brake control system that includes an Anti-Lock Brake System (ABS), Traction Control System (TCS), Brake Assist System (BAS), Electronic Roll Mitigation (ERM) and Electronic Stability Program (ESP). All five systems work together to enhance vehicle stability and control in various driving conditions and are commonly referred to as ESP.

Anti-Lock Brake System (ABS)

This system aids the driver in maintaining vehicle control under adverse braking conditions. The system controls hydraulic brake pressure to prevent wheel lockup and help avoid skidding on slippery surfaces during braking. Refer to “Anti-Lock Brake System” in “Starting and Operating” for further information.

WARNING!

The Anti-Lock Brake System (ABS) cannot prevent the natural laws of physics from acting on the vehicle, nor can it increase the traction afforded by prevailing road conditions. ABS cannot prevent accidents, including those resulting from excessive speed in turns, driving on very slippery surfaces, or hydroplaning. Only a safe, attentive, and skillful driver can prevent accidents. The capabilities of an ABS-equipped vehicle must never be exploited in a reckless or dangerous manner which could jeopardize the user's safety or the safety of others.

Traction Control System (TCS)

This system monitors the amount of wheel spin of each of the driven wheels. If wheel spin is detected, brake pressure is applied to the slipping wheel(s) and engine power is reduced to provide enhanced acceleration and

stability. A feature of the TCS system functions similar to a limited slip differential and controls the wheel spin across a driven axle. If one wheel on a driven axle is spinning faster than the other, the system will apply the brake of the spinning wheel. This will allow more engine torque to be applied to the wheel that is not spinning. This feature remains active even if TCS and ESP are in the "Partial Off" mode. Refer to "ESP (Electronic Stability Program)" in this section.

Brake Assist System (BAS)

The BAS is designed to optimize the vehicle's braking capability during emergency braking maneuvers. The system detects an emergency braking situation by sensing the rate and amount of brake application and then applies optimum pressure to the brakes. This can help reduce braking distances. The BAS complements the Anti-Lock Brake System (ABS). Applying the brakes very quickly results in the best BAS assistance. To receive the

benefit of the system, you must apply continuous braking pressure during the stopping sequence. Do not reduce brake pedal pressure unless braking is no longer desired. Once the brake pedal is released, the BAS is deactivated.

WARNING!

The Brake Assist System (BAS) cannot prevent the natural laws of physics from acting on the vehicle, nor can it increase the traction afforded by prevailing road conditions. BAS cannot prevent accidents, including those resulting from excessive speed in turns, driving on very slippery surfaces, or hydroplaning. Only a safe, attentive, and skillful driver can prevent accidents. The capabilities of a BAS-equipped vehicle must never be exploited in a reckless or dangerous manner which could jeopardize the user's safety or the safety of others.

Electronic Roll Mitigation (ERM)

This system anticipates the potential for wheel lift by monitoring the driver's steering wheel input and the speed of the vehicle. When ERM determines that the rate of change of the steering wheel angle and vehicle speed are sufficient to potentially cause wheel lift, it applies the appropriate brake and may reduce engine power to lessen the chance that wheel lift will occur. ERM will only intervene during very severe or evasive driving maneuvers. ERM can only reduce the chance of wheel lift occurring during severe or evasive driving maneuvers. It can not prevent wheel lift due to other factors such as road conditions, leaving the roadway, striking objects and/or other vehicles.

WARNING!

Many factors, such as vehicle loading, road conditions and driving conditions, influence the chance that wheel lift or rollover may occur. ERM cannot prevent all wheel lift or rollovers, especially those that involve leaving the roadway or striking objects or other vehicles. Only a safe, attentive, and skillful driver can prevent accidents. The capabilities of an ERM-equipped vehicle must never be exploited in a reckless or dangerous manner which could jeopardize the user's safety or the safety of others.

Electronic Stability Program (ESP)

This system enhances directional control and stability of the vehicle under various driving conditions. ESP corrects for over/under steering of the vehicle by applying the brake of the appropriate wheel to assist in counteracting the over/under steer condition. Engine power may also be reduced to help the vehicle maintain the desired path.

ESP uses sensors in the vehicle to determine the vehicle path intended by the driver and compares it to the actual path of the vehicle. When the actual path does not match the intended path, ESP applies the brake of the appropriate wheel to assist in counteracting the oversteer or understeer condition.

- Oversteer - when the vehicle is turning more than appropriate for the steering wheel position.
- Understeer - when the vehicle is turning less than appropriate for the steering wheel position.

ESP/TCS Indicator Light



The "ESP/TCS Indicator Light" located in the instrument cluster, starts to flash as soon as the tires lose traction and the ESP system becomes active. The "ESP/TCS Indicator Light" also flashes when TCS is active. If the "ESP/TCS Indicator Light" begins to flash during acceleration, ease up on the accelerator and apply as little throttle as possible. Be sure to adapt your speed and driving to the prevailing road conditions.

WARNING!

The Electronic Stability Program (ESP) cannot prevent the natural laws of physics from acting on the vehicle, nor can it increase the traction afforded by prevailing road conditions. ESP cannot prevent accidents, including those resulting from excessive speed in turns, driving on very slippery surfaces, or hydroplaning. Only a safe, attentive, and skillful driver can prevent accidents. The capabilities of an ESP-equipped vehicle must never be exploited in a reckless or dangerous manner which could jeopardize the user's safety or the safety of others.

The ESP system has two available operating modes in 2WD, 4WD Part Time, 4WD Full Time, and on 2WD vehicles.

ESP On

This is the normal operating mode for ESP in 2WD, 4WD Part Time, 4WD Full Time, and on 2WD vehicles. Whenever the vehicle is started, the ESP system will be in this mode. This mode should be used for most all driving situations. ESP should only be turned off for specific reasons as noted below.

Partial Off

This mode is entered by momentarily pressing the ESP OFF switch (located in the center stack lower switch bank). When in "Partial Off" mode, the TCS portion of ESP, except for the "limited slip" feature described in the TCS section, has been disabled and the "ESP/TCS Indicator Light" will be illuminated. All other stability features of ESP function normally. This mode is intended to be used if the vehicle is in deep snow, sand or gravel conditions and more wheel spin than ESP would normally allow is required to gain traction. To turn ESP on

again, momentarily press the ESP OFF switch. This will restore the normal “ESP ON” mode of operation.

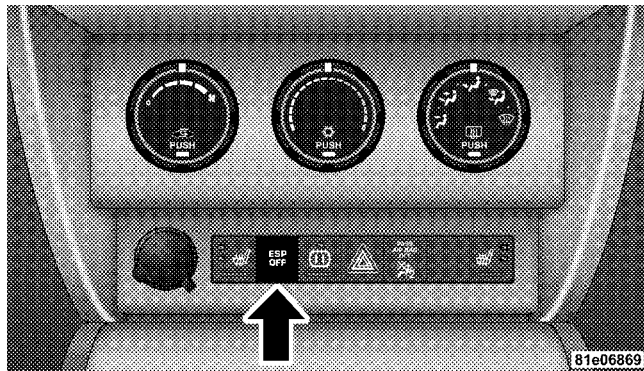

ESP Off Switch

NOTE: To improve the vehicle’s traction when driving with snow chains, or starting off in deep snow, sand or gravel, it may be desirable to switch to the “Partial Off” mode by pressing the ESP OFF switch. Once the situation

requiring ESP to be switched to the “Partial Off” mode is overcome, turn ESP back on by briefly pressing the ESP OFF switch. This may be done while the vehicle is in motion.

ESP/BAS Warning Lamp

ESP BAS

The malfunction indicator lamp for the ESP is combined with BAS. The “ESP/BAS Warning Lamp” and the “ESP/TCS Indicator Light” in the instrument cluster both come on when the ignition switch is turned to the ON position. They should go out with the engine running. If the “ESP/BAS Warning Lamp” comes on continuously with the engine running, a malfunction has been detected in either the ESP or the BAS system. If this lamp remains on after several ignition cycles, and the vehicle has been driven several miles at speeds greater than 30 mph (48 km/h), see your authorized dealer as soon as possible to have the problem diagnosed and corrected.

NOTE:

- The "ESP/TCS Indicator Light" and the "ESP/BAS Warning Lamp" come on momentarily each time the ignition switch is turned ON.
- Each time the ignition is turned ON, the ESP System will be on even if it was turned off previously.
- The ESP Control System will make buzzing or clicking sounds when it is active. This is normal; the sounds will stop when ESP becomes inactive following the maneuver that caused the ESP activation.

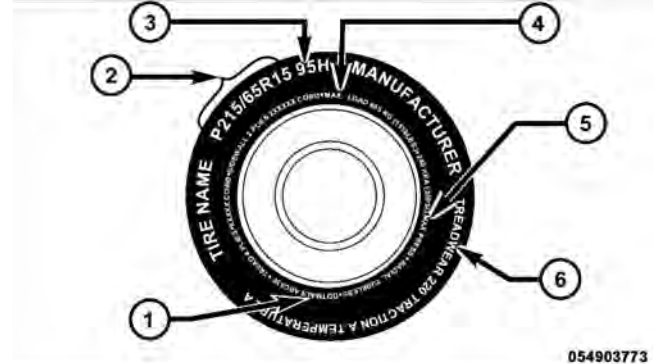
TIRE SAFETY INFORMATION**Tire Markings**

054903773

1 — U.S. DOT Safety Standards Code (TIN)

2 — Size Designation

3 — Service Description

4 — Maximum Load

5 — Maximum Pressure

6 — Treadwear, Traction and Temperature Grades

NOTE:

- P (Passenger) - Metric tire sizing is based on U.S. design standards. P-Metric tires have the letter "P" molded into the sidewall preceding the size designation. Example: P215/65R15 95H.
- European-Metric tire sizing is based on European design standards. Tires designed to this standard have the tire size molded into the sidewall beginning with the section width. The letter "P" is absent from this tire size designation. Example: 215/65R15 96H.
- LT (Light Truck) - Metric tire sizing is based on U.S. design standards. The size designation for LT-Metric tires is the same as for P-Metric tires except for the letters "LT" that are molded into the sidewall preceding the size designation. Example: LT235/85R16.
- Temporary spare tires are high-pressure compact spares designed for temporary emergency use only. Tires designed to this standard have the letter "T" molded into the sidewall preceding the size designation. Example: T145/80D18 103M.
- High flotation tire sizing is based on U.S. design standards and it begins with the tire diameter molded into the sidewall. Example: 31x10.5 R15 LT.

Tire Sizing Chart

EXAMPLE:	
Size Designation:	
P	= Passenger car tire size based on U.S. design standards
"...blank..."	= Passenger car tire based on European design standards
LT	= Light truck tire based on U.S. design standards
T	= Temporary spare tire
31	= Overall diameter in inches (in)
215	= Section width in millimeters (mm)
65	= Aspect ratio in percent (%) — Ratio of section height to section width of tire
10.5	= Section width in inches (in)
R	= Construction code — "R" means radial construction — "D" means diagonal or bias construction
15	= Rim diameter in inches (in)

EXAMPLE:**Service Description:**

95 = Load Index

— A numerical code associated with the maximum load a tire can carry

H = Speed Symbol

— A symbol indicating the range of speeds at which a tire can carry a load corresponding to its load index under certain operating conditions

— The maximum speed corresponding to the speed symbol should only be achieved under specified operating conditions (i.e., tire pressure, vehicle loading, road conditions, and posted speed limits)

Load Identification:

"...**blank**..." = Absence of any text on the sidewall of the tire indicates a Standard Load (SL) tire

Extra Load (XL) = Extra load (or reinforced) tire

Light Load = Light load tire

C, D, E = Load range associated with the maximum load a tire can carry at a specified pressure

Maximum Load — Maximum load indicates the maximum load this tire is designed to carry

Maximum Pressure — Maximum pressure indicates the maximum permissible cold tire inflation pressure for this tire

Tire Identification Number (TIN)

The TIN may be found on one or both sides of the tire, however, the date code may only be on one side. Tires with white sidewalls will have the full TIN, including the date code, located on the white sidewall side of the tire.

Look for the TIN on the outboard side of black sidewall tires as mounted on the vehicle. If the TIN is not found on the outboard side, then you will find it on the inboard side of the tire.

EXAMPLE:

DOT MA L9 ABCD 0301

DOT = Department of Transportation

— This symbol certifies that the tire is in compliance with the U.S. Department of Transportation tire safety standards and is approved for highway use

MA = Code representing the tire manufacturing location (two digits)

L9 = Code representing the tire size (two digits)

ABCD = Code used by the tire manufacturer (one to four digits)

03 = Number representing the week in which the tire was manufactured (two digits)

—03 means the 3rd week.

01 = Number representing the year in which the tire was manufactured (two digits)

—01 means the year 2001

— Prior to July 2000, tire manufacturers were only required to have one number to represent the year in which the tire was manufactured. Example: 031 could represent the 3rd week of 1981 or 1991

Tire Terminology and Definitions

Term	Definition
Accessory Weight	This means the combined weight of optional accessories. Some examples of optional accessories are automatic transmission, power steering, power brakes, power windows, power seats, and air conditioning.
Air Pressure	The amount of air inside the tire pressing outward on each square inch of the tire. Air pressure is expressed in pounds per square inch (psi) or kilopascal (kPa).
Bead	The tire bead contains steel wires wrapped by steel cords that hold the tire onto the rim.
Bias Ply Tire	A pneumatic tire in which the plies are laid at alternate angles less 90 degrees to the centerline of the tread.
Cold Tire Pressure	The amount of air pressure in a tire, measured in pounds per square inch (psi) or kilopascal (kPa) before a tire has built up heat from driving.
Curb Weight	The weight of a motor vehicle with standard and optional equipment including the maximum capacity of fuel, oil, and coolant, but without passengers and cargo.

Term	Definition
Light Truck (LT-Metric) Tire	A tire used on light duty trucks and some multipurpose passenger vehicles.
Maximum Inflation Pressure	The maximum air pressure to which a cold tire can be inflated. The maximum air pressure is molded onto the sidewall.
Maximum Load Rating	The load rating for a tire at the maximum permissible inflation pressure for that tire.
Maximum Loaded Vehicle Weight	The sum of curb weight, accessory weight, vehicle capacity weight, and production options weight.
Normal Occupant Weight	The number of occupants a vehicle is designed to seat multiplied by 150 lbs (68 kg).
Occupant Distribution	Designated seating positions.
Passenger (P-Metric) Tire	A tire used on passenger cars and some light duty trucks and multipurpose vehicles.
Radial Ply Tire	A pneumatic tire in which the ply cords that extend to the beads are laid at 90 degrees to the centerline of the tread.
Recommended Inflation Pressure	Vehicle manufacturer's recommended tire inflation pressure as shown on the tire placard.

Term	Definition
Rim	A metal support for a tire and upon which the beads are seated.
Sidewall	The portion of a tire between the tread and the bead.
Tread	The portion of a tire that comes into contact with the road.
Treadwear Indicators	Narrow bands, sometimes called wear bars, that show across the tread of a tire when only 1/16 inch (1.6 mm) of tread remains.
Vehicle Capacity Weight	The number of designated seating positions multiplied by 150 lbs (68 kg) plus the rated cargo load.
Vehicle Maximum Load on the Tire	Load on a individual tire due to curb weight, accessory weight, occupant weight, and cargo weight.

Tire Loading and Tire Pressure

Tire Placard Location

NOTE: The proper cold tire inflation pressure is listed on the driver's side B-Pillar.

Tire and Loading Information Placard

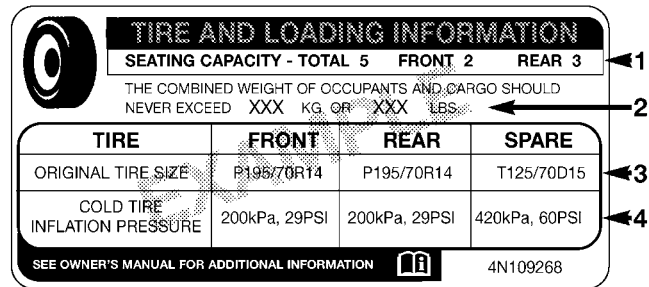

TIRE AND LOADING INFORMATION

SEATING CAPACITY - TOTAL 5 FRONT 2 REAR 3

THE COMBINED WEIGHT OF OCCUPANTS AND CARGO SHOULD NEVER EXCEED XXX KG OR XXX LBS.

TIRE	FRONT	REAR	SPARE
ORIGINAL TIRE SIZE	P195/70R14	P195/70R14	T125/70D15
COLD TIRE INFLATION PRESSURE	200kPa, 29PSI	200kPa, 29PSI	420kPa, 60PSI

SEE OWNER'S MANUAL FOR ADDITIONAL INFORMATION  4N109268

811b5a9a

Tire and Loading Information Placard

This placard tells you important information about the:

- 1) number of people that can be carried in the vehicle
- 2) total weight your vehicle can carry
- 3) tire size designed for your vehicle
- 4) cold tire inflation pressures for the front, rear, and spare tires.

Loading

The vehicle maximum load on the tire must not exceed the load carrying capacity of the tire on your vehicle. You will not exceed the tire's load carrying capacity if you adhere to the loading conditions, tire size, and cold tire inflation pressures specified on the Tire and Loading Information placard and in the "Vehicle Loading" section of this manual.

NOTE: Under a maximum loaded vehicle condition, gross axle weight ratings (GAWRs) for the front and rear axles must not be exceeded. For further information on GAWRs, vehicle loading, and trailer towing, refer to “Vehicle Loading” in this section.

To determine the maximum loading conditions of your vehicle, locate the statement “The combined weight of occupants and cargo should never exceed XXX lbs or XXX kg” on the Tire and Loading Information placard. The combined weight of occupants, cargo/luggage and trailer tongue weight (if applicable) should never exceed the weight referenced here.

Steps for Determining Correct Load Limit

1. Locate the statement “The combined weight of occupants and cargo should never exceed XXX lbs or XXX kg” on your vehicle’s placard.
2. Determine the combined weight of the driver and passengers that will be riding in your vehicle.
3. Subtract the combined weight of the driver and passengers from XXX lbs or XXX kg.
4. The resulting figure equals the available amount of cargo and luggage load capacity. For example, if “XXX” amount equals 1,400 lbs (635 kg) and there will be five 150 lb (68 kg) passengers in your vehicle, the amount of available cargo and luggage load capacity is 650 lbs (295 kg) (since $5 \times 150 = 750$, and $1400 - 750 = 650$ lbs [295 kg]).

5. Determine the combined weight of luggage and cargo being loaded on the vehicle. That weight may not safely exceed the available cargo and luggage load capacity calculated in Step 4.
6. If your vehicle will be towing a trailer, load from your trailer will be transferred to your vehicle. Consult this manual to determine how this reduces the available cargo and luggage load capacity of your vehicle.

NOTE:

- The following table shows examples on how to calculate total load, cargo/luggage, and towing capacities of your vehicle with varying seating configurations and number and size of occupants. This table is for illustration purposes only and may not be accurate for the seating and load carry capacity of your vehicle.
- For the following example, the combined weight of occupants and cargo should never exceed 865 lbs (392 kg).

Occupants			Combined weight of occupants and cargo from Tire Placard	MINUS	Combined Occupant's weight	=	AVAILABLE Cargo/Luggage and Trailer Tongue Weight
TOTAL	FRONT	REAR					
<u>EXAMPLE 1</u>							
5	2	3	↓ 865 lbs	minus	Occupant 1: 200 lbs Occupant 2: 130 lbs Occupant 3: 160 lbs Occupant 4: 100 lbs Occupant 5: 80 lbs TOTAL WEIGHT: 670 lbs 670 lbs	=	↓ 195 lbs
<u>EXAMPLE 2</u>							
3	2	1	865 lbs	minus	Occupant 1: 210 lbs Occupant 2: 180 lbs Occupant 3: 150 lbs TOTAL WEIGHT: 540 lbs 540 lbs	=	325 lbs
<u>EXAMPLE 3</u>							
2	2	0	865 lbs	minus	Occupant 1: 200 lbs Occupant 2: 200 lbs TOTAL WEIGHT: 400 lbs 400 lbs	=	465 lbs

WARNING!

Overloading of your tires is dangerous. Overloading can cause tire failure, affect vehicle handling, and increase your stopping distance. Use tires of the recommended load capacity for your vehicle. Never overload them.

TIRES — GENERAL INFORMATION**Tire Pressure**

Proper tire inflation pressure is essential to the safe and satisfactory operation of your vehicle. Three primary areas are affected by improper tire pressure:

Safety**WARNING!**

- Improperly inflated tires are dangerous and can cause accidents.
- Under-inflation increases tire flexing and can result in over-heating and tire failure.
- Over-inflation reduces a tire's ability to cushion shock. Objects on the road and chuckholes can cause damage that result in tire failure.
- Unequal tire pressures can cause steering problems. You could lose control of your vehicle.
- Over-inflated or under-inflated tires can affect vehicle handling and can fail suddenly, resulting in loss of vehicle control.

(Continued)

WARNING! (Continued)

- Unequal tire pressures from one side of the vehicle to the other can cause the vehicle to drift to the right or left.
- Always drive with each tire inflated to the recommended cold tire inflation pressure.

Economy

Improper inflation pressures can cause uneven wear patterns to develop across the tire tread. These abnormal wear patterns will reduce tread life resulting in a need for earlier tire replacement. Under-inflation also increases tire rolling resistance and results in higher fuel consumption.

Ride Comfort and Vehicle Stability

Proper tire inflation contributes to a comfortable ride. Over-inflation produces a jarring and uncomfortable ride. Both under-inflation and over-inflation affect the

stability of the vehicle and can produce a feeling of sluggish response or over responsiveness in the steering.

Unequal tire pressures can cause erratic and unpredictable steering response.

Unequal tire pressure from side to side may cause the vehicle to drift left or right.

Tire Inflation Pressures

The proper cold tire inflation pressure is listed on the driver's side "B" Pillar.

The pressure should be checked and adjusted, as well as inspected for signs of tire wear or visible damage, at least once a month. Use a good quality pocket-type gauge to check tire pressure. Do not make a visual judgement when determining proper inflation. Radial tires may look properly inflated even when they are under-inflated.

CAUTION!

After inspecting or adjusting the tire pressure, always reinstall the valve stem cap. This will prevent moisture and dirt from entering the valve stem, which could damage it.

Inflation pressures specified on the placard are always cold tire inflation pressure. Cold tire inflation pressure is defined as the tire pressure after the vehicle has not been driven for at least three hours, or driven less than 1 mile (1.6 km) after a three-hour period. The cold tire inflation pressure must not exceed the maximum inflation pressure molded into the tire sidewall.

Check tire pressures more often if subject to a wide range of outdoor temperatures, as tire pressures vary with temperature changes.

Tire pressures change by approximately 1 psi (7 kPa) per 12°F (7°C) of air temperature change. Keep this in mind when checking tire pressure inside a garage, especially in the winter.

Example: If garage temperature = 68°F (20°C) and the outside temperature = 32°F (0°C) then the cold tire inflation pressure should be increased by 3 psi (21 kPa), which equals 1 psi (7 kPa) for every 12°F (7°C) for this outside temperature condition.

Tire pressure may increase from 2 to 6 psi (13 to 40 kPa) during operation. DO NOT reduce this normal pressure build-up, or your tire pressure will be too low.

Tire Pressures For High Speed Operation

The manufacturer advocates driving at safe speeds within posted speed limits. Where speed limits or conditions are such that the vehicle can be driven at high speeds, maintaining correct tire inflation pressure is very important. Increased tire pressure and reduced vehicle

loading may be required for high-speed vehicle operation. Refer to original equipment or an authorized tire dealer for recommended safe operating speeds, loading and cold tire inflation pressures.

WARNING!

High speed driving with your vehicle at or above maximum load is dangerous. The added strain on your tires could cause them to fail. You could have a serious accident. Do not drive a vehicle loaded to the maximum capacity at continuous speeds above 75 mph (120 km/h).

Radial-Ply Tires**WARNING!**

Combining radial ply tires with other types of tires on your vehicle will cause your vehicle to handle poorly. The instability could cause an accident. Always use radial tires in sets of four. Never combine them with other types of tires.

Cuts and punctures in radial tires are repairable only in the tread area because of sidewall flexing. Consult your authorized dealer for radial tire repairs.

Compact Spare Tire – If Equipped

The compact spare is for temporary emergency use with radial tires. It is engineered to be used on your style vehicle only. Since this tire has limited tread life, the original tire should be repaired (or replaced) and reinstalled at the first opportunity.

WARNING!

Temporary use spare tires are for emergency use only. With these tires, do not drive more than 50 mph (80 km/h). Temporary use spare tires have limited tread life. When the tread is worn to the tread wear indicators, the temporary use spare tire needs to be replaced. Be sure to follow the warnings, which apply to your spare. Failure to do so could result in spare tire failure and loss of vehicle control.

Do not install a wheel cover or attempt to mount a conventional tire on the compact spare wheel, since the wheel is designed specifically for the compact spare.

Do not install more than one compact spare tire/wheel on the vehicle at any given time.

CAUTION!

Because of the reduced ground clearance, do not take your vehicle through an automatic car wash with the compact spare installed. Damage to the vehicle may result.

Tire Spinning

When stuck in mud, sand, snow, or ice conditions, do not spin your vehicle's wheels above 30 mph (48 km/h).

WARNING!

Fast spinning tires can be dangerous. Forces generated by excessive wheel speeds may cause tire damage or failure. A tire could explode and injure someone. Do not spin your vehicle's wheels faster than 30 mph (48 km/h) when you are stuck, and do not let anyone near a spinning wheel no matter what the speed.

Tread Wear Indicators

Tread wear indicators are in the original equipment tires to help you in determining when your tires should be replaced.

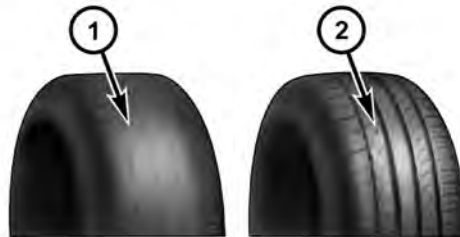

055007576

- 1 — Worn Tire
2 — New Tire

These indicators are molded into the bottom of the tread grooves. They will appear as bands when the tread depth becomes 1/16 in (2 mm). When the tread is worn to the tread wear indicators, the tire should be replaced.

CAUTION!

Proper operation of four-wheel drive vehicles depends on tires of equal size, type and circumference on each wheel. Any difference in tire size can cause damage to the transfer case. Tire rotation schedule should be followed to balance tire wear.

WARNING!

Tires and the spare tire should be replaced after six years, regardless of the remaining tread. Failure to follow this warning can result in sudden tire failure. You could lose control and have an accident resulting in serious injury or death.

Life Of Tire

The service life of a tire is dependent upon various factors including but not limited to:

- Driving style
- Tire pressure
- Distance driven

Keep dismantled tires in a cool, dry place with as little exposure to light as possible. Protect tires from contact with oil, grease, and gasoline.

Replacement Tires

The tires on your new vehicle provide a balance of many characteristics. They should be inspected regularly for wear and correct cold tire inflation pressure. The manufacturer strongly recommends that you use tires equivalent to the originals in size, quality and performance when replacement is needed. (Refer to the paragraph on "Tread Wear Indicators"). Refer to the "Tire and Loading

Information” placard for the size designation of your tires. The service description and load identification will be found on the original equipment tire. Failure to use equivalent replacement tires may adversely affect the safety, handling, and ride of your vehicle. We recommend that you contact your original equipment or an authorized tire dealer with any questions you may have on tire specifications or capability.

WARNING!

- **Do not use a tire, wheel size or rating other than that specified for your vehicle. Some combinations of unapproved tires and wheels may change suspension dimensions and performance characteristics, resulting in changes to steering, handling, and braking of your vehicle. This can cause unpredictable handling and stress to steering and suspension components. You could lose control and have an accident resulting in serious injury or death. Use only the tire and wheel sizes with load ratings approved for your vehicle.**
- **Never use a tire with a smaller load index or capacity than what was originally equipped on your vehicle. Using a tire with a smaller load index could result in tire overloading and failure. You could lose control and have an accident.**

(Continued)

WARNING! (Continued)

- Failure to equip your vehicle with tires having adequate speed capability can result in sudden tire failure and loss of vehicle control.

CAUTION!

Replacing original tires with tires of a different size may result in false speedometer and odometer readings.

TIRE CHAINS

Use "Class S" chains or other traction aids that meet SAE Type "S" specifications.

NOTE: Chains must be the proper size for the vehicle as recommended by the chain manufacturer.

CAUTION!

To avoid damage to your vehicle, tires or chains, observe the following precautions:

- Because of limited chain clearance between tires and other suspension components, it is important that only chains in good condition are used. Broken chains can cause serious vehicle damage. Stop the vehicle immediately if noise occurs that could suggest chain breakage. Remove the damaged parts of the chain before further use.
- Install chains as tightly as possible and then retighten after driving about 1/2 mile (0.8 km).
- Do not exceed 45 mph (72 km/h).
- Drive cautiously and avoid severe turns and large bumps, especially with a loaded vehicle.
- Do not drive for a prolonged period on dry pavement.

(Continued)

CAUTION! (Continued)

- Observe the tire chain manufacturer's instructions on method of installation, operating speed, and conditions for usage. Always use the lower suggested operating speed of the chain manufacturer if different than the speed recommended by the manufacturer.

These cautions apply to all chain traction devices, including link and cable (radial) chains.

Tire chain use is permitted only on the rear tires.

NOTE: The use of class "S" chains is permitted with P235/65R17 and P225/75R16 tires.

CAUTION!

Do not use tire chains on vehicles equipped with tires other than P235/65R17 and P225/75R16 tires. There may not be adequate clearance for the chains and you are risking structural or body damage to your vehicle.

TIRE ROTATION RECOMMENDATIONS

Tires on the front and rear axles of vehicles operate at different loads and perform different steering, handling, and braking functions. For these reasons, they wear at unequal rates and develop irregular wear patterns.

These effects can be reduced by timely rotation of tires. The benefits of rotation are especially worthwhile with aggressive tread designs such as those on On/Off-Road type tires. Rotation will increase tread life, help to maintain mud, snow, and wet traction levels, and contribute to a smooth, quiet ride.

CAUTION!

Proper operation of four-wheel drive vehicles depends on tires of equal size, type and circumference on each wheel. Any difference in tire size can cause damage to the transfer case. Tire rotation schedule should be followed to balance tire wear.

Refer to “Maintenance Schedule” for the proper maintenance intervals. More frequent rotation is permissible if desired. The reasons for any rapid or unusual wear should be corrected prior to rotation being performed.

NOTE: The premium Tire Pressure Monitor System will automatically locate the pressure values displayed in the correct vehicle position following a tire rotation.

The suggested rotation method is the “forward-cross” shown in the following diagram.

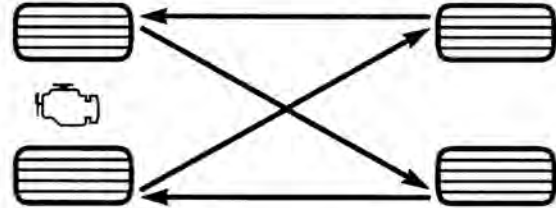

055703771

Tire Rotation**TIRE PRESSURE MONITOR SYSTEM (TPMS)**

The Tire Pressure Monitor System (TPMS) will warn the driver of a low tire pressure based on the vehicle recommended cold placard pressure.

The tire pressure will vary with temperature by about 1 psi (6.9 kPa) for every 12°F (6.5°C). This means that when the outside temperature decreases, the tire pressure will decrease. Tire pressure should always be set based on cold inflation tire pressure. This is defined as the tire pressure after the vehicle has not been driven for at least three hours, or driven less than 1 mile (1.6 km) after a three hour period. The cold tire inflation pressure must not exceed the maximum inflation pressure molded into the tire sidewall. Refer to “Tires – General Information” in “Starting and Operating” for information on how to properly inflate the vehicle’s tires. The tire pressure will also increase as the vehicle is driven. This is normal and there should be no adjustment for this increased pressure.

The TPMS will warn the driver of a low tire pressure if the tire pressure falls below the low-pressure warning limit for any reason, including low temperature effects and natural pressure loss through the tire.

The TPMS will continue to warn the driver of low tire pressure as long as the condition exists, and will not turn off until the tire pressure is at or above the recommended cold placard pressure. Once the low tire pressure warning (Tire Pressure Monitoring Telltale Light) illuminates, you must increase the tire pressure to the recommended cold placard pressure in order for the “Tire Pressure Monitoring Telltale Light” to turn off. The system will automatically update and the “Tire Pressure Monitoring Telltale Light” will turn off once the system receives the updated tire pressures. The vehicle may need to be driven for up to 20 minutes above 15 mph (25 km/h) in order for the TPMS to receive this information.

For example, your vehicle may have a recommended cold (parked for more than three hours) placard pressure of 33 psi (227 kPa). If the ambient temperature is 68°F (20°C) and the measured tire pressure is 28 psi (193 kPa), a temperature drop to 20°F (-7°C) will decrease the tire pressure to approximately 24 psi (165 kPa). This tire pressure is low enough to turn ON the “Tire Pressure Monitoring Telltale Light.” Driving the vehicle may cause the tire pressure to rise to approximately 28 psi (193 kPa), but the “Tire Pressure Monitoring Telltale Light” will still be on. In this situation, the “Tire Pressure Monitoring Telltale Light” will turn off only after the tires are inflated to the vehicle’s recommended cold placard pressure value.

CAUTION!

- The TPMS has been optimized for the original equipment tires and wheels. TPMS pressures and warning have been established for the tire size equipped on your vehicle. Undesirable system operation or sensor damage may result when using replacement equipment that is not of the same size, type, and/or style. Aftermarket wheels can cause sensor damage. Do not use aftermarket tire sealants or balance beads if your vehicle is equipped with a TPMS, as damage to the sensors may result.
- After inspecting or adjusting the tire pressure, always reinstall the valve stem cap. This will prevent moisture and dirt from entering the valve stem, which could damage the Tire Pressure Monitoring Sensor.

NOTE:

- The TPMS is not intended to replace normal tire care and maintenance, or to provide warning of a tire failure or condition.
- The TPMS should not be used as a tire pressure gauge while adjusting your tire pressure.
- Driving on a significantly under-inflated tire causes the tire to overheat and can lead to tire failure. Under-inflation also reduces fuel efficiency and tire tread life, and may affect the vehicle's handling and stopping ability.
- The TPMS is not a substitute for proper tire maintenance, and it is the driver's responsibility to maintain correct tire pressure using an accurate tire pressure gauge, even if under-inflation has not reached the level to trigger illumination of the "Tire Pressure Monitoring Telltale Light."

- Seasonal temperature changes will affect tire pressure, and the TPMS will monitor the actual tire pressure in the tire.

Base System

The Tire Pressure Monitor System (TPMS) uses wireless technology with wheel rim mounted electronic sensors to monitor tire pressure levels. Sensors, mounted to each wheel as part of the valve stem, transmit tire pressure readings to the receiver module.

NOTE: It is particularly important for you to check the tire pressure in all of the tires on your vehicle monthly and to maintain the proper pressure.

The TPMS consists of the following components:

- Receiver Module
- Four Tire Pressure Monitoring Sensors
- Tire Pressure Monitoring Telltale Light

The matching full-size spare wheel and tire assembly (if equipped) has a tire pressure monitoring sensor. The matching full-size spare can be used in place of any of the four road tires. The TPMS will only monitor the pressure in the full-size spare when it is used in place of a road tire. Otherwise, a spare with a pressure below the low-pressure limit will not cause the “Tire Pressure Monitoring Telltale Light” to illuminate or the chime to sound.

Tire Pressure Monitoring Low Pressure Warnings



The “Tire Pressure Monitoring Telltale Light” will illuminate in the instrument cluster and a chime will sound when tire pressure is low in one or more of the four active road tires. Should this occur, you should stop as soon as possible, check the inflation pressure of each tire on your vehicle, and inflate each tire to the vehicle’s recommended cold placard pressure value. Once the system receives the updated tire pressures, the system will automatically update and the “Tire Pressure Monitoring Telltale Light” will turn off. The

vehicle may need to be driven for up to 20 minutes above 15 mph (25 km/h) in order for the TPMS to receive this information.

Check TPMS Warning

When a system fault is detected, the “Tire Pressure Monitoring Telltale Light” will flash on and off for 75 seconds and then remain on solid. The system fault will also sound a chime. If the ignition key is cycled, this sequence will repeat, providing the system fault still exists. The “Tire Pressure Monitoring Telltale Light” will turn off when the fault condition no longer exists. A system fault can occur due to any of the following:

1. Jamming due to electronic devices or driving next to facilities emitting the same radio frequencies as the TPMS sensors.
2. Installing some form of aftermarket window tinting that affects radio wave signals.

3. Lots of snow or ice around the wheels or wheel housings.
4. Using tire chains on the vehicle.
5. Using wheels/tires not equipped with TPMS sensors.

Vehicles with Full-Size Spare

1. The matching full-size spare wheel and tire assembly has a tire pressure monitoring sensor that can be monitored by the TPMS.
2. If you install the full-size spare in place of a road tire that has a pressure below the low-pressure warning limit, a chime will sound and the “TPMS Telltale Light” will turn on upon the next ignition key cycle.
3. Driving the vehicle for up to 20 minutes above 15 mph (25 km/h) will turn off the “TPMS Telltale Light,” as long as no tire pressure is below the low-pressure warning limit in any of the four active road tires.

Vehicles with Compact Spare

1. The compact spare tire does not have a tire pressure monitoring sensor. Therefore, the TPMS will not monitor the pressure in the compact spare tire.
2. If you install the compact spare tire in place of a road tire that has a pressure below the low-pressure warning limit, a chime will sound and the “TPMS Telltale Light” will turn on upon the next ignition key cycle.
3. After driving the vehicle for up to 20 minutes above 15 mph (25 km/h), the “TPMS Telltale Light” will flash on and off for 75 seconds and then remain on solid.
4. For each subsequent ignition key cycle, a chime will sound and the “TPMS Telltale Light” will flash on and off for 75 seconds and then remain on solid.
5. Once you repair or replace the original road tire and reinstall it on the vehicle in place of the compact spare, the TPMS will update automatically and the “TPMS

Telltale Light” will turn off, as long as no tire pressure is below the low-pressure warning limit in any of the four active road tires. The vehicle may need to be driven for up to 20 minutes above 15 mph (25 km/h) in order for the TPMS to receive this information.

Premium System – If Equipped

The Tire Pressure Monitor System (TPMS) uses wireless technology with wheel rim mounted electronic sensors to monitor tire pressure levels. Sensors, mounted to each wheel as part of the valve stem, transmit tire pressure readings to the receiver module.

NOTE: It is particularly important for you to check the tire pressure in all of the tires on your vehicle monthly and to maintain the proper pressure.

The TPMS consists of the following components:

- Receiver Module

- Four Tire Pressure Monitoring Sensors
- Three Trigger Modules (mounted in three of the four wheel-wells)
- Various Tire Pressure Monitoring System messages, which display in the Electronic Vehicle Information Center (EVIC)
- Tire Pressure Monitoring Telltale Light

The matching full size spare wheel and tire assembly (if equipped) has a tire pressure monitoring sensor. The full size spare can be used in place of any of the four road tires. A spare with a pressure below the low-pressure limit will not cause the “Tire Pressure Monitoring Telltale Light” to illuminate or the chime to sound. However, it will cause a “SPARE LOW PRESSURE” message to display in the EVIC.

Tire Pressure Monitoring Low Pressure Warnings



The “Tire Pressure Monitoring Telltale Light” will illuminate in the instrument cluster and a chime will sound when tire pressure is low in one or more of the four active road tires. In addition, the Electronic Vehicle Information Center (EVIC) will display a graphic showing the pressure values of each tire with the low tire pressure values flashing.

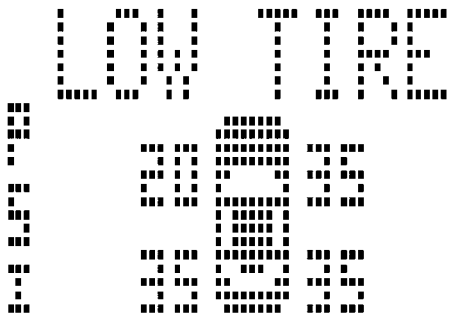

81826bed

Should this occur, you should stop as soon as possible and inflate the tires with low pressure (those flashing in the EVIC graphic) to the vehicle’s recommended cold placard pressure value. Once the system receives the updated tire pressures, the system will automatically update, the graphic display in the EVIC will stop flashing, and the “Tire Pressure Monitoring Telltale Light” will turn off. The vehicle may need to be driven for up to 20 minutes above 15 mph (25 km/h) in order for the TPMS to receive this information.

Check TPMS Warning

When a system fault is detected, the “Tire Pressure Monitoring Telltale Light” will flash on and off for 75 seconds and then remain on solid. The system fault will also sound a chime. In addition, the EVIC will display a “CHECK TPM SYSTEM” message for three seconds and then display dashes (- -) in place of the pressure value to indicate which sensor is not being received.

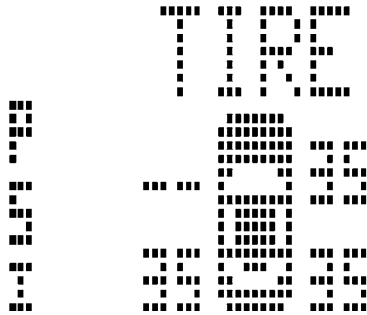

81826bd7

If the ignition key is cycled, this sequence will repeat, providing the system fault still exists. If the system fault no longer exists, the "Tire Pressure Monitoring Telltale Light" will no longer flash, and the "CHECK TPM SYSTEM" message will no longer display, and a pressure value will display in place of the dashes. A system fault can occur due to any of the following:

1. Jamming due to electronic devices or driving next to facilities emitting the same radio frequencies as the TPMS sensors.
2. Installing some form of aftermarket window tinting that affects radio wave signals.
3. Lots of snow or ice around the wheels or wheel housings.
4. Using tire chains on the vehicle.
5. Using wheels/tires not equipped with TPMS sensors.

Vehicles with Full-Size Spare

1. The matching full size spare wheel and tire assembly has a tire pressure monitoring sensor that can be monitored by the TPMS.
2. If you install the full size spare in place of a road tire that has a pressure below the low-pressure warning limit, a chime will sound and the "TPMS Telltale Light" will

turn on upon the next ignition key cycle. In addition, the EVIC will display a Low Pressure message and a graphic showing the low tire pressure value flashing.

3. After driving the vehicle for up to 20 minutes above 15 mph (25 km/h) the "TPMS Telltale Light" will turn OFF, as long as no tire pressure is below the low-pressure warning limit in any of the four active road tires.

4. The EVIC will display a graphic showing the tire pressure value in place of the flashing low tire pressure value. The EVIC will also display a "SPARE LOW PRESSURE" message to remind you to service the flat tire.

Vehicles with Compact Spare

1. The compact spare tire does not have a tire pressure monitoring sensor. Therefore, the TPMS will not monitor the pressure in the compact spare tire.

2. If you install the compact spare tire in place of a road tire that has a pressure below the low-pressure warning limit, upon the next ignition key cycle, the "TPMS Telltale Light" will remain on and a chime will sound. In addition, the graphic in the EVIC will still display a flashing pressure value.

3. After driving the vehicle for up to 20 minutes above 15 mph (25 km/h), the "TPMS Telltale Light" will flash on and off for 75 seconds and then remain on solid. In addition, the EVIC will display a "CHECK TPM SYSTEM" message for three seconds and then display dashes (- -) in place of the pressure value.

4. For each subsequent ignition key cycle, a chime will sound, the "TPMS Telltale Light" will flash on and off for 75 seconds and then remain on solid, and the EVIC will display a "CHECK TPM SYSTEM" message for three seconds and then display dashes (- -) in place of the pressure value.

5. Once you repair or replace the original road tire and reinstall it on the vehicle in place of the compact spare, the TPMS will update automatically. In addition, the “TPMS Telltale Light” will turn off and the graphic in the EVIC will display a new pressure value instead of dashes (- -), as long as no tire pressure is below the low-pressure warning limit in any of the four active road tires. The vehicle may need to be driven for up to 20 minutes above 15 mph (25 km/h) in order for the TPMS to receive this information.

General Information

This device complies with Part 15 of the FCC rules and RSS 210 of Industry Canada. Operation is subject to the following conditions:

- This device may not cause harmful interference.
- This device must accept any interference received, including interference that may cause undesired operation.

The tire pressure sensors are covered under one of the following licenses:

United States	KR5S120123
Canada	2671-S120123

FUEL REQUIREMENTS

3.7L Engine



All engines are designed to meet all emissions regulations and provide excellent fuel economy and performance when using high quality unleaded “regular” gasoline having an octane rating of 87. The use of premium gasoline is not recommended, as it will not provide any benefit over regular gasoline in these engines.

4.0L Engine



The 4.0L engine is designed to meet all emissions regulations and provide satisfactory fuel economy and performance when using high quality unleaded gasoline having an octane range of 87 to 89. The manufacturer recommends the use of 89 octane

for optimum performance. The use of premium gasoline is not recommended, as it will not provide any benefit over regular gasoline in these engines.

Light spark knock at low engine speeds is not harmful to your engine. However, continued heavy spark knock at high speeds can cause damage and immediate service is required.

Poor quality gasoline can cause problems such as hard starting, stalling and hesitations. If you experience these symptoms, try another brand of gasoline before considering service for the vehicle.

Over 40 auto manufacturers worldwide have issued and endorsed consistent gasoline specifications (the Worldwide Fuel Charter, WWFC) to define fuel properties necessary to deliver enhanced emissions, performance, and durability for your vehicle. The manufacturer recommends the use of gasoline that meets the WWFC specifications if they are available.

Reformulated Gasoline

Many areas of the country require the use of cleaner burning gasoline referred to as reformulated gasoline.

Reformulated gasolines contain oxygenates and are specifically blended to reduce vehicle emissions and improve air quality.

The manufacturer supports the use of reformulated gasolines. Properly blended reformulated gasolines will provide excellent performance and durability of engine and fuel system components.

Gasoline/Oxygenate Blends

Some fuel suppliers blend unleaded gasoline with oxygenates such as 10% ethanol, MTBE, and ETBE. Oxygenates are required in some areas of the country during the winter months to reduce carbon monoxide emissions. Fuels blended with these oxygenates may be used in your vehicle.

CAUTION!

DO NOT use gasolines containing methanol or E85 ethanol. Use of these blends may result in starting and drivability problems and may damage critical fuel system components.

Problems that result from using methanol/gasoline or E85 ethanol blends are not the responsibility of the manufacturer. While MTBE is an oxygenate made from methanol, it does not have the negative effects of methanol.

E-85 Usage In Non-Flex Fuel Vehicles

Non-FFV vehicles are compatible with gasoline containing 10% ethanol (E10). Gasoline with higher ethanol content may void the vehicle's warranty.

If a Non-FFV vehicle is inadvertently fueled with E-85 fuel, the engine will have some or all of these symptoms:

- operate in a lean mode
- OBD II "Malfunction Indicator Light" on
- poor engine performance
- poor cold start and cold drivability
- increased risk for fuel system component corrosion

To fix a Non-FFV vehicle inadvertently fueled once with E-85 perform the following:

- drain the fuel tank (see your authorized dealer)
- change the engine oil and oil filter

- disconnect and reconnect the battery to reset the engine controller memory

More extensive repairs will be required for prolonged exposure to E-85 fuel.

MMT In Gasoline

MMT is a manganese containing metallic additive that is blended into some gasoline to increase octane. Gasoline blended with MMT provides no performance advantage beyond gasoline of the same octane number without MMT. Gasoline blended with MMT reduces spark plug life and reduces emission system performance in some vehicles. The manufacturer recommends that gasoline without MMT be used in your vehicle. The MMT content of gasoline may not be indicated on the gasoline pump, therefore, you should ask your gasoline retailer whether or not his/her gasoline contains MMT.

It is even more important to look for gasolines without MMT in Canada, because MMT can be used at levels higher than those allowed in the United States.

MMT is prohibited in Federal and California reformulated gasoline.

Materials Added To Fuel

All gasoline sold in the United States is required to contain effective detergent additives. Use of additional detergents or other additives is not needed under normal conditions and would result in additional cost. Therefore you should not have to add anything to the fuel.

Fuel System Cautions

CAUTION!

Follow these guidelines to maintain your vehicle's performance:

- The use of leaded gas is prohibited by Federal law. Using leaded gasoline can impair engine performance and damage the emission control system.
- An out-of-tune engine or certain fuel or ignition malfunctions, can cause the catalytic converter to overheat. If you notice a pungent burning odor or some light smoke, your engine may be out of tune or malfunctioning and may require immediate service. Contact your authorized dealer for service assistance.

(Continued)

CAUTION! (Continued)

- The use of fuel additives which are now being sold as octane enhancers is not recommended. Most of these products contain high concentrations of methanol. Fuel system damage or vehicle performance problems resulting from the use of such fuels or additives is not the responsibility of the manufacturer.

NOTE: Intentional tampering with emissions control systems can result in civil penalties being assessed against you.

Carbon Monoxide Warnings**WARNING!**

Carbon monoxide (CO) in exhaust gases is deadly. Follow the precautions below to prevent carbon monoxide poisoning:

- Do not inhale exhaust gases. They contain carbon monoxide, a colorless and odorless gas which can kill. Never run the engine in a closed area such as a garage, and never sit in a parked vehicle with the engine running for an extended period. If the vehicle is stopped in an open area with the engine running for more than a short period, adjust the ventilation system to force fresh, outside air into the vehicle.

(Continued)

WARNING! (Continued)

- Guard against carbon monoxide with proper maintenance. Have the exhaust system inspected every time the vehicle is raised. Have any abnormal conditions repaired promptly. Until repaired, drive with all side windows fully open.
- Keep the liftgate closed when driving your vehicle to prevent carbon monoxide and other poisonous exhaust gases from entering the vehicle.

ADDING FUEL

Fuel Filler Cap (Gas Cap)

The gas cap is located behind the fuel filler door, on the driver's side of the vehicle. If the gas cap is lost or damaged, be sure the replacement cap has been designed for use with this vehicle.

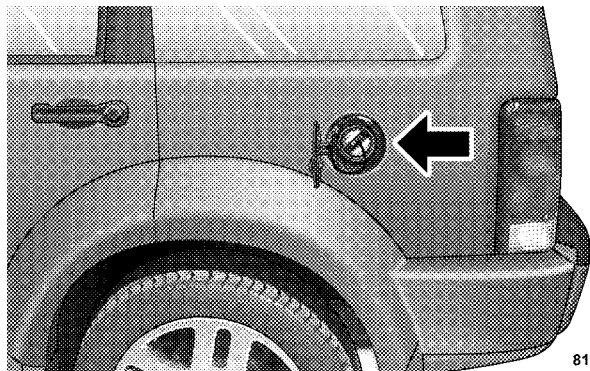

81937590

Fuel Filler Cap

CAUTION!

- Damage to the fuel system or emission control system could result from using an improper fuel cap (gas cap). A poorly fitting cap could let impurities into the fuel system. Also, a poorly fitting aftermarket cap can cause the "Malfunction Indicator Light (MIL)" to illuminate, due to fuel vapors escaping from the system.
- A poorly fitting gas cap may cause the MIL to turn on.
- To avoid fuel spillage and overfilling, do not "top off" the fuel tank after filling.

WARNING!

- Never have any smoking materials lit in or near the vehicle when the gas cap is removed or the tank filled.
- Never add fuel when the engine is running. This is in violation of most state and federal fire regulations and will cause the MIL to turn on.
- A fire may result if gasoline is pumped into a portable container that is inside of a vehicle. You could be burned. Always place gas containers on the ground while filling.

NOTE:

- When the fuel nozzle “clicks” or shuts off, the fuel tank is full.
- Tighten the gas cap about one quarter turn until you hear one click. This is an indication that the cap is properly tightened.

- If the gas cap is not tightened properly, the MIL will come on. Be sure the gas cap is tightened every time the vehicle is refueled.

Loose Fuel Filler Cap Message

If the vehicle diagnostic system determines that the fuel filler cap is loose, improperly installed, or damaged, a “GASCAP” message will display in the odometer or a “CHECK GASCAP” message will be displayed in the Electronic Vehicle Information Center (EVIC). Refer to “Electronic Vehicle Information Center” in “Understanding Your Instrument Panel” for further information. Tighten the fuel filler cap until a “clicking” sound is heard. This is an indication that the fuel filler cap is properly tightened. Refer to “Onboard Diagnostic System” in “Maintaining Your Vehicle” for further information.

VEHICLE LOADING

Certification Label

As required by National Highway Traffic Safety Administration regulations, your vehicle has a certification label affixed to the driver's side door or B-Pillar.

This label contains the month and year of manufacture, Gross Vehicle Weight Rating (GVWR), Gross Axle Weight Rating (GAWR) front and rear, and Vehicle Identification Number (VIN). A Month-Day-Hour (MDH) number is included on this label and indicates the month, day, and hour of manufacture. The bar code that appears on the bottom of the label is your VIN.

Gross Vehicle Weight Rating (GVWR)

The GVWR is the total permissible weight of your vehicle including driver, passengers, vehicle, options, trailer tongue weight, and cargo. The label also specifies maximum capacities of front and rear axle systems (GAWR). Total load must be limited, so GVWR, and front and rear GAWR are not exceeded.

Payload

The payload of a vehicle is defined as the allowable load weight a truck or any given vehicle can carry, including the weight of the driver, all passengers, options and cargo.

Gross Axle Weight Rating (GAWR)

The GAWR is the maximum permissible load on the front and rear axles. The load must be distributed in the cargo area so that the GAWR of each axle is not exceeded.

Each axle's GAWR is determined by the components in the system with the lowest load carrying capacity (axle, springs, tires, or wheels). Heavier axles or suspension components, sometimes specified by purchasers for increased durability, does not necessarily increase the vehicle's GVWR.

Tire Size

The tire size on the label represents the actual tire size on your vehicle. Replacement tires must be equal to the load capacity of this tire size.

Rim Size

This is the rim size that is appropriate for the tire size listed.

Inflation Pressure

This is the cold tire inflation pressure for your vehicle for all loading conditions up to full GAWR.

Curb Weight

The curb weight of a vehicle is defined as the total weight of the vehicle with all fluids, including vehicle fuel, at full capacity conditions, and with no occupants or cargo loaded into the vehicle. The front and rear curb weight values are determined by weighing your vehicle on a commercial scale before any occupants or cargo are added.

Loading

The actual total weight and the weight of the front and rear of your vehicle at the ground can best be determined by weighing it when it is loaded and ready for operation.

The entire vehicle should first be weighed on a commercial scale to ensure that the GVWR has not been exceeded. The weight on the front and rear of the vehicle should then be determined separately to be sure that the load is properly distributed over front and rear axle. Weighing the vehicle may show that the GAWR of either the front or rear axles has been exceeded, but the total load is within the specified GVWR. If so, weight must be shifted from front to rear, or rear to front, as appropriate until the specified weight limitations are met. Store the heavier items down low and be sure that the weight is distributed equally. Stow all loose items securely before driving.

Improper weight distributions can have an adverse affect on the way your vehicle steers and handles, and the way the brakes operate.

CAUTION!

Do not load your vehicle any heavier than the GVWR or the maximum front and rear GAWR. If you do, parts on your vehicle can break, or it can change the way your vehicle handles. This could cause you to lose control. Also, overloading can shorten the life of your vehicle.

TRAILER TOWING

In this section you will find safety tips and information on limits to the type of towing you can reasonably do with your vehicle. Before towing a trailer, carefully review this information to tow your load as efficiently and safely as possible.

To maintain warranty coverage, follow the requirements and recommendations in this manual concerning vehicles used for trailer towing.

Common Towing Definitions

The following trailer towing related definitions will assist you in understanding the following information:

Gross Vehicle Weight Rating (GVWR)

The GVWR is the total allowable weight of your vehicle. This includes driver, passengers, cargo and tongue weight. The total load must be limited so that you do not exceed the GVWR.

Gross Trailer Weight (GTW)

The GTW is the weight of the trailer plus the weight of all cargo, consumables and equipment (permanent or temporary) loaded in or on the trailer in its "loaded and ready for operation" condition. The recommended way to measure GTW is to put your fully loaded trailer on a vehicle scale. The entire weight of the trailer must be supported by the scale.

WARNING!

If the gross trailer weight is 3,500 lbs (1 587 kg) or more, it is mandatory to use a weight-distributing hitch to ensure stable handling of your vehicle. If you use a standard weight-carrying hitch, you could lose control of your vehicle and cause an accident.

Gross Combination Weight Rating (GCWR)

The GCWR is the total permissible weight of your vehicle and trailer when weighed in combination.

NOTE: The GCWR rating includes a 150 lbs (68 kg) allowance for the presence of a driver.

Gross Axle Weight Rating (GAWR)

The GAWR is the maximum capacity of the front and rear axles. Distribute the load over the front and rear axles evenly. Make sure that you do not exceed either front or rear GAWR.

WARNING!

It is important that you do not exceed the maximum front or rear GAWR. A dangerous driving condition can result if either rating is exceeded. You could lose control of the vehicle and have an accident.

Tongue Weight

The tongue weight is the downward force exerted on the hitch ball by the trailer. In most cases it should not be less than 10% or more than 15% of the trailer load. You must consider this as part of the load on your vehicle.

Frontal Area

The frontal area is the maximum height and maximum width of the front of a trailer.

Trailer Sway Control

The trailer sway control is a telescoping link that can be installed between the hitch receiver and the trailer tongue that typically provides adjustable friction associated with the telescoping motion to dampen any unwanted trailer swaying motions while traveling.

Weight-Carrying Hitch

A weight-carrying hitch supports the trailer tongue weight, just as if it were luggage located at a hitch ball or some other connecting point of the vehicle. These kind of hitches are the most popular on the market today and they are commonly used to tow small- and medium-sized trailers.

Weight-Distributing Hitch

A weight-distributing system works by applying leverage through spring (load) bars. They are typically used for heavier loads to distribute trailer tongue weight to the tow vehicle's front axle and the trailer axle(s). When used in accordance with the manufacturer's directions, it provides for a more level ride, offering more consistent steering and brake control, thereby enhancing towing safety. The addition of a friction/hydraulic sway control also dampens sway caused by traffic and crosswinds and contributes positively to tow vehicle and trailer stability. Trailer sway control and a weight distributing (load equalizing) hitch are recommended for heavier Tongue Weights (TW) and may be required depending on vehicle and trailer configuration/loading to comply with gross axle weight rating (GAWR) requirements.

WARNING!

- An improperly adjusted weight distributing hitch system may reduce handling, stability, and braking performance and could result in an accident.
- Weight distributing systems may not be compatible with surge brake couplers. Consult with your hitch and trailer manufacturer or a reputable recreational vehicle dealer for additional information.

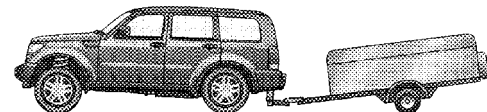

057005576

Without Weight-Distributing Hitch (Incorrect)

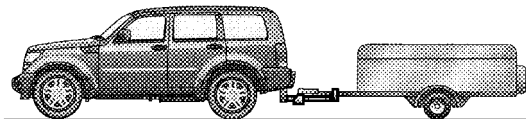

057005577

With Weight-Distributing Hitch (Correct)

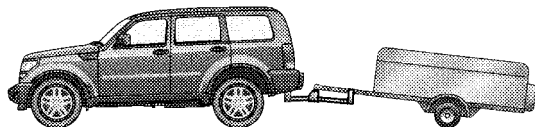

057005578

Improper Adjustment of Weight-Distributing Hitch
(Incorrect)

Trailer Hitch Classification

Your vehicle is capable of towing trailers up to 2,000 lbs (907 kg) without added equipment or alterations to the standard equipment. Your vehicle may be factory equipped for safe towing of trailers weighing over 2,000 lbs (907 kg) with the optional trailer tow prep package. See your authorized dealer for package content.

The following chart provides the industry standard for the maximum trailer weight a given trailer hitch class can tow and should be used to assist you in selecting the correct trailer hitch for your intended towing condition. Refer to the Trailer Towing Weights (Maximum Trailer Weight Ratings) chart for the Max. GTW towable for your given drivetrain.

Trailer Hitch Classification Definitions	
Class	Max. Trailer Hitch Industry Standards
Class I - Light Duty	2,000 lbs (907 kg)
Class II - Medium Duty	3,500 lbs (1 587 kg)
Class III - Heavy Duty	5,000 lbs (2 268 kg)
Class IV - Extra Heavy Duty	10,000 lbs (4 540 kg)
Refer to the "Trailer Towing Weights (Maximum Trailer Weight Ratings)" chart for the Maximum Gross Trailer Weight (GTW) towable for your given drivetrain.	

All trailer hitches should be professionally installed on your vehicle.

Trailer Towing Weights (Maximum Trailer Weight Ratings)

The following chart provides the maximum trailer weight ratings towable for your given drivetrain.

Engine/ Transmission	Model	Frontal Area	Max GTW (Gross Trailer Wt)	Tongue Wt. (See Note)
3.7L/Automatic	4x2	32 sq ft (2.97 sq m)	2,000 lbs (907 kg)	200 lbs (91 kg)
3.7L/Automatic	4x4	32 sq ft (2.97 sq m)	2,000 lbs (907 kg)	200 lbs (91 kg)
4.0L/Automatic	4x2	32 sq ft (2.97 sq m)	2,000 lbs (907 kg)	200 lbs (91 kg)
4.0L/Automatic	4x4	32 sq ft (2.97 sq m)	2,000 lbs (907 kg)	200 lbs (91 kg)
Refer to local laws for maximum trailer towing speeds.				

NOTE: The trailer tongue weight must be considered as part of the combined weight of occupants and cargo, and should never exceed the weight referenced on the tire and loading information placard. Refer to “Tire Safety Information” in “Starting and Operating” for further information.

When Towing Trailers with Gross Trailer Weight (GTW) between 3,500 Lbs (1 588 kg) and 5,000 Lbs (2 268 kg)

The following chart provides maximum trailer weight ratings towable for the following engine/transmission combinations, **ONLY** if using a weight distributing hitch.

Engine/ Transmission	Model	Frontal Area	Max GTW (Gross Trailer Wt)	Tongue Wt. (See Note)
3.7L/Automatic w/Trailer Tow Package	4x2	64 sq ft (5.94 sq m)	5,000 lbs (2 268 kg)	500 lbs (227 kg)
3.7L/Automatic w/Trailer Tow Package	4x4	64 sq ft (5.94 sq m)	5,000 lbs (2 268 kg)	500 lbs (227 kg)
4.0L/Automatic w/Trailer Tow Package	4x2	64 sq ft (5.94 sq m)	5,000 lbs (2 268 kg)	500 lbs (227 kg)
4.0L/Automatic w/Trailer Tow Package	4x4	64 sq ft (5.94 sq m)	5,000 lbs (2 268 kg)	500 lbs (227 kg)
Refer to local laws for maximum trailer towing speeds.				

NOTE: The trailer tongue weight must be considered as part of the combined weight of occupants and cargo, and should never exceed the weight referenced on the tire and loading information placard. Refer to “Tire Safety Information” in “Starting and Operating” for further information.

Trailer and Tongue Weight

Always load a trailer with 60% to 65% of the weight in the front of the trailer. This places 10% to 15% of the Gross Trailer Weight (GTW) on the tow hitch of your vehicle. Loads balanced over the wheels or heavier in the rear can cause the trailer to sway **severely** from side-to-side which will cause loss of control of vehicle and trailer. Failure to load trailers heavier in front is the cause of many trailer accidents.

Never exceed the maximum tongue weight stamped on your bumper or trailer hitch.

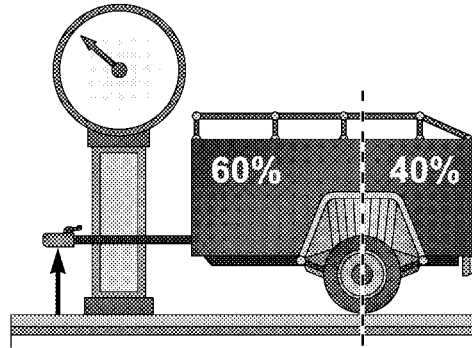

Consider the following items when computing the weight on the rear axle of the vehicle:

- The tongue weight of the trailer.
- The weight of any other type of cargo or equipment put in or on your vehicle.
- The weight of the driver and all passengers.

NOTE: Remember that everything put into or on the trailer adds to the load on your vehicle. Also, additional factory-installed options or authorized dealer-installed options must be considered as part of the total load on your vehicle. Refer to “Tire Safety Information/Tire and Loading Information Placard” in “Starting and Operating” for the maximum combined weight of occupants and cargo for your vehicle.

Towing Requirements

To promote proper break-in of your new vehicle drive-train components the following guidelines are recommended:

CAUTION!

- Avoid towing a trailer for the first 500 miles (805 km) of vehicle operation. Doing so may damage your vehicle.

(Continued)

CAUTION! (Continued)

- During the first 500 miles (805 km) of trailer towing, limit your speed to 50 mph (80 km/h).

WARNING!

Improper towing can lead to an injury accident. Follow these guidelines to make your trailer towing as safe as possible:

- **Make certain that the load is secured in the trailer and will not shift during travel. When trailering cargo that is not fully secured, dynamic load shifts can occur that may be difficult for the driver to control. You could lose control of your vehicle and have an accident.**

(Continued)

WARNING! (Continued)

- When hauling cargo or towing a trailer, do not overload your vehicle or trailer. Overloading can cause a loss of control, poor performance or damage to brakes, axle, engine, transmission, steering, suspension, chassis structure or tires.
- Safety chains must always be used between your vehicle and trailer. Always connect the chains to the frame or hook retainers of the vehicle hitch. Cross the chains under the trailer tongue and allow enough slack for turning corners.
- Vehicles with trailers should not be parked on a grade. When parking, apply the parking brake on the tow vehicle. Put the tow vehicle transmission in PARK. Always, block or "chock" the trailer wheels.
- GCWR must not be exceeded.

(Continued)

WARNING! (Continued)

- Total weight must be distributed between the tow vehicle and the trailer such that the following four ratings are not exceeded:
 1. GVWR
 2. GTW
 3. GAWR
 4. Tongue weight rating for the trailer hitch utilized. (This requirement may limit the ability to always achieve the 10% to 15% range of tongue weight as a percentage of total trailer weight).

Towing Requirements – Tires

- Do not attempt to tow a trailer while using a compact spare tire.
- Proper tire inflation pressures are essential to the safe and satisfactory operation of your vehicle. Refer to “Tires – General Information” in “Starting and Operating” for proper tire inflation procedures.
- Check the trailer tires for proper tire inflation pressures before trailer usage.
- Check for signs of tire wear or visible tire damage before towing a trailer. Refer to “Tires – General Information” in “Starting and Operating” for the proper inspection procedure.
- When replacing tires, refer to “Tires – General Information” in “Starting and Operating” for proper tire

replacement procedures. Replacing tires with a higher load carrying capacity will not increase the vehicle’s GVWR and GAWR limits.

Towing Requirements – Trailer Brakes

- Do **not** interconnect the hydraulic brake system or vacuum system of your vehicle with that of the trailer. This could cause inadequate braking and possible personal injury.
- An electronically actuated trailer brake controller is required when towing a trailer with electronically actuated brakes. When towing a trailer equipped with a hydraulic surge actuated brake system, an electronic brake controller is not required.
- Trailer brakes are recommended for trailers over 1,000 lbs (454 kg) and required for trailers in excess of 2,000 lbs (907 kg).

CAUTION!

If the trailer weighs more than 1,000 lbs (454 kg) loaded, it should have its own brakes and they should be of adequate capacity. Failure to do this could lead to accelerated brake lining wear, higher brake pedal effort, and longer stopping distances.

WARNING!

- Do not connect trailer brakes to your vehicle's hydraulic brake lines. It can overload your brake system and cause it to fail. You might not have brakes when you need them and could have an accident.

(Continued)

WARNING! (Continued)

- Towing any trailer will increase your stopping distance. When towing you should allow for additional space between your vehicle and the vehicle in front of you. Failure to do so could result in an accident.

Towing Requirements – Trailer Lights and Wiring

Whenever you pull a trailer, regardless of the trailer size, stop lights and turn signals on the trailer are required for motoring safety.

The trailer tow package may include a four-pin and seven-pin wiring harness. Use a factory approved trailer harness and connector.

NOTE: Do not cut or splice wiring into the vehicles wiring harness.

370 STARTING AND OPERATING

The electrical connections are all complete to the vehicle, but you must mate the harness to a trailer connector. Refer to the following illustrations.

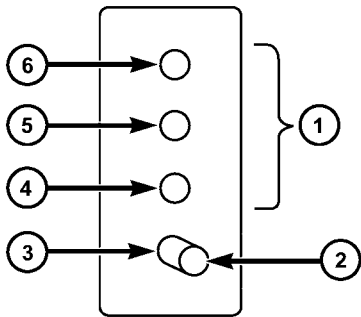

Four-Pin Connector

057003766

- | | |
|-----------------|---------------------|
| 1 — Female Pins | 4 — Park |
| 2 — Male Pin | 5 — Left Stop/Turn |
| 3 — Ground | 6 — Right Stop/Turn |

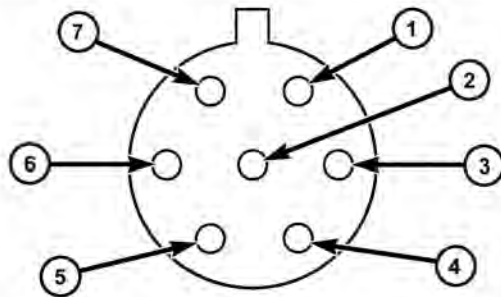

057003765

Seven-Pin Connector

- | | |
|---------------------|--------------------|
| 1 — Battery | 5 — Ground |
| 2 — Backup Lamps | 6 — Left Stop/Turn |
| 3 — Right Stop/Turn | 7 — Running Lamps |
| 4 — Electric Brakes | |

Towing Tips

Before setting out on a trip, practice turning, stopping and backing up the trailer in an area away from heavy traffic.

Automatic Transmission

The “D” range can be selected when towing. However, if frequent shifting occurs while in this range, the “TOW/HAUL” button (if equipped) or a lower gear range should be selected.

NOTE: Using the “TOW/HAUL” button (3.7L engine) or “4” range (4.0L engine) while operating the vehicle under heavy operating conditions will improve performance and extend transmission life by reducing excessive shifting and heat build up. This action will also provide better engine braking.

The automatic transmission fluid and filter should be changed if you regularly tow a trailer for more than

45 minutes of continuous operation. Refer to “Maintenance Schedule” for the proper maintenance intervals.

TOW/HAUL – If Equipped

To reduce potential for automatic transmission overheating, press the “TOW/HAUL” button when driving in hilly areas or shift the transmission to DRIVE position 2 on more severe grades. Refer to “Automatic Transmission” in “Starting and Operating” for further information.

Electronic Speed Control – If Equipped

- Do not use in hilly terrain or with heavy loads.
- When using the speed control, if you experience speed drops greater than 10 mph (16 km/h), disengage until you can get back to cruising speed.
- Use speed control in flat terrain and with light loads to maximize fuel efficiency.

Cooling System

To reduce potential for engine and transmission overheating, take the following actions:

– *City Driving*

When stopped for short periods of time, shift the transmission into NEUTRAL and increase engine idle speed.

– *Highway Driving*

Reduce speed.

– *Air Conditioning*

Turn off temporarily.

RECREATIONAL TOWING (BEHIND MOTORHOME, ETC.)

Two-Wheel Drive Models

All Four Wheels On The Ground

Recreational towing is allowed **ONLY** if the driveshaft is removed. Towing with the rear wheels on the ground while the driveshaft is connected can result in severe transmission damage.

WARNING!

If the driveshaft is removed, the vehicle can roll even if the transmission is in PARK, which could cause serious injury or death.

The parking brake must be firmly engaged and the wheels chocked during driveshaft removal and installation. The parking brake must remain engaged unless the vehicle is securely and properly connected to the tow vehicle, or the driveshaft is completely reinstalled. See your authorized dealer for proper driveshaft removal and reinstallation procedures, including flange orientation/alignment, use of thread-locking compound, proper bolt torque specifications, etc.

NOTE: This vehicle may be towed on a flatbed or vehicle trailer provided all four wheels are **OFF** the ground.

Four-Wheel Drive or All-Wheel Drive Models

CAUTION!

Front or rear wheel lifts should not be used. Internal damage to the transmission or transfer case will occur if a front or rear wheel lift is used when recreational towing.

All Four Wheels On The Ground

Recreational towing is **NOT** allowed. These models do not have a NEUTRAL position in the transfer case.

NOTE: This vehicle may be towed on a flatbed or vehicle trailer provided all four wheels are **OFF** the ground.

WHAT TO DO IN EMERGENCIES

CONTENTS

■ Hazard Warning Flasher	376	□ Jacking Instructions	380
■ If Your Engine Overheats	376	■ Jump-Starting Procedures	384
■ Jacking And Tire Changing	378	□ Preparations For Jump-Start	384
□ Jack Location	378	□ Jump-Starting Procedure	386
□ Spare Tire Stowage	378	■ Towing A Disabled Vehicle	388
□ Spare Tire Removal	379	□ Two-Wheel Drive Vehicles	388
□ Preparations For Jacking	379	□ Four-Wheel Drive Vehicles	388

HAZARD WARNING FLASHER

The Hazard Warning Flasher switch is located on the lower switch bank below the climate controls.

 Press the switch to turn on the Hazard Warning flasher. When the switch is activated, all directional turn signals will flash on and off to warn oncoming traffic of an emergency. Press the switch a second time to turn off the Hazard Warning flasher.

This is an emergency warning system and should not be used when the vehicle is in motion. Use it when your vehicle is disabled and is creating a safety hazard for other motorists.

If it is necessary to leave the vehicle to go for service, the Hazard Warning flasher will continue to operate with the ignition key removed and the vehicle locked.

NOTE: With extended use, the Hazard Warning flasher may wear down your battery.

IF YOUR ENGINE OVERHEATS

In any of the following situations, you can reduce the potential for overheating your engine by taking the appropriate action.

- On the highways — slow down.
- In city traffic — while stopped, put transmission in NEUTRAL, but do not increase engine idle speed.

CAUTION!

Driving with a hot cooling system could damage your vehicle. If the temperature gauge reads "H," pull over and stop the vehicle. Idle the vehicle with the air conditioner turned off until the pointer drops back into the normal range. If the pointer remains on the "H" and you hear continuous chimes, turn the engine off immediately and call for service.

NOTE: There are steps that you can take to slow down an impending overheat condition:

- If your air conditioner (A/C) is on, turn it off. The A/C system adds heat to the engine cooling system and turning the A/C off can help remove this heat.
- You can also turn the temperature control to maximum heat, the mode control to floor and the blower control to high. This allows the heater core to act as a supplement to the radiator and aids in removing heat from the engine cooling system.

WARNING!

You or others can be badly burned by hot engine coolant (antifreeze) or steam from your radiator. If you see or hear steam coming from under the hood, do not open the hood until the radiator has had time to cool. Never try to open a cooling system pressure cap when the radiator or coolant bottle is hot.

JACKING AND TIRE CHANGING

WARNING!

- Getting under a jacked-up vehicle is dangerous. The vehicle could slip off the jack and fall on you. You could be crushed. Never get any part of your body under a vehicle that is on a jack. If you need to get under a raised vehicle, take it to a service center where it can be raised on a lift.
- The jack is designed to use as a tool for changing tires only. The jack should not be used to lift the vehicle for service purposes. The vehicle should be jacked on a firm level surface only. Avoid ice or slippery areas.

Jack Location

The scissor-type jack and tire changing tools are located in the left rear trim panel behind the second row seat.

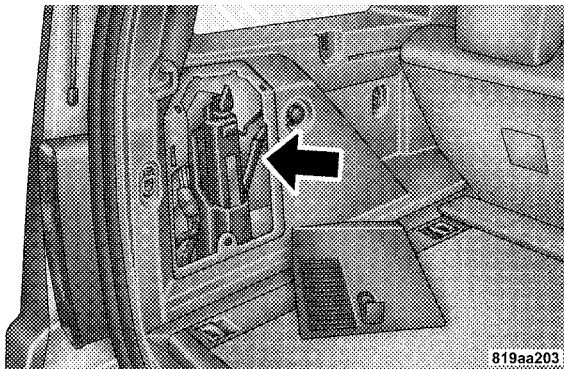

Jack Storage Location

Spare Tire Stowage

The spare tire is stowed underneath the rear of the vehicle and is held in place by a cable winch mechanism.

Spare Tire Removal

Fit the jack handle extension over the drive nut. Use the lug wrench to rotate the nut counterclockwise until the spare is on the ground with enough slack in the cable to allow you to pull the tire out from under the vehicle.

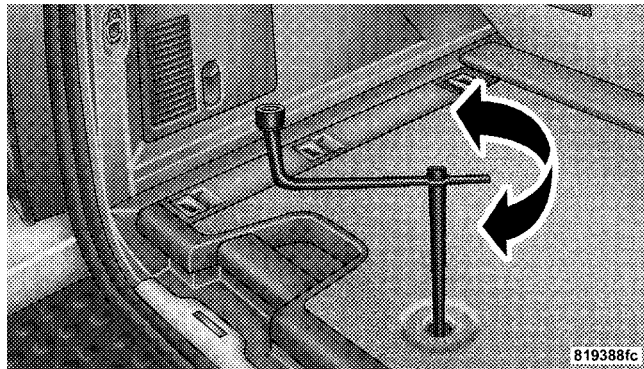

Lowering/Raising Spare Tire

CAUTION!

The winch mechanism is designed for use with the jack extension tube only. Use of an air wrench or other power tools is not recommended and they can damage the winch.

When the spare is clear, tilt the retainer at the end of the cable and pull it through the center of the wheel.

Preparations For Jacking

1. Park the vehicle on a firm, level surface. Avoid icy or slippery areas.

WARNING!

Do not attempt to change a tire on the side of the vehicle close to moving traffic. Pull far enough off the road to avoid being hit when operating the jack or changing the wheel.

2. Set the parking brake.
3. Place the shift lever into PARK.
4. Turn the ignition to the LOCK position.
5. Turn on the Hazard Warning flasher.
6. Block both the front and rear of the wheel diagonally opposite of the jacking position. For example, if changing the right front tire, block the left rear wheel.

**Jacking Instructions****WARNING!**

Carefully follow these tire changing warnings to help prevent personal injury or damage to your vehicle:

- Always park on a firm, level surface as far from the edge of the roadway as possible before raising the vehicle.
- Block the wheel diagonally opposite the wheel to be raised.
- Set the parking brake firmly and set an automatic transmission in PARK; a manual transmission in REVERSE.
- Never start or run the engine with the vehicle on a jack.

(Continued)

WARNING! (Continued)

- Do not let anyone sit in the vehicle when it is on a jack.
- Do not get under the vehicle when it is on a jack.
- Only use the jack in the positions indicated and for lifting this vehicle during a tire change.
- If working on or near a roadway, be extremely careful of motor traffic.
- To assure that spare tires, flat or inflated, are securely stowed, spares must be stowed with the valve stem facing the ground.
- Turn on the Hazard Warning flasher.



Jack Warning Label

1. Remove spare tire.
2. Remove jack and tools from mounting bracket. Assemble the tools by connecting the driver to the extension, and then to the lug wrench.
3. Loosen (but do not remove) the wheel lug nuts by turning them to the left one turn while the wheel is still on the ground.

4. Locate the jack as shown. For the front tires, place it (rearward) of the notch on the body weld seam behind wheel to be changed. For the rear tires, place it under the axle by the wheel to be changed. Position the jack handle on the jack. **Do not raise the vehicle until you are sure the jack is fully engaged.**

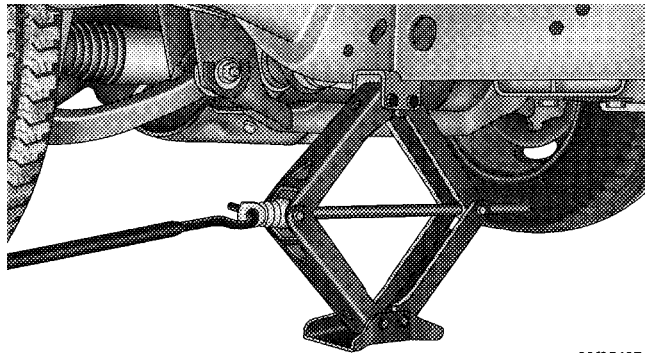

80f35497

Front Jacking Location

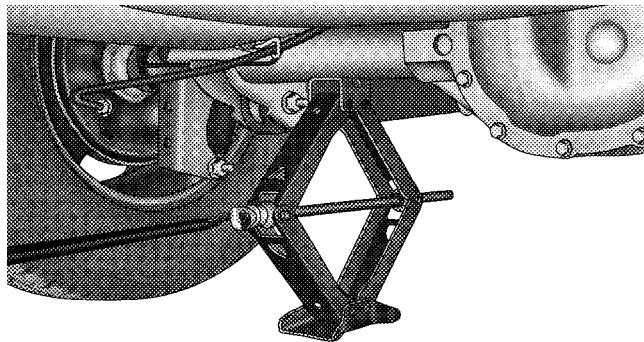

80f354b4

Rear Jacking Location

5. Raise the vehicle by turning the jack screw to the right. Raise the vehicle only until the tire just clears the surface and enough clearance is obtained to install the spare tire. Minimum tire lift provides maximum stability.

WARNING!

Raising the vehicle higher than necessary can make the vehicle less stable and cause an accident. It could slip off the jack and hurt someone near it. Raise the vehicle only enough to remove the tire.

6. Remove the lug nuts and wheel.
7. Position the spare wheel/tire on the vehicle and install the lug nuts with the cone-shaped end toward the wheel. Lightly tighten the nuts. To avoid the risk of forcing the vehicle off the jack, do not tighten the nuts fully until the vehicle has been lowered.
8. Lower the vehicle by turning the jack screw to the left, and remove the jack and wheel blocks.

9. Finish tightening the lug nuts. Push down on the wrench while tightening for increased leverage. Alternate nuts until each nut has been tightened twice. The correct wheel nut tightness is 95 ft lbs (130 N·m). If in doubt about the correct tightness, have them checked with a torque wrench by your authorized dealer or at a service station.

10. Lower the jack to its fully closed position.

WARNING!

A loose tire or jack thrown forward in a collision or hard stop could endanger the occupants of the vehicle. Always stow the jack parts and the spare tire in the places provided.

11. Secure the tire, jack, and tools in their proper locations.

JUMP-STARTING PROCEDURES

If your vehicle has a discharged battery it can be jump-started using a set of jumper cables and a battery in another vehicle or by using a portable battery booster pack. Jump-starting can be dangerous if done improperly so please follow the procedures in this section carefully.

NOTE: When using a portable battery booster pack follow the manufacturer's operating instructions and precautions.

CAUTION!

Do not use a portable battery booster pack or any other booster source with a system voltage greater than 12 Volts or damage to the battery, starter motor, alternator or electrical system may occur.

WARNING!

When temperatures are below the freezing point, electrolyte in a discharged battery may freeze. Do not attempt jump-starting because the battery could rupture or explode and cause personal injury. Battery temperature must be brought above the freezing point before attempting a jump-start.

Preparations for Jump-Start

The battery in your vehicle is located in the front of the engine compartment, behind the left headlight assembly.

NOTE: The positive battery post is covered with a protective cap. Lift up on the cap to gain access to the positive battery post.



Positive Battery Post

WARNING!

- Take care to avoid the radiator cooling fan whenever the hood is raised. It can start anytime the ignition switch is on. You can be injured by moving fan blades.
- Remove any metal jewelry such as watch bands or bracelets that might make an inadvertent electrical contact. You could be seriously injured.
- Batteries contain sulfuric acid that can burn your skin or eyes and generate hydrogen gas which is flammable and explosive. Keep open flames or sparks away from the battery.

1. Set the parking brake, shift the automatic transmission into PARK and turn the ignition to LOCK.
2. Turn off the heater, radio, and all unnecessary electrical accessories.

3. If using a another vehicle to jump-start the battery, park the vehicle within the jumper cables reach, set the parking brake and make sure the ignition is OFF.

WARNING!

Do not allow vehicles to touch each other as this could establish a ground connection and personal injury could result.

Jump-Starting Procedure**WARNING!**

Failure to follow this procedure could result in personal injury or property damage due to battery explosion.

CAUTION!

Failure to follow these procedures could result in damage to the charging system of the booster vehicle or the discharged vehicle.

1. Connect the positive (+) end of the jumper cable to the positive (+) post of the discharged vehicle.
2. Connect the opposite end of the positive (+) jumper cable to the positive (+) post of the booster battery.
3. Connect the negative end (-) of the jumper cable to the negative (-) post of the booster battery.
4. Connect the opposite end of the negative (-) jumper cable to a good engine ground (exposed metal part of the discharged vehicle's engine) away from the battery and the fuel injection system.

WARNING!

Do not connect the cable to the negative post (-) of the discharged battery. The resulting electrical spark could cause the battery to explode and could result in personal injury.

5. Start the engine in the vehicle that has the booster battery, let the engine idle a few minutes, and then start the engine in the vehicle with the discharged battery.

Once the engine is started, remove the jumper cables in the reverse sequence:

6. Disconnect the negative (-) jumper cable from the engine ground of the vehicle with the discharged battery.
7. Disconnect the negative end (-) of the jumper cable from the negative (-) post of the booster battery.

8. Disconnect the opposite end of the positive (+) jumper cable from the positive (+) post of the booster battery.
9. Disconnect the positive (+) end of the jumper cable from the positive (+) post of the discharged vehicle.

If frequent jump-starting is required to start your vehicle you should have the battery and charging system inspected at your authorized dealer.

CAUTION!

Accessories that can be plugged into the vehicle power outlets draw power from the vehicle's battery, even when not in use (i.e., cellular phones, etc.). Eventually, if plugged in long enough, the vehicle's battery will discharge sufficiently to degrade battery life and/or prevent the engine from starting.

TOWING A DISABLED VEHICLE

Proper towing or lifting equipment is required to prevent damage to your vehicle. Use of safety chains is recommended. **Attach towing device to main structural members of the vehicle, not to bumpers or associated brackets. State and local laws applying to vehicles under tow must be observed.**

NOTE: The transmission must be in NEUTRAL under any towing configuration.

Two-Wheel Drive Vehicles

Front Wheels Raised

The speed must **not** exceed 30 mph (50 km/h) and the distance must **not** exceed 15 miles (25 km).

This vehicle may be towed with the transmission in NEUTRAL, the ignition key in the LOCK position, the front wheels raised, and the rear wheels on the ground.

CAUTION!

Towing the vehicle with the rear wheels on the ground at more than 30 mph (50 km/h) or for more than 15 miles (25 km) can cause severe transmission damage. Such damage is not covered by the New Vehicle Limited Warranty.

If the vehicle is to be towed more than 15 miles (25 km) or faster than 30 mph, it must be towed on a flatbed.

Rear Wheels Raised

The vehicle may be towed with the transmission in NEUTRAL, the ignition key in the LOCK position, the rear wheels raised, and the front wheels on the ground.

Four-Wheel Drive Vehicles

Four-wheel drive vehicles must be towed with all four wheels **OFF** the ground using a flatbed.

CAUTION!

Towing this vehicle using any other method could result in extensive damage to the transfer case and/or transmission. Such damage is not covered by the New Vehicle Limited Warranty.

MAINTAINING YOUR VEHICLE

CONTENTS

■ Engine Compartment — 3.7L	393	□ Engine Oil	399
■ Engine Compartment — 4.0L	394	□ Engine Oil Filter	402
■ Onboard Diagnostic System — OBD II	395	□ Engine Air Cleaner Filter	402
□ Loose Fuel Filler Cap Message	396	□ Maintenance-Free Battery	403
■ Emissions Inspection And Maintenance Programs	396	□ Air Conditioner Maintenance	404
■ Replacement Parts	398	□ Body Lubrication	405
■ Dealer Service	398	□ Windshield Wiper Blades	406
■ Maintenance Procedures	398	□ Adding Washer Fluid	406
		□ Exhaust System	407

- Cooling System 409
- Brake System 415
- Automatic Transmission 417
- Transfer Case 418
- Front/Rear Axle Fluid 419
- Appearance Care And Protection From Corrosion 419
- Fuses 424
 - Totally Integrated Power Module 424
- Replacement Bulbs 431
- Bulb Replacement 431
 - Headlamp 431
 - Left Front Turn Signal 432
 - Right Front Turn Signal 433
 - Front Side Marker 433
 - Front Fog Lamp (Front Fascia Mounted) 433
 - Rear Tail, Stop, Turn Signal, And Backup Lamp 434
 - Center High Mounted Stop Lamp (CHMSL) 435
- Fluid Capacities 436
- Fluids, Lubricants And Genuine Parts 437
 - Engine 437
 - Chassis 438

ENGINE COMPARTMENT — 3.7L

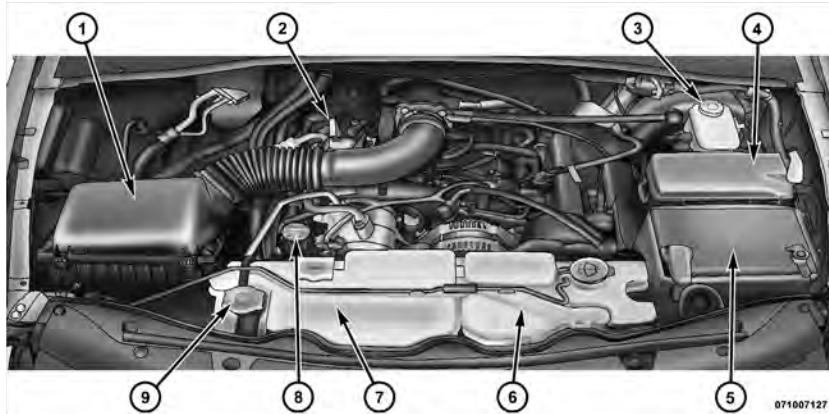

- 1 — Air Cleaner Filter
- 2 — Engine Oil Dipstick
- 3 — Brake Fluid Reservoir
- 4 — Integrated Power Module
- 5 — Battery

- 6 — Washer Fluid Reservoir
- 7 — Engine Coolant Reservoir
- 8 — Engine Oil Fill
- 9 — Coolant Pressure Cap

ENGINE COMPARTMENT — 4.0L

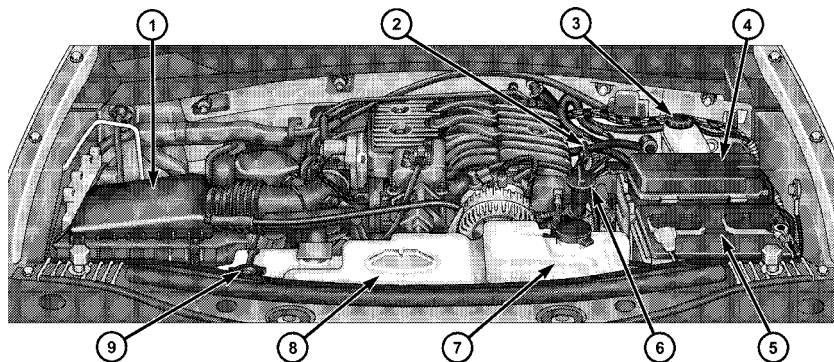

071205585

- 1 — Air Cleaner Filter
- 2 — Engine Oil Dipstick
- 3 — Brake Fluid Reservoir
- 4 — Integrated Power Module
- 5 — Battery

- 6 — Engine Oil Fill
- 7 — Washer Fluid Reservoir
- 8 — Engine Coolant Reservoir
- 9 — Coolant Pressure Cap

ONBOARD DIAGNOSTIC SYSTEM — OBD II

Your vehicle is equipped with a sophisticated Onboard Diagnostic system called OBD II. This system monitors the performance of the emissions, engine, and automatic transmission control systems. When these systems are operating properly, your vehicle will provide excellent performance and fuel economy, as well as engine emissions well within current government regulations.

If any of these systems require service, the OBD II system will turn on the “Malfunction Indicator Light (MIL).” It will also store diagnostic codes and other information to assist your service technician in making repairs. Although your vehicle will usually be drivable and not need towing, see your authorized dealer for service as soon as possible.

CAUTION!

- **Prolonged driving with the MIL on could cause further damage to the emission control system. It could also affect fuel economy and drivability. The vehicle must be serviced before any emissions tests can be performed.**
- **If the MIL is flashing while the engine is running, severe catalytic converter damage and power loss will soon occur. Immediate service is required.**

Loose Fuel Filler Cap Message

If the vehicle diagnostic system determines that the fuel filler cap is loose, improperly installed, or damaged, a “gASCAP” message will display in the odometer or a “CHECK GASCAP” message will be displayed in the Electronic Vehicle Information Center (EVIC). Refer to “Electronic Vehicle Information Center (EVIC)” in “Understanding Your Instrument Panel” for further information. Tighten the gas cap until a “clicking” sound is heard. This is an indication that the gas cap is properly tightened.

Press the odometer reset button to turn the message off. If the problem persists, the message will appear the next time the vehicle is started. This might indicate a damaged cap. If the problem is detected twice in a row, the system will turn on the MIL. Resolving the problem will turn the MIL light off.

EMISSIONS INSPECTION AND MAINTENANCE PROGRAMS

In some localities, it may be a legal requirement to pass an inspection of your vehicle’s emissions control system. Failure to pass could prevent vehicle registration.



For states that require an Inspection and Maintenance (I/M), this check verifies the “Malfunction Indicator Light (MIL)” is functioning and is not on when the engine is running, and that the OBD II system is ready for testing.

Normally, the OBD II system will be ready. The OBD II system may **not** be ready if your vehicle was recently serviced, recently had a dead battery or a battery replacement. If the OBD II system should be determined not ready for the I/M test, your vehicle may fail the test.

Your vehicle has a simple ignition key-actuated test, which you can use prior to going to the test station. To check if your vehicle's OBD II system is ready, you must do the following:

1. Turn the ignition switch to the ON position, but do not crank or start the engine.
2. If you crank or start the engine, you will have to start this test over.
3. As soon as you turn the ignition switch to the ON position, you will see the MIL symbol come on as part of a normal bulb check.
4. Approximately 15 seconds later, one of two things will happen:
 - a. The MIL will flash for about 10 seconds and then return to being fully illuminated until you turn OFF the ignition or start the engine. This means that your vehicle's OBD II system is **not ready** and you should **not** proceed to the I/M station.

- b. The MIL will not flash at all and will remain fully illuminated until you turn OFF the ignition or start the engine. This means that your vehicle's OBD II system is **ready** and you can proceed to the I/M station.

If your OBD II system is **not ready**, you should see your authorized dealer or repair facility. If your vehicle was recently serviced or had a battery failure or replacement, you may need to do nothing more than drive your vehicle as you normally would in order for your OBD II system to update. A recheck with the above test routine may then indicate that the system is now ready.

Regardless of whether your vehicle's OBD II system is ready or not, if the MIL is illuminated during normal vehicle operation you should have your vehicle serviced before going to the I/M station. The I/M station can fail your vehicle because the MIL is on with the engine running.

REPLACEMENT PARTS

Use of genuine MOPAR® parts for normal/scheduled maintenance and repairs is highly recommended to ensure the designed performance. Damage or failures caused by the use of non-MOPAR® parts for maintenance and repairs will not be covered by the manufacturer's warranty.

DEALER SERVICE

Your authorized dealer has the qualified service personnel, special tools, and equipment to perform all service operations in an expert manner. Service Manuals are available which include detailed service information for your vehicle. Refer to these manuals before attempting any procedure yourself.

NOTE: Intentional tampering with emissions control systems may void your warranty and could result in civil penalties being assessed against you.

WARNING!

You can be badly injured working on or around a motor vehicle. Only do service work for which you have the knowledge and the proper equipment. If you have any doubt about your ability to perform a service job, take your vehicle to a competent mechanic.

MAINTENANCE PROCEDURES

The pages that follow contain the **required** maintenance services determined by the engineers who designed your vehicle.

Besides those maintenance items specified in the fixed maintenance schedule, there are other components which may require servicing or replacement in the future.

CAUTION!

- Failure to properly maintain your vehicle or perform repairs and service when necessary could result in more costly repairs, damage to other components or negatively impact vehicle performance. Immediately have potential malfunctions examined by an authorized Chrysler Group LLC dealership or qualified repair center.
- Your vehicle has been built with improved fluids that protect the performance and durability of your vehicle and also allow extended maintenance intervals. Do not use chemical flushes in these components as the chemicals can damage your engine, transmission, power steering or air conditioning. Such damage is not covered by the New Vehicle Limited Warranty. If a flush is needed because of component malfunction, use only the specified fluid for the flushing procedure.

Engine Oil**Checking Oil Level**

To assure proper lubrication of your vehicle's engine, the engine oil must be maintained at the correct level. Check the oil level at regular intervals, such as every fuel stop. The best time to check the engine oil level is about five minutes after a fully warmed up engine is shut off.

Checking the oil while the vehicle is on level ground will improve the accuracy of the oil level readings. Always maintain the oil level within the SAFE zone on the dipstick. Adding one quart of oil when the reading is at the bottom of the SAFE zone will result in a reading at the top of the safe zone on these engines.

CAUTION!

Overfilling or underfilling the crankcase will cause aeration or loss of oil pressure. This could damage your engine.

Change Engine Oil

The oil change indicator system will remind you that it is time to take your vehicle in for scheduled maintenance. Refer to “Maintenance Schedule” for further information.

NOTE: Under no circumstances should oil change intervals exceed 6,000 miles (10 000 km) or six months, whichever occurs first.

Engine Oil Selection

For best performance and maximum protection for all engines under all types of operating conditions, the manufacturer recommends engine oils that are API Certified and meet the requirements of Chrysler Material Standard MS-6395.

American Petroleum Institute (API) Engine Oil Identification Symbol

This symbol means that the oil has been certified by the American Petroleum Institute (API). The manufacturer only recommends API Certified engine oils.

CAUTION!

Do not use chemical flushes in your engine oil as the chemicals can damage your engine. Such damage is not covered by the New Vehicle Limited Warranty.

Engine Oil Viscosity – 3.7L Engine

SAE 5W-20 engine oil is recommended for all operating temperatures. This engine oil improves low temperature starting and vehicle fuel economy. Your engine oil filler cap shows the recommended engine oil viscosity for your vehicle.

Lubricants which do not have both the engine oil certification mark and the correct SAE viscosity grade number should not be used.

Engine Oil Viscosity – 4.0L Engine

SAE 10W-30 engine oil is preferred. SAE 5W-30 engine oil is allowed during cold weather only to improve cold weather starting.

Lubricants which do not have both the engine oil certification mark and the correct SAE viscosity grade number should not be used.

Synthetic Engine Oils

You may use synthetic engine oils provided the recommended oil quality requirements are met, and the recommended maintenance intervals for oil and filter changes are followed.

Materials Added to Engine Oils

The manufacturer strongly recommends against the addition of any additives (other than leak detection dyes) to engine oil. Engine oil is an engineered product and its performance may be impaired by supplemental additives.

Disposing of Used Engine Oil and Oil Filters

Care should be taken in disposing of used engine oil and oil filters from your vehicle. Used oil and oil filters, indiscriminately discarded, can present a problem to the environment. Contact your authorized dealer, service station, or governmental agency for advice on how and where used oil and oil filters can be safely discarded in your area.

Engine Oil Filter

The engine oil filter should be replaced at every engine oil change.

NOTE: For best access to the oil filter, a drive on hoist should be used instead of a chassis hoist (3.7L Only).

Engine Oil Filter Selection

All of the manufacturer's engines have a full-flow type disposable oil filter. Use a filter of this type for replacement. The quality of replacement filters varies considerably. Only high quality filters should be used to assure most efficient service. MOPAR® engine oil filters are high quality oil filters and are recommended.

Engine Air Cleaner Filter

Refer to "Maintenance Schedule" for further information.

WARNING!

The air induction system (air cleaner, hoses, etc.) can provide a measure of protection in the case of engine backfire. Do not remove the air induction system (air cleaner, hoses, etc.) unless such removal is necessary for repair or maintenance. Make sure that no one is near the engine compartment before starting the vehicle with the air induction system (air cleaner, hoses, etc.) removed. Failure to do so can result in serious personal injury.

Engine Air Cleaner Filter Selection

The quality of replacement engine air cleaner filters varies considerably. Only high quality filters should be used to assure most efficient service. MOPAR® engine air cleaner filters are a high quality filter and are recommended.

Maintenance-Free Battery

The top of the maintenance-free battery is permanently sealed. You will never have to add water, nor is periodic maintenance required.

WARNING!

- **Battery acid is a corrosive acid solution and can burn or even blind you. Do not allow battery fluid to contact your eyes, skin, or clothing. Do not lean over a battery when attaching clamps. If acid splashes in your face or on your skin, flush the area immediately with large amounts of water.**
- **Battery gas is flammable and explosive. Keep flame or sparks away from the battery. Do not use a booster battery or any other booster source with an output greater than 12 Volts. Do not allow cable clamps to touch each other.**
- **Battery posts, terminals, and related accessories contain lead and lead compounds. Wash your hands after handling the battery.**

CAUTION!

It is essential when replacing the cables on the battery that the positive cable is attached to the positive post and the negative cable is attached to the negative post. Battery posts are marked (+) positive and negative (-) and are identified on the battery case. Also, if a "fast charger" is used while the battery is in the vehicle, disconnect both vehicle battery cables before connecting the charger to the battery. Do not use a "fast charger" to provide starting voltage.

Air Conditioner Maintenance

For best possible performance, your air conditioner should be checked and serviced by an authorized dealer at the start of each warm season. This service should include cleaning of the condenser fins and a performance test. Drive belt tension should also be checked at this time.

CAUTION!

Do not use chemical flushes in your air conditioning system as the chemicals can damage your air conditioning components. Such damage is not covered by the New Vehicle Limited Warranty.

WARNING!

- Use only refrigerants and compressor lubricants approved by the manufacturer for your air conditioning system. Some unapproved refrigerants are flammable and can explode, injuring you. Other unapproved refrigerants or lubricants can cause the system to fail, requiring costly repairs. Refer to Warranty Information Book, located on the DVD, for further warranty information.
- The air conditioning system contains refrigerant under high pressure. To avoid risk of personal injury or damage to the system, adding refrigerant or any repair requiring lines to be disconnected should be done by an experienced repairman.

Refrigerant Recovery and Recycling

R-134a air conditioning refrigerant is a hydrofluorocarbon (HFC) that is endorsed by the Environmental

Protection Agency and is an ozone-saving product. However, the manufacturer recommends that air conditioning service be performed by authorized dealers or other service facilities using recovery and recycling equipment.

NOTE: Use only manufacturer approved A/C system sealers, stop leak products, seal conditioners, compressor oil, and refrigerants.

Body Lubrication

Locks and all body pivot points, including such items as seat tracks, door hinge pivot points and rollers, liftgate, tailgate, sliding doors and hood hinges, should be lubricated periodically with a lithium based grease, such as MOPAR® Spray White Lube or equivalent, to assure quiet, easy operation and to protect against rust and wear. Prior to the application of any lubricant, the parts concerned should be wiped clean to remove dust and grit; after lubricating excess oil and grease should be removed. Particular attention should also be given to

hood latching components to ensure proper function. When performing other underhood services, the hood latch, release mechanism and safety catch should be cleaned and lubricated.

The external lock cylinders should be lubricated twice a year, preferably in the Fall and Spring. Apply a small amount of a high quality lubricant, such as MOPAR® Lock Cylinder Lubricant or equivalent, directly into the lock cylinder.

Windshield Wiper Blades

Clean the rubber edges of the wiper blades and the windshield periodically with a sponge or soft cloth and a mild non-abrasive cleaner. This will remove accumulations of salt or road film.

Operation of the wipers on dry glass for long periods may cause deterioration of the wiper blades. Always use washer fluid when using the wipers to remove salt or dirt from a dry windshield.

Avoid using the wiper blades to remove frost or ice from the windshield. Keep the blade rubber out of contact with petroleum products such as engine oil, gasoline, etc.

NOTE: Life expectancy of wiper blades varies depending on geographical area and frequency of use. Poor performance of blades may be present with chattering, marks, water lines or wet spots. If any condition is present please proceed to clean wiper blades with humid cloth removing any debris that may be affecting its function.

Adding Washer Fluid

The fluid reservoir in the engine compartment should be checked for fluid level at regular intervals. Fill the reservoir with windshield washer solvent/antifreeze (not radiator antifreeze). Operate the system for a few seconds to flush out the residual water.

WARNING!

Commercial windshield washer solvents are flammable. They could ignite and burn you. Care must be exercised when filling or working around the washer solution.

Exhaust System

The best protection against carbon monoxide entry into the vehicle body is a properly maintained engine exhaust system.

If you notice a change in the sound of the exhaust system or if the exhaust fumes can be detected inside the vehicle or when the underside or rear of the vehicle is damaged, have an authorized technician inspect the complete exhaust system and adjacent body areas for broken, damaged, deteriorated, or mispositioned parts. Open seams or loose connections could permit exhaust fumes to seep

into the passenger compartment. In addition, inspect the exhaust system each time the vehicle is raised for lubrication or oil change. Replace as required.

CAUTION!

The catalytic converter requires the use of unleaded fuel only. Leaded gasoline will destroy the effectiveness of the catalyst as an emissions control device and may seriously reduce engine performance and cause serious damage to the engine.

Under normal operating conditions, the catalytic converter will not require maintenance. However, it is important to keep the engine properly tuned to assure proper catalyst operation and prevent possible catalyst damage.

CAUTION!

Damage to the catalytic converter can result if your vehicle is not kept in proper operating condition. In the event of engine malfunction, particularly involving engine misfire or other apparent loss of performance, have your vehicle serviced promptly. Continued operation of your vehicle with a severe malfunction could cause the converter to overheat, resulting in possible damage to the converter and vehicle.

WARNING!

A hot exhaust system can start a fire if you park over materials that can burn. Such materials might be grass or leaves coming into contact with your exhaust system. Do not park or operate your vehicle in areas where your exhaust system can contact anything that can burn.

In unusual situations involving grossly malfunctioning engine operation, a scorching odor may suggest severe and abnormal catalyst overheating. If this occurs, stop the vehicle, turn OFF the engine and allow it to cool. Service, including a tune up to manufacturer's specifications, should be obtained immediately.

To minimize the possibility of catalytic converter damage:

- Do not shut off the engine or interrupt the ignition when the transmission is in gear and the vehicle is in motion.
- Do not try to start the engine by pushing or towing the vehicle.
- Do not idle the engine with any spark plug wires disconnected or removed, such as when diagnostic testing.
- Do not idle the engine for prolonged periods during very rough idle or malfunctioning operating conditions.
- Do not allow vehicle to run out of fuel.

NOTE: Intentional tampering with emissions control systems can result in civil penalties being assessed against you.

Cooling System

WARNING!

You or others can be badly burned by hot engine coolant (antifreeze) or steam from your radiator. If you see or hear steam coming from under the hood, do not open the hood until the radiator has had time to cool. Never try to open a cooling system pressure cap when the radiator or coolant bottle is hot.

Engine Coolant Checks

Check engine coolant (antifreeze) protection every 12 months (before the onset of freezing weather, where applicable). If the engine coolant (antifreeze) is dirty or rusty in appearance, the system should be drained, flushed and refilled with fresh engine coolant (antifreeze). Check the front of the A/C condenser (if equipped) or radiator for any accumulation of bugs, leaves, etc. If dirty, clean by gently spraying water from a garden hose vertically down the face of the A/C condenser (if equipped) or the back of the radiator core.

Check the engine cooling system hoses for brittle rubber, cracking, tears, cuts, and tightness of the connection at the coolant recovery bottle and radiator. Inspect the entire system for leaks.

With the engine at normal operating temperature (but not running), check the cooling system pressure cap for proper vacuum sealing by draining a small amount of

engine coolant (antifreeze) from the radiator drain cock. If the cap is sealing properly, the engine coolant (antifreeze) will begin to drain from the coolant recovery bottle. **DO NOT REMOVE THE COOLANT PRESSURE CAP WHEN THE COOLING SYSTEM IS HOT.**

Cooling System – Drain, Flush, and Refill

If the engine coolant (antifreeze) is dirty and contains a considerable amount of sediment, clean and flush with reliable cooling system cleaner. Follow with a thorough rinsing to remove all deposits and chemicals. Properly dispose of the old engine coolant (antifreeze).

Refer to “Maintenance Schedule” for further information.

Selection of Engine Coolant

Use only the manufacturer’s recommended engine coolant (antifreeze). Refer to “Fluids, Lubricants, and Genuine Parts” in “Maintaining Your Vehicle” for further information.

CAUTION!

- Mixing of engine coolant (antifreeze) other than the specified HOAT engine coolant (antifreeze) may result in decreased corrosion protection and engine damage. If a non-HOAT engine coolant (antifreeze) is introduced into the cooling system in an emergency, it should be replaced with the specified engine coolant (antifreeze) as soon as possible.
- Do not use water alone or alcohol based engine coolant (antifreeze) products. Do not use additional rust inhibitors or antirust products, as they may not be compatible with the engine coolant (antifreeze) and may plug the radiator.

(Continued)

CAUTION! (Continued)

- This vehicle has not been designed for use with propylene glycol based engine coolant (antifreeze). Use of propylene glycol based engine coolant (antifreeze) is not recommended.

Adding Engine Coolant

Your vehicle has been built with an improved engine coolant (antifreeze) that allows extended maintenance intervals. This engine coolant (antifreeze) can be used up to five years or 102,000 miles (170 000 km) before replacement. To prevent reducing this extended maintenance period, it is important that you use the same engine coolant (antifreeze) throughout the life of your vehicle. Please review these recommendations for using Hybrid Organic Additive Technology (HOAT) engine coolant (antifreeze).

When adding engine coolant (antifreeze):

- The manufacturer recommends using MOPAR® Antifreeze/ Coolant 5 Year/100,000 Mile Formula HOAT (Hybrid Organic Additive Technology) or equivalent.
- Mix a minimum solution of 50% HOAT engine coolant (antifreeze) and distilled water. Use higher concentrations (not to exceed 70%) if temperatures below -34°F (-37°C) are anticipated.
- Use only high purity water such as distilled or deionized water when mixing the water/antifreeze (coolant) solution. The use of lower quality water will reduce the amount of corrosion protection in the engine cooling system.

Please note that it is the owner's responsibility to maintain the proper level of protection against freezing according to the temperatures occurring in the area where the vehicle is operated.

NOTE: Mixing engine coolant (antifreeze) types will decrease the life of the engine coolant (antifreeze) and will require more frequent engine coolant (antifreeze) changes.

Cooling System Pressure Cap

The cap must be fully tightened to prevent the loss of engine coolant (antifreeze) and to ensure that the engine coolant (antifreeze) will return to the radiator from the coolant reserve tank.

The cap should be inspected and cleaned if there is any accumulation of foreign material on the sealing surfaces.

WARNING!

- The warning words “DO NOT OPEN HOT” on the cooling system pressure cap are a safety precaution. Never add engine coolant (antifreeze) when the engine is overheated. Do not loosen or remove the cap to cool an overheated engine. Heat causes pressure to build up in the cooling system. To prevent scalding or injury, do not remove the pressure cap while the system is hot or under pressure.
- Do not use a pressure cap other than the one specified for your vehicle. Personal injury or engine damage may result.

Disposal of Used Engine Coolant

Used ethylene glycol based engine coolant (antifreeze) is a regulated substance requiring proper disposal. Check with your local authorities to determine the disposal rules for your community. To prevent ingestion by animals or children, do not store ethylene glycol based engine coolant (antifreeze) in open containers or allow it to remain in puddles on the ground. If ingested by a child or pet, seek emergency assistance immediately. Clean up any ground spills immediately.

Engine Coolant Level

The coolant bottle provides a quick visual method for determining that the coolant level is adequate. With the engine idling and warm to normal operating temperature, the level of the engine coolant (antifreeze) in the bottle should be between the ranges indicated on the bottle.

The radiator normally remains completely full, so there is no need to remove the radiator cap unless checking for engine coolant (antifreeze) freeze point or replacing the engine coolant (antifreeze). Advise your service attendant of this. As long as the engine operating temperature is satisfactory, the coolant bottle need only be checked once a month.

When additional engine coolant (antifreeze) is needed to maintain the proper level, it should be added to the coolant bottle. Do not overfill.

Points to Remember

NOTE: When the vehicle is stopped after a few miles/kilometers of operation, you may observe vapor coming from the front of the engine compartment. This is normally a result of moisture from rain, snow, or high humidity accumulating on the radiator and being vaporized when the thermostat opens, allowing hot engine coolant (antifreeze) to enter the radiator.

If an examination of your engine compartment shows no evidence of radiator or hose leaks, the vehicle may be safely driven. The vapor will soon dissipate.

- Do not overfill the coolant recovery bottle.
- Check engine coolant (antifreeze) freeze point in the radiator and in the coolant recovery bottle. If engine coolant (antifreeze) needs to be added, contents of coolant recovery bottle must also be protected against freezing.
- If frequent engine coolant (antifreeze) additions are required, or if the level in the recovery bottle does not drop when the engine cools, the cooling system should be pressure tested for leaks.
- Maintain engine coolant (antifreeze) concentration at 50% HOAT engine coolant (antifreeze) (minimum) and distilled water for proper corrosion protection of your engine which contains aluminum components.

- Make sure that the radiator and coolant recovery bottle hoses are not kinked or obstructed.
- Keep the front of the radiator clean. If your vehicle is equipped with air conditioning, keep the front of the condenser clean, also.
- Do not change the thermostat for Summer or Winter operation. If replacement is ever necessary, install only the correct type thermostat. Other designs may result in unsatisfactory cooling performance, poor gas mileage, and increased emissions.

Brake System

In order to assure brake system performance, all brake system components should be inspected periodically. Refer to “Maintenance Schedule” for further information.

WARNING!

Riding the brakes can lead to brake failure and possibly an accident. Driving with your foot resting or riding on the brake pedal can result in abnormally high brake temperatures, excessive lining wear, and possible brake damage. You would not have your full braking capacity in an emergency.

Brake Master Cylinder

The fluid level in the master cylinder should be checked when performing under hood services or immediately if the BRAKE warning light is illuminated.

Be sure to clean the top of the master cylinder area before removing the cap. If necessary, add fluid to bring the fluid level up to the requirements described on the brake fluid reservoir. With disc brakes, fluid level can be expected to fall as the brake pads wear. Brake fluid level

should be checked when pads are replaced. However, low fluid level may be caused by a leak and a checkup may be needed.

Use only manufacturer's recommended brake fluid. Refer to "Fluids, Lubricants, and Genuine Parts" in "Maintaining Your Vehicle" for further information.

WARNING!

- Use only manufacturer's recommended brake fluid. Refer to "Fluids, Lubricants, and Genuine Parts" in "Maintaining Your Vehicle" for further information. Using the wrong type of brake fluid can severely damage your brake system and/or impair its performance. The proper type of brake fluid for your vehicle is also labeled on the original factory installed hydraulic master cylinder reservoir.

(Continued)

WARNING! (Continued)

- To avoid contamination from foreign matter or moisture, use only new brake fluid or fluid that has been in a tightly closed container. Keep the master cylinder reservoir cap secured at all times. Brake fluid in an open container absorbs moisture from the air resulting in a lower boiling point. This may cause it to boil unexpectedly during hard or prolonged braking, resulting in sudden brake failure. This could result in an accident.
- Overfilling the brake fluid reservoir can result in spilling brake fluid on hot engine parts, causing the brake fluid to catch fire. Brake fluid can also damage painted and vinyl surfaces, care should be taken to avoid its contact with these surfaces.

(Continued)

WARNING! (Continued)

- **Do not allow petroleum based fluid to contaminate the brake fluid. Brake seal components could be damaged, causing partial or complete brake failure. This could result in an accident.**

Automatic Transmission**Fluid Level Check**

Your vehicle is equipped with a capped transmission oil fill tube. It is sealed and should not be tampered with. Your authorized dealer has the proper tools to ensure that the fluid level is set properly.

Selection of Lubricant

It is important that the proper lubricant is used in the transmission to assure optimum transmission performance. Use only manufacturer's recommended transmission fluid. Refer to "Fluids, Lubricants, and Genuine

Parts" in "Maintaining Your Vehicle" for further information. It is important that the transmission fluid be maintained at the prescribed level using the recommended fluid.

CAUTION!

Using a transmission fluid other than the manufacturer's recommended fluid may cause deterioration in transmission shift quality and/or torque converter shudder. Using a transmission fluid other than the manufacturer's recommended fluid will result in more frequent fluid and filter changes. Refer to "Fluids, Lubricants, and Genuine Parts" in "Maintaining Your Vehicle" for further information.

Special Additives

The manufacturer strongly recommends against the addition of any additives to the transmission. The only exception to this policy is the use of special dyes to aid in detecting fluid leaks. The use of transmission sealers should be avoided as they may adversely affect seals.

CAUTION!

Do not use chemical flushes in your transmission as the chemicals can damage your transmission components. Such damage is not covered by the New Vehicle Limited Warranty.

Transfer Case

Fluid Level Check

The fluid level should be to the bottom edge of the fill hole (1) when the vehicle is in a level position.

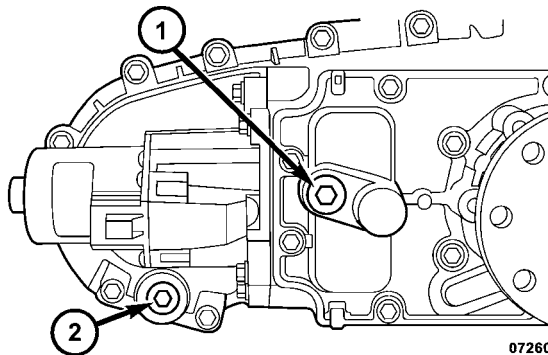

072607575

- 1 — Fill Plug
- 2 — Drain Plug

Adding Fluid

Fluid should be added only to fill hole until fluid begins to run out of the hole.

Draining Fluid

First remove the fill plug (1), then the drain plug (2). Recommended tightening torque for the drain and fill plugs is 15–25 ft lbs (20–34 N·m).

CAUTION!

Do not over-tighten the plugs. You could damage them and cause a leak.

Lubricant Selection

Use only manufacturer's recommended fluid. Refer to "Fluids, Lubricants, and Genuine Parts" in "Maintaining Your Vehicle" for further information.

Frequency of Fluid Change

Under normal operating conditions, the fluid installed at the factory will give satisfactory lubrication for the life of the vehicle. Fluid changes are not necessary unless the fluid becomes contaminated with water. Change the fluid immediately if contaminated with water.

Front/Rear Axle Fluid

Fluid Level Check

Lubricant should be at bottom edge of the oil fill hole.

Adding Fluid

Add lubricant only at the fill hole and only to the level specified above.

Selection of Lubricant

Use only manufacturer's recommended fluid. Refer to "Fluids, Lubricants, and Genuine Parts" in "Maintaining Your Vehicle" for further information.

Appearance Care and Protection from Corrosion

Protection of Body and Paint from Corrosion

Vehicle body care requirements vary according to geographic locations and usage. Chemicals that make roads passable in snow and ice, and those that are sprayed on trees and road surfaces during other seasons, are highly corrosive to the metal in your vehicle. Outside parking,

which exposes your vehicle to airborne contaminants, road surfaces on which the vehicle is operated, extreme hot or cold weather and other extreme conditions will have an adverse effect on paint, metal trim, and underbody protection.

The following maintenance recommendations will enable you to obtain maximum benefit from the corrosion resistance built into your vehicle.

What Causes Corrosion?

Corrosion is the result of deterioration or removal of paint and protective coatings from your vehicle.

The most common causes are:

- Road salt, dirt and moisture accumulation.
- Stone and gravel impact.
- Insects, tree sap and tar.
- Salt in the air near seacoast localities.

- Atmospheric fallout/industrial pollutants.

Washing

- Wash your vehicle regularly. Always wash your vehicle in the shade using MOPAR® Car Wash or equivalent, or a mild car wash soap, and rinse the panels completely with clear water.
- If insects, tar, or other similar deposits have accumulated on your vehicle, use MOPAR® Super Kleen Bug and Tar Remover or equivalent to remove.
- Use a high quality cleaner wax, such as MOPAR® Cleaner Wax or equivalent, to remove road film, stains, and to protect your paint finish. Take care never to scratch the paint.
- Avoid using abrasive compounds and power buffing that may diminish the gloss or thin out the paint finish.

CAUTION!

- Do not use abrasive or strong cleaning materials such as steel wool or scouring powder, which will scratch metal and painted surfaces.
- Use of power washers exceeding 1,200 psi (8 274 kPa) can result in damage or removal of paint and decals.

Special Care

- If you drive on salted or dusty roads or if you drive near the ocean, hose off the undercarriage at least once a month.
 - It is important that the drain holes in the lower edges of the doors, rocker panels and liftgate are kept clear and open.
- If you detect any stone chips or scratches in the paint, touch them up immediately. The cost of such repairs is considered the responsibility of the owner.
 - If your vehicle is damaged due to an accident or similar cause which destroys the paint and protective coating, have your vehicle repaired as soon as possible. The cost of such repairs is considered the responsibility of the owner.
 - If you carry special cargo such as chemicals, fertilizers, de-icer salt, etc., assure that such materials are well packaged and sealed.
 - If a lot of driving is done on gravel roads, consider mud or stone shields behind each wheel.
 - Use MOPAR® Touch Up Paint or equivalent on scratches or chips as soon as possible. Your authorized dealer has touch up paint to match the color of your vehicle.

Wheel and Wheel Trim Care

All wheels and wheel trim, especially aluminum and chrome-plated wheels, should be cleaned regularly with a mild soap and water to prevent corrosion. To remove heavy soil, use MOPAR® Wheel Cleaner or equivalent, or select a nonabrasive, non-acidic cleaner. Do not use scouring pads, steel wool, a bristle brush or metal polishes. Only MOPAR® cleaners or equivalent are recommended. Do not use oven cleaner. Avoid automatic car washes that use acidic solutions or harsh brushes that may damage the wheels' protective finish.

Stain Repel Fabric Cleaning Procedure – If Equipped

Stain Repel seats may be cleaned in the following manner:

- Remove as much of the stain as possible by blotting with a clean, dry towel.
- Blot any remaining stain with a clean, damp towel.

- For tough stains, apply MOPAR® Total Clean or equivalent, or a mild soap solution to a clean, damp cloth and remove the stain. Use a fresh, damp towel to remove soap residue.
- For grease stains, apply MOPAR® Multi-Purpose Cleaner or equivalent to a clean, damp cloth and remove the stain. Use a fresh, damp towel to remove soap residue.
- Do not use any harsh solvents or any other form of protectants on Stain Repel products.

Interior Care

Use MOPAR® Total Clean or equivalent to clean fabric upholstery and carpeting.

Interior trim should be cleaned starting with a damp cloth, a damp cloth with MOPAR® Total Clean or equivalent, then MOPAR® Spot & Stain Remover or equivalent if absolutely necessary. Do not use harsh cleaners or Armor All®. Use MOPAR® Total Clean or equivalent to clean vinyl upholstery.

WARNING!

Do not use volatile solvents for cleaning purposes. Many are potentially flammable, and if used in closed areas they may cause respiratory harm.

Glass Surfaces

All glass surfaces should be cleaned on a regular basis with MOPAR® Glass Cleaner or any commercial household-type glass cleaner. Never use an abrasive cleaner. Use caution when cleaning inside rear windows equipped with electric defrosters. Do not use scrapers or other sharp instruments that may scratch the elements.

When cleaning the rear view mirror, spray cleaner on the towel or rag that you are using. Do not spray cleaner directly on the mirror.

Cleaning Plastic Instrument Cluster Lenses

The lenses in front of the instruments in this vehicle are molded in clear plastic. When cleaning the lenses, care must be taken to avoid scratching the plastic.

1. Clean with a wet soft rag. A mild soap solution may be used, but do not use high alcohol content or abrasive cleaners. If soap is used, wipe clean with a clean damp rag.
2. Dry with a soft cloth.

Seat Belt Maintenance

Do not bleach, dye or clean the seat belts with chemical solvents or abrasive cleaners. This will weaken the fabric. Sun damage will also weaken the fabric.

If the seat belts need cleaning, use MOPAR® Total Clean or equivalent, a mild soap solution, or lukewarm water. Do not remove the seat belts from the vehicle to wash them.

Replace the seat belts if they appear frayed or worn or if the buckles do not work properly.

FUSES

Totally Integrated Power Module

The Totally Integrated Power Module (TIPM) is located in the engine compartment near the battery. This center contains cartridge fuses, mini fuses and relays. A label that identifies each component is printed on the inside of the cover.

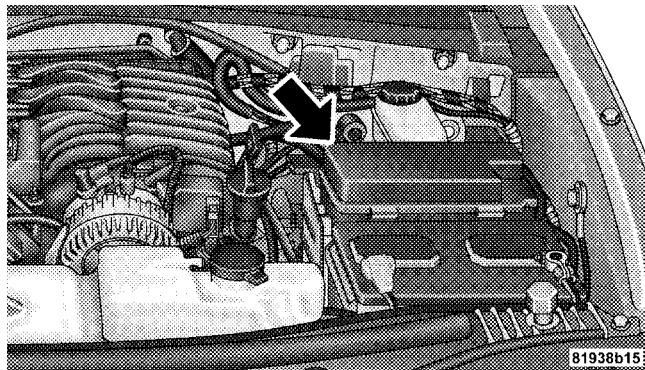

Totally Integrated Power Module (TIPM)

Cavity	Cartridge Fuse	Mini-Fuse	Description
J1	40 Amp Green		Power Folding Seat
J2	30 Amp Pink		Transfer Case/Pwr Liftgate Module
J3	40 Amp Green		Rear Door Module (RR DOOR NODE)
J4	25 Amp Natural		Driver Door Node
J5	25 Amp Natural		Passenger Door Node
J6	40 Amp Green		Anti-Lock Brake System (ABS) Pump/ESP
J7	30 Amp Pink		Anti-Lock Brake System (ABS) Valve/ESP
J8	40 Amp Green		Power Memory Seat – If Equipped

Cavity	Cartridge Fuse	Mini-Fuse	Description
J9	40 Amp Green		PZEV Motor/Flex Fuel
J10	30 Amp Pink		Hdlp Wash Relay/Manual Tuning Valve
J11	30 Amp Pink		Sway Bar/THATCHAM Lock-Unlock/Power Sliding Door Module
J13	60 Amp Yellow		Ignition Off Draw (IOD) – Main
J14	40 Amp Green		EBL (Rear Window Defogger)
J15	30 Amp Pink		Rear Blower
J17	40 Amp Green		Starter Solenoid

Cavity	Cartridge Fuse	Mini-Fuse	Description
J18	20 Amp Blue		Powertrain Control Module (PCM) Trans Range
J19	60 Amp Yellow		Radiator Fan
J20	30 Amp Pink		Front Wiper LO/HI
J21	20 Amp Blue		Front/Rear Washer
J22	25 Amp Natural		Sunroof Module
M1		15 Amp Blue	Center High Mounted Stop Light (CHMSL)/Brake Switch
M2		20 Amp Yellow	Trailer Lighting

Cavity	Cartridge Fuse	Mini-Fuse	Description
M3		20 Amp Yellow	Frt/Rear Axle Lockers
M4		10 Amp Red	Trailer Tow
M5		25 Amp Natural	Inverter
M6		20 Amp Yellow	Power Outlet #1/Rain Sensor
M7		20 Amp Yellow	Power Outlet #2 (BATT/ACC SELECT)
M8		20 Amp Yellow	Front Heated Seat
M9		20 Amp Yellow	Rear Heated Seat – If Equipped

Cavity	Cartridge Fuse	Mini-Fuse	Description
M10		20 Amp Yellow	Ignition Off Draw – Vehicle Entertainment System (IOD-VES), Satellite Digital Audio Receiver (SDARS), DVD, Hands-Free Module (HFM), RADIO, Antenna (ANT), Universal Garage Door Opener (UGDO), Vanity Lamp (VANITY LP)
M11		10 Amp Red	(Ignition Off Draw) IOD-HVAC/ATC, MW SENSR, Underhood Lamp (UH LMP)

Cavity	Cartridge Fuse	Mini-Fuse	Description
M12		30 Amp Green	Amplifier (AMP)
M13		20 Amp Yellow	Ignition Off Draw – Cabin Compartment Node (IOD-CCN), Wireless Control Module (WCM), SIREN, Clock Module (CLK MOD), Multifunction Control Switch (MULTIFCTN SW)
M14		20 Amp Yellow	Trailer Tow (Export Only)

Cavity	Cartridge Fuse	Mini-Fuse	Description
M15		20 Amp Yellow	COL MOD, IR SNS, Heater Ventilation, Air Conditioning/ Automatic Temperature Control (HVAC/ ATC), Rearview Mirror (RR VW MIR), Cabin Compartment Node (CCN), Transfer Case Switch (T-CASE SW), RUN/ST, Multifunction Control Switch (MULTIFCTN SW), Tire Pressure Monitor (TPM), Glow Plug Module (GLW PLG MOD) – Export Diesel Only

Cavity	Cartridge Fuse	Mini-Fuse	Description
M16		10 Amp Red	Occupant Restraint Controller/Occupant Classification Module (ORC/OCM)
M17		15 Amp Blue	Left Tail/License/Park Lamp (LT-TAIL/LIC/PRK LMP)
M18		15 Amp Blue	Right Tail/Park/Run Lamp (RT-TAIL/PRK/RUN LMP)
M19		25 Amp Natural	Auto Shut Down (ASD #1 and #2)

Cavity	Cartridge Fuse	Mini-Fuse	Description
M20		15 Amp Blue	Cabin Compartment Node Interior Light (CCN INT LIGHT), Switch Bank (SW BANK), Steering Control Module (SCM)
M21		20 Amp Yellow	Auto Shut Down (ASD #3)
M22		10 Amp Red	Right Horn (RT HORN (HI/LOW)
M23		10 Amp Red	Left Horn (LT HORN (HI/LOW)
M24		25 Amp Natural	Rear Wiper (REAR WIPER)

Cavity	Cartridge Fuse	Mini-Fuse	Description
M25		20 Amp Yellow	Fuel Pump (FUEL PUMP), Diesel Lift Pump (DSL LIFT PUMP) – Export Only
M26		10 Amp Red	Power Mirror Switch (PWR MIRR SW), Driver Window Switch (DRVR WIND SW)
M27		10 Amp Red	Ignition Switch (IGN SW), Window Module (WIN MOD)
M28		10 Amp Red	Next Generation Controller (NGC), Transmission Feed (TRANS FEED), J1962

Cavity	Cartridge Fuse	Mini-Fuse	Description
M29		10 Amp Red	Occupant Classification Module (OCM)
M30		15 Amp Blue	Rear Wiper Module (RR WIPER MOD), Power Folding Mirror (PWR FOLD MIR)
M31		20 Amp Yellow	Back-Up Lamps (B/U LAMPS)
M32		10 Amp Red	Occupant Restraint Controller (ORC), TT EUROPE
M33		10 Amp Red	Next Generation Controller (NGC), Global Powertrain Engine Controller (GPEC)

Cavity	Cartridge Fuse	Mini-Fuse	Description
M34		10 Amp Red	Park Assist (PRK ASST), Heater Ventilation, Air Conditioning Module (HVAC MOD), Headlamp Wash (HDLP WASH), Compass (COMPAS)
M35		10 Amp Red	Heated Mirrors
M36		20 Amp Yellow	Power Outlet #3 (BATT)
M37		10 Amp Red	Anti-Lock Brake System (ABS), Electronic Stability Program (ESP), Stop Lamp Switch (STP LP SW), Fuel Pump Rly Hi Control

Cavity	Cartridge Fuse	Mini-Fuse	Description
M38		25 Amp Natural	Lock/Unlock Motors (LOCK/UNLOCK MTRS)

CAUTION!

- When installing the integrated power module cover, it is important to ensure the cover is properly positioned and fully latched. Failure to do so may allow water to get into the integrated power module, and possibly result in a electrical system failure.

(Continued)

CAUTION! (Continued)

- When replacing a blown fuse, it is important to use only a fuse having the correct amperage rating. The use of a fuse with a rating other than indicated may result in a dangerous electrical system overload. If a properly rated fuse continues to blow, it indicates a problem in the circuit that must be corrected.

REPLACEMENT BULBS

LIGHT BULBS – Interior	Bulb No.
Dome Lamp	TL212-2
Liftgate Lamp	567
Overhead Console Lamps.	PLW214-2A
Reading Lamp	WL212-2

LIGHT BULBS – Exterior	Bulb No.
Headlamp	9008 H13
Front Park/Turn	3157AK
Front Sidemarker.	168
Back-Up	3057K
Center High Mounted Stoplamp	LED (serviced at an authorized dealer)
Fog Lamp.	H10 9145
License Plate Lamp	168
Rear Tail, Stop, Turn Signal.	3057K

BULB REPLACEMENT

Headlamp

1. Open the hood.
2. Reach behind the headlamp unit in the engine compartment to access the headlamp bulb lock ring.
3. Firmly grasp the lock ring on the back of the headlamp unit housing.

4. Rotate the lock ring on the back of the headlamp housing counterclockwise to unlock it.

CAUTION!

Do not touch the new bulb with your fingers. Oil contamination will severely shorten bulb life. If the bulb comes in contact with any oily surface, clean the bulb with rubbing alcohol.

5. Disconnect the electrical connector and replace the bulb.

Left Front Turn Signal

1. Turn the steering wheel all the way to the right (full right lock).

2. Remove the door in the left wheel liner by twisting counter clockwise. Access to the bulb can be gained through the wheel liner hole.

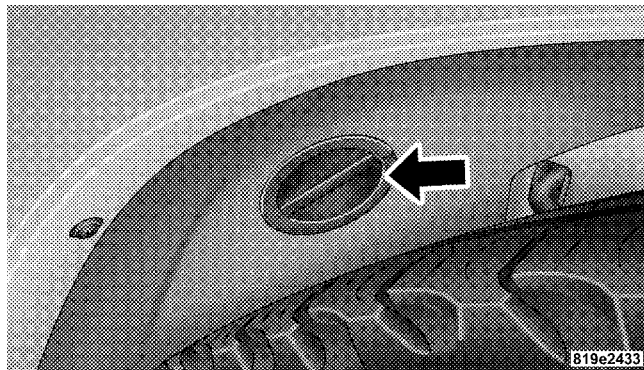

Access Door

3. Disconnect the electrical connector.
4. Twist the bulb counter clockwise to remove.

Right Front Turn Signal

1. Open the hood.
2. Reach behind the headlight unit in the engine compartment to access the turn signal bulb.
3. Twist the bulb counterclockwise to remove.
4. Disconnect the electrical connector and replace the bulb.

Front Side Marker

1. Open the hood.
2. Remove the grille assembly as follows:
 - a. Remove eight fasteners.
 - b. Remove two screws from each headlamp.
 - c. Remove two rivets from the center of the grille.

- d. Remove one push pin from the top of each fender.
 - e. Pull the grille assembly toward you to disconnect the grille clips to the fender and the headlamp ball-studs to the front end module.
3. Disconnect electrical connector.
 4. Turn the bulb counterclockwise to remove.

Front Fog Lamp (Front Fascia Mounted)

1. Reach between the front fascia and wheel liner from under the vehicle.
2. Turn the front fog lamp bulb one quarter turn counterclockwise to remove from housing.
3. Disconnect the electrical connector and replace bulb.

CAUTION!

Do not touch the new bulb with your fingers. Oil contamination will severely shorten bulb life. If the bulb comes in contact with any oily surface, clean the bulb with rubbing alcohol.

Rear Tail, Stop, Turn Signal, and Backup Lamp

1. Open the lift gate.
2. Remove the two push pins.

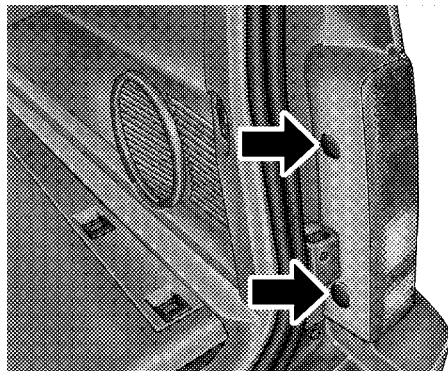

819e23d7

Push Pins

3. Pull lamp straight back and disconnect electrical connection.
4. Remove the two screws attaching the backplate to the lamp assembly.

5. Pull the backplate straight back from the lamp housing.
6. Disconnect the electrical connector.
7. Remove the bulb from the backplate.

Center High Mounted Stop Lamp (CHMSL)

1. Remove the two screws securing the CHMSL.

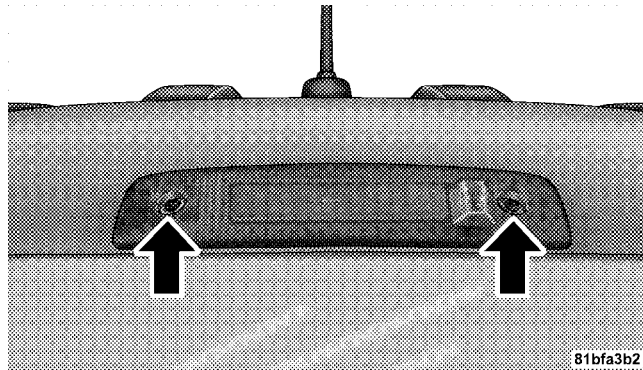

Screw Locations

2. Disconnect the electrical connector and washer hose (if equipped) from the CHMSL.
3. Replace the CHMSL.

FLUID CAPACITIES

	U.S.	Metric
Fuel (Approximate)	19.5 Gallons	73.8 Liters
Engine Oil with Filter		
3.7 Liter Engine (SAE 5W-20, API Certified)	5 Quarts	4.7 Liters
4.0 Liter Engine (SAE 10W-30, API Certified)	5.5 Quarts	5.2 Liters
Cooling System *		
3.7 Liter Engine (MOPAR® Antifreeze/Engine Coolant 5 Year/100,000 Mile Formula or equivalent)	14 Quarts	13.3 Liters
4.0 Liter Engine (MOPAR® Antifreeze/Engine Coolant 5 Year/100,000 Mile Formula or equivalent)	14 Quarts	13.3 Liters
* Includes heater and coolant recovery bottle filled to MAX level.		

FLUIDS, LUBRICANTS AND GENUINE PARTS

Engine

Component	Fluid, Lubricant, or Genuine Part
Engine Coolant	MOPAR® Antifreeze/Coolant 5 Year/100,000 Mile Formula HOAT (Hybrid Organic Additive Technology) or equivalent.
Engine Oil – 3.7L Engine	Use API Certified SAE 5W-20 Engine Oil, meeting the requirements of Chrysler Material Standard MS-6395. Refer to your engine oil filler cap for correct SAE grade.
Engine Oil – 4.0L Engine	Use API Certified SAE 10W-30 Engine Oil, meeting the requirements of Chrysler Material Standard MS-6395. Refer to your engine oil filler cap for correct SAE grade.
Engine Oil Filter	MOPAR® Engine Oil Filter or equivalent.
Spark Plugs – 3.7L Engine	ZFR6F-11G (Gap 0.043 in [1.09 mm])
Spark Plugs – 4.0L Engine	ZFR5LP-13G (Gap 0.050 in [1.27 mm])
Fuel Selection – 3.7L Engine	87 Octane
Fuel Selection – 4.0L Engine	87 Octane Acceptable – 89 Octane Preferred

Chassis

Component	Fluid, Lubricant, or Genuine Part
Automatic Transmission	MOPAR® ATF+4® Automatic Transmission Fluid or equivalent licensed ATF+4® product.
Transfer Case	MOPAR® ATF+4® Automatic Transmission Fluid or equivalent licensed ATF+4® product.
Front Axle	SAE 80W-90 Multi-Purpose Type, GL-5 Gear Lubricant or equivalent.
Rear Axle	SAE 75W-140 Synthetic Gear Lubricant or equivalent.
Brake Master Cylinder	MOPAR® DOT 3 Brake Fluid, SAE J1703 should be used. If DOT 3, SAE J1703 brake fluid is not available, then DOT 4 is acceptable. Use only recommended brake fluids.
Power Steering Reservoir	MOPAR® Power Steering Fluid +4, MOPAR® ATF+4® Automatic Transmission Fluid or equivalent licensed ATF+4® product.

MAINTENANCE SCHEDULES

CONTENTS

<ul style="list-style-type: none"> ■ Emissions Control System Maintenance 440 ■ Maintenance Schedule 440 	<ul style="list-style-type: none"> □ Required Maintenance Intervals 442
--	--

EMISSIONS CONTROL SYSTEM MAINTENANCE

The Scheduled Maintenance services listed in **bold type** must be done at the times or mileages specified to ensure the continued proper functioning of the emissions control system. These and all other maintenance services included in this manual, should be done to provide best vehicle performance and reliability. More frequent maintenance may be needed for vehicles in severe operating conditions, such as dusty areas and very short trip driving.

Inspection and service should also be done anytime a malfunction is suspected.

NOTE: Maintenance, replacement or repair of the emissions control devices and systems on your vehicle may be performed by any automotive repair establishment or individual using any automotive part that has been certified pursuant to U.S. EPA or in the State of California, California Air Resources Board regulations.

MAINTENANCE SCHEDULE

The oil change indicator system will remind you that it is time to take your vehicle in for scheduled maintenance.

On Electronic Vehicle Information Center (EVIC) equipped vehicles “Oil Change Required” will be displayed in the EVIC and a single chime will sound, indicating that an oil change is necessary.

On Non-EVIC equipped vehicles “Change Oil” will flash in the instrument cluster odometer and a single chime will sound, indicating that an oil change is necessary.

Based on engine operation conditions the oil change indicator message will illuminate, this means that service is required for your vehicle. Have your vehicle serviced as soon as possible, within the next 500 miles (805 km).

NOTE:

- The oil change indicator message will not monitor the time since the last oil change. Change your vehicle's oil if it has been six months since your last oil change even if the oil change indicator message is NOT illuminated.
- Change your engine oil more often if you drive your vehicle off-road for an extended period of time.
- Under no circumstances should oil change intervals exceed 6,000 miles (10 000 km) or six months, whichever comes first.

Your authorized dealer will reset the oil change indicator message after completing the scheduled oil change. If a scheduled oil change is performed by someone other than your authorized dealer, the message can be reset by

referring to the steps described under “Electronic Vehicle Information Center (EVIC)/Oil Change Required” in “Understanding Your Instrument Panel” or under “Instrument Cluster Description/Odometer/Trip Odometer” in “Understanding Your Instrument Panel” for further information.

At Each Stop for Fuel

- Check the engine oil level about five minutes after a fully warmed engine is shut off. Checking the oil level while the vehicle is on level ground will improve the accuracy of the oil level reading. Add oil only when the level is at or below the ADD or MIN mark.
- Check the windshield washer solvent and add if required.

Once a Month

- Check tire pressure and look for unusual wear or damage.
- Inspect the battery and clean and tighten the terminals as required.
- Check the fluid levels of the coolant reservoir and the brake master cylinder, add as needed.
- Check all lights and other electrical items for correct operation.

At Each Oil Change

- Change the engine oil filter.
- Inspect the brake hoses and lines.

CAUTION!

- **Failure to perform the required maintenance items may result in damage to the vehicle.**
- **Proper operation of four-wheel drive vehicles depends on tires of equal size, type and circumference on each wheel. Any difference in tire size can cause damage to the transfer case. Tire rotation schedule should be followed to balance tire wear.**

Required Maintenance Intervals

Refer to the Maintenance Schedules on the following pages for the required maintenance intervals.

6,000 Miles (10,000 km) or 6 Months Maintenance Service Schedule

- Change the engine oil and engine oil filter.
- Rotate tires.

Odometer Reading Date

Repair Order # Dealer Code

Signature Authorized Chrysler Dealer

12,000 Miles (20,000 km) or 12 Months Maintenance Service Schedule

- Change the engine oil and engine oil filter.
- Rotate tires.
- If using your vehicle for any of the following: Dusty or off-road conditions. Inspect the engine air cleaner filter; replace if necessary.
- Inspect the brake linings; replace if necessary.
- Inspect the CV joints. Perform the first inspection at 12,000 miles (20 000 km) or 12 months.
- Inspect exhaust system. Perform the first inspection at 12,000 miles (20 000 km) or 12 months.
- Inspect the front suspension, tie rod ends and boot seals for cracks or leaks and all parts for damage, wear, improper looseness or end play; replace if necessary.

Odometer Reading Date

Repair Order # Dealer Code

Signature Authorized Chrysler Dealer

18,000 Miles (30,000 km) or 18 Months Maintenance Service Schedule

- Change the engine oil and engine oil filter.
- Rotate tires.
- Inspect the front and rear axle fluid; change if using your vehicle for police, taxi, fleet, off-road or frequent trailer towing.

_____ Date

_____ Dealer Code

Signature Authorized Chrysler Dealer

24,000 Miles (40,000 km) or 24 Months Maintenance Service Schedule

- Change the engine oil and engine oil filter.
- Rotate tires.
- If using your vehicle for any of the following: Dusty or off-road conditions. Inspect the engine air cleaner filter; replace if necessary.
- Inspect the brake linings; replace if necessary.
- Inspect the CV joints.
- Inspect exhaust system.
- Inspect the front suspension, tie rod ends and boot seals for cracks or leaks and all parts for damage, wear, improper looseness or end play; replace if necessary.

_____ Date

_____ Dealer Code

Signature Authorized Chrysler Dealer

30,000 Miles (50,000 km) or 30 Months Maintenance Service Schedule

- Change the engine oil and engine oil filter.
- Rotate tires.
- Replace the engine air cleaner filter.
- Replace the spark plugs (3.7L Engine).**
- Adjust parking brake on vehicles equipped with four-wheel disc brakes.
- Inspect the transfer case fluid.

_____ Date

_____ Dealer Code

Signature Authorized Chrysler Dealer

36,000 Miles (60,000 km) or 36 Months Maintenance Service Schedule

- Change the engine oil and engine oil filter.
- Rotate tires.
- If using your vehicle for any of the following: Dusty or off-road conditions. Inspect the engine air cleaner filter; replace if necessary.
- Inspect the brake linings; replace if necessary.
- Inspect the front and rear axle fluid; change if using your vehicle for police, taxi, fleet, off-road or frequent trailer towing.
- Inspect the front suspension, tie rod ends and boot seals for cracks or leaks and all parts for damage, wear, improper looseness or end play; replace if necessary.

_____ Date

_____ Dealer Code

Signature Authorized Chrysler Dealer

42,000 Miles (70,000 km) or 42 Months Maintenance Service Schedule

- Change the engine oil and engine oil filter.
- Rotate tires.

_____ Date

_____ Dealer Code

Signature Authorized Chrysler Dealer

48,000 Miles (80,000 km) or 48 Months Maintenance Service Schedule

- Change the engine oil and engine oil filter.
- Rotate tires.
- If using your vehicle for any of the following: Dusty or off-road conditions. Inspect the engine air cleaner filter; replace if necessary.
- Inspect the brake linings; replace if necessary.
- Inspect the CV joints.
- Inspect exhaust system.
- Inspect the front suspension, tie rod ends and boot seals for cracks or leaks and all parts for damage, wear, improper looseness or end play; replace if necessary.

_____ Date

_____ Dealer Code

Signature Authorized Chrysler Dealer

**54,000 Miles (90,000 km) or
54 Months Maintenance
Service Schedule**

- Change the engine oil and engine oil filter.
- Rotate tires.
- Inspect the front and rear axle fluid; change if using your vehicle for police, taxi, fleet, off-road or frequent trailer towing.

Odometer Reading

Date

Repair Order #

Dealer Code

Signature Authorized Chrysler Dealer

60,000 Miles (100,000 km) or 60 Months Maintenance Service Schedule

- Change the engine oil and engine oil filter.
- Rotate tires.
- Replace the engine air cleaner filter.
- Replace the ignition cables (3.7L Engine).**
- Replace the spark plugs (3.7L Engine).**
- Inspect the brake linings; replace if necessary.
- Adjust parking brake on vehicles equipped with four-wheel disc brakes.
- Change the automatic transmission fluid and filter if using your vehicle for any of the following: police, taxi, fleet or frequent trailer towing.
- Change the transfer case fluid if using your vehicle for any of the following: police, taxi, fleet, off-road or frequent trailer towing.
- Flush and replace the engine coolant at 60 months if not done at 102,000 miles (170 000 km).
- Inspect the front suspension, tie rod ends and boot seals for cracks or leaks and all parts for damage, wear, improper looseness or end play; replace if necessary.

_____ Date

_____ Dealer Code

_____ Signature Authorized Chrysler Dealer

66,000 Miles (110,000 km) or 66 Months Maintenance Service Schedule

- Change the engine oil and engine oil filter.
- Rotate tires.

Odometer Reading Date

Repair Order # Dealer Code

Signature Authorized Chrysler Dealer

72,000 Miles (120,000 km) or 72 Months Maintenance Service Schedule

- Change the engine oil and engine oil filter.
- Rotate tires.
- If using your vehicle for any of the following: Dusty or off-road conditions. Inspect the engine air cleaner filter; replace if necessary.
- Inspect the brake linings; replace if necessary.
- Inspect the front and rear axle fluid; change if using your vehicle for police, taxi, fleet, off-road or frequent trailer towing.
- Inspect the CV joints.
- Inspect exhaust system.
- Inspect the front suspension, tie rod ends and boot seals for cracks or leaks and all parts for damage, wear, improper looseness or end play; replace if necessary.

Odometer Reading Date

Repair Order # Dealer Code

Signature Authorized Chrysler Dealer

78,000 Miles (130,000 km) or 78 Months Maintenance Service Schedule

- Change the engine oil and engine oil filter.
- Rotate tires.

_____ Date

_____ Dealer Code

Signature Authorized Chrysler Dealer

84,000 Miles (140,000 km) or 84 Months Maintenance Service Schedule

- Change the engine oil and engine oil filter.
- Rotate tires.
- If using your vehicle for any of the following: Dusty or off-road conditions. Inspect the engine air cleaner filter; replace if necessary.
- Inspect the brake linings; replace if necessary.
- Inspect the front suspension, tie rod ends and boot seals for cracks or leaks and all parts for damage, wear, improper looseness or end play; replace if necessary.

_____ Date

_____ Dealer Code

Signature Authorized Chrysler Dealer

90,000 Miles (150,000 km) or 90 Months Maintenance Service Schedule

- Change the engine oil and engine oil filter.
- Rotate tires.
- Replace the engine air cleaner filter.
- Inspect and replace PCV valve if necessary. †**
- Replace the spark plugs (3.7L Engine).**
- Adjust parking brake on vehicles equipped with four-wheel disc brakes.
- Inspect the transfer case fluid.
- Inspect the front and rear axle fluid; change if using your vehicle for police, taxi, fleet, off-road or frequent trailer towing.

_____ Date

_____ Dealer Code

Signature Authorized Chrysler Dealer

96,000 Miles (160,000 km) or 96 Months Maintenance Service Schedule

- Change the engine oil and engine oil filter.
- Rotate tires.
- If using your vehicle for any of the following: Dusty or off-road conditions. Inspect the engine air cleaner filter; replace if necessary.
- Inspect the brake linings; replace if necessary.
- Inspect the CV joints.
- Inspect exhaust system.
- Inspect the front suspension, tie rod ends and boot seals for cracks or leaks and all parts for damage, wear, improper looseness or end play; replace if necessary.

_____ Date

Odometer Reading

_____ Dealer Code

Repair Order #

Signature Authorized Chrysler Dealer

102,000 Miles (170,000 km) or 102 Months Maintenance Service Schedule

- Change the engine oil and engine oil filter.
- Rotate tires.
- Replace the spark plugs (4.0L Engine).**
- Replace the timing belt (4.0L Engine).**
- Flush and replace the engine coolant if not done at 60 months.

_____ Date

Odometer Reading

_____ Dealer Code

Repair Order #

Signature Authorized Chrysler Dealer

108,000 Miles (180,000 km) or 108 Months Maintenance Service Schedule

- Change the engine oil and engine oil filter.
- Rotate tires.
- If using your vehicle for any of the following: Dusty or off-road conditions. Inspect the engine air cleaner filter; replace if necessary.
- Inspect the brake linings; replace if necessary.
- Inspect the front and rear axle fluid; change if using your vehicle for police, taxi, fleet, off-road or frequent trailer towing.
- Inspect the front suspension, tie rod ends and boot seals for cracks or leaks and all parts for damage, wear, improper looseness or end play; replace if necessary.

_____ Date
Odometer Reading

_____ Dealer Code
Repair Order #

Signature Authorized Chrysler Dealer

114,000 Miles (190,000 km) or 114 Months Maintenance Service Schedule

- Change the engine oil and engine oil filter.
- Rotate tires.

_____ Date
Odometer Reading

_____ Dealer Code
Repair Order #

Signature Authorized Chrysler Dealer

120,000 Miles (200,000 km) or 120 Months Maintenance Service Schedule

- Change the engine oil and engine oil filter.
- Rotate tires.
- Replace the engine air cleaner filter.
- Replace the ignition cables (3.7L Engine).**
- Replace the spark plugs (3.7L Engine).**
- Inspect the brake linings; replace if necessary.
- Adjust parking brake on vehicles equipped with four-wheel disc brakes.
- Inspect the CV joints.
- Inspect exhaust system.
- Inspect the front suspension, tie rod ends and boot seals for cracks or leaks and all parts for damage, wear, improper looseness or end play; replace if necessary.
- Change the transfer case fluid if using your vehicle for any of the following: police, taxi, fleet, off-road or frequent trailer towing.
- Change the automatic transmission fluid and filter.
- Replace accessory drive belt(s).

_____ Date

_____ Dealer Code

_____ Signature Authorized Chrysler Dealer

126,000 Miles (210,000 km) or 126 Months Maintenance Service Schedule

- Change the engine oil and engine oil filter.
- Rotate tires.
- Inspect the front and rear axle fluid; change if using your vehicle for police, taxi, fleet, off-road or frequent trailer towing.

Odometer Reading Date

Repair Order # Dealer Code

Signature Authorized Chrysler Dealer

132,000 Miles (220,000 km) or 132 Months Maintenance Service Schedule

- Change the engine oil and engine oil filter.
- Rotate tires.
- If using your vehicle for any of the following: Dusty or off-road conditions. Inspect the engine air cleaner filter; replace if necessary.
- Inspect the brake linings; replace if necessary.
- Inspect the front suspension, tie rod ends and boot seals for cracks or leaks and all parts for damage, wear, improper looseness or end play; replace if necessary.

Odometer Reading Date

Repair Order # Dealer Code

Signature Authorized Chrysler Dealer

138,000 Miles (230,000 km) or 138 Months Maintenance Service Schedule

- Change the engine oil and engine oil filter.
- Rotate tires.

_____ Date

_____ Dealer Code

Signature Authorized Chrysler Dealer

144,000 Miles (240,000 km) or 144 Months Maintenance Service Schedule

- Change the engine oil and engine oil filter.
- Rotate tires.
- If using your vehicle for any of the following: Dusty or off-road conditions. Inspect the engine air cleaner filter; replace if necessary.
- Inspect the brake linings; replace if necessary.
- Inspect the front and rear axle fluid; change if using your vehicle for police, taxi, fleet, off-road or frequent trailer towing.
- Inspect the CV joints.
- Inspect exhaust system.
- Inspect the front suspension, tie rod ends and boot seals for cracks or leaks and all parts for damage, wear, improper looseness or end play; replace if necessary.

_____ Date

_____ Dealer Code

Signature Authorized Chrysler Dealer

150,000 Miles (250,000 km) or 150 Months Maintenance Service Schedule

- Change the engine oil and engine oil filter.
- Rotate tires.
- Replace the engine air cleaner filter.
- Replace the spark plugs (3.7L Engine).**
- Adjust parking brake on vehicles equipped with four-wheel disc brakes.
- Inspect the transfer case fluid.

_____ Date

_____ Dealer Code

Signature Authorized Chrysler Dealer

† This maintenance is recommended by the manufacturer to the owner, but is not required to maintain emissions warranty.

WARNING!

- **You can be badly injured working on or around a motor vehicle. Do only service work for which you have the knowledge and the right equipment. If you have any doubt about your ability to perform a service job, take your vehicle to a competent mechanic.**
- **Failure to properly inspect and maintain your vehicle could result in a component malfunction and effect vehicle handling and performance. This could cause an accident**

IF YOU NEED CONSUMER ASSISTANCE

CONTENTS

■ Suggestions For Obtaining Service For Your Vehicle.	461	□ Customer Assistance For The Hearing Or Speech Impaired (TDD/TTY)	463
□ Prepare For The Appointment	461	□ Service Contract	463
□ Prepare A List	461	■ Warranty Information (U.S. Vehicles Only)	464
□ Be Reasonable With Requests	461	■ MOPAR® Parts	464
■ If You Need Assistance	461	■ Reporting Safety Defects	464
□ Chrysler LLC Customer Center	462	□ In The 50 United States And Washington, D.C.	464
□ Chrysler Canada Inc. Customer Center	462	□ In Canada	465
□ In Mexico Contact	462		

460 IF YOU NEED CONSUMER ASSISTANCE

■ Publication Order Forms	465	□ Traction Grades	467
■ Department Of Transportation Uniform Tire Quality Grades	466	□ Temperature Grades	467
□ Treadwear	467		

SUGGESTIONS FOR OBTAINING SERVICE FOR YOUR VEHICLE

Prepare For The Appointment

If you're having warranty work done, be sure to have the right papers with you. Take your warranty folder. All work to be performed may not be covered by the warranty. Discuss additional charges with the service manager. Keep a maintenance log of your vehicle's service history. This can often provide a clue to the current problem.

Prepare A List

Make a written list of your vehicle's problems or the specific work you want done. If you've had an accident or work done that is not on your maintenance log, let the service advisor know.

Be Reasonable With Requests

If you list a number of items and you must have your vehicle by the end of the day, discuss the situation with

the service advisor and list the items in order of priority. At many authorized dealers, you may obtain a rental vehicle at a minimal daily charge. If you need a rental, it is advisable to make these arrangements when you call for an appointment.

IF YOU NEED ASSISTANCE

The manufacturer and its authorized dealers are vitally interested in your satisfaction. We want you to be happy with our products and services.

Warranty service must be done by an authorized dealer. We strongly recommend that you take the vehicle to an authorized selling dealer. They know you and the vehicle best, and are most concerned that you get prompt and high quality service. The manufacturer's authorized dealers have the facilities, factory-trained technicians, special tools, and the latest information to ensure the vehicle is fixed correctly and in a timely manner.

This is why you should always talk to an authorized dealer's service manager first. Most matters can be resolved with this process.

- If for some reason you are still not satisfied, talk to the general manager or owner of the authorized dealership. They want to know if you need assistance.
- If an authorized dealership is unable to resolve the concern, you may contact the Manufacturer's Customer Center.

Any communication to the Manufacturer's Customer Center should include the following information:

- Owner's name and address
- Owner's telephone number (home and office)
- Authorized dealership name
- Vehicle Identification Number (VIN)

- Vehicle delivery date and mileage

Chrysler LLC Customer Center

P.O. Box 21-8004

Auburn Hills, MI 48321-8004

Phone: (800) 992-1997

Chrysler Canada Inc. Customer Center

P.O. Box 1621

Windsor, Ontario N9A 4H6

Phone: (800) 465-2001

In Mexico contact:

Av. Prolongacion Paseo de la Reforma, 1240

Sante Fe C.P. 05109

Mexico, D. F.

In Mexico City: 5081-4568

Outside Mexico City: 1-800-505-1300

Customer Assistance For The Hearing Or Speech Impaired (TDD/TTY)

To assist customers who have hearing difficulties, the manufacturer has installed special TDD (Telecommunication Devices for the Deaf) equipment at its Customer Center. Any hearing or speech impaired customer, who has access to a TDD or a conventional teletypewriter (TTY) in the United States, can communicate with the manufacturer by dialing 1-800-380-CHRY.

Service Contract

You may have purchased a service contract for a vehicle to help protect you from the high cost of unexpected repairs after the manufacturer's New Vehicle Limited Warranty expires. The manufacturer stands behind only the manufacturer's Service Contracts. If you purchased a manufacturer's Service Contract, you will receive Plan Provisions and an Owner Identification Card in the mail within three weeks of the vehicle delivery date. If you

have any questions about the service contract, call the manufacturer's Service Contract National Customer Hotline at 1-800-521-9922.

The manufacturer will not stand behind any service contract that is not the manufacturer's Service Contract. It is not responsible for any service contract other than the manufacturer's Service Contract. If you purchased a service contract that is not a manufacturer's Service Contract, and you require service after the manufacturer's New Vehicle Limited Warranty expires, please refer to the contract documents, and contact the person listed in those documents.

We appreciate that you have made a major investment when you purchased the vehicle. An authorized dealer has also made a major investment in facilities, tools, and training to assure that you are absolutely delighted with the ownership experience. You'll be pleased with their sincere efforts to resolve any warranty issues or related concerns.

WARNING!

Engine exhaust, some of its constituents, and certain vehicle components contain, or emit, chemicals known to the State of California to cause cancer and birth defects or other reproductive harm. In addition, certain fluids contained in vehicles and certain products of component wear contain, or emit, chemicals known to the State of California to cause cancer and birth defects or other reproductive harm.

WARRANTY INFORMATION (U.S. Vehicles Only)

See the Warranty Information Booklet, located on the DVD, for the terms and provisions of Chrysler Group LLC warranties applicable to this vehicle.

MOPAR® PARTS

MOPAR® fluids, lubricants, parts, and accessories are available from an authorized dealer. They are recommended for your vehicle in order to help keep the vehicle operating at its best.

REPORTING SAFETY DEFECTS**In the 50 United States and Washington, D.C.**

If you believe that your vehicle has a defect that could cause a crash or cause injury or death, you should immediately inform the National Highway Traffic Safety Administration (NHTSA) in addition to notifying the manufacturer.

If NHTSA receives similar complaints, it may open an investigation, and if it finds that a safety defect exists in a group of vehicles, it may order a recall and remedy campaign. However, NHTSA cannot become involved in individual problems between you, your authorized dealer, and the manufacturer.

To contact NHTSA, you may either call the Auto Safety Hotline toll free at 1-888-327-4236 (TTY: 1-800-424-9153), or go to <http://www.safercar.gov>; or write to: Administrator, NHTSA, 1200 New Jersey Avenue, SE., West Building, Washington, D.C. 20590. You can also obtain other information about motor vehicle safety from <http://www.safercar.gov>.

In Canada

If you believe that your vehicle has a safety defect, you should contact the Customer Service Department immediately. Canadian customers who wish to report a safety defect to the Canadian government should write to: Transport Canada, Motor Vehicle Defect Investigations and Recalls, 2780 Sheffield Road, Ottawa, Ontario K1B 3V9.

PUBLICATION ORDER FORMS

To order the following manuals, you may use either the website or the phone numbers listed below. Visa, Mastercard, American Express, and Discover orders are accepted. If you prefer mailing your payment, please call for an order form.

NOTE: A street address is required when ordering manuals (no P.O. Boxes).

- *Service Manuals*

These comprehensive Service Manuals provide the information that students and professional technicians need in diagnosing/troubleshooting, problem solving, maintaining, servicing, and repairing Chrysler Group LLC vehicles. A complete working knowledge of the vehicle, system, and/or components is written in straightforward language with illustrations, diagrams, and charts.

- *Diagnostic Procedure Manuals*

Diagnostic Procedure Manuals are filled with diagrams, charts and detailed illustrations. These practical manuals make it easy for students and technicians to find and fix problems on computer-controlled vehicle systems and features. They show exactly how to find and correct problems the first time, using step-by-step troubleshooting and drivability procedures, proven diagnostic tests and a complete list of all tools and equipment.

- *Owner's Manuals*

These Owner's Manuals have been prepared with the assistance of service and engineering specialists to acquaint you with specific Chrysler Group LLC vehicles. Included are starting, operating, emergency and maintenance procedures as well as specifications, capabilities and safety tips.

Call toll free at:

- 1-800-890-4038 (U.S.)
- 1-800-387-1143 (Canada)

Or

Visit us on the Worldwide Web at:

- www.techauthority.com

DEPARTMENT OF TRANSPORTATION UNIFORM TIRE QUALITY GRADES

The following tire grading categories were established by the National Highway Traffic Safety Administration. The specific grade rating assigned by the tire's manufacturer in each category is shown on the sidewall of the tires on your vehicle.

All passenger car tires must conform to Federal safety requirements in addition to these grades.

Treadwear

The Treadwear grade is a comparative rating, based on the wear rate of the tire when tested under controlled conditions on a specified government test course. For example, a tire graded 150 would wear one and one-half times as well on the government course as a tire graded 100. The relative performance of tires depends upon the actual conditions of their use, however, and may depart significantly from the norm due to variations in driving habits, service practices, and differences in road characteristics and climate.

Traction Grades

The Traction grades, from highest to lowest, are AA, A, B, and C. These grades represent the tire's ability to stop on wet pavement, as measured under controlled conditions on specified government test surfaces of asphalt and concrete. A tire marked C may have poor traction performance.

WARNING!

The traction grade assigned to this tire is based on straight-ahead braking traction tests, and does not include acceleration, cornering, hydroplaning, or peak traction characteristics.

Temperature Grades

The temperature grades are A (the highest), B, and C, representing the tire's resistance to the generation of heat and its ability to dissipate heat, when tested under controlled conditions on a specified indoor laboratory test wheel. Sustained high temperature can cause the material of the tire to degenerate and reduce tire life, and excessive temperature can lead to sudden tire failure. The grade C corresponds to a level of performance, which all passenger car tires must meet under the Federal Motor

Vehicle Safety Standard No. 109. Grades B and A represent higher levels of performance on the laboratory test wheel, than the minimum required by law.

WARNING!

The temperature grade for this tire is established for a tire that is properly inflated and not overloaded. Excessive speed, under-inflation, or excessive loading, either separately or in combination, can cause heat buildup and possible tire failure.

INDEX

About Your Brakes	304	Alarm, Panic	23
ABS (Anti-Lock Brake System)	306	Alarm (Security Alarm)	17
Adding Fuel	353	Alarm System (Security Alarm)	17
Air Cleaner, Engine (Engine Air Cleaner Filter)	402	Alterations/Modifications, Vehicle	8
Air Conditioner Maintenance	404	Antenna, Satellite Radio	256
Air Conditioning	261	Antifreeze (Engine Coolant)	436
Air Conditioning Controls	261	Anti-Lock Brake System (ABS)	306,309
Air Conditioning Filter	273	Anti-Lock Warning Light	191
Air Conditioning, Operating Tips	274	Anti-Theft System	17
Air Conditioning Refrigerant	405	Appearance Care	419
Air Conditioning System	261,265	Assistance Towing	107
Air Filter	402	Auto Down Power Windows	33
Air Pressure, Tires	328	Automatic Dimming Mirror	90
Airbag	51	Automatic Temperature Control (ATC)	265
Airbag Deployment	66	Automatic Transaxle	282
Airbag Light	69,83,192	Automatic Transmission	285,290,417
Airbag Maintenance	68	Fluid and Filter Changes	417
Airbag, Window (Side Curtain)	55	Fluid Level Check	417
Alarm Light	186	Fluid Type	417,438

Special Additives	418	Parking	304
Torque Converter	289,294	Warning Light	188
Autostick	292	Brake/Transmission Interlock	284
Auxiliary Electrical Outlet (Power Outlet)	167	Break-In Recommendations, New Vehicle	81
Auxiliary Power Outlet	167	Bulb Replacement	431
Axle Fluid	438	Bulbs, Light	84,431
Battery	403	Calibration, Compass	202,209
Keyless Transmitter Replacement (RKE)	23	Capacities, Fluid	436
Belts, Seat	38,83	Caps, Filler	
Body Mechanism Lubrication	405	Fuel	353
B-Pillar Location	323	Power Steering	303
Brake Assist System	310	Car Washes	420
Brake Control System, Electronic	309	Carbon Monoxide Warning	82,352
Brake Fluid	438	Cargo Area Features	172
Brake, Parking	304	Cargo Compartment	172
Brake System	415	Light	172
Anti-Lock (ABS)	306,309	Cargo Light	172
Master Cylinder	415	Cargo Load Floor	173

- Cargo Tie-Downs 172
- Cargo (Vehicle Loading) 355
- Cellular Phone 92,261
- Center High Mounted Stop Light 435
- Certification Label 355
- Changing A Flat Tire 378
- Chart, Tire Sizing 317
- Check Engine Light
(Malfunction Indicator Light) 197,396
- Checking Your Vehicle For Safety 81
- Checks, Safety 81
- Child Restraint 71,72,76,79
- Child Restraint Tether Anchors 75,76
- Child Safety Locks 31
- Climate Control 261
- Clock 215,230,231,235,244
- Coin Holder 171
- Compact Disc (CD) Maintenance 260
- Compact Spare Tire 330
- Compass 199,202,208
- Compass Calibration 202,209
- Compass Variance 201,210
- Computer, Trip/Travel 207
- Console 171
- Console, Floor 171
- Contract, Service 463
- Cooling System 409
- Adding Coolant (Antifreeze) 411
- Coolant Capacity 436
- Coolant Level 413
- Disposal of Used Coolant 413
- Drain, Flush, and Refill 410
- Inspection 410
- Points to Remember 414
- Pressure Cap 412
- Selection of Coolant (Antifreeze) 410,436,437
- Corrosion Protection 419
- Cupholders 170

Customer Assistance	461	Off-Road	298
Daytime Running Lights	142	Electric Remote Mirrors	91
Dealer Service	398	Electrical Outlet, Auxiliary (Power Outlet)	167
Defroster, Rear Window	175	Electrical Power Outlets	167
Defroster, Windshield	83,263,269	Electronic Brake Control System	309
Delay (Intermittent) Wipers	145	Anti-Lock Brake System	309
Diagnostic System, Onboard	395	Brake Assist System	310
Dimmer Switch, Headlight	141	Electronic Roll Mitigation	311
Dipsticks		Electronic Stability Program	312
Oil (Engine)	399	Traction Control System	309
Power Steering	303	Electronic Roll Mitigation (ERM)	311
Disposal		Electronic Speed Control (Cruise Control)	148
Engine Oil	401	Electronic Stability Program (ESP)	186,312
Used Coolant (Antifreeze)	413	Electronic Vehicle Information Center (EVIC)	203
Door Locks	27	Emergency, In Case of	
Door Opener, Garage	157	Jacking	378
Driving	297	Jump Starting	384
Off-Pavement	298	Overheating	376

Towing	388	Overheating	376
Emission Control System Maintenance	396,440	Starting	279
Engine	393	Temperature Gauge	184
Air Cleaner	402	Engine Oil Viscosity	401
Block Heater	282	Engine Oil Viscosity Chart	401
Break-In Recommendations	81	Enhanced Accident Response Feature	67
Compartment	393,394	Entry System, Illuminated	19
Compartment Identification	394	Exhaust Gas Caution	82,352
Coolant (Antifreeze)	437	Exhaust System	82,407
Exhaust Gas Caution	82,352	Exterior Finish Care	420
Fails to Start	280	Exterior Lights	84
Flooded, Starting	280	Fabric Care	422
Fuel Requirements	347,436	Filters	
Jump Starting	384	Air Cleaner	402
Oil	399,436,437	Air Conditioning	273
Oil Disposal	401	Engine Oil	402,437
Oil Filter	402	Finish Care	420
Oil Selection	436		
Oil Synthetic	401		

Flashers		Four Wheel Drive Operation	295
Hazard Warning	376	Four-Way Hazard Flasher	376
Turn Signal	84,187,432,433,434	Front Axle (Differential)	419
Flooded Engine Starting	280	Fuel	347
Floor Console	171	Filler Cap (Gas Cap)	353
Fluid, Brake	438	Gasoline	347
Fluid Capacities	436	Gauge	184
Fluid Leaks	84	Light	185
Fluid Level Checks	418,419	Materials Added	350
Automatic Transmission	417	Octane Rating	347,348,437
Engine Oil	399	Requirements	436
Power Steering	303	Tank Capacity	436
Fluids, Lubricants and Genuine Parts	437	Fuel System Caution	351
Fog Light Service	433	Fuses	424
Fog Lights	141,433	Garage Door Opener (HomeLink®)	157
Folding Rear Seat	134	Gas Cap (Fuel Filler Cap)	353,354,396
Four Wheel Drive	295	Gas Gauge (Fuel Gauge)	184
Operation	295	Gasoline (Fuel)	347
Systems	295		

Gasoline, Reformulated	348	Headlights	
Gasoline/Oxygenate Blends	349	Bulb Replacement	431
Gauges		Dimmer Switch	141
Coolant Temperature	184	Replacing	431
Fuel	184	Switch	139
Odometer	194	Heated Seats	133
Speedometer	186	Heater	261
Tachometer	192	Heater, Engine Block	282
Gear Ranges	290	Hitches	
General Information	17,121,347	Trailer Towing	362
Glass Cleaning	423	Holder, Coin	171
Gross Axle Weight Rating	355,358	Holder, Cup	170
Gross Vehicle Weight Rating	355,357	HomeLink® (Garage Door Opener) Transmitter . . .	157
GVWR	355	Hood Release	137
Hands-Free Phone (uconnect™)	92	Ignition	12
Hazard Warning Flasher	376	Key	12
Head Restraints	130	Ignition Key Removal	12
Head Rests	130	Illuminated Entry	19

- Immobilizer (Sentry Key) 14
- Infant Restraint 71,72
- Inflation Pressure Tires 328
- Information Center, Vehicle 203
- Inside Rearview Mirror 89
- Instrument Cluster 183,184
- Instrument Panel and Controls 182
- Instrument Panel Lens Cleaning 423
- Integrated Power Module (Fuses) 424
- Interior Appearance Care 422
- Interior Lights 143
- Intermittent Wipers (Delay Wipers) 145
- Introduction 4

- Jack Location 378
- Jack Operation 378,380
- Jacking Instructions 380
- Jump Starting 384

- Key, Programming 16
- Key, Replacement 15
- Key, Sentry (Immobilizer) 14
- Key-In Reminder 13
- Keyless Entry System 19
- Keys 12

- Lane Change Assist 142
- Lap/Shoulder Belts 38
- LATCH
(Lower Anchors and Tether for CHildren) 75,76
- Latches 84
- Lead Free Gasoline 347
- Leaks, Fluid 84
- Life of Tires 333
- Liftgate 36
- Light Bulbs 84
- Lights 84,139
 - Airbag 69,83,192

Alarm	186	Headlights	431
Anti-Lock	191	High Beam Indicator	186
Back-Up	434	Illuminated Entry	19
Brake Assist Warning	314	Instrument Cluster	139,184
Brake Warning	188	Interior	143
Bulb Replacement	431	Lights On Reminder	140
Cargo	172	Low Fuel	184,185
Center Mounted Stop	435	Malfunction Indicator (Check Engine)	197
Cruise	198	Oil Pressure	191
Daytime Running	142	Passing	141
Dimmer Switch, Headlight	141	Rear Servicing	434
Electronic Stability Program (ESP)		Rear Tail	434
Indicator	186,312	Seat Belt Reminder	185
Engine Temperature Warning	185	Security Alarm (Theft Alarm)	186
Exterior	84	Service	431
Fog	141,191,433	Service Engine Soon (Malfunction Indicator)	197
Four-Wheel Drive Indicator	199	Side Marker	434
Hazard Warning Flasher	376	Theft Alarm (Security Alarm)	186
Headlight Switch	139	Tire Pressure Monitoring (TPMS)	192,337

Traction Control	312	Maintenance Procedures	398
Turn Signal	84,142,432,433,434	Maintenance Schedule	440
Voltage	190	Maintenance, Sunroof	166
Warning (Instrument Cluster Description)	184	Malfunction Indicator Light (Check Engine)	197,396
Load Floor, Cargo	173	Manual, Service	465
Loading Vehicle	355	Manual Transmission	
Tires	323	Lubricant Selection	438
Locks	27	Master Cylinder (Brakes)	415
Child Protection	31	Mini-Trip Computer	199,207
Door	27	Mirrors	89
Power Door	28	Automatic Dimming	90
Steering Wheel	14	Electric Powered	91
Low Tire Pressure System	337	Outside	90
Lower Anchors and Tether for CHildren		Rearview	89
(LATCH)	75,76	Vanity	92
Lubrication, Body	405	Modifications/Alterations, Vehicle	8
Luggage Carrier	176	Monitor, Tire Pressure System	337
Maintenance Free Battery	403	Mopar Parts	398,464
		Multi-Function Control Lever	139

New Vehicle Break-In Period	81	Opener, Garage Door (HomeLink®)	157
Occupant Restraints	37	Operator Manual (Owner's Manual)	5
Occupant Restraints (Sedan)	55	Outside Rearview Mirrors	90
Octane Rating, Gasoline (Fuel)	347,348	Overdrive	192,287,292
Odometer		Overdrive OFF Switch	287,292
Trip	198	Overheating, Engine	184,376
Off-Pavement Driving (Off-Road)	298	Owner's Manual (Operator Manual)	5,465
Off-Road Driving (Off-Pavement)	298	Paint Care	419
Oil, Engine	399,437	Paint Damage	419
Capacity	436	Panic Alarm	23
Dipstick	399	Park Sense System, Rear	151
Filter	402,437	Parking Brake	304
Identification Logo	400	Parking On Hill	304
Materials Added to	401	Passing Light	141
Recommendation	400,436	Personal Settings	211
Synthetic	401	Pets	80
Viscosity	401,436	Pets, Transporting	80
Onboard Diagnostic System	395,396	Phone, Cellular	92

Phone, Hands-Free (uconnect™)	92	Rear Window Defroster	175
Placard, Tire and Loading Information	323	Rear Window Features	174
Polishing and Waxing	420	Rear Wiper/Washer	174
Power		Rearview Mirrors	89
Door Locks	28	Reclining Front Seats	128
Mirrors	91	Recreational Towing	372
Steering	302,303	Reformulated Gasoline	348
Sunroof	164	Refrigerant	405
Windows	32	Release, Hood	137
Power Steering Fluid	438	Reminder, Lights On	140
Pregnant Women and Seat Belts	50	Reminder, Seat Belt	49
Preparation for Jacking	379	Remote Keyless Entry (RKE)	19
Programmable Electronic Features	211	Remote Sound System (Radio) Controls	259
		Remote Starting System	25
Radial Ply Tires	330	Replacement Keys	15
Radio Operation	261	Replacement Parts	398
Radio, Satellite (uconnect® studios)	254	Replacement Tires	333
Rear Axle (Differential)	419	Reporting Safety Defects	464
Rear Park Sense System	151	Restraint, Head	130

Restraints, Child	71	Child Restraint	71,79
Restraints, Occupant	37	Extender	50
Roll Over Warning	4	Front Seat	38
Roof Type Carrier	176	Inspection	83
Rotation, Tires	336	Maintenance	423
Safety Checks Inside Vehicle	83	Shoulder Belt Anchorage	43
Safety Checks Outside Vehicle	84	Seats	126
Safety Defects, Reporting	464	Adjustment	127
Safety, Exhaust Gas	82	Head Restraints	130
Safety Information, Tire	315	Heated	133
Safety Tips	81	Rear Folding	134
Satellite Radio Antenna	256	Reclining	128
Satellite Radio (uconnect® studios)	254	Security Alarm (Theft Alarm)	17
Schedule, Maintenance	440	Selection of Coolant (Antifreeze)	437
Seat Belt Reminder	49	Selection of Oil	400
Seat Belts	38,83	Sentry Key (Immobilizer)	14
Adjustable Upper Shoulder Anchorage	43	Sentry Key Programming	16
And Pregnant Women	50	Sentry Key Replacement	15
		Service Assistance	461

Service Contract	463	Starting	279
Service Engine Soon Light (Malfunction Indicator)	197	Cold Weather	279
Service Manuals	465	Engine Block Heater	282
Setting the Clock 215,230,231,235,244		Engine Fails to Start	280
Settings, Personal	211	Remote	25
Shift Lock Manual Override	284	Steering	
Shifting		Power	302,303
Automatic Transmission	285,290	Tilt Column	147
Shoulder Belts	38	Wheel Lock	14
Side Window Demisters (Defrosters)	272	Wheel, Tilt	147
Signals, Turn 84,142,187,432,433,434		Steering Wheel Mounted Sound System	
Snow Chains (Tire Chains)	335	Controls	259
Spare Tire	330,378	Storage	171
Specifications		Storage Bin	171
Fuel (Gasoline)	347	Storage, Vehicle	272
Oil	400	Sun Roof	164
Speed Control (Cruise Control)	148	Sun Visor Extension	92
Speedometer	186	Sunroof Maintenance	166
		Supplemental Restraint System - Airbag	51

Synthetic Engine Oil	401	General Information	327
System, Remote Starting	25	High Speed	329
Tachometer	192	Inflation Pressures	328
Temperature Control, Automatic (ATC)	265	Jacking	378
Temperature Gauge, Engine Coolant	184	Life of Tires	333
Tether Anchor, Child Restraint	75	Load Capacity	323
Tie Down Hooks, Cargo	172	Pressure Monitor System (TPMS)	337
Tilt Steering Column	147	Pressure Warning Light	192
Tip Start	279	Quality Grading	466
Tire and Loading Information Placard	323	Radial	330
Tire Identification Number (TIN)	319	Replacement	333
Tire Markings	315	Rotation	336
Tire Safety Information	315	Safety	315
Tires	84,327,466	Sizes	317
Air Pressure	328	Spare Tire	378
Chains	335	Spinning	331
Changing	378	Tread Wear Indicators	332
Compact Spare	330	Tongue Weight/Trailer Weight	365
		Torque Converter Clutch	289,294

Towing	357	Transfer Case	418
24-Hour Towing Assistance	107	Fluid	418,438
Disabled Vehicle	388	Maintenance	418
Guide	363	Transmission	285,290
Recreational	372	Automatic	285,290
Weight	363	Fluid	438
Towing Assistance	107	Maintenance	417
Traction Control	190,309	Transmitter Battery Service (Remote Keyless Entry)	23
Trailer Towing	357	Transmitter, Garage Door Opener (HomeLink®) . .	157
Cooling System Tips	372	Tread Wear Indicators	332
Hitches	362	Trip Computer	199
Minimum Requirements	366	Trip Odometer	194
Trailer and Tongue Weight	365	Trip Odometer Reset Button	198
Wiring	369	Turn Signals	142,187,432,433,434
Trailer Towing Guide	363	uconnect™ (Hands-Free Phone)	92
Trailer Weight	363	Uniform Tire Quality Grades	466
Transaxle	282	Universal Transmitter	157
Automatic	282		
Operation	282		

Upholstery Care	422	Wheel and Wheel Trim	422
Vanity Mirrors	92	Wheel and Wheel Trim Care	422
Variance, Compass	201,210	Wheel Mounting	383
Vehicle Certification Label	355	Wind Buffeting	36,166
Vehicle Identification Number (VIN)	7	Window Fogging	272
Vehicle Loading	323,355	Windows	32
Vehicle Modifications/Alterations	8	Power	32
Vehicle Storage	272	Windshield Defroster	83,263,269
Viscosity, Engine Oil	401	Windshield Washers	143,146,406
Voice Recognition System (VR)	121	Fluid	406
Warning Lights		Windshield Wiper Blades	406
(Instrument Cluster Description)	184	Windshield Wipers	143
Warning, Roll Over	4	Wiper, Delay	145
Warnings and Cautions	7	Wiper, Rear	174
Warranty Information	464	Wipers, Intermittent	145
Washers, Windshield	143,146,406	Wrecker Towing	388
Waxing and Polishing	420		



STICK WITH THE SPECIALISTS®

Chrysler Group LLC

10KA74-126-AB



2nd Edition

Printed in U.S.A.