

# FORD **ECOSPORT** Owner's Manual



The information contained in this publication was correct at the time of going to print. In the interest of continuous development, we reserve the right to change specifications, design or equipment at any time without notice or obligation. No part of this publication may be reproduced, transmitted, stored in a retrieval system or translated into any language in any form by any means without our written permission. Errors and omissions excepted.

© Ford Motor Company 2014

All rights reserved.

Part Number: 19A321 CA 02/2013 20140724121304

# Table of Contents

---

## Introduction

About This Manual.....	5
Symbols Glossary.....	5
Replacement Parts Recommendation.....	7
Special Notices.....	8
Mobile Communications Equipment.....	8

## At a Glance

At a Glance.....	9
------------------	---

## Child Safety

Installing Child Seats.....	13
Child Seat Positioning.....	15
Child Safety Locks.....	17

## Safety Belts

Fastening the Safety Belts.....	18
Safety Belt Minder.....	19

## Supplementary Restraints System

Principle of Operation.....	20
Driver Airbag.....	20
Passenger Airbag.....	21
Side Airbags.....	21
Side Curtain Airbags.....	21

## Keys and Remote Controls

General Information on Radio Frequencies.....	23
Remote Control.....	23
Replacing a Lost Key or Remote Control.....	25

## Locks

Locking and Unlocking.....	26
Keyless Entry.....	28
Tailgate.....	30

## Security

Passive Anti-Theft System.....	31
--------------------------------	----

## Steering Wheel

Adjusting the Steering Wheel.....	32
Audio Control.....	32
Voice Control.....	33

## Wipers and Washers

Windshield Wipers.....	34
Windshield Washers.....	34
Rear Window Wiper and Washers.....	35

## Lighting

Lighting Control.....	36
Headlamp Exit Delay.....	36
Front Fog Lamps.....	37
Rear Fog Lamps.....	37
Headlamp Leveling.....	37
Direction Indicators.....	38
Interior Lamps.....	38

## Windows and Mirrors

Power Windows.....	39
Exterior Mirrors.....	40
Interior Mirror.....	41

## Instrument Cluster

Gauges.....	42
Warning Lamps and Indicators.....	44
Audible Warnings and Indicators.....	47

## Information Displays

General Information.....	49
Trip Computer.....	50
Information Messages.....	53

## Climate Control

Principle of Operation.....	59
-----------------------------	----

# Table of Contents

---

Manual Climate Control.....	60
Automatic Climate Control.....	61
Hints on Controlling the Interior Climate.....	62
Heated Windows.....	64

## Seats

Sitting in the Correct Position.....	65
Head Restraints.....	65
Manual Seats.....	66
Rear Seats.....	67
Front Seat Armrest.....	70

## Auxiliary Power Points

Auxiliary Power Points.....	71
Cigar Lighter.....	71

## Storage Compartments

Center Console.....	73
Glasses Holder.....	73
Under Seat Storage.....	73

## Starting and Stopping the Engine

General Information.....	74
Ignition Switch.....	74
Keyless Starting.....	74
Steering Wheel Lock.....	76
Starting a Gasoline Engine.....	76
Starting a Diesel Engine.....	77
Switching Off the Engine.....	78

## Fuel and Refueling

Safety Precautions.....	79
Fuel Quality.....	79
Fuel Quality - Diesel.....	80
Running Out of Fuel.....	80
Catalytic Converter.....	80
Refueling.....	81
Fuel Consumption.....	82

## Transmission

Manual Transmission.....	83
Automatic Transmission.....	85
Hill Start Assist.....	87

## Brakes

General Information.....	89
Hints on Driving With Anti-Lock Brakes.....	89
Parking Brake.....	89

## Traction Control

Principle of Operation.....	91
Using Traction Control.....	91

## Stability Control

Principle of Operation.....	92
Using Stability Control.....	92

## Parking Aids

Principle of Operation.....	93
Parking Aid.....	93

## Driving Aids

Steering.....	95
---------------	----

## Load Carrying

General Information.....	96
Luggage Anchor Points.....	96
Luggage Covers.....	96
Roof Racks and Load Carriers.....	96

## Towing

Towing Points.....	98
Transporting the Vehicle.....	98
Towing the Vehicle on Four Wheels.....	99

## Driving Hints

Breaking-In.....	100
------------------	-----

# Table of Contents

---

Driving Through Water.....	100
Floor Mats.....	100

## Roadside Emergencies

Hazard Warning Flashers.....	102
Warning Triangle.....	102
Fuel Shutoff.....	102
Jump Starting the Vehicle.....	102

## Fuses

Fuse Box Locations.....	105
Fuse Specification Chart.....	106
Changing a Fuse.....	113

## Maintenance

General Information.....	114
Opening and Closing the Hood.....	114
Under Hood Overview - 1.0L EcoBoost™.....	116
Under Hood Overview - 1.5L Duratec-16V Ti-VCT (81kW/110PS) - Sigma.....	117
Under Hood Overview - 1.5L Duratorq-TDCi (67kW/91PS).....	118
Engine Oil Dipstick - 1.0L EcoBoost™.....	119
Engine Oil Dipstick - 1.5L Duratec-16V Ti-VCT (81kW/110PS) - Sigma.....	119
Engine Oil Dipstick - 1.5L Duratorq-TDCi (67kW/91PS).....	119
Engine Oil Check.....	119
Engine Coolant Check.....	121
Brake and Clutch Fluid Check.....	121
Washer Fluid Check.....	122
Changing the 12V Battery.....	122
Changing the Wiper Blades.....	123
Removing a Headlamp.....	125
Changing a Bulb.....	126
Bulb Specification Chart.....	130
Changing the Engine Air Filter.....	130
Technical Specifications.....	131

## Vehicle Care

Cleaning the Exterior.....	134
Cleaning the Engine.....	134
Repairing Minor Paint Damage.....	135

## Wheels and Tires

General Information.....	136
Tire Care.....	136
Using Snow Chains.....	136
Changing a Road Wheel.....	136
Technical Specifications.....	141

## Capacities and Specifications

Vehicle Identification Plate.....	142
Vehicle Identification Number.....	143
Technical Specifications.....	144

## Audio System

General Information.....	145
Audio Unit - Vehicles With: Bluetooth.....	146
Audio Unit - Vehicles With: AM/FM/ CD.....	153
Audio Unit.....	158
Compact Disc Player.....	163
Audio Input Jack.....	166
USB Port.....	167
Audio Troubleshooting.....	167

## Appendices

Electromagnetic Compatibility.....	168
End User License Agreement.....	169



# Introduction

## ABOUT THIS MANUAL

Thank you for choosing Ford. We recommend that you take some time to get to know your vehicle by reading this manual. The more that you know about it, the greater the safety and pleasure you will get from driving it.

### WARNING



Driving while distracted can result in loss of vehicle control, crash and injury. We strongly recommend that you use extreme caution when using any device that may take your focus off the road. Your primary responsibility is the safe operation of your vehicle. We recommend against the use of any hand-held device while driving and encourage the use of voice-operated systems when possible. Make sure you are aware of all applicable local laws that may affect the use of electronic devices while driving.

**Note:** This manual describes product features and options available throughout the range of available models, sometimes even before they are generally available. It may describe options not fitted to the vehicle you have purchased.

**Note:** Some of the illustrations in this manual may show features as used in different models, so may appear different to you on your vehicle.

**Note:** Always use and operate your vehicle in line with all applicable laws and regulations.

**Note:** Pass on this manual when selling your vehicle. It is an integral part of your vehicle.

This manual may qualify the location of a component as left-hand side or right-hand side. The side is determined when facing forward in the seat.

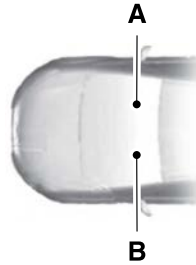

E154903

- A Right-hand side.
- B Left-hand side.

## SYMBOLS GLOSSARY

These are some of the symbols you may see on your vehicle.



Safety alert



See Owner's Manual



Air conditioning system



Anti-lock braking system



Avoid smoking, flames or sparks



Battery



Battery acid



Brake fluid - non petroleum based

# Introduction



Brake system



Cabin air filter



Check fuel cap



Child safety door lock or unlock



Child seat lower anchor



Child seat tether anchor



Cruise control



Do not open when hot



Engine air filter



Engine coolant



Engine coolant temperature



Engine oil



Explosive gas



Fan warning



Fasten safety belt



Front airbag



Front fog lamps



Fuel pump reset



Fuse compartment



Hazard warning flashers



Heated rear window



Heated windshield



Interior luggage compartment release



Jack



Keep out of reach of children



Lighting control



Low tire pressure warning



Maintain correct fluid level



Note operating instructions



# Introduction

---



Panic alarm



Parking aid



Parking brake



Power steering fluid



Power windows front/rear



Power window lockout



Service engine soon



Side airbag



Shield the eyes



Stability control



Windshield wash and wipe

## REPLACEMENT PARTS RECOMMENDATION

Your vehicle has been built to the highest standards using quality parts. We recommend that you demand the use of genuine Ford and Motorcraft parts whenever your vehicle requires scheduled maintenance or repair. You can clearly identify genuine Ford and Motorcraft parts by looking for the Ford, FoMoCo or Motorcraft branding on the parts or their packaging.

## Scheduled Maintenance and Mechanical Repairs

One of the best ways for you to make sure that your vehicle provides years of service is to have it maintained in line with our recommendations using parts that conform to the specifications detailed in this Owner's Manual. Genuine Ford and Motorcraft parts meet or exceed these specifications.

## Collision Repairs

We hope that you never experience a collision, but accidents do happen. Genuine Ford replacement collision parts meet our stringent requirements for fit, finish, structural integrity, corrosion protection and dent resistance. During vehicle development we validate these parts deliver the intended level of protection as a whole system. A great way to know for sure you are getting this level of protection is to use genuine Ford replacement collision parts.

# Introduction

---

## Warranty on Replacement Parts

Genuine Ford and Motorcraft replacement parts are the only replacement parts that benefit from a Ford Warranty. Damage caused to your vehicle as a result of the failure of non-Ford parts may not be covered by the Ford Warranty. For additional information, refer to the terms and conditions of the Ford Warranty.

## SPECIAL NOTICES

### WARNING



Do not use abrasives or chemicals solvents on the tag.

We have installed the radio frequency identifier (RFID) tag in your vehicle in compliance with the government directives under the MORTH final notification GSR 207 (E), dated 08 April 2013. Ford does not in any way guarantee or warrant the quality, contents, accuracy of the product or data contained in the tag.

This tag is for the exclusive use of government authorities or personnel authorized by the government. The responsibility of using this tag is on the owner of the vehicle.

**Note:** *The tag is located on the top left-hand side of the windshield.*

## MOBILE COMMUNICATIONS EQUIPMENT

Using mobile communications equipment is becoming increasingly important in the conduct of business and personal affairs. However, you must not compromise your own or others' safety when using such equipment. Mobile communications can enhance personal safety and security when appropriately used, particularly in

emergency situations. Safety must be paramount when using mobile communications equipment to avoid negating these benefits. Mobile communication equipment includes, but is not limited to, cellular phones, pagers, portable email devices, text messaging devices and portable two-way radios.

### WARNING



Driving while distracted can result in loss of vehicle control, crash and injury. We strongly recommend that you use extreme caution when using any device that may take your focus off the road. Your primary responsibility is the safe operation of your vehicle. We recommend against the use of any hand-held device while driving and encourage the use of voice-operated systems when possible. Make sure you are aware of all applicable local laws that may affect the use of electronic devices while driving.

---

# At a Glance

---

## Front Exterior Overview

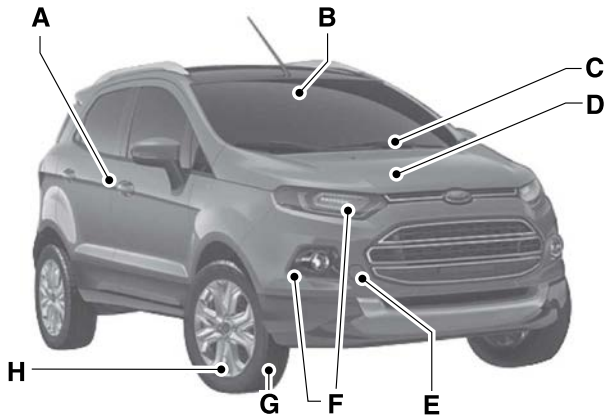

E147752

- A See **Locking and Unlocking** (page 26).
- B See **Interior Mirror** (page 41).
- C See **Changing the Wiper Blades** (page 123).
- D See **Under Hood Overview** (page 116). See **Under Hood Overview** (page 117). See **Under Hood Overview** (page 118).
- E See **Towing Points** (page 98).
- F See **Changing a Bulb** (page 126).
- G Tire pressures. See **Technical Specifications** (page 141).
- H See **Changing a Road Wheel** (page 136).

# At a Glance

---

## Vehicle Interior Overview

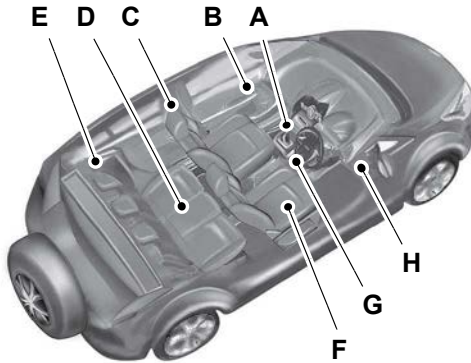

E159198

- A See **Manual Transmission** (page 83). See **Automatic Transmission** (page 85).
- B See **Power Windows** (page 39). See **Exterior Mirrors** (page 40).
- C See **Head Restraints** (page 65).
- D See **Rear Seats** (page 67).
- E See **Fastening the Safety Belts** (page 18).
- F See **Manual Seats** (page 66).
- G See **Parking Brake** (page 89).
- H See **Opening and Closing the Hood** (page 114).

# At a Glance

## Instrument Panel Overview

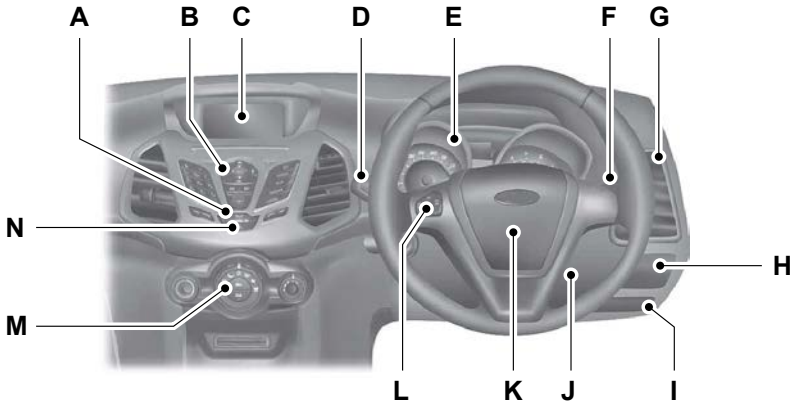

E159197

- A Door lock button. See **Locking and Unlocking** (page 26).
- B Audio unit. See **Audio System** (page 145).
- C Information display. See **Information Displays** (page 49).
- D Direction indicators. See **Direction Indicators** (page 38). High Beam See **Lighting Control** (page 36).
- E Instrument cluster. See **Gauges** (page 42). See **Warning Lamps and Indicators** (page 44).
- F Wiper lever. See **Wipers and Washers** (page 34).
- G Air vents.
- H Lighting control. See **Lighting Control** (page 36).
- I Hood release lever. See **Opening and Closing the Hood** (page 114).
- J Steering wheel adjustment. See **Adjusting the Steering Wheel** (page 32).
- K Horn.
- L Audio control. See **Audio Control** (page 32).
- M Climate controls. See **Climate Control** (page 59).
- N Hazard warning flasher switch. See **Hazard Warning Flashers** (page 102).

# At a Glance

## Rear Exterior Overview

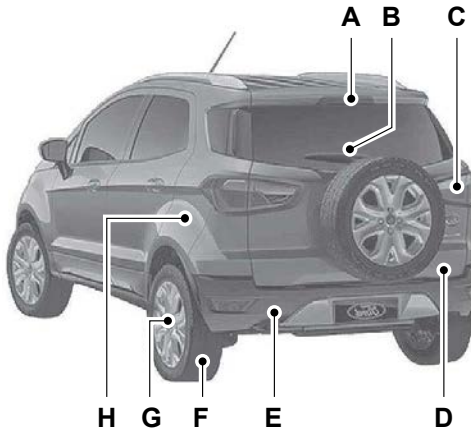

E166595

- A See **Changing a Bulb** (page 126).
- B See **Changing the Wiper Blades** (page 123).
- C See **Changing a Bulb** (page 126).
- D See **Warning Triangle** (page 102). Spare wheel. See **Changing a Road Wheel** (page 136). Jack. See **Changing a Road Wheel** (page 136).
- E See **Towing Points** (page 98).
- F Tire pressures. See **Technical Specifications** (page 141).
- G See **Changing a Road Wheel** (page 136).
- H See **Refueling** (page 81).

# Child Safety

## INSTALLING CHILD SEATS







E133140





E68916

### WARNINGS

-  Use an approved child restraint to secure children less than 150 centimeters (59 inches) tall in the rear seat.
-  **Extreme Hazard!** Do not use a rearward facing child restraint on a seat protected by an air bag in front of it!
-  Read and follow the manufacturer's instructions when you are fitting a child restraint.
-  Do not modify child restraints in any way.
-  Do not hold a child on your lap when the vehicle is moving.

### WARNINGS

-  Do not leave unattended children in your vehicle.
-  If your vehicle has been involved in an accident, have the child restraints checked by an authorized dealer.

**Note:** Children should be properly restrained in a rear seating position whenever possible. When using a child safety seat ensure that the rear seat back is in the most upright position.

## Child Restraints for Different Mass Groups

Use the correct child restraint as follows:

### Baby Safety Seat



E68918

Secure children that weigh less than 13 kilograms (29 pounds) in a rearward facing baby safety seat (Group 0+) in the rear seat.

# Child Safety

## Child Safety Seat



E68920

Secure children that weigh between 13 and 18 kilograms (29 and 40 pounds) in a child safety seat (Group 1) in the rear seat.

## Booster Seats

### WARNINGS

-  Do not install a booster seat or a booster cushion with only the lap strap of the safety belt.
-  Do not install a booster seat or a booster cushion with a safety belt that is slack or twisted.
-  Do not put the safety belt under your child's arm or behind its back.
-  Do not use pillows, books or towels to boost your child's height.
-  Make sure that your children sit in an upright position.
-  Secure children that weigh more than 15 kilograms (33 pounds) but are less than 150 centimeters (59 inches) tall in a booster seat or a booster cushion.

**Note:** When using a child seat on a rear seat, make sure that the child seat rests tightly against the vehicle seat. It may be necessary to lift or remove the head restraint. See **Head Restraints** (page 65).

## Booster Seat (Group 2)



E70710

We recommend that you use a booster seat that combines a cushion with a backrest instead of a booster cushion only. The raised seating position will allow you to position the shoulder strap of the adult safety belt over the center of your child's shoulder and the lap strap tightly across its hips.



# Child Safety

## Booster Cushion (Group 3)

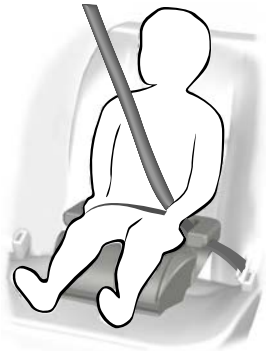

E68924

## ISOFIX Anchor Points

### WARNING

 Use an anti-rotation device when using the ISOFIX system. We recommend the use of a top tether or support leg.

**Note:** When you are purchasing an ISOFIX restraint, make sure that you know the correct mass group and ISOFIX size class for the intended seating locations. See **Child Seat Positioning** (page 15).

Your vehicle is fitted with ISOFIX anchor points that accommodate universally approved ISOFIX child restraints.

The ISOFIX system comprises two rigid attachment arms on the child restraint that attach to anchor points on the outboard rear seats, where the cushion and backrest meet.







E87145

Push the child seat back firmly to engage the ISOFIX lower anchor points.

## CHILD SEAT POSITIONING

### WARNINGS

-  Please consult your dealer for the latest details relating to Ford recommended child seats.
-  Extreme Hazard! Do not use a rearward facing child restraint on a seat protected by an air bag in front of it!
-  When using a child seat with a support leg, the support leg must rest securely on the floor.
-  When using a child seat with a safety belt, make sure that the safety belt is not slack or twisted.
-  The child seat must rest tightly against the vehicle seat. It may be necessary to lift or remove the head restraint. See **Head Restraints** (page 65).

# Child Safety

Seating positions	Mass group categories				
	0	0+	1	2	3
	Up to 10 kg (22 lbs)	Up to 13 kg (29 lbs)	9 - 18 kg (20 - 40 lbs)	15 - 25 kg (33 - 55 lbs)	22 - 36 kg (46 - 79 lbs)
Rear seats	U	U	U	U	U

U Suitable for universal category child seats approved for use in this mass group.

## ISOFIX Child Seats

Seating positions		Mass group categories	
		0+	1
		Rear facing	Forward facing
		13 kg (Up to 29 lbs)	9 - 18 kg (20 - 40 lbs)
Rear outboard seat ISOFIX	Size class	C, D, E*	A, B, B1*
	Seat type	IL	IL, IUF

IL Suitable for particular ISOFIX child restraints systems of the semi-universal category. Please consult child restraints systems suppliers' vehicle recommendation lists.

IUF Suitable for ISOFIX forward facing child restraints systems of universal category approved for use in this mass group and ISOFIX size class.

\*The ISOFIX size class for both universal and semi-universal child restraints systems is defined by the capital letters A to G. These identification letters are displayed on ISOFIX child restraints.

# Child Safety

---

## CHILD SAFETY LOCKS

### WARNING



You cannot open the rear doors from inside if you have put the child safety locks on.

---



E155301

### Rear Left-Hand Door

Turn anti-clockwise to lock and clockwise to unlock.

### Rear Right-Hand Door

Turn clockwise to lock and anti-clockwise to unlock.

# Safety Belts

## FASTENING THE SAFETY BELTS

### WARNINGS



Insert the tongue into the buckle until you hear a distinct click. You have not fastened the safety belt properly if you do not hear a click.



Make sure that your safety belt is securely stored away and is not outside the vehicle when closing the door.

Always use the safety belts and child restraint systems.

The upper belt strap should rest on the shoulder; never over the neck. The lower belt strap should rest over the pelvic area; never over the stomach.

Never use one belt for more than one person. Make sure the belts are not twisted or loose, nor obstructed by other passengers or packages.

Fasten the safety belt only with the vehicle at a standstill; never when the vehicle is moving.

Do not recline the front seat backrests excessively, as the seatbelts only provide maximum protection when the backrests are in a nearly vertical position.

### Retractable-inertial three-point safety belts

This type of safety belt is available with the front seats of all models, and with the rear seat of some models. Keep the belt retention buckle on the back floor, free from luggage or objects.

### Buckling the safety belt

Pull the safety belt with a steady movement to avoid a block. Insert the buckle tab into the belt lock until you hear a click, and make sure it is locked in place.

### Releasing the safety belt

Press the red button on the buckle. Then let the belt roll up smoothly and completely.



E74124

### Fixed rear center lap belt



E102129

When buckling, make sure you hear a click confirming that the tab is latched into the belt lock. To tighten it, pull the loose end through the buckle until the belt is comfortably adjusted around the hips.

# Safety Belts

Pull the belt out steadily. It may lock if you pull it sharply or if the vehicle is on a slope.

Press the red button on the buckle to release the belt. Let it retract completely and smoothly.

## Using Safety Belts During Pregnancy

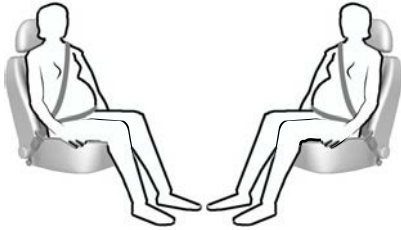

E68587

### WARNING



Position the safety belt correctly for your safety and that of your unborn child. Do not use only the lap strap or the shoulder strap.

Position the lap strap comfortably across your hips and low beneath your pregnant abdomen. Position the shoulder strap between your breasts, above and to the side of your pregnant abdomen.

## SAFETY BELT MINDER

### WARNING



The system will only provide protection when you use the safety belt properly.

The warning lamp illuminates and an audible warning will sound when any of the following conditions have been met:

- The driver's safety belt has not been fastened.
- The front passenger's seat is occupied and the safety belt has not been fastened.
- The vehicle exceeds a relatively low speed.

If you do not fasten your safety belt, both warnings will switch off automatically after about five minutes.







## Deactivating the Safety Belt Minder

See your authorized dealer.

# Supplementary Restraints System

## PRINCIPLE OF OPERATION

### WARNINGS

-  Do not modify the front of your vehicle in any way. This could adversely affect deployment of the airbags.
-  Never use a child or baby seat in the front seat on the passenger side.
-  Maximum airbag efficiency is obtained with the correct seat and seat backrest adjustment. Adjust them so that the steering wheel can be held with the arms slightly bent, and place the seat backrest almost in the vertical position (30° at most). Fasten the seatbelt and keep a distance of at least 25 centimeters between the steering wheel and the driver's chest to reduce the risk of injury for being much too close to the airbag when it is inflated. The same applies to the front passenger.
-  Have repairs to the steering wheel, steering column, seats, airbags and safety belts carried out only by an authorized dealer.
-  Do not place anything over the airbag. Objects placed over the airbag inflation area may be projected on your face and torso when the airbag is triggered, causing serious injury. Failure to follow these instructions may increase the risk of injury in case of a crash.
-  Do not puncture the seat with pins, needles or other pointed objects. This could cause damage and adversely affect deployment of the airbags.
-  Use seat covers designed for seats with side airbags. Have them installed by an authorized dealer.

### WARNINGS

-  Many airbag system components become hot after triggering. Avoid touching any component of the airbag system soon after triggering as this may result in serious injury.

**Note:** You will hear a loud bang and see a cloud of harmless powdery residue if an airbag deploys. This is normal.

**Note:** Only wipe airbag covers with a damp cloth.

**Note:** Do not allow passengers in the front seat to ride with their feet, knees or any other body part touching or too close to the airbag cover. There is a risk of serious injury if the airbag is triggered.

**Note:** Never place your arm over the airbag as a deploying airbag can result in serious arm fractures or other injuries.

**Note:** Modifying or adding equipment to the front part of the vehicle (including chassis, bumper, front body structures and towing hooks) may affect the performance of the airbag system, increasing the risk of injury. Do not modify the front part of your vehicle.

## DRIVER AIRBAG

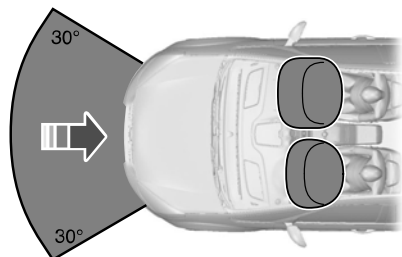

E74302

# Supplementary Restraints System

The airbag will deploy during significant frontal collisions or collisions that are up to 30 degrees from the left or the right. The airbag will inflate within a few thousandths of a second and deflate on contact with the occupant, thus cushioning forward body movement. During minor frontal collisions, overturns, rear collisions and side collisions, the airbag will not deploy.

## PASSENGER AIRBAG

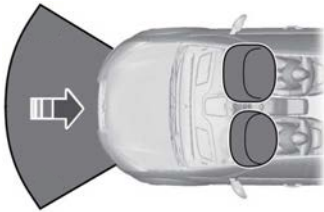

E151127

The passenger airbag will deploy during significant frontal or near-frontal collisions. The airbag will inflate within a few thousandths of a second and deflate on contact with the occupant, thus cushioning forward body movement. During minor frontal collisions, overturns, rear collisions and side collisions, the front passenger airbag will not deploy.

## SIDE AIRBAGS (If Equipped)

### WARNING



Use seat covers designed for seats with side airbags. Have these fitted by an authorized dealer.



E72658

The airbags are located inside the seatback of the front seats. There is a label attached to the side of the seatback to indicate this.

The airbag will deploy during significant lateral collisions. The airbag will not deploy in minor lateral and frontal collisions, rear collisions, or overturns.

**Note:** Do not install running boards to vehicles equipped with side airbags.

## SIDE CURTAIN AIRBAGS (If Equipped)

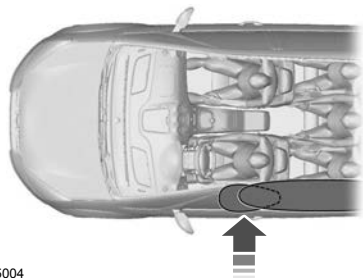

E75004

The airbags are located over the front and rear side windows.

## **Supplementary Restraints System**

---

The airbag will deploy during significant lateral collisions. It will also deploy during significant frontal angled collisions. The curtain airbag will not deploy in minor lateral and frontal collisions, rear collisions, or overturns.



# Keys and Remote Controls

## GENERAL INFORMATION ON RADIO FREQUENCIES

**Note:** Changes or modifications not expressly approved by the party responsible for compliance could void the user's authority to operate the equipment.

The typical operating range for your transmitter is approximately 10 m.

A decrease in operating range could be caused by:

- weather conditions
- nearby radio towers
- structures around your vehicle
- other vehicles parked next to your vehicle.

The radio frequency used by your remote control can also be used by other short distance radio transmissions (e.g. amateur radios, medical equipment, wireless headphones, remote controls and alarm systems). If the frequencies are jammed, you will not be able to use your remote control. You can lock and unlock the doors with the key.

**Note:** Make sure your vehicle is locked before leaving it unattended.

**Note:** If you are in range, the remote control will operate if you press any button unintentionally.

**Note:** The remote control contains sensitive electrical components. Exposure to moisture or impact may cause permanent damage.

## REMOTE CONTROL

You can program a maximum of eight remote controls to your vehicle. This includes any that were supplied with your vehicle. See an authorized dealer.

## Reprogramming the Unlocking Function

**Note:** When you press the unlock button either all the doors are unlocked or only the driver's door is unlocked. Pressing the unlock button again unlocks all the doors.

Press and hold the unlock and lock buttons on the remote key simultaneously for at least four seconds with the ignition off. The direction indicators will flash twice to confirm the change.

To return to the original unlocking function, repeat the process.

## Changing the Remote Control Battery



Make sure that you dispose of old batteries in an environmentally friendly way. Seek advice from your local authority regarding recycling.

## Remote Control With a Folding Key Blade

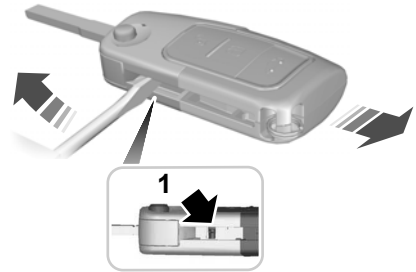

E74383

1. Insert a screwdriver as far as possible into the slot on the side of the remote control, push it toward the key blade and remove the key blade.

# Keys and Remote Controls

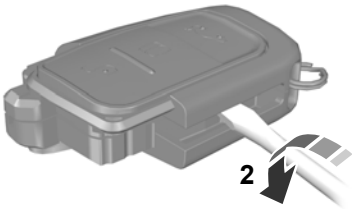

E74384

2. Twist the screwdriver in the position shown to start separating the two halves of the remote control.

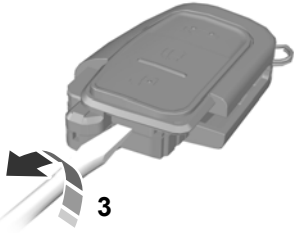

E74385

3. Twist the screwdriver in the position shown to separate the two halves of the remote control.

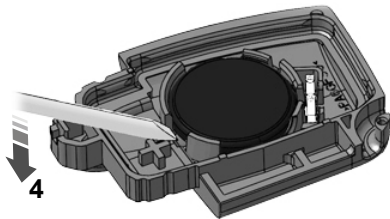

E126280

**Note:** Do not touch the battery contacts or the printed circuit board with the screwdriver.

4. Carefully remove the battery with the screwdriver.
5. Install a new battery (3V CR 2032) with the + facing downward.
6. Assemble the two halves of the remote control.
7. Install the key blade.

## Remote Control Without a Folding Key Blade

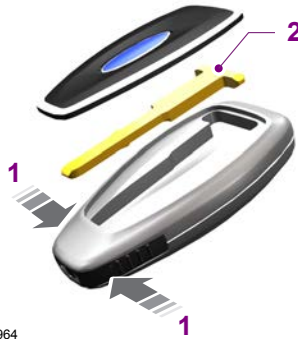

E87964

1. Press and hold the buttons on the edges to release the cover. Carefully remove the cover.
2. Remove the key blade.

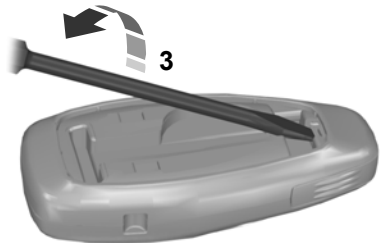

E105362

3. Twist a flat bladed screwdriver in the position shown to separate the two halves of the remote control.

# Keys and Remote Controls

## REPLACING A LOST KEY OR REMOTE CONTROL

Replacement keys or remote controls can be purchased from an authorized dealer. Authorized dealers can program remote controls for your vehicle. See **Passive Anti-Theft System** (page 31).

To re-program the passive anti-theft system see an authorized dealer.



E119190

- Carefully insert the screwdriver in the position shown to open the remote control.

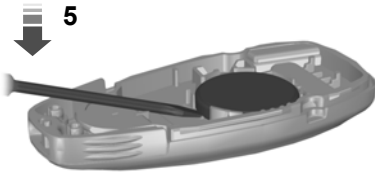

E125860

**Note:** Do not touch the battery contacts or the printed circuit board with the screwdriver.

- Carefully remove the battery with the screwdriver.
- Install a new battery (3V CR 2032) with the + facing downward.
- Assemble the two halves of the remote control.
- Install the key blade.

# Locks

## LOCKING AND UNLOCKING

**Note:** All doors will be automatically unlocked when the airbag deploys due to impact and following this the hazard warning flashers will flash.

### Power Door Locks (If Equipped)



E146263

The power door lock control is located on the instrument panel near the radio.

- Press the button once. The doors will lock.
- Press the button again. The doors will unlock.

For item location. See **At a Glance** (page 9).

### Autolock

The autolock feature will lock all the doors when:

- all doors and tailgate are closed,
- the ignition is on,
- you shift into any gear putting the vehicle in motion, and
- the vehicle attains a speed greater than 20 km/h.

If one or more doors are opened, the autolock feature will repeat when:

- the vehicle speed has been 15 km/h for at least two seconds; and
- the conditions for autolock are met again.

### Deactivating and Activating Autolock

**Note:** Your authorized dealer can perform this procedure, or you can do the procedure yourself

To enable or disable these features, do the following:

**Note:** Make sure all the doors are closed before starting the procedure.

**Note:** You will have 30 seconds to complete the procedure.

1. Switch the ignition on.
2. Press the power door lock button three times.
3. Switch the ignition off.
4. Press the power door lock button three times.
5. Switch the ignition on.
6. Press the power door lock button three times.
7. Switch the ignition off.
8. Switch the ignition on. A chime will sound indicating the programming mode has been entered.

Once in programming mode, each subsequent short press (less than 1 second) of the power door lock button will toggle autolock between on and off.

### Remote Control

The remote control can be used any time the vehicle is not running.

### Unlocking the Doors

**Note:** You can unlock the driver's door with the key. Use the key when the remote control is not functioning.

# Locks

**Note:** When you lock your vehicle for several weeks, the remote control will be switched off. Your vehicle must be unlocked and the engine started using the key. Unlocking and starting your vehicle once will enable the remote control.



Press the button to unlock the driver's door. The turn signals will flash once.

Press the button again within three seconds to unlock all doors. The turn signals will flash once.

## Reprogramming the Unlocking Function

You can reprogram the unlocking function so that all doors will unlock when you press the button once. See **Remote Control** (page 23).

## Locking the Doors



Press the button to lock all the doors. The turn signals will flash once.

Press the button again within three seconds to confirm that all the doors are closed. The doors will lock again and the turn signals will flash once if all the doors and the luggage compartment are closed.

**Note:** If any door or the luggage compartment is not closed, or if the hood is not closed on vehicles equipped with an anti-theft alarm, the lamps will not flash.

## Automatic Relocking (If Equipped)

The doors will relock automatically if you do not open a door within 45 seconds of unlocking the doors with the remote control. The door locks and the alarm will return to their previous state.

## Locking and Unlocking the Doors from Inside



Press the button. For item location. See **At a Glance** (page 9).

## Locking and Unlocking the Doors with the Key

**Note:** Do not leave your keys in your vehicle.

### Locking with the Key

Turn the top of the key toward the front of your vehicle and rotate the key a clockwise direction.

### Unlocking with the key

**Note:** If the child safety locks are on and you pull the interior handle, you will only switch off the emergency locking, not the child safety lock. You can only open the doors using the external door handle.

**Note:** If the doors have been unlocked using this method, the doors must be locked individually until the central locking function has been repaired.

Unlock the driver's door using the key. You can unlock all other doors individually by pulling the interior door handles.

**Note:** When the central locking function fails to operate, lock the doors individually using the key in the position shown.

# Locks

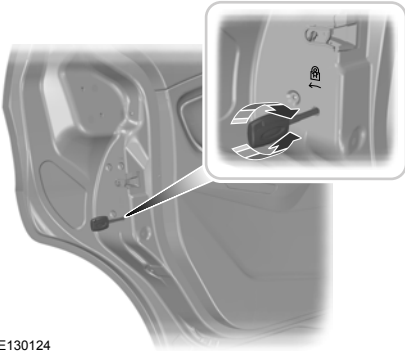

E130124

Push to lock.

## KEYLESS ENTRY (If Equipped)

### General Information

#### WARNING



The system may not function if the key is close to metal objects or electronic devices such as cell phones.

The system will not function if:

- Your vehicle battery has no charge.
- The passive key frequencies are jammed.
- The passive key battery is flat.

**Note:** If the system does not function, you will need to use the key blade to lock and unlock your vehicle.

The system allows you to operate your vehicle without the use of a key or remote control.

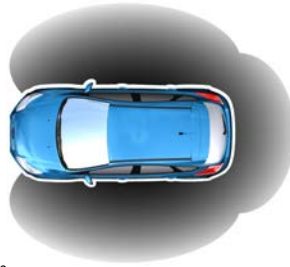

E78276

Passive locking and unlocking requires a valid passive key to be located within one of the two external detection ranges. These are located approximately 1.5 m from the front door handles and tailgate.

### Passive Key

Your vehicle can be locked and unlocked with the passive key. You can use the passive key as a remote control. See **Locking and Unlocking** (page 26).

### Locking Your Vehicle

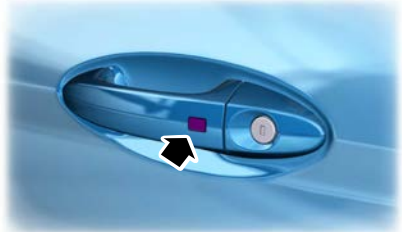

E87384

#### WARNING



Your vehicle does not lock itself automatically. If you do not press a locking button your vehicle will remain unlocked.

Locking buttons are located on each of the front doors and the tailgate.

# Locks

For central locking and to arm the alarm:

- Press a locking button once.

**Note:** *Your vehicle will remain locked for approximately three seconds. When the delay period is over, you can open the doors again, provided the passive key is within the respective detection range.*

Two short flashes of the direction indicators confirms that all the doors and tailgate have been locked and that the alarm has been armed.

## Unlocking Your Vehicle

**Note:** *Your vehicle remains locked for longer than three days, the system will enter an energy-saving mode. This is to reduce the discharge of your vehicle battery. When your vehicle is unlocked while in this mode, the reaction time of the system may be a little longer than normal. To exit the energy-saving mode, unlock your vehicle.*

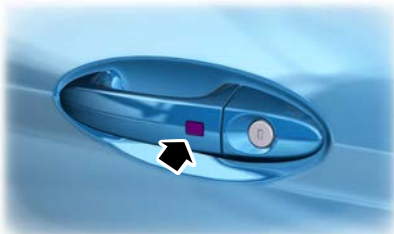

E87384

Press a locking button once.

**Note:** *A valid passive key must be located within the detection range of that door or tailgate.*

One long flash of the direction indicators confirms that all the doors and tailgate have been unlocked and that the alarm has been disarmed.

## Unlocking Only the Driver Door

If the unlocking function is reprogrammed so that only the driver door is unlocked See **Remote Control** (page 23). Note the following:

If the driver door is the first door which is unlocked, the other doors and tailgate will remain locked. All the other doors can be unlocked from inside your vehicle by pressing the unlock button on the instrument panel. For item location: See **At a Glance** (page 9). Doors can be unlocked individually by pulling the interior door handles on those doors.

If the front passenger door is the first door which is unlocked, all the doors will be unlocked.

## Disabled Keys

Any keys left inside your vehicle interior when it is locked will be disabled.

You cannot use a disabled key to switch the ignition on or start the engine.

You must enable all passive keys again in order to use them.

To enable all your passive keys, unlock your vehicle using a passive key or the remote control unlocking function.

All passive keys will then be enabled if you switch the ignition on or your vehicle is started using a valid key.

# Locks

## Locking and Unlocking the Doors with the Key Blade (If Equipped)

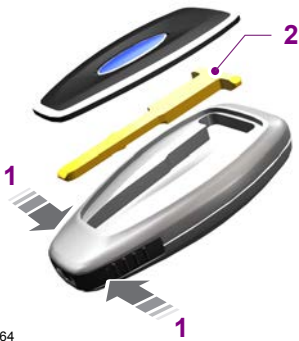

E87964

1. Carefully remove the cover.
2. Remove the key blade and insert it into the lock.

**Note:** Only the driver door handle has a lock cylinder.

## TAILGATE



E162987

To open the tailgate:

1. Unlock the tailgate with the remote control.
2. Press the release button located on the tailgate right-hand tail lamp.



## **PASSIVE ANTI-THEFT SYSTEM**

### **Principle of Operation**

The system prevents someone from starting the engine with an incorrectly coded key.

### **Coded Keys**

If you lose a key, you can obtain a replacement from an authorized dealer. If possible, provide them with the key number from the tag provided with the original keys. You can also obtain extra keys from an authorized dealer.

**Note:** *Have all of your remaining keys erased and recoded if you lose a key. Have replacement keys coded together with recoding your remaining keys. See an authorized dealer for further information.*

**Note:** *Do not shield your keys with metal objects. This may prevent the receiver from recognizing a coded key.*

### **Arming the Engine Immobilizer**

When you switch the ignition off the engine immobilizer will arm automatically after a short time.

### **Disarming the Engine Immobilizer**

When you switch the ignition on the engine immobilizer will disarm automatically if a correctly coded key is used.

If you are unable to start the engine with a correctly coded key, have your vehicle checked by an authorized dealer.

# Steering Wheel

## ADJUSTING THE STEERING WHEEL

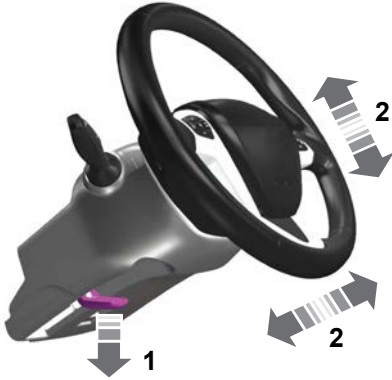

E95178



E95179

### WARNING



Never adjust the steering wheel when the vehicle is moving.

**Note:** The driver's airbag and the horn are inside the steering wheel.

See **Sitting in the Correct Position** (page 65).

1. Pull the lever down to unlock the steering column.
2. While the lever is in the down position, move the steering wheel up or down and in or out until you find the desired position.
3. While holding the steering wheel in place, push the lever up to its original position to lock the steering column.

## AUDIO CONTROL

Select the required source on the audio unit.

You can operate the following functions with the control:

### Type 1

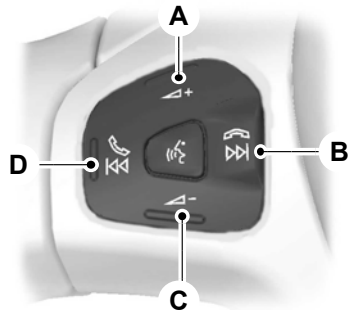

E164289

- A Volume up
- B Seek up, next or end call
- C Volume down
- D Seek down, previous or accept call

# Steering Wheel

## Type 2

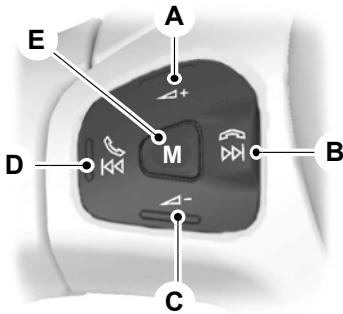

E164290

- A Volume up
- B Seek up or next
- C Volume down
- D Seek down or previous
- E Mode

Press **M** to select the audio source.

### Seek, Next or Previous

Press the seek button to:

- tune the radio to the next or previous stored preset.
- play the next or the previous track.

Press and hold the seek button to:

- tune the radio to the next station up or down the frequency band.
- seek through a track.

## VOICE CONTROL (If Equipped)

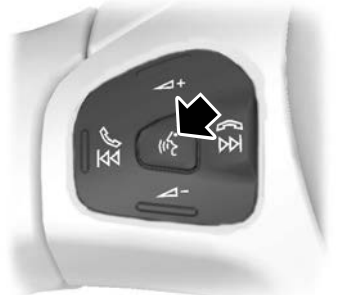

E141533

Push the control to switch on or off the voice control.

# Wipers and Washers

## WINDSHIELD WIPERS

**Note:** Fully defrost the windshield before switching on the windshield wipers.

**Note:** Make sure you switch off the windshield wipers before entering a car wash.

**Note:** Install new wiper blades as soon as they begin to leave bands of water and smears on the windshield.

**Note:** Do not operate the wipers on a dry windshield. This may scratch the glass, damage the wiper blades or cause the wiper motor to burn out. Always use the windshield washers before wiping a dry windshield.

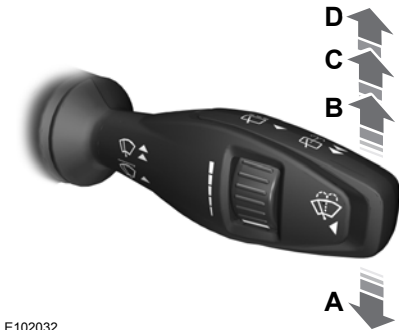

E102032

- A Single wipe
- B Intermittent wipe
- C Normal wipe
- D High speed wipe

## Intermittent Wipe

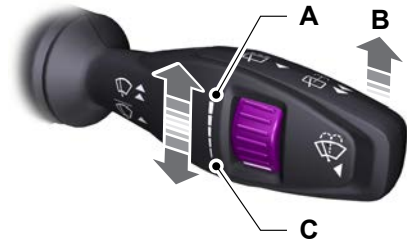

E102033

- A Short wipe interval
- B Intermittent wipe
- C Long wipe interval

Use the rotary control to adjust the intermittent wipe interval.

## Speed Dependent Wipers (If Equipped)

When your vehicle speed increases, the interval between wipes will decrease.

## WINDSHIELD WASHERS

**Note:** Do not operate the washers when the washer reservoir is empty. This may cause the washer pump to overheat.



E102051

Push the button to operate the washers. When you release the button, the wipers will operate for a short time.

# Wipers and Washers

## REAR WINDOW WIPER AND WASHERS (If Equipped)

### Intermittent Wipe



E102052

Pull the lever toward you.

### Reverse Gear Wipe (If Equipped)

The rear wiper will turn on automatically when selecting reverse gear if:

- the rear wiper is not already switched on
- the wiper lever is in position A, B, C or D
- the front wiper is operating (when set to position B).

The rear wiper will follow the front wiper interval (at intermittent or normal speed).

### Rear Window Washer

**Note:** Do not operate the washers when the washer reservoir is empty. This may cause the washer pump to overheat.

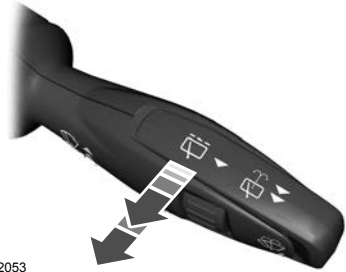

E102053

Pull the lever toward you to operate the washers. They will operate for a maximum of 10 seconds. When you release the lever, the wiper will operate for a short time.

# Lighting

## LIGHTING CONTROL

### Lighting Control Positions

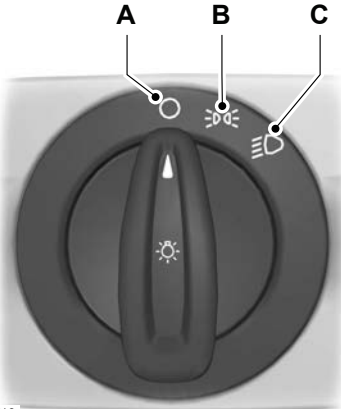

E70718

- A Off
- B Parking lamps, instrument panel lamps, license plate lamps and tail lamps
- C Headlamps

### Parking Lamps

**Note:** Prolonged use of the parking lamps when the ignition is off will cause the battery to run out of charge.

To operate the parking lamps turn the lighting control to position B. The parking lamps operate with the ignition on or off.

### High Beams



E101829

Pull the lever fully toward you to switch the high beams on.

Pull the lever fully toward you again to switch the high beams off.

### Headlamp Flasher

Pull the lever toward you slightly and release it to flash the headlamps.

### HEADLAMP EXIT DELAY

After you switch the ignition off, you can switch the headlamps on by pulling the direction indicator lever toward you. You will hear a short tone. The headlamps will switch off automatically after three minutes with any door open or 30 seconds after the last door has been closed. You can cancel this feature by pulling the direction indicator toward you again or switching the ignition on.

# Lighting

## FRONT FOG LAMPS (If Equipped)

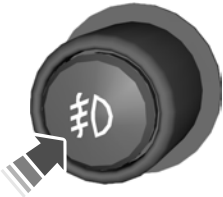

E70721

### WARNING



Only use the front fog lamps when visibility is considerably restricted by fog, snow or rain.

## REAR FOG LAMPS (If Equipped)



E70720

**Note:** Only use the rear fog lamps when visibility is restricted to less than 50 meters (164 feet).

**Note:** Do not use the rear fog lamps when it is raining or snowing and visibility is more than 50 meters (164 feet).

## HEADLAMP LEVELING

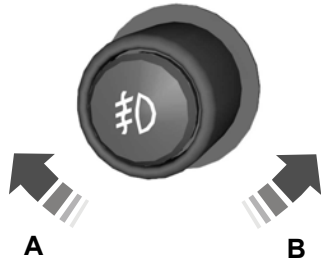

E70722

- A Raised headlamp beams
- B Lowered headlamp beams

You can adjust the level of the headlamp beams according to the vehicle load.

## Recommended headlamp leveling control positions

Load		Load in luggage compartment <sup>1</sup>	Control position
Front seats	Rear seats		
1-2	-	-	0
1-2	3	-	1
1-2	3	Max	2
1	-	Max	3

<sup>1</sup> See **Vehicle Identification Plate** (page 142).

# Lighting

## DIRECTION INDICATORS



E102016

- Push down to switch on the left direction indicator.
- Push up to switch on the right direction indicator.

Tap the lever up or down to make the direction indicators flash three times to indicate a lane change.

**Note:** For vehicles with an information display, you can change the number of times the direction indicators will flash. See **Information Displays** (page 49).

## INTERIOR LAMPS

### Courtesy lamp

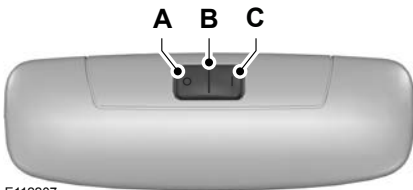

E112207

- A Off
- B Door contact
- C On

If you set the switch to position **B**, the courtesy lamp will come on when you unlock or open a door or the luggage compartment lid. If you leave a door open with the ignition switch off, the courtesy lamp will go off automatically after some time to prevent the vehicle battery from discharging. To switch it back on, switch on the ignition for a short time.

The courtesy lamp will also come on when you switch off the ignition. It will go off automatically after a short time or when you start or restart the engine.

If you set the switch to position **C** with the ignition switch off, the courtesy lamp will come on. It will go off automatically after a short time to prevent the vehicle battery from discharging. To switch it back on, switch on the ignition for a short time.

### Reading lamps



E112208

If you switch off the ignition, the reading lamps will go off automatically after some time to prevent the vehicle battery from discharging. To switch them back on, switch on the ignition for a short time.



# Windows and Mirrors

## POWER WINDOWS

### WARNINGS

 Do not leave children unattended in your vehicle and do not let them play with the power windows. They may seriously injure themselves.

 When closing the power windows, you should verify they are free of obstructions and make sure that children and pets are not in the proximity of the window openings.



E70848

**Note:** You may hear a rumbling noise when just one of the windows are open. Lower the opposite window slightly to reduce this noise.

Press the switch to open the window.

Lift the switch to close the window.

### One-Touch Down (If Equipped)

Press the switch fully and release it. Press again or lift it to stop the window.

### One-Touch Up (If Equipped)

Lift the switch fully and release it. Press or lift it again to stop the window.

## Window Lock



E70850

Press the control to lock or unlock the rear window controls. It will illuminate when the rear window controls are locked.

### Bounce-Back (If Equipped)

The window will stop automatically while closing. It will reverse some distance if there is an obstacle in the way.

### Overriding the Bounce-Back Feature

#### WARNING

 When you override the bounce-back feature the window will not reverse if it detects an obstacle. Take care when closing the windows to avoid personal injury.

Proceed as follows to override this protection feature when there is a resistance, for example in winter:

1. Close the window twice until it reaches the point of resistance and let it reverse.

# Windows and Mirrors

2. Close the window a third time to the point of resistance. The bounce-back feature is now disabled and you can close the window manually. The window will go past the point of resistance and you can close it fully.

See an authorized dealer as soon as possible if the window does not close after the third attempt.

## Resetting the Bounce-Back Feature

### WARNING



The bounce-back feature remains turned off until you reset the memory.

If you have disconnected the battery, you must reset the bounce-back memory separately for each window.

1. Lift and hold the switch until the window is fully closed.
2. Release the switch.
3. Lift the switch again for one more second.
4. Press and hold the switch until the window is fully open.
5. Release the switch.
6. Lift and hold the switch until the window is fully closed.
7. Open the window and then try to close it automatically.
8. Reset and repeat the procedure if the window does not close automatically.

## EXTERIOR MIRRORS

### Power Exterior Mirrors (If Equipped)

### WARNING



Do not adjust the mirrors when your vehicle is moving.

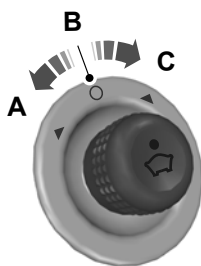

E71280

- A Left-hand mirror
- B Off
- C Right-hand mirror

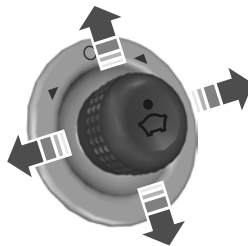

E71281

Move in the direction of the arrows to tilt the mirror.

### Fold-Away Exterior Mirrors (If Equipped)

Push the mirror toward the door window glass. Make sure that you fully engage the mirror in its support when returning it to its original position.

### Integrated Blind Spot Mirrors (If Equipped)

### WARNING



Objects in the blind spot mirror are closer than they appear.

# Windows and Mirrors

Blind spot mirrors have the outboard section of the mirror that curves aspheric. They are designed to increase your visibility along the side of your vehicle.

Check the main mirror first before a lane change, then check the blind spot mirror. If no vehicles are present in the blind spot mirror and the traffic in the adjacent lane is at a safe distance, signal that you intend to change lanes. Glance over your shoulder to verify traffic is clear and carefully change lanes.

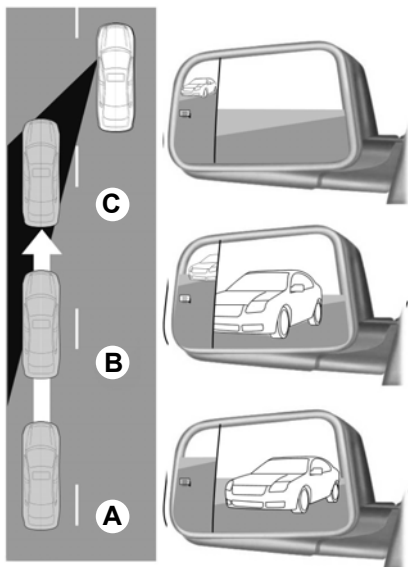

E151232

The image of the approaching vehicle is small and near the inboard edge of the main mirror when it is at a distance. The image becomes larger and begins to move outboard across the main mirror as the vehicle approaches (A). The image will transition from the main mirror and begin to appear in the blind spot mirror as the vehicle approaches (B). The vehicle will transition to your peripheral field of view as it leaves the blind spot mirror (C).

## INTERIOR MIRROR

### WARNING



Do not adjust the mirror when your vehicle is moving.

**Note:** Do not clean the housing or glass of any mirror with harsh abrasives, fuel or other petroleum or ammonia-based cleaning products

You can adjust the interior mirror to your preference. Some mirrors also have a second pivot point. This lets you move the mirror head up or down and from side to side.

Pull the tab below the mirror toward you to reduce glare at night.

# Instrument Cluster

## GAUGES

### Type 1

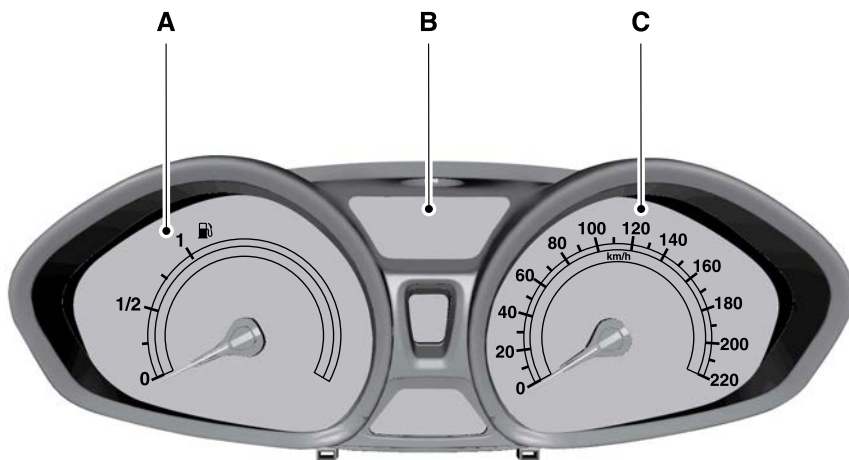

E151662

- A Fuel gauge
- B Information display
- C Speedometer

# Instrument Cluster

## Type 2

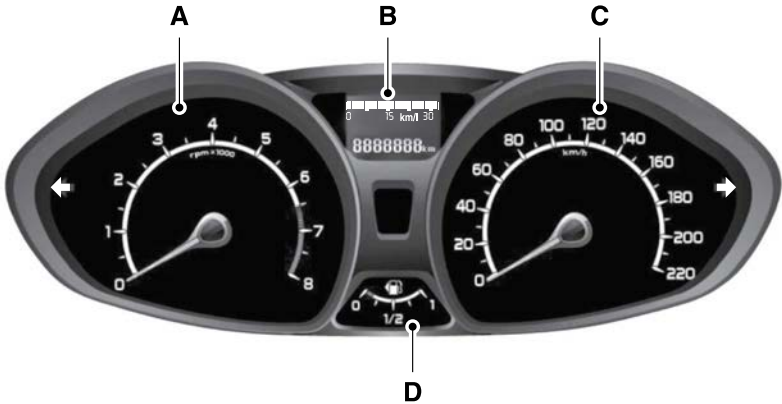

E144826

- A Tachometer
- B Information display
- C Speedometer
- D Fuel gauge

### Tachometer (If Equipped)

Indicates the engine speed in revolutions per minute. Driving with your tachometer pointer continuously at the top of the scale may damage the engine.

### Information Display

- Odometer/Trip odometer/Instantaneous Fuel Consumption
- Outside Air Temperature (if equipped)
- Trip Computer See **Trip Computer** (page 50).
- PRNDS display (automatic transmission vehicles only)

### PRNDS display

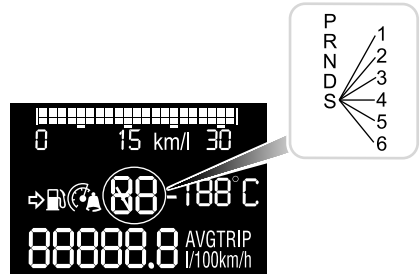

If manual mode selected at S positions, the gears used will be displayed. See **Automatic Transmission** (page 85).

# Instrument Cluster

## Fuel Gauge

Switch the ignition on. The fuel gauge will indicate approximately how much fuel is left in the fuel tank. The fuel gauge may vary slightly when your vehicle is moving or on a gradient. The arrow adjacent to the fuel pump symbol indicates on which side of the vehicle the fuel filler door is located.

## Maximum Engine Speed

The electronic management system, under certain conditions, limits the engine speed (fuel cut-off) below a preset value, in order to avoid engine damage. This speed limit can occur when the vehicle is stopped or during speeds less than 10 km/h, not being considered as an engine failure.

### WARNING



When the engine is running, keep clothing, such as neckties, and any other objects away from the rotating engine components in order to avoid serious injuries.

## WARNING LAMPS AND INDICATORS

The following warning lamps and indicators will alert you to a vehicle condition that may become serious. Some lamps will illuminate when you start your vehicle to make sure they work. If any lamps remain on after starting your vehicle, refer to the respective system warning lamp for further information.

**Note:** Some warning indicators appear in the information display and function the same as a warning lamp but do not display when you start your vehicle.

## Anti-lock Braking System (If Equipped)



If it illuminates when you are driving, this indicates a malfunction. You will continue to have normal braking (without Anti-lock braking system). Have the system checked by an authorized dealer as soon as possible.

## Anti-theft System Indicator



Flashes when the Anti-theft System (PATS) has been activated.

## Airbag (If Equipped)



If it illuminates when driving, this indicates a malfunction. Have the system checked by an authorized dealer.

## Battery Charge System



If it illuminates when driving, this indicates a malfunction. Switch off all unnecessary electrical equipment. Have the system checked by an authorized dealer immediately.

## Brake System



It illuminates when you apply the parking brake or when the brake fluid level is low or if the anti-lock braking system (if equipped) is malfunctioning.

### WARNING



Reduce your speed gradually and stop your vehicle as soon as it is safe to do so. Use your brakes with care.

# Instrument Cluster

If it illuminates when you are driving, check that the parking brake is not applied. If the parking brake is not applied, this indicates a malfunction. Have the system checked by an authorized dealer immediately.

## Coolant Temperature

### WARNING



Do not resume your journey if it illuminates in red color despite the level being correct. Have the system checked by an authorized dealer immediately.



If the blue lamp stays on or illuminates after starting the engine or while driving, this indicates that the engine is cold and its performance can be reduced. If you keep the engine running this lamp should switch off after a few minutes, this indicates that the engine has reached its normal working temperature.

If the red lamp stays on or illuminates after starting the engine or while driving, this indicates an engine coolant malfunction. Stop your vehicle as soon as it is safe to do so and switch the engine off. Check the coolant level. See **Engine Coolant Check** (page 121).

## Direction Indicator



Flashes during operation. A sudden increase in the rate of flashing warns of a failed indicator bulb. See **Changing a Bulb** (page 126).

## Doors Open (If Equipped)



Illuminates when the ignition is switched on and any door, the hood or the luggage compartment is not closed properly.

## Front Fog Lamp (If Equipped)



It will illuminate when you switch the front fog lamps on.

## Glow Plug (If Equipped)



If it illuminates, wait until the light goes off before starting.

## Headlamp



It will illuminate when you switch the headlamp beam or the parking lamps on.

## Hill Start Assist (If Equipped)



If it illuminates when your are driving this indicates a malfunction.

## Information Indicator (If Equipped)



It will illuminate when a new message is stored in the information display. It will be red or amber in color depending on the severity of the message and will remain on until the cause of the message has been rectified. See **Information Messages** (page 53).

## Low Fuel Level



If it illuminates when driving, refuel as soon as possible.

## Main Beam



It will illuminate when you switch the headlamp main beam on. It will flash when you use the headlamp flasher.

# Instrument Cluster

## Engine warning lamps

### Malfunction indicator lamp



### Powertrain warning lamp



### All vehicles

If either lamp illuminates when the engine is running, this indicates a fault. The engine will continue to run but it may have limited power. If it flashes when you are driving, reduce the speed of your vehicle immediately. If it continues to flash, avoid heavy acceleration or deceleration. Have the system checked by a properly trained technician immediately.

#### WARNING



Have this checked immediately.

If both lamps illuminate together, stop your vehicle as soon as it is safe to do so (continued use may cause reduced power and cause the engine to stop). Turn the ignition off and attempt to restart the engine. If the engine restarts have the system checked by a properly trained technician immediately. If the engine does not restart the vehicle must be checked before continuing your journey.

## Oil Pressure

#### WARNING



Do not resume your journey if it illuminates despite the level being correct. Have the system checked by an authorized dealer immediately.



If it stays on after starting or illuminates when driving, this indicates a malfunction. Stop your vehicle as soon as it is safe to do so and switch the engine off. Check the engine oil level. See **Engine Oil Check** (page 119).

## Power Steering



If it illuminates when driving, this indicates a malfunction of the power steering system. You will continue to have full steering but will need to exert greater force on the steering wheel. Have the system checked by an authorized dealer as soon as possible.

## Rear Fog Lamp (If Equipped)



It will illuminate when you switch the rear fog lamps on.

## Safety Belt Minder (If Equipped)



See **Safety Belt Minder** (page 19).

## Stability Control (If Equipped)



While driving, it flashes during activation of the system. After switching on the ignition, if it does not illuminate or illuminates continuously while driving, this indicates a malfunction. During a malfunction, the system switches off. Have the system checked by an authorized dealer as soon as possible.

## Stability Control Off (If Equipped)



It will illuminate when you switch the system off. It will go out when you switch the system back on or when you switch the ignition off.



# Instrument Cluster

## Water-In-Fuel (If Equipped)



It will illuminate if there is excess water in the fuel filter. Drain off the water immediately. See **Fuel Quality** (page 80).

## AUDIBLE WARNINGS AND INDICATORS

### Anti-theft Alarm (If Equipped)

#### Category One Alarm

Sounds when you unlock and open the driver door using the key in the door lock. The chime will stop when the ignition is turned on with a valid key. The chime will sound for 12 seconds before the vehicle alarm is triggered.

#### Door Ajar (If Equipped)

Sounds if the vehicle's speed exceeds the pre-determined limit and any of the doors are open or ajar. The chime will only sound once per ignition key cycle.

#### Headlamps On (If Equipped)

Sounds when you turn the key to off and open the driver's door and you have left the headlamps or parking lamps on.

#### Headlight Exit Delay (If Equipped)

Sounds when the headlight exit delay has been activated.

#### Ignition Left On (Keyless Vehicles Only) (If Equipped)

Sounds if the ignition is left on and the vehicle driver's door is ajar or opened. The chime will stop once the door is closed or the ignition is turned off.

## Low Fuel Level (If Equipped)

A low fuel level reminder sounds when the fuel gauge needle is at one-sixteenth above empty. The reminder sounds once per ignition key cycle.

## Message Center Display (If Equipped)

Sounds every time that the message center displays a warning message.

## Parking Brake

Sounds if the vehicle's speed exceeds the pre-determined limit with the parking brake engaged. It will stop as soon as the vehicle is stopped or the parking brake is released.

## Safety Belt Minder (If Equipped)

### WARNINGS



The safety belt minder remains in stand-by mode when the driver and the front passenger (if equipped) safety belts have been fastened. It will be reactivated if the driver or front passenger (if equipped) safety belt is unfastened.



Do not sit on top of a fastened safety belt to prevent the safety belt minder from coming on. The occupant protection system will only provide optimum protection when you use the safety belt properly.

Sounds when the vehicle's speed exceeds the pre-determined limit, and the driver or front passenger (if equipped) safety belts are unfastened. The chime will stop after five minutes.

## Speed Alarm (If Equipped)

When the speed alarm is active, every time the vehicle reaches the selected speed a warning will be sounded and the display will flash.

# Instrument Cluster

---

If the vehicle speed is at least 5 km/h above the selected speed, a double beep will be sounded every 10 seconds.

## **Vehicle Not in Park**

Sounds if the vehicle is out of **P** park and driver's door is ajar or opened. The chime will stop once the vehicle is put in **P** park or if the driver's door is closed properly.

# Information Displays

## GENERAL INFORMATION

### WARNING



Driving while distracted can result in loss of vehicle control, accident, damages to the vehicle and injury to passengers. Ford strongly recommends that drivers use extreme caution when using any device or feature that may direct their focus elsewhere. Your primary responsibility is the safe operation of the vehicle. We recommend against the use of any handheld device while driving and that you comply with all applicable laws.

Various systems on your vehicle can be controlled using the information display controls on your audio unit (if equipped). Corresponding information is displayed in the information display (if equipped).

### Information Display Controls (If Equipped)



E103626

- Press the up and down arrow buttons to scroll through and highlight the options within a menu.
- Press the right arrow button to enter a sub-menu.
- Press the left arrow button to exit a menu.
- Press and hold the left arrow button at any time to return to the main menu display (escape button).
- Press the OK button to choose and confirm settings or messages.

Press the MENU button on the radio to access some configurable features. Use the control arrow to the following features:

- SYNC-config; access general SYNC configurations. See separate SYNC manual.
- SYNC-applications; access SYNC applications (if equipped). See separate SYNC manual.
- Audio configuration; defines the audio configurations. See **Audio Unit** (page 158).
- Vehicle configurations; allow you to configure these features:
  - Traction control -- you can activate or deactivate traction control. See **General Information** (page 49).
  - Lane change indicator -- you can set the lane change indicator to blink once or three times when changing lanes while driving. See **Direction Indicators** (page 38).
  - Chimes -- you can set if an audible warning will be sound for some information messages. See **Information Messages** (page 53).
- Clock; allows you to adjust the time and date.
- Display; allows you to set the language on the display and in the voice recognition system.
- System; allows you to see current active information messages.

### Adjusting the Clock

1. Press the MENU button on the radio.
2. Select Clock then press OK.
3. Select Adjust Clock then press OK.
4. Use the up or down arrows to increase or decrease the hour and minutes.
5. Use the left or right arrows to alternate between hour or minute adjustment.

# Information Displays

6. Press OK when done.
- or
1. Press the # symbol on the radio to access the clock adjustment.
2. Use the up or down arrows to increase or decrease the hour and minutes.
3. Use the left or right arrows to alternate between hour or minute adjustment.
4. Press OK when done.

## Adjusting the Date

1. Press the MENU button on the radio.
2. Select Clock then press OK.
3. Select Adjust Date then press OK.
4. Use the up or down arrows to increase or decrease the day, month and year.
5. Use the left or right arrows to alternate between day, month and year adjustment.
6. Press OK when done.

## 24 Hour Mode

1. Press the MENU button on the radio.
2. Select Clock then press OK.
3. Choose 24h Mode.
4. Check the selection box with the OK button to enable 24h Mode or uncheck to enable 12h mode.

## INSTANTANEOUS FUEL CONSUMPTION



E146280

Indicates the current fuel consumption.

 The symbol + is activated when the value to be displayed is higher than the maximum scale value. For applications that use km/l it means low fuel consumption. For applications that use l/100km it means high fuel consumption.

## TRIP COMPUTER (If Equipped)

### STANDARD



E146272

Press the button to scroll through the displays:

- total distance odometer
- trip odometer

### Total Distance Odometer

 Registers the total distance of the vehicle.

### Trip Odometer

 Registers the distance traveled of individual journeys.

When on this screen, press and hold the trip button until the screen appears completely full with dashes (from: current mileage to: \_\_\_\_\_) to reset this function.

# Information Displays

## TRIP COMPUTER OPTIONAL



E146272

Press the button to scroll through the displays:

- total distance odometer
- trip odometer
- average fuel economy
- speed alarm
- average speed
- distance to empty
- outside ambient temperature (always displayed)

You can reset the trip odometer, average fuel economy and average speed. To do this, scroll to the required display, then press and hold the button until the screen appears completely full with dashes.

The trip computer includes the following information displays:

### Total Distance Odometer

**km**

Registers the total distance of the vehicle.

### Trip Odometer

**TRIP  
km**

Registers the distance traveled of individual journeys.

### Average Fuel Consumption

**AVG  
km/l**

Indicates the average fuel consumption since the function was last reset.

## Speed Alarm



To set the desired speed value for the speed warning, select the speed alarm screen.

The speed alarm can be set to work with the following speeds: 30, 40, 50, 60, 70, 80, 90, 100, 110, 120, 130, 140 km/h.

The process to switch the speed alarm ON when the system is switched OFF.

From:



To:



1. Press the reset button with a long press (for at least two seconds) until the display of the speed alarm symbol and the OFF indicator begins to blink. This indicates that the screen is now in edit mode.
2. Release the button.
3. Press the button with short presses (less than two seconds) several times until the desired speed appears in the display.

# Information Displays

4. To save, wait five seconds on this screen or press the button for at least two seconds. You will hear a beep and the display will stop blinking indicating that your selection has been saved. This step must be followed for all three sections (OFF to ON, ON to OFF and ON to ON) that describes the speed alarm save process.

**Note:** The maximum selectable speed for the alarm is 140 km/h. If you continue to press the reset button with short presses the display will go back to the OFF mode and so the multiples of 10 speeds will be displayed again.

**Note:** In set mode, the selectable speed displayed after the OFF screen will always be the next multiple of 10 in speed from the speedometer (i.e. if your speedometer indicates 63 km/h, the speed alarm will give you option from 70 to 140 km/h. If speedometer indicates 100 km/h, the speed alarm will give you options from 110 to 140 km/h. If speedometer indicates 30 km/h, the options will be from 40 to 140 km/h).

The process to switch the speed alarm Off.

From:



To:



1. Press the reset button with a long press (for at least two seconds) until the display of the speed alarm symbol and the speed unit begins to blink. This indicates that the screen is now in edit mode.
2. Release the button.
3. Press the button with a short press (less than two seconds) once, the display will change to OFF.
4. To save this speed, wait five seconds on this screen or press the button after at least two seconds. You will hear a beep and the display will stop blinking indicating that your selection has been saved.

The process to set a new speed when the speed alarm is active.

From:



To:



1. Press the reset button with a long press (for at least two seconds) until the display of the speed alarm symbol and the speed unit begins to blink. This indicates that the screen is now in edit mode.
2. Release the button.

# Information Displays

3. Press the button with short presses (less than two seconds) several times until the desired speed displays. The first screen after the first short press will be the OFF option. Continue with short presses to see the next speed alarm option.
4. To save this speed, wait five seconds on this screen or press the button during for at least two seconds. You will hear a beep and the display will stop blinking indicating that your selection has been saved.

## Average Speed

**AVG**  
km/h

Indicates the average speed calculated since the function was last reset.

## Distance to Empty

 Indicates the approximate distance the vehicle will travel on the fuel remaining in the tank. Change in driving pattern may cause the value to vary.

## Outside Ambient Temperature Indication

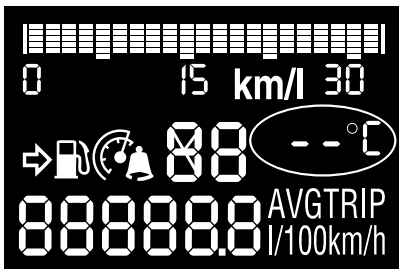

This will display the outside ambient temperature in degrees Celsius.

## INFORMATION MESSAGES

**Note:** Depending on the vehicle options equipped with your vehicle, not all of the messages will display or be available. Certain messages may be abbreviated or shortened depending upon which cluster type you have.



E103626

Press the OK button to acknowledge and remove some messages from the information display. Other messages will be removed automatically after a short time.

Certain messages need to be confirmed before you can access the menus.

 The message indicator illuminates to supplement some messages. It will be red or amber depending on the severity of the message and will remain on until the cause of the message has been rectified.

Some messages will be supplemented by a system specific symbol with a message indicator.

# Information Displays

## Airbag

Message	Message indicator	Action
Airbag malfunction service now	amber	Have the system checked by a authorized dealer as soon as possible.

## Diesel

Message	Message indicator	Action
Engine preheating	amber	See <b>Starting a Diesel Engine</b> (page 77).
Diesel filter overloaded Refer to handbook	amber	See <b>Starting a Diesel Engine</b> (page 77).

## Doors Open

Message	Message indicator	Action
Driver door open	red	Vehicle is moving. Stop your vehicle as soon as safely possible and close.
Driver side rear door open	red	Vehicle is moving. Stop your vehicle as soon as safely possible and close.
Passenger door open	red	Vehicle is moving. Stop your vehicle as soon as safely possible and close.
Passenger side rear door open	red	Vehicle is moving. Stop your vehicle as soon as safely possible and close.
Boot open	red	Vehicle is moving. Stop your vehicle as soon as safely possible and close.
Driver door open	amber	Vehicle not moving. Close.
Drivers side rear door open	amber	Vehicle not moving. Close.



# Information Displays

Message	Message indicator	Action
Passenger door open	amber	Vehicle not moving. Close.
Passenger side rear door open	amber	Vehicle not moving. Close.
Boot open	amber	Vehicle not moving. Close.

## Engine Immobilizer

Message	Message indicator	Action
Immobilizer malfunction service now	red	Have the system checked by a authorized dealer as soon as possible.

## Keyless System

Message	Message indicator	Action
Key battery low replace battery	amber	See <b>Remote Control</b> (page 23).
Turn ignition off use POWER button	amber	See <b>Keyless Starting</b> (page 74).
Press brake to start	-	See <b>Keyless Starting</b> (page 74).
Press clutch to start	-	See <b>Keyless Starting</b> (page 74).

## Lighting

Message	Message indicator	Action
Left indicator malfunction change bulb	-	See <b>Changing a Bulb</b> (page 126).
Right indicator malfunction change bulb	-	See <b>Changing a Bulb</b> (page 126).

# Information Displays

## Maintenance

Message	Message indicator	Action
Brake fluid level low service now	red	See <b>Brake and Clutch Fluid Check</b> (page 121).
Brake system malfunction stop safely	red	Have the system checked by a authorized dealer immediately.
Engine oil pressure low stop safely	red	See <b>Engine Oil Check</b> (page 119).
Engine malfunction service now	amber	Have the system checked by a authorized dealer as soon as possible.
Auto wiper/lights malfunction service required	amber	Have the system checked by a authorized dealer.
Engine oil change due service required	-	Have the system checked by a authorized dealer.

## Steering

Message	Message indicator	Action
Steering lock malfunction stop safely	red	Have the system checked by a authorized dealer immediately.
Power steering malfunction service now	amber	Full steering will be maintained but you will need to exert greater force on the steering wheel. Have the system checked by a authorized dealer as soon as possible.

# Information Displays

## Transmission

Message	Message indicator	Action
Transmission malfunction service now	red	Have the system checked by a authorized dealer immediately.
Transmission overtemperature stop safely	red	Under certain driving conditions it is possible that the clutches in the transmission can overheat. In these circumstances it is necessary to press the brake pedal and stop your vehicle to prevent damage to the transmission. Select N or P and apply the parking brake until the transmission has cooled and the message disappears from the display.
Vehicle not in park select P	-	See <b>Automatic Transmission</b> (page 85). See <b>Starting and Stopping the Engine</b> (page 74).
To start select N or P	-	See <b>Automatic Transmission</b> (page 85). See <b>Starting and Stopping the Engine</b> (page 74).
Press brake to start	-	See <b>Starting and Stopping the Engine</b> (page 74).
To start select N	-	See <b>Automatic Transmission</b> (page 85). See <b>Starting and Stopping the Engine</b> (page 74).
Door open apply brake	-	See <b>Automatic Transmission</b> (page 85). See <b>Starting and Stopping the Engine</b> (page 74).
Cranking time exceeded		See <b>Starting a Gasoline Engine</b> (page 76).
Hill start assist active		See <b>Hill Start Assist</b> (page 87).
Hill start assist off		See <b>Hill Start Assist</b> (page 87).

# Information Displays

---

## Stability Control

Message	Message indicator	Action
ABS malfunction service now	amber	Have the system checked by a authorized dealer as soon as possible.
Reduced electronic stability control	-	Have the system checked by a authorized dealer.
Electronic stability control off	-	See <b>Using Stability Control</b> (page 92).

# Climate Control

---

## PRINCIPLE OF OPERATION

### Outside Air

Keep the air intakes in front of the windshield free from obstruction (such as snow or leaves) to allow the climate control system to function effectively.

### Recirculated Air

#### WARNING



Prolonged use of recirculated air may cause the windows to mist up. If the windows mist up, follow the settings for demisting the windshield.

---

The air currently in the passenger compartment recirculates. Outside air does not enter your vehicle.

### Heating

Heating performance depends on the temperature of the engine coolant.

## General Information on Controlling the Interior Climate

Fully close all the windows.

### Warming the Interior

Direct the air toward your feet. In cold or humid weather conditions, direct some of the air toward the windshield and the door windows.

### Cooling the Interior

Direct the air toward your face.

### Air Conditioning

The system directs air through the evaporator for cooling. The evaporator extracts humidity from the air to help keep the windows free of mist. The system directs the resulting condensation to the outside of your vehicle, which may cause a small pool to form under your vehicle. This is normal.

**Note:** *The air conditioning operates only when the temperature is above 4°C.*

**Note:** *When you use air conditioning, your vehicle uses more fuel.*

# Climate Control

## MANUAL CLIMATE CONTROL (If Equipped)

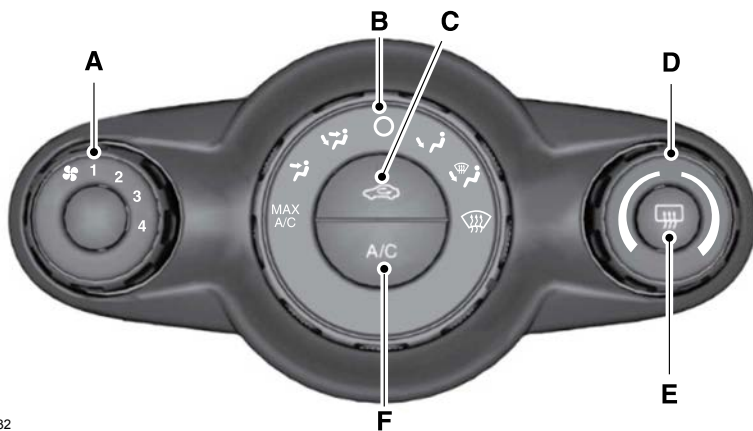

E144832

- A Controls the volume of air circulated in your vehicle. Adjust to select the desired fan speed or to switch the fan off. If you switch the fan off, the windshield may fog up.
- B Adjust to select the desired air distribution. **0** turns off the system.
- C Press the button to switch between outside air and recirculated air. When you select recirculated air, the button illuminates and the air currently in the passenger compartment recirculates. This can reduce the time needed to cool the interior and reduce unwanted odors from entering your vehicle.
- D Controls the temperature of the air circulated in your vehicle. Adjust to select the desired temperature. If you select **MAX A/C**, the system distributes recirculated air through the instrument panel air vents.
- E Press the button to defog and clear the rear screen of a thin covering of mist.
- F Press the button to switch the air conditioning on and off. Air conditioning cools your vehicle using outside air or recirculated air. To improve air conditioning when starting your vehicle, drive with the windows slightly open for two to three minutes and select recirculated air.

# Climate Control

## AUTOMATIC CLIMATE CONTROL (If Equipped)

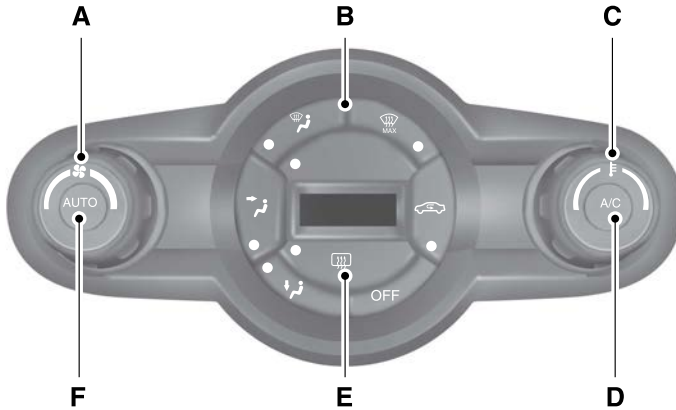

E144831

- A Controls the volume of air circulated in your vehicle. Rotate the control to select the desired fan speed. The setting appears in the display.
- B Adjust to select the desired air distribution. **OFF** turns off the system. Press the recirculated air button to switch between outside air and recirculated air. When you select recirculated air, the button illuminates and the air currently in the passenger compartment recirculates. This can reduce the time needed to cool the interior and reduce unwanted odors from entering your vehicle.
- C Controls the temperature of the air circulated in your vehicle. Adjust to select the desired temperature. The setting appears in the display.
- D Press the button to switch the air conditioning on and off. Air conditioning cools your vehicle using outside air or recirculated air. To improve air conditioning when starting your vehicle, drive with the windows slightly open for two to three minutes and select recirculated air.
- E Press the button to defog and clear the rear screen of a thin covering of mist.
- F Press the button to select automatic operation. The system automatically controls the temperature, amount and distribution of the air to reach and maintain your previously selected temperature.

# Climate Control

## HINTS ON CONTROLLING THE INTERIOR CLIMATE

### General Hints

**Note:** Prolonged use of recirculated air may cause the windows to fog up.

**Note:** You may feel a small amount of air from the footwell air vents regardless of the air distribution setting.

**Note:** To reduce humidity build-up inside your vehicle, do not drive with the system switched off or with recirculated air always switched on.

**Note:** Do not place objects under the front seats as this may interfere with the airflow to the rear seats.

**Note:** Remove any snow, ice or leaves from the air intake area at the base of the windshield.

To minimize humidity in the air conditioning system and reduce unpleasant odors, switch off the air conditioning and keep the fan going for at least two minutes before switching off the engine. Do the following:

1. Keep the engine running.
2. Switch off the air conditioning by pressing the **A/C** button.
3. Keep the fan switched on.
4. Set the temperature to the full hot position.
5. Use outside air, not recirculated air.
6. Wait one to two minutes, and then switch off the engine.

### Heating the Interior Quickly

	Vehicle with manual climate control	Vehicle with automatic climate control
1	Adjust the fan speed to the highest speed setting.	Adjust the fan speed to the highest speed setting.
2	Adjust the temperature control to the highest setting.	Adjust the temperature control to the highest setting.
3	Adjust the air distribution control to the footwell air vents position.	Press the footwell button to distribute air to the footwell air vents.

### Recommended Settings for Heating

	Vehicle with manual climate control	Vehicle with automatic climate control
1	Adjust the fan speed to the second speed setting.	Press the <b>AUTO</b> button.
2	Adjust the temperature control to the midway point of the hot settings.	Adjust the temperature control setting to the desired setting.
3	Adjust the air distribution control to the footwell and windshield air vents position.	



# Climate Control

## Cooling the Interior Quickly

	Vehicle with manual climate control	Vehicle with automatic climate control
1	Adjust the fan speed to the highest speed setting.	Press the <b>AUTO</b> button.
2	Adjust the temperature control to the <b>MAX A/C</b> position.	Adjust the temperature control setting to low.
3	Adjust the air distribution control to the instrument panel air vents position.	

## Recommended Settings for Cooling

	Vehicle with manual climate control	Vehicle with automatic climate control
1	Adjust the fan speed to the second speed setting.	Press the <b>AUTO</b> button.
2	Adjust the temperature control to the midway point of the cold settings.	Adjust the temperature control to the desired setting.
3	Adjust the air distribution control to the instrument panel air vents position.	Open all instrument panel air vents and direct as desired.

## Vehicle Stationary for Extended Periods during Extreme High Ambient Temperatures

	Vehicle with manual climate control	Vehicle with automatic climate control
1	Apply the parking brake.	Apply the parking brake.
2	Move the transmission selector lever to position <b>P</b> (automatic transmission) or neutral (manual transmission).	Move the transmission selector lever to position <b>P</b> (automatic transmission) or neutral (manual transmission).
3	Adjust the fan speed to the desired setting.	Press the <b>AUTO</b> button.
4	Adjust the temperature control to the <b>MAX A/C</b> position.	Adjust the temperature control setting to low.
5	Adjust the air distribution control to the instrument panel air vents position.	Adjust the air distribution control to the instrument panel air vents position.

# Climate Control

## Windshield and Side Window Defrosting or Defogging in Cold Weather

	Vehicle with manual climate control	Vehicle with automatic climate control
1	Press the windshield defrosting and defogging button.	Press the maximum windshield defrosting and defogging button.
2	Adjust the temperature control to the desired setting.	Adjust the temperature control to the desired setting.
3	Direct the outboard instrument panel air vents toward the side windows.	Direct the outboard instrument panel air vents toward the side windows.
4	Adjust the fan speed to the highest setting.	

## HEATED WINDOWS

Use the heated windows to demist the rear window.

**Note:** *The heated windows operate only when the engine is running.*

### Heated Rear Window (If Equipped)





# Seats

## SITTING IN THE CORRECT POSITION

### WARNINGS

 Sitting improperly, out of position or with the seat back reclined too far can take weight off the seat cushion and affect the decision of the passenger sensing system, resulting in serious injury or death in the event of a collision. Always sit upright against your seat back, with your feet on the floor.

 Do not recline the seat back as this can cause the occupant to slide under the safety belt, resulting in serious injury in the event of a collision.

 Do not place objects higher than the seat back to reduce the risk of serious injury in the event of a collision or during heavy braking.

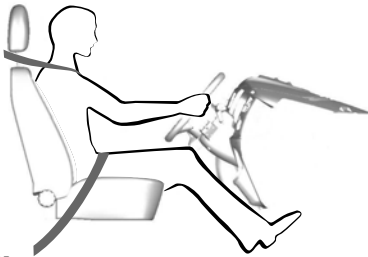

E68595

The correct use of these components provide better protection for the occupants in case of accident.

### WARNING

 Never adjust the seats when the vehicle is moving.

**Note:** *The seat belt must be used properly to hold the body in a position to allow the airbag to achieve maximum effect.*

### Correct Driving Position

- Sit in the most vertical position possible, and with the seat backrest not reclined by more than 30 degrees.
- Adjust the head restraints.
- Do not place the front seat much too close to the dashboard. The same applies to the front passenger.
- The driver should hold the steering wheel with the arms slightly bent, as well as the legs, so that the pedals can be fully pressed.
- Position the shoulder strap of the safety belt over the center of your shoulder and position the lap strap tightly across your hips.

Make sure that your driving position is comfortable and that you can maintain full control of your vehicle.

## HEAD RESTRAINTS

### WARNINGS

 Raise the rear head restraint when the rear seat is occupied by a passenger.

 When front seats are in use the head restraints must not be removed.

### Adjusting the head restraints

Adjust the head restraint so that the top of it is level with the top of your head.

# Seats

## Removing the head restraints

### Front head restraints

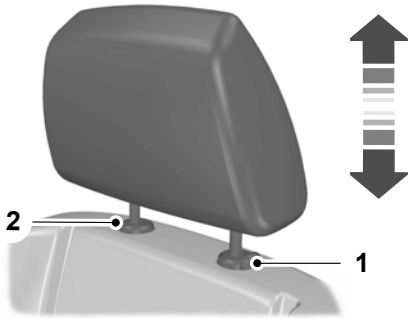

E140447

Press locking button 1 and at the same time release the retaining clip 2 using a suitable implement.

### Rear outer head restraints

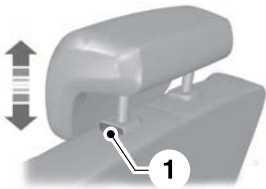



E151804

Pull to move the head restraint upward. Press the locking button 1 to lower the head restraint or to remove the head restraint.

## MANUAL SEATS

### WARNINGS

 Do not place any objects behind the seat back before returning it to the original position. Pull on the seat back to make sure that it has fully latched after returning the seat back to its original position. An unlatched seat may become dangerous if you stop suddenly or have a collision.

 Rock the seat backward and forward after releasing the lever to make sure that it is fully engaged in its catch.

### Moving the Seat Backward and Forward



E149153

# Seats

## Adjusting the Lumbar Support (If Equipped)



E70729

## Adjusting the Height of the Driver's Seat (If Equipped)



E142198

## Recline Adjustment



E157024

## REAR SEATS

### Reclining the Seat Back (If Equipped)

Your vehicle may have split seat backs that can be folded individually.

### Folding the Seat Backrest (If Equipped)

#### WARNINGS

 Do not use the bench seats as a bed when your vehicle is moving. Failure to follow this warning could result in serious personal injury or death.

 When folding or unfolding the seats, take care not to get your fingers caught between the seat backrest and seat frame. Failure to follow this warning could result in serious personal injury.

 Do not place any objects on a folded seat. Hard objects may become projectiles in a crash or sudden stop, which may increase the risk of serious personal injury.

 Do not attempt to fold the rear seat cushion forward before folding the seat backrest.

# Seats

Lower the head restraints. See **Head Restraints** (page 65).

## Type 1

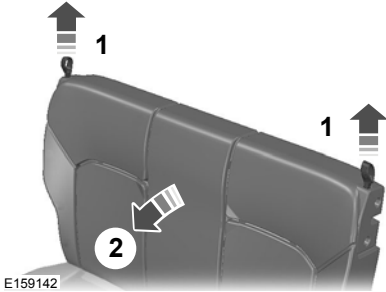

E159142

1. With the seat unoccupied and gently pushing the seatback rearward, lift the strap shown on both the sides of the seat to fold the seatback flat.
2. Fold the seat backrest forward.

## Type 2

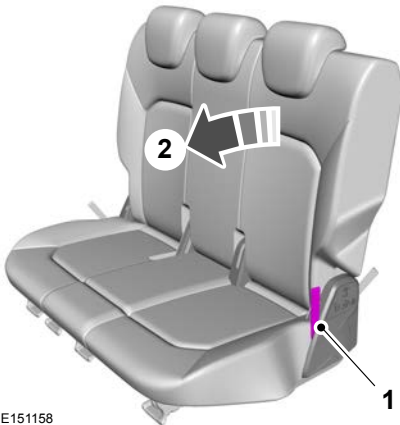

E151158

1. While gently pushing the seat backrest rearwards, pull the strap on the side of the seat straight up.

2. Fold the seat backrest forward.

## Unfolding the Seat Backrest

### WARNING



When unfolding the seat backrests, make sure that the safety belts are not trapped behind the seat.

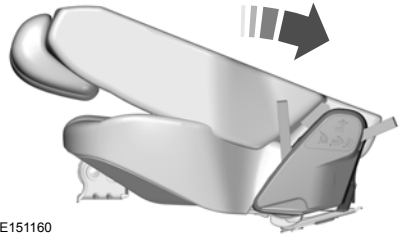

E151160

Unfold the seat backrest and lock it into position.

## Folding the Seat Forward



E151159

1. With the seat backrest in the folded position, pull the strap on the side of the seat straight up and lift the seat.

# Seats

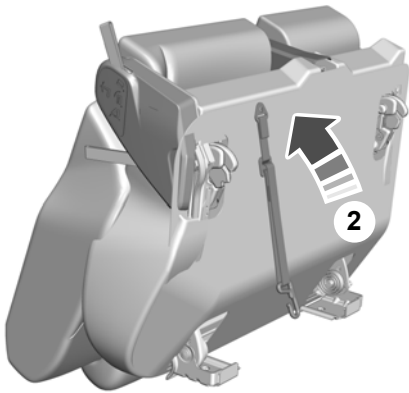

E181630

2. Fold the seat forward.

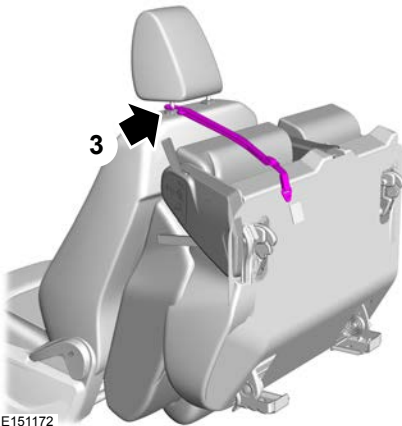



E151172

3. Attach the tether straps to the front head restraint post to hold the seat in the folded position.

## Unfolding the Seat

### WARNINGS

-  When folding the seat backs up, make sure that the belts are visible to an occupant and not caught behind the seat.
-  Make sure that the seats and the seat backrests are secure and fully locked in their catches.

## Type 1

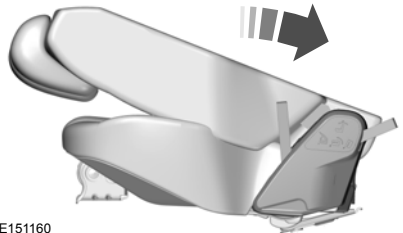

E151160

1. Lift the seatback toward the rear of the vehicle, and rotate the seatback until you hear a click, locking it in the upright position.

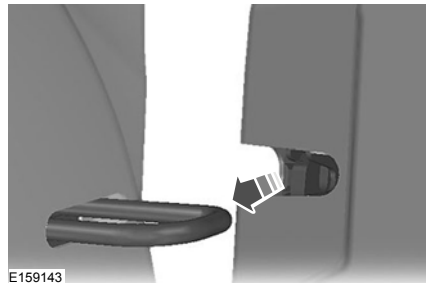

E159143

2. Ensure that the rear latch hooks are properly engaged with the pillar striker.

# Seats

## Type 2

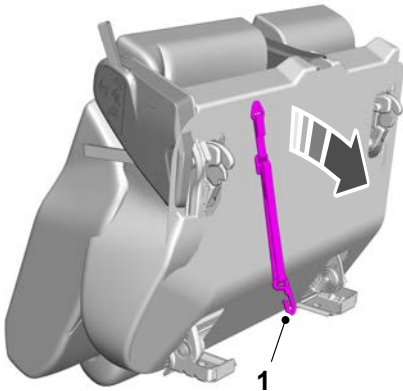

E151161

1. Detach the tether straps and lower the seat.

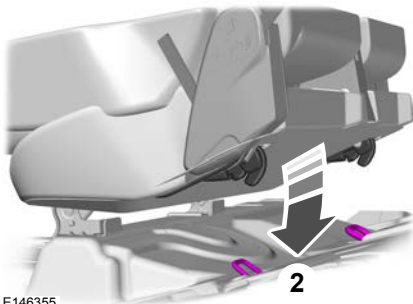

E146355

2. Allow the seat to drop under its own weight for the last 6-8 in (15-20 cm).

**Note:** Make sure that the lock is in open position before you unfold the seat backrest. If the lock is in closed position, the seat backrest will not lock into the catches.

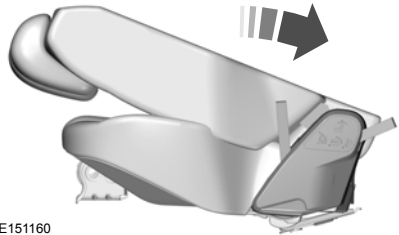

E151160

3. Unfold the seat backrest and lock it into position.

**Note:** Do not apply excessive force if the seat backrest is not unfolding. Improper use of the mechanism can cause damage not covered by your warranty.

## FRONT SEAT ARMREST (if Equipped)

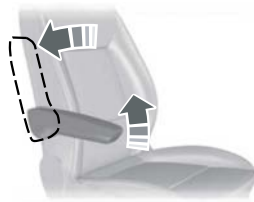

E156683



# Auxiliary Power Points

## WARNING



Do not plug optional electrical accessories into the cigar lighter socket (if equipped). Improper use of the lighter can cause damage not covered by your warranty, and can result in fire or serious injury.

**Note:** When the ignition is switched on, you can use the socket to power 12 volt appliances with a maximum current rating of 10 Amps.

**Note:** Do not insert objects other than an accessory plug into the power point. This will damage the outlet and blow the fuse.

**Note:** Do not hang any type of accessory or accessory bracket from the plug.

**Note:** Do not use the power point for operating a cigar lighter element.

**Note:** Improper use of the power point can cause damage not covered by your warranty.

**Note:** Always keep the power point caps closed when not in use.

Run the engine for full capacity use of the power point. To prevent the battery from being discharged:

- Do not use the power point longer than necessary when the engine is not running.
- It is strongly recommended that you always disconnect the accessories from the power point (12 volt) when leaving the vehicle.

## Location

Power point may be found:



E147757

in the center console.



E147758

next to the rear seat on the right hand side (if equipped).

## CIGAR LIGHTER (If Equipped)

**Note:** Do not hold the cigar lighter element pressed in.

**Note:** If you use the socket when the engine is not running, the battery may discharge.

**Note:** When the ignition is switched on, you can use the socket to power 12 volt appliances with a maximum current rating of 20 amps.

**Note:** Use only Ford accessory connectors or connectors specified for use with SAE standard sockets.

## Auxiliary Power Points

---

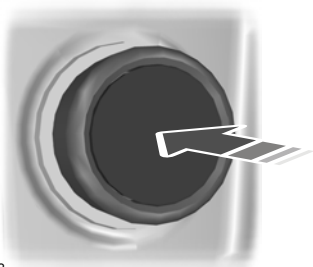

E103382

Press the element in to use the cigar lighter. It will pop out automatically.

# Storage Compartments

## CENTER CONSOLE

### WARNING



Use only soft cups in the cup holders. Hard objects can injure you in a collision.

Your vehicle may be equipped with a variety of console features. These include:

- front cup holders
- rear cup holders
- auxiliary input jack (if equipped)
- USB (if equipped)
- auxiliary power point.

## GLASSES HOLDER (If Equipped)



E150040

The glasses must be placed in the glasses holder with the lenses facing downward as shown in the picture. If not, the glasses can fall down when the glasses holder is open.

## UNDER SEAT STORAGE

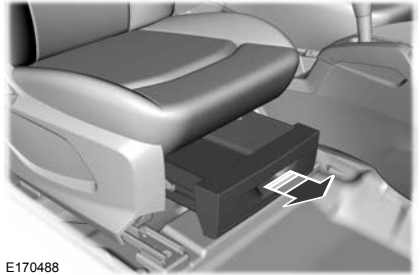

E170488

To open, hold the storage box handle and press to release the latch. Pull forward.

# Starting and Stopping the Engine

## GENERAL INFORMATION

### WARNINGS



Extended idling at high engine speeds can produce very high temperatures in the engine and exhaust system, creating the risk of fire or other damage.



Do not park, idle or drive your vehicle on dry grass or other dry ground cover. The emission system heats up the engine compartment and exhaust system, creating the risk of fire.



Do not start the engine in a closed garage or in other enclosed areas. Exhaust fumes can be toxic. Always open the garage door before you start the engine.



If you smell exhaust fumes inside your vehicle, have it checked by a Ford Dealer immediately. Do not drive your vehicle if you smell exhaust fumes.

If you disconnect the battery, your vehicle may exhibit some unusual driving characteristics for approximately 10 km after you reconnect it. This is because the engine management system must realign itself with the engine. You can disregard any unusual driving characteristics during this period.

When you start the engine, avoid pressing the accelerator pedal before and during operation. Only use the accelerator pedal when you have difficulty starting the engine.

## IGNITION SWITCH



E72128

**0** (off) - The ignition is off.

**I** (accessory) - Allows the electrical accessories to operate while the engine is not running.

**Note:** Do not leave the ignition key in this position for too long to avoid your vehicle battery losing charge.

**II** (on) - All the electrical circuits are operational. Warning lamps and indicators illuminate.

**III** (start) - cranks the engine. Release the key as soon as the engine starts.

## KEYLESS STARTING

### WARNING



Always check that the steering wheel lock is deactivated before attempting to move your vehicle. Failure to deactivate the steering wheel lock could result in a crash.

**Note:** The system may not function if the remote control is close to metal objects or electronic devices such as cell phones.

**Note:** The ignition will automatically switch off if your vehicle is left unattended. This is to prevent the vehicle battery from losing charge.

**Note:** A valid passive key must be located inside your vehicle to switch the ignition on and start the engine.

# Starting and Stopping the Engine

## Switching the Ignition On (Accessory Mode)



E142318

Press the button once without your foot on the brake or clutch pedal. It is located on the instrument panel near the steering wheel. All electrical circuits and accessories are operational and the warning lamps and indicators illuminate.

Press the button again without your foot on the brake or clutch pedal to turn your vehicle off completely.

## Starting Your Vehicle

### Manual Transmission

1. Fully depress the clutch pedal.
2. Briefly press the button.

**Note:** Releasing the clutch pedal during engine start will stop the engine cranking and return to ignition on.

### Automatic Transmission

1. Move the transmission selector lever to park.
2. Fully depress the brake pedal.
3. Briefly press the button.

**Note:** Releasing the brake pedal during engine start will stop the engine cranking and return to ignition on.

## Diesel Engine

**Note:** Engine cranking will not commence until the engine glow plug cycle has been completed. This may take several seconds in extremely cold conditions.

## Failure to Start

The system does not function if:

- The passive key frequencies are jammed.
- The passive key battery has no charge.

If you are unable to start your vehicle, do the following.

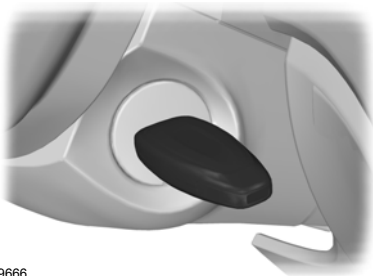

E99666

1. Hold the passive key next to the symbol on the steering column.
2. With the passive key in this position, you can use the button to switch the ignition on and start your vehicle.

## Manual Transmission

If the engine does not crank when the clutch pedal has been fully depressed and the button is pressed:

1. Fully depress both the clutch and brake pedals.
2. Press the button until the engine has started.

**Note:** Releasing the clutch pedal during engine start will stop the engine cranking and return to ignition on. A message will be shown in the display.

# Starting and Stopping the Engine

---

## Stopping the Engine When Your Vehicle is Stationary

**Note:** *The ignition, all electrical circuits warning lamps and indicators will be switched off.*

### Manual Transmission

Briefly press the button.

### Automatic Transmission

1. Move the transmission selector lever to park.
2. Press the button.

## Stopping the Engine When Your Vehicle is Moving

### WARNING



If you switch the engine off when your vehicle is moving it will result in a loss of brake and steering assistance. The steering will not lock, but higher effort will be required. With the engine switched off some electrical circuits, warning lamps and indicators may also be off.

1. Press and hold the button for a moment, or press it three times within two seconds.
2. Move the transmission selector lever to neutral and use the brakes to bring your vehicle to a safe stop.
3. When your vehicle has stopped, move the transmission selector lever to park and switch the ignition off.

## STEERING WHEEL LOCK

### WARNING



Always check that the steering is unlocked before attempting to move your vehicle.

## Vehicles without Keyless Starting

To lock the steering wheel:

1. Remove the key from the ignition switch.
2. Rotate the steering wheel slightly to engage the lock.

## Vehicles with Keyless Starting

**Note:** *The steering wheel lock does not engage when the ignition is on or if your vehicle is moving.*

Your vehicle has an electronically controlled steering wheel lock. This operates automatically.

The steering wheel lock engages after a short period after you have parked your vehicle and the passive key is outside of your vehicle.

## Unlocking the Steering Wheel

### Vehicles with Automatic Transmission

Switch the ignition on or press the brake pedal.

### Vehicles with Manual Transmission

Switch the ignition on or press the clutch pedal.

## STARTING A GASOLINE ENGINE

**Note:** *You can only operate the starter 10 seconds. The number of start attempts is limited to approximately six. If you exceed this limit, the system does not allow you to try again for about 30 minutes.*

## Cold or Hot Engine

### Vehicles with Manual Transmission

**Note:** *Do not touch the accelerator pedal.*

# Starting and Stopping the Engine

**Note:** *Releasing the clutch pedal while the engine is starting stops the engine cranking and returns the ignition to on.*

1. Fully depress the clutch pedal.
2. Start the engine.

## Vehicles with Automatic Transmission

**Note:** *Do not touch the accelerator pedal.*

1. Depress the brake pedal.
2. Move the transmission selector lever to position **P** or **N**.
3. Start the engine.

## All Vehicles

If the engine does not start within 10 seconds, wait for a short period and try again.

If the engine does not start after three attempts, wait 10 seconds and follow the flooded engine procedure.

If you have difficulty starting the engine when the temperature is below  $-13^{\circ}\text{F}$  ( $-25^{\circ}\text{C}$ ), press the accelerator pedal to the mid-way point of its travel and try again.

## Flooded Engine

### Vehicles with Manual Transmission

1. Fully depress the clutch pedal.
2. Fully depress the accelerator pedal and hold it there.
3. Start the engine.

### Vehicles with Automatic Transmission

1. Depress the brake pedal.
2. Move the transmission selector lever to position **P** or **N**.
3. Fully depress the accelerator pedal and hold it there.
4. Start the engine.

## All Vehicles

If the engine does not start, repeat the cold or hot engine procedure.

## Engine Idle Speed after Starting

The speed at which the engine idles immediately after starting minimizes vehicle emissions and maximizes cabin comfort and fuel economy.

The idle speed varies depending on certain factors. These include vehicle component and ambient temperatures as well as electrical and climate system demands.

## Failure to Start

### Vehicles with Manual Transmission

If the engine does not crank when you full depress the clutch pedal with the ignition key in position **III**, follow this procedure:

1. Fully depress the clutch and brake pedals.
2. Turn the key to position **III** until the engine has started.

## STARTING A DIESEL ENGINE

### Cold or Hot Engine

#### All Vehicles

**Note:** *When the temperature is below  $5^{\circ}\text{F}$  ( $-15^{\circ}\text{C}$ ), you may need to crank the engine for up to 10 seconds.*

**Note:** *You can only operate the starter for a limited period of time.*

**Note:** *After a limited number of attempts to start your engine, the system will not allow you to try again until a period of time has elapsed, for example 30 minutes.*



Switch the ignition on and wait until the glow plug indicator goes off.

# Starting and Stopping the Engine

---

## Vehicles With Manual Transmission

**Note:** Do not touch the accelerator pedal.

**Note:** Releasing the clutch pedal while the engine is starting will stop the engine cranking and return to ignition on.

1. Fully depress the clutch pedal.
2. Start the engine.

## Vehicles With Automatic Transmission

**Note:** Do not touch the accelerator pedal.

**Note:** Releasing the brake pedal while the engine is starting will stop the engine cranking and return to ignition on.

1. Move the transmission selector lever to position **P** or **N**.
2. Fully depress the brake pedal.
3. Start the engine.

## Failure to Start

### Vehicles With Manual Transmission

If the engine does not crank when the clutch pedal has been fully depressed and the ignition key is turned to position **III**.

1. Fully depress the clutch and brake pedals.
2. Turn the key to position **III** until the engine has started.

## SWITCHING OFF THE ENGINE

### Vehicles With a Turbocharger

#### WARNING



Do not switch the engine off when it is running at high speed. If you do, the turbocharger will continue running after the engine oil pressure has dropped to zero. This will lead to premature turbocharger bearing wear.

---

Release the accelerator pedal. Wait until the engine has reached idle speed and then switch it off.



# Fuel and Refueling

## SAFETY PRECAUTIONS

### WARNINGS



Do not overfill the fuel tank. The pressure in an overfilled tank may cause leakage and lead to fuel spray and fire.



Automotive fuels can cause serious injury or death if misused or mishandled.



The flow of fuel through a fuel pump nozzle can produce static electricity, which can cause a fire if fuel is pumped into an ungrounded fuel container.



Fuel ethanol and gasoline may contain benzene, which is a cancer-causing agent.



When refueling always shut the engine off and never allow sparks or open flames near the filler neck.

Never smoke while refueling. Fuel vapor is extremely hazardous under certain conditions. Care should be taken to avoid inhaling excess fumes.

Observe the following guidelines when handling automotive fuel:

- Extinguish all smoking materials and any open flames before refueling your vehicle.
- Always turn off the vehicle before refueling.
- Automotive fuels can be harmful or fatal if swallowed. Fuel such as gasoline is highly toxic and if swallowed can cause death or permanent injury. If fuel is swallowed, call a physician immediately, even if no symptoms are immediately apparent. The toxic effects of fuel may not be visible for hours.

- Avoid inhaling fuel vapors. Inhaling too much fuel vapor of any kind can lead to eye and respiratory tract irritation. In severe cases, excessive or prolonged breathing of fuel vapor can cause serious illness and permanent injury.
- Avoid getting fuel liquid in your eyes. If fuel is splashed in the eyes, remove contact lenses (if worn), flush with water for 15 minutes and seek medical attention. Failure to seek proper medical attention could lead to permanent injury.
- Fuels can also be harmful if absorbed through the skin. If fuel is splashed on the skin, clothing or both, promptly remove contaminated clothing and wash skin thoroughly with soap and water. Repeated or prolonged skin contact with fuel liquid or vapor causes skin irritation.

## FUEL QUALITY

### WARNINGS



Do not mix gasoline with oil, diesel or other liquids. This could cause a chemical reaction.



Do not use leaded gasoline or gasoline with additives containing other metallic compounds (e.g. manganese-based). They could damage the emission system.

**Note:** We recommend that you use only high quality fuel.

**Note:** We do not recommend the use of additional additives or other engine treatments for normal vehicle use.

# Fuel and Refueling

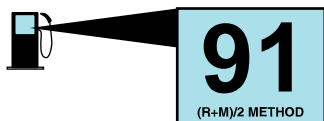

E185193

Use minimum 91 octane unleaded gasoline that meets the specification defined by EN 228 or the equivalent national specification.

Your vehicle is suitable for use with ethanol blends up to 20% (E20).

## Long-Term Storage

Most gasoline contains ethanol. We recommend that you fill the fuel tank with fuel that does not contain ethanol if you intend to store your vehicle for more than two months. Alternatively, we recommend that you seek advice from an authorized dealer.

## FUEL QUALITY - DIESEL

### WARNINGS



Do not mix diesel with oil, gasoline or other liquids. This could cause a chemical reaction.



Do not add kerosene, paraffin or gasoline to diesel. This could cause damage to the fuel system.



Use diesel that meets the specification defined by EN 590 or the relevant national specification.

**Note:** We recommend that you use only high quality fuel.

**Note:** We do not recommend the use of additional additives or other engine treatments for normal vehicle use.

**Note:** We do not recommend the use of additional additives to prevent fuel waxing.

## Long-Term Storage

Most diesel fuels contain biodiesel. We recommend that you fill the fuel tank with fuel that does not contain biodiesel if you intend to store your vehicle for more than two months. Alternatively, we recommend that you seek advice from your dealer.

## RUNNING OUT OF FUEL

Avoid running out of fuel because this situation may have an adverse effect on engine components.

If you have run out of fuel:

- You may need to cycle the ignition from off to on several times after refueling to allow the fuel system to pump the fuel from the tank to the engine. On restarting, cranking time will take a few seconds longer than normal. With keyless ignition, just start the engine. Crank time will be longer than usual.
- Normally, adding 3.8 liters of fuel is enough to restart the engine. If the vehicle is out of fuel and on a steep grade, more than 3.8 liters may be required.

## CATALYTIC CONVERTER

### WARNING



Do not park or idle your vehicle over dry leaves, dry grass or other combustible materials. The exhaust will radiate a considerable amount of heat during use, and after you have switched the engine off. This is a potential fire hazard.

# Fuel and Refueling

## Driving with a Catalytic Converter

### WARNINGS



Avoid running out of fuel.



Do not crank the engine for long periods.



Do not run the engine when a spark plug lead is disconnected.



Do not push-start or tow-start your vehicle. Use booster cables. See **Jump Starting the Vehicle** (page 102).



Do not switch the ignition off when driving.

## REFUELING

### WARNINGS



Do not attempt to start the engine if you have filled the fuel tank with the incorrect fuel. This could damage the engine. Have the system checked immediately by a Ford Dealer.



Do not use any kind of flames or heat near the fuel system. The fuel system is under pressure. There is a risk of injury if the fuel system is leaking.



If you use a high pressure spray to wash your vehicle, only spray the fuel filler flap briefly from a distance not less than 20 centimeters.

**Note:** *Flex fuel vehicles can be fueled with gasoline, ethanol or a mixture of both.*

If you are refueling with a different fuel than that used previously, we recommend that you drive the vehicle immediately after refueling for at least 10 minutes. This is necessary because the engine control module needs to adapt itself to the fuel present in the tank. This procedure is especially important when the fuel level gauge indicates less than half before refueling.

If your vehicle stopped due to lack of fuel (empty tank) you should refuel preferably with gasoline.

## Fuel Filler Cap

Your fuel tank filler cap has a regular turn style design, with two to three turns on or off.

When fueling your vehicle:

1. Turn the engine off.
2. Carefully turn the filler cap counterclockwise two to three turns, until it opens.
3. Hang the fuel cap tether cord on the filler door hook.
4. After refueling, to install the cap, align it with the filler pipe.
5. Turn the filler cap clockwise two to three turns until it clicks twice.

If you must replace the fuel filler cap, replace it with a fuel filler cap that is designed for your vehicle. The customer warranty may be void for any damage to the fuel tank or fuel system if the correct genuine Ford fuel filler cap is not used.

# Fuel and Refueling

---

## FUEL CONSUMPTION

**Note:** *The amount of usable fuel in the empty reserve varies and should not be relied upon to increase driving range. When refueling your vehicle after the fuel gauge indicates empty, you might not be able to refuel the full amount of the advertised capacity of the fuel tank due to the empty reserve still present in the tank.*

Indicated capacity is the difference in the amount of fuel in a full tank and a tank when the fuel gauge indicates empty. Empty reserve is the amount of fuel in the tank after the fuel gauge indicates empty.

Your dealer can give you advice on improving your fuel consumption.

### Filling the Tank

For consistent results when filling the fuel tank:

- Turn the ignition off before fueling; an inaccurate reading results if the engine is left running.
- Use the same fill rate (low-medium-high) each time the tank is filled.
- The maximum tank capacity, during fueling, is reached when the pump is automatically cut off for the second time.

Results are most accurate when the filling method is consistent.

### Calculating Fuel Economy

Do not measure fuel economy during the first 1600 kilometers of driving (this is your engine's break-in period); a more accurate measurement is obtained after 3200 kilometers - 4800 kilometers. Also, fuel expense, frequency of fill ups or fuel gauge readings are not accurate ways to measure fuel economy.

1. Fill the fuel tank completely and record the initial odometer reading.
2. Each time you fill the tank, record the amount of fuel added.
3. After at least three to five tank fill ups, fill the fuel tank and record the current odometer reading.
4. Subtract your initial odometer reading from the current odometer reading.
5. Calculate fuel economy by multiplying liters used by 100, and then dividing it by the traveled kilometers.

Keep a record for at least one month and record the type of driving (city or highway). This provides an accurate estimate of the vehicle's fuel economy under current driving conditions. Additionally, keeping records during summer and winter show how temperature impacts fuel economy. In general, lower temperatures mean lower fuel economy.

# Transmission

## MANUAL TRANSMISSION

### 5-Speed Manual Transmission

#### Using the Clutch

**Note:** Failure to fully press the clutch pedal to the floor may cause increased shift efforts, prematurely wear transmission components or damage the transmission.

**Note:** Do not drive with your foot resting on the clutch pedal or use the clutch pedal to hold your vehicle at a standstill while waiting on a hill. These actions will reduce the life of the clutch.

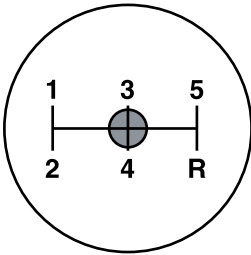

E144905

Manual transmission vehicles have a starter interlock that prevents cranking the engine unless the clutch pedal is fully pressed.

To start the vehicle:

1. Make sure the parking brake is fully set.

2. Press the clutch pedal to the floor, then put the gearshift lever in the neutral position.
3. Start the engine.
4. Press the brake pedal and move the gearshift lever to the desired gear; **1** (First) or **R** (Reverse).
5. Release the parking brake, then slowly release the clutch pedal while slowly pressing on the accelerator.

#### Recommended Shift Speeds

**Note:** Do not downshift into **1** (First) when your vehicle is moving faster than 24 km/h. This will damage the clutch.

**Note:** Upshift following your shift indicator, if fitted to your vehicle.

The engine is designed to operate at a minimum of 1250 RPM for optimal power, fuel economy, and durability. When driving a vehicle equipped with a manual transmission, do not operate the engine below 1250 RPM while driving with the transmission in any gear. This does not apply while starting or idling the engine while the transmission is in neutral and/or the clutch pedal is pressed. Lugging the engine below 1250 RPM may result in damage to the vehicle engine, poor fuel economy, poor acceleration, and undesirable noise, vibration, and harshness. Choose the next lowest gear until a proper engine RPM is reached.

#### Recommended upshifts (for best fuel economy) when accelerating

Gear selection	Speed range	
	1.5L	1.0L
1	0–20 km/h	0–23 km/h
2	20–35 km/h	23–34 km/h

# Transmission

Gear selection	Speed range	
	3	35–45 km/h
4	45–60 km/h	46–59 km/h
5	>60 km/h	>59 km/h

## Recommended downshifts (for best fuel economy)

Gear selection	Speed range
	1.5L and 1.0L
5-4	50 km/h
4-3	40 km/h
3-2	25 km/h
2-1	15 km/h

## Reverse

**Note:** Make sure that your vehicle is at a complete stop before you shift into **R** (Reverse). Failure to do so may damage the transmission.

**Note:** The gearshift lever can only be moved into **R** (Reverse) by moving it from left of **3** (Third) and **4** (Fourth) before shifting into **R** (Reverse). This is a lockout feature that protects the transmission from accidentally being shifted into **R** (Reverse) from **5** (Fifth).

Hold the clutch pedal down and move the gearshift lever into the neutral position. Shift into **R** (Reverse).

If **R** (Reverse) is not fully engaged, press the clutch pedal down and return the gearshift to the neutral position. Release the clutch pedal for a moment, then press it down and shift to **R** (Reverse) again.

## Parking Your Vehicle

### WARNING



Do not park your vehicle in Neutral, it may move unexpectedly and injure someone. Use **1** (First) gear and set the parking brake fully.

To park your vehicle:

1. Apply the brake and shift into the neutral position.
2. Fully apply the parking brake, hold the clutch pedal down, then shift into **1** (First).
3. Turn the ignition off.

# Transmission

## AUTOMATIC TRANSMISSION

### PowerShift Automatic Transmission

#### WARNINGS



Always set the parking brake fully and make sure the gearshift is latched in **P** (Park). Turn the ignition to the off position and remove the key whenever you leave your vehicle.



Do not apply the brake pedal and accelerator pedal simultaneously. Applying both pedals simultaneously for more than three seconds will limit engine rpm, which may result in difficulty maintaining speed in traffic and could lead to serious injury.

**Note:** *Some sound and shift characteristics are unique to the transmission in your vehicle. These operations are normal and do not affect the durability of the transmission.*

#### Putting your vehicle in gear:

1. Fully press down the brake pedal.
2. Press and hold the button on the front of the gearshift lever.
3. Move the gearshift lever into the desired gear.
4. Release the button and your transmission will remain in the selected gear.



E161746

#### **P (Park)**

This position locks the transmission and prevents the front wheels from turning. Come to a complete stop before putting your vehicle into and out of **P** (Park).

#### **R (Reverse)**

With the gearshift lever in **R** (Reverse), the vehicle will move backward. Always come to a complete stop before shifting into and out of **R** (Reverse).

#### **N (Neutral)**

With the gearshift lever in **N** (Neutral), you have the ability to start your vehicle and it is free to roll. Hold the brake pedal down while in this position.

#### **D (Drive)**

The normal driving position for the best fuel economy.

#### **S (Sport)**

With the gearshift lever in **S** (Sport), you have the ability to select gears quicker and at higher engine speeds.

# Transmission

Sport mode will remain on until you either shift manually up or down the gears using the **+** or **-** buttons on the side of the gearshift lever or you move the transmission selector lever to **D** (Drive).

## SelectShift Automatic™ Transmission

Your SelectShift Automatic transmission allows you the ability to change gears manually.

To use SelectShift, move the gearshift lever into **S** (Sport). Use the **+** or **-** buttons on the side of your gearshift lever to manually change gears.

- Press the **(+)** button to upshift.
- Press the **(-)** button to downshift.

**Note:** After you have assumed manual control with SelectShift, your vehicle will remain in this mode until you return the gearshift lever from **S** (Sport), back to **D** (Drive).

Upshift to the recommended shift speeds according to the following chart:



Recommended upshift speed when accelerating using SelectShift mode (for optimum fuel economy)		
Gear Upshift		mph (km/h)
From	To	
1	2	15 mph (24 km/h)
2	3	25 mph (40 km/h)
3	4	40 mph (64 km/h)
4	5	45 mph (72 km/h)
5	6	50 mph (80 km/h)

The instrument cluster will display your currently selected gear.

**Note:** The transmission will automatically upshift if your engine speed is too high or downshift if your engine speed is too low.

## Brake-Shift Interlock Override

### WARNINGS

-  Do not drive your vehicle until you verify that the brake lamps are working.
-  When doing this procedure, you will be taking your vehicle out of **P** (park), which means your vehicle can roll freely. To avoid unwanted vehicle movement, always fully set the parking brake prior to doing this procedure. Use wheel chocks if appropriate.
-  If the parking brake is fully released, but the brake warning lamp remains illuminated, the brakes may not be working properly. See your authorized dealer.

Use the brake shift override to move the gearshift lever from the park position in the event of an electrical malfunction or if your vehicle has a dead battery.

Apply the parking brake and turn the ignition off before performing this procedure.

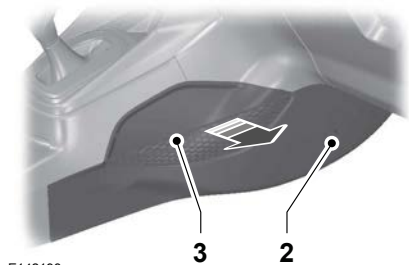

E142193



# Transmission

1. Apply the parking brake and switch the ignition off before carrying out this procedure.
2. Remove the retaining screw.
3. Remove the right side center console side panel.

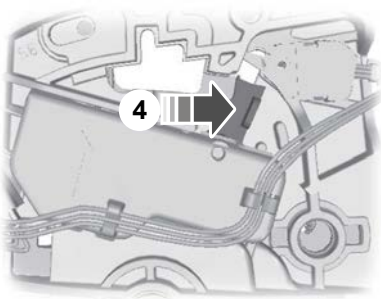

E142214

4. Press the brake pedal. Using a suitable tool rotate the lever forward while pulling the transmission selector lever out of the **P** (park) position and into the **N** (neutral) position.
5. Install the console cover.
6. Apply the brake pedal, start your vehicle and release the parking brake.

## HILL START ASSIST (If Equipped)

### WARNINGS



The hill start assist feature does not replace the parking brake. When you leave the vehicle, always apply the parking brake.



You must remain in the vehicle once you have activated the hill start assist feature.



During all times, you are responsible for controlling the vehicle, supervising the hill start assist system and intervening, if required.

### WARNINGS



If the engine is revved excessively, or if a malfunction is detected when the hill start assist feature is active, the hill start assist feature will be deactivated.

This feature makes it easier to pull away when the vehicle is on a slope without the need to use the parking brake.

When this feature is active, the vehicle will remain stationary on the slope for two to three seconds after you release the brake pedal. This allows you time to move your foot from the brake to the accelerator pedal. The brakes are released automatically once the engine has developed sufficient drive to prevent the vehicle from rolling down the slope. This is an advantage when pulling away on a slope, (for example from a car park ramp, traffic lights or when reversing uphill into a parking space).

This feature is activated automatically on any slope that can result in significant vehicle rollback.

### Activating Hill Start Assist

**Note:** *If the engine is revved excessively, hill start assist will be deactivated.*

1. Press the brake pedal to bring the vehicle to a complete standstill. Keep the brake pedal pressed.
2. If the sensors detect that the vehicle is on a slope, the hill start assist feature will be activated automatically.
3. When you remove your foot from the brake pedal, the vehicle will remain on the slope without rolling away for approximately two or three seconds. This hold time will automatically be extended if you are in the process of driving off.
4. Drive off in the normal manner. The brakes will be released automatically.

# Transmission

---

## **Deactivating Hill Start Assist**

Perform one of the following:

- To deactivate hill start assist, Drive off uphill without reapplying the brake.
- Wait for two to three seconds until the hill start assist system deactivates automatically.
- If a forward gear was selected when the system is active on, select reverse gear.
- If reverse gear was selected when the system is active, select a forward gear.

# Brakes

## GENERAL INFORMATION

### Disc Brakes

Wet brake discs result in reduced braking efficiency. Dab the brake pedal when driving from a car wash to remove the film of water.

### Emergency Brake Assist

#### WARNING



The system does not relieve you of your responsibility to drive with due care and attention.

The system will detect when you brake heavily by measuring the rate at which you press the brake pedal. It will provide maximum braking efficiency as long as you press the pedal.

### Anti-lock Brakes (If Equipped)

#### WARNING



The system does not relieve you of your responsibility to drive with due care and attention.

The system helps you to maintain steering and directional stability when you brake heavily in an emergency, by preventing the road wheels from locking.

## HINTS ON DRIVING WITH ANTI-LOCK BRAKES

**Note:** When the system is operating, the brake pedal will pulse and may travel further. Maintain pressure on the brake pedal. You may also hear a noise from the system. This is normal.

The anti-lock braking system will not eliminate the risks when:

- You drive too closely to the vehicle in front of you.
- Your vehicle is hydroplaning.
- You take corners too fast.
- The road surface is poor.

## PARKING BRAKE

### Vehicles With Automatic Transmission

#### WARNING



Always set the parking brake fully and leave your vehicle with the transmission selector lever in position P.

**Note:** If you park your vehicle on a hill and facing uphill move the transmission selector lever to position P and turn the steering wheel away from the curb.

**Note:** If you park your vehicle on a hill and facing downhill move the transmission selector lever to position P and turn the steering wheel toward the curb.

### Vehicles With Manual Transmission

#### WARNING



Always set the parking brake fully.

**Note:** If you park your vehicle on a hill and facing uphill select first gear and turn the steering wheel away from the curb.

**Note:** If you park your vehicle on a hill and facing downhill select reverse gear and turn the steering wheel toward the curb.

# Brakes

---

## All Vehicles

**Note:** *Do not press the release button while pulling the lever up.*

To apply the parking brake:

1. Press the foot brake pedal firmly.
2. Pull the parking brake lever up to its fullest extent.

To release the parking brake:

1. Press the brake pedal firmly.
2. Pull the lever up slightly.
3. Press the release button and push the lever down.

# Traction Control (If Equipped)

## PRINCIPLE OF OPERATION

The traction control system helps avoid drive wheel spin and loss of traction.

If your vehicle begins to slide, the system applies the brakes to individual wheels and, when needed, reduces engine power at the same time. If the wheels spin when accelerating on slippery or loose surfaces, the system reduces engine power in order to increase traction.

## USING TRACTION CONTROL

In certain situations for example, stuck in snow or mud, turning the traction control off may be beneficial as this allows the wheels to spin with full engine power. Depending on the type of system you have on your vehicle, you can either turn the system off using the information display or by pressing the button.

### Switching the System Off Using the Information Display Controls

(If Equipped)

Your vehicle comes with this feature already enabled. If required, you can switch this feature off using the information display controls. See **Principle of Operation** (page 91).

### Switching the System Off Using a Switch (If Equipped)

The button is located in the instrument panel.

Press the button. You will see a message in conjunction with an illuminated icon in the display. Press the button again to return the system to normal mode.

When you switch the traction control system off, stability control remains fully active.

## System Indicator Lights and Messages

### WARNING



If a failure has been detected within the AdvanceTrac system, the stability control light will illuminate steadily. Verify that the AdvanceTrac system was not manually disabled through the information display. If the stability control light still illuminates steadily, have the system serviced by an authorized dealer immediately. Operating your vehicle with AdvanceTrac disabled could lead to an increased risk of loss of vehicle control, vehicle rollover, personal injury and death.



The stability control light temporarily illuminates on engine start-up and flashes when a driving condition activates the stability system.



The stability control off light temporarily illuminates on engine start-up and stays on when you turn the traction control system off.

When you turn the traction control system off or on, a message appears in the information display showing system status.

# Stability Control (If Equipped)

## PRINCIPLE OF OPERATION

### Electronic Stability Program

#### WARNING



The system does not relieve you of your responsibility to drive with due care and attention. Failure to do so could result in loss of vehicle control, personal injury or death.

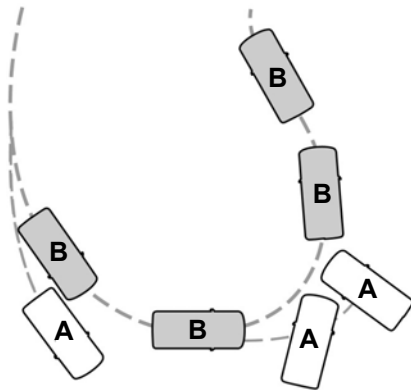

E72903

- A Without ESP
- B With ESP

The system supports stability when your vehicle starts to slide away from your intended path. The system performs this by braking individual wheels and reducing engine torque as required.

The system also provides an enhanced traction control function by reducing engine torque if the wheels spin when you accelerate. This improves your ability to pull away on slippery roads or loose surfaces, and improves comfort by limiting wheel spin in hairpin bends.

### Stability Control Warning Lamp

While driving, it flashes when the system is operating. See **Warning Lamps and Indicators** (page 44).

## USING STABILITY CONTROL

**Note:** *The system is automatically activated when you start the engine.*

The traction control portion of the system can be turned off through the information display. See **Using Traction Control** (page 91).

# Parking Aids (If Equipped)

## PRINCIPLE OF OPERATION

### WARNINGS



The parking aid does not relieve you of your responsibility to drive with due care and attention.



The sensors may not detect objects in heavy rain or other conditions that cause disruptive reflections.



The sensors may not detect objects with surfaces that absorb ultrasonic waves.



The parking aid does not detect obstacles moving away from the vehicle. They will only be detected shortly after they start to move towards the vehicle again.



Take particular care when reversing with rear fitted accessories e.g. a bicycle carrier, as the rear parking aid will only indicate the distance from the bumper to the obstacle.



If you use a high pressure spray to wash your vehicle, only spray the sensors briefly from a distance not less than 8 inches (20 centimeters).

**Note:** Keep the sensors free from dirt, ice and snow. Do not clean with sharp objects.

**Note:** The parking aid may emit false tones if it detects a signal using the same frequency as the sensors or if the vehicle is fully laden.

**Note:** The outer sensors may detect the side walls of a garage. If the distance between the outer sensor and the side wall remains constant for three seconds, the tone will switch off. As you continue, the inner sensors will detect rearward objects.

## PARKING AID

### WARNINGS



To help avoid personal injury, please read and understand the limitations of the system as contained in this section. Sensing is only an aid for some (generally large and fixed) objects when moving in reverse on a flat surface at parking speeds. Traffic control systems, inclement weather, air brakes, and external motors and fans may also affect the function of the sensing system; this may include reduced performance or a false activation.



To help avoid personal injury, always use caution when in R (Reverse) and when using the sensing system.



This system is not designed to prevent contact with small or moving objects. The system is designed to provide a warning to assist the driver in detecting large stationary objects to avoid damaging the vehicle. The system may not detect smaller objects, particularly those close to the ground.



Certain add-on devices such as large trailer hitches, bike or surfboard racks and any device that may block the normal detection zone of the system, may create false beeps.

**Note:** Keep the sensors located on the bumper or fascia free from snow, ice and large accumulations of dirt. If the sensors are covered, the system's accuracy can be affected. Do not clean the sensors with sharp objects.

**Note:** If your vehicle sustains damage to the bumper or fascia, leaving it misaligned or bent, the sensing zone may be altered causing inaccurate measurement of obstacles or false alarms.

## Parking Aids (If Equipped)

The sensing system warns the driver of obstacles within a certain range of the bumper area. The system turns on automatically whenever the ignition is switched on.

When receiving a detection warning, the radio volume is reduced to a predetermined level. After the warning goes away, the radio volume returns to the previous level.

### Rear Sensing System

The rear sensors are only active when the transmission is in R (Reverse). As the vehicle moves closer to the obstacle, the rate of the audible warning increases. When the obstacle is fewer than 25 centimeters away, the warning sounds continuously. If a stationary or receding object is detected farther than 25 centimeters from the side of the vehicle, the tone sounds for only three seconds. Once the system detects an object approaching, the warning sounds again.

The system detects certain objects while the transmission is in R (Reverse):

- and moving toward a stationary object at a speed of 5 km/h or less
- but not moving, and a moving object is approaching the rear of the vehicle at a speed of 5 km/h or less
- and moving at a speed of less than 5 km/h and a moving object is approaching the rear of the vehicle at a speed of less than 5 km/h.

If a fault is present in the system, a warning message appears in the information display and does not allow the driver to switch the faulted system on.



E130178

- A Coverage area of up to 2 meters from the rear bumper (with a decreased coverage area at the outer corners of the bumper).



## STEERING

### Electric Power Steering

#### WARNING



Obtain immediate service if a system error is detected. You may not notice any difference in the feel of your steering, but a serious condition may exist. Failure to do so may result in loss of steering control.

**Note:** *Your vehicle is equipped with an electric power-assisted steering system. There is no fluid reservoir to check or fill.*

The electric power steering system operates by an electric motor, which reduces the effort on the driver's steering wheel.

The system operates progressively and during maneuvers, the system leaves the effort lighter. As the vehicle speed increases, it reduces its action to improve the control of the vehicle.

The electric power steering system has diagnostic checks that continuously monitor the system to ensure proper operation. When a system error occurs, a message will appear in the information display. If this happens, stop the vehicle in a safe place, and switch off the engine. After at least 10 seconds, reset the system by restarting the engine, and watch the information display for a steering message. If a steering message returns, or returns while driving, take the vehicle to an authorized dealer to have it checked.

If your vehicle loses electrical power while you are driving (or if the ignition is turned off), you can steer the vehicle manually, but it takes more effort. Extreme continuous steering may increase the effort it takes for you to steer. This occurs to prevent internal overheating and permanent damage to your steering

system. If this should occur, you will not lose the ability to steer the vehicle manually nor will it cause permanent damage. Typical steering and driving maneuvers will allow the system to cool and steering assist will return to normal.

#### Steering Tips

Avoid sudden movements with the steering wheel. The force required to change the vehicle direction is lower, compared to a vehicle with mechanical steering.

If the steering wanders or pulls, check for:







- An improperly inflated tire
- Uneven tire wear
- Loose or worn suspension components
- Loose or worn steering components
- Improper vehicle alignment

A high crown in the road or high crosswinds may also make the steering seem to wander or pull.

# Load Carrying

## GENERAL INFORMATION

### WARNINGS

-  Use only load securing straps that meet your needs, and that prevent the load from turning loose and causing an accident.
-  Make sure that you secure all loose items properly.
-  Place luggage and other loads as low and as far forward as possible within the luggage or loadspace.
-  Do not drive with the liftgate or rear door open. Exhaust fumes may enter your vehicle.
-  Do not exceed the maximum front and rear axle loads for your vehicle. See **Vehicle Identification Plate** (page 142).
-  Do not allow items to contact the rear windows.

## LUGGAGE ANCHOR POINTS



E142324

## LUGGAGE COVERS

### WARNING

-  Do not place objects on the luggage cover.

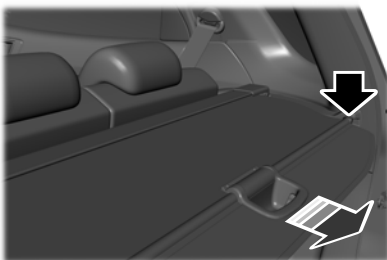

E156538

Pull out the cover and secure it in the retaining points.

Release it from the retaining points and let it roll back into the case.

## ROOF RACKS AND LOAD CARRIERS

### WARNING

-  When loading the roof rail crossbars, it is recommended to evenly distribute the load, as well as maintain a low center of gravity. Loaded vehicles, with higher centers of gravity, may handle differently than unloaded vehicles. Extra precautions, such as slower speeds and increased stopping distance, should be taken when driving a heavily loaded vehicle.

The maximum recommended load, evenly distributed on the crossbars, is:

- 20 kilograms.

# Load Carrying

**Note:** *Loads should never be placed directly on the roof panel. The roof panel is not designed to directly carry a load.*

For proper function of the roof rack system, loads must be placed directly on crossbars affixed to the roof rack side rails. Your vehicle may be equipped with factory-installed crossbars. Ford Genuine Accessory crossbars, designed specifically for your vehicle, are also recommended for use with your roof rack system.

Make sure that the load is securely fastened. Check the tightness of the load before driving and at each fuel stop.

## Adjusting the Crossbar (If Equipped)

**Note:** *Wind noise can be minimized by either removing or repositioning the crossbar when not in use. Position the front crossbar in the intermediate position to minimize wind noise. The crossbar can be adjusted or removed using the steps below.*

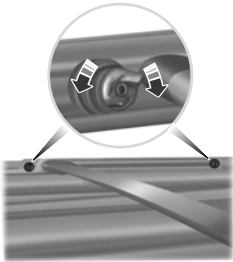

E142448

1. Remove the crossbar thumbwheels at both sides of the crossbar by turning them counterclockwise.
  2. Remove the crossbar by rotating it clockwise and sliding the ends off of the shoulder bolts in the side rails.
  3. Move the front crossbar to the new side rail position and slide the crossbar onto the shoulder bolt at that position.
  4. Replace and tighten the thumbwheels at both sides of the crossbar by turning them clockwise until tight.
- Make sure to check that the thumbwheels are tight each time load is added or removed from the roof rack, and periodically while traveling. Make sure that the load is secure before traveling.

# Towing

## TOWING POINTS (If Equipped)

### Front Towing Eye

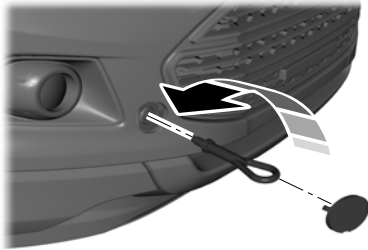

E156610

The towing eye is located in the luggage compartment under the floor cover.

The towing eye must always be carried in the vehicle.

Pry off the cover and install the towing eye.

**Note:** The screw-in towing eye has a left-hand thread. Turn it anti-clockwise to install it. Make sure that the towing eye is fully tightened.

### Rear Towing Hook

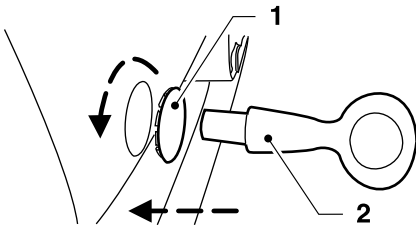

E146284

Insert a suitable object into the hole on the underside of the cover and pry off the cover.

**Note:** The screw-in towing eye has a left-hand thread. Turn it anti-clockwise to install it. Make sure that the towing eye is fully tightened.

## TRANSPORTING THE VEHICLE

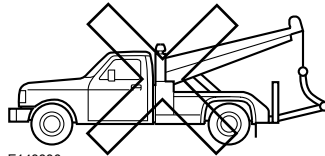
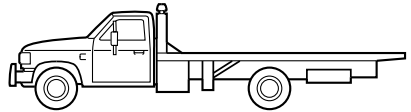
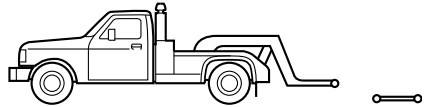

E143886

If you need to have your vehicle towed, contact a professional towing service or, if you are a member of a roadside assistance program, your roadside assistance service provider.

We recommend the use of a wheel lift and dollies or flatbed equipment to tow your vehicle. Do not tow with a slingbelt. Ford Motor Company has not approved a slingbelt towing procedure. Vehicle damage may occur if towed incorrectly, or by any other means.

It is acceptable to have your front-wheel drive vehicle towed from the front if using proper wheel lift equipment to raise the front wheels off the ground. When towing in this manner, the rear wheels can remain on the ground.

# Towing

Front-wheel drive vehicles must have the front wheels placed on a tow dolly when towing your vehicle from the rear using wheel lift equipment. This prevents damage to the transmission.

## TOWING THE VEHICLE ON FOUR WHEELS

### All Vehicles

#### WARNINGS



You must switch the ignition on when your vehicle is being towed.



The brake and steering assistance will not operate unless the engine is running. Press the brake pedal harder and allow for increased stopping distances and heavier steering.



Too much tension in the tow rope could cause damage to your vehicle or the vehicle that is towing.



Do not use a rigid tow bar on the front towing eye.



When towing your vehicle you must select neutral.

Drive off slowly and smoothly without jerking the towed vehicle.

### Vehicles with Automatic Transmission

#### WARNINGS



If a speed of 12 mph (20 km/h) and a distance of 12 miles (20 kilometers) is to be exceeded the drive wheels must be lifted clear of the ground.

#### WARNINGS



It is recommended not to tow with the drive wheels on the ground. However, if it is required to move your vehicle from a dangerous location, do not tow your vehicle faster than 12 mph (20 km/h) or further than 12 miles (20 kilometers).



Do not tow your vehicle backward.



In the event of a mechanical failure of the transmission the drive wheels must be lifted clear of the ground.



Do not tow your vehicle if the ambient temperature is below 32°F (0°C).

# Driving Hints

## BREAKING-IN

### Tires

#### WARNING



New tires need to be run-in for approximately 500 kilometers.

During this time, you may experience different driving characteristics.

### Brakes and Clutch

#### WARNING



If possible, avoid hard braking and clutching during the first 150 kilometers in the city, and the first 1,500 kilometers in highways.

### Engine

#### WARNING



Avoid driving too fast during the first 1500 kilometers. Vary your speed frequently and change up through the gears early. Do not labor the engine.

## DRIVING THROUGH WATER

#### WARNINGS



Do not attempt to start a vehicle that has been submerged in water.

Contact an authorized dealer for support.



Never drive through water when it flows above the bottom of the bumper or the center of the tyre.



Engine damage can occur if attempts are made to cross through deep water.



All fluids including engine and transmission fluid need to be changed in case of water ingress and contamination.

#### WARNINGS



During the crossing, avoid creating a bow wave in front of the vehicle.



Never enter into unknown terrain, there may be hidden obstacles such as ditches, manholes etc.

If the situation demands to drive through water in an emergency even at great risk, then:

- Maintain a low speed of maximum 10km/h.
- Make sure the engine does not stall in water.

After driving through water, and as soon as it is safe to do so:

- Have the engine and transmission assembly checked by an authorized dealer for any water ingress.
- Depress the brake pedal lightly and check that full brake function is achieved.
- Check that the horn works.
- Check that the vehicle lights are fully operational.
- Check the power assistance of the steering system.

## FLOOR MATS



E142666

# Driving Hints

---

Always use floor mats that are designed to fit the footwell of your vehicle. Only use floor mats that are firmly secured to retention posts.

## **WARNING**



Make sure that the floor mat is secured properly using the appropriate fixings, and do not position the floor mat so that it interferes with the operation of the pedals.

Pedals that cannot move freely can cause loss of vehicle control and increase the risk of serious personal injury.

Always make sure that the floor mats are properly attached to the retention posts in the carpet that are supplied with your vehicle. Floor mats must be properly secured to both retention posts to ensure mats do not shift out of position.

Never place floor mats or any other covering in the vehicle footwell that cannot be properly secured to prevent them from moving and interfering with the pedals or the ability to control the vehicle.

Never place floor mats or any other covering on top of already installed floor mats. Floor mats should always rest on top of the vehicle carpeting surface and not another floor mat or other covering. Additional floor mats or any other covering will reduce the pedal clearance and potentially interfere with pedal operation.

Check attachment of floor mats on a regular basis. Always properly reinstall and secure floor mats that have been removed for cleaning or replacement.

Failure to properly follow floor mat installation or attachment instructions can potentially cause interference with pedal operation causing loss of control of vehicle.

---

1. To install floor mats, position the floor mat so that the eyelets are over the retention posts and press down to lock the floor mat in.
2. To remove the floor mat, place your hands under the floor mat by the eyelets and pull upward.

# Roadside Emergencies

## HAZARD WARNING FLASHERS



The hazard warning button is located on the instrument panel. Use it when your vehicle is creating a safety hazard for other motorists.

Press the button to turn on the hazard warning function, and the front and rear direction indicators will flash.

Press the button again to turn them off.

**Note:** *If used when the engine is not running, the battery will lose charge. There may be insufficient power to restart your engine.*

**Note:** *Depending on applicable laws and regulations in the country for which your vehicle was originally built, the hazard warning flashers may flash if you brake heavily.*

## WARNING TRIANGLE

Space is provided in the luggage compartment.

## FUEL SHUTOFF

The fuel pump shut-off switch is located behind an access panel in the left rear quarter trim panel, near the liftgate. The fuel pump shut-off switch has a red reset button on top of it.

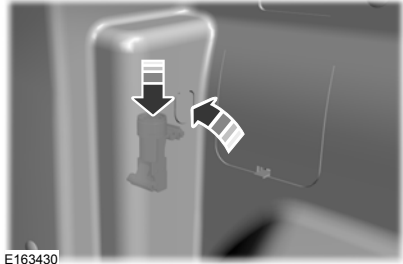

E163430

In the event of a moderate to severe collision, your vehicle is equipped with a fuel pump shut-off feature that stops the flow of fuel to the engine. Not every impact will cause a shut-off.

Should your vehicle shut off after a collision, you may restart your vehicle by doing the following:

1. Turn the ignition off.
2. Check the fuel system for leaks.
3. If no leak is apparent, reset the fuel pump shut-off switch by pushing in on the reset button.
4. Turn the ignition to the **on** position. Pause for a few seconds and return the ignition to the **off** position.
5. Make a further check for leaks in the fuel system.
6. If no leaks are apparent, restart your vehicle.

## JUMP STARTING THE VEHICLE

### WARNINGS



The gases around the battery can explode if exposed to flames, sparks, or lit cigarettes. An explosion could result in injury or vehicle damage.



Batteries contain sulfuric acid which can burn skin, eyes and clothing, if contacted.



# Roadside Emergencies

Do not attempt to push-start your automatic transmission vehicle. Automatic transmissions do not have push-start capability. Attempting to push-start a vehicle with an automatic transmission may cause transmission damage.

## Preparing Your Vehicle

**Note:** Use only a 12-volt supply to start your vehicle.

**Note:** Do not disconnect the battery of the disabled vehicle as this could damage the vehicle's electrical system.

1. Park the booster vehicle close to the hood of the disabled vehicle making sure the two vehicles do not touch. Set the parking brake on both vehicles and stay clear of the engine cooling fan and other moving parts.
2. Check all battery terminals and remove any excessive corrosion before you attach the battery cables. Ensure that vent caps are tight and level.
3. Turn the heater fan on in both vehicles to protect from any electrical surges. Turn all other accessories off.

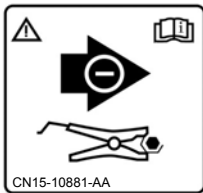

E146271

Refer to the label located above the battery cover; the arrow on the label is showing the correct location to make the jump start connection.

## Connecting the Jumper Cables

**Note:** In the illustration, the vehicle on the bottom is used to designate the assisting (boosting) battery.

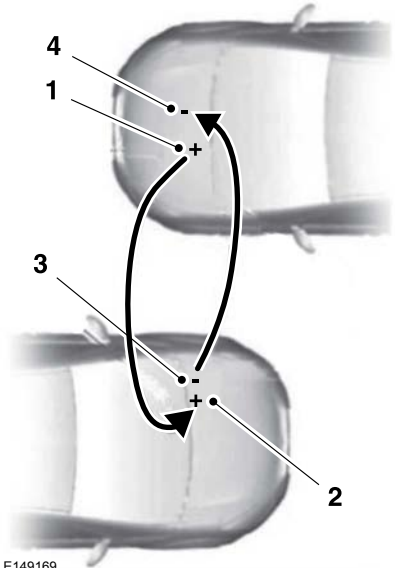

E149169

1. Connect the positive (+) jumper cable to the positive (+) terminal of the discharged battery.
2. Connect the other end of the positive (+) cable to the positive (+) terminal of the assisting battery.
3. Connect the negative (-) cable to the negative (-) terminal of the assisting battery.
4. Make the final connection of the negative (-) cable to an exposed metal part of the stalled vehicle's engine, away from the battery and the carburetor or fuel injection system.

# Roadside Emergencies

**Note:** Do not attach the negative (-) cable to fuel lines, engine rocker covers, the intake manifold or electrical components as grounding points.

## WARNING



Do not connect the end of the second cable to the negative (-) terminal of the battery to be jumped.

A spark may cause an explosion of the gases that surround the battery.

Ensure that the cables are clear of fan blades, belts, moving parts of both engines, or any fuel delivery system parts.

## Jump Starting

1. Start the engine of the booster vehicle and run the engine at moderately increased speed.
2. Start the engine of the disabled vehicle.

**Note:** For vehicles with a manual transmission, if the battery goes flat or you install a new battery, the engine will not start until you press and hold the clutch pedal down for two seconds then release the clutch pedal and wait two seconds with the key turned to the on position and the engine is off.

3. Once the disabled vehicle has been started, run both engines for an additional three minutes before disconnecting the jumper cables.

## Removing the Jumper Cables

Remove the jumper cables in the reverse order that they were connected.

**Note:** In the illustration, the vehicle on the bottom is used to designate the assisting (boosting) battery.

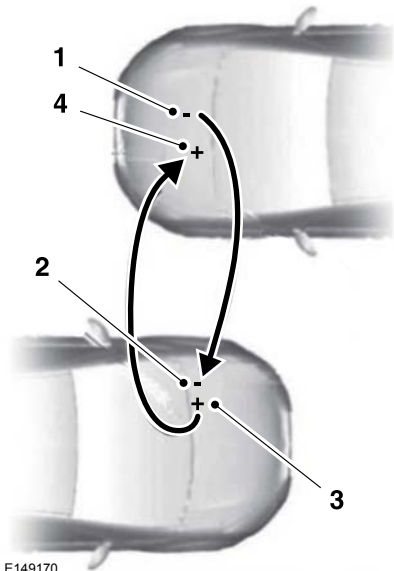

E149170

1. Remove the jumper cable from the ground metal surface.
2. Remove the jumper cable on the negative (-) terminal of the booster vehicle's battery.
3. Remove the jumper cable from the positive (+) terminal of the booster vehicle's battery.
4. Remove the jumper cable from the positive (+) terminal of the disabled vehicle's battery.

After the disabled vehicle has been started and the jumper cables removed, allow it to idle for several minutes so the engine computer can relearn its idle conditions.

# Fuses

## FUSE BOX LOCATIONS

### Engine Compartment Fuse Box



E146269

This fuse box is located in the engine compartment.

### Passenger Compartment Fuse Box

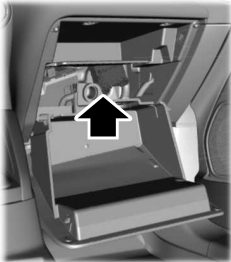

E159184

This fuse box is located behind the glove box. To access the fuse box, do the following:

1. Open the glove box and empty the contents.
2. Remove the four screws and then remove the shelf in the glove box.
3. Remove the side cover.
4. Remove the glove box assembly.

**Note:** Any improper modification to the electrical system can compromise the safety of the vehicle, implying risk of fire or engine damage. For any clarifications or questions, contact a Ford Distributor.

### Battery Fuse Box

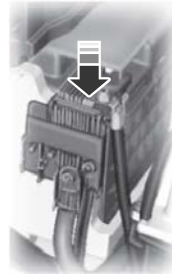

E146270

This fuse box is attached to the battery positive terminal.

# Fuses

## FUSE SPECIFICATION CHART

### Engine Compartment Fuse Box

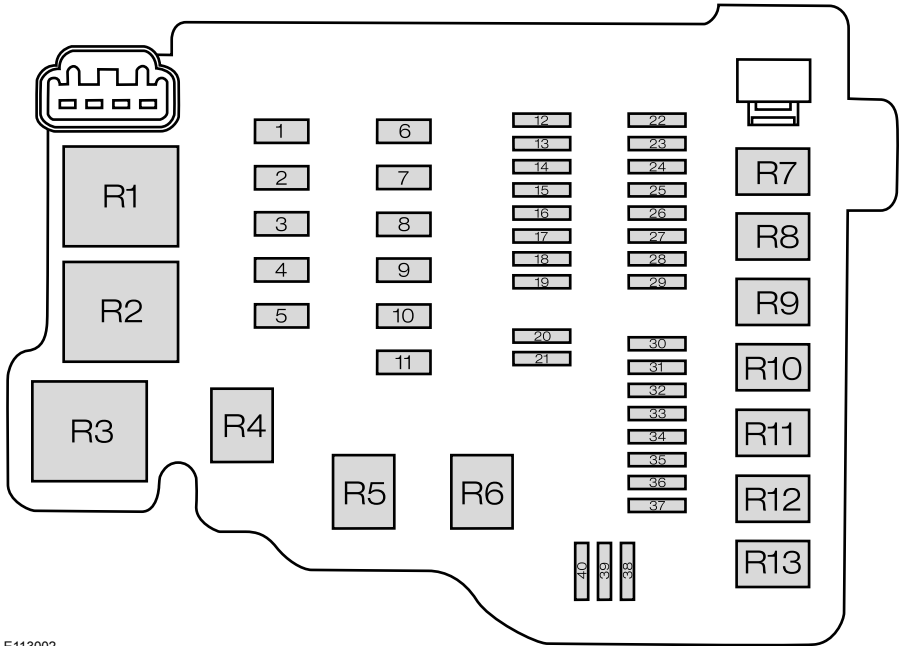

E113002

Fuse	Fuse rating	Circuits protected
1	40 A	Anti-lock braking system, electronic stability program module
2	60 A	Cooling system fan high speed
3	30 A	Cooling system fan low speed
4	40 A	Heater blower relay
5	60 A	Passenger compartment fuse box supply (battery)
6	30 A	Power door locks (body control module)
7	60 A	Passenger compartment fuse box supply (ignition relay)

# Fuses

<b>Fuse</b>	<b>Fuse rating</b>	<b>Circuits protected</b>
8	60 A	Glow plug relay (diesel)
9	30 A	Automatic transmission module
10	-	Not used
11	30 A	Starter relay
12	15 A	High beam relay
13	-	Not used
14	-	Not used
15	-	Not used
16	15 A	Cooling fan relay, powertrain control module, canister purge valve (petrol), wastegate valve (1.0L petrol), variable oil pump valve (1.0L petrol), variable camshaft timing valve (1.0L petrol)
17	15 A	Heated oxygen sensors (petrol), variable camshaft timing (1.5L petrol), catalyst monitoring sensor (1.5L petrol), mass air flow sensor (1.5L petrol and diesel), powertrain control module (diesel), metering fuel valve (diesel), temperature sensor (diesel), vehicle speed sensor (diesel), water in fuel sensor (diesel)
18 (1.0L petrol)	10 A	Run on pump, vacuum valve
19 (1.0L petrol)	20 A	Ignition coil
19 (1.5L petrol)	15 A	Ignition coil
20	-	Not used
21	15 A	Horn
22	15 A	Exterior lighting left-hand side (low beam)
23	15 A	Fog lamp relay
24	15 A	Turn signals
25	-	Not used
26	-	Not used

# Fuses

<b>Fuse</b>	<b>Fuse rating</b>	<b>Circuits protected</b>
27	7.5 A	Powertrain control module relay coil, automatic transmission module, powertrain control module (1.5L petrol)
28	20 A	Anti-lock Braking System (electronic stability program)
29	7.5 A	Air conditioning clutch relay
30	15 A	Exterior lighting right-hand side (low beam)
31	-	Not used
32	20 A	Body control module power supply
33	20 A	Rear window defroster
34	20 A	Fuel pump relay (petrol)
35	-	Not used
36	-	Not used
37	-	Not used
38	-	Not used
39	-	Not used
40	-	Not used

<b>Relay</b>	<b>Circuits switched</b>
R1	Cooling fan motor - high speed
R2	Glow plug module (diesel)
R3	Powertrain control module
R4	High beam
R5	Horn
R6	Not used
R7	Cooling fan motor - low speed
R8	Starter motor
R9	Air conditioning
R10	Front fog lamp

# Fuses

Relay	Circuits switched
R11	Fuel pump (1.5L petrol)
R12	Backup lamp
R13	Heater fan/blower

## Passenger Compartment Fuse Box



E144835

Fuse	Fuse rating	Circuits protected
1	7.5 A	Air conditioning clutch, rain sensor
2	10 A	Stop lamps
3	7.5 A	Reversing lamp
4	7.5 A	Headlamp leveling
5	20 A	Windshield wipers

# Fuses

<b>Fuse</b>	<b>Fuse rating</b>	<b>Circuits protected</b>
6	15 A	Rear window wiper
7	15 A	Washer pump
8	-	Not used
9	-	Not used
10	15 A	Ignition switch or keyless ignition relay, keyless accessory relay
11	3 A	Instrument cluster
12	15 A	Data link connector
13	7.5 A	Heating control head (manual A/C), electronic automatic temperature control, receiver remote (vehicles with keyless system), integrated control panel, multi-function display
14	15 A	Audio, SYNC
15	3 A	Power exterior mirrors, power windows
16	20 A	Keyless vehicle module
17	20 A	Keyless vehicle module
18	-	Not used
19	7.5 A	Instrument cluster
20	-	Not used
21	-	Not used
22	-	Not used
23	-	Not used
24	-	Not used
25	7.5 A	Air conditioning control module, heater blower relay, front fog lamp relay
26	3 A	Airbag control module
27	10 A	Body control module (ignition), anti-lock brake system, ignition (for vehicles without keyless system), cluster (ignition), electrical power assist steering (ignition)



# Fuses

<b>Fuse</b>	<b>Fuse rating</b>	<b>Circuits protected</b>
28	7.5 A	Accelerator pedal, fuel pump, powertrain control module (ignition), automatic transmission module
29	-	Not used
30	-	Not used
31	20 A	Front power point
32	20 A	Rear power point
33	-	Not used
34	30 A	Power driver and passenger window switches
35	30 A	Power rear window switches
36	-	Not used

<b>Relay</b>	<b>Circuits switched</b>
R1	Ignition
R2	Keyless system ignition
R3	Keyless system accessory

# Fuses

## Battery Fuse Box

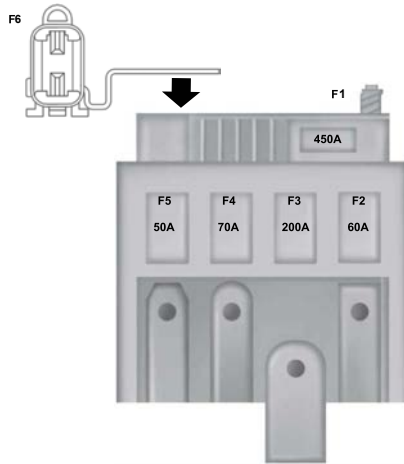

E163706

Fuse	Fuse rating	Circuits protected
1	450 A	Starter
2	60 A	Electric power assist steering
3	200 A	Engine junction box
4	-	Not used
5	-	Not used
6	3 A	Battery monitor system

# Fuses

## CHANGING A FUSE

### WARNINGS



Do not modify the electrical system of your vehicle in any way. Have repairs to the electrical system and the replacement of relays and high current fuses carried out by an authorized dealer.



Switch the ignition and all electrical equipment off before attempting to change a fuse.



Always replace a fuse with one that has the specified amperage rating. Using a fuse with a higher amperage rating can cause severe wire damage and could start a fire.

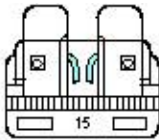

E142430

If electrical components in your vehicle are not working, a fuse may have blown. A break in the fuse wire will indicate a blown fuse. Check the appropriate fuses before replacing any electrical components.

# Maintenance

## GENERAL INFORMATION

Have your vehicle serviced regularly to help maintain its roadworthiness. There is a large network of Ford Dealers that are there to help you with their professional servicing expertise. We believe that their specially trained technicians are best qualified to service your vehicle properly and expertly, with a wide range of highly specialized tools.

In addition to regular servicing, we recommend that you carry out the following checks.

### WARNINGS



Switch the ignition off before touching or attempting adjustment of any kind.



Do not touch the electronic ignition system parts after you have switched the ignition on or when the engine is running. The system operates at high voltage.



Keep your hands and clothing clear of the engine cooling fan. Under certain conditions, the fan may continue to run for several minutes after you have switched the engine off.



Make sure that you fit filler caps securely after carrying out maintenance checks.

## Daily Checks

- Exterior lamps.
- Interior lamps.
- Warning lamps and indicators.

## Check When Refueling

- Engine oil level. See **Engine Oil Check** (page 119).
- Brake fluid level. See **Brake and Clutch Fluid Check** (page 121).

- Washer fluid level. See **Washer Fluid Check** (page 122).
- Tire pressures (when cold). See **Technical Specifications** (page 141).
- Tire condition. See **Wheels and Tires** (page 136).

## Monthly Checks

- Engine coolant level (engine cold). See **Engine Coolant Check** (page 121).
- Pipes, hoses and reservoirs for leaks.
- Air conditioning operation.
- Parking brake operation.
- Horn operation.
- Tightness of lug nuts. See **Technical Specifications** (page 141).

## OPENING AND CLOSING THE HOOD

### Opening the Hood

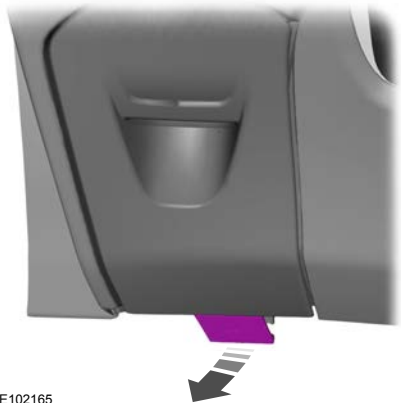

# Maintenance

---

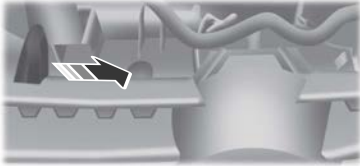

E154746

Move the catch to the right.

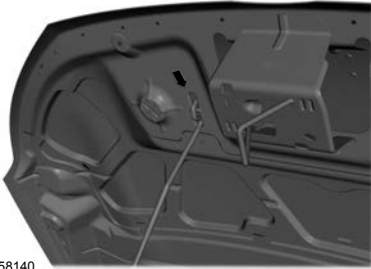

E158140

Open the hood and support it with the hood prop rod. Attach the prop rod to the hood, the correct location is indicated by an arrow.

## Closing the Hood

**Note:** *You must secure the hood prop correctly after use.*

**Note:** *Make sure that the hood is closed properly.*

Lower the hood and allow it to drop from under its own weight for the last 20-30 centimeters.

# Maintenance

## UNDER HOOD OVERVIEW - 1.0L ECOBOOST™

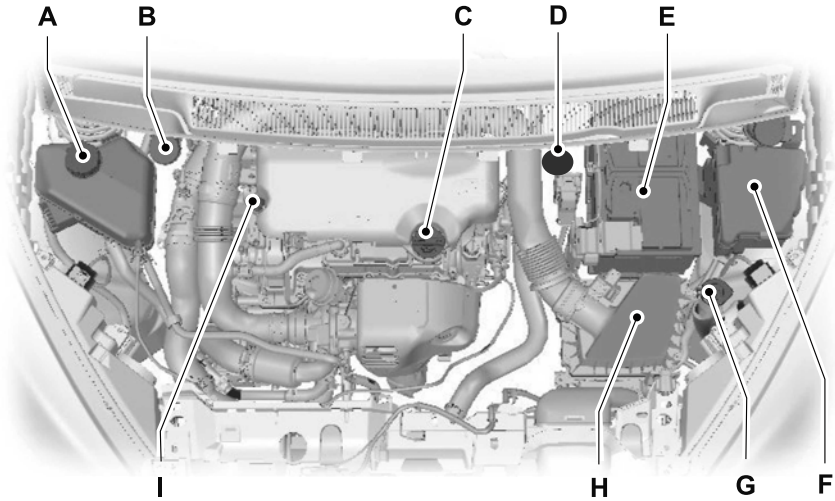

E151694

- A Engine coolant reservoir\*: See **Engine Coolant Check** (page 121).
- B Brake and clutch fluid reservoir (right-hand drive)\*: See **Brake and Clutch Fluid Check** (page 121).
- C Engine oil filler cap\*: See **Engine Oil Check** (page 119).
- D Brake and clutch fluid reservoir (left-hand drive)\*: See **Brake and Clutch Fluid Check** (page 121).
- E Battery: See **Changing the 12V Battery** (page 122).
- F Engine compartment fuse box. See **Fuses** (page 105).
- G Windshield and rear window washer fluid reservoir: See **Washer Fluid Check** (page 122).
- H Air cleaner: No maintenance necessary.
- I Engine oil dipstick\*: See **Engine Oil Check** (page 119).

\* The filler caps and the engine oil dipstick are colored for easy identification.

# Maintenance

## UNDER HOOD OVERVIEW - 1.5L DURATEC-16V TI-VCT (81KW/110PS) - SIGMA

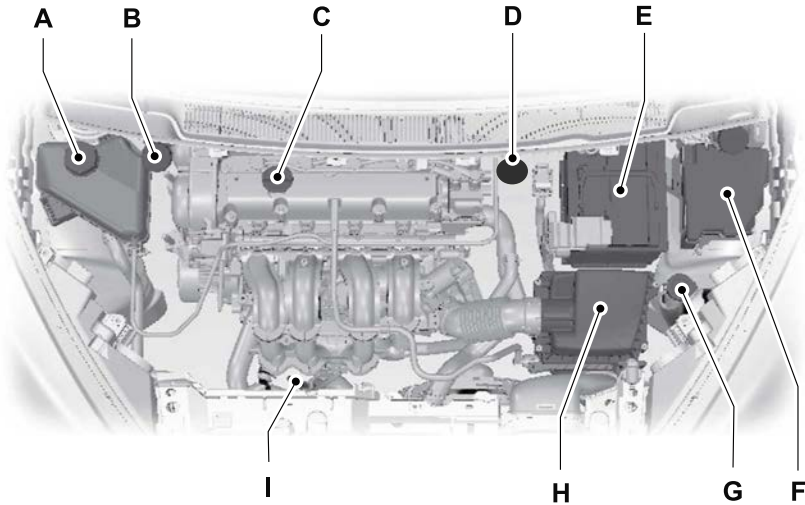

E151696

- A Engine coolant reservoir\*: See **Engine Coolant Check** (page 121).
- B Brake and clutch fluid reservoir (right-hand drive)\*: See **Brake and Clutch Fluid Check** (page 121).
- C Engine oil filler cap\*: See **Engine Oil Check** (page 119).
- D Brake and clutch fluid reservoir (left-hand drive)\*: See **Brake and Clutch Fluid Check** (page 121).
- E Battery: See **Changing the 12V Battery** (page 122).
- F Engine compartment fuse box. See **Fuses** (page 105).
- G Windshield and rear window washer fluid reservoir: See **Washer Fluid Check** (page 122).
- H Air cleaner: No maintenance necessary.
- I Engine oil dipstick\*: See **Engine Oil Check** (page 119).

\* The filler caps and the engine oil dipstick are colored for easy identification.

# Maintenance

## UNDER HOOD OVERVIEW - 1.5L DURATORQ-TDCI (67KW/91PS)

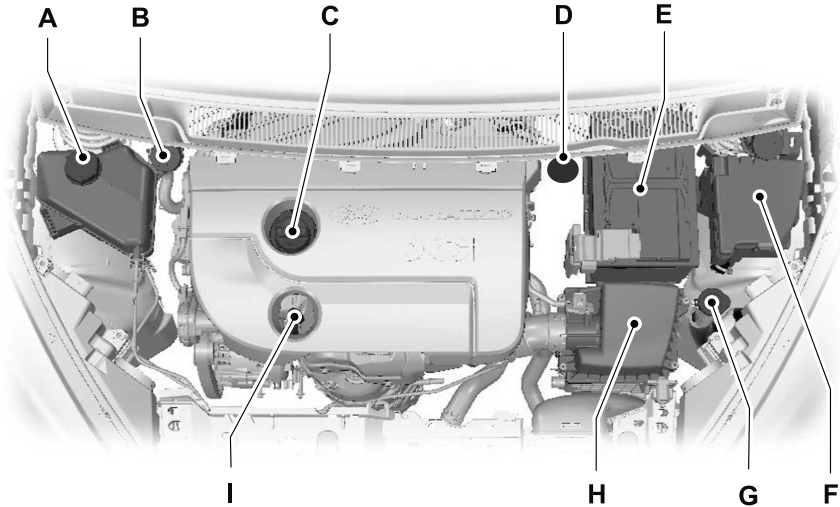

E151697

- A Engine coolant reservoir\*: See **Engine Coolant Check** (page 121).
- B Brake and clutch fluid reservoir (right-hand drive)\*: See **Brake and Clutch Fluid Check** (page 121).
- C Engine oil filler cap\*: See **Engine Oil Check** (page 119).
- D Brake and clutch fluid reservoir (left-hand drive)\*: See **Brake and Clutch Fluid Check** (page 121).
- E Battery: See **Changing the 12V Battery** (page 122).
- F Engine compartment fuse box. See **Fuses** (page 105).
- G Windshield and rear window washer fluid reservoir: See **Washer Fluid Check** (page 122).
- H Air cleaner: No maintenance necessary.
- I Engine oil dipstick\*: See **Engine Oil Check** (page 119).

\* The filler caps and the engine oil dipstick are colored for easy identification.



# Maintenance

## ENGINE OIL DIPSTICK - 1.0L ECOBOOST™

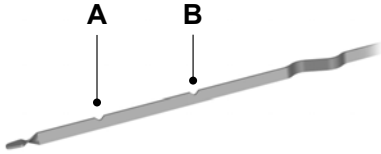

E141337

- A Minimum
- B Maximum

## ENGINE OIL DIPSTICK - 1.5L DURATEC-16V TI-VCT (81KW/110PS) - SIGMA

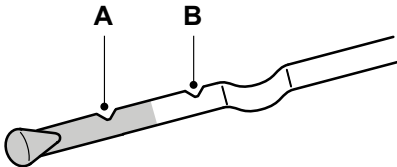

E95540

- A Minimum
- B Maximum

## ENGINE OIL DIPSTICK - 1.5L DURATORQ-TDCI (67KW/91PS)

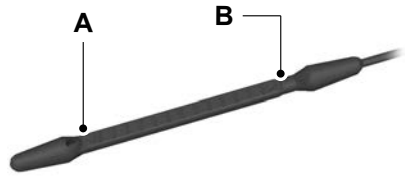

E140423

- A Minimum
- B Maximum

## ENGINE OIL CHECK

### WARNINGS



Do not use oil additives or other engine treatments. Under certain conditions, they could damage the engine and it is not covered under warranty.



Empty engine oil containers should not be disposed of in domestic trash bins. Use only proper containers to dispose of this type of waste.



When changing your oil, ensure that the oil used is the same as specified and the correct amount. Do not use unknown types of oil or from already opened containers.

**Note:** The oil consumption of new engines reaches its normal level after approximately 5,000 km.

### Checking the Oil Level

**Note:** Check the level before starting the engine.

# Maintenance

**Note:** Make sure that the level is between the MIN and the MAX marks.

**Note:** Level measurement will not be accurate if this procedure is not followed.

1. Make sure that your vehicle is on level ground.
2. If the engine is running turn it off and wait 15 minutes for the oil to drain into the oil pan.
3. Remove the dipstick and wipe it with a clean, lint free cloth. Replace the dipstick and remove it again to check the oil level.

If the level is at the MIN mark, top up immediately.

## Topping Up

### WARNINGS



Only top up when the engine is cold. If the engine is hot, wait 15 minutes for the engine to cool down.



Do not remove the filler cap when the engine is running.

Remove the filler cap.

### WARNING



Do not top up further than the MAX mark.

**Note:** Oil expands when it is hot. Checking the oil level when hot will be above the MAX mark.

**Note:** Soak up any spillage with an absorbent cloth immediately.

Top up with fluid that meets the Ford specification. See **Technical Specifications** (page 144).

Replace the filler cap. Turn it until you feel a strong resistance.

## Engine severe usage conditions

In case of vehicle severe usage, engine oil should be changed every 5,000 km or 3 months, whichever occurs first.

Severe usage conditions:

- Short distances (less than 5 km), in which the engine does not reach normal operating temperature,
- Frequent usage of vehicle on dusty roads or in mountain areas,
- Usage in heavy urban traffic,
- Usage as driving instructors vehicle, taxi vehicle, ambulance, military usage or similar activities,
- Extended usage with contaminated fuel.

## Oil Consumption

In the first 5,000 km (run-in period) the oil consumption is higher, and therefore the oil level should be checked more frequently. Maximum acceptable consumption in this period is one liter. After the break-in period the engine can consume up to one liter every 10,000 km. If the consumption is higher, go to your Ford Dealer.

Oil consumption also depends on driving style and vehicle use. Special operating conditions such as, operating your vehicle frequently at high speeds, could increase oil consumption.

## Oil Filter

The oil filter's function is to filter out harmful particles without obstructing the flow of oil to vital parts. Use of oil filters not meeting Ford specifications could damage the engine.

# Maintenance

## ENGINE COOLANT CHECK

### WARNING



Do not allow the fluid to touch your skin or eyes. If this happens, rinse the affected areas immediately with plenty of water and contact your physician.

**Note:** Make sure that the level is between the MIN and the MAX marks.

**Note:** Coolant expands when it is hot. The level may therefore extend beyond the MAX mark.

If the level is at the MIN mark, add coolant immediately.

## Adding Engine Coolant

### WARNINGS



Only add coolant when the engine is cold. If the engine is hot, wait 10 minutes for the engine to cool down.



Do not remove the filler cap when the engine is running.



Do not remove the filler cap when the engine is hot. Wait for the engine to cool down.



Undiluted coolant is flammable and may ignite if splilt on a hot exhaust.

**Note:** Inspect or replace the lid with the car turned off and the engine cold, to avoid injuries or burns.

**Note:** In an emergency, you can add just water to the cooling system to reach a vehicle service station. Have the system checked by a Ford Dealer as soon as possible.

**Note:** Prolonged use of incorrect dilution of the coolant can cause engine damage from corrosion, overheating or freezing.

**Note:** Do not add coolant further than the MAX mark.

**Note:** If coolant levels are outside the standard operational range, the performance of the system may be compromised; seek a Ford Dealer immediately.

**Note:** The cooling system expansion reservoir lid should be inspected and cleaned every 3 years approximately. If there are any evidences of deterioration of the sealing ring, the lid should be replaced.

**Note:** It is normal to see some air bubbles in the coolant reservoir fluid.

1. Remove the filler cap. Any pressure will escape slowly as you unscrew the cap.
2. Add a mixture of 50% coolant and 50% water using fluid that meets the Ford specifications. See **Technical Specifications** (page 131).
3. Replace the filler cap. Turn it until you feel a strong resistance.

## BRAKE AND CLUTCH FLUID CHECK

### WARNINGS



Use of any fluid other than the recommended brake fluid may reduce brake efficiency and not meet Ford's performance standards.



Do not allow the fluid to touch your skin or eyes. If this happens, rinse the affected areas immediately with plenty of water and contact your doctor.



Clean the filler cap before removing. Use only fluid that meets Ford specifications and from a sealed container.

# Maintenance

**Note:** Keep brake fluid clean and dry. Contamination with dirt, water, petroleum products or other materials may result in brake system damage and possible failure.

**Note:** The brake and the clutch systems are supplied from the same reservoir.

The fluid level will drop slowly as the brakes wear, and will rise when the brake components are replaced.

Fluid levels between the MIN and MAX lines are within the normal operating range; there is no need to add fluid.

If the fluid levels are outside of the normal operating range, the performance of the system could be compromised; seek service from your authorized dealer immediately.

Top up with fluid that meets the Ford specification. See **Technical Specifications** (page 131).

## WASHER FLUID CHECK

**Note:** The reservoir supplies the front and rear washer systems.

When adding fluid, use a mixture of washer fluid and water to help prevent freezing in cold weather and improve the cleaning capability. We recommend that you use only high quality washer fluid.

For information on fluid dilution, refer to the product instructions.

## CHANGING THE 12V BATTERY



Make sure that you dispose of old batteries in an environmentally friendly way. Seek advice from your local authority regarding recycling.

### WARNING



You must replace the battery with one of exactly the same specification.

**Note:** For vehicles with a manual transmission, if the battery goes flat or you install a new battery, the engine will not start until you press and hold the clutch pedal down for two seconds then release the clutch pedal and wait two seconds with the key turned to the on position and the engine is off.

The battery is located in the engine compartment. See **Maintenance** (page 114).

To remove and install the battery:

**Note:** Do not loosen the powertrain control module from the bracket.

**Note:** Do not disconnect the powertrain control module from the connector.

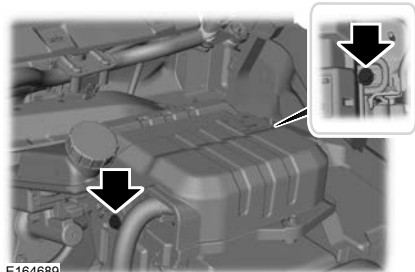

E164689

1. Remove the two screws from the powertrain control module cover.

# Maintenance

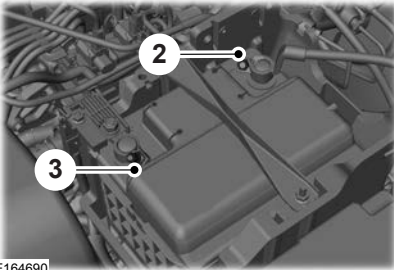

E164690

2. Remove the negative battery cable.
3. Remove the positive battery cable.

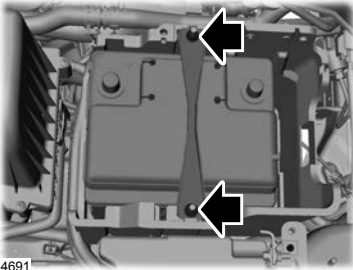

E164691

4. Remove the two nuts from the clamp.
5. Remove the battery.
6. Install in the reverse order.

## CHANGING THE WIPER BLADES

### Changing the Windshield Wiper Blades

**Note:** The windshield wiper blades are different in length. If you install wiper blades of the wrong length, the rain sensor may not work correctly.

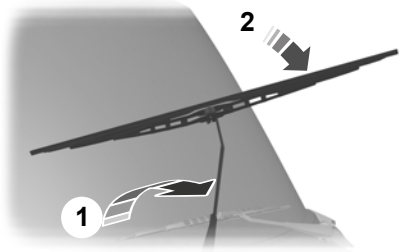

E93783

1. Lift the wiper arm.
2. Position the wiper blade at right angles to the wiper arm.

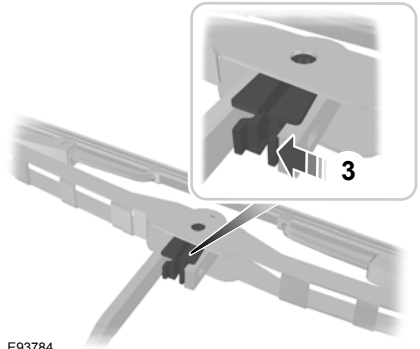

E93784

3. Press the locking lever.

# Maintenance

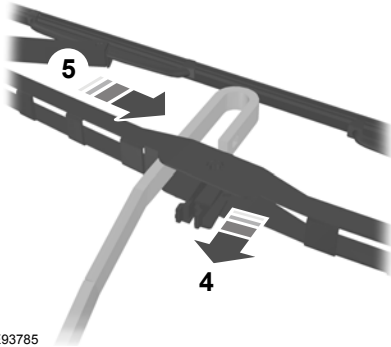

E93785

4. Disengage the wiper blade from the wiper arm.
5. Slide the wiper blade to the side.

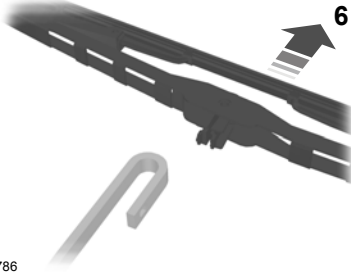

E93786

6. Remove the wiper blade.
7. Install in the reverse order. Make sure that the wiper blade locks into place.

## Changing the Rear Window Wiper Blade

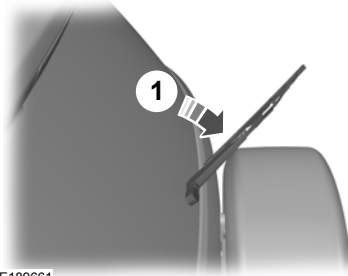

E189661

1. Lift the wiper arm.
2. Position the wiper blade at right angles to the wiper arm.

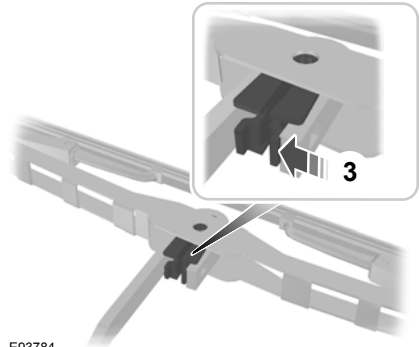

E93784

3. Press the locking lever.

# Maintenance

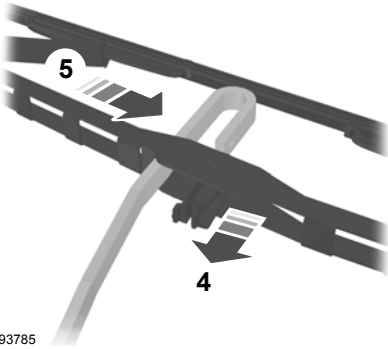

E93785

4. Disengage the wiper blade from the wiper arm.
5. Slide the wiper blade to the side.

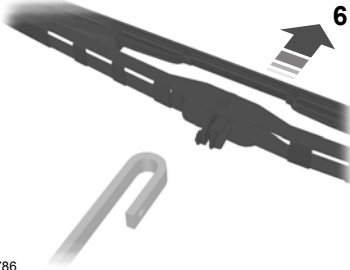

E93786

6. Remove the wiper blade.
7. Install in the reverse order. Make sure that the wiper blade locks into place.

## REMOVING A HEADLAMP

1. Open the hood. See **Opening and Closing the Hood** (page 114).

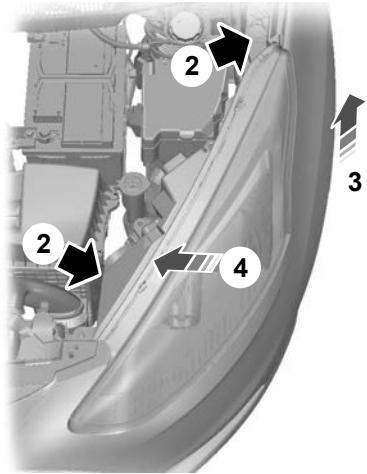

E144433

2. Remove the screws and push pins.
3. Lift the outer side of the headlamp to disengage it from the lower fixing point.
4. Pull the headlamp as far as possible toward the center of your vehicle and remove.

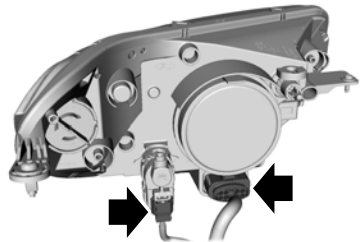

E164963

5. Disconnect the two electrical connectors.

**Note:** When fitting the headlamp, make sure that you reconnect the electrical connector correctly.

# Maintenance

**Note:** When fitting the headlamp, make sure that you fully engage the headlamp in the lower fixing point.

## CHANGING A BULB

### WARNINGS



Switch the lights and the ignition off.



Let the bulb cool down before removing it.



Do not touch the glass of the new bulb.

**Note:** Only fit bulbs of the correct specification.

**Note:** The following instructions describe how to remove the bulbs. Fit replacements in the reverse order unless otherwise stated.

### Headlamp

**Note:** Disconnect the bulb electrical connectors and remove the covers to gain access to the bulbs.

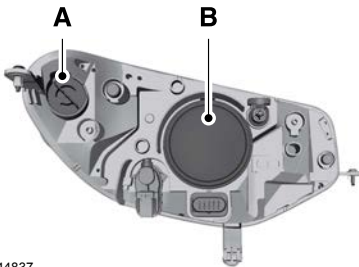

E144837

- A Direction indicator
- B Headlamp main beam

### Direction Indicator

1. Open the hood.

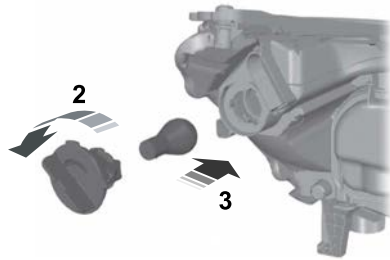

E144838

2. Turn the bulb holder anti-clockwise and remove it.
3. Gently press the bulb into the bulb holder, turn it anti-clockwise and remove it.

### Headlamp Main Beam

**Note:** Do not touch the glass of the bulb.

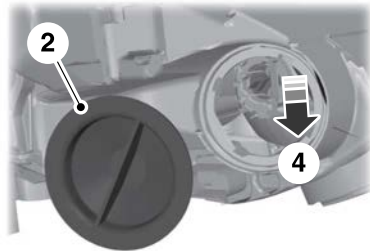

E144839

1. Open the hood.
2. Remove the cover.
3. Disconnect the electrical connector.
4. Release the clip and remove the bulb.



# Maintenance

## Side Lamp

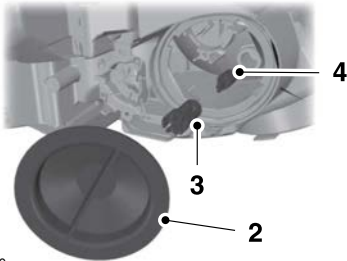

E144840

1. Remove the cover.
2. Remove the bulb holder.
3. Remove the bulb.

## Vanity Lamp

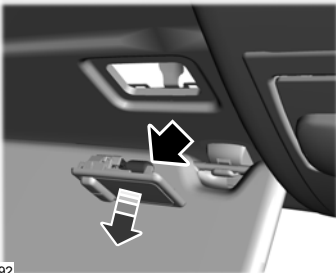

E164692

1. Position the visor in the down position.
2. When removing the vanity lamp, be careful not to damage the roof trim. Using appropriate plastic spatula, insert it between the vanity mirror and the roof trim and release the metal retaining clip.
3. Remove the lamp.
4. Remove the bulb.

## Front Fog Lamps

**Note:** Do not separate the fog lamp bulb from the bulb holder

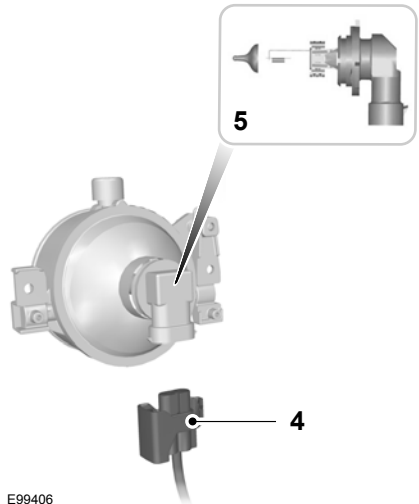

E99406

### **Note:**

1. Disconnect the electrical connector.
2. Turn the bulb holder anti-clockwise.
3. Remove the fog lamp bulb and holder assembly.
4. Connect the electrical connector.
5. Install a new fog lamp assembly.

# Maintenance

## Rear Lamps

### Direction Indicator, Tail and Brake Lamp



E163920

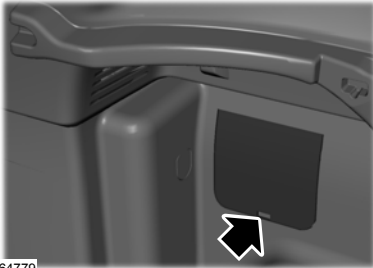

E164779

1. Remove the trim panel.

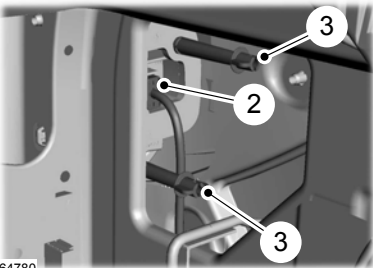

E164780

2. Disconnect the electrical connector.
3. Remove the wing nuts.
4. Remove the lamp.

5. Remove the bulb holder.
6. Gently press the bulb into the bulb holder, turn it anti-clockwise and remove it.

### Reversing Lamp and Fog Lamp

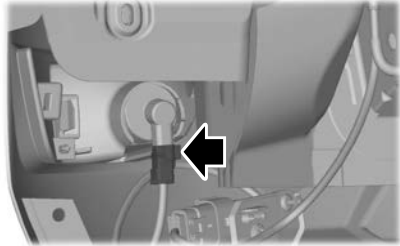

E160639

1. Disconnect the electrical connector.

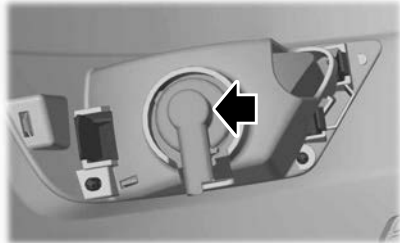

E160638

2. Turn the bulb holder anti-clockwise and remove the bulb holder from the housing.
3. Remove the bulb from the holder.
4. Gently press the new bulb into the bulb holder, install new bulb and holder into the housing, turning it clockwise.

### Central High Mounted Brake Lamp

**Note:** On some vehicles the lamps are LED. They are not serviceable items, please consult a Ford Dealer if they fail.

# Maintenance

## Number Plate Lamp

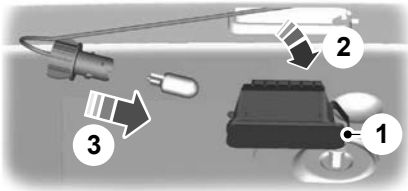

E72789

1. Carefully release the spring clip.
2. Remove the lamp.
3. Turn the bulb anti-clockwise and remove it.

## Interior Lamp

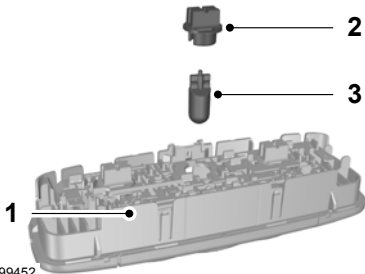

E99452

1. Carefully remove the lamp.
2. Turn the bulb holder counterclockwise and remove it.
3. Remove the bulb.

## Reading Lamps

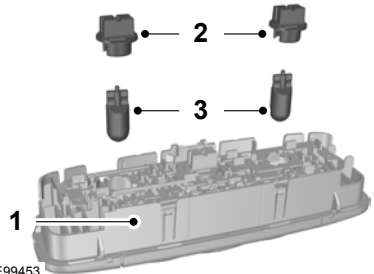

E99453

1. Carefully remove the lamp.
2. Turn the bulb holder counterclockwise and remove it.
3. Remove the bulb.

## Map Lamp (driver side)

1. Position the visor down.
2. Carefully remove the lamp.
3. Turn the bulb holder counterclockwise and remove it.
4. Remove the bulb.

## Luggage Compartment Lamp, Footwell Lamp and Tailgate Lamp (If Equipped)

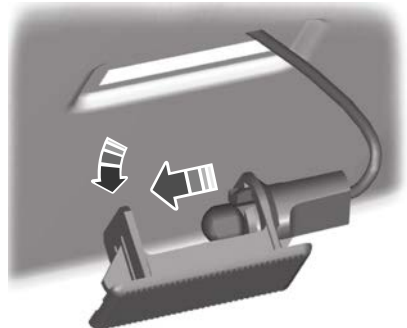

E72784

# Maintenance

1. Carefully remove the lamp.
2. Remove the bulb.

## BULB SPECIFICATION CHART

Lamp	Specification	Power (watt)
Front direction indicator	PY21W	21
Headlamp main beam / dipped beam	H4	55 / 60W
Front fog lamp	H11	55
Side repeater	WY5W	5
Rear direction indicator	PY21W	21
Brake and tail lamp	P21/5W	21/5
Rear fog lamp	P21W	21
Reversing lamp	P21W	21
Number plate lamp	W5W	5
Luggage compartment lamp	W5W	5
Vanity lamp	W5W	5

**Note:** On some vehicles the lamps are LED. These are not serviceable items, please consult your dealer if they fail.

## CHANGING THE ENGINE AIR FILTER

### WARNING



To reduce the risk of vehicle damage and/or personal burn injuries do not start your engine with the air cleaner removed and do not remove it while the engine is running.

**Note:** Failure to use the correct air filter element may result in severe engine damage.

## Changing the Air Filter Element

1. Remove the four screws that secure the air filter housing cover.
2. Carefully separate the two halves of the air filter housing.
3. Remove the air filter element from the air filter housing.
4. Wipe the air filter housing and cover clean to remove any dirt or debris and to ensure good sealing.
5. Install a new air filter element. Be careful not to crimp the filter element edges between the air filter housing and cover. This could cause filter damage and allow unfiltered air to enter the engine if not properly seated.
6. Replace the air filter housing cover and install the screws.

# Maintenance

## TECHNICAL SPECIFICATIONS

### Vehicle fluids

Item	Specification	Viscosity Grade	Recommended fluid
1.0L EcoBoost engine oil	WSS-M2C913-C or WSS-M2C948-B	SAE 5W-30 or SAE 5W-20	Ford Specification Engine Oil
1.5L TiVCT Sigma engine oil	WSS-M2C913-C	SAE 5W-30	Ford Specification Engine Oil
1.5L Duratorq TDCi engine oil	WSS-M2C913-C	SAE 5W-30	Ford Specification Engine Oil
Manual transmission lubricant	WSD-M2C200-C	SAE 75W-85	Motorcraft or Ford Synthetic Manual Transmission Lubricant
Automatic transmission lubricant	WSS-M2C200-D2	SAE 75W	Motorcraft Dual Clutch transmission Fluid
Air conditioning system lubricant	WSH-M1C231-B	AE J639	Motorcraft or Ford Air Conditioning System Lubricant
Air conditioning system refrigerant	-	R134a	Motorcraft or Ford Air Conditioning System Refrigerant
Brake fluid	WSS-M6C65-A2 ISO 4925 Class 6	-	Motorcraft or Ford DOT 4 LV High Performance Brake Fluid
Clutch fluid			
Engine coolant	WSS-M97B44-D	-	Motorcraft or Ford Super Plus Antifreeze Coolant
Windshield and rear window washer fluid	Windshield washer fluid	-	Motorcraft or Ford Windshield Washer Fluid

Your engine has been designed to be used with Ford Specification Engine Oil, which gives a fuel economy benefit whilst maintaining the durability of your engine.

**Topping up the oil:** If you are unable to find an oil that meets the specification defined by WSS-M2C913-C or WSS-M2C948-B (petrol engines only), you must use SAE 5W-30 that meets the specification defined by ACEA A5/B5 certification.

Using topping up oils other than the one specified can result in longer engine cranking periods, reduced engine performance, reduced fuel economy and increased emission levels.

# Maintenance

## Capacities

Variant	Item	Capacity
1.0L EcoBoost engine	Engine oil with filter	4.1 L
1.0L EcoBoost engine	Engine oil without filter	4 L
1.0L EcoBoost engine	Engine oil top up	0.8 L
1.5L TiVCT Sigma engine	Engine oil with filter	4.1 L
1.5L TiVCT Sigma engine	Engine oil without filter	3.8 L
1.5L TiVCT Sigma engine	Engine oil top up	0.8 L
1.5L Duratorq TDCi engine	Engine oil with filter	3.8 L
1.5L Duratorq TDCi engine	Engine oil without filter	3.4 L
1.5L Duratorq TDCi engine	Engine oil top up	1.6 L
Manual transmission	Clutch fluid	Between the MIN line and the MAX line
Manual transmission	Manual transmission lubricant	2.1 L
Automatic transmission	Automatic transmission lubricant	1.2 L
Air conditioning	Air conditioning system lubricant	0.12 kg
1.0L EcoBoost engine	Air conditioning system refrigerant	0.7 ± 0.03 kg
1.5L TiVCT Sigma engine	Air conditioning system refrigerant	0.625 ± 0.03 kg
1.5L Duratorq TDCi engine		
All	Brake fluid	Between the MIN line and the MAX line
1.0L EcoBoost engine	Engine coolant	6.3 L
1.5L TiVCT Sigma engine	Engine coolant	5.5 L
1.5L Duratorq TDCi engine	Engine coolant	6 L

# Maintenance

Variant	Item	Capacity
All	Windshield washer fluid	2.7 L
Vehicles with a petrol engine	Fuel tank	52 L
Vehicles with a diesel engine	Fuel tank	47 L

## Engine specifications

Engine type	1.0L Ecoboost	1.5L Duratec-16V Ti-VCT (Sigma)	1.5L Duratorq-TDCi (DV5) Diesel
Capacity	999 cm <sup>3</sup>	1,499 cm <sup>3</sup>	1,498 cm <sup>3</sup>
Power output	92 kW (125 PS) @ 6000 rpm	82 kW (112 PS) @ 6300 rpm	67 kW (91 PS) @ 3750 rpm
Max.torque	170 Nm @ 1400 - 4500 rpm	140 Nm @ 4400 rpm	204 Nm @ 2000-2750 rpm
Continuous engine speed	6450 rpm	6500 rpm	4500 rpm
Max.Intermittent engine speed	6675 rpm	6720 rpm	5100 rpm
Idle speed	860 ± 50 rpm	750 ± 50 rpm	780 ± 50 rpm
Induction system	Turbocharged inter-cooled	Naturally aspirated	Turbocharged inter-cooled
Firing order	1-2-3	1-3-4-2	1-3-4-2
Spark plug gap	0.7 ± 0.05 mm	1 ± 0.05 mm	-
Ignition system	Electronic Ignition	Electronic Ignition	Compression Ignition

# Vehicle Care

---

## CLEANING THE EXTERIOR

**Note:** If you use a car wash with a waxing cycle, make sure that you remove the wax from the windshield.

**Note:** Prior to using a car wash facility check the suitability of it for your vehicle.

**Note:** Some car wash installations use water at high pressure. This could damage certain parts of your vehicle.

**Note:** Remove the aerial before using an automatic car wash.

**Note:** Switch the heater blower off to prevent contamination of the fresh air filter.

We recommend that you wash your vehicle with a sponge and lukewarm water containing a car shampoo.

### Cleaning the Headlamps

**Note:** Do not scrape the headlamp lenses or use abrasives, alcoholic solvents or chemical solvents to clean them.

**Note:** Do not wipe the headlamps when they are dry.

### Cleaning the Rear Window

**Note:** Do not scrape the inside of the rear window or use abrasives or chemical solvents to clean it.

Use a clean, lint free cloth or a damp chamois leather to clean the inside of the rear window.

### Cleaning the Chrome Trim

**Note:** Do not use abrasives or chemical solvents. Use soapy water.

**Note:** Do not apply cleaning product to hot surfaces and do not leave cleaning product on chrome surfaces for a period of time exceeding that which is recommended.

**Note:** Industrial-strength (heavy-duty) cleaners, or cleaning chemicals, may cause damage over a period of time.

## Body Paintwork Preservation

### WARNINGS



Do not polish your vehicle in strong sunshine.



Do not allow polish to touch plastic surfaces. It could be difficult to remove.



Do not apply polish to the windshield or rear window. This could cause the wipers to become noisy and they may not clear the window properly.

---

We recommend that you wax the paintwork once or twice a year.

## CLEANING THE ENGINE

### WARNING



Due to the different materials found in the engine compartment, avoid using chemical cleaning products, aggressive detergents, degreasers, and acid and alkaline products that, due to their corrosive action, may be aggressive to certain components. Water steam cleaning should also be avoided.

---

**Note:** During the engine compartment wash, do not remove the transparent label that protects the VIN code. Engine oil, brake fluid, radiator additive, batteries and tires should be packed and stored in facilities especially prepared for handling industrial waste. Do not dispose of these items in public sewer systems or with domestic garbage. Environment preservation is a responsibility shared by all. You too should do your share.



# Vehicle Care

---

It is recommended to avoid frequent engine washes. However, when you do wash the engine, be careful not to use strong jets of water on the engine. Never wash a hot or running engine with cold water, because the thermal shock on warm surfaces may damage the engine. The air conditioned condenser and the radiator have aluminum fins that may be deformed when washed with high-pressure water jets. To avoid damages, wash only with low-pressure water jets.

**Note:** *Do not spill water, soap, or any other product on the generator and the starter motor. They may be damaged from the contact with liquids.*

When washing:

- Take care when using a power washer to clean the engine. The high-pressure fluid could penetrate the sealed parts and cause damage.
- Do not spray a hot engine with cold water to avoid cracking the engine block or other engine components.
- Never wash or rinse the engine while it is hot or running; water in the running engine may cause internal damage.
- Never wash or rinse any ignition coil, spark plug wire or spark plug well, or the area in and around these locations.
- Cover the battery, power distribution box, and air filter assembly to prevent water damage when cleaning the engine.

You should repair paintwork damage caused by stones from the road or minor scratches as soon as possible.

## REPAIRING MINOR PAINT DAMAGE

Remove any apparently harmless looking substances from the paintwork immediately (e.g. bird droppings, tree resins, insect remains, tar spots, road salt and industrial fall out).

# Wheels and Tires

## GENERAL INFORMATION

Your vehicle may have an adhesive label with tire pressure data, located in the driver's door opening.

Check and set the tire pressure when the tires are cold.

**Note:** Check your tire pressures regularly to optimize fuel economy.

**Note:** Use only approved wheel and tire sizes. Using other sizes could damage your vehicle.

**Note:** If you change the diameter of the tires from the tires fitted at the factory, the speedometer may not display the correct speed.

**Note:** If you intend to change the diameter of the tires from the tires fitted at the factory, ask your authorized dealer about the fit.

## TIRE CARE



E70415

To make sure the front and rear tires of your vehicle wear evenly and last longer, we recommend that you swap the tires from front to rear and vice versa at regular intervals of between 3000 and 6000 miles (5000 and 10000 kilometers).

### WARNING

 Do not scrub the sidewalls of the tires when you are parking.

If you have to mount a curb, do so slowly and approach it with the wheels at right-angles to the curb.

Examine the tires regularly for cuts, foreign objects and uneven wear of the tread. Uneven wear could mean that the wheel alignment is outside specification.

Check the tire pressures (including the spare) when cold, every two weeks.

## USING SNOW CHAINS

### WARNINGS



Do not exceed 40 km/h (25 mph).



Do not use snow chains on snow-free roads.



The snow chains must be fitted in the front axle only with tire size 195/65R15.

If your vehicle is fitted with wheel trims, remove them before fitting snow chains.

## CHANGING A ROAD WHEEL

### Vehicles With a Spare Wheel

If the spare wheel is exactly the same type and size as the other fitted wheels, you can replace the existing road wheel with the spare wheel and continue to drive in the normal manner.

If the spare wheel is different to the other wheels, it will carry a yellow label with the appropriate speed limit.

See the following information before changing the wheel.





### WARNINGS



Drive the shortest possible distances.

# Wheels and Tires

## WARNINGS

-  Do not fit more than one spare wheel on your vehicle at any one time.
-  Do not carry out any tire repairs on a spare wheel.
-  Do not drive through an automatic car wash.
-  If you are not sure what type of spare wheel you have, do not exceed 80 km/h.
-  The ground clearance of your vehicle may be reduced. Take care when parking next to a curb.

**Note:** Your vehicle may exhibit some unusual driving characteristics.



## Scissor Lift Hoist

### WARNING

-  Use a suitable rubber block while lifting the vehicle on a scissor lift to avoid damage to the fuel tank or vehicle.

## Vehicle Jack

### WARNINGS

-  The vehicle jack supplied with your vehicle should only be used when changing a wheel in emergency situations.
-  Before using the vehicle jack, check that it is not damaged or deformed and that the thread is lubricated and free from foreign matter.
-  Never place anything between the jack and the ground, or the jack and your vehicle.

## Jack and Associated Tools

Your vehicle's jack, wheel brace, towing hook, warning triangle and locking wheel nut key are located in the luggage compartment under the floor cover, in a tool kit.

## Jacking and Lifting Points

### WARNING

-  Use only the specified jacking points. If you use other positions, you may damage the body, steering, suspension, engine, braking system or the fuel lines.

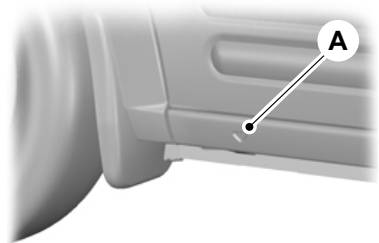

E93302

- |   |  |
|---|--|
| A | Small arrow-shaped marks on the sills show the location of the jacking points. |
|---|--|

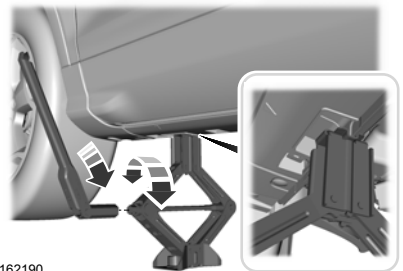

E162190

# Wheels and Tires

## Removing a Wheel Trim

The wheel trim fitted to your wheel is retained by three of the lug nuts. The fourth lug nut passes through the larger of the holes and holds the wheel in position. This allows you to remove the trim without the need to raise your vehicle.



E186441

1. Remove the three lug nuts as shown.
2. Remove the wheel trim.

**Note:** Do not loosen the lug nut diagonally opposite to the valve stem.

## Installing a Wheel Trim

### WARNING











 Make sure there is no grease or oil on the threads or the surface between the wheel lugs and nuts. This can cause the lug nuts to loosen while driving.

1. Install in the reverse order.

**Note:** Tighten the lug nuts to 133 Nm.

## Removing a Road Wheel

### WARNINGS

-  Park your vehicle in such a position that neither the traffic nor you are hindered or endangered.
-  Set up a warning triangle.
-  Make sure that your vehicle is on firm, level ground with the wheels pointing straight ahead.
-  Switch off the ignition and apply the parking brake.
-  If your vehicle has a manual transmission, select first or reverse gear. If it has an automatic transmission, select park.
-  Have the passengers leave your vehicle.
-  Secure the diagonally opposite wheel with an appropriate block or wheel chock.
-  Make sure that the arrows on directional tires point in the direction of rotation when your vehicle is moving forwards. If you have to fit a spare wheel with the arrows pointing in the opposite direction, have the tire refitted in the correct direction by an authorized dealer.
-  Do not work underneath your vehicle when it is supported only by a jack.
-  Make sure that the jack is vertical to the jacking point and the base is flat on the ground.
-  Do not lay alloy wheels face down on the ground, this will damage the paint.

**Note:** The spare wheel is located on the rear swing gate.

# Wheels and Tires

To remove the spare wheel, slacken the lug nuts (including the locking nut). The locking wheel nut key is located in the luggage compartment, under the floor cover in the tool kit.

1. Loosen each wheel lug nut one-half turn counterclockwise, but do not remove them.
2. Jack up your vehicle until the tire is clear of the ground.
3. Remove the lug nuts and the wheel.

## Removing and Installing a Spare Wheel

**Note:** The spare wheel is located on the rear swing gate.

**Note:** The locking wheel nut key is located in the luggage compartment, under the floor cover in the tool kit.

## Vehicles Without Spare Wheel Cover

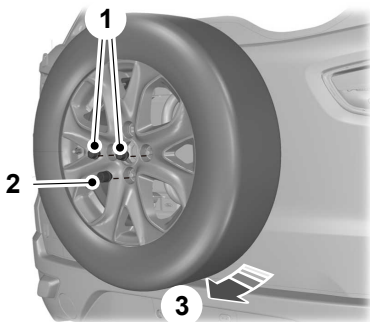

E191028

1. Remove the two nuts.
2. Remove the locking nut.
3. Remove the spare wheel.
4. Install in the reverse order.

## Vehicles With Spare Wheel Cover

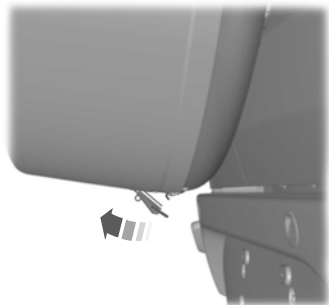

E162830

1. Unlock the outer cover and the inner cover together with the lock bracket at the bottom.



E162831

2. Pull out the outer cover.

# Wheels and Tires

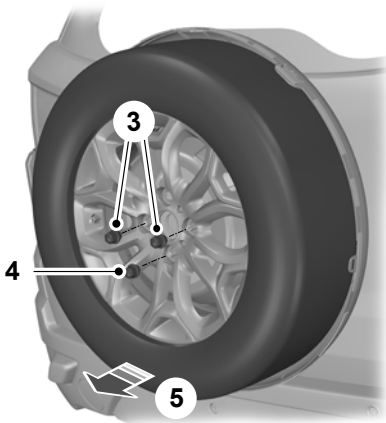



E190642

3. Remove the two nuts.
4. Remove the locking nut.
5. Remove the spare wheel.
6. Install in the reverse order.

## Installing a Road Wheel

### WARNINGS

 Use only approved wheel and tire sizes. Using other sizes could damage your vehicle. See **Technical Specifications** (page 141).

 Do not fit run flat tires on vehicles that were not originally fitted with them. Please contact your dealer for more details regarding compatibility.

### WARNING

 Do not install alloy wheels using lug nuts designed for use with steel wheels.

**Note:** Make sure the wheel and hub contact surfaces are free from foreign matter.

**Note:** Make sure that the cones on the lug nuts are against the wheel.

1. Install the wheel.
2. Install the lug nuts finger tight.

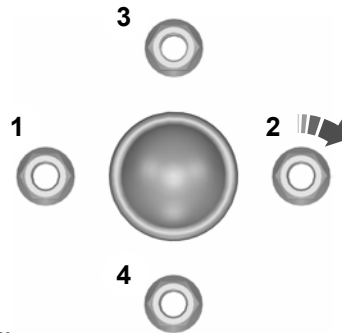

E90589

3. Partially tighten the lug nuts in the sequence shown.
4. Lower your vehicle and remove the jack.
5. Fully tighten the lug nuts in the sequence shown. See **Technical Specifications** (page 141).

### WARNING

 Have the lug nuts checked for tightness and the tire pressure checked as soon as possible.

# Wheels and Tires

## TECHNICAL SPECIFICATIONS

### Wheel Nut Torque

Wheel type	lb-ft (Nm)
Road wheels	100 (135)
Spare wheel when mounted on the tailgate	41 (55)

### Tire Pressures (Cold Tires)

Variant	Tire size	Normal load		Full load	
		Front	Rear	Front	Rear
		lbf/in <sup>2</sup> (bar)	lbf/in <sup>2</sup> (bar)	lbf/in <sup>2</sup> (bar)	lbf/in <sup>2</sup> (bar)
All engines	195/65 R15	30 (2.1)	30 (2.1)	35 (2.4)	40 (2.7)
All engines	205/60 R16	30 (2.07)	30 (2.1)	35 (2.4)	40 (2.7)

# Capacities and Specifications

## VEHICLE IDENTIFICATION PLATE

**Note:** Your vehicle identification plate design may vary to that shown.

**Note:** The information shown on the vehicle identification plate is dependent upon market requirements.

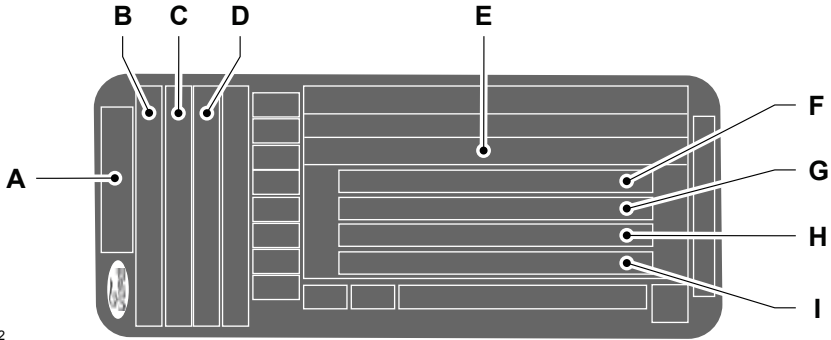

E135662

- A Model
- B Variant
- C Engine designation
- D Engine power and emission level
- E Vehicle identification number
- F Gross vehicle weight
- G Gross train weight
- H Maximum front axle weight
- I Maximum rear axle weight

Your vehicle identification number and maximum weights are shown on a plate, located at the bottom of the lock side of the right-hand door aperture.



# Capacities and Specifications

## VEHICLE IDENTIFICATION NUMBER

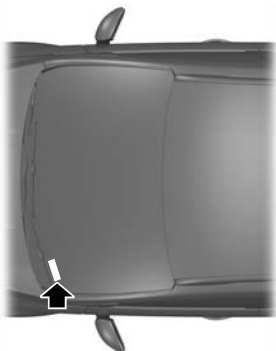

E163915

The vehicle identification number is on the left-hand side of the instrument panel.

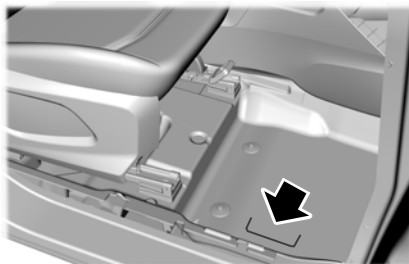

E163913

The vehicle identification number is also stamped into the floor panel, in front of the passenger front seat.

# Capacities and Specifications

## TECHNICAL SPECIFICATIONS

### Vehicle dimensions

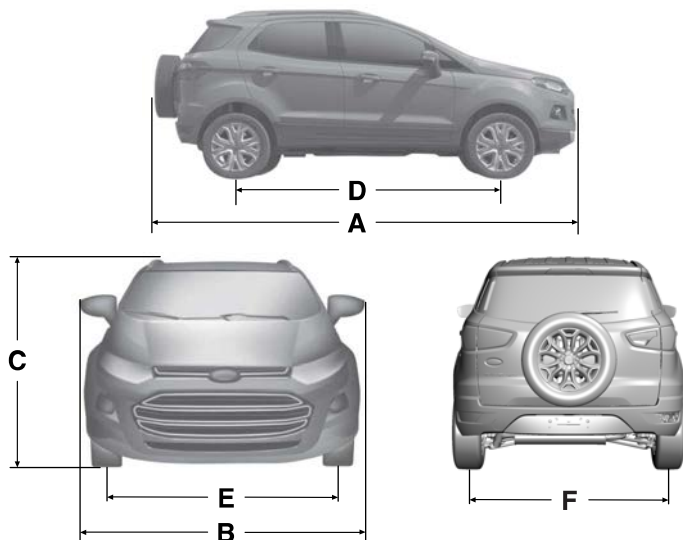

E147763

<b>Dimension description</b>	<b>Dimension in mm</b>
Maximum length	4245
Overall width including exterior mirrors	2057
Overall height	1708
Wheelbase	2521
Front track	1519
Rear track	1524

# Audio System

## GENERAL INFORMATION

### Radio Frequencies and Reception Factors

Radio reception factors	
Distance and Strength	The further you travel away from an FM station, the weaker the signal and the weaker the reception.
Terrain	Hills, mountains, tall buildings, bridges, tunnels, freeway overpasses, parking garages, dense tree foliage and thunderstorms can interfere with the reception.
Station overload	When you pass near a radio transmission tower, a stronger signal can override a weaker signal and can cause interference in the audio system.

### CD and CD Player Information

**Note:** *CD units play commercially pressed 4.75-inch (12 centimeter) audio compact discs only. Due to technical incompatibility, certain recordable and re-recordable compact discs may not function correctly when used in Ford CD players.*

**Note:** *Do not insert CDs with homemade paper (adhesive) labels into the CD player as the label may peel and cause the CD to become jammed. You should use a permanent felt tip marker rather than adhesive labels on your homemade CDs. Ballpoint pens may damage CDs. Please contact an authorized dealer for further information.*

**Note:** *Do not use any irregularly shaped discs or discs with a scratch protection film attached.*

Always handle discs by their edges only. Clean the disc with an approved CD cleaner only. Wipe it from the center of the disc toward the edge. Do not clean in a circular motion.

Do not expose discs to direct sunlight or heat sources for extended periods.

### MP3 and WMA Track and Folder Structure

Audio systems capable of recognizing and playing MP3 and WMA individual tracks and folder structures work as follows:

- There are two different modes for MP3 and WMA disc playback: MP3 and WMA track mode (system default) and MP3 and WMA folder mode.
- MP3 and WMA track mode ignores any folder structure on the MP3 and WMA disc. The player numbers each MP3 and WMA track on the disc (noted by the MP3 or WMA file extension) from T001 to a maximum of T255. The maximum number of playable MP3 and WMA files may be less depending on the structure of the CD and exact model of radio present.

# Audio System

---

- MP3 and WMA folder mode represents a folder structure consisting of one level of folders. The CD player numbers all MP3 and WMA tracks on the disc (noted by the MP3 or WMA file extension) and all folders containing MP3 and WMA files, from F001 (folder) T001 (track) to F253 T255.
- Creating discs with only one level of folders helps with navigation through the disc files.

If you are burning your own MP3 and WMA discs, it is important to understand how the system reads the structures you create. While various files may be present, (files with extensions other than MP3 and WMA), only files with the MP3 and WMA extension are played; other files are ignored by the system. This enables you to use the same MP3 and WMA disc for a variety of tasks on your work computer, home computer and your in-vehicle system.

In track mode, the system displays and plays the structure as if it were only one level deep (all MP3 and WMA files play, regardless of being in a specific folder). In folder mode, the system only plays the MP3 and WMA files in the current folder.

## AUDIO UNIT - VEHICLES WITH: BLUETOOTH

### WARNING



Driving while distracted can result in loss of vehicle control, crash and injury. We strongly recommend that you use extreme caution when using any device that may take your focus off the road. Your primary responsibility is the safe operation of your vehicle. We recommend against the use of any handheld device while driving and encourage the use of voice-operated systems when possible. Make sure you are aware of all applicable local laws that may affect the use of electronic devices while driving.

---

# Audio System

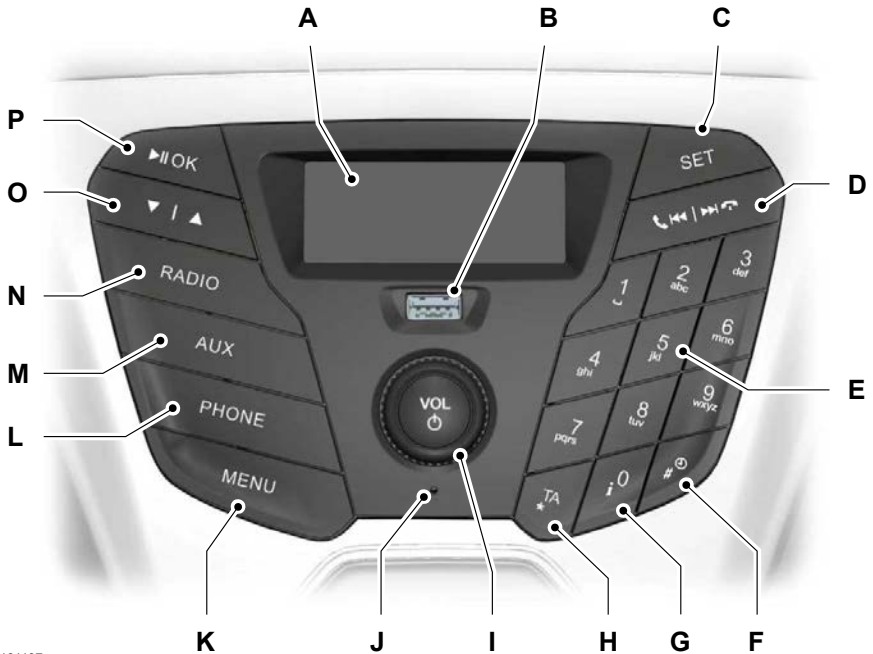

E161197

- A **Display:** Shows the status of the current mode selected.
- B **USB socket:** Insert to play audio from a compatible external device or memory stick.
- C **SET:** Press the button to adjust the sound settings for bass, treble, balance and fade.
- D **Seek up:** Press the button to go to the next station up the radio frequency band or the next track. **Seek down:** Press the button to go to the next station down the radio frequency band or the previous track. In Bluetooth audio and USB modes press the buttons to go to the next or previous track.
- D **Dial and end call:** Press the button to make and end a call.
- E **Numeric keypad:** Press the button to recall a previously stored station. To store a favorite station press and hold until the sound returns.
- F **Clock:** Press the button to select clock setup.

# Audio System

---

- G **Information:** Press the button to access more information if it does not fit the display.
- H **TA:** Press the button to turn traffic announcements on or off and cancel announcements during an active announcement.
- I **On, Off and Volume:** Press the button to switch the audio system on or off. Turn the dial to adjust the volume.
- J **Microphone:** Cell phone microphone.
- K **MENU:** Press the button to access different audio system features, depending on which mode has been selected.
- L **PHONE:** Press the button to access the Bluetooth phone feature of the system by pressing **PHONE** then **MENU**. When paired further presses of this button will display phone name, signal strength and the battery level.
- M **AUX:** Press the button to access Bluetooth audio streaming, USB or Aux input playback.
- N **RADIO:** Press the button to select different radio bands. Press to cancel the menu or list browsing.
- O **Cursor up and down:** Press a button to scroll through on-screen choices. In radio mode press to manual tune.
- P **OK, Play and Pause:** Press the button to confirm on-screen selections. Press to play or pause during playback with compatible external devices.

## Set Button

This will allow you to adjust the sound settings (for example bass, treble, balance and fade).

1. Press the **SET** button until the required setting is displayed.
2. Use the up and down arrow buttons to select the required level.
3. Press the **OK** button to confirm the new settings.

## Waveband Button

Press the **RADIO** button to select from the wavebands available.

You can use the button to return to radio reception when you have been listening to another source.

## Station Tuning Control

### Seek Tuning

Select a waveband and briefly press one of the seek buttons. The unit will stop at the first station it finds in the direction you have chosen.

### Manual Tuning

Use the up and down arrow buttons to tune down or up the waveband in small increments or press and hold to increment quickly, until you find a station you want to listen to.

## Station Preset Buttons

This feature allows you to store your favorite stations. They can be recalled by selecting the appropriate waveband and pressing one of the preset buttons.

# Audio System

---

1. Select a waveband.
2. Tune to the station required.
3. Press and hold one of the preset buttons. A progress bar and message will appear. When the progress bar completes the station has been stored. The audio unit will also mute momentarily as confirmation.

You can repeat this on each waveband and for each preset button.

**Note:** *When you drive to another part of the country, stations that broadcast on alternative frequencies, and are stored on preset buttons, may be updated with the correct frequency and station name for that area.*

## Traffic Information Control

Many stations that broadcast on the FM waveband have a TP code to signify that they carry traffic program information.

## Turning Traffic Announcements On and Off

Before you can receive traffic announcements, you must press the **TA** button. A TA display will appear to show the feature is switched on.

If you are already tuned to a station that broadcasts traffic information, TP will also be displayed. Otherwise the unit will search for a traffic program.

When traffic information is broadcast, it will automatically interrupt normal radio or device playback.

If a non-traffic station is selected or recalled using a preset button, the audio unit will remain on that station unless **TA** is turned off, then on again.

**Note:** *If traffic announcement is on and you select a preset or manual tune to a non traffic announcement station no traffic announcement will be heard.*

**Note:** *When you are listening to a non traffic announcement station and turn traffic announcement off and on again a TP seek will occur.*

## Traffic Announcement Volume

Traffic announcements interrupt normal broadcasts at a preset minimum level that is usually louder than normal listening volumes.

To adjust the preset volume use the volume control to make the necessary adjustment during an incoming traffic announcement broadcast. The display will show the level selected.

## Ending Traffic Announcements

The audio unit will return to normal operation at the end of each traffic announcement. To end the announcement prematurely, press **TA** during the announcement.

**Note:** *If you press TA at any other time it will switch all announcements off.*

## News Broadcasts

Your audio unit may interrupt normal reception to broadcast news bulletins from stations on the FM waveband, radio data system or other enhanced network linked stations.

The display will indicate there is an incoming announcement, during news broadcasts. When the audio unit interrupts for a news broadcast the preset volume level will be the same as traffic announcements.

1. Press the **MENU** button.
2. Scroll to **NEWS** and turn on or off with the up and down arrow buttons.
3. Press the **OK** button to return.

# Audio System

---

## Alternative Frequencies

The majority of programs that broadcast on the FM waveband have a program identification code, it can be recognized by audio units.

When your vehicle moves from one transmission area to another with the alternative frequencies tuning switched on, this function will search for the strongest station signal.

Under certain conditions, however, alternative frequencies tuning may temporarily disrupt normal reception.

When selected, the unit continually evaluates signal strength and, if a better signal becomes available, the unit will switch to that alternative. It mutes while it checks a list of alternative frequencies and if necessary, it will search once across the selected waveband for a genuine alternative frequency.

It will restore radio reception when it finds one or if one is not found, the unit will return to the original stored frequency.

When selected, AF will appear in the display.

1. Press the **MENU** button.
2. Scroll to **AF** and turn to auto or off with the up and down arrow buttons.
3. Press the **OK** button to return.

## Regional Mode

Regional mode controls the behavior of alternative frequencies switching between regionally related networks of a parent broadcaster. A broadcaster may run a fairly large network across a large part of the country. At various times of the day this

large network may be broken down into a number of smaller regional networks, typically centered on major towns or cities. When the network is not split into regional variants, the whole network carries the same programming.

**Regional mode on:** This prevents random alternative frequency switches when neighboring regional networks are not carrying the same programming.

**Regional mode off:** This allows a larger coverage area if neighboring regional networks are carrying the same programming, but can cause random alternative frequency switches if they are not.

1. Press the **MENU** button.
2. Scroll to **REGION** and turn on or off with the up and down arrow buttons.
3. Press the **OK** button to return.

## Phone

**Note:** *Using the system with the engine off will drain the battery.*

**Note:** *As no common agreement exists, cell phone manufacturers are able to implement a variety of profiles in their Bluetooth devices. Because of this, an incompatibility can occur between the phone and hands free system, which in some cases may significantly degrade the system performance. To avoid this situation, only recommended phones should be used. To check your cell phone's compatibility, refer to your device's manual or visit the regional Ford website.*

This section describes the functions and features of the Bluetooth cell phone hands free system.



# Audio System

---

The Bluetooth cell phone part of the system provides interaction with the audio system and your cell phone. It allows you to use the audio system to make and receive calls without having to hold your cell phone.

## Bluetooth Setup

**Note:** Up to five Bluetooth devices can be paired to the system.

**Note:** If there is an ongoing call when the phone in use is selected as the new active phone, the call is transferred to the vehicle audio system.

**Note:** Even if connected to the system, your phone can still be used in the usual way.

**Note:** A call will be disconnected if the audio unit is switched off. If the ignition is switched off the phone call will remain in progress.

Before you can use your cell phone with your vehicle it must be paired to the audio system.

The following procedure is required before an initial Bluetooth phone connection can be made.

1. Press the **PHONE** button and then keep pressing the **MENU** button to scroll to the **ADD DEVICE** display. Press the **OK** button.
2. Press the **OK** button again and note the six digit number displayed.
3. Search for Bluetooth devices using the cell phone. For information on phone settings, refer to your phone user guide.
4. Select **FORD AUDIO** from the list of Bluetooth devices found by your phone.

5. Enter the six digit number into your phone when prompted to pair the audio system and phone. If the audio display changes to **SECURE PIN**, together with a different six digit number you do not need to enter a code into your phone. Check the number on the audio display matches the number displayed on your phone and confirm pairing if prompted.
6. Once pairing has been successful **SET PRIMARY** will be displayed on the audio display.
7. Press the **OK** button twice to confirm your phone as the primary device for all future connections.
8. **LOAD PHONEBK** will then be displayed on the audio unit. Press the **OK** button twice to confirm that the contents of your phonebook are downloaded to the system.
9. The Bluetooth device name is displayed on the audio unit.

## Phonebook Downloading

If your phonebook was not downloaded during initial Bluetooth pairing follow this process:

1. Press the **PHONE** button and then keep pressing the **MENU** button to scroll to the **LOAD PHONEBK** display.
2. Press the **OK** button.

# Audio System

---

## Deleting a Paired Device or Phone

To remove a paired device follow this process:

1. Press the **PHONE** button and then keep pressing the **MENU** button to scroll to the **DEL DEVICE** display.
2. Press the **OK** button. The first paired device name will be shown. Scroll to the required device name using the up and down arrow buttons. Select delete all to erase all paired devices.
3. Press the **OK** button multiple times to unpair the device from the audio unit.

## Privacy Mode

You can transfer a call from hands free to private mode during an active call.

Press the **MENU** button until **PRIVACY** appears, then press the **OK** button to transfer. To return to hands free mode, press the dial button.

## Phone Menu Options

Press the **PHONE** button to select phone mode. Press the **PHONE** button again to display information such as phone name, signal strength and battery level.

When in phone mode, press the **MENU** button to scroll through the various phone options:

- Redial.
- Phonebook.
- Call History.
- Add Device.
- Select Device.
- Set Primary.
- Delete Device.
- Bluetooth on and off.
- Load Phonebook.

Press the **OK** button to select the required option, and use the up and down arrows to change features.

## Making and Receiving Calls

Outgoing calls can be made by:

- entering a number using the keys on the radio
- selecting a contact from the downloaded phonebook
- selecting a number or contact from the call history log
- using quick dial by pressing one of the radio preset buttons
- using the redial function
- using the cell phone.

Incoming calls can be answered by:

- pressing the call pickup button on the audio unit
- using the cell phone.

Calls can be rejected using the end call button on the audio unit, or by using the cell phone directly.

## USB

**Note:** Only use USB Mass-Storage device compliant devices.

**Note:** Always switch your audio unit to a different source (for example the radio) before unplugging the USB device.

**Note:** Do not install or connect USB hubs or splitters.

**Note:** The system is only designed to recognize and read suitable audio files from a USB device that conforms to the USB Mass-Storage device class or an iPod. Not all available USB devices can be guaranteed to function with the system.

# Audio System

**Note:** It is possible to connect compatible devices with a trailing USB lead as well as those that plug into the USB socket directly (for example USB memory sticks and pen drives).

**Note:** Some USB devices with a higher power consumption may not be compatible (for example some larger hard drives).

**Note:** Access time to read the files on the external device will vary depending upon factors such as the file structure, size and device content.

The audio unit supports a range of external devices. Once connected, control of the external device is possible via the audio unit.

## Operating the USB Device

**Note:** USB playback will start automatically when you connect a compatible device. To turn this feature off, select **AUTOPL** and then select **OFF** using the menu function.

Connect the device to the audio unit.

Select the USB device as the audio source by pressing the **AUX** button until the USB screen appears in the display. After first connecting the USB device, the first track within the first folder will start to play automatically. Following audio source switching, the position of playback on the USB device is remembered.

Press the seek up and down keys to skip backward and forward through tracks. Press and hold to fast forward and reverse through the track.

## iPod

Connect the iPod to the audio unit.

Select the iPod as the audio source by pressing the **AUX** button until **IPOD** appears in the display. After first connecting the iPod, the first track within the first folder will start to play automatically. Following audio source switching, the position of playback on the iPod is remembered.

Press the seek up and down keys to skip backward and forward through tracks.

Press and hold the seek keys to enable fast rewind or fast forward through track content.

Various functions may be controlled from the audio unit including:

- Next and previous track select.
- Track seek.
- Shuffle.
- Repeat.

## Bluetooth Audio Streaming

**Note:** Make sure the device is paired before using this feature.

Compatible Bluetooth devices can be connected to the audio unit to playback using the vehicle audio system.

Select the device as the audio source by pressing the **AUX** button until **BT AUDIO** appears in the display.

The device playback can be controlled using the audio unit buttons play, pause, next and previous track.

## AUDIO UNIT - VEHICLES WITH: AM/FM/CD

### WARNINGS



Radio sound levels can go above 85dB. Listening to sounds about 85 decibels can harm the human auditory system.

# Audio System

## WARNINGS



Driving while distracted can result in loss of vehicle control, crash and injury. We strongly recommend that you use extreme caution when using any device that may take your focus off the road. Your primary responsibility is the safe operation of your vehicle. We recommend

## WARNINGS

against the use of any hand-held device while driving and encourage the use of voice-operated systems when possible. Make sure you are aware of all applicable local laws that may affect the use of electronic devices while driving.

**Note:** Some systems do not have a CD player.

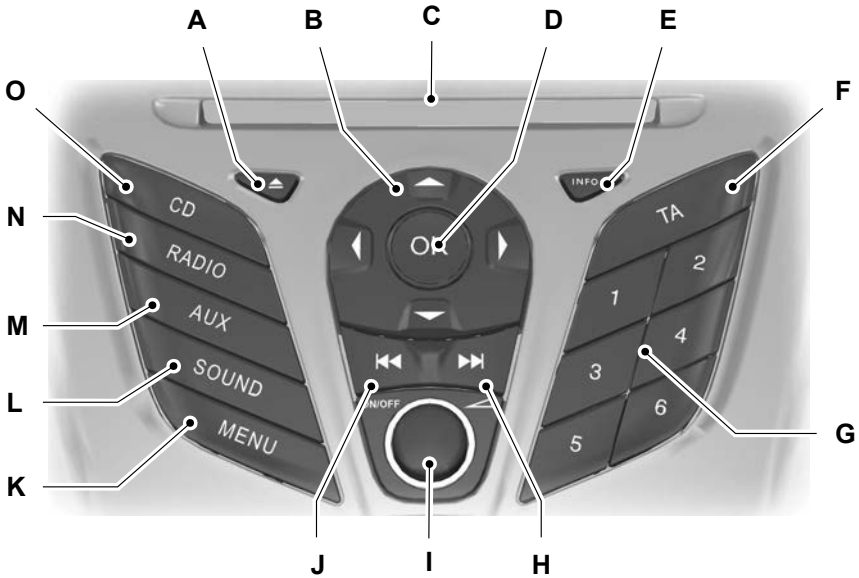

E130324

- A Ejects a CD.
- B Cursor arrows allow you to scroll through on-screen choices.
- C CD slot is where you insert a CD.
- D OK confirms on-screen selections.
- E INFO allows you to access radio, CD, USB and iPod information.
- F TA allows you to turn traffic announcements on or off.

# Audio System

---

- G Number block allows you to store your favorite radio stations. When tuned to a station, press and hold a button until sound returns. Press to recall a previously stored station.
- H Seek allows you to go to the next station up the radio frequency band or the next track on a CD or USB device.
- I ON/OFF and Volume allows you to switch the audio system on or off by pressing the button. Turn the dial to adjust the volume.
- J Seek allows you to go to the next station down the radio frequency band or the previous track on a CD or USB device.
- K MENU allows you to access different audio system features.
- L SOUND allows you to adjust the sound settings for Treble, Middle, Bass, Fade and Balance.
- M AUX allows you to access the AUX and SYNC features, and cancels menu or list browsing.
- N RADIO allows you to select different radio bands, and cancels menu or list browsing.
- O Change source to CD, and cancels menu or list browsing.

## Sound Button

This allows you to adjust the sound settings (such as bass, middle and treble).

1. Press **SOUND**.
2. Use the up and down arrow buttons to select the required setting.
3. Use the left and right arrow buttons to make the necessary adjustment. The display indicates the level selected.
4. Press the **OK** button to confirm the new settings.

## Waveband Button

Press **RADIO** to select from the wavebands available.

You can use the selector to return to radio reception when you have been listening to another source.

Alternatively, press the left arrow button to display the available wavebands. Scroll to the required waveband and press **OK**.

## Station Tuning Control

### Seek Tuning

Select a waveband and briefly press one of the seek buttons. The unit stops at the first station it finds in the direction you have chosen.

### Manual Tuning

1. Press **MENU**.
2. Select RADIO mode, and then MANUAL TUNE.
3. Use the left and right arrow buttons to tune down or up the waveband in small increments or press and hold to increment quickly, until you find the desired station.
4. Press **OK** to continue listening to a station.

### Scan Tuning

Scan allows you to listen to a few seconds of each station detected.

# Audio System

---

1. Press **MENU**.
2. Select RADIO mode and then SCAN.
3. Use the seek buttons to scan up or down the selected waveband.
4. Press **OK** to continue listening to a station.

## Station Preset Buttons

This feature allows you to store your favorite stations. You can recall them by selecting the appropriate waveband and pressing one of the preset buttons.

1. Select a waveband.
2. Tune to the station required.
3. Press and hold one of the preset buttons. A progress bar and message appear. When the progress bar completes the station has been stored. The audio unit briefly mutes as confirmation.

You can repeat this on each waveband and for each preset button.

**Note:** *When you drive to another part of the country, stations that broadcast on alternative frequencies, and are stored on preset buttons, may update with the correct frequency and station name for that area.*

## Autostore Control

**Note:** *This stores up to a maximum of the 10 strongest signals available, either from the AM or the FM waveband, and overwrite the previously stored stations. You can also store stations manually in the same way as other wavebands.*

- Press **MENU**, select RADIO mode, then press AUTOSTORE.
- When the search is complete, sound returns and the strongest signals are stored on the autostore presets.

## Traffic Information Control

Many stations that broadcast on the FM waveband have a TP code to signify that they carry traffic program information.

### Turning Traffic Announcements On and Off

Before you can receive traffic announcements, you must press either the **TA** or **TRAFFIC** button. A TA display appears to show the feature is on.

If you are listening to a station that broadcasts traffic information, TP also displays. Otherwise, the unit searches for a traffic program.

When traffic information broadcasts, it automatically interrupts normal radio or CD playback and Traffic announcement appears in the display.

If you select a non-traffic station using a preset button, the audio unit remains on that station unless you turn TA or TRAFFIC off, then on again.

**Note:** *If traffic announcement is on and you select a preset or manually tune to a non-traffic announcement station, you do not hear traffic announcements.*

**Note:** *When you are listening to a non-traffic announcement station and turn traffic announcement off and on again, a TP seek occurs.*

## Traffic Announcement Volume

Traffic announcements interrupt normal broadcasts at a preset minimum level that is usually louder than normal listening volumes.

To adjust the preset volume:

- Use the volume control to make the necessary adjustment during an incoming traffic announcement broadcast. The display shows the selected level.

# Audio System

---

## Ending Traffic Announcements

The audio unit returns to the previous settings at the end of each traffic announcement. To end a traffic announcement early, press any button.

**Note:** *If you press **TA** or **TRAFFIC** at any other time, it switches all announcements off.*

## Automatic Volume Control

When available, automatic volume control adjusts the volume level to compensate for engine noise and road speed noise.

1. Press **MENU**, and then select AUDIO or AUDIO SETTINGS.
2. Select AVC LEVEL or ADAPTIVE VOL.
3. Use the left or right arrow button to adjust the setting.
4. Press **OK** to confirm your selection.
5. Press **MENU** to return.

## News Broadcasts

Your audio unit may interrupt normal reception to broadcast news bulletins from stations on the FM waveband, radio data system or other enhanced network linked stations.

The display indicates there is an incoming announcement during news broadcasts. When the audio unit interrupts for a news broadcast, the preset volume level is the same as traffic announcements.

1. Press **MENU**.
2. Select AUDIO or AUDIO SETTINGS.
3. Scroll to NEWS and turn on or off by pressing **OK**.
4. Press **MENU** to return.

## Alternative Frequencies

The majority of programs that broadcast on the FM waveband have a program identification code that audio units can recognize.

When your vehicle moves from one transmission area to another with the alternative frequencies tuning switched on, this function searches for the strongest station signal.

Under certain conditions, however, alternative frequencies tuning may temporarily disrupt normal reception.

When selected, the unit continually evaluates signal strength and if a better signal becomes available, the unit switches to that alternative. It mutes while it checks a list of alternative frequencies and if necessary, it searches once across the selected waveband for a genuine alternative frequency.

It restores radio reception when it finds one or, if it cannot find one, returns to the original stored frequency.

When selected, **AF** appears in the display.

1. Press **MENU**.
2. Select AUDIO or AUDIO SETTINGS.
3. Scroll to ALTERNAT FREQ. or ALTERNATIVE FREQ. and turn on or off by pressing **OK**.
4. Press **MENU** to return.

## Regional Mode

Regional mode controls the behavior of alternative frequencies switching between regionally related networks of a parent broadcaster. A broadcaster may run a large network across a large part of the country. At various times of the day this large

# Audio System

---

network may be broken down into a number of smaller regional networks, typically centered on major towns or cities. When not split into these smaller variants, the whole network carries the same programming.

Regional mode ON: This prevents random alternative frequency switches when neighboring regional networks are not carrying the same programming.

Regional mode OFF: This allows a larger coverage area if neighboring regional networks carry the same programming, but it can cause random alternative frequency switches if they are not.

1. Press **MENU**.
2. Select **AUDIO** or **AUDIO SETTINGS**.
3. Scroll to **RDS REGIONAL** and turn on or off by pressing **OK**.
4. Press **MENU** to return.

## AUDIO UNIT

### WARNINGS



Radio sound levels can go above 85dB and listening to sounds above 85 decibels can harm the human auditory system. Law 11.291/2006.



Driving while distracted can result in loss of vehicle control, crash and injury. We strongly recommend that you use extreme caution when using any device that may take your focus off the road. Your primary responsibility is the safe operation of your vehicle. We recommend against the use of any hand-held device while driving and encourage the use of voice-operated systems when possible. Make sure you are aware of all applicable local laws that may affect the use of electronic devices while driving.

---



# Audio System

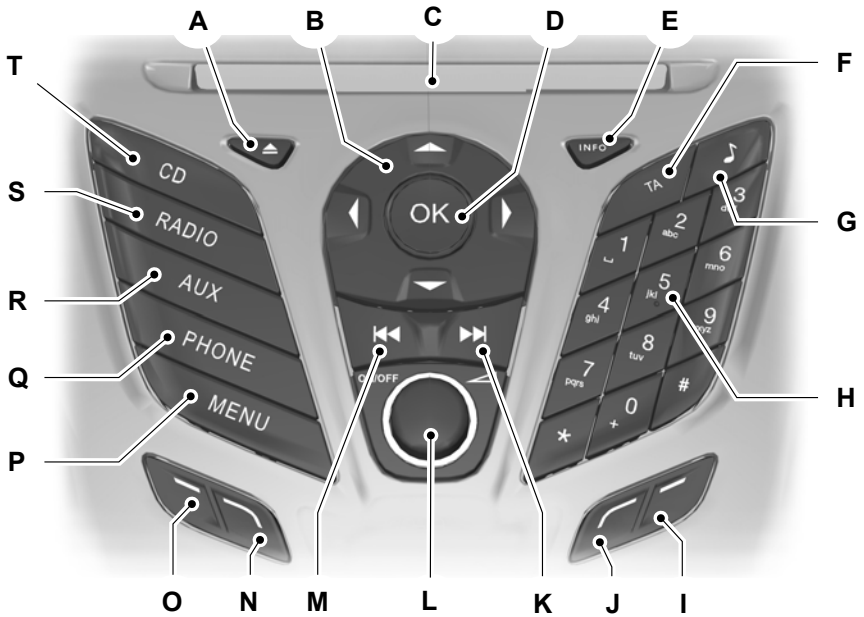

E130142

- A Ejects a CD.
- B Arrow keys let you navigate through the options displayed on the display.
- C Opening access for CD.
- D OK confirms the selections shown on the display.
- E INFO let you access information from CD, USB and iPod.
- F TA allows you to turn traffic announcements on or off.
- G SOUND lets you adjust the sound settings for Treble, Mid, Low, Fade, Balance, Equalizer Settings and DSP.
- H Number block can store your favorite radio stations. When turned to a station, press and hold the button until the station is memorized. Press to go to a station previously stored. In CD mode, press a number to select a track. In phone mode, use the buttons to dial a phone number.
- I Function button allows you to mute the radio or pause a CD. You can also select four different functions of the audio system depending on the listening mode.

# Audio System

---

- J Function button allows you to select three different functions of the audio system depending on the listening mode.
- K Seek allows you to go to the next station up the radio frequency band, or to the next track on a CD, USB, iPod and Bluetooth audio (if your device supports Bluetooth).
- L ON/OFF and Volume allows you to turn on or off the audio system by pressing the button. Turn the knob to adjust the volume.
- M Seek allows you to go to the next station down the radio frequency band or the previous track on a CD, USB, iPod and Bluetooth audio (if your device supports Bluetooth).
- N Function button allows you to select two different functions of the audio system depending on the listening mode.
- O Function button allows you to select different functions of the audio system depending on the listening mode.
- P MENU allows you to access different audio system features.
- Q PHONE allows you to access the phone features of the SYNC system. See separate manual.
- R AUX allows you to access the AUX, USB, iPod, Bluetooth Audio, SYNC and also cancels the scrolling menu or list. See separate manual.
- S RADIO lets you select different radio bands and will also cancel the scrolling menu or list.
- T Change source to CD, will also cancel menu or list browsing.

## Sound Button

This will allow you to adjust the sound settings (for example bass, middle and treble).

1. Press the sound button.
2. Use the up and down arrow buttons to select the required setting.
3. Use the left and right arrow buttons to make the necessary adjustment. The display indicates the level selected.
4. Press the OK button to confirm the new settings.

## Frequency Band Button

Press RADIO to select one of the frequency bands available: AM, AM AST, FM, FM AST.

You can use the selector to return to radio reception when you have been listening to another source.

Alternatively, press the left arrow button to display the available frequency bands. Scroll to the required frequency band and press OK.

## Station Tuning Control

### Seek Tuning

Select a frequency band and briefly press one of the seek buttons. The unit will stop at the first station it finds in the direction you have chosen.

### Manual Tuning

1. Press function button 2.

# Audio System

2. Use the left and right arrow buttons to tune down or up the frequency band in small increments or press and hold to increment quickly, until you find a station you want to listen to.
3. Press OK to continue listening to a station.

## Scan Tuning

Scan allows you to listen to a few seconds of each station detected.

1. To activate, press the function button 3.
2. Use the seek buttons to scan up or down the frequency band.
3. To deactivate, press the function button 3 again or OK to continue listening to a station.

## Station Preset Buttons

This feature allows you to store your favorite stations, they can be recalled by selecting the appropriate frequency band and pressing one of the preset buttons.

1. Select a frequency band.
2. Tune to the station required.
3. Press and hold one of the preset buttons. A progress bar and message will appear. When the progress bar completes the station has been stored. The audio unit will also mute momentarily as confirmation.

You can repeat this on each frequency band and for each preset button.

**Note:** *When you drive to another part of the country, stations that broadcast on alternative frequencies, and are stored on preset buttons, may be updated with the correct frequency and station name for that area.*

## Autostore Control

**Note:** *Stores the 10 strongest signals available in the frequency band AM AST or FM AST, and overwrites the previously stored stations. You can also manual store a station in the same manner as other frequency bands.*

- Press and hold the function button 1. A progress bar and a message will be displayed.
- When the search is complete, sound is restored and the strongest signals are stored on the autostore presets.

## Traffic Information Control (if Equipped)

To receive alerts about traffic, you must press the TA button. A TA symbol is displayed to show that the feature was activated.

## Turning Traffic Announcements On and Off

Before you can receive traffic announcements, you must press either the TA button. A TA display will appear to show the feature is switched on.

If you are already tuned to a station that broadcasts traffic information, TP will also be displayed. Otherwise the unit will search for a traffic program.

When traffic information is broadcast, it will automatically interrupt normal radio or CD playback and Traffic announcement will appear in the display.

If a non-traffic station is selected or recalled using a preset button, the audio unit will remain on that station unless TA is turned off, then on again.

**Note:** *If traffic announcement is on and you select a preset or manual tune to a non traffic announcement station no traffic announcement will be heard.*

# Audio System

---

**Note:** When you are listening to a non traffic announcement station and turn traffic announcement off and on again a TP seek will occur.

## Traffic Announcement Volume

Traffic announcements interrupt normal broadcasts at a preset minimum level that is usually louder than normal listening volumes.

To adjust the preset volume:

- Use the volume control to make the necessary adjustment during an incoming traffic announcement broadcast. The display will show the level selected.

## Ending Traffic Announcements

The audio unit returns to the previous settings at the end of each traffic announcement. To end a traffic announcement early, press any button.

**Note:** If you press **TA** or **TRAFFIC** at any other time, it switches all announcements off.

## Automatic Volume Control

When available, automatic volume control adjusts the volume level to compensate for engine noise and road speed noise.

1. Press the MENU button and AUDIO SETTINGS.
2. Select VOL. ADJUSTABLE.
3. Use the arrow button, left or right, to adjust the setting.
4. Press the OK button to confirm your selection.
5. Press the MENU button to return.

## News Broadcasts

Your audio unit may interrupt normal reception to broadcast news bulletins from stations on the FM frequency band, radio data system or other enhanced network linked stations.

The display will indicate there is an incoming announcement, during news broadcasts. When the audio unit interrupts for a news broadcast the preset volume level will be the same as traffic announcements.

1. Press the MENU button.
2. Select AUDIO SETTINGS.
3. Scroll to NEWS and turn on or off with the OK button.
4. Press the MENU button to return.

## Alternative Frequencies

The majority of programs that broadcast on the FM frequency band have a program identification code, it can be recognized by audio units.

When your vehicle moves from one transmission area to another with the alternative frequencies tuning switched on, this function will search for the strongest station signal.

Under certain conditions, however, alternative frequencies tuning may temporarily disrupt normal reception.

When selected, the unit continually evaluates signal strength and, if a better signal becomes available, the unit will switch to that alternative. It mutes while it checks a list of alternative frequencies and if necessary, it will search once across the selected frequency band for a genuine alternative frequency.

It will restore radio reception when it finds one or if one is not found, the unit will return to the original stored frequency.

# Audio System

---

When selected, AF will be shown in the display.

1. Press the MENU button.
2. Select AUDIO SETTINGS.
3. Scroll to ALTERNAT FREQ. or ALTERNATIVE FREQ. and turn on or off with the OK button.
4. Press the MENU button to return.

## Regional Mode

The regional mode controls the behavior of switching between alternative frequencies list of regional networks of a station. The station can maintain a fairly wide network coverage over a large part of the country. At various times of the day this large network can be separated into several smaller regional networks, typically centralized in major cities or areas. When the network is not divided into regional variants, the entire network broadcasts the same programming.

**Regional mode ON:** This prevents random alternative frequency switches when neighboring regional networks are not carrying the same programming.

**Regional mode OFF:** This allows a larger coverage area if neighboring regional networks are carrying the same programming, but can cause random alternative frequency switches if they are not.

1. Press the MENU button.
2. Select AUDIO SETTINGS.
3. Scroll to RDS REGIONAL and turn on or off with the OK button.
4. Press the MENU button to return.

## COMPACT DISC PLAYER

### Compact Disc Playback

**Note:** *During playback, the display indicates the disc, track and time that have elapsed since the start of the track.*

During radio reception, press **CD** once to start CD playback.

After a disc is loaded, playback starts immediately.

### Track Selection

- Press the seek down button once to replay the current track. If pressed within two seconds of the start of a track, the previous track plays.
- Press the up or down arrow buttons to select the required track, then press **OK**.

You can select a track by using the numeric keypad. Dial the required track number until complete (for example, 1 then 2 for track 12), or dial the number and directly press **OK**.

### Fast Forward and Reverse

Press and hold the seek down or up buttons to search backward or forward within the tracks on the disc.

### Shuffle and Random

Random track playback, also known as shuffle, plays all tracks on the CD in random order.

Press function button 2.

**Note:** *When an MP3 CD is playing, you can have the system shuffle tracks for the whole CD, or within the current folder. Pressing function button 2 toggles these options.*

Use the seek up or down button to select the next track to shuffle, if required.

# Audio System

---

## Repeat Compact Disc Tracks

Press function button 1.

**Note:** *When an MP3 or WMA CD is playing, you can have the system repeat the current track or all tracks within the current folder. Pressing function button 1 toggles these options.*

## Compact Disc Track Scanning

Press function button 3.

**Note:** *When an MP3 or WMA CD is playing, you can have the system scan tracks on the CD or within the current folder. Pressing function button 3 toggles these options.*

## MP3 and WMA File Playback

MP3 (MPEG 1 Audio Layer-3) or WMA (Windows media audio) is a standard technology and format for compressing audio data. This allows a more efficient use of the media.

You can play MP3 files recorded on CD-ROM, CD-R and CD-RW formats. The disc must be in the ISO 9660 level 1 or level 2 format, or Joliet or Romeo in the expansion format. You can also use a disc recorded in multi session.

## ISO 9660 Format

This is the most common international standard for the logical format of files and folders on a CD-ROM.

There are several specification levels. In Level 1, file names must be in the 8.3 format (no more than eight characters in the name, no more than three characters in the extension MP3 and WMA) and in capital letters.

Folder names can be no longer than eight characters. There can be no more than eight folder levels (trees). Level 2 specifications allow file names up to 31 characters long.

Each folder can have up to eight trees.

For Joliet or Romeo in the expansion format, consider these restrictions when configuring your CD writing software.

## Multi Session

This recording method enables adding of data using the track-at-once method.

Conventional CDs begin at a CD control area called the lead-in and end at an area called lead-out. A multi session CD is a CD having multiple sessions, with each segment from lead-in to lead-out regarded as a single session.

CD-Extra: The format that records audio (audio CD data) as tracks on session 1, and records data as tracks on session 2.

Mixed CD: In this format, data records as track 1 and audio (audio CD data) records as track 2.

## File Formats

With formats other than ISO 9660 level 1 and level 2, folder names or file names may not display correctly.

When naming, be sure to add the file extension MP3 or WMA to the file name.

If you put the extension MP3 or WMA to a file other than MP3 or WMA, the unit cannot recognize the file correctly and generates random noise that could damage your speakers.

The following discs take a longer time to start playback.

- A disc recorded with complicated tree structure.
- A disc recorded in multi session.
- A non-finalized disc, where you can add more data.

# Audio System

## Playing a Multi Session Disc

When the first track of the first session is audio CD data only, the audio CD data of the first session plays. Non-audio CD data, MP3 or WMA file information (such as track number and time) displays with no sound.

When the first track of the first session is not audio CD data:

- If an MP3 or WMA file is on the disc, the system skips these file and other data. Audio CD data is not recognized.
- If no MP3 or WMA file is in the disc, nothing plays. Audio CD data is not recognized.

## MP3 and WMA Files Playback Order

The playback order of the folders and files are as shown.

**Note:** *The system skips any folder that does not include an MP3 or WMA file.*

To specify a desired playback order before the folder or file name, input the order by number (for example, 01 or 02) then record the contents onto a disc. The order differs depending on the writing software.

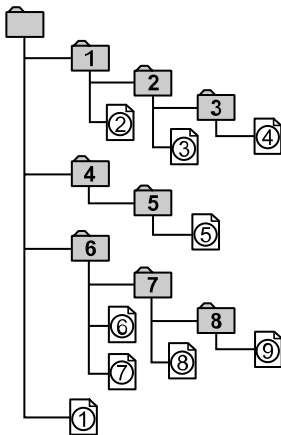

E104206

## ID3 Tag Version 2

The following occurs when an MP3 or WMA file containing a tag plays:

- When skipping a portion of a tag (at the beginning of the track) there is no sound output. Skip time changes depending on the tag capacity. Example: At 64 kbytes, it is about 2 seconds (with RealJukebox).
- The displayed elapsed playing time when skipping a portion of the tag is inaccurate. For MP3 files of a bit rate other than 128 kbps, time does not display accurately during playback.
- When an MP3 file is created with MP3 conversion software (such as RealJukebox - a registered trademark of RealNetworks Inc.), the tag generates automatically.

## MP3 or WMA Navigation

You can record MP3 tracks on the CD in several ways. You can place them in the root directory like a conventional audio CD, or in folders that may represent categories, such as album, artist, or genre.

The normal playing sequence on CDs with multiple folders is:

- Play the tracks within the root (top level) first
- Then the tracks in any folder(s) within the root
- Then move onto the second folder, and so forth.

To navigate to a track:

1. Press the up or down arrow buttons to enter the track list.
2. Navigate the hierarchy using the arrow buttons to select another folder or track (file).
3. Press **OK** to select a highlighted track.

# Audio System

## MP3 and WMA Display Options

When an MP3 or WMA disc is playing, certain information encoded in each track can display. Such information normally includes:

- The file name.
- The folder name.
- ID3 information, which might be the album or artist name.

The unit normally shows the file name that is playing. To select one of the other items of information, press **INFO** repeatedly until the required item appears in the display.

**Note:** If the ID3 information selected is unavailable, **NO MP3** or **WMA TAG** appears in the display.

## CD Text Display Options

When an audio disc with CD text is playing, limited information encoded in each track can display. Such information normally includes:

- The disc name.
- The artist name.
- The track name.

**Note:** You can select these display options in the same way as MP3 displays. **NO DISC NAME** or **NO TRACK NAME** appears in the display if there is no encoded information.

## Ending Compact Disc Playback

To restore radio reception on all units, press **RADIO**.

**Note:** The CD does not eject. The disc pauses at the point where radio reception returned.

To resume CD playback, press **CD** again.

## AUDIO INPUT JACK

### WARNINGS

 Driving while distracted can result in loss of vehicle control, accident and injury. We strongly recommend that you use extreme caution when using any device or feature that may take your focus off the road. Your primary responsibility is the safe operation of your vehicle. We recommend against the use of any handheld device while driving and encourage the use of voice-operated systems when possible. Make sure that you are aware of applicable state and local laws that may affect use of electronic devices while driving.

 For safety reasons, do not connect or adjust the settings on your portable music player while your vehicle is moving.

 Store the portable music player in a secure location, such as the center console or the glove box, when your vehicle is moving. Hard objects may become projectiles in a collision or sudden stop, which may increase the risk of serious injury. The audio extension cable must be long enough to allow the portable music player to be safely stored while your vehicle is moving.

**Note:** You cannot index songs using the auxiliary input jack.



E146367



# Audio System

The auxiliary input jack allows you to connect and play music from your portable music player through your vehicle speakers. You can use any portable music player designed for use with headphones. Your audio extension cable must have male 1/8th-inch (3.5 millimeter) connectors at each end.

1. Switch off the engine, radio and portable music player. Set the parking brake and put the transmission in position **P** (vehicle with an automatic transmission) or neutral (vehicle with a manual transmission).
2. Plug the extension cable from the portable music player into the auxiliary input jack.
3. Switch the radio on. Select either a tuned FM station or a CD.
4. Adjust the volume as desired.
5. Switch your portable music player on and adjust its volume to half its maximum level.

6. Press **AUX** until **LINE** or **LINE IN** appears in the display. You should hear music from your device even if it is low.
7. Adjust the volume on your portable music player until it reaches the volume level of the FM station or CD. Do this by switching back and forth between the AUX and FM or CD controls.

## USB PORT (If Equipped)



The USB port allows you to plug in media playing devices, memory sticks and charge devices (if supported).

## AUDIO TROUBLESHOOTING

Audio unit display	Rectification
Please check CD	General error message for CD fault conditions. For example cannot read the CD, data-CD inserted, etc. Make sure the disc is loaded correctly. Clean and re-try, or replace disc with known music disc. If error persists contact an authorized dealer.
CD drive malfunction	General error message for CD fault conditions. For example a mechanism fault.
CD drive high temp.	Ambient temperature too hot – unit will not work until it has cooled down.





# Appendices

## ELECTROMAGNETIC COMPATIBILITY

### WARNINGS

 Your vehicle has been tested and certified to legislations relating to electromagnetic compatibility (72/245/EEC, UN ECE Regulation 10 or other applicable local requirements). It is your responsibility to make sure that any equipment you have fitted complies with applicable local legislations. Have any equipment fitted by an authorized dealer.

### WARNINGS

-  The radio frequency transmitter equipment (e.g. cellular telephones, amateur radio transmitters etc.) may only be fitted to your vehicle if they keep to the parameters shown in the table below. There are no special provisions or conditions for installations or use.
-  Do not mount any transceiver, microphones, speakers, or any other item in the deployment path of the airbag system.
-  Do not fasten antenna cables to original vehicle wiring, fuel pipes and brake pipes.
-  Keep antenna and power cables at least 4 inches (10 centimeters) from any electronic modules and airbags.

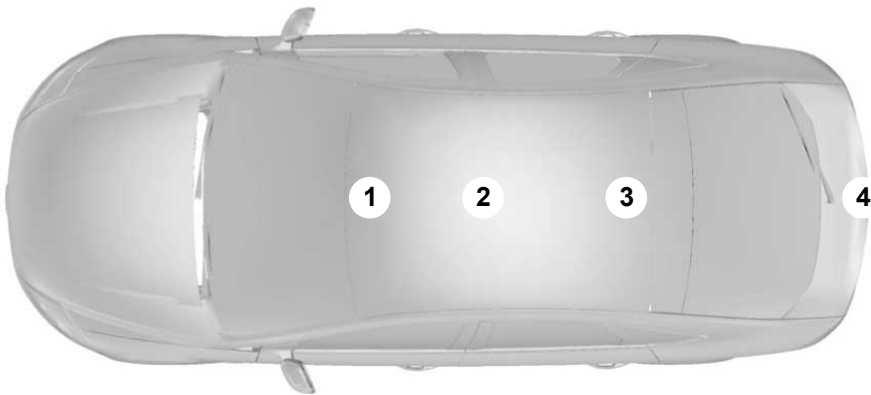

E85998

Frequency Band MHz	Maximum output power Watt (Peak RMS)	Antenna Positions
1 – 30	50 W	3, 4
30 – 54	50 W	1, 2, 3
68 – 87.5	50 W	1, 2, 3

# Appendices

Frequency Band MHz	Maximum output power Watt (Peak RMS)	Antenna Positions
142 – 176	50 W	1, 2, 3
380 – 512	50 W	1, 2, 3
806 – 940	10 W	1, 2, 3
1200 – 1400	10 W	1, 2, 3
1710 – 1885	10 W	1, 2, 3
1885 – 2025	10 W	1, 2, 3

**Note:** After the installation of radio frequency transmitters, check for disturbances from and to all electrical equipment in your vehicle, both in the standby and transmit modes.

Check all electrical equipment:

- with the ignition ON
- with the engine running
- during a road test at various speeds.

Check that electromagnetic fields generated inside your vehicle cabin by the transmitter installed do not exceed applicable human exposure requirements.

## END USER LICENSE AGREEMENT

### SYNC® End User License Agreement (EULA)

- You have acquired a device ("DEVICE") that includes software licensed by Ford Motor Company and its affiliates ("FORD MOTOR COMPANY") from an affiliate of Microsoft Corporation ("MS"). Those installed software products of MS origin, as well as associated media, printed materials,

and "online" or electronic documentation ("MS SOFTWARE") are protected by international intellectual property laws and treaties. The MS SOFTWARE is licensed, not sold. All rights reserved.

- The MS SOFTWARE may interface with and/or communicate with, or may be later upgraded to interface with and/or communicate with additional software and/or systems provided by FORD MOTOR COMPANY. The additional software and systems of FORD MOTOR COMPANY origin, as well as associated media, printed materials, and "online" or electronic documentation ("FORD SOFTWARE") are protected by international intellectual property laws and treaties. The FORD SOFTWARE is licensed, not sold. All rights reserved.

# Appendices

- The MS SOFTWARE and/or FORD SOFTWARE may interface with and/or communicate with, or may be later upgraded to interface with and/or communicate with additional software and/or systems provided by third party software and service suppliers. The additional software and services of third party origin, as well as associated media, printed materials, and "online" or electronic documentation ("THIRD PARTY SOFTWARE") are protected by international intellectual property laws and treaties. The THIRD PARTY SOFTWARE is licensed, not sold. All rights reserved.
- The MS SOFTWARE, FORD SOFTWARE and THIRD PARTY SOFTWARE hereinafter collectively and individually will be referred to as "SOFTWARE".

**IF YOU DO NOT AGREE TO THIS END USER LICENSE AGREEMENT ("EULA") DO NOT USE THE DEVICE OR COPY THE SOFTWARE. ANY USE OF THE SOFTWARE, INCLUDING BUT NOT LIMITED TO USE ON THE DEVICE, WILL CONSTITUTE YOUR AGREEMENT TO THIS EULA (OR RATIFICATION OF ANY PREVIOUS CONSENT).**

**GRANT OF SOFTWARE LICENSE:** This EULA grants you the following license:

- You may use the SOFTWARE as installed on the DEVICE and as otherwise interfacing with systems and/or services provide by or through FORD MOTOR COMPANY or its third party software and service providers.

## **Description of Other Rights and Limitations**

- **Speech Recognition:** If the SOFTWARE includes speech recognition component(s), you should understand that speech recognition is an inherently statistical process and that recognition errors are inherent in the process. Neither FORD MOTOR COMPANY nor its suppliers shall be liable for any damages arising out of errors in the speech recognition process.
- **Limitations on Reverse Engineering, Decompilation and Disassembly:** You may not reverse engineer, decompile, or disassemble nor permit others to reverse engineer, decompile or disassemble the SOFTWARE, except and only to the extent that such activity is expressly permitted by applicable law notwithstanding this limitation.
- **Limitations on Distributing, Copying, Modifying and Creating Derivative Works:** You may not distribute, copy, make modifications to or create derivative works based on the SOFTWARE, except and only to the extent that such activity is expressly permitted by applicable law notwithstanding this limitation.
- **Single EULA:** The end user documentation for the DEVICE and related systems and services may contain multiple EULAs, such as multiple translations and/or multiple media versions (e.g., in the user documentation and in the software). Even if you receive multiple EULAs, you are licensed to use only one (1) copy of the SOFTWARE.

# Appendices

---

- **SOFTWARE Transfer:** You may permanently transfer your rights under this EULA only as part of a sale or transfer of the DEVICE, provided you retain no copies, you transfer all of the SOFTWARE (including all component parts, the media and printed materials, any upgrades, and, if applicable, the Certificate(s) of Authenticity), and the recipient agrees to the terms of this EULA. If the SOFTWARE is an upgrade, any transfer must include all prior versions of the SOFTWARE.
- **Termination:** Without prejudice to any other rights, FORD MOTOR COMPANY or MS may terminate this EULA if you fail to comply with the terms and conditions of this EULA.
- **Security Updates/Digital Rights Management:** Content owners use the WMDRM technology included in your DEVICE to protect their intellectual property, included copyrighted content. Portions of the SOFTWARE on your DEVICE use WMDRM software to access WMDRM-protected content. If the WMDRM software fails to protect the content, content owners may ask Microsoft to revoke the SOFTWARE's ability to use WMDRM to play or copy protected content. This action does not affect unprotected content. When your DEVICE downloads licenses for protected content, you agree that Microsoft may include a revocation list with the licenses. Content owners may require you to upgrade the SOFTWARE on your DEVICE to access their content. If you decline an upgrade, you will not be able to access content that requires the upgrade.
- **Consent to Use of Data:** You agree that MS, Microsoft Corporation, FORD MOTOR COMPANY, third party software and systems suppliers, their affiliates and/or their designated agent may collect and use technical information gathered in any manner as part of product support services related to the SOFTWARE or related services. MS, Microsoft Corporation, FORD MOTOR COMPANY, third party software and services suppliers, their affiliates and/or their designated agent may use this information solely to improve their products or to provide customized services or technologies to you. MS, Microsoft Corporation, FORD MOTOR COMPANY, third party software and systems suppliers, their affiliates and/or their designated agent may disclose this information to others, but not in a form that personally identifies you.
- **Internet-Based Services Components:** The SOFTWARE may contain components that enable and facilitate the use of certain Internet-based services. You acknowledge and agree that MS, Microsoft Corporation, FORD MOTOR COMPANY, third party software and service suppliers, their affiliates and/or their designated agent may automatically check the version of the SOFTWARE and/or its components that you are utilizing and may provide upgrades or supplements to the SOFTWARE that may be automatically downloaded to your DEVICE.
- **Additional Software/Services:** The SOFTWARE may permit FORD MOTOR COMPANY, third party software and service suppliers, MS, Microsoft Corporation, their affiliates and/or their designated agent to provide or make available to you SOFTWARE updates,

# Appendices

---

supplements, add-on components, or Internet-based services components of the SOFTWARE after the date you obtain your initial copy of the SOFTWARE ("Supplemental Components").

If FORD MOTOR COMPANY or third party software and services suppliers provide or make available to you Supplemental Components and no other EULA terms are provided along with the Supplemental Components, then the terms of this EULA shall apply.

If MS, Microsoft Corporation, their affiliates and/or their designated agent make available Supplemental Components, and no other EULA terms are provided, then the terms of this EULA shall apply, except that the MS, Microsoft Corporation or affiliate entity providing the Supplemental Component(s) shall be the licensor of the Supplemental Component(s).

FORD MOTOR COMPANY, MS, Microsoft Corporation, their affiliates and/or their designated agent reserve the right to discontinue without liability any Internet-based services provided to you or made available to you through the use of the SOFTWARE.

- **Links to Third Party Sites:** The MS SOFTWARE may provide you with the ability to link to third party sites through the use of the SOFTWARE. The third party sites are not under the control of MS, Microsoft Corporation, their affiliates and/or their designated agent. Neither MS nor Microsoft Corporation nor their affiliates nor their designated agent are responsible for (i) the contents of any third party sites, any links contained in third party sites, or any changes or updates to third party sites, or (ii) webcasting or any other form of transmission received from any third party sites. If the SOFTWARE provides links to third party sites, those links are provided to you only as a convenience, and the inclusion of any link does not imply an endorsement of the third party site by MS, Microsoft Corporation, their affiliates and/or their designated agent.
- **Obligation to Drive Responsibly:** You recognize your obligation to drive responsibly and keep attention on the road. You will read and abide with the DEVICE operating instructions particularly as they pertain to safety and assumes any risk associated with the use of the DEVICE.

## **UPGRADES AND RECOVERY MEDIA:**

If the SOFTWARE is provided by FORD MOTOR COMPANY separate from the DEVICE on media such as a ROM chip, CD ROM disk(s) or via web download or other means, and is labeled "For Upgrade Purposes Only" or "For Recovery Purposes Only" you may install one (1) copy of such SOFTWARE onto the DEVICE as a replacement copy for the existing SOFTWARE, and use it in accordance with this EULA, including any additional EULA terms accompanying the upgrade SOFTWARE.

# Appendices

---

## **INTELLECTUAL PROPERTY RIGHTS:**

All title and intellectual property rights in and to the SOFTWARE (including but not limited to any images, photographs, animations, video, audio, music, text and "applets" incorporated into the SOFTWARE), the accompanying printed materials, and any copies of the SOFTWARE, are owned by MS, Microsoft Corporation, FORD MOTOR COMPANY, or their affiliates or suppliers. The SOFTWARE is licensed, not sold. You may not copy the printed materials accompanying the SOFTWARE. All title and intellectual property rights in and to the content which may be accessed through use of the SOFTWARE is the property of the respective content owner and may be protected by applicable copyright or other intellectual property laws and treaties. This EULA grants you no rights to use such content. All rights not specifically granted under this EULA are reserved by MS, Microsoft Corporation, FORD MOTOR COMPANY, third party software and service providers, their affiliates and suppliers. Use of any on-line services which may be accessed through the SOFTWARE may be governed by the respective terms of use relating to such services. If this SOFTWARE contains documentation that is provided only in electronic form, you may print one copy of such electronic documentation.

**EXPORT RESTRICTIONS:** You acknowledge that the SOFTWARE is subject to U.S. and European Union export jurisdiction. You agree to comply with all applicable international and national laws that apply to the SOFTWARE, including the U.S. Export Administration Regulations, as well as end-user, end-use and destination restrictions issued by U.S. and other governments. For additional information, see <http://www.microsoft.com/exporting/>.

**TRADEMARKS:** This EULA does not grant you any rights in connection with any trademarks or service marks of FORD MOTOR COMPANY, MS, Microsoft Corporation, third party software or service providers, their affiliates or suppliers.

**PRODUCT SUPPORT:** Product support for the SOFTWARE is not provided by MS, its parent corporation Microsoft Corporation, or their affiliates or subsidiaries. For product support, please refer to FORD MOTOR COMPANY instructions provided in the documentation for the DEVICE. Should you have any questions concerning this EULA, or if you desire to contact FORD MOTOR COMPANY for any other reason, please refer to the address provided in the documentation for the DEVICE.

**No Liability for Certain Damages:** EXCEPT AS PROHIBITED BY LAW, FORD MOTOR COMPANY, ANY THIRD PARTY SOFTWARE OR SERVICES SUPPLIERS, MS, MICROSOFT CORPORATION AND THEIR AFFILIATES SHALL HAVE NO LIABILITY FOR ANY INDIRECT, SPECIAL, CONSEQUENTIAL OR INCIDENTAL DAMAGES ARISING FROM OR IN CONNECTION WITH THE USE OR PERFORMANCE OF THE SOFTWARE. THIS LIMITATION SHALL APPLY EVEN IF ANY REMEDY FAILS OF ITS ESSENTIAL PURPOSE. IN NO EVENT SHALL MS, MICROSOFT CORPORATION AND/OR THEIR AFFILIATES BE LIABLE FOR ANY AMOUNT IN EXCESS OF U.S. TWO HUNDRED FIFTY DOLLARS (U.S. \$250.00).

- THERE ARE NO WARRANTIES OTHER THAN THOSE THAT MAY EXPRESSLY BE PROVIDED FOR YOUR NEW VEHICLE.

# Appendices

---

## Adobe

Contains Adobe® [Flash® Player] or [AIR®] technology by Adobe Systems Incorporated. This [Licensee Product] contains [Adobe® Flash® Player] [Adobe® AIR®] software under license from Adobe Systems Incorporated, Copyright ©1995-2009 Adobe Macromedia Software LLC. All rights reserved. Adobe, Flash and AIR are trademarks of Adobe Systems Incorporated.

## End User Notice

### **Microsoft® Windows® Mobile for Automotive Important Safety Information**

This system Ford SYNC™ contains software that is licensed to Manufacturer FORD MOTOR COMPANY by an affiliate of Microsoft Corporation pursuant to a license agreement. Any removal, reproduction, reverse engineering or other unauthorized use of the software from this system in violation of the license agreement is strictly prohibited and may subject you to legal action.

**Read and follow instructions:** Before using your Windows Automotive-based system, read and follow all instructions and safety information provided in this end user manual ("User's Guide"). Not following precautions found in this User's Guide can lead to an accident or other serious consequences.

**Keep User's Guide in vehicle:** When kept in the vehicle, the User's Guide will be a ready reference for you and other users unfamiliar with the Windows Automotive-based system. Please make certain that before using the system for the first time, all persons have access to the User's Guide and read its instructions and safety information carefully.

## WARNING



Operating certain parts of this system while driving can distract your attention away from the road, and possibly cause an accident or other serious consequences. Do not change system settings or enter data non-verbally (using your hands) while driving. Stop the vehicle in a safe and legal manner before attempting these operations. This is important since while setting up or changing some functions you might be required to distract your attention away from the road and remove your hands from the wheel.

---

## General Operation

**Voice Command Control:** Functions within the Windows Automotive-based system may be accomplished using only voice commands. Using voice commands while driving allows you to operate the system without removing your hands from the wheel.

**Prolonged Views of Screen:** Do not access any function requiring a prolonged view of the screen while you are driving. Pull over in a safe and legal manner before attempting to access a function of the system requiring prolonged attention. Even occasional short scans to the screen may be hazardous if your attention has been diverted away from your driving task at a critical time.

**Volume Setting:** Do not raise the volume excessively. Keep the volume at a level where you can still hear outside traffic and emergency signals while driving. Driving while unable to hear these sounds could cause an accident.



# Appendices

---

## **Use of Speech Recognition Functions:**

Speech recognition software is inherently a statistical process which is subject to errors. It is your responsibility to monitor any speech recognition functions included in the system and address any errors.

**Navigation Features:** Any navigation features included in the system are intended to provide turn by turn instructions to get you to a desired destination. Please make certain all persons using this system carefully read and follow instructions and safety information fully.

**Distraction Hazard:** Any navigation features may require manual (non-verbal) setup. Attempting to perform such set-up or insert data while driving can seriously distract your attention and could cause an accident or other serious consequences. Stop the vehicle in a safe and legal manner before attempting these operations.

**Let Your Judgment Prevail:** Any navigation features are provided only as an aid. Make your driving decisions based on your observations of local conditions and existing traffic regulations. Any such feature is not a substitute for your personal judgment. Any route suggestions made by this system should never replace any local traffic regulations or your personal judgment or knowledge of safe driving practices.

**Route Safety:** Do not follow the route suggestions if doing so would result in an unsafe or illegal maneuver, if you would be placed in an unsafe situation, or if you would be directed into an area that you consider unsafe. The driver is ultimately responsible for the safe operation of the vehicle and therefore, must evaluate whether it is safe to follow the suggested directions.

**Potential Map Inaccuracy:** Maps used by this system may be inaccurate because of changes in roads, traffic controls or driving conditions. Always use good judgment and common sense when following the suggested routes.

**Emergency Services:** Do not rely on any navigation features included in the system to route you to emergency services. Ask local authorities or an emergency services operator for these locations. Not all emergency services such as police, fire stations, hospitals and clinics are likely to be contained in the map database for such navigation features.

## **TeleNav Software End User License Agreement**

Please read these terms and conditions carefully before you use the TeleNav Software. Your use of the TeleNav Software indicates that you accept these terms and conditions. If you do not accept these terms and conditions, do not break the seal of the package, launch, or otherwise use the TeleNav Software.

TeleNav may revise this Agreement and the privacy policy at any time, with or without notice to you. You agree to visit <http://www.telenav.com> from time to time to review the then current version of this Agreement and of the privacy policy.

### **1. Safe and Lawful Use**

You acknowledge that devoting attention to the TeleNav Software may pose a risk of injury or death to you and others in situations that otherwise require your undivided attention, and you therefore agree to comply with the following when using the TeleNav Software: (a) observe all traffic laws and otherwise drive safely; (b) use your own personal judgment while driving. If you feel that a route suggested by the TeleNav Software instructs you to perform an unsafe or illegal maneuver,

# Appendices

---

places you in an unsafe situation, or directs you into an area that you consider to be unsafe, do not follow such instructions; (c) do not input destinations, or otherwise manipulate the TeleNav Software, unless your vehicle is stationary and parked; (d) do not use the TeleNav Software for any illegal, unauthorized, unintended, unsafe, hazardous, or unlawful purposes, or in any manner inconsistent with this Agreement; (e) arrange all GPS and wireless devices and cables necessary for use of the TeleNav Software in a secure manner in your vehicle so that they will not interfere with your driving and will not prevent the operation of any safety device (such as an airbag).

You agree to indemnify and hold TeleNav harmless against all claims resulting from any dangerous or otherwise inappropriate use of the TeleNav Software in any moving vehicle, including as a result of your failure to comply with the directions above.

## **2. Account Information**

You agree: (a) when registering the TeleNav Software, to provide TeleNav with true, accurate, current, and complete information about yourself, and (b) to inform TeleNav promptly of any changes to such information, and to keep it true, accurate, current and complete.

## **3. Software License**

Subject to your compliance with the terms of this Agreement, TeleNav hereby grants to you a personal, non-exclusive, non-transferable license (except as expressly permitted below in connection with your permanent transfer of the TeleNav Software license), without the right to sublicense, to use the TeleNav Software (in object code form only) in order to access and use the TeleNav Software. This license shall terminate upon

any termination or expiration of this Agreement. You agree that you will use the TeleNav Software only for your personal business or leisure purposes, and not to provide commercial navigation services to other parties.

### **3.1 License Limitations**

You agree not to do any of the following: (a) reverse engineer, decompile, disassemble, translate, modify, alter or otherwise change the TeleNav Software or any part thereof; (b) attempt to derive the source code, audio library or structure of the TeleNav Software without the prior express written consent of TeleNav; (c) remove from the TeleNav Software, or alter, any of TeleNav's or its suppliers' trademarks, trade names, logos, patent or copyright notices, or other notices or markings; (d) distribute, sublicense or otherwise transfer the TeleNav Software to others, except as part of your permanent transfer of the TeleNav Software; or (e) use the TeleNav Software in any manner that (i) infringes the intellectual property or proprietary rights, rights of publicity or privacy or other rights of any party, (ii) violates any law, statute, ordinance or regulation, including but not limited to laws and regulations related to spamming, privacy, consumer and child protection, obscenity or defamation, or (iii) is harmful, threatening, abusive, harassing, tortuous, defamatory, vulgar, obscene, libelous, or otherwise objectionable; and (f) lease, rent out, or otherwise permit unauthorized access by third parties to the TeleNav Software without advanced written permission of TeleNav.

# Appendices

---

## **4. Disclaimers**

To the fullest extent permissible pursuant to applicable law, in no event will TeleNav, its licensors and suppliers, or agents or employees of any of the foregoing, be liable for any decision made or action taken by you or anyone else in reliance on the information provided by the TeleNav Software. TeleNav also does not warrant the accuracy of the map or other data used for the TeleNav Software. Such data may not always reflect reality due to, among other things, road closures, construction, weather, new roads and other changing conditions. You are responsible for the entire risk arising out of your use of the TeleNav Software. For example but without limitation, you agree not to rely on the TeleNav Software for critical navigation in areas where the well-being or survival of you or others is dependent on the accuracy of navigation, as the maps or functionality of the TeleNav Software are not intended to support such high risk applications, especially in more remote geographical areas.

TELENAV EXPRESSLY DISCLAIMS AND EXCLUDES ALL WARRANTIES IN CONNECTION WITH THE TELENAV SOFTWARE, WHETHER STATUTORY, EXPRESS OR IMPLIED, INCLUDING ALL WARRANTIES WHICH MAY ARISE FROM COURSE OF DEALING, CUSTOM OR TRADE AND INCLUDING, BUT NOT LIMITED TO, THE IMPLIED WARRANTIES OF MERCHANTABILITY, FITNESS FOR A PARTICULAR PURPOSE AND NON-INFRINGEMENT OF THIRD PARTY RIGHTS WITH RESPECT TO THE TELENAV SOFTWARE. Certain jurisdictions do not permit the disclaimer of certain warranties, so this limitation may not apply to you.

## **5. Limitation of Liability**

TO THE EXTENT PERMITTED UNDER APPLICABLE LAW, UNDER NO CIRCUMSTANCES SHALL TELENAV OR ITS LICENSORS AND SUPPLIERS BE LIABLE TO YOU OR TO ANY THIRD PARTY FOR ANY INDIRECT, INCIDENTAL, CONSEQUENTIAL, SPECIAL OR EXEMPLARY DAMAGES (INCLUDING IN EACH CASE, BUT NOT LIMITED TO, DAMAGES FOR THE INABILITY TO USE THE EQUIPMENT OR ACCESS DATA, LOSS OF DATA, LOSS OF BUSINESS, LOSS OF PROFITS, BUSINESS INTERRUPTION OR THE LIKE) ARISING OUT OF THE USE OF OR INABILITY TO USE THE TELENAV SOFTWARE, EVEN IF TELENAV HAS BEEN ADVISED OF THE POSSIBILITY OF SUCH DAMAGES.

NOTWITHSTANDING ANY DAMAGES THAT YOU MIGHT INCUR FOR ANY REASON WHATSOEVER (INCLUDING, WITHOUT LIMITATION, ALL DAMAGES REFERENCED HEREIN AND ALL DIRECT OR GENERAL DAMAGES IN CONTRACT, TORT (INCLUDING NEGLIGENCE) OR OTHERWISE), THE ENTIRE LIABILITY OF TELENAV AND OF ALL OF TELENAV'S SUPPLIERS SHALL BE LIMITED TO THE AMOUNT ACTUALLY PAID BY YOU FOR THE TELENAV SOFTWARE. SOME STATES AND/OR JURISDICTIONS DO NOT ALLOW THE EXCLUSION OR LIMITATION OF INCIDENTAL OR CONSEQUENTIAL DAMAGES, SO THE ABOVE LIMITATIONS OR EXCLUSIONS MAY NOT APPLY TO YOU.

## **6. Arbitration and Governing Law**

You agree that any dispute, claim or controversy arising out of or relating to this Agreement or the TeleNav Software shall be settled by independent arbitration involving a neutral arbitrator and administered by the American Arbitration Association in the County of Santa Clara, California. The arbitrator shall apply the

# Appendices

---

Commercial Arbitration Rules of the American Arbitration Association, and the judgment upon the award rendered by the arbitrator may be entered by any court having jurisdiction. Note that there is no judge or jury in an arbitration proceeding and the decision of the arbitrator shall be binding upon both parties. You expressly agree to waive your right to a jury trial.

This Agreement and performance hereunder will be governed by and construed in accordance with the laws of the State of California, without giving effect to its conflict of laws provisions. To the extent judicial action is necessary in connection with the binding arbitration, both TeleNav and you agree to submit to the exclusive jurisdiction of the courts of the County of Santa Clara, California. The United Nations Convention on Contracts for the International Sale of Goods shall not apply.

## **7. Assignment**

You may not resell, assign, or transfer this Agreement or any of your rights or obligations, except in totality, in connection with your permanent transfer of the TeleNav Software, and expressly conditioned upon the new user of the TeleNav Software agreeing to be bound by the terms and conditions of this Agreement. Any such sale, assignment or transfer that is not expressly permitted under this paragraph will result in immediate termination of this Agreement, without liability to TeleNav, in which case you and all other parties shall immediately cease all use of the TeleNav Software. Notwithstanding the foregoing, TeleNav may assign this Agreement to any other party at any time without notice, provided the assignee remains bound by this Agreement.

## **8. Miscellaneous**

### **8.1**

This Agreement constitutes the entire agreement between TeleNav and you with respect to the subject matter hereof.

### **8.2**

Except for the limited licenses expressly granted in this Agreement, TeleNav retains all right, title and interest in and to the TeleNav Software, including without limitation all related intellectual property rights. No licenses or other rights which are not expressly granted in this Agreement are intended to, or shall be, granted or conferred by implication, statute, inducement, estoppel or otherwise, and TeleNav and its suppliers and licensors hereby reserve all of their respective rights other than the licenses explicitly granted in this Agreement

### **8.3**

By using the TeleNav Software, you consent to receive from TeleNav all communications, including notices, agreements, legally required disclosures or other information in connection with the TeleNav Software (collectively, "Notices") electronically. TeleNav may provide such Notices by posting them on TeleNav's Website or by downloading such Notices to your wireless device. If you desire to withdraw your consent to receive Notices electronically, you must discontinue your use of the TeleNav Software.

### **8.4**

TeleNav's or your failure to require performance of any provision shall not affect that party's right to require performance at any time thereafter, nor shall a waiver of any breach or default of this Agreement constitute a waiver of any subsequent breach or default or a waiver of the provision itself.

# Appendices

## 8.5

If any provision herein is held unenforceable, then such provision will be modified to reflect the intention of the parties, and the remaining provisions of this Agreement will remain in full force and effect

## 8.6

The headings in this Agreement are for convenience of reference only, will not be deemed to be a part of this Agreement, and will not be referred to in connection with the construction or interpretation of this Agreement. As used in this Agreement, the words "include" and "including" and variations thereof, will not be deemed to be terms of limitation, but rather will be deemed to be followed by the words "without limitation".

## 9. Other Vendors Terms and Conditions

The TeleNav Software utilizes map and other data licensed to TeleNav by third party vendors for the benefit of you and other end users. This Agreement includes end-user terms applicable to these companies (included at the end of this Agreement), and thus your use of the TeleNav Software is also subject to such terms. You agree to comply with the following additional terms and conditions, which are applicable to TeleNav's third party vendor licensors:

### *NavTeq End User License Agreement*

#### **END USER TERMS**

The content provided ("Data") is licensed, not sold. By opening this package, or installing, copying, or otherwise using the Data, you agree to be bound by the terms of this agreement. If you do not agree to the terms of this agreement, you are not permitted to install, copy, use, resell or transfer the Data. If you wish to reject the terms of this agreement, and have not

installed, copied, or used the Data, you must contact your retailer or NAVTEQ North America, LLC ("NT") within thirty (30) days of purchase for a refund of your purchase price. To contact NT, please visit [www.navteq.com](http://www.navteq.com).

The Data is provided for your personal, internal use only and may not be resold. It is protected by copyright, and is subject to the following terms (this "End User License Agreement") and conditions which are agreed to by you, on the one hand, and NAVTEQ North America, LLC ("NT") and its licensors (including their licensors and suppliers) on the other hand.

The Data for areas of Canada includes information taken with permission from Canadian authorities, including: © Her Majesty the Queen in Right of Canada, © Queen's Printer for Ontario, © Canada Post Corporation, GeoBase®.

NT holds a nonexclusive license from the United States Postal Service ® to publish and sell ZIP+4 ® information.

© United States Postal Service ® 2009. Prices are not established, controlled or approved by the United States Postal Service ® The following trademarks and registrations are owned by the USPS: United States Postal Service, USPS, and ZIP+4.

The Data for Mexico includes certain Data from Instituto Nacional de Estadística y Geografía.

#### **TERMS AND CONDITIONS**

**License Limitations on Use:** You agree that your license to use this Data is limited to and conditioned on use for solely personal, noncommercial purposes, and not for service bureau, timesharing or other similar purposes. Except as otherwise set forth herein, you agree not to otherwise

# Appendices

reproduce, copy, modify, decompile, disassemble or reverse engineer any portion of this Data, and may not transfer or distribute it in any form, for any purpose, except to the extent permitted by mandatory laws.

**License Limitations on Transfer:** Your limited license does not allow transfer or resale of the Data, except on the condition that you may transfer the Data and all accompanying materials on a permanent basis if: (a) you retain no copies of the Data; (b) the recipient agrees to the terms of this End User License Agreement; and (c) you transfer the Data in the exact same form as you purchased it by physically transferring the original media (e.g., the CD-ROM or DVD you purchased), all original packaging, all Manuals and other documentation. Specifically, Multi-disc sets may only be transferred or sold as a complete set as provided to you and not as a subset thereof.

**Additional License Limitations:** Except where you have been specifically licensed to do so by NT in a separate written agreement, and without limiting the preceding paragraph, your license is conditioned on use of the Data as prescribed in this agreement, and you may not (a) use this Data with any products, systems, or applications installed or otherwise connected to or in communication with vehicles capable of vehicle navigation, positioning, dispatch, real time route guidance, fleet management or similar applications; or (b) with, or in communication with, including without limitation, cellular phones, palmtop and handheld computers, pagers, and personal digital assistants or PDAs.

## WARNING



This Data may contain inaccurate or incomplete information due to the passage of time, changing circumstances, sources used and the nature of collecting comprehensive geographic Data, any of which may lead to incorrect results.

**No Warranty:** This Data is provided to you "as is", and you agree to use it at your own risk. NT and its licensors (and their licensors and suppliers) make no guarantees, representations or warranties of any kind, express or implied, arising by law or otherwise, including but not limited to, content, quality, accuracy, completeness, effectiveness, reliability, fitness for a particular purpose, usefulness, use or results to be obtained from this Data, or that the Data or server will be uninterrupted or error free.

**Disclaimer of Warranty:** NT AND ITS LICENSORS (INCLUDING THEIR LICENSORS AND SUPPLIERS) DISCLAIM ANY WARRANTIES, EXPRESS OR IMPLIED, OF QUALITY, PERFORMANCE, MERCHANTABILITY, FITNESS FOR A PARTICULAR PURPOSE OR NON-INFRINGEMENT. Some States, Territories and Countries do not allow certain warranty exclusions, so to that extent the above exclusion may not apply to you.

**Disclaimer of Liability:** NT AND ITS LICENSORS (INCLUDING THEIR LICENSORS AND SUPPLIERS) SHALL NOT BE LIABLE TO YOU IN RESPECT OF ANY CLAIM, DEMAND OR ACTION, IRRESPECTIVE OF THE NATURE OF THE CAUSE OF THE CLAIM, DEMAND OR ACTION ALLEGING ANY LOSS, INJURY OR DAMAGES, DIRECT OR INDIRECT, WHICH MAY RESULT FROM THE USE OR POSSESSION OF THIS DATA; OR FOR ANY LOSS OF PROFIT, REVENUE, CONTRACTS

# Appendices

---

OR SAVINGS, OR ANY OTHER DIRECT, INDIRECT, INCIDENTAL, SPECIAL OR CONSEQUENTIAL DAMAGES ARISING OUT OF YOUR USE OF OR INABILITY TO USE THIS DATA, ANY DEFECT IN THIS DATA, OR THE BREACH OF THESE TERMS OR CONDITIONS, WHETHER IN AN ACTION IN CONTRACT OR TORT OR BASED ON A WARRANTY, EVEN IF NT OR ITS LICENSORS HAVE BEEN ADVISED OF THE POSSIBILITY OF SUCH DAMAGES. Some States, Territories and Countries do not allow certain liability exclusions or damages limitations, so to that extent the above may not apply to you.

**Export Control:** You agree not to export from anywhere any part of the Data or any direct product thereof except in compliance with, and with all licenses and approvals required under, applicable export laws, rules and regulations, including but not limited to the laws, rules and regulations administered by the Office of Foreign Assets Control of the U.S. Department of Commerce and the Bureau of Industry and Security of the U.S. Department of Commerce. To the extent that any such export laws, rules or regulations prohibit NT from complying with any of its obligations hereunder to deliver or distribute Data, such failure shall be excused and shall not constitute a breach of this Agreement.

**Entire Agreement:** These terms and conditions constitute the entire agreement between NT (and its licensors, including their licensors and suppliers) and you pertaining to the subject matter hereof, and supersedes in their entirety any and all written or oral agreements previously existing between us with respect to such subject matter.

**Severability:** You and NT agree that if any portion of this agreement is found illegal or unenforceable, that portion shall be severed and the remainder of the Agreement shall be given full force and effect.

**Governing Law:** The above terms and conditions shall be governed by the laws of the State of Illinois, without giving effect to (i) its conflict of laws provisions, or (ii) the United Nations Convention for Contracts for the International Sale of Goods, which is explicitly excluded. You agree to submit to the personal jurisdiction of the State of Illinois for any and all disputes, claims and actions arising from or in connection with the Data provided to you hereunder.

**Government End Users:** If the Data is being acquired by or on behalf of the United States government or any other entity seeking or applying rights similar to those customarily claimed by the United States government, this Data is a "commercial term" as that term is defined at 48 C.F.R. ("FAR") 2.101, is licensed in accordance with this End User License Agreement, and each copy of Data delivered or otherwise furnished shall be marked and embedded as appropriate with the following "Notice of Use", and be treated in accordance with such Notice:

## NOTICE OF USE

CONTRACTOR  
(MANUFACTURER/SUPPLIER)

NAME:

## NAVTEQ

CONTRACTOR  
(MANUFACTURER/SUPPLIER)

ADDRESS:

**425 West Randolph Street, Chicago, IL  
60606.**

# Appendices

---

This Data is a commercial item as defined in FAR 2.101

and is subject to the End User License Agreement under

which this Data was provided.

© 2011 NAVTEQ. All rights reserved.

If the Contracting Officer, federal government agency, or any federal official refuses to use the legend provided herein, the Contracting Officer, federal government agency, or any federal official must notify NAVTEQ prior to seeking additional or alternative rights in the Data.

Wi-Fi hotspot data provided by JiWire, © 2013 JiWire.

## **Gracenote® Copyright**

CD and music-related data from Gracenote, Inc., copyright© 2000-2007 Gracenote. Gracenote Software, copyright © 2000-2007 Gracenote. This product and service may practice one or more of the following U.S. Patents #5,987,525, #6,061,680, #6,154,773, #6,161,132, #6,230,192, #6,230,207, #6.240,459, #6,330,593 and other patents issued or pending. Some services supplied under license from Open Globe, Inc. for U.S. Patent: #6,304,523.

Gracenote and CDDB are registered trademarks of Gracenote. The Gracenote logo and logotype, and the "Powered by Gracenote™" logo are trademarks of Gracenote.

## **Gracenote® End User License Agreement (EULA)**

This device contains software from Gracenote, Inc. of 2000 Powell Street Emeryville, California 94608 ("Gracenote").

The software from Gracenote (the "Gracenote Software") enables this device to do disc and music file identification and obtain music-related information, including name, artist, track, and title information ("Gracenote Data") from online servers ("Gracenote Servers"), and to perform other functions. You may use Gracenote Data only by means of the intended End User functions of this device.

This device may contain content belonging to Gracenote's providers. If so, all of the restrictions set forth herein with respect to Gracenote Data shall also apply to such content and such content providers shall be entitled to all of the benefits and protections set forth herein that are available to Gracenote.

You agree that you will use the content from Gracenote ("Gracenote Content"), Gracenote Data, the Gracenote Software, and Gracenote Servers for your own personal, non-commercial use only. You agree not to assign, copy, transfer or transmit the Gracenote Content, Gracenote Software or any Gracenote Data (except in a Tag associated with a music file) to any third party. YOU AGREE NOT TO USE OR EXPLOIT GRACENOTE CONTENT, GRACENOTE DATA, THE GRACENOTE SOFTWARE, OR GRACENOTE SERVERS, EXCEPT AS EXPRESSLY PERMITTED HEREIN.

You agree that your non-exclusive licenses to use the Gracenote Content, Gracenote Data, the Gracenote Software, and Gracenote Servers will terminate if you violate these restrictions. If your licenses terminate, you agree to cease any and all use of the Gracenote Content, Gracenote Data, the Gracenote Software, and Gracenote Servers. Gracenote, respectively, reserve all rights in Gracenote Data, the Gracenote Software, and the Gracenote Servers and Gracenote Content, including all ownership rights. Under no circumstances will either Gracenote



# Appendices

---

become liable for any payment to you for any information that you provide, including any copyrighted material or music file information. You agree that Gracenote may enforce its respective rights, collectively or separately, under this agreement against you, directly in each company's own name.

Gracenote uses a unique identifier to track queries for statistical purposes. The purpose of a randomly assigned numeric identifier is to allow Gracenote to count queries without knowing anything about who you are. For more information, see the web page at [www.gracenote.com](http://www.gracenote.com) for the Gracenote Privacy Policy.

THE GRACENOTE SOFTWARE, EACH ITEM OF GRACENOTE DATA AND THE GRACENOTE CONTENT ARE LICENSED TO YOU "AS IS". NEITHER GRACENOTE MAKES ANY REPRESENTATIONS OR WARRANTIES, EXPRESS OR IMPLIED, REGARDING THE ACCURACY OF ANY GRACENOTE DATA FROM THE GRACENOTE SERVERS OR GRACENOTE CONTENT. GRACENOTE COLLECTIVELY AND SEPARATELY RESERVE THE RIGHT TO DELETE DATA AND/OR CONTENT FROM THE COMPANIES' RESPECTIVE SERVERS OR, IN THE CASE OF GRACENOTE, CHANGE DATA CATEGORIES FOR ANY CAUSE THAT GRACENOTE DEEMS SUFFICIENT. NO WARRANTY IS MADE THAT EITHER GRACENOTE CONTENT OR THE GRACENOTE SOFTWARE OR GRACENOTE SERVERS ARE ERROR-FREE OR THAT THE FUNCTIONING OF THE GRACENOTE SOFTWARE OR GRACENOTE SERVERS WILL BE UNINTERRUPTED. GRACENOTE IS NOT OBLIGATED TO PROVIDE YOU WITH ANY ENHANCED OR ADDITIONAL DATA TYPES THAT GRACENOTE MAY CHOOSE TO PROVIDE IN THE FUTURE AND IS FREE TO DISCONTINUE ITS ONLINE SERVICES AT ANY TIME. GRACENOTE DISCLAIMS ALL

WARRANTIES EXPRESS OR IMPLIED, INCLUDING, BUT NOT LIMITED TO, IMPLIED WARRANTIES OF MERCHANTABILITY, FITNESS FOR A PARTICULAR PURPOSE, TITLE, AND NON-INFRINGEMENT. NEITHER GRACENOTE WARRANTS THE RESULTS THAT WILL BE OBTAINED BY YOUR USE OF THE GRACENOTE SOFTWARE OR ANY GRACENOTE SERVER. IN NO CASE WILL GRACENOTE BE LIABLE FOR ANY CONSEQUENTIAL OR INCIDENTAL DAMAGES OR FOR ANY LOST PROFITS OR LOST REVENUES FOR ANY REASON WHATSOEVER.

© Gracenote 2007.

FCC ID: KMHSYNG2

IC: 1422A-SYNG2

This device complies with Part 15 of the FCC Rules and with RSS-210 of Industry Canada. Operation is subject to the following two conditions: (1) This device may not cause harmful interference, and (2) this device must accept any interference received, including interference that may cause undesired operation.

## WARNING



Changes or modifications not expressly approved by the party responsible for compliance could void the user's authority to operate the equipment. The term "IC" before the radio certification number only signifies that Industry Canada technical specifications were met.

The antenna used for this transmitter must not be co-located or operating in conjunction with any other antenna or transmitter.



# Index

## A

A/C	
See: Climate Control.....	59
About This Manual.....	5
ABS	
See: Brakes.....	89
ABS driving hints	
See: Hints on Driving With Anti-Lock Brakes.....	89
Accessories	
See: Replacement Parts Recommendation.....	7
Adjusting the Steering Wheel.....	32
Air Conditioning	
See: Climate Control.....	59
Appendices.....	168
At a Glance.....	9
Front Exterior Overview.....	9
Instrument Panel Overview.....	11
Rear Exterior Overview.....	12
Vehicle Interior Overview.....	10
Audible Warnings and Indicators.....	47
Anti-theft Alarm.....	47
Door Ajar.....	47
Headlamps On.....	47
Headlight Exit Delay.....	47
Ignition Left On (Keyless Vehicles Only).....	47
Low Fuel Level.....	47
Message Center Display.....	47
Parking Brake.....	47
Safety Belt Minder.....	47
Speed Alarm.....	47
Vehicle Not in Park.....	48
Audio Control.....	32
Type 1.....	32
Type 2.....	33
Audio Input Jack.....	166
Audio System.....	145
General Information.....	145
Audio Troubleshooting.....	167
Audio Unit.....	158
Alternative Frequencies.....	162
Automatic Volume Control.....	162
Autostore Control.....	161
Frequency Band Button.....	160
News Broadcasts.....	162
Regional Mode.....	163
Sound Button.....	160
Station Preset Buttons.....	161
Station Tuning Control.....	160
Traffic Information Control.....	161
Audio Unit - Vehicles With: AM/FM/CD.....	153
Alternative Frequencies.....	157
Automatic Volume Control.....	157
Autostore Control.....	156
News Broadcasts.....	157
Regional Mode.....	157
Sound Button.....	155
Station Preset Buttons.....	156
Station Tuning Control.....	155
Traffic Information Control.....	156
Waveband Button.....	155
Audio Unit - Vehicles With:	
Bluetooth.....	146
Alternative Frequencies.....	150
Bluetooth Audio Streaming.....	153
iPod.....	153
Making and Receiving Calls.....	152
News Broadcasts.....	149
Phone.....	150
Phone Menu Options.....	152
Regional Mode.....	150
Set Button.....	148
Station Preset Buttons.....	148
Station Tuning Control.....	148
Traffic Information Control.....	149
USB.....	152
Waveband Button.....	148
Automatic Climate Control.....	61
Automatic Transmission.....	85
Brake-Shift Interlock Override.....	86
PowerShift Automatic Transmission.....	85
SelectShift Automatic™ Transmission.....	86
Auxiliary Power Points.....	71
Location.....	71

# Index

## B

Bonnet Lock	
See: Opening and Closing the Hood.....	114
Brake and Clutch Fluid Check.....	121
Brakes.....	89
General Information.....	89
Breaking-In.....	100
Brakes and Clutch.....	100
Engine.....	100
Tires.....	100
Bulb Specification Chart.....	130

## C

Capacities and Specifications.....	142
Technical Specifications.....	144
Car Wash	
See: Cleaning the Exterior.....	134
Catalytic Converter.....	80
Driving with a Catalytic Converter.....	81
Center Console.....	73
Changing a Bulb.....	126
Central High Mounted Brake Lamp.....	128
Front Fog Lamps.....	127
Headlamp.....	126
Interior Lamp.....	129
Luggage Compartment Lamp, Footwell Lamp and Tailgate Lamp.....	129
Map Lamp (driver side).....	129
Number Plate Lamp.....	129
Reading Lamps.....	129
Rear Lamps.....	128
Side Lamp.....	127
Vanity Lamp.....	127
Changing a Fuse.....	113
Changing a Road Wheel.....	136
Installing a Road Wheel.....	140
Installing a Wheel Trim.....	138
Jacking and Lifting Points.....	137
Removing and Installing a Spare Wheel.....	139
Removing a Road Wheel.....	138
Removing a Wheel Trim.....	138
Scissor Lift Hoist.....	137
Vehicle Jack.....	137
Vehicles With a Spare Wheel.....	136
Changing the 12V Battery.....	122

Changing the Engine Air Filter.....	130
Changing the Air Filter Element.....	130
Changing the Wiper Blades.....	123
Changing the Rear Window Wiper Blade .....	124
Changing the Windshield Wiper Blades.....	123
Child Safety.....	13
Child Safety Locks.....	17
Rear Left-Hand Door.....	17
Rear Right-Hand Door.....	17
Child Seat Positioning.....	15
Cigar Lighter.....	71
Cleaning the Engine.....	134
Cleaning the Exterior.....	134
Body Paintwork Preservation.....	134
Cleaning the Chrome Trim.....	134
Cleaning the Headlamps.....	134
Cleaning the Rear Window.....	134
Climate Control.....	59
Principle of Operation.....	59
Compact Disc Player.....	163
CD Text Display Options.....	166
Compact Disc Playback.....	163
Compact Disc Track Scanning.....	164
Ending Compact Disc Playback.....	166
Fast Forward and Reverse.....	163
MP3 and WMA Display Options.....	166
MP3 and WMA File Playback.....	164
Repeat Compact Disc Tracks.....	164
Shuffle and Random.....	163
Track Selection.....	163
Coolant Check	
See: Engine Coolant Check.....	121

## D

Direction Indicators.....	38
Driver Airbag.....	20
Driving Aids.....	95
Driving Hints.....	100
Driving Through Water.....	100

## E

Electromagnetic Compatibility.....	168
------------------------------------	-----

# Index

End User License Agreement.....169	Fuses.....105
SYNC® End User License Agreement	Fuse Specification Chart.....106
(EULA).....169	Battery Fuse Box.....112
Engine Coolant Check.....121	Engine Compartment Fuse Box.....106
Adding Engine Coolant.....121	Passenger Compartment Fuse Box.....109
Engine Immobilizer	
See: Passive Anti-Theft System.....31	
Engine Oil Check.....119	
Checking the Oil Level.....119	
Oil Consumption.....120	
Oil Filter.....120	
Topping Up.....120	
Engine Oil Dipstick - 1.0L	
EcoBoost™.....119	
Engine Oil Dipstick - 1.5L Duratec-16V	
Ti-VCT (81kW/110PS) - Sigma.....119	
Engine Oil Dipstick - 1.5L Duratorq-TDCi	
(67kW/91PS).....119	
Exterior Mirrors.....40	
Fold-Away Exterior Mirrors.....40	
Integrated Blind Spot Mirrors.....40	
Power Exterior Mirrors.....40	
<b>F</b>	
Fastening the Safety Belts.....18	
Fixed rear center lap belt.....18	
Using Safety Belts During Pregnancy.....19	
Floor Mats.....100	
Fog Lamps - Front	
See: Front Fog Lamps.....37	
Fog Lamps - Rear	
See: Rear Fog Lamps.....37	
Front Fog Lamps.....37	
Front Seat Armrest.....70	
Fuel and Refueling.....79	
Fuel Consumption.....82	
Calculating Fuel Economy.....82	
Filling the Tank.....82	
Fuel Quality - Diesel.....80	
Long-Term Storage.....80	
Fuel Quality.....79	
Long-Term Storage.....80	
Fuel Shutoff.....102	
Fuse Box Locations.....105	
Battery Fuse Box.....105	
Engine Compartment Fuse Box.....105	
Passenger Compartment Fuse Box.....105	
	<b>G</b>
	Gauges.....42
	Fuel Gauge.....44
	Information Display.....43
	Maximum Engine Speed.....44
	Tachometer.....43
	Type 1.....42
	Type 2.....43
	General Information on Radio
	Frequencies.....23
	Glasses Holder.....73
	<b>H</b>
	Handbrake
	See: Parking Brake.....89
	Hazard Warning Flashers.....102
	Headlamp Exit Delay.....36
	Headlamp Leveling.....37
	Recommended headlamp leveling control
	positions.....37
	Head Restraints.....65
	Adjusting the head restraints.....65
	Removing the head restraints.....66
	Heated Windows.....64
	Heated Rear Window (If Equipped).....64
	Heating
	See: Climate Control.....59
	Hill Start Assist.....87
	Activating Hill Start Assist.....87
	Deactivating Hill Start Assist.....88

# Index

Hints on Controlling the Interior	
Climate.....	62
Cooling the Interior Quickly.....	63
General Hints.....	62
Heating the Interior Quickly.....	62
Recommended Settings for Cooling.....	63
Recommended Settings for Heating.....	62
Vehicle Stationary for Extended Periods during Extreme High Ambient Temperatures.....	63
Windshield and Side Window Defrosting or Defogging in Cold Weather.....	64
Hints on Driving With Anti-Lock Brakes.....	89
Hood Lock See: Opening and Closing the Hood.....	114
<b>I</b>	
Ignition Switch.....	74
Information Displays.....	49
General Information.....	49
Information Messages.....	53
Installing Child Seats.....	13
Booster Seats.....	14
Child Restraints for Different Mass Groups.....	13
ISOFIX Anchor Points.....	15
Instrument Cluster.....	42
Interior Lamps.....	38
Courtesy lamp.....	38
Reading lamps.....	38
Interior Mirror.....	41
Introduction.....	5

<b>J</b>	
Jump Starting the Vehicle.....	102
Connecting the Jumper Cables.....	103
Jump Starting.....	104
Preparing Your Vehicle.....	103
Removing the Jumper Cables.....	104

## K

Keyless Entry.....	28
Disabled Keys.....	29
General Information.....	28
Locking and Unlocking the Doors with the Key Blade.....	30
Locking Your Vehicle.....	28
Passive Key.....	28
Unlocking Your Vehicle.....	29
Keyless Starting.....	74
Failure to Start.....	75
Starting Your Vehicle.....	75
Stopping the Engine When Your Vehicle is Moving.....	76
Stopping the Engine When Your Vehicle is Stationary.....	76
Switching the Ignition On (Accessory Mode).....	75
Keys and Remote Controls.....	23

## L

Lighting Control.....	36
Headlamp Flasher.....	36
High Beams.....	36
Lighting Control Positions.....	36
Parking Lamps.....	36
Lighting.....	36
Load Carriers See: Roof Racks and Load Carriers.....	96
Load Carrying.....	96
General Information.....	96
Locking and Unlocking.....	26
Autolock.....	26
Locking and Unlocking the Doors from Inside.....	27
Locking and Unlocking the Doors with the Key.....	27
Power Door Locks.....	26
Remote Control.....	26
Locks.....	26
Luggage Anchor Points.....	96
Luggage Covers.....	96
Lug Nuts See: Changing a Road Wheel.....	136

# Index

## M

Maintenance.....	114
General Information.....	114
Technical Specifications.....	131
Manual Climate Control.....	60
Manual Seats.....	66
Adjusting the Height of the Driver's Seat.....	67
Adjusting the Lumbar Support.....	67
Moving the Seat Backward and Forward.....	66
Recline Adjustment.....	67
Manual Transmission.....	83
5-Speed Manual Transmission.....	83
Message Center See: Information Displays.....	49
Mirrors See: Windows and Mirrors.....	39
Mobile Communications Equipment.....	8

## O

Oil Check See: Engine Oil Check.....	119
Opening and Closing the Hood.....	114
Closing the Hood.....	115
Opening the Hood.....	114

## P

Parking Aid.....	93
Rear Sensing System.....	94
Parking Aids.....	93
Principle of Operation.....	93
Parking Brake.....	89
All Vehicles.....	90
Vehicles With Automatic Transmission.....	89
Vehicles With Manual Transmission.....	89
Passenger Airbag.....	21
.....	21
Passive Anti-Theft System.....	31
Arming the Engine Immobilizer.....	31
Coded Keys.....	31
Disarming the Engine Immobilizer.....	31
Principle of Operation.....	31

## PATS

  See: Passive Anti-Theft System.....31

## Power Door Locks

  See: Locking and Unlocking.....26

## Power Windows.....

  Bounce-Back.....39

  One-Touch Down.....39

  One-Touch Up.....39

  Window Lock.....39

## R

### Rear Fog Lamps.....

### Rear Seats.....

  Folding the Seat Backrest.....67

  Folding the Seat Forward.....68

  Reclining the Seat Back.....67

  Unfolding the Seat.....69

  Unfolding the Seat Backrest.....68

### Rear Window Wiper and Washers.....

  Intermittent Wipe.....35

  Rear Window Washer.....35

  Reverse Gear Wipe.....35

### Refueling.....

  Fuel Filler Cap.....81

### Remote Control.....

  Changing the Remote Control Battery.....23

  Remote Control With a Folding Key

    Blade.....23

  Remote Control Without a Folding Key

    Blade.....24

  Reprogramming the Unlocking

    Function.....23

### Removing a Headlamp.....

### Repairing Minor Paint Damage.....

### Replacement Parts

  Recommendation.....7

  Collision Repairs.....7

  Scheduled Maintenance and Mechanical

    Repairs.....7

  Warranty on Replacement Parts.....8

### Replacing a Lost Key or Remote

  Control.....25

### Roadside Emergencies.....

### Roof Racks and Load Carriers.....

  Adjusting the Crossbar.....97

### Running-In

  See: Breaking-In.....100

# Index

Running Out of Fuel.....80

## S

Safety Belt Minder.....19

Deactivating the Safety Belt Minder.....19

Safety Belts.....18

Safety Precautions.....79

Seats.....65

Security.....31

Side Airbags.....21

Side Curtain Airbags.....21

Sitting in the Correct Position.....65

Snow Chains

See: Using Snow Chains.....136

Special Notices.....8

Stability Control.....92

Principle of Operation.....92

Starter Switch

See: Ignition Switch.....74

Starting a Diesel Engine.....77

Cold or Hot Engine.....77

Failure to Start.....78

Starting a Gasoline Engine.....76

Cold or Hot Engine.....76

Engine Idle Speed after Starting.....77

Failure to Start.....77

Flooded Engine.....77

Starting and Stopping the Engine.....74

General Information.....74

Steering.....95

Electric Power Steering.....95

Steering Wheel Lock.....76

Vehicles with Keyless Starting.....76

Vehicles without Keyless Starting.....76

Steering Wheel.....32

Storage Compartments.....73

Supplementary Restraints System.....20

Principle of Operation.....20

Switching Off the Engine.....78

Vehicles With a Turbocharger.....78

Symbols Glossary.....5

## T

Tailgate.....30

Technical Specifications

See: Capacities and Specifications.....142

Tire Care.....136

Tires

See: Wheels and Tires.....136

Towing Points.....98

Towing the Vehicle on Four Wheels.....99

All Vehicles.....99

Vehicles with Automatic

Transmission.....99

Towing.....98

Traction Control.....91

Principle of Operation.....91

Transmission.....83

Transmission

See: Transmission.....83

Transporting the Vehicle.....98

Trip Computer.....50

STANDARD.....50

TRIP COMPUTER OPTIONAL.....51

## U

Under Hood Overview - 1.0L

EcoBoost™.....116

Under Hood Overview - 1.5L Duratec-16V

Ti-VCT (81kW/110PS) - Sigma.....117

Under Hood Overview - 1.5L

Duratorq-TDCi (67kW/91PS).....118

Under Seat Storage.....73

USB Port.....167

Using Snow Chains.....136

Using Stability Control.....92

Using Traction Control.....91

Switching the System Off Using a

Switch.....91

Switching the System Off Using the

Information Display Controls.....91

System Indicator Lights and

Messages.....91

## V

Vehicle Care.....134

Vehicle Identification Number.....143

Vehicle Identification Plate.....142

Ventilation

See: Climate Control.....59

VIN

See: Vehicle Identification Number.....143



# Index

---

Voice Control.....33

## W

Warning Lamps and Indicators.....	44
Airbag.....	44
Anti-lock Braking System.....	44
Anti-theft System Indicator.....	44
Battery Charge System.....	44
Brake System.....	44
Coolant Temperature.....	45
Direction Indicator.....	45
Doors Open.....	45
Engine warning lamps.....	46
Front Fog Lamp.....	45
Glow Plug.....	45
Headlamp.....	45
Hill Start Assist.....	45
Information Indicator.....	45
Low Fuel Level.....	45
Main Beam.....	45
Oil Pressure.....	46
Power Steering.....	46
Rear Fog Lamp.....	46
Safety Belt Minder.....	46
Stability Control.....	46
Stability Control Off.....	46
Water-In-Fuel.....	47
Warning Triangle.....	102
Washer Fluid Check.....	122
Washers	
See: Cleaning the Exterior.....	134
See: Wipers and Washers.....	34
Wheel Nuts	
See: Changing a Road Wheel.....	136
Wheels and Tires.....	136
General Information.....	136
Technical Specifications.....	141
Windows and Mirrors.....	39
Windshield Washers.....	34
Windshield Wipers.....	34
Intermittent Wipe.....	34
Speed Dependent Wipers.....	34
Wipers and Washers.....	34





