

The information contained in this publication was correct at the time of going to print. In the interest of development the right is reserved to change specifications, design or equipment at any time without notice and without incurring any obligations. This publication, or part thereof, may not be reproduced nor translated without our approval. Errors and omissions excepted.

© Ford Motor Company 2014

All rights reserved.

Part Number: 08/2013 20140711074429

Table of Contents

Introduction

About This Manual.....	5
Symbols Glossary.....	5
Replacement Parts Recommendation.....	5
Special Notices.....	6

At a Glance

At a Glance.....	8
------------------	---

Child Safety

Booster Seats.....	12
Child Seats.....	13
Child Seat Positioning.....	14
Child Safety Locks.....	15

Occupant protection

Principle of Operation.....	16
Fastening the seat belts.....	19
Using seat belts during pregnancy.....	20

Keys and Remote Controls

General Information on Radio Frequencies.....	21
Programming the remote control.....	21
Changing the remote control battery.....	22

Locks

Locking and Unlocking.....	23
----------------------------	----

Engine immobiliser

Principle of Operation.....	26
Coded keys.....	26
Arming the engine immobiliser.....	26
Disarming the engine immobiliser.....	26

Steering Wheel

Adjusting the Steering Wheel.....	27
Audio Control.....	27

Wipers and Washers

Windscreen Wipers.....	29
Windscreen Washers.....	29
Rear Window Wiper and Washers.....	30
Adjusting the windscreen washer jets.....	30
Checking the Wiper Blades.....	30
Changing the Wiper Blades.....	31

Lighting

Lighting Control.....	32
Headlamp Levelling.....	32
Front Fog Lamps.....	33
Hazard Warning Flashers.....	33
Direction Indicators.....	33
Interior Lamps.....	34
Changing a Bulb.....	35
Bulb Specification Chart.....	39

Windows and Mirrors

Power Windows.....	40
Exterior Mirrors.....	40
Electric exterior mirrors.....	41
Interior Mirror.....	41

Instrument Cluster

Gauges.....	42
Warning Lamps and Indicators.....	43

Information Displays

General Information.....	46
--------------------------	----

Climate Control

Principle of Operation.....	47
Air Vents.....	47
Manual Climate Control.....	48
Heated Windows.....	50

Table of Contents

Seats

Sitting in the Correct Position.....	51
Manual Seats.....	51
Head Restraints.....	53
Rear Seats.....	53

Convenience features

Sun Visors.....	55
Auxiliary Power Points.....	55
Glove Box.....	55
USB Port.....	56
Floor Mats.....	56

Starting and Stopping the Engine

General Information.....	57
Ignition Switch.....	57
Starting a Petrol Engine.....	57
Starting a Diesel Engine.....	58
Switching Off the Engine.....	59

Fuel and Refuelling

Safety Precautions.....	60
Catalytic Converter.....	60
Fuel filler flap.....	60
Refuelling.....	61
Fuel Quality.....	61
Fuel Quality.....	61
Fuel Consumption.....	61

Transmission

Manual Transmission.....	62
--------------------------	----

Brakes

Principle of Operation.....	63
Hints on Driving With Anti-Lock Brakes.....	63
Parking Brake.....	64

Automatic speed limiter (ASL)

Principle of Operation.....	65
-----------------------------	----

Load Carrying

General Information.....	66
Luggage Covers.....	66

Driving Hints

General Driving Points.....	67
Running-In.....	67
Driving Through Water.....	67

Roadside Emergencies

First Aid Kit.....	68
Warning Triangle.....	68

Status after a collision

Inspecting safety system components.....	69
Fuel Shutoff.....	69

Fuses

Changing a Fuse.....	70
Fuse Labels.....	70
Fuse Box Locations.....	71
Fuse Specification Chart.....	72

Vehicle recovery

Towing Points.....	76
Towing the Vehicle on Four Wheels.....	76

Maintenance

General Information.....	77
Opening and Closing the Bonnet.....	77
Under Bonnet Overview.....	79
Under Bonnet Overview.....	80
Engine Oil Dipstick.....	81
Engine Oil Dipstick.....	81

Table of Contents

Engine Oil Check.....	81
Engine Coolant Check.....	83
Brake and Clutch Fluid Check.....	83
Power Steering Fluid Check.....	84
Washer Fluid Check.....	84
Technical Specifications.....	85

Vehicle Care

Cleaning the Exterior.....	88
Cleaning the Interior.....	89
Repairing Minor Paint Damage.....	89

Vehicle battery

Battery care.....	90
Jump Starting the Vehicle.....	90

Wheels and Tyres

General Information.....	92
Changing a Road Wheel.....	92
Tyre Care.....	97
Technical Specifications.....	97

Vehicle identification

Vehicle Identification Number.....	99
------------------------------------	----

Capacities and Specifications

Weights.....	100
Vehicle Dimensions.....	101

Introduction

ABOUT THIS MANUAL

Thank you for choosing Ford. We recommend that you take some time to get to know your vehicle by reading this manual. The more that you know about it, the greater the safety and pleasure you will get from driving it.

WARNING



Always drive with due care and attention when using and operating the controls and features on your vehicle.

Note: *This manual describes product features and options available throughout the range, sometimes even before they are generally available. It may describe options not fitted to your vehicle.*

Note: *Some of the illustrations in this manual may be used for different models, so may appear different to your vehicle. However, the essential information in the illustrations is always correct.*

Note: *Always use and operate your vehicle in line with all applicable laws and regulations.*

Note: *Pass on this manual when selling your vehicle. It is an integral part of the vehicle.*

SYMBOLS GLOSSARY

Symbols in this handbook

WARNING



You risk death or serious injury to yourself and others if you do not follow the instructions highlighted by the warning symbol.

CAUTION



You risk damaging your vehicle if you do not follow the instructions highlighted by the caution symbol.

Symbols on your vehicle



When you see these symbols, read and follow the relevant instructions in this handbook before touching or attempting adjustment of any kind.

REPLACEMENT PARTS RECOMMENDATION

Now you can be sure that your Ford parts are Ford parts

Your Ford has been built to the highest standards using high quality Ford Original Parts. As a result, you can enjoy driving it for many years.

Should the unexpected occur and a major part needs replacing, we recommend that you accept nothing less than Ford Original Parts.

The use of Ford Original Parts ensures that your vehicle is repaired to its pre-accident condition and maintains its maximum residual value.

Ford Original Parts match Ford's stringent safety requirements and high standards of fit, finish and reliability. Quite simply, they represent the best overall repair value, including parts and labour costs.

Introduction

Now it is easier to tell if you have really been given Ford Original Parts. The Ford logo is clearly visible on the following parts if they are Ford Original Parts. If your vehicle has to be repaired, look for the clearly visible Ford branding and make sure that only Ford Original Parts have been used.

Look for the Ford logo on the following parts

Sheet metal

- Fenders
- Doors

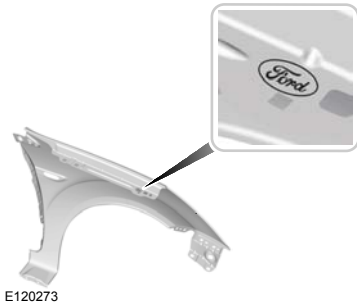

Glass

- Rear window
- Side glass
- Windscreen



Lighting

- Headlamps
- Rear lamps

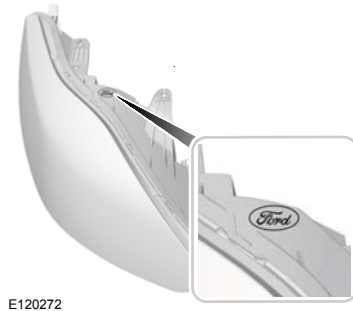

SPECIAL NOTICES

WARNING



Do not use abrasives or chemicals solvents on the tag.

Introduction

We have installed the radio frequency identifier (RFID) tag in your vehicle in compliance with the government directives under the MORTH final notification GSR 207 (E), dated 08 April 2013. Ford does not in any way guarantee or warranties the quality, contents, accuracy of the product or data contained in the tag.

This tag is for the exclusive use of government authorities or personnel authorised by the government. The responsibility of using this tag is on the owner of the vehicle.

Note: *The tag is located on the top left-hand side of the windscreen.*

At a Glance

Instrument panel overview - RHD

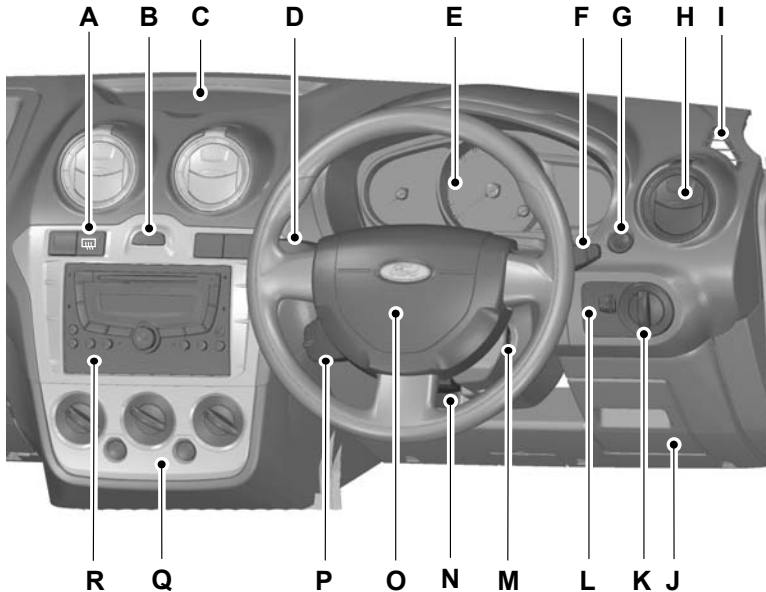

E154371

- A Heated rear window switch. See **Heated Windows** (page 50).
- B Hazard warning flasher switch. See **Hazard Warning Flashers** (page 33).
- C Storage tray.
- D Direction indicators. See **Direction Indicators** (page 33). Main beam. See **Lighting Control** (page 32).
- E Instrument cluster. See **Gauges** (page 42). See **Warning Lamps and Indicators** (page 43).
- F Wiper lever. See **Wipers and Washers** (page 29).
- G Luggage compartment release switch.
- H Air vent. See **Air Vents** (page 47).
- I Window demister.
- J Window demister.
- K Window demister.
- L Wiper lever.
- M Wiper lever.
- N Wiper lever.
- O Instrument cluster.
- P Direction indicators.
- Q Storage tray.
- R Hazard warning flasher switch.

















At a Glance

- J Driver side storage compartment.
- K Lighting control. See **Lighting Control** (page 32). Front fog lamps. See **Front Fog Lamps** (page 33).
- L Headlamp levelling control. See **Headlamp Levelling** (page 32).
- M Ignition switch. See **Ignition Switch** (page 57).
- N Steering wheel adjustment. See **Adjusting the Steering Wheel** (page 27).
- O Horn.
- P Audio control. See **Audio Control** (page 27).
- Q Climate controls. See **Climate Control** (page 47).
- R Audio unit. See separate handbook.

Engine idle speed after starting

The engine may idle at a higher speed than normal immediately after starting from cold. See **Starting a Petrol Engine** (page 57). See **Starting a Diesel Engine** (page 58).

Warning lamps and indicators

- | | | | |
|--|----------------------------------|---|---|
|  | ABS warning lamp |  | Illumination ON indicator |
|  | Airbag warning lamp |  | Ignition warning lamp |
|  | Brake system warning lamp |  | Low fuel level warning lamp |
|  | Direction indicator |  | Main beam indicator |
|  | Door open warning lamp |  | Oil pressure warning lamp |
|  | MIL (Malfunction indicator lamp) |  | Front fog lamp indicator |
|  | Glow plug indicator |  | Engine check warning lamp |
| | |  | Water in fuel warning lamp |
| | |  | Engine coolant temperature warning lamp |

At a Glance

Information display

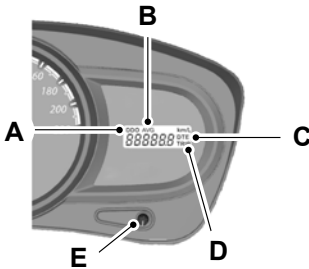

E171745

- A Odometer
- B Average fuel consumption
- C Distance to empty
- D Tripmeter
- E Reset button

Press the Reset button to scroll through the displays. See (page 46).

Defrosting and demisting the windscreen

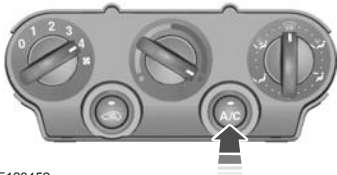

E123452

If necessary use the heated rear window to defrost or demist the rear window. See **Heated Windows** (page 50).



See **Manual Climate Control** (page 48).

Cooling the interior quickly

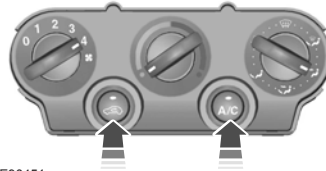

E90451

See **Manual Climate Control** (page 48).

Locking and unlocking the doors with the remote control

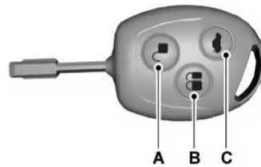

E122028

- A Unlock
- B Lock
- C Luggage compartment lid unlock

Locking the doors

Press button **B** once.

Unlocking the luggage compartment lid

Press button **C** twice within three seconds.

See **Locking and Unlocking** (page 23).

Adjusting the steering wheel

WARNING



Never adjust the steering wheel when the vehicle is moving.

At a Glance

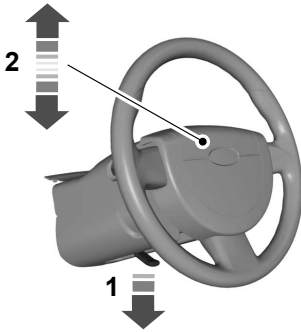

E101516

WARNING



Make sure that you fully engage the locking lever when returning it to its original position.



E95179

See **Adjusting the Steering Wheel** (page 27).

Child Safety

BOOSTER SEATS

WARNINGS

-  Do not install a booster seat or a booster cushion with only the lap strap of the seat belt.
-  Do not install a booster seat or a booster cushion with a seat belt that is slack or twisted.
-  Do not put the seat belt under your child's arm or behind its back.
-  Do not use pillows, books or towels to boost your child's height.
-  Make sure that your children sit in an upright position.
-  Secure children that weigh more than 15 kilograms but are less than 150 centimetres tall in a booster seat or a booster cushion.

Booster seat (Group 2)



E70710

We recommend that you use a booster seat that combines a cushion with a backrest instead of a booster cushion only. The raised seating position will allow you to position the shoulder strap of the adult seat belt over the centre of your child's shoulder and the lap strap tightly across its hips.

Booster cushion (Group 3)



E68924

Child Safety

CHILD SEATS



E102143

WARNINGS

-  Secure children that are less than 150 centimetres tall or less than 12 years of age in a suitable, approved child restraint, in the rear seat.
-  Original warning according to ECE R94.01: Extreme Hazard! Do not use a rearward facing child restraint on a seat protected by an air bag in front of it!
-  Read and follow the manufacturer's instructions when you are fitting a child restraint.
-  Do not modify child restraints in any way.
-  Do not hold a child on your lap when the vehicle is moving.
-  Do not leave children unattended inside your vehicle in a doors closed condition.

WARNINGS

-  If your vehicle has been involved in an accident, have the child restraints checked by properly trained Ford approved technicians.

Note: *Mandatory use of child restraints varies from country to country.*

A choice of approved child restraints, which have been specifically tested and approved for your vehicle are available from your Dealer.

Child restraints for different mass groups

Use the correct child restraint as follows:

Baby safety seat



E68918

Secure children that weigh less than 13 kilograms in a rearward facing baby safety seat (Group 0+) in the rear seat.

Child Safety

Child safety seat



Secure children that weigh between 13 and 18 kilograms in a child safety seat (Group 1) in the rear seat.

E68920

CHILD SEAT POSITIONING

Seating positions	Mass group categories				
	0	0+	I	II	III
	Up to 10 kg	Up to 13 kg	9 - 18 kg	15 - 25 kg	22 - 36 kg
Front co-driver seat (without PAB)	UF ¹	UF ¹	UF ¹	UF ¹	UF ¹
Front co-driver seat (with PAB)	X	X	UF ¹	UF ¹	UF ¹
Rear seat (3 point belt)	U	U	U	U	U
Rear seat (lap belt only)	X	X	X	X	X

PAB - Passenger airbag.

X Not suitable for children in this mass group.

U Suitable for universal category child seats approved for use in this mass.

UF¹ Suitable for universal category forward facing child seats approved for use in this mass group. However, we recommend that you secure children in a government approved child restraint, in the rear seat.

Child Safety

CHILD SAFETY LOCKS

WARNING



You cannot open the doors from inside if you have put the child safety locks on.

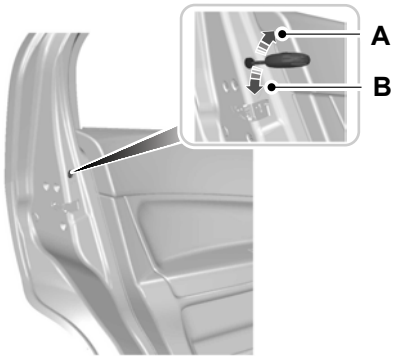

E102138

A Unlock

B Lock

Turn the key in the rear door rearward to activate the lock. To deactivate the lock, turn the key forward.

Occupant protection

PRINCIPLE OF OPERATION

This Seating position is fitted with an air bag for your protection

⚠ WARNING

- YOU MUST ALWAYS WEAR YOUR SEAT BELT
- CHILDREN MUST ALWAYS BE PROPERLY RESTRAINED
- THE REAR SEAT IS THE SAFEST PLACE FOR THE CHILDREN

- If you are **TOO CLOSE** to an inflating air bag, it could **SERIOUSLY INJURE** you. Move your seat as far back as practical to allow room for air bag inflation.
- **NEVER** install any child restraint (e.g. baby capsule, child seat or booster seat) in the front seat where a passenger air bag is fitted.
- **NEVER** place objects in front of you while you are seated in the seat.
- **NEVER** rest anything on the air bag cover (e.g. feet or dash panel covers).

YOUR AIR BAG SYSTEM DOES NOT REQUIRE REGULAR MAINTENANCE

However if any of the following OCCUR see your Authorised Ford Dealer without delay

- the "air bag" light does not operate briefly when the ignition key is turned ON or,
- the "air bag" light operates while driving or,
- group of 5 beeps are heard

E123935

Airbags

WARNINGS



Do not modify the front of your vehicle in any way. This could adversely affect deployment of the airbags.



Original warning according to ECE R94.01: Extreme Hazard! Do not use a rearward facing child restraint on a seat protected by an airbag in front of it!



Wear a seat belt and keep sufficient distance between yourself and the steering wheel. Only when you use the seat belt properly, can it hold you in a position that allows the airbag to achieve its optimum effect.

WARNINGS



Have repairs to the steering wheel, steering column, seats, airbags and seat belts carried out by properly trained technicians from Ford authorised dealerships.



Keep the areas in front of the airbags free from obstruction. Do not affix anything to or over the airbag covers.



Do not poke sharp objects into areas where airbags are fitted. This could damage and adversely affect deployment of the airbags.



The airbag may only deploy with the ignition switch in the on (II) position.

Occupant protection

WARNINGS



Always keep the areas in front of the airbags free. Never affix anything to or over these areas.



If you are too close to an inflating airbag, it could seriously injure you. Move your seat as far back as practical to allow room for airbag inflation.



Several airbag system components get hot after inflation. Do not touch after inflation.



Fitment of certain accessories e.g. bull bars or nudge bars may cause inadvertent or premature deployment of air bags.

Note: You will hear a loud bang and see a cloud of harmless powdery residue if an airbag deploys. This is normal.

Note: Only wipe airbag covers with a damp cloth.

Your vehicle is equipped with an event data recorder which is capable of collecting and storing data during a crash or near crash event. The recorded information may assist in the investigation of such an event. To access this information special equipment must be directly connected to the recording modules. Ford does not access event data recorder information without obtaining consent unless pursuant to a court order or where required by law enforcement, other government authorities or other third parties may seek access to the information independent of Ford.

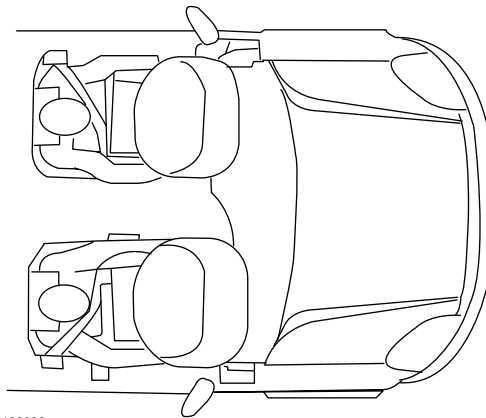

E123936

The airbag is a supplementary restraint system. It is designed to be used in addition to seat belts to help protect against head and chest injuries in certain moderate to severe frontal collisions.

The airbag system is not visible until it is activated. The air bag system is designed to deploy the driver and passenger front air bags in certain frontal and front angled collisions.

Occupant protection

Because the system senses crash severity, some frontal and side collisions will not inflate the airbags. Front airbags are not designed to inflate in rollover, rear and low speed impacts.

The restraint system comprises:

- a driver airbag
- a front passenger airbag
- crash sensors
- an airbag warning lamp
- an electronic control and diagnostic unit.

Driver and front passenger airbags

Your vehicle is equipped with an air bag for the driver, located in the steering wheel and a passenger air bag is located in the instrument panel above the glove compartment. The passenger air bag can be identified by the 'Airbag' mark embedded on the airbag cover.

The seat back must be set correctly for the airbags to be optimally effective. See **Sitting in the Correct Position** (page 51). This helps to reduce the risk of injury from sitting too close to an inflating airbag.

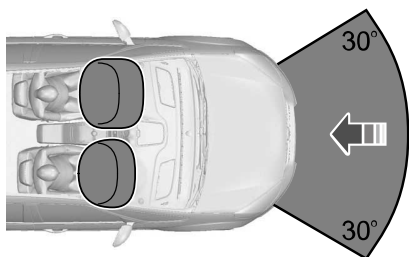

The driver and front passenger airbags will deploy during significant frontal collisions or collisions that are up to 30 degrees from the left or the right. The airbags will inflate within a few thousandths of a second and deflate on contact with the occupants, thus cushioning forward face/body movement. During minor frontal collisions, overturns, rear collisions and side collisions, the driver and front passenger airbags will not deploy.

WARNINGS



If the passenger airbag cover shows signs of having been removed, the car should be towed to the nearest Authorised Ford Dealer for repair. Do not attempt to reinstall the cover. If the vehicle must be driven then on no account should there be an occupant in the front passenger seat.



The airbag(s) and energy management retractors will activate only once. Once activated, the airbags and energy management retractors will not function again and must be replaced immediately. The crash sensor must also be replaced. If the airbag(s) are not replaced, the un-repaired area will increase the risk of injury in a collision.

Airbag warning light



E123944

When the ignition switch is turned to position II, the airbag warning light on the instrument panel illuminates for approximately 3 seconds to indicate that the system is functional.

Occupant protection

If the airbag warning light does not illuminate, if it stays on or illuminates intermittently or continuously while driving, it means there is a malfunction. Have the system checked by an Authorised Ford Dealer.

Seat belts

WARNINGS

 Wear a seat belt and keep sufficient distance between yourself and the steering wheel. Only when you use the seat belt properly, it can hold you in a position to achieve its optimum effect.

 The wearing of seat belts is required by law, even when airbags are fitted.

 Never use a seat belt for more than one person.

 Use the correct buckle for each seat belt.

 Do not use a seat belt that is slack or twisted.

 Do not wear thick clothing. The seat belt must fit tightly around your body to achieve its optimum effect.

 Position the shoulder strap of the seat belt over the centre of your shoulder and position the lap strap tightly across your hips.



E123937

The importance of wearing seat belts

Seat belts must be worn by all vehicle occupants to be properly restrained and help reduce the risk of injury in a collision. Wearing a seat belt will:



E123940

- help keep you in the proper position when the airbags inflate,
- reduce the risk of harm in rollover, side or rear impact collisions,
- reduce the risk of harm in frontal collisions that are not severe enough to activate the airbags,
- reduce the risk of being thrown from your vehicle.



E123941

FASTENING THE SEAT BELTS

WARNINGS

 Insert the tongue into the buckle until you hear a distinct click. You have not fastened the seat belt properly if you do not hear a click.

 Do not use a seat belt that is slack or twisted.

Occupant protection



E74124



E102129

Pull the belt out steadily. It may lock if you pull it sharply or if the vehicle is on a slope.
Press the red button on the buckle to release the belt. Let it retract completely and smoothly.

USING SEAT BELTS DURING PREGNANCY

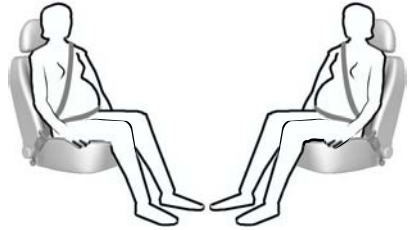

E68587

WARNING

 Position the seat belt correctly for your safety and that of your unborn child. Do not use only the lap strap or the shoulder strap.

Position the lap strap comfortably across your hips and low beneath your pregnant abdomen. Position the shoulder strap between your breasts, above and to the side of your pregnant abdomen.

Keys and Remote Controls

GENERAL INFORMATION ON RADIO FREQUENCIES

CAUTIONS

! The radio frequency used by your remote control can also be used by other short distance radio transmissions (e.g. amateur radios, medical equipment, wireless headphones, remote controls and alarm systems). If the frequencies are jammed, you will not be able to use your remote control. You can lock and unlock the doors with the key.

! Check your vehicle is locked before leaving it unattended. This will safeguard against any potential malicious frequency blocking.

Note: You could unlock the doors if you press the buttons on the remote control unintentionally.

The operating range between your remote control and your vehicle varies depending on the environment.

PROGRAMMING THE REMOTE CONTROL

A maximum of four remote controls (Coded Keys) (including the ones supplied with the vehicle) can be programmed.

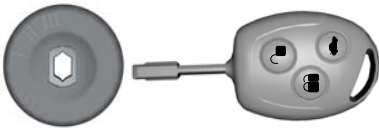

E102144

- Turn the ignition key to position II four times within six seconds.
- Switch off the ignition. Cluster indicator flashes to indicate that it is now possible to programme a new remote control.
- Press any button on a new remote control. Cluster indicator flashes as confirmation. Repeat this last step for all of your remote controls, including the original.
- Switch the ignition back on or wait for ten seconds without programming another remote control to end remote control programming. Only the remote controls which you have just programmed are now able to lock and unlock your vehicle.

Re-programming the unlocking function

You can change the unlocking function so that pressing the unlock button once deactivates the central locking and unlocks the driver's door. Pressing the unlock button twice within three seconds also unlocks the passengers' doors.

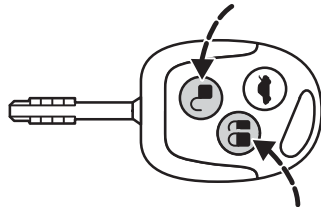

E72190

To programme a new remote control:

Keys and Remote Controls

In order to re-programme the function, press and hold the unlock and lock buttons simultaneously for at least four seconds with the ignition switched off. The direction indicators will flash twice to indicate that the unlocking function has been successfully re-programmed.

Pressing and holding both buttons simultaneously for at least four seconds again will change the function back.

CHANGING THE REMOTE CONTROL BATTERY



Make sure that you dispose of old batteries in an environmentally friendly way. Seek advice from your local authority regarding recycling.

If the range of the transmitter in the key decreases gradually, the battery (type 3V CR 2032) should be replaced.

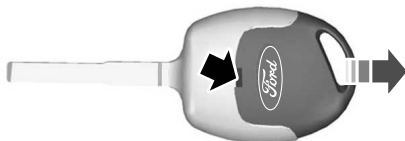

E68726

- Carefully separate the transmitter unit from the key using a flat object (e.g. a screwdriver) at the recess on the back.
- Carefully prise out the battery with the flat object. Fit the new battery between the contacts with the + sign facing downwards. Reassemble the transmitter unit in reverse order.

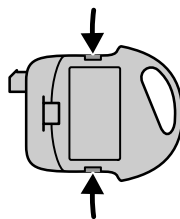

E68727

- Open the transmitter unit by separating the retaining clips on the sides with the flat object.

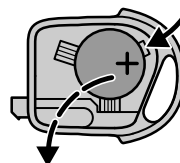

E68729

- Carefully prise out the battery with the flat object. Fit the new battery between the contacts with the + sign facing downwards. Reassemble the transmitter unit in reverse order.

Locks

LOCKING AND UNLOCKING

Manual locking



- A Push to lock
- B Pull to unlock

You need to lock all the doors individually and lock the driver side door with the key.

Central locking

You can only centrally lock the doors if they are all closed. Central locking can only be operated from driver door either by the handle in the bezel or by the remote control.

Locking and unlocking confirmation

The direction indicators will flash once while unlocking the doors using the remote control.

The direction indicators will flash twice while locking the doors using the remote control.

Locking and unlocking the doors with the key and inner handle

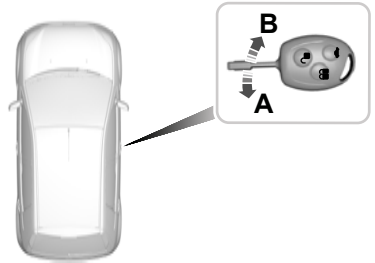

- A Unlock
- B Lock

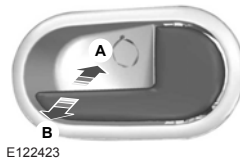

- A Lock
- B Unlock

Locks

Locking and unlocking the doors with the remote control

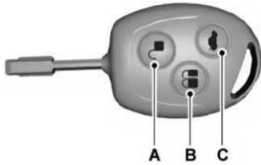

E122028

- A Unlock
- B Lock
- C Luggage compartment lid unlock

Locking the doors with the remote control

CAUTION



Do not put metal accessories/other immobilizer keys with the key bunch. This may affect the engine immobilizer function.

Note: Keep each key separate in order to avoid a starting malfunction.

Remote will not operate at ignition on position.

Press the appropriate button **once**.

Unlocking the luggage compartment lid

Press button **C** twice within three seconds.

Automatic relocking

NOTE: To prevent the vehicle being left unlocked inadvertently, central locking will be reactivated automatically 45 seconds after the unlock button is pressed, if the following occurs during the period.

- No door is opened.

- The luggage compartment is not opened.
- The ignition is not switched on.

WARNING



If a failure in the vehicle's electrical system, the drivers door can be unlocked with a key, the boot can be still access through the folding rear seat or boot lock (where respective feature fitted).

Drive away locking

When the vehicle reaches a speed greater than 7 Km/h, the central locking is automatically applied.

Note: All the doors to be closed fully for proper functioning of drive away locking.

Ignition off auto unlock

If the ignition is switched off the vehicle will unlock automatically.

Vehicle Search

If the remote Lock button is pressed twice within 0.5 seconds then the vehicle will give few short flashes to easily identify your vehicle amongst a group of vehicle.

Crash sensing door unlock

All doors will be automatically unlocked when an impact causes the airbags to deploy and following this the hazard warning flashers will flash.

Luggage compartment

Opening the luggage compartment

The luggage compartment can be opened either by pressing the remote button **C** twice within three seconds or pressing the luggage compartment release switch near the instrument panel.

Locks

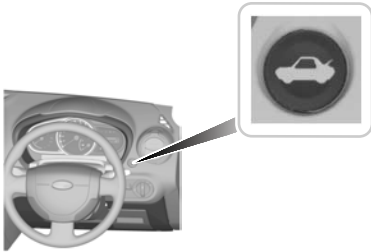

E121245

Using the key.



E121246

To unlock/open, turn the key clockwise.

Closing the luggage compartment

WARNING



Close the luggage compartment properly to prevent it opening while you are driving.



E89132

Engine immobiliser

PRINCIPLE OF OPERATION

The engine immobiliser is a theft protection system that prevents someone from starting the engine with an incorrectly coded key.

CODED KEYS

Note: *Do not shield your keys with metal objects. This may prevent the receiver from recognising your key as a valid one.*

Note: *Have all of your remaining keys erased and recoded if you lose a key. Ask your dealer for further information. Have replacement keys recoded together with your existing keys.*

If you lose a key, you can obtain a replacement from your Ford Dealer. If possible, provide them with the key number from the tag provided with the original keys. You can also obtain additional keys from your Ford Dealer.

ARMING THE ENGINE IMMOBILISER

The engine immobiliser is armed automatically a short time after you have switched the ignition off.

The indicator in the instrument cluster will flash to confirm that the system is operating.

DISARMING THE ENGINE IMMOBILISER

Switching on the ignition disarms the system if the correct code is recognised. The indicator **illuminates** for approximately three seconds and then **extinguishes**.

If the indicator illuminates constantly for one minute or flashes for approximately one minute and then repeatedly at irregular intervals, the system did not recognise the key code or a system fault is present. Remove the key and try again.

If the engine does not start, a system malfunction has occurred. Have the system checked by an expert immediately.

Steering Wheel

ADJUSTING THE STEERING WHEEL

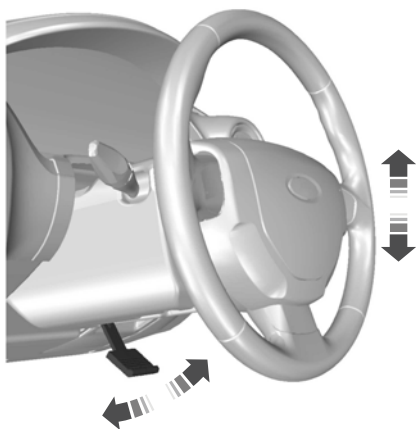

E102147

WARNING



Never adjust the steering wheel when the vehicle is moving.

Release the locking lever to adjust the height of the steering wheel.

Return the lever to its original position to secure the wheel.

See **Sitting in the Correct Position** (page 51).

AUDIO CONTROL

Select radio, CD or cassette mode on the audio unit.

The following functions can be operated with the remote control:

Volume

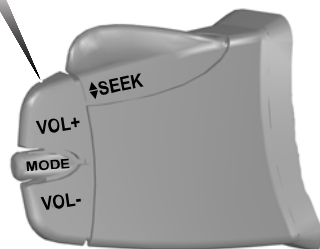
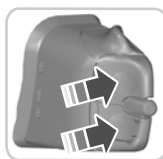

E153170

Volume up: Press the **VOL +** button on the back of the remote control.

Volume down: Press the **VOL -** button on the back of the remote control.

Seek



E153171

Move the lever up or down:

Steering Wheel

- In **radio mode**, this will locate the next radio station up or down the frequency band.
- In **CD, MP3, USB and Bluetooth audio mode**, it will select the next or previous track.

Mode



E153172

Briefly press the button on the side:

- In **radio mode**, this will locate the next pre-set radio station.
- In **MP3 and USB mode**, this will play first song of next folder.

Press and hold the button on the side:

- In **all modes**, this will change the mode function to AM /FM/CD or MP3/USB/Bluetooth audio/Aux.

Wipers and Washers

WINDSCREEN WIPERS

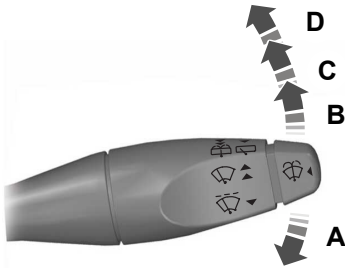

E165816

- A Single wipe
- B Intermittent wiping
- C Normal wiping
- D High speed wiping

Intermittent wiping

Fixed intermittent

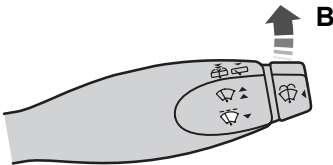

E124015

Select the wiper switch to position **B** for intermittent wiping.

WINDSCREEN WASHERS



E165229

WARNING

 Do not operate the windscreen washer for more than 10 seconds or when the reservoir is empty.

When the button at the end of the lever is pressed the washer will work in conjunction with the wiper operating four times.

Once the wash/wipe cycle is completed, the wipers will pause and then perform one more wipe to clear the screen.

Wipers and Washers

REAR WINDOW WIPER AND WASHERS

Intermittent Wipe

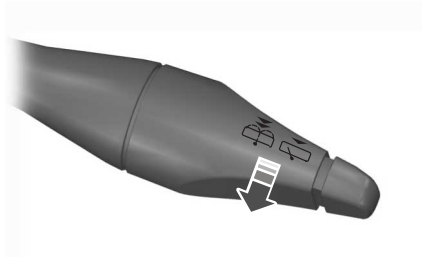

E165819

Pull the lever towards the steering wheel.

Washer

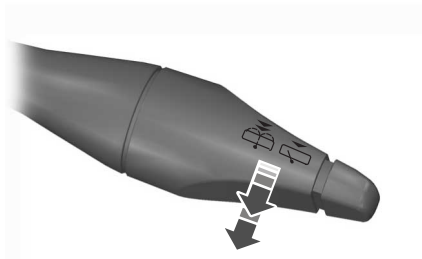

E165820

WARNING



Do not operate the washer for more than 10 seconds at a time, and never when the reservoir is empty.

Pull the lever fully towards the steering wheel and hold it to operate the washer.

The washer will operate in conjunction with the wipers.

The washer jet for the rear window is located on the central high mount stop lamp above the rear window.

Note: Avoid dry wiping operation, this will reduce the wiper rubber life.

ADJUSTING THE WINDSCREEN WASHER JETS

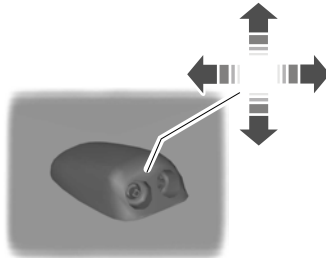

E73425

The eye ball jets can be adjusted precisely using a pin.

CHECKING THE WIPER BLADES

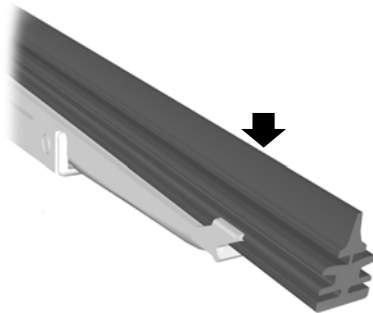

E66644

Run the tip of your fingers over the edge of the blade to check for roughness.

Wipers and Washers

Clean the wiper blade lips with water applied with a soft sponge.

CHANGING THE WIPER BLADES

WARNING



Avoid the contact between wiper arm and windscreen when the wiper arm is placed over windscreen without wiper blade.

Note: *Ensure to keep a thick paper or foam between the wiper arm and windscreen to avoid scratches.*



E102139

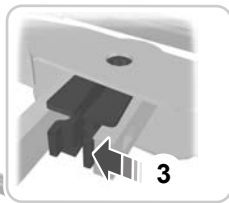

E93784

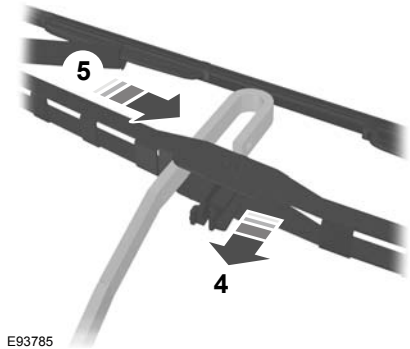

E93785

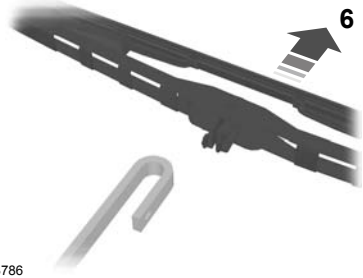

E93786

Install in the reverse order.

Lighting

LIGHTING CONTROL

Lighting control positions

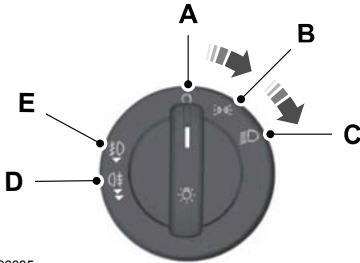

E126635

- A Off
- B Side and tail lamps
- C Headlamps
- D Front fog lamps
- E Rear fog lamps

Note: To remind you to switch off the headlamps, a chime will come on when the driver door is opened with headlamps on.

Welcome lighting

The side repeaters and tail lamps will flash once when you unlock the doors with the remote control. Courtesy lamp comes on if the lamp control is in door mode.

Main/dipped beam



E102128

Pull the lever fully towards the steering wheel to switch between main and dipped beam.

Headlamp flasher



E102128

Pull the lever slightly towards the steering wheel.

HEADLAMP LEVELLING

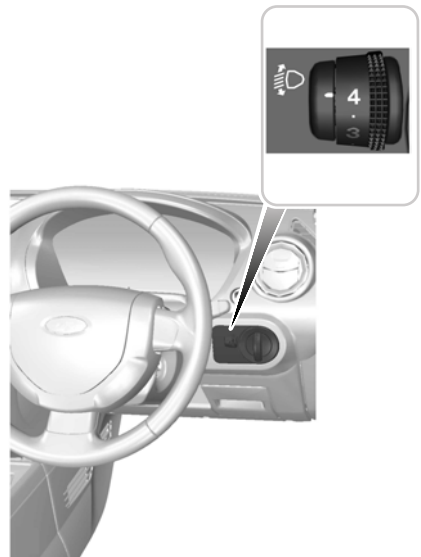

E102133

Lighting

You can adjust the level of the headlamp beams according to the vehicle load.

Recommended headlamp levelling switch positions

Load		Load in luggage compartment	Control position
Front seats	Rear seats		
1	-	-	0
1-2	-	-	0
1-2	3	-	1.0
1-2	3	Max	1.5
1	-	Max	3.0

FRONT FOG LAMPS

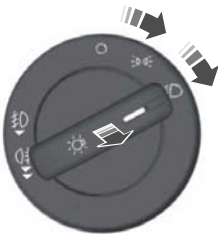

E126656

Switch on the headlamps and pull out the control switch one position.

The front fog lamps should be used only when visibility is considerably restricted by fog, snow or rain.

The indicator light in the instrument cluster will illuminate, when the front fog lamps are in use.

HAZARD WARNING FLASHERS

For item location: See **At a Glance** (page 8).



E124503

Use only in an emergency to warn other traffic of vehicle breakdown or approaching danger. Press the switch to turn on or off.

You can also operate the hazard warning flashers when the ignition is off.

Note: *The hazard warning flashers flash during emergency braking.*

DIRECTION INDICATORS



E102191

Move the lever up/down to activate right/left direction indicators respectively.

Lighting

During lane changing flick the lever up or down and the direction indicators will flash three times.

Sudden increase in the rate of flashing warns a failed indicator bulb.

If you set the switch to position **A**, the courtesy lamp will be off irrespective of the doors being opened or closed.

If you set the switch to position **B** the courtesy lamp turns on during the following conditions.

INTERIOR LAMPS

Courtesy lamp

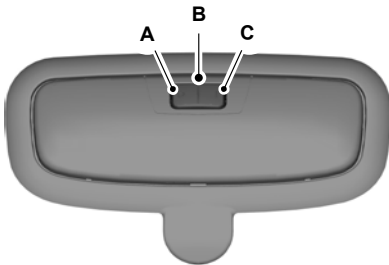

E120292

- A Off
- B Door contact
- C On

	Base variant	Mid variant	High variant
Any of the 4 door open	Does not illuminate	Illuminates ¹	Illuminates ¹
Luggage compartment open		Does not illuminate	Illuminates

¹ - The illumination will have theatre dimming effect.

If you set the switch to position **C**, the courtesy lamp will come on irrespective of the door condition and ignition switch position. It will go off automatically after a short time to prevent the vehicle battery from discharging. To switch it back on, switch on the ignition for a short time.

Lighting

Luggage compartment lamp

The luggage compartment lamp turns on during the following conditions.

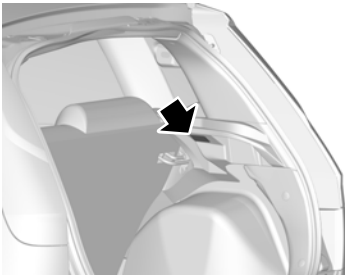

E120328

	Base variant	Mid variant	High variant
Any of the 4 door open	No Luggage compartment lamp fitted	No Luggage compartment lamp fitted	Illuminates
Luggage compartment open			Illuminates

CHANGING A BULB

WARNINGS



Switch the lights and the ignition off.



Let the bulb cool down before removing it.

CAUTIONS



Do not touch the glass of the bulb.



Only fit bulbs of the correct specification. See **Bulb Specification Chart** (page 39).

Note: *The following instructions describe how to remove the bulbs. Fitting is the reverse order unless otherwise stated.*

Headlamp main and dipped beam

Note: *To remove the right hand side headlamp bulb, detach the coolant reservoir.*

Detach the coolant reservoir

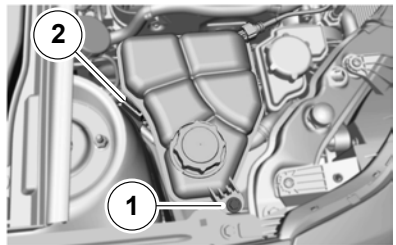

E125296

1. Remove the bolt.
2. Pull the container from the bracket.

Headlamp bulb

Lighting

1. Remove the headlamp cover.

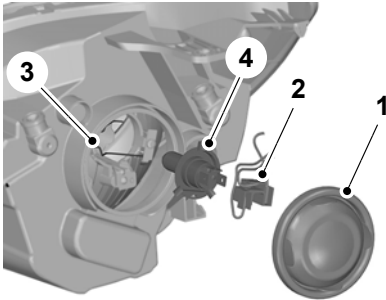

E154463

2. Disconnect the electrical connector.
3. Release the clip.
4. Remove the bulb.

Side lamps

1. Remove the headlamp cover. See headlamp bulb removal.

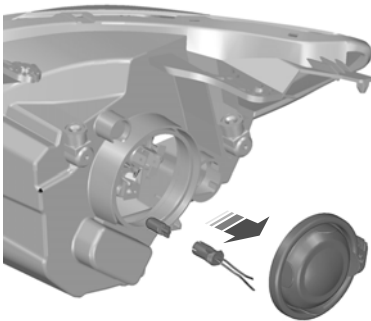

E154464

2. Carefully prise out the bulb holder.
3. Remove the bulb.

Front direction indicators

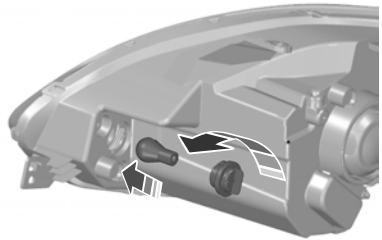

E154465

1. Turn the bulb holder anticlockwise and remove it.
2. Gently press the bulb into the bulb holder, turn it anticlockwise and remove it.

Side Repeaters

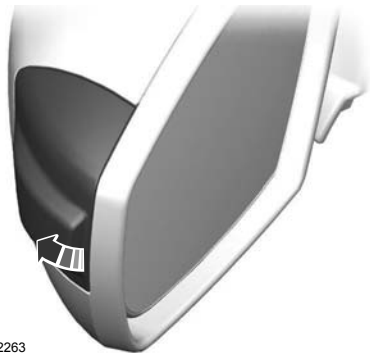

E72263

1. Carefully remove the side repeater.

Lighting

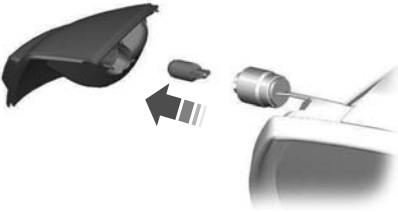

E72291

2. Remove the bulb holder.
3. remove the bulb.

Rear lamps

1. Open the tailgate.

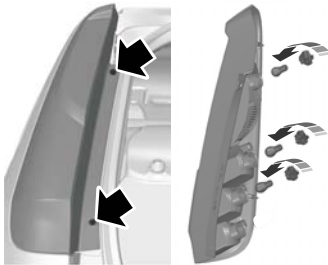

E154483

2. Unscrew the screws and remove the rear lamp assembly.
3. Gently press the bulbs into the bulb holder, turn them anticlockwise and remove them.

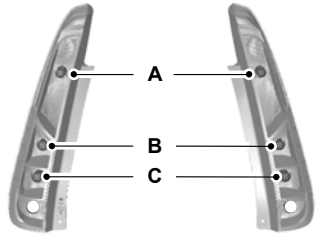

E154484

- A Parking/Brake bulb
- B Turn signal bulb
- C Reverse lamp bulb

Lighting

Central high mounted stop lamp

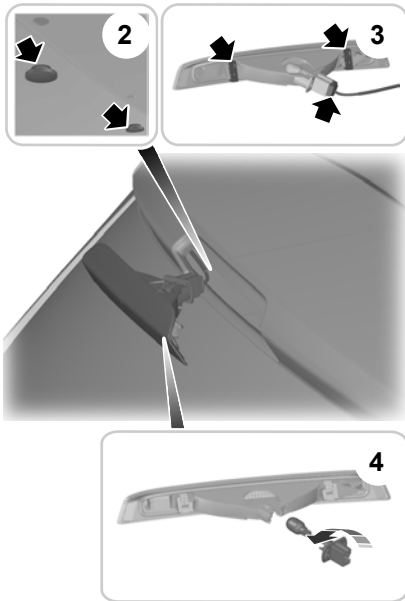

E154784

1. Open the tailgate.
2. Remove the rubber grommet.
3. Release the clips using a flat-bladed screwdriver, remove the lamp and disconnect the connector.
4. Unclip the bulb holder and remove the bulb.

Number plate lamp

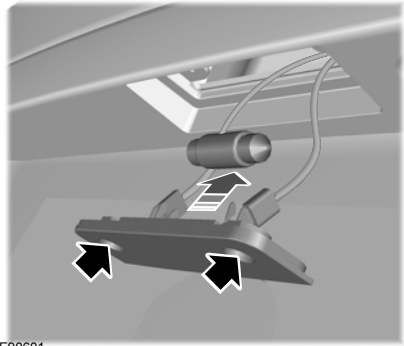

E90601

1. Loosen the screws and remove the lamp.
2. Remove the bulb.

Courtesy lamp

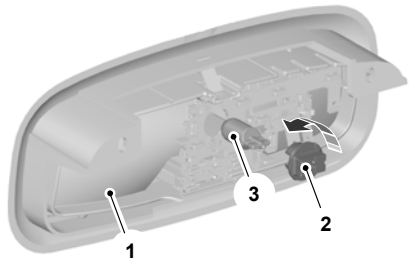

E120231

1. Carefully prise out the lamp.
2. Turn the bulb holder anticlockwise and remove it.
3. Remove the bulb.

Lighting

Luggage compartment lamp

1. Carefully prise out the lamp.
2. Remove the bulb.

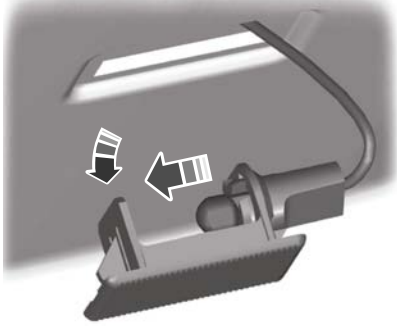

E72784

BULB SPECIFICATION CHART

Bulb	Specification	Rating (watt)
Front direction indicator	PY21W	21
Side lamp	P21/5W	5
Headlamp	H4	55/60
Side repeater	W5W	5
Front fog lamp	H3	55
Brake and parking lamp (rear)	P21/5W	5
Rear direction indicator	P21W	21
Reversing lamp and rear fog lamp	P21W	21
Central high mounted stop lamp	W16W	16
Number plate lamp	C5W	5
Courtesy lamp	6WX	6
Luggage compartment lamp	W5W	5

Windows and Mirrors

POWER WINDOWS

WARNING

 Do not operate the electric windows unless they are free from obstruction.

Note: *If you operate the switches often during a short period of time, the system might become inoperable for a certain time to prevent damage due to overheating.*

The power windows can be operated only when the ignition is switched on.

The front power window can be operated by the switches located on either of the door trims (driver door and front passenger door). To lower or raise the window, press or pull the power window switch respectively.



E120219

Manual windows

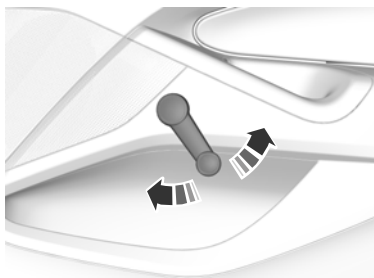

E120310

To raise/lower the window rotate the handle.

Note: *The rear window cannot be fully lowered.*

EXTERIOR MIRRORS

Folding mirrors

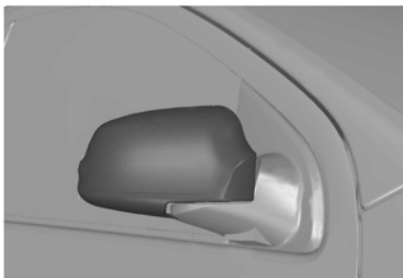

E102162

You can fold back your exterior mirror in narrow spaces or when the vehicle is parked to avoid accidental damage to the mirrors.

Make sure that you fully engage the mirror in its support when returning it to its original position.

Windows and Mirrors

WARNING

 Do not overestimate the distance of the objects that you see in the exterior mirror. Objects seen in the mirror will appear smaller and further away than they actually are.

Manual Exterior Mirrors

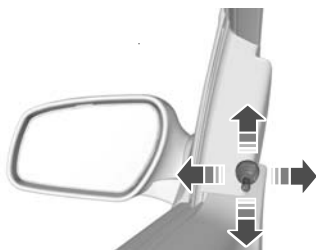

E123951

Both door mirrors are adjustable from inside the vehicle.

ELECTRIC EXTERIOR MIRRORS

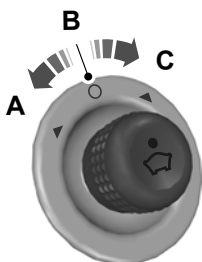

E71280

- A Left-hand mirror
- B Off
- C Right-hand mirror

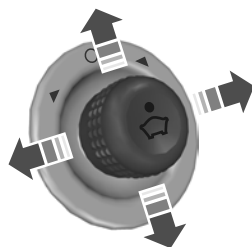

E71281

INTERIOR MIRROR

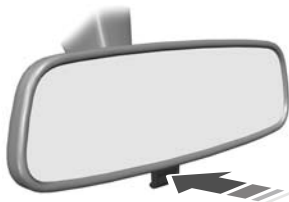

E71272

Dip the mirror to reduce glare when driving at night.

Instrument Cluster

GAUGES

Type A

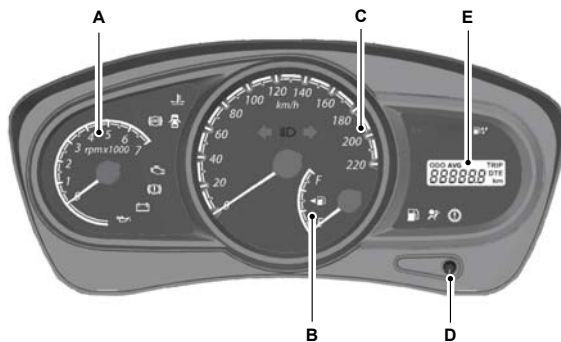

E120228

Type B

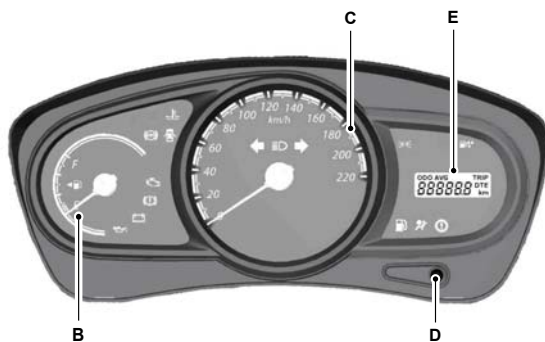

E120229

- A Tachometer
- B Fuel gauge
- C Speedometer
- D Reset button
- E Information display

Instrument Cluster

Theater dimming

The instrument cluster illuminates gradually with a theater dimming effect when the side lamps are switched on.

Fuel gauge

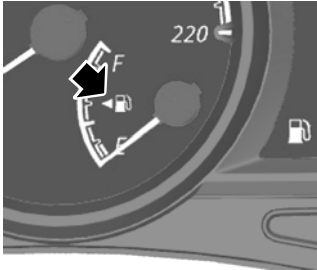

E121144

CAUTION



Check the fuel level prior starting the journey.

The arrow adjacent to the fuel pump symbol tells you on which side of your vehicle the fuel filler cap is located.

The low fuel level warning light illuminates at approximately 80 kms before the tank is empty and audible chimes will be heard to alert you at 80 kms, 40 kms, 20 kms and at empty respectively. Refuel as soon as possible.

Tachometer

Indicates the current engine speed.

Speedometer

Indicates the current vehicle speed.

WARNING LAMPS AND INDICATORS

The following warning lamps and indicators will come on briefly when you switch the ignition on to confirm that the system is operational:

- Brake warning lamp
- Door open warning lamp
- Engine coolant temperature warning lamp
- ABS warning lamp
- Low fuel warning lamp
- Airbag warning lamp
- PATS
- Engine check warning lamp
- Water in fuel warning lamp
- MIL (malfunction indicator warning lamp)

If a warning or indicator lamp does not illuminate when the ignition is switched on, it indicates a malfunction. Have the system checked as soon as possible.

ABS warning lamp



If ABS warning lamp illuminates (with audible chimes) when you are driving, this indicates a malfunction. You will continue to have normal braking (without ABS) but have this checked as soon as possible.

Airbag warning lamp



If the airbag warning lamp illuminates when you are driving, this indicates a malfunction. Have this checked as soon as possible.

Instrument Cluster

Brake system warning lamp

WARNING



Reduce your speed gradually. Use your brakes with great care. Do not step on the brake pedal abruptly.



The brake system warning lamp illuminates (with audible chimes) when:

- the parking brake is engaged.
- low brake fluid.
- EBD (Electronic brake force distribution) failure in ABS equipped vehicles.

The brake system warning lamp will stay on until you release the parking brake. If it illuminates when you are driving, this indicates a malfunction in one of the brake circuits. Check the brake fluid level. See **Brake and Clutch Fluid Check** (page 83).

WARNING



If the brake system warning lamp comes on with the ABS warning lamp, this indicates a malfunction.

Stop your vehicle as soon as it is safe to do so and have this checked before continuing your journey.

Door open warning lamp



The door open warning lamp illuminates (with audible chimes) if a door or the tailgate is open, only when engine is running.

MIL



If the malfunction indicator warning lamp illuminates when the engine is running, this indicates a malfunction. If it flashes when you are driving, reduce the speed of your vehicle immediately. If it continues to flash, avoid heavy acceleration or deceleration. The engine will continue to run but it will have limited power. Have this checked immediately.

Ignition warning lamp



If the ignition warning lamp illuminates (with audible chimes) when you are driving, this indicates a malfunction. Switch off all unnecessary electrical equipment and have this checked immediately.

Low fuel level warning lamp



If the low fuel level warning lamp illuminates (with audible chimes), refuel as soon as possible. See **Gauges** (page 42).

Oil pressure warning lamp

CAUTION



Do not resume your journey if the oil pressure warning lamp comes on despite the oil level being correct. Have this checked immediately.



If the oil pressure warning lamp illuminates (with audible chimes) when you are driving, this indicates a malfunction. Stop your vehicle as soon as it is safe to do so and switch the engine off. Check the engine oil level. See **Engine Oil Check** (page 81).

Instrument Cluster

Engine check warning lamp



If the engine check warning lamp illuminates when the engine is running, this indicates a malfunction. The engine will continue to run but it will have limited power. Have this checked as soon as possible.

Front fog lamp indicator



It will illuminate when you switch the front fog lamps on.

Water in fuel warning lamp (if

Equipped)



If the water in fuel warning lamp illuminates whilst driving immediately see an Authorised Ford Dealer to have the water drained from the fuel filter.

CAUTION



Failure to do so could damage the vehicle's fuel injection system causing engine failure.

Note: *Such failures are not covered under warranty repair.*

Engine coolant temperature warning lamp



If it stays on after starting or illuminates (with audible chimes) when driving, this indicates a malfunction. Stop your vehicle as soon as it is safe to do so and switch the engine off. Check the coolant level. See **Engine Coolant Check** (page 83).

CAUTIONS



Do not resume your journey if it illuminates despite the level being correct. Have the system checked by a properly trained technician immediately.

CAUTIONS



Do not restart the engine until the cause of overheating has been resolved.

Glow plug indicator



See **Starting a Diesel Engine** (page 58).

Main beam indicator



The main beam indicator illuminates when you switch the headlamp main beam on. It will flash when you use the headlamp flasher.

Illumination ON indicator



The illumination on indicator illuminates when the side lamps are switched on.

Direction indicator



The direction indicator will flash when you use the direction indicators. A sudden increase in the rate of flashing warns of a failed bulb.

Information Displays

GENERAL INFORMATION

WARNING



Do not operate the information display controls when the vehicle is moving. The driver should at all times be alert and focus his attention on the road ahead only.

Note: The information display will remain on for several minutes after you switch off the ignition.

Information display

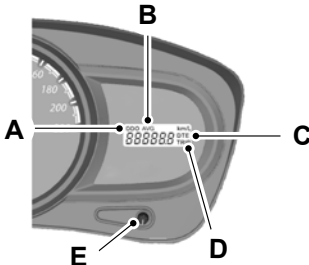

E171745

- A Odometer
- B Average fuel consumption
- C Distance to empty
- D Tripmeter
- E Reset button

Press the reset button to scroll through the displays.

Note: The information display illuminates when the driver door is opened.

Display definitions

Odometer

Note: The maximum value for odometer measurement is 999,999 kms after that it automatically resets and starts from zero.

Registers the total mileage of the vehicle.

Average fuel consumption

Indicates the average fuel consumption since the function was last reset.

Distance to empty

Indicates the approximate distance that your vehicle will travel on the fuel in the fuel tank.

Distance to empty display will stay on for approximately 5 seconds when the ignition is switched on and then cluster will go back to the pre-set mode.

Tripmeter

Note: The maximum value for tripmeter is 9999.9kms and after that it automatically resets and starts from zero.

The tripmeter can register the mileage of individual journeys.

Reset button

A short press toggles the display between odometer, trip, distance to empty and average fuel consumption.

A long press of more than two seconds resets the trip to zero.

Climate Control

PRINCIPLE OF OPERATION

Outside air

In this mode the climate control system utilizes outside air.

Cowl filter and wire mesh filter

These filters remove the dust that is brought in from the outside air through the cooling and heating system, when the blower is operated.

Have your dealer replace/clean the filters as mentioned in the Periodical maintenance schedule.

Recirculated air

CAUTION

! Prolonged use of recirculated air may cause the windows to mist up. If the windows mist up, follow the settings for defrosting and demisting the windscreen.

The air currently in the passenger compartment will be recirculated. Outside air will not enter the vehicle.

Ensure maximum utilization of the recirculation mode to avoid dust entering into the passenger compartment and bad smell entering from outside.

Heating

The purpose of heating is to heat the interior compartment in cold weather conditions.

Heating performance depends on the temperature of the engine coolant.

Air conditioning

The purpose of air conditioning is to cool the interior compartment.

Air is directed through the evaporator where it is cooled. Humidity is extracted from the air to help keep the windows free of mist. The resulting condensation is directed to the outside of the vehicle and it is therefore normal if you see a small pool of water under your vehicle.

If you use the air conditioning, the fuel consumption of your vehicle will be higher.

Note: *The air conditioning operates only when the temperature is above 4°C (39°F).*

General information on controlling the interior climate

Warming the interior

Direct the air towards your feet. In cold or humid weather conditions, direct some of the air towards the windscreen and the door windows.

Cooling the interior

Direct the air towards your face.

AIR VENTS



E71942

Climate Control

MANUAL CLIMATE CONTROL

Blower

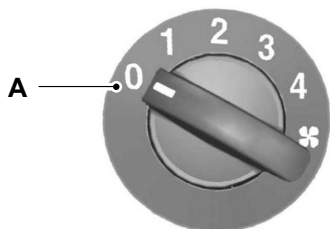

E124410

A Off position

Temperature control

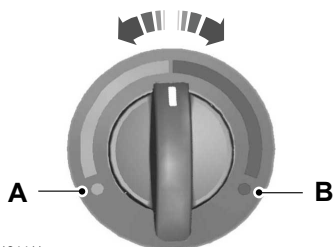

E124411

A Cold side - Blue in colour

B Warm side - Red in colour

Air distribution control

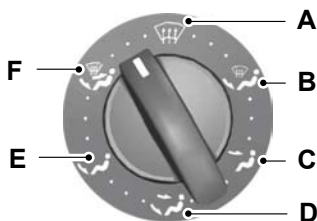

E124416

A Windscreen

B Footwell and windscreen

C Face level

D Face level and footwell

E Footwell

F Face level, windscreen and footwell

You can set the air distribution control to any position between the symbols.

A small amount of air is always directed towards the windscreen.

Defrosting and demisting the windscreen

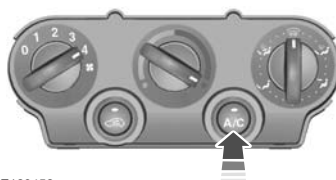

E123452

Steps to be followed:

1. Set air distribution control to windscreen.
2. Switch off the recirculation mode.
3. Set the temperature control knob to maximum hot position.

Climate Control

4. Set the blower to maximum speed.
5. Switch on the A/C.

If necessary, switch the heated windows on in the instrument panel. See **Heated Windows** (page 50).



Ventilation

There are two types of ventilation.

Normal ventilation

Use outside/fresh air mode. Air will flow from outside through the air vents during driving with the blower in off position. The air distribution control mode can be at any desired position.

Forced ventilation

In this type of ventilation the blower can be positioned at any speed and the rest are same as normal ventilation.

Switching the air conditioning on and off



E124402

Press the button, to switch on/off the A/C.

If you turn the blower off, the air conditioning will turn off. When you turn the blower on again, the air conditioning will come on automatically (if the A/C switch is in on position).

Switching the recirculated air on and off



E124407

Press the recirculated air button to switch on/off.

To use the outside/fresh air switch off the recirculation mode.

The last setting will be kept in memory, press the recirculated air button to change over to the other mode.

Cooling with outside air

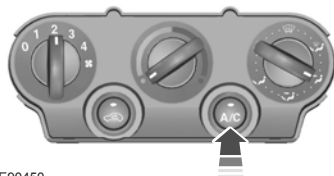

E90450

Cooling the interior quickly

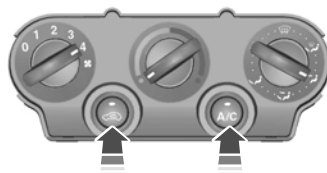

E90451

Steps to be followed:

1. Switch on the blower to maximum speed.
2. Open the windows for 2-3 minutes to allow the inside hot air to go out.
3. Switch on the A/C and recirculation mode.

Climate Control

4. Set the temperature control knob to maximum cold position.
5. Close the windows and set the blower to 2nd speed or to your convenience.

Heating the interior quickly



E90449

Reducing interior air humidity

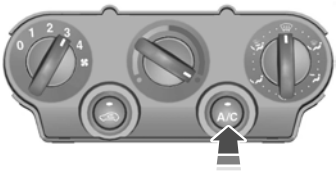

E90452

HEATED WINDOWS

Use the heated rear window to defrost or demist the rear window.

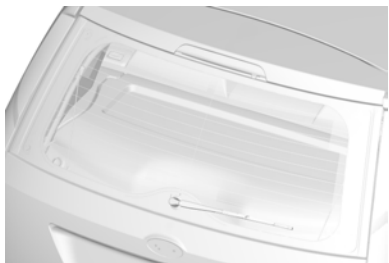

E124041

The heating of rear window will function only when the ignition Key is in run position or ON position. Also this has a timer to auto cut-off the heating of rear window operation.

The heated rear window switch is located in the instrument panel.

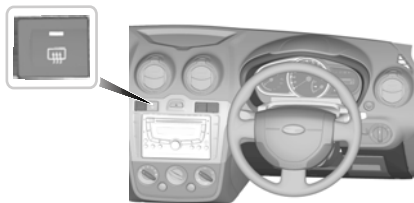

E124040

Seats

SITTING IN THE CORRECT POSITION

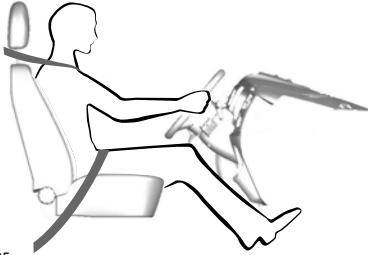

E68595

WARNINGS



Do not adjust the seats when the vehicle is moving.



Only when you use the seat belt properly, can it hold you in a position that allows the airbag to achieve its optimum effect.

When you use them properly, the seat, head restraint, seat belt and airbags will provide optimum protection in the event of a collision. We recommend that you:

- sit in an upright position with the base of your spine as far back as possible.
- do not recline the seatback more than 30 degrees.
- adjust the head restraint so that the top of it is level with the top of your head and as far forwards as possible, remaining comfortable.
- keep sufficient distance between yourself and the steering wheel. We recommend a minimum of 250 millimetres (10 inches) between your breastbone and the airbag cover.
- hold the steering wheel with your arms slightly bent.

- bend your legs slightly so that you can press the pedals fully.
- position the shoulder strap of the seat belt over the centre of your shoulder and position the lap strap tightly across your hips.

Make sure that your driving position is comfortable and that you can maintain full control of your vehicle.

MANUAL SEATS

Moving the seats backwards and forwards



E102370

- 1 Raise the lever to unlock the seat from track
- 2 Seat forward and rearward movement

Seats

WARNING



Rock the seat backwards and forwards after releasing the lever to make sure that it is fully engaged in its catch.

Adjusting the height of the driver's seat

CAUTION



Do not perform seat cushion height adjustment while driving.



E102371

Pull the lever upward to raise the driver seat cushion.

Push the lever downward to lower the driver seat cushion

Adjusting the angle of the seatback



E102372

To adjust the front seatback, lift the handle and hold in the fully up position.

Adjust the seatback to the required back angle then release the adjustment handle. Slight rocking of the seatback may be required to ensure engagement.

The handle will return to the downward position when locked.

Seats

HEAD RESTRAINTS



E75767

Adjusting the head restraint

Adjust the head restraint so that the top of it is level with the top of your head.

Removing the head restraint

Press the locking buttons and remove the head restraint.

REAR SEATS

WARNING



Make sure that the seats and the seatbacks are secured and fully engaged in their catches.

Folding the seatbacks down

WARNING



When folding the seatbacks down, take care not to get your fingers caught between the seatback and seat frame.

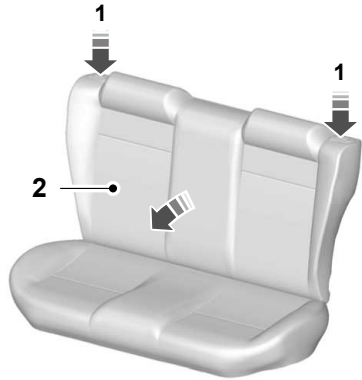

E123947

1. Push the unlock levers.
2. Push the seatback forwards.

Creating a level load floor

WARNING



Make sure the red indicator is not showing when you engage the seat in the catches.

Seats

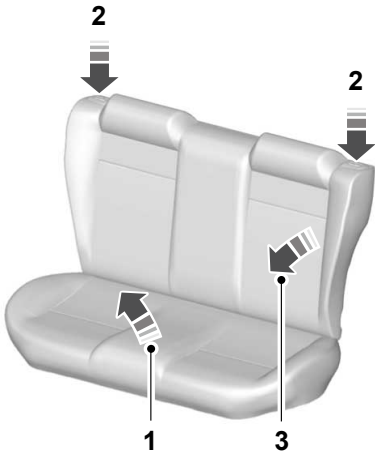

E123948

1. Insert your fingers between the seat cushion and seatback and fold the seat cushion forwards.
2. Push the unlock levers.
3. Push the seatback forwards.

WARNING



When folding the seatbacks up, make sure that the belts are visible to an occupant and not caught behind the seat.



E123949

Convenience features

SUN VISORS



E66493

The sun visors can be released from the retention clips and swivelled towards the side window. The sun visor on the front passenger side also has a mirror in it.

AUXILIARY POWER POINTS

CAUTION

 If you use the socket when the engine is not running, the battery may discharge.

The power socket can be used to power 12 volt electrical appliances having a maximum current rating of 10 amperes.

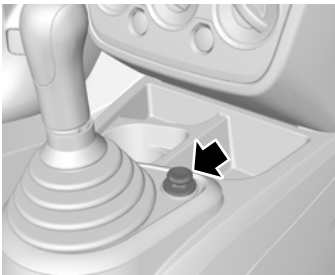

E120275

When connecting to appliances, use only specified connectors from the Ford Accessory range or connectors suitable for use with SAE standard sockets.

Audio jack

Audio jack is provided in the audio panel. It is used for connecting MP3 players, iPod's, etc, to the audio system.



E122031

GLOVE BOX

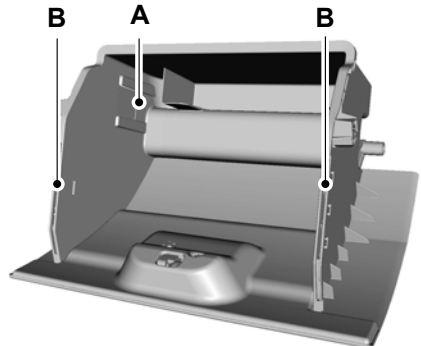

E102199

- A Card holder
- B Coin holders

Convenience features

Note: Do not store heavy and bulky items in the glove box as it may lead to failure of the glove box securing lock.

USB PORT

The USB port is located inside the glove box.

FLOOR MATS

WARNINGS



When using the floor mats, always make sure the floor mat is properly secured using the appropriate fixings and positioned so that it does not interfere with the operation of the pedals.



Do not install additional floor mats on top of the factory installed floor mats.

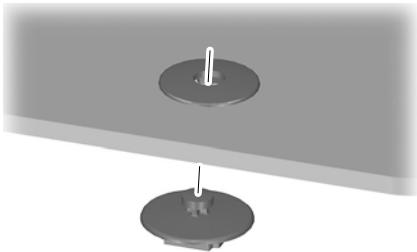

E135555

Starting and Stopping the Engine

GENERAL INFORMATION

General points on starting

If the battery has been disconnected the vehicle may exhibit some unusual driving characteristics for approx. 8 kilometres (5 miles) after reconnecting the battery.

This is because the engine management system must realign itself with the engine. Any unusual driving characteristics during this period may be disregarded.

The starter should not be operated for longer than 10 seconds during each start cycle. Release the ignition key as soon as the engine has started. If the engine has not started, return the ignition key to position **O** and repeat the starting procedure.

If the engine does not start, See **Fuel Shutoff** (page 69).

Starting the engine by towing or pushing

WARNING



To prevent damage you must not push or tow start your vehicle. Use booster cables and a booster battery.

See **Jump Starting the Vehicle** (page 90).

IGNITION SWITCH

Ignition switch positions

Position O

WARNING



Never return the key to the O position when the vehicle is in motion.

Ignition off. When the key is removed from the ignition switch, the steering column lock will be activated as soon as the steering wheel is turned.

Position I

Steering unlocked. Ignition and all main electrical circuits are disabled. The ignition key should not be left in this position for too long to avoid discharging the battery.

Position II

Ignition switched on, all electrical circuits operational. Warning and indicator lamps illuminate. This is the key position when driving, and must also be selected when being towed.

Position III

Starter motor activated. Release the key as soon as the engine starts.

STARTING A PETROL ENGINE

Note: You can only operate the starter for a maximum of 10 seconds at a time.

Cold or hot engine

All vehicles

CAUTION



When the temperature is below -10°C , switch the ignition on for at least one second before starting the engine.

This will make sure that the maximum fuel pressure is established for starting the engine.

Note: Do not touch the accelerator pedal.

1. Fully depress the clutch pedal.
2. Start the engine.

Starting and Stopping the Engine

If the engine does not start within 10 seconds, wait for a short period and try again.

If the engine does not start after **three** attempts, wait 10 seconds and follow the **Flooded engine** procedure.

If you have difficulty starting the engine when the temperature is below -10°C , press the accelerator pedal between $\frac{1}{4}$ to $\frac{1}{2}$ of its travel and try again.

Flooded engine

1. Fully depress the clutch pedal.
2. Fully depress the accelerator pedal and hold it there.
3. Start the engine.

If the engine does not start, repeat the **Cold or hot engine** procedure.

Engine idle speed after starting

The speed at which the engine idles immediately after starting will vary depending on the engine temperature.

If the engine is cold then the idle speed will automatically be increased.

The idle speed will slowly decrease to the normal level as the engine warms up.

STARTING A DIESEL ENGINE

Cold or hot engine

Note: When the temperature is below -10°C , you may need to crank the engine for up to 10 seconds. To aid ease of cranking, turn the ignition key to position II for at least couple of seconds before starting the engine. This ensures that maximum fuel pressure is established.

Note: Continue cranking the engine until it starts.

Note: You can only operate the starter for a maximum of 10 seconds at a time.



Switch the ignition on and wait until the glow plug indicator goes off.

Note: Do not touch the accelerator pedal.

1. Fully depress the clutch pedal.
2. Start the engine.
3. Repeat this exercise for 3 to 4 times until the engine cranks properly.

Note: If starting difficulty is experienced at temperatures below -10°C , depress the accelerator pedal $\frac{1}{4}$ to $\frac{1}{2}$ of its travel to assist starting. This should be done only, if the engine fails to start after several attempts of cranking as given in the above steps.

Flooded Engine

Note: Do not depress the accelerator pedal fully.

1. Depress the clutch pedal fully.
2. Slowly, depress the accelerator fully, hold it in this position and start the engine.
3. If the engine does not start repeat this exercise for 3 to 4 times.

Note: Avoid repeated unsuccessful cranking of Engine. The number of start attempts is limited to approximately six. If you exceed this limit, the system will not allow you to try again until a period of 10 minutes has elapsed.

Note: You cannot start the vehicle, if the fuel level reaches below threshold limit. Upon refueling, you can start the vehicle.

Starting and Stopping the Engine

SWITCHING OFF THE ENGINE

Vehicles with a turbocharger

CAUTION



Do not switch the engine off when it is running at high speed. If you do, the turbocharger will continue running after the engine oil pressure has dropped to zero. This will lead to premature turbocharger bearing wear.

Release the accelerator pedal. Wait until the engine has reached idle speed and then switch it off.

Fuel and Refuelling

SAFETY PRECAUTIONS

WARNINGS

 Stop refuelling after the fuel nozzle stops the second time. Additional fuel will fill the expansion space in the fuel tank which could lead to fuel overflowing. Fuel spillage could be hazardous to other road users.

 Do not use any kind of flames or heat near the fuel system. The fuel system is under pressure. There is a risk of injury if the fuel system is leaking.





CATALYTIC CONVERTER

WARNING

 Do not park or idle your vehicle over dry leaves, dry grass or other combustible materials. The exhaust will radiate a considerable amount of heat during use, and after you have switched the engine off. This is a potential fire hazard.

Driving with a catalytic converter

CAUTIONS

-  Avoid running out of fuel.
-  Do not crank the engine for long periods.
-  Do not run the engine when a spark plug lead is disconnected.
-  Do not push-start or tow-start your vehicle. Use booster cables. See **Jump Starting the Vehicle** (page 90).
-  Do not switch the ignition off when driving.

FUEL FILLER FLAP

Pull the release lever located in the floor to the side of front driver seat for opening the fuel filler flap.

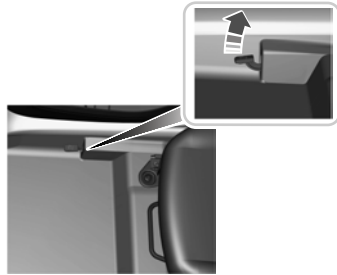

E120174

Turn the cap anti-clockwise to remove. When the filler cap is removed, a hissing noise may be heard. This is normal and should be disregarded.

To close, turn the cap clockwise until it engages fully.

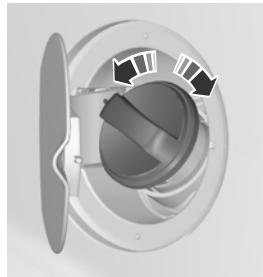

E120197

Fuel and Refuelling

REFUELLING

CAUTION

 Do not attempt to start the engine if you have filled the fuel tank with the incorrect fuel. This could damage the engine. Have the system checked by a properly trained technician immediately.

FUEL QUALITY

Note: Add 1 ml of IFTEX System G with every litre of Gasoline (Petrol). It is available at all Ford authorised dealerships.

CAUTION

 Do not use leaded petrol or petrol with additives containing other metallic compounds (e.g. manganese-based). They could damage the emission system.

Use **minimum 91 octane unleaded** petrol that meets the specification defined by **EN 228**, or equivalent.

FUEL QUALITY

Note: We recommend that you use only high quality fuel without additives or other engine treatments.

WARNING

 Do not mix diesel with oil, petrol or other liquids. This could cause a chemical reaction.

CAUTION

 Do not add kerosene, paraffin or petrol to diesel. This could cause damage to the fuel system.

Use diesel that meets the specification defined by **EN 590**, or equivalent.

You can use diesel that contains up to 5% RME (bio diesel).

Prolonged use of supplemental additives to prevent fuel waxing is not recommended.

FUEL CONSUMPTION

Length of journey/engine temperature

Frequent cold starts and short distance driving leads to considerably increased fuel usage.

Traffic and road conditions

Slow moving traffic, uphill driving, frequent sharp bends and rough roads all have an adverse effect on fuel consumption.

Erratic driving habits

Anticipate hazards ahead and keep a safe distance from the vehicle in front.

This not only reduces fuel consumption but also the noise level.

If you have a prolonged wait at a railway crossing or at traffic lights in built-up areas, it is advisable to switch off the engine during this period.

Vehicle load conditions

Driving in a fully laden condition will result in high fuel consumption.

Vehicle condition

Low tyre pressure or inadequate engine or vehicle maintenance will also result in higher fuel consumption.

Transmission

MANUAL TRANSMISSION

WARNINGS



Engage reverse gear only when the vehicle is stationary.



Do not apply any undue lateral force to the gear lever when changing from 5th to 4th gear as this could lead to the inadvertent selection of 2nd gear.

Reverse gear

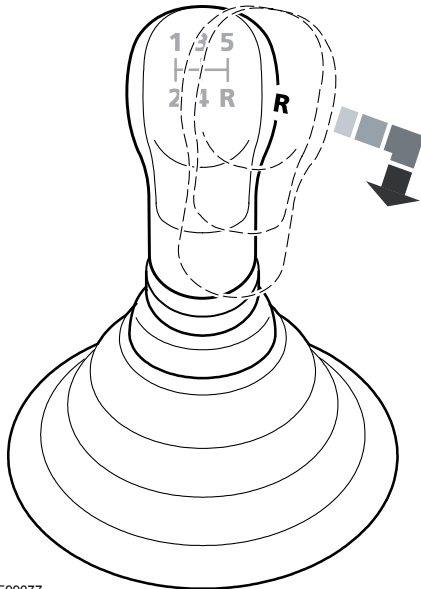

E99077

To avoid shifting noises when engaging the reverse gear, wait approximately three seconds with the clutch depressed when the vehicle is stationary.

To select the reverse gear, shift the lever into the neutral position and then press the lever fully to the right against a spring pressure, before pulling rearwards.

Driving speed and gear selection

Petrol

Gear	Speed range	Engine RPM range
1	0-15	800-2000
2	15-30	1100-2250
3	30-45	1500-2250
4	45-60	1700-2250
5	Greater than 60	Greater than 1750

Diesel

Gear	Speed range	Engine RPM range
1	0-15	750-1750
2	15-30	1000-2000
3	30-45	1400-2000
4	45-60	1500-2000
5	Greater than 60	Greater than 1750

Brakes

PRINCIPLE OF OPERATION

Dual circuit braking system

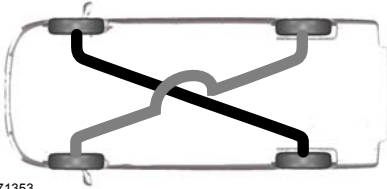

E71353

WARNING



If a brake circuit fails, you will at first experience a softer feel to the brake pedal. You will then need to exert a greater force on the brake pedal, and make allowances for increased stopping distances. Have the braking system checked by an expert before continuing your journey. Authorised Ford Dealers are recommended.

Your vehicle is fitted with a diagonally split, dual circuit brake system. If a brake circuit fails, the other remains operational.

Disc brakes

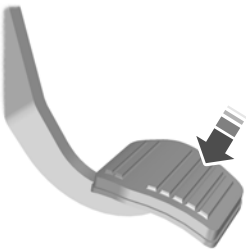

E71354

Wet brake discs result in reduced braking efficiency. Dab the brake pedal when driving from a car wash to remove the film of water.

After leaving a car wash or driving the vehicle through water, dab the brake pedal while driving to remove the film of water.

ABS

WARNING



The ABS does not relieve you of your responsibility to drive with due care and attention.

The ABS helps you to maintain full steering and directional stability when you brake heavily in an emergency, by preventing the road wheels from locking.

HINTS ON DRIVING WITH ANTI-LOCK BRAKES



E71355

When the ABS is operating, the brake pedal will pulse. This is normal. Maintain pressure on the brake pedal.

The ABS will not eliminate the dangers inherent when:

- you drive too close to the vehicle in front of you.
- the vehicle is aquaplaning.
- you take corners too fast.
- the road surface is poor.

PARKING BRAKE

Applying the parking brake

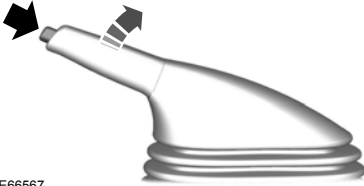

E66567

WARNING



Make sure that the parking brake is applied before you release the lever.

Note: Do not press the release button when you apply the parking brake.

1. Press the brake pedal firmly.
2. Pull the parking brake lever upwards to its fullest extent.

Parking on a hill

If you have to park facing uphill, select first gear and turn the front wheels away from the kerb. If you have to park facing downhill, select reverse gear and turn the front wheels towards the kerb.

Releasing the parking brake

1. Press the brake pedal firmly.
2. Pull the parking brake lever upwards slightly, press the release button and push the lever downwards.

Automatic speed limiter (ASL)

PRINCIPLE OF OPERATION





Engine speed limiter

The engine speed is limited electronically to protect the engine.

Load Carrying

GENERAL INFORMATION

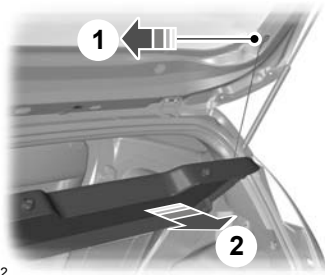

WARNINGS

-  Use load securing straps to an approved standard, e.g. DIN.
-  Make sure that you secure all loose items properly.
-  Place luggage and other loads as low and as far forward as possible within the luggage or loadspace.
-  Do not drive with the tailgate or rear door open. Exhaust fumes may enter the vehicle.
-  Do not exceed the maximum front and rear axle loads for your vehicle.



E72512

CAUTIONS

-  Do not allow items to contact the rear windows.
-  Do not use any abrasive materials to clean the interior of the rear windows.
-  Do not install stickers or labels to the interior of the rear windows.

LUGGAGE COVERS

CAUTION

-  Do not place objects on the luggage cover.

Driving Hints

GENERAL DRIVING POINTS

Vehicles with a diesel engine

If the low fuel level warning lamp comes on, refuel as soon as possible. If you continue driving without refuelling, the engine will start to run unevenly. This indicates that you are about to run out of fuel. Refuel immediately.

RUNNING-IN

Tyres

WARNING



New tyres need to be run-in for approximately 500 kilometres (300 miles). During this time, you may experience different driving characteristics.

Brakes and clutch

WARNING



Avoid heavy use of the brakes and clutch if possible for the first 150 kilometres (100 miles) in town and for the first 1500 kilometres (1000 miles) on motorways.

Engine

CAUTION



Avoid driving too fast during the first 1500 kilometres (1000 miles). Vary your speed frequently and change up through the gears early. Do not labour the engine.

DRIVING THROUGH WATER

Driving through water

CAUTIONS



Drive through water in an emergency only, and not as part of normal driving.



Engine damage can occur if water enters the air filter.

In an emergency, the vehicle can be driven through water to a maximum depth of 200 millimetres (8 inches) and at a maximum speed of 10 km/h (6 mph). Extra caution should be exercised when driving through flowing water.

When driving in water, maintain a low speed and do not stop the vehicle. After driving through water, and as soon as it is safe to do so:

- Depress the brake pedal lightly and check that full brake function is achieved.
- Check that the horn works.
- Check that the vehicle's lights are fully operational.
- Check the power assistance of the steering system.

Roadside Emergencies

FIRST AID KIT

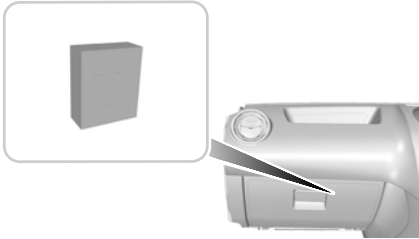

E102206

First aid kit is stored in the glove box. It contains spare fuses, spare bulbs and emergency medical treatment kit. Use it under emergency situations.

WARNING TRIANGLE

Space is provided in the spare wheel well to store a warning triangle.

Status after a collision

INSPECTING SAFETY SYSTEM COMPONENTS

Seat belts

Belts subjected to strain, as a result of an accident, should be renewed and the anchorages checked by a properly trained technician.

FUEL SHUTOFF

Vehicles with a Duratec Petrol engine

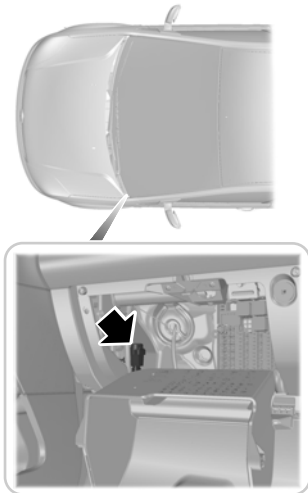

E90982

The fuel supply may be cut off as a result of an accident or sudden vibrations (e.g. collision when parking).

The switch is located behind the glove box. Open the glove box and empty the contents. Press the sides inwards and swivel the glove box downwards. The button under the yellow cap will be raised when the switch is activated.

Resetting the switch

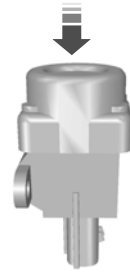

E102200

WARNING



Do not reset the fuel cut-off switch if you see or smell leaking fuel.

1. Turn the ignition switch to position **0**.
2. Check fuel system for leaks.
3. If no fuel leak is apparent, reset the switch by pushing in the button.
4. Turn the ignition switch to position **II**. After a few seconds return the key to position **I**.
5. Make a further check for leaks in the fuel system.

Fuses

CHANGING A FUSE

WARNINGS



Do not modify the electrical system of your vehicle in any way. Have repairs to the electrical system and the replacement of relays and high current fuses carried out by a Ford authorized dealer personnel.



Switch the ignition and all electrical equipment off before touching or attempting to change a fuse.

CAUTION



Fit a replacement fuse with the same rating as the one you have removed.

Note: You can identify a blown fuse by a break in the filament.

Note: All fuses, except high current fuses, are a push fit.

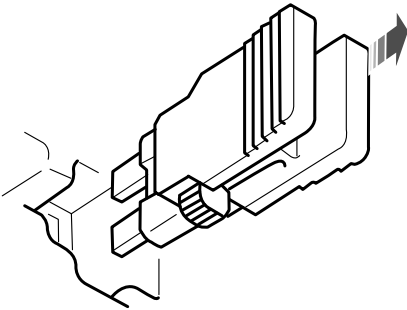

E102376

Fuse puller is available in the First aid kit. Remove the fuses using fuse puller only.

FUSE LABELS

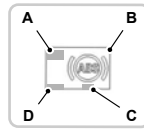

E120323

- A Fuse number
- B Circuits protected
- C Location (**L** = left and **R** = right)
- D Fuse rating (Amperes)



See Owner's handbook



Airbag



ABS



Headlamp dipped beam



Headlamp main beam



Lighting control



Windscreen wipers



Heated rear window

Fuses



Blower motor



Air conditioning



Horn



Engine management or electronic module



Fuel pump



Battery and charging system



Instrument cluster, battery saver, number plate lamp.



Side and tail lamps



Central locking



Hazard warning flashers and direction indicators



Ignition



Brake lamps



Reversing lamp

FUSE BOX LOCATIONS

Engine compartment fuse box

The engine compartment fuse box is attached with the battery tray in the engine compartment.

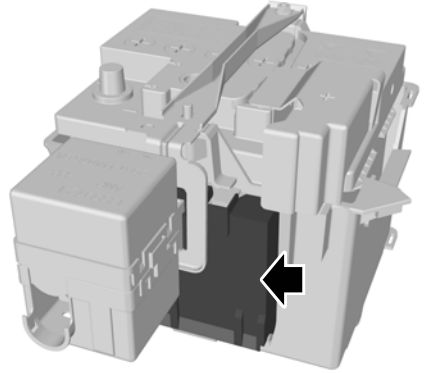

E102377

Passenger compartment fuse box

The passenger compartment fuse box is located behind the glove box in the instrument panel.

Fuses

1. Open the glove box and empty it before continuing.
2. Press the side clips of the glove box inwards and swivel the box further down.

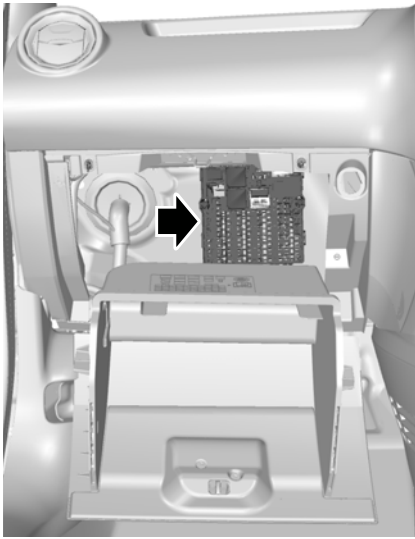

E102208

FUSE SPECIFICATION CHART

Engine junction box

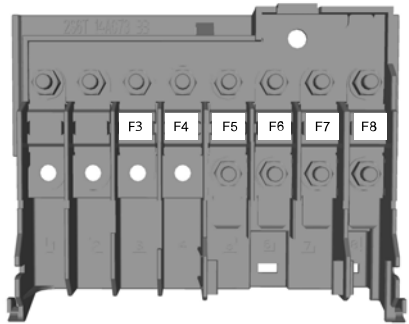

E120757

Fuse	Ampere rating	Circuits protected
F1	-	Not used
F2	-	Not used
F3	60	Diesel glow plug relay
F4	40	Cooling fan and AC (Duratec - Petrol)
	50	Cooling fan and AC (Duratorq - Diesel)
F5	60	PJB busbar BB1
F6	60	Ignition Relay
F7	60	PJB busbar BB4
F8	60	PJB busbar BB5

Fuses

Passenger junction box

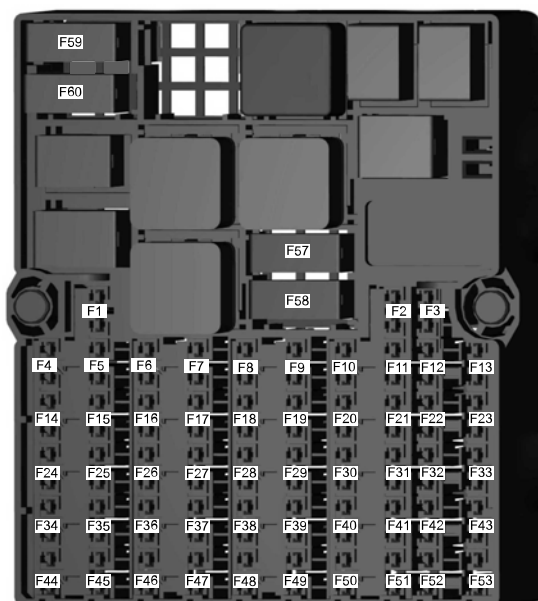

E122292

Fuse	Ampere rating	Circuits protected
F1	-	Not used
F2	-	Not used
F3	-	Not used
F4	10	Air conditioning clutch
F5	20	ABS valve
F6	3	Power mirrors
F7	10	Electric decklid release

Fuses

Fuse	Ampere rating	Circuits protected
F8	-	Not used
F9	10	Head lamp low (dipped) beam - LHS
F10	10	Head lamp low (dipped) beam - RHS
F11	-	Not Used
F12	15	Powertrain control module fuse
F13	20	Heated oxygen sensor - Petrol
		Powertrain control module - Diesel
F14	-	Not used
F15	20	Fuel pump
F16	3	Powertrain control module power
F17	15	Lighting switch
F18	15	Onboard diagnostics/radio
F19	-	Not used
F20	7.5	Instrument cluster
F21	-	Not used
F22	7.5	Park/tail lamp - LHS
F23	7.5	Park/tail lamp - RHS
F24	20	Power door locks (BFC)
F25	15	Turn/hazard lamp
F26	20	Heated back window
F27	15	Horn
F28	3	Alternator
F29	20	Front power outlet connector
F30	15	Ignition switch
F31	7.5	Cargo/dome Lamp
F32	10	Driver door unlock power (BFC)
F33	7.5	License plate lamp

Fuses

Fuse	Ampere rating	Circuits protected
F34	3	Rear window heater switch
F35	-	Not used
F36	10	Turn/hazard flasher
F37	3	ABS module
F38	7.5	HVAC control panel/Thermistor assy/BFC
F39	7.5	Air bag module
F40	10	Light/dimmer switch
F41	7.5	Instrument cluster
F42	-	Not used
F43	-	Not used
F44	3	Radio/Instrument cluster
F45	15	Stop lamps
F46	20	Front wiper
F47	10	Rear wiper park position
F48	7.5	Back up lamp
F49	-	Not used
F50	20	Fog lamps
F51	-	Not used
F52	10	High beam - LHS
F53	10	High beam - RHS
F54	-	Not used
F55	-	Not used
F56	-	Not used
F57	30	Front power windows
F58	30	Heated blower motor
F59	30	Starter motor
F60	30	ABS Pump

Vehicle recovery

TOWING POINTS

Front towing eye

The towing eye is located in the spare wheel well.



E122232

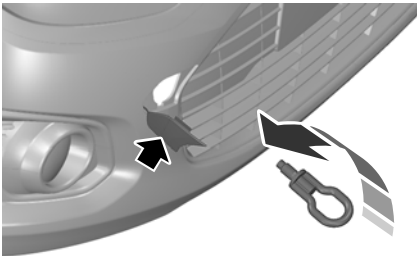

E154486

The screw-in towing eye is attached to the vehicle jack in the luggage compartment. Keep the towing eye with the vehicle at all times.

CAUTION

- ! The screw-in towing eye has a **left-hand thread**. Turn it **anticlockwise** to install it.

Prise off the cover and install the towing eye.

TOWING THE VEHICLE ON FOUR WHEELS

All vehicles

WARNINGS

- ! Switch the ignition on when your vehicle is being towed. The steering lock will engage and the direction indicators and brake lamps will not work if you do not.
- ! The brake servo and the power steering pump do not operate unless the engine is running. Press the brake pedal harder and allow for increased stopping distances and heavier steering.

CAUTIONS

- ! Too much tension in the tow rope could cause damage to your vehicle or the vehicle that is towing.
- ! Do not use a rigid tow bar on the front towing eye. This may cause damage to both the vehicles.

Drive off slowly and smoothly without jerking the vehicle that is towing.

Maintenance

GENERAL INFORMATION

Have your vehicle serviced regularly to help maintain its roadworthiness and resale value. There is a large network of Ford Authorised Repairers that are there to help you with their professional servicing expertise. We believe that their specially trained technicians are best qualified to service your vehicle properly and expertly. They are supported by a wide range of highly specialised tools developed specifically for servicing your vehicle.

In addition to regular servicing, we recommend that you carry out the following additional checks.

WARNINGS



Switch the ignition off before touching or attempting adjustment of any kind.



Do not touch the electronic ignition system parts after you have switched the ignition on or when the engine is running. The system operates at high voltage.



Keep your hands and clothing clear of the engine cooling fan. Under certain conditions, the fan may continue to run for several minutes after you have switched the engine off.

CAUTION



When carrying out maintenance checks, make sure that filler caps are fitted securely.

Daily checks

- Exterior lamps.
- Interior lamps.
- Warning lamps and indicators.

Check when refuelling

- Engine oil level. See **Engine Oil Check** (page 81).
- Brake fluid level. See **Brake and Clutch Fluid Check** (page 83).
- Washer fluid level. See **Washer Fluid Check** (page 84).
- Tyre pressures (when cold). See **Technical Specifications** (page 97).
- Tyre condition. See **Tyre Care** (page 97).

Monthly checks

- Engine coolant level (engine cold). See **Engine Coolant Check** (page 83).
- Pipes, hoses and reservoirs for leaks.
- Power steering fluid level. See **Power Steering Fluid Check** (page 84).
- Air conditioning operation.
- Parking brake operation.
- Horn operation.
- Tightness of wheel nuts. See **Technical Specifications** (page 97).

OPENING AND CLOSING THE BONNET

Opening the bonnet

1. Pull the lever.

Maintenance

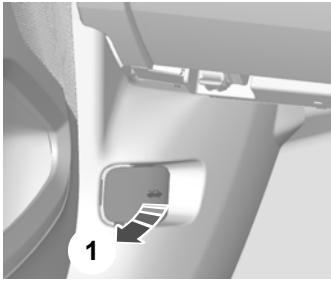

E120200

2. Raise the bonnet slightly and pull the catch towards you.
3. Lift the bonnet from the lock.

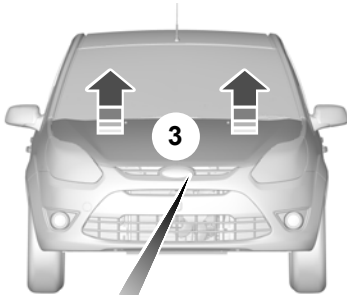

E120201

4. Open the bonnet.
5. Support the bonnet with the bonnet stay rod.

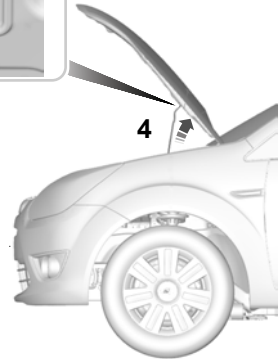

E120202

Closing the bonnet

Note: Make sure that the bonnet is closed properly.

Lower the bonnet and allow it to drop from under its own weight for the last 20 – 30 centimetres.

Maintenance

UNDER BONNET OVERVIEW

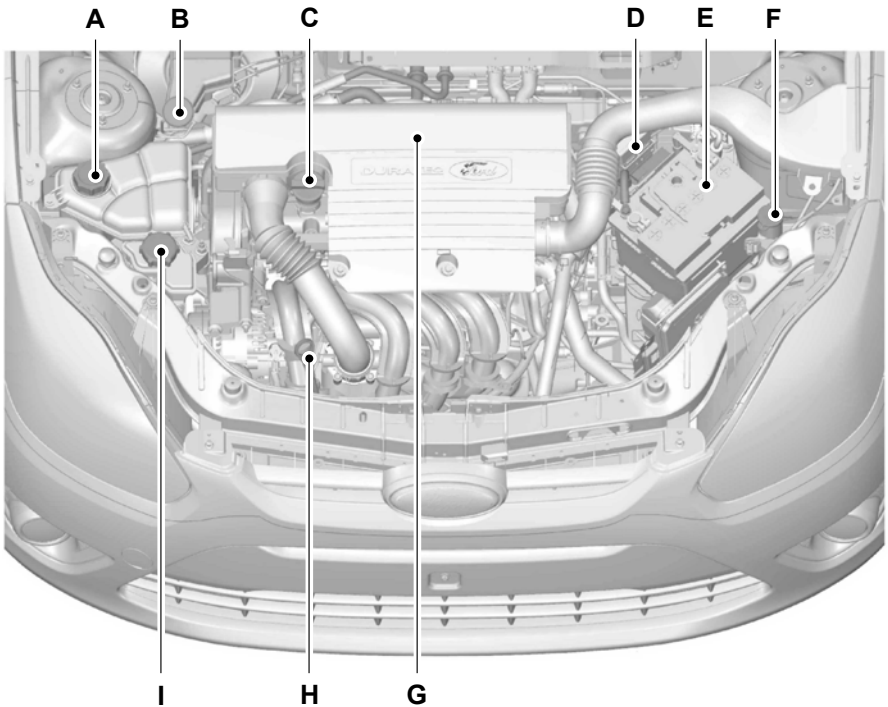

E121060

- A Engine coolant reservoir: See **Engine Coolant Check** (page 83).
- B Brake and clutch fluid reservoir: See **Brake and Clutch Fluid Check** (page 83).
- C Engine oil filler cap: See **Engine Oil Check** (page 81).
- D Engine compartment fuse box. See **Fuse Labels** (page 70).
- E Battery: No maintenance necessary.
- F Windscreen and rear window washer fluid reservoir: See **Washer Fluid Check** (page 84).
- G Air cleaner: No maintenance necessary.

Maintenance

H Engine oil dipstick: See **Engine Oil Dipstick** (page 81).

I Power steering fluid reservoir: See **Power Steering Fluid Check** (page 84).

* The filler caps and the engine oil dipstick are coloured for easy identification.

UNDER BONNET OVERVIEW

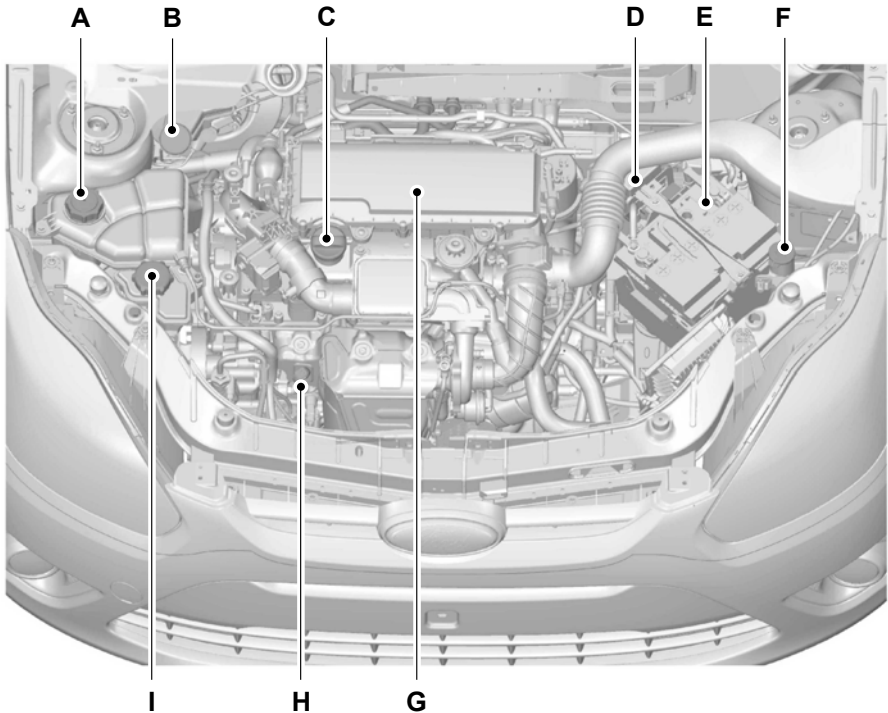

E121061

A Engine coolant reservoir: See **Engine Coolant Check** (page 83).

B Brake and clutch fluid reservoir: See **Brake and Clutch Fluid Check** (page 83).

Maintenance

- C Engine oil filler cap: See **Engine Oil Check** (page 81).
- D Engine compartment fuse box. See **Fuse Labels** (page 70).
- E Battery: No maintenance necessary.
- F Windscreen and rear window washer fluid reservoir: See **Washer Fluid Check** (page 84).
- G Air cleaner: No maintenance necessary.
- H Engine oil dipstick: See **Engine Oil Dipstick** (page 81).
- I Power steering fluid reservoir: See **Power Steering Fluid Check** (page 84).

* The filler caps and the engine oil dipstick are coloured for easy identification.

ENGINE OIL DIPSTICK

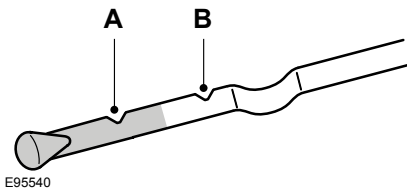

E95540

- A MIN
- B MAX

ENGINE OIL DIPSTICK

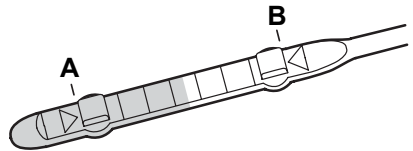

E95911

- A MIN
- B MAX

ENGINE OIL CHECK

The function of the Engine oil is to lubricate and cool the engine.

Engine oil consumption

It is normal for the engine to consume some engine oil during normal operation, the amount of oil consumption depends upon viscosity, quality and the driving conditions. Oil consumption will be more during the following conditions.

Maintenance

- High speed driving.
- Frequent acceleration and deceleration.
- Low speed driving in congested cities.
- Dusty environment such as off road driving and construction site etc.
- Driving with high load.
- Commercial usage such as taxi operation.
- Repeated short trip driving.
- Usage of non Ford oil.

Oil change interval

Oil is to be changed as per the periodic maintenance chart given in periodic maintenance service schedule. However, if the vehicle is used under the above conditions then the engine oil, oil filter and air filter has to be checked at every 5,000 kms (3,000 miles).

Engine Oil Check

CAUTION

- ⚠ Do not use oil additives or other engine treatments. Under certain conditions, they could damage the engine.

Note: *The oil consumption of new engines reaches its normal level after approximately 5,000 kilometres (3,000 miles).*

Checking the oil level

CAUTION

- ⚠ Make sure that the level is between the **MIN** and the **MAX** marks.

Note: *Check the level before starting the engine.*

Note: *Make sure that your vehicle is on level ground.*

Note: *Oil expands when it is hot. The level may therefore extend a few millimetres beyond the **MAX** mark.*

Remove the dipstick and wipe it with a clean, lint free cloth. Replace the dipstick and remove it again to check the oil level.

If the level is at the **MIN** mark, top up immediately.

Topping up



E73940

WARNINGS

- ⚠ Only top up when the engine is cold. If the engine is hot, wait 10 minutes for the engine to cool down.
- ⚠ Do not remove the filler cap when the engine is running.

Remove the filler cap.

CAUTION

- ⚠ Do not top up further than the **MAX** mark.

Top up with fluid that meets the Ford specification. See **Technical Specifications** (page 85).

Maintenance

ENGINE COOLANT CHECK

Checking the coolant level

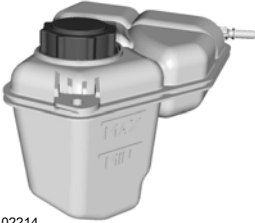

E102214

WARNING

 Do not allow the fluid to touch your skin or eyes. If this happens, rinse the affected areas immediately with plenty of water and contact your doctor.

CAUTION

 Make sure that the level is between the **MIN** and the **MAX** marks.

Note: *Coolant expands when it is hot. The level may therefore extend beyond the **MAX** mark.*

If the level is at the **MIN** mark, top up immediately.

Topping up

WARNINGS

 Only top up when the engine is cold. If the engine is hot, wait 10 minutes for the engine to cool down.

 Do not remove the filler cap when the engine is running.

 Do not remove the filler cap when the engine is hot. Wait for the engine to cool down.

Unscrew the cap **slowly**. Any pressure will escape slowly as you unscrew the cap.

CAUTIONS

 Do not spill coolant on any part of the engine.

 Do not top up further than the **MAX** mark.

Top up with fluid that meets the Ford specification. See **Technical Specifications** (page 85).

BRAKE AND CLUTCH FLUID CHECK



E102211

WARNING

 Do not allow the fluid to touch your skin or eyes. If this happens, rinse the affected areas immediately with plenty of water and contact your doctor.

CAUTION

 Make sure that the level is between the **MIN** and the **MAX** marks.

Note: *The brake and the clutch systems are supplied from the same reservoir.*

If the level is at the **MIN** mark, top up immediately.

Maintenance

Topping up

Remove the filler cap.

CAUTION

⚠ Do not top up further than the **MAX** mark.

Top up with fluid that meets the Ford specification. See **Technical Specifications** (page 85).

POWER STEERING FLUID CHECK



E102222

WARNING

⚠ Do not allow the fluid to touch your skin or eyes. If this happens, rinse the affected areas immediately with plenty of water and contact your doctor.

CAUTION

⚠ Make sure that the level is between the **MIN** and the **MAX** marks.

If the level is at the **MIN** mark, top up immediately.

Topping up

Remove the filler cap.

CAUTION

⚠ Do not top up further than the **MAX** mark.

Top up with fluid that meets the Ford specification. See **Technical Specifications** (page 85).

WASHER FLUID CHECK



E102213

Note: *The front and rear washer systems are supplied from the same reservoir.*

Maintenance

TECHNICAL SPECIFICATIONS

Vehicle fluids

Item	Recommended fluid	Specification
Engine Oil-1.2L Duratec	10W-30 oil	WSS-M2C923-A1
Engine Oil-1.4L Duratorq-TDCi	5W-30 oil	WSS-M2C913-B
Power steering fluid	Ford or Motorcraft Power Steering Fluid	ESW-M2C33-F
Engine coolant	Motorcraft SuperPlus Anti-freeze	WSS-M97B44-D
Brake/Clutch fluid	Ford or Motorcraft Super DOT 4 Brake Fluid	WSS-M6C57-A2
Manual transmission fluid	Ford or Motorcraft Transmission fluid	WSD-M2C200-C
Washer fluid	Ford approved washer fluid	WSD-M8B16-AA

CAUTION



Do not use oils which do not meet the specifications or requirements. Use of unsuitable oil may lead to engine damage which is not covered by the Ford Warranty.

Topping up the oil: If you are unable to find an oil that meets the specification, you must use **SAE 5W-30** (Duratorq) and **SAE 10W-30** (Duratec).

Capacities

Variant	Item	Capacity in litres (gallons)
All	Windscreen and rear window washer system	2.5 (0.55)
All	Fuel tank	45 (9.89)
1.2L Duratec	Engine lubrication system - including the oil filter	4.0 (0.88)
1.2L Duratec	Engine lubrication system - excluding the oil filter	3.8 (0.84)
1.2L Duratec	Engine cooling system	5 (1.1)

Maintenance

Variant	Item	Capacity in litres (gallons)
1.4L Duratorq-TDCi	Engine lubrication system - including the oil filter	3.8 (0.84)
1.4L Duratorq-TDCi	Engine lubrication system - excluding the oil filter	3.4 (0.75)
1.4L Duratorq-TDCi	Engine cooling system	5.5 (1.21)

Variant	Item	Capacity
All	Refrigerant charge	500±20 gms
All	Power steering system	MAX mark

Engine specifications

Engine type	1.2L Duratec	1.4L Duratorq- TDCi
Capacity	1196cc	1399cc
Power output	52.44kW (71.3PS) @ 6250rpm	50kW (68PS) @ 4000rpm
Max.torque	102Nm @ 4000rpm	160Nm @ 2000rpm
Continuous engine speed	6400rpm	4500rpm
Max.Intermittent engine speed	6500rpm	4860rpm
Idle speed	750±50rpm	750±50rpm
Induction system	Naturally aspirated	Turbo charged
Firing order	1-3-4-2	1-3-4-2
Spark/glow plug	AYFS 22 CB	BERU-276-021-11V
Spark plug gap	1.3mm	-
Ignition system	Electronic Ignition	Compression Ignition
Valve clearance inlet*	0.20(±0.03) mm	0.20 mm

Maintenance

Engine type	1.2L Duratec	1.4L Duratorq- TDCI
Valve clearance exhaust*	0.30(±0.03) mm	0.34 mm
Engine oil filter	EFL 600	AC J9B

NOTE: *Check/adjust with engine stationary, not less than 5 minutes after stopping the engine.

Vehicle Care

CLEANING THE EXTERIOR

WARNING



If you use a car wash with a waxing cycle, make sure that you remove the wax from the windscreen.

CAUTIONS



Prior to using a car wash facility check the suitability of it for your vehicle.



Some car wash installations use water at high pressure. This could damage certain parts of your vehicle.



Remove the aerial before using an automatic car wash.



Switch the heater blower off to prevent contamination of the fresh air filter.

We recommend that you wash your vehicle with a sponge and lukewarm water containing a car shampoo.

Cleaning the headlamps

CAUTIONS



Do not scrape the headlamp lenses or use abrasives, alcoholic solvents or chemical solvents to clean them.



Do not wipe the headlamps when they are dry.

Cleaning the rear window

CAUTION



Do not scrape the inside of the rear window or use abrasives or chemical solvents to clean it.

Use a clean, lint free cloth or a damp chamois leather to clean the inside of the rear window.

Cleaning the chrome trim

CAUTION



Do not use abrasives or chemical solvents. Use soapy water.

Cleaning the alloy wheels

Note: Do not apply a cleaning chemical to warm or hot wheel rims and covers.

Note: Industrial-strength (heavy-duty) cleaners, or cleaning chemicals, in combination with brush agitation to remove brake dust and dirt, could wear away the clear coat finish over a period time.

Note: Do not use hydrofluoric acid-based or high caustic-based wheel cleaners, steel wool, fuels or strong household detergent.

Note: If you intend parking your vehicle for an extended period after cleaning the wheels with a wheel cleaner, drive your vehicle for a few minutes before doing so. This will reduce the risk of increased corrosion of the brake discs, brake pads and linings.

Note: Some automatic car washes may cause damage to the finish on your wheel rims and covers.

Alloy wheels and wheel covers are coated with a clear coat paint finish. To maintain their condition we recommend that you:

- Clean them weekly with the recommended wheel and tyre cleaner.
- Use a sponge to remove heavy deposits of dirt and brake dust accumulation.
- Rinse them thoroughly with a pressurised stream of water when you have completed the cleaning process.



We recommend that you use Ford service wheel cleaner. Make sure that you read and follow the manufacturer's instructions.

Vehicle Care

Using other non-recommended cleaning products can result in severe and permanent cosmetic damage.

Body paintwork preservation

CAUTIONS



-  Do not polish your vehicle in strong sunshine.
 -  Do not allow polish to touch plastic surfaces. It could be difficult to remove.
 -  Do not apply polish to the windscreen or rear window. This could cause the wipers to become noisy and they may not clear the window properly.
-

We recommend that you wax the paintwork once or twice a year.

CLEANING THE INTERIOR

Seat belts

WARNINGS

-  Do not use abrasives, or chemical solvents to clean them.
 -  Do not allow moisture to penetrate the seat belt retractor mechanism.
-

Clean the seat belts with interior cleaner or water applied with a soft sponge. Let the seat belts dry naturally, away from artificial heat.



Instrument cluster screens, LCD screens, radio screens

WARNING

-  Do not use abrasives, alcoholic solvents or chemical solvents to clean them.
-

Rear windows

CAUTIONS

-  Do not use any abrasive materials to clean the interior of the rear windows.
 -  Do not install stickers or labels to the interior of the rear windows.
-

REPAIRING MINOR PAINT DAMAGE

CAUTION

-  Remove apparently harmless looking substances from the paintwork immediately (e.g. bird droppings, tree resins, insect remains, tar spots, road salt and industrial fall out).
-

You should repair paintwork damage caused by stones from the road or minor scratches as soon as possible. A choice of products is available from your Ford Dealer. Read and follow the manufacturer's instructions.

Vehicle battery

BATTERY CARE

The battery requires very little maintenance. The fluid level is checked regularly during the routine service inspections.

JUMPSTARTING THE VEHICLE

CAUTIONS

- ❗ Connect batteries with only the same nominal voltage.
- ❗ Always use booster cables with insulated clamps and adequate size cable.
- ❗ Do not disconnect the battery from the vehicle's electrical system.

To connect the booster cables

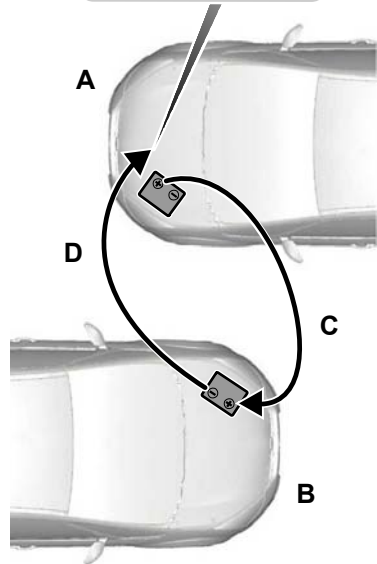
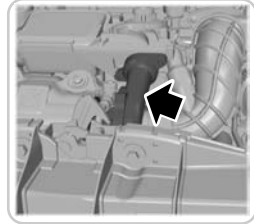

E90587

- A Flat battery vehicle
- B Booster battery vehicle
- C Positive connection cable
- D Negative connection cable

Vehicle battery

Vehicles with a petrol engine

CAUTIONS

 **Do not connect to the negative (-) terminal of the flat battery.**

 Make sure that the jump leads are clear of any moving parts.

1. Position the vehicles so that they do not touch one another.
2. Switch off the engine and any electrical equipment.
3. Connect the positive (+) terminal of vehicle **A** with the positive (+) terminal of vehicle **B** (cable **C**).
4. Connect the negative (-) terminal of vehicle **B** to the engine block or engine mount of vehicle **A** (cable **D**), as far from the battery as possible.

Vehicles with a diesel engine

CAUTIONS

 **Do not connect to the negative (-) terminal of the flat battery.**

 Make sure that the jump leads are clear of any moving parts.

1. Position the vehicles so that they do not touch one another.
2. Switch off the engine and any electrical equipment.
3. Connect the positive (+) terminal of vehicle **A** with the positive (+) terminal of vehicle **B** (cable **C**).
4. Connect the negative (-) terminal of vehicle **B** to the turbocharger of vehicle **A** (cable **D**).

To start the engine

1. Run the engine of vehicle **B** at moderately high speed.
2. Start the engine of vehicle **A**.

3. Run both vehicles for a minimum of three minutes before disconnecting the leads.

CAUTION

 Do not switch on the headlamps when disconnecting the cables. The peak voltage could blow the bulbs.

Disconnect the cables in the reverse order.

Wheels and Tyres

GENERAL INFORMATION

CAUTIONS

- ⚠ Use only approved wheel and tyre sizes. Using other sizes could damage the vehicle and will void the warranty.
- ⚠ If you change the diameter of the tyres from that fitted at the factory, the speedometer may not display the correct speed. Take the vehicle to your dealer to have the engine management system reprogrammed.

A decal with tyre pressure data is located in the front passenger door opening at the B-pillar.

Check and set the tyre pressure at the ambient temperature in which you are intending to drive the vehicle and when the tyres are cold.

CHANGING A ROAD WHEEL

Spare wheel

If the spare wheel differs from the other fitted wheels, these rules must be followed:

WARNINGS

- ⚠ Do not exceed 80 km/h (50 mph).
- ⚠ Drive the shortest possible distances before having the spare wheel changed.
- ⚠ Do not fit more than one spare wheel on your vehicle at any one time.
- ⚠ Do not use snow chains on this type of wheel.

The spare wheel is located under the floor cover in the luggage compartment. Raise the rear of the floor cover in the luggage compartment and remove it.

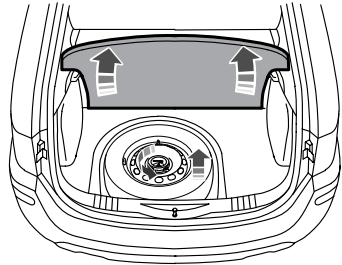

E122058

Completely unscrew the retaining device and lift out the spare wheel.

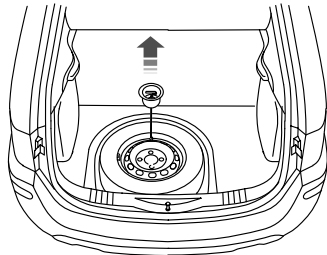

E122163

Vehicle jack

WARNINGS

- ⚠ The vehicle jack supplied with your vehicle should only be used when changing a wheel in emergency situations.
- ⚠ Before using the vehicle jack, check that it is not damaged or deformed and that the thread is lubricated and free from foreign matter.

Wheels and Tyres

WARNINGS



Never place anything between the jack and the ground, or the jack and the vehicle.

Note: Vehicles with a tyre repair kit or run flat tyres are not equipped with a vehicle jack or a wheel brace.

It is recommended to use a workshop type hydraulic jack for changing between summer and winter tyres.

Note: Use a jack with a minimum lifting capacity of 1.5 tonnes and a lifting plate with a minimum diameter of 80 millimetres (3.1 inches).

The jack and wheel brace are located in the spare wheel well. The jack handle is clipped in to the jack.



E122059

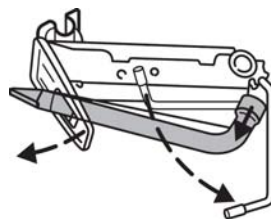

E122055

Jacking and lifting points

CAUTION



Use only the specified jacking points. If you use other positions, you may damage the body, steering, suspension, engine, braking system or the fuel lines.

Note: The jacking points for the vehicle jack and maintenance jack are the same.

Wheels and Tyres

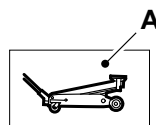
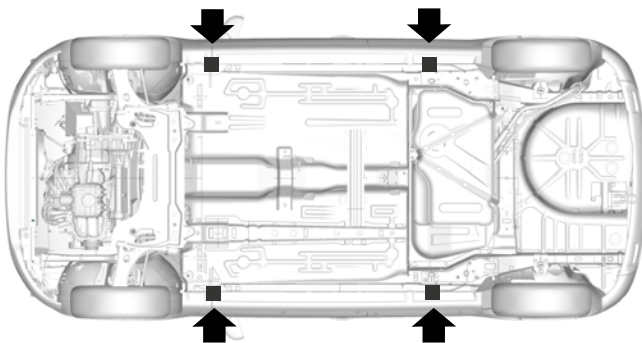

E120276

A Maintenance jack

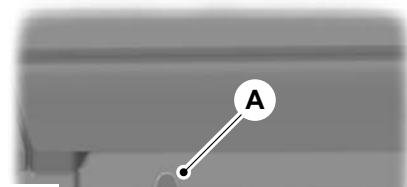
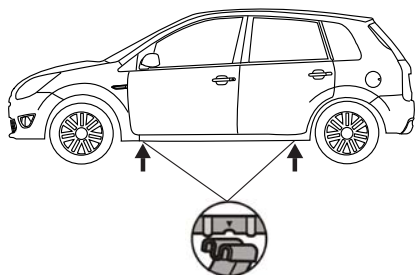

E93184

Indentations in the sills **A** show the location of the jacking points.

E122056

Wheels and Tyres



E113400

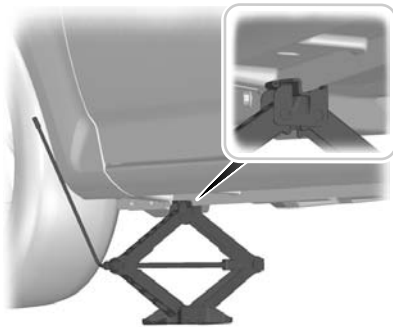









E92932



E93020

Removing a road wheel

WARNINGS

-  Park your vehicle in such a position that neither the traffic nor you are hindered or endangered.
-  Set up a warning triangle.
-  Make sure that the vehicle is on firm, level ground with the wheels pointing straight ahead.
-  Switch off the ignition and apply the parking brake.
-  Select first or reverse gear.
-  Have the passengers leave the vehicle.
-  Secure the diagonally opposite wheel with an appropriate block or wheel chock.
-  Do not work underneath the vehicle when it is supported only by a jack.
-  Make sure that the jack is vertical to the jacking point and the base is flat on the ground.

CAUTION

-  Do not lay alloy wheels face down on the ground, this will damage the paint.

1. Insert the flat end of the wheel brace between the rim and the hub cover and carefully remove the hub cap or cover.

Wheels and Tyres

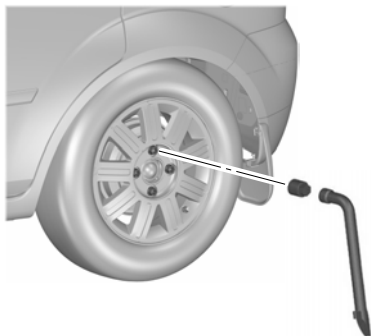

E90922

2. Fully extend the wheel brace if applicable.
3. Slacken the wheel nuts.
4. Jack up the vehicle until the tyre is clear of the ground.
5. Remove the wheel nuts and the wheel.

Installing a road wheel

WARNINGS

 Use only approved wheel and tyre sizes. Using other sizes could damage the vehicle and will make the National Type Approval invalid. See **Technical Specifications** (page 97).

 Do not fit run flat tyres on vehicles that were not originally fitted with them. Please contact your dealer for more details regarding compatibility.

 Make sure that the arrows on directional tyres point in the direction of rotation when the vehicle is moving forwards. If you have to fit a spare wheel with the arrows pointing in the opposite direction, have the tyre refitted in the correct direction by a properly trained technician.

CAUTION

 Do not install alloy wheels using wheel nuts designed for use with steel wheels.

Note: Make sure the wheel and hub contact surfaces are free from foreign matter.

Note: Make sure that the cones on the wheel nuts are against the wheel.

1. Install the wheel.

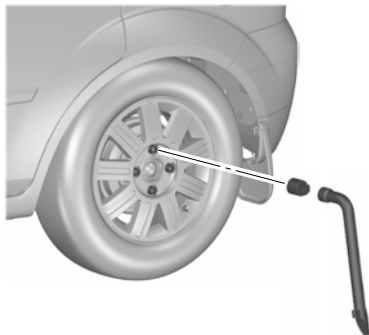

E90922

2. Install the wheel nuts finger tight.

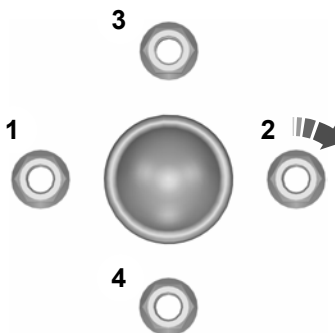

E90589

3. Partially tighten the wheel nuts in the sequence shown.

Wheels and Tyres

4. Lower the vehicle and remove the jack.
5. Fully tighten the wheel nuts in the sequence shown. See **Technical Specifications** (page 97).
6. Install the hub cap or cover using the ball of your hand.

WARNING



Have the wheel nuts checked for tightness and the tyre pressure checked as soon as possible.

TYRE CARE

Tyre rotation including spare wheel

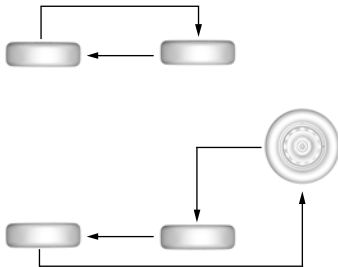

E120217

Tyre rotation without spare wheel



E70415

To make sure the front and rear tyres of your vehicle wear evenly and last longer, we recommend that you swap the tyres from front to rear and vice versa at regular intervals of between 5,000 and 10,000 km (3,000 and 6,000 miles).

CAUTION



Do not scrub the sidewalls of the tyres when you are parking.

If you have to mount a kerb, do so slowly and approach it with the wheels at right-angles to the kerb.

Examine the tyres regularly for cuts, foreign objects and uneven wear of the tread. Uneven wear could mean that the wheel alignment is outside specification.

Check the tyre pressures (including the spare) when cold, every two weeks.

TECHNICAL SPECIFICATIONS

Wheel nut torque

Variant	Specification Nm (lb-ft)
All (except alloy wheel)	95 (70)
Alloy wheel	133 (98)

Wheels and Tyres

Tyre pressures

Inflation pressure – Unladen in bar/psi

Tyre	Pressure bar (psi)
Front	2.06 (30)
Rear	2.06 (30)

Inflation pressure – Laden in bar/psi

Tyre	Pressure bar (psi)
Front	2.48 (36)
Rear	2.82 (41)

Tyre size

Tyre/wheel rim/engine	175/65 R 14T 5.5J x 14	175/65 R 14H 5.5J x 14
1.2L Duratec 16V (Sigma)	X	-
1.4L Duratorq-TDCi (DV4) diesel	X	X

Vehicle identification

VEHICLE IDENTIFICATION NUMBER

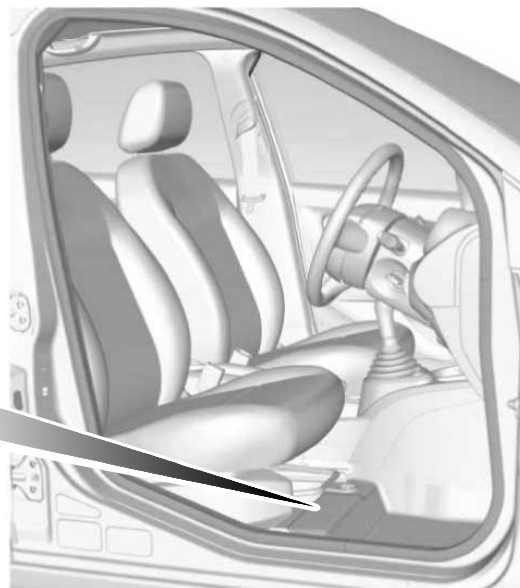
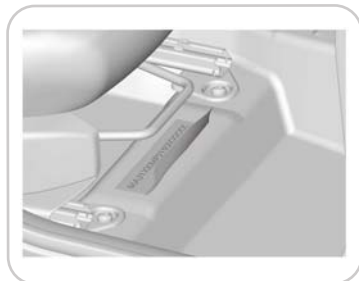

E121140

The vehicle identification number is stamped into the floor panel on the right-hand side, below the front driver seat.

Capacities and Specifications

WEIGHTS

Vehicle kerb weight in kg

	1.2L Duratec, 5- speed manual transmission	1.4L Duratorq-TDCi, 5-speed manual transmission
Front axle	629 to 659	659 to 684
Rear axle	411 to 431	431 to 446
Total kerb weight	1040 to 1090	1090 to 1130

Maximum permissible axle weights in kg

	1.2L Duratec, 5- speed manual transmission	1.4L Duratorq-TDCi, 5-speed manual transmission
Front axle	790	840
Rear axle	800	800
Gross vehicle weight	1460 to 1510	1510 to 1550

Capacities and Specifications

VEHICLE DIMENSIONS

Vehicle dimensions

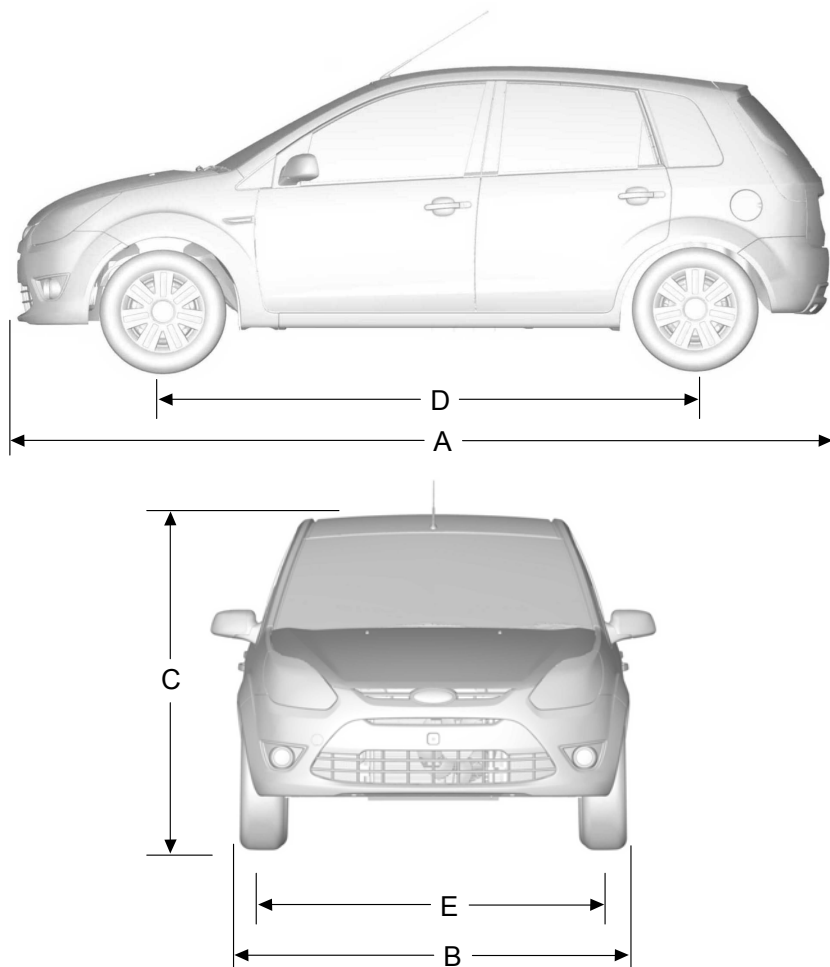

E120756

Capacities and Specifications

Item	Dimension Description	Dimension in mm (inches)
A	Maximum length	3795 (149.4)
B	Overall width including exterior mirrors	1912 (75.3)
C	Overall height at EC kerb weight	1427 (56.2)
D	Wheelbase	2489 (98.0)
E	Front track	1465 (57.7)
E	Rear track	1435 (56.5)



FIGO PERIODICAL MAINTENANCE SERVICE

Scheduled Maintenance

I Inspect : Inspect & clean, repair, adjust or replace & Top-up if necessary

A Adjust : Examination resulting in adjustment or replacement

R Replace

C Clean

T Tighten & Torque

L Lubricate

Maintenance Interval (number of months or mileage (kms) which ever occurs earlier)	Months	3	12	24	36	48	60	72	84	96	108
	X1000 km	2.5	10	20	30	40	50	60	70	80	90

Engine & Transmission

Engine oil	I	R	R	R	R	R	R	R	R	R	R
Engine oil filter	I	R	R	R	R	R	R	R	R	R	R
Sump plug gasket	I	R	R	R	R	R	R	R	R	R	R
Drive belts (Alternator & PAS pump)	I	I	I	I	I	I	I	I	I	I	I
Engine timing belt, Drive belts and Tensioner *	Replace every 1,20,000kms or 5 years whichever occurs first.										
Spark plug - only petrol					R					R	
Air filter	I	I	R	I	R	I	R	I	R	I	I
Transmission oil	I	I	I	I	I	I	I	I	I	I	I

Cooling system

Coolant degas bottle pressure cap	I	I	I	I	I	I	I	I	I	R	I
-----------------------------------	---	---	---	---	---	---	---	---	---	---	---

Fuel system

Fuel filter - Petrol	I	I	I	I	I	I	I	R	I	I	I
Fuel filter - Diesel	I	I	I	R	I	I	R	I	I	I	R
Drain water from fuel filter housing - Diesel	I	C	C	C	C	C	C	C	C	C	C
Fuel lines and hoses	I	I	I	I	I	I	I	I	I	I	I
Breather hose	I	C	C	C	C	C	C	C	C	C	C

Valve clearance to be checked every 1,60,000kms or 8 years.

*Engine coolant need to be replaced at every 1,00,000kms or 5 years.

*Engine timing belt idler need to be replaced, if found defective at the time of timing belt replacement.



FIGO PERIODICAL MAINTENANCE SERVICE

Scheduled Maintenance

I Inspect : Inspect & clean, repair, adjust or replace & Top-up if necessary

A Adjust : Examination resulting in adjustment or replacement

R Replace

C Clean

T Tighten & Torque

L Lubricate

Maintenance Interval (number of months or mileage (kms) which ever occurs earlier)	Months	3	12	24	36	48	60	72	84	96	108
	X1000 km	2.5	10	20	30	40	50	60	70	80	90

Chassis & Body

Brake & Clutch pedals	I	I	I	I	I	I	I	I	I	I	I
Brake & Fluid lines (Routing, damage & chaffing)	I	I	I	I	I	I	I	I	I	I	I
Brake & Clutch Fluid	Inspect every 10,000Kms Replace every 2 Years or 40,000Kms whichever occurs earlier.										
Parking Brake	I	I	I	I	I	I	I	I	I	I	I
Power steering Fluid	I	I	I	I	I	I	I	I	I	I	I
Power steering lines	I	I	I	I	I	I	I	I	I	I	I
Ball joint & Gaiters, Steering & Suspension Linkages	I	I	I	I	I	I	I	I	I	I	I
Wheels & Tyres (Wear, condition & pressure)	I	I	I	I	I	I	I	I	I	I	I
Wheel nuts	T	T	T	T	T	T	T	T	T	T	T
Door stricker & check arm	L	L	L	L	L	L	L	L	L	L	L
Door hinge cavity wax application	L	L	L	L	L	L	L	L	L	L	L
Bonnet lock & safety catch	L	L	L	L	L	L	L	L	L	L	L
Licence plate foam pads	I	I	I	I	I	I	I	I	I	I	I
Seat belts	I	I	I	I	I	I	I	I	I	I	I
Brake pads, brake discs & rear brake linings	I	I	I	I	I	I	I	I	I	I	I

NOTE: Wheel alignment / wheel balancing / tyre rotation to be carried out as and when required.



FIGO PERIODICAL MAINTENANCE SERVICE

Scheduled Maintenance

I Inspect : Inspect & clean, repair, adjust or replace & Top-up if necessary

A Adjust : Examination resulting in adjustment or replacement

R Replace

C Clean

T Tighten & Torque

L Lubricate

Maintenance Interval (number of months or mileage (kms) which ever occurs earlier)	Months	3	12	24	36	48	60	72	84	96	108
	X1000 km	2.5	10	20	30	40	50	60	70	80	90

Electrical & A/C System

Battery electrolyte level and specific gravity	I	I	I	I	I	I	I	I	I	I	I
Cleanliness of the battery terminals	C	C	C	C	C	C	C	C	C	C	C
Exterior lights	I	I	I	I	I	I	I	I	I	I	I
Wipers & Washer	I	I	I	I	I	I	I	I	I	I	I
Instrument panel (Illumination, Gauges & Warning lamps)	I	I	I	I	I	I	I	I	I	I	I
Electrically operated rear view mirrors	I	I	I	I	I	I	I	I	I	I	I
Horn	I	I	I	I	I	I	I	I	I	I	I
Air conditioning function	I	I	I	I	I	I	I	I	I	I	I
A/C Pollen filter**	I	C	C	C	C	C	C	C	C	C	C
A/C Cowl filter	I	I	R	I	R	I	R	I	R	I	I

**A/C Pollen filter to be replaced only if found damaged.

Index

A

A/C	
See: Climate Control.....	47
About This Manual.....	5
ABS	
See: Brakes.....	63
ABS driving hints	
See: Hints on Driving With Anti-Lock Brakes.....	63
Accessories	
See: Replacement Parts Recommendation.....	5
Adjusting the Steering Wheel.....	27
Adjusting the windscreen washer jets.....	30
Air Conditioning	
See: Climate Control.....	47
Air Vents.....	47
Arming the engine immobiliser.....	26
ASL	
See: Automatic speed limiter (ASL).....	65
At a Glance.....	8
Adjusting the steering wheel.....	10
Cooling the interior quickly.....	10
Defrosting and demisting the windscreen.....	10
Engine idle speed after starting.....	9
Information display.....	10
Instrument panel overview - RHD.....	8
Locking and unlocking the doors with the remote control.....	10
Warning lamps and indicators.....	9
Audio Control.....	27
Mode.....	28
Seek.....	27
Volume.....	27
Automatic speed limiter (ASL).....	65
Principle of Operation.....	65
Auxiliary Power Points.....	55
Audio jack.....	55

B

Battery care.....	90
Bonnet Lock	
See: Opening and Closing the Bonnet.....	77

Booster cables	
See: Jump Starting the Vehicle.....	90
Booster Seats.....	12
Booster cushion (Group 3).....	12
Booster seat (Group 2).....	12
Brake and Clutch Fluid Check.....	83
Topping up.....	84
Brakes.....	63
Principle of Operation.....	63
Breaking-In	
See: Running-In.....	67
Bulb changing	
See: Changing a Bulb.....	35
Bulb Specification Chart.....	39

C

Capacities and Specifications.....	100
Car Wash	
See: Cleaning the Exterior.....	88
Catalytic Converter.....	60
Driving with a catalytic converter.....	60
Changing a Bulb.....	35
Central high mounted stop lamp.....	38
Courtesy lamp.....	38
Front direction indicators.....	36
Headlamp main and dipped beam.....	35
Luggage compartment lamp.....	39
Number plate lamp.....	38
Rear lamps.....	37
Side lamps.....	36
Side Repeaters.....	36
Changing a Fuse.....	70
Changing a Road Wheel.....	92
Installing a road wheel.....	96
Jacking and lifting points.....	93
Removing a road wheel.....	95
Spare wheel.....	92
Vehicle jack.....	92
Changing the remote control battery.....	22
Changing the Wiper Blades.....	31
Checking the Wiper Blades.....	30
Child Safety.....	12
Child Safety Locks.....	15
Child Seat Positioning.....	14

Index

Child Seats.....	13
Child restraints for different mass groups.....	13
Cleaning the Exterior.....	88
Body paintwork preservation.....	89
Cleaning the alloy wheels.....	88
Cleaning the chrome trim.....	88
Cleaning the headlamps.....	88
Cleaning the rear window.....	88
Cleaning the Interior.....	89
Instrument cluster screens, LCD screens, radio screens.....	89
Rear windows.....	89
Seat belts.....	89
Climate Control.....	47
Principle of Operation.....	47
Coded keys.....	26
Convenience features.....	55
Coolant Check	
See: Engine Coolant Check.....	83

D

Direction Indicators.....	33
Disarming the engine immobiliser.....	26
Driving Hints.....	67
Driving Through Water.....	67
Driving through water.....	67

E

Electric exterior mirrors.....	41
Engine Coolant Check.....	83
Checking the coolant level.....	83
Topping up.....	83
Engine immobiliser.....	26
Principle of Operation.....	26
Engine Oil Check.....	81
Checking the oil level.....	82
Engine Oil Check.....	82
Engine oil consumption.....	81
Oil change interval.....	82
Topping up.....	82
Engine Oil Dipstick.....	81
Exterior Mirrors.....	40
Folding mirrors.....	40
Manual Exterior Mirrors.....	41

F

Fastening the seat belts.....	19
First Aid Kit.....	68
Floor Mats.....	56
Fog Lamps - Front	
See: Front Fog Lamps.....	33
Front Fog Lamps.....	33
Fuel and Refuelling.....	60
Fuel Consumption.....	61
Erratic driving habits.....	61
Length of journey/engine temperature.....	61
Traffic and road conditions.....	61
Vehicle condition.....	61
Vehicle load conditions.....	61
Fuel filler flap.....	60
Fuel Quality.....	61
Fuel Shutoff.....	69
Vehicles with a Duratec Petrol engine.....	69
Fuse Box Locations.....	71
Engine compartment fuse box.....	71
Passenger compartment fuse box.....	71
Fuse Labels.....	70
Fuses.....	70
Fuse Specification Chart.....	72
Engine junction box.....	72
Passenger junction box.....	73

G

Gauges.....	42
Fuel gauge.....	43
Speedometer.....	43
Tachometer.....	43
Theater dimming.....	43
Gearbox	
See: Transmission.....	62
General Driving Points.....	67
Vehicles with a diesel engine.....	67
General Information on Radio	
Frequencies.....	21
Glove Box.....	55

H

Handbrake	
See: Parking Brake.....	64
Hazard Warning Flashers.....	33

Index

Headlamp Levelling.....	32
Recommended headlamp levelling switch positions.....	33
Head Restraints.....	53
Adjusting the head restraint.....	53
Removing the head restraint.....	53
Heated Windows.....	50
Heating	
See: Climate Control.....	47
Hints on Driving With Anti-Lock Brakes.....	63
Hood Lock	
See: Opening and Closing the Bonnet.....	77

I

Ignition Switch.....	57
Ignition switch positions.....	57
Immobiliser	
See: Engine immobiliser.....	26
Information Displays.....	46
General Information.....	46
Inspecting safety system components.....	69
Seat belts.....	69
Instrument Cluster.....	42
Interior Lamps.....	34
Courtesy lamp.....	34
Luggage compartment lamp.....	35
Interior Mirror.....	41
Introduction.....	5

J

Jump starting	
See: Jump Starting the Vehicle.....	90
Jump Starting the Vehicle.....	90
To connect the booster cables.....	90
To start the engine.....	91

K

Keys and Remote Controls.....	21
-------------------------------	----

L

Lighting Control.....	32
Headlamp flasher.....	32
Main/dipped beam.....	32
Welcome lighting.....	32
Lighting.....	32
Load Carrying.....	66
General Information.....	66
Locking and Unlocking.....	23
Central locking.....	23
Locking and unlocking confirmation.....	23
Locking and unlocking the doors with the key and inner handle.....	23
Locking and unlocking the doors with the remote control.....	24
Manual locking.....	23
Locks.....	23
Luggage Covers.....	66
Lug Nuts	
See: Changing a Road Wheel.....	92

M

Maintenance.....	77
General Information.....	77
Technical Specifications.....	85
Manual Climate Control.....	48
Air distribution control.....	48
Blower.....	48
Cooling the interior quickly.....	49
Cooling with outside air.....	49
Defrosting and demisting the windscreen.....	48
Heating the interior quickly.....	50
Reducing interior air humidity.....	50
Switching the air conditioning on and off.....	49
Switching the recirculated air on and off.....	49
Temperature control.....	48
Ventilation.....	49
Manual Seats.....	51
Adjusting the angle of the seatback.....	52
Adjusting the height of the driver's seat.....	52
Moving the seats backwards and forwards.....	51

Index

Manual Transmission.....	62	Replacement Parts	
Driving speed and gear selection.....	62	Recommendation.....	5
Reverse gear.....	62	Look for the Ford logo on the following	
Message Centre		parts.....	6
See: Information Displays.....	46	Now you can be sure that your Ford parts	
Mirrors		are Ford parts.....	5
See: Windows and Mirrors.....	40	Roadside Emergencies.....	68
O		Running-In.....	67
Occupant protection.....	16	Brakes and clutch.....	67
Principle of Operation.....	16	Engine.....	67
Oil Check		Tyres.....	67
See: Engine Oil Check.....	81	S	
Opening and Closing the Bonnet.....	77	Safety Precautions.....	60
Closing the bonnet.....	78	Seats.....	51
Opening the bonnet.....	77	Sitting in the Correct Position.....	51
P		Special Notices.....	6
Parking Brake.....	64	Starter Switch	
Applying the parking brake.....	64	See: Ignition Switch.....	57
Parking on a hill.....	64	Starting a Diesel Engine.....	58
Releasing the parking brake.....	64	Cold or hot engine.....	58
Power Door Locks		Flooded Engine.....	58
See: Locking and Unlocking.....	23	Starting and Stopping the Engine.....	57
Power Steering Fluid Check.....	84	General Information.....	57
Topping up.....	84	Starting a Petrol Engine.....	57
Power Windows.....	40	Cold or hot engine.....	57
Manual windows.....	40	Engine idle speed after starting.....	58
Programming the remote control.....	21	Flooded engine.....	58
Re-programming the unlocking		Status after a collision.....	69
function.....	21	Steering Wheel.....	27
R		Sun Visors.....	55
Rear Seats.....	53	Switching Off the Engine.....	59
.....	54	Vehicles with a turbocharger.....	59
Creating a level load floor.....	53	Symbols Glossary.....	5
Folding the seatbacks down.....	53	Symbols in this handbook.....	5
Rear Window Wiper and Washers.....	30	Symbols on your vehicle.....	5
Intermittent Wipe.....	30	T	
Washer.....	30	Technical Specifications	
Refuelling.....	61	See: Capacities and Specifications.....	100
Repairing Minor Paint Damage.....	89	Towing Points.....	76
		Front towing eye.....	76
		Towing the Vehicle on Four Wheels.....	76
		All vehicles.....	76
		Transmission.....	62
		Tyre Care.....	97

Index

Tyres	
See: Wheels and Tyres.....	92
U	
Under Bonnet Overview.....	79
USB Port.....	56
Using seat belts during pregnancy.....	20
V	
Vehicle battery.....	90
Vehicle Care.....	88
Vehicle Dimensions.....	101
Vehicle Identification Number.....	99
Vehicle identification.....	99
Vehicle recovery.....	76
Ventilation	
See: Climate Control.....	47
Vents	
See: Air Vents.....	47
VIN	
See: Vehicle Identification Number.....	99
W	
Warning Lamps and Indicators.....	43
ABS warning lamp.....	43
Airbag warning lamp.....	43
Brake system warning lamp.....	44
Direction indicator.....	45
Door open warning lamp.....	44
Engine check warning lamp.....	45
Engine coolant temperature warning lamp.....	45
Front fog lamp indicator.....	45
Glow plug indicator.....	45
Ignition warning lamp.....	44
Illumination ON indicator.....	45
Low fuel level warning lamp.....	44
Main beam indicator.....	45
MIL.....	44
Oil pressure warning lamp.....	44
Water in fuel warning lamp.....	45
Warning Triangle.....	68
Washer Fluid Check.....	84
Washers	
See: Wipers and Washers.....	29
Washing	
See: Cleaning the Exterior.....	88
Weights.....	100
Wheel Nuts	
See: Changing a Road Wheel.....	92
Wheels and Tyres.....	92
General Information.....	92
Technical Specifications.....	97
Windows and Mirrors.....	40
Windscreen Washers.....	29
Windscreen Wipers.....	29
Intermittent wiping.....	29
Wipers and Washers.....	29

