

2007 S2000

Owner's Manual

(Unlinked)

This document does not contain hyperlinks and may be formatted for printing instead of web us. This is due to changes in content and specifications of the vehicle that happen throughout the model year. This manual will be replaced with a hyperlinked version at the end of the model year.

© 2006 Honda Motor Co., Ltd.

P/N 31S2A670



Owner's Identification

OWNER _____

ADDRESS _____

STREET

CITY

STATE/PROVINCE

ZIP CODE/
POSTAL CODE

V. I. N. _____

DELIVERY DATE _____

(Date sold to original retail purchaser)

DEALER NAME _____ DEALER NO. _____

ADDRESS _____

STREET

CITY

STATE/PROVINCE

ZIP CODE/
POSTAL CODE

OWNER'S SIGNATURE _____

DEALER'S SIGNATURE _____

This owner's manual should be considered a permanent part of the vehicle and should remain with the vehicle when it is sold.

This owner's manual covers all models of the S2000. You may find descriptions of equipment and features that are not on your particular model.

The information and specifications included in this publication were in effect at the time of approval for printing. Honda Motor Co., Ltd. reserves the right, however, to discontinue or change specifications or design at any time without notice and without incurring any obligation whatsoever.





Introduction

Congratulations on your selection of the 2007 Honda S2000. We are certain you will be pleased with your purchase of one of the most sophisticated and technologically-advanced sports cars in the world.

One of the best ways to enhance the enjoyment of your new vehicle is to read this manual. In it, you will learn how to operate its driving controls and convenience items. Afterwards, keep this owner's manual in your vehicle so you can refer to it at any time.

Several warranties protect your new vehicle. Read the warranty booklet thoroughly so you understand the coverages and are aware of your rights and responsibilities.

Maintaining your vehicle according to the messages shown on the information display helps to keep your driving trouble-free while it preserves your investment. When your vehicle needs maintenance, keep in mind that your dealer's staff is specially trained in servicing the many systems unique to your vehicle. Your Honda dealer is dedicated to your satisfaction and will be pleased to answer any questions and concerns.

As you read this manual, you will find information that is preceded by a **NOTICE** symbol. This information is intended to help you avoid damage to your vehicle, other property, or the environment.





Introduction

California Proposition 65 Warning

WARNING: This product contains or emits chemicals known to the state of California to cause cancer and birth defects or other reproductive harm.

Event Data Recorders

This vehicle is equipped with one or more devices commonly referred to as event data recorders. These devices record seat belt use, passenger seat occupancy, airbag deployment data, and the failure of any airbag system component. This data belongs to the vehicle owner and may not be accessed by anyone else except as legally required or with the permission of the vehicle owner.

Service Diagnostic Recorders

This vehicle is equipped with service-related devices that record information about powertrain performance. The data can be used to verify emissions law requirements and/or help technicians diagnose and solve service problems. It may also be combined with data from other sources for research purposes, but it remains confidential and is never linked to the vehicle owner.

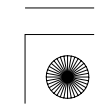
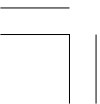



A Few Words About Safety

Your safety, and the safety of others, is very important. And operating this vehicle safely is an important responsibility.

To help you make informed decisions about safety, we have provided operating procedures and other information on labels and in this manual. This information alerts you to potential hazards that could hurt you or others.

Of course, it is not practical or possible to warn you about all the hazards associated with operating or maintaining your vehicle. You must use your own good judgement.

You will find this important safety information in a variety of forms, including:

- **Safety Labels** — on the vehicle.
- **Safety Messages** — preceded by a safety alert symbol  and one of three signal words: **DANGER**, **WARNING**, or **CAUTION**. These signal words mean:

 **DANGER**

You **WILL** be **KILLED** or **SERIOUSLY HURT** if you don't follow instructions.

 **WARNING**

You **CAN** be **KILLED** or **SERIOUSLY HURT** if you don't follow instructions.

 **CAUTION**

You **CAN** be **HURT** if you don't follow instructions.

- **Safety Headings** — such as Important Safety Reminders or Important Safety Precautions.
- **Safety Section** — such as Driver and Passenger Safety.
- **Instructions** — how to use this vehicle correctly and safely.

This entire book is filled with important safety information — please read it carefully.





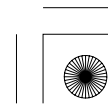
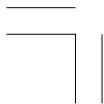





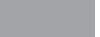



06/07/13 17:12:46 31S2A670 0005



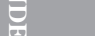

Contents

Your Vehicle at a Glance (main controls)	3	
Driver and Passenger Safety (seat belts, SRS, and child protection)	5	
Instruments and Controls (indicators, gauges, dashboard, and steering column)	43	
Features (heating and cooling, audio, steering wheel, and cruise control)	83	
Before Driving (fuel, vehicle break-in, and cargo loading)	109	
Driving (engine and transmission operation).....	121	
Maintenance (minder, fluid checking, minor services, and vehicle storage).....	133	
Taking Care of the Unexpected (flat tire, dead battery, overheating, fuses).....	173	
Technical Information (vehicle specifications, tires, fuels, and emissions controls)	199	
Warranty and Customer Relations (U.S. and Canada only) (warranty and contact information).....	211	
Authorized Manuals (U.S. only) (how to order)	215	
Index	I	
Service Information Summary (fluid capacities and tire pressures)	last page	

INDEX

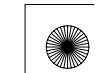



Overview of Contents

Contents

A convenient reference to the sections in this manual.

Your Vehicle at a Glance

A quick reference to the main controls in your vehicle.

Driver and Passenger Safety

Important information about the proper use and care of your vehicle's seat belts, an overview of the supplemental restraint system, and valuable information on how to protect children with child restraints.

Instruments and Controls

Explains the purpose of each instrument panel indicator and gauge, and how to use the controls on the dashboard and steering column.

Features

How to operate the heating and air conditioning system, the audio system, and other convenience features.

2

Before Driving

What gasoline to use, how to break-in your new vehicle, and how to load luggage and other cargo.

Driving

The proper way to start the engine, shift the transmission, and park.

Maintenance

The maintenance minder shows you when you need to take your vehicle to the dealer for maintenance service. There is also a list of things to check and instructions on how to check them.

Taking Care of the Unexpected

This section covers several problems motorists sometimes experience, and details how to handle them.

Technical Information

ID numbers, dimensions, capacities, and technical information.

Warranty and Customer Relations

(U.S. and Canada only)

A summary of the warranties covering your new vehicle, and how to contact us for any reason. Refer to your warranty manual for detailed information.

Authorized Manuals

(U.S. only)

How to order manuals and other technical literature.

Index

Service Information Summary

A summary of the information you need when you pull up to the fuel pump.





Your Vehicle at a Glance

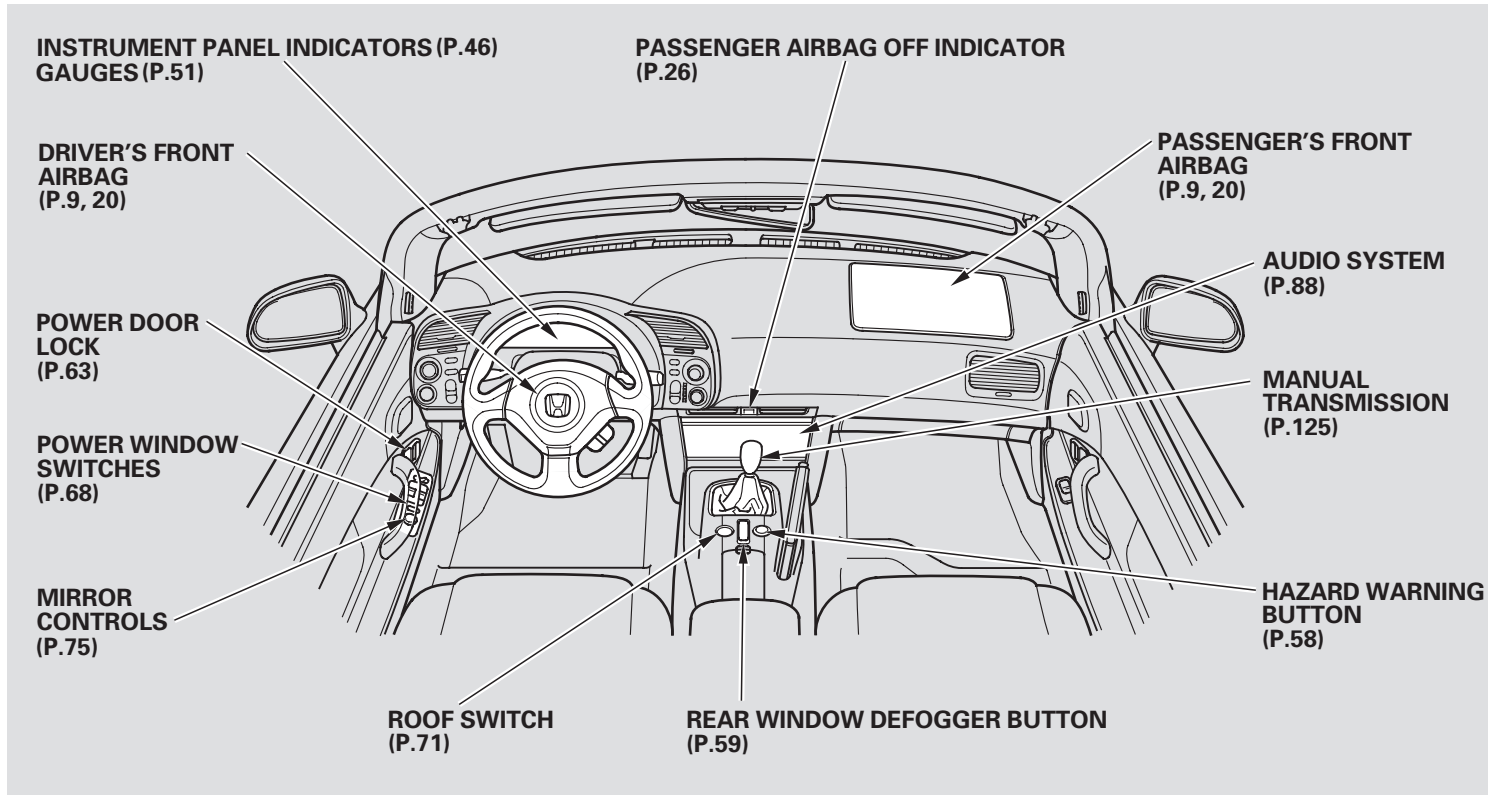

Your Vehicle at a Glance

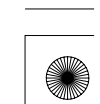
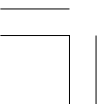



Your Vehicle at a Glance

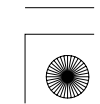
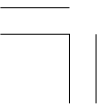
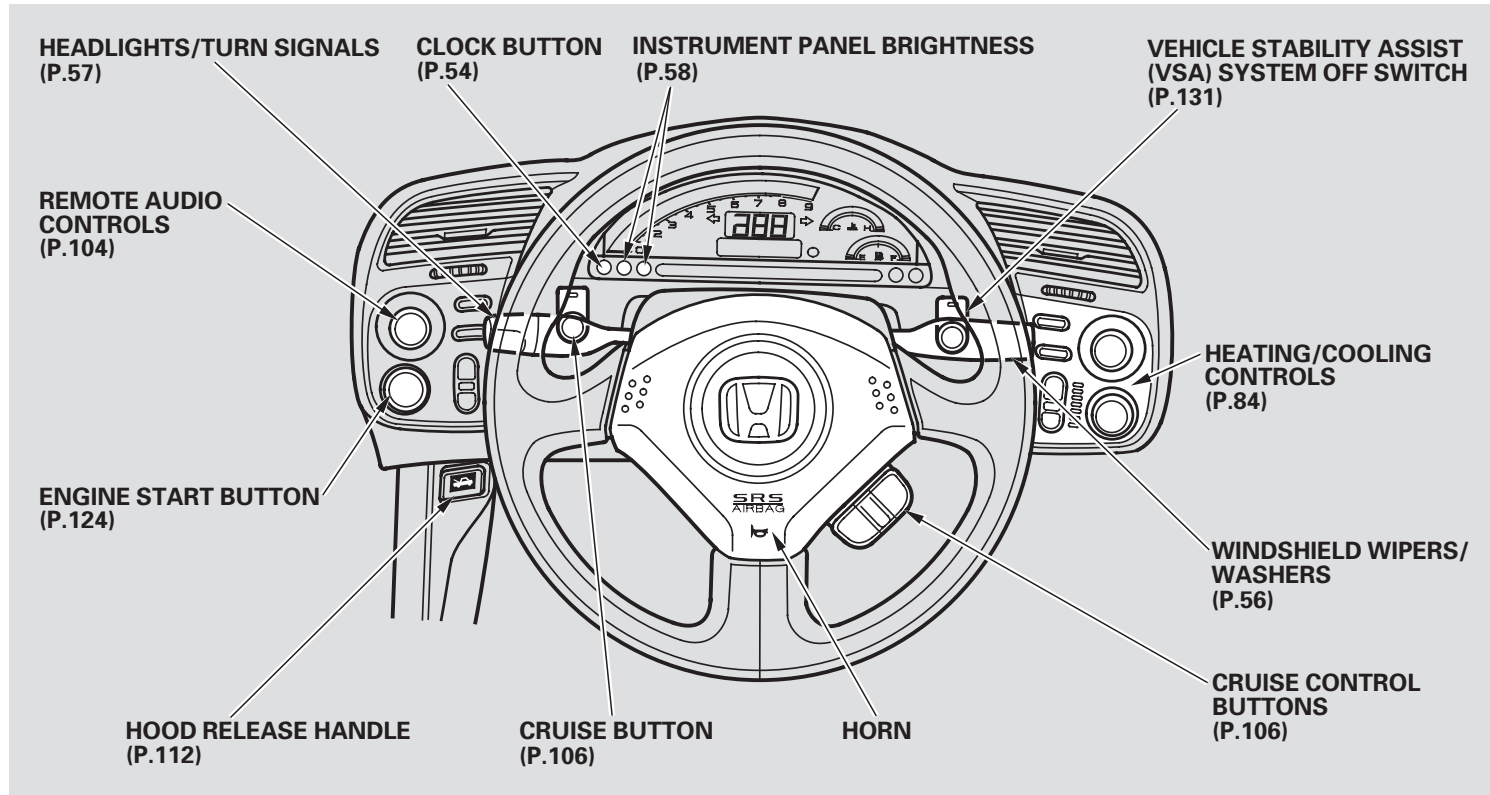



Driver and Passenger Safety

This section gives you important information about how to protect yourself and your passenger. It shows you how to use seat belts. It explains how your airbags work. And it tells you how to properly restrain children in your vehicle.

Important Safety Precautions	6
Your Vehicle's Safety Features.....	7
Seat Belts	8
Airbags	9
Protecting Adults and Teens.....	10
1. Close and Lock the Doors	10
2. Adjust the Seats	10
3. Adjust the Seat-Backs	11
4. Fasten and Position the Seat Belts.....	12
5. Maintain a Proper Sitting Position	13
Advice for Pregnant Women.....	14
Additional Safety Precautions....	15
Additional Information About Your Seat Belts	16
Seat Belt System Components...	16
Lap/Shoulder Belt	17
Automatic Seat Belt Tensioners.....	18
Seat Belt Maintenance	18
Additional Information About Your Airbags.....	20
Airbag System Components.....	20
How Your Airbags Work	22
How the SRS Indicator Works...	25

How the Passenger Airbag Off Indicator Works	26
Airbag Service	27
Additional Safety Precautions....	28
Protecting Children – General Guidelines.....	29
All Children Must Be Restrained	29
Your Vehicle is Not Recommended for Child Passengers	30
The Passenger's Airbag Can Pose Serious Risks	30
Additional Safety Precautions....	32
Protecting Small Children	33
Selecting a Child Seat.....	34
Installing a Child Seat	34
Protecting Larger Children	37
Checking Seat Belt Fit	37
Using a Booster Seat.....	38
When Can a Larger Child Ride in This Vehicle	39
Additional Safety Precautions....	40
Carbon Monoxide Hazard	41
Safety Labels	42





Important Safety Precautions

You'll find many safety recommendations throughout this section, and throughout this manual. The recommendations on this page are the ones we consider to be the most important.

Always Wear Your Seat Belt

A seat belt is your best protection in all types of collisions. Airbags are designed to supplement seat belts, not replace them. So even though your vehicle is equipped with airbags, make sure you and your passenger always wear your seat belts, and wear them properly (see page 12).

Your Vehicle is Not Recommended for Child Passengers

Since all children are safest in the back seat of a vehicle, and your vehicle does not have a back seat, we recommend that you do not carry a child passenger.

Never carry an infant in a rear-facing child seat in this vehicle.

If an older child must ride in this vehicle, follow all child safety instructions and warnings in this manual (see pages 29 – 40).

Be Aware of Airbag Hazards

While airbags can save lives, they can cause serious or fatal injuries to occupants who sit too close to them, or are not properly restrained. Infants, young children, and short adults are at the greatest risk. Be sure to follow all instructions and warnings in this manual.

Don't Drink and Drive

Alcohol and driving don't mix. Even one drink can reduce your ability to respond to changing conditions, and your reaction time gets worse with every additional drink. So don't drink and drive, and don't let your friends drink and drive, either.

Control Your Speed

Excessive speed is a major factor in crash injuries and deaths. Generally, the higher the speed, the greater the risk, but serious injuries can also occur at lower speeds. Never drive faster than is safe for current conditions, regardless of the maximum speed posted.

Keep Your Vehicle in Safe Condition

Having a tire blowout or a mechanical failure can be extremely hazardous. To reduce the possibility of such problems, check your tire pressures and condition frequently, and perform all regularly scheduled maintenance (see page 134).





Your Vehicle's Safety Features

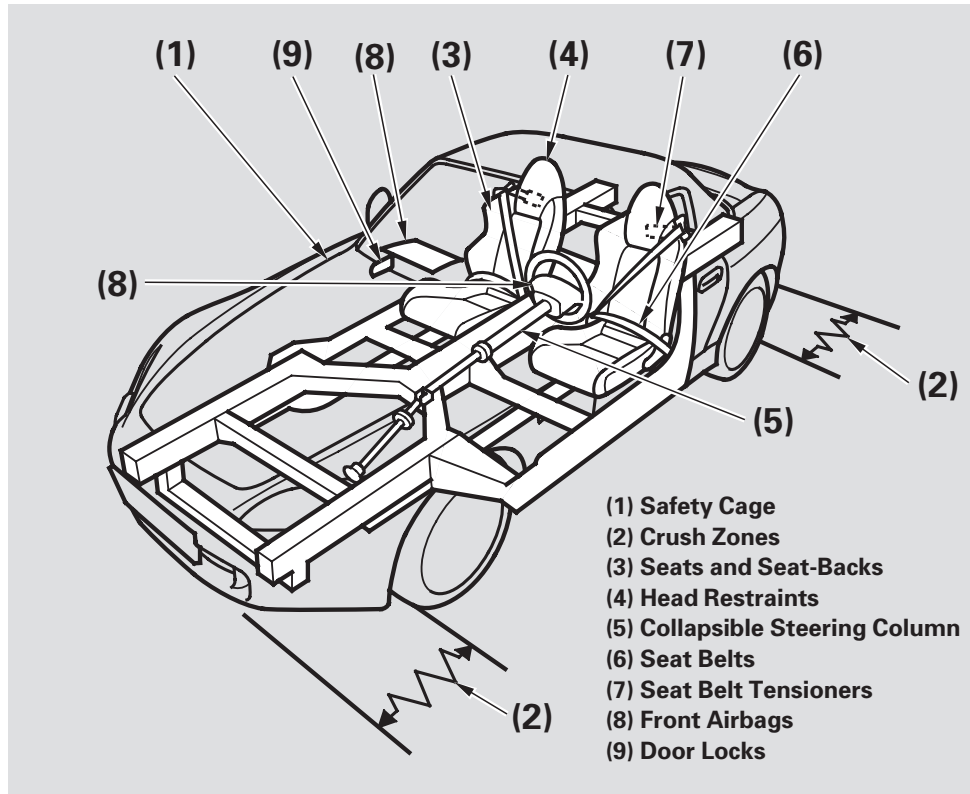

Your vehicle is equipped with many features that work together to protect you and your passenger during a crash.

Some features do not require any action on your part. These include a strong steel framework that forms a safety cage around the passenger compartment; front and rear crush zones, a collapsible steering column; and tensioners that tighten the seat belts in a crash.

However, you and your passenger can't take full advantage of these features unless you remain sitting in a proper position and ***always wear your seat belts***. In fact, some safety features can contribute to injuries if they are not used properly.

The following pages explain how you can take an active role in protecting yourself and your passenger.

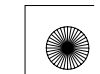



Your Vehicle's Safety Features

Seat Belts

Your vehicle is equipped with seat belts in both seating positions.

Your seat belt system also includes an indicator on the instrument panel and a beeper to remind you and your passengers to fasten your seat belts.

Why Wear Seat Belts

Seat belts have proven to be the single most effective safety device for adults and larger children.

Not wearing a seat belt properly increases the chance of serious injury or death in a crash, even though your vehicle has airbags.

In addition, most states and all Canadian provinces require you to wear seat belts.

⚠ WARNING

Not wearing a seat belt properly increases the chance of serious injury or death in a crash, even though your vehicle has airbags.

Be sure you and your passenger always wear seat belts and wear them properly.

When properly worn, seat belts:

- Keep you connected to the vehicle so you can take advantage of the vehicle's built-in safety features.
- Help protect you in almost every type of crash, including frontal, side, and rear impacts and rollovers.

- Help keep you from being thrown against the inside of the vehicle and against a passenger.
- Keep you from being thrown out of the vehicle.
- Help keep you in a good position should the airbags ever deploy. A good position reduces the risk of injury from an inflating airbag and allows you to get the best advantage from the airbag.

Of course, seat belts cannot completely protect you in every crash. But in most cases, seat belts can reduce your risk of serious injury.

What you should do: Always wear your seat belt, and make sure you wear it properly.





Your Vehicle's Safety Features

Airbags

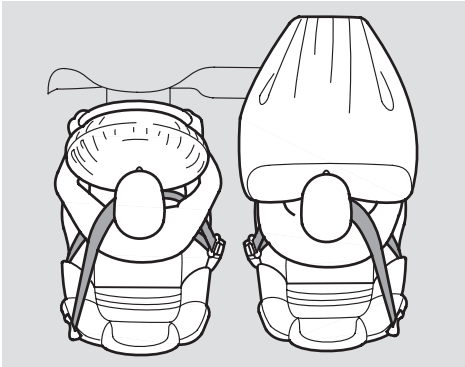

Your vehicle has a supplemental restraint system (SRS) with front airbags to help protect the heads and chests of the driver and a passenger during a moderate to severe frontal collision (see page 22 for more information on how your airbags work).

The most important things you need to know about your airbags are:

- **Airbags do not replace seat belts.** They are designed to supplement the seat belts.
- **Airbags offer no protection in side impacts, rear impacts, rollovers, or minor frontal collisions.**
- **Airbags can pose serious hazards.** To do their job, airbags must inflate with tremendous force. So while airbags help save lives, they can cause minor injuries or more serious or even fatal injuries if occupants are not properly restrained or sitting properly.

What you should do: Always wear your seat belt properly, and sit upright and as far back from the steering wheel as possible while allowing full control of the vehicle. A passenger should move the seat as far back from the dashboard as possible.

The rest of this section gives more detailed information about how you can maximize your safety.

Remember, however, that no safety system can prevent all injuries or deaths that can occur in a severe crash, even when seat belts are properly worn and the airbags deploy.





Protecting Adults and Teens

Introduction

The following pages provide instructions on how to properly protect the driver, an adult passenger or teenage child large enough and mature enough to drive or ride in your vehicle. See pages 29 – 40 for important guidelines on how to properly protect a child in a forward-facing child seat or a larger child passenger.

1. Close and Lock the Doors

After everyone has entered the vehicle, be sure the doors are closed and locked.



Your vehicle has door and trunk monitor indicators on the instrument panel to indicate when either door or the trunk is not tightly closed.

Locking the doors reduces the chance of someone being thrown out of the vehicle during a crash, and it helps prevent a passenger from accidentally opening a door and falling out.

Locking the doors also helps prevent an outsider from unexpectedly opening a door when you come to a stop.

See page 63 for how to lock the doors, and page 47 for how the door-open indicator works.

2. Adjust the Seats

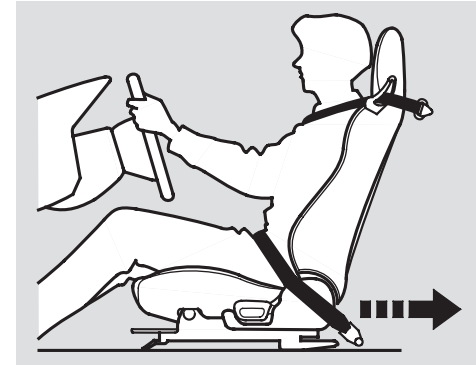

Adjust the driver's seat as far to the rear as possible while allowing you to maintain full control of the vehicle. Have a passenger adjust his or her seat as far to the rear as possible.

If you sit too close to the steering wheel or dashboard, you can be seriously injured by an inflating front airbag, or by striking the steering wheel or dashboard.

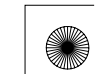



Protecting Adults and Teens

The National Highway Traffic Safety Administration and Transport Canada recommend that drivers allow at least 10 inches (25 cm) between the center of the steering wheel and the chest.

If you cannot get far enough away from the steering wheel and still reach the controls, we recommend that you investigate whether some type of adaptive equipment may help.

Once your seat is adjusted correctly, rock it back and forth to make sure the seat is locked in position.

See page 67 for how to adjust the seats.

⚠ WARNING

Sitting too close to a front airbag can result in serious injury or death if the front airbags inflate.

Always sit as far back from the front airbags as possible.

3. Adjust the Seat-Backs

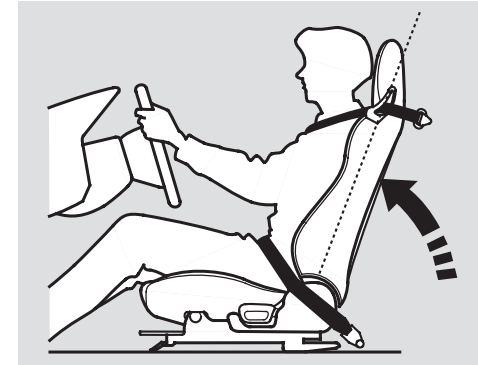

Driver and Passenger Safety

Adjust the driver's seat-back to a comfortable, upright position, leaving ample space between your chest and the airbag cover in the center of the steering wheel.

A passenger should also adjust their seat-back to a comfortable, upright position.

CONTINUED





Protecting Adults and Teens

Reclining a seat-back so that the shoulder part of the belt no longer rests against the occupant's chest reduces the protective capability of the belt. It also increases the chance of sliding under the belt in a crash and being seriously injured. The farther a seat-back is reclined, the greater the risk of injury.

See page 67 for how to adjust the seat-backs.

⚠ WARNING

Reclining the seat-back too far can result in serious injury or death in a crash.

Adjust the seat-back to an upright position, and sit well back in the seat.

4. Fasten and Position the Seat Belts

Insert the latch plate into the buckle, then tug on the belt to make sure the belt is securely latched. Check that the belt is not twisted, because a twisted belt can cause serious injuries in a crash.

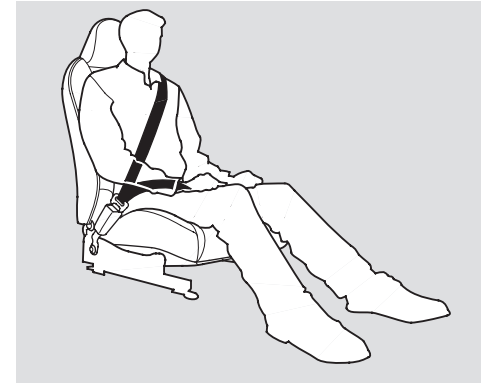

Position the lap part of the belt as low as possible across your hips, then pull up on the shoulder part of the belt so the lap part fits snugly. This lets your strong pelvic bones take the force of a crash and reduces the chance of internal injuries.

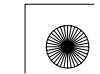



Protecting Adults and Teens

If necessary, pull up on the belt again to remove any slack, then check that the belt rests across the center of your chest and over your shoulder. This spreads the forces of a crash over the strongest bones in your upper body.

⚠ WARNING

Improperly positioning the seat belts can cause serious injury or death in a crash.

Make sure all seat belts are properly positioned before driving.

Never place the shoulder portion of a lap/shoulder belt under your arm or behind your back. This could cause very serious injuries in a crash.

If a seat belt does not seem to work properly, it may not protect the occupant in a crash.

No one should sit in a seat with an inoperative seat belt. Using a seat belt that is not working properly can result in serious injury or death. Have your dealer check the belt as soon as possible.

See page 18 for additional information about your seat belts and how to take care of them.

5. Maintain a Proper Sitting Position

After occupants have adjusted their seats and put on seat belts, it is very important that they continue to sit upright, well back in their seats, with their feet on the floor, until the vehicle is parked and the engine is off.

Sitting improperly can increase the chance of injury during a crash. For example, if an occupant slouches, lies down, turns sideways, sits forward, leans forward or sideways, or puts one or both feet up, the chance of injury during a crash is greatly increased.



CONTINUED





Protecting Adults and Teens

In addition, an occupant who is out of position can be seriously or fatally injured in a crash by striking interior parts of the vehicle or being struck by an inflating front airbag.

▲ WARNING

Sitting improperly or out of position can result in serious injury or death in a crash.

Always sit upright, well back in the seat, with your feet on the floor.

Advice for Pregnant Women



If you are pregnant, the best way to protect yourself and your unborn child when driving or riding in a vehicle is to always wear a seat belt, and keep the lap part of the belt as low as possible across the hips.

When driving, remember to sit upright and adjust the seat as far back as possible while allowing full control of the vehicle. When riding as a passenger, adjust the seat as far back as possible.

This will reduce the risk of injuries to both you and your unborn child that can be caused by a crash or an inflating front airbag.

Each time you have a checkup, ask your doctor if it's okay for you to drive.





Protecting Adults and Teens

Additional Safety Precautions

- **Two people should never use the same seat belt.** If they do, they could be very seriously injured in a crash.
- **Do not put any accessories on seat belts.** Devices intended to improve occupant comfort or reposition the shoulder part of a seat belt can reduce the protective capability of the belt and increase the chance of serious injury in a crash.

- **Do not place hard or sharp objects between yourself and a front airbag.** Carrying hard or sharp objects on your lap, or driving with a pipe or other sharp object in your mouth, can result in injuries if your front airbag inflates.
- **Do not attach or place objects on the airbag covers.** Objects on the covers marked SRS AIRBAG could interfere with the proper operation of the airbags or be propelled inside the vehicle and hurt someone if the airbags inflate.

- **Keep your hands and arms away from the airbag covers.** If your hands or arms are close to an airbag cover, they could be injured if the airbag inflates.





Additional Information About Your Seat Belts

Seat Belt System Components

Your seat belt system includes lap/shoulder belts in both seating positions. The seat belts are also equipped with automatic seat belt tensioners.

This system uses the same sensors as the front airbags to monitor whether the seat belts are latched or unlatched, and how much weight is on the passenger's seat (see page 24).



The seat belt system includes an indicator on the instrument panel and a beeper to remind you and your passenger to fasten your seat belts.

This system monitors the seat belts. If you turn the ignition switch to the ON (II) position before your seat belt is fastened, the beeper will sound and the indicator will flash. If your seat belt is not fastened before

the beeper stops, the indicator will stop flashing but remain on.

If a passenger does not fasten their seat belt, the indicator will come on about 6 seconds after the ignition switch is turned to the ON (II) position.

If either the driver or passenger does not fasten their seat belt, the beeper will sound and the indicator will flash again at regular intervals.

When no one is sitting in the passenger's seat, or a child or small adult is riding there, the indicator should not come on and the beeper should not sound.

If the indicator comes on or the beeper sounds when the driver's seat belt is latched and there is no passenger and no items on the passenger's seat, something may be interfering with the monitoring system. Look for and remove:

- Any items under the passenger's seat.
- Any objects hanging on the seat.
- Any object touching the rear of the seat-back.

If no obstructions are found, have your vehicle checked by a dealer.

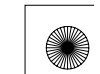



Additional Information About Your Seat Belts

Lap/Shoulder Belt

The lap and shoulder belt goes over your shoulder, across your chest, and across your hips.

To fasten the belt, insert the latch plate into the buckle, then tug on the belt to make sure the buckle is latched (see page 12 for how to properly position the belt).

To unlock the belt, press the red PRESS button on the buckle. Guide the belt across your body so that it retracts completely. After exiting the vehicle, be sure the belt is out of the way and will not get closed in the door.

Both seat belts have an emergency retractor. In normal driving, the retractor lets you move freely in your seat while it keeps some tension on the belt. During a collision or sudden stop, the retractor automatically locks the belt to help restrain your body.

The passenger's seat belt has a lockable retractor that must be activated to secure a forward-facing child seat (see page 34).

If the shoulder part of the belt is pulled all the way out, the lockable retractor will activate. The belt will retract, but it will not allow the passenger to move freely.

To deactivate the lockable retractor, unlatch the buckle and let the seat belt fully retract. To refasten the seat belt, pull it out only as far as needed.





Additional Information About Your Seat Belts

Automatic Seat Belt Tensioners



For added protection, the seat belts are equipped with automatic seat belt tensioners. When activated, the tensioners immediately tighten the belts to help hold the driver and a passenger in place.

The tensioners are designed to activate primarily in frontal collisions, and they should activate in any collision severe enough to cause airbag inflation.

However, the tensioners can be activated during a collision in which the airbags do not deploy. In this case, the airbags would not be needed, but the additional restraint could be helpful.

When the tensioners are activated, the seat belts will remain tight until they are unbuckled.

Seat Belt Maintenance

For safety, you should check the condition of your seat belts regularly.

Pull each belt out fully and look for frays, cuts, burns, and wear. Check that the latches work smoothly and the belts retract easily. If a belt does not retract easily, cleaning it may correct the problem (see page 160). Any belt that is not in good condition or not working properly will not provide good protection and should be replaced as soon as possible.

Honda provides a limited warranty on seat belts. See your *Honda Warranty Information* booklet for details.

If a seat belt is worn during a crash, it must be replaced by your dealer. A belt that has been worn during a crash may not provide the same level of protection in a subsequent crash.





Additional Information About Your Seat Belts

The dealer should also inspect the anchors for damage and replace them if needed. If the automatic seat belt tensioners activate during a crash, they must be replaced.

WARNING

Not checking or maintaining seat belts can result in serious injury or death if the seat belts do not work properly when needed.

Check your seat belts regularly and have any problem corrected as soon as possible.

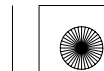



Additional Information About Your Airbags

Airbag System Components

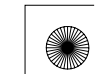
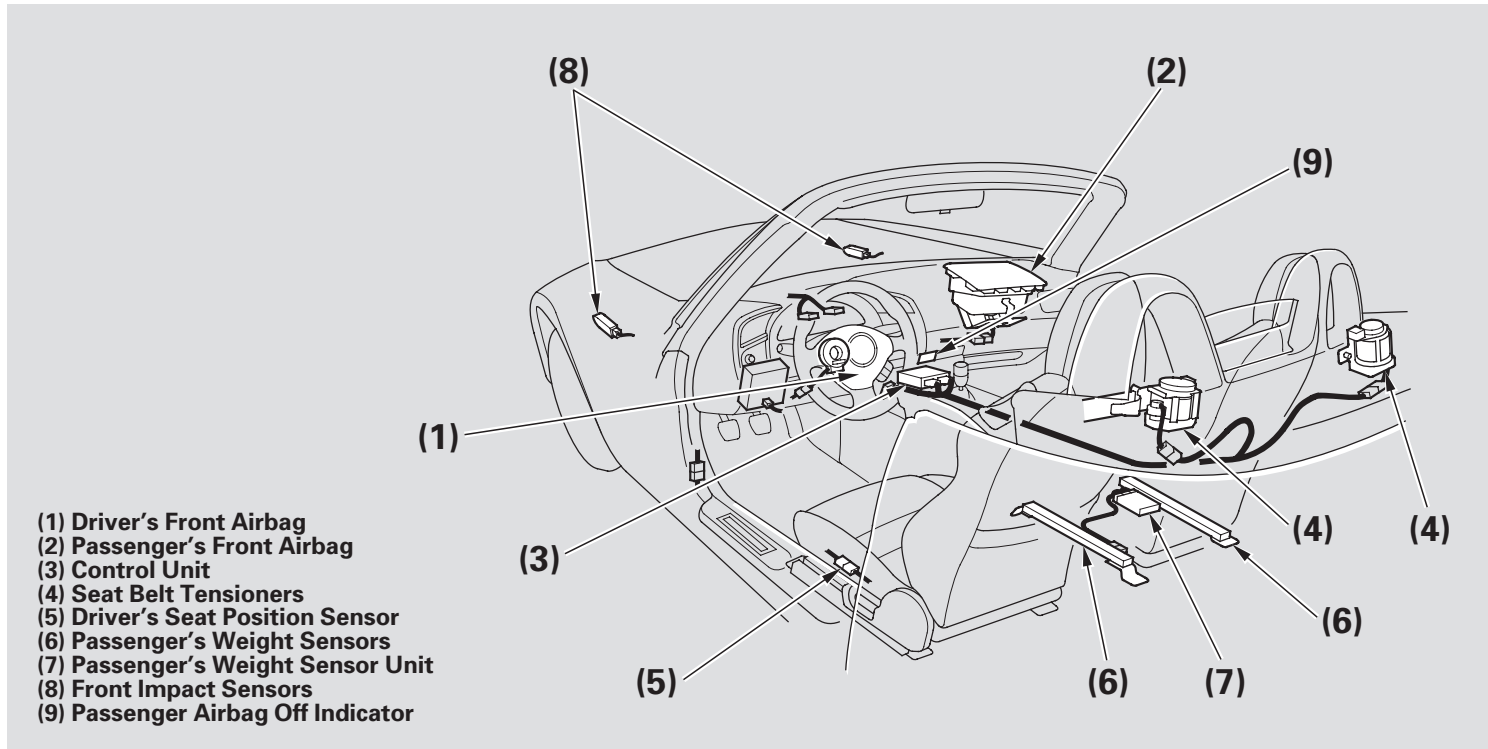



Additional Information About Your Airbags

Your airbag system includes:

- Two SRS (supplemental restraint system) airbags. The driver's airbag is stored in the center of the steering wheel; the passenger's airbag is stored in the dashboard. Both are marked "SRS AIRBAG."
- Automatic seat belt tensioners (see page 18).
- Sensors that can detect a moderate to severe front impact.
- Sensors that can detect whether the driver's seat belt and the passenger's seat belt are latched or unlatched (see page 16).
- A driver's seat position sensor that monitors the distance of the seat from the airbag. If the seat is too far forward, the airbag will inflate with less force (see page 24).

- Weight sensors that monitor the weight on the passenger's seat. If the weight is about 65 lbs (29 kg) or less (the weight of an infant or small child), the passenger's airbag will be turned off (see page 24).
- A sophisticated electronic system that continually monitors and records information about the sensors, the control unit, the airbag activators, the seat belt tensioners, and driver and passenger seat belt use when the ignition switch is in the ON (II) position.
- An indicator on the instrument panel that alerts you to a possible problem with your airbags, sensors, or seat belt tensioners (see page 25).

- An indicator on the dashboard that alerts you that the passenger's airbag has been turned off (see page 26).
- Emergency backup power in case your vehicle's electrical system is disconnected in a crash.





Additional Information About Your Airbags

How Your Airbags Work

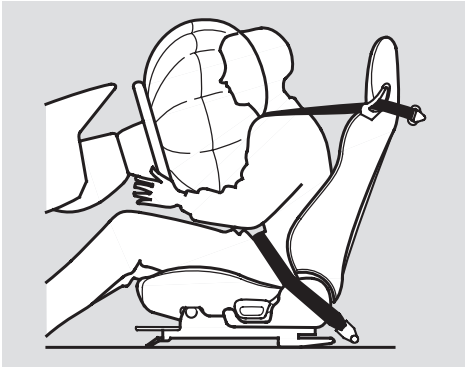

If you ever have a moderate to severe frontal collision, sensors will detect the vehicle's rapid deceleration.

If the rate of deceleration is high enough, the control unit will instantly inflate the driver's and passenger's airbags, at the time and with the force needed.

During a frontal crash, your seat belt restrains your lower body and torso, and the front airbag helps protect your head and chest.

Although both airbags normally inflate within a split second of each other, it is possible for only one airbag to deploy.

This can happen if the severity of a collision is at the margin, or threshold, that determines whether or not the airbags will deploy. In such cases, the seat belt will provide sufficient protection, and the supplemental protection offered by the airbag would be minimal.

Only the driver's airbag can deploy if there is no passenger in the passenger's seat, or if the advanced airbag system has turned the passenger's airbag off (see page 24).

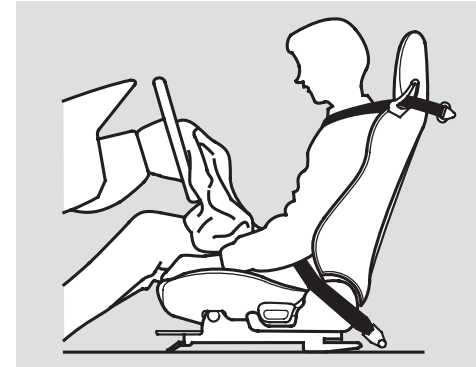

After inflating, the front airbags will immediately deflate, so they won't interfere with the driver's visibility, or the ability to steer or operate other controls.

The total time for inflation and deflation is one-tenth of a second, so fast that most occupants are not aware that the airbags deployed until they see them lying in their laps.

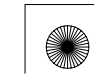



Additional Information About Your Airbags

After a crash, you may see what looks like smoke. This is actually powder from the airbag's surface. Although the powder is not harmful, people with respiratory problems may experience some temporary discomfort. If this occurs, get out of the vehicle as soon as it is safe to do so.

Dual-Stage Airbags

Your front airbags are dual-stage airbags. This means they have two inflation stages that can be ignited sequentially or simultaneously, depending on crash severity.

In a **more severe** crash, both stages will ignite simultaneously to provide the quickest and greatest protection.

In a **less severe** crash, one stage will ignite first, then the second stage will ignite a split second later. This provides longer airbag inflation time with a little less force.

Dual-Threshold Airbags

Your front airbags are also dual-threshold airbags. Airbags with this feature have two deployment thresholds that depend on whether sensors detect the occupant is wearing a seat belt or not.

If the occupant's belt is **not latched**, the airbag will deploy at a slightly lower threshold, because the occupant would need extra protection.

If the occupant's belt **is latched**, the airbag will inflate at a slightly higher threshold, when the airbag would be needed to supplement the protection provided by the seat belt.





Additional Information About Your Airbags

Advanced Airbags

Your airbags are also advanced airbags. The main purpose of this feature is to help prevent airbag-caused injuries to short drivers and children who ride in the passenger's seat.

For both advanced airbags to work properly:

- Occupants must sit upright and wear their seat belts properly.
- Do not spill any liquids on or under the seats, cover the sensors, or put any objects or metal items under the seats.

Failure to follow these instructions could damage the sensors or prevent them from working properly.

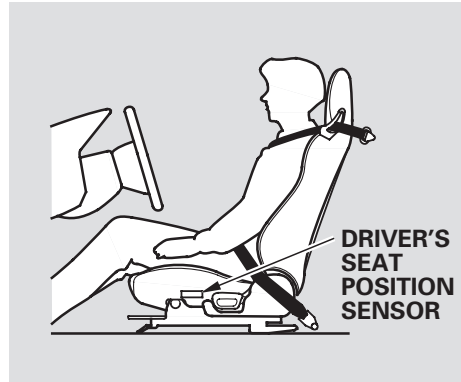

The driver's advanced front airbag system includes a seat position sensor under the seat. If the seat is too far forward, the airbag will inflate with less force, regardless of the severity of the impact.

If there is a problem with the sensor, the SRS indicator will come on, and the airbag will inflate in the normal manner regardless of the driver's seating position.

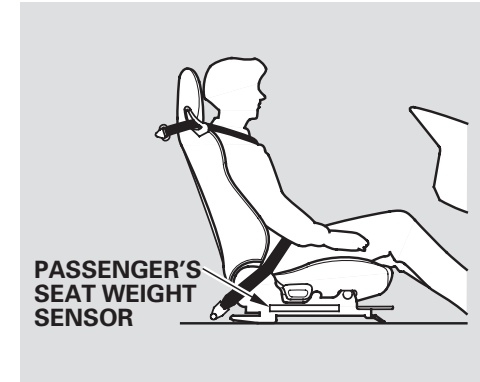

The passenger's advanced airbag system has weight sensors under the seat. Although Honda does not encourage carrying a child in the passenger's seat, if the sensors detect the weight of an infant or small child (up to about 65 lbs or 29 kg), the system will automatically turn the passenger's airbag off.

Be aware that objects placed on the passenger's seat can also cause the airbag to be turned off.

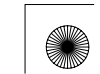



Additional Information About Your Airbags

When the airbag is turned off, a “passenger airbag off” indicator in the center of the dashboard comes on (see page 26).

If the weight sensors detect there is no passenger in the seat, the airbag will be off. However, the passenger airbag off indicator will not come on.

To ensure that the passenger’s advanced airbag system will work properly, ***do not do anything that would increase or decrease the weight on the passenger’s seat, such as hanging heavy objects on the seat.***

How the SRS Indicator Works



The SRS indicator alerts you to a potential problem with your airbags or seat belt tensioners.

When you turn the ignition switch to the ON (II) position, this indicator comes on briefly then goes off. This tells you the system is working properly.

If the indicator comes on at any other time, or does not come on at all, you should have the system checked by your dealer. For example:

- If the SRS indicator does not come on after you turn the ignition switch to the ON (II) position.
- If the indicator stays on after the engine starts.
- If the indicator comes on or flashes on and off while you drive.

CONTINUED





Additional Information About Your Airbags

If you see any of these indications, the airbags and seat belt tensioners may not work properly when you need them.

⚠ WARNING

Ignoring the SRS indicator can result in serious injury or death if the airbag systems or tensioners do not work properly.

Have your vehicle checked by a dealer as soon as possible if the SRS indicator alerts you to a possible problem.

How the Passenger Airbag Off Indicator Works

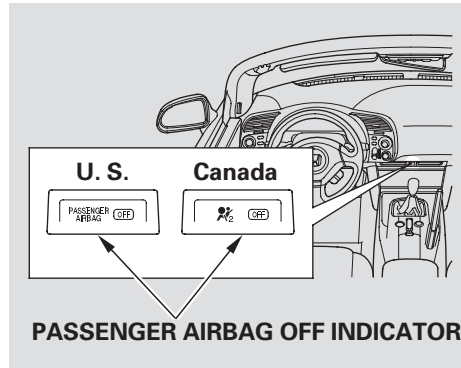

This indicator alerts you that the passenger's airbag has been shut off because weight sensors detect about 65 lbs (29 kg) or less (the weight of an infant or small child) on the passenger's seat. It does **not mean** there is a problem with the airbag.

Be aware that objects placed on the passenger's seat can cause the indicator to come on.

If no weight is detected on the passenger's seat, the airbag will be automatically shut off. However, the indicator will not come on.





Additional Information About Your Airbags

The passenger airbag off indicator may come on and off repeatedly if the total weight on the seat is near the airbag cutoff threshold.

If this happens, adjust the seat as far to the rear as possible and have the passenger sit upright and wear the seat belt properly.

If the indicator comes on with no passenger and no objects on the passenger seat, or with an adult riding there, something may be interfering with the weight sensors. Look for and remove:

- Any items under the passenger's seat.
- Any objects hanging on the seat.
- Any object touching the rear of the seat-back.

If no obstructions are found, have your vehicle checked by a dealer as soon as possible.

Airbag Service

Your airbag systems are virtually maintenance free, and there are no parts you can safely service. However, you must have your vehicle serviced if:

- **An airbag ever inflates.** Any airbag that has deployed must be replaced along with the control unit and other related parts. Any seat belt tensioner that activates must also be replaced.

Do not try to remove or replace any airbag by yourself. This must be done by an authorized dealer or a knowledgeable body shop.





Additional Information About Your Airbags

- ***The SRS indicator alerts you to a problem.*** Take your vehicle to an authorized dealer as soon as possible. If you ignore this indication, your airbags may not operate properly.
- ***If your vehicle has a moderate to severe impact.*** Even if your airbags do not inflate, your dealer should inspect the driver's seat position sensor, the passenger's weight sensors, the seat belt tensioners, and all seat belts worn during the crash to make sure they are operating properly.

Additional Safety Precautions

- ***Do not attempt to deactivate your airbags.*** Together, airbags and seat belts provide the best protection.
- ***Do not tamper with airbag components or wiring for any reason.*** Tampering could cause the airbags to deploy, possibly causing very serious injury.

- ***Do not remove or modify a seat without consulting your dealer.*** This could make the driver's seat position sensor or the passenger's weight sensors ineffective. If it is necessary to remove or modify a seat to accommodate a person with disabilities, first contact Honda Automobile Customer Service at (800) 999-1009.





Protecting Children – General Guidelines

Children depend on adults to protect them. However, despite their best intentions, many adults do not know how to *properly* protect child passengers.

If you ever need to drive with a child in your vehicle, be sure to read this section. It begins with important general guidelines, then presents special information for small children who must ride in a forward-facing child seat, and for larger children.

All Children Must Be Restrained

Each year, many children are injured or killed in vehicle crashes because they are either unrestrained or not properly restrained. In fact, vehicle accidents are the number one cause of the death of children ages 12 and under.

To reduce the number of child deaths and injuries, every state and Canadian province requires that children be properly restrained when they ride in a vehicle.

Any child who is too small to wear a seat belt must be restrained in an approved child seat that is properly secured to the vehicle (see pages 33 – 36).

Larger children must be restrained with a lap/shoulder belt and ride on a booster seat until the seat belt fits them properly (see pages 37 – 40).

⚠ WARNING

Children who are unrestrained or improperly restrained can be seriously injured or killed in a crash.

Any child too small for a seat belt should be properly restrained in a child seat. A larger child should be properly restrained with a seat belt and use a booster seat if necessary.





Protecting Children – General Guidelines

Your Vehicle is Not Recommended for Child Passengers

The National Highway Traffic Safety Administration and Transport Canada recommend that all children age 12 and under be properly restrained in a back seat.

Since this vehicle does not have a back seat, we strongly recommend that you do not carry any child who is not large enough or mature enough to ride in front (see page 37).

The Passenger's Airbag Can Pose Serious Risks

Airbags have been designed to help protect adults in a moderate to severe frontal collision. To do this, the passenger's airbag is quite large, and it can inflate with enough force to cause very serious injuries.

Even though your vehicle has an advanced airbag system that automatically turns the passenger's airbag off (see page 24), please follow these guidelines:

Infants

Never put a rear-facing child seat in this vehicle. If the airbag inflates, it can hit the back of the child seat with enough force to kill or very seriously injure an infant.

Small Children

Placing a forward-facing child seat in the passenger's seat can be hazardous. If the vehicle seat is too far forward, or the child's head is thrown forward during a collision, an inflating airbag can strike the child with enough force to kill or very seriously injure a small child.

Larger Children

Children who have outgrown child seats are also at risk of being injured or killed by an inflating passenger's airbag. If a larger child must ride in this vehicle, see page 37 for important guidelines on how to decide when a child is ready to ride in the passenger's seat and how to properly protect the child.





Protecting Children – General Guidelines

To remind you of the passenger's airbag hazards, your vehicle has warning labels on the dashboard (U.S. models) and on the driver's and passenger's visors. Please read and follow the instructions on these labels.

U.S. Models Sun Visor



Canadian Models Sun Visor

CAUTION
TO AVOID SERIOUS INJURY:

- FOR MAXIMUM SAFETY PROTECTION IN ALL TYPES OF CRASHES, YOU MUST ALWAYS WEAR YOUR SAFETY BELT.
- DO NOT INSTALL REARWARD-FACING CHILD SEATS IN ANY FRONT PASSENGER SEAT POSITION.
- DO NOT SIT OR LEAN UNNECESSARILY CLOSE TO THE AIR BAG.
- DO NOT PLACE ANY OBJECTS OVER THE AIR BAG OR BETWEEN THE AIR BAG AND YOURSELF.
- SEE THE OWNER'S MANUAL FOR FURTHER INFORMATION AND EXPLANATIONS.

Dashboard

This Vehicle is Equipped with Advanced Air Bags

Even with Advanced Air Bags

Children can be killed or seriously injured by the air bag. Never put a rear-facing child seat in the front. Always use seat belts and child restraints. See owner's manual for more information about air bags.

To be removed by owner only.

Driver and Passenger Safety





Protecting Children – General Guidelines

Additional Safety Precautions

- **Never hold a small child on your lap.** If you are not wearing a seat belt in a crash, you could be thrown forward and crush the child against the dashboard. If you are wearing a seat belt, the child can be torn from your arms and be seriously hurt or killed.
- **Never put a seat belt over yourself and a child.** During a crash, the belt could press deep into the child and cause serious or fatal injuries.
- **Never let two children use the same seat belt.** If they do, they could be very seriously injured in a crash.

- **Do not leave children alone in a vehicle.** Leaving children without adult supervision is illegal in most states and Canadian provinces, and can be very hazardous.

For example, a small child left in a vehicle on a hot day can die from heatstroke. A child left alone with the key in the ignition switch can accidentally set the vehicle in motion, possibly injuring themselves or others.

- **Lock both doors and the trunk when your vehicle is not in use.** Children who play in vehicles can accidentally get trapped inside. Teach your children not to play in or around vehicles. Know how to operate the emergency trunk opener and decide if your children should be shown how to use this feature (see page 64).

- **Keep vehicle keys and remote transmitters out of the reach of children.** Even very young children learn how to unlock vehicle doors, turn on the ignition switch, and open the trunk, which can lead to accidental injury or death.





Protecting Small Children

Because an inflating airbag can seriously injure or kill small children, we recommend that you do not carry a small child as a passenger in this vehicle.

If you decide to transport a small child in this vehicle, be sure to move the passenger seat as far to the rear as possible, and follow the instructions and guidelines in the following pages.



A child who is at least one year old, and who fits within the child seat maker's weight and height limits, should be restrained in a forward-facing, upright child seat.

Of the different seats available, we recommend those that have a five-point harness system as shown.

We also recommend that a small child use the child seat until the child reaches the weight or height limit for the seat.

⚠ WARNING

Placing a forward-facing child seat in the passenger's seat can result in serious injury or death if the airbag inflates.

If you must place a forward-facing child seat in the passenger's seat, move the vehicle seat as far back as possible and properly restrain the child.





Selecting a Child Seat, Installing a Child Seat

Selecting a Child Seat

To provide proper protection, a child seat should meet three requirements:

- 1. The child seat should meet U.S. or Canadian Motor Vehicle Safety Standard 213.*** Look for FMVSS 213 or CMVSS 213 on the box.
- 2. The child seat should be of the proper type and size to fit the child.***
- 3. The child seat should fit the passenger's seat.***

Before purchasing a child seat, or using a previously purchased one, we recommend that you test the seat to make sure it fits properly in the passenger's seat.

Installing a Child Seat

After selecting a proper child seat, there are three main steps in installing a child seat:

- 1. Properly secure the child seat to the vehicle.*** All child seats must be secured to the vehicle with the lap part of a lap/shoulder belt. A child whose seat is not properly secured to the vehicle can be endangered in a crash.
- 2. Make sure the child seat is firmly secured.*** After installing a child seat, push and pull the seat forward and from side-to-side to verify that it is secure.

A child seat secured with a seat belt should be installed as firmly as possible. However, it does not need to be "rock solid." Some side-to-side movement can be expected and should not reduce the child seat's effectiveness.

If the child seat is not secure, use a different style of child seat that can be firmly secured.

- 3. Secure the child in the child seat.*** Make sure the child is properly strapped in the child seat according to the child seat maker's instructions. A child who is not properly secured in a child seat can be seriously injured in a crash.

The following pages provide guidelines on how to properly install a forward-facing child seat.





Installing a Child Seat

In this vehicle, a forward-facing child seat must be secured to the vehicle with the lap part of the lap/shoulder belt. In addition, the lockable retractor must be activated to secure a child seat.

1. Move the vehicle seat to the rear-most position. Moving the seat as far back as possible reduces the chance of a child being injured or killed if the passenger's airbag inflates.

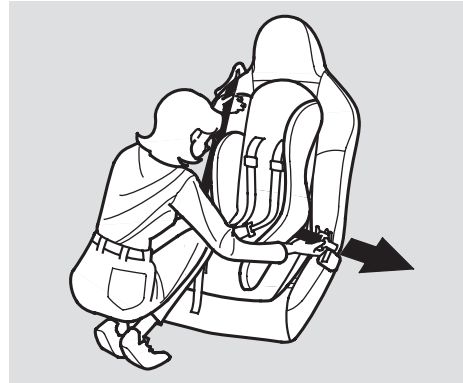

2. With the child seat in position, route the belt through the child seat according to the seat maker's instructions, then insert the latch plate into the buckle.
3. To activate the lockable retractor, slowly pull the shoulder part of the belt all the way out until it stops, then let the belt feed back into the retractor.

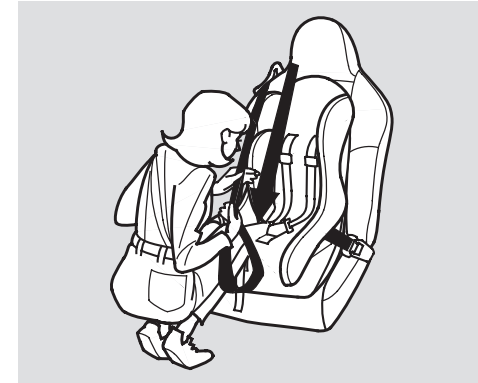

4. After the belt has retracted, tug on it. If the belt is locked, you will not be able to pull it out. If you can pull the belt out, it is not locked and you will need to repeat these steps.

Driver and Passenger Safety



Installing a Child Seat



5. After confirming that the belt is locked, grab the shoulder part of the belt near the buckle, and pull up to remove any slack from the lap part of the belt. Remember, if the lap part of the belt is not tight, the child seat will not be secure.

To remove slack, it may help to put weight on the child seat, or push on the back of the seat while pulling up on the belt.

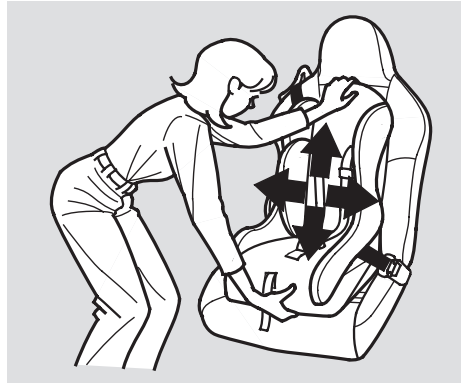

6. Push and pull the child seat forward and from side-to-side to verify that it is secure enough to stay upright during normal driving maneuvers. If the child seat is not secure, unlatch the belt, allow it to retract fully, then repeat these steps.

To deactivate the lockable retractor and remove a child seat, unlatch the buckle, unrout the seat belt, and let the belt fully retract.





Protecting Larger Children

When a child reaches the recommended weight or height limit for a forward-facing child seat, the child should sit on a booster seat and wear a lap/shoulder belt.

Since this vehicle does not have a back seat, we recommend that you do not carry a larger child, age 12 or under, as a passenger.

However, the following pages provide guidelines to help you decide when a given child may ride in this vehicle, and how to properly protect the child.

⚠ WARNING

Allowing a larger child age 12 or under to ride in the vehicle can result in injury or death if the passenger's airbag inflates.

If a larger child must ride in the vehicle, adjust the vehicle seat as far back as possible, use a booster seat if needed, and have the child sit up properly and wear the seat belt properly.

Checking Seat Belt Fit



Driver and Passenger Safety

To determine if a lap/shoulder belt properly fits a child, have the child put on the seat belt, then ask yourself:

1. Does the child sit all the way back against the seat?
2. Do the child's knees bend comfortably over the edge of the seat?





Protecting Larger Children

3. Does the shoulder belt cross between the child's neck and arm?
4. Is the lap part of the belt as low as possible, touching the child's thighs?
5. Will the child be able to stay seated like this for the whole trip?

If you answer yes to all these questions, the child is ready to wear the lap/shoulder belt correctly. If you answer no to any question, the child needs to ride on a booster seat.

Using a Booster Seat



A child who has outgrown a forward-facing child seat should use a booster seat until the lap/shoulder belt fits them properly without the booster.

Some states and Canadian provinces also require children to use a booster seat until they reach a given age or weight (e.g., 6 years or 60 lbs). Be sure to check current laws in the states or provinces where you intend

to drive.

Booster seats can be high-back or low-back. Whichever style you select, make sure the booster meets federal safety standards and that you follow the booster seat maker's instructions.

If a child who uses a booster seat rides in this vehicle, move the vehicle seat as far to the rear as possible, and be sure the child is wearing the seat belt properly.

A child may continue using a booster seat until the tops of their ears are even with the top of the vehicle's or booster's seat-back. A child of this height should be tall enough to use the lap/shoulder belt without a booster seat.





Protecting Larger Children

When Can a Larger Child Ride in This Vehicle

The National Highway Traffic Safety Administration and Transport Canada recommend that all children age 12 and under be properly restrained in a back seat.

If the passenger's airbag inflates in a moderate to severe frontal collision, the airbag can cause serious injuries to a child who is unrestrained, improperly restrained, sitting too close to the airbag, or out of position.

Of course, children vary widely. And while age may be one indicator of when a child can safely ride in this vehicle. There are other important factors you should consider.

Physical Size

Physically, a child must be large enough for the lap/shoulder belt to properly fit (see page 37). If the seat belt does not fit properly, with or without the child sitting on a booster, the child should not sit in this vehicle.

Maturity

To safely ride in this vehicle, a child must be able to follow the rules, including sitting properly, and wearing the seat belt properly throughout ride.

If you decide that a child can safely ride in this vehicle, be sure to:

- Carefully read the owner's manual, and make sure you understand all seat belt instructions and all safety information.
- Move the vehicle seat to the rear-most position.
- Have the child sit up straight, back against the seat, and feet on or near the floor.
- Check that the child's seat belt is properly and securely positioned.
- Supervise the child. Even mature children sometimes need to be reminded to fasten the seat belts or sit properly.





Protecting Larger Children

Additional Safety Precautions

- ***Do not let a child wear a seat belt across the neck.*** This could result in serious neck injuries during a crash.
- ***Do not let a child put the shoulder part of a seat belt behind the back or under the arm.*** This could cause very serious injuries during a crash. It also increases the chance that the child will slide under the belt in a crash and be injured.
- ***Two children should never use the same seat belt.*** If they do, they could be very seriously injured in a crash.
- ***Do not put any accessories on a seat belt.*** Devices intended to improve a child's comfort or reposition the shoulder part of a seat belt can make the belt less effective and increase the chance of serious injury in a crash.

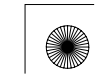



Carbon Monoxide Hazard

Your vehicle's exhaust contains carbon monoxide gas. Carbon monoxide should not enter the vehicle in normal driving if you maintain your vehicle properly and follow the information on this page.

Have the exhaust system inspected for leaks whenever:

- The vehicle is raised for an oil change.
- You notice a change in the sound of the exhaust.
- The vehicle was in an accident that may have damaged the underside.

⚠ WARNING

Carbon monoxide gas is toxic. Breathing it can cause unconsciousness and even kill you.

Avoid any enclosed areas or activities that expose you to carbon monoxide.

High levels of carbon monoxide can collect rapidly in enclosed areas, such as a garage. Do not run the engine with the garage door closed. Even with the door open, run the engine only long enough to move the vehicle out of the garage.

With the trunk open, airflow can pull exhaust gas into your vehicle's interior and create a hazardous condition. If you must drive with the trunk open, open all the windows, and set the heating and cooling system as shown below.

If you must sit in your parked vehicle with the engine running, even in an unconfined area, adjust the heating and cooling system as follows:

1. Select the fresh air mode.
2. Select the  mode.
3. Set the fan speed to high.
4. Set the temperature control to a comfortable setting.





Safety Labels

These labels are in the locations shown. They warn you of potential hazards that could cause serious injury. Read these labels carefully.

If a label comes off or becomes hard to read (except for the U.S. dashboard label which may be removed by the owner), contact your dealer for a replacement.

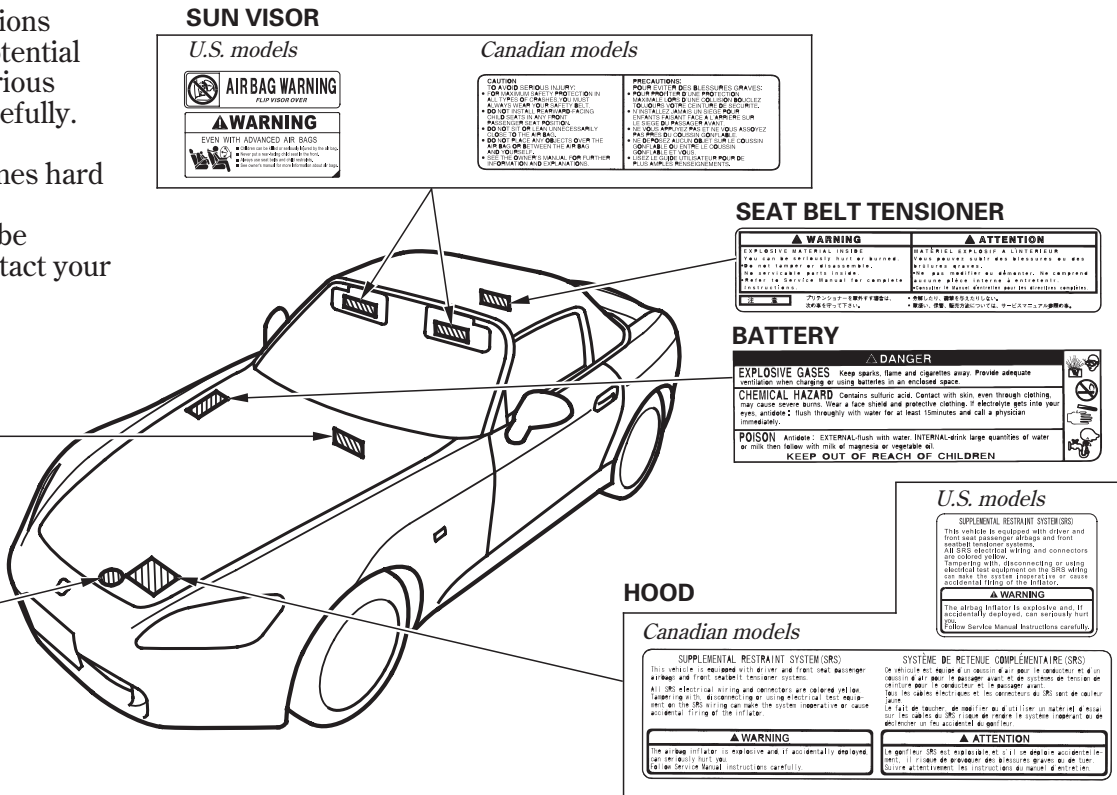



Instruments and Controls

This section gives information about the controls and displays that contribute to the daily operation of your vehicle. All the essential controls are within easy reach.

Control Locations	44	Trunk.....	63
Instrument Panel.....	45	Emergency Trunk Opener	64
Instrument Panel Indicators.....	46	Remote Transmitter.....	65
Gauges	51	Seats	67
Odometer.....	51	Power Windows	68
Trip meter.....	51	Convertible Top	70
Select Button.....	51	Mirrors.....	75
Fuel Gauge	52	Parking Brake	76
Check Fuel Cap Message.....	52	Interior Convenience Items.....	77
Temperature Gauge.....	53	Beverage Holder.....	78
Outside Temperature		Accessory Power Socket	78
Indicator.....	53	Console Compartments	79
Maintenance Minder.....	54	Audio Panel	79
Clock	54	Dashboard Lower Pocket.....	80
Controls Near the Steering		Interior Light.....	80
Wheel.....	55		
Windshield Wipers and			
Washers.....	56		
Turn Signal and Headlights.....	57		
Instrument Panel Brightness	58		
Hazard Warning Button.....	58		
Rear Window Defogger	59		
Keys and Locks.....	60		
Immobilizer System.....	61		
Ignition Switch	62		
Power Door Locks.....	63		

Instruments and Controls



Control Locations

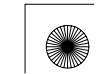
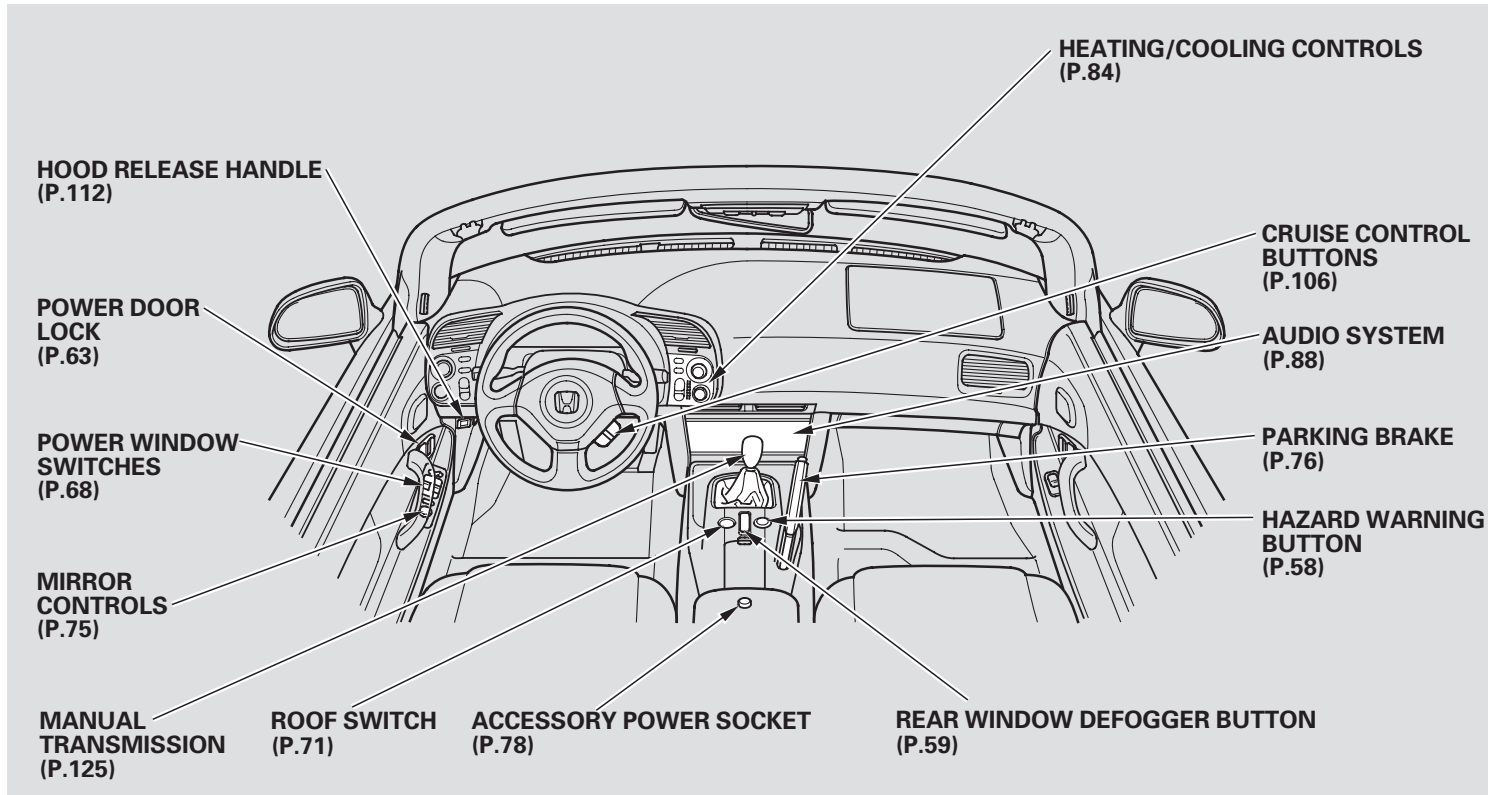



Instrument Panel

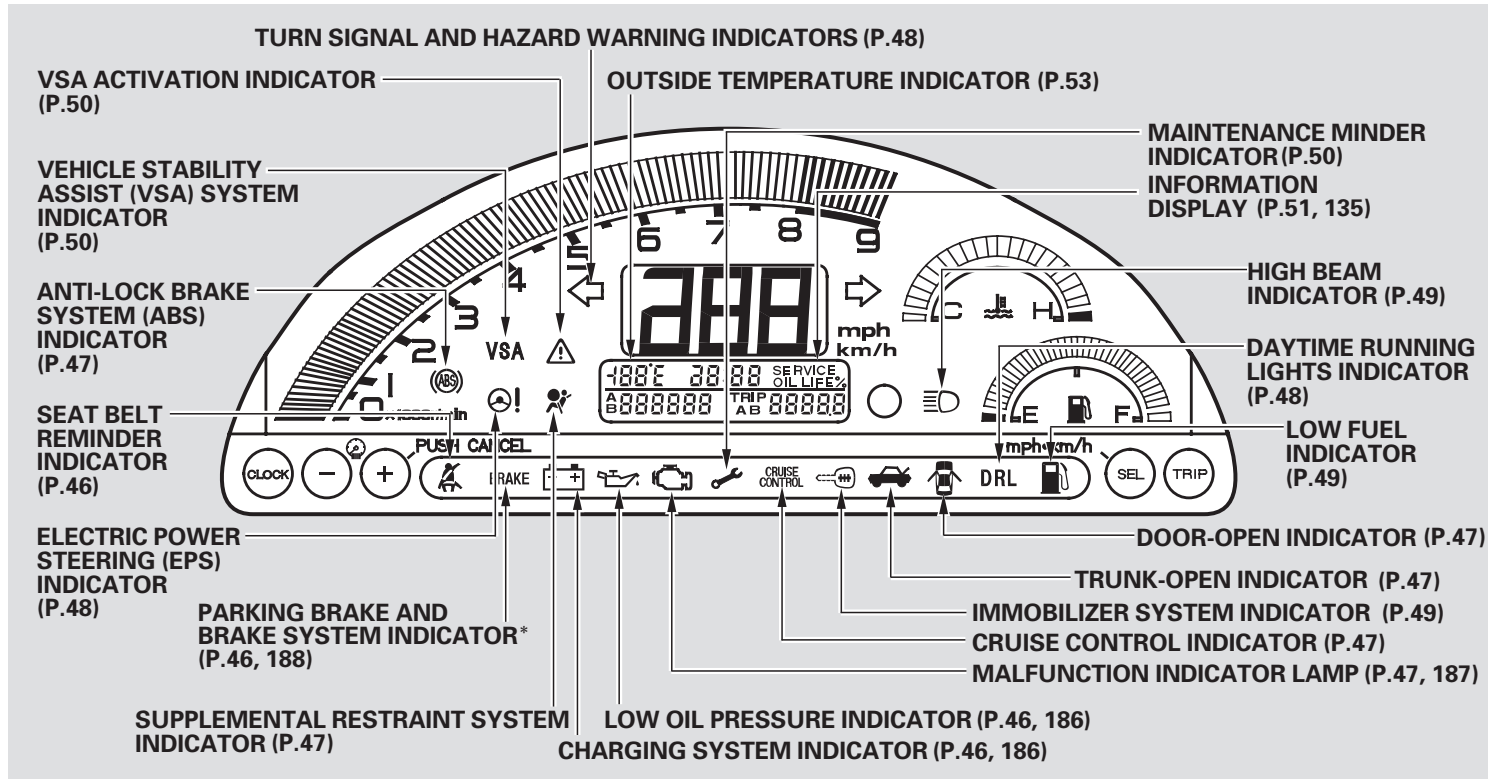

Instruments and Controls



* The U.S. instrument panel is shown. Differences for Canadian models are noted in the text.

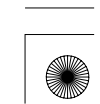
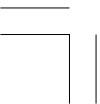



Instrument Panel Indicators

The instrument panel has many indicators to give you important information about your vehicle.



Seat Belt Reminder Indicator

This indicator comes on when you turn the ignition switch to the ON (II) position. It reminds you and your passenger to fasten your seat belts. A beeper also sounds if you and your passenger have not fastened your seat belts.

If you turn the ignition switch to the ON (II) position before fastening your seat belts, the beeper sounds, and the indicator flashes. If you do not fasten your seat belts before the beeper stops, the indicator stops flashing but remains on.

If your passenger does not fasten their seat belt, the indicator comes on about 6 seconds after the ignition switch is turned to the ON (II) position.

If either of you do not fasten your seat belt while driving, the beeper will sound and the indicator will flash again at regular intervals. For more information, see page 16 .



Low Oil Pressure Indicator

The engine can be severely damaged if this indicator flashes or stays on when the engine is running. For more information, see page 186 .



Charging System Indicator

If this indicator comes on when the engine is running, the battery is not being charged. For more information, see page 186 .

U.S. BRAKE Canada Parking Brake and Brake System Indicator

This indicator has two functions:

1. It comes on when you turn the ignition switch to the ON (II) position. It is a reminder to check the parking brake. A beeper sounds if you drive with the parking brake not fully released. Driving with the parking brake not fully released can damage the brakes and tires.
2. If it stays on after you have fully released the parking brake while the engine is running, or if it comes on while driving, there could be a problem with the brake system. For more information, see page 188 .





Instrument Panel Indicators



Supplemental Restraint System Indicator

This indicator comes on briefly when you turn the ignition switch to the ON (II) position. If it comes on at any other time, it indicates a potential problem with your airbags. This indicator will also alert you to a potential problem with your automatic seat belt tensioners, driver's seat position sensor, or the passenger's seat weight sensors. For more information, see page 25 .



Anti-lock Brake System (ABS) Indicator

This indicator normally comes on for a few seconds when you turn the ignition switch to the ON (II) position, and when you push the START button. If it comes on at any other time, there is a problem with the ABS. If this happens, have your vehicle checked at a dealer. With this indicator on, your vehicle still has normal braking ability but no anti-lock function. For more information, see page 128 .



Malfunction Indicator Lamp

See page 187 .



Trunk-open Indicator

This indicator comes on if the trunk lid is not closed tightly.



Door-open Indicator

This indicator comes on if either door is not closed tightly.



Cruise Control Indicator

This indicator comes on when you set the cruise control. See page 106 for information on operating the cruise control.



Instrument Panel Indicators



Electric Power Steering (EPS) Indicator

This indicator normally comes on when you turn the ignition to the ON (II) position and goes off after the engine starts. If it comes on at any other time, there is a problem in the electric power steering system. If this happens, stop the vehicle in a safe place and turn off the engine. Reset the system by restarting the engine. The indicator will not turn off immediately. If it does not go off after driving a short distance, or comes on again while driving, take the vehicle to your dealer to have it checked. With the indicator on, the EPS may be turned off, making the vehicle harder to steer.

If the power steering system overheats while driving, the assist is reduced and steering may feel slightly harder.

Driving with the power steering system continuously overheating can cause system damage.



Turn Signal and Hazard Warning Indicators

The left or right turn signal indicator blinks when you signal a lane change or turn. If the indicator does not blink or blinks rapidly, it usually means one of the turn signal bulbs is burned out (see page 157). Replace the bulb as soon as possible, since other drivers cannot see that you are signaling.

When you press the hazard warning button, both turn signal indicators blink. All turn signals on the outside of the vehicle should flash.

DRL

“Daytime Running Lights” Indicator

If this indicator comes on when the ignition switch is turned to the ON (II) position and the parking brake is released, it means there is a problem in the high beam headlight’s circuit. Have your vehicle checked by your dealer.





Instrument Panel Indicators



High Beam Indicator

This indicator comes on with the high beam headlights. For more information, see page 57 .

When the daytime running lights (DRL) are on, this indicator comes on with reduced brightness.



Immobilizer System Indicator

This indicator comes on for a few seconds when you turn the ignition switch to the ON (II) position. It will then go off if you have inserted a properly-coded ignition key. If it is not a properly-coded key, the indicator will blink, and the engine will not start (see page 61).

This indicator also blinks several times when you turn the ignition switch from the ON (II) position to the ACCESSORY (I) or LOCK (0) position.



Low Fuel Indicator

This indicator comes on as a reminder that you must refuel soon.

When the indicator comes on, there is about 2.22 US gal (8.4 ℓ) of fuel remaining in the tank before the reading reaches E. There is a small reserve of fuel remaining in the tank when the reading does reach E.





Instrument Panel Indicators

Vehicle Stability Assist (VSA) System Indicator

This indicator normally comes on for a few seconds when you turn the ignition switch to the ON (II) position.

If it comes on and stays on at any other time, or if it does not come on when you turn the ignition switch to the ON (II) position, there is a problem with the VSA system. Take your vehicle to a dealer to have it checked. Without VSA, your vehicle still has normal driving ability, but will not have VSA traction and stability enhancement. See page 128 for more information on the VSA system.

VSA Activation Indicator

This indicator has three functions:

1. It comes on as a reminder that you have turned off the vehicle stability assist (VSA) system.
2. It flashes when VSA is active (see page 130).
3. It comes on along with the VSA system indicator if there is a problem with the VSA system.

This indicator normally comes on for a few seconds when you turn the ignition switch to the ON (II) position. For more information, see page 130.

Maintenance Minder Indicator

This indicator reminds you that it is time to take your vehicle in for scheduled maintenance. The maintenance main items and sub items will be displayed in the information display. See page 135 for more information on the maintenance minder.

This indicator goes off when your dealer resets it after completing the required maintenance service.





Gauges

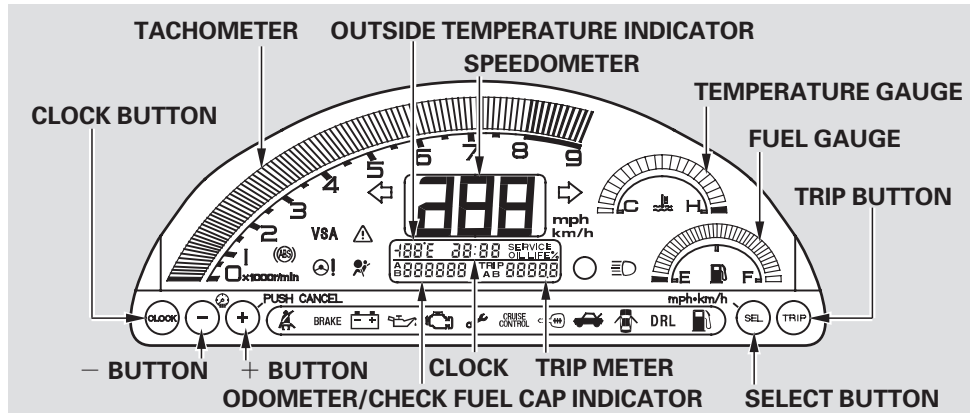

Odometer

The odometer shows the total distance your vehicle has been driven. It measures miles in U.S. models and kilometers in Canadian models. It is illegal under U.S. federal law and Canadian provincial regulations to disconnect, reset, or alter the odometer with the intent to change the number of miles or kilometers indicated.

Trip Meter

The trip meter shows the number of miles or kilometers driven since you last reset it.

There are two trip meters: Trip A and Trip B. Switch between these displays by pressing the TRIP button repeatedly. Each trip meter works independently, so you can keep track of two different distances.

To reset a trip meter, display it, and then press and hold the TRIP button until you hear a beep and the number resets to "0.0".

Select Button

The select button switches the speedometer reading between miles per hour and kilometers per hour. It also changes the odometer and trip meters to read in miles or kilometers correspondingly. To change the readings, push the SELECT button, and hold it until you hear a beep.





Gauges

Fuel Gauge

This shows how much fuel you have. It may show slightly more or less than the actual amount.

NOTICE

Avoid driving with an extremely low fuel level. Running out of fuel could cause the engine to misfire, damaging the catalytic converter.

Check Fuel Cap Message

Your vehicle's on board diagnostic system will detect a loose or missing fuel fill cap as an evaporative system leak. The first time a leak is detected a "CHECK FUEL CAP" message appears on the information display. Turn the engine off, and confirm the fuel fill cap is installed. If it is, loosen it, then retighten it until it clicks at least once. The message should go off after several days of normal driving once you tighten or replace the fuel fill cap. To scroll to another display, press the trip button. The "CHECK FUEL CAP" message will appear each time you restart the engine until the system turns the message off.

If the system still detects a leak in the vehicle's evaporative emissions system, the malfunction indicator lamp (MIL) comes on. If the fuel fill cap was not already tightened, turn the engine off, and check or retighten the fuel fill cap until it clicks at least once. The MIL should go off after several days of normal driving once the cap is tightened or replaced. If the MIL does not go off, have your vehicle inspected by a dealer. For more information, see page 187.

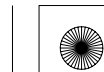



Gauges

Temperature Gauge

This shows the temperature of the engine's coolant. During normal operation, the reading should be in the middle of the gauge. In severe driving conditions, such as very hot weather or a long period of uphill driving, the reading may reach near the red mark. If it reaches the red (Hot) mark, pull safely to the side of the road. See page 183 for instructions and precautions on checking the engine's cooling system.

Outside Temperature Indicator

This indicator displays the outside temperature in Fahrenheit (U.S. models) or Centigrade (Canadian models).

The temperature sensor is in the front bumper. Therefore, the temperature reading can be affected by heat reflection from the road surface, engine heat, and the exhaust from surrounding traffic. This can cause an incorrect temperature reading when your speed is under 19 mph (30 km/h).

The sensor delays the indicator update until it reaches the correct outside temperature. This may take several minutes.

If the outside temperature is incorrectly displayed, you can adjust it up to $\pm 5^{\circ}\text{F}$ in U.S. models ($\pm 3^{\circ}\text{C}$ in Canadian models) warmer or cooler.

NOTE: The temperature must be stabilized before doing this procedure.

To adjust the outside temperature indicator, make sure the outside temperature indicator is shown in the display, then press and hold the TRIP button for 10 seconds (the TRIP A or B is also reset). The following sequence will appear for 1 second each: 0, 1, 2, 3, 4, 5, -5, -4, -3, -2, -1, 0 (U.S.) or 0, 1, 2, 3, -3, -2, -1, 0 (Canada).

When it reaches the desired value, release the TRIP button. You should see the new outside temperature displayed.

In certain weather conditions, temperature readings near freezing (32°F , 0°C) could mean that ice is forming on the road surface.



Gauges

Maintenance Minder

The information display in the instrument panel shows you the engine oil life and maintenance service items when the ignition switch is in the ON (II) position. This information helps to keep you aware of the periodic maintenance your vehicle needs for continued trouble-free driving. Refer to page 135 for more information.

Clock

The clock displays the time with the ignition switch in the ON (II) position.

To set the clock:

1. Turn the ignition switch to the ON (II) position.
2. Press and hold the CLOCK button until the minute display blinks. Adjust the minute by pressing the + or - button.
3. When you finish the minute adjustment, press and release the CLOCK button. The hour display will blink. Adjust the hour by pressing the + or - button.

4. When you finish your adjustments, press the CLOCK button again.





Controls Near the Steering Wheel

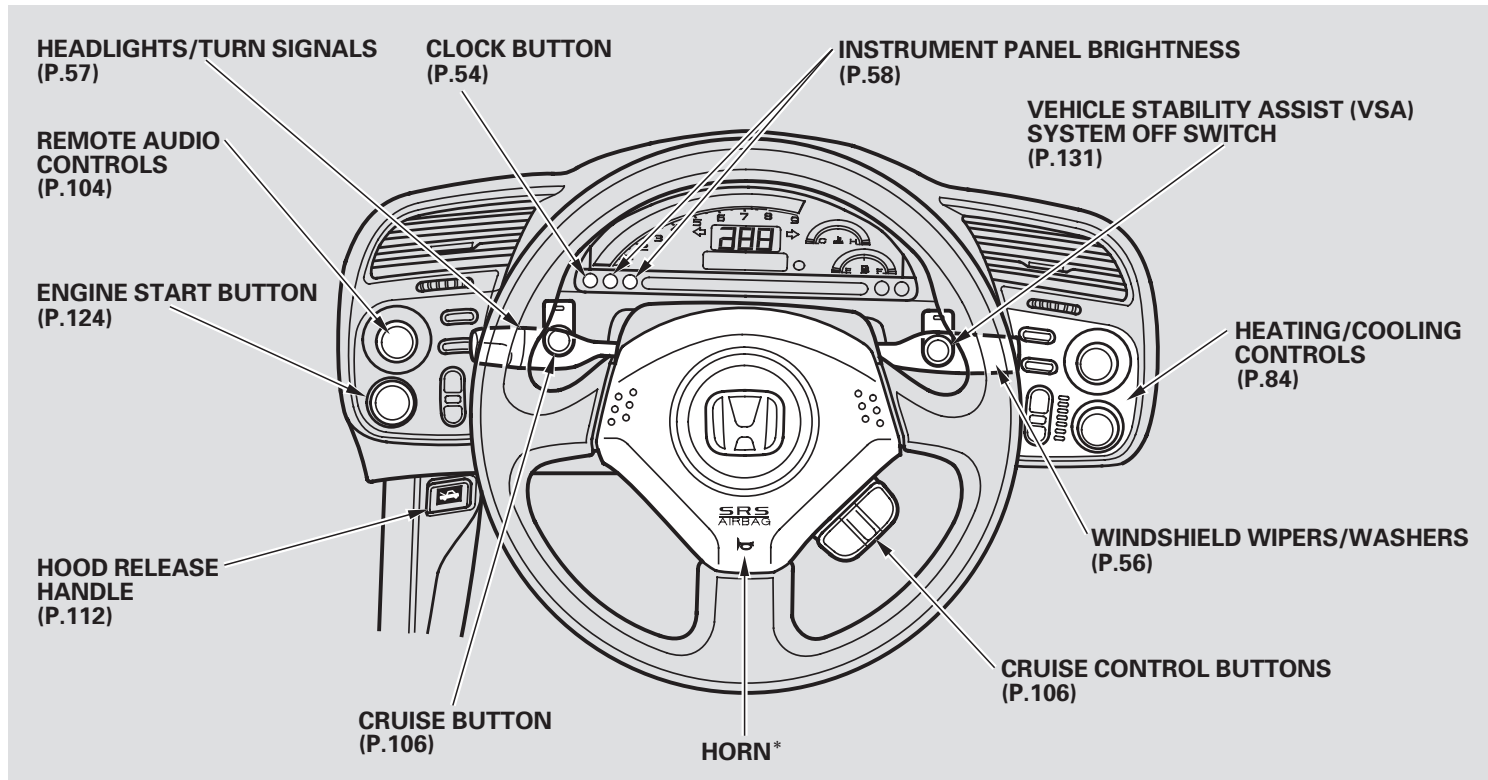

* To use the horn, press the pad around the “H” logo.

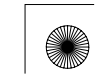



Windshield Wipers and Washers

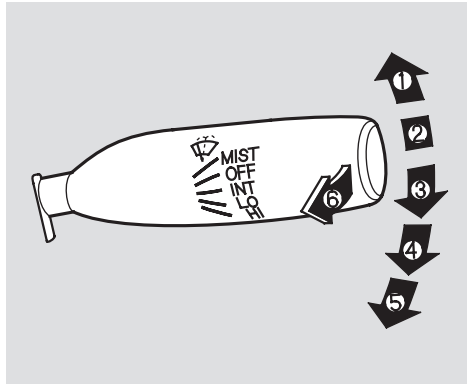

1. MIST
2. OFF
3. INT – Intermittent
4. LO – Low speed
5. HI – High speed
6. Windshield washers

Push the right lever up or down to select a position.

MIST – The wipers run at high speed until you release the lever.

OFF – The wipers are not activated.

INT – The wipers operate every few seconds. In low speed and high speed, the wipers run continuously.

LO – The wipers run at low speed.

HI – The wipers run at high speed.

Windshield Washers – Pull the wiper control lever toward you, and hold it. The washers spray until you release the lever. The wipers run at low speed, then complete one more sweep after you release the lever.





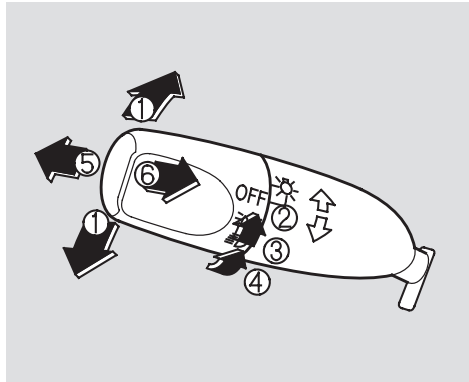

Turn Signal and Headlights



1. Turn Signal
2. Off
3. Parking and indicator lights
4. Headlights on
5. High beams
6. Flash high beams

Turn Signal — Push down on the lever to signal a left turn and up to signal a right turn. To signal a lane change, push lightly on the lever, and hold it. The lever will return to center when you release it or complete a turn.

Headlights On — Turning the switch to the “ ” position turns on the parking lights, taillights, instrument panel lights, side-marker lights, and rear license plate lights.

Turning the switch to the “ ” position turns on the headlights. If you leave the lights on with the key removed from the ignition switch, you will hear a reminder buzzer when you open the driver’s door.

High Beams — Push the lever forward until you hear a click. The high beam indicator will come on (see page 49). Pull the lever back to return to the low beams.

To flash the high beams, pull the lever back lightly, then release it. The high beams will stay on as long as you hold the lever back.

Daytime Running Lights

With the headlight switch off, the high beam headlights and the high beam indicator come on with reduced brightness when you turn the ignition switch to the ON (II) position and release the parking brake. They remain on until you turn the ignition switch off, even if you set the parking brake.

The headlights revert to normal operation when you turn them on with the switch.





Instrument Panel Brightness, Hazard Warning Button

Instrument Panel Brightness

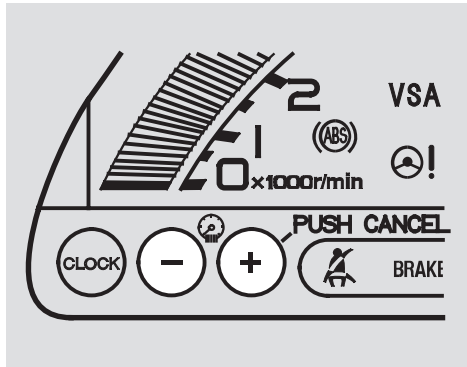

The buttons in the lower left corner of the instrument panel adjust the brightness of the display in five steps. Push the + or - button five times to see the full range.

To reduce glare at night, the instrument panel illumination dims when you turn the light switch to the D or D position. Adjust the brightness to the desired level with the headlight switch off, and also with the headlight switch on. Both settings will remain at those levels until you change them.

With the headlight switch on, you can switch the display to full daytime brightness by pushing and holding the + button. Push the - button to return the display to the original brightness.

Hazard Warning Button

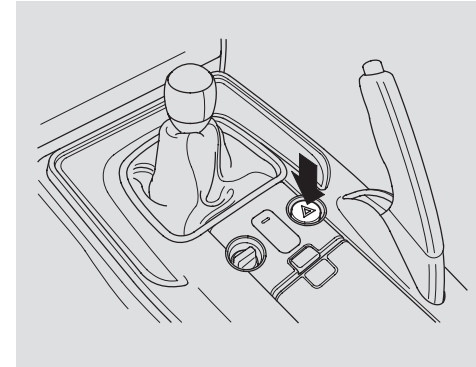

Push the red button next to the parking brake to turn on the hazard warning lights (four-way flashers). This causes all four outside turn signals and both indicators in the instrument panel to flash. Use the hazard warning lights if you need to park in a dangerous area near heavy traffic, or if your vehicle is disabled.

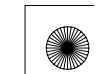



Rear Window Defogger

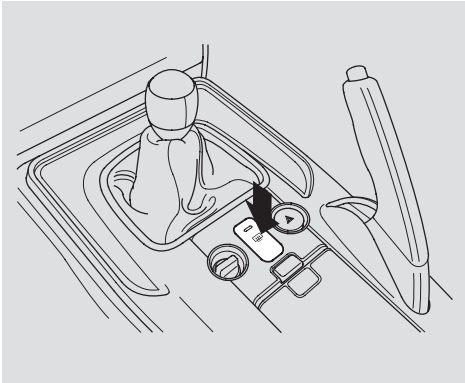

The rear window defogger will clear fog, frost, and thin ice from the window. Push the defogger button to turn it on and off. The indicator in the button comes on to show the defogger is on. If you do not turn it off, the defogger will shut itself off after about 15 minutes. It also shuts off when you turn off the ignition switch. You have to turn the defogger on again when you restart the vehicle.

Do not push the defogger button when the convertible top is folded.

Make sure the rear window is clear and you have good visibility before starting to drive.

The defogger wires on the inside of the rear window can be accidentally damaged. When cleaning the glass, always wipe side-to-side.





Keys and Locks

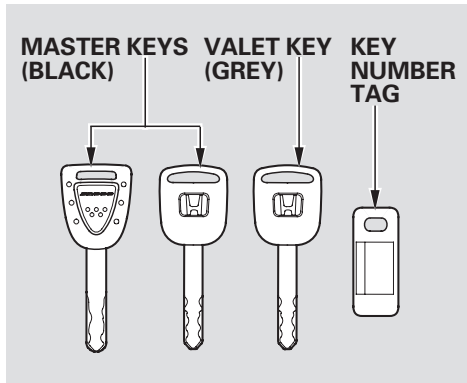

The master key fits all the locks on your vehicle.

The valet key works only in the ignition and the door locks. You can keep the trunk and the lower console compartment locked when you leave your vehicle and the valet key at a parking facility.

You should have received a key number tag with your keys. You will need this key number if you ever have to get a key replaced. Use only Honda-approved key blanks.

These keys contain electronic circuits that are activated by the immobilizer system. They will not work to start the engine if the circuits are damaged.

- Protect the keys from direct sunlight, high temperature, and high humidity.
- Do not drop the keys or set heavy objects on them.
- Keep the keys away from liquids. If they get wet, dry them immediately with a soft cloth.

The keys do not contain batteries. Do not try to take them apart.





Immobilizer System

The immobilizer system protects your vehicle from theft. If an improperly-coded key (or other device) is used, the engine's fuel system is disabled.

When you turn the ignition switch to the ON (II) position, the immobilizer system indicator should come on for a few seconds, then go off. If the indicator starts to blink, it means the system does not recognize the coding of the key. Turn the ignition switch to the LOCK (0) position, remove the key, reinsert it, and turn the ignition switch to the ON (II) position again.

The system may not recognize your key's coding if another immobilizer key or other metal object (i.e. key fob) is near the ignition switch when you insert the key.

If the system repeatedly does not recognize the coding of your key, contact your dealer.

Do not attempt to alter this system or add other devices to it. Electrical problems could result that may make your vehicle undrivable.

If you lose your key and cannot start the engine, contact your dealer.

*As required by the FCC:
This device complies with Part 15 of the FCC rules. Operation is subject to the following two conditions: (1) This device may not cause harmful interference, and (2) this device must accept any interference received, including interference that may cause undesired operation.*

Changes or modifications not expressly approved by the party responsible for compliance could void the user's authority to operate the equipment.

*This device complies with Industry Canada Standard RSS-210.
Operation is subject to the following two conditions: (1) this device may not cause interference, and (2) this device must accept any interference that may cause undesired operation of the device.*





Ignition Switch

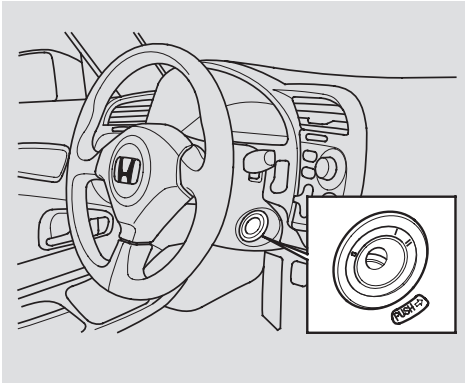

The ignition switch has three positions: LOCK (0), ACCESSORY (I), and ON (II).

LOCK (0) – You can insert or remove the key only in this position. To turn the key, push it in slightly.

If the front wheels are turned, the anti-theft lock may make it difficult to turn the key. Firmly turn the steering wheel to the left or right as you turn the key.

ACCESSORY (I) – You can operate the audio system and the accessory power socket in this position.

ON (II) – This is the normal key position when driving. Several of the indicators on the instrument panel come on as a test when you turn the ignition switch from the ACCESSORY (I) to the ON (II) position.

The engine can be started with the key in this position by pressing the engine START button (see page 122).

You will hear a reminder beeper if you leave the key in the ignition switch in the LOCK (0) or the ACCESSORY (I) position and open the driver's door. Remove the key to turn off the beeper.

⚠ WARNING

Removing the key from the ignition switch while driving locks the steering. This can cause you to lose control of the vehicle.

Remove the key from the ignition switch only when parked.





Power Door Locks, Trunk

Power Door Locks

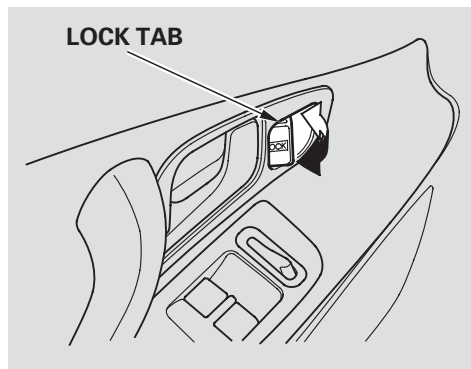

Each door has a lock tab next to the inside door handle. When you push in the lock tab on the driver's door, both doors lock. Pulling out the lock tab on the driver's door only unlocks that door. The lock tab on the passenger's door only locks and unlocks that door.

To lock the passenger's door when getting out of the vehicle, push the lock tab in and close the door. To lock the driver's door, remove the key from the ignition switch, pull out either the inside or outside door handle and push the lock tab in, then close the door.

Both doors lock when you use the key in the driver's door. Using the key in the passenger's door only locks and unlocks that door. To unlock only the driver's door from the outside, insert the key in the driver's door lock, turn the key and release it. If you turn the key and hold it, both doors will unlock.

Trunk

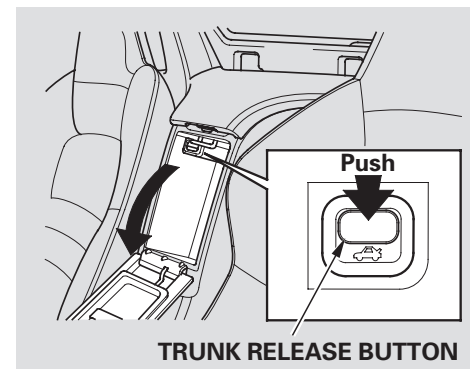

To open the trunk, press the trunk release button in the lower console compartment. To protect items in the trunk when you need to give the key to someone else, lock the lower console compartment with the master key, and give the other person the valet key.

To close the trunk, press down on the trunk lid.





Trunk

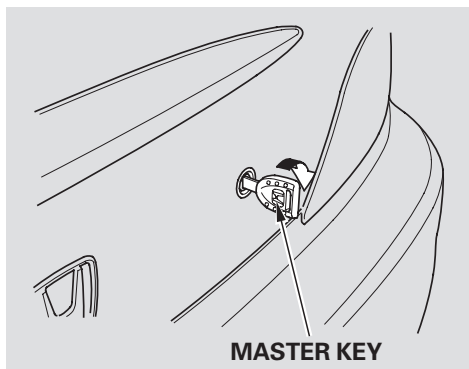

You can also use the master key to open the trunk lock.

To open the trunk with the remote transmitter, press and hold the TRUNK RELEASE button for about 1 second (see page 65).

Keep the trunk lid closed at all times while driving to avoid damaging the lid, and to prevent exhaust gas from getting into the interior. See **Carbon Monoxide Hazard** on page 41.

Emergency Trunk Opener

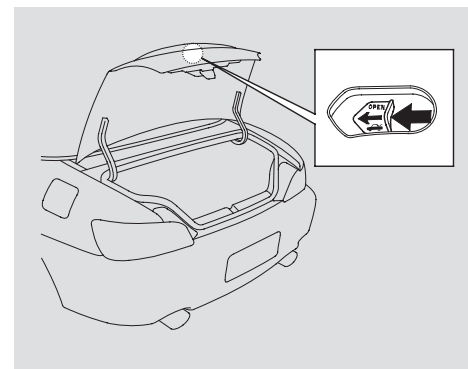

As a safety feature, your vehicle has a release lever on the trunk latch so the trunk can be opened from the inside. To open the trunk, push the release lever to the left.

Parents should decide if their children should be shown how to use this feature. For more information about child safety, see page 32.





Remote Transmitter

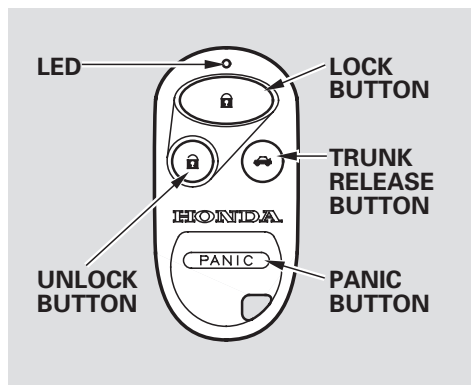

LOCK – Press this button once to lock both doors. Some exterior lights will flash. When you push LOCK twice within 5 seconds, you will hear a beep to verify that the doors are locked.

UNLOCK – Press this button once to unlock the driver’s door. Push it twice to also unlock the passenger’s door.

The interior light (if the interior light

switch is in the center position) will come on when you press the UNLOCK button. If you do not open either door within 30 seconds, the light goes out. If you relock the doors with the remote transmitter before 30 seconds have elapsed, the light will go off immediately.

If you do not open either door within 30 seconds, the doors automatically relock.

You cannot lock or unlock the doors with the remote transmitter if either door is not fully closed or the key is in the ignition switch.

TRUNK – Press this button for about 1 second to open the trunk. You cannot open the trunk if the key is in the ignition switch.

PANIC – Press this button for about 1 second to attract attention; the horn will sound and the exterior

lights will flash for about 30 seconds. To cancel panic mode, press any other button on the remote transmitter, or turn the ignition switch to the ON (II) position.

Remote Transmitter Care

- Avoid dropping or throwing the transmitter.
- Protect the transmitter from extreme temperature.
- Do not immerse the transmitter in any liquid.
- If you lose a transmitter, the replacement needs to be reprogrammed by your dealer.





Remote Transmitter

Replacing the Transmitter Battery

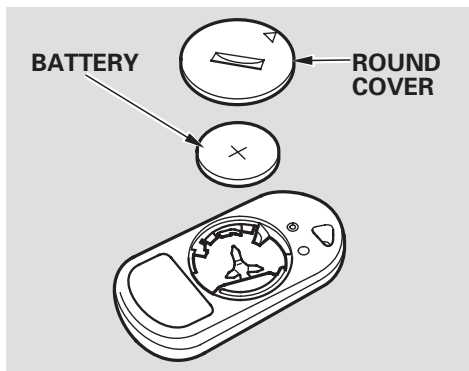

If it takes several pushes on the button to lock or unlock the doors, replace the battery as soon as possible.

Battery type: CR2025

To replace the battery, remove the round cover on the back of the transmitter by turning it counterclockwise with a coin. Insert a new battery with the + side facing up. Align the ∇ mark on the cover with the \odot mark on the transmitter. Set the cover in place, and turn it clockwise.

An improperly disposed of battery can hurt the environment. Always confirm local regulations for battery disposal.

*As required by the FCC:
This device complies with Part 15 of the FCC rules. Operation is subject to the following two conditions: (1) This device may not cause harmful interference, and (2) this device must accept any interference received, including interference that may cause undesired operation.*

Changes or modifications not expressly approved by the party responsible for compliance could void the user's authority to operate the equipment.

*This device complies with Industry Canada Standard RSS-210.
Operation is subject to the following two conditions: (1) this device may not cause interference, and (2) this device must accept any interference that may cause undesired operation of the device.*





Seats

See pages 10 – 12 for important safety information and warnings about how to properly position the seats and seat-backs.

Make all seat adjustments before you start driving.

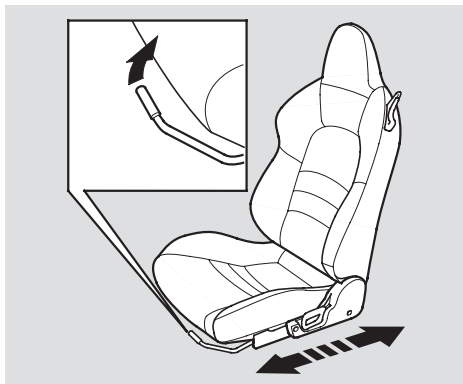

To adjust the seat forward and backward, pull up on the lever under the seat cushion's front edge. Then try to move the seat to make sure it is locked in position.

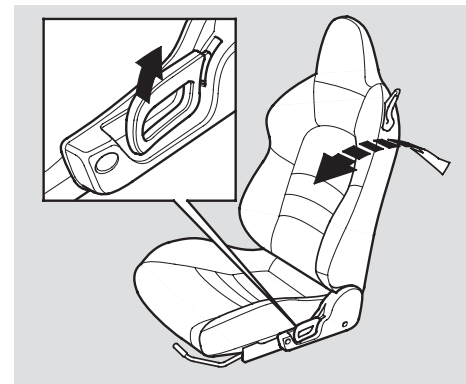

To change the seat-back angle, pull up on the lever on the outside of the seat bottom.





Power Windows

Turn the ignition switch to the ON (II) position to raise or lower either window. To open the window, push the switch down and hold it. Release the switch when you want the window to stop. Pull back on the switch and hold it to close the window.

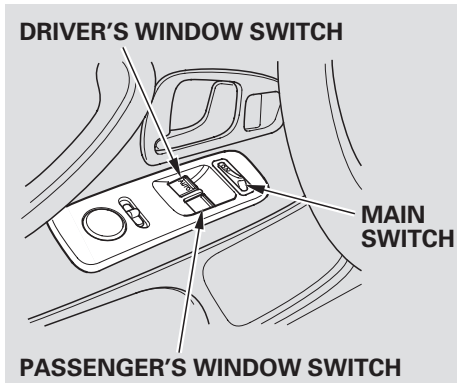

The driver's armrest has a master power window control panel. To open the passenger's window, push down on the switch and hold it until the window reaches the desired position. To close the window, pull back on the window switch. Release the switch when the window gets to the position you want.

⚠ WARNING

Closing a power window on someone's hands or fingers can cause serious injury.

Make sure your passenger is away from the window before closing it.

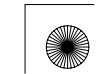



Power Windows

The master control panel also contains these extra features:

AUTO – To open the driver’s window fully, push the window switch firmly down to the second detent, and release it. The window automatically goes all the way down. To stop the window, pull back on the window switch briefly.

To open the driver’s window only partially, push the window switch down lightly and hold it. The window will stop as soon as you release the switch.

The AUTO function only works to lower the driver’s window. To raise the window, you must pull back on the window switch and hold it until the window reaches the desired position.

If the MAIN switch is OFF, the passenger’s window cannot be raised or lowered. Keep the MAIN switch off when you have a child in the vehicle so the child does not get injured by operating the window unintentionally.





Convertible Top

The convertible top on your vehicle lowers and raises electrically.

It is advisable to raise the top whenever you park the vehicle. This helps to protect the vehicle from unexpected weather changes, and from theft of your valuables.

NOTICE

- *Do not operate the convertible top in freezing weather. You can damage the material and the mechanism.*
- *Do not operate the top if it is wet, dirty, or covered with ice or snow.*
- *Never drive the vehicle with the convertible top half open.*
- *Do not operate the convertible top if the vehicle is on a jack, a hoist, or on jack stands.*
- *Park your vehicle in the shade whenever possible. Extended exposure to sunlight can cause the convertible top to deteriorate.*

Lowering the Convertible Top

Before operating the convertible top, make sure the vehicle is parked on level ground, the rear defogger is off, and there is enough clearance above the top.

1. Apply the parking brake. The convertible top will not operate unless the parking brake is fully engaged.
2. Turn the ignition switch to the ON (II) position.

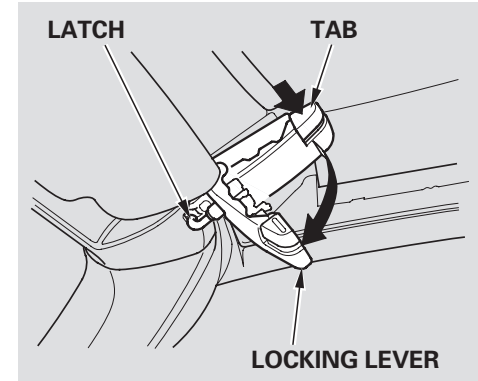

3. There is a latch on each side. Push in the tabs, and pull the locking levers down.





Convertible Top

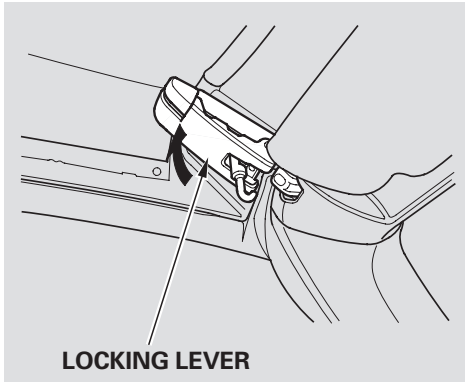

4. With the latches released, push the locking levers up until they latch.

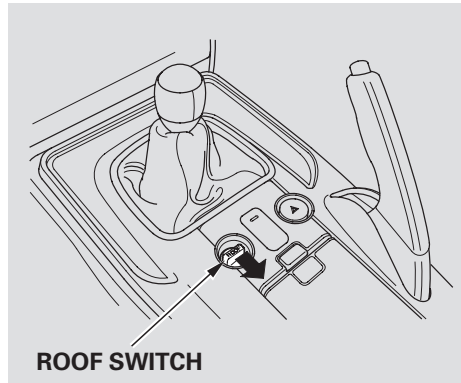

5. Pull back and hold the ROOF switch. The windows lower and the roof folds back. Release the ROOF switch when the roof is retracted completely into the rear shelf.

NOTICE

Do not sit on the folded convertible top, or place any items on top of it. You could damage the top or the rear window.

⚠ WARNING

Operating the convertible top while any part of a passenger is in the way of the convertible top can cause serious injury.

Make sure that you, your passenger, or any other people around the vehicle are clear of the moving convertible top.





Convertible Top

Convertible Top Cover

Use the convertible top cover when the top is folded to help prevent foreign objects, dirt, etc., from getting into the material and the mechanism.

The cover is attached to the body with four snaps: two behind the roll bars, and one on the side of each seat. To install or remove the convertible top cover *correctly*, do this:

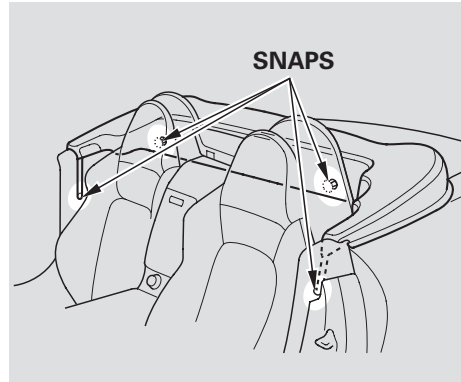

1. Remove the convertible top cover from the trunk, and lay it into position behind the roll bar.

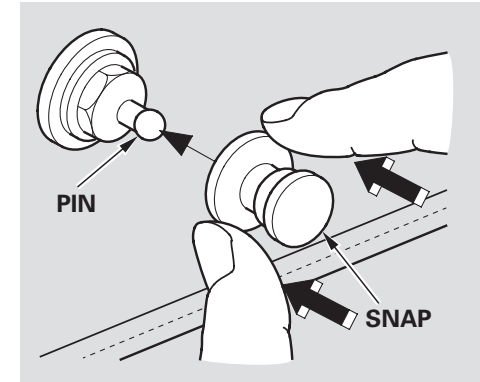

2. Hold the cover in place with its snap on the driver's side of the roll bar aligned with the pin on the roll bar. Press on both sides of the snap to attach it to the pin. Do not push or pull the snap button when installing the snap.

3. Align the snap on the passenger's side of the roll bar with the pin. Press on both sides of the snap to attach it to the pin.

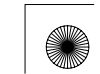



Convertible Top

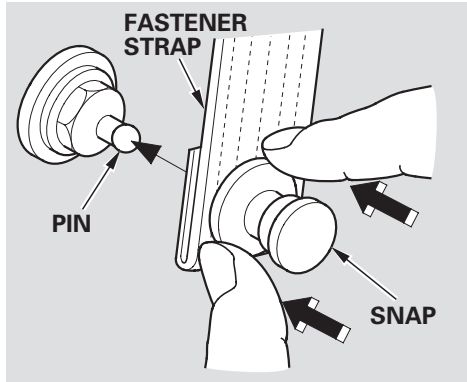

4. Pull down the strap on the passenger's side of the cover, and align its snap with the pin on the trim panel behind the door. Press on both sides of the snap to attach it to the pin.
5. Pull down the strap on the driver's side of the cover, and align its snap with the pin on the trim panel behind the door. Press on both sides of the snap to attach it to the pin.

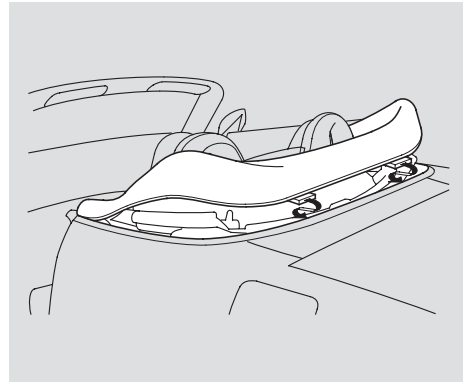

6. Fit the rear of the cover into the space between the convertible top and its molding.
7. To remove the cover, reverse the procedure.

Raising the Convertible Top

1. Apply the parking brake. The convertible top will not operate unless the parking brake is fully engaged.
2. Turn the ignition switch to the ON (II) position.
3. Push the ROOF switch forward and hold it. The windows, if raised, will lower automatically.

The convertible top will rise. Release the ROOF switch when the top reaches the windshield header.

CONTINUED

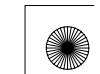



Convertible Top

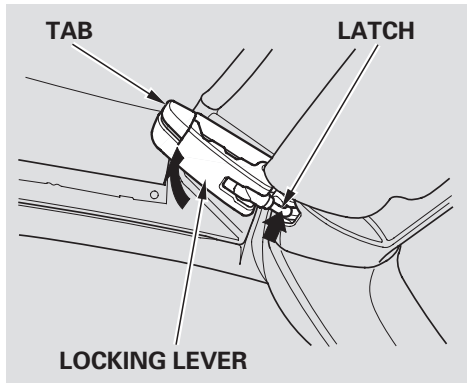

4. Push in the tab to release the locking levers, and pull them down. Note the movement of the latch when you push in the tab.
5. While holding the lever down, push in the tab to engage the latch in the windshield header. Pull the top down and forward if necessary.

6. Push the locking levers up while holding the tab. When the latch is in place, release the tab. Make sure the convertible top is securely latched.

⚠ WARNING

Operating the convertible top while any part of a passenger is in the way of the convertible top can cause serious injury.

Make sure that you, your passenger, or any other people around the vehicle are clear of the moving convertible top.

NOTICE

Do not put any heavy items on the folded convertible top. You could damage the material and the mechanism.

Maintenance

Dust is the main cause of creaks or other sounds coming from the convertible top.

Regularly clean the body seals with glass cleaner and a soft cloth. Do not use a scraper or de-icing chemicals to remove frost, snow, or ice from the top or the rear window.

Every 3 to 6 months, depending on how often the top is folded, rub a thin film of Shin-Etsu Silicon Grease (available from your dealer, P/N 08798-9013) onto the seals wherever they touch the convertible top or each other.





Convertible Top, Mirrors

To reduce the possibility of leaks:

- Do not lean or sit on an open door.
- Do not push or pull the door glass to open and close the door.
- The convertible top seals are designed to promote the flow of water off the roof. Spraying high-pressure water directly on the seals can distort them, causing a leak. Use only a low-pressure water stream when using a hose, and avoid commercial car washes.

Mirrors

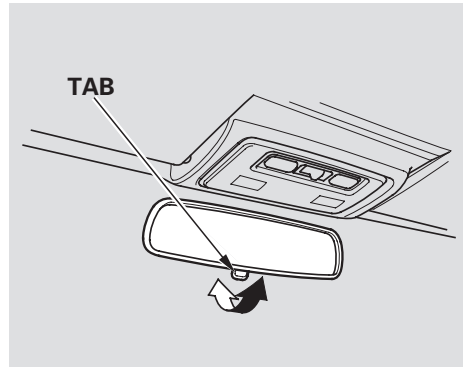

Keep the inside and outside mirrors clean and adjusted for best visibility. Be sure to adjust the mirrors before you start driving.

The inside mirror has day and night positions. The night position reduces glare from headlights behind you. Flip the tab on the bottom edge of the mirror to select the day or night position.

Adjusting the Power Mirrors

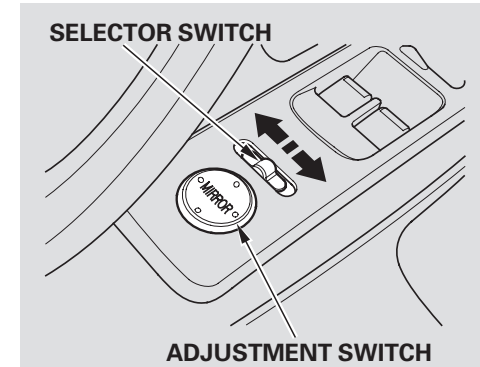

1. Turn the ignition switch to the ON (II) position.
2. Move the selector switch to L (driver's side) or R (passenger's side).
3. Push the appropriate edge of the adjustment switch to move the mirror right, left, up, or down.

CONTINUED

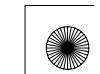



Mirrors, Parking Brake

- When you finish, move the selector switch to the center (off) position. This turns the adjustment switch off to keep your settings.

Parking Brake

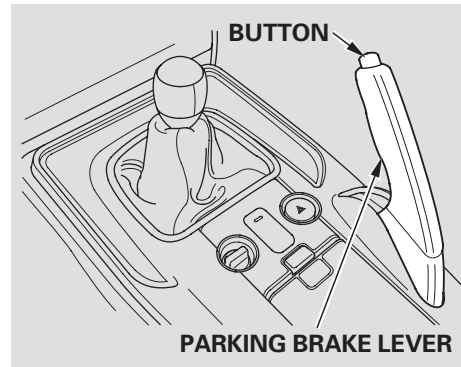

To apply the parking brake, pull the lever up fully. To release it, pull up slightly, push the button, and lower the lever. The parking brake indicator on the instrument panel should go out when the parking brake is fully released (see page 46).

NOTICE

Driving the vehicle with the parking brake applied can damage the rear brakes and axles. A beeper will sound if the vehicle is driven with the parking brake on.





Interior Convenience Items

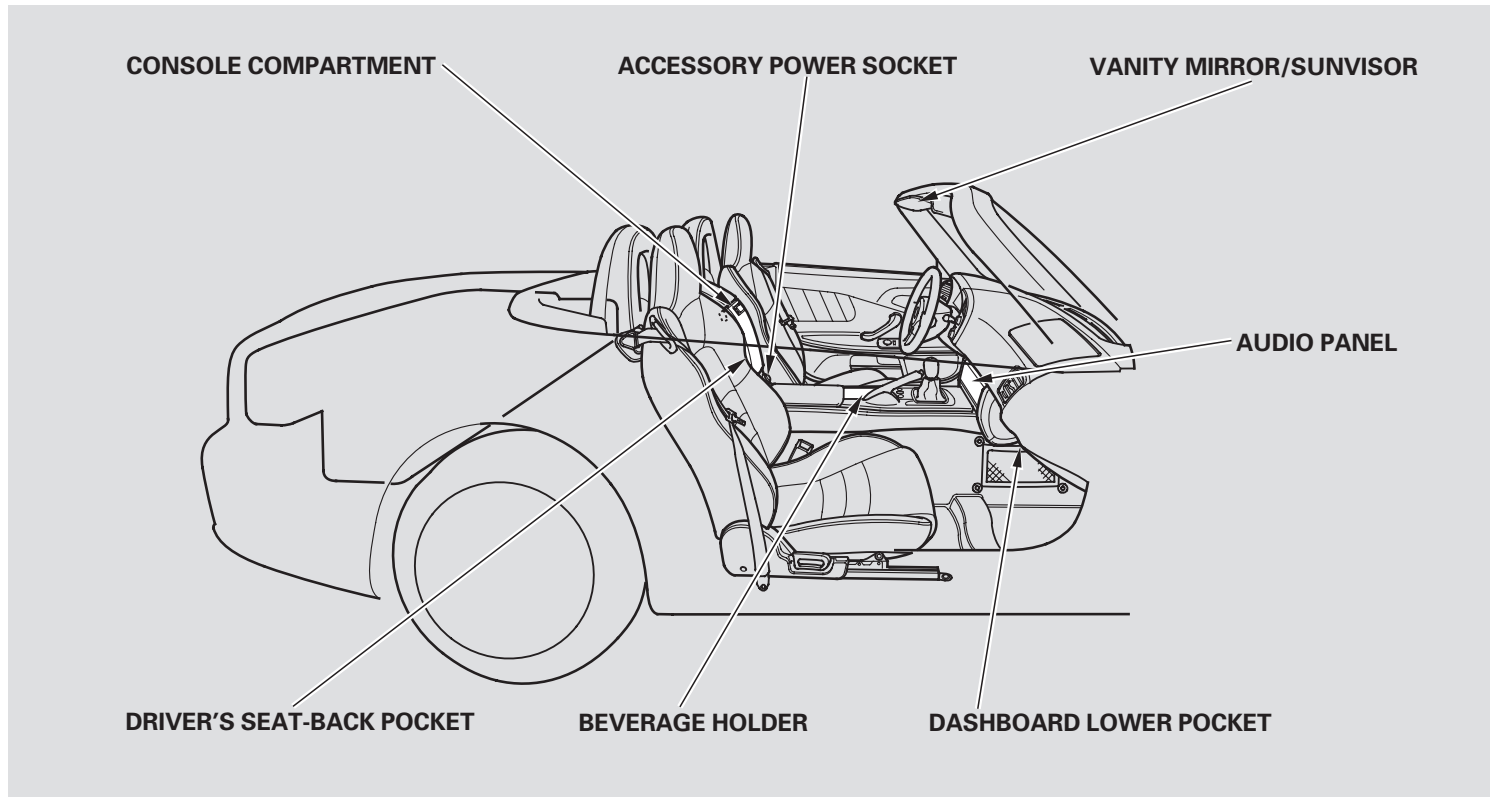

Instruments and Controls





Interior Convenience Items

Beverage Holder

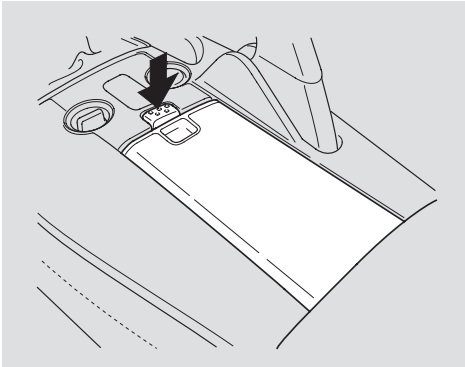

Open the beverage holder by pushing on the tab. The lid will slide open.

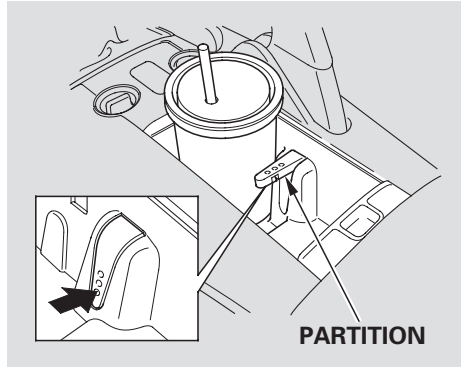

To hold two cups in the beverage holder, flip the partition up.

Be careful when you are using the beverage holder. A spilled liquid that is very hot can scald you or your passenger. Spilled liquids can also damage the upholstery, carpeting, and electrical components in the interior.

Accessory Power Socket

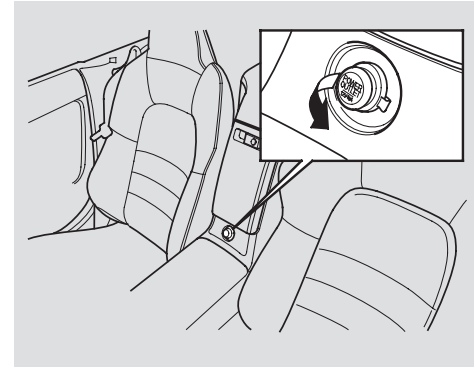

This socket is intended to supply power for 12 volt DC accessories that are rated 120 watts or less (10 amps). It will not power an automotive type cigarette lighter element.

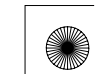



Interior Convenience Items

Console Compartments

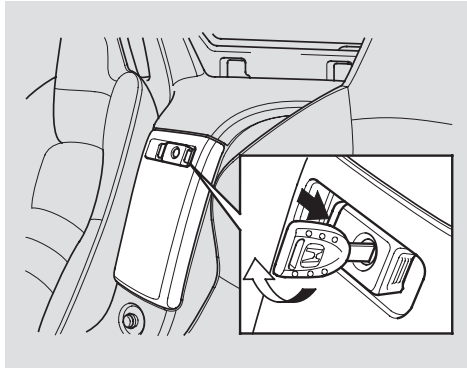

The area between the seats has two compartments. Open the lower compartment by squeezing the handle. Close it with a firm push. You can lock or unlock the lower compartment with the master key.

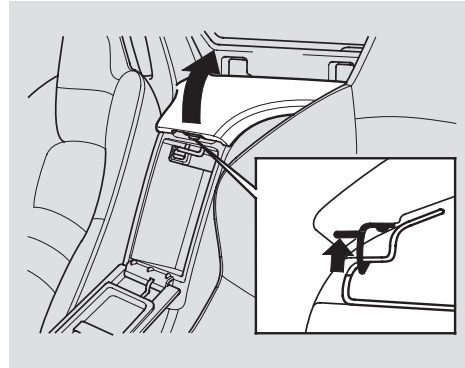

The lever to open the upper compartment is inside the lower compartment. Push up the lever, and lift the lid. To close, lower the lid, and push it down until it latches.

Audio Panel

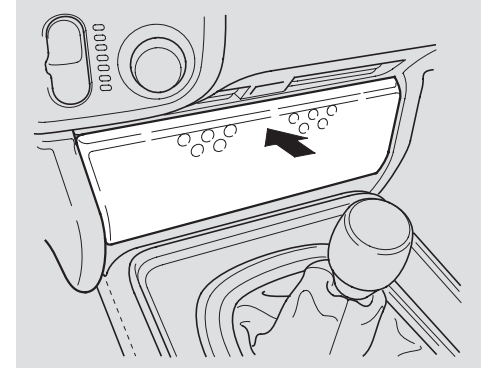

To open the audio panel, push on the top center, and let the panel swing down. To close, pivot the panel up, and push on it until it latches.

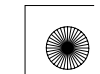



Interior Convenience Items, Interior Light

Dashboard Lower Pocket

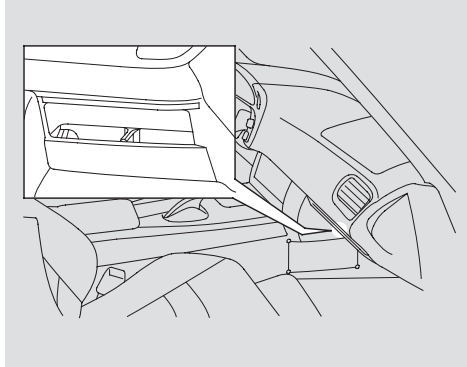

The dashboard lower pocket is located next to the audio panel.

Interior Light

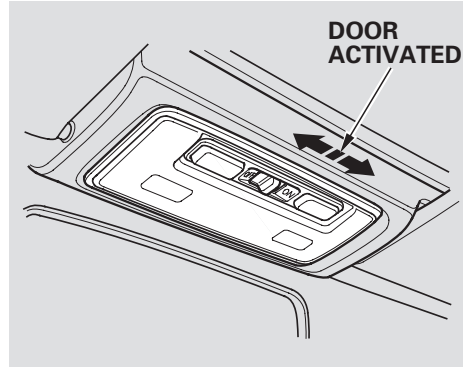

The interior light has a three-position switch; ON, Door Activated, and OFF. In the Door Activated (center) position, the light comes on when you:

- Open either door.
- Unlock the doors with the key or the remote transmitter.

If the switch is in the center position, the interior light will come on when you remove the key from the ignition switch.

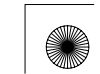



Interior Light

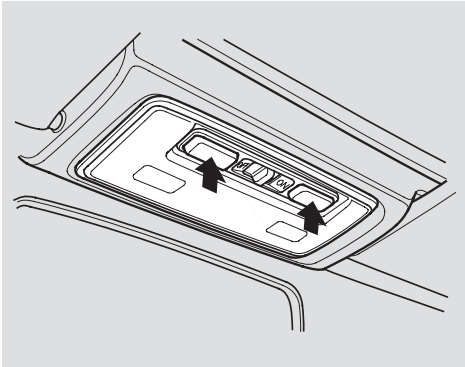

When the switch is in the center position with both doors closed, the two bulbs in the interior light can each be turned on and off with the button next to it.

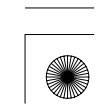
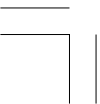



06/07/13 17:23:20 31S2A670 0087

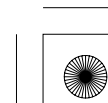
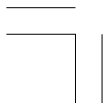



Features

The heating and air conditioning system in your vehicle provides a comfortable driving environment in all weather conditions.

The standard audio system has many features. This section describes those features and how to use them. (If you have an optional audio system, refer to the operating instructions that came with it.)

Your vehicle has an anti-theft audio system that requires a code number to enable it.

Vents, Heating, and A/C	84
Playing the AM/FM Radio.....	88
AM/FM Radio Reception	91
Playing the XM® Satellite Radio	93
Playing a CD.....	98
CD Changer.....	100
Protecting Your CDs.....	101
CD Player Error Messages	102
CD Changer Error Messages	103
Remote Audio Controls.....	104
Radio Theft Protection.....	105
Cruise Control.....	106

Features

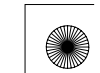



Vents, Heating, and A/C

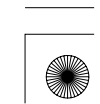
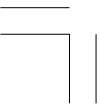
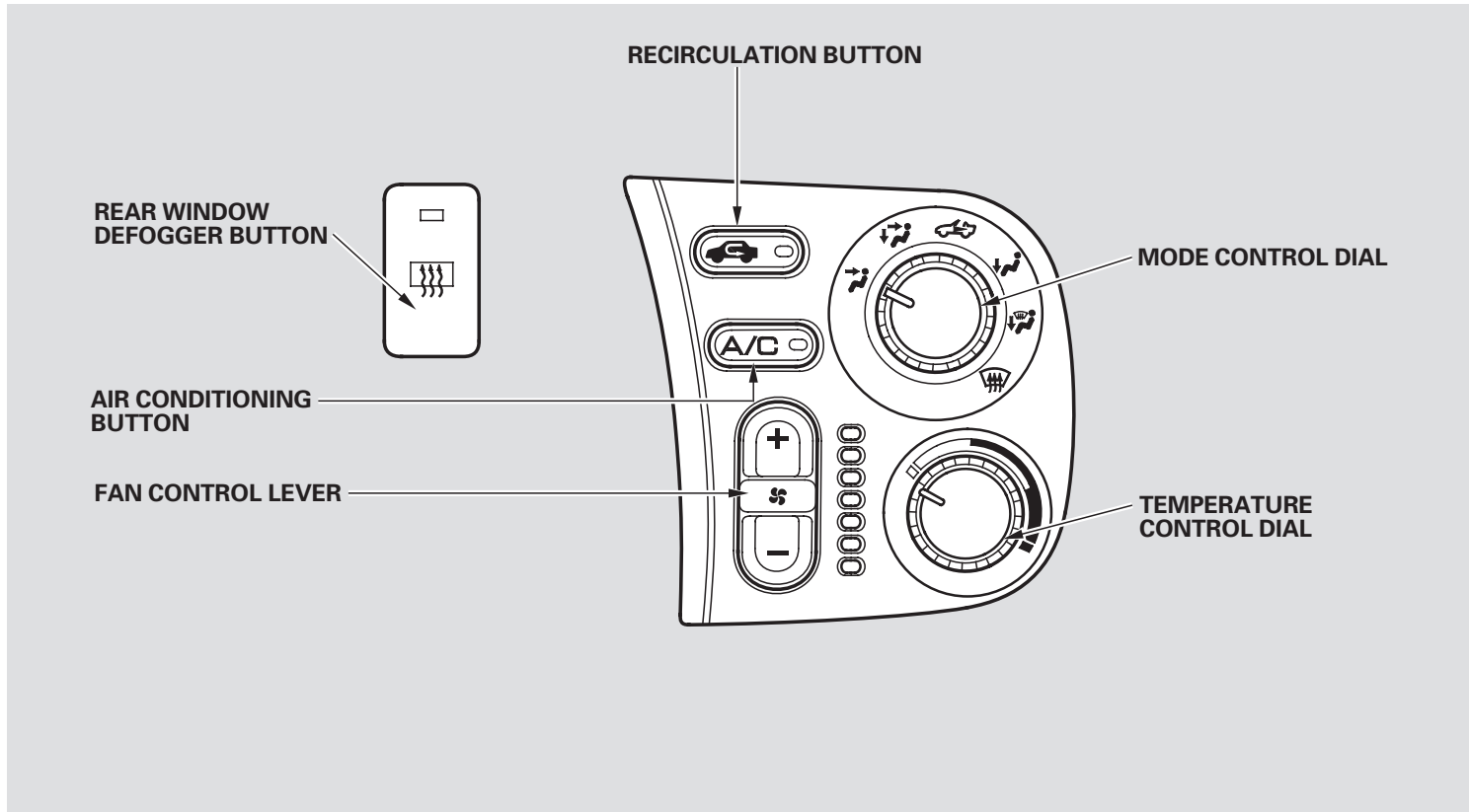



Vents, Heating, and A/C

Airflow Controls

Fan Control Lever

Push this lever up and down to increase or decrease the fan speed and airflow. The indicators next to the lever show you the speed and airflow selected.

Temperature Control Dial

Turning this dial clockwise increases the temperature of the airflow.

Air Conditioning (A/C) Button

This button turns the air conditioning on and off. The indicator in the button comes on when the A/C is on.

Recirculation Button

When the recirculation indicator is on, air from the vehicle's interior is sent through the system again (recirculation mode). When the indicator is off, air is brought in from the outside of the vehicle (fresh air mode).

The outside air intakes for the heating and cooling system are at the base of the windshield. Keep this area clear of leaves and other debris.

The system should be left in fresh air mode under almost all conditions. Keeping the system in recirculation mode, particularly with the A/C off, can cause the windows to fog up.

Switch to recirculation mode when driving through dusty or smoky conditions, then return to fresh air mode.

Rear Window Defogger Button

This button turns the rear window defogger off and on (see page 59).

Do not push the defogger button when the convertible top is folded.

Mode Control Dial

Use the mode control dial to select the vents the air flows from. Some air will flow from the dashboard vents in all modes.

 Air flows from the vents on both sides of the instrument panel, and from the dashboard vent in front of the passenger.

 Airflow is divided between the vents in the dashboard and the floor vents.

Features

CONTINUED





Vents, Heating, and A/C

 Air flows from the center vents in the dashboard above the audio system, the vents on both sides of the instrument panel, and from the floor vents. Select this position when you drive with the convertible top folded.

 Air flows from the floor vents and the vents on both sides of the instrument panel.

 Airflow is divided between the floor vents and the defroster vents at the base of the windshield, and the vents on both sides of the instrument panel.

 Air flows from the defroster vents at the base of the windshield and the vents on both sides of the instrument panel.

When you select  or , the system automatically switches to fresh air mode and turns on the A/C.

Ventilation

The flow-through ventilation system draws in outside air, circulates it through the interior, then exhausts it through vents behind the seat-backs.

1. Set the temperature to the lower limit.
2. Make sure the A/C is off.
3. Select  and fresh air mode.
4. Set the fan to the desired speed.

Using the Heater

The heater uses engine coolant to warm the air. If the engine is cold, it will be several minutes before you feel warm air coming from the system.

1. Select  and fresh air mode.
2. Set the fan to the desired speed.
3. Adjust the warmth of the air with the temperature control dial.

Using the A/C

Air conditioning places an extra load on the engine. Watch the engine coolant temperature gauge (see page 53). If it moves near the red zone, turn off the A/C until the gauge reading returns to normal.

1. Turn on the A/C by pressing the button. The indicator in the button comes on when a fan speed is selected.
2. Make sure the temperature is set to maximum cool.
3. Select .
4. If the outside air is humid, select recirculation mode. If the outside air is dry, select fresh air mode.
5. Set the fan to the desired speed.

If the interior is very warm, you can cool it down more rapidly by partially opening the windows, turning on the A/C, and setting the fan to maximum speed in fresh air mode.





Vents, Heating, and A/C

Dehumidify the Interior

Air conditioning, as it cools, removes moisture from the air. When used in combination with the heater, it makes the interior warm and dry and can prevent the windows from fogging up.

1. Turn the fan on.
2. Turn on the air conditioning.
3. Select  and fresh air mode.
4. Adjust the temperature to your preference.



This setting is suitable for all driving conditions whenever the outside temperature is above 32°F (0°C).

To Defog and Defrost

To remove fog from the inside of the windows:



1. Set the fan to the desired speed, or high for faster defrosting.
2. Select . The system automatically switches to fresh air

- mode and turns on the A/C.
3. Adjust the temperature so the airflow feels warm.
4. Select  to help clear the rear window.
5. To increase airflow to the windshield, close the corner vents.

When you select  or , the system automatically turns on the A/C. This helps to dehumidify the air and to defog the windshield. In either mode, you cannot turn off the A/C.

When you switch to another mode from , the A/C stays on. Press the A/C button to turn it off.

To Remove Exterior Frost or Ice From the Windows

1. Select . The system automatically switches to fresh air mode and turns on the A/C.
2. Select .

3. Set the fan and temperature controls to the maximum level.

To clear the windows faster, you can close the dashboard corner vents and the vents on both sides of the instrument panel by rotating the wheel below the vent. This will send more warm air to the windshield defroster vents. Once the windshield is clear, select fresh air mode to avoid fogging the windows.

For your safety, make sure you have a clear view through all the windows before driving.

To Turn Everything Off

Push the fan control level down until the indicator goes off. A lack of airflow can cause the windows to fog up. You should keep the fan on at all times so stale air and moisture do not build up in the interior and cause fogging.

Features



Playing the AM/FM Radio

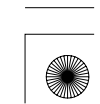
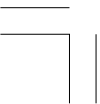
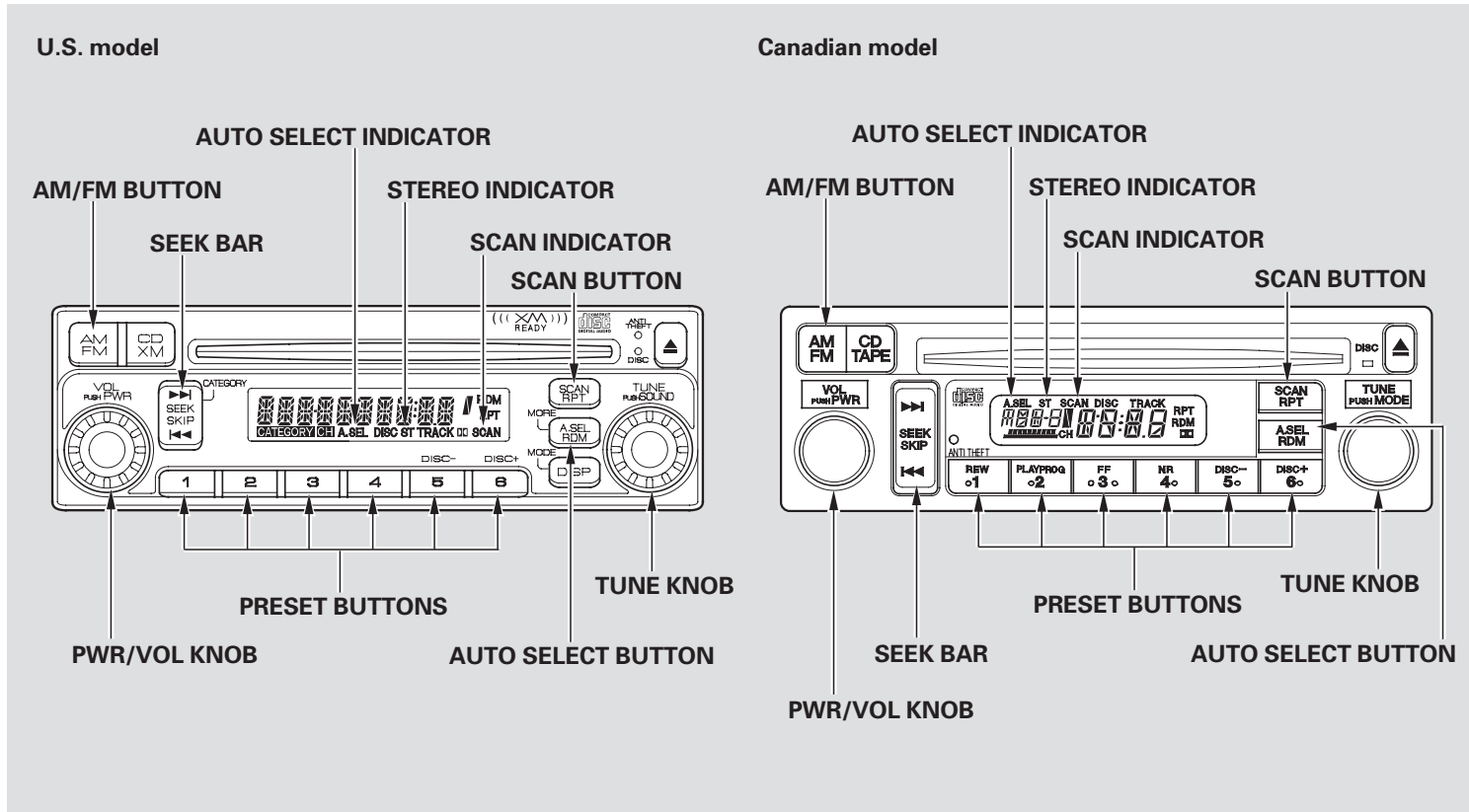



Playing the AM/FM Radio

To Play the Radio

The ignition switch must be in the ACCESSORY (I) or the ON (II) position. Turn the system on by pushing the PWR/VOL knob or the AM/FM button. Adjust the volume by turning the same knob.

The band and frequency that the radio was last tuned to is displayed. To change bands, press the AM/FM button. On the FM band, ST will be displayed if the station is broadcasting in stereo. Stereo reproduction in AM is not available.

To Select a Station

You can use any of five methods to find radio stations on the selected band: tune, seek, scan, the preset buttons, and auto select.

TUNE – Use the TUNE knob to tune the radio to a desired frequency. Turn the knob right to tune to a higher frequency, or left to tune to a

lower frequency.

SEEK – The seek function searches up and down from the current frequency to find a station with a strong signal. To activate it, press the ◀◀ or ▶▶ side of the bar, then release it.

SCAN – The scan function samples all stations with strong signals on the selected band. To activate it, press the SCAN button, then release it. You will see SCAN in the display. The system will scan for a station with a strong signal. When it finds one, it will stop and play that station for about 5 seconds.

If you do nothing, the system will scan for the next strong station and play it for 5 seconds. When it plays a station you want to listen to, press the SCAN button again.

PRESET – Each preset button (1–6) can store one station on AM, and two stations on FM.

1. Select the desired band, AM or FM. FM1 and FM2 let you store twelve stations.
2. Use the tune, seek, or scan function to tune the radio to a desired station.
3. Pick a preset number (1–6), and hold it until you hear a beep.
4. Repeat steps 1 through 3 to store a total of six stations on AM and twelve stations on FM.

The preset frequencies may be lost if your vehicle's battery goes dead, is disconnected, or the radio fuse is removed.

CONTINUED





Playing the AM/FM Radio

AUTO SELECT – If you are traveling far from home and can no longer receive your preset stations, you can use the auto select feature to find stations in the local area.

Press the A. SEL button. “A. SEL” flashes in the display, and the system goes into scan mode for several seconds. It stores the frequencies of six AM and twelve FM stations in the preset buttons.

You will see a “0” displayed after pressing a preset button if auto select cannot find a strong station for that preset button.

If you do not like the stations auto select has stored, you can store other frequencies on the preset buttons as previously described.

To turn off auto select, press the A. SEL (auto select) button. This restores the presets you originally set.

Adjusting the Sound

BAL – Adjusts the balance, or side-to-side strength of the sound.

FAD – Adjusts the fader, or the front-to-back strength of the sound.

TRE – Adjusts the treble in the sound.

BAS – Adjusts the bass in the sound.

Press the SOUND/MODE (TUNE) knob repeatedly to display the bass (BAS), treble (TRE), fader (FAD), and balance (BAL) setting.

Turn the knob to adjust the setting. When the level reaches the center, you will see a “C” in the display. The system will return to the audio display in about 5 seconds.

Audio System Lighting

You can use the instrument panel brightness control buttons to adjust the illumination of the audio system (see page 58). The audio system illuminates when the parking lights are on, even if the radio is off.





AM/FM Radio Reception

Radio Frequencies

The radio can receive the complete AM and FM bands.

Those bands cover these frequencies:

AM band: 530 to 1,710 kHz
FM band: 87.7 to 107.9 MHz

Radio stations on the AM band are assigned frequencies at least 10 kHz apart (530, 540, 550). Stations on the FM band are assigned frequencies at least 0.2 MHz apart (87.9, 88.1, 88.3).

Stations must use these exact frequencies. It is fairly common for stations to round-off the frequency in their advertising, so your radio could display a frequency of 100.9 even though the announcer may identify the station as “FM101.”

Radio Reception

How well the radio receives stations is dependent on many factors, such as the distance from the station’s transmitter, nearby large objects, and atmospheric conditions.

A radio station’s signal gets weaker as you get farther away from its transmitter. If you are listening to an AM station, you will notice the sound volume becoming weaker, and the station drifting in and out. If you are listening to an FM station, you will see the stereo indicator flickering off and on as the signal weakens. Eventually, the stereo indicator will go off and the sound will fade completely as you get out of range of the station’s signal.

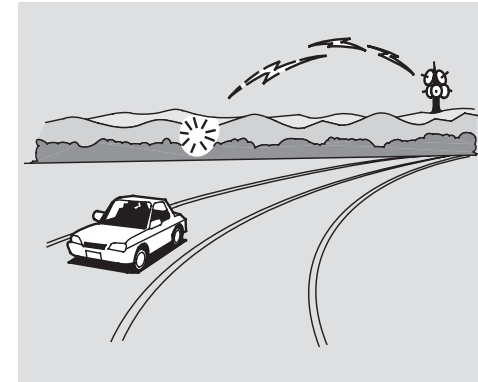

Features

Driving very near the transmitter of a station that is broadcasting on a frequency close to the frequency of the station you are listening to can also affect your radio’s reception. You may temporarily hear both stations, or hear only the station you are close to.

CONTINUED





AM/FM Radio Reception

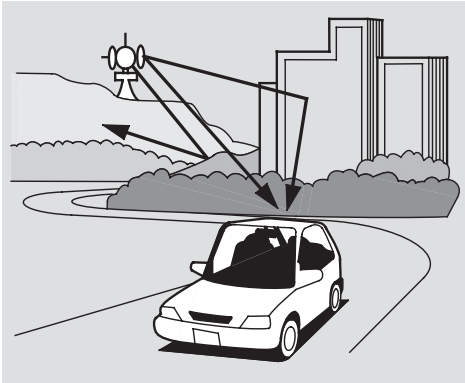

Radio signals, especially on the FM band, are deflected by large objects such as buildings and hills. Your radio then receives both the direct signal from the station's transmitter, and the deflected signal. This causes the sound to distort or flutter. This is a main cause of poor radio reception in city driving.



Radio reception can be affected by atmospheric conditions such as thunderstorms, high humidity, and even sunspots. You may be able to receive a distant radio station one day and not receive it the next day because of a change in conditions.

Electrical interference from passing vehicles and stationary sources can cause temporary reception problems.

*As required by the FCC:
Changes or modifications not expressly
approved by the party responsible for
compliance could void the user's
authority to operate the equipment.*

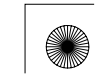



Playing the XM® Satellite Radio (Optional on U.S. Models)

Optional on U.S. models

Not available on Canadian models

Your vehicle is capable of receiving XM® Satellite Radio anywhere in the United States, except Hawaii and Alaska.

XM® is a registered trademark of XM Satellite Radio, Inc.

Satellite radio receives signals from two satellites to produce clear, high-quality digital reception. It offers many channels in several categories. Along with a large selection of different types of music, satellite radio also allows you to view channel and category selections in the audio display.

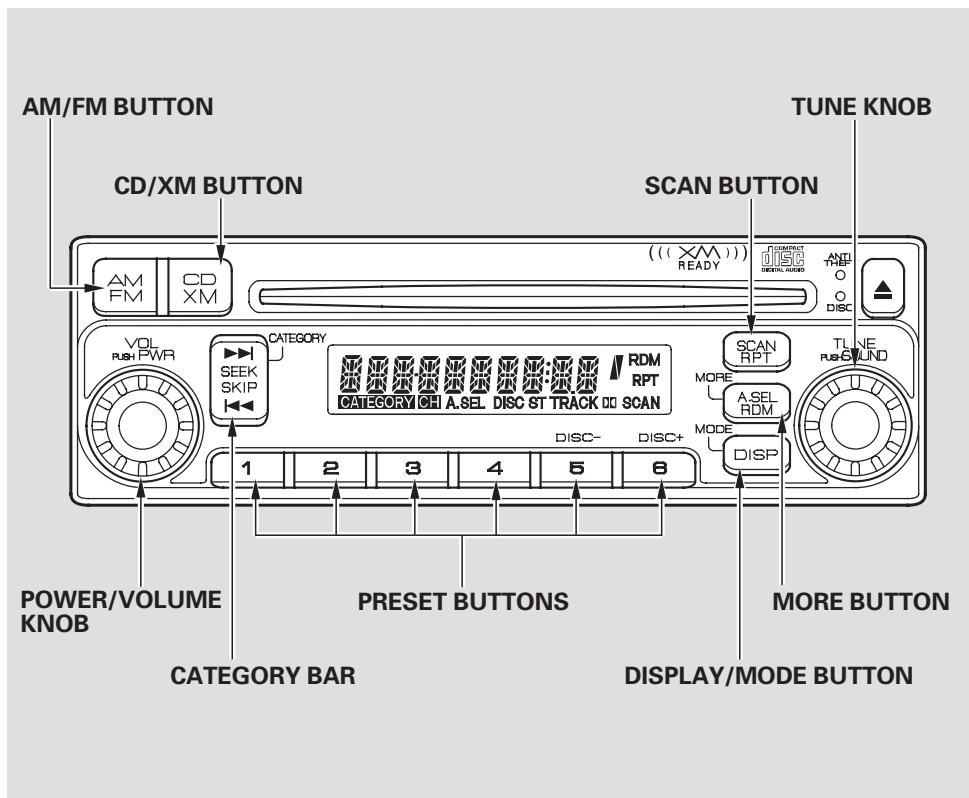

Features

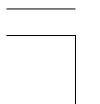
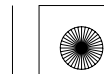



Playing the XM[®] Satellite Radio (Optional on U.S. Models)

Playing the Satellite Radio

To listen to satellite radio, turn the ignition switch to the ACCESSORY (I) or the ON (II) position. Push the PWR/VOL knob to turn on the audio system, and press the CD/XM button. Adjust the volume by turning the PWR/VOL knob. The last channel you listened to will show in the display.

DISPLAY/MODE – Each time the DISP button is pressed and released, the display information changes in the following sequence: channel name, channel number, category, artist name, and music title.

You may experience periods when XM radio does not transmit the artist name and or the song title information. If this happens, there is nothing wrong with your system. This information is not available under certain situations.

If you press and hold the DISP/MODE button for 5 seconds, it will change between category mode and channel mode. The display will show CH for the channel mode or CATEGORY for the category mode.

In the channel mode, you can receive all of the available channels in all of the different categories. In category mode, you will receive only the stations within the selected category.

MORE – Expands the display to show the 6 remaining letters beyond the first 10 letters in an artist's name or song title. The system is set up so only 16 letters can be displayed for

any title or name. Press MORE to view the next 6 letters. The system will return to the original display after 8 seconds.

TUNE – Turn the TUNE knob left to go down the channels or right to go up. In the channel mode, the TUNE knob will tune up or down through all the channels available from the XM radio. In the category mode, the TUNE knob will cycle through only the channels within the category you have currently selected.

CATEGORY (SEEK/SKIP) – Use the CATEGORY bar to select a desired category, such as jazz, rock, classical, etc. In both category mode and channel mode, pressing the category bar will change the category up or down.



Playing the XM® Satellite Radio (Optional on U.S. Models)

SCAN – The scan function gives you a sampling of all channels while in the channel mode. In the category mode, only the channels within that category are scanned. To activate scan, press the SCAN button. The system plays each channel in numerical order for a few seconds, then selects the next channel. When you hear a channel you want to continue listening to, press the button again.

To store a channel:

Preset – You can store up to 12 preset channels using the six preset buttons. Each button stores one channel from the XM1 band and one channel from the XM2 band.

To store a channel:

1. Press the CD/XM button. Either XM1 or XM2 will show in the display.
2. Use the TUNE knob, the CATEGORY bar, or the SCAN buttons to tune to a desired channel.

In category mode, only channels within that category can be selected. In channel mode, all channels can be selected.

3. Pick the preset button you want for that channel. Press and hold the button until you hear a beep.
4. Repeat steps 2 through 3 to store the first six channels.
5. Press the CD/XM button again. The available XM band will show. Store the next six channels using steps 2 through 3.

Once a channel is stored, simply press and release the proper preset button to tune to it.

The presets may be lost if your vehicle's battery goes dead, is disconnected, or the radio fuse is removed.

Features

CONTINUED



Playing the XM[®] Satellite Radio (Optional on U.S. Models)

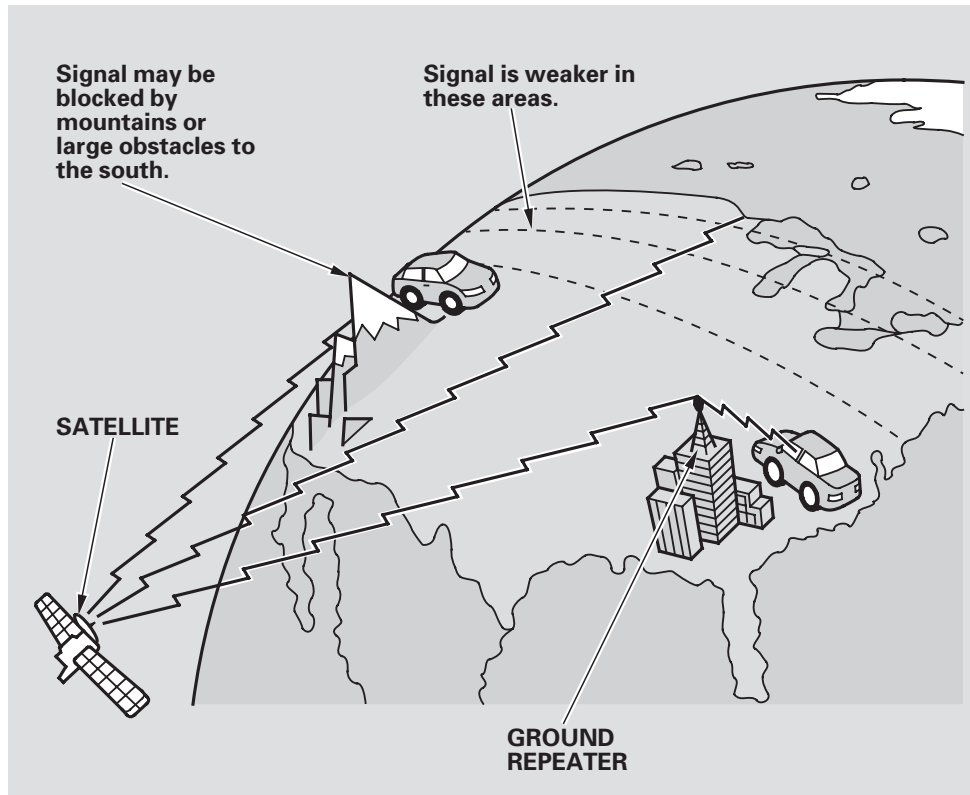

The XM satellites are in orbit over the equator; therefore, objects south of the vehicle may cause satellite reception interruptions. To help compensate for this, ground-based repeaters are placed in major metropolitan areas.

Satellite signals are more likely to be blocked by tall buildings and mountains the farther north you travel from the equator.

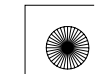



Playing the XM® Satellite Radio (Optional on U.S. Models)

Depending on where you drive, you may experience reception problems. Interference can be caused by any of these conditions:

- Driving on the south side of an east/west mountain road.
- Driving on the north side of a large commercial truck on an east/west road.
- Driving in tunnels.
- Driving on a road beside a vertical wall, steep cliff, or hill to the south of you.
- Driving on the lower level of a multi-tiered road.
- Driving on a single lane road alongside dense trees taller than 50 ft. (15 m) to the south of you.

There may also be other geographic situations that could affect satellite radio reception.

*As required by the FCC:
Changes or modifications not expressly approved by the party responsible for compliance could void the user's authority to operate the equipment.*

Receiving Satellite Radio Service

If your XM Radio service has expired, or you purchased your vehicle from a previous owner, you can listen to a sampling of the broadcasts available on XM Satellite Radio. With the ignition switch in the ACCESSORY (I) or the ON (II) position, push the PWR/VOL knob to turn on the audio system, and press the CD/XM button. A variety of music types and styles will play.

If you decide to purchase XM satellite radio service, contact XM Radio at www.xmradio.com, or at

1-800-852-9696. You will need to give them your radio I.D. number and your credit card number. To get your radio I.D. number, turn the TUNE knob until "0" appears in the display. Your I.D. will appear in the display.

After you've registered with XM Radio, keep your audio system in the Satellite Radio mode while you wait for activation. This should take about 30 minutes.

While waiting for activation, make sure your vehicle remains in an open area with good reception. Once your audio system is activated, "category" or "CH" will appear in the display, and you'll be able to listen to XM Radio broadcasts. XM Radio will continue to send an activation signal to your vehicle for at least 12 hours from the activation request. If the service has not been activated after 36 hours, contact XM Radio.

Features



Playing a CD

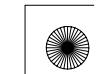
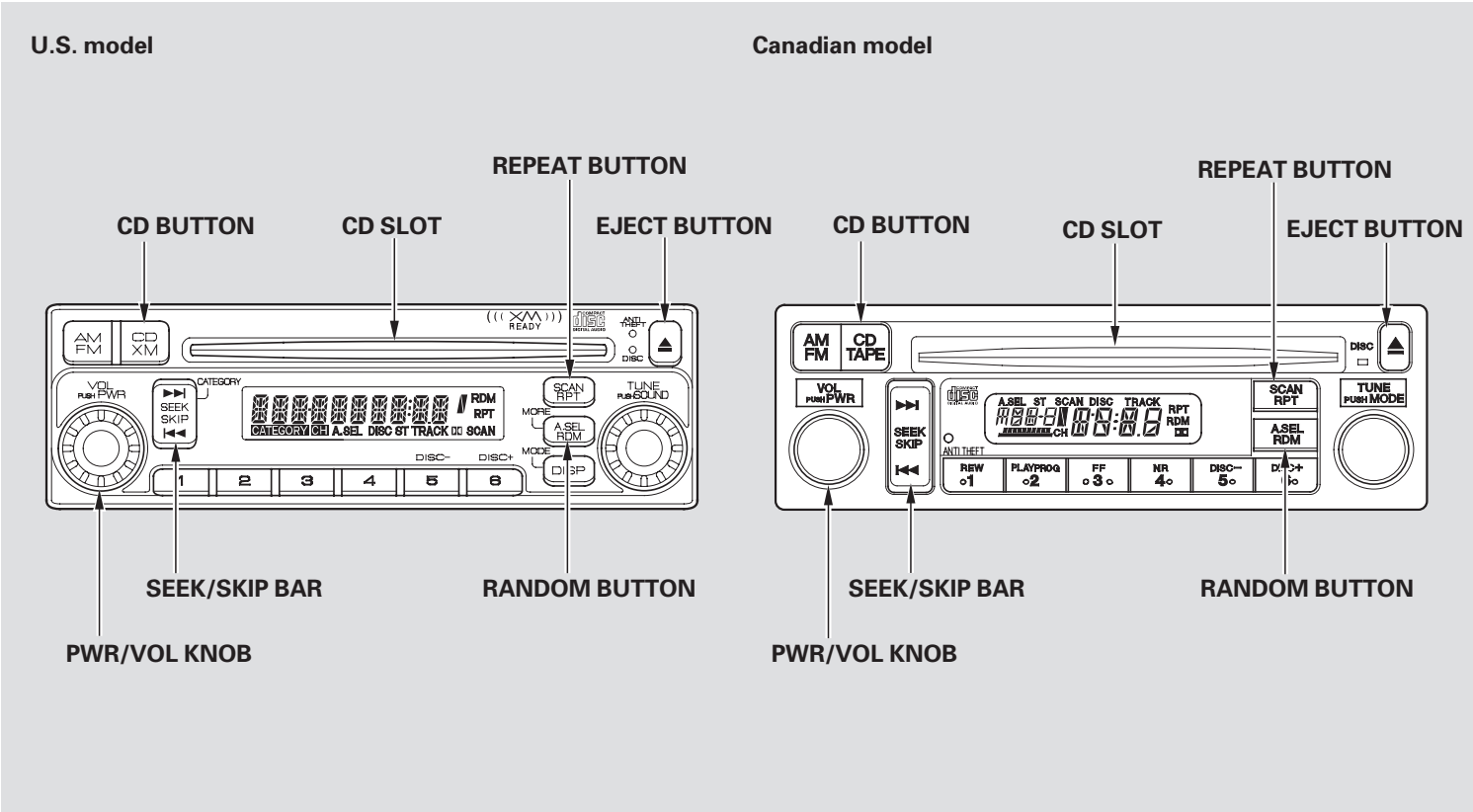



Playing a CD

To Play a CD

To load or play CDs, the ignition switch must be in the ACCESSORY (I) or the ON (II) position.

You operate the CD player with the same controls used for the radio. To select the CD player, press the CD button. The number of the track playing is shown in the display. The system will continuously play a CD until you change modes.

Insert a CD about halfway into the CD slot. The drive will pull the CD in the rest of the way and begin to play it. When the system reaches the end of the disc, it will return to the beginning and play the disc again.

NOTICE

Do not use discs with adhesive labels. The label can curl up and cause the disc to jam in the unit.

To play the radio when a CD is playing, press the AM/FM button. Press the CD button again to switch back to the CD player.

If you turn the system off while a CD is playing, either with the PWR/VOL knob or by turning off the ignition switch, the disc will stay in the drive. When you turn the system back on, the CD will begin playing where it left off.

To Change or Select Tracks

SKIP – Each time you press and release the ►► side of the skip bar, the player skips forward to the beginning of the next track. Press and release the ◄◄ side of the bar to skip backward to the beginning of the current track. Press it again to skip to the beginning of the previous track.

To move rapidly within a track, press and hold ►► or ◄◄ .

SEEK – To move rapidly within a track, press and hold the SEEK/SKIP bar. Press and hold ►► to move forward. Press and hold ◄◄ to move backward. Release the bar when the system reaches the point you want.

Features

CONTINUED





Playing a CD, CD Changer

REPEAT – To continuously replay a track, press and release the RPT button. You will see RPT in the display. Press it again to turn it off.

RANDOM – This feature plays the tracks in random order. To activate random play, press and release the RDM button. You will see RDM in the display. Press it again to return to normal play.

To Stop Playing a CD

Press the eject button () to remove the CD. If you eject the CD, but do not remove it from the slot, the system will automatically reload the CD after 15 seconds and put it in pause mode. To begin playing, press the CD button.

Press the AM/FM button to switch to the radio while a CD is playing.

If you turn the system off while a CD is playing, either with the PWR/VOL knob or by turning off the ignition switch, the disc will stay in the drive. When you turn the system back on, the CD will begin playing where it left off.

Operating the Optional CD Changer

An optional six disc CD changer is available for your vehicle. This CD changer uses the same controls used for the in-dash CD player.

Load the desired CDs into the magazine, and load the magazine into the changer according to the instructions that came with the unit.

To select the CD changer, press the CD button. The CD and track numbers will be displayed. To select a different CD, use the preset 5 (DISC –) or preset 6 (DISC +) button. If you select an empty slot in the magazine, the changer will, after finding that slot empty, try to load the CD in the next slot.





Protecting Your CDs

Protecting Your CDs

General Information

- When using CD-R discs, use only high quality CDs labeled for audio use.
- When recording a CD-R, the recording must be closed for it to be used by the system.
- CD-RW discs will not work in this unit.
- Play only standard round CDs. Odd-shaped CDs may jam in the drive or cause other problems.
- Handle your CDs properly to prevent damage and skipping.

Protecting CDs

When a CD is not being played, store it in its case to protect it from dust and other contamination. To prevent warpage, keep CDs out of direct sunlight and extreme heat.

To clean a CD, use a clean soft cloth. Wipe across the CD from the center to the outside edge.

A new CD may be rough on the inner and outer edges. The small plastic pieces causing this roughness can flake off and fall on the recording surface of the CD, causing skipping or other problems. Remove these pieces by rubbing the inner and outer edges with the side of a pencil or pen.

Never try to insert foreign objects in the CD player or the magazine.

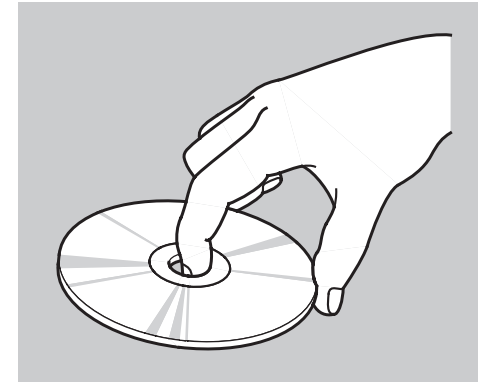

Features

Handle a CD by its edges; never touch either surface. Do not place stabilizer rings or labels on the CD. These, along with contamination from fingerprints, liquids, and felt-tip pens, can cause the CD to not play properly or possibly jam in the drive.





CD Player Error Messages







The chart on the right explains the error messages you may see in the display while playing a disc.

If you see an error message in the display while playing a disc, press the eject button. After ejecting the disc, check it for damage or deformation. If there is no damage, insert the disc again.

The audio system will try to play the disc. If there is still a problem, the error message will reappear. Press the eject button, and pull out the disc.

Insert a different disc. If the new disc plays, there is a problem with the first disc. If the error message cycle repeats and you cannot clear it, take your vehicle to a dealer.

CD Player Error Messages

Error Message	Cause	Solution
 DISC *1  DISC *2	FOCUS Error	Press the EJECT button, and pull out the CD. Check if the CD is inserted correctly in the CD player. Make sure the CD is not scratched or damaged.
 ERR *1  ERR *2	Mechanical Error	Press the EJECT button, and pull out the CD. Check the CD for damage or deformation. If the CD cannot be pulled out or the error message does not disappear after the CD is ejected, see your dealer. Do not try to force the disc out of the player.
 HOT *1  HOT *2	High temperature	Will disappear when the temperature returns to normal.

*1 : U.S. model

*2 : Canadian model





CD Changer Error Messages

The chart on the right explains the error messages you may see in the display while playing a disc.

If you see an error message in the display while playing a disc, press the eject button. After ejecting the disc, check it for damage or deformation. If there is no damage, insert the disc again.

The audio system will try to play the disc. If there is still a problem, the error message will reappear. Press the eject button, and pull out the disc.

Insert a different disc. If the new disc plays, there is a problem with the first disc. If the error message cycle repeats and you cannot clear it, take your vehicle to a dealer.

Error Message	Cause	Solution
<i>CDC DISC</i> * ¹	FOCUS Error	Press the magazine eject button, pull out the magazine, and check for an error message. Insert the magazine again. If the error message does not disappear or the magazine cannot be pulled out, see your dealer.
<i>CDC DISC</i> * ²		
	No CD in the CD magazine	Insert CD.
<i>CDC ERR</i> * ¹	Mechanical Error	Press the magazine eject button, and pull it out. Check for an error message, and insert the magazine again. If the error message does not disappear or the magazine cannot be pulled out, see your dealer.
<i>CDC ERR</i> * ²		
<i>CDC HOT</i> * ¹	High temperature	Will disappear when the temperature returns to normal.
<i>CDC HOT</i> * ²		
<i>CDC EJECT</i> * ¹	No CD magazine in the CD changer	Insert CD magazine.
<i>CDC EJECT</i> * ²		

*1 : U.S. model

*2 : Canadian model



Remote Audio Controls

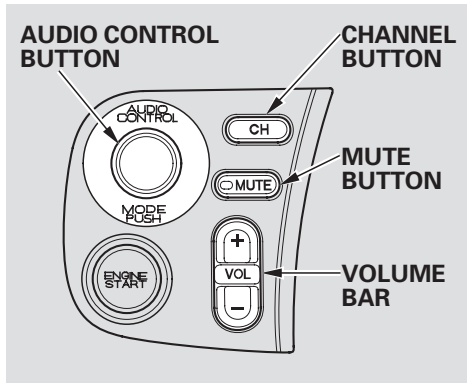

Four controls for the audio system are on the left side of the dashboard by the instrument panel. These let you control basic functions without distracting your attention from driving.

Use the VOLUME bar to adjust the volume. Push + to increase the volume and – to decrease it. Hold the lever until the volume reaches the desired level, then release it.

If you want to mute the sound temporarily, push the MUTE button. The indicator in the button will come on to indicate the mute function is on. Press the button again to cancel mute.

The AUDIO CONTROL button changes the mode. Pressing the button repeatedly selects FM1, FM2, AM, CD (if a CD is loaded), CD changer (if you have the optional CD changer), or XM1 and XM2 (if you have the optional satellite radio feature).

The CHANNEL button has two functions, depending on whether you are listening to the radio, or playing a CD.

If you are listening to the radio, use the CHANNEL button to change stations. Each time you press this button, the system advances to the next preset station on the band you

are listening to. You will see the number of the selected preset button in the audio system display.

If you are playing a CD, the system skips to the beginning of the next track each time you push the CHANNEL button.

These controls work only with the factory-installed audio system. They will not function if you install any non-Honda system.

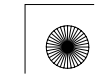



Radio Theft Protection

Your vehicle's audio system will disable itself if it is disconnected from electrical power for any reason. To make it work again, you must enter a specific five-digit code in the preset buttons. Because there are hundreds of number combinations possible from five digits, making the system work without knowing the exact code is nearly impossible.

You should have received a card that lists your audio system's code and serial numbers. It is best to store this card in a safe place at home. In addition, you should write the audio system's serial number in this owner's manual.

If you lose the card, you must obtain the code number from a dealer. To do this, you will need the system's serial number.

If your vehicle's battery is disconnected or goes dead, or the radio fuse is removed, the audio system will disable itself. If this happens, you will see "CODE" (U.S. model) or "Code" (Canadian model) in the frequency display the next time you turn on the system. Use the preset buttons to enter the five-digit code. The code is on the radio code card included in your owner's manual kit. When it is entered correctly, the radio will start playing.

If you make a mistake entering the code, do not start over; complete the five-digit sequence, then enter the correct code. You have 10 tries to enter the correct code. If you are unsuccessful in 10 attempts, you must then leave the system on for 1 hour before trying again.

You will have to store your favorite stations in the preset buttons after the system begins working. Your original settings were lost when the power was disconnected.





Cruise Control

Cruise control allows you to maintain a set speed above 25 mph (40 km/h) without keeping your foot on the accelerator pedal. It should be used for cruising on straight, open highways. It is not recommended for city driving, winding roads, slippery roads, heavy rain, or bad weather.

⚠ WARNING

Improper use of the cruise control can lead to a crash.

Use the cruise control only when traveling on open highways in good weather.

Using the Cruise Control

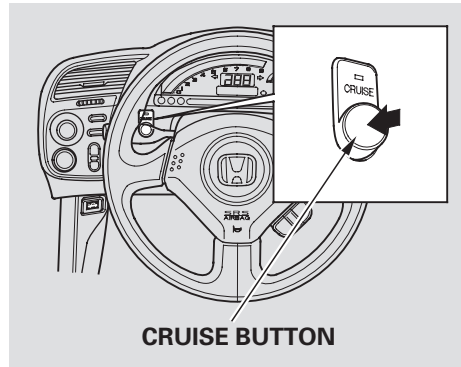

1. Push in the CRUISE button. The indicator over the button comes on.
2. Accelerate to the desired cruising speed above 25 mph (40 km/h).

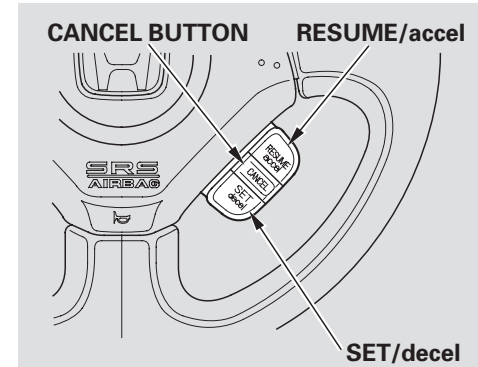

3. Press and release the SET/deccl button on the steering wheel. The indicator on the instrument panel comes on to show the system is now activated.

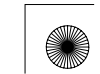



Cruise Control

Cruise control may not hold the set speed when you are going up and down hills. If your speed increases going down a hill, use the brakes to slow down. This will cancel the cruise control. To resume the set speed, press the RESUME/accel button. The indicator on the instrument panel will come back on.

Changing the Set Speed

You can increase the set cruising speed in any of these ways:

- Press and hold the RESUME/accel button. When you reach the desired cruising speed, release the button.
- Push on the accelerator pedal. Accelerate to the desired cruising speed, and press the SET/decel button.
- To increase the speed in very small amounts, tap the RESUME/accel button. Each time you do this, your vehicle speeds up about 1 mph (1.6 km/h).

You can decrease the set cruising speed in any of these ways:

- Press and hold the SET/decel button. Release the button when you reach the desired speed.
- To slow down in very small amounts, tap the SET/decel button. Each time you do this, your vehicle will slow down about 1 mph (1.6 km/h).
- Tap the brake or clutch pedal lightly with your foot. The CRUISE CONTROL indicator on the instrument panel goes out. When the vehicle slows to the desired speed, press the SET/decel button.

Features

CONTINUED



Cruise Control

Even with the cruise control turned on, you can still use the accelerator pedal to speed up for passing. After completing the pass, take your foot off the accelerator pedal. The vehicle will return to the set cruising speed.

Resting your foot on the brake or clutch pedal causes the cruise control to cancel.

Canceling Cruise Control

You can cancel cruise control in any of these ways:

- Tap the brake or clutch pedal.
- Push the CANCEL button on the steering wheel.
- Push the CRUISE button.

Resuming the Set Speed

When you push the CANCEL button, or tap the brake or clutch pedal, the system will remember the previously set cruising speed. To return to that speed, accelerate to above 25 mph (40 km/h), then press and release the RESUME/accel button. The CRUISE CONTROL indicator comes on. The vehicle will accelerate to the same cruising speed as before.

Pressing the CRUISE button turns the system off and erases the previous cruising speed.





Before Driving

Before you begin driving your vehicle, you should know what gasoline to use and how to check the levels of important fluids. You also need to know how to properly store luggage or packages. The information in this section will help you. If you plan to add any accessories to your vehicle, please read the information in this section first.

Break-in Period	110
Fuel Recommendation	110
Service Station Procedures	111
Refueling.....	111
Opening and Closing the	
Hood.....	112
Oil Check.....	113
Engine Coolant Check	114
Fuel Economy	114
Accessories and Modifications	115
Carrying Cargo	117

Before Driving





Break-in Period, Fuel Recommendation

Break-in Period

Help assure your vehicle's future reliability and performance by paying extra attention to how you drive during the first 600 miles (1,000 km). During this period:

- Avoid full-throttle starts and rapid acceleration. Do not exceed 5,500 rpm for the first 600 miles (1,000 km) of operation.
- Do not change the oil until the scheduled maintenance time.
- Avoid hard braking for the first 200 miles (300 km).

You should also follow these recommendations with an overhauled or exchanged engine, or when the brakes are replaced.

Fuel Recommendation

Your vehicle is designed to operate on premium unleaded gasoline with a pump octane number of 91 or higher. Use of a lower octane gasoline can cause occasional metallic knocking noises in the engine and will result in decreased engine performance. Use of a gasoline with a pump octane number less than 87 can lead to engine damage.

We recommend quality gasoline containing detergent additives that help prevent fuel system and engine deposits.

In addition, in order to maintain good performance, fuel economy, and emissions control, we strongly recommend, in areas where it is available, the use of gasoline that does NOT contain manganese-based fuel additives such as MMT.

Use of gasoline with these additives may adversely affect performance,

and cause the malfunction indicator lamp on your instrument panel to come on. If this happens, contact your authorized dealer for service.

Some gasoline today is blended with oxygenates such as ethanol or MTBE. Your vehicle is designed to operate on oxygenated gasoline containing up to 10% ethanol by volume and up to 15% MTBE by volume. Do not use gasoline containing methanol.

If you notice any undesirable operating symptoms, try another service station or switch to another brand of gasoline.

For further important fuel-related information, please refer to your **Quick Start Guide**.





Service Station Procedures

Refueling

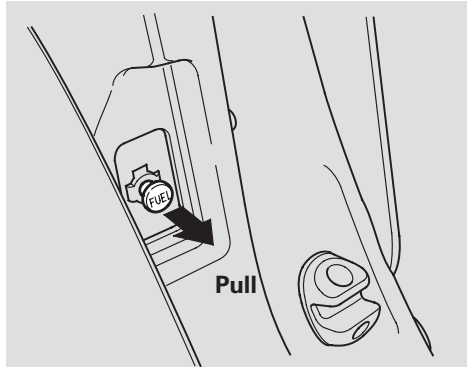

1. Park with the driver's side closest to the service station pump.
2. Open the fuel fill door by pulling on the knob on the driver's door jamb.

⚠ WARNING

Gasoline is highly flammable and explosive. You can be burned or seriously injured when handling fuel.

- Stop the engine, and keep heat, sparks, and flame away.
- Handle fuel only outdoors.
- Wipe up spills immediately.

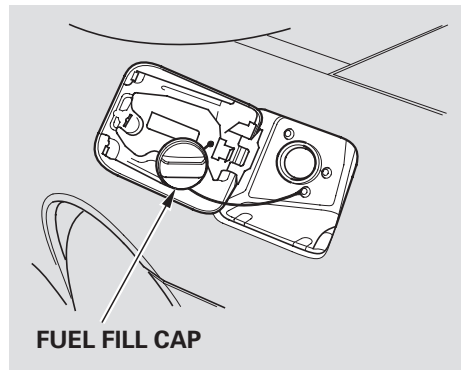

3. Remove the fuel fill cap slowly. You may hear a hissing sound as pressure inside the tank escapes. Place the cap in the holder on the fuel fill door.
4. Stop filling the tank after the fuel nozzle automatically clicks off. Do not try to "top off" the tank. Leave some room for the fuel to expand with temperature changes.

If the fuel nozzle keeps clicking off even though the tank is not full, there may be a problem with your vehicle's fuel vapor recovery system. The system helps keep fuel vapor from going into the atmosphere. Try filling at another pump. If this does not fix the problem, consult your dealer.

Before Driving

CONTINUED



Service Station Procedures

5. Screw the fuel fill cap back on until it clicks at least once. If you do not properly tighten the cap, the malfunction indicator lamp may come on (see page 187). You will also see a “CHECK FUEL CAP” message on the information display.
6. Push the fuel fill door closed until it latches.

Opening and Closing the Hood



1. Park the vehicle, and set the parking brake. Pull the hood release handle located under the lower left corner of the dashboard. The hood will pop up slightly.

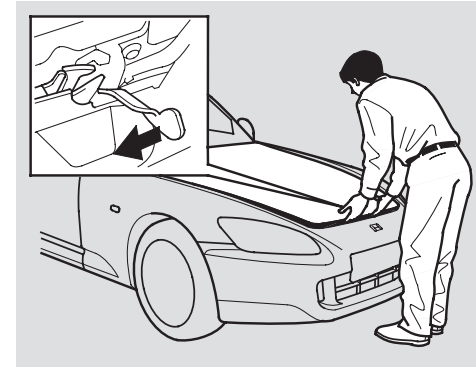

2. Put your fingers under the front edge of the hood near the center. Slide your hand to the left until you feel the hood latch handle. Push this handle to the left to release the hood. Lift up the hood.

If the hood latch handle moves stiffly, or if you can open the hood without lifting the handle, the mechanism should be cleaned and lubricated.





Service Station Procedures

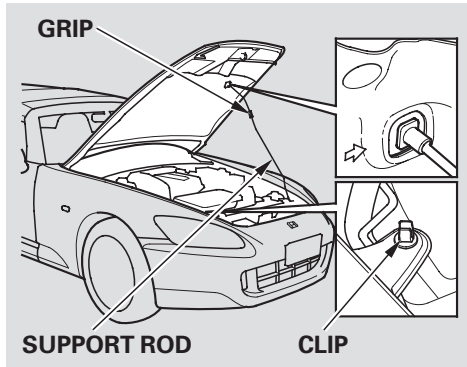

3. Holding the grip, pull the support rod out of its clip. Insert the end into the designated hole in the hood.

To close the hood, lift it up slightly to remove the support rod from the hole. Put the support rod back into its holding clip. Lower the hood to about a foot (30 cm) above the fender, then let it drop. Make sure it is securely latched.

Oil Check

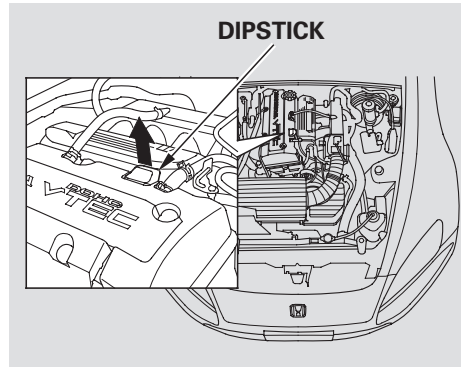

Wait a few minutes after turning the engine off before you check the oil.

1. Remove the dipstick (black handle).
2. Wipe off the dipstick with a clean cloth or paper towel.
3. Insert the dipstick all the way back into its hole.

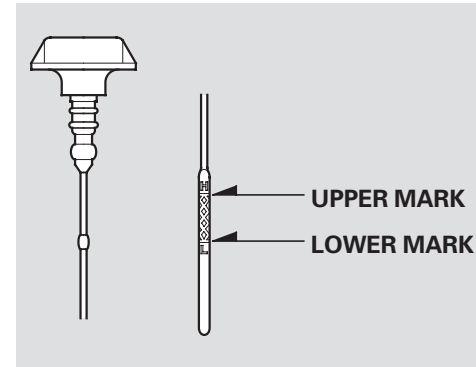

4. Remove the dipstick again, and check the level. It should be between the upper and lower marks.

If it is near or below the lower mark, see **Adding Engine Oil** on page 146 .

Before Driving





Service Station Procedures, Fuel Economy

Engine Coolant Check

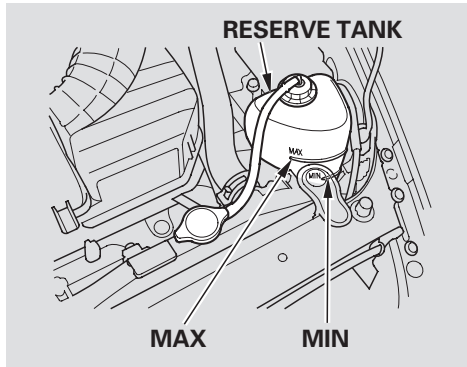

Look at the coolant level in the radiator reserve tank. Make sure it is between the MAX and MIN lines. If it is below the MIN line, see **Adding Engine Coolant** on page 149 for information on adding the proper coolant.

Refer to **Owner's Maintenance Checks** on page 141 for information about checking other items on your vehicle.

Fuel Economy

Improving Fuel Economy

- Always maintain your vehicle according to the maintenance messages displayed on the information display. See **Owner's Maintenance Checks** on page 141.

For example, an underinflated tire causes more "rolling resistance," which uses more fuel.

The build-up of snow or mud on your vehicle's underside adds weight and rolling resistance. Frequent cleaning helps your fuel mileage and reduces the chance of corrosion.

- Drive moderately. Rapid acceleration, abrupt cornering, and hard braking use more fuel.
- Always drive in the highest gear possible.

- Try to maintain a constant speed. Every time you slow down and speed up, your vehicle uses extra fuel. Use cruise control when appropriate.
- Combine several short trips into one.
- The air conditioning puts an extra load on the engine which makes it use more fuel. Use the fresh-air ventilation when possible.





Accessories and Modifications

Modifying your vehicle, or installing some non-Honda accessories, can make it unsafe. Before you make any modifications or add any accessories, be sure to read the following information.

Accessories

Your dealer has Honda accessories that allow you to personalize your vehicle. These accessories have been designed and approved for your vehicle, and are covered by warranty.

Although non-Honda accessories may fit on your vehicle, they may not meet factory specifications, and could adversely affect your vehicle's handling and stability.

WARNING

Improper accessories or modifications can affect your vehicle's handling, stability, and performance, and cause a crash in which you can be hurt or killed.

Follow all instructions in this owner's manual regarding accessories and modifications.

When properly installed, cellular phones, alarms, two-way radios, and low-powered audio systems should not interfere with your vehicle's computer controlled systems, such as your airbags and anti-lock brakes.

Before installing any accessory:

- Make sure the accessory does not obscure any lights, or interfere with proper vehicle operation or performance.
- Be sure electronic accessories do not overload electrical circuits (see page 190) or interfere with the proper operation of your vehicle.
- Before installing any electronic accessory, have the installer contact your dealer. If possible, have your dealer inspect the final installation.

Before Driving





Accessories and Modifications

Modifying Your Vehicle

Removing parts from your vehicle, or replacing components with non-Honda components could seriously affect your vehicle's handling, stability, and reliability.

Here are some examples:

- Lowering the vehicle with a non-Honda suspension kit that significantly reduces ground clearance can allow the undercarriage to hit speed bumps or other raised objects, which could cause the airbags to deploy.
- Raising your vehicle with a non-Honda suspension kit can affect the handling and stability.
- Non-Honda wheels can cause excessive stress on suspension components.

- Larger or smaller wheels and tires can interfere with the operation of your vehicle's anti-lock brakes and other systems.
- Modifying your steering wheel or any other part of your vehicle's safety systems could make the systems ineffective.

If you plan to modify your vehicle, consult your dealer.

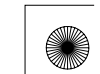



Carrying Cargo

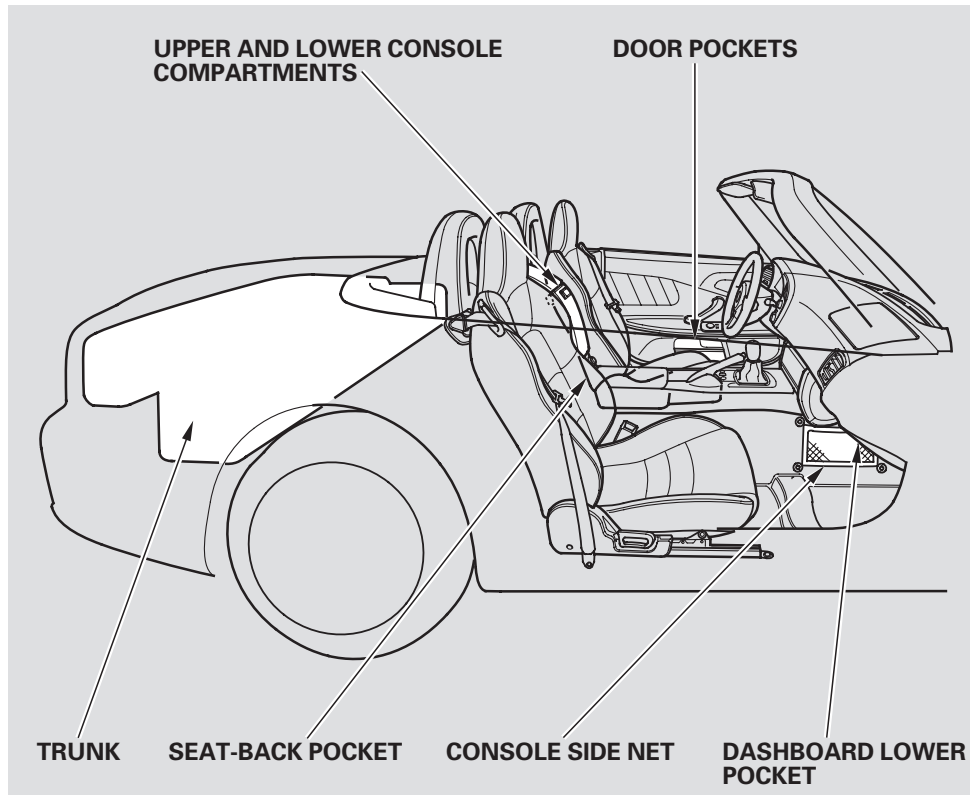

Your vehicle has several convenient storage areas:

- Upper and lower console compartments
- Dashboard lower pocket
- Door pockets
- Console side net
- Seat-back pocket
- Trunk

However, carrying too much cargo, or improperly storing it, can affect your vehicle's handling, stability, stopping distance, and tires, which may make it unsafe. Before carrying any type of cargo, be sure to read the following pages.

Before Driving



Carrying Cargo

Load Limits

The maximum load for your vehicle is 400 lbs (181 kg) for U.S. vehicles, and 185 kg for Canadian vehicles. This figure includes the total weight of all occupants, cargo, and accessories.

⚠ WARNING

Overloading or improper loading can affect handling and stability and cause a crash in which you can be hurt or killed.

Follow all load limits and other loading guidelines in this manual.

Steps for Determining Correct Load Limit:

1. Locate the statement, “the combined weight of occupants and cargo should never exceed 400 lbs” on your vehicle’s placard. [The placard is on the driver’s doorjamb.]
2. Determine the combined weight of the driver and passenger that will be riding in your vehicle.
3. Subtract the combined weight of the driver and passenger from 400 lbs.
4. The resulting figure equals the available amount of cargo and luggage load capacity. For example, if the maximum load is 400 lbs and there will be two 150 lb. passengers in your vehicle, the amount of available cargo and luggage load capacity is 100 lbs. [400 – 300 (2 × 150) = 100 lbs.]
5. Determine the combined weight of luggage and cargo being loaded on the vehicle. That weight may not safely exceed the available cargo and luggage load capacity calculated in step 4.

In addition, the total weight of the vehicle, all occupants, accessories and cargo must not exceed the gross vehicle weight rating (GVWR) or the gross axle weight rating (GAWR). Both are on a label on the driver’s doorjamb.





Carrying Cargo

Carrying Items in the Passenger Compartment

- Store or secure all items that could be thrown around and hurt someone during a crash.
- Be sure items placed on the floor behind the front seats cannot roll under the seats and interfere with the driver's ability to operate the pedals, the proper operation of the seats, or proper operation of the sensors under the seats.

Carrying Cargo in the Trunk

- Distribute cargo evenly on the floor of the trunk, placing the heaviest items on the bottom and as far forward as possible.

Before Driving





06/07/13 17:28:26 31S2A670 0125



120

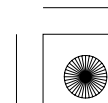
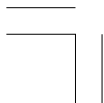



Driving

This section gives you tips on starting the engine under various conditions, and how to operate the manual transmission. It also includes important information on parking your vehicle and the braking system.

Driving Guidelines.....	122
Preparing to Drive	123
Starting the Engine.....	124
Manual Transmission.....	125
Parking.....	127
Braking System.....	127
Anti-lock Brakes (ABS)	128
Vehicle Stability Assist (VSA) System.....	130
Towing a Trailer	131

Driving

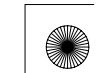



Driving Guidelines

Your vehicle is designed to give you optimum handling and performance on well-maintained roads. As part of this design, your vehicle has a minimum of ground clearance and very low-profile tires.

- Use caution if you ever drive your vehicle on very rough or rutted roads. You could damage the suspension and underbody by bottoming out. Going too fast over parking lot “speed bumps” can also cause damage.

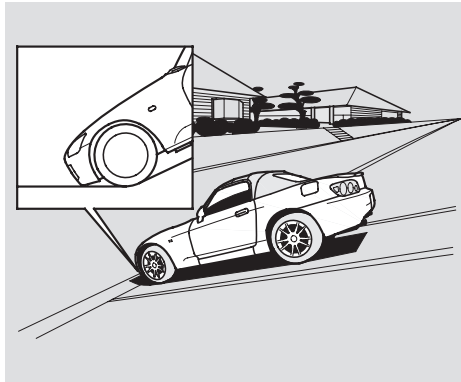

- Curbs and steep inclines could damage the front and rear bumpers. Low curbs that do not affect the average vehicle may be high enough to hit the bumper on your vehicle. The front or rear bumper may scrape when trying to drive onto an incline, such as a steep driveway or trailer ramps.

- Because of the low-profile tires fitted to your vehicle, the alloy wheels are closer to the ground. Driving over a pothole or road debris at too high a speed can seriously damage a wheel. Slow down under these conditions.

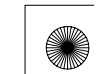



Preparing to Drive

You should do the following checks and adjustments before you drive your vehicle.

1. Make sure all windows, mirrors, and outside lights are clean and unobstructed. Remove frost, snow, or ice.
2. Check that the hood is fully closed.
3. Check that the trunk is fully closed.
4. Visually check the tires. If a tire looks low, use a gauge to check its pressure.
5. Check that any items you may be carrying are stored properly or fastened down securely.
6. Check the seat adjustment (see page 67).
7. Check the adjustment of the inside and outside mirrors (see page 75).
8. Make sure the doors are securely closed and locked.
9. Fasten your seat belt. Check that your passenger has fastened his or her seat belt (see page 12).
10. When you start the engine, check the gauges and indicators in the instrument panel (see page 45).

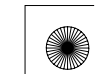



Starting the Engine

1. Apply the parking brake.
2. In cold weather, turn off all electrical accessories to reduce the drain on the battery.
3. Push the clutch pedal down all the way. The ENGINE START button has no effect unless the clutch pedal is pressed.
4. Turn the ignition key to the ON (II) position.
5. Without touching the accelerator pedal, push the ENGINE START button. Do not hold the ENGINE START button for more than 15 seconds at a time. If the engine does not start right away, pause for at least 10 seconds before trying again.

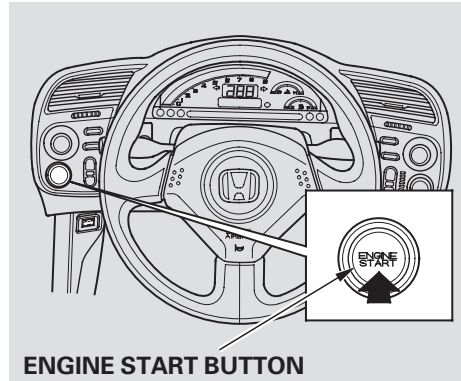

NOTICE

The immobilizer system protects your vehicle from theft. If an improperly-coded key (or other device) is used, the engine's fuel system is disabled. For more information, see page 61 .

6. If the engine does not start within 15 seconds, or starts but stalls right away, repeat step 5 with the accelerator pedal pressed halfway down. If the engine starts, release pressure on the accelerator pedal so the engine does not race.
7. If the engine fails to start, press the accelerator pedal all the way down and hold it there while starting to clear flooding. If the engine still does not start, return to step 6.

NOTICE

The engine is harder to start in cold weather. Also, the thinner air found at altitudes above 8,000 feet (2,400 meters) adds to this problem.





Manual Transmission

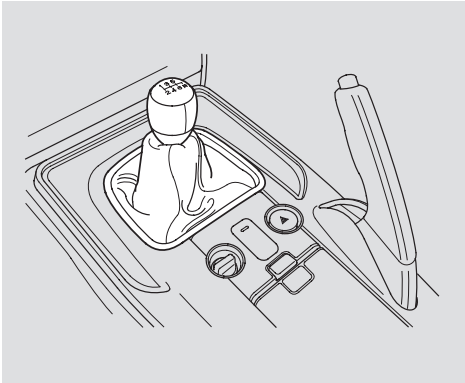

The manual transmission is synchronized in all forward gears for smooth operation. It has a lockout so you cannot shift directly from fifth to reverse instead of sixth (see page 126). When shifting up or down, make sure you push the clutch pedal down all the way, shift to the next gear, and let the pedal up gradually. When you are not shifting, do not rest your foot on the clutch pedal. This can cause your clutch to wear out faster.

Come to a full stop before you shift into reverse. You can damage the transmission by trying to shift into reverse with the vehicle moving. Push down the clutch pedal, and pause for a few seconds before shifting into reverse, or shift into one of the forward gears for a moment. This stops the gears so they won't "grind."

When slowing down, you can get extra braking from the engine by shifting to a lower gear. This extra braking can help you maintain a safe speed and prevent your brakes from overheating while going down a steep hill. Before downshifting, make sure the engine speed will not go into the tachometer's red zone in the lower gear.

⚠ WARNING

Rapid slowing or speeding up can cause loss of control on slippery surfaces. If you crash, you can be injured.

Use extra care when driving on slippery surfaces.

Your vehicle is equipped with an aluminum shift lever. If you leave the vehicle parked outside for a long time on a hot day, be careful before moving the shift lever. Because of the heat, the shift lever may be extremely hot. If the outside temperature is low, the shift lever feels cold.

Driving



Manual Transmission

Recommended Shift Points

Drive in the highest gear that lets the engine run and accelerate smoothly. This will give you good fuel economy and effective emissions control. The following shift points are recommended:

Shift Up	Normal Acceleration
1st to 2nd	15 mph (24 km/h)
2nd to 3rd	25 mph (40 km/h)
3rd to 4th	40 mph (64 km/h)
4th to 5th	47 mph (75 km/h)
5th to 6th	52 mph (83 km/h)

Engine Speed Limiter

If you exceed the maximum speed for the gear you are in, the engine speed will enter into the tachometer's red zone. If this occurs, you may feel the engine cut in and out. This is caused by a limiter in the engine's computer controls. The engine will run normally when you reduce the rpm below the red zone.

Before downshifting, make sure the engine will not go into the tachometer's red zone.

Reverse Lockout



The manual transmission has a lockout so you cannot accidentally shift from fifth to reverse instead of sixth while the vehicle is moving.

With the clutch pedal pressed, move the shift lever to the reverse side of the neutral gate. Then push the shift lever down, and shift to reverse.





Parking, Braking System

Parking

Always use the parking brake when you park your vehicle. Make sure the parking brake is set firmly, or your vehicle may roll if it is parked on an incline.

Parking Tips

- Make sure the convertible top and the windows are closed.
- Turn off the lights.
- Place any packages, valuables, etc., in the trunk or take them with you.
- Lock the doors.
- Never park over dry leaves, tall grass, or other flammable materials. The hot three way catalytic converter could cause these materials to catch on fire.

- If the vehicle is facing uphill, turn the front wheels away from the curb, and put the transmission in first gear.
- If the vehicle is facing downhill, turn the front wheels toward the curb, and put the transmission in reverse gear.
- Make sure the parking brake is fully released before driving away. Driving with the parking brake partially set can overheat or damage the rear brakes.

Braking System

Your vehicle is equipped with disc brakes at all four wheels. A power assist helps reduce the effort needed on the brake pedal. The anti-lock brake system (ABS) helps you retain steering control when braking very hard.

Resting your foot on the pedal keeps the brakes applied lightly, builds up heat, and reduces their effectiveness. It also keeps your brake lights on all the time, confusing drivers behind you.

Constant application of the brakes when going down a long hill builds up heat and reduces their effectiveness. Use the engine to assist the brakes by taking your foot off the accelerator and downshifting to a lower gear.

CONTINUED



Braking System, Anti-lock Brakes (ABS)

Check the brakes after driving through deep water. Apply the brakes moderately to see if they feel normal. If not, apply them gently and frequently until they do. Be extra cautious in your driving.

Braking System Design

The hydraulic system that operates the brakes has two separate circuits. Each circuit works diagonally across the vehicle (the left-front brake is connected with the right-rear brake, etc.). If one circuit should develop a problem, you will still have braking at two wheels.

Brake Pad Wear Indicators

If the brake pads need replacing, you will hear a distinctive, metallic screeching sound when you apply the brake pedal. If you do not have the brake pads replaced, they will screech all the time. It is normal for the brakes to occasionally squeal or squeak when you apply them.

Anti-lock Brakes (ABS)

The anti-lock brake system (ABS) helps prevent the brakes from locking up, and helps you retain steering control by pumping the brakes rapidly, much faster than a person can do it.

The ABS also balances the front-to-rear braking distribution according to vehicle loading.

You should never pump the brake pedal. Let the ABS work for you by always keeping firm, steady pressure on the brake pedal. This is sometimes referred to as “stomp and steer.”

You will feel a pulsation in the brake pedal when the ABS activates, and may hear some noise. This is normal: it is the ABS rapidly pumping the brakes. On dry pavement, you will need to press on the brake pedal very hard before the ABS activates. However, you may feel the ABS activate immediately if you are trying to stop on snow or ice.





Anti-lock Brakes (ABS)

ABS Indicator

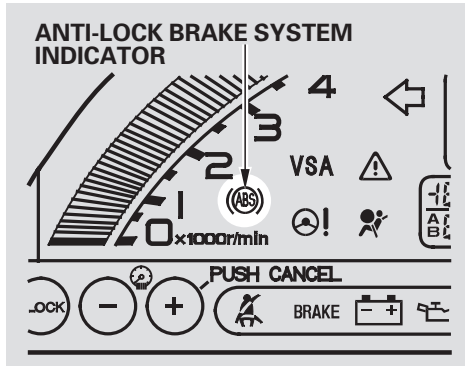

If this indicator comes on, the anti-lock function of the braking system has shut down. The brakes still work like a conventional system, but without anti-lock. You should have your dealer inspect your vehicle as soon as possible.

Important Safety Reminders
ABS does not reduce the time or distance it takes to stop the vehicle; it only helps with steering control during braking.

ABS will not prevent a skid that results from changing direction abruptly, such as trying to take a corner too fast or making a sudden lane change.

ABS cannot prevent a loss of stability. Always steer moderately when you are braking hard. Severe or sharp steering wheel movement can still cause your vehicle to veer into oncoming traffic or off the road.

A vehicle with ABS may require a longer distance to stop on loose or uneven surfaces, such as gravel or snow, than a vehicle without anti-lock.





Vehicle Stability Assist (VSA) System

The vehicle stability assist (VSA) system helps to stabilize the vehicle during cornering if the vehicle turns more or less than desired. It also assists you in maintaining traction while accelerating on loose or slippery road surfaces. It does this by regulating the engine's output and by selectively applying the brakes.

When VSA activates, you may notice that the engine does not respond to the accelerator in the same way it does at other times.

The VSA system cannot enhance the vehicle's driving stability in all situations and does not control your vehicle's entire braking system. It is still your responsibility to drive and corner at reasonable speeds and to leave a sufficient margin of safety.



VSA Activation Indicator

When VSA activates, you will see the VSA activation indicator blink (see page 50).



VSA System Indicator

If this indicator comes on while driving, pull to the side of the road when it is safe, and turn off the engine. Reset the system by restarting the engine. If the VSA system indicator stays on, or comes back on while driving, have the VSA system inspected by your dealer.

If the indicator does not come on when the ignition switch is turned to the ON (II) position, there may be a problem with the VSA system. Have your dealer inspect your vehicle as soon as possible (see page 50).

Without VSA, your vehicle still has normal braking and cornering ability, but it does not have VSA traction and stability enhancement.





Vehicle Stability Assist (VSA) System, Towing a Trailer

VSA Off Switch

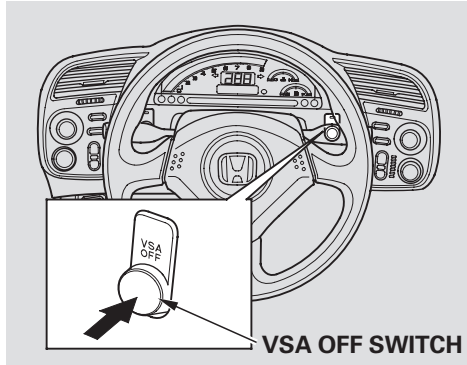

In certain unusual conditions when your vehicle gets stuck in shallow mud or fresh snow, it may be easier to free it with the VSA temporarily switched off. When the VSA system is off, the traction control system is also off. You should only attempt to free your vehicle with the VSA off if you are not able to free it when the VSA is on.

Immediately after freeing your vehicle, be sure to switch the VSA on again. We do not recommend driving your vehicle with the VSA and traction control systems switched off.

This switch is at the left side of the right vent. Press it to turn VSA on and off.

When VSA is off, the VSA activation indicator comes on as a reminder.

VSA is turned on every time you start the engine, even if you turned it off the last time you drove the vehicle.

VSA and Tire Sizes

Driving with varying tire or wheel sizes may cause the VSA to malfunction. When replacing tires, make sure they are of the same size and type as your original tires (see page 165).

Deactivate the VSA system if you need to drive with the compact spare tire installed (see page 174).

If you install winter tires, make sure they are the same size as those that were originally supplied with your vehicle. Exercise the same caution during winter driving as you would if your vehicle was not equipped with VSA.

Towing a Trailer

Your vehicle is not designed to tow a trailer; Attempting to do so can void your warranties.



06/07/13 17:29:55 31S2A670 0137

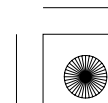
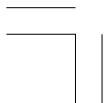



Maintenance

This section explains why it is important to keep your vehicle well maintained and how to follow basic maintenance safety precautions.

This section also includes instructions on how to read the maintenance minder messages on the information display, a maintenance record, and instructions for simple maintenance tasks you may want to take care of yourself.

If you have the skills and tools to perform more complex maintenance tasks on your vehicle, you may want to purchase the service manual. See page 215 for information on how to obtain a copy, or see your dealer.

Maintenance Safety	134
Maintenance Minder	135
Maintenance Record	143
Fluid Locations.....	145
Adding Engine Oil	146
Changing the Oil and Filter.....	147
Engine Coolant.....	149
Windshield Washers	151
Manual Transmission Fluid	152
Differential Fluid	153
Brake and Clutch Fluid.....	154
Lights	155
Cleaning the Seat Belts.....	160
Floor Mats	161
Dust and Pollen Filter	161
Audio Antenna	161
Wiper Blades	162
Wheels	163
Tires	163
Checking the Battery	169
Vehicle Storage	171

Maintenance

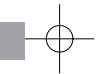



Maintenance Safety

All service items not detailed in this section should be performed by a certified technician or other qualified mechanic.

Important Safety Precautions

To eliminate potential hazards, read the instructions before you begin, and make sure you have the tools and skills required.

- Make sure your vehicle is parked on level ground, the parking brake is set, and the engine is off.
- To clean parts, use a commercially available degreaser or parts cleaner, not gasoline.
- To reduce the possibility of fire or explosion, keep cigarettes, sparks, and flames away from the battery and all fuel-related parts.
- Wear eye protection and protective clothing when working with the battery or compressed air.

WARNING

Improperly maintaining this vehicle, or failing to correct a problem before driving can cause a crash in which you can be seriously hurt or killed.

Always follow the inspection and maintenance recommendations and schedules in this owner's manual.

Potential Vehicle Hazards

- **Carbon Monoxide poison from engine exhaust.** Be sure there is adequate ventilation whenever you operate the engine.
- **Burns from hot parts.** Let the engine and exhaust system cool down before touching any parts.

- **Injury from moving parts.** Do not run the engine unless instructed to do so.

WARNING

Failure to properly follow maintenance instructions and precautions can cause you to be seriously hurt or killed.

Always follow the procedures and precautions in this owner's manual.

Some of the most important safety precautions are given here. However, we cannot warn you of every conceivable hazard that can arise in performing maintenance. Only you can decide whether or not you should perform a given task.





Maintenance Minder

Your vehicle displays engine oil life and maintenance service items on the information display to show you when you should have your dealer do engine oil replacement and indicated maintenance service.

Based on the engine operating conditions and accumulated engine revolutions, the onboard computer in your vehicle calculates the remaining engine oil life and displays it as a percentage.

Engine Oil Life Display

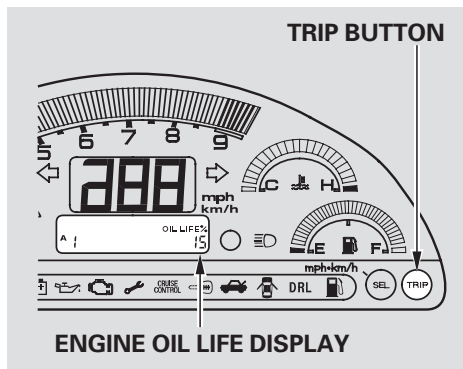

To see the current engine oil life, turn the ignition switch to the ON (II) position, and push and release the TRIP button repeatedly until the engine oil life display appears (see page 51).

The remaining engine oil life is shown on the display according to this table:

Calculated Engine Oil Life (%)	Displayed Engine Oil Life (%)
100 % – 91 %	100 %
90 % – 81 %	90 %
80 % – 71 %	80 %
70 % – 61 %	70 %
60 % – 51 %	60 %
50 % – 41 %	50 %
40 % – 31 %	40 %
30 % – 21 %	30 %
20 % – 16 %	20 %
15 % – 11 %	15 %
10 % – 6 %	10 %
5 % – 1 %	5 %
0 %	0 %

Maintenance



CONTINUED





Maintenance Minder

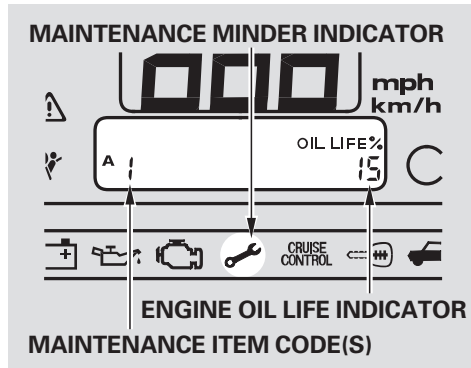

If the remaining engine oil life is 15 to 6 percent, you will see the engine oil life indicator every time you turn the ignition switch to the ON (II) position. The maintenance minder indicator will also come on, and the maintenance item code(s) for other scheduled maintenance items needing service will be displayed next to the engine oil life indicator.

The maintenance item code or codes indicate the main and sub items required at the time of the oil change (see page 142).

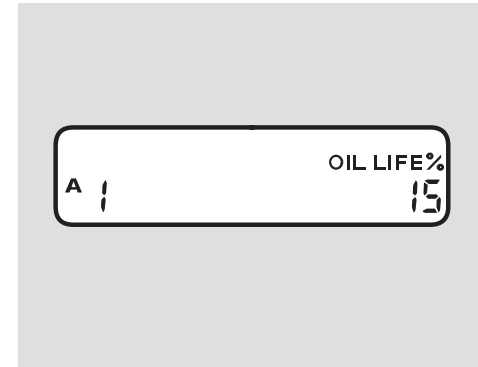

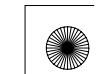

The 15 and 10 percent oil life indicator reminds you that the time is coming soon to take your vehicle in for the required maintenance.





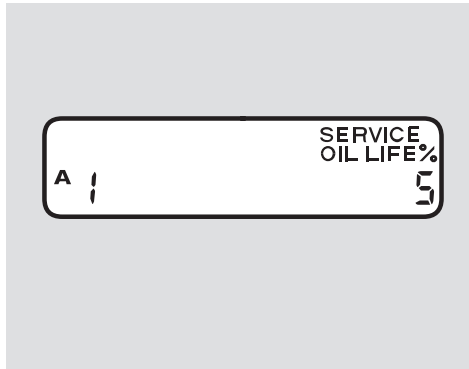

Maintenance Minder

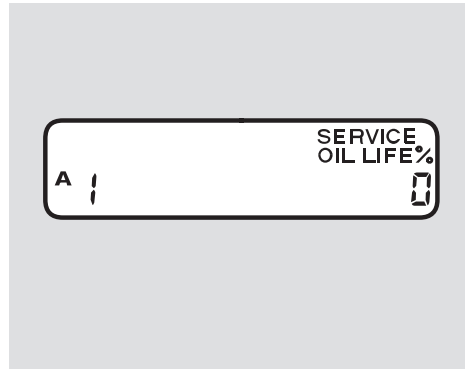

When the remaining engine oil life is 5 to 1 percent, you will see a “SERVICE OIL LIFE” message along with the same maintenance item code(s), every time you turn the ignition switch to the ON (II) position. The maintenance minder indicator () also comes on and remains on in the instrument panel.



When the remaining engine oil life is 0 percent, the engine oil life indicator will blink. The display comes on every time you turn the ignition switch to the ON (II) position. The maintenance minder indicator () also comes on and remains on in the instrument panel. When you see this message, immediately have the indicated maintenance done by your dealer.

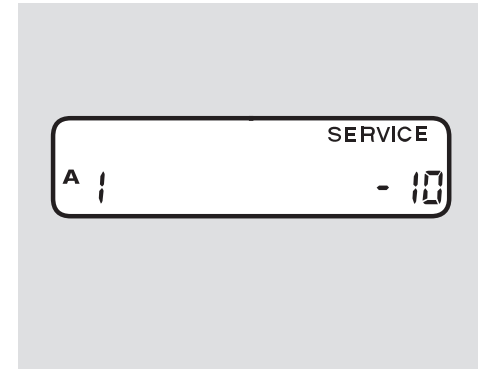

If you do not perform the indicated maintenance, negative mileage is displayed and begins to blink after the vehicle has been driven 10 miles (10 km) or more.

Negative mileage means your vehicle has passed the maintenance required point. Immediately have the indicated maintenance done by your dealer.

CONTINUED

Maintenance



Maintenance Minder

The maximum total mileage shown is “-9999.”

You can change the information display from the engine oil life display to the odometer, the trip meter, or the outside temperature every time you press and release the TRIP button.

When the engine oil life is 0 percent or negative mileage, the maintenance minder indicator () remains on even if you change the information display.

Immediately have the service done, and make sure to reset the display as described on the next page.

Maintenance Main Items and Sub Items

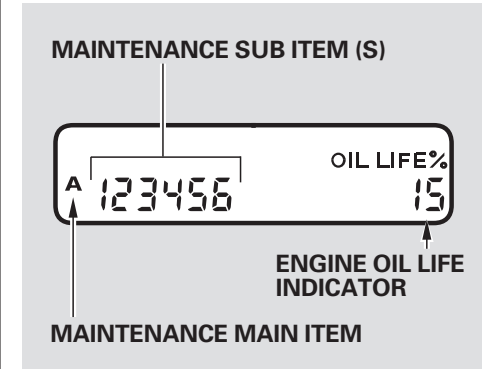

All maintenance items displayed in the information display are in code. For an explanation of these maintenance codes, see page 142 .





Maintenance Minder

Resetting the Engine Oil Life Indicator

Your dealer will reset the display after completing the required maintenance service. You will see “OIL LIFE 100%” on the information display the next time you turn the ignition switch to the ON (II) position.

If maintenance service is done by someone other than your dealer, reset the maintenance minder as follows:

1. Turn the ignition switch to the ON (II) position.
2. Press the TRIP button until the engine oil life indicator is displayed.

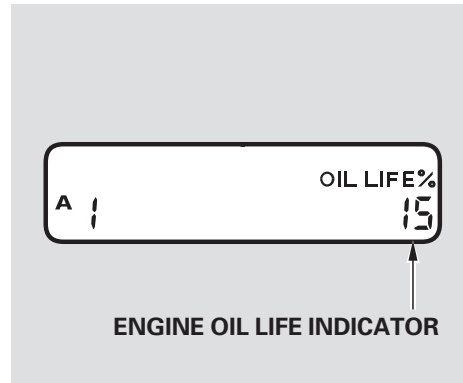

3. Press the TRIP button for about 10 seconds. The engine oil life indicator and the maintenance item code(s) will blink.

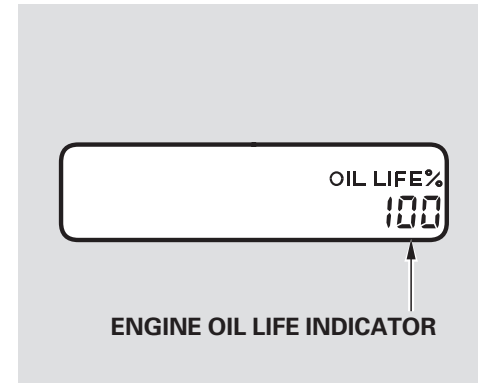

4. Press the TRIP button for about 5 seconds. The maintenance items code(s) will disappear, and the engine oil life will reset to “100.”

Maintenance





Maintenance Minder

Important Maintenance Precautions

If you have the required service done but do not reset the display, or reset the display without doing the service, the system will not show the proper maintenance intervals. This can lead to serious mechanical problems because you will no longer have an accurate record of when maintenance is needed.

Your authorized Honda dealer knows your vehicle best and can provide competent, efficient service.

However, service at a dealer is not mandatory to keep your warranties in effect. Maintenance may be done by any qualified service facility or person who is skilled in this type of automotive service. Make sure to have the service facility or person reset the display as previously described. Keep all receipts as proof of completion, and have the person who does the work fill out the maintenance record. Check your warranty booklet for more information.

We recommend using Honda parts and fluids whenever you have maintenance done. These are manufactured to the same high quality standards as the original components, so you can be confident of their performance and durability.

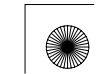



Maintenance Minder

U.S. Vehicles:
Maintenance, replacement, or repair of emissions control devices and systems may be done by any automotive repair establishment or individual using parts that are “certified” to EPA standards.

According to state and federal regulations, failure to perform maintenance on the items marked with # will not void your emissions warranties. However, all maintenance services should be performed in accordance with the intervals indicated by the information display.

Owner’s Maintenance Checks

You should check the following items at the specified intervals. If you are unsure of how to perform any check, turn to the appropriate page listed.

- Engine oil level – Check every time you fill the fuel tank. See page 113 .
- Engine coolant level – Check the radiator reserve tank every time you fill the fuel tank. See page 114 .
- Brakes and clutch – Check the fluid level monthly. See page 154 .
- Tires – Check the tire pressure monthly. Examine the tread for wear and foreign objects. See page 164 .

- Lights – Check the operation of the headlights, parking lights, taillights, high-mount brake light, and license plate lights monthly. See page 155 .



Maintenance

CONTINUED

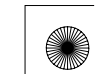



Maintenance Minder

Symbol	Maintenance Main Items
A	<ul style="list-style-type: none"> • Replace engine oil*¹
B	<ul style="list-style-type: none"> • Replace engine oil and oil filter • Inspect front and rear brakes • Check parking brake adjustment • Inspect these items: <ul style="list-style-type: none"> • Tie rod ends, steering gear box, and boots • Suspension components • Driveshaft boots • Brake hoses and lines (including ABS) • All fluid levels and condition of fluids • Exhaust system[#] • Fuel lines and connections[#]

* 1: If the message "SERVICE" does not appear more than 12 months after the display is reset, change the engine oil every year.

: See information on maintenance and emissions warranty on page 141.

NOTE: • Independent of the maintenance minder messages, replace the brake fluid every 3 years.
 • Inspect idle speed every 160,000 miles (256,000 km).
 • Adjust the valves during services A, B, 1, 2, or 3 if they are noisy.

Symbol	Maintenance Sub Items
1	<ul style="list-style-type: none"> • Check tire inflation and condition
2	<ul style="list-style-type: none"> • Replace air cleaner element If you drive in dusty conditions, replace every 15,000 miles (24,000 km). • Replace dust and pollen filter If you drive primarily in urban areas that have high concentrations of soot in the air from industry and from diesel-powered vehicles, replace every 15,000 miles (24,000 km). • Inspect drive belt
3	<ul style="list-style-type: none"> • Replace transmission fluid
4	<ul style="list-style-type: none"> • Replace spark plugs • Inspect valve clearance
5	<ul style="list-style-type: none"> • Replace engine coolant
6	<ul style="list-style-type: none"> • Replace rear differential fluid Driving in mountainous areas results in higher level of mechanical (shear) stress to fluid. This requires differential fluid changes more frequently than recommended by the maintenance minder. If you regularly drive your vehicle under these conditions, have the differential fluid changed every 15,000 miles (24,000 km).





Maintenance Record

You or the servicing dealer can record all completed maintenance here. When maintenance is performed, record the mileage, circle the coded item(s) completed, and write in any other non-coded items (such as brake fluid replacement) below the codes. Keep the receipts for all work done on your vehicle. Maintenance can also be recorded in your Honda service history booklet.

Mileage	Maintenance Performed	Signature
		Date
mi km	A B 1 2 3 4 5 6	
mi km	A B 1 2 3 4 5 6	
mi km	A B 1 2 3 4 5 6	
mi km	A B 1 2 3 4 5 6	
mi km	A B 1 2 3 4 5 6	
mi km	A B 1 2 3 4 5 6	
mi km	A B 1 2 3 4 5 6	

Mileage	Maintenance Performed	Signature
		Date
mi km	A B 1 2 3 4 5 6	
mi km	A B 1 2 3 4 5 6	
mi km	A B 1 2 3 4 5 6	
mi km	A B 1 2 3 4 5 6	
mi km	A B 1 2 3 4 5 6	
mi km	A B 1 2 3 4 5 6	
mi km	A B 1 2 3 4 5 6	

Maintenance

CONTINUED
143



Maintenance Record

Mileage	Maintenance Performed	Signature
		Date
mi km	A B 1 2 3 4 5 6	
mi km	A B 1 2 3 4 5 6	
mi km	A B 1 2 3 4 5 6	
mi km	A B 1 2 3 4 5 6	
mi km	A B 1 2 3 4 5 6	
mi km	A B 1 2 3 4 5 6	
mi km	A B 1 2 3 4 5 6	

Mileage	Maintenance Performed	Signature
		Date
mi km	A B 1 2 3 4 5 6	
mi km	A B 1 2 3 4 5 6	
mi km	A B 1 2 3 4 5 6	
mi km	A B 1 2 3 4 5 6	
mi km	A B 1 2 3 4 5 6	
mi km	A B 1 2 3 4 5 6	
mi km	A B 1 2 3 4 5 6	

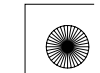



Fluid Locations

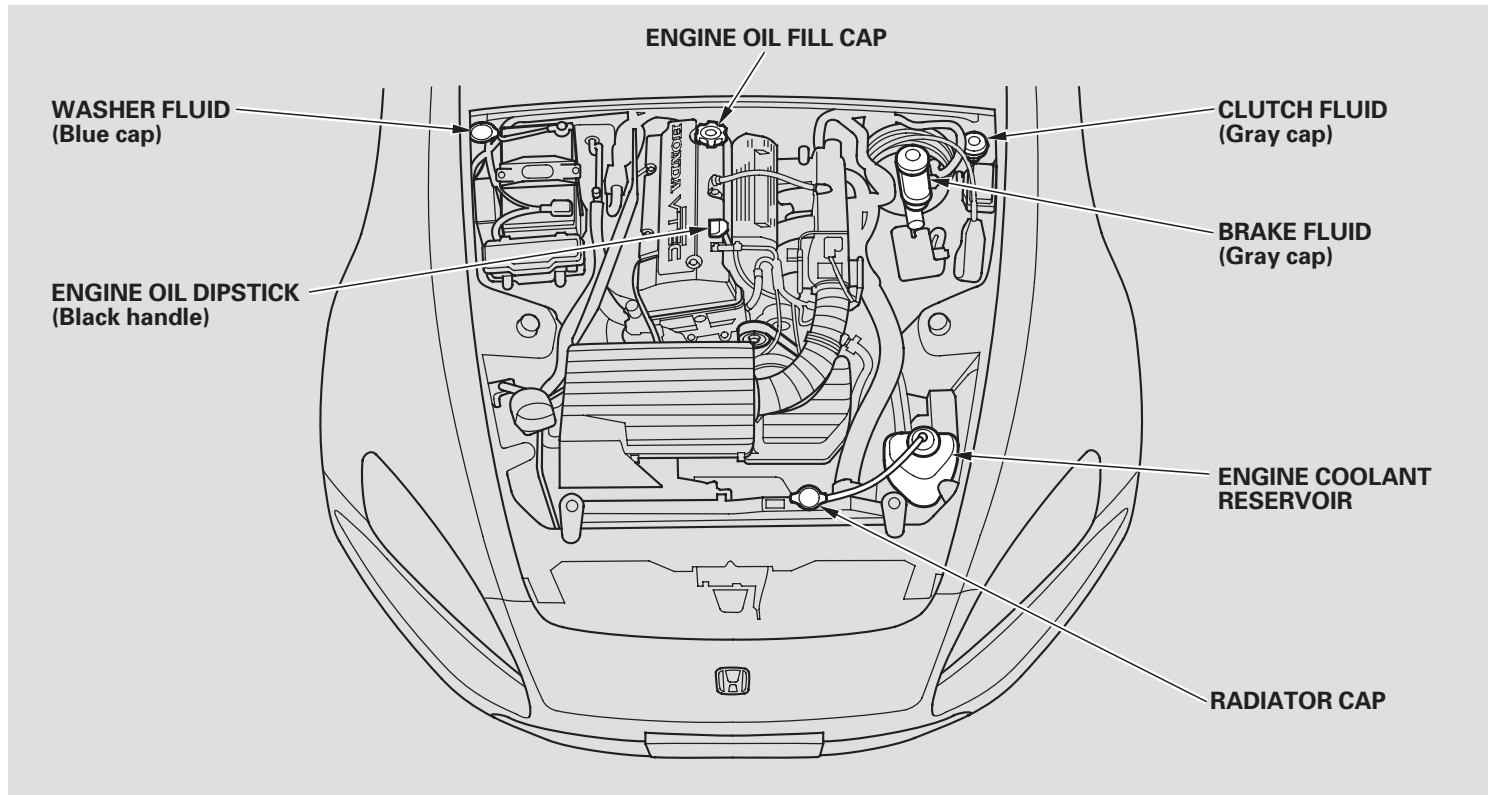

Maintenance

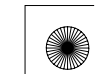



Adding Engine Oil

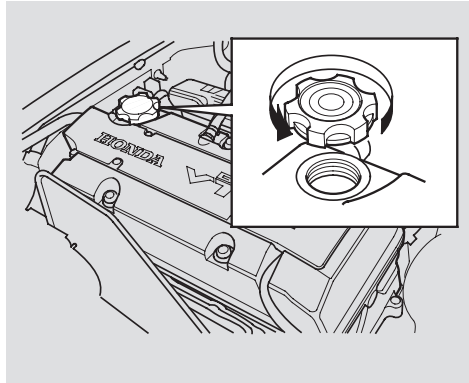

Unscrew and remove the engine oil fill cap on the valve cover. Pour in the oil slowly and carefully so you do not spill any. Clean up any spills immediately. Spilled oil could damage components in the engine compartment. Reinstall the engine oil fill cap, and tighten it securely. Wait a few minutes, and recheck the oil level on the engine oil dipstick. Do not fill above the upper mark; you could damage the engine.

Recommended Engine Oil

Oil is major contributor to your engine's performance and longevity. Always use a premium-grade detergent oil displaying the API certification seal. This seal indicates the oil is energy conserving, and that it meets the American Petroleum Institute's latest requirements. It is highly recommended that you use Honda motor oil in your vehicle for as long as you own it.

Make sure the API Certification Seal says "For Gasoline Engines."

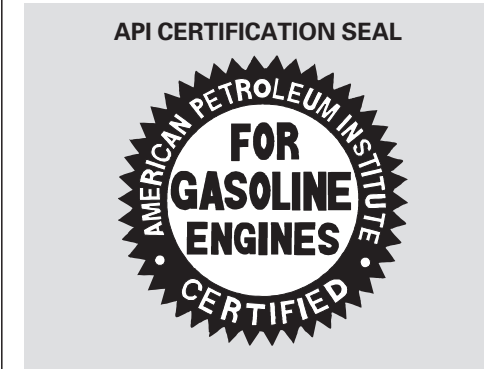



Adding Engine Oil, Changing the Oil and Filter

The oil's viscosity or weight is provided on the container's label. Select the oil for your vehicle according to this chart.

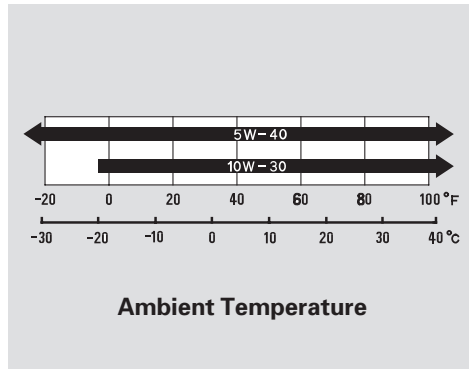

An oil with a viscosity of 10W-30 is preferred for optimum fuel economy and year-round protection in your vehicle. You may use 5W-40 oil if the temperature in your area goes below 0°F (-20°C).

Synthetic Oil

You may use a synthetic motor oil if it meets the same requirements given for a conventional motor oil: it displays the API Certification Seal, and it is the proper weight. You must follow the oil and filter change intervals shown on the information display.

Engine Oil Additives

Your vehicle does not require any oil additives. Additives may adversely affect the engine or transmission performance and durability.

Changing the Oil and Filter

Always change the oil and filter according to the maintenance messages shown on the information display. The oil and filter collect contaminants that can damage your engine if they are not removed regularly.

Changing the oil and filter requires special tools and access from underneath the vehicle. The vehicle should be raised on a service station-type hydraulic lift for this service. Unless you have the knowledge and proper equipment, you should have this maintenance done by a skilled mechanic.

1. Run the engine until it reaches normal operating temperature, then shut it off.

Maintenance

CONTINUED



Changing the Oil and Filter

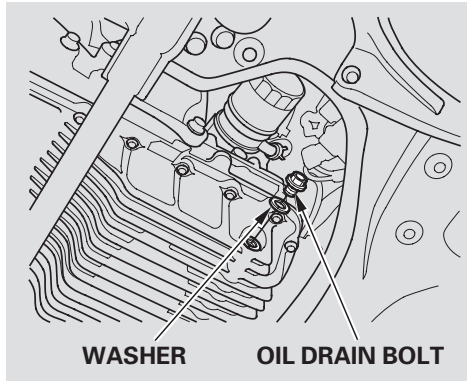

2. Open the hood, and remove the engine oil fill cap. Remove the oil drain bolt and washer from the bottom of the engine. Drain the oil into an appropriate container.

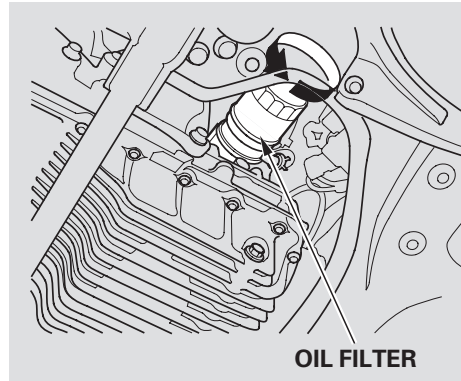

3. Remove the oil filter, and let the remaining oil drain. A special wrench (available from your dealer) is required.

Make sure the oil filter gasket is not stuck to the engine block. If it is, remove it before installing a new oil filter.

4. Install a new oil filter according to the instructions that come with it.
5. Put a new washer on the drain bolt, then reinstall the drain bolt. Tighten the drain bolt to:
29 lbf·ft (39 N·m , 4.0 kgf·m)
6. Refill the engine with the recommended oil.

Engine oil change capacity
(including filter):
5.1 US qt (4.8 l)

7. Install the engine oil fill cap. Start the engine. The oil pressure indicator should go out within 5 seconds. If it does not, turn off the engine, and check your work.





Changing the Oil and Filter, Engine Coolant

8. Let the engine run for several minutes, then check the drain bolt and oil filter for leaks.
9. Turn off the engine and let it sit for several minutes, then check the oil level on the dipstick. If necessary, add more oil.

NOTICE

Improper disposal of engine oil can be harmful to the environment. If you change your own oil, please dispose of the used oil properly. Put it in a sealed container and take it to a recycling center. Do not discard it in a trash bin or dump it on the ground.

Adding Engine Coolant

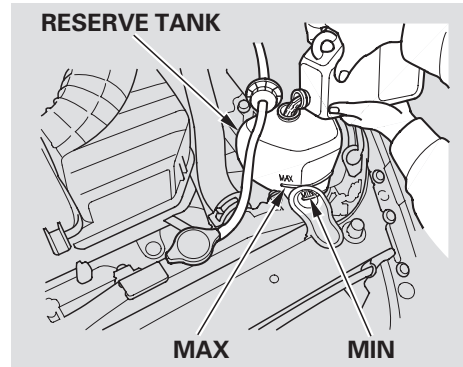

If the coolant level in the reserve tank is at or below the MIN line, add coolant to bring it up to the MAX line. Inspect the cooling system for leaks.

Always use Honda Long-Life Antifreeze/Coolant Type 2. This coolant is pre-mixed with 50 % antifreeze and 50 % water. Never add straight antifreeze or plain water.

If Honda antifreeze/coolant is not available, you may use another major-brand non-silicate coolant as a temporary replacement. Make sure it is a high-quality coolant recommended for aluminum engines. Continued use of any non-Honda coolant can result in corrosion, causing the cooling system to malfunction or fail. Have the cooling system flushed and refilled with Honda antifreeze/coolant as soon as possible.

CONTINUED

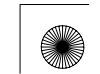
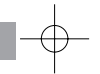



Engine Coolant

If the reserve tank is completely empty, you should also check the coolant level in the radiator.

⚠ WARNING

Removing the radiator cap while the engine is hot can cause the coolant to spray out, seriously scalding you.

Always let the engine and radiator cool down before removing the radiator cap.

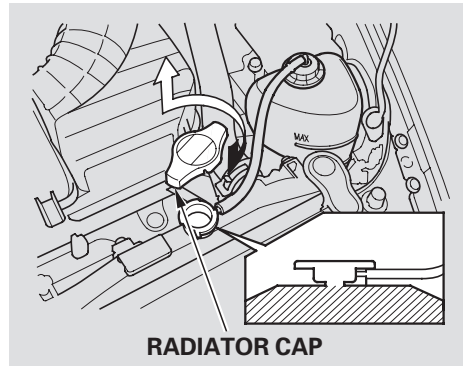

1. When the radiator and engine are cool, relieve any pressure in the cooling system by turning the radiator cap counterclockwise, without pressing down.
2. Remove the radiator cap by pushing down and turning counterclockwise.

3. The coolant level should be up to the base of the filler neck. Add coolant if it is low.

Pour the coolant slowly and carefully so you do not spill any. Clean up any spill immediately; it could damage components in the engine compartment.

4. Put the radiator cap on, and tighten it fully.
5. Pour coolant into the reserve tank. Fill it to halfway between the MAX and MIN marks. Put the cap back on the reserve tank.

Do not add any rust inhibitors or other additives to your vehicle's cooling system. They may not be compatible with the coolant or engine components.

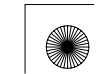



Windshield Washers

Check the fluid level in the windshield washer reservoir at least monthly during normal use.

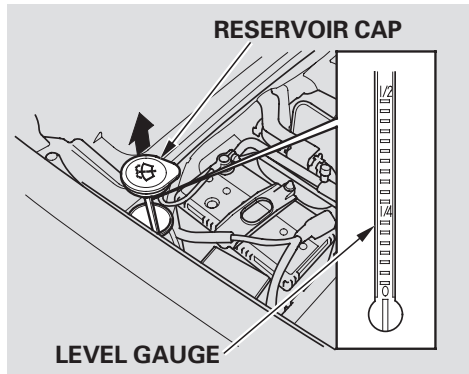

Check the fluid level by looking at the level gauge attached to the cap.

Fill the reservoir with a good-quality windshield washer fluid. This increases the cleaning capability and prevents freezing in cold weather.

When you refill the reservoir, clean the edges of the windshield wiper blades with windshield washer fluid on a clean cloth. This will help to condition them.

NOTICE

Do not use engine antifreeze or a vinegar/water solution in the windshield washer reservoir. Antifreeze can damage your vehicle's paint, while a vinegar/water solution can damage the windshield washer pump. Use only commercially-available windshield washer fluid.



Manual Transmission Fluid

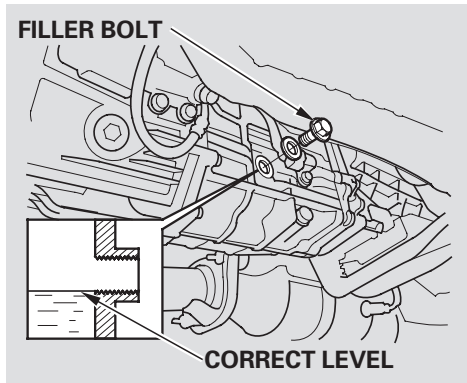

Check the fluid level with the transmission at normal operating temperature and the vehicle sitting on level ground. Remove the transmission filler bolt, and carefully feel inside the bolt hole with your finger. The fluid level should be up to the edge of the bolt hole. If it is not, add Honda Manual Transmission Fluid (MTF) until it starts to run out of the hole. Install the filler bolt, and tighten it securely.

Put a new washer on the filler bolt, then reinstall the filler bolt and tighten it securely.

If Honda MTF is not available, you may use an SAE 10W-30 or 10W-40 viscosity motor oil with the API Certification seal that says "FOR GASOLINE ENGINES" as a temporary replacement. However, motor oil does not contain the proper additives, and continued use can cause stiffer shifting. Replace as soon as it is convenient.

The transmission should be drained and refilled with new fluid according to the intervals shown on the information display.

If you are not sure how to check and add fluid, contact your dealer.





Differential Fluid

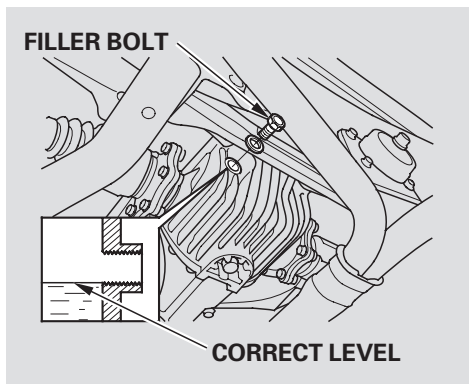

Check the fluid level with the differential at normal operating temperature and the vehicle sitting on level ground. Remove the differential fluid filler bolt and washer, and carefully feel inside the bolt hole with your finger. The fluid level should be up to the edge of the bolt hole. If it is not, slowly add fluid until it starts to run out of the hole.

Use an SAE 90 viscosity hypoid gear oil, API service classified GL5 or GL6 only.

Put a new washer on the filler bolt, then reinstall the filler bolt. Tighten it securely. Tightening torque: 33 lbf·ft (45 N·m , 4.6 kgf·m)

The differential should be drained and refilled with new fluid according to the intervals shown on the information display.

If you are not sure how to check and add fluid, contact your dealer.





Brake and Clutch Fluid

Check the brake fluid level in the reservoirs monthly.

Replace the brake fluid according to the time recommendation in the maintenance schedule.

Always use Honda Heavy Duty Brake Fluid DOT 3. If it is not available, you should use only DOT 3 or DOT 4 fluid, from a sealed container, as a temporary replacement.

Using any non-Honda brake fluid can cause corrosion and decrease the life of the system. Have the brake system flushed and refilled with Honda Heavy Duty Brake Fluid DOT 3 as soon as possible.

Brake fluid marked DOT 5 is not compatible with your vehicle's braking system and can cause extensive damage.

Brake Fluid

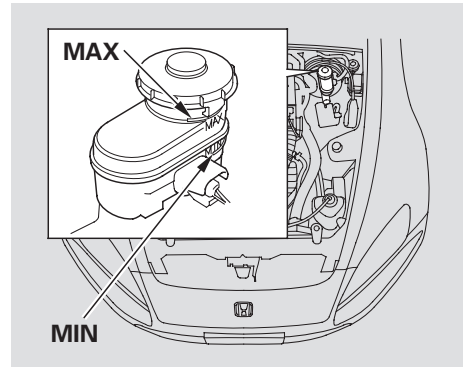

The fluid level should be between the MIN and MAX marks on the side of the reservoir. If the level is at or below the MIN mark, your brake system needs attention. Have the brake system inspected for leaks or worn brake pads.

Clutch Fluid

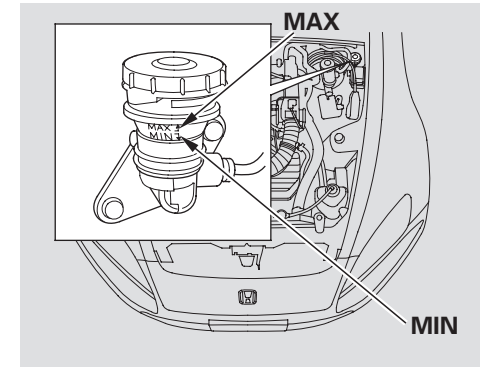

The fluid level should be between the MIN and MAX marks on the side of the reservoir. If it is not, add brake fluid to bring it up to that level. Use the same fluid specified for the brake system.

A low fluid level can indicate a leak in the clutch system. Have this system inspected as soon as possible.





Lights

Headlight Aiming

The headlights were properly aimed when your vehicle was new. If you regularly carry heavy items in the trunk, readjustment may be required. Adjustment should be done by your dealer or other qualified mechanic.

Replacing a Headlight Bulb

The low beam headlight bulbs are a type of high voltage discharge tube. High voltage can remain in the circuit even with the light switch off and the key removed. Because of this, you should not attempt to examine or change a low beam headlight bulb yourself. If a low beam headlight bulb fails, take the vehicle to your dealer to have it replaced.

Halogen bulbs are used for the high beam headlight bulbs. When replacing a high beam headlight bulb, handle it by its base, and protect the glass from contact with your skin or hard objects. If you touch the glass, clean it with denatured alcohol and a clean cloth.

NOTICE

Halogen headlight bulbs get very hot when lit. Oil, perspiration, or a scratch on the glass can cause the bulb to overheat and shatter.

Maintenance

CONTINUED



Lights

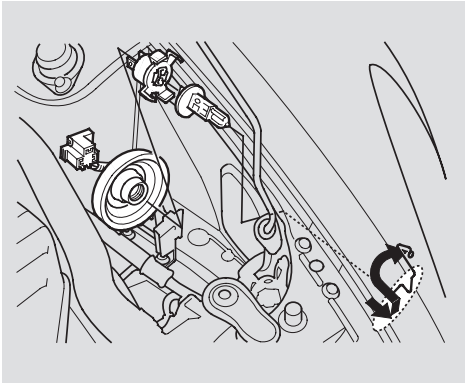

1. Open the hood.
If you need to change the high beam headlight bulb on the driver's side, remove the coolant reserve tank from its holder by pulling it straight up.
2. Remove the electrical connector from the bulb by squeezing the connector to unlock the tab, then slide the connector off the bulb.

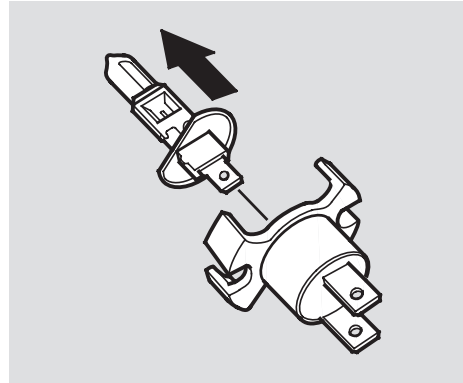

3. Remove the rubber weather seal by pulling on the tab.
4. Unclip the end of the hold-down wire from its slot. Pivot it out of the way, and remove the bulb socket.
5. Pull the bulb straight out of its socket. Push the new bulb straight into the socket until it bottoms.

6. Insert the socket back into the headlight assembly. Make sure the bulb is installed correctly by looking through the headlight lens. The pins on the base of the bulb should fit in the holes in the headlight assembly. Pivot the hold-down wire back in place, and clip the end into the slot.
7. Install the rubber seal over the back of the headlight assembly.
8. Push the electrical connector onto the new bulb. Turn on the headlights to test the new bulb.
9. (Driver's side)
Reinstall the coolant reserve tank.





Lights

Replacing Front Turn Signal and Side Marker/Parking Light Bulbs

1. If you are changing the bulb on the driver's side, start the engine, turn the steering wheel all the way to the right, then turn off the engine. If you are changing the bulb on the passenger's side, turn the steering wheel to the left.

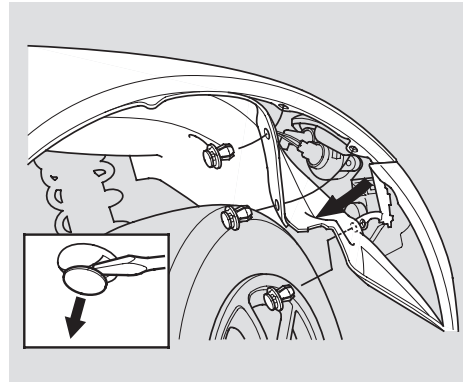

2. Use a flat-tipped screwdriver to remove the three holding clips from the inner fender.
3. Pull the inner fender cover back.
4. Remove the socket from the headlight assembly by turning it one-quarter turn counterclockwise.
5. Pull the bulb straight out of its socket.

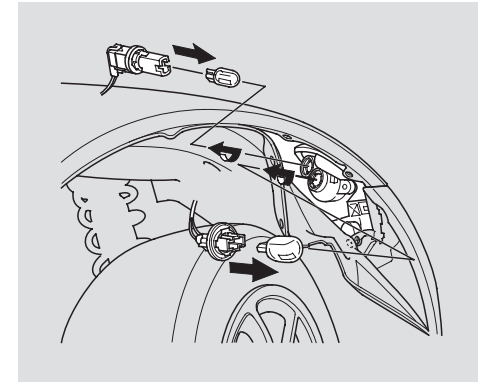

6. Install the new bulb in the socket.
7. Insert the socket back into the headlight assembly. Turn it clockwise to lock it in place.
8. Turn on the lights to make sure the new bulb is working.
9. Put the inner fender cover in place. Install the three holding clips. Lock each clip in place by pushing on the center.

Maintenance



Lights

Replacing a Side Turn Signal Bulb

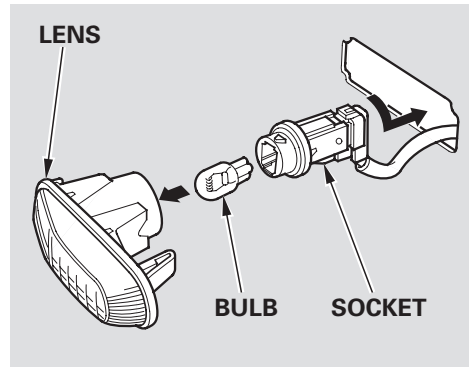

1. Use a small flat-tipped screwdriver to pry carefully on the back edge of the side turn signal assembly until it pops out of the body.
2. Turn the bulb holder one-quarter turn counterclockwise to remove it from the lens.
3. Pull the bulb straight out of its socket. Push the new bulb straight into the socket until it bottoms.
4. Put the bulb holder back into its hole in the lens, and turn it clockwise until it locks.
5. Turn on the lights to make sure the new bulb is working.
6. Put the side turn signal assembly back into the body, front first. Push on the back edge until it snaps into place.

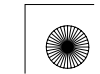



Lights

Replacing Rear Bulbs

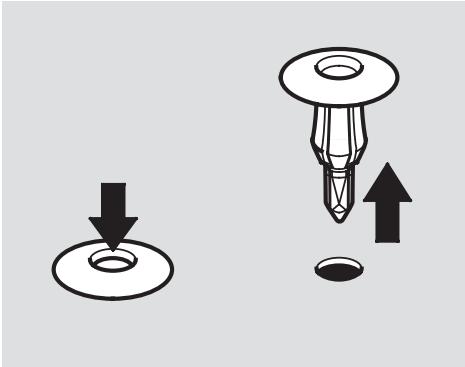

1. Open the trunk.
2. Remove the fasteners from the trunk lining. To remove a fastener, push on the center of the head until it pops in, then pull the fastener out.
3. Pull the lining back.

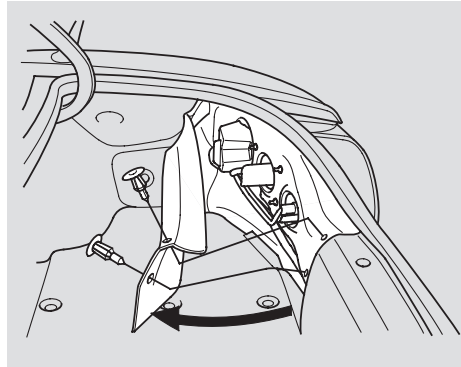

4. Determine which bulb is burned out: turn signal or back-up light.

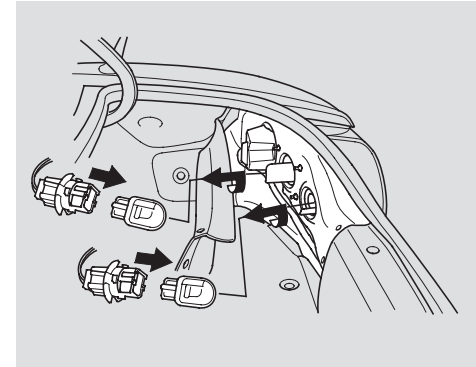

5. Remove the socket by turning it one-quarter turn counterclockwise.
6. Remove the burned out bulb by pulling it straight out of its socket.

Maintenance

CONTINUED



Lights, Cleaning the Seat Belts

7. Install the new bulb into the socket.
8. Push the socket into the light assembly, and turn it clockwise until it locks.
9. Turn on the lights to make sure the new bulb is working.

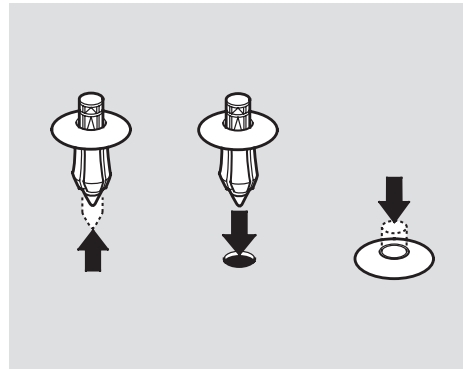

10. Install the trunk lining, and secure it with the fasteners. To reinstall a fastener, reset the fastener by pushing on the pointed end until it pops back almost flush with the fingers on the housing. Put the fastener in the hole of the trunk lining, and push on the center until it locks (the center is flush with the head).

Cleaning the Seat Belts

If your seat belts get dirty, use a soft brush with a mixture of mild soap and warm water to clean them. Do not use bleach, dye, or cleaning solvents. Let the belts air-dry before you use the vehicle.

Dirt build-up in the loops of the seat belt anchors can cause the belts to retract slowly. Wipe the insides of the loops with a clean cloth dampened in mild soap and warm water or isopropyl alcohol.





Floor Mats, Dust and Pollen Filter, Audio Antenna

Floor Mats

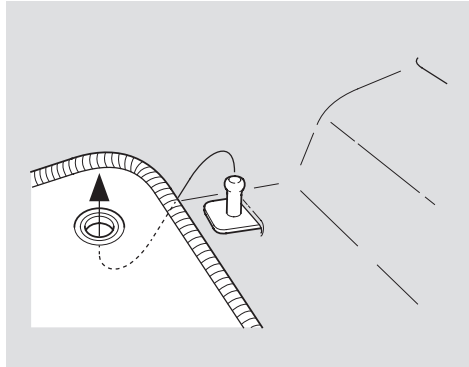

The floor mats that came with your vehicle hook over the floor mat anchors. This keeps them from sliding forward and possibly interfering with vehicle operation.

If you remove a floor mat, make sure to re-anchor it when you put it back in your vehicle.

If you use a non-Honda floor mat, make sure it fits properly and that it can be used with the floor mat anchor. Do not put additional floor mats on top of the anchored mat.

Dust and Pollen Filter

This filter removes the dust and pollen that is brought in from the outside through the heating and cooling system.

Have your dealer replace the filter when this service is indicated by a maintenance message on the information display. It should be replaced every 15,000 miles (24,000 km) if you drive primarily in urban areas that have high concentrations of soot in the air, or if the flow from the heating and cooling system becomes less than usual.

Audio Antenna

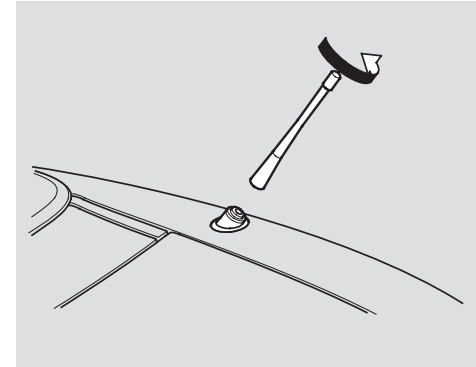

NOTICE

Your vehicle is equipped with an antenna at the right rear fender. Before using a "drive-through" car wash, remove the antenna by unscrewing it by hand. This prevents the antenna from being damaged by the car wash brushes.

Maintenance





Wiper Blades

Check the condition of the wiper blades at least every six months. Replace them if you find signs of cracking in the rubber, areas that are getting hard, or if they leave streaks and unwiped areas when used.

To replace a wiper blade:

1. Raise the wiper arm off the windshield.

NOTICE

Do not open the hood when the wiper arms are raised, or you will damage the hood and the wiper arms.

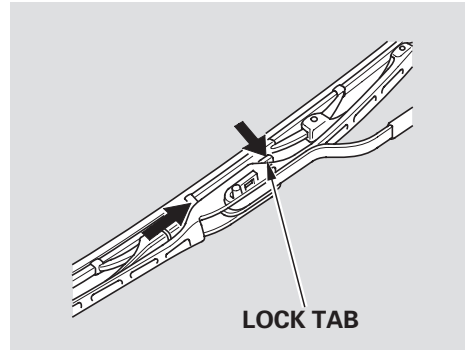

2. Disconnect the blade assembly from the wiper arm by pushing in the lock tab. Hold the lock tab in while you push the blade assembly toward the base of the arm.

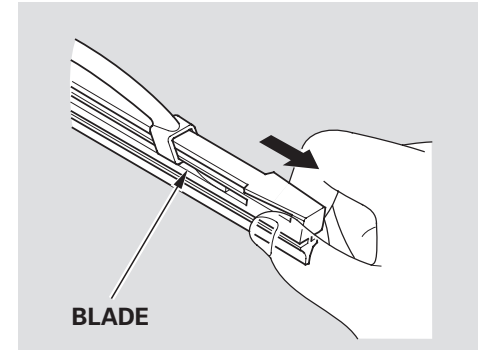

3. Remove the blade from its holder by grasping the tabbed end of the blade. Pull firmly until the tabs come out of the holder.

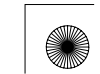



Wiper Blades, Wheels, Tires

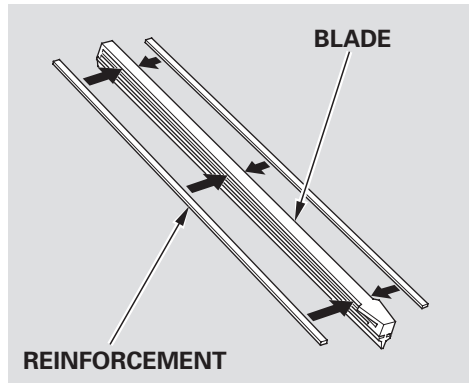

4. Examine the new wiper blades. If they have no plastic or metal reinforcement along the back edge, remove the metal reinforcement strips from the old wiper blade, and install them in the slots along the edge of the new blade.
5. Slide the new wiper blade into the holder until the tabs lock.

6. Slide the wiper blade assembly onto the wiper arm. Make sure it locks in place.
7. Lower the wiper arm down against the windshield.

Wheels

Clean the wheels as you would the rest of the exterior. Wash them with the same solution, and rinse them thoroughly.

Aluminum alloy wheels have a protective clear-coat that keeps the aluminum from corroding and tarnishing. Cleaning the wheels with harsh chemicals (including some commercial wheel cleaners) or a stiff brush can damage the clear-coat. To clean the wheels, use a mild detergent and a soft brush or sponge.

Tires

To safely operate your vehicle, your tires must be the proper type and size, in good condition with adequate tread, and correctly inflated.

The following pages give more detailed information on how to take care of your tires and what to do when they need to be replaced.

WARNING

Using tires that are excessively worn or improperly inflated can cause a crash in which you can be seriously hurt or killed.

Follow all instructions in this owner's manual regarding tire inflation and maintenance.





Tires

Inflation Guidelines

Keeping the tires properly inflated provides the best combination of handling, tread life, and riding comfort.

- Underinflated tires wear unevenly, adversely affect handling and fuel economy, and are more likely to fail from being overheated.
- Overinflated tires can make your vehicle ride more harshly, are more prone to damage from road hazards, and wear unevenly.

We recommend that you visually check your tires every day. If you think a tire might be low, check it immediately with a tire gauge.

Use a gauge to measure the air pressure in each tire at least once a month. Even tires that are in good condition may lose 1 to 2 psi (10 to 20 kPa, 0.1 to 0.2 kgf/cm²) per month. Remember to check the spare tire at the same time.

Check the air pressures when the tires are cold. This means the vehicle has been parked for at least 3 hours, or driven less than 1 mile (1.6 km). Add or release air, if needed, to match the recommended cold tire pressures on page 165 .

If you check air pressures when the tires are hot [driven for several miles (kilometers)], you will see readings 4 to 6 psi (30 to 40 kPa, 0.3 to 0.4 kgf/cm²) higher than the cold readings. This is normal. Do not let air out to match the recommended cold air pressure. The tire will be underinflated.

You should use your own tire pressure gauge and use it whenever you check your tire pressures. This will make it easier for you to tell if a pressure loss is due to a tire problem and not due to a variation between gauges.

While tubeless tires have some ability to self-seal if they are punctured, you should look closely for punctures if a tire starts losing pressure.





Tires

Recommended Tire Pressures

The following charts show the recommended cold tire pressures for most normal and high-speed driving conditions.

Front:

Tire Size	Cold Tire Pressure
215/45R17 87W	32 psi (220 kPa , 2.2 kgf/cm ²)

Rear:

Tire Size	Cold Tire Pressure
245/40R17 91W	32 psi (220 kPa , 2.2 kgf/cm ²)

The compact spare tire pressure is: 60 psi (420 kPa , 4.2 kgf/cm²)

For convenience, the recommended cold air pressures and tire sizes are on a label on the driver's doorjamb.

For additional information about your tires, see page 206 .

Tire Inspection

Every time you check inflation, you should also examine the tires for damage, foreign objects, and wear. You should look for:

- Bumps or bulges in the tread or side of the tire. Replace the tire if you find either of these conditions.
- Cuts, splits, or cracks in the side of the tire. Replace the tire if you can see fabric or cord.
- Excessive tread wear.

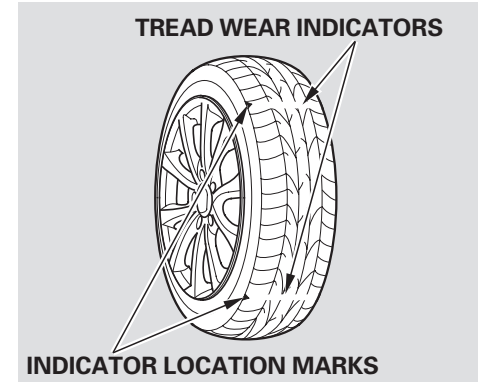

Your tires have wear indicators molded into the tread. When the tread wears down, you will see a 1/2 inch (12.7 mm) wide band across the tread. This shows there is less than 1/16 inch (1.6 mm) of tread left on the tire.

A tire this worn gives very little traction on wet roads. You should replace the tire if you can see three or more tread wear indicators.



Tires

Tire Maintenance

In addition to proper inflation, correct wheel alignment helps to decrease tire wear. If you find a tire is worn unevenly, have your dealer check the wheel alignment.

Have your dealer check the tires if you feel a consistent vibration while driving. A tire should always be rebalanced if it is removed from the wheel. When you have new tires installed, make sure they are balanced. This increases riding comfort and tire life. For best results, have the installer perform a dynamic balance.

NOTICE

Improper wheel weights can damage your vehicle's aluminum wheels. Use only Honda wheel weights for balancing.

Tire Rotation

You should not rotate your vehicle's tires. The front and rear tires are different sizes, so they cannot be rotated front-to-rear. The original-equipment tires on your vehicle have a unidirectional tread pattern, so they cannot be rotated side-to-side.

Tire Wear

The tires that came on your vehicle were designed and constructed to provide superior grip during acceleration, braking, and cornering.

As a trade-off, they will wear more rapidly than tires used on ordinary passenger vehicles. Because of the vehicle's weight distribution, and the fact that the rear wheels are the driving wheels, you can expect them to wear more rapidly than the front tires.

The mileage you can expect from your vehicle tires is the same as comparable mid-and rear-engine sports cars, and it will vary greatly with your driving habits.

If you drive moderately, the rear tires could last more than 10,000 miles (16,000 km). However, the mileage will be substantially less if you tend to drive your vehicle at the upper limits of its capabilities.

You should carefully inspect your vehicle's tires for wear, damage, and proper inflation every 7,500 miles (12,000 km) or when tire inspection is indicated on the information display (see page 142).





Tires

Replacing Tires and Wheels

Replace your tires with radial tires of the same size, load range, speed rating, and maximum cold tire pressure rating (as shown on the tire's side wall).

Mixing radial and bias-ply tires on your vehicle can reduce braking ability, traction, and steering accuracy. Using tires of a different size or construction can cause the anti-lock brake and the vehicle stability assist systems to work inconsistently.

It is best to replace all four tires at the same time. If that is not possible or necessary, replace the two front tires or two rear tires as a pair. Replacing just one tire can seriously affect your vehicle's handling.

The ABS works by comparing the speed of the wheels. When replacing tires, use the same size originally supplied with the vehicle. Tire size and construction can affect wheel speed and may cause the system to activate.

If you ever replace a wheel, make sure that the wheel's specifications match those of the original wheels. Replacement wheels are available at your dealer.

WARNING

Installing improper tires on your vehicle can affect handling and stability. This can cause a crash in which you can be seriously hurt or killed.

Always use the size and type of tires recommended in this owner's manual.

Wheel and Tire Specifications

Wheels:

Front:

17 x 7 J

Rear:

17 x 8 1/2 J

Tires:

Front:

215/45R17 87W

Rear:

245/40R17 91W

See page 204 for information about DOT Tire Quality Grading, and page 206 for tire size and labeling information.



Tires

Winter Driving

Tires marked “M + S” or “All Season” on the sidewall have an all-weather tread design suitable for most winter driving conditions.

For the best performance in snowy or icy conditions, you should install snow tires or tire chains. They may be required by local laws under certain conditions.

Snow Tires

If you mount snow tires on your vehicle, make sure they are radial tires of the same size and load range as original tires. Mount snow tires on all four wheels. The traction provided by snow tires on dry roads may be lower than your original tires. Check with the tire dealer for maximum speed recommendations.

Tire Chains

Because your vehicle has limited tire clearance, mount only SAE Class “S” cable-type traction devices, with rubber chain tensioners on the rear tires. Use traction devices only when required by driving conditions or local laws. Make sure they are the correct size for your tires. Metal link-type “chains” should not be used.

When installing cables, follow the manufacturer’s instructions, and mount them as tight as you can. Make sure they are not contacting the brake lines or suspension. Drive slowly with them installed. If you hear them coming into contact with the body or chassis, stop and investigate. Remove them as soon as you begin driving on cleared roads.

NOTICE

Traction devices that are the wrong size or improperly installed can damage your vehicle’s brake lines, suspension, body, and wheels. Stop driving if they are hitting any part of the vehicle.





Checking the Battery

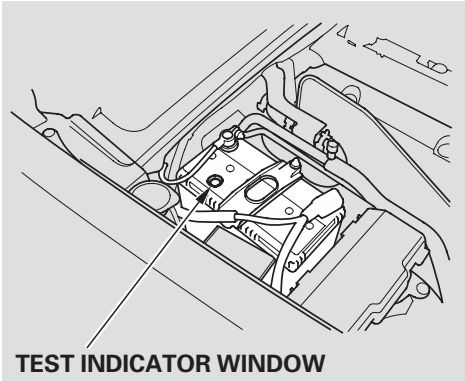

Check the condition of the battery monthly by looking at the test indicator window. The label on the battery explains the test indicator's colors.

Check the terminals for corrosion (a white or yellowish powder). To remove it, cover the terminals with a solution of baking soda and water. It will bubble up and turn brown. When this stops, wash it off with plain water. Dry off the battery with a cloth or paper towel. Coat the terminals with grease to help prevent future corrosion.

If your vehicle's battery is disconnected, or goes dead, the clock setting in the instrument panel will be canceled. To reset the time, see page 54 .

If your vehicle's battery is disconnected, or goes dead, the audio system will disable itself. The next time you turn on the radio, you may see "CODE" (U.S. model) or "Code" (Canadian model) in the frequency display. Use the preset buttons to enter the code (see page 105).

CONTINUED



Checking the Battery

If additional battery maintenance is needed, see your dealer or a qualified technician.

WARNING: Battery posts, terminals, and related accessories contain lead and lead compounds. **Wash your hands after handling.**

If you need to connect the battery to a charger, disconnect both cables to prevent damaging your vehicle's electrical system. Always disconnect the negative (–) cable first, and reconnect it last.

WARNING

The battery gives off explosive hydrogen gas during normal operation.

A spark or flame can cause the battery to explode with enough force to kill or seriously hurt you.

Wear protective clothing and a face shield, or have a skilled technician do the battery maintenance.





Vehicle Storage

If you need to park your vehicle for an extended period (more than 1 month), there are several things you should do to prepare it for storage. Proper preparation helps prevent deterioration and makes it easier to get your vehicle back on the road. If possible, store your vehicle indoors.

- Fill the fuel tank.
- Change the engine oil and filter.
- Wash and dry the exterior completely.
- Clean the interior. Make sure the carpeting, floor mats, etc., are completely dry.
- Raise the convertible top cover.
- Leave the parking brake off. Put the transmission in reverse.

- Block the rear wheels.
- If the vehicle is to be stored for a longer period, it should be supported on jackstands so the tires are off the ground.
- Leave one window open slightly (if the vehicle is being stored indoors).
- Disconnect the battery.
- Support the front wiper blade arms with a folded towel or rag so they do not touch the windshield.
- To minimize sticking, apply a silicone spray lubricant to all door and trunk seals. Also, apply a vehicle body wax to the painted surfaces that mate with the door and trunk seals.

- Cover the vehicle with a “breathable” cover, one made from a porous material such as cotton. Non-porous materials, such as plastic sheeting, trap moisture, which can damage the paint.
- If possible, periodically run the engine until it reaches full operating temperature (the cooling fan cycles on and off twice). Preferably, do this once a month.



06/07/13 17:34:55 31S2A670 0177

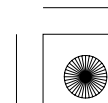
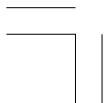



Taking Care of the Unexpected

This section covers the more common problems that motorists experience with their vehicles. It gives you information about how to safely evaluate the problem and what to do to correct it. If the problem has stranded you on the side of the road, you may be able to get going again. If not, you will also find instructions on getting your vehicle towed.

Compact Spare Tire.....	174
Changing a Flat Tire	175
If the Engine Won't Start.....	180
Jump Starting	182
If the Engine Overheats	183
Low Oil Pressure Indicator	186
Charging System Indicator.....	186
Malfunction Indicator Lamp	187
Brake System Indicator	188
Closing the Convertible Top	189
Fuses	190
Checking and Replacing	191
Fuse Locations	194
Emergency Towing	196
If Your Vehicle Gets Stuck.....	196

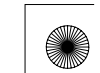



Compact Spare Tire

Use the compact spare tire as a temporary replacement only. Get your regular tire repaired or replaced, and put it back on your vehicle as soon as you can.

Check the inflation pressure of the compact spare tire every time you check the other tires. It should be inflated to:
60 psi (420 kPa , 4.2 kgf/cm²)

Follow these precautions:

- Never exceed 50 mph (80 km/h).
- This tire gives a harsher ride and less traction on some road surfaces. Use greater caution while driving.
- Do not mount tire chains on the compact spare tire.
- Do not use your compact spare tire on another vehicle unless it is the same make and model.
- Do not mount the compact spare tire on either rear wheel position; it will damage the limited slip differential (see page 175).

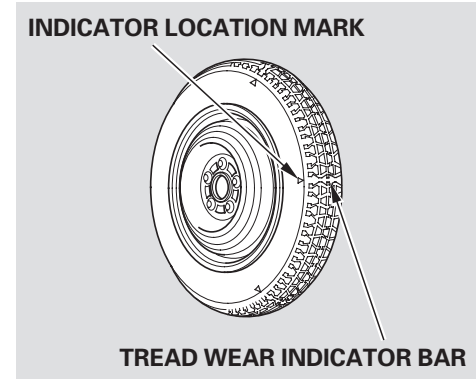

Replace the tire when you can see the tread wear indicator bars. The replacement should be the same size and design tire, mounted on the same wheel. The spare tire is not designed to be mounted on a regular wheel, and the spare wheel is not designed for mounting a regular tire.

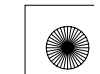



Changing a Flat Tire

If you have a flat tire while driving, stop in a safe place to change it. Drive slowly along the shoulder until you get to an exit or an area to stop that is far away from the traffic lanes.

▲ WARNING

The vehicle can easily roll off the jack, seriously injuring anyone underneath.

Follow the directions for changing a tire exactly, and never get under the vehicle when it is supported only by the jack.

The compact spare tire is smaller than a standard tire, which will affect the vehicle's handling. Drive cautiously when this spare is mounted on your vehicle.

The size difference may also cause damage to the rear differential, so do not mount the compact spare on the rear. If either rear tire goes flat, remove the front tire on that same side, mount the compact spare tire on the front, then mount the front tire on the rear.

1. Park the vehicle on firm, level, and non-slippery ground. Put the transmission in reverse. Apply the parking brake.
2. Turn on the hazard warning lights, and turn the ignition switch to the LOCK (0) position. Have your passenger get out of the vehicle while you change the tire.

TOOL BOX LID

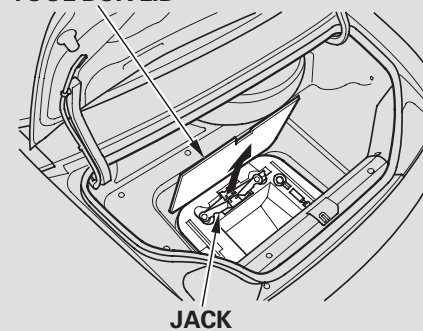

3. Open the trunk. Lift up the tool box lid, and take the jack, the wheel nut wrench, and the extension out of the tool box.

NOTICE

Use the jack that came with your vehicle. If you try to raise another vehicle with this jack or use another jack to raise your vehicle, the vehicle or jack can be damaged.

CONTINUED

Taking Care of the Unexpected





Changing a Flat Tire

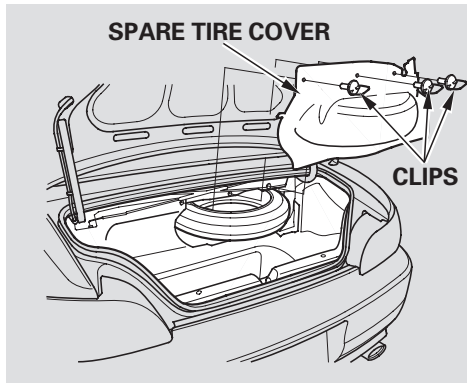

4. Remove the three clips holding the spare tire cover by pulling the rings straight back. Remove the spare tire cover.

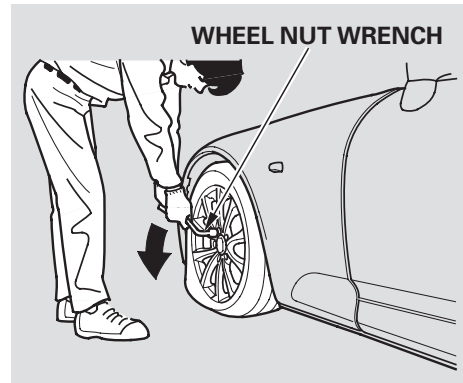

5. Unscrew the wing bolt, and take the spare tire out of the spare tire shelf.
6. Loosen each wheel nut 1/2 turn with the wheel nut wrench.

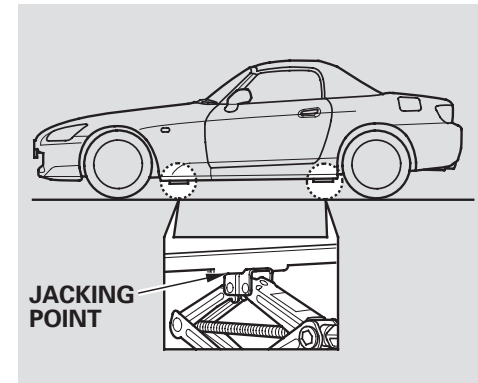

7. Place the jack under the jacking point nearest the tire you need to change. Turn the end bracket clockwise until the top of the jack contacts the jacking point. Make sure the center of the jacking point tab is resting in the jack notch.

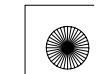



Changing a Flat Tire

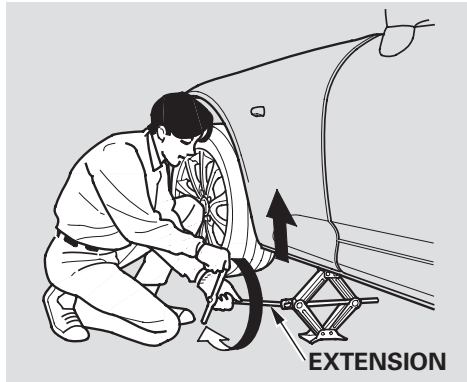

8. Use the extension and the wheel nut wrench as shown to raise the vehicle until the flat tire is off the ground.

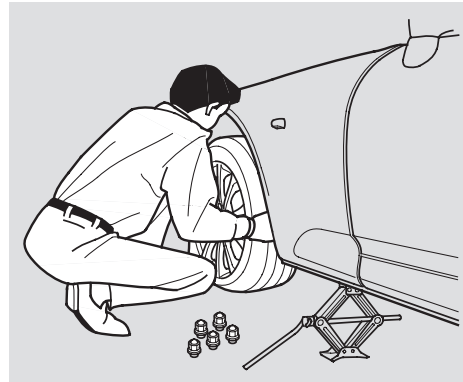

9. Remove the wheel nuts, then remove the flat tire. Handle the wheel nuts carefully; they may be hot from driving. Place the flat tire on the ground with the outside surface facing up.

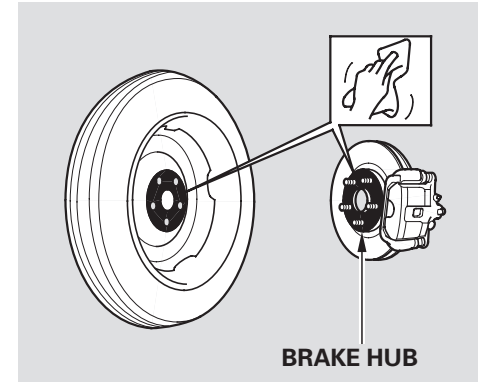

10. Before mounting the spare tire, wipe any dirt off the mounting surface of the wheel and hub with a clean cloth. Wipe the hub carefully; it may be hot from driving.

Taking Care of the Unexpected

CONTINUED





Changing a Flat Tire

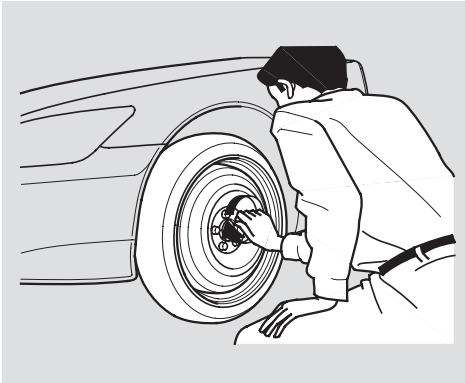

11. Put on the spare tire. Put the wheel nuts back on finger-tight, then tighten them in a crisscross pattern with the wheel nut wrench until the wheel is firmly against the hub. Do not try to tighten the wheel nuts fully.



12. Lower the vehicle to the ground, and remove the jack.

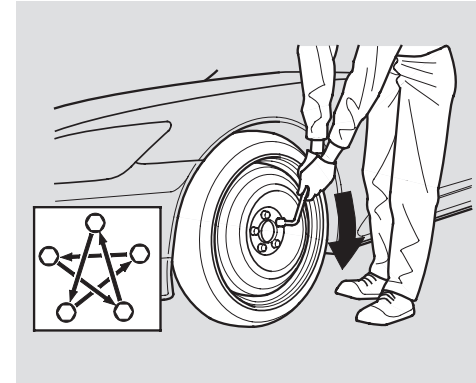

13. Tighten the wheel nuts securely in a crisscross pattern. Have the wheel nut torque checked at the nearest automotive service facility. Tighten the wheel nuts to:
80 lbf·ft (108 N·m , 11 kgf·m)

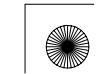



Changing a Flat Tire

14. Remove the tool box from the trunk well, and replace the jack, wheel wrench, and extension in the tool box.
15. Place the tool box into the spare tire shelf in the trunk.

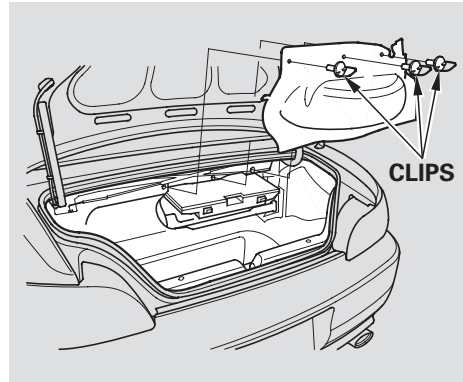

16. Replace the spare tire cover. Secure it with the three clips. Push each clip in securely, and pivot the ring down flat.

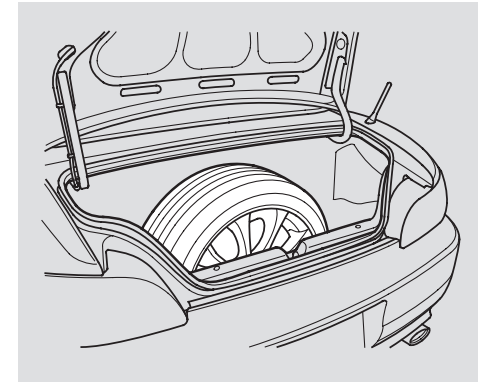

17. Put the flat tire in the trunk well vertically as shown.



If the Engine Won't Start

Diagnosing why the engine won't start falls into two areas, depending on what you hear when you press the ENGINE START button.

- You hear nothing, or almost nothing. The engine's starter motor does not operate at all, or operates very slowly.
- You can hear the starter motor operating normally, or the starter motor sounds like it is spinning faster than normal, but the engine does not start up and run.

Nothing Happens or the Starter Motor Operates Very Slowly

When you press the ENGINE START button, you do not hear the normal noise of the engine trying to start. You may hear a clicking sound or series of clicks, or nothing at all. Check these things:

- Check the transmission interlock. The clutch pedal must be pushed all the way to the floor or the starter will not operate.
- Turn the ignition switch to the ON (II) position. Turn on the headlights, and check their brightness. If the headlights are very dim or do not come on at all, the battery is discharged. See **Jump Starting** on page 182 .

- Press the ENGINE START button, then release it. If the headlights do not dim, check the condition of the fuses. If the fuses are OK, there is probably something wrong with the electrical circuit for the ignition switch or starter motor. You will need a qualified mechanic to determine the problem. (See **Emergency Towing** on page 196 .)





If the Engine Won't Start

If the headlights dim noticeably or go out when you try to start the engine, either the battery is discharged or the connections are corroded. Check the condition of the battery and terminal connections (see page 169). You can then try jump starting the vehicle from a booster battery (see page 182).

The Starter Operates Normally

In this case, the starter motor's speed sounds normal, or even faster than normal, when you press the ENGINE START button, but the engine does not run.

- Are you using a properly coded key? An improperly coded key will cause the immobilizer system indicator in the instrument panel to blink rapidly (see page 61).
- Are you using the proper starting procedure? Refer to **Starting the Engine** on page 124.
- Do you have fuel? Check the fuel gauge; the low fuel indicator may not be working.

- There may be an electrical problem, such as no power to the fuel pump. Check all the fuses (see page 190).

If you find nothing wrong, you will need a qualified mechanic to find the problem. See **Emergency Towing** on page 196.



Jump Starting

Although this seems like a simple procedure, you should take several precautions.

⚠ WARNING

A battery can explode if you do not follow the correct procedure, seriously injuring anyone nearby.

Keep all sparks, open flames, and smoking materials away from the battery.

To jump start your vehicle:

1. Open the hood, and check the physical condition of the battery. In very cold weather, check the condition of the electrolyte. If it seems slushy or frozen, do not try jump starting until it thaws.

NOTICE

If a battery sits in extreme cold, the electrolyte inside can freeze. Attempting to jump start with a frozen battery can cause it to rupture.

2. Turn off all the electrical accessories: heater, A/C, audio system, lights, etc. Put the transmission in neutral, and set the parking brake.

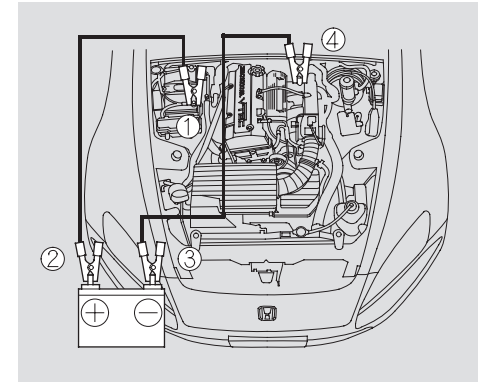

The numbers in the illustrations show you the order to connect the jumper cables.

3. Connect one jumper cable to the positive (+) terminal on your battery. Connect the other end to the positive (+) terminal on the booster battery.





Jump Starting, If the Engine Overheats

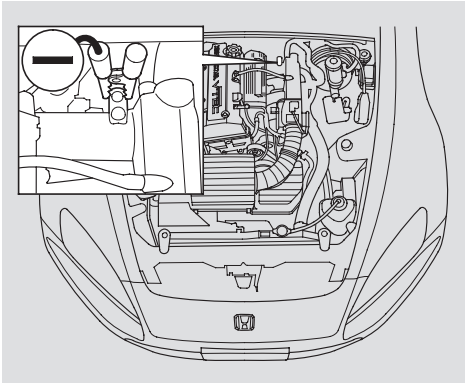

4. Connect the second jumper cable to the negative (–) terminal on the booster battery. Connect the other end to the grounding strap as shown. Do not connect this jumper cable to any other part of the engine.

5. If the booster battery is in another vehicle, have an assistant start that vehicle and run it at a fast idle.
6. Start your vehicle. If the starter motor still operates slowly, check that the jumper cables have good metal-to-metal contact.
7. Once your vehicle is running, disconnect the negative cable from your vehicle, then from the booster battery. Disconnect the positive cable from your vehicle, then from the booster battery.

Keep the ends of the jumper cables away from each other and any metal on the vehicle until everything is disconnected. Otherwise, you may cause an electrical short.

If the Engine Overheats

The reading on your vehicle's temperature gauge should stay in the midrange under most conditions. If it reaches the red mark, you should determine the reason (hot day, driving up a steep hill, etc.).

If your vehicle overheats, you should take immediate action. The only indication may be the temperature gauge reading reaching the red mark. Or you may see steam or spray coming from under the hood.

NOTICE

Driving with the temperature gauge reading at the red mark can cause serious damage to your engine.

CONTINUED

Taking Care of the Unexpected





If the Engine Overheats

WARNING

Steam and spray from an overheated engine can seriously scald you.

Do not open the hood if steam is coming out.

1. Safely pull to the side of the road. Put the transmission in neutral, and set the parking brake. Turn off the all accessories, and turn on the hazard warning indicators.
2. If you see steam and/or spray coming from under the hood, turn off the engine. Wait until you see no more signs of steam or spray, then open the hood.
3. If you do not see steam or spray, leave the engine running, and watch the temperature gauge. If the high heat is due to overloading, the engine should start to cool down almost immediately. If it does, wait until the temperature gauge comes down to the midpoint, then continue driving.
4. If the temperature gauge stays at the red mark, turn off the engine.
5. Look for any obvious coolant leaks, such as a split radiator hose. Everything is still extremely hot, so use caution. If you find a leak, it must be repaired before you continue driving (see **Emergency Towing** on page 196).
6. If you don't find an obvious leak, check the coolant level in the radiator reserve tank. Add coolant if the level is below the MIN mark (see **Adding Engine Coolant** on page 149).





If the Engine Overheats

7. If there was no coolant in the reserve tank, you may need to add coolant to the radiator. Let the engine cool down until the reading reaches the middle of the temperature gauge or lower before checking the radiator.

WARNING

Removing the radiator cap while the engine is hot can cause the coolant to spray out, seriously scalding you.

Always let the engine and radiator cool down before removing the radiator cap.

8. Using gloves or a large heavy cloth, turn the radiator cap counterclockwise, without pushing down, to the first stop. After the pressure releases, push down on the cap, and turn it until it comes off.

9. Start the engine, and set the temperature control dial to maximum heat. Add coolant to the radiator up to the base of the filler neck. If you do not have the proper coolant mixture available, you can add plain water. Remember to have the cooling system drained and refilled with the proper mixture as soon as you can.

10. Put the radiator cap back on tightly. Run the engine, and check the temperature gauge. If it goes back to the red mark, the engine needs repair (see **Emergency Towing** on page 196).

11. If the temperature stays normal, check the coolant level in the radiator reserve tank. If it has gone down, add coolant to the MAX mark. Put the cap back on tightly.



Low Oil Pressure Indicator, Charging System Indicator

Low Oil Pressure Indicator



This indicator should never come on when the engine is running. If it starts flashing or stays on, the oil pressure has dropped very low or lost pressure. Serious engine damage is possible, and you should take immediate action.

NOTICE

Running the engine with low oil pressure can cause serious mechanical damage almost immediately. Turn off the engine as soon as you can safely get the vehicle stopped.

1. Safely pull off the road, and shut off the engine. Turn on the hazard warning indicators.
2. Let the vehicle sit for a minute. Open the hood, and check the oil level (see page 113). An engine very low on oil can lose pressure during cornering and other driving maneuvers.
3. If necessary, add oil to bring the level back to the full mark on the dipstick (see page 146).
4. Start the engine, and watch the oil pressure indicator. If it does not go out within 10 seconds, turn off the engine. There is a mechanical problem that needs to be repaired before you can continue driving (see **Emergency Towing** on page 196).

Charging System Indicator



If the charging system indicator comes on brightly when the engine is running, the battery is not being charged.

Immediately turn off all electrical accessories. Try not to use other electrically operated controls such as the power windows. Keep the engine running; starting the engine will discharge the battery rapidly.

Go to a service station or garage where you can get technical assistance.





Malfunction Indicator Lamp



If this indicator comes on while driving, it means one of the engine's emissions control systems may have a problem. Even though you may feel no difference in your vehicle's performance, it can reduce your fuel economy and cause increased emissions. Continued operation may cause serious damage.

If you have recently refueled your vehicle, the indicator coming on could be due to a loose or missing fuel fill cap. You will also see a "CHECK FUEL CAP" message on the information display. Tighten the cap until it clicks at least once. Tightening the cap will not turn the indicator off immediately; it can take several days of normal driving.

If the indicator comes on repeatedly, even though it may go off as you continue driving, have your vehicle checked by a dealer as soon as possible.

NOTICE

If you keep driving with the malfunction indicator lamp on, you can damage your vehicle's emissions controls and engine. Those repairs may not be covered by your vehicle's warranties.

Readiness Codes

Your vehicle has certain "readiness codes" that are part of the on-board diagnostics for the emissions systems. In some states, part of the emissions testing is to make sure these codes are set. If they are not set, the test cannot be completed.

If your vehicle's battery has been disconnected or gone dead, these codes are erased. It can take several days of driving under various conditions to set the codes again.

To check if they are set, turn the ignition switch to the ON (II) position, without starting the engine. The malfunction indicator lamp will come on for 20 seconds. If it then goes off, the readiness codes are set. If it blinks five times, the readiness codes are not set. If possible, do not take your vehicle for a state emissions test until the readiness codes are set. Refer to **State Emissions Testing** for more information (see page 210).





Brake System Indicator

U.S.

BRAKE

Canada



The brake system indicator normally comes on when you turn the ignition switch to the ON (II) position, and as a reminder to check the parking brake. It will stay on if you do not fully release the parking brake.

If the brake system indicator comes on while driving, the brake fluid level is probably low. Press lightly on the brake pedal to see if it feels normal. If it does, check the brake fluid level the next time you stop at a service station (see page 154).

If the fluid level is low, take your vehicle to a dealer, and have the brake system inspected for leaks or worn brake pads.

However, if the brake pedal does not feel normal, you should take immediate action. A problem in one part of the system's dual circuit design will still give you braking at two wheels. You will feel the brake pedal go down much farther before the vehicle begins to slow down, and you will have to press harder on the pedal.

Slow down by shifting to a lower gear, and pull to the side of the road when it is safe. Because of the long distance needed to stop, it is hazardous to drive the vehicle. You should have it towed and repaired as soon as possible (see **Emergency Towing** on page 196).

If you must drive the vehicle a short distance in this condition, drive slowly and carefully.





Closing the Convertible Top

If the electric motor will not close the convertible top, do the following.

1. Check the fuse for the convertible top motor (see page 190). If the fuse is blown, replace it with one of the same or lower rating.
2. Try closing the convertible top. If the new fuse blows immediately or the convertible top still does not operate, you can close it manually.

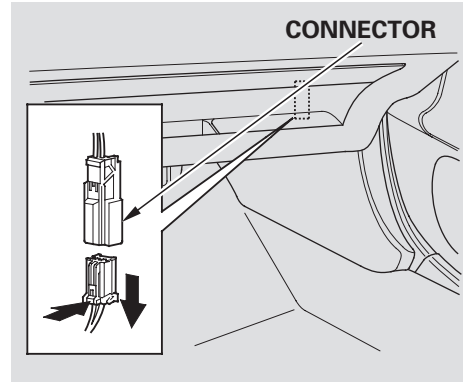

3. Locate the electrical connector for the convertible top motor. It is under the lower corner of the dashboard on the passenger's side. Disconnect the connector by pushing the tab and pulling the connector down.

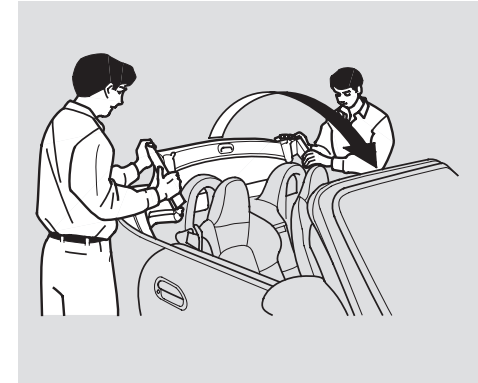

4. Holding each corner of the convertible top, raise the top and push it forward as far as it will go.
5. Follow steps 4 through 6 of the closing procedure on page 74 .

Taking Care of the Unexpected

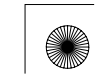



Fuses

The vehicle's fuses are contained in three fuse boxes.

INTERIOR

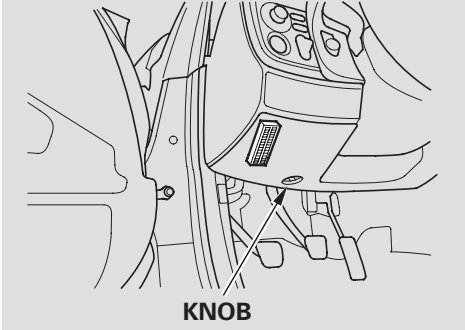

The interior fuse box is underneath the dashboard on the driver's side. To open it, turn the knob.

UNDER-HOOD (PRIMARY)

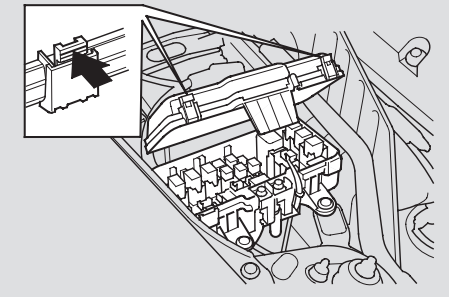

The primary under-hood fuse box is on the passenger's side next to the battery. To open it, push the two tabs as shown.

UNDER-HOOD (AUXILIARY)

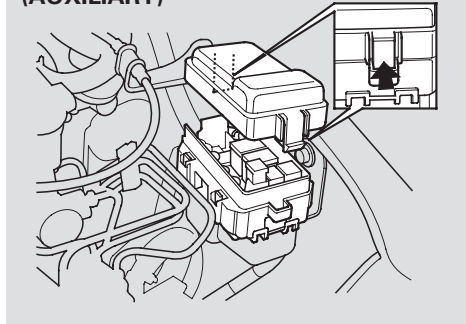

The auxiliary under-hood fuse box is on the driver's side, near the brake fluid reservoir. To open it, push the tab on each side, and remove the lid.





Fuses

Checking and Replacing Fuses

If something electrical in your vehicle stops working, check for a blown fuse first. Determine from the chart on pages 194 and 195, or the diagram on the fuse box lid, which fuse or fuses control that device. Check those fuses first, but check all the fuses before deciding that a blown fuse is the cause. Replace any blown fuses, and check if the device works.

1. Turn the ignition switch to the LOCK (0) position. Make sure the headlights and all other accessories are off.
2. Remove the cover from the fuse box.

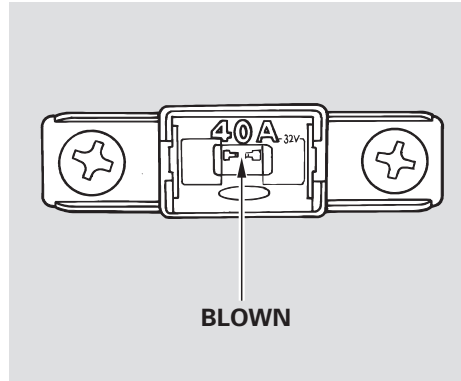

3. Check each of the large fuses in the primary under-hood fuse box by looking through the top at the wire inside. Removing these fuses requires a Phillips-head screwdriver.

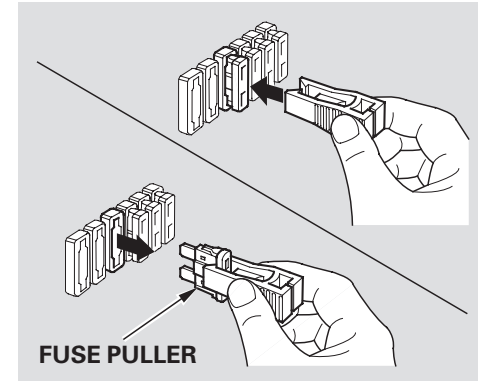

4. Check the smaller fuses in the under-hood fuse boxes and all the fuses in the interior fuse box by pulling out each one with the fuse puller provided in the interior fuse box.

CONTINUED

Taking Care of the Unexpected





Fuses

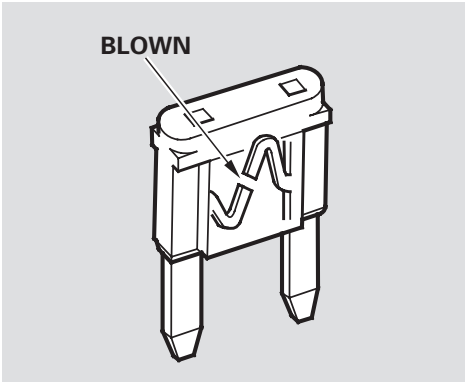

5. Look for a blown wire inside the fuse. If it is blown, replace it with one of the spare fuses of the same rating or lower.

If you cannot drive the vehicle without fixing the problem, and you do not have a spare fuse, take a fuse of the same rating or a lower rating from one of the other circuits. Make sure you can do without that circuit temporarily (such as the accessory power socket or radio).

If you replace the blown fuse with a spare fuse that has a lower rating, it might blow out again. This does not indicate anything wrong. Replace the fuse with one of the correct rating as soon as you can.

NOTICE

Replacing a fuse with one that has a higher rating greatly increases the chances of damaging the electrical system. If you do not have a replacement fuse with the proper rating for the circuit, install one with a lower rating.

6. If the replacement fuse of the same rating blows in a short time, there is probably a serious electrical problem with your vehicle. Leave the blown fuse in that circuit, and have your vehicle checked by a qualified technician.





06/07/13 17:37:21 31S2A670 0198



Fuses

If the radio fuse is removed, the audio system will disable itself. The next time you turn on the radio you will see “CODE” (U.S. model) or “Code” (Canadian model) in the frequency display. Use the preset buttons to enter the five-digit code (see page 105).

If the instrument panel fuse is removed, the clock setting in the instrument panel will be canceled. To reset the time, see page 54 .

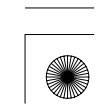
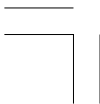



Fuse Locations

INTERIOR FUSE BOX

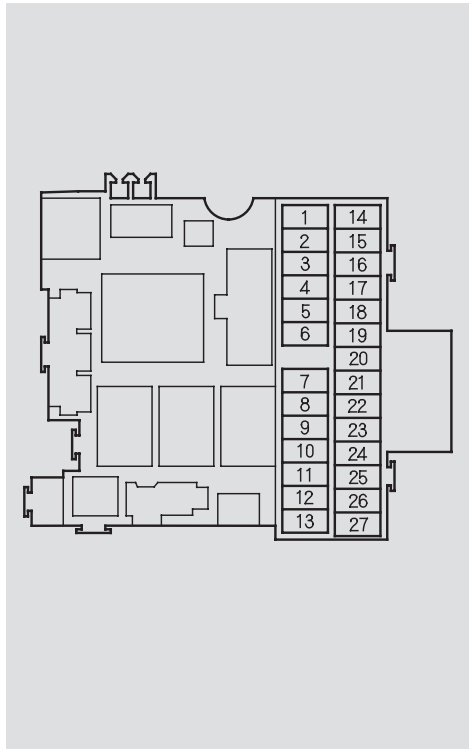

No.	Amps.	Circuits Protected
1	7.5 A	Windshield Wiper, Auto Stop Signal
2	15 A	Washer Motor
3	7.5 A	IGP (DBW)
4	7.5 A	IGP (LAF)
5	10 A	Accessory Socket
6	20 A	Windshield Wiper
7	7.5 A	Turn Signal Light
8	15 A	ACG
9	7.5 A	Meter, Backup Lights
10	—	Not used
11	7.5 A	Engine Start
12	15 A	Fuel Pump, SRS
13	10 A	SRS

No.	Amps.	Circuits Protected
14	10 A	Daytime Running Lights
15	15 A	Keyless Entry
16	7.5 A	Back-up
17	7.5 A	Interior Light
18	10 A	Small Lights
19	15 A	Radio
20	—	Not used
21	7.5 A	Heater Control, Cooling Fan Relay
22	7.5 A	Power Mirrors
23	20 A	Right Power Window
24	20 A	Left Power Window
25	15 A	IG Coil
26	20 A	LAF
27	15 A	DBW





Fuse Locations

UNDER-HOOD FUSE BOXES:

PRIMARY FUSE BOX

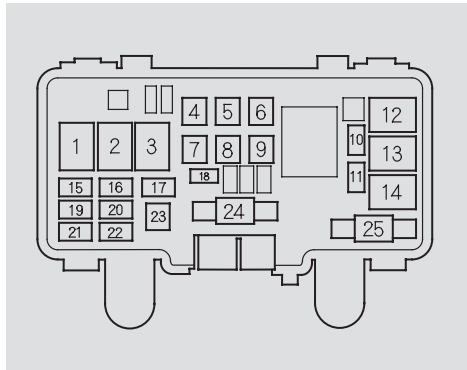

No.	Amps.	Circuits Protected
1	—	Lighting 1 Relay
2	—	Lighting 2 Relay
3	—	Horn Relay
4	40 A	Power Window Motor
5	20 A	Right Roof Motor
6	—	Not used
7	30 A	Backup ACC
8	20 A	Left Roof Motor
9	40 A	Heater Motor
10	20 A	Condenser Fan
11	20 A	DBW
12	—	Condenser Fan Relay
13	—	Cooling Fan Relay

No.	Amps.	Circuits Protected
14	—	Magnetic Clutch Relay
15	20 A	Right Headlight
16	15 A	ACG S
17	10 A	Hazard Warning Lights
18	20 A	Cooling Fan
19	—	Not used
20	15 A	Stop
21	20 A	Left Headlight
22	30 A	VSA F/S
23	30 A	VSA Motor
24	100 A	Battery
25	40 A	IG1 Main

AUXILIARY FUSE BOX

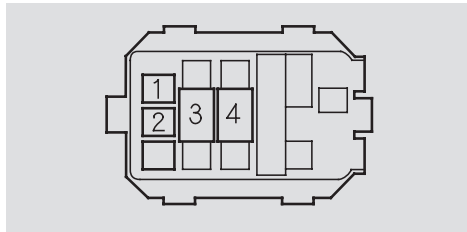

No.	Amps.	Circuits Protected
1	20 A	Rear Window Defogger
2	—	Not used
3	70 A	EPS
4	—	Not used



Emergency Towing, If Your Vehicle Gets Stuck

Emergency Towing

If your vehicle needs to be towed, call a professional towing service or organization. Never tow your vehicle with just a rope or chain. It is very dangerous.

The only way you can safely tow your vehicle is with flat-bed equipment. The operator will load your vehicle on the back of a truck. Any other method of towing will damage the drive system. When you contact the towing agency, inform them a flat-bed is required.

If Your Vehicle Gets Stuck

If your vehicle gets stuck in sand, mud, or snow, call a towing service to pull it out (see the previous column).

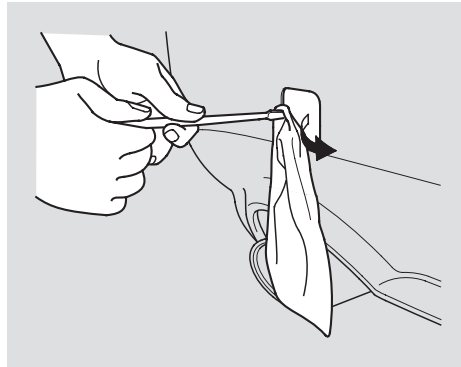

For very short distances, such as freeing the vehicle, you can use the detachable towing hook that mounts on the anchors in the front and rear bumpers.

To use the towing hook:

1. Remove the cover from the bumper.

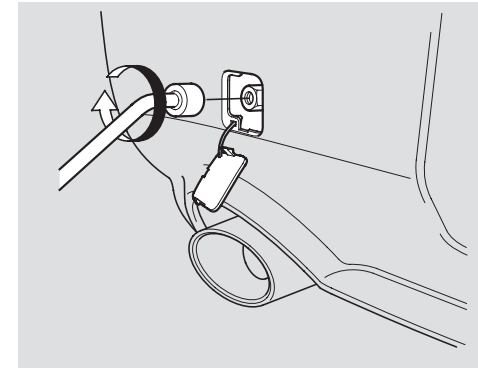

2. Remove the towing hook, hook extension, and wheel nut wrench from the tool box.
3. Using the wheel nut wrench, fasten the extension into the bolt hole in the anchor.





If Your Vehicle Gets Stuck

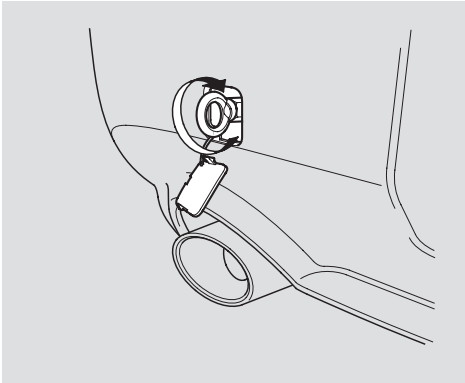

4. Screw the towing hook into the extension and tighten it securely by hand.

NOTICE

To avoid damage to your vehicle, use the towing hook for straight, flat ground towing only. Do not tow at an angle. The tow hook should not be used to tow the vehicle onto a flat bed. Do not use it as a tie down.

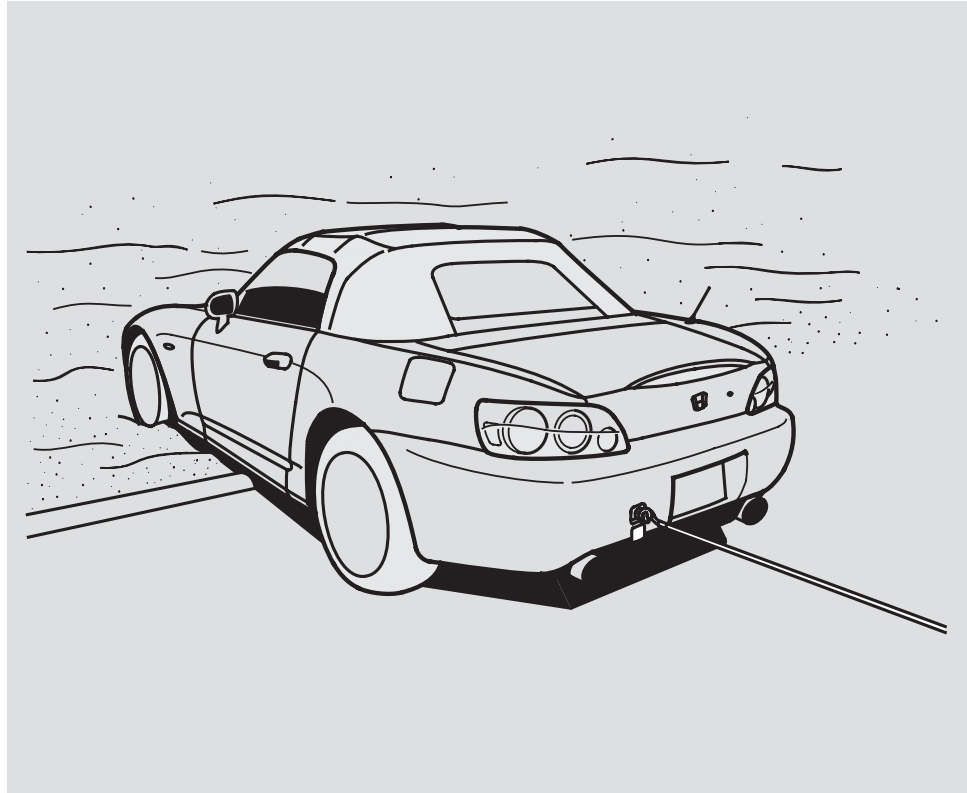

Taking Care of the Unexpected



06/07/13 17:37:52 31S2A670 0203

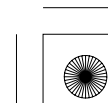
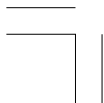



Technical Information

The diagrams in this section give you the dimensions and capacities of your vehicle and the locations of the identification numbers. It also includes information you should know about your vehicle's tires and emissions control systems.

Identification Numbers.....	200	Emissions Controls.....	207
Specifications	202	The Clean Air Act.....	207
DOT Tire Quality Grading		Crankcase Emissions Control	
(U.S. Vehicles)	204	System.....	207
Uniform Tire Quality		Evaporative Emissions Control	
Grading	204	System.....	207
Treadwear	204	Onboard Refueling Vapor	
Traction.....	204	Recovery	207
Temperature	205	Exhaust Emissions Controls ...	208
Tire Labeling.....	206	PGM-FI System	208
		Ignition Timing Control	
		System.....	208
		Three Way Catalytic	
		Converter.....	208
		Replacement Parts.....	208
		Three Way Catalytic Converter...	209
		State Emissions Testing	210

Technical Information



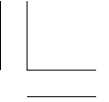

Identification Numbers

Your vehicle has several identifying numbers located in various places.

The vehicle identification number (VIN) is the 17-digit number your dealer uses to register your vehicle for warranty purposes. It is also necessary for licensing and insuring your vehicle. The easiest place to find the VIN is on a plate fastened to the top of the dashboard. You can see it by looking through the windshield on the driver's side. It is also on the certification label attached to the driver's doorjamb, and is stamped on the engine compartment bulkhead. The VIN is also provided in bar code on the certification label.

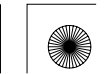
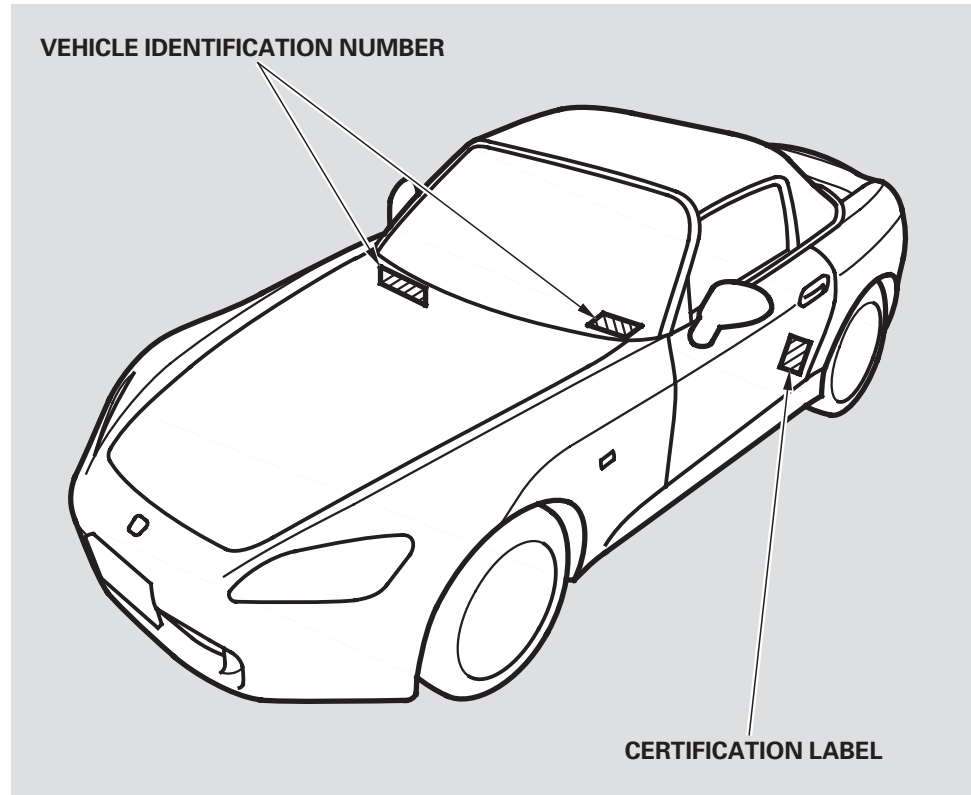

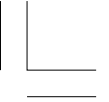

Identification Numbers

The engine number is stamped on the front right corner of the engine block, below the valve cover.

The transmission number is on a label underneath the transmission.

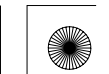
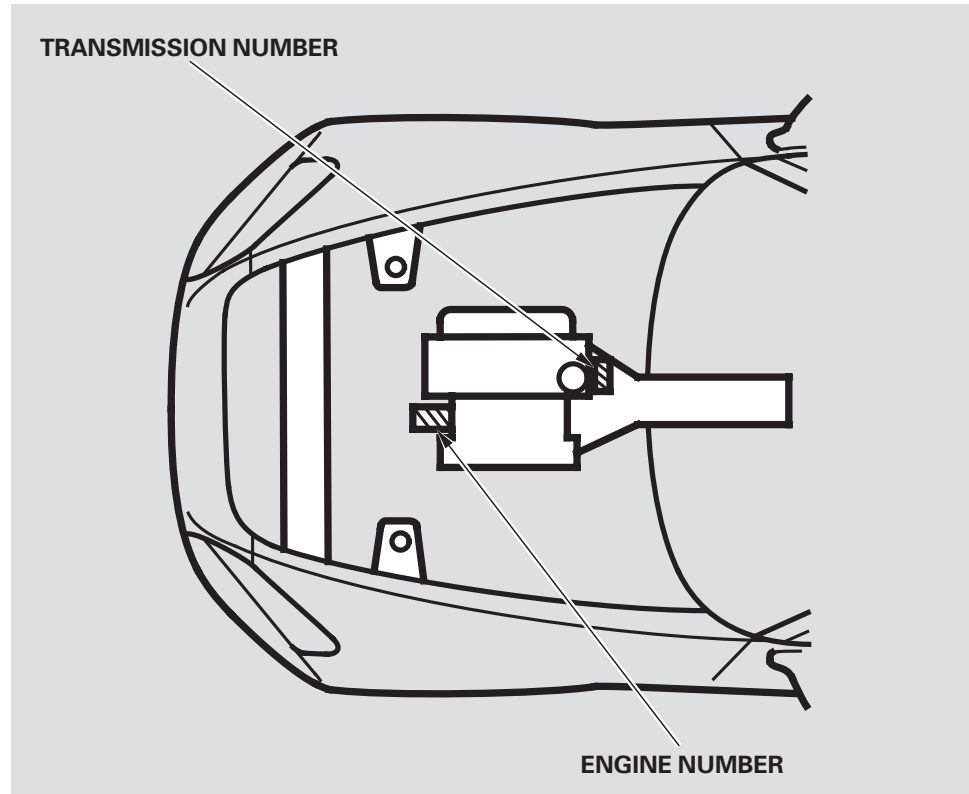



Specifications

Dimensions

Length	162.0 in (4,115 mm)
Width	68.9 in (1,750 mm)
Height	50.6 in (1,285 mm)
Wheelbase	94.5 in (2,400 mm)
Track	Front 57.9 in (1,470 mm)
	Rear 59.4 in (1,510 mm)

Weights

Gross vehicle weight rating (GVWR)	See the certification label attached to the driver's doorjamb.
------------------------------------	--

Engine

Type	Water cooled 4-stroke DOHC VTEC 4-cylinder gasoline engine
Bore x Stroke	3.43 x 3.57 in (87.0 x 90.7 mm)
Displacement	132 cu-in (2,157 cm ³)
Compression ratio	11.1 : 1
Spark plugs	NGK : PFR7G-11S DENSO : PK22PR-L11S
Spark Plug Gap	0.04 in (1.1 mm) ^{+ 0 mm} _{- 0.1 mm}

Capacities

Fuel tank		13.2 US gal (50 ℓ)
Engine coolant	Change* ¹	1.72 US gal (6.5 ℓ)
	Total	2.01 US gal (7.6 ℓ)
Engine oil	Change* ²	
	Including filter	5.1 US qt (4.8 ℓ)
	Without filter	4.8 US qt (4.5 ℓ)
	Total	5.9 US qt (5.6 ℓ)
Manual transmission fluid	Change	1.6 US qt (1.5 ℓ)
	Total	1.7 US qt (1.6 ℓ)
Differential fluid	Change	0.78 US qt (0.74 ℓ)
	Total	0.81 US qt (0.77 ℓ)
Windshield washer reservoir	U.S. Vehicles	2.6 US qt (2.5 ℓ)
	Canadian Vehicles	6.3 US qt (6.0 ℓ)

* 1 : Including the coolant in the reserve tank and that remaining in the engine

Reserve tank capacity:
0.16 US gal (0.6 ℓ)

* 2 : Excluding the oil remaining in the engine





Specifications

Lights

Headlights	High	12 V — 55 W (H1)
	Low*	12 V — 35 W
Front turn signal lights		12 V — 21 W
Rear turn signal lights		12 V — 21 W
Front side marker/ parking lights		12 V — 5 W (AMBER)
Back-up lights		12 V — 21 W
License plate light		12 V — 5 W
Interior light		12 V — 5 W
Trunk light		12 V — 5 W
Side turn signal lights		12 V — 5 W

* : High voltage discharge type

Air conditioning

Refrigerant type	HFC-134a (R-134a)
Charge quantity	21.2 – 22.9 oz (600 – 650 g)* ¹ 24.7 – 26.5 oz (700 – 750 g)* ²
Lubricant type	SP-10

* 1 : U. S. model

* 2 : Canadian model

Battery

Capacity	12 V — 36 AH/5 HR
----------	-------------------

Fuses

Under-hood	See page 195 or the fuse box cover.
Interior	See page 194 or the fuse label attached to the inside of the fuse box door under the dashboard.

Alignment

Toe	Front	0.00 in (0.0 mm)
	Rear	in 0.15 in (3.7 mm)
Camber	Front	– 0°30'
	Rear	– 1°30'
Caster	Front	6°

Tires

Size	Front	215/45R17 87W
	Rear	245/40R17 91W
	Spare Tire	T125/70D16 96M
Pressure	Front	32 psi (220 kPa , 2.2 kgf/cm ²)
	Rear	32 psi (220 kPa , 2.2 kgf/cm ²)
	Spare Tire	60 psi (420 kPa , 4.2 kgf/cm ²)





DOT Tire Quality Grading (U.S. Vehicles)

The tires on your vehicle meet all U.S. Federal Safety Requirements. All tires are also graded for treadwear, traction, and temperature performance according to Department of Transportation (DOT) standards. The following explains these gradings.

Uniform Tire Quality Grading

Quality grades can be found where applicable on the tire sidewall between the tread shoulder and the maximum section width. For example:

Treadwear 200
Traction AA
Temperature A

All passenger car tires must conform to Federal Safety Requirements in addition to these grades.

Treadwear

The treadwear grade is a comparative rating based on the wear rate of the tire when tested under controlled conditions on a specified government test course. For example, a tire graded 150 would wear one and one-half (1 1/2) times as well on the government course as a tire graded 100. The relative performance of tires depends upon the actual conditions of their use, however, and may depart significantly from the norm due to variations in driving habits, service practices, and differences in road characteristics and climate.

Traction – AA, A, B, C

The traction grades, from highest to lowest, are AA, A, B, and C. Those grades represent the tire's ability to stop on wet pavement as measured under controlled conditions on specified government test surfaces of asphalt and concrete. A tire marked C may have poor traction performance.

Warning: The traction grade assigned to this tire is based on straight-ahead braking traction tests, and does not include acceleration, cornering, hydroplaning, or peak traction characteristics.





DOT Tire Quality Grading (U.S. Vehicles)

Temperature – A, B, C

The temperature grades are A (the highest), B, and C, representing the tire's resistance to the generation of heat and its ability to dissipate heat when tested under controlled conditions on a specified indoor laboratory test wheel. Sustained high temperature can cause the material of the tire to degenerate and reduce tire life, and excessive temperature can lead to sudden tire failure. The grade C corresponds to a level of performance which all passenger car tires must meet under the Federal Motor Vehicle Safety Standard No. 109. Grades B and A represent higher levels of performance on the laboratory test wheel than the minimum required by law.

Warning: The temperature grade for this tire is established for a tire that is properly inflated and not overloaded. Excessive speed, underinflation, or excessive loading, either separately or in combination, can cause heat buildup and possible tire failure.



Technical Information





Tire Labeling

The tires that came on your vehicle have a number of markings. Those you should be aware of are described below.

Tire Size

Whenever tires are replaced, they should be replaced with tires of the same size. The following is an example of tire size with an explanation of what each component means.

245/40R17 91W

- 245 – Tire width in millimeters.
- 40 – Aspect ratio (the tire's section height as a percentage of its width).
- R – Tire construction code (R indicates radial).
- 17 – Rim diameter in inches.

91 – Load index (a numerical code associated with the maximum load the tire can carry).

W – Speed symbol (an alphabetical code indicating the maximum speed rating).

Tire Identification Number

The tire identification number (TIN) is a group of numbers and letters that look like the following example TIN. TIN is located on the sidewall of the tire.

DOT B97R FW6X 2202

DOT – This indicates that the tire meets all requirements of the U.S. Department of Transportation.

B97R – Manufacturer's identification mark.

FW6X – Tire type code.

2202 – Date of manufacture.

Maximum Tire Pressure

Max Press – The maximum air pressure the tire can hold.

Maximum Tire Load

Max Load – The maximum load the tire can carry at maximum air pressure.





Emissions Controls

The burning of gasoline in your vehicle's engine produces several by-products. Some of these are carbon monoxide (CO), oxides of nitrogen (NOx), and hydrocarbons (HC). Gasoline evaporating from the tank also produces hydrocarbons. Controlling the production of NOx, CO, and HC is important to the environment. Under certain conditions of sunlight and climate, NOx and HC react to form photochemical "smog." Carbon monoxide does not contribute to smog creation, but it is a poisonous gas.

The Clean Air Act

The United States Clean Air Act* sets standards for automobile emissions. It also requires that automobile manufacturers explain to owners how their emissions controls work and what to do to maintain them. This section summarizes how the emissions controls work.

* In Canada, Honda vehicles comply with the Canadian emission requirements, as specified in an agreement with Environment Canada, at the time they are manufactured.

Crankcase Emissions Control System

Your vehicle has a positive crankcase ventilation system. This keeps gasses that build up in the engine's crankcase from going into the atmosphere. The positive crankcase ventilation valve routes them from the crankcase back to the

intake manifold. They are then drawn into the engine and burned.

Evaporative Emissions Control System

As gasoline evaporates in the fuel tank, an evaporative emissions control canister filled with charcoal adsorbs the vapor. It is stored in this canister while the engine is off. After the engine is started and warmed up, the vapor is drawn into the engine and burned during driving.

Onboard Refueling Vapor Recovery

The onboard refueling vapor recovery (ORVR) system captures the fuel vapors during refueling. The vapors are adsorbed in a canister filled with activated carbon. While driving, the fuel vapors are drawn into the engine and burned off.





Emissions Controls

Exhaust Emissions Controls

The exhaust emissions controls include three systems: PGM-FI, ignition timing control, and three way catalytic converter. These three systems work together to control the engine's combustion and minimize the amount of HC, CO, and NOx that comes out the tailpipe. The exhaust emissions control systems are separate from the crankcase and evaporative emissions control systems.

PGM-FI System

The PGM-FI System uses sequential multiport fuel injection. It has three subsystems: air intake, engine control, and fuel control. The engine control module (ECM) uses various sensors to determine how much air is going into the engine. It then controls how much fuel to inject under all operating conditions.

Ignition Timing Control System

This system constantly adjusts the ignition timing, reducing the amount of HC, CO, and NOx produced.

Three Way Catalytic Converter

The three way catalytic converter is in the exhaust system. Through chemical reactions, it converts HC, CO, and NOx in the engine's exhaust to carbon dioxide (CO₂), nitrogen (N₂), and water vapor.

Replacement Parts

The emissions control systems are designed and certified to work together in reducing emissions to levels that comply with the Clean Air Act. To make sure the emissions remain low, you should use only new Honda replacement parts or their equivalent for repairs. Using lower quality parts may increase the emissions from your vehicle.

The emissions control systems are covered by warranties separate from the rest of your vehicle. Read your warranty manual for more information.





Three Way Catalytic Converter

The three way catalytic converter contains precious metals that serve as catalysts, promoting chemical reactions to convert the exhaust gasses without affecting the metals. The catalytic converter is referred to as a three-way catalyst, since it acts on HC, CO, and NOx. A replacement unit must be an original Honda part or its equivalent.

The three way catalytic converter must operate at a high temperature for the chemical reactions to take place. It can set on fire any combustible materials that come near it. Park your vehicle away from high grass, dry leaves, or other flammables.

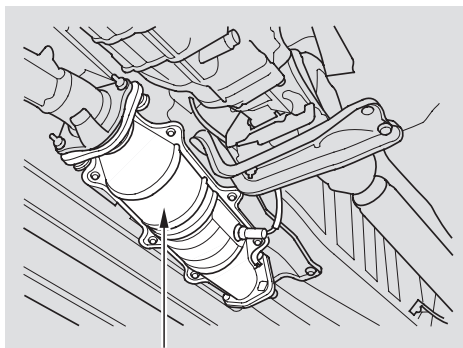

THREE WAY CATALYTIC CONVERTER

A defective three way catalytic converter contributes to air pollution, and can impair your engine's performance. Follow these guidelines to protect your vehicle's three way catalytic converter.

- Always use unleaded gasoline. Even a small amount of leaded gasoline can contaminate the catalyst metals, making the three way catalytic converter ineffective.

- Keep the engine well maintained.
- Have your vehicle diagnosed and repaired if it is misfiring, back-firing, stalling, or otherwise not running properly.



State Emissions Testing

Testing of Readiness Codes

If you take your vehicle for a state emissions test shortly after the battery has been disconnected or gone dead, it may not pass the test. This is because of certain “readiness codes” that must be set in the on-board diagnostics for the emissions systems. These codes are erased when the battery is disconnected, and set again only after several days of driving under a variety of conditions.

If the testing facility determines that the readiness codes are not set, you will be requested to return at a later date to complete the test. If you must get the vehicle retested within the next two or three days, you can condition the vehicle for retesting by doing the following.

- Make sure the gas tank is nearly, but not completely, full (around 3/4).

- Make sure the vehicle has been parked with the engine off for 6 hours or more.
- Make sure the ambient temperature is between 40° and 95° F.
- Without touching the accelerator pedal, start the engine, and let it idle for 20 seconds.
- Keep the vehicle in Neutral. Increase the engine speed to 2,000 rpm, and hold it there until the temperature gauge rises to at least 1/4 of the scale (about 3 minutes).
- Select a nearby lightly traveled major highway where you can maintain a speed of 50 to 60 mph (80 to 97 km/h) for at least 20 minutes. Drive on the highway in 6th. Do not use the cruise control. When traffic allows, drive for 90 seconds without moving the

accelerator pedal. (Vehicle speed may vary slightly; this is okay.) If you cannot do this for a continuous 90 seconds because of traffic conditions, drive for at least 30 seconds, then repeat it two more times (for a total of 90 seconds).

- Then drive in city/suburban traffic for at least 10 minutes. When traffic conditions allow, let the vehicle coast for several seconds without using the accelerator pedal or the brake pedal.
- Stop the vehicle, turn off the ignition switch, and leave it off for 30 minutes.

If the testing facility determines the readiness codes are still not set, see your dealer.





Warranty and Customer Relations

Customer Service	
Information.....	212
Warranty Coverages	213
Reporting Safety Defects	
(U.S. Vehicles)	214
Authorized Manuals.....	215

Warranty and Customer Relations





Customer Service Information

Honda dealership personnel are trained professionals. They should be able to answer all your questions. If you encounter a problem that your dealership does not solve to your satisfaction, please discuss it with the dealership's management. The service manager or general manager can help. Almost all problems are solved in this way.

If you are dissatisfied with the decision made by the dealership's management, contact your Honda Customer Service Office.

U.S. Owners:
American Honda Motor Co., Inc.
Automobile Customer Service
Mail Stop 500-2N-7A
1919 Torrance Boulevard
Torrance, California 90501-2746

Tel: (800) 999-1009

Canadian Owners:
CUSTOMER RELATIONS
RELATIONS AVEC LA CLIENTÉLE

Honda Canada Inc.
715 Milner Avenue
Toronto, ON
M1B 2K8

Tel: 1-888-9-HONDA-9
Fax: Toll-free 1-877-939-0909
Toronto (416) 287-4776

In Puerto Rico and the U.S. Virgin Islands:

Vortex Motor Corp.
Bella International
P.O. Box 190816
San Juan, PR 00919-0816

Tel: (787) 620-7546

When you call or write, please give us this information:

- Vehicle identification number (see page 200)
- Name and address of the dealer who services your vehicle
- Date of purchase
- Mileage on your vehicle
- Your name, address, and telephone number
- A detailed description of the problem
- Name of the dealer who sold the vehicle to you





Warranty Coverages

U.S. Owners

Your new vehicle is covered by these warranties:

New Vehicle Limited Warranty – covers your new vehicle, except for the battery, emissions control systems, and accessories, against defects in materials and workmanship.

Emissions Control Systems Defects Warranty and Emissions Performance Warranty – these two warranties cover your vehicle’s emissions control systems. Time, mileage, and coverage are conditional. Please read your warranty booklet for exact information.

Original Equipment Battery Limited Warranty – this warranty gives up to 100 % credit toward a replacement battery.

Seat Belt Limited Warranty – a seat belt that fails to function properly is covered by a limited warranty. Please read your warranty booklet for details.

Rust Perforation Limited Warranty – all exterior body panels are covered for rust-through from the inside for the specified time period with no mileage limit.

Accessory Limited Warranty – Honda accessories are covered under this warranty. Time and mileage limits depend on the type of accessory and other factors. Please read your warranty booklet for details.

Replacement Parts Limited Warranty – covers all Honda replacement parts against defects in materials and workmanship.

Replacement Battery Limited Warranty – provides prorated coverage for a replacement battery purchased from your dealer.

Replacement Muffler Lifetime Limited Warranty – provides coverage for as long as the purchaser of the muffler owns the vehicle.

Restrictions and exclusions apply to all these warranties. Please read the 2007 Honda warranty information booklet that came with your vehicle for precise information on warranty coverages. Your vehicle’s original tires are covered by their manufacturer. Tire warranty information is in a separate booklet.

Canadian Owners

Please refer to the 2007 warranty manual that came with your vehicle.





Reporting Safety Defects (U.S. Vehicles)

If you believe that your vehicle has a defect which could cause a crash or could cause injury or death, you should immediately inform the National Highway Traffic Safety Administration (NHTSA) in addition to notifying American Honda Motor Co., Inc.

If NHTSA receives similar complaints, it may open an investigation, and if it finds that a safety defect exists in a group of vehicles, it may order a recall and remedy campaign. However, NHTSA cannot become involved in individual problems between you, your dealer, or American Honda Motor Co., Inc.

To contact NHTSA, you may call the Vehicle Safety Hotline toll-free at 1-888-327-4236 (TTY: 1-800-424-9153); go to <http://www.safercar.gov>; or write to: Administrator, NHTSA, 400 Seventh Street, SW., Washington, DC 20590. You can also obtain other information about motor vehicle safety from <http://www.safercar.gov>.

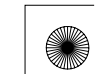



Authorized Manuals

Purchasing Factory Authorized Manuals (U.S. only)

The publications shown below can be purchased from Helm Incorporated. You can order in any of three ways:

- Detach and mail the order form on the right half of this page
- Call Helm Inc. at 1-800-782-4356 (credit card orders only)
- Go online at www.helminc.com

If you are interested in other years or models, contact Helm Inc. at 1-800-782-4356.

Publication Form Number	Form Description	Price Each*
61S2A07	2000-2007 Honda S2000 Service Manual	\$75.00
61S2A07EL	2000-2007 Honda S2000 Electrical Troubleshooting Manual	\$50.00
61S2A30	2000-2007 Honda S2000 Body Repair Manual	\$44.00
31S2A670	2007 Honda S2000 Owner's Manual	\$35.00
31S2AM20	2007 Honda S2000 Honda Service History	\$12.00
31S2AQ40	2007 Honda S2000 Quick Start Guide	\$12.00
HON-R	Order Form for Previous Years- Indicate Year and Model Desired	FREE

* Prices are subject to change without notice and without incurring obligation.

Valid only for sales within the United States. Canadian owners should contact their authorized Honda dealer.

ORDER TOLL FREE: 1-800-782-4356

(NOTE: For Credit Card Holder Orders Only)

Monday-Friday 8:00 A.M. – 6:00 P.M. EST

MINIMUM CREDIT CARD PURCHASE \$10.00

OR

By completing this form you can order the materials desired. You can pay by check or money order, or charge to your credit card. Mail to Helm Incorporated at the address shown on the back of the order form.

2007 HON	PUBLICATION NUMBER	VEHICLE MODEL		Qty	Price Each*	Total Price
		Name	Year			
* Prices are subject to change without notice and without incurring obligation.					TOTAL MATERIAL	
					Mich. Purchases Add 6% Sales Tax	
Orders are mailed within 10 days. Please allow adequate time for delivery.					HANDLING CHARGE	\$6.95
					GRAND TOTAL	

Authorized Manuals





Authorized Manuals

**S
H
I
P

T
O**

NOTE: Dealers and Companies please provide dealer or company name, and also the name of the person to whose attention the shipment should be sent. For purchases outside U.S.A. please write to the address shown below for a quotation.

Customer Name _____ Attention _____

Street Address — No P.O. Box Number _____ Apartment Number _____

City _____ State & Zip Code _____

Daytime Telephone Number () _____

**P
A
Y
M
E
N
T**

Check or money order enclosed payable to Helm Inc — U.S. funds only. Do not send cash

Master Card VISA Check here if your billing address is different from the shipping address shown above.

Account Number _____ Expiration: Mo. Yr. _____

CUSTOMER SIGNATURE _____ DATE _____

These Publications cannot be returned for credit without receiving advance authorization within 14 days of delivery. On returns, a restocking fee may be applied against the original order.

HELM P.O. BOX 07280-DETROIT, MICHIGAN 48207-1-800-782-4356

Service Manual:

This manual covers maintenance and recommended procedures for repair to engine and chassis components. It is written for the journeyman mechanic, but is simple enough for most mechanically-inclined owners to understand.

Electrical Troubleshooting Manual:

This manual complements the service manual by providing in-depth troubleshooting information for each electrical circuit in your vehicle.

Body Repair Manual:

This manual describes the procedures involved in the replacement of damaged body parts.





Index

A

- Accessories..... 115
- ACCESSORY (Ignition Key Position) 62
- Accessory Power Socket 78
- Additives, Engine Oil..... 146
- Airbag (SRS) 9, 20
- Air Conditioning System..... 84
 - Usage..... 86
- Air Pressure, Tires 165
- Alcohol in Gasoline..... 110
- AM/FM Stereo Radio
 - Reception..... 91
- Antifreeze 149
- Anti-lock Brakes (ABS)
 - Indicator..... 45, 129
 - Operation..... 128
- Anti-theft Steering Column Lock .. 62
- Anti-theft System..... 61
- Audio Panel..... 79
- Audio System 88
- Automatic Seat Belt Tensioners 18
- Automatic Speed Control..... 106

B

- Back-up Light Replacement 159
- Battery
 - Charging System
 - Indicator..... 46, 186
 - Jump Starting 182
 - Maintenance..... 169
 - Specifications 203
- Before Driving 109
- Belts, Seat 8, 16
- Beverage Holder..... 78
- Booster Seats 38
- Brakes..... 127
 - Anti-lock System (ABS) 128
 - Break-in, New Linings 110
 - Fluid 154
 - Parking..... 76
 - System Design 128
 - System Indicator..... 46, 188
 - Wear Indicators 128
- Braking System..... 127
- Break-in, New Vehicle 110
- Brightness Control, Instruments... 58
- Brights, Headlights 57

- Bulb Replacement..... 155
 - Back-up Lights 159
 - Headlights 155
 - Side Turn Signal Lights 158
 - Specifications 203
 - Turn Signal Lights..... 157
- Bulbs, Halogen..... 155

C

- Capacities Chart..... 202
- Carbon Monoxide Hazard 41
- Cargo, How to Carry 117
- CAUTION, Explanation of iii
- CD Care 101
- CD Changer..... 100
- CD Changer Error Messages 103
- CD Player Error Messages 102
- CD Player..... 98
- Certification Label..... 200
- Chains, Tires 168
- Changing a Flat Tire 175

INDEX

CONTINUED





Index

Changing Oil
 How to..... 147
 When to..... 135
 Charging System Indicator 46, 186
 Checklist, Before Driving..... 123
 Child Safety 29
 Booster Seats 38
 Child Seats..... 34
 Important Safety Reminders..... 32
 Larger Children 37
 Risk with Airbags 30
 Small Children..... 33
 Child Seats..... 34
 Cleaning Seat Belts..... 160
 Clock..... 54
 Clutch Fluid..... 154
 CO in the Exhaust 207
 Cold Weather, Starting in 124
 Compact Spare Tire..... 174
 Consumer Information* 212
 Controls, Instruments and..... 43
 Convertible Top 70
 Convertible Top Cover..... 72
 Lowering the Convertible Top... 70
 Maintenance..... 74
 Raising the Convertible Top 73

Coolant
 Adding..... 149
 Checking..... 114
 Proper Solution 149
 Temperature Gauge..... 53
 Crankcase Emission Control
 System..... 207
 Cruise Control Indicator 47
 Cruise Control Operation 106
 Cup Holder 78
 Customer Service Office 212

D

DANGER, Explanation of iii
 Dashboard 3, 44
 Dashboard Lower Pocket..... 80
 Daytime Running Lights..... 57
 Daytime Running Lights
 Indicator..... 48
 Dead Battery 182
 Defects, Reporting Safety* 214
 Defogger, Rear Window 59
 Defrosting the Windows..... 87
 Differential Fluid 153
 Dimensions..... 202

Dimming the Headlights 57
 Dipstick
 Engine Oil..... 113
 Directional Signals..... 57
 Disc Brake Wear Indicators..... 128
 Disposal of Used Oil..... 149
 Do Not Tow a Trailer 131
 Doors
 Locking and Unlocking..... 63
 Monitor Indicator 47
 Power Door Locks..... 63
 DOT Tire Quality Grading* 204
 Downshifting, Manual
 Transmission..... 126
 Driver and Passenger Safety..... 5
 Driving 121
 Economy 114
 Driving Guidelines..... 122
 Dust and Pollen Filter 161

E

Economy, Fuel 114
 Emergencies..... 173
 Battery, Jump Starting 182
 Brake System Indicator 188





Index

- Changing a Flat Tire 175
- Charging System Indicator 186
- Checking the Fuses..... 191
- Closing the Convertible Top ... 189
- Hazard Warning Flashers 58
- Jump Starting 182
- Low Oil Pressure Indicator 186
- Malfunction Indicator Lamp ... 187
- Overheated Engine 183
- Towing 196
- Emergency Brake..... 76
- Emergency Flashers 58
- Emergency Towing 196
- Emergency Trunk Opener 64
- Emissions Controls..... 207
- Emissions Testing, State 210
- Engine
 - Adding Engine Coolant..... 149
 - Coolant Temperature Gauge 53
 - If It Won't Start 180
 - Malfunction Indicator Lamp 47, 187
 - Oil Life Indicator..... 136
 - Oil Pressure Indicator 46, 186
 - Oil, What Kind to Use 146
 - Overheating..... 183

- Specifications 202
- Speed Limiter..... 126
- Start Button 124
- Starting..... 124
- Ethanol in Gasoline 110
- Evaporative Emission Controls... 207
- Exhaust Fumes 41
- Expectant Mothers, Use of Seat Belts by 14

F

- Fan, Interior..... 85
- Features..... 83
- Filling the Fuel Tank..... 111
- Filters
 - Dust and Pollen..... 161
 - Oil 147
- Flashers, Hazard Warning..... 58
- Flat Tire, Changing a 175
- Fluids
 - Brake..... 154
 - Clutch..... 154
 - Manual Transmission 152
 - Windshield Washer 151
- Four-way Flashers 58

- Fuel..... 110
 - Fill Door and Cap..... 111
 - Gauge 52
 - Low Fuel Indicator 49
 - Octane Requirement 110
 - Oxygenated 110
 - Tank, Refueling 111
- Fuel Economy 114
- Fuel Station Procedures 111
- Fuses, Checking the..... 191

G

- Gas Mileage, Improving..... 114
- Gasoline 110
 - Gauge 52
 - Low Fuel Indicator 49
 - Octane Requirement 110
 - Tank, Refueling 111
- Gauges 51
 - Engine Coolant Temperature ... 53
 - Fuel..... 52
- Gearshift Lever Positions
 - Manual Transmission 126

INDEX

CONTINUED





Index

Gross Vehicle Weight Rating (GVWR)..... 118, 202

H

Halogen Headlight Bulbs..... 155
 Hazard Warning Flashers..... 58
 Headlights
 Aiming..... 155
 Daytime Running Lights..... 57
 High Beam Indicator..... 49
 Reminder Tone..... 57
 Replacing Halogen Bulbs..... 155
 Turning on..... 57
 Heating and Cooling System..... 85
 High Beam Lever..... 57
 Hood, Opening the..... 112
 Horn..... 55
 Hydraulic Clutch..... 154

I

Identification Number, Vehicle..... 200
 Ignition Keys..... 60

Switch..... 62
 Timing Control System..... 208
 Immobilizer System..... 61
 Important Safety Precautions..... 6
 Indicators
 ABS (Anti-Lock Brake)..... 47
 Brake (Parking and Brake System)..... 46, 188
 Charging System..... 46, 186
 Cruise Control..... 47
 Door-open..... 47
 DRL (Daytime Running Lights)..... 48
 EPS (Electrical Power Steering)..... 48
 High Beam..... 49
 Key (Immobilizer System)..... 49
 Low Fuel..... 49
 Low Oil Pressure..... 46, 186
 Maintenance Required..... 50
 Malfunction Indicator Lamp..... 47, 187
 Seat Belt..... 46
 SRS..... 47
 Trunk-open..... 47

Turn Signal and Hazard Warning..... 48
 VSA (Vehicle Stability Assist) ... 50
 Indicators, Instrument Panel..... 46
 Inflation, Proper Tire..... 164
 Recommended Pressures..... 165
 Inside Mirror..... 75
 Inspection, Tire..... 165
 Installing a Child Seat..... 34
 Instrument Panel..... 45
 Instrument Panel Brightness..... 58
 Interior Lights..... 80
 Introduction..... i

J

Jacking Up the Vehicle..... 176
 Jack, Tire..... 175
 Jump Starting..... 182

K

Keys..... 60

IV





Index

L

Label, Certification 200
 Lane Change, Signaling 57
 Lap/Shoulder Belts 12, 17
 Lights
 Bulb Replacement 155
 Turn Signal 57
 Load Limits 118
 LOCK (Ignition Key Position) 62
 Locks
 Anti-theft Steering Column 62
 Fuel Fill Door 111
 Power Door 63
 Trunk 63
 Low Coolant Level 114
 Low Fuel Indicator 49
 Low Oil Pressure Indicator 46, 186
 Lubricant Specifications Chart 202
 Luggage, Storing (Cargo) 117

M

Maintenance 133
 Minder 135
 Minder Indicator 50

Owner's Maintenance
 Checks 141
 Record 143
 Safety 134
 Malfunction Indicator Lamp .. 47, 187
 Manual Transmission 125
 Manual Transmission Fluid 152
 Meters, Gauges 51
 Methanol in Gasoline 110
 Mirrors, Adjusting 75
 Modifying Your Vehicle 116

N

New Vehicle Break-in 110
 Normal Shift Speeds 126
 NOTICE, Explanation of i
 Numbers, Identification 200

O

Octane Requirement, Gasoline 110
 Odometer 51
 Odometer, Trip 51
 Oil
 Change, How to 147

Change, When to 135
 Checking Engine 113
 Pressure Indicator 46, 186
 Selecting Proper Viscosity
 Chart 147
 ON (Ignition Key Position) 62
 Onboard Refueling Vapor
 Recovery 207
 Opening the Trunk 63
 Outside Mirrors 75
 Outside Temperature Indicator 53
 Overheating, Engine 183
 Owner's Maintenance Checks 141
 Oxygenated Fuels 110

P

Panel Brightness Control 58
 Parking 127
 Parking Brake 76
 Parking Brake and Brake System
 Indicator 188
 Parking Lights 57
 PGM-FI System 208

CONTINUED

INDEX

V





Index

Pollen Filter	161
Power Door Locks	63
Power Socket Location	78
Power Windows	68
Pregnancy, Using Seat Belts	14
Preparing to Drive	123
Protecting Adults and Teens.....	10
Additional Safety Precautions....	15
Advice for Pregnant Women.....	14
Protecting Children	29
General Guidelines	29
Protecting Larger Children	37
Protecting Small Children	33

R

Radiator Overheating	183
Radio/CD Sound System.....	88
Radio Theft Protection.....	105
Readiness Codes.....	187, 210
Rear Lights, Bulb Replacement...	159
Rear View Mirror.....	75
Rear Window Defogger	59
Reclining the Seat-backs.....	67
Recommended Shift Speeds	126

Recovery Vehicle, Emergency	
Towing	196
Refueling.....	111
Reminder Indicators.....	45
Remote Transmitter	65
Replacement Information	
Dust and Pollen Filter	161
Engine Oil and Filter	147
Fuses	190
Light Bulbs	155
Schedule	142
Tires	167
Wiper Blades	162

Replacing Seat Belts After a	
Crash	18
Reporting Safety Defects*	214
Reserve Tank, Engine	
Coolant	114, 149
Restraint, Child	29
Reverse Lockout.....	126
Rotation, Tire	166

S

Safety Belts.....	8, 16
Safety Defects, Reporting*	214

Safety Features	7
Airbags.....	9
Seat Belts	8
Safety Labels, Location of	42
Safety Messages	iii
Satellite Radio*	93
Seat Belts	8, 16
Additional Information.....	16
Advice for Pregnant Women.....	14
Automatic Seat Belt	
Tensioners.....	18
Cleaning	160
Lap/Shoulder Belt.....	17
Maintenance.....	18
Reminder Indicator and	
Beeper.....	16, 46
System Components.....	16
Use During Pregnancy.....	14
Seats, Adjusting the.....	67
Serial Number	200
Service Intervals	141, 142
Service Manual*	215
Service Station Procedures	111
Setting the Clock	54
Shifting	
Manual Transmission	125





Index

Side Turn Signal, Bulb Replacement..... 158	State Emissions Testing 210	Time, Setting the 54
Signaling Turns..... 57	Steam Coming from Engine..... 183	Tire Chains..... 168
Snow Tires..... 168	Steering Wheel	Tire, How to Change a Flat 175
Sound System..... 88	Anti-theft Column Lock 62	Tire Labeling..... 206
Spare Tire	Stereo Sound System 88	Tires 163
Inflating..... 165	Storing Your Vehicle 171	Air Pressure 165
Specifications 203	Stuck Vehicle 196	Balancing 166
Spark Plugs..... 202	Supplemental Restraint System	Chains 168
Specifications 202	Servicing 27	Checking Wear 165, 166
Speed Control..... 106	SRS Indicator..... 25, 47	Compact Spare Tire 174
Speed Limiter 126	System Components..... 20	DOT Tire Quality Grading* 204
SRS, Additional Information..... 20	Synthetic Oil..... 147	Inflation..... 164
Additional Safety Precautions... 28		Inspection 165
Airbag Service..... 27	T	Replacing 167
Airbag System Components..... 20	Taillights, Changing Bulbs..... 159	Rotation, Do not..... 166
How the SRS Indicator	Taking Care of the Unexpected .. 173	Snow 168
Works..... 25	Technical Descriptions	Specifications 203
How Your Airbags	DOT Tire Quality Grading* 204	Wear 165, 166
Work..... 22	Emissions Control Systems..... 207	Tools, Tire Changing 175
SRS Indicator..... 25, 47	Three Way Catalytic	Towing
Start Button 124	Converter..... 209	A Trailer, Do Not..... 131
Starting the Engine..... 124	Temperature Gauge 53	Emergency Wrecker 196
In Cold Weather at High	Tensioners, Seat Belts 18	Trailer, Do Not Tow a..... 131
Altitude 124	Theft Protection, Radio..... 105	
With a Dead Battery 182	Three Way Catalytic Converter... 209	

INDEX

CONTINUED



Index

Transmission
 Checking Fluid Level, Manual
 Transmission..... 152
 Fluid Selection..... 152
 Identification Number..... 201
 Shifting the Manual
 Transmission..... 125
 Treadwear 204
 Trip Meter 51
 Trunk..... 63
 Emergency Trunk Opener 64
 Opening the 63
 Open Monitor Indicator 47
 Turn Signals 57

U

Unexpected, Taking Care
 of the 173
 Uniform Tire Quality Grading* ... 204
 Unleaded Gasoline..... 110
 Used Oil, How to Dispose of 149

V

Vehicle Capacity Load 118

Vehicle Dimensions..... 202
 Vehicle Identification Number.... 200
 Vehicle Stability Assist (VSA)
 System..... 130
 VSA System Indicator 50
 VSA Activation Indicator 50
 VSA Off Switch..... 131
 Vehicle Storage..... 171
 Ventilation..... 86
 VIN 200
 Viscosity, Oil..... 147

W

WARNING, Explanation of iii
 Warning Labels, Location of 42
 Warranty Coverages* 213
 Washer, Windshield
 Checking the Fluid Level 151
 Operation..... 56
 Wheels 163
 Alignment and Balance..... 166
 Wrench, Nut..... 176
 Windows, Operating the Power.... 68
 Windshield
 Cleaning 56

Defroster 87
 Washers 56
 Wipers, Windshield
 Changing Blades..... 162
 Operation 56
 Worn Tires 167
 Wrecker, Emergency Towing..... 196

X

XM Satellite Radio* 94

*: U.S. only





06/07/13 17:41:05 31S2A670 0230

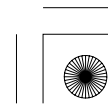
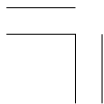



06/07/13 17:41:07 31S2A670 0231

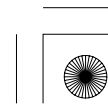
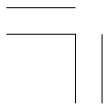



06/07/13 17:41:08 31S2A670 0232

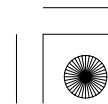
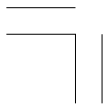



Service Information Summary

Gasoline:

Premium unleaded gasoline, pump octane number of 91 or higher.

Fuel Tank Capacity:

13.2 US gal (50 ℓ)

Recommended Engine Oil:

API premium grade 10W-30 detergent oil (see page 146).

Oil change capacity (including filter):

5.1 US qt (4.8 ℓ)

Manual Transmission Fluid:

Honda Manual Transmission Fluid preferred, or an SAE 10W-30 or 10W-40 motor oil as a temporary replacement (see page 152).

Capacity:

1.7 US qt (1.6 ℓ)

Brake Fluid:

Honda Heavy Duty Brake Fluid DOT 3 preferred, or a DOT 3 or DOT 4 brake fluid as a temporary replacement (see page 154).

Tire Pressure (measured cold):

Front:

32 psi (220 kPa , 2.2 kgf/cm²)

Rear:

32 psi (220 kPa , 2.2 kgf/cm²)

Spare Tire Pressure:

Front:

60 psi (420 kPa , 4.2 kgf/cm²)

