

TABLE OF CONTENTS

| SECTION | | PAGE |
|-----------|--|------------|
| 1 | INTRODUCTION | 3 |
| 2 | THINGS TO KNOW BEFORE STARTING YOUR VEHICLE | 9 |
| 3 | UNDERSTANDING THE FEATURES OF YOUR VEHICLE | 71 |
| 4 | UNDERSTANDING YOUR INSTRUMENT PANEL | 145 |
| 5 | STARTING AND OPERATING | 207 |
| 6 | WHAT TO DO IN EMERGENCIES | 271 |
| 7 | MAINTAINING YOUR VEHICLE | 283 |
| 8 | MAINTENANCE SCHEDULES | 329 |
| 9 | IF YOU NEED CONSUMER ASSISTANCE | 347 |
| 10 | INDEX | 357 |

INTRODUCTION

CONTENTS

| | | | |
|------------------------------------|---|---|---|
| ■ Introduction | 4 | ■ Warnings And Cautions | 7 |
| □ Roll Over Warning | 4 | ■ Vehicle Identification Number | 7 |
| ■ How To Use This Manual | 6 | ■ Vehicle Modifications / Alterations | 8 |

INTRODUCTION

Thank you for selecting a Jeep® Liberty and welcome to our worldwide family.

This is a specialized utility vehicle designed for both on-road and off-road use. It can go places and perform tasks for which conventional two-wheel drive vehicles were not intended. However, on-road ride and handling will have a different feel from what drivers experience with other vehicles, so take time to become familiar with your vehicle.

The two-wheel drive utility vehicle was designed for on-road use only. It is not intended for off-road driving or use in other severe conditions suited to a four-wheel drive vehicle.

Before you start to drive this vehicle, read this manual. Be sure you are familiar with all vehicle controls, particularly those used for braking, steering and transmission and transfer case shifting. Learn how your vehicle

handles on different road surfaces. Your driving skills will improve with experience. When driving off-road or working the vehicle, don't overload it or expect it to overcome the laws of nature. Always observe federal, state, provincial, and local laws wherever you drive.

As with other vehicles of this type, failure to operate this vehicle correctly may result in loss of control or an accident. Be sure to read "On-Road/Off-Road Driving Tips" in Section 5 of this manual.

Roll Over Warning

Utility vehicles have a significantly higher roll over rate than other types of vehicles. This vehicle has a higher ground clearance, higher center of gravity, and narrower track than many passenger cars. It is capable of performing better in a wide variety of off-road applications. Driven in an unsafe manner, all vehicles can be caused to go out of control. Because of the higher center of gravity

and the narrower track, if this vehicle is out of control it may roll over when some other vehicles may not.

Do not attempt sharp turns or abrupt maneuvers or other unsafe driving actions that can cause loss of vehicle control. Failure to operate this vehicle safely may result in an accident, roll over of the vehicle, and severe or fatal injury. Drive carefully.



80bfe0f0

Failure to use driver and passenger seat belts provided is a major cause of severe or fatal injury. In fact, the U.S. government notes that the universal use of existing seat belts could cut the highway death toll by 10,000 or more each year, and could reduce disabling injuries by 2 million annually. In a roll over crash an unbelted person is significantly more likely to die than a person wearing a seat belt. Always buckle up.

This manual has been prepared with the assistance of service and engineering specialists to acquaint you with the operation and maintenance of your new vehicle. It is supplemented by a Warranty Information Booklet and various customer oriented documents. You are urged to read these publications carefully. Following the instructions and recommendations in this manual will help assure safe and enjoyable operation of your vehicle.

NOTE: After you read the manual, it should be stored in the vehicle for convenient reference and remain with the vehicle when sold so that the new owner will be aware of all safety warnings.

When it comes to service, remember that the manufacturer knows your vehicle best, has the factory-trained technicians and genuine Mopar® parts, and is interested in your satisfaction.

WARNING!

Engine exhaust, some of its constituents, and certain vehicle components contain or emit chemicals known to the State of California to cause cancer and birth defects or other reproductive harm. In addition, certain fluids contained in vehicles and certain products of component wear contain or emit chemicals known to the State of California to cause cancer and birth defects or other reproductive harm.

HOW TO USE THIS MANUAL

Consult the table of contents to determine which section contains the information you desire.

The detailed index, at the rear of the manual, contains a complete listing of all subjects.

WARNINGS AND CAUTIONS

This manual contains **WARNINGS** against operating procedures which could result in an accident or bodily injury. It also contains **CAUTIONS** against procedures which could result in damage to your vehicle. If you do not read this entire manual you may miss important information. Observe all Warnings and Cautions.

VEHICLE IDENTIFICATION NUMBER

The vehicle identification number (VIN) is located on a stamped plate on the bottom of the left front A-Pillar, visible from outside of the vehicle through the windshield. This number also appears on the Automobile Information Disclosure Label affixed to a window on your vehicle. Save this label for a convenient record of your vehicle identification number and optional equipment.

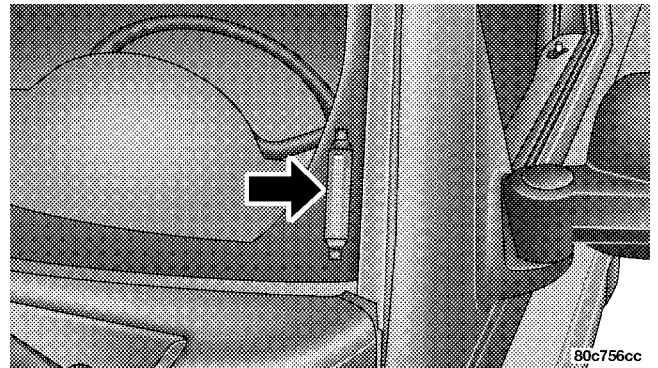

NOTE: It is illegal to remove the VIN plate.

VEHICLE MODIFICATIONS / ALTERATIONS

WARNING!

Any modifications or alterations to this vehicle could seriously affect its roadworthiness and safety and may lead to an accident resulting in serious injury or death.

THINGS TO KNOW BEFORE STARTING YOUR VEHICLE

CONTENTS

| | | | |
|---|-----|---|-----|
| ■ A Word About Your Keys | .12 | □ To Manually Lock The Steering Wheel | .17 |
| □ Ignition Key | .12 | □ To Release The Steering Wheel Lock | .17 |
| □ Key-In-Ignition Reminder | .14 | ■ Illuminated Entry | .17 |
| ■ Sentry Key Immobilizer System — If Equipped . . .14 | | ■ Doors And Door Locks | .18 |
| □ Important Note About Service | .15 | □ Manual Door Locks | .19 |
| □ Replacement Keys | .15 | □ Power Door Locks — If Equipped | .21 |
| □ Customer Key Programming | .16 | □ Automatic Door Locks — If Equipped | .21 |
| □ General Information | .16 | □ Child Protection Locks | .22 |
| ■ Steering Wheel Lock — If Equipped | .17 | ■ Remote Keyless Entry | .23 |

10 THINGS TO KNOW BEFORE STARTING YOUR VEHICLE

| | | | |
|---|-----|---|-----|
| <input type="checkbox"/> To Unlock The Doors | .23 | <input type="checkbox"/> Power Windows — If Equipped | .32 |
| <input type="checkbox"/> To Lock The Doors | .24 | <input type="checkbox"/> Wind Buffeting | .34 |
| <input type="checkbox"/> To Unlatch The Swing Gate Flip-Up Window | .24 | <input checked="" type="checkbox"/> Occupant Restraints | .34 |
| <input type="checkbox"/> Panic Alarm | .25 | <input type="checkbox"/> Lap/Shoulder Belts | .35 |
| <input type="checkbox"/> To Use The Panic Alarm | .25 | <input type="checkbox"/> Lap/Shoulder Belt Operating Instructions | .36 |
| <input type="checkbox"/> To Program Additional Transmitters | .26 | <input type="checkbox"/> Adjustable Upper Shoulder Belt Anchorage | .40 |
| <input type="checkbox"/> General Information | .26 | <input type="checkbox"/> Automatic Locking Mode — If Equipped | .41 |
| <input type="checkbox"/> Transmitter Battery Service | .27 | <input type="checkbox"/> Energy Management Feature | .42 |
| <input checked="" type="checkbox"/> Security Alarm System — If Equipped | .28 | <input type="checkbox"/> Seat Belt Pretensioners | .43 |
| <input type="checkbox"/> To Set The Alarm | .28 | <input type="checkbox"/> Enhanced Driver Seat Belt Use Reminder System (BeltAlert) | .44 |
| <input type="checkbox"/> To Disarm The System | .28 | <input type="checkbox"/> Seat Belts And Pregnant Women | .45 |
| <input checked="" type="checkbox"/> Rear Swing Gate | .29 | <input type="checkbox"/> Seat Belt Extender | .45 |
| <input checked="" type="checkbox"/> Windows | .32 | | |

| | | | |
|-------------------------------------|---|--|-----------|
| <hr/> | | THINGS TO KNOW BEFORE STARTING YOUR VEHICLE | 11 |
| <input type="checkbox"/> | Driver And Front Passenger Supplemental Restraint Systems (SRS) — Airbags | | .46 |
| <input type="checkbox"/> | Child Restraint | | .58 |
| <input checked="" type="checkbox"/> | Engine Break-In Recommendations | | .68 |
| <input checked="" type="checkbox"/> | Safety Tips | | .68 |
| <input type="checkbox"/> | Exhaust Gas | | .68 |
| <input type="checkbox"/> | Safety Checks You Should Make Inside The Vehicle | | .69 |
| <input type="checkbox"/> | Safety Checks You Should Make Outside The Vehicle | | .70 |

A WORD ABOUT YOUR KEYS

The keys for your new vehicle are enclosed in a plastic bag with the key code number on it. If you received your keys without the bag, ask your dealer to give you the number. The key code can also be obtained by the dealer from your vehicle invoice.

Ignition Key

Insert the key fully, then turn the switch to one of the four illustrated positions. The key can be inserted or withdrawn only in the LOCK position. The automatic transmission gear selector must be in the P (Park) position.

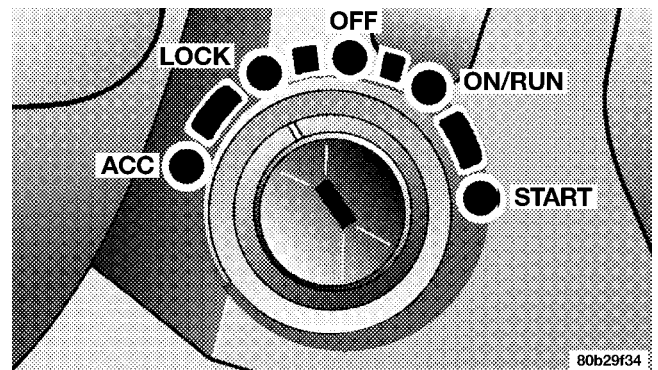

To remove the ignition key on models with an automatic transmission, place the gearshift lever in P (Park), turn the ignition key to LOCK and remove the key.

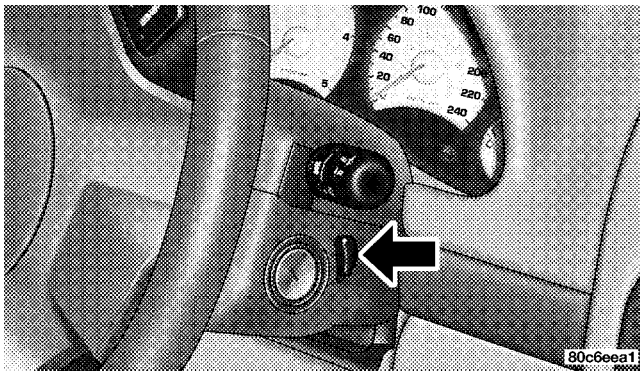

To remove the ignition key on models with a manual transmission, depress and hold the key release button, turn the ignition key to LOCK and remove the key.

WARNING!

Leaving children in a vehicle unattended is dangerous for a number of reasons. A child or others could be injured. Children should be warned not to touch the parking brake, brake pedal, or the gear selector lever. Do not leave the keys in the ignition. A child could operate power windows, other controls, or move the vehicle.

2

CAUTION!

An unlocked vehicle is an invitation to thieves. Always remove the key from the ignition, and lock all doors when leaving the vehicle unattended.

Key-In-Ignition Reminder

If you open the driver's door and the key is fully inserted in the ignition switch, a chime will sound to remind you to remove the key.

SENTRY KEY IMMOBILIZER SYSTEM — IF EQUIPPED

The Sentry Key Immobilizer System (SKIS) prevents unauthorized operation of the vehicle by disabling the engine. The system will shut the engine down after 2 seconds of running if an invalid key is used to start the vehicle. This system utilizes ignition keys which have an electronic chip (transponder) embedded into them. Only keys that have been programmed to the vehicle can be used to start and operate the vehicle for longer than the 2 second validation time period.

The Sentry Key Immobilizer System does not need to be armed or activated. Operation of the system is automatic regardless of whether or not the vehicle is locked or

unlocked. During normal operation, the SKIS indicator light will come on for 3 seconds immediately after the ignition switch is turned on for a bulb check. Afterwards, if the bulb remains on, this indicates a malfunction in the electronics. If the bulb begins to flash immediately after the ignition switch is turned on, this indicates that an invalid key is being used to start the vehicle. Both of these conditions will result in the engine being shut down after 2 seconds of running. Keep in mind that a key which has not been programmed is also considered an invalid key even if it is cut to fit the ignition for that vehicle.

If the SKIS indicator light comes on during normal vehicle operation (it has been running for longer than 10 seconds) a fault has been detected in the electronics and the vehicle should be serviced as soon as possible.

NOTE:

- The Sentry Key Immobilizer System is not compatible with remote starting systems. Use of these systems may result in vehicle starting problems and loss of security protection.
- Mobil Speedpass™, additional Sentry Keys, or any other transponder equipped components on the same keychain will not cause a key-related (Transponder) fault unless the additional part is **physically held against the ignition key** being used when starting the vehicle. Also, cell phones, pagers, or other RF electronics will not cause interference with this system.

All of the keys provided with your new vehicle have been programmed to the vehicle electronics.

Important Note About Service

A four digit PIN number is needed to service the Sentry Key Immobilizer System. This number can be obtained from your authorized dealer. However, this number can also be found on your customer invoice that you were given upon receipt of your vehicle.

Replacement Keys

NOTE: Only keys that have been programmed to the vehicle electronics can be used to start the vehicle. Once a Sentry Key has been programmed to a vehicle, it cannot be programmed to any other vehicle.

At the time of purchase, the original owner is provided with a four digit PIN number. This number is required for dealer replacement of keys. Duplication of keys may be performed at an authorized dealer or by using the Customer Key Programming procedure. This procedure

consists of programming a blank key to the vehicle electronics. A blank key is one which has never been programmed.

NOTE: When having the Sentry Key System serviced, bring all vehicle keys to the dealer.

Customer Key Programming

You can program new keys to the system if you have two valid keys by doing the following:

1. Cut the additional Sentry Key Transponder blank(s) to match the ignition switch lock cylinder key code.
2. Insert the first valid key into the ignition switch and turn the ignition switch ON for at least 3 seconds but no longer than 15 seconds. Turn the ignition switch OFF and remove the first key.
3. Insert the second valid key and turn the ignition switch ON within 15 seconds. After ten seconds, a chime

will sound and the SKIS indicator light will begin to flash. Turn the ignition switch OFF and remove the second key.

4. Insert a blank Sentry Key into the ignition switch and turn the ignition switch ON within 60 seconds. After 10 seconds, a single chime will sound. The SKIS indicator light will stop flashing, turn on for 3 seconds; then turn off.

The new Sentry Key has been programmed. Repeat this process to program up to a total of 8 keys.

General Information

The Sentry Key Immobilizer System complies with FCC rules part 15 and with RSS-210 of Industry Canada. Operation is subject to the following two conditions:

1. This device may not cause harmful interference.

2. This device must accept any interference that may be received, including interference that may cause undesired operation.

STEERING WHEEL LOCK — IF EQUIPPED

Your vehicle may be equipped with a passive steering wheel lock (manual transmission only). This lock prevents steering the vehicle without the ignition key. If the steering wheel is moved a half turn in either direction and the key is not in the ignition, the steering wheel will lock.

To Manually Lock the Steering Wheel

With the engine running, rotate the steering wheel 1/2 revolution from straight ahead position, turn off the engine and remove the key. Rotate the steering wheel slightly in both directions until the lock engages.

To Release the Steering Wheel Lock

Insert the key in the ignition and turn the wheel slightly to the right or left to disengage the lock.

NOTE: If you turned the wheel to the right to engage the lock, you must turn the wheel slightly to the right to disengage it. If you turned the wheel to the left to engage the lock, turn the wheel slightly to the left to disengage it.

ILLUMINATED ENTRY

The interior lights come on when you open any door. They will remain on for about 30 seconds after all doors are closed then fade to off.

The lights also will fade to off if you turn on the ignition after you close all the doors.

DOORS AND DOOR LOCKS

The vacuum fluorescent (VF) display located in the odometer area displays the word “door” as an indication of a door ajar or door not completely closed. When the vehicle is not moving and the door is ajar or not completely closed, the VF display will show the word “door” and then show the odometer/trip odometer mileage (each for 2 seconds). The display will continue to cycle.

NOTE: If vehicle is equipped with the optional Electronic Vehicle Information Center (EVIC) in the overhead console, all warnings including “door”, “GATE”, “GLASS”, and “LOWASH” will only be displayed in the EVIC display (not in the instrument cluster). For additional information, refer to “Overhead Console — If Equipped” in Section 3.



If any other active warnings including “GATE”, “GLASS”, or “LOWASH” are present, they will be shown in the VF display and will also continue to cycle. If the vehicle is moving, three single chimes will occur (One chime for each complete display cycle (three cycles total). After this, the display will continue to cycle only (no chimes).

If the trip/reset button is pressed while the VF warnings are being displayed, the VF display will revert back to only displaying the odometer/trip odometer mileage.

Manual Door Locks

Use the manual door lock plunger to lock the doors from inside the vehicle. If the plunger is down when the door is closed, the door will lock. Therefore, make sure the keys are not inside the vehicle before closing the door.

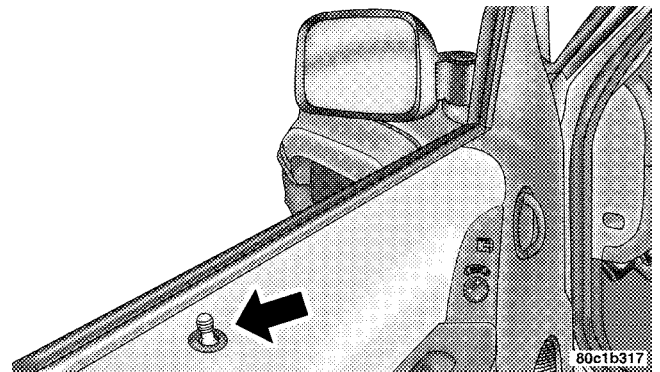

WARNING!

- For personal security, and safety in the event of an accident, lock the vehicle doors as you drive as well as when you park and leave the vehicle.
- When leaving the vehicle always remove the key from the ignition lock, and lock your vehicle. Do not leave children unattended in the vehicle, or with access to an unlocked vehicle. Unsupervised use of vehicle equipment may cause severe personal injuries and death.

CAUTION!

An unlocked vehicle is an invitation to thieves. Always remove the key from the ignition and lock all of the doors when leaving the vehicle unattended.

Power Door Locks — If Equipped

A door lock switch is on each front door panel. Press this switch to lock or unlock the doors.

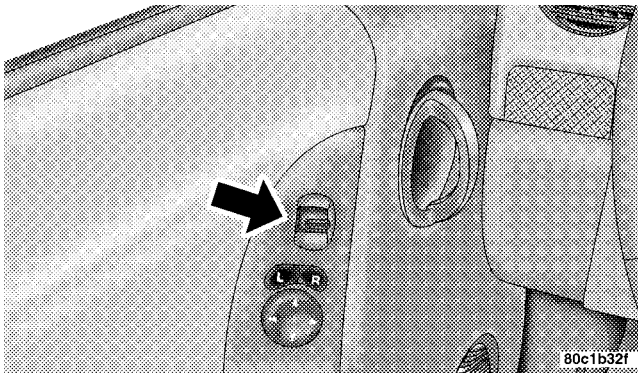

If the plunger is down when the door is closed, the door will lock. Therefore, make sure the keys are not inside the vehicle before closing the door.

If you press the door lock switch while the keys are in the ignition switch, and the driver's door is open, the doors will not lock.

The rear doors cannot be opened from inside the vehicle until you pull up the lock plungers.

2

Automatic Door Locks — If Equipped

The doors will lock automatically if:

1. all doors are closed,
2. vehicle speed is above 15 mph (24 km/h),
3. and the accelerator pedal is depressed.

This will occur only once, will not reoccur until a door is opened.

Child Protection Locks

The rear doors of your vehicle are equipped with child protection locks. If you push up on the lever on the open edge of the door it cannot be opened from the inside of the vehicle. Push the lever down to disengage the child protection locks.

WARNING!

Avoid trapping anyone in the vehicle in a collision. Remember that the rear doors can only be opened from the outside when the child protection locks are engaged.

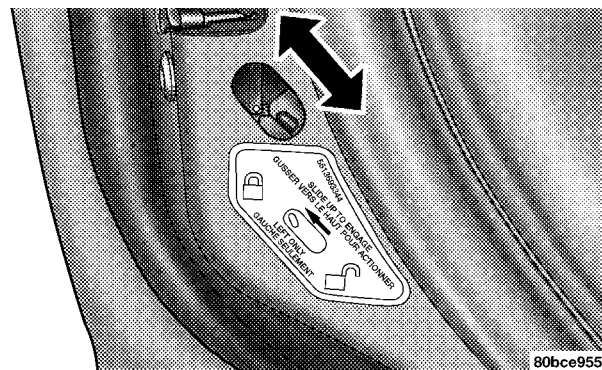

REMOTE KEYLESS ENTRY

This system allows you to lock or unlock the doors or open the swing gate flip-up window from distances of 23–50 feet (7–15 meters) using a transmitter. You don't have to point the transmitter at the vehicle to activate the system. Each vehicle comes with two transmitters.

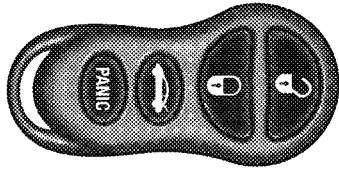

809112a0

To Unlock the Doors

Press and release the "Unlock" button once to unlock the driver's door. Press the button again within 5 seconds to unlock all the doors. If your vehicle is equipped with Illuminated Entry, the interior lights also come on and remain on for about 30 seconds, when you unlock the doors. The park lights will flash twice to acknowledge the unlock signal.

NOTE: The transmitter can be programmed to unlock all the doors upon the first press of the "Unlock" button (within 23–50 feet (7–15 meters) of the vehicle) by performing the following procedure:

1. Press and hold the "Unlock" button on the transmitter.
2. Continue to hold the "Unlock" button, wait at least 4 but no longer than 10 seconds, then press the "Lock" button.
3. Release both buttons.
4. Repeating steps 1–3 will restore original operation.

NOTE: The Light Flash can be enabled or disabled (within 23–50 feet (7–15 meters) of the vehicle) by performing the following procedure:

1. Press and hold the "Lock" button on the transmitter.

24 THINGS TO KNOW BEFORE STARTING YOUR VEHICLE

2. Continue to hold the "Lock" button, wait at least 4 but no longer than 10 seconds, then press the "Rear Release" button.
3. Release both buttons.
4. Repeating steps 1-3 will restore original transmitter operation.

To Lock the Doors

Press and release the "Lock" button once to lock the doors, swing gate flip-up window, and swing gate.

The horn will chirp and the park lights will flash once to acknowledge the lock signal.

NOTE: The horn chirp can be enabled or disabled (within 23-50 feet (7-15 meters) of the vehicle) by the following procedure:

1. Press and hold the "Lock" button on the transmitter.

2. Continue to hold the "Lock" button, wait at least 4 but no longer than 10 seconds, then press the "Unlock" button.
3. Release both buttons.
4. Repeating steps 1-3 will restore original transmitter operation.

To Unlatch the Swing Gate Flip-Up Window

Press and hold the "Rear Release" button on the transmitter to unlatch the swing gate flip-up window.

WARNING!

To avoid injury stand back when opening. Glass will automatically rise.

NOTE: The transmitter can be programmed to unlatch the flip-up window immediately upon activation of the “Rear Release” button (without pressing and holding) (within 23–50 feet (7–15 meters) of the vehicle) by performing the following procedure:

1. Press and hold the “Unlock” button on the transmitter.
2. Continue to hold the “Unlock” button, wait at least 4 but no longer than 10 seconds, then press the “Rear Release” button.
3. Release both buttons.
4. Repeating steps 1–3 will restore original transmitter operation.

NOTE: Unlatching the flip-up window will unlock the swing gate. After closing the flip-up window, press the “Lock” button on the transmitter to lock the swing gate.

Panic Alarm

The panic mode flashes the park lights, and sounds the horn for about 3 minutes or until the alarm is turned off.

To Use the Panic Alarm

Press and hold the PANIC button for at least 1 second to activate the panic alarm. Press and hold the PANIC button a second time to deactivate the alarm. The alarm will also shut itself off after starting the vehicle and accelerating to 15 mph (24 km/h).

NOTE: The “Panic” and “Security” alarms are quite different. Please take a moment to activate the “Panic” and the “Security” modes to hear the differences in the horn. In case one should go off in the future, you will need to know which mode has been activated in order to deactivate it.

To Program Additional Transmitters

NOTE: If vehicle is equipped with the optional Electronic Vehicle Information Center (EVIC) in the overhead console, the transmitters may also be programmed through the EVIC display. For additional information, refer to “Overhead Console — If Equipped” in Section 3.

Up to 4 transmitters can be programmed to your vehicle. To obtain additional transmitters, contact your authorized dealer. To program a transmitter (within 23–50 feet (7–15 meters) of the vehicle), perform the following procedure:

1. Gather every transmitter that is to be used with the vehicle including any transmitters that are currently programmed.
2. **Enter Program Mode:** Turn the ignition to the ON position, and using a currently programmed transmitter; press and hold the “Unlock” button on the transmitter.

Continue to hold the “Unlock” button, wait at least 4 but no longer than 10 seconds, then press and hold the PANIC button for at least 1 second. Release both buttons simultaneously.

3. Program Each Transmitter: All transmitters to be used with your vehicle must be programmed as follows:

Press and release the “Lock” and “Unlock” buttons simultaneously, followed by a press and release of ANY button on each transmitter to be programmed. You will hear a chime when a transmitter has been successfully programmed.

General Information

This transmitter complies with FCC rules part 15 and with RSS-210 of Industry Canada. Operation is subject to the following two conditions:

1. This device may not cause harmful interference.

2. This device must accept any interference that may be received, including interference that may cause undesired operation.

If your Remote Keyless Entry fails to operate from a normal distance, check for these two conditions:

1. Weak batteries in transmitter. The expected life of batteries is from one to two years
2. Closeness to a radio transmitter such as a radio station tower, airport transmitter, and some mobile or CB radios.

Transmitter Battery Service

The recommended replacement battery is the Panasonic CR2016 or equivalent.

1. Pry the transmitter halves apart with a dime or similar object. Make sure not to damage the rubber gasket material during removal.

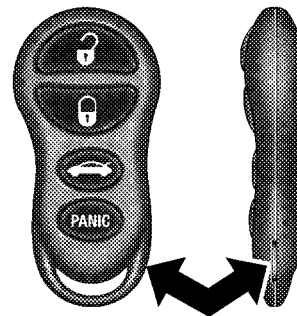

8091f2a8

2. Remove and replace the batteries. Avoid touching the new batteries with your fingers. Skin oils may cause battery deterioration. If you touch the battery, clean it with rubbing alcohol.
3. Reassemble the transmitter case. Snap the halves together and test transmitter operation.

SECURITY ALARM SYSTEM — IF EQUIPPED

This system monitors the vehicle doors, swing gate, swing gate flip-up window, and ignition for unauthorized operation. When the alarm is activated, the system provides both audible and visual signals. The horn, headlights, and tail lights will sound/flash repeatedly for three minutes. If disturbance is still present (driver's door, passenger door, other doors, ignition) after three minutes, the headlights and tail lights will flash for an additional 15 minutes.

NOTE: The "Panic" and "Security" alarms are quite different. Please take a moment to activate the "Panic" and the "Security" modes to hear the differences in the horn. In case one should go off in the future, you will need to know which mode has been activated in order to deactivate it.

To Set the Alarm

The alarm will set when you use the remote keyless entry transmitter to lock the doors and swing gate or when you use the power door lock switch while the door is open. After all the doors are locked and closed, a red light in the instrument cluster will flash rapidly for about 16 seconds to signal that the system is arming. During this 16 second arming period, opening any door or the swing gate will cancel the arming. If the system successfully arms, the red light will flash at a slower rate to indicate the alarm is set.

To Disarm the System

To disarm the system, use the remote keyless entry transmitter or the key to unlock the driver's door. If something has triggered the system in your absence, the horn will sound three times when you unlock the doors. Check the vehicle for tampering.

NOTE: On vehicles equipped with Remote Keyless Entry (RKE), there will not be a door lock cylinder on the front passenger door, rear doors, or rear swing gate. Therefore, you will be unable to disarm the system with a manual unlock of the passenger or rear doors.

The Security Alarm System is designed to protect your vehicle; however, you can create conditions where the system will arm unexpectedly. If you remain in the vehicle and lock the doors with the transmitter, once the system is armed (after 16 seconds), when you pull the door handle to exit the alarm will sound. If this occurs, press the “Unlock” button on the remote keyless entry transmitter to disarm the system. You may also accidentally disarm the system by unlocking the driver’s door with the key and then locking it. The door will be locked but the Security Alarm will not arm.

REAR SWING GATE

NOTE: The master key that is used to start the vehicle is also used to lock or unlock the front doors, and open the rear swing gate.

To unlock the rear swing gate, insert the key into the lock (if equipped) and turn counter clockwise. The swing gate flip-up window will unlatch and the swing gate will unlock.

WARNING!

To avoid injury stand back when opening. Glass will automatically rise.

On vehicles equipped with power locks, the swing gate can also be unlocked using the remote keyless entry, or by activating the power door lock switches located on the front doors.

30 THINGS TO KNOW BEFORE STARTING YOUR VEHICLE

To open the swing gate, pull the gate handle to its first detent to open just the flip-up window. Pull the handle to its second detent (all the way) to open both the flip-up window and swing gate.

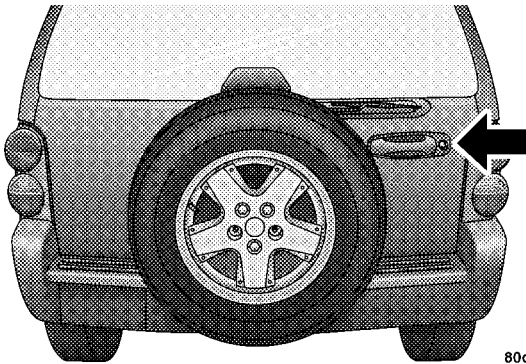

80d1f443

WARNING!

To avoid injury stand back when opening. Glass will automatically rise.

The vacuum fluorescent (VF) display located in the odometer area displays the words "GATE" and/or "GLASS" as an indication of when the swing gate and/or flip-up window, is not completely closed. When the vehicle is not moving and the swing gate and/or flip-up window is not completely closed, the VF display will show the word "GATE" and/or "GLASS" and then show the odometer/trip odometer mileage (each for 2 seconds). The display will continue to cycle.

NOTE: If vehicle is equipped with the optional Electronic Vehicle Information Center (EVIC) in the overhead console, all warnings including “door”, “GATE”, “GLASS”, and “LOWASH” will only be displayed in the EVIC display (not in the instrument cluster). For additional information, refer to “Overhead Console — If Equipped” in Section 3.

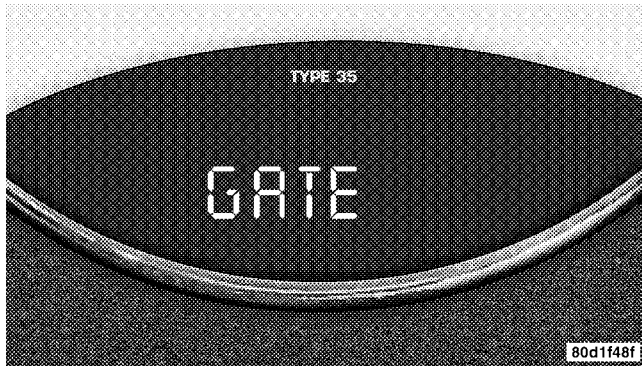

2

If any other active warnings including “door” or “LOWASH” are present, they will be shown in the VF display and will also continue to cycle. If the vehicle is moving, two single chimes will occur if the rear glass is open or three single chimes will occur if the rear swing gate is open (one chime for each complete display cycle). After this, the VF display will continue to sequence only (no chimes).

If the trip/reset button is pressed while the VF warnings are being displayed, the VF display will revert back to only displaying the odometer/trip odometer mileage.

NOTE: Close swing gate before flip-up window.

CAUTION!

Do not press on rear wiper blade when closing swing gate, as damage to the blade will result.

WARNING!

Driving with the flip-up window open can allow poisonous exhaust gases into your vehicle. You and your passengers could be injured by these fumes. Keep the flip-up window closed when you are operating the vehicle.

NOTE: The rear swing gate will lock while the rear wiper is operating. The gate will stay locked until the wiper is turned off and the gate is unlocked (by key, lock switch, or key fob).

WINDOWS

Power Windows — If Equipped

The power window switches are located on the center floor console. The top left switch controls the left rear passenger window and the top right switch controls the right rear passenger window. The lower left switch controls the left front window, and the lower right switch controls the right front window. The switches will operate only when the ignition is in the ON or ACCESSORY position.

The window lock switch located next to the window switches allows you to disable the rear passenger window switches that are located on the back of the center floor console.

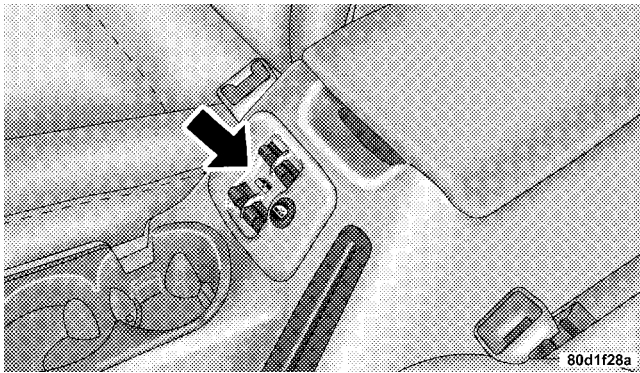

Auto Down Feature — If Equipped

The driver's and passenger's front window switches have an auto down feature. Press the window switch past the detent, release, and the window will go down automatically.

To open the window part way, press the window switch part way and release it when you want the window to stop.

Rear Passenger Window Switches

The rear passenger window switches are located on the back of the center floor console.

2

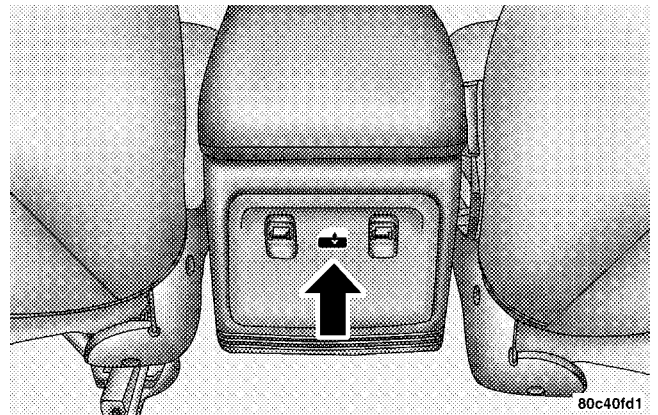

Wind Buffeting

Wind buffeting can be described as the perception of pressure on the ears or a helicopter type sound in the ears. Your vehicle may exhibit wind buffeting with the windows down, or the sunroof (if equipped) in certain open or partially open positions. This is a normal occurrence and can be minimized. If the buffeting occurs with the sunroof open, adjust the sunroof opening to minimize the buffeting.

OCCUPANT RESTRAINTS

Some of the most important safety features in your vehicle are the restraint systems. These include the front and rear seat belts for the driver and all passengers, front airbags for both the driver and front passenger and, if equipped, window bags for the driver and passengers seated next to a window. If you will be carrying children too small for adult-size belts, your seat belts also can be used to hold infant and child restraint systems.

NOTE: The front airbags have a multi stage inflator design. This allows the airbag to have different rates of inflation that are based on collision severity.

Please pay close attention to the information in this section. It tells you how to use your restraint system properly to keep you and your passengers as safe as possible.

WARNING!

In a collision, you and your passengers can suffer much greater injuries if you are not properly buckled up. You can strike the interior of your vehicle or other passengers, or you can be thrown out of the vehicle. Always be sure you and others in your vehicle are buckled up properly.

Buckle up even though you are an excellent driver, even on short trips. Someone on the road may be a poor driver and cause a collision which includes you. This can happen far away from home or on your own street.

Research has shown that seat belts save lives, and they can reduce the seriousness of injuries in a collision. Some of the worst injuries happen when people are thrown from the vehicle. Seat belts reduce the possibility of ejection and the risk of injury caused by striking the inside of the vehicle. **Everyone** in a motor vehicle should be belted at all times.

Lap/Shoulder Belts

All the seats in your vehicle are equipped with lap/shoulder belts.

The belt webbing retractor is designed to lock during very sudden stops or collisions. This feature allows the shoulder part of the belt to move freely with you under normal conditions. But in a collision, the belt will lock and reduce the risk of you striking the inside of the vehicle or being thrown out.

2

WARNING!

- **Wearing a seat belt incorrectly is dangerous. Seat belts are designed to go around the large bones of your body. These are the strongest parts of your body and can take the forces of a collision the best. Wearing your belt in the wrong place could make your injuries in a collision much worse. You might suffer internal injuries, or you could even slide out of part of the belt. Follow these instructions to wear your seat belt safely and to keep your passengers safe, too.**
- **Two people should never be belted into a single seat belt. People belted together can crash into one another in an accident, hurting one another badly. Never use a lap/shoulder belt or a lap belt for more than one person, no matter what their size.**

Lap/Shoulder Belt Operating Instructions

1. Enter the vehicle and close the door. Sit back and adjust the seat.
2. The seat belt latch plate is above the back of your seat. Grasp the latch plate and pull out the belt. Slide the latch plate up the webbing as far as necessary to make the belt go around your lap.

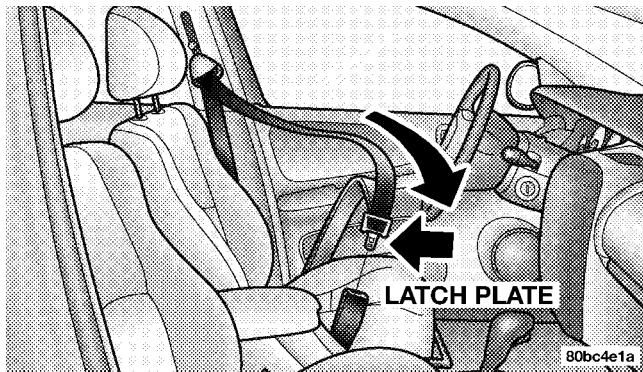

3. When the belt is long enough to fit, insert the latch plate into the buckle until you hear a “click.”

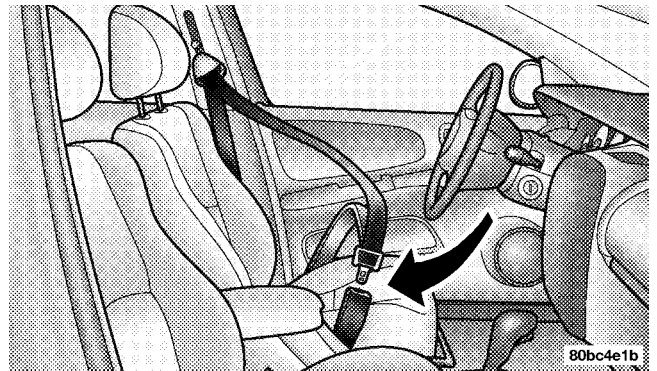

WARNING!

A belt that is buckled into the wrong buckle will not protect you properly. The lap portion could ride too high on your body, possibly causing internal injuries. Always buckle your belt into the buckle nearest you.

A belt that is too loose will not protect you as well. In a sudden stop you could move too far forward, increasing the possibility of injury. Wear your seat belt snugly.

A belt that is worn under your arm is very dangerous. Your body could strike the inside surfaces of the vehicle in a collision, increasing head and neck injury. A belt worn under the arm can cause internal injuries. Ribs aren't as strong as shoulder bones. Wear the belt over your shoulder so that your strongest bones will take the force in a collision.

A shoulder belt placed behind will not protect you from injury during a collision. You are more likely to hit your head in a collision if you do not wear your shoulder belt. The lap and shoulder belt are meant to be used together.

4. Position the lap belt across your thighs, below your abdomen. To remove slack in the lap portion, pull up a bit on the shoulder belt. To loosen the lap belt if it is too tight, tilt the latch plate and pull on the lap belt. A snug belt reduces the risk of sliding under the belt in a collision.

NOTE: The "Seat Belt Indicator Light" will remain on until the driver's seat belt is buckled.

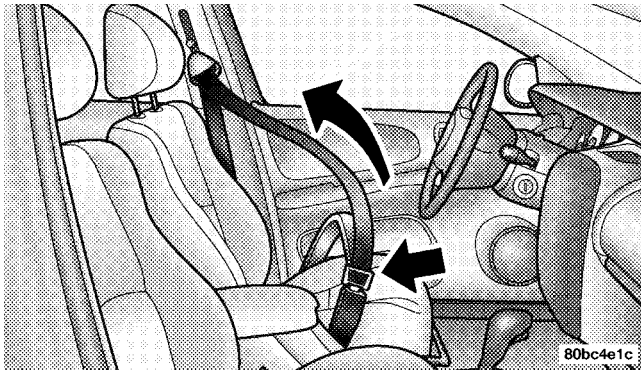

WARNING!

A lap belt worn too high can increase the risk of injury in a collision. The belt forces won't be at the strong hip and pelvic bones, but across your abdomen. Always wear the lap part of your seat belt as low as possible and keep it snug.

A twisted belt cannot do its job as well. In a collision it could even cut into you. Be sure the belt is straight. If you cannot straighten a belt in your vehicle, take it to your authorized dealer and have it fixed.

5. Position the shoulder belt on your chest so that it is comfortable and not resting on your neck. The retractor will withdraw any slack in the belt.

6. To release the belt, push the red button marked PRESS on the buckle. The belt will automatically retract to its stowed position. If necessary, slide the latch plate down the webbing to allow it to retract fully.

WARNING!

A frayed or torn belt could rip apart in a collision and leave you with no protection. Inspect the belt system periodically, checking for cuts, frays, or loose parts. Damaged parts must be replaced immediately. Do not disassemble or modify the system. Seat belt assemblies must be replaced after an accident if they have been damaged (bent retractor, torn webbing, pretensioner, etc.).

Adjustable Upper Shoulder Belt Anchorage

In the front seat positions, the shoulder belt can be adjusted upward or downward to position the belt away from your neck. To lower the shoulder belt height, push the button and slide the height adjuster down. To raise the height of the shoulder belt, slide the height adjuster up. Pull down on the height adjuster to make sure it is locked in place.

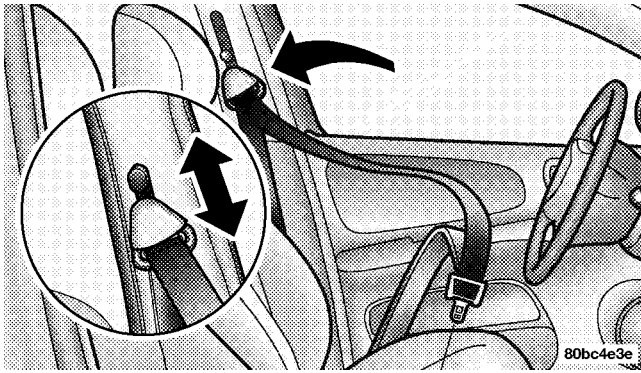
**WARNING!**

Position the shoulder belt height adjusters so that the belt rests across the middle of your shoulder. Failure to adjust the safety belt properly could reduce the effectiveness of the seat belt and increase the risk of injury in a collision.

2

As a guide, if you are shorter than average, you will prefer a lower position, and if you are taller than average, you'll prefer a higher position. When you release the anchorage, try to move it up or down to make sure that it is locked in position.

Automatic Locking Mode — If Equipped

In this mode, the shoulder belt is automatically pre-locked. The belt will still retract to remove any slack in the shoulder belt.

When To Use The Automatic Locking Mode

Anytime a child safety seat is installed in a passenger front or outboard rear seating position (if equipped). Children 12 years old and under should be properly restrained in the rear seat whenever possible.

How To Use The Automatic Locking Mode

1. Buckle the combination lap and shoulder belt.
2. Grasp the shoulder portion and pull downward until the entire belt is extracted.
3. Allow the belt to retract. As the belt retracts, you will hear a clicking sound. This indicates the safety belt is now in the automatic locking mode.

How to Disengage The Automatic Locking Mode

Disconnect the combination lap/shoulder belt and allow it to retract completely to disengage the automatic locking mode and activate the vehicle sensitive (emergency) locking mode.

Energy Management Feature

This vehicle has a safety belt system with an energy management feature at the driver and front passenger seating positions to help further reduce the risk of injury in the event of a head-on collision.

This safety belt system has a retractor assembly that is designed to pay out webbing in a controlled manner. This feature is designed to help reduce the belt force acting on the occupant's chest.

WARNING!

- After a vehicle collision, the driver and front passenger outboard seat belt system must be checked by a qualified technician to verify that the “automatic locking retractor” feature for child seats is still functioning properly. In addition, all seat belts should be checked for proper function.
- The belt and retractor assembly must be replaced if the seat belt assembly “automatic locking retractor” feature or any other seat belt function is not working properly when checked according to the procedures in the Service Manual.
- Failure to replace the belt and retractor assembly could increase the risk of injury in collisions.

Seat Belt Pretensioners

The driver and front passenger seat belts are equipped with a pretensioning device that is designed to remove any slack from the seat belt systems in the event of a collision. This device improves the performance of the seat belt by assuring that the belt is tight around the occupant early in a collision. Pretensioners work for all size occupants, including those in child restraints.

NOTE: These devices are not a substitute for proper seat belt placement by the occupant. The seat belt must still be worn snugly and positioned properly.

The pretensioners are triggered by the front Airbag Control Module. Like the front airbags, the pretensioners are a single use item. After a collision that is severe enough to deploy the airbags and pretensioners, they must be replaced.

Enhanced Driver Seat Belt Use Reminder System (BeltAlert)

If the driver's seat belt has not been buckled within 60 seconds of starting the vehicle and if the vehicle speed is greater than 5 mph (8 km/h), the Enhanced Warning System (BeltAlert) will alert the driver to buckle their seat belt. The driver should also instruct all other occupants to buckle their seat belts. Once the warning is triggered, the Enhanced Warning System (BeltAlert) will continue to chime and flash the Seat Belt Warning Light for 96 seconds or until the driver's seat belt is buckled.

The Enhanced Warning System (BeltAlert) will be reactivated if the driver's seat belt is unbuckled for more than 10 seconds and the vehicle speed is greater than 5 mph (8 km/h).

The Enhanced Warning System (BeltAlert) can be enabled or disabled by your authorized dealer or by following these steps:

NOTE: The following steps must occur within the first 60 seconds of the ignition switch being turned to the ON or START position. The manufacturer does not recommend deactivating the Enhanced Warning System (BeltAlert).

1. Turn the ignition switch to the OFF position, and buckle the driver's seat belt.
2. Turn the ignition key to the ACCESSORY/RUN position (engine does not need to be running), and wait for the Seat Belt Warning Light to turn off.
3. Within 60 seconds of starting the vehicle, unbuckle and then re-buckle the driver's seat belt at least three times within 10 seconds, ending with the seat belt buckled.
4. Turn the ignition key to the OFF position. A single chime will sound to signify that you have successfully completed the programming.

The Enhanced Warning System (BeltAlert) can be reactivated by repeating this procedure.

NOTE: Although the Enhanced Warning System (BeltAlert) has been deactivated, the Seat Belt Warning Light will continue to illuminate while the driver's seat belt remains unfastened.

Seat Belts and Pregnant Women

We recommend that pregnant women use the seat belts throughout their pregnancy. Keeping the mother safe is the best way to keep the baby safe.

Pregnant women should wear the lap part of the belt across the thighs and as snug across the hips as possible. Keep the belt low so that it does not come across the abdomen. That way the strong bones of the hips will take the force if there is a collision.

Seat Belt Extender

If a seat belt is too short, even when fully extended and when the adjustable upper shoulder belt anchorage (if equipped) is in its lowest position, your authorized dealer can provide you with a seat belt extender. This extender should be used only if the existing belt is not long enough. When it is not required, remove the extender and store it.

WARNING!

Using a seat belt extender when not needed can increase the risk of injury in a collision. Only use when the lap belt is not long enough when it is worn low and snug, and in the recommended seating positions. Remove and store the extender when not needed.

Driver And Front Passenger Supplemental Restraint Systems (SRS) — Airbags

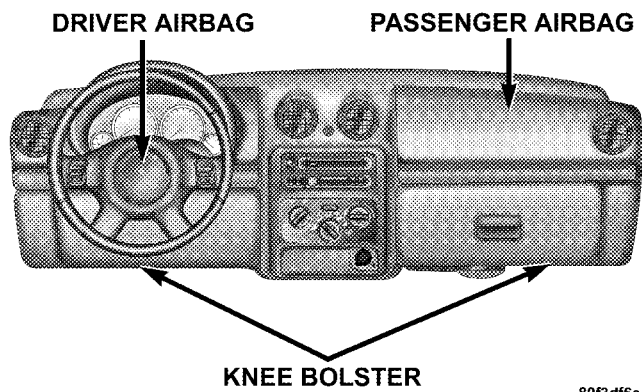

This vehicle has airbags for both the driver and right front passenger as a supplement to the seat belt restraint systems. The driver's front airbag is mounted in the steering wheel. The passenger side airbag is mounted in the instrument panel, above the glove compartment. The words SRS/AIRBAG are embossed on the airbag covers.

NOTE: The front airbags are certified to the Federal regulations that allow less forceful deployment.

The front airbags have a multi stage inflator design. This may allow the airbag to have different rates of inflation that are based on collision severity and occupant size. Also, the front passenger airbag is certified to the Federal regulations that define Occupant Classification (Refer to "Occupant Classification System" in this section).

This vehicle may also be equipped with window bags to protect the driver, front, and rear passengers sitting next to a window. If the vehicle is equipped with window bags, they are located above the side windows. Their covers are also labeled SRS AIRBAG.

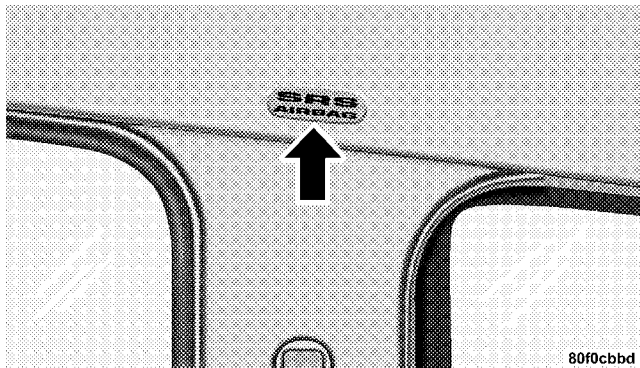

NOTE: Airbag covers may not be obvious in the interior trim; but they will open to allow airbag deployment.

WARNING!

- Do not put anything on or around the front airbag covers or attempt to manually open them. You may damage the airbags and you could be injured because the airbags are not there to protect you. These protective covers for the airbag cushions are designed to open only when the airbags are inflating.
- If your vehicle is equipped with window bags, do not stack luggage or other cargo up high enough to block the location of the window bag. The area where the window bag is located should remain free from any obstructions.
- If your vehicle is equipped with window bags, do not have any accessory items installed which will alter the roof, including adding a sunroof to your vehicle. Do not add roof racks that require permanent attachments (bolts or screws) for installation on the vehicle roof. Do not drill into the roof of the vehicle for any reason.

Along with the seat belts, front airbags work with the instrument panel knee bolsters to provide improved protection for the driver and front passenger. Window bags also work with seat belts to improve occupant protection.

The seat belts are designed to protect you in many types of collisions. The front airbags deploy in moderate to severe frontal collisions.

NOTE: The passenger front airbag may not deploy even when the driver front airbag has if the Occupant Classification System (refer to “Occupant Classification System” in this section) has determined the seat is empty or is occupied by someone that is classified in the “child” category. This could be a child, a teenager, or even a small adult.

If your vehicle is so equipped, the window bag on the crash side of the vehicle is triggered in moderate to severe side collisions. But even in collisions where the airbags work, you need the seat belts to keep you in the right position for the airbags to protect you properly.

Here are some simple steps you can take to minimize the risk of harm from a deploying airbag.

1. Children 12 years and under should always ride buckled up in a rear seat in an appropriate child restraint.

Infants in rear-facing child restraints should **NEVER** ride in the front seat of a vehicle with a passenger front airbag. An airbag deployment can cause severe injury or death to infants in that position.

If a child from 1 to 12 years old must ride in the front passenger seat because the vehicle is crowded, move the seat as far back as possible, and use the proper child restraint. See “Child Restraint” in this section.

You should read the instructions provided with your child restraint to make sure that you are using it properly.

2. All occupants should use their lap and shoulder belts properly.
3. The driver and front passenger seats should be moved back as far as practical to allow the airbag room to inflate.
4. If your vehicle has window bags, do not lean against the door or window, airbags will inflate forcefully into the space between you and the door.

WARNING!

- **Relying on the airbags alone could lead to more severe injuries in a collision. The airbags work with your seat belt to restrain you properly. In some collisions the airbags won't deploy at all. Always wear your seat belts even though you have airbags.**
- **Being too close to the steering wheel or instrument panel during airbag deployment could cause serious injury. Airbags need room to inflate. Sit back, comfortably extending your arms to reach the steering wheel or instrument panel.**
- **If the vehicle has window bags, they also need room to inflate. Do not lean against the door or window. Sit upright in the center of the seat.**

Airbag System Components

The airbag system consists of the following:

- Occupant Restraint Controller
- Remote Acceleration Sensors
- Airbag Warning Light
- Driver Airbag
- Passenger Airbag
- Window Bags above Side Windows (If Equipped)
- Steering Wheel and Column
- Instrument Panel
- Interconnecting Wiring
- Knee Impact Bolsters
- Front Acceleration Sensors
- Driver and Front Passenger Seat Belt Pretensioners
- Front Passenger Seat Occupant Classification System (OCS)
 - Occupant Classification Module
 - Passenger Airbag Disabled (PAD) Indicator Light
 - Interconnecting Wiring
 - Pressure Sensor, Bladder Assembly, and Belt Tension Sensor

How The Airbag System Works

- The **Occupant Restraint Controller (ORC)** determines if a frontal collision is severe enough to require the airbags to inflate. Based on the level of collision severity, the front control module determines the proper rate of inflation. The front airbag inflators are designed to provide different rates of airbag inflation from direction provided by the ORC. The ORC may

modify the rate of inflation based on the occupant size provided by the Occupant Classification Module. The ORC will not detect roll over, or rear impacts.

The ORC monitors the readiness of the electronic parts of the system whenever the ignition switch is in the START or RUN positions. These include all of the items listed above except the steering wheel and column, and knee bolsters. If the key is in the OFF position, in the ACC position, or not in the ignition, the airbags are not on and will not inflate.

Also, the ORC turns on the AIRBAG warning light and PAD indicator light in the instrument panel for 6 to 8 seconds for a self-check when the ignition is first turned on. After the self-check, the AIRBAG warning light will turn off. The PAD indicator light will function normally (Refer to “Passenger Airbag Disable (PAD) Indicator Light” in this section). If the ORC detects a malfunction in any part of the system, it turns on the AIRBAG

warning light either momentarily or continuously. A single chime will sound if the light comes on again after initial start up.

WARNING!

Ignoring the AIRBAG warning light in your instrument panel could mean you won't have the airbags to protect you in a collision. If the light does not come on, stays on after you start the vehicle, or if it comes on as you drive, have the airbag system checked right away.

- The **Occupant Classification System (OCS)** will classify an occupant into a size category based on sensor readings from within the seat cushion. Occupants should try to remain in a normally seated position. If the occupant's weight is transferred to another object in the vehicle (i.e. feet on the dashboard), the OCS may

52 THINGS TO KNOW BEFORE STARTING YOUR VEHICLE

not be able to properly approximate occupant size. Furthermore, the occupant size may appear to increase or decrease due to objects hanging on the seat, other passengers pushing on the seat, or objects lodged underneath the seat. If there is a rapid change in temperature or humidity, the OCS may not be able to properly approximate occupant size. If your seat including your trim cover and cushion needs to be serviced in any way, take the vehicle to your authorized dealer. Only manufacturer approved seat accessories may be used.

If there is a fault present in the system, the AIRBAG warning light will light indicating that you should take the vehicle to an authorized dealer. In the presence of an occupant in the passenger seat, if both the PAD indicator light and AIRBAG warning light are illuminated the airbag will be disabled.

The ORC will not allow front airbag deployment in the event of a collision for occupants classified into the empty or child size categories. The PAD indicator light will illuminate indicating that the Passenger Airbag is OFF when the OCS has determined that the occupant size category is a child. Also, when the seat is empty or an object that weighs less than a predetermined threshold is placed on the seat, the light will remain OFF. (The PAD indicator light is an amber light located on the grab handle in front of the passenger seat.)

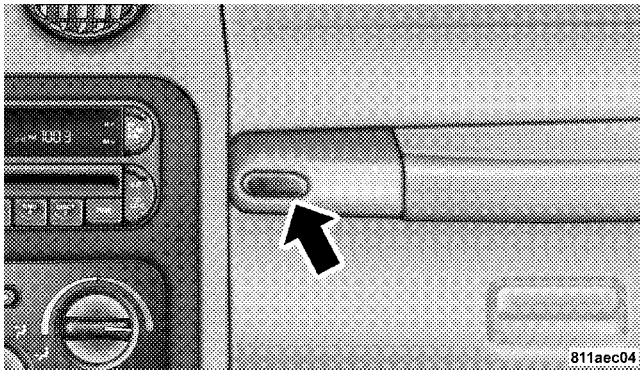

For almost all sizes of properly seated adults, the passenger frontal airbag will be enabled in the event of a collision. For small teenagers and some small adults, depending on size, the airbag may or may not be enabled in the event of a collision. For small teenagers and some small adults, depending on size, the airbag may or may not be enabled in the event of a collision. Both drivers

and passengers should always use the PAD indicator light as an indication if the front passenger is properly positioned or not. If the PAD indicator light comes on when an adult is in the passenger seat, have the passenger re-position themselves in the seat until the light goes out. Remember, if the PAD indicator light is illuminated the passenger front airbag will not inflate. For properly installed child restraint systems and children properly seated on the front passenger seat, the airbag will be disabled. If at all possible, place children 12 years and younger in a back seat.

- The **Driver and Passenger Airbag/Inflator Units** are located in the center of the steering wheel and the right side of the instrument panel. When the ORC detects a collision requiring the airbags, it signals the inflator units. A large quantity of nontoxic gas is generated to inflate the front airbags. Different airbag inflation rates may be possible based on collision severity and occupant size. The steering wheel hub trim cover and the

upper right side of the instrument panel separate and fold out of the way as the bags inflate to their full size. The bags fully inflate in about 50–70 milliseconds. This is about half of the time it takes to blink your eyes. The bags then quickly deflate while helping to restrain the driver and front passenger.

The driver's front airbag gas is vented through vent holes in the sides of the airbag. The passenger's front airbag gas is vented through vent holes in the sides of the airbag. In this way the airbags do not interfere with your control of the vehicle.

- The **Occupant Classification Module (OCM)** is located beneath the front passenger seat. The OCM classifies the occupant into one of three size categories based on the input from the Bladder Assembly and a Belt Tension Sensor. The size categories include empty,

child, and adult. The OCM sends the Occupant Classification to the ORC to determine if a front passenger airbag is allowed. If a fault is present, the AIRBAG warning light is illuminated.

- The **Passenger Airbag Disabled (PAD) Indicator Light** indicates to the driver and passenger when the airbag is turned OFF. In the presence of a properly seated occupant, when the PAD indicator light is illuminated, the airbag is OFF. Also, when the Occupant Classification System detects either an empty seat or a weight less than the predetermined threshold, the ORC will not illuminate the PAD indicator light even though the airbag is turned OFF.
- The **Belt Tension Sensor (BTS)** is located at the outboard passenger lap belt anchor. The BTS creates a signal based on outboard lap belt tension. This signal is sent to the OCM to ensure that the resultant bladder

pressure increase due to applied lap belt tension does not cause a small occupant to be classified as a larger occupant.

- The **Bladder Mat and Pressure Sensor** are located beneath the seat cushion foam. The pressure sensor sends a signal to the OCM.
- The **Side Impact SRS Window Bags** are designed to activate only in certain side collisions. When the ORC (with side impact option) detects a collision requiring the window bags to inflate, it signals the inflators on the crash side of the vehicle. A quantity of nontoxic gas is generated to inflate the window bag. The inflating window bag pushes the outside edge of the headliner out of the way and covers the window. The airbag inflates in about 30 milliseconds (about one quarter of the time it takes to blink your eyes) with enough force to injure you if you are not belted and seated properly, or if items are positioned in the area where the

window bag inflates. This especially applies to children. The window bag is only about 3½ inches (9 cm) thick when it is inflated.

- The **Knee Impact Bolsters** help protect the knees of the driver and the front passenger, and position everyone for the best interaction with the front airbag.

If A Deployment Occurs

The airbag system is designed to deploy the airbags when the impact sensors detect a moderate-to-severe frontal collision, to help restrain the driver and front passenger, and then immediately deflate.

NOTE: A frontal collision that is not severe enough to need airbag protection will not activate the system. This does not mean something is wrong with the airbag system.

If you do have a collision which deploys the airbags, any or all of the following may occur:

- The nylon airbag material may sometimes cause abrasions and/or skin reddening to the driver and front passenger as the airbags deploy and unfold. The abrasions are similar to friction rope burns or those you might get sliding along a carpet or gymnasium floor. They are not caused by contact with chemicals. They are not permanent and normally heal quickly. However, if you haven't healed significantly within a few days, or if you have any blistering, see your doctor immediately. As the airbags deflate you may see some smoke-like particles. The particles are a normal by-product of the process that generates the nontoxic gas used for airbag inflation. These airborne particles may irritate the skin, eyes, nose, or throat. If you have skin or eye irritation, rinse the area with cool water. For nose or throat irritation, move to fresh air. If the irritation continues, see your doctor. If these particles settle on your clothing, follow the garment manufacturer's instructions for cleaning.
- It is not advisable to drive your vehicle after the airbags have deployed. If you are involved in another collision, the airbags will not be in place to protect you.

WARNING!

Deployed airbags and seat belt pretensioners cannot protect you in another collision. Have the airbags, seat belt pretensioners, and the front passenger seat belt retractor assembly, replaced by an authorized dealer as soon as possible. Also, have the Occupant Classification System serviced as well.

Enhanced Accident Response System (E.A.R.S.)

If the airbags deploy after an impact and the electrical system remains functional, the interior lights will turn on and the power door locks (if equipped) will unlock 10 seconds after airbag deployment.

Also, the fuel system will shut off immediately upon airbag deployment (gasoline models only). The ignition switch will need to be cycled (i.e. turn the ignition key from the ON position to the LOCK position) after approximately 5 seconds in order to restart the vehicle.

Maintaining Your Airbag System

WARNING!

- Modifications to any part of the airbag system could cause it to fail when you need it. You could be injured if the airbag system is not there to protect you. Do not modify the components or wiring, including adding any kind of badges or stickers to the steering wheel hub trim cover or the upper right side of the instrument panel. Do not modify the front bumper, vehicle body structure, or add aftermarket side steps or running boards.
- Do not attempt to modify any part of your advanced airbag system. The airbag may inflate accidentally or may not function properly if modifications are made. Take your vehicle to an authorized dealer for any advanced airbag system service. If your seat including your trim cover and cushion needs to be serviced in any way, take the vehicle to your authorized dealer. Only manufacturer approved seat accessories may be used. If it is necessary to modify an advanced airbag system for persons with disabilities, contact your authorized dealer.

WARNING!

- You need proper knee impact protection in a collision. Do not mount or locate any aftermarket equipment on or behind the knee bolsters.
- It is dangerous to try to repair any part of the airbag system yourself. Be sure to tell anyone who works on your vehicle that it has an airbag system.

Airbag Warning Light

You will want to have the airbag system ready to inflate for your protection in an impact. The airbag system is designed to be maintenance free. If any of the following occurs, have an authorized dealer service the system promptly:

- Does not come on during the 6 to 8 seconds after the ignition switch is first turned on.

- Remains on after the 6 to 8 second interval.
- Comes on for any period of time while driving.

Child Restraint

Everyone in your vehicle needs to be buckled up all the time — babies and children, too. Every state in the United States and all Canadian provinces require that small children ride in proper restraint systems. This is the law, and you can be prosecuted for ignoring it.

Children 12 years and under should ride properly buckled up in a rear seat, if available. According to crash statistics, children are safer when properly restrained in the rear seats rather than in the front.

WARNING!

In a collision, an unrestrained child, even a tiny baby, can become a missile inside the vehicle. The force required to hold even an infant on your lap can become so great that you could not hold the child, no matter how strong you are. The child and others could be badly injured. Any child riding in your vehicle should be in a proper restraint for the child's size.

Infants and Small Children

There are different sizes and types of restraints for children from newborn size to the child almost large enough for an adult seat belt. Always check the child seat owner's manual to ensure you have the right seat for your child. Use the restraint that is correct for your child:

- This vehicle is not capable of accommodating the installation of a car bed used for carrying newborn babies at the right front passenger seat position. If a car bed must be used to transport a newborn baby, the car bed must be installed in the second seating row only.
- Safety experts recommend that children ride rearward-facing in the vehicle until they are at least one year old and weigh at least 20 lbs (9 kg). Two types of child restraints can be used rearward facing: infant carriers and "convertible" child seats.
- The infant carrier is only used rearward-facing in the vehicle. It is recommended for children who weigh up to about 20 lbs (9 kg). "Convertible" child seats can be used either rearward-facing or forward-facing in the vehicle. Convertible child seats often have a higher weight limit in the rearward-facing direction than infant carriers do, so they can be used rearward-facing by children who weigh more than 20 lbs (9 kg) but are less than one year old.

60 THINGS TO KNOW BEFORE STARTING YOUR VEHICLE

- Rearward-facing child seats must **NEVER** be used in the front seat of a vehicle with a front passenger airbag. An airbag deployment could cause severe injury or death to infants in this position.
- Children who weigh more than 20 lbs (9 kg) and who are older than one year can ride forward-facing in the vehicle. Forward-facing child seats and convertible child seats used in the forward-facing direction are for children who weigh 20 to 40 lbs (9 to 18 kg), and are older than one year old. These child seats are also held in the vehicle by the lap/shoulder belt.
- The belt-positioning booster seat is for children weighing more than 40 lbs (18 kg), but who are still too small to fit the vehicle's seat belts properly. If the child cannot sit with knees bent over the seat cushion while the child's back is against the seatback, they need a belt-positioning booster seat. The child and booster seat are held in the vehicle by the lap/shoulder belt.

(Some booster seats are equipped with a front shield and are held in the vehicle by the lap portion.)

- For additional information, refer to www.seatcheck.org.

WARNING!

- **Improper installation can lead to failure of an infant or child restraint. It could come loose in a collision. The child could be badly injured or killed. Follow the manufacturer's directions exactly when installing an infant or child restraint.**
- **A rearward facing infant restraint should only be used in a rear seat. A rearward facing infant restraint in the front seat may be struck by a deploying passenger airbag which may cause severe or fatal to the infant.**

Here are some tips for getting the most out of your child restraint:

- Before buying any restraint system, make sure that it has a label certifying that it meets all applicable Safety Standards. The manufacturer recommends that you try a child restraint in the vehicle seats where you will use it before you buy it.
- The restraint must be appropriate for your child's weight and height. Check the label on the restraint for weight and height limits.
- Carefully follow the instructions that come with the restraint. If you install the restraint improperly, it may not work when you need it.
- The passenger seat belts are equipped with either cinching latch plates or automatic locking retractors, which are designed to keep the lap portion tight around the child restraint so that it is not necessary to

use a locking clip. If the seat belt has a cinching latch plate, pulling up on the shoulder portion of the lap/shoulder belt will tighten the belt. The cinching latch plate will keep the belt tight, however, any seat belt system will loosen with time, so check the belt occasionally and pull it tight if necessary.

If the seat belt has an automatic locking retractor, it will have a distinctive label. Pull the belt from the retractor until there is enough to allow you to pass through the child restraint and slide the latch plate into the buckle. Then, pull the belt until it is all extracted from the retractor. Allow the belt to return to the retractor, pulling on the excess webbing to tighten the lap portion about the child restraint. Refer to "Automatic Locking Mode" earlier in this section.

- Buckle the child into the restraint exactly as the manufacturer's instructions tell you.

- When your child restraint is not in use, secure it in the vehicle with the seat belt or remove it from the vehicle. Do not leave it loose in the vehicle. In a sudden stop or collision, it could strike the occupants or seat backs and cause serious personal injury.

LATCH — Child Seat Anchorage System (Lower Anchors and Tether for Children)

Your vehicle's rear seat is equipped with the child restraint anchorage system called LATCH. The LATCH system provides for the installation of the child restraint without using the vehicle's seat belts, instead securing the child restraint using lower anchorages and upper tether straps from the child restraint to the vehicle structure.

LATCH-compatible child restraint systems are now available. However, because the lower anchorages are to be introduced over a period of years, child restraint systems having attachments for those anchorages will continue to

also have features for installation using the vehicle's seat belts. Child restraints having tether straps and hooks for connection to the top tether anchorages have been available for some time. For some older child restraints, many child restraint manufacturers offer add-on tether strap kits or retro-fit kits. You are urged to take advantage of all the available attachments provided with your child restraint in any vehicle.

All three rear seating positions have lower anchorages that are capable of accommodating LATCH-compatible child seats having flexible, webbing-mounted lower attachments. Child seats with fixed lower attachments must be installed in the outboard positions only. Regardless of the specific type of lower attachment, **NEVER** install LATCH-compatible child seats such that two seats share a common lower anchorage. If installing child seats in adjacent rear-seating positions or if your child restraints are not LATCH-compatible, install the restraints using the vehicle's seat belts.

Installing the LATCH-Compatible Child Restraint System

We urge that you carefully follow the directions of the manufacturer when installing your child restraint. Not all child restraint systems will be installed as described here. Again, carefully follow the installation instructions that were provided with the child restraint system.

The rear seat lower anchorages are round bars, located at the rear of the seat cushion where it meets the seat back, and are just visible when you lean into the rear seat to install the child restraint. You will easily feel them if you run your finger along the intersection of the seatback and seat cushion surfaces.

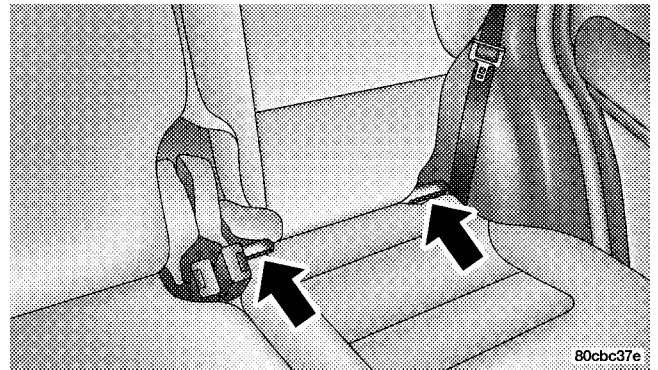

In addition, there are tether strap anchorages behind each rear seating position located on the back of the seat.

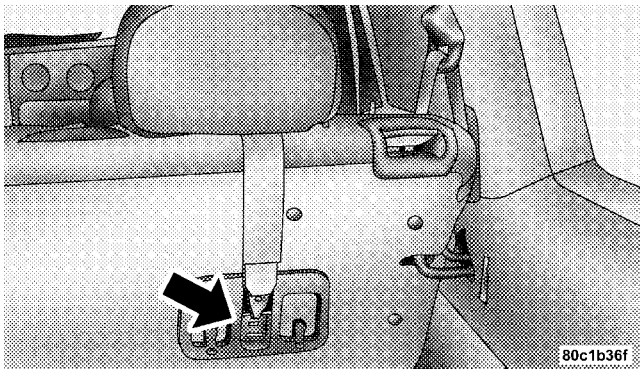

Many, but not all restraint systems will be equipped with separate straps on each side, with each having a hook or connector for attachment to the lower anchorage and a means of adjusting the tension in the strap. Forward-facing toddler restraints and some rear-facing infant

restraints will also be equipped with a tether strap, a hook for attachment to the tether strap anchorage and a means of adjusting the tension of the strap.

You will first loosen the adjusters on the lower straps and on the tether strap so that you can more easily attach the hooks or connectors to the vehicle anchorages. Next attach the lower hooks or connectors over the top of the anchorage bars, pushing aside the seat cover material. Then lift the tether anchorage cover directly behind the seat where you are placing the child restraint and attach the tether strap to the anchorage, being careful to route the tether strap to provide the most direct path between the anchor and the child restraint. If your vehicle is equipped with adjustable rear head restraints, raise the head restraint and, route the tether strap under the head restraint and between the two posts. Finally, tighten all three straps as you push the child restraint rearward and downward into

the seat, removing slack in the straps according to the child restraint manufacturer's instructions.

WARNING!

Improper installation of a child restraint to the LATCH anchorages can lead to failure of an infant or child restraint. The child could be badly injured or killed. Follow the manufacturer's directions exactly when installing an infant or child restraint.

Installing Child Restraints Using the Vehicle Seat Belt

The passenger seat belts are equipped with either cinching latch plates or automatic locking retractors, which are designed to keep the lap portion tight around the child restraint so that it is not necessary to use a locking clip. If the seat belt has a cinching latch plate, pulling up on the shoulder portion of the lap/shoulder belt will tighten the

belt. The cinching latch plate will keep the belt tight, however, any seat belt system will loosen with time, so check the belt occasionally and pull it tight if necessary.

If the seat belt has an automatic locking retractor, it will have a distinctive label. Pull the belt from the retractor until there is enough to allow you to pass through the child restraint and slide the latch plate into the buckle. Then, pull the belt until it is all extracted from the retractor. Allow the belt to return to the retractor, pulling on the excess webbing to tighten the lap portion about the child restraint. Refer to "Automatic Locking Mode" earlier in this section.

In the rear seat, you may have trouble tightening the lap/shoulder belt on the child restraint because the buckle or latch plate is too close to the belt path opening on the restraint. Disconnect the latch plate from the buckle and twist the short buckle-end belt several times to shorten it. Insert the latch plate into the buckle with the release button facing out.

66 THINGS TO KNOW BEFORE STARTING YOUR VEHICLE

If the belt still can't be tightened, or if by pulling and pushing on the restraint loosens the belt, you may need to do something more. Disconnect the latch plate from the buckle, turn the buckle around, and insert the latch plate into the buckle again. If you still can't make the child restraint secure, try a different seating position.

To attach a child restraint tether strap:

Route the tether strap over the seat back and attach the hook to the tether anchor located on the back of the seat. For the outboard seating positions, route the tether under the head restraint between the head restraint posts.

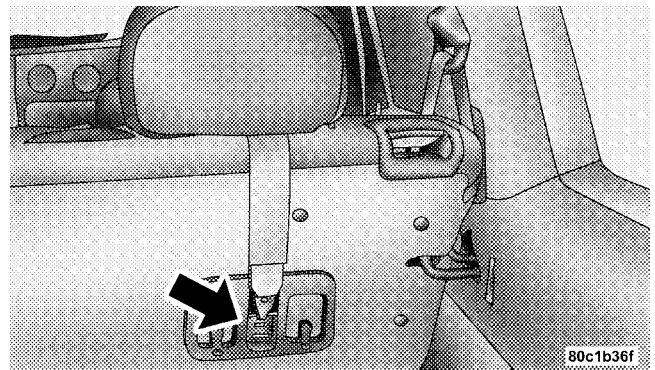

WARNING!

An incorrectly anchored tether strap could lead to increased head motion and possible injury to the child. Use only the anchor positions directly behind the child seat to secure a child restraint top tether strap.

Children Too Large for Booster Seats

Children who are large enough to wear the shoulder belt comfortably, and whose legs are long enough to bend over the front of the seat when their back is against the seat back should use the lap/shoulder belt in a rear seat.

- Make sure that the child is upright in the seat.
- The lap portion should be low on the hips and as snug as possible.

- Check belt fit periodically. A child's squirming or slouching can move the belt out of position.
- If the shoulder belt contacts the face or neck, move the child closer to the center of the vehicle. Never allow a child to put the shoulder belt under an arm.

Transporting Pets

Airbags deploying in the front seat could harm your pet. An unrestrained pet will be thrown about and possibly injured, or injure a passenger during panic braking or in a collision.

Pets should be restrained in the rear seat in pet harnesses or pet carriers that are secured by seat belts.

ENGINE BREAK-IN RECOMMENDATIONS

A long break-in period is not required for the engine in your new vehicle.

Drive moderately during the first 300 miles (500 km). After the initial 60 miles (100 km), speeds up to 50 or 55 mph (80 or 90 km/h) are desirable.

While cruising, brief full-throttle acceleration, within the limits of local traffic laws, contributes to a good break-in. Wide open throttle acceleration in low gear can be detrimental and should be avoided.

The engine oil installed in the engine at the factory is a high quality energy conserving type lubricant. Oil changes should be consistent with anticipated climate conditions under which vehicle operations will occur. The recommended viscosity and quality grades are shown in Section 7 of this manual. **NON-DETERGENT OR STRAIGHT MINERAL OILS MUST NEVER BE USED.**

A new engine may consume some oil during its first few thousand miles (kilometers) of operation. This should be considered as a normal part of the break-in and not interpreted as an indication of difficulty.

SAFETY TIPS

Exhaust Gas

WARNING!

Exhaust gases can injure or kill. They contain carbon monoxide (CO) which is colorless and odorless. Breathing it can make you unconscious and can eventually poison you. To avoid breathing (CO) follow the safety tips below.

- Do not inhale exhaust gases. They contain carbon monoxide, a colorless and odorless gas which can kill. Never run the engine in a closed area, such as a garage, and never sit in a parked vehicle with the engine running for an extended period. If the vehicle is stopped in an open area with engine running for more than a short period, adjust the ventilation system to force fresh, outside air into the vehicle.
- Guard against carbon monoxide with proper maintenance. Have the exhaust system inspected every time the vehicle is raised. Have any abnormal conditions repaired promptly. Until repaired, drive with all side windows fully open.
- Always run the climate control in panel or floor mode when driving with any windows open, even if only slightly, to help keep fresh air circulating inside vehicle. Otherwise poisonous gases could be drawn into the vehicle.

Safety Checks You Should Make Inside The Vehicle

Seat Belts

Inspect the belt system periodically, checking for cuts, frays and loose parts. Damaged parts must be replaced immediately. Do not disassemble or modify the system.

Seat belt assemblies must be replaced after an accident if they have been damaged (bent retractor, torn webbing, pretensioners, etc.). If there is any question regarding belt or retractor condition, replace the belt.

NOTE: The “Seat Belt Indicator Light” will remain on until the driver’s seat belt is buckled.

Airbag Warning Light

The light should come on and remain on for 6 to 8 seconds as a bulb check when the ignition switch is first turned on. If the bulb is not lit during starting, have the system checked by an authorized dealer.

Defrosters

Check operation by selecting the defrost mode and place the blower control on high speed. You should feel the air directed against the windshield.

Safety Checks You Should Make Outside The Vehicle

Tires

Examine tires for excessive tread wear or uneven wear patterns. Check for stones, nails, glass, or other objects lodged in the tread. Inspect for tread cuts or sidewall cracks. Check wheel nuts for tightness and tires (including spare) for proper pressure.

Lights

Have someone observe the operation of all exterior lights while you work the controls. Check turn signal and high beam indicator lights on the instrument panel.

Fluid Leaks

Check area under vehicle after overnight parking for fuel, coolant, oil or other fluid leaks. Also, if gasoline fumes are detected, the cause should be located and corrected immediately.

UNDERSTANDING THE FEATURES OF YOUR VEHICLE

CONTENTS

| | | | |
|---|-----|---|-----|
| ■ Mirrors | .75 | ■ Hands-Free Communication (UConnect™) | |
| □ Inside Day/Night Mirror | .75 | — If Equipped | .78 |
| □ Inside Automatic Dimming Mirror If Equipped | .76 | □ Operation | .80 |
| □ Outside Mirrors | .76 | □ Phone Call Features | .84 |
| □ Power Remote Control Outside Mirrors — If Equipped | .77 | □ Advanced Phone Connectivity | .86 |
| □ Heated Remote Control Mirrors — If Equipped | .78 | □ UConnect™ System Features | .87 |
| □ Illuminated Vanity Mirrors — If Equipped | .78 | ■ Seats | .90 |
| | | □ Front Seat (Manual) Adjustment | .90 |
| | | □ Front Seat Adjustment — Recline | .91 |

72 UNDERSTANDING THE FEATURES OF YOUR VEHICLE

| | | | |
|--|-----|---|-----|
| □ Head Restraints | 92 | □ Turn Signals | 101 |
| □ Power Seat Adjuster — If Equipped | 93 | □ Lights-On Reminder | 102 |
| □ 65/35 Split Folding Rear Seat | 94 | □ Battery Saver Feature — Exterior Lights | 102 |
| □ Heated Seats — If Equipped | 97 | □ Fog Lights — If Equipped | 102 |
| ■ To Open And Close The Hood | 97 | □ Daytime Running Lights — If Equipped | 102 |
| ■ Lights | 98 | □ Light Bar — If Equipped | 103 |
| □ Interior Lights | 98 | ■ Windshield Wipers And Washers | 104 |
| □ Front Map/Reading Lights | 100 | □ Windshield Washers | 105 |
| □ Multi-Function Control Lever | 100 | □ Mist Feature | 106 |
| □ Parking Lights, Instrument Panel Lights, And Headlights | 101 | □ Windshield Wiper Operation | 106 |
| □ High Beam/Low Beam Select Switch | 101 | □ Intermittent Wiper System | 107 |
| □ Passing Light | 101 | ■ Tilt Steering Column | 107 |

| | | |
|--|--|--|
| <hr/> | | UNDERSTANDING THE FEATURES OF YOUR VEHICLE 73 |
| <ul style="list-style-type: none"> ■ Electronic Speed Control108 <ul style="list-style-type: none"> □ To Activate108 □ To Set At A Desired Speed109 □ To Deactivate109 □ To Resume Speed109 □ To Vary The Speed Setting109 □ To Accelerate For Passing109 ■ Overhead Console — If Equipped110 <ul style="list-style-type: none"> □ Dome/Reading Lights111 □ Electronic Vehicle Information Center112 □ Tire Pressure Monitor System113 □ General Information115 □ Customer Programmable Features115 | <ul style="list-style-type: none"> □ Mini-Trip Computer120 ■ Garage Door Opener — If Equipped125 <ul style="list-style-type: none"> □ When Your Vehicle Is New126 □ Programming Homelink126 □ Gate Operator/Canadian Programming129 □ Using Homelink130 ■ Power Sunroof — If Equipped130 <ul style="list-style-type: none"> □ Express Open Feature132 □ Sunroof Maintenance132 ■ Power Outlet133 ■ Cigar Lighter — If Equipped135 ■ Glove Compartment135 ■ Cup Holders136 | 3 |

74 UNDERSTANDING THE FEATURES OF YOUR VEHICLE

| | | | |
|--|-----|--|-----|
| <input type="checkbox"/> Smoker's Package — If Equipped | 136 | <input type="checkbox"/> Cargo Tie-Down Hooks | 138 |
| <input checked="" type="checkbox"/> Cargo Area Features | 137 | <input type="checkbox"/> Cargo Organizer — If Equipped | 140 |
| <input type="checkbox"/> Cargo Light | 137 | <input checked="" type="checkbox"/> Roof Luggage Rack | 142 |
| <input type="checkbox"/> Retractable Cargo Area Cover — If Equipped | 137 | | |

MIRRORS

Inside Day/Night Mirror

The mirror should be adjusted to center on the view through the rear window. A two-point pivot system allows for horizontal and vertical adjustment of the mirror. The mirror should be adjusted while set in the day position (toward windshield).

Annoying headlight glare from vehicles behind you can be reduced by moving the small control under the mirror to the night position (toward rear of vehicle).

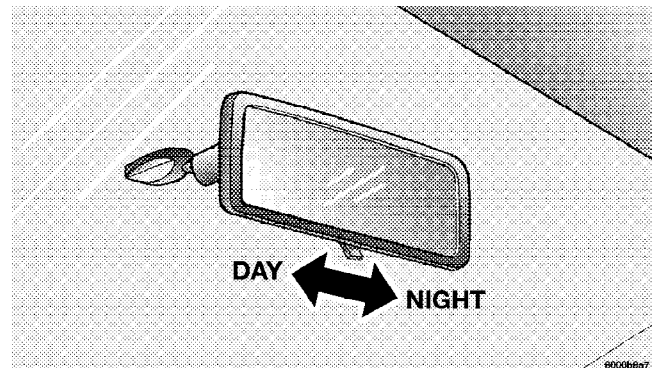

Inside Automatic Dimming Mirror — If Equipped

This mirror automatically adjusts for annoying headlight glare from vehicles behind you. You can turn the feature on or off by pressing the button at the base of the mirror. A light in the button will indicate when the dimming feature is activated.

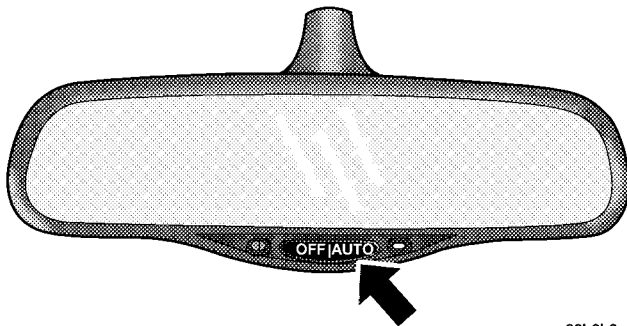

80b6b3a6

CAUTION!

To avoid damage to the mirror during cleaning, never spray any cleaning solution directly onto the mirror. Apply the solution onto a clean cloth and wipe the mirror clean.

Outside Mirrors

To receive maximum benefit, adjust the outside mirrors to center on the adjacent lane of traffic with a slight overlap of the view obtained on the inside mirror.

WARNING!

Vehicles and other objects seen in the right side convex mirror will look smaller and farther away than they really are. Relying too much on your right side mirror could cause you to collide with another vehicle or other objects. Use your inside mirror when judging the size or distance of a vehicle seen in the right side mirror.

Power Remote Control Outside Mirrors — If Equipped

The controls for the power mirrors are located on the driver's door trim panel below the door lock switch.

Set the top switch to the left or right for the left or right mirror, and set it to the center off position to prevent accidentally moving a mirror when you are finished adjusting the mirror. Press one of the four arrows for the direction you want the mirror to move.

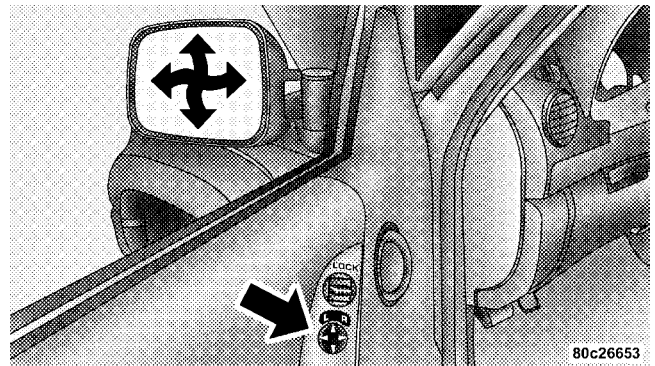

Heated Remote Control Mirrors — If Equipped



These mirrors are heated to melt frost or ice. This feature is activated whenever you turn on the rear window defrost.

Illuminated Vanity Mirrors — If Equipped

An illuminated vanity mirror is on the sun visor. To use the mirror, rotate the sun visor down and swing the mirror cover upward. The lights turn on automatically. Closing the mirror cover turns off the lights.

When the ignition is turned off, the light will turn off automatically (after approximately 8 minutes).

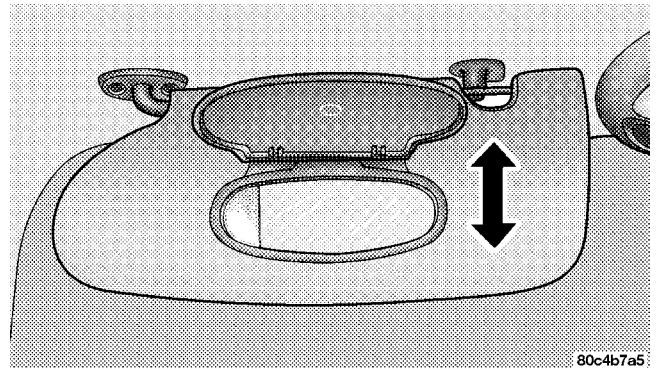

HANDS-FREE COMMUNICATION (UConnect™) — IF EQUIPPED

UConnect™ is a voice-activated, hands-free, in-vehicle communications system. UConnect™; allows you to dial your cellular phone using simple voice commands (e.g., “Call Mike Work” or “Dial 248-555-1212”). Your cellular

phone’s audio is transmitted through your vehicle’s stereo system; the system will automatically mute your radio before receiving or sending a call.

UConnect™ allows you to transfer calls between the system and your cellular phone as you enter or exit your vehicle, and enables you to mute the system’s microphone for private conversations.

The UConnect™; phone book enables you to store up to 32 names and four numbers per name. This system is driven through your Bluetooth™ Hands-Free Profile cellular phone. UConnect™ features Bluetooth™ technology - the global standard that enables different electronic devices to connect to each other without wires or a docking station, so UConnect™ works no matter where you stow your cellular phone (be it your purse, pocket, or briefcase). UConnect™ allows up to seven cellular phones to be linked to the system, and it is available in English, French, or Spanish formats (as equipped).

The rearview mirror contains the microphone for the system and the control buttons that will enable you to access the system. The diagram below shows the mirror with the appropriate buttons. Individual button behavior is discussed in the “Operation” Section.

3

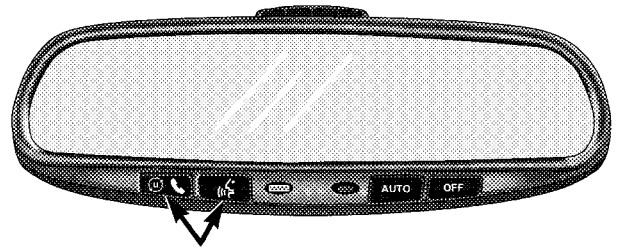

8105b20d

The UConnect™ system can be used with any Hands Free Profile certified Bluetooth™ cellular phone. If your

cellular phone has a different profile (i.e. headset profile), you will not be able to use any UConnect™ features.

The UConnect™ system is fully integrated into your vehicle, including your vehicle's stereo system. All voice prompts as well as the other party's voice in a conversation will be played over your vehicle's stereo system. The volume of the UConnect™ system can be controlled through your normal stereo controls.

The radio display will be used for visual prompts from the UConnect™ system such as caller ID.

Operation

Voice commands can be used in the operation of the UConnect™ system and to navigate through the UConnect™ menu structure. Voice commands should be given after each UConnect™ system prompt. You will be prompted for a specific command and then guided through the available options. There are two ways to give commands to the UConnect™ system:

- You can say "Dial" at the "Ready" prompt. When prompted for the phone number you wish to dial, say the phone number ("123 456 7890").
- Alternatively as you become familiar with the UConnect™ system, you can combine the commands and say "Dial 123 456 7890".

Pairing a Cellular Phone to the UConnect™ System

To begin using your UConnect™ system, you must pair your compatible Bluetooth™ enabled cellular phone. To complete the registration process, you will need to reference your cellular phone owner's manual.

- Press the 'Phone' button to begin.
- After the "Ready" prompt, say "Setup Phone Pairing".
- You will be asked to say a four-digit pin number into the UConnect™ system which you will later need to enter into your cellular phone during the cellular phone pairing process. You can enter any four-digit

pin number. You will not need to remember this pin number after the initial registration process.

- The UConnect™ system will then prompt you to begin the cellular phone pairing process on your cellular phone. Please see your cellular phone user's manual for instructions on how to complete this step.
- For identification purposes, you will be prompted to give the UConnect™ system a name for your cellular phone. Each cellular phone that is paired should be given a unique phone name.
- You will then be asked to give your cellular phone a priority level between 1 and 7, 1 having the highest priority. You can connect up to seven cellular phones to your UConnect™ system and the priority allows the UConnect™ system to know which cellular phone to use if multiple cellular phones are in the vehicle at the same time. For example, if a priority 3 and priority 5 cellular phone are both in the vehicle, the UConnect™

system will use the priority 3 cellular phone when you make a call. You can select to use a lower priority cellular phone at any time.

Making a Phone Call Using Digit Dialing

- Press the 'Phone' button to begin.
- After the "Ready" prompt, say "Dial" or "Call" followed by the phone number you wish to dial. For example, you can say "Dial 123 456 7890". The phone number that you enter must be a valid length.

Making a Phone Call Using Your UConnect™ Phonebook

- Press the "Phone" button to begin.
- After the "Ready" prompt, say "Dial" or "Call" followed by the name and designation of a phonebook entry that you wish to dial. For example, you can say "Call John Doe Work".

Add Names to Your UConnect™ Phonebook

- Press the “Phone” button to begin.
- After the “Ready” prompt, say “Phonebook New Entry”.
- When prompted, say the name of the new entry.
- Next, enter the number designation (e.g. “Home”, “Work”, “Mobile”, or “Pager”). This will allow you to have multiple numbers for each phonebook entry.
- Recite the phone number for the phonebook entry that you are adding.

After you are finished adding an entry into the phonebook, you will be given the opportunity to add more phone numbers to the current entry or to return to the main menu.

The UConnect™ system will allow you to enter up to 32 names into the phonebook with each name having up to four associated phone numbers and designations.

Edit Entries in the UConnect™ Phonebook

- Press the ‘Phone’ button to begin.
- After the “Ready” prompt, say “Phonebook Edit”.
- You will then be asked for the name of the phonebook entry that you wish to edit.
- Next, choose the number designation that you wish to edit. The choices are home, work, mobile, or pager.
- Recite the new phone number for the phonebook entry that you are editing.

After you are finished editing an entry in the phonebook, you will be given the opportunities to edit another entry in the phonebook, call the number you just edited, or return to the main menu.

Phonebook edit can be used to add another phone number to a name entry that already exists in the phonebook. For example, the entry John Doe may have a mobile and a home number, but you can add John Doe's work number later through phonebook edit.

Delete Entries in the UConnect™ Phonebook

- Press the 'Phone' button to begin.
- After the "Ready" prompt, say "Phonebook Delete".
- After you enter the phonebook delete menu, you will then be asked for the name of the phonebook entry that you wish to delete. You can either say the name of a phonebook entry that you wish to delete or you can say "List Names" to hear a list of the entries in the phonebook from which you can choose. To select one of the entries from the list, press the "Voice Recognition" button while the UConnect™ system is playing the desired entry and say "Delete".

- After you enter the name, the UConnect™ system will ask you if you wish to delete the home, work, mobile, or pager number for this entry.

Delete All Entries in the UConnect™ Phonebook

- Press the 'Phone' button to begin.
- After the "Ready" prompt, say "Phonebook Delete All".
- The UConnect™ system will ask you to verify that you wish to delete all the entries from the phonebook.
- After confirmation, the phonebook entries will be deleted.

List All Names in the UConnect™ Phonebook

- Press the 'Phone' button to begin.
- After the "Ready" prompt, say "Phonebook List Names".

- The UConnect™ system will play the names of all the phonebook entries.
- To call one of the names in the list, press the 'Voice Recognition' button during the playing of the desired name and say "Call".
- The UConnect™ system will then prompt you as to number designation you wish to call.
- The selected number will be dialed.

Phone Call Features

The following feature(s) can be accessed through the UConnect™ system if the feature(s) are available on your cellular service plan. For example, if your cellular service plan provides three-way calling, this feature can be accessed through the UConnect™ system.

Answer or Reject an Incoming Call - No Call Currently in Progress

When you receive a call on your cellular phone, the UConnect™ system will interrupt the stereo audio and will ask if you would like to answer the call by pressing the 'Phone' button. Press the 'Phone' button to answer the call. To reject the call, press the 'Phone' button until you hear a single beep indicating that the incoming call was rejected.

Answer or Reject an Incoming Call - Call Currently in Progress

If a call is currently in progress and you have another incoming call, press the 'Phone' button to place the current call on hold and answer the incoming call. To reject the incoming call, you can disregard the call and continue with your current conversation.

Making a Second Call while Current Call in Progress

To make a second call while you are currently in a call, press the 'Voice Recognition' button and say "Dial" or "Call" followed by the phone number or phonebook entry you wish to call. The first call will be on hold while the second call is in progress.

Putting a Call on Hold and Retrieving a Call from Hold

To put a call on hold, press the 'Phone' button until you hear a single beep which will indicate that the call has been placed on hold. To bring the call back from hold, press the 'Phone' button.

Toggling Between Two Calls

If two calls are in progress (one active and one on hold), press the 'Phone' button until you hear a single beep

indicating that the active and hold status of the two calls have switched. Only one call can be placed on hold at one time.

Conference Call

When two calls are in progress (one active and one on hold), press the 'Phone' button until you hear a double beep indicating that the two calls have been joined into one conference call.

Three-Way Calling

To initiate three-way calling, press the 'Voice Recognition' button while a call is in progress and make a second phone call. When the second call is established, press the 'Phone' button until you hear a double beep indicating that the two calls have been joined into one conference call.

Call Termination

To end a call in progress, press the 'Phone' button. All calls in progress will be terminated.

Phone Redial

- Press the 'Phone' button to begin.
- After the "Ready" prompt, say "Redial".
- The UConnect™ system will call the last number that was dialed on your cellular phone. This may not be the last number dialed by your UConnect™ system.

Advanced Phone Connectivity

Transferring an Active Call between the UConnect™ System and Your Cellular Phone

The UConnect™ system allows ongoing calls to be transferred to your cellular phone or to the UConnect™ system without terminating the call. To transfer an ongoing call from your cellular phone to the UConnect™ system or vice versa, press the 'Voice Recognition' button and say "Transfer Call".

Delete Paired Cellular Phones

- Press the 'Phone' button to begin.
- After the "Ready" prompt, say "Setup Phone Pairing".
- At the next prompt, say "Delete".
- You will be asked to say the name of the phone that you wish to delete. You can either say the name of the phone that you wish to delete or you can say "All" to delete all the phones.

Connect or Disconnect the Connection between the UConnect™ System and Your Cellular Phone

Your cellular phone can be paired with many different electronic devices, but can only be actively "connected" with one electronic device at a time.

If you would like to connect or disconnect the Bluetooth™ connection between a paired cellular phone and the UConnect™ system, follow the instruction described in your cellular phone user's manual.

List Paired Cellular Phone Names

- Press the 'Phone' button to begin.
- After the "Ready" prompt, say "Setup List Phones" and the UConnect™ system will play the phone names of all paired cellular phones in order from highest priority to lowest priority.

Select a Lower Priority Paired Cellular Phone

- Press the 'Phone' button to begin.
- After the "Ready" prompt, say "Setup Select Phone".
- When prompted, say the phone name of the cellular phone you wish to use, or say "List Phones" to hear a list of all the phones that have been paired to your

UConnect™ system. To select a phone from the list, press the 'Voice Recognition' button and say "Select".

- The lower priority phone will only be used for the next phone call. After that, the UConnect™ system will return to using the highest priority phone in the vehicle.

UConnect™ System Features

Barge In - Touch Tone Phone Inputs

You can use your UConnect™ system to access a voice mail system, an automated service, or any other phone number that you can dial with any phone. When calling a number with your UConnect™ system that normally requires you to enter in a touch-tone sequence on your cellular phone keypad, you can push the 'Voice Recognition' button and say the sequence you wish to enter followed by "Send". For example, if required to enter your pin number, you can press the 'Voice Recognition' button and say "3 7 4 6 Send", or whatever you have made your

pin. This method can also be used in instances where you are pressing a number on your keypad to navigate through a menu structure or to enter a number for a pager.

Barge In - Overriding Prompts

The 'Voice Recognition' button can be used when you wish to skip part of a prompt and issue your voice recognition command immediately. For example, if a prompt is playing "Would you like to pair a phone, clear a...", you could press the 'Voice Recognition' button and say "Pair A Phone" to select that option without having to listen to the rest of the voice prompt.

Language Selection

To change the language that the UConnect™ system is using, press the 'Phone' button and say the name of the language you wish to switch to (English, Español, or

Français as equipped). After selecting one of the languages, all prompts and voice commands will be in the selected language.

Turning Confirmation Prompts On/Off

Turning confirmation prompts off will stop the system from confirming your choices (e.g. the UConnect™ system will not repeat a phone number before you dial it).

- Press the 'Phone' button to begin.
- After the "Ready" prompt, say "Setup Confirmation". The UConnect™ system will play the current confirmation prompt status and you will be given the choice to change it.

Low Signal, Battery Strength, and Roam Notification

The UConnect™ system will provide notification to inform you if your cellular phone is in roaming status, has low signal strength, or has a low battery when you are trying to place a phone call.

Dialing Using the Cellular Phone Keypad

You can dial a phone number with your cellular phone keypad and still use the UConnect™ system. By dialing a number with your paired Bluetooth™ cellular phone, the audio will be played through your vehicle's stereo system. The UConnect™ system will work the same as if you dialed the number using voice recognition.

Mute/Unmute

When you mute the UConnect™ system, you will still be able to hear the conversation coming from the other party, but the other party will not be able to hear you. In order to mute the UConnect™ system press the 'Voice

Recognition' button and say "Mute". In order to unmute the UConnect™ system; press the 'Voice Recognition' button and say "Unmute".

Help

If you need assistance at any prompt or if you want to know what your options are at any prompt, say "Help". The UConnect™ system will play all the options at any prompt if you ask for help.

Cancel

At any prompt, you can say "Cancel" and you will be returned to the previous menu.

Emergency Assistance

If you are in an emergency, say "Dial Emergency" or "Call Emergency" and the UConnect™ system will instruct your cellular phone to call 911.

Towing Assistance

If you need towing assistance, say "Dial Towing Assistance" or "Call Towing Assistance". Please refer to the 24-Hour Towing Assistance coverage details in the DaimlerChrysler Motors Company 24-Hour Towing Assistance Program Guide.

SEATS

Front Seat (Manual) Adjustment

Move the seat forward or rearward using the adjustment bar. Lift up on the bar located on the front of the seat near the floor. Position the seat and be sure the latch engages fully.

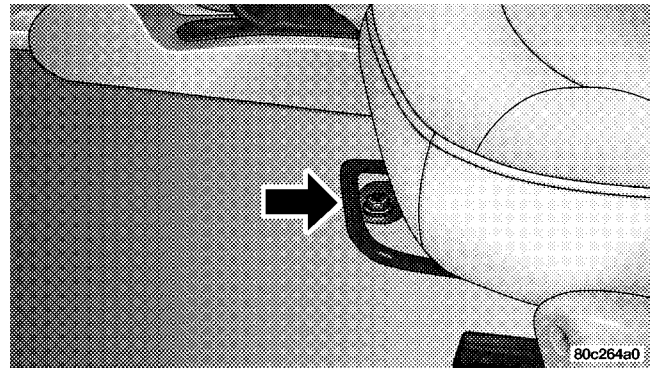

Using body pressure, move forward and rearward on the seat to be sure the seat adjusters have latched.

WARNING!

- **Adjusting a seat while the vehicle is moving is dangerous.** The sudden movement of the seat could cause you to lose control. The seat belt might not be properly adjusted and you could be injured. Adjust any seat only while the vehicle is parked.
- **Do not ride with the seatback reclined so that the seat belt is no longer resting against your chest.** In a collision you could slide under the seat belt and be seriously or even fatally injured. Use the recliner only when the vehicle is parked.

Front Seat Adjustment — Recline

To adjust the seatback, lift the lever located on the outboard side of the seat, lean back, and release the lever at the desired position. To return the seatback, lift the lever, lean forward, and release the lever.

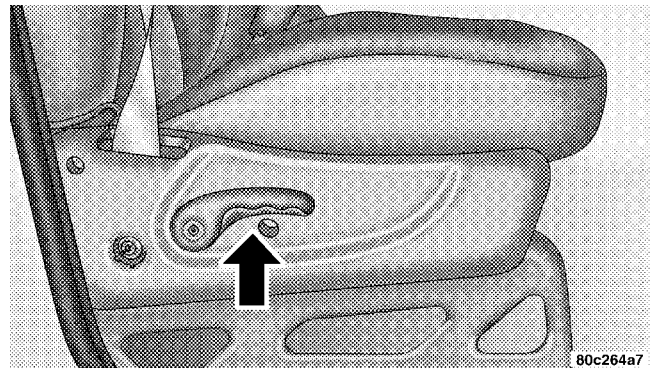

Head Restraints

Head restraints can reduce the risk of whiplash injury in the event of impact from the rear. Adjustable head restraints should be adjusted so that the upper edge is as high as practical. The head restraints have a locking button that must be pushed inward to lower the head restraint. The restraints may be raised without pushing in the button.

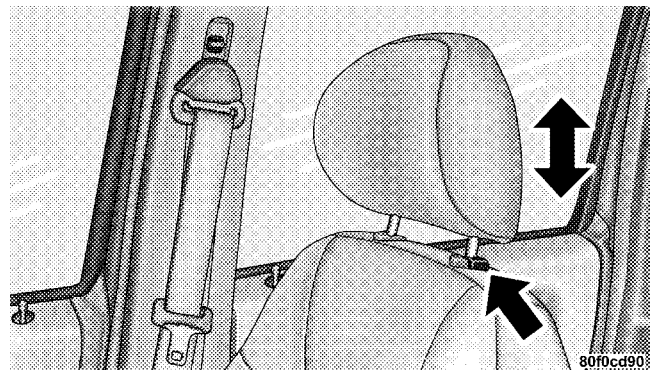

Power Seat Adjuster — If Equipped**WARNING!**

Do not ride with the seatback reclined so that the seat belt is no longer resting against your chest. In a collision you could slide under the seat belt and be seriously or even fatally injured. Use the recliner only when the vehicle is parked.

6-Way Power Seat with Manual Recliner

The seat switch is on the outboard side of the seat near the floor. Use this switch to move the seat up or down, forward or rearward, or to tilt the seat.

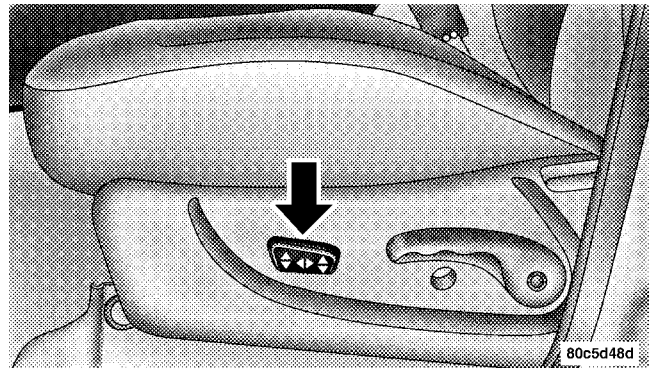

This seat also has a manual recline lever located just to the rear of the power seat switch. Pull up on the lever to recline the seat.

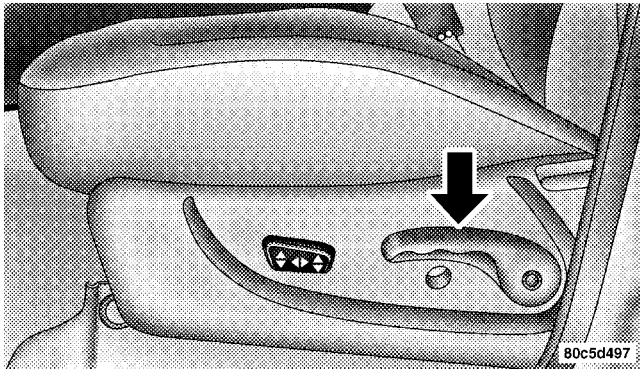

65/35 Split Folding Rear Seat

To provide additional storage area, each rear seat can be folded flat to allow for extended cargo space and still maintain some rear seating room.

NOTE: Prior to folding the rear seat, it may be necessary to reposition the front seat to its mid-track position.

Also, be sure that the front seats are fully upright and positioned forward. This will allow the rear seat to fold down easily.

WARNING!

- It is extremely dangerous to ride in a cargo area, inside or outside of a vehicle. In a collision, people riding in these areas are more likely to be seriously injured or killed.
- Do not allow people to ride in any area of your vehicle that is not equipped with seats and seat belts.
- Be sure everyone in your vehicle is in a seat and using a seat belt properly.

To fold the 65/35 rear seat, perform the following steps:

1. Locate the seatback release handle on the outboard top side of each rear seatback; lift up on the handle, and rotate the lever forward until the seatback releases. Fold the seatback completely forward.

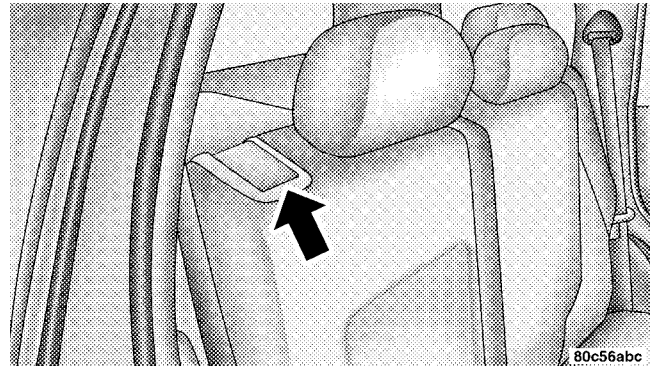

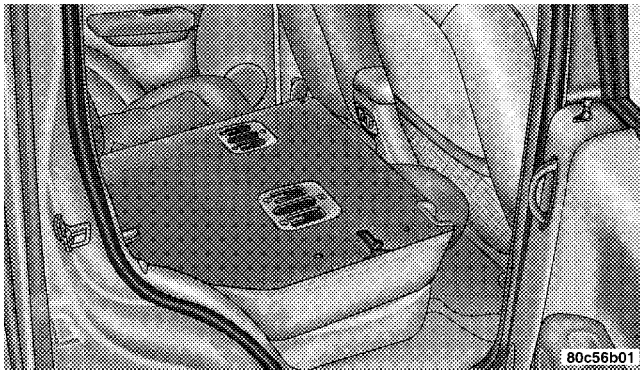

NOTE: When lifting up on the release handle, the seatback will release easier if you do not pull forward on the seatback; only lift up on the release handle until the seatback disengages, then fold the seat forward.

When the seatback is folded completely forward, the head restraints should be flush against the seat cushion.

To restore the 65/35 rear seat to the upright position perform the following steps:

Raise the seatback and lock it into place. If interference from the cargo area prevents the seatback from fully locking, you will have difficulty returning the seat to its proper position.

WARNING!

Be certain that the seatback is securely locked into position. If the seatback is not securely locked into position the seat will not provide the proper stability for child seats and/or passengers. An improperly latched seat could cause serious injury.

Heated Seats — If Equipped

The heated seat switch is located on the outboard side of the front seats. Pressing this switch to its desired setting (HI or LO) will activate the respective heating element for the heated seat.

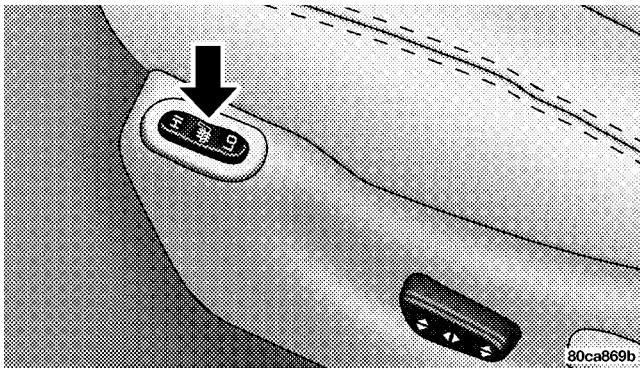

Once the heated seat switch is activated, depressing it a second time will de-activate it.

TO OPEN AND CLOSE THE HOOD

To open the hood, two latches must be released. First pull the hood release lever inside your vehicle located under the left side of the instrument panel.

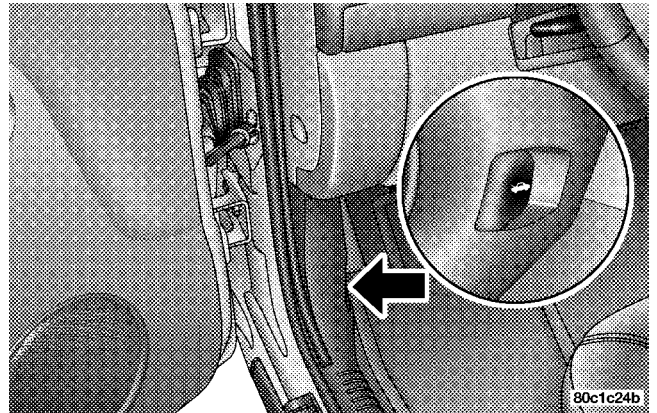

Then, reach under the hood and slide the safety latch to the right and lift the hood.

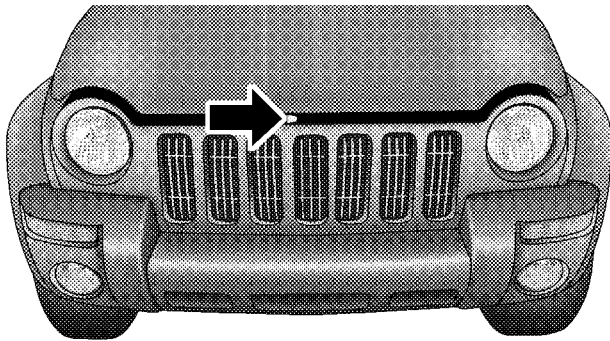

80d1f79e

To prevent possible damage, do not slam the hood to close it. Lower the hood until it is open approximately 12 inches (30 cm) and then push hood closed. This should secure both latches. Never drive your vehicle unless the hood is fully closed, with both latches engaged.

WARNING!

If the hood is not fully latched, it could fly up when the vehicle is moving and block your forward vision. Be sure all hood latches are latched fully before driving.

LIGHTS

Interior Lights

The overhead lights will come on when a door is opened, and when the rotating ring on the multi-function control lever is in a position other than OFF. They may also be turned on by rotating the control for the dimmer switch on the multi-function control lever fully upward or by pressing the “Unlock” button on the keyfob.

The overhead lights will automatically turn off in about 8 minutes if a door is left open or the dimmer control is left in the dome light position. Turn the ignition switch ON to restore the overhead light operation.

Rear Cargo Light

The rear cargo light includes an independent “On/Off” switch, which when “off” will not allow the illumination of any interior lighting when the rear swing gate or flipper glass is opened. All other methods of turning the interior lighting on/off will function normally regardless of the rear cargo light switch position.

Dimmer Control

With the park lights or headlights on, rotating the control for the dimmer switch on the multi-function control lever upward will increase the brightness of the instrument panel lights. Rotating the control completely upward turns on the dome light.

Daytime Brightness Feature

Certain components (odometer, radio, etc.) can be illuminated at full brightness during the daytime. This can be helpful when driving with your headlights on during the daytime such as in a parade or a funeral procession. To activate this feature, rotate the multi-function control lever one detent lower than the dome light.

Front Map/Reading Lights

These lights are mounted in the overhead console. Each light can be turned on by pressing the recessed area of the lens. To turn these lights off, press the recessed area of the lens a second time.

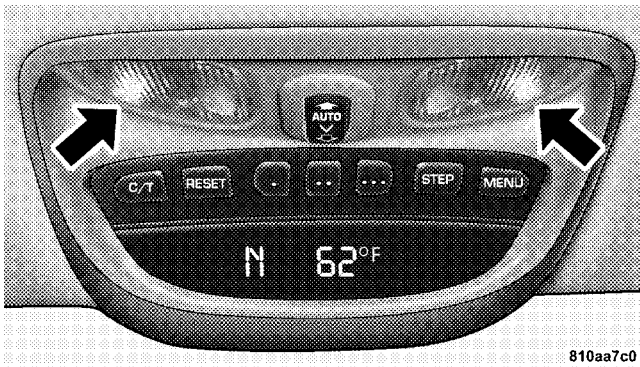

Multi-Function Control Lever

The multi-function control lever controls the operation of the park lights, headlights, headlight beam selection, passing light, fog lights, instrument panel light dimming, and turn signals.

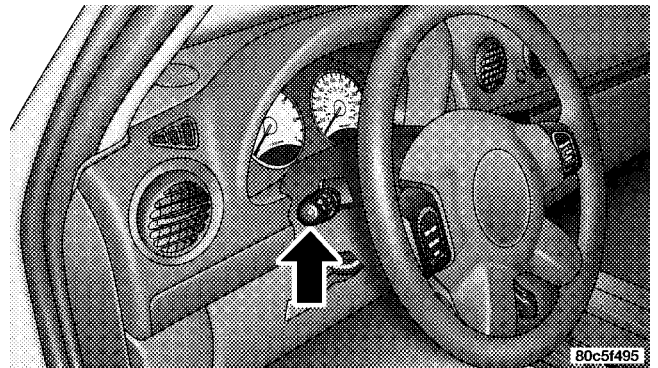

Parking Lights, Instrument Panel Lights, and Headlights

Turn the end cap of the multi-function control lever to the first detent for parking lights and instrument panel lights. Turn to the second detent for headlight operation.

To change the brightness of the instrument panel lights, rotate the center portion of the multi-function control lever up or down.

High Beam/Low Beam Select Switch

Pull the multi-function control lever towards you to switch the headlights to HIGH beam. Pull the multi-function control lever a second time to switch the headlights to LOW beam. The “High Beam Indicator Light” will illuminate when the high beams are on.

Passing Light

You can signal another vehicle with your headlights by lightly pulling the multi-function control lever toward the steering wheel. This will cause the headlights to turn on at high beam and remain on until the lever is released. The “High Beam Indicator Light” will illuminate when the high beams are on.

Turn Signals

Move the multi-function control lever up or down and the arrows on each side of the instrument cluster flash to show proper operation of the front and rear turn signal lights. You can signal a lane change by moving the lever partially up or down without moving beyond the detent.

If either light flashes at a very fast rate, check for a defective outside light bulb. If an indicator fails to light when the lever is moved, it would suggest that the fuse or indicator is defective.

NOTE: A tone will chime if the turn signals are left on for more than 2 miles (3.2 km).

Lights-On Reminder

A chime will sound if the driver's door is left open, and the headlights or parking lights are left on.

Battery Saver Feature — Exterior Lights

If the park lights, headlights, fog lights, or high beams are left on when the ignition switch is in the OFF position, the battery saver feature will automatically turn off the exterior lights after eight minutes. Normal operation will resume when the ignition is turned ON or when the switch is turned to another position.

Fog Lights — If Equipped

#D The front fog light switch is in the multi-function control lever. To activate the front fog lights, turn on the park or low beam headlights and pull out the end of the lever. The "Fog Light Indicator Light" will illuminate when the fog lights are on.

NOTE: The fog lights will only operate with the park lights or the headlights on low beam. Selecting high beam headlights will turn off the fog lights.

Daytime Running Lights — If Equipped

The headlights come on at a low intensity level after the engine has started. They will turn off when the vehicle is turned off, when the headlights are switched on, or when the parking brake is set.

Light Bar — If Equipped

1. Remove lamp covers by pressing the thumb tab upwards, and pulling the cover off.

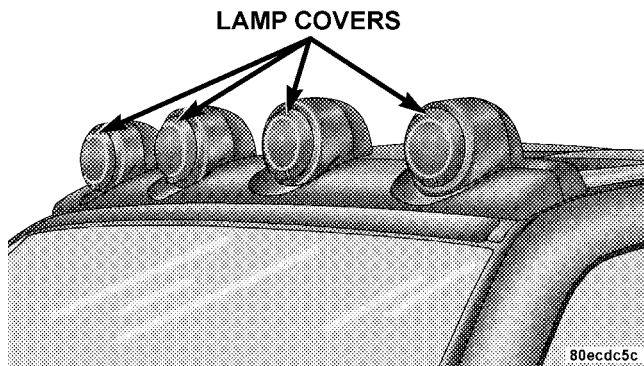
**CAUTION!**

The auxiliary lights mounted on the off road light bar should be illuminated during "OFF-ROAD USE ONLY." Having them illuminated on public streets, highways, roads, etc. may be illegal in your state. Your state may also require auxiliary lights be covered when operating your vehicle on the public streets, highways, roads, etc. Further, illuminating these lights with the supplied covers installed could cause permanent damage to the light bar. Before using these auxiliary lights, contact your State Authorities for proper operation and use of these lights.

2. With the ignition in the ON position, press the button to turn on the light bar (located on the instrument panel to the left of the steering column). Press the button again to turn off the light bar.

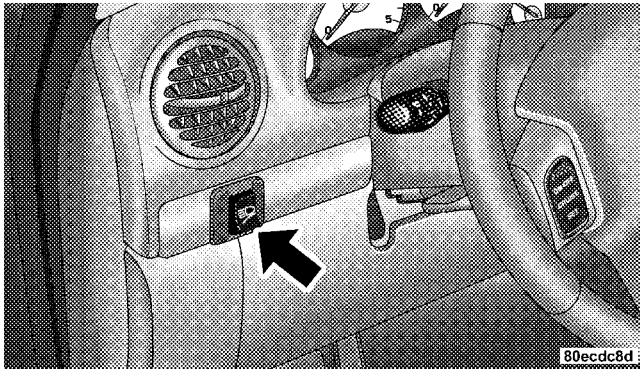

An indicator light in the instrument cluster will illuminate when the light bar has been activated.

To reinstall lamp covers, insert the tab under the top center lip of the lamp housing. Rotate the cover until snap fit is aligned with notch in the bottom center of the housing. Push cover until it is securely snapped (flush) in the housing.

WINDSHIELD WIPERS AND WASHERS

The wipers and washers are operated by a switch on the control lever. This control lever is located on the right side of the steering column. For front wiper operation, turn the control lever end cap upward to select the desired wiper speed.

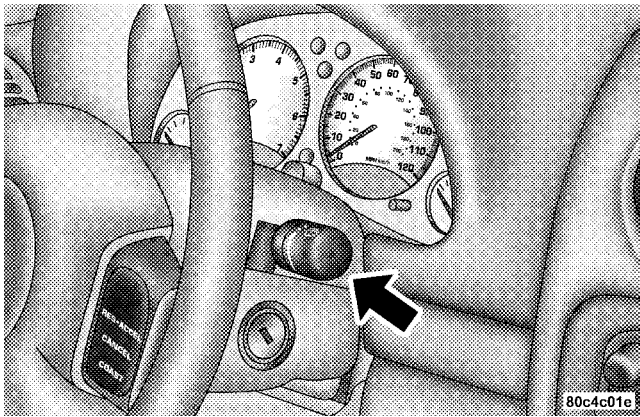

Windshield Washers

To use the washer, pull the lever toward you and hold while spray is desired. If the lever is pulled while in the delay range, the wiper will operate for two wipe cycles after the lever is released, and then resume the intermittent interval previously selected.

NOTE: If vehicle is equipped with the optional Electronic Vehicle Information Center (EVIC) in the overhead console, all warnings including “door”, “GATE”, “GLASS”, and “LOWASH” will only be displayed in the EVIC display (not in the instrument cluster). For additional information, refer to “Overhead Console — If Equipped” in Section 3.

The vacuum fluorescent (VF) display located in the odometer area displays the word “LOWASH” when the washer solvent needs to be refilled. If the vehicle is not moving, when a low washer fluid condition is detected, the VF display will show the word “LOWASH” and then show the odometer/trip odometer mileage (each for 2 seconds). The display will continue to cycle.

If any other active warnings including “door”, “GATE”, or “GLASS” are present, they will be shown in the VF display and will continue to cycle. If the vehicle starts moving, two single chimes will occur (one chime for each

complete display cycle). After this, the display will continue to sequence. After fifteen "LOWASH" sequences, the VF display will no longer provide this warning.

If the trip/reset button is pressed while the VF warnings are being displayed, the VF display will revert back to only displaying the odometer/trip odometer mileage. Once the warning is removed from the display, it will not return for the duration of the ignition cycle.

If the lever is pulled while in the OFF position, the wipers will operate for several wipe cycles, then turn off.

Mist Feature

Push down on the wiper lever to activate a single wipe to clear off road mist or spray from a passing vehicle. As long as the lever is held down, the wipers will continue to operate.

CAUTION!

In cold weather, always turn off the wiper switch and allow the wipers to return to the park position before turning off the engine. If the wiper switch is left on and the wipers freeze to the windshield, damage to the wiper motor may occur when the vehicle is restarted.

Windshield Wiper Operation

Turn the control lever end cap upward to the middle mark (sixth detent) for Low speed wiper operation, or to the upper mark (seventh detent) for High speed operation.

Intermittent Wiper System

Use the intermittent wiper when weather conditions make a single wiping cycle, with a variable pause between cycles, desirable. Move the control lever to any of the first five wiper switch positions by turning the end cap of the control lever. The delay can be regulated from a maximum of approximately 18 seconds between cycles, to a cycle every second.

TILT STEERING COLUMN

To tilt the column, push down on the lever below the turn signal control and move the wheel up or down, as desired. Pull the lever back towards you and firmly push the lever until it is above the lower surface of the shroud to lock the column in place.

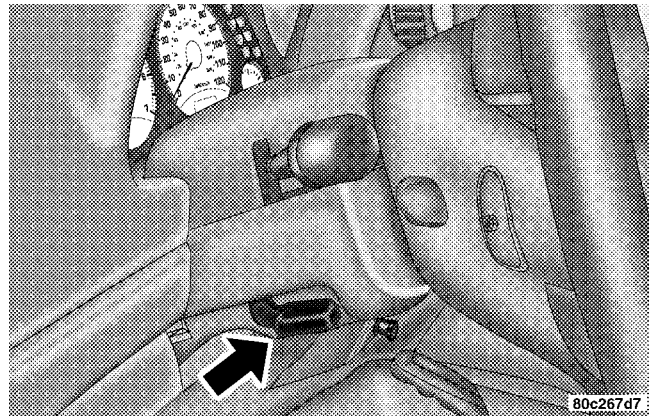

WARNING!

Tilting the steering column while the vehicle is moving is dangerous. Without a stable steering column, you could lose control of the vehicle and have an accident. Adjust the column only while the vehicle is stopped. Be sure it is locked before driving.

ELECTRONIC SPEED CONTROL

When engaged, this device takes over accelerator operations at speeds greater than 35 mph (60 km/h). The controls are mounted on the steering wheel and consist of ON·OFF, SET, RES·ACCEL, CANCEL, and COAST controls.

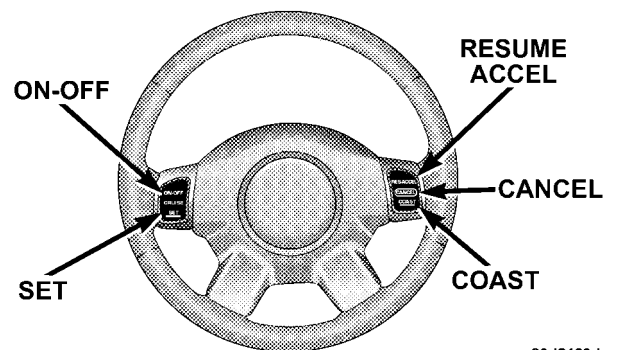

80d2123d

To Activate

Press and release the ON·OFF button to turn the system on. To turn the system off, press the ON·OFF button again. The system should be turned off when not in use. The CRUISE indicator light in the instrument cluster illuminates when the system is on.

To Set At A Desired Speed

When the vehicle has reached the desired speed, press and release the SET button. Release the accelerator and the vehicle will operate at the selected speed.

To Deactivate

A soft tap on the brake pedal, normal braking, or pressing the CANCEL button will deactivate the Speed Control without erasing the memory. Pressing the ON-OFF button or turning off the ignition erases the memory.

To Resume Speed

To resume a previously set speed, press and release the RES-ACCEL button. Resume can be used at any speed above 30 mph (50 km/h).

To Vary The Speed Setting

When the Speed Control is on and set, speed can be increased by pressing and holding the RES-ACCEL button. When the button is released, a new set speed will be established.

Tapping the RES-ACCEL button once will result in a 2 mph (3 km/h) speed increase. Each time the button is tapped, speed increases, so tapping the button three times will increase speed by 6 mph (9 km/h), etc.

To decrease speed while speed control is on and set, press and hold the COAST button. Release the button when the desired speed is reached, and the new speed will be set.

To Accelerate for Passing

Depress the accelerator as you would normally. When the pedal is released, the vehicle will return to the set speed.

NOTE: When driving uphill, at elevations above 2,000 ft. (610 meters), or when the vehicle is heavily loaded (especially when towing) the vehicle may slow below the SET speed. (If the vehicle speed drops below 30 mph (48 km/h), the Speed Control will automatically disengage). If this happens, you can push down on the accelerator pedal to maintain the desired speed.

A full throttle (high RPM) acceleration, while the system is engaged, will cause the system to disengage.

Vehicles may exhibit several 4-3 downshifts under the above conditions. To reduce the frequency of the downshifts and to improve vehicle performance, it is advisable to lock out overdrive. Press the O/D OFF button on the right side of the shift lever.

WARNING!

Leaving the Speed Control on when not in use is dangerous. You could accidentally set the system or cause it to go faster than you want. You could lose control and have an accident. Always turn the system off when you are not using it.

OVERHEAD CONSOLE — IF EQUIPPED

The overhead console contains dome/reading lights, an optional universal garage door opener (HomeLink®), an optional sunroof switch, and an Electronic Vehicle Information Center (EVIC) that consists of the following:

- Compass/temperature display
- Trip information displays
- Vehicle information warning message displays
- Customer programmable features

Pressing the MENU button will change the displayed programming features. Pressing the STEP button will select the available choices. Pressing the C/T (Compass/Temperature) button will return the display to the normal compass/temperature display.

NOTE: Temperature accuracy can be effected from heat soak. For best accuracy, the vehicle should be driven at a speed greater than 20 mph (32 km/h) for several minutes.

Dome/Reading Lights

Located in the overhead console are two dome/reading lights.

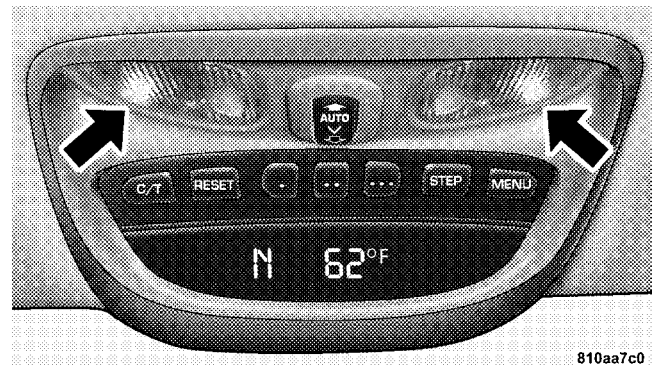

The dome/reading lights illuminate when a door or the swing gate is opened or when the interior lights are turned on by rotating the dimmer control located on the multi-function lever.

The reading lights are activated by pressing on the recessed area of the corresponding lens.

NOTE: The dome/reading lights will remain on until the switch is pressed a second time, so be sure they have been turned off before leaving the vehicle.

Electronic Vehicle Information Center

The electronic vehicle information center (EVIC), when the appropriate conditions exist, displays the following messages and symbols. Each message is accompanied by a series of beeps:

- DRIVER DOOR OPEN
- PASSENGER DOOR OPEN
- N DOORS OPEN (N = 2, 3, 4)
- RIGHT REAR DOOR OPEN
- REARGATE OPEN
- LEFT REAR DOOR OPEN
- LIFTGLASS OPEN
- TURN SIGNAL ON (with graphic)
- PERFORM SERVICE
- WASHER FLUID LOW
- REMOTE KEY BATTERY LOW
- NO J1850 BUS MSGS RECEIVED
- LEFT FRONT LOW PRESSURE
- LEFT FRONT HIGH PRESSURE
- RIGHT FRONT LOW PRESSURE
- RIGHT FRONT HIGH PRESSURE
- LEFT REAR LOW PRESSURE
- LEFT REAR HIGH PRESSURE
- RIGHT REAR LOW PRESSURE
- RIGHT REAR HIGH PRESSURE

- SPARE LOW PRESSURE
- SPARE HIGH PRESSURE
- TIRE PRESSURE UNAVAILABLE
- TIRE PRESSURE NOW AVAILABLE
- TIRE SENSOR BAD/MISSING
- SPARE SWAP DETECTED

Tire Pressure Monitor System

The Tire Pressure Monitor (TPM) system uses wireless technology to monitor tire pressure levels. Sensors, mounted to each wheel as part of the valve stem transmit tire pressure readings to a receiver located in the overhead console.

The tire pressure is shown in the Electronic Vehicle Information Center (EVIC) display. The TPM system remains active even if it is not displayed in the EVIC.

CAUTION!

The TPM system is designed to monitor your tire pressure and will not function as a tire pressure gauge while adjusting the pressure in your tires. There will be a delay between the instant you adjust the air pressure in a tire and when the system updates the display.

3

NOTE: The TPM system can inform you about a low or high tire pressure condition, but it does not replace normal tire maintenance.

The TPM system is not intended to provide you with notification of rapid pressure loss.

1. If any tire pressure has exceeded the low or high pressure (refer to STARTING AND OPERATING — TIRES AND WHEELS), the TPM system will display a message in the EVIC and sound a chime. It will then go

into the tire pressure display screen and flash the pressure value of the tire that is low or high. This will be displayed for the rest of the ignition cycle, or until the C/T, MENU, STEP, or RESET button is pressed.

NOTE: This display will return 60 seconds after the C/T, MENU, STEP, or RESET button is pressed. If a tire is low or high, you should correct your tire inflation pressure as soon as possible and inspect all of your tires. Refer to STARTING AND OPERATING — TIRES AND WHEELS for more details.

Once the low or high tire pressure message has occurred, it will continue to blink until the tire pressure is corrected.

2. If the spare tire pressure has exceeded the low or high pressure allowed, the TPM system will display a message in the EVIC for 60 seconds and sound a chime each ignition cycle.

NOTE: This message will return every ignition cycle, until the tire pressures are corrected.

3. When the vehicle is moving and the EVIC cannot receive a valid sensor signal from the tire pressure sensors, the TIRE PRESSURE UNAVAILABLE message will be displayed for 3 seconds along with a chime. The display will then shift to the individual tire pressure display screen and display dashes for the tire or tires that are affected. If the TIRE PRESSURE UNAVAILABLE message has been displayed, and valid sensor signals are received, the EVIC will display the TIRE PRESSURE NOW AVAILABLE message for 3 seconds along with a chime. This is meant to inform you when the TPM system has returned to its normal operation. This will occur when valid tire pressure sensor messages have been received from all 4 road tires. TPM system function may be temporarily unavailable due to external electromagnetic interference, such as electronic devices or nearby radio or TV towers.

4. In addition to monitoring the vehicle tires, the TPM system monitors faults within the system. When any fault has been set, the TPM system will display TIRE SENSOR BAD/MISSING. Be sure to inspect your tires for proper inflation pressure. After you determine that your tires are properly inflated, see your authorized dealer for service to diagnose the problem with the TPM system.

5. If a road tire is replaced by the spare, the TPM system will automatically detect that the tires have been switched (after the ignition has been cycled) and display SPARE SWAP DETECTED along with a chime. This could take up to 10 minutes with vehicle speed above 25 mph (40 km/h).

General Information

This device complies with FCC rules part 15 and with RSS-210 of Industry Canada. Operation is subject to the following conditions:

1. This device may not cause harmful interference

2. This device must accept any interference that may be received, including interference that may cause undesired operation

Changes or modifications not expressly approved by the party responsible for compliance could void the user's authority to operate the device.

For further assistance, questions, or comments about the TPM system, please call **1-877-774-8473**.

Customer Programmable Features

Press the MENU button until one of the display choices following appears:

Language?

When in this display you may select one of five languages for all display nomenclature, including the trip computer functions. Press the STEP button while in this display to select English, Francais, Deutsch, Italiana, or Espanol. As you continue the displayed information will be shown in the selected language.

Display U.S. or Metric?

Pressing the STEP button when in this display selects US or Metric. The overhead console and instrument panel displays will be in the selected units.

Auto Door Locks?

When this feature is selected, all doors and the swing gate will lock automatically when the speed of the vehicle reaches 15 mph (25 km/h). Pressing the STEP button when in this display will select "Yes" or "No."

Auto Unlock On Exit? (Available Only When the AUTO DOOR LOCKS Feature is Turned On)

When this feature is selected all the vehicle's doors will unlock when the driver's door is opened if the vehicle is stopped and the transmission is in P (Park) or N (Neutral) position. Pressing the STEP button when in this display will select "Yes" or "No."

Remote Unlock Driver's Door 1st?

When this feature is selected only the driver's door will unlock on the first press of the remote keyless entry unlock button and require a second press to unlock the remaining locked doors and swing gate. When **REMOTE UNLOCK ALL DOORS** is selected all of the doors and the swing gate will unlock at the first press of the remote keyless entry unlock button. Pressing the STEP button when in this display will select DRIVER'S DOOR 1ST or ALL DOORS. This can also be programmed using the key fob, refer to "Remote Keyless Entry" earlier in this section.

Train Remote?

Pressing the STEP button when in this display will select "Yes" or "No."

NOTE: Any time you perform this procedure, it is necessary to retrain all currently trained key fobs.

To Train Additional Key Fobs (using the EVIC module)

1. Press the MENU button until TRAIN REMOTE? NO is displayed. Press the STEP button to change to YES. Then, PRESS A VALID FOB KEY will be displayed. Press either the “Lock” or “Unlock” button on the current key fob.
2. The next display will say PRESS FOB 2 LOCK & UNLOCK. Press both key fob buttons simultaneously.
3. The next display will say PRESS FOB 2 UNLOCK. Press the unlock button on the second key fob.
4. The next display will say FOB 2 TRAINED. At this point, the procedure can be exited by pressing the STEP, RESET, or C/T button.
5. Repeat step 2 — 4 to train additional key fobs. A total of four key fobs can be programmed.

Can also be programmed using the key fob, refer to “Remote Keyless Entry” earlier in this section.

Sound Horn On Lock?

When this feature is selected, a short horn sound will occur when the remote keyless entry “Lock” button is pressed. This feature may be selected with or without the flash lights on lock/unlock feature. Pressing the STEP button when in this display will select “Yes” or “No.” Can also be programmed using the key fob, refer to “Remote Keyless Entry” earlier in this section.

Flash Lights With Locks?

When this feature is selected, the front and rear turn signals will flash when the doors are locked or unlocked using the remote keyless entry transmitter. This feature may be selected with or without the sound horn on lock feature selected. Pressing the STEP button when in this display will select “Yes” or “No.” Can also be programmed using the key fob, refer to “Remote Keyless Entry” earlier in this section.

Headlamp Delay

When this feature is selected the driver can choose, when exiting the vehicle, to have the headlamps remain on for 30, 60, or 90 seconds, or not remain on. Pressing the STEP button when in this display will select 30, 60, 90, or OFF.

Service Interval

When this feature is selected a service interval between 2,000 miles (3 200 km) and 6,000 miles (10 000 km) in 500 mile (800 km) increments may be selected. Pressing the STEP button when in this display will select distances between 2,000 miles (3 200 km) and 6,000 miles (10 000 km) in 500 mile (800 km) increments.

Reset Service Distance (Displays Only if Service Interval was Changed)

When this feature is selected the current accumulated service distance can be reset to the newly selected service interval. Pressing the STEP button when in this display will select “Yes” or “No.”

Low Fuel Chime?

When this feature is selected a chime will sound when the “Low Fuel Indicator Light” is displayed in the instrument panel cluster. Pressing the STEP button when in this display will select “Yes” or “No.”

Retrain Tire Sensors? (Available with TPM System Only)

When this feature is selected, the TPM system will start the retraining procedure (Refer to Training Procedure below). Pressing the STEP button when in this display will select “Yes” or “No.” Then, press the MENU button to enter selection.

WARNING!

Death or serious injury can occur if magnetically sensitive devices are exposed to this magnet. Magnets can affect pacemakers.

NOTE: The tire pressure sensors must be retrained after rotating the tires or replacing one or more sensors. If a wheel rotation is not followed by the retrain procedure, the system will not properly inform you of the correct vehicle location for a low or high pressure tire.

The following describes how to use this feature:

1. Locate the training magnet in the glove compartment (shaped like a doughnut).
2. Press the MENU button until RETRAIN TIRE SENSORS is displayed.
3. Press the STEP button to select YES to retrain TPM sensor.
4. Press the MENU button to enter selection.
5. Display will read TRAIN LEFT FRONT TIRE.

NOTE: There is a 60 second timer for training the first tire and a 30 second timer between training the remaining tires. If either of these timers expire, the EVIC will abort the training procedure.

6. Starting at the left front tire, place the training magnet over the valve stem until the horn chirps (This takes approximately 5 seconds).

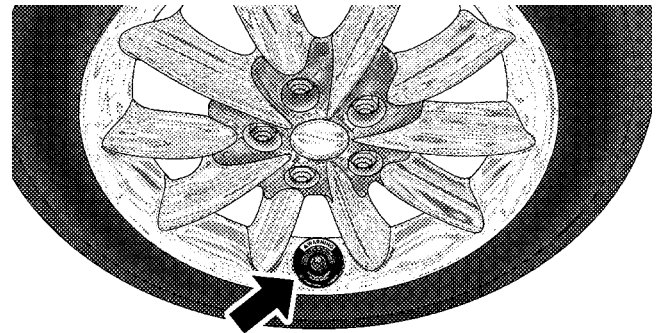

80d236ef

7. Repeat step 6 working clockwise around the vehicle (Left Front, Right Front, Right Rear, Left Rear, Spare) until all five TPM sensor positions are trained.

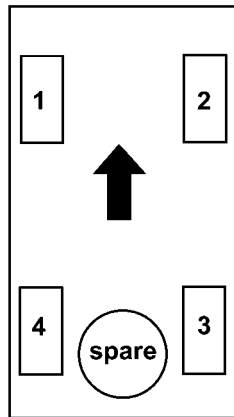

8. Return magnet to storage location.

If the display reads TRAINING COMPLETE, pressing either the STEP, C/T, RESET, or MENU buttons will exit the training mode.

If the display reads TRAINING ABORTED, move the vehicle ahead at least 1 foot and complete steps 1-8 again.

For further assistance, questions, or comments about the Tire Pressure Monitor system, please call 1-877-774-8473.

Mini-Trip Computer

This feature, located in the overhead console, displays information on outside temperature, compass direction, and trip information.

Reset Button

Use this button to reset the Average Economy, Trip Miles, and Time Elapsed displays to zero. This will occur only if

80ce79be

a resettable function is currently being displayed (Average Economy, Trip Miles, and Time Elapsed). A single chime will sound to indicate that a reset has occurred.

Global Reset

If the RESET button is pressed twice within 3 seconds while in any of the three resettable displays, the RESET button will reset all three displays.

A chime (two beeps) will sound to indicate that a reset has occurred.

Menu Button

Press the Menu button to scroll through the following screens: LANGUAGE, DISPLAY U.S. OR METRIC, AUTO DOOR LOCKS, AUTO UNLOCK ON EXIT, REMOTE UNLOCK DRIV DOOR 1ST, SOUND HORN WITH LOCK, FLASH LIGHTS WITH LOCKS, HEADLAMP DELAY, SERVICE INTV, LOW FUEL CHIME, TRAIN REMOTE, and RETRAIN TIRE SENSORS.

C/T Button

Press the C/T button to display the outside temperature and one of eight compass readings to indicate the direction the vehicle is facing.

WARNING!

Even if the display still reads a few degrees above 32°F (0°C), the road surface may be icy, particularly in woods or on bridges. Drive carefully under such conditions to prevent an accident and possible personal injury or property damage.

3

Step Button

Press the STEP button to cycle through all of the displays.

The displays are: Average Miles/GAL, Miles To Empty, Trip Miles, Time Elapsed, Miles To Service, Tire PSI, and Blank Screen.

Average Miles/GAL

Shows the average fuel economy in miles per gallon (MPG), or liters per 100 km (L/100 km) since the last reset.

Miles To Empty

Shows the estimated distance that can be traveled before the fuel gauge shows E (Empty). The distance is calculated by multiplying the amount of fuel remaining by the projected fuel economy. The distance predicted will change every few seconds to a higher or lower number as these factors change. This display cannot be reset.

Trip Miles

Shows the distance travelled since the last reset.

Time Elapsed

Shows the accumulated ignition ON time since the last reset.

Miles To Service

Shows the amount of miles remaining until service is required (owner selected).

Tire PSI

Shows the pressure and location of each tire, except for the spare tire. The tire location will blink when under pressure.

Blank Screen

Shows a blank screen. Pressing the C/T button returns to the Compass and Temperature display. Pressing the STEP button returns you to the Average Miles per Gallon display.

Automatic Compass Calibration

This compass is self-calibrating which eliminates the need to manually set the compass. When the vehicle is new, the compass may appear erratic and the CAL symbol will be displayed.

After completing three 360 degree turns in an area free from large metal or metallic objects, the CAL symbol will turn off and the compass will function normally.

Manual Compass Calibration

If the compass appears erratic and the CAL symbol does not appear, you must manually put the compass into the “Calibration” mode.

To Put Into a Calibration Mode

Turn on the ignition and set the display to “Compass/ Temperature.” Press and hold the RESET button (more than 10 seconds) to change the display between VARIANCE (compass variance) and CAL (compass calibration) modes. When the CAL symbol is displayed complete three 360 degree turns in an area free from large metal objects or power lines. The CAL symbol will turn off and the compass will function normally.

Compass Variance is the difference between magnetic north and geographic north. In some areas of the country, the difference between magnetic and geographic north is great enough to cause the compass to give false readings. If this occurs, the compass variance must be set according to the Compass Variance Map.

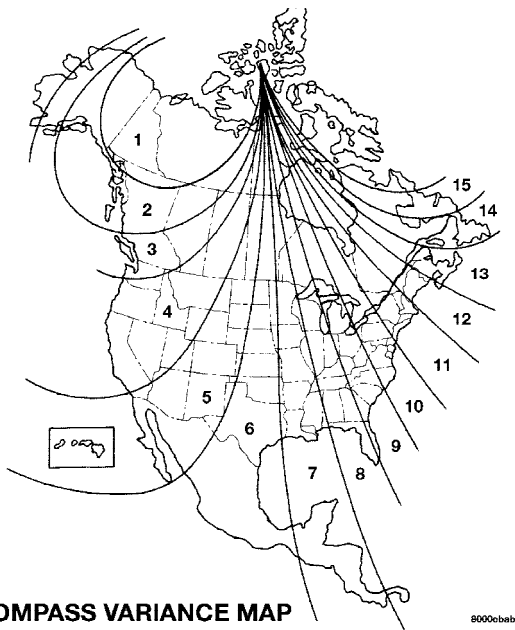

To set the variance: Turn the ignition ON and set the display to “Compass/Temperature.” Press and hold the RESET button five seconds (no more than 10 seconds). The last variance zone number will be displayed. Press the STEP button to select the new variance zone and press the RESET button to resume normal operation.

General Information

This transmitter complies with FCC rules part 15 and with RSS-210 of Industry Canada. Operation is subject to the following two conditions:

1. This device may not cause harmful interference
2. This device must accept any interference that may be received, including interference that may cause undesired operation

CAUTION!

Changes or modifications not expressly approved by the party responsible for compliance could void the user's authority to operate this equipment.

GARAGE DOOR OPENER — IF EQUIPPED

Equipped in vehicles that have the optional Electronic Vehicle Information Center (EVIC)

The HomeLink® Wireless Control System provides a convenient way to replace up to three hand-held radio-frequency (RF) transmitters used to activate devices such as gate operators, garage door openers, entry door locks, security systems, even home lighting. Additional HomeLink information can be found at: www.homelink.com or by calling 1-800-355-3515.

WARNING!

Before programming HomeLink to a garage door opener or gate operator, make sure that people and objects are out of the way of the device to prevent potential harm or damage. When programming a garage door opener, it is advised to park outside of the garage. Do not use HomeLink with any garage door opener that lacks safety stop and reverse features as required by U.S. federal safety standards (this includes any garage door opener model manufactured before April 1, 1982). A garage door that cannot detect an object - signaling the door to stop and reverse - does not meet current U.S. federal safety standards. For more information, contact HomeLink at: www.homelink.com or by calling: 1-800-355-3515.

Retain the original transmitter of the RF device you are programming for use in other vehicles as well as for future HomeLink programming. It is also suggested that upon the sale of the vehicle, the programmed HomeLink buttons be erased for security purposes. To erase the programmed buttons, perform the procedure shown below under "When Your Vehicle Is New", or, for assistance, contact HomeLink at: www.homelink.com or by calling: 1-800-355-3515.

When Your Vehicle Is New

Prior to programming HomeLink for the first time the factory test codes must be erased. To erase HomeLink memory, press and hold the two outer HomeLink buttons (buttons one and three). The message CLEARING CHANNELS will appear on the HomeLink display. After approximately 20 seconds, the message CHANNELS CLEARED will appear on the EVIC display. Do not hold the buttons for longer than 30 seconds.

Programming HomeLink

NOTE: It is recommended that a new battery be placed in the hand-held transmitter of the device being programmed to HomeLink for quicker training and accurate transmission of the radio frequency signal.

WARNING!

Vehicle exhaust contains carbon monoxide, a dangerous gas. Do not run the vehicle's engine while programming HomeLink. Exhaust gas can cause serious injury or death.

WARNING!

Your motorized door or gate will open and close while you are programming HomeLink. Do not program HomeLink if people or pets are in the path of the door or gate. A moving door or gate can cause serious injury or death to people and pets or damage to objects.

1. Position the end of your hand-held transmitter 1-3 inches (5-14 cm) away from the lower left corner of the EVIC display while keeping the display in view.

NOTE: Some gate operators and garage door openers may require you to replace the next step with procedures noted in the "Gate Operator/Canadian Programming" section.

2. Simultaneously press and hold both the desired HomeLink button and the hand-held transmitter button.

After a short time, the message TRAINING will show on HomeLink display. Do not release the buttons until the next step has been completed.

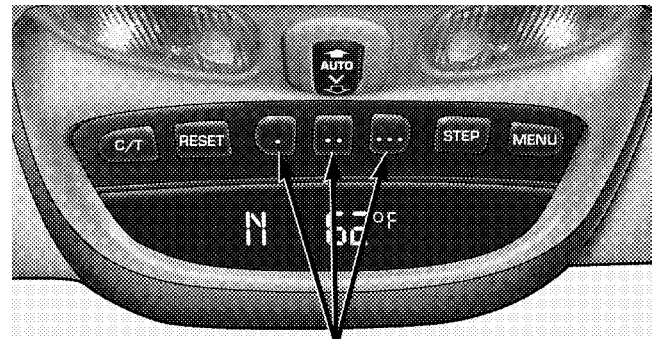
**BUTTONS**

810aa849

3. When the message TRAINED appears on the HomeLink display, release both the HomeLink and hand-held transmitter buttons.

NOTE: If the HomeLink display does not change to TRAINED, contact HomeLink at www.homelink.com or call 1-800-355-3515 for assistance.

4. Press and hold the just-trained HomeLink button. TRANSMIT should appear on the display.

If your device activates when the HomeLink button is depressed and released, programming is complete.

NOTE: To program the remaining two HomeLink buttons, simply repeat the "Programming HomeLink" process.

If the message TRANSMIT appears on the HomeLink display but your device does not activate, the device may be equipped with a "rolling code" system. Continue with steps five through seven below to complete the programming of a rolling code equipped device (most commonly a garage door opener).

5. At the garage door opener receiver (motor-head unit) in the garage, locate the "learn" or "smart" button. This can usually be found where the hanging antenna wire is attached to the motor-head unit.

6. Firmly press and release the "learn" or "smart" button. (The name and color of the button may vary by manufacturer.)

NOTE: There are 30 seconds in which to initiate the next step.

7. Return to the vehicle and firmly press, hold for two seconds and release the programmed HomeLink button. Repeat the "press/hold/release" sequence a second time, and, depending on the brand of the garage door opener (or other rolling code equipped device), repeat this sequence a third time to complete the programming process.

HomeLink should now activate your rolling code equipped device.

NOTE: To program the remaining two HomeLink buttons, simply repeat the "Programming Homelink" process.

If, after programming the HomeLink Wireless Control System, the hand-held transmitter and/or other HomeLink units in other vehicles fail to activate the rolling code equipped device, you may need to clear (or "erase") the device's receiver memory. Refer to your garage door opener's Owner's Manual for the procedure or contact HomeLink at 1-800-355-3515 or on the Internet at www.homelink.com. After clearing the receiver, you must reprogram the original hand-held transmitter(s) to the receiver using the procedure in the garage door opener's Owner's Manual. Finally, reprogram the hand-held transmitter(s) to HomeLink using the steps under "Programming HomeLink".

Gate Operator/Canadian Programming

Canadian radio-frequency laws require transmitter signals to "time-out" (or quit) after several seconds of transmission - which may not be long enough for HomeLink to pick up the signal during programming. Similar to this Canadian law, some U.S. gate operators are designed to "time-out" in the same manner.

If you live in Canada or you are having difficulties programming a gate operator by using the "Programming HomeLink" procedures (regardless of where you live), replace step two with the following:

NOTE: If programming a garage door opener or gate operator, it is advised to unplug the device during the "cycling" process to prevent possible overheating.

Press and hold the HomeLink button while you press and release - every two seconds ("cycle") your hand-held transmitter button until the radio signal has successfully been accepted by HomeLink. (The message TRAINED will appear on the HomeLink display.)

Proceed with the remaining steps under "Programming HomeLink" to complete.

Using HomeLink

To operate, simply press and release the programmed HomeLink button. Activation will now occur for the trained device (i.e. garage door opener, gate operator, security system, entry door lock, home/office lighting, etc.). For convenience, the hand-held transmitter of the device may also be used at any time. In the event that there are still programming difficulties or questions, contact HomeLink at: www.homelink.com or 1-800-355-3515.

POWER SUNROOF — IF EQUIPPED

The sunroof control is located on the headliner between the sun visors.

Press and hold the switch rearward to fully open the sunroof. The sunroof can be stopped at any position between closed and full open. Momentarily pressing the switch rearward will activate the Express Open Feature, causing the sunroof to open automatically.

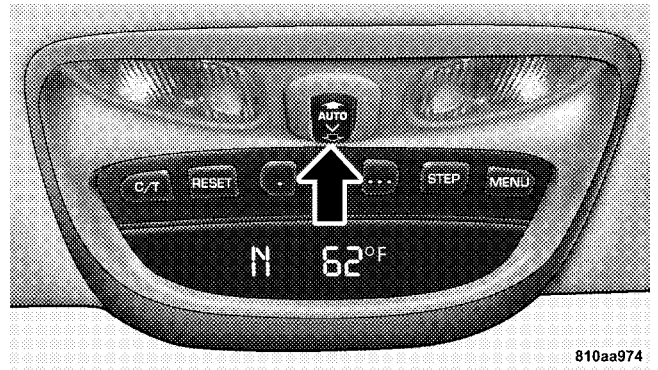
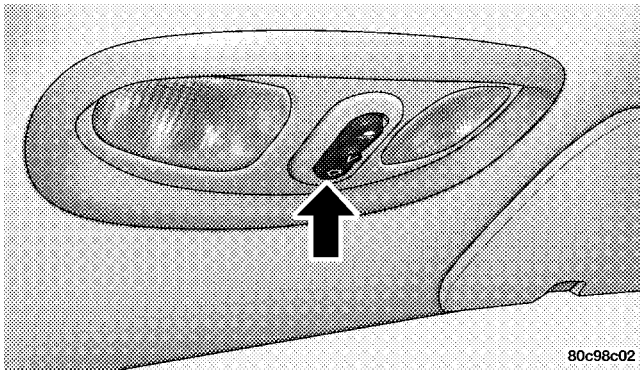

Press and hold the “V” button in the center of the sunroof switch to open the vent. The sunroof can be stopped at any position between closed and full vent. To close the sunroof from the vent position, press and hold the switch forward. Releasing the switch will stop the movement of the sunroof and the sunroof will remain in the partial vent position until the switch is pushed forward again.

Express Open Feature

During the Express Open operation, any movement of the switch will stop the sunroof and it will remain in a partial open position. Again, momentarily pressing the switch rearward will activate the Express Open Feature.

To close the sunroof, hold the switch in the forward position. Again, any release of the switch will stop the movement and the sunroof will remain in a partial open condition until the switch is pushed forward again. The sunroof is not completely closed until the rear of the sunroof glass moves upward at the end of its travel.

The sunshade can be opened manually. It will also open as the sunroof opens. The sunshade cannot be closed if the sunroof is open.

WARNING!

- **In an accident, there is a greater risk of being thrown from a vehicle with an open sunroof. You could also be seriously injured or killed. Always fasten your seat belt properly and make sure all passengers are properly secured too.**
- **Do not allow small children to operate the sunroof. Never allow fingers or other body parts, or any object to project through the sunroof opening. Injury may result.**

Sunroof Maintenance

Use only a non-abrasive cleaner and a soft cloth to clean the glass panel.

POWER OUTLET

To the right of the convenience tray (lower center of instrument panel) is an outlet for electrically powered accessories. Pull lightly on the top of the plastic cover to open the outlet.

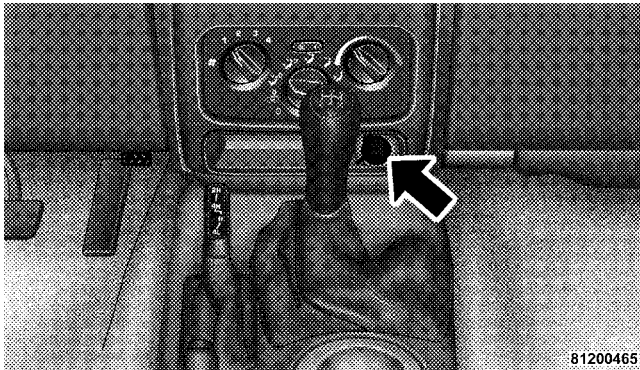

There is a rear power outlet located in the right rear cargo area above the storage cargo net/CD changer (if equipped).

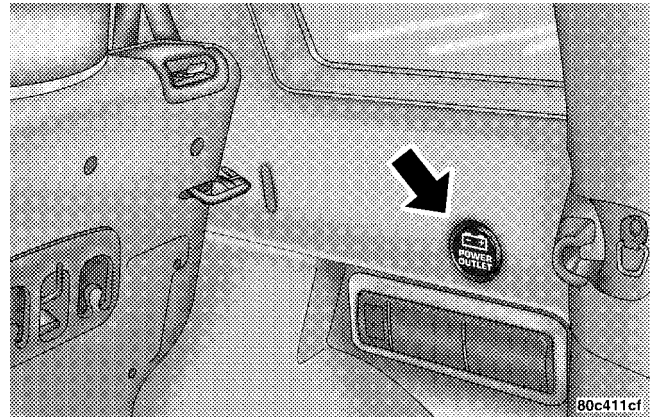

The rear power outlet is a direct feed from the battery so it receives power whether the ignition is in the ON or OFF position.

All accessories connected to this outlet should be removed or turned off when the vehicle is not in use.

CAUTION!

Electrical Outlet Use With Engine Off

- Many accessories that can be plugged in draw power from the vehicle's battery, even when not in use (i.e., cellular phones, etc.). Eventually, if plugged in long enough, the vehicle's battery will discharge sufficiently to degrade battery life and/or prevent engine starting.
- Accessories that draw higher power (i.e., coolers, vacuum cleaners, lights, etc.) will degrade the battery even more quickly. Only use these intermittently and with greater caution.
- After the use of high power draw accessories, or long periods of the vehicle not being started (with accessories still plugged in), the vehicle must be driven a sufficient length of time to allow the alternator to recharge the vehicle's battery.

CIGAR LIGHTER — IF EQUIPPED

The lighter is a direct feed from the battery so it receives power whether the ignition is in the ON or OFF position. It heats when pushed in and pops out automatically when ready for use. **To preserve the heating element, do not hold the lighter element in the heating position.**

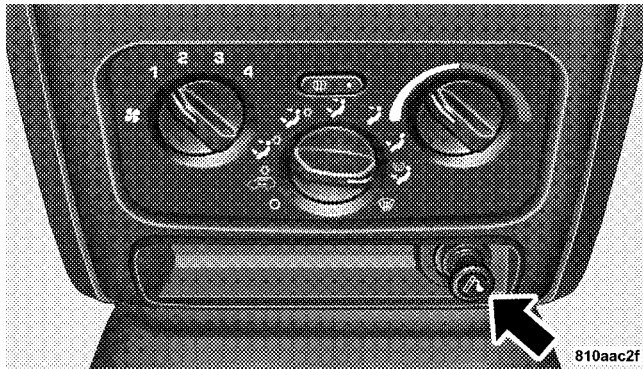

GLOVE COMPARTMENT

To open the glove box, lift up on the latch.

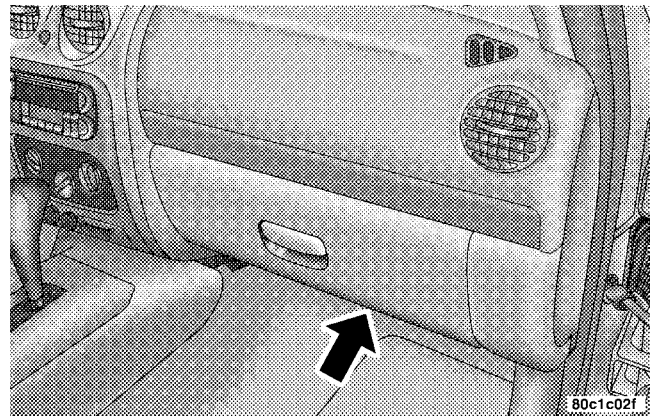

CUP HOLDERS

In the center console there are two cup holders for the front seat passengers.

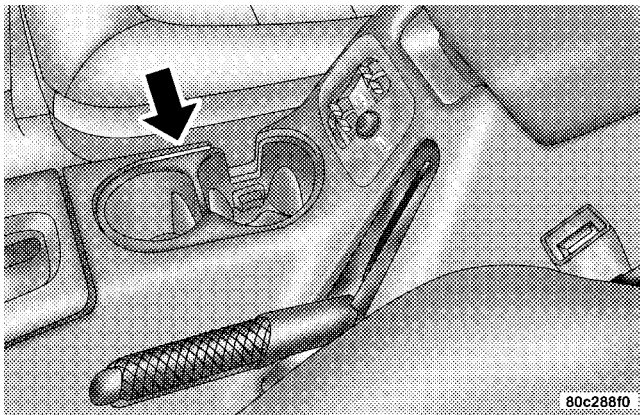

Front Cup Holders

NOTE: The front cup holder insert is removable from the console, for cleaning.

Smoker's Package — If Equipped

With the optional Smoker's package, a removable ash tray is inserted into the front cup holder location.

The rear passengers have access to a cup holder on each rear door trim panel.

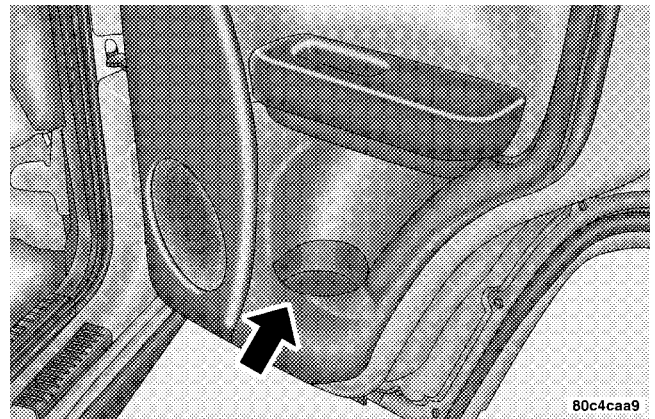

Rear Cup Holders

CARGO AREA FEATURES

Cargo Light

The cargo area light is activated by opening the swing gate, opening any door, or by rotating the dimmer control on the multi-function control lever to the extreme top position. If all doors are closed and only the swing gate is open, pushing on the cargo light lens surface will turn off all interior lights. Push on the lens surface a second time to restore the interior lights to normal operation.

Retractable Cargo Area Cover — If Equipped

To cover the cargo area:

1. Grasp the center portion of the cover flap. Pull it over the cargo area.
2. Insert the pins on the ends of the cover into the slots in the pillar trim cover.

3. The swing gate may be opened or closed with the cargo cover in place.

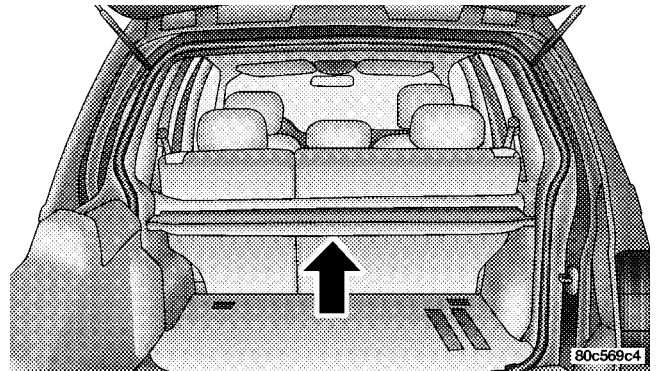

3

WARNING!

In an accident a cargo cover loose in the vehicle could cause injury. It could fly around in a sudden stop and strike someone in the vehicle. Do not store the cargo cover on the cargo floor or in the passenger compartment. Remove the cover from the vehicle when taken from its mounting. Do not store in the vehicle.

Cargo Tie-Down Hooks

The tie-downs located on cargo area floor should be used to safely secure loads when vehicle is moving.

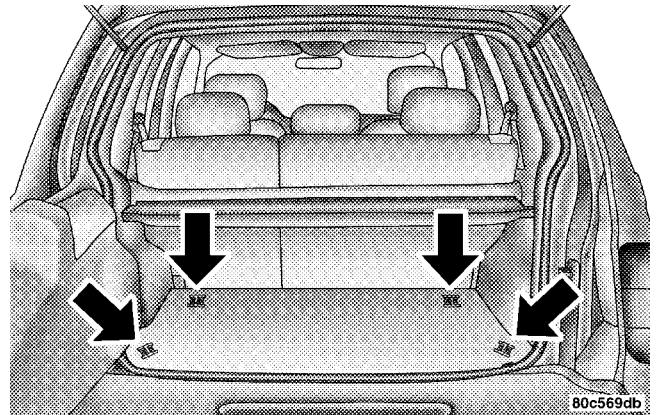

WARNING!

- **Cargo tie-down hooks are not safe anchors for a child seat tether strap. In a sudden stop or collision a hook could pull loose and allow the child seat to come loose. A child could be badly injured. Use only the anchors provided for child seat tethers.**
 - **The weight and position of cargo and passengers can change the vehicle center of gravity and vehicle handling. To avoid loss of control resulting in personal injury, follow these guidelines for loading your vehicle:**
- Always place cargo evenly on the cargo floor. Put heavier objects as low and as far forward as possible.

- Place as much cargo as possible in front of the rear axle. Too much weight or improperly placed weight over or behind the rear axle can cause the rear of the vehicle to sway.
- Do not pile luggage or cargo higher than the top of the seatback. This could impair visibility or become a dangerous projectile in a sudden stop or collision.

3**WARNING!**

To help protect against personal injury, passengers should not be seated in the rear cargo area. The rear cargo space is intended for load carrying purposes only, not for passengers, who should sit in seats and use seat belts.

Cargo Organizer — If Equipped

This vehicle may be equipped with a cargo organizer that mounts on the floor behind the rear seat. Items may be placed on the flat surface or stored in the three storage compartments.

WARNING!

- To avoid tipping, lock the shelf securely in all positions.
- Do not drive this vehicle with the liftgate open, or use the shelf as a seat.
- Failure to follow these warnings could result in serious or fatal injury.

1. To raise the cargo organizer pull up on the handle and pull towards the rear of the vehicle.

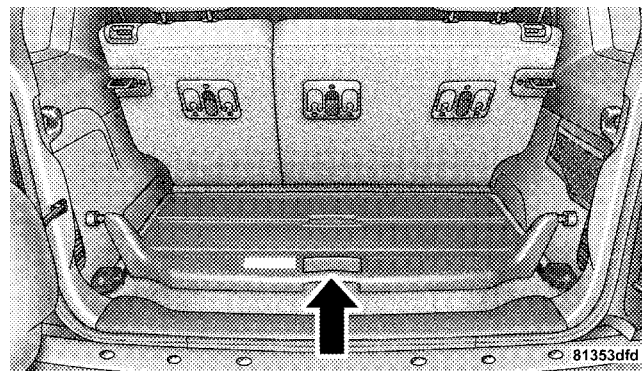

2. Place the rear corners of the cargo organizer into the supports located on the rear trim panel. Press down on the back of the cargo organizer to lock it into place.

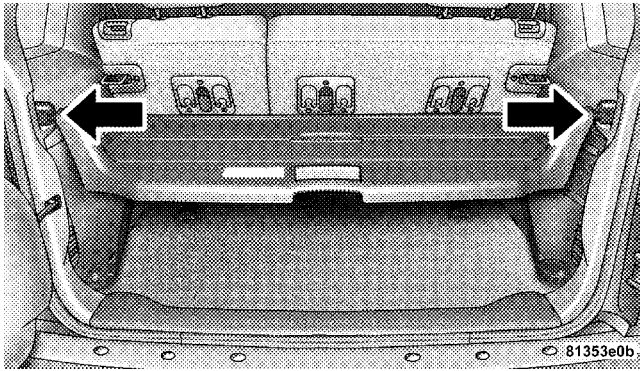
**WARNING!**

Do not load objects over 30 lbs (13.5 kg) in the upper position. Failure to follow this warning could cause the cargo organizer to collapse resulting in personal injury.

3

CAUTION!

Do not load objects over 100 lbs (45 kg) in the lower position. Failure to follow this could cause damage to the cargo organizer.

To Open Storage Compartments

1. Pull up on the center opening of the cargo organizer.

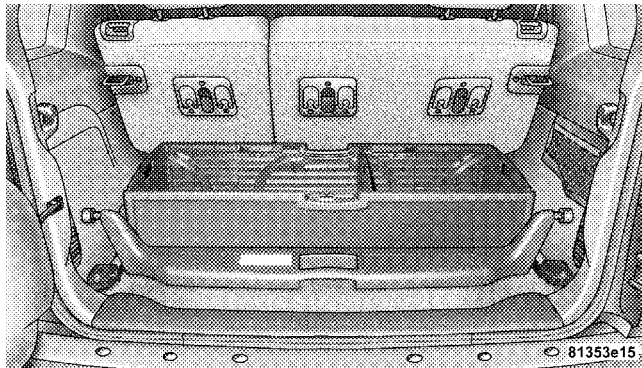

2. Lift up on the storage compartment dividers and lock into place.

Cargo Organizer Removal

Loosen screw, then lift lever from each mount located on the floor of the rear cargo area, and remove the cargo organizer from the vehicle.

ROOF LUGGAGE RACK

External racks do not increase the total load carrying capacity of the vehicle. Be sure that the total occupant and luggage load inside the vehicle, plus the load on the luggage rack, do not exceed the rated vehicle capacity as shown on the label attached to the drivers door shut face.

CAUTION!

- To avoid damage to the roof rack and vehicle, do not exceed the maximum roof rack load capacity of 150 lbs (68 kg) or 65 lbs (29.5 kg) on Renegade models. Always distribute heavy loads as evenly as possible and secure the load appropriately.
- Long loads which extend over the windshield, such as wood panels or surfboards, should be secured to both the front and rear of the vehicle.
- Place a blanket or other protection between the surface of the roof and the load.
- Travel at reduced speeds and turn corners carefully when carrying large or heavy loads on the roof rack. Wind forces, due to natural causes or nearby truck traffic, can add sudden upward loads. This is especially true on large flat loads and may result in damage to the cargo or your vehicle.

WARNING!

Cargo must be securely tied before driving your vehicle. Improperly secured loads can fly off the vehicle, particularly at high speeds, resulting in personal injury or property damage. Follow the roof rack "Cautions" when carrying cargo on your roof rack.

UNDERSTANDING YOUR INSTRUMENT PANEL

CONTENTS

| | | | |
|--|-----|---|-----|
| ■ Instrument Panel And Interior Controls | 149 | □ AM Reception | 159 |
| ■ Instrument Cluster | 150 | □ FM Reception | 159 |
| ■ Instrument Cluster Description | 151 | ■ Sales Code RBB—AM/FM Stereo Radio With Cassette Tape Player And CD Changer Capability | 160 |
| ■ Electronic Digital Clock | 158 | □ Operating Instructions | 160 |
| □ Clock Setting Procedure | 158 | □ Power Button | 160 |
| ■ Radio General Information | 158 | □ Electronic Volume Control | 160 |
| □ Radio Broadcast Signals | 158 | □ Seek | 161 |
| □ Two Types Of Signals | 159 | □ Tune | 161 |
| □ Electrical Disturbances | 159 | | |

146 UNDERSTANDING YOUR INSTRUMENT PANEL

| | | | |
|---|-----|---|-----|
| □ To Set The Push-Button Memory | 161 | □ CD Changer Control Capability | |
| □ Balance | 162 | — If Equipped | 171 |
| □ Fade | 162 | □ Radio Display Messages | 173 |
| □ Bass And Treble Tone Control | 162 | ■ Sales Code RBP—AM & FM Stereo Radio With | |
| □ AM/FM Selection | 162 | Cassette Tape Player, CD Player, And Optional | |
| □ Mode Button | 162 | CD/DVD Changer Controls | 174 |
| □ Cassette Player Features | 162 | □ Radio Operation | 174 |
| □ CD Changer Control Capability | | □ Tape Player Operation | 178 |
| — If Equipped | 164 | □ CD Player Operation | 180 |
| □ Radio Display Messages | 166 | □ CD/DVD Changer Operation | |
| ■ Sales Code RBK—AM/ FM Stereo Radio With | | — If Equipped | 182 |
| CD Player And CD Changer Controls | 167 | ■ Sales Code RBQ—AM/FM Stereo Radio With | |
| □ Radio Operation | 167 | 6 - Disc CD Changer | 183 |
| □ CD Player Operation | 169 | □ Radio Operation | 184 |
| | | □ CD Player Operation | 186 |

| | | | |
|--|-----|--|-----|
| ■ Satellite Radio — If Equipped | 190 | □ Satellite Antenna | 193 |
| □ System Activation | 190 | □ Reception Quality | 193 |
| □ Electronic Serial Number/Sirius Identification Number (ENS/SID) | 190 | ■ Remote Sound System Controls — If Equipped . . . | 194 |
| □ Selecting Satellite Mode In RBB And RBK Radios | 191 | □ Radio Operation | 195 |
| □ Selecting Satellite Mode In RBP, RBU, RAZ, And RBQ Radios | 191 | □ Tape Player | 195 |
| □ Selecting a Channel | 192 | □ CD Player — Single Disc In Radio | 195 |
| □ Storing And Selecting Pre-Set Channels | 192 | □ CD Player — 6 Disc In Cargo Area | 196 |
| □ Using The PTY (Program Type) Button (If Equipped) | 192 | ■ Cassette Tape And Player Maintenance | 196 |
| □ PTY Button "Scan" | 193 | ■ CD/DVD Disc Maintenance | 197 |
| □ PTY Button "Seek" | 193 | ■ Radio Operation And Cellular Phones | 198 |
| | | ■ Climate Controls | 198 |
| | | □ Heater | 198 |
| | | □ Air Conditioning | 200 |

148 UNDERSTANDING YOUR INSTRUMENT PANEL

| | | | |
|----------------------------------|-----|--------------------------------------|-----|
| □ Operating Tips | 202 | □ Rear Window Wiper/Washer | 203 |
| ■ Rear Window Features | 203 | □ Rear Window Defroster | 204 |

INSTRUMENT PANEL AND INTERIOR CONTROLS

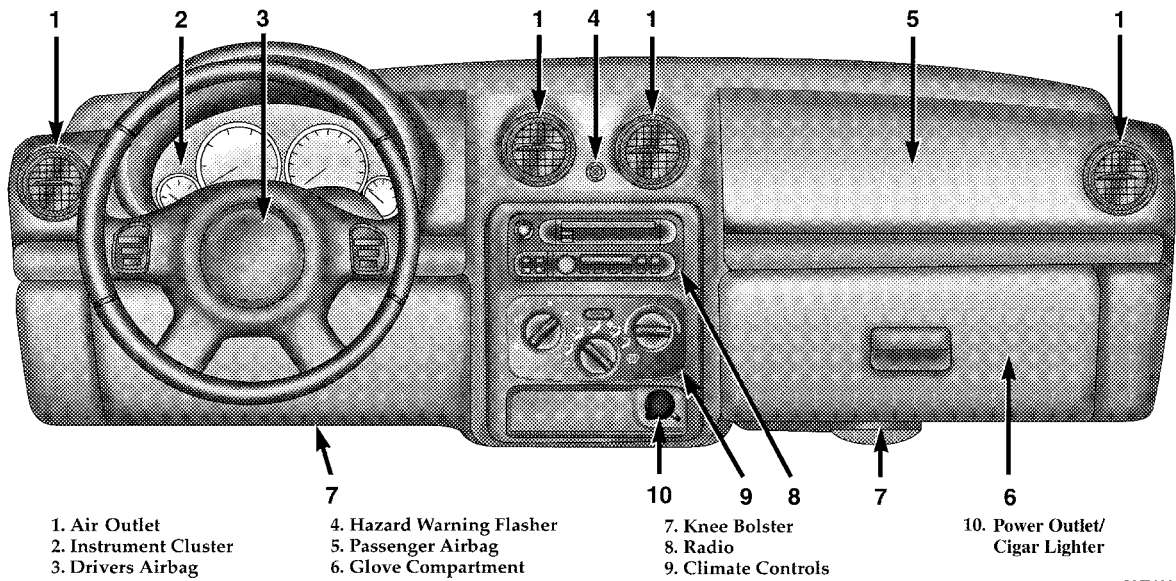

80F71899

INSTRUMENT CLUSTER

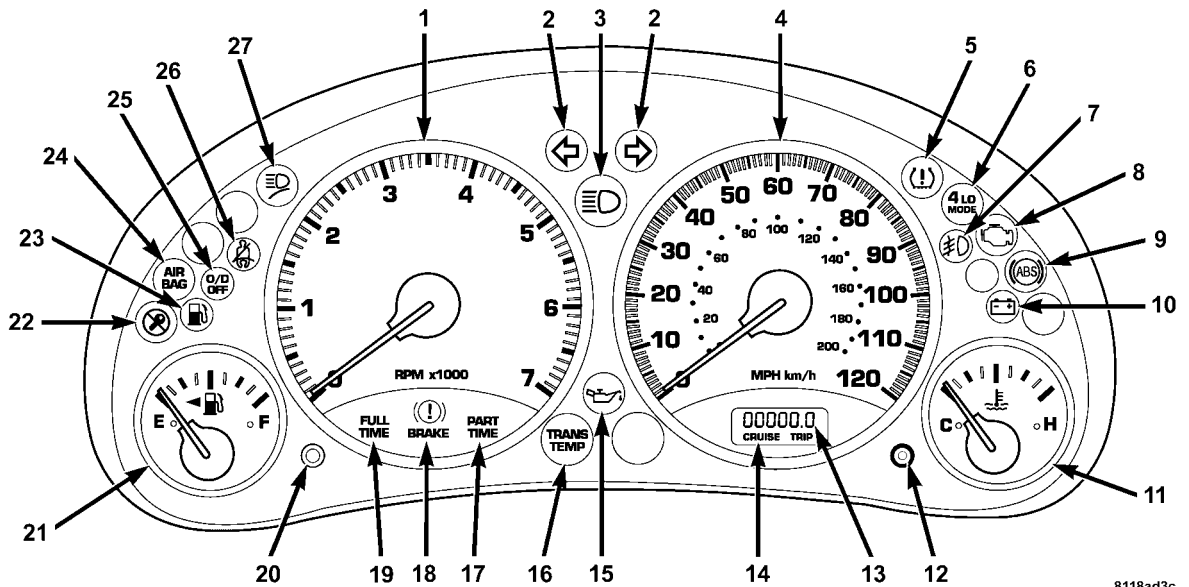

8118ad3c

INSTRUMENT CLUSTER DESCRIPTION

1. *Tachometer*

Indicates the permissible engine revolutions-per-minute for each gear range. Before reaching the red area, ease up on the accelerator to prevent engine damage.

2. *Turn Signal Indicator Light*

 The arrows will flash in unison with the exterior turn signals, when using the multi-function control lever. A chime will sound if the turn signals are left on continuously for 2 miles (3 km) until they are deactivated.

3. *High Beam Indicator Light*

 This light shows that the headlights are on high beam. Pull the multi-function control lever towards the steering wheel to switch the headlights from high to low beam.

4. *Speedometer*

Indicates vehicle speed.

5. *Tire Pressure Monitor Warning Light — If Equipped*



This light will turn on when there is a low tire pressure condition. The light will also turn on if a problem exist with any tire sensor. The light will remain on until the tire pressure is properly set or the problem with the sensor is corrected.

This light will turn on momentarily as a bulb check when the engine is started.

When the “Tire Pressure Monitor Warning Light” is lit, one or more of your tires is significantly under-inflated. You should stop and check your tires as soon as possible, and inflate them to the proper pressure as indicated on the vehicle’s tire information placard. Driving on a significantly under-inflated tire causes the tire to over-heat and can lead to tire failure. Under-inflation also reduces fuel efficiency and tire tread life, and may affect

the vehicle's handling and stopping ability. Each tire, including the spare, should be checked monthly when cold and set to the recommended inflation pressure as specified on the vehicle placard.

6. *4LO Mode Indicator Light — If Equipped*



This light alerts the driver that the vehicle is in the 4 LO four-wheel drive mode. The front and rear driveshafts are mechanically locked together forcing the front and rear wheels to rotate at the same speed.

7. *Fog Light Indicator Light — If Equipped*



This light shows when the front fog lights are on.

8. *Malfunction Indicator Light*



This light is part of an onboard diagnostic system called OBD II which monitors engine and automatic transmission control systems. This light will illuminate when the ignition is in the ON position

before engine start. If the bulb does not come on when turning the ignition key from OFF to ON, have the condition checked promptly.

Certain conditions such as a loose or missing gas cap, poor fuel quality, etc. may illuminate the light after engine start. The vehicle should be serviced if the light stays on through several typical driving cycles. In most situations, the vehicle will drive normally and will not require towing.

When the engine is running, the "Malfunction Indicator Light" may flash to alert of serious conditions that could lead to immediate loss of power or severe catalytic converter damage. The vehicle should be serviced as soon as possible if this occurs.

9. *Anti-Lock Warning Light (ABS) — If Equipped*



This light monitors the Anti-Lock Brake System (ABS) described elsewhere in this manual. This

light will come on when the ignition switch is turned to the ON position and may stay on for as long as three seconds.

If the light comes back on immediately or comes on during driving, it indicates that the Anti-Lock portion of the brake system is not functioning and that service is required, however, the conventional brake system will continue to operate normally provided that the BRAKE warning light is not on. Also, a chime will sound if the light comes back on.

If the ABS light is on, the brake system should be serviced as soon as possible to restore the benefit of Anti-Lock Brakes.

The operation of the ABS light can be checked by turning the ignition switch from the OFF position to the ON position. The light should illuminate for approximately two seconds. The light should then turn off unless the

parking brake is applied or a brake fault is detected. If the light does not illuminate, have the light inspected by an authorized dealer.

10. Charging System Warning Light

 This light shows the status of the electrical charging system. The light should come on for three seconds when the ignition is first turned ON. If the light comes back on immediately or comes on while driving, it means that there is a problem with the charging system or the battery is low. Also, a chime will sound if the light comes back on. See your authorized dealer immediately.

11. Temperature Gage

 Indicates engine coolant temperature. Any reading within the normal range indicates that the cooling system is operating satisfactorily.

The gage pointer will likely indicate a higher temperature (above center scale) when driving in hot weather, up mountain grades, in heavy stop and go traffic, or when

towing a trailer. It should not be allowed to exceed the upper limits of the normal operating range.

If the pointer rises to the red zone (five chimes will occur), pull over and stop the vehicle. Do not turn the engine off. Idle the vehicle with the air conditioning turned off, until the pointer drops back into the normal range. If the engine remains in the high range, turn the engine off and call for service.

12. Reset Button

Press this button to toggle between the odometer and trip odometer display. When in the trip odometer mode, holding the button in resets the trip odometer. Also, pressing the “Reset” button will clear out any warning messages in the odometer display.

13. Odometer/Trip Odometer

A vacuum fluorescent display indicates the total distance the vehicle has been driven. Also, the cluster will display, replacing the odometer/trip odometer, vehicle warning

messages such as: door/gate/glass ajar and low washer fluid. See appropriate sections for more information.

NOTE: If vehicle is equipped with the optional Electronic Vehicle Information Center (EVIC) in the overhead console, all warnings including “door”, “GATE”, “GLASS”, and “LOWASH” will only be displayed in the EVIC display (not in the instrument cluster). For additional information, refer to “Overhead Console — If Equipped” in Section 3.

U.S. federal regulations require that upon transfer of vehicle ownership, the seller certify to the purchaser the correct mileage that the vehicle has been driven. Therefore, if the odometer reading is changed during repair or replacement, be sure to keep a record of the reading before and after the service so that the correct mileage can be determined.

14. Cruise Indicator Light

CRUISE This indicator lights when the speed control system is turned ON.

15. Oil Pressure Warning Light

 Shows low engine oil pressure. The light will come on and remain on when the ignition switch is turned from the OFF to the ON position, and the light will turn off after the engine is started. If the bulb does not come on, have the system checked by your authorized dealer.

If the warning light comes on and remains on while driving, stop the vehicle and shut off the engine. **DO NOT OPERATE THE VEHICLE UNTIL THE CAUSE IS CORRECTED.** Also, a single chime will sound.

16. Transmission Temperature Warning Light

TRANS TEMP This light indicates that there is excessive transmission fluid temperature that might occur with severe usage such as trailer towing or snow plowing. If

this light comes on, stop the vehicle and run the engine at idle or faster, with the transmission in N (Neutral) until the light goes off.

17. Part Time Indicator Light — If Equipped

PART TIME This light alerts the driver that the vehicle is in the PART TIME four-wheel drive high range mode, and the front and rear driveshafts are mechanically locked together forcing the front and rear wheels to rotate at the same speed.

18. Brake Warning Light

 **BRAKE** This light monitors various brake functions, including brake fluid level and parking brake application. If the light comes on, it may indicate that the parking brake is applied, or there is a low brake fluid level. On vehicles equipped with Anti-Lock brakes (ABS), it may also indicate an ABS malfunction that could lead to reduced braking performance.

WARNING!

Driving a vehicle with the BRAKE warning light on is dangerous. A significant decrease in braking performance or vehicle stability during braking may occur. It will take you longer to stop the vehicle or will make your vehicle harder to control. You could have an accident. Have the vehicle checked immediately.

The operation of the BRAKE warning light can be checked by turning the ignition switch from the OFF position to the ON position. The light should illuminate for approximately two seconds. The light should then turn off unless the parking brake is applied or a brake fault is detected. If the light does not illuminate, have the light inspected by an authorized dealer.

Also, the light will come on when the parking brake is applied with the ignition switch in the ON position.

NOTE: This light shows only that the parking brake is applied. It does not show the degree of brake application.

If the parking brake is off and the light remains on, have the brake system inspected as soon as possible.

19. Full Time Indicator Light — If Equipped**FULL TIME**

This light alerts the driver that the vehicle is in the FULL TIME four-wheel drive mode, and employs the inter-axle differential which allows the front and rear wheels to rotate at different speeds.

20. Security Alarm System Indicator Light — If Equipped

This light will flash rapidly for approximately 16 seconds after all of the doors are locked and closed to signal that

the system is arming. After the alarm successfully arms, the light will flash at a slower rate to indicate the alarm is set.

21. Fuel Gage

When the ignition key is in the ON position, the pointer will show the level of fuel remaining in the fuel tank. A small arrow indicates the side of the vehicle where the filler cap (gas cap) is located.

22. Sentry Key Indicator Light — If Equipped



Refer to “Sentry Key Immobilizer System” in Section 2 of this manual for more information.

23. Low Fuel Warning Light



When the fuel level reaches approximately 2.7 U.S. Gallons (10L) this light will come on and remain on until fuel is added. The “Low Fuel Warning Light” may turn on and off again, especially during and after

hard braking, accelerations, or turns. This occurs due to the shifting of the fuel in the tank. Also, a single chime will sound.

24. Airbag Warning Light

AIR BAG This indicator lights and remains lit for 6 to 8 seconds when the ignition is first turned on. If the light doesn't come on, stays on, or comes on while driving, have the airbag system checked by an authorized dealer.

25. O/D (Overdrive) Off Indicator Light

O/D OFF This light will illuminate when the O/D OFF button has been selected. The O/D OFF button is located on the gear shift lever.

26. Seat Belt Indicator Light



When the ignition switch is first turned ON, this light will turn on for 5 to 8 seconds as a bulb check. During the bulb check, if the driver's seat belt is unbuckled, a chime will sound. After the bulb check or

when driving, if the driver seat belt remains unbuckled, the Seat Belt Warning Light will flash or remain on continuously. Refer to "Enhanced Driver Seat Belt Reminder System (BeltAlert™)" in the Occupant Restraints section for more information.

27. Light Bar Indicator Light — If Equipped



This light indicates when the light bar lamps are on.

ELECTRONIC DIGITAL CLOCK

The clock and radio each use the display panel built into the radio. A digital readout shows the time in hours and minutes whenever the ignition switch is in the ON or ACC position and the time button is pressed.

When the ignition switch is in the OFF position, or when the radio frequency is being displayed, time keeping is accurately maintained.

Clock Setting Procedure

1. Turn the ignition switch to the ON or ACC position and press the time button. Using the tip of a ballpoint pen or similar object, press either the hour (H) or minute (M) buttons on the radio.
2. Press the H button to set hours or the M button to set minutes. The time setting will increase each time you press a button.

RADIO GENERAL INFORMATION

Radio Broadcast Signals

Your new radio will provide excellent reception under most operating conditions. Like any system, however, car radios have performance limitations, due to mobile operation and natural phenomena, which might lead you to believe your sound system is malfunctioning. To help

you understand and save you concern about these “apparent” malfunctions, you must understand a point or two about the transmission and reception of radio signals.

Two Types of Signals

There are two basic types of radio signals... AM or Amplitude Modulation, in which the transmitted sound causes the amplitude, or height, of the radio waves to vary... and FM or Frequency Modulation, in which the frequency of the wave is varied to carry the sound.

Electrical Disturbances

Radio waves may pick up electrical disturbances during transmission. They mainly affect the wave amplitude, and thus remain a part of the AM reception. They interfere very little with the frequency variations that carry the FM signal.

AM Reception

AM sound is based on wave amplitude, so AM reception can be disrupted by such things as lightning, power lines and neon signs.

FM Reception

Because FM transmission is based on frequency variations, interference that consists of amplitude variations can be filtered out, leaving the reception relatively clear, which is the major feature of FM radio.

SALES CODE RBB—AM/FM STEREO RADIO WITH CASSETTE TAPE PLAYER AND CD CHANGER CAPABILITY

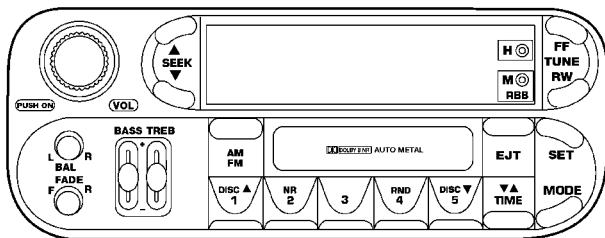

80ef1613

Operating Instructions

NOTE: Power to operate the radio is supplied through the ignition switch. It must be in the ON or ACC position to operate the radio.

NOTE: When first learning the control functions, the user should set the controls as shown in the following list.

Tone Controls...As illustrated.

Speaker Control...Centered.

Power Button

The volume control/power button pops out when pressed, this turns the sound system ON in the mode last used. Pushing the button back in turns the sound system OFF.

Electronic Volume Control

The electronic volume control turns continuously (360 degrees) in either direction without stopping. Turning the volume control to the right increases the volume and to the left decreases it.

When the audio system is turned on, the sound will be set at the same volume level as last played.

For your convenience, the volume can be turned down, but not up, when the audio system is off and the ignition is ON.

Seek

Press and release the SEEK button to search for the next station in either the AM or FM mode. Press the top of the button to seek up and the bottom to seek down. The radio will remain tuned to the new station until you make another selection. Holding the button will bypass stations without stopping until you release it.

Tune

Press the TUNE control up or down to increase or decrease the frequency. If the button is pushed and held, the radio will continue to tune until the button is released. The frequency will be displayed and continuously updated while the button is pushed.

To Set The Push-Button Memory

When you are receiving a station that you wish to commit to push-button memory, press the SET button. The symbol SET 1 will now show in the display window. Select the “1-5” button you wish to lock onto this station and press and release that button. If a button is not selected within 5 seconds after pressing the SET button, the station will continue to play but will not be locked into push-button memory.

You may add a second station to each push-button by repeating the above procedure with this exception: Press the SET button twice and SET 2 will show in the display window. Each button can be set for SET 1 and SET 2 in both AM and FM. This allows a total of 10 AM and 10 FM stations to be locked into push-button memory. The stations stored in SET 2 memory can be selected by pressing the push-button twice.

Every time a preset button is used a corresponding button number will be displayed.

Balance

The balance control adjusts the left-to-right speaker balance. Press the BAL button in and it will pop out. Adjust the balance and push the button back in.

Fade

The fade control provides for balance between the front and rear speakers. Press the FADE button in and it will pop out. Adjust the balance and push the button back in.

Bass and Treble Tone Control

The tone controls consist of 2 separate bands. The bass band is on the left, and the treble band is on the right. Each band is adjusted by a slider control with a detent at the mid-position. Moving the control up or down increases or decreases amplification of that band. The mid position provides a balanced output.

AM/FM Selection

Press the AM/FM button to change from AM to FM. The operating mode will be displayed next to the station frequency. The display will show ST when a stereo station is received in the FM mode.

Mode Button

Press the MODE button to select between the cassette tape player, CD changer, or the Satellite Radio (if equipped). When the Satellite Radio (if equipped) is selected "SA" will appear in your radio display.

A CD or tape may remain in the player while in the Satellite or radio mode.

Cassette Player Features

With ignition OFF and the sound system OFF, you can eject the tape cassette by pushing the EJECT button.

You can turn the tape player ON by inserting a cassette or activating the MODE button (with a cassette in the radio), but only when the ignition and radio are on.

Each time a cassette is inserted the tape player will begin playing on the side of the cassette that is facing up in the player.

Music Search

Pressing the SEEK button while playing a tape will start the Music Search mode. Press the SEEK button up for the next selection on the tape and down to return to the beginning of the current selection, or return to the beginning of the previous selection if the tape is within the first 5 seconds of the current selection.

The SEEK symbol appears on the display when Music Search is in operation. Music Search shuts off automatically when a selection has been located.

Selective Music Search

Press the SEEK button up or down to move the track number to skip forward or backward 1 to 7 selections. Press the SEEK button once to move 1 selection, twice to move 2 selections, etc.

Fast Forward And Rewind Buttons

Pressing the TUNE button up or down momentarily activates Fast Forward or Rewind and makes the directional arrows appear on the display.

To stop Fast Forward or Rewind, press the TUNE button again.

Time Button

Press the time button to toggle between station frequency and time of day.

Pressing this button while playing a cassette tape will change the side of the tape being played.

NR (Noise Reduction)

Pushing the Number 2 Pre-set button when a tape is playing deactivates the Dolby Noise Reduction System*. When Dolby is ON, the NR symbol appears on the display. Each time a tape is inserted the Dolby will turn ON.

* “Dolby” noise reduction manufactured under license from Dolby Laboratories Licensing Corporation. Dolby and the double-D symbol are trademarks of Dolby Laboratories Licensing Corporation.

CD Changer Control Capability — If Equipped

This radio is compatible with a remote mounted CD changer available through Mopar Accessories. The following instructions are for the radio controls that operate this CD changer.

Mode Button

To activate the CD changer, press the MODE button until CD information appears on the display.

Push-Button

While the CD changer is playing, press the NUMBER 1 push-button or the NUMBER 5 push-button to select a disc numbered higher or lower than the one currently being played.

Seek Button

Press the SEEK up or down to select another track on the same disc. A SEEK symbol will appear on the display.

Fast Forward And Rewind Buttons

Press and hold the FF button for fast forward. Press and hold the RW button for fast reverse.

The audio output can be heard when fast forward and fast reverse are activated.

Random Play (RND)

Press the Random button to play the tracks on the selected disc in random order for an interesting change of pace.

Random can be cancelled by pressing the button a second time or by ejecting the CD from the changer.

CD Diagnostic Indicators

When driving over a very rough road, the CD player may skip momentarily. Skipping will not damage the disc or the player, and play will resume automatically.

As a safeguard and to protect your CD player, one of the following warning symbols may appear on your display.

A CD HOT symbol indicates the player is too hot.



CD HOT will pause the operation. Play can be resumed when the operating temperature is corrected or another MODE is selected.

An ERR symbol will appear on the display if the laser is unable to read the Disc data for the following reasons:

- Excessive vibration
- Disc inserted upside down
- Damaged disc
- Water condensation on optics

Radio Display Messages

Your radio has been designed to display certain messages when a problem is detected with the CD player.

| DISPLAY | EXPLANATION | WHAT TO DO |
|--|------------------------|---|
| E-01 | Deadlock problem | See your dealer for service |
| E-02 | Disc eject problem | See your dealer for service |
| E-06 | Elevator problem | See your dealer for service |
| E-07 | Magazine eject problem | Check that magazine is OK- if not see your dealer for service |
|  | No discs in magazine. | Load discs in magazine. |
|  | Player overheating. | Allow to cool down. |

805c2ab6

SALES CODE RBK—AM/ FM STEREO RADIO WITH CD PLAYER AND CD CHANGER CONTROLS

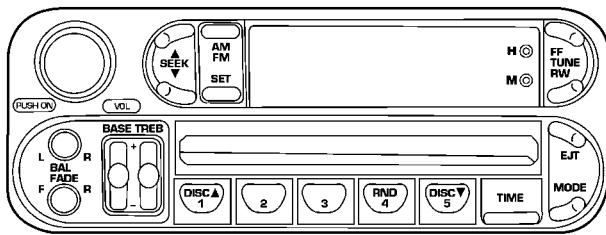

80e571f6

Radio Operation

Power/Volume Control

Press the ON/VOL control to turn the radio on. Turn the volume control clockwise to increase the volume.

NOTE: Power to operate the radio is supplied through the ignition switch. It must be in the ON or ACC position to operate the radio.

Seek

Press and release the SEEK button to search for the next station in either the AM or FM mode. Press the top of the button to seek up and the bottom to seek down. The radio will remain tuned to the new station until you make another selection. Holding the button in will bypass stations without stopping until you release it.

Tune

Press the TUNE control up or down to increase or decrease the frequency. If you press and hold the button,

the radio will continue to tune until you release the button. The frequency will be displayed and continuously updated while the button is pressed.

Balance

The Balance control adjusts the left-to-right speaker balance. Press the BAL button in and it will pop out. Adjust the balance and push the button back in.

Fade

The Fade control provides for balance between the front and rear speakers. Press the FADE button in and it will pop out. Adjust the balance and push the button back in.

Bass and Treble Tone Control

The tone controls consist of 2 separate bands. The bass band is on the left, and the treble band is on the right. Each band is adjusted by a slider control with a detent at the mid-position. Moving the control up or down increases or decreases amplification of that band. The mid position provides a balanced output.

AM/FM Selection

Press the AM/FM button to change from AM to FM. The operating mode will be displayed next to the station frequency. The display will show ST when a stereo station is received.

To Set The Radio Push-Button Memory

When you are receiving a station that you wish to commit to push-button memory, press the SET button. SET 1 will show in the display window. Select the "1-5" button you wish to lock onto this station and press and release that button. If a button is not selected within 5 seconds after pressing the SET button, the station will continue to play but will not be locked into push-button memory.

You may add a second station to each push-button by repeating the above procedure with this exception: Press the SET button twice and SET 2 will show in the display window. Each button can be set for SET 1 and SET 2 in

both AM and FM. This allows a total of 10 AM and 10 FM stations to be locked into push-button memory. The stations stored in SET 2 memory can be selected by pressing the push-button twice. Every time a preset button is used a corresponding button number will be displayed.

Time

Press the TIME button to change the display between radio frequency and time.

General Information

This radio complies with Part 15 of FCC rules and with RSS-210 of Industry Canada. Operation is subject to the following conditions:

1. This device may not cause harmful interference,
2. This device must accept any interference received, including interference that may cause undesired operation.

NOTE: Changes or modifications not expressly approved by the party responsible for compliance could void the user's authority to operate the equipment.

CD Player Operation

NOTE: The ignition switch must be in the ON or ACC position and the volume control ON before the CD player will operate.

Inserting The Compact Disc

CAUTION!

This CD player will accept 4 ¾ inch (12 cm) discs only. The use of other sized discs may damage the CD player mechanism.

You may either insert or eject a disc with the radio OFF.

If you insert a disc with the ignition ON and the radio OFF, the display will show the time of day.

If the power is ON, the unit will switch from radio to CD mode and begin to play when you insert the disc. The display will show the track number and index time in minutes and seconds. Play will begin at the start of track one.

Seek

Press the top of the SEEK button for the next selection on the CD. Press the bottom of the button to return to the beginning of the current selection, or return to the beginning of the previous selection if the CD is within the first second of the current selection.

EJT — Eject

Press the EJT button and the disc will unload and move to the entrance for easy removal. The unit will switch to the radio mode.

If you do not remove the disc within 15 seconds, it will be reloaded. The unit will continue in radio mode.

The disc can be ejected with the radio and ignition OFF.

FF/TUNE/RW

Press FF (Fast Forward) and the CD player will begin to fast forward until FF is released. The RW (Reverse) button works in a similar manner.

Random Play — RND/Program Button 4

Press the RND (button 4) button while the CD is playing to activate Random Play. This feature plays the tracks on the selected disc in random order to provide an interesting change of pace.

Press the SEEK button to move to the next randomly selected track.

Press the RND (button 4) button a second time to stop Random Play.

Mode

Press the MODE button repeatedly to select between the CD player, the optional remote CD changer and the Satellite Radio (if equipped). When Satellite Radio (if equipped) is selected “SA” will appear in your radio display.

A CD or tape may remain in the player while in the Satellite mode.

Time

Press the TIME button to change the display from elapsed CD playing time to time of day.

CD Changer Control Capability — If Equipped

This radio is compatible with a remote mounted CD changer available through Mopar Accessories. The following instructions are for the radio controls that operate this CD changer.

Mode Button

To activate the CD changer, press the MODE button until CD information appears on the display.

Push-Button

While the CD changer is playing, press the NUMBER 1 push-button or the NUMBER 5 push-button to select a disc numbered higher or lower than the one currently being played.

Seek Button

Press the SEEK up or down to select another track on the same disc. A SEEK symbol will appear on the display.

Fast Forward And Rewind Buttons

Press and hold the FF button for fast forward. Press and hold the RW button for fast reverse.

The audio output can be heard when fast forward and fast reverse are activated.

Random Play (RND)

Press the Random button to play the tracks on the selected disc in random order for an interesting change of pace.

Random can be cancelled by pressing the button a second time or by ejecting the CD from the changer.

CD Diagnostic Indicators

When driving over a very rough road, the CD player may skip momentarily. Skipping will not damage the disc or the player, and play will resume automatically.

As a safeguard and to protect your CD player, one of the following warning symbols may appear on your display.

A CD HOT symbol indicates the player is too hot.



CD HOT will pause the operation. Play can be resumed when the operating temperature is corrected or another MODE is selected.

An ERR symbol will appear on the display if the laser is unable to read the Disc data for the following reasons:

- Excessive vibration
- Disc inserted upside down
- Damaged disc
- Water condensation on optics

Radio Display Messages

Your radio has been designed to display certain messages when a problem is detected with the CD player.

| DISPLAY | EXPLANATION | WHAT TO DO |
|--|------------------------|---|
| E-01 | Deadlock problem | See your dealer for service |
| E-02 | Disc eject problem | See your dealer for service |
| E-06 | Elevator problem | See your dealer for service |
| E-07 | Magazine eject problem | Check that magazine is OK- if not see your dealer for service |
|  | No discs in magazine. | Load discs in magazine. |
|  | Player overheating. | Allow to cool down. |

805c2ab6

SALES CODE RBP—AM & FM STEREO RADIO WITH CASSETTE TAPE PLAYER, CD PLAYER, AND OPTIONAL CD/DVD CHANGER CONTROLS

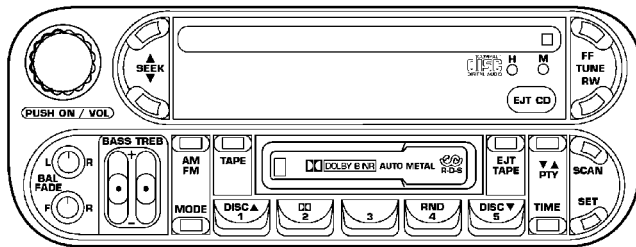

80e7c9a0

Radio Operation

Power/Volume Control

Press the ON/VOL control to turn the radio on. Turn the volume control to the right to increase the volume.

NOTE: Power to operate the radio is supplied through the ignition switch. It must be in the ON or ACC position to operate the radio.

PTY (Program Type) Button

Pressing this button once will turn on the PTY mode for 5 seconds. If no action is taken during the 5 second time out the PTY icon will turn off. Pressing the PTY button within 5 seconds will allow the program format type to be selected. Many radio stations do not currently broadcast PTY information.

Toggle the PTY button to select the following format types:

| Program Type | Radio Display |
|------------------|---------------|
| Adult Hits | Adlt Hit |
| Classical | Classicl |
| Classic Rock | Cls Rock |
| College | College |
| Country | Country |
| Information | Inform |
| Jazz | Jazz |
| Foreign Language | Language |
| News | News |
| Nostalgia | Nostalga |
| Oldies | Oldies |
| Personality | Persnlty |
| Public | Public |
| Rhythm and Blues | R & B |

| Program Type | Radio Display |
|-----------------------|---------------|
| Religious Music | Rel Musc |
| Religious Talk | Rel Talk |
| Rock | Rock |
| Soft | Soft |
| Soft Rock | Soft Rck |
| Soft Rhythm and Blues | Soft R&B |
| Sports | Sports |
| Talk | Talk |
| Top 40 | Top 40 |
| Weather | Weather |

By pressing the SEEK button when the PTY icon is displayed, the radio will be tuned to the next frequency station with the same selected PTY name. The PTY function only operates when in the FM and Satellite (if equipped) modes.

The radio display will flash “SEEK” and the selected PTY program type when searching for the next PTY station. If no station is found with the selected PTY program type, the radio will return to the last preset station.

If a preset button is activated while in the PTY (Program Type) mode, the PTY mode will be exited and the radio will tune to the preset station.

Pressing PTY, then SCAN will scan the FM Band and stop at all RDS stations that broadcast the station type. Each RDS station will be played for a 5 second scan once around the FM Band and stop at the last station. The PTY icon will then turn off.

Seek

Press and release the SEEK button to search for the next station in either the AM or FM mode. Press the top of the button to seek up and the bottom to seek down. The radio will remain tuned to the new station until you

make another selection. Holding the button in will bypass stations without stopping until you release it.

Scan

Press and release the SCAN button to search for the next station in either the AM or FM mode. The radio will pause for 5 seconds at each listenable station before continuing to the next. To stop the search, press the SCAN button a second time.

Tune

Press the TUNE control up or down to increase or decrease the frequency. If you press and hold the button, the radio will continue to tune until you release the button. The frequency will be displayed and continuously updated while the button is pressed.

Balance — BAL

The Balance control adjusts the left-to-right speaker balance. Press the BAL button in and it will pop out. Adjust the balance and push the button back in.

Fade

The Fade control provides for balance between the front and rear speakers. Press the FADE button in and it will pop out. Adjust the balance and push the button back in.

Tone Control

The tone controls affect the BASS and TREBLE frequency bands. Each is controlled by a slider control with a detent at the mid position. Moving a control up or down increases or decreases amplification of the band. The mid position provides a balanced output.

AM/FM Selection

Press the AM/FM button to toggle between AM and FM mode. The operating mode will be displayed next to the station frequency. The display will show "ST" when a stereo station is received (FM only).

To Set The Radio Push-Button Memory

When you are receiving a station that you wish to commit to push-button memory, press the SET button.

SET 1 will now show in the display window. Select the "1-5" button you wish to lock onto this station and press and release that button. If a button is not selected within 5 seconds after pressing the SET button, the station will continue to play but will not be locked into push-button memory.

You may add a second station to each push-button by repeating the above procedure with this exception: Press the SET button twice and SET 2 will show in the display window. Each button can be set for SET 1 and SET 2 in both AM and FM. This allows a total of 10 AM and 10 FM stations to be locked into push-button memory. The stations stored in SET 2 memory can be selected by pressing the push-button twice.

Time

Press the TIME button to change the display between radio frequency and time.

To set the clock, use a ballpoint pen or similar object to press the hour (H) or minute (M) buttons on the radio. The time setting will increase each time you press the button. Press any other button to exit from the clock setting mode.

General Information

This radio complies with Part 15 of FCC rules and with RSS-210 of Industry Canada. Operation is subject to the following conditions:

1. This device may not cause harmful interference,
2. This device must accept any interference received, including interference that may cause undesired operation.

NOTE: Changes or modifications not expressly approved by the party responsible for compliance could void the user's authority to operate the equipment.

Tape Player Operation

Insert the cassette with the exposed tape side toward the right and the mechanical action of the player will gently pull the cassette into the play position.

NOTE: When subjected to extremely cold temperatures, the tape mechanism may require a few minutes to warm up for proper operation. Sometimes poor playback may be experienced due to a defective cassette tape. Clean and demagnetize the tape heads at least twice a year.

Tape Side — ∇Δ/PTY

Pressing the ∇Δ button during tape mode will cause the other side of the tape to be played. The display will confirm the selected tape play direction. The time is always displayed.

Tape

Press the TAPE button to select the Tape mode.

Seek

Press the SEEK button up for the next selection on the tape and down to return to the beginning of the current selection.

Press the SEEK button up or down to move the track number to skip forward or backward 1 to 7 selections. Press the SEEK button once to move 1 selection, twice to move 2 selections, etc. the display will show the total number of times the SEEK button was pushed. The SEEK function will be cancelled by pressing either the FF/RW or AM/FM button.

Fast Forward — FF

Press the FF button up momentarily to advance the tape in the direction that it is playing. The tape will advance until the button is pressed again or the end of the tape is reached. At the end of the tape, the tape will play in the opposite direction.

Rewind — RW

Press the RW button down momentarily to reverse the tape direction. The tape will rewind until the button is pressed again or until the beginning of the tape is reached. At the beginning of the tape, the tape will play in the opposite direction.

EJT Tape

Press the EJT TAPE button and the cassette will disengage and eject from the radio.

Metal Tape Selection (70µs)

If a standard 70 µ (metal) tape is inserted into the player, the player will automatically select the correct equalization.

Pinch Roller Release

If ignition power or the radio ON/OFF switch are turned off, the pinch roller will automatically retract to protect

the tape from any damage. When power is restored to the tape player, the pinch roller will automatically reengage and the tape will resume play.

Dolby Noise Reduction

 The Dolby Noise Reduction System* is on whenever the tape player is on, but may be switched on/off.

To turn the Dolby Noise Reduction System on/off: Press the Dolby NR button (button 2) after you insert the tape. The NR light in the display will go off when the Dolby System is off.

* "Dolby" noise reduction manufactured under license from Dolby Laboratories Licensing Corporation. Dolby and the double-D symbol are trademarks of Dolby Laboratories Licensing Corporation.

CD Player Operation

NOTE: The ignition switch must be in the ON or ACC position and the volume control ON before the CD player will operate.

Inserting The Compact Disc

You may either insert or eject a disc with the radio OFF.

If you insert a disc with the ignition ON and the radio off, the display will show CD and the time of day will be displayed.

If the power is on, the unit will switch from radio to CD mode and begin to play when you insert the disc. The display will show the track number and index time in minutes and seconds. Play will begin at the start of track 1.

Seek

Press the top of the SEEK button for the next selection on the CD. Press the bottom of the button to return to the beginning of the current selection, or return to the beginning of the previous selection if the CD is within the first second of the current selection.

Scan

Press the SCAN button to play 10 seconds of each selection. Press the SCAN button a second time to cancel this feature.

EJECT CD

Press the EJECT CD button and the disc will unload and move to the entrance for easy removal. The unit will switch to the radio mode.

If you do not remove the disc within 15 seconds, it will be reloaded. The unit will continue in radio mode.

The disc can be ejected with the radio and ignition off.

FF/TUNE/RW

Press FF (Fast Forward) and the CD player will begin to fast forward until FF is released. The RW (Reverse) button works in a similar manner.

Random Play — RND/Program Button 4

Press the RND (button 4) button while the CD is playing to activate Random Play. This feature plays the selections on the compact disc in random order to provide an interesting change of pace.

Press the top of the SEEK button to move to the next randomly selected track.

Press the RND (button 4) button a second time to stop Random Play.

MODE

Press the MODE button to select between the CD player, remote CD/DVD changer (if equipped), or satellite radio (if equipped).

To select Satellite Radio (if equipped), press the MODE button until the word SIRIUS™ appears. The following will be displayed in this order: After three seconds, the current channel name and number will be displayed for five seconds. The current program type and channel number will then be displayed for five seconds. The current channel name and number will then be displayed until an action occurs. A CD or tape may remain in the player while in the Satellite Radio mode.

Time

Press the TIME button to change the display from elapsed CD playing time to time of day.

CD/DVD Changer Operation — If Equipped**MODE**

Press the MODE button to select between the CD player, and the CD/DVD changer (if equipped).

Disc Up/Program Button 1

Press the DISC (button 1) button to play the next available disc.

Random Play — RND/Program Button 4

Press the RND (button 4) button while the CD is playing to activate Random Play. This feature plays the selections on the currently playing compact disc in random order to provide an interesting change of pace.

Press the top of the SEEK button to move to the next randomly selected track.

Press the RND (button 4) button a second time to stop Random Play.

FF/RW — TUNE

Press and hold the FF button for fast forward. Press and hold the RW button for fast reverse. The audio output can be heard when fast forward and fast reverse are activated.

Disc Down/Program Button 5

Press the DISC (button 5) button to play the previous disc.

Seek

Press the top of the SEEK button for the next selection on the CD. Press the bottom of the button to return to the beginning of the current selection, or return to the beginning of the previous selection if the CD is within the first second of the current selection.

Time

Press the TIME button to switch between time of day and CD track time.

Scan

Press the SCAN button to play 10 seconds of each track. Press the SCAN button a second time to cancel the feature.

SALES CODE RBQ—AM/FM STEREO RADIO WITH 6 - DISC CD CHANGER

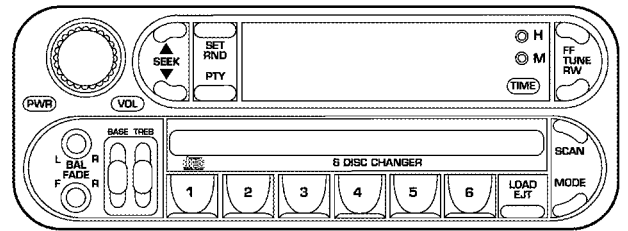

80f1ee0e

Radio Operation

Power/Volume Control

Press the PWR/VOL control to turn the radio on. Turn the volume control clockwise to increase the volume.

NOTE: Power to operate the radio is controlled by the ignition switch. It must be in the ON or ACC position to operate the radio.

Mode

Press the MODE button repeatedly to select between AM, FM, the CD changer and Sirius Satellite Radio™ (if equipped). The display will show ST when a stereo station is received.

To select Sirius Satellite Radio™ (if equipped), press the MODE button until the word SIRIUS appears. The following will be displayed in this order: After three seconds, the current channel name and number will be displayed for five seconds. The current program type and

channel number will then be displayed for five seconds. The current channel name and number will then be displayed until an action occurs. CD's may remain in the player while in the Satellite Radio mode.

Seek

Press and release the SEEK button to search for the next station in either the AM or FM mode. Press the top of the button to seek up and the bottom to seek down. The radio will remain tuned to the new station until you make another selection. Holding the button in will bypass stations without stopping until you release it.

Tune

Press the TUNE control up or down to increase or decrease the frequency. If the button is pressed and held, the radio will continue to tune until the button is released. The frequency will be displayed and continuously updated while the button is pressed.

Balance — BAL

The Balance control adjusts the left-to-right speaker balance. Press the BAL button in and it will pop out. Adjust the balance and push the button back in.

Fade

The Fade control provides for balance between the front and rear speakers. Press the FADE button in and it will pop out. Adjust the balance and push the button back in.

Tone Control

The tone controls affect the Bass and Treble frequency bands. Each is controlled by a slider control with a detent at the mid position. Moving a control up or down increases or decreases amplification of the band. The mid position provides a balanced output.

To Set The Radio Push-Button Memory

When you are receiving a station that you wish to commit to push-button memory, press the SET RND button. SET 1 will show in the display window. Select the

“1-6” button you wish to lock onto this station and press and release that button. If a button is not selected within 5 seconds after pressing the SET RND button, the station will continue to play but will not be locked into push-button memory.

You may add a second station to each push-button by repeating the above procedure with this exception: Press the SET button twice and SET 2 will show in the display window. Each button can be set for SET 1 and SET 2 in both AM and FM. This allows a total of 12 AM and 12 FM stations to be locked into push-button memory. The stations stored in SET 2 memory can be selected by pressing the corresponding push-button twice. Every time a preset button is used, a corresponding button number will be displayed.

Time Button

Press the TIME button to change the display between radio frequency and time.

General Information

This radio complies with Part 15 of FCC rules and with RSS-210 of Industry Canada. Operation is subject to the following conditions:

1. This device may not cause harmful interference,
2. This device must accept any interference received, including interference that may cause undesired operation.

NOTE: Changes or modifications not expressly approved by the party responsible for compliance could void the user's authority to operate the equipment.

CD Player Operation

NOTE: The ignition switch must be in the ON or ACC position and the Power / Volume control pushed ON before the CD player will operate.

Inserting The Compact Disc**CAUTION!**

This CD player will accept 4 ¾ inch (12 cm) discs only. The use of other sized discs may damage the CD player mechanism.

You may either insert or eject a disc with the radio OFF.

If you insert a disc with the ignition ON and the radio OFF, the display will show the time of day. If you insert a disc with the ignition OFF, the display will show the time of day for about 5 seconds, then go out.

If you insert a disc with the ignition ON and the radio ON, the unit will switch from radio to CD mode and begin to play when you insert the disc. The display will

show the disc number, the track number, and index time in minutes and seconds. Play will begin at the start of track 1.

LOAD/ EJT — Load

Press the LOAD/ EJT button and the button with the corresponding number where the CD is being loaded. After the radio displays “load” insert the CD into the player.

Radio display will show “loading” when it is being loaded.

LOAD / EJT — Eject

Press the LOAD/ EJT button and the button with the corresponding number where the CD was loaded and the disc will unload and move to the entrance for easy removal.

Radio display will show “ejecting” when it is being ejected.

If you have ejected a disc and have not removed it within 15 seconds, it will be reloaded. If the CD is not removed, the radio will continue to play the non-removed CD. If the CD is removed and there are other CD's in the radio, the radio will play the next CD. If the CD is removed and there are no other CD's in the radio, the radio will return to the last selected AM or FM mode.

The disc can be ejected with the radio and ignition OFF.

Seek

Press the top of the SEEK button for the next selection on the CD. Press the bottom of the button to return to the beginning of the current selection, or return to the beginning of the previous selection if the CD is within the first second of the current selection.

Scan

Press the Scan button to scan through each track on the CD currently playing.

FF/TUNE/RW

Press FF (Fast Forward) and the CD player will begin to fast forward until FF is released. The RW (Reverse) button works in a similar manner.

Random Play — SET / RND

Press the RND button while the CD is playing to activate Random Play. This feature plays the tracks on the disc in random order to provide an interesting change of pace.

Press the SEEK button to move to the next randomly selected track.

Press TUNE FF to fast forward through the tracks. Press the FF button a second time to stop the fast forward feature. If TUNE RW is pressed, the current track will reverse to the beginning of the track and begin playing.

Press the SET / RND button a second time to stop Random Play.

PTY (Program Type) Button

Pressing this button once will turn on the PTY mode for 5 seconds. If no action is taken during the 5 second time out the PTY icon will turn off. Pressing the PTY button within 5 seconds will allow the program format type to be selected. Many radio stations do not currently broadcast PTY information.

Toggle the PTY button to select the following format types:

| Program Type | Radio Display |
|----------------|---------------|
| Adult Hits | Adlt Hit |
| Classical | Classicl |
| Classic Rock | Cls Rock |
| College | College |
| Country | Country |
| Emergency | ALERT! |
| Emergency Test | Test |

| Program Type | Radio Display |
|-----------------------|---------------|
| Information | Inform |
| Jazz | Jazz |
| Foreign Language | Language |
| News | News |
| Nostalgia | Nostalga |
| Oldies | Oldies |
| Personality | Persnlty |
| Public | Public |
| Rhythm and Blues | R & B |
| Religious Music | Rel Musc |
| Religious Talk | Rel Talk |
| Rock | Rock |
| Soft | Soft |
| Soft Rock | Soft Rck |
| Soft Rhythm and Blues | Soft R&B |
| Sports | Sports |

| Program Type | Radio Display |
|--------------|---------------|
| Talk | Talk |
| Top 40 | Top 40 |
| Weather | Weather |

By pressing the SEEK button when the PTY icon is displayed, the radio will be tuned to the next frequency station with the same selected PTY name. The PTY function only operates when in the FM mode.

The radio display will flash “SEEK” and the selected PTY program type when searching for the next PTY station. If no station is found with the selected PTY program type, the radio will return to the last station.

If a preset button is activated while in the PTY (Program Type) mode, the PTY mode will be exited and the radio will tune to the preset station.

By pressing the SCAN button when the PTY icon is displayed, the radio will stop at every PTY station on the band and list each corresponding program type in the radio display.

Time

Press the TIME button to change the display from elapsed CD playing time to time of day.

SATELLITE RADIO — IF EQUIPPED

Satellite radio uses direct satellite to receiver broadcasting technology to provide clear digital sound, coast to coast. The subscription service provider is Sirius™ Satellite Radio. This service offers up to 100 channels of music, sports, news, entertainment, and programming for children, directly from its satellites and broadcasting studios.

System Activation

To activate your Sirius Satellite Radio service, call the toll-free number 888-539-7474, or visit the Sirius web site at www.sirius.com. Please have the following information available when activating your system:

1. The Electronic Serial Number/Sirius Identification Number (ESN/SID).
2. Credit card information.
3. Your Vehicle Identification Number.

Electronic Serial Number/Sirius Identification Number (ENS/SID)

The Electronic Serial Number/Sirius Identification Number is needed to activate your Sirius Satellite Radio system. To access the ESN/SID, refer to the following steps:

ESN/SID Access With RBB and RBK Radios

With the ignition switch in the ACCESSORY position and the radio OFF, press the Tape Eject or CD Eject (depending on the radio type) and Time buttons simultaneously for 3 seconds. The first four digits of the twelve-digit ESN/SID number will be displayed. Press the SEEK UP button to display the next four digits. Continue to press the SEEK UP button until all twelve ESN/SID digits have been displayed. The SEEK DOWN will page down until the first four digits are displayed. The radio will exit the ESN/SID mode when any other button is pushed, the ignition is turned OFF, or 5 minutes has passed since any button was pushed.

ESN/SID Access With RBP, RBU, RAZ, and RBQ Radios

With the ignition switch in the ACCESSORY position and the radio OFF, press the CD Eject and TIME buttons simultaneously for 3 seconds. All twelve ESN/SID numbers will be displayed. The radio will exit the ESN/SID

mode when any other button is pushed, the ignition is turned OFF, or 5 minutes has passed since any button was pushed.

Selecting Satellite Mode in RBB and RBK Radios

Press the MODE button repeatedly until "S A" appears in the display. A CD or tape may remain in the radio while in the Satellite radio mode.

Selecting Satellite Mode in RBP, RBU, RAZ, and RBQ Radios

Press the MODE button repeatedly until the word "SIRIUS" appears in the display. These radios will also display the following:

- After 3 seconds, the current channel name and channel number will be displayed for 5 seconds.
- The current program type and channel number will then be displayed for 5 seconds.

- The current channel number will then be displayed until an action occurs.

A CD or tape may remain in the radio while in the Satellite radio mode.

Selecting a Channel

Press and release the SEEK or TUNE buttons to search for the next channel. Press the top of the button to search up and the bottom of the button to search down. Holding the TUNE button causes the radio to bypass channels until the button is released.

Press and release the SCAN button (if equipped) to automatically change channels every 7 seconds. The radio will pause on each channel for 7 seconds before moving on to the next channel. The word "SCAN" will appear in the display between each channel change. Press the SCAN button a second time to stop the search.

NOTE: Channels that may contain objectionable content can be blocked. Contact Sirius Customer Care at 888-539-7474 to discuss options for channel blocking or unblocking. Please have your ESN/SID information available.

Storing and Selecting Pre-Set Channels

In addition to the 10 AM and 10 FM pre-set stations, you may also commit 10 satellite stations to push button memory. These satellite channel pre-set stations will not erase any AM or FM pre-set memory stations. Follow the memory pre-set procedures that apply to your radio.

Using the PTY (Program Type) Button (if equipped)

Follow the PTY button instructions that apply to your radio.

PTY Button "SCAN"

When the desired program type is obtained, press the "SCAN" button within five seconds. The radio will play 7 seconds of the selected channel before moving to the next channel of the selected program type. Press the "SCAN" button a second time to stop the search.

NOTE: Pressing the "SEEK" or "SCAN" button while performing a music type scan will change the channel by one and stop the search. Pressing a pre-set memory button during a music type scan, will call up the memory channel and stop the search.

PTY Button "SEEK"

When the desired program is obtained, press the "SEEK" button within five seconds. The channel will change to the next channel that matches the program type selected.

Satellite Antenna

To ensure optimum reception, do not place items on the roof around the rooftop antenna location. Metal objects placed within the line of sight of the antenna will cause decreased performance. Larger luggage items should be placed as far forward as possible. Do not place items directly on or above the antenna.

Reception Quality

Satellite reception may be interrupted due to one of the following reasons.

- The vehicle is parked in an underground parking structure or under a physical obstacle.
- Dense tree coverage may interrupt reception in the form of short audio mutes.

- Driving under wide bridges or along tall buildings can cause intermittent reception.
- Placing objects over or too close to the antenna can cause signal blockage.

REMOTE SOUND SYSTEM CONTROLS — IF EQUIPPED

The remote sound system controls are located on the rear surface of the steering wheel. Reach behind the wheel to access the switches.

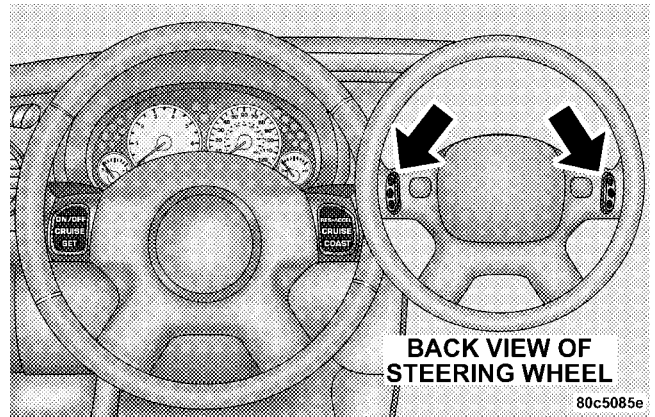

The right hand control is a rocker type switch with a push-button in the center and controls the volume and mode of the sound system. Pressing the top of the rocker switch will increase the volume and pressing the bottom of the rocker switch will decrease the volume.

Pressing the center button will make the radio switch between the various modes available (AM/FM/TAPE/CD, Etc.).

The left hand control is a rocker type switch with a push-button in the center. The function of the left hand control is different depending on which mode you are in.

The following describes the left hand control operation in each mode.

Radio Operation

Pressing the top of the switch will “Seek” up for the next listenable station and pressing the bottom of the switch will “Seek” down for the next listenable station.

The button located in the center of the left hand control will tune to the next preset station that you have programmed in the radio preset push-button.

Tape Player

Pressing the top of the switch once will go to the next selection on the cassette. Pressing the bottom of the switch once will go to the beginning of the current selection or to the beginning of the previous selection if it is within the first 5 seconds of the current selection.

If you press the switch up or down twice it plays the second selection, three times, it will play the third, etc.

The button in the center of the left hand switch switches the side of the tape to be played.

CD Player — Single Disc in Radio

Pressing the top of the switch once will go to the next track on the CD. Pressing the bottom of the switch once will go to the beginning of the current track or to the beginning of the previous track if it is within one second after the current track begins to play.

If you press the switch up or down twice it plays the second track, three times, it will play the third, etc.

The button in the center of the left hand switch has no function in this mode.

CD Player — 6 Disc in Cargo Area

Pressing the top of the switch once will go to the next track on the CD. Pressing the bottom of the switch once will go to the beginning of the current track or to the beginning of the previous track if it is within one second after the current track begins to play.

If you press the switch up or down twice it plays the second track, three times, it will play the third, etc.

The button in the center of the left hand switch will cause the CD changer to play the next available disc in the 6-disc magazine.

CASSETTE TAPE AND PLAYER MAINTENANCE

To keep the cassette tapes and player in good condition, take the following precautions:

1. Do not use cassette tapes longer than C-90; otherwise, sound quality and tape durability will be greatly diminished.
2. Keep the cassette tape in its case to protect from slackness and dust when it is not in use.
3. Keep the cassette tape away from direct sunlight, heat and magnetic fields such as the radio speakers.
4. Before inserting a tape, make sure that the label is adhering flatly to the cassette.
5. A loose tape should be corrected before use. To rewind a loose tape, insert the eraser end of a pencil into the tape drive gear and twist the pencil in the required directions.

Maintain your cassette tape player. The head and capstan shaft in the cassette player can pick up dirt or tape deposits each time a cassette is played. The result of deposits on the capstan shaft may cause the tape to wrap around and become lodged in the tape transport. The other adverse condition is low or “muddy” sound from one or both channels, as if the treble tone control were turned all the way down. To prevent this, you should periodically clean the head with a commercially available WET cleaning cassette.

As preventive maintenance, clean the head about every 30 hours of use. If you wait until the head becomes very dirty (noticeably poor sound), it may not be possible to remove all deposits with a simple WET cleaning cassette.

CD/DVD DISC MAINTENANCE

To keep the CD/DVD discs in good condition, take the following precautions:

1. Handle the disc by its edge; avoid touching the surface.
2. If the disc is stained, clean the surface with a soft cloth, wiping from center to edge.
3. Do not apply paper, paper CD labels, or tape to the disc; avoid scratching the disc.
4. Do not use solvents such as benzine, thinner, cleaners, or antistatic sprays.
5. Store the disc in its case after playing.
6. Do not expose the disc to direct sunlight.
7. Do not store the disc where temperatures may become too high.

RADIO OPERATION AND CELLULAR PHONES

Under certain conditions, the cellular phone being On in your vehicle can cause erratic or noisy performance from your radio. This condition may be lessened or eliminated by relocating the cellular phone antenna. This condition is not harmful to the radio. If your radio performance does not satisfactorily “clear” by the repositioning of the antenna, it is recommended that the radio volume be turned down or off during cellular phone operation.

CLIMATE CONTROLS

The controls for the heating, air conditioning, and ventilation system in this vehicle consist of a series of rotary knobs. These comfort controls can be set to obtain desired interior conditions.

Heater

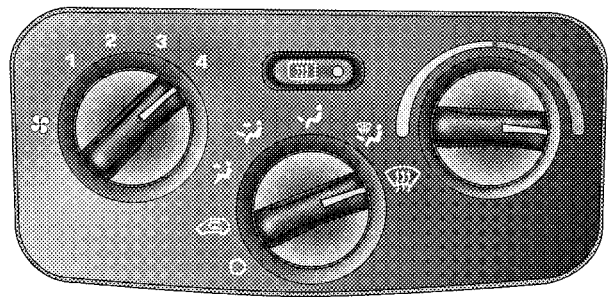

80c49e38

Blower Control

The rotary knob on the left controls the blower and can be set in one of four positions from Low to High.

Temperature Control

The degree of comfort can be selected by rotating the temperature control knob on the right. The coldest temperature setting is fully counterclockwise and the warmest setting fully clockwise. The knob can be positioned at any detent.

Mode Selection

The mode selector (the center rotary knob) can be set in any of the following positions:

OFF

- This position turns off the blower motor and outside air will not pass through any outlets.

Recirculate



Air flows through the outlets located in the instrument panel. Allows for circulation of interior air only. This mode can also be used to temporarily block out outside odors, smoke,

and dust. Slight airflow from the floor outlets and the defrost outlets, located at the base of the windshield, may be noticed.

Panel

- Air flows through the outlets located in the instrument panel. Slight airflow from the defrost outlet, located at the base of the windshield, may be noticed.

Bi-Level

- Air flows through the outlets located in the instrument panel, on the floor, and in the rear of the center console. Slight airflow from the defrost outlet, located at the base of the windshield, may be noticed.

Floor

- Air flows through the floor outlets located under the instrument panel and through the outlets located in the rear of the center console. Slight airflow from the defrost outlet, located at the base of the windshield, may be noticed.

Mix

 Air flows through the floor outlets, the outlets at the base of the windshield, and the side window demisters outlets.

Defrost

 Air flows through the outlets at the base of the windshield and through the side window demister outlets.

Air Conditioning

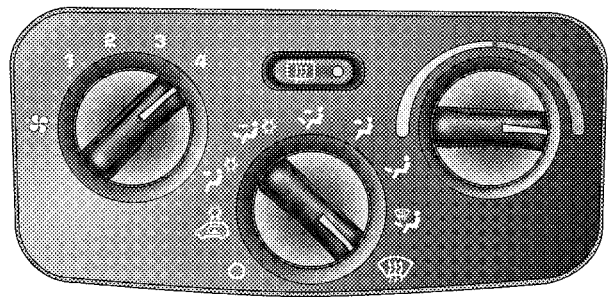

80c49e3c

Blower Control

The rotary knob on the left controls the blower and can be set in one of four positions from Low to High.

Temperature Control

The degree of comfort can be selected by rotating the temperature control knob on the right. The coldest temperature setting is fully counterclockwise and the warmest setting fully clockwise. The knob can be positioned at any detent.

Mode Selection

The mode selector (the center rotary knob) can be set in any of the following positions:

OFF

 This position turns off the blower motor and outside air will not pass through any outlets.

Max A/C - Recirculation

 Cool air flows through the outlets located in the instrument panel. Use this mode to rapidly cool the inside of the vehicle. This feature allows for recirculation of interior air only. This mode can also be

used to temporarily block out outside odors, smoke, and dust. Slight airflow from the defrost outlet, located at the base of the windshield, may be noticed.

Normal A/C

 Cool air flows through the outlets located in the instrument panel. Slight airflow from the defrost outlet, located at the base of the windshield, may be noticed.

Bi-Level A/C

 Cool air flows through the outlets located in the instrument panel, on the floor, and in the rear of the center console. Slight airflow from the defrost outlet, located at the base of the windshield, may be noticed.

Bi-Level

 Air flows through the outlets located in the instrument panel, on the floor, and in the rear of the center console. Slight airflow from the defrost outlet, located at the base of the windshield, may be noticed.

Panel

 Air flows through the outlets located in the instrument panel. Slight airflow from the defrost outlet, located at the base of the windshield, may be noticed.

Floor

 Air flows through the floor outlets located under the instrument panel and through the outlets located in the rear of the center console. Slight airflow from the defrost outlet, located at the base of the windshield, may be noticed.

Mix

 Air flows through the floor outlets, the outlets at the base of the windshield, and the side window demisters outlets.

Defrost

 Air flows through the outlets at the base of the windshield and through the side window demister outlets.

NOTE: To improve fuel economy, leave in Defrost only when necessary.

Operating Tips**Fast Cool Down**

For a fast cool down, turn the blower fan rotary knob to the extreme clockwise position, turn the mode selector to the panel position and drive with the windows open for the first few minutes. Once the hot air has been expelled, close the windows and turn the mode selector to Max A/C-Recirculation. When a comfortable condition has been reached, choose a mode position and adjust the temperature control knob and blower speed as necessary to maintain comfort. For high humidity conditions it may be necessary to remain in the Max A/C-Recirculation mode to maintain comfort.

Window Fogging

In mild but rainy or humid weather, windows will fog on the inside. To rapidly clear the fog off all the windows, select the defrost mode, turn the temperature control knob fully clockwise, and position the blower control to its highest speed. Once the windshield has been cleared, adjust the controls for your comfort.

On air conditioned vehicles, the compressor will operate when in the Mix or Defrost modes and when the outside temperature is approximately 30°F (-1°C) to provide additional defrost/defog.

Summer Operation

Air conditioned vehicles must be protected with a high quality anti-freeze coolant during summer to provide proper corrosion protection and to raise the boiling point of the coolant for protection against overheating. A 50% concentration is recommended.

Winter Operation

When operating the system during the winter months, make sure the air intake, located directly in front of the windshield, is free of ice, slush, snow, or other obstructions.

REAR WINDOW FEATURES**Rear Window Wiper/Washer**

A rotary ring switch on the control lever, located on the right side of the steering column, controls operation of the rear wiper/washer function. Rotating the center of the switch up to the DEL (Delay) position or the ON position will activate the wiper. Rotating the switch ring beyond the ON or OFF position will activate the rear washer. The wash pump will continue to operate as long as the lever or ring is engaged. Upon release, the wipers will cycle three times before returning to the set position.

If the rear wiper is operating when the ignition is turned OFF, the wiper will automatically return to the “Park” position. When the vehicle is restarted, the wiper will resume function at whichever position the switch is set at.

If the swing gate flip-up window is open or the swing gate is open, connection to the rear window wiper is interrupted preventing activation of the rear wiper blade. When the swing gate flip-up window or the swing gate is closed, the rear wiper switch or the ignition switch needs to be turned OFF, and then to ON to restart the rear wiper.

NOTE: The rear swing gate will lock while the rear wiper is operating. The gate will stay locked until the wiper is turned off and the gate is unlocked (by key, lock switch, or key fob).

Adding Washer Fluid

The fluid reservoir for the windshield washers and the rear window washer is shared. It is located in the front of the engine compartment on the passenger side and should be checked for fluid level at regular intervals. Fill the reservoir with windshield washer solvent (not radiator antifreeze) and operate the system for a few seconds to flush out the residual water.

Rear Window Defroster

 On the top of the climate control panel is a push button for rear window defrosting. An amber indicator in the push button will light when the defroster is turned on. Push again to turn off the defroster prior to an automatic time-out.

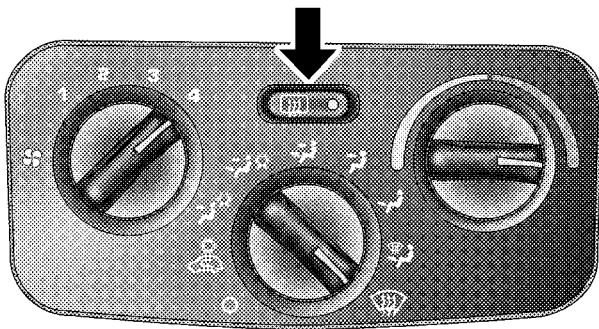

80c5355e

The defroster will automatically turn off after about ten minutes. For about five more minutes of operation, push the button again. To prevent excessive battery drain, use the defroster only when the engine is operating. The push button also activates the heated exterior mirrors, if so equipped.

CAUTION!

Use care when washing the inside of the rear window to prevent damage to heating elements. Use a soft cloth and a mild washing solution, wiping parallel to the heating elements. Also, keep all objects a safe distance from the window to prevent damaging the heating elements.

STARTING AND OPERATING

CONTENTS

| | | | |
|---|-----|--|-----|
| ■ Starting Procedures | 210 | □ 5-Speed Manual Overdrive Transmission | 213 |
| □ Manual Transmission | 210 | □ Automatic Transmission | 216 |
| □ Automatic Transmission | 210 | ■ Four-Wheel Drive Operation | 222 |
| □ Normal Starting | 210 | □ Command-Trac® Operating Information/Precautions | 222 |
| □ Extreme Cold Weather | 211 | □ Shift Positions | 224 |
| □ If Engine Fails To Start | 211 | □ Shifting Procedure | 225 |
| □ After Starting | 212 | □ Selec-Trac® Operating Information/Precautions — If Equipped | 226 |
| ■ Engine Block Heater — If Equipped | 212 | □ Shift Positions | 229 |
| ■ Transmission Shifting | 213 | | |

208 STARTING AND OPERATING

| | | | |
|--|-----|---|-----|
| □ Shifting Procedure | 230 | □ Tire Identification Number (TIN) | 243 |
| ■ Trac-Lok™ Rear Axle — If Equipped | 231 | □ Tire Loading And Tire Pressure | 244 |
| ■ Parking Brake | 232 | ■ Tires — General Information | 248 |
| ■ Anti-Lock Brake System — If Equipped | 234 | □ Tire Inflation Pressures | 249 |
| ■ On-Road Driving Tips | 236 | □ High Speed Operation | 250 |
| ■ Off-Road Driving Tips | 236 | □ Radial-Ply Tires | 251 |
| □ When To Use 4L Or 4 Lo (Low) Range | 236 | □ Tire Spinning | 251 |
| □ In Snow, Mud And Sand | 237 | □ Tread Wear Indicators | 252 |
| □ Hill Climbing | 237 | □ Replacement Tires | 252 |
| □ Traction Downhill | 238 | □ Alignment And Balance | 253 |
| □ After Driving Off-Road | 238 | ■ Tire Pressure Monitor System — If Equipped | 254 |
| ■ Tire Safety Information | 239 | □ Tire Pressure Monitor System Tire/Wheel Rotation And Sensor Replacement — If Equipped | 256 |
| □ Tire Markings | 239 | | |

| | |
|--|---|
| <ul style="list-style-type: none"> <input type="checkbox"/> Tire Pressure Monitor System/4-Lo Mode — If Equipped256 <input type="checkbox"/> General Information256 ■ Tire Chains257 ■ Tire Rotation Recommendations258 ■ Fuel Requirements259 <ul style="list-style-type: none"> <input type="checkbox"/> Reformulated Gasoline260 <input type="checkbox"/> Gasoline/Oxygenate Blends260 <input type="checkbox"/> MMT In Gasoline261 <input type="checkbox"/> Sulfur In Gasoline261 | <ul style="list-style-type: none"> <input type="checkbox"/> Materials Added To Fuel262 ■ Fuel Tank Filler Cap (Gas Cap)262 ■ Trailer Towing264 <ul style="list-style-type: none"> <input type="checkbox"/> Warranty Requirements264 ■ Recreational Towing (Behind Motorhome, Etc.) . . .267 <ul style="list-style-type: none"> <input type="checkbox"/> Towing – 2WD Models267 <input type="checkbox"/> Towing — 4WD Models267 ■ Snow Plow270 |
|--|---|

STARTING PROCEDURES

Before starting your vehicle, adjust your seat, adjust both inside and outside mirrors, and fasten your seat belts.

WARNING!

Do not leave children or animals inside parked vehicles in hot weather. Interior heat build up may cause serious injury or death.

Manual Transmission

Apply the parking brake, place the gearshift control lever in N (Neutral) and depress the clutch pedal before starting vehicle. This vehicle is equipped with a clutch interlocking ignition system.

4WD Models Only

In 4L mode, this vehicle will start regardless of whether or not the clutch pedal is pressed to the floor. This feature enhances off-road performance by allowing the vehicle to start when in 4L without having to depress the clutch pedal. The 4 LO MODE indicator light will illuminate when the transfer case has been shifted into this mode.

Automatic Transmission

Start the engine with the selector lever in the N (Neutral) or P (Park) position. Apply the brake before shifting to any driving range.

Normal Starting

Normal starting of either a cold or a warm engine is obtained without pumping or depressing the accelerator pedal. Turn the key to the START position and release when the engine starts. If the engine fails to start within 10 seconds, turn the key to the OFF position, wait 5 seconds, then repeat the normal starting procedure.

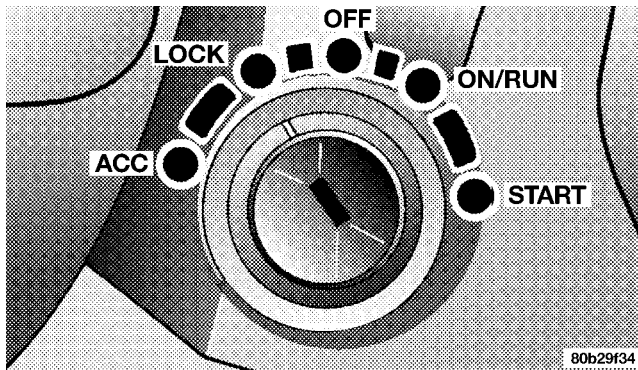
**WARNING!**

Never pour fuel or other flammable liquids into the throttle body air inlet opening in an attempt to start the vehicle. This could result in a flash fire causing serious personal injury.

Extreme Cold Weather

To insure reliable starting at temperatures below -20°F (-29°C), use of an externally powered electric engine block heater (available from your dealer) is recommended.

If Engine Fails to Start

If the engine fails to start after you have followed the "Normal Starting" or "Extreme Cold Weather" procedures, it may be flooded. Push the accelerator pedal all the way to the floor and hold it there while cranking the engine. This should clear any excess fuel in case the engine is flooded.

5

CAUTION!

To prevent damage to the starter, do not crank the engine for more than 15 seconds at a time. Wait 10 to 15 seconds before trying again.

If the engine has been flooded, it may start to run, but not have enough power to continue running when the key is released. If this occurs, continue cranking with the accelerator pedal pushed all the way to the floor. Release the accelerator pedal and the key once the engine is running smoothly.

If the engine shows no sign of starting after two 15 second periods of cranking with the accelerator pedal held to the floor, the “Normal Starting” or “Extreme Cold Weather” procedures should be repeated.

WARNING!

Never pour fuel or other flammable liquids into the throttle body air inlet opening in an attempt to start the vehicle. This could result in a flash fire causing serious personal injury.

After Starting

The idle speed will automatically decrease as the engine warms up.

CAUTION!

Long periods of engine idling, especially at high engine speeds can cause excessive exhaust temperatures which can damage your vehicle. Do not leave your vehicle unattended with the engine running.

ENGINE BLOCK HEATER — IF EQUIPPED

The engine block heater warms engine coolant and permits quicker starts in cold weather. Connect the cord to a standard 110-115 volt AC electrical outlet with a grounded, three wire extension cord. The engine block heater cord is found under the hood clipped to the heater line on the left side of the engine (3.7L only).

WARNING!

Remember to disconnect the cord before driving. Damage to the 110-115 volt AC electrical cord could cause electrocution.

Use the heater when temperatures below 0°F (-18°C) are expected to last for several days.

TRANSMISSION SHIFTING**5-Speed Manual Overdrive Transmission**

Follow the shift pattern on the gearshift knob.

NOTE: The backup lights will come on when your vehicle is in R (Reverse) gear and the ignition is in the ON position.

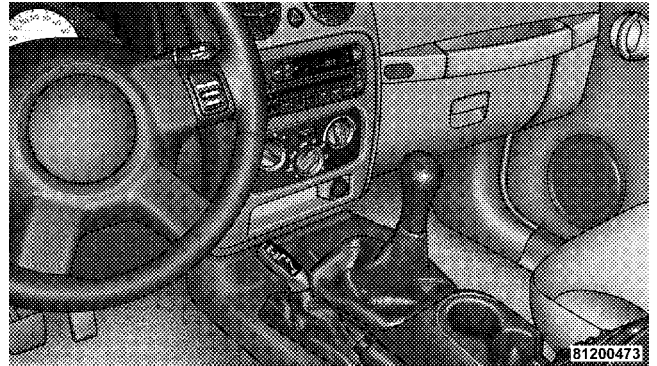
**WARNING!**

When parking your vehicle, always leave a manual transmission in first gear and apply the parking brake fully to guard against vehicle movement and possible injury or damage. Never use any gear as a substitute for the parking brake.

CAUTION!

To drive as safely as possible and to prolong the life of your manual transmission, follow these tips:

- Before shifting from a forward gear into reverse, or from reverse to a forward gear, stop vehicle completely. Otherwise, accelerated transmission wear may result.
- Do not operate at sustained high engine or road speeds in lower gears. Engine damage may result.
- Do not downshift into a low gear while traveling at too high a speed for that gear. Engine, clutch, or transmission damage may result.
- Do not rest your foot on the clutch pedal. This causes heat buildup and damages the clutch.
- When you slow down or go up a grade, downshift as speed requires or the engine may overheat.
- Never hold the vehicle stopped on a hill by using the clutch pedal. The clutch may be damaged.
- During cold weather, you may experience increased effort in shifting until the transmission fluid warms up. This is normal.
- Push in the clutch pedal completely when shifting. Otherwise, transmission or clutch damage may result.
- When “rocking” a stuck vehicle by shifting between a forward gear and reverse, do not spin wheels faster than 15 mph (24 km/h), or drivetrain damage may result.

- The manual transmission may be equipped with a “Reverse Blocker” to prevent inadvertent shifts from 5th gear to Reverse. If you experience difficulty shifting into “Reverse”, make sure that you are not inadvertently moving the shift lever toward 5th gear when shifting into “Reverse.”

Recommended Manual Transmission Shifting Speeds

The manufacturer recommends that you use the shift speeds listed in the chart below.

| Manual Transmission Shift Speeds in MPH (KM/H) | | | | | |
|--|--------|---------|---------|---------|---------|
| Engine | Speeds | 1 to 2 | 2 to 3 | 3 to 4 | 4 to 5 |
| 2.4L | Accel. | 15 (24) | 25 (40) | 40 (64) | 45 (72) |
| | Cruise | 15 (24) | 25 (40) | 40 (64) | 45 (72) |
| 3.7L | Accel. | 15 (24) | 25 (40) | 40 (64) | 45 (72) |
| | Cruise | 15 (24) | 25 (40) | 40 (64) | 45 (72) |

Clutch Interlocking Ignition System

2WD Models Only — Manual transmission vehicles are equipped with a clutch interlock safety feature. The clutch pedal must be fully depressed to allow cranking of the engine.

4WD Models Only — The exception to this clutch interlock is 4WD models equipped with a manual transmission. For these models, the clutch interlock feature is overridden when the vehicle is operated in 4L to enhance off-road capability. Refer to “Starting Procedures — Manual Transmission (4WD Models Only)” in this section.

Automatic Transmission

Shifting from D (Drive) to P (Park) or R (Reverse) (or from P or R to D) should be done only after the accelerator pedal is released and the vehicle is stopped. Be sure to keep your foot on the brake when moving the shift lever between these gears.

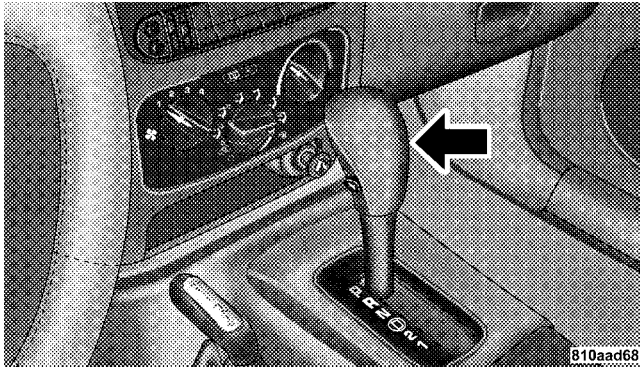

WARNING!

It is dangerous to shift the selector lever out of “P” or “N” if the engine speed is higher than idle speed. If your foot is not firmly on the brake pedal, the vehicle could accelerate quickly forward or in reverse. You could lose control of the vehicle and hit someone or something. Only shift into gear when the engine is idling normally and when your right foot is firmly on the brake pedal.

Brake Transmission Shift Interlock System

This vehicle is equipped with a brake transmission shift interlock system (BTSI) that holds the gearshift lever in the P (Park) position when the ignition switch is in the OFF position. To move the gear selector lever out of the P (Park) position, the ignition switch must be turned to the ON position, the brake pedal and the button on the front of the shifter handle must be depressed.

Gear Ranges

P (Park)

Supplements the parking brake by locking the transmission. The engine can be started in this range. Never use P (Park) while the vehicle is in motion. Apply the parking brake when leaving the vehicle in this range. Always apply the parking brake first, and then place the selector in P (Park) position.

WARNING!

Unintended movement of a vehicle could injure those in and near the vehicle. As with all vehicles, you should never exit a vehicle while the engine is running. Before exiting a vehicle, you should always shift the vehicle into P (Park), remove the key from the ignition, and apply the parking brake. Once the key is removed from the ignition, the transmission shift lever is locked in the P (Park) position, securing the vehicle against unwanted movement. Furthermore, you should never leave children unattended inside a vehicle.

5

The following indicators should be used to ensure that you have engaged the transmission shift lever into the P (Park) position:

- When shifting into P (Park), depress the button on the shift lever and firmly move the lever all the way forward until it stops.
- Look at the shift indicator window on the console to ensure it is in the P (Park) position.
- When engaged in P (Park), you will not be able to move the shifter rearward without depressing the shift lever button.

CAUTION!

Before moving the shift lever out of P (Park), you must turn the ignition from LOCK to ON so the steering wheel and shift lever are released. Otherwise, damage to the steering column or shifter could result.

R (Reverse)

For moving the vehicle rearward. Always stop before moving the lever to R (Reverse), except when rocking the vehicle.

N (Neutral)

Engine may be started in this position.

WARNING!

Do not coast in N (Neutral) and never turn off the ignition to coast down a hill. These are unsafe practices that limit your response to changing traffic or road conditions. You might lose control of the vehicle.

Overdrive (O/D)

For most city and highway driving. The transmission contains an electronically controlled Overdrive, and will automatically shift from D (Drive) to O/D (Overdrive) if the following conditions are present:

- The transmission selector is in D (Drive).
- The O/D OFF switch has not been activated.
- Vehicle speed is above approximately 30 mph (48 km/h).
- Transmission has reached normal operating temperature.

When frequent transmission shifting occurs while using Overdrive, such as when operating the vehicle under heavy load conditions (for example, in hilly terrain, strong head winds, or trailer towing), turning off overdrive will improve performance and extend transmission life by reducing excessive shifting and heat buildup.

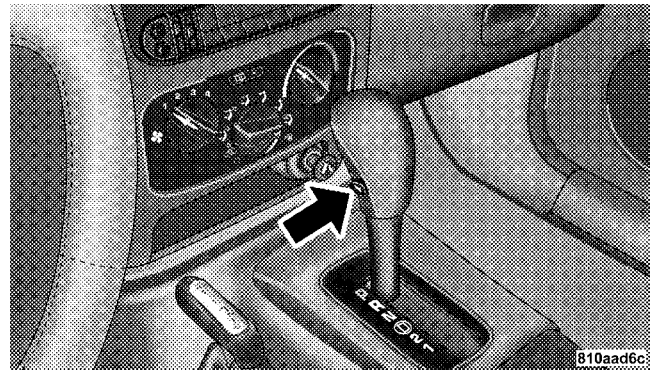

Overdrive can be locked out by pressing the O/D OFF switch located on side of the gearshift lever. The O/D OFF indicator light will illuminate to show that the switch has been activated. When the indicator light is on, Overdrive is locked out. Pressing the switch a second time restores the Overdrive function. The lockout feature is useful when towing a trailer or carrying a heavy load.

NOTE: If the vehicle is started in cold outside temperatures, shifts into Overdrive may be delayed. Normal Overdrive and shifting operation will resume when the temperature of the transmission reaches the appropriate temperature. Refer to the “Note” under “Torque Converter Clutch” later in this section.

If the transmission temperature gets too hot, the transmission may downshift out of Overdrive or engage overdrive at higher vehicle speeds until the transmission cools down. After cooldown, Overdrive will resume normal operation.

2 (Second)

For moderate grades and to assist braking on dry pavement or in mud and snow. Begins at a stop in low gear with automatic upshift to 2nd gear. Will not shift to 3rd.

1 (First)

For hard pulling at low speeds in mud, sand, snow, or on steep grades. Begins and stays in low gear with no upshift. Provides engine compression braking at low speeds.

CAUTION!

- **Never race the engine with the brakes on and the vehicle in gear, and never hold the vehicle on an incline without applying the brakes. These practices can cause overheating and damage to the transmission.**
- **When “rocking” a stuck vehicle by moving between “First” and R (Reverse), do not spin the wheels faster than 15 mph (24 km/h), or drivetrain damage may result.**

Over Temperature Mode

The transmission electronics constantly monitor the transmission oil temperature. If the transmission gets too hot, the transmission will change the way it shifts to help control the condition. This may result in a slightly different feeling or response during normal operation in D (Drive) position. If the transmission becomes hot enough the TRANS TEMP warning light in the instrument cluster will come on. After the transmission cools down, it will return to normal operation.

Torque Converter Clutch

A feature designed to improve fuel economy has been added to the automatic transmission of this vehicle. A clutch within the torque converter engages automatically at calibrated speeds. This may result in a slightly different feeling or response during normal operation in high gear. When the vehicle speed drops or during acceleration, the clutch automatically and smoothly disengages.

NOTE:

- The torque converter clutch will not engage until the transmission fluid and engine coolant is warm (usually after 1–3 miles (1.6–4.8 km) of driving). Because engine speed is higher when the torque converter clutch is not engaged, it may seem as if the transmission is not shifting into “Overdrive” when cold. This is considered a normal condition. Pressing the “O/D OFF” switch will show that the transmission is able to shift into and out of “Overdrive.”
- If the vehicle has not been driven for several days, the first few seconds of operation after shifting the transmission into gear may seem sluggish. This is due to the transmission fluid partially draining from the torque converter into the transmission. This is considered a normal condition and will not cause damage to the transmission. The torque converter will refill within 5 seconds of shifting from P (Park) into any other gear position.

FOUR-WHEEL DRIVE OPERATION

Command-Trac® Operating Information/Precautions

The Command-Trac® transfer case provides 4 mode positions - 2 (rear) wheel drive high range, 4-wheel drive high range, neutral, and 4-wheel drive low range.

This transfer case is intended to be driven in the 2-wheel drive position (2H) for normal street and highway conditions such as dry hard surfaced roads.

When additional traction is required the transfer case 4H and 4L positions can be used to lock the front and rear driveshafts together and force the front and rear wheels to rotate at the same speed. This is accomplished by simply moving the shift lever to these positions. The 4H and 4L positions are intended for loose, slippery road surfaces only. Driving in the 4H and 4L positions on dry hard surfaced roads may cause increased tire wear and damage to the driveline components.

The PART TIME indicator light, located in the instrument cluster, illuminates when the transfer case is shifted to the 4H position.

The 4 LO MODE indicator light, located in the instrument cluster, illuminates when the transfer case is shifted to the 4L position. There is no light for the 2H or N (Neutral) positions.

CAUTION!

- Do not attempt to make a shift while only the front or rear wheels are spinning. The Command-Trac transfer case is not equipped with a synchronizer and therefore the front and rear driveshaft speeds must be equal for the shift to take place. Shifting while only the front or rear wheels are spinning can cause damage to the transfer case.
- When operating your vehicle in 4L, the engine speed is approximately three times that of the 2H or 4H positions at a given road speed. Take care not to overspeed the engine and do not exceed 25 mph (40 km/h).

Proper operation of 4-wheel drive vehicles depends on tires of equal size, type and circumference on each wheel. Any difference will adversely affect shifting and can cause damage to the transfer case.

WARNING!

- Because 4-wheel drive provides improved traction, there is a tendency to exceed safe turning and stopping speeds. Do not go faster than road conditions permit.
- You or others could be injured if you leave the vehicle unattended with the transfer case in the Neutral (N) position without first fully engaging the parking brake. The transfer case Neutral (N) position disengages both the front and rear driveshafts from the powertrain and will allow the vehicle to move despite the transmission position. The parking brake should always be applied when the driver is not in the vehicle.

Shift Positions

For additional information on the appropriate use of each transfer case mode position see the information below:

2H

Rear Wheel Drive High Range - Normal street and highway driving. Dry hard surfaced roads.

4H

4-Wheel-Drive High Range - Locks the front and rear driveshafts together. Forces the front and rear wheels to rotate at the same speed. Additional traction for loose, slippery road surfaces only.

N

Neutral - Disengages both the front and rear driveshafts from the powertrain. To be used for flat towing behind another vehicle. Refer to "Recreational Towing" in Section 5 for more information.

4L

4-Wheel-Drive Low Range - Low speed 4 wheel drive. Locks the front and rear driveshafts together. Forces the front and rear wheels to rotate at the same speed. Additional traction and maximum pulling power for loose, slippery road surfaces only. Do not exceed 25 mph (40 km/h). (Allows engine starting without depressing the clutch pedal on vehicles equipped with manual transmission. Refer to "Starting Procedures — Manual Transmission (4WD Models Only)" in this section.

Shifting Procedure**2H to 4H or 4H to 2H**

Shifting between 2H and 4H can be made with the vehicle in motion up to 55 mph (88 km/h). The transfer case will engage/disengage faster if you momentarily release the accelerator pedal after completing the shift. Apply a constant force when shifting the transfer case lever.

4H to 4L or 4L to 4H

With the vehicle rolling at 2 to 3 mph (3 to 5 km/h), shift an automatic transmission to N (Neutral) or depress the clutch on a manual transmission. While the vehicle is coasting at 2 to 3 mph (3 to 5 km/h), shift the transfer case lever firmly to the desired position. Do not pause in transfer case N (Neutral).

NOTE: To shift from 4H to 4L, the shift lever should be pushed away from the driver, and then rearward into 4L. In 4H, there is a neutral stop to prevent shifting into N (Neutral) by accident.

NOTE: Pausing in transfer case N (Neutral) in vehicles equipped with an automatic transmission may require shutting the engine OFF to avoid gear clash while completing the shift. If difficulty occurs, shift automatic transmission to N (Neutral), hold foot on brake, and turn engine OFF. Make shift to the desired mode.

NOTE: Shifting into or out of 4L is possible with the vehicle completely stopped, however difficulty may occur due to the mating clutch teeth not being properly aligned. Several attempts may be required for clutch teeth alignment and shift completion to occur. The preferred method is with the vehicle rolling 2 to 3 mph (3 to 5 km/h). Avoid attempting to engage or disengage 4L with the vehicle moving faster than 2 to 3 mph (3 to 5 km/h).

Selec-Trac® Operating Information/Precautions — If Equipped

The Selec-Trac® transfer case provides 5 mode positions - normal 2-wheel drive mode, part-time 4-wheel drive high range, full-time 4-wheel drive high range, neutral, and 4-wheel drive low range.

This transfer case is equipped with an inter-axle differential which allows driving the vehicle in the 4 FULL TIME position at all times on any given road surface

including dry hard surfaced roads. The 4 FULL TIME mode allows the front and rear wheels to rotate at different speeds which eliminates driveline binding and component wear that is normally associated with driving the vehicle in the 4 PART TIME position on dry hard surfaced roads. This feature provides the safety, security, and convenience of operating in 4-wheel drive at all times regardless of road conditions.

When additional traction is required the 4 PART TIME and 4LO positions can be used to lock the front and rear driveshafts together through the transfer case inter-axle differential and force the front and rear driveshafts to rotate at the same speed. This is accomplished by simply moving the shift lever to these positions. The 4 PART TIME and 4LO positions are intended for loose, slippery road surfaces only. Driving in the 4 PART TIME and 4LO positions on dry hard surfaced roads may cause increased tire wear and damage to driveline components.

The PART TIME indicator light, located on the instrument cluster, illuminates when the transfer case is shifted to the 4 PART TIME position.

The FULL TIME indicator light, located on the instrument cluster, illuminates when the transfer case is shifted to the 4 FULL TIME position.

The 4LO MODE indicator light, located on the instrument cluster, illuminates when the transfer case is shifted to the 4LO position. There is no light for the 2WD, or N (Neutral) positions.

CAUTION!

- Do not attempt to make a shift while only the front or rear wheels are spinning. The Selec-Trac transfer case is not equipped with a synchronizer and therefore the front and rear driveshaft speeds must be equal for the shift to take place. Shifting while only the front or rear wheels are spinning can cause damage to the transfer case.
- When operating your vehicle in 4LO, the engine speed is approximately three times that of the 2WD, 4 PART TIME, or 4 FULL TIME positions at a given road speed. Take care not to overspeed the engine and do not exceed 25 mph (40 km/h).

Proper operation of 4-wheel drive vehicles depends on tires of equal size, type, and circumference on each wheel. Any difference will adversely affect shifting and can cause damage to the transfer case.

WARNING!

- **Because 4-wheel drive provides improved traction, there is a tendency to exceed safe turning and stopping speeds. Do not go faster than road conditions permit.**
- **You or others could be injured if you leave the vehicle unattended with the transfer case in the Neutral (N) position without first fully engaging the parking brake. The transfer case Neutral (N) position disengages both the front and rear drive-shafts from the powertrain and will allow the vehicle to move regardless of the transmission position. The parking brake should always be applied when the driver is not in the vehicle.**

Shift Positions

For additional information on the appropriate use of each transfer case mode position see the information below:

2WD

Rear Wheel Drive High Range - Normal street and highway driving. Dry hard surfaced roads.

4 PART TIME

Part Time 4-Wheel Drive High Range - Locks the transfer case inter-axle differential. Forces the front and rear wheels to rotate at the same speed. Additional traction for loose, slippery road surfaces only.

4 FULL TIME

Full Time 4-Wheel Drive High Range - Employs an inter-axle differential. This allows front and rear wheels to rotate at different speeds, on all road surfaces.

N

Neutral - Disengages both the front and rear driveshafts from the powertrain. To be used for flat towing behind another vehicle. Refer to "Recreational Towing" in Section 5 for more information.

4LO

Part Time 4-Wheel Drive Low Range - Low speed 4-wheel drive. Locks the transfer case inter-axle differential. Forces the front and rear wheels to rotate at the same speed. Additional traction and maximum pulling power for loose, slippery road surfaces only. Do not exceed 25 mph (40 km/h).

Shifting Procedure

2WD to 4 PART TIME or 4 PART TIME to 2WD

Shifting between 2WD and 4 PART TIME can be made with the vehicle stopped or in motion. If the vehicle is in motion, shifts can be made up to 55 mph (88 km/h). With the vehicle in motion two momentary releases of the accelerator pedal may be required after shifting. This will induce a torque interrupt and allow full engagement of the newly selected position. With the vehicle stationary it may be necessary to shift the automatic transmission from D (Drive) to R (Reverse) and back to D (Drive) after shifting. This will allow full engagement of the newly selected position. Apply a constant force when shifting the transfer case lever.

4 PART TIME to 4 FULL TIME or 4 FULL TIME to 4 PART TIME

Shifting between 4 PART TIME and 4 FULL TIME can be made with the vehicle stopped or in motion. If the vehicle

is in motion shifts can be made up to 55 mph (88 km/h). With the vehicle in motion two momentary releases of the accelerator pedal may be required after shifting. This will induce a torque interrupt and allow full engagement of the newly selected position. With the vehicle stationary it may be necessary to shift the automatic transmission from D (Drive) to R (Reverse) and back to D (Drive) after shifting. This will allow full engagement of the newly selected position. Apply a constant force when shifting the transfer case lever.

4 FULL TIME to 4 LO or 4 LO to 4 FULL TIME

With the vehicle rolling at 2 to 3 mph (3 to 5 km/h), shift an automatic transmission to N (Neutral). While the vehicle is coasting at 2 to 3 mph (3 to 5 km/h), shift the transfer case lever firmly to the desired position. Do not pause in transfer case N (Neutral).

NOTE: To shift from 4 FULL TIME to 4LO, the shift lever should be pushed away from the driver, and then

rearward into 4LO. In 4 FULL TIME, there is a neutral stop to prevent shifting into N (Neutral) by accident.

NOTE: Pausing in transfer case N (Neutral) in vehicles equipped with an automatic transmission may require shutting the engine OFF to avoid gear clash while completing the shift. If difficulty occurs, shift transmission to N (Neutral), hold foot on brake, and turn engine OFF. Make shift to desired mode.

NOTE: Shifting into or out of 4LO is possible with the vehicle completely stopped, however difficulty may occur due to the mating clutch teeth not being properly aligned. Several attempts may be required for clutch teeth alignment and shift completion to occur. The preferred method is with the vehicle rolling 2 to 3 mph (3 to 5 km/h). Avoid attempting to engage or disengage 4LO with the vehicle moving faster than 2 to 3 mph (3 to 5 km/h).

TRAC-LOK™ REAR AXLE — IF EQUIPPED

The optional Trac-Lok™ rear axle provides a constant driving force to both rear wheels and reduces wheel spin caused by the loss of traction at one driving wheel. If traction differs between the two rear wheels, the differential automatically proportions the usable torque by providing more torque to the wheel that has traction.

Trac-Lok™ is especially helpful during slippery driving conditions. With both rear wheels on a slippery surface, a slight application of the accelerator will supply maximum traction. When starting with only one rear wheel on an excessively slippery surface, slight application of the parking brake may be necessary to gain maximum traction.

WARNING!

On vehicles equipped with a limited-slip differential, never run the engine with one rear wheel off the ground. The vehicle may drive through the rear wheel remaining on the ground and cause you to lose control of your vehicle.

PARKING BRAKE

To set the parking brake, pull the lever up as firmly as possible. When the parking brake is applied with the ignition ON, the “Brake Warning Light” in the instrument cluster will light.

NOTE: The instrument cluster “Brake Warning Light” indicates only that the parking brake is applied. You must be sure the parking brake is fully applied before leaving the vehicle.

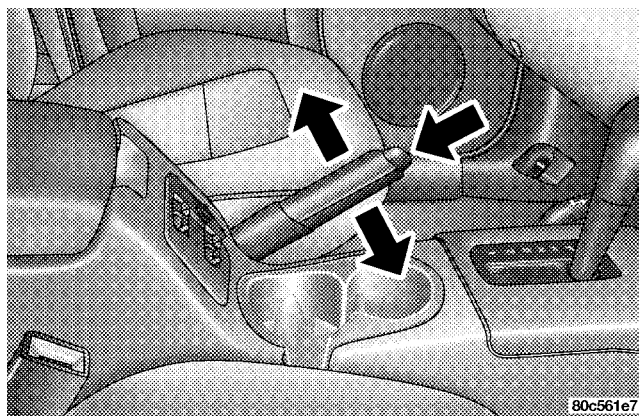

To release the parking brake, pull up slightly, press the center button, then lower the lever completely.

Before leaving the vehicle parked on a hill, you must make sure the parking brake is fully applied and place the gear selector in the P (Park) position. Make certain the transfer case is in gear. Failure to do so may cause the vehicle to roll and cause damage or injury.

When parking on a hill, it is important to set the parking brake before placing the gear selector in P (Park), otherwise the load on the transmission locking mechanism may make it difficult to move the selector out of P (Park).

WARNING!

- **Leaving children unattended in a vehicle is dangerous for a number of reasons. A child or others could be injured. Children should be warned not to touch the parking brake or the gear selector lever. Don't leave the keys in the ignition. A child could operate power windows, other controls, or move the vehicle.**
- **Do not leave children or animals inside parked vehicles in hot weather. Interior heat build up may cause serious injury or death.**

5

Be sure the parking brake is fully disengaged before driving. Failure to do so can lead to brake failure.

NOTE: Parking brake adjustment and maintenance should be performed by your authorized dealer.

ANTI-LOCK BRAKE SYSTEM — IF EQUIPPED

The Anti-Lock Brake System is designed to aid the driver in maintaining vehicle control under adverse braking conditions. The system operates with a separate computer to modulate hydraulic pressure to prevent wheel lock-up and help avoid skidding on slippery surfaces.

All vehicle wheels and tires must be the same size and type and tires must be properly inflated to produce accurate signals for the computer.

WARNING!

Significant over or under-inflation of tires, or mixing sizes of tires or wheels on the vehicle can lead to loss of braking effectiveness.

The Anti-Lock Brake System conducts a low speed self-test at about 12 mph (20 km/h). If for any reason, your foot is on the brake when the vehicle reaches 12 mph (20 km/h), this check will be delayed until 25 mph (40 km/h).

The Anti-Lock Brake System pump motor runs during the self-test and during an ABS stop to provide the regulated hydraulic pressure. The motor pump makes a low humming noise during operation, this is normal.

During off-road use, loss of traction can temporarily defeat the system and cause the warning light to illuminate. Turn the ignition OFF and ON again to restore Anti-Lock Brake System function.

WARNING!

Pumping of the Anti-Lock Brakes will diminish their effectiveness and may lead to an accident. Pumping makes the stopping distance longer. Just press firmly on your brake pedal when you need to slow down or stop.

WARNING!

- **Anti-lock system (ABS) cannot prevent the natural laws of physics from acting on the vehicle, nor can it increase braking or steering efficiency beyond that afforded by the condition of the vehicle brakes and tires or the traction afforded.**
- **The ABS cannot prevent accidents, including those resulting from excessive speed in turns, following another vehicle too closely, or hydroplaning. Only a safe, attentive, and skillful driver can prevent accidents.**
- **The capabilities of an ABS equipped vehicle must never be exploited in a reckless or dangerous manner which could jeopardize the user's safety or the safety of others.**

CAUTION!

The Anti-Lock Brake System is subject to possible detrimental effects of electronic interference caused by improperly installed aftermarket radios or telephones.

NOTE: During severe braking conditions, a pulsing sensation may occur and a clicking noise will be heard. This is normal, indicating that the Anti-Lock Brake System is functioning.

ON-ROAD DRIVING TIPS

Utility vehicles have higher ground clearance and a narrower track to make them capable of performing in a wide variety of off-road applications. Specific design characteristics give them a higher center of gravity than ordinary cars.

An advantage of the higher ground clearance is a better view of the road, allowing you to anticipate problems. They are not designed for cornering at the same speeds as conventional 2-wheel drive vehicles any more than low-slung sports cars are designed to perform satisfactorily in off-road conditions. If at all possible, avoid sharp turns or abrupt maneuvers. As with other vehicles of this type, failure to operate this vehicle correctly may result in loss of control or vehicle rollover.

OFF-ROAD DRIVING TIPS**When To Use 4L or 4 LO (Low) Range**

When driving off-road, shift to 4L or 4 LO for additional traction in moving forward or descending a hill, for low-speed pulling power or to improve handling and control on slippery or difficult terrain. Also use 4L or 4 LO range on the road in rain, ice, snow, mud or sand to get heavy loads rolling, or whenever "High" range four-wheel drive traction is insufficient.

In Snow, Mud and Sand

In heavy snow, when pulling a load, or for additional control at slower speeds, shift the transmission to a low gear and shift the transfer case to 4L or 4 LO if necessary. Don't shift to a lower gear than necessary to maintain headway. Over-revving the engine can spin the wheels and traction will be lost.

Do not downshift on icy or slippery roads, because engine braking may cause skidding and loss of control.

Hill Climbing

Before climbing a steep hill, shift the transmission to a lower gear and shift the transfer case to 4L or 4 LO. Use first gear and 4L or 4 LO for very steep hills.

If you stall or begin to lose headway while climbing a steep hill, allow your vehicle to come to a stop and immediately apply the brakes. Restart the engine and shift to R (Reverse). Back slowly down the hill allowing the compression braking of the engine and transmission to help regulate your speed. If the brakes are required to control vehicle speed, apply them lightly and avoid locking or skidding the tires.

WARNING!

If the engine stalls or you lose headway or cannot make it to the top of a steep hill or grade, never attempt to turn around. To do so may result in tipping and rolling the vehicle. Always back carefully straight down a hill in R (Reverse) gear. Never back down a hill in N (Neutral) using only the brake.

Remember, never drive diagonally across a hill—always drive straight up or down.

If the wheels start to slip as you approach the crest of a hill, ease off the accelerator and maintain headway by turning the front wheels sharply left and right. This will provide fresh “bite” into the surface and will usually provide traction to complete the climb.

Traction Downhill

Shift the transmission into a low gear and the transfer case to 4L or 4 LO range. Let the vehicle go slowly down the hill with all four wheels turning against engine compression drag. This will permit you to control the vehicle speed and direction.

When descending mountains or hills, repeated braking can cause brake fade with loss of braking control. Avoid repeated heavy braking by downshifting the transmission whenever possible.

After Driving Off-Road

Off-road operation puts more stress on your vehicle than does most on-highway driving. After going off-road it is always a good idea to check for damage. That way you can get any problems taken care of right away and have your vehicle ready when you need it.

- Completely inspect the underbody of your vehicle. Check tires, body structure, steering, suspension, and exhaust system for damage.
- Check threaded fasteners for looseness, particularly on the chassis, drivetrain components, steering, and suspension. Retighten them, if required, and torque to the values specified in the Service Manual.
- Check for accumulations of plants or brush. These things could be a fire hazard. They might hide damage to fuel lines, brake hoses, axle pinion seals, and propeller shafts.

- After extended operation in mud, sand, water, or similar dirty conditions, have brake rotors, wheels, brake linings, and axle yokes inspected and cleaned as soon as possible.

| WARNING! |
|--|
| <p>Abrasive material in any part of the brakes may cause excessive wear or unpredictable braking. You might not have full braking power when you need it to prevent an accident. If you have been operating your vehicle in dirty conditions, get your brakes checked and cleaned as necessary.</p> |

- If you experience unusual vibration after driving in mud, slush or similar conditions, check the wheels for impacted material. Impacted material can cause a wheel imbalance and freeing the wheels of it will correct the situation.

TIRE SAFETY INFORMATION

Tire Markings

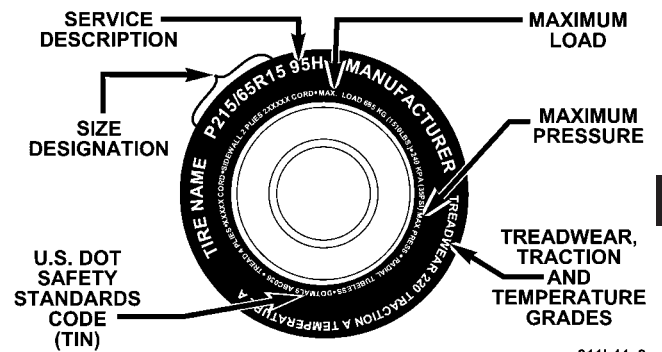

NOTE:

- P(Passenger)-Metric tire sizing is based on U.S. design standards. P-Metric tires have the letter "P" molded into the sidewall preceding the size designation. Example: P215/65R15 95H.

811b44e8

- European Metric tire sizing is based on European design standards. Tires designed to this standard have the tire size molded into the sidewall beginning with the section width. The letter "P" is absent from this tire size designation. Example: 215/65R15 96H
- LT(Light Truck)-Metric tire sizing is based on U.S. design standards. The size designation for LT-Metric tires is the same as for P-Metric tires except for the letters "LT" that are molded into the sidewall preceding the size designation. Example: LT235/85R16.
- Temporary Spare tires are high pressure compact spares designed for temporary emergency use only. Tires designed to this standard have the letter "T" molded into the sidewall preceding the size designation. Example: T145/80D18 103M.
- High Flotation tire sizing is based on U.S. design standards and begins with the tire diameter molded into the sidewall. Example: 31x10.5 R15 LT.

Tire Sizing Chart

| EXAMPLE: | |
|--|--|
| Size Designation: | |
| P = Passenger car tire size based on U.S. design standards | |
| "...blank..." = Passenger car tire based on European design standards | |
| LT = Light Truck tire based on U.S. design standards | |
| T = Temporary Spare tire | |
| 31 = Overall Diameter in Inches (in) | |
| 215 = Section Width in Millimeters (mm) | |
| 65 = Aspect Ratio in Percent (%) | |
| —Ratio of section height to section width of tire. | |
| 10.5 = Section Width in Inches (in) | |
| R = Construction Code | |
| —"R" means Radial Construction. | |
| —"D" means Diagonal or Bias Construction. | |
| 15 = Rim Diameter in Inches (in) | |

| EXAMPLE: | |
|--|--|
| Service Description: | |
| 95 = Load Index | —A numerical code associated with the maximum load a tire can carry. |
| H = Speed Symbol | —A symbol indicating the range of speeds at which a tire can carry a load corresponding to its load index under certain operating conditions. —The maximum speed corresponding to the Speed Symbol should only be achieved under specified operating conditions. (ie. tire pressure, vehicle loading, road conditions and posted speed limits). |
| Load Identification: | |
| "...blank..." | = Absence of any text on sidewall of the tire indicates a Standard Load (SL) Tire |
| Extra Load (XL) | = Extra Load (or Reinforced) Tire |
| Light Load | = Light Load Tire |
| C,D,E | = Load range associated with the maximum load a tire can carry at a specified pressure |
| Maximum Load — Maximum Load indicates the maximum load this tire is designed to carry. | |
| Maximum Pressure — Maximum Pressure indicates the maximum permissible cold tire inflation pressure for this tire. | |

Tire Identification Number (TIN)

The TIN may be found on one or both sides of the tire however the date code may only be on one side. Tires with white sidewalls will have the full TIN including date code located on the white sidewall side of the tire.

Look for the TIN on the outboard side of black sidewall tires as mounted on the vehicle. If the TIN is not found on the outboard side then you will find it on the inboard side of the tire.

| | |
|----------------------------|--|
| EXAMPLE: | |
| DOT MA L9 ABCD 0301 | |
| DOT | = Department of Transportation —This symbol certifies that the tire is in compliance with the U.S. Department of Transportation tire safety standards, and is approved for highway use. |
| MA | = Code representing the tire manufacturing location.(2 digits) |
| L9 | = Code representing the tire size.(2 digits) |
| ABCD | = Code used by tire manufacturer.(1 to 4 digits) |
| 03 | = Number representing the week in which the tire was manufactured.(2 digits) —03 means the 3rd week. |
| 01 | = Number representing the year in which the tire was manufactured.(2 digits) —01 means the year 2001. —Prior to July 2000, tire manufacturers were only required to have 1 number to represent the year in which the tire was manufactured. Example: 031 could represent the 3rd week of 1981 or 1991. |

Tire Loading and Tire Pressure

Tire Placard Location

NOTE: Some vehicles have a “Tire and Loading Information” placard located on the driver’s side “B” pillar.

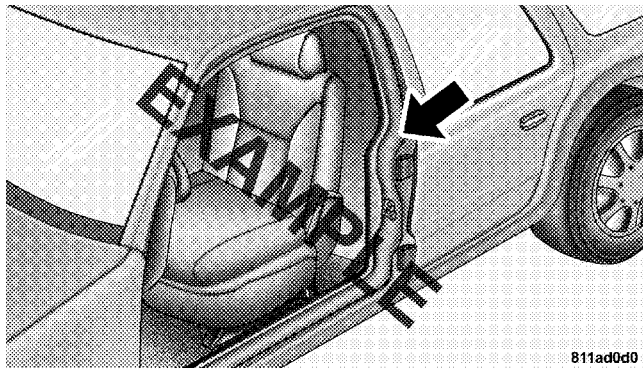

Tire and Loading Information Placard

| TIRE AND LOADING INFORMATION | | | |
|---|---------------|---------------|---------------|
| SEATING CAPACITY - TOTAL 5 FRONT 2 REAR 3 | | | |
| THE COMBINED WEIGHT OF OCCUPANTS AND CARGO SHOULD NEVER EXCEED XXX KG OR XXX LBS. | | | |
| TIRE | FRONT | REAR | SPARE |
| ORIGINAL TIRE SIZE | P195/70R14 | P195/70R14 | T125/70D15 |
| COLD TIRE INFLATION PRESSURE | 200kPa, 29PSI | 200kPa, 29PSI | 420kPa, 60PSI |
| SEE OWNER'S MANUAL FOR ADDITIONAL INFORMATION | | | 4N109268 |

811b5a9a

This placard tells you important information about the,

- 1) number of people that can be carried in the vehicle
- 2) the total weight your vehicle can carry
- 3) the tire size designed for your vehicle

4) the cold tire inflation pressures for the front, rear and spare tires.

Loading

The vehicle maximum load on the tire must not exceed the load carrying capacity of the tire on your vehicle. You will not exceed the tire's load carrying capacity if you adhere to the loading conditions, tire size and cold tire inflation pressures specified on the Tire and Loading Information placard and the Vehicle Loading section of this manual.

NOTE: Under a maximum loaded vehicle condition, gross axle weight ratings (GAWR's) for the front and rear axles must not be exceeded. For further information on GAWR's, vehicle loading and trailer towing, see the Vehicle Loading section of this manual.

To determine the maximum loading conditions of your vehicle, locate the statement "The combined weight of occupants and cargo should never exceed XXX kg or XXX lbs." on the Tire and Loading Information placard. The combined weight of occupants, cargo/luggage and trailer tongue weight (if applicable) should never exceed the weight referenced here.

Steps for Determining Correct Load Limit

1. Locate the statement "The combined weight of occupants and cargo should never exceed XXX pounds" on your vehicle's placard.
2. Determine the combined weight of the driver and passengers that will be riding in your vehicle.

3. Subtract the combined weight of the driver and passengers from XXX kilograms or XXX pounds.
4. The resulting figure equals the available amount of cargo and luggage load capacity. For example, if “XXX” amount equals 1400 lbs. and there will be five 150 lb. passengers in your vehicle, the amount of available cargo and luggage load capacity is 650 lb. (1400–750 (5 x 150) = 650 lb.)
5. Determine the combined weight of luggage and cargo being loaded on the vehicle. That weight may not safely exceed the available cargo and luggage load capacity calculated in step 4.

6. If your vehicle will be towing a trailer, load from your trailer will be transferred to your vehicle. Consult this manual to determine how this reduces the available cargo and luggage load capacity of your vehicle.

NOTE: The following table shows examples on how to calculate total load, cargo/luggage and towing capacities of your vehicle with varying seating configurations and number and size of occupants. This table is for illustration purposes only and may not be accurate for the seating and load carry capacity of your vehicle.

NOTE: For the following example the combined weight of occupants and cargo should never exceed 865 lbs. (392 Kg).

| Occupants | | | Combined weight of occupants and cargo from Tire Placard | MINUS | Combined Occupant's weight | = | AVAILABLE Cargo/Luggage and Trailer Tongue Weight |
|------------------|-------|------|--|-------|----------------------------|---|---|
| TOTAL | FRONT | REAR | | | | | |
| EXAMPLE 1 | | | 865 lbs | minus | 670 lbs | = | 195 lbs |
| 5 | 2 | 3 | | | | | |
| EXAMPLE 2 | | | 865 lbs | minus | 540 lbs | = | 325 lbs |
| 3 | 2 | 1 | | | | | |
| EXAMPLE 3 | | | 865 lbs | minus | 400 lbs | = | 465 lbs |
| 2 | 2 | 0 | | | | | |

EXAMPLE

5

811a4d11

WARNING!

Overloading of your tire is dangerous. Overloading can cause tire failure, affect vehicle handling, and increase your stopping distance. Use tires of the recommended load capacity for your vehicle. Never overload them.

TIRES — GENERAL INFORMATION

Proper tire inflation pressure is essential to the safe and satisfactory operation of your vehicle. Three primary areas are affected by improper tire pressure:

1. Safety—**WARNING!**

Improperly inflated tires are dangerous and can cause accidents.

- Under inflation increases tire flexing and can result in tire failure.
- Over inflation reduces a tire's ability to cushion shock. Objects on the road and chuck holes can cause damage that results in tire failure.
- Unequal tire pressures can cause steering problems. You could lose control of your vehicle.
- Overinflated or under inflated tires can affect vehicle handling and can fail suddenly, resulting in loss of vehicle control.

Always drive with each tire inflated to the recommended pressure.

2. *Economy*—

Improper inflation pressures can cause uneven wear patterns to develop across the tire tread. These abnormal wear patterns will reduce tread life resulting in a need for earlier tire replacement. Under inflation also increases tire rolling resistance and results in higher fuel consumption.

3. *Ride Comfort and Vehicle Stability*—

Proper tire inflation contributes to a comfortable ride. Over inflation produces a jarring and uncomfortable ride. Both under inflation and over inflation affect the stability of the vehicle and can produce a feeling of sluggish response or over responsiveness in the steering.

Unequal tire pressures can cause erratic and unpredictable steering response.

Unequal tire pressure from side to side may cause the vehicle to drift left or right.

Tire Inflation Pressures

The proper cold tire inflation pressure for passenger cars is listed on either the face of the driver's door or the driver's side "B" pillar. For vehicles other than passenger cars, the cold tire inflation pressures are listed on either the "B" pillar or the Certification Label.

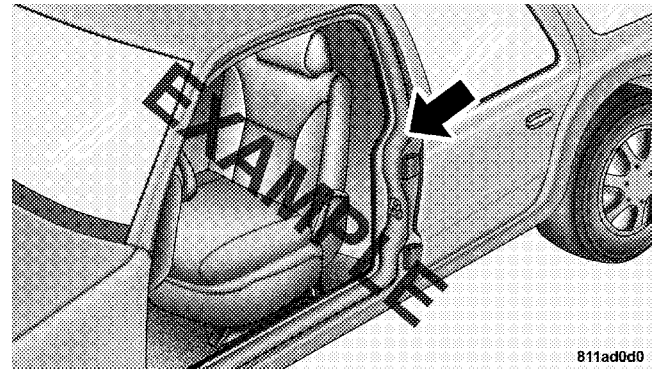

The tire pressure should be checked and adjusted at least once every month. Check more often if subject to a wide range of outdoor temperatures, as tire pressures vary with temperature changes.

Inflation pressures specified on the label are always “Cold Inflation Pressure.” Cold inflation pressure is defined as the tire pressure after the vehicle has been idle for at least 3 hours, or driven less than a mile after a 3 hour period. The cold inflation pressure must not exceed the maximum values molded into the tire sidewall.

Tire pressures may increase from 13 to 40 kPa (2 to 6 psi) [0.138 to 0.414 bar] during operation. DO NOT reduce this normal pressure buildup.

High Speed Operation

WARNING!

High speed driving with your vehicle under load is dangerous. The added strain on your tires could cause them to fail. You could have a serious accident. Don't drive a vehicle loaded to maximum capacity at continuous speeds above 75 mph (120 km/h).

The manufacturer advocates driving at safe speeds within posted speed limits. Where speed limits or conditions are such that the vehicle can be driven at high speeds, correct tire inflation pressure is very important.

Radial-Ply Tires

WARNING!

Combining radial ply tires with other types of tires on your vehicle will cause your vehicle to handle poorly. The instability could cause an accident. Always use radial tires in sets of four. Never combine them with other types of tires.

Cuts and punctures in radial tires are repairable only in the tread area because of sidewall flexing. Consult your dealer for radial tire repairs.

Tire Spinning

When stuck in mud, sand, snow, or ice conditions, do not spin your vehicle's wheels above 35 mph (55 km/h).

WARNING!

Fast spinning tires can be dangerous. Forces generated by excessive wheel speeds may cause tire damage or failure. A tire could explode and injure someone. Do not spin your vehicle's wheels faster than 35 mph (55 km/h) when you are stuck. And don't let anyone near a spinning wheel, no matter what the speed.

Tread Wear Indicators

These indicators are narrow strips 1/16 inch (1.6 mm) thick and are found in the tread pattern grooves.

When the tread pattern is worn down to these treadwear indicators, the tires should be replaced.

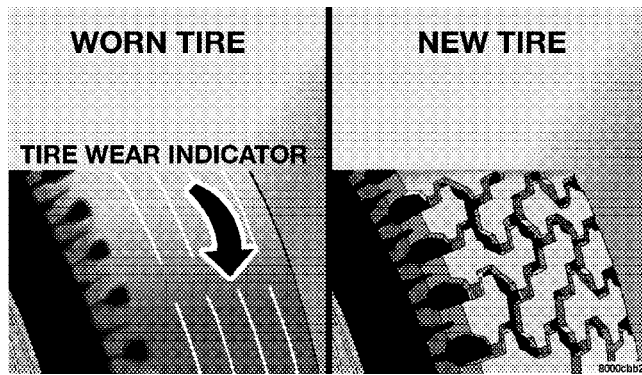

Overloading your vehicle, long trips in very hot weather, and driving on bad roads may result in greater wear.

Replacement Tires

The tires on your new vehicle provide a balance of many characteristics. They should be inspected regularly for wear and correct inflation pressure. The manufacture strongly recommends that you use tires equivalent to the originals in quality and performance when replacement is needed (see section on tread wear indicators). Failure to use equivalent replacement tires may adversely affect the safety, handling, ride and fuel economy of your vehicle. We recommend that you contact your original equipment tire dealer on any questions you may have on tire specifications or capability.

WARNING!

- Do not use a tire, wheel size or rating other than that specified for your vehicle. Some combinations of unapproved tires and wheels may change suspension dimensions and performance characteristics, resulting in changes to steering, handling, and braking of your vehicle. This can cause unpredictable handling and stress to steering and suspension components. You could lose control and have an accident resulting in serious injury or death. Use only the tire and wheel sizes with load ratings approved for your vehicle.
- Never use a tire smaller than the minimum tire size listed on your vehicle's tire label. Using a smaller tire could result in tire overloading and failure. You could lose control and have an accident.
- Failure to equip your vehicle with tires having adequate speed capability can result in sudden tire failure and loss of vehicle control.
- Overloading your tires is dangerous. Overloading can cause tire failure. Use tires of the recommended load capacity for your vehicle - never overload them.

CAUTION!

Replacing original tires with tires of a different size may result in false speedometer and odometer readings. Check with your dealer before replacing tires with a different size.

Alignment and Balance

The suspension components of your vehicle should be inspected and aligned when needed, to obtain maximum tire tread life.

Poor suspension alignment may result in:

- reduced tread life;
- uneven tire wear, such as feathering and one-sided wear;
- vehicle pull to the right or to the left.

Tires may also cause the vehicle to pull left or right. Alignment will not correct this problem. See your dealer for proper diagnosis of the problem.

Improper alignment will not normally cause vehicle vibration, which may be a result of tire and wheel out-of-balance. Proper balancing will reduce vibration and avoid tire cupping and spotty wear.

TIRE PRESSURE MONITOR SYSTEM — IF EQUIPPED

The Tire Pressure Monitor System (TPM) monitors the pressure in all 4 road tires and the full size spare. The TPM system uses wireless technology to monitor tire pressure levels. Sensors, mounted to each wheel as part of the valve stem, transmit tire pressure readings to a receiver located in the overhead console. The tire pressure status is shown in the Electronic Vehicle Information Center (EVIC) display. Refer to “Overhead Console” in

Section 3 for more information. The TPM system functions even when the EVIC is not set on the tire pressure display screen.

The TPM system informs you of a low or high tire pressure condition. If this occurs, correct your tire inflation pressure as soon as possible, and inspect all of your tires. Be sure to use a high quality gauge when adjusting pressure. The TPM system is designed to monitor your tire pressure but will not function as a tire pressure gauge. There will be a delay between the instant you adjust the air pressure in a tire and when the system updates the display. The TPM system is not intended to provide you with notification of rapid air loss.

The following chart indicates the TPM system pressure levels. A threshold is the level at which the TPM system provides you with an indication.

| | |
|-------------------------|-------------------|
| High Pressure Threshold | 44 psi (303 kPa) |
| Placard Pressure (Cold) | 33 psi (227 kPa) |
| Low Pressure Threshold | 25 psi (172 kPa) |

NOTE: A TPM system does not replace normal tire maintenance.

CAUTION!

- The TPM system has been optimized for the original equipment tires and wheels. TPM system pressures have been established for the tire size equipped on your vehicle. Undesirable operation or sensor damage may result when using replacement equipment that is not of the same size, type, and/or style. Aftermarket wheels can cause sensor damage. Do not use tire sealant or balance beads if your vehicle is equipped with TPM system as damage to the sensors may result.
- After inspecting or adjusting the tire pressure always reinstall the valve stem cap. This will prevent moisture and dirt from entering the valve stem, which could damage the wheel rim sensor.

Tire Pressure Monitor System Tire/Wheel Rotation and Sensor Replacement — If Equipped

With the TPM System, if a road tire and wheel is replaced by the spare, the TPM system will detect the swap automatically (after the ignition has been cycled) and display SPARE SWAP DETECTED along with a chime. This could take up to 10 minutes with vehicle speed above 25 mph (40 km/h).

The tire pressure sensors **must** be retrained following a wheel rotation or sensor replacement. Refer to “EVIC — Retrain Tire Sensors” in Section 3 for more information. It is necessary to program the EVIC with the new sensor(s) or the new position of each sensor as it is rotated to a different corner of the vehicle.

If a wheel rotation is not followed by the retrain procedure, the system will not properly inform you of the correct vehicle location of a low or high tire pressure.

Tire Pressure Monitor System/4-LO Mode — If Equipped

When the 4-LO mode is selected, the chime will not sound until either: the vehicle speed is greater or equal to 25 mph (40 km/h) or the vehicle is taken out of the 4-LO mode.

The low tire pressure warning messages (on the EVIC) and the “Tire Pressure Monitor Warning Light” will continue to be displayed until the tire pressure has been increased to the proper operating pressure.

General Information

This device complies with part 15 of the FCC rules and RSS 210 of Industry Canada. Operation is subject to the following conditions:

- This device may not cause harmful interference.

- This device must accept any interference received, including interference that may cause undesired operation.

The tire pressure sensors are covered under one of the following licenses:

United States KR5S120123
 Canada 2671-S120123

TIRE CHAINS

CAUTION!

To avoid damage to your vehicle or tires, observe the following precautions:

- Because of restricted chain clearance between tires and other suspension components, it is important that only chains in good condition are used. Broken chains can cause serious damage. Stop the vehicle immediately if noise occurs that could indicate chain breakage. Remove the damaged parts of the chain before further use.
- Install chains on the rear wheels as tightly as possible and then retighten after driving about ½ mile (0.8 km).
- Do not exceed 30 mph (48 km/h).
- Drive cautiously and avoid severe turns and large bumps, especially with a loaded vehicle.
- Do not drive for prolonged period on dry pavement.
- Observe the tire chain manufacturer's instructions on the method of installation, operating speed, and conditions for use. Always use the lower suggested operating speed of the chain manufacturer if different than the speed recommended by the manufacture.

Tire chains that are recommended for this vehicle are listed below:

- Mopar® P/N 82206828 with P235/70R16 and P235/65R17 tires.
- Mopar® P/N 82207074 with P215/75R16 tires.

NOTE: In order to avoid damage to tires, chains, and your vehicle do not drive for a prolonged period of time on dry pavement. Observe the tire chain manufacturer's instructions on method of installation, operating speed, and conditions for usage.

Always use the lower suggested operating speed if both the chain manufacturer and vehicle manufacturer suggest a maximum speed. This notice applies to all chain traction devices, including link and cable (radial) chains.

TIRE ROTATION RECOMMENDATIONS

Tires on the front and rear axles of vehicles operate at different loads and perform different steering, handling, and braking functions. For these reasons, they wear at unequal rates, and develop irregular wear patterns.

These effects can be reduced by timely rotation of tires. The benefits of rotation are especially worthwhile with aggressive tread designs such as those on On/Off Road type tires. Rotation will increase tread life, help to maintain mud, snow, and wet traction levels, and contribute to a smooth, quiet ride.

Follow the recommended tire rotation frequency for your type of driving found in the "Maintenance Schedules" Section of this manual. More frequent rotation is permissible if desired. The reasons for any rapid or unusual wear should be corrected prior to rotation being performed.

NOTE: The Tire Pressure Monitor system must be retrained following a tire rotation. See your authorized dealer for service.

The suggested rotation method is the “forward-cross” shown in the following diagram.

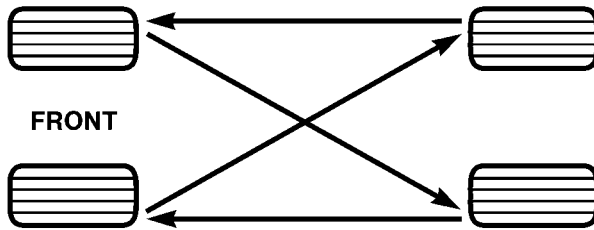

8031e864

FUEL REQUIREMENTS



Your engine is designed to meet all emissions regulations and provide excellent fuel economy and performance when using high quality unleaded gasoline having an octane rating of 87. The use of premium gasoline is not recommended. The use of premium gasoline will provide no benefit over high quality regular gasoline, and in some circumstances may result in poorer performance.

Mid-grade gasoline (89 octane) will enhance engine performance during the following conditions (3.7L Only):

- Hot weather
- Towing
- Hard accelerations
- Hilly terrain
- Low humidity

Light spark knock at low engine speeds is not harmful to your engine. However, continued heavy spark knock at high speeds can cause damage and immediate service is required. Engine damage resulting from operation with a heavy spark knock may not be covered by the new vehicle warranty.

Poor quality gasoline can cause problems such as hard starting, stalling and hesitations. If you experience these symptoms, try another brand of gasoline before considering service for the vehicle.

Over 40 auto manufacturer's world wide have issued and endorsed consistent gasoline specifications (the World-wide Fuel Charter, WWFC) to define fuel properties necessary to deliver enhanced emissions, performance, and durability for your vehicle. The manufacturer recommends the use of gasoline that meets the WWFC specifications if they are available.

Reformulated Gasoline

Many areas of the country require the use of cleaner burning gasoline referred to as Reformulated Gasoline. Reformulated gasoline contains oxygenates, and is specifically blended to reduce vehicle emissions and improve air quality.

The manufacturer strongly supports the use of reformulated gasoline. Properly blended reformulated gasoline will provide excellent performance and durability for the engine and fuel system components.

Gasoline/Oxygenate Blends

Some fuel suppliers blend unleaded gasoline with oxygenates such as 10% ethanol, MTBE, and ETBE. Oxygenates are required in some areas of the country during the winter months to reduce carbon monoxide emissions. Fuels blended with these oxygenates may be used in your vehicle.

CAUTION!

DO NOT use gasoline containing METHANOL. Gasoline containing methanol may damage critical fuel system components.

MMT In Gasoline

MMT is a manganese containing metallic additive that is blended into some gasoline to increase octane. Gasoline blended with MMT provides no performance advantage beyond gasoline of the same octane number without MMT. Gasoline blended with MMT reduces spark plug life and reduces emission system performance in some vehicles. The manufacturer recommends that gasoline without MMT be used in your vehicle. The MMT content of gasoline may not be indicated on the gasoline pump, therefore, you should ask your gasoline retailer whether or not his/her gasoline contains MMT.

It is even more important to look for gasoline without MMT in Canada because MMT can be used at levels higher than allowed in the United States. MMT is prohibited in Federal and California reformulated gasoline.

Sulfur In Gasoline

If you live in the northeast United States, your vehicle may have been designed to meet California low emission standards with clean burning, low sulfur, California gasoline. Gasoline sold outside of California is permitted to have higher sulfur levels which may affect the performance of the vehicle's catalytic converter. This may cause the "Malfunction Indicator Light" to illuminate.

Illumination of this light while operating on high sulfur gasoline does not necessarily mean your emission control system is malfunctioning. The manufacturer recommends that you try a different brand of unleaded gasoline having lower sulfur to determine if the problem is fuel related prior to returning your vehicle to an authorized dealer for service.

CAUTION!

If the “Malfunction Indicator Light” is flashing, immediate service is required. See “Onboard Diagnostic System” in Section 7 of this manual.

Materials Added To Fuel

All gasoline sold in the United States is required to contain effective detergent additives. Use of additional detergents or other additives is not needed under normal conditions.

FUEL TANK FILLER CAP (GAS CAP)**WARNING!**

To avoid fuel spillage and overfilling, do not “top off” the fuel tank after filling.

The gas cap is located behind the fuel filler door, on the left side of the vehicle. If the gas cap is lost or damaged, be sure the replacement cap has been designed for use with this vehicle.

When tightening the gas cap, tighten until 2 or 3 clicks are heard to insure that the cap is properly seated.

NOTE: A loose gas cap may cause the “Malfunction Indicator Light” to illuminate.

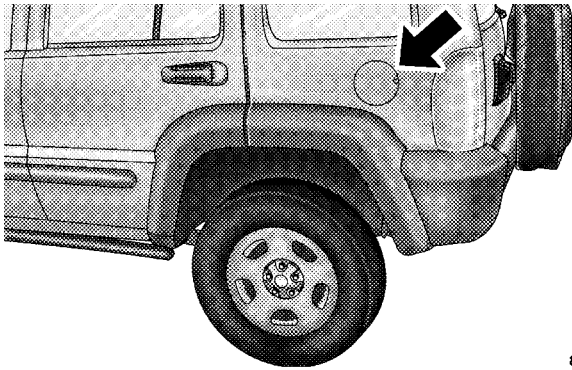

80c579c7

CAUTION!

Damage to the fuel system or emission control system could result from using an improper fuel tank filler cap (gas cap). A poorly fitting cap could let impurities into the fuel system.

WARNING!

- Remove the fuel cap slowly to prevent fuel spray from the filler neck which may cause injury.
- The volatility of some gasoline may cause a buildup of pressure in the fuel tank which may increase while you drive. This pressure can result in a spray of gasoline and/or vapors when the cap is removed from a hot vehicle. Removing the cap slowly allows the pressure to vent and prevents fuel spray.
- Never add fuel when the engine is running.
- Never have any smoking materials lit in or near the vehicle when the fuel cap is removed or the tank filled.

TRAILER TOWING

In this section you will find information on limits to the type of towing you can reasonably do with your vehicle. Before towing a trailer, carefully review this information to tow your load as efficiently and safely as possible.

To maintain warranty coverage, follow the requirements and recommendations in this manual concerning vehicles used for trailer towing.

Perform maintenance services as prescribed in the “Maintenance Schedules” section. When your vehicle is used for trailer towing, never exceed the gross axle weight rating (GAWR) by the addition of:

- The tongue weight of the trailer.
- The weight of any other type of cargo or equipment put in or on your vehicle.

Remember that everything put in or on the trailer adds to the load on your vehicle.

Warranty Requirements

The manufacturer’s warranty will apply to vehicles used to tow trailers for noncommercial use, however the following conditions must be met:

- The “D” Overdrive range can be selected when towing. However, if frequent shifting occurs select the “O/D Off” function or move the shift lever to the next lower position to eliminate excessive automatic transmission shifting. This action will also reduce the possibility of transmission overheating and provide better engine braking. Refer to “Transmission Shifting” in this section for additional information.
- A load equalizing hitch is recommended for loaded trailer weights above 1,000 lbs (454 kg).

CAUTION!





If the trailer weighs more than 1,000 lbs (454 kg) loaded, it should have its own brakes and they should be of adequate capacity. Failure to do this could lead to accelerated brake lining wear, higher brake pedal effort, and longer stopping distances.

- Whenever you pull a trailer, regardless of the trailer size, stop lights and turn signals on the trailer are mandatory for motoring safety.
- Follow the maintenance intervals in schedule "B" for changing the automatic transmission fluid and filter, if you REGULARLY tow a trailer for more than 45 minutes of continuous operation.

WARNING!

Connecting trailer brakes to your vehicle's hydraulic brake lines can overload your brake system and cause it to fail. You might not have brakes when you need them and could have an accident.

266 STARTING AND OPERATING

| Trailer Type | Gross Trailer Weight | Tongue Weight | Towing Pkg. | GCWR (Max.) (See Note 1) | Engine | Transmission | Cooling | Axle |
|--|------------------------------|--|------------------------------|---|--------|--------------------------|------------|------|
| Fold Down and Low Profile • 25 ft ² (2.3m ²) or Less Frontal Area  • Up to 2,000 lbs. (907 kg) also Small Boats Flatbed Trailers etc. | 2,000 lbs. (907 kg) (Max.) | 300 lbs. (136 kg) (Max.) 10 to 15% of GTW | Class I Hitch (Light Duty) | 4x2 6,750 lbs. (3,062 kg) 4x4 7,000 lbs. (3,175 kg) | 2.4L | Manual | All | All |
| Fold Down and Low Profile • 25 ft ² (2.3m ²) or Less Frontal Area  • Up to 2,000 lbs. (907 kg) also Small Boats Flatbed Trailers etc. | 2,000 lbs. (907 kg) (Max.) | 300 lbs. (136 kg) (Max.) 10 to 15% of GTW | Class I Hitch (Light Duty) | 4x2 7,100 lbs. (3,220 kg) 4x4 7,400 lbs. (3,357 kg) | 3.7L | Automatic | All | All |
| • Up to 3,500 lbs. (1588 kg) GTW • Single-axle, small to medium length • Maximum trailer length: 18 ft (5.5m) | 3,500 lbs. (1,588 kg) (Max.) | 525 lbs. (238 kg) (Max.) | Class II Hitch (Medium Duty) | 4x2 7,100 lbs. (3,220 kg) 4x4 8,750 lbs. (3,969 kg) | 3.7L | Manual 5 Spd. Only | All | All |
| Other Trailer Types and Weights Up to Full Box Shape • Up to 64 ft ² (5.8m ²) Frontal Area  • Up to 5,000 lbs ¹ (2,268 kg) GTW  • Maximum Travel Trailer Length: 25 ft. (7.6m)  | 5,000 lbs. (2,268 kg) (Max.) | 750 lbs. (340 kg) (Max.) | Class III Hitch (Heavy Duty) | 4x2 9,800 lbs. (4,445 kg) 4x4 10,100 lbs. (4,581 kg) | 3.7L | Auto. Trans. with Cooler | Heavy Duty | All |

¹ GCWR = Total combined weight of trailer and tow vehicle.

80d3f3a2

Minimum Vehicle Requirements for Trailer Towing

RECREATIONAL TOWING (BEHIND MOTORHOME, ETC.)**Towing – 2WD Models**

Recreational towing is not recommended. Provided that the transmission is operable, tow only in N (Neutral) at speeds not exceeding 45 mph (72 km/h) and distances less than 100 miles (161 km).

If the vehicle is to be towed more than 100 miles (161 km), the propeller shaft should be disconnected or place tow dollies under the rear wheels.

Towing — 4WD Models**CAUTION!**

Internal damage to the transfer case will occur if a front or rear wheel lift is used when recreational towing.

NOTE: The transfer case must be shifted into N (Neutral) for recreational towing.

Shifting Into Neutral (N)

Use the following procedure to prepare your vehicle for recreational towing.

CAUTION!

It is necessary to follow these steps to be certain that the transfer case is fully in N (Neutral) before recreational towing to prevent damage to internal parts.

1. Depress brake pedal.
2. Shift transmission into N (Neutral).
3. Shift transfer case lever into N (Neutral).
4. Start engine.
5. Shift automatic transmission into D (Drive) or manual transmission into any forward gear.
6. Release brake pedal and ensure that there is no vehicle movement.

7. Shut the engine OFF and place the ignition key into the unlocked OFF position.

8. Shift automatic transmission into P (Park) or ensure manual transmission is in any forward gear.

9. Apply parking brake.

10. Attach vehicle to the tow vehicle with tow bar.

11. Release parking brake.

CAUTION!

Transmission damage may occur if the automatic transmission is shifted into P (Park) with the transfer case in N (Neutral) and the engine running. With the transfer case in N (Neutral) ensure that the engine is OFF prior to shifting the transmission into P (Park) (refer to steps 7 – 8 above).

Shifting Out Of Neutral (N)

Use the following procedure to prepare your vehicle for normal usage.

1. Shift transmission into N (Neutral).
2. Shift transfer case lever to desired position.
3. Shift automatic transmission into D (Drive) or manual transmission into any forward gear.

NOTE: When shifting out of transfer case N (Neutral) on automatic transmission equipped vehicles, turning the engine OFF may be required to avoid gear clash.

WARNING!

You or others could be injured if you leave the vehicle unattended with the transfer case in the N (Neutral) position without first fully engaging the parking brake. The transfer case N (Neutral) position disengages both the front and rear driveshafts from the powertrain and will allow the vehicle to move regardless of the transmission position. The parking brake should always be applied when the driver is not in the vehicle.

5

CAUTION!

Do not use a bumper mounted clamp-on tow bar on your vehicle. The bumper face bar will be damaged.

SNOW PLOW

Snow plows, winches, and other aftermarket equipment should **not** be added to the front end of your vehicle. The airbag crash sensors may be affected by the change in the front end structure. The airbags could deploy unexpectedly or could fail to deploy during a collision.

WARNING!

Do not add a snow plow, winches, or any other aftermarket equipment to the front of your vehicle. This could adversely affect the functioning of the airbag system and you could be injured.

WHAT TO DO IN EMERGENCIES

CONTENTS

| | | | |
|---|-----|---|-----|
| ■ Hazard Warning Flashers | 272 | □ Tire Changing Procedures | 275 |
| ■ If Your Engine Overheats | 273 | ■ Jump Starting Procedure | 279 |
| ■ Changing A Flat Tire | 274 | ■ Emergency Tow Hooks — If Equipped | 281 |
| □ Jack And Lug Wrench Locations | 274 | ■ Towing A Disabled Vehicle | 281 |
| □ Spare Tire Location | 275 | | |

HAZARD WARNING FLASHERS

Your vehicle's hazard warning flasher is an emergency warning system. When you activate it, all front and rear directional signals will flash intermittently. Use it when your vehicle is disabled on or near the road. It warns other drivers to steer clear of you and your vehicle. This is an emergency warning system, not to be used when the vehicle is in motion.

To activate the warning flashers, press the button on the instrument panel (between center air outlets). To turn the warning flashers off, press the button again.

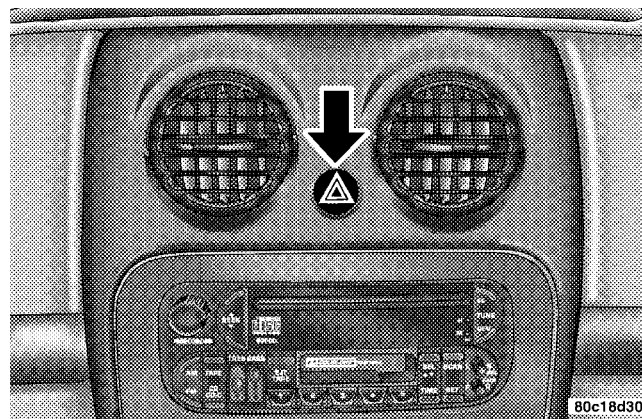

NOTE: With extended use, the flashers may run down your battery.

IF YOUR ENGINE OVERHEATS

In any of the following situations, you can reduce the potential for overheating by taking the appropriate action.

- On the highways — Slow down.
- In city traffic — While stopped, put transmission in N (Neutral), but do not increase engine idle speed.

NOTE: There are steps that you can take to slow down an impending overheat condition. If your air conditioner is on, turn it off. The air conditioning system adds heat to the engine cooling system and turning off the A/C removes this heat. You can also turn the Temperature Control to maximum heat, the Mode Control to floor, and the Fan Control to High. This allows the heater core to act as a supplement to the radiator and aids in removing heat from the engine cooling system.

CAUTION!

Driving with a hot cooling system could damage your vehicle. If the temperature gauge reads “H”, pull over and stop the vehicle. Idle the vehicle with the air conditioner turned off until the pointer drops back into the normal range. If the pointer remains on the “H”, and you hear continuous chimes, turn the engine off immediately, and call for service.

CHANGING A FLAT TIRE

Jack And Lug Wrench Locations

The jack, jack handle, and lug wrench are stored beneath the right rear seat. To remove the jack from its stowage position, turn the thumb screw counterclockwise to loosen jack assembly and then remove it.

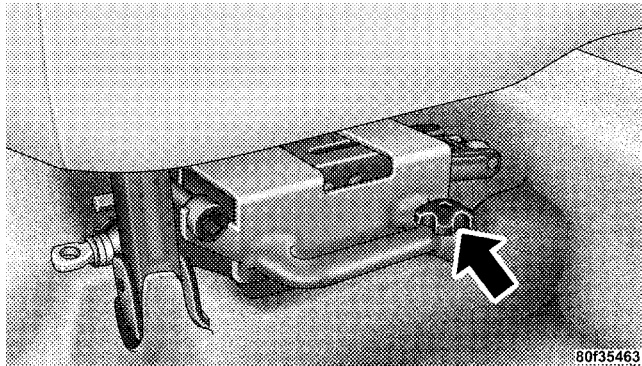

WARNING!

- Always store the jack, lug wrench and spare, flat or damaged tire securely in the proper place. Never leave them loose in the vehicle where they could become dangerous projectiles during a quick stop or collision.
- The jack is designed to use as a tool for changing tires only. The jack should not be used to lift the vehicle for service purposes, unless suitable supports are placed under the vehicle as a safety measure. The vehicle should be jacked on a firm level surface only. Avoid ice or slippery areas.

Spare Tire Location

To remove the spare tire from the carrier, remove the tire cover, if equipped, and remove the lug nuts with the lug wrench turning them counterclockwise.

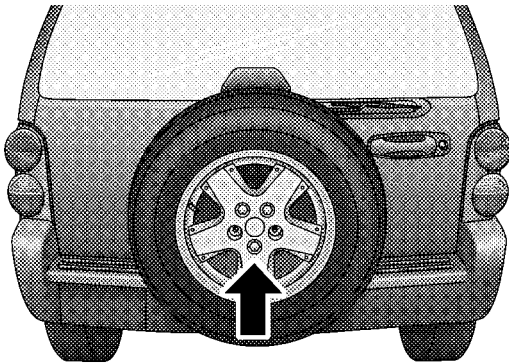

80d1f789

NOTE: If you have added aftermarket accessories to the spare tire mounted carrier, it cannot exceed a gross weight of 50 lbs (23 kg) including the weight of the spare tire.

Tire Changing Procedures**WARNING!**

You can be injured or killed if you try to change a wheel too close to moving traffic. Pull far enough off the road to avoid being hit when operating the jack or changing the wheel.

Preparation

- Park on a firm, level surface well off the road, to provide ample work space. Place automatic transmission in P (Park), or manual transmission in R (Reverse), and stop engine. Set parking brake firmly and activate hazard warning flasher.

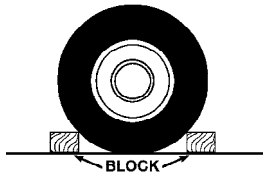

- Block tire diagonally opposite tire to be changed to prevent forward and backward vehicle movement.

Instructions

1. Remove spare tire, jack and tools from stored location.
2. Before raising vehicle, loosen lug nuts on wheel with flat tire.

3. Assemble the jack and jacking tools as shown. Connect jack handle driver to extensions, then to lug wrench.

4. Locate the jack as shown. For the front tires, place it in the notch on the body weld seam behind wheel to be changed. For the rear tires, place it under the axle as shown. Position the jack handle on the jack.

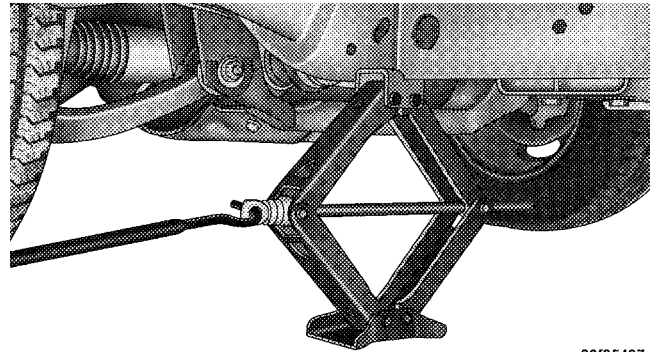

80F35497

Front Scissor Jack Location

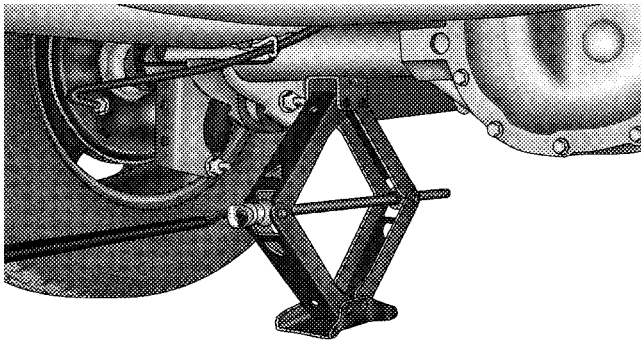

80f354b4

Rear Scissor Jack Location

5. Raise the vehicle by turning the jack handle clockwise until the tire clears the ground.

WARNING!

Raising the vehicle higher than necessary can make the vehicle less stable and cause an accident. It could slip off the jack and hurt someone near it. Raise the vehicle only enough to remove the tire.

6. Remove the lug nuts and wheel.

7. Position the spare wheel/tire on the vehicle and install lug nuts with cone-shaped end toward wheel. Lightly tighten nuts clockwise. To avoid the risk of forcing the vehicle off the jack, do not tighten the nuts fully until the vehicle has been lowered.

8. Lower the vehicle by using a counterclockwise rotation to lower the jack.

9. Finish tightening the lug nuts securely in crisscross pattern. Have an authorized service technician check that the torque is 85-110 ft. lbs. (115-149 N·m) as soon as possible.

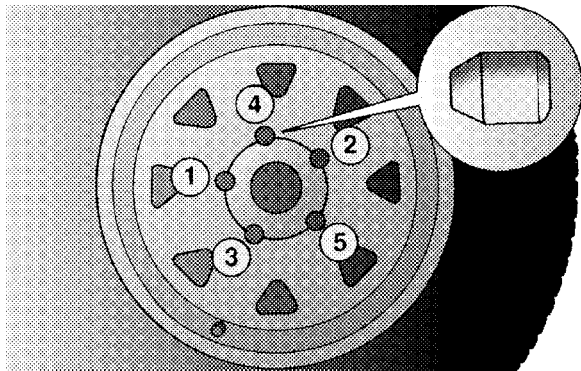

80e9t35c

10. Remove jack assembly and wheel blocks.

11. Secure jack, lug wrench, jack handle driver, jack extension, and tire in proper locations.

WARNING!

Carefully follow these tire changing warnings to help prevent personal injury or damage to your vehicle:

- Always park on a firm, level surface as far from the edge of the roadway as possible before raising the vehicle.
- Apply the parking brake firmly before jacking.
- Always block the wheel diagonally opposite the wheel being raised.
- Do not raise the vehicle higher than is necessary to remove the tire.
- Never start the engine with the vehicle on a jack.

- Do not let passengers sit in the vehicle when it is on a jack.
- Do not get under the vehicle when it is on a jack.
- Failure to follow the “Tire Changing Procedure” may result in personal injury or damage to your vehicle.
- Only use the jack in the positions indicated.

JUMP STARTING PROCEDURE

NOTE: Check the charge indicator on the battery. If the indicator is light or yellow, replace the battery.

1. Wear eye protection and remove any metal jewelry such as watch bands or bracelets that might make an unintended electrical contact.
2. When boost is provided by a battery in another vehicle, park that vehicle within booster cable reach but without letting the vehicles touch. Set the parking brake,

place the automatic transmission in P (Park), or manual transmission in N (Neutral), and turn the ignition to OFF for both vehicles.

3. Turn off the heater, radio and all unnecessary electrical loads.
4. Connect one end of a jumper cable to the positive terminal of the discharged battery. Connect the other end of the same cable to the positive terminal of the booster battery.
5. Connect the other cable, first to the negative terminal of the booster battery and then connect the other end to a non-paint metal surface on the engine of the vehicle with the discharged battery. Make sure you have a good contact on the engine.
6. Start the engine in the vehicle which has the booster battery, let the engine idle a few minutes, then start the engine in the vehicle with the discharged battery.

7. When removing the jumper cables, reverse the above sequence exactly. Be careful of the moving belts and fan.

NOTE: To start the vehicle following connection of a booster battery, the Security Alarm System must first be disabled by cycling a front door key cylinder or by using the keyless entry transmitter.

WARNING!

Jump starting can be dangerous. To avoid personal injury or damage to electrical components in vehicle, observe the following warnings:

- Battery fluid is a corrosive acid solution and can burn or even blind you. Don't allow battery fluid to contact your eyes, skin, or clothing. Don't lean over a battery

when attaching clamps. If acid splashes in eyes or on skin, flush the area immediately with large amounts of water.

- Do not use a booster battery or any other booster source that has a greater than 12-volt system, i.e., do not use a 24-volt power source.
- Never attempt to jump start a discharged battery that is frozen, because it could rupture or explode during jump starting.
- Be sure your vehicle is not touching the jump start vehicle.
- Observe all Battery Warnings in Section 7 of this manual, while jump starting your vehicle.

WARNING!

Do not attempt to push or tow your vehicle to get it started. Unburned fuel could enter the catalytic converter and, once the engine has started, ignite and damage the converter and vehicle.

EMERGENCY TOW HOOKS — IF EQUIPPED

If your vehicle is equipped with tow hooks, they are mounted in the front and the rear.

CAUTION!

Tow hooks are for emergency use only, to rescue a vehicle stranded off road. Do not use tow hooks for tow truck hookup or highway towing. You could damage your vehicle. Tow straps are recommended when towing the vehicle, chains may cause vehicle damage.

WARNING!

Stand clear of vehicles when pulling with tow hooks. Tow straps and chains may break, causing serious injury.

TOWING A DISABLED VEHICLE

The manufacturer recommends towing with all four wheels off the ground. Acceptable methods are to tow the vehicle on a flatbed or with one end of the vehicle raised and the other end on a towing dolly.

MAINTAINING YOUR VEHICLE

CONTENTS

| | | | |
|---|-----|---|-----|
| ■ 2.4L Engine | 285 | □ Drive Belts — Check Condition And Tension . . . | 294 |
| ■ 3.7L Engine | 286 | □ Spark Plugs | 295 |
| ■ Onboard Diagnostic System — OBD II | 287 | □ Catalytic Converter | 295 |
| ■ Emissions Inspection And Maintenance Programs | 288 | □ Engine Timing Belt — 2.4L Engine | 297 |
| ■ Replacement Parts | 289 | □ Ignition Wiring System — 2.4L Engine | 297 |
| ■ Dealer Service | 289 | □ Crankcase Emission Control System | 297 |
| ■ Maintenance Procedures | 290 | □ Air Cleaner Filter | 297 |
| □ Engine Oil | 290 | □ Maintenance-Free Battery | 298 |
| | | □ Air Conditioner Maintenance | 299 |

284 MAINTAINING YOUR VEHICLE

| | | | |
|---|-----|---|-----|
| □ Power Steering Fluid Check | 300 | □ Transfer Case | 313 |
| □ Driveline And Steering Component Lubrication | 301 | □ Front/Rear Axle Fluid | 315 |
| □ Body Lubrication | 301 | □ Appearance Care And Protection From Corrosion | 315 |
| □ Windshield Wiper Blades | 301 | ■ Fuse Panel | 320 |
| □ Windshield Washers | 302 | □ Interior Fuses | 320 |
| □ Exhaust System | 302 | □ Underhood Fuses (Power Distribution Center) . | 323 |
| □ Cooling System | 303 | ■ Vehicle Storage | 324 |
| □ Hoses And Vacuum/Vapor Harnesses | 307 | ■ Replacement Bulbs | 324 |
| □ Brake System | 308 | ■ Fluid Capacities | 326 |
| □ Automatic Transmission | 311 | ■ Recommended Fluids, Lubricants And Genuine Parts | 327 |
| □ Hydraulic Clutch Fluid — Manual Transmission | 313 | □ Engine | 327 |
| □ Manual Transmission | 313 | □ Chassis | 328 |

2.4L ENGINE

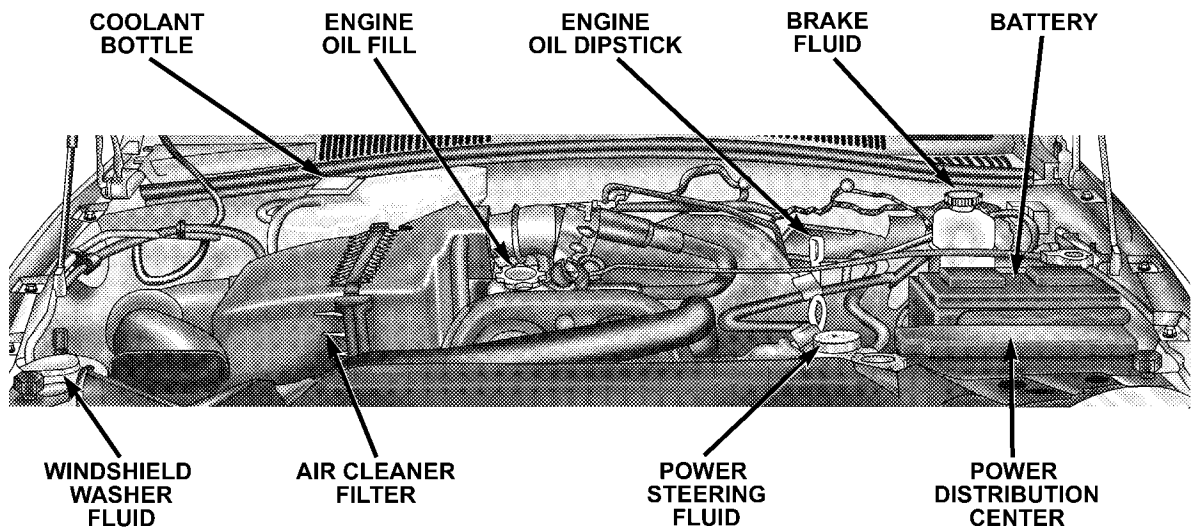

80cb201a

3.7L ENGINE

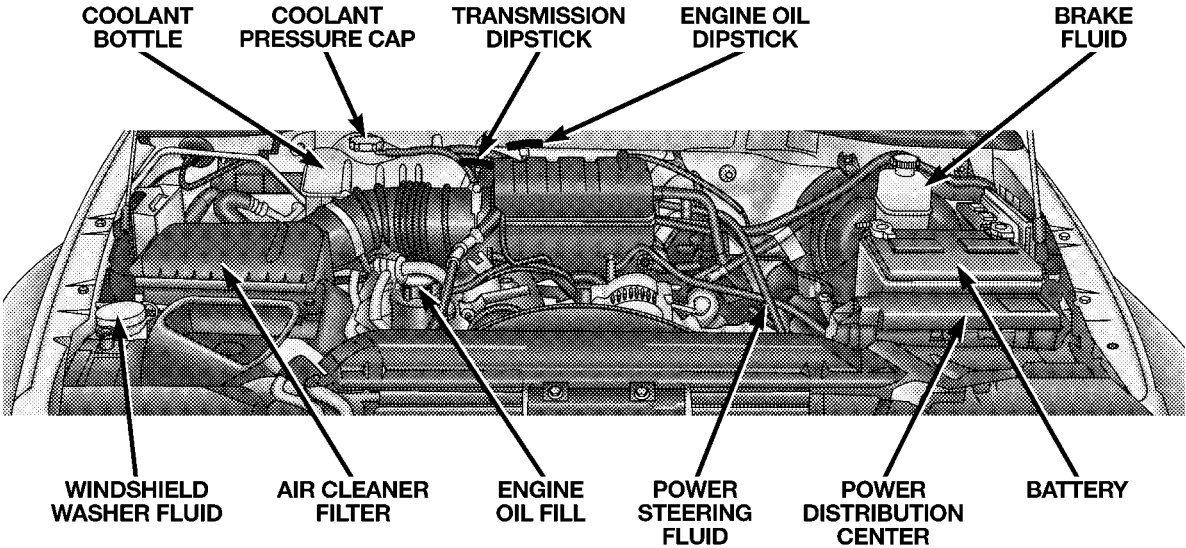

80c8de5a

ONBOARD DIAGNOSTIC SYSTEM — OBD II

Your vehicle is equipped with a sophisticated onboard diagnostic system called OBD II. This system monitors the performance of the emissions, engine, and automatic transmission control systems. When these systems are operating properly, your vehicle will provide excellent performance and fuel economy, as well as engine emissions well within current government regulations.

If any of these systems require service, the OBD II system will turn on the “Malfunction Indicator Light.” It will also store diagnostic codes and other information to assist your service technician in making repairs. Although your vehicle will usually be drivable and not need towing, see your dealer for service as soon as possible.

CAUTION!

- **Prolonged driving with the “Malfunction Indicator Light” on could cause further damage to the emission control system. It could also affect fuel economy and driveability. The vehicle must be serviced before any emissions tests can be performed.**
- **If the “Malfunction Indicator Light” is flashing while the engine is running, severe catalytic converter damage and power loss will soon occur. Immediate service is required.**

EMISSIONS INSPECTION AND MAINTENANCE PROGRAMS

In some localities, it may be a legal requirement to pass an inspection of your vehicle's emissions control system. Failure to pass could prevent vehicle registration.

 For states which have an I/M (Inspection and Maintenance) requirement, this check verifies the following: the MIL (Malfunction Indicator Lamp) is functioning and is not on when the engine is running, and that the OBD (On Board Diagnostic) system is ready for testing.

Normally, the OBD system will be ready. The OBD system may **not** be ready if your vehicle was recently serviced, if you recently had a dead battery, or a battery replacement. If the OBD system should be determined not ready for the I/M test, your vehicle may fail the test.

Your vehicle has a simple ignition key actuated test which you can use prior to going to the test station. To check if your vehicle's OBD system is ready, you must do the following:

1. Insert your ignition key into the ignition switch.
2. Turn the ignition to the ON position, but do not crank or start the engine.
3. If you crank or start the engine, you will have to start this test over.
4. As soon as you turn your key to the ON position, you will see your MIL symbol come on as part of a normal bulb check.
5. Approximately 15 seconds later, one of two things will happen:
 - a. The MIL will flash for about 10 seconds and then return to being fully illuminated until you turn off the

ignition key or start the engine. This means that your vehicle's OBD system is **not ready** and you should **not** proceed to the I/M station.

b. The MIL will not flash at all and will remain fully illuminated until you turn off the ignition key or start the engine. This means that your vehicle's OBD system is **ready** and you can proceed to the I/M station.

If your OBD system is **not ready**, you should see your authorized dealer or repair facility. If your vehicle was recently serviced or had a battery failure or replacement, you may need to do nothing more than drive your vehicle as you normally would in order for your OBD system to update. A recheck with the above test routine may then indicate that the system is now ready.

Regardless of whether your vehicle's OBD system is ready or not ready, if the MIL symbol is illuminated during normal vehicle operation, you should have your

vehicle serviced before going to the I/M station. The I/M station can fail your vehicle because the MIL symbol is on with the engine running.

REPLACEMENT PARTS

Use of genuine Mopar® parts for normal/scheduled maintenance and repairs is highly recommended to insure the designed performance. Damage or failures caused by the use of non-Mopar® parts for maintenance and repairs will not be covered by the manufacturer's warranty.

DEALER SERVICE

Your dealer has the qualified service personnel, special tools and equipment to perform all service operations in an expert manner. Service Manuals are available which include detailed service information for your vehicle. Refer to these manuals before attempting any procedure yourself.

NOTE: Intentional tampering with emissions control systems can result in civil penalties being assessed against you.

WARNING!

You can be badly injured working on or around a motor vehicle. Do only that service work for which you have the knowledge and the proper equipment. If you have any doubt about your ability to perform a service job, take your vehicle to a competent mechanic.

MAINTENANCE PROCEDURES

The pages that follow contain the **required** maintenance services determined by the engineers who designed your vehicle.

Besides the maintenance items for which there are fixed maintenance intervals, there are other items that should operate satisfactorily without periodic maintenance. However, if a malfunction of these items does occur, it could adversely affect the engine or vehicle performance. These items should be inspected if a malfunction is observed or suspected.

Engine Oil

Checking Oil Level

To assure proper lubrication of your vehicle's engine, the engine oil must be maintained at the correct level. Check the oil level at regular intervals, such as every fuel stop.

The best time to check the engine oil level is about 5 minutes after a fully warmed engine has been shut off, or before starting the engine after it has sat overnight.

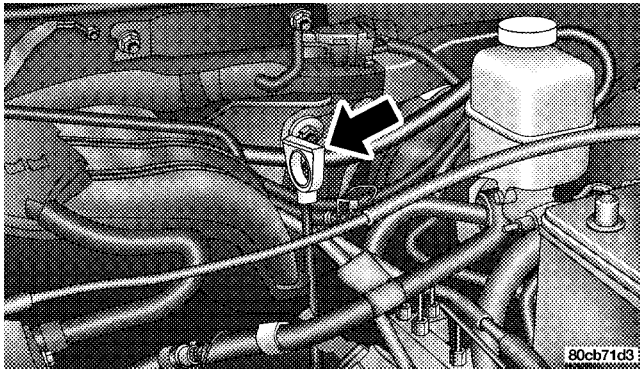

2.4L Engines

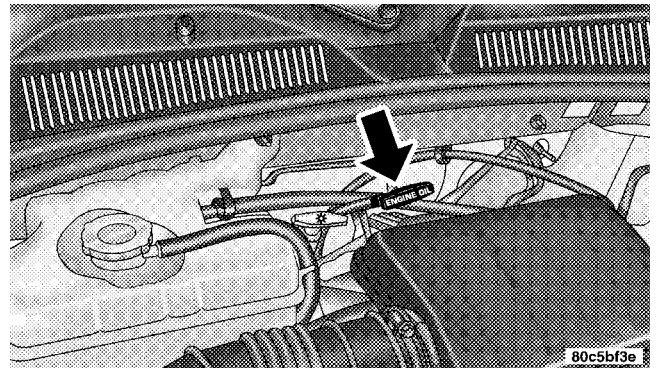

3.7L Engines

Checking the oil while the vehicle is on level ground will improve the accuracy of the oil level readings. Maintain the oil level between the ADD and SAFE markings on the dipstick. Adding 1 U.S. Quart (0.95L) of oil when the reading is at the ADD mark will result in a SAFE reading on these engines.

CAUTION!

Overfilling or underfilling the crankcase will cause aeration or loss of oil pressure. This could damage your engine.

Change Engine Oil

Road conditions as well as your kind of driving affect the interval at which your oil should be changed. Check the following to determine if any apply to you:

- Day or night temperatures are below 32°F (0°C)
- Stop and go driving
- Extensive engine idling
- Driving in dusty conditions
- Short trip driving of less than 10 miles (16.2 km)

- More than 50% of your driving is at sustained high speeds during hot weather, above 90°F (32°C)
- Taxi, Police, or delivery service (commercial service)
- Trailer towing
- Off-road or desert driving

If **ANY** of these apply to you, then change your engine oil at every interval shown in schedule “B” of the “Maintenance Schedules” section of this manual.

If none of these apply to you, then change your engine oil at every interval shown on schedule “A” of the “Maintenance Schedules” section of this manual

NOTE: Under no circumstances should oil change intervals exceed 6,000 miles (10 000 km) or 6 months whichever comes first.

Engine Oil Selection

For best performance and maximum protection for all engines under all types of operating conditions, the manufacturer recommends engine oils that are API Certified and meet the requirements of DaimlerChrysler Material Standard MS-6395.

American Petroleum Institute (API) Engine Oil Identification Symbol



This symbol means that the oil has been certified by the American Petroleum Institute (API). The manufacturer only recommends API Certified engine oils.

Engine Oil Viscosity Chart

The proper SAE viscosity grade of engine oil should be selected based on the following recommendation and be within the operating temperature shown in the engine oil viscosity chart.

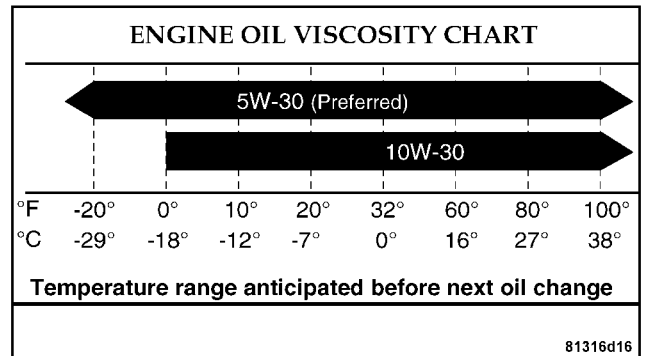

Materials Added To Engine Oils

The manufacturer **strongly recommends** against the addition of any additives (other than leak detection dyes) to engine oil. Engine oil is an engineered product and its performance may be impaired by supplemental additives.

Disposing of Used Engine Oil

Care should be taken in disposing of used engine oil from your vehicle. Used oil and oil filters, indiscriminately discarded, can present a problem to the environment. Contact your authorized dealer, service station, or governmental agency for advice on how and where used oil can be safely discarded in your area.

Engine Oil Filter

The engine oil filter should be replaced at every engine oil change.

Engine Oil Filter Selection

All of the manufacturer's engines have a full-flow type disposable oil filter. Use a filter of this type for replacement. The quality of replacement filters varies considerably. Only high quality filters should be used to assure most efficient service. Mopar® engine oil filters are high quality oil filters and are recommended.

Drive Belts — Check Condition and Tension

At the mileage shown in the appropriate "Maintenance Schedule," check all drive belts for condition and proper tension. Improper belt tension can cause belt slippage and failure.

Inspect the drive belt for evidence of cuts, cracks, or glazing and replace them if there is any sign of damage which could result in belt failure. If adjustment is required, adjust the belts according to the specifications and procedures shown in the Service Manual.

Special tools are required to properly measure tension and to restore belt tension to factory specifications. Also, check belt routing to make sure there is no interference between the belts and other engine components.

Spark Plugs

Spark plugs must fire properly to assure engine performance and emission control. New plugs should be installed at the mileage specified in the appropriate maintenance chart. The entire set should be replaced if there is any malfunction due to a faulty spark plug.

Refer to the “Vehicle Emission Control Information” label in the engine compartment for spark plug information.

Catalytic Converter

The catalytic converter requires the use of unleaded fuel only. Leaded gasoline will destroy the effectiveness of the converter as an emission control device.

Under normal operating conditions, the catalytic converter will not require maintenance. However, it is important to keep the engine properly tuned to assure proper catalyst operation and prevent possible catalyst damage.

CAUTION!

Damage to the catalytic converter can result if your vehicle is not kept in proper operating condition. In the event of engine malfunction, particularly involving engine misfire or other apparent loss of performance, have your vehicle serviced promptly. Continued operation of your vehicle with a severe malfunction could cause the converter to overheat, resulting in possible damage to the converter and vehicle.

WARNING!

A hot exhaust system can start a fire if you park over materials that can burn. Such materials might be grass or leaves coming into contact with your exhaust system. Do not park or operate your vehicle in areas where your exhaust system can contact anything that can burn.

In unusual situations involving grossly malfunctioning engine operation, a scorching odor may suggest severe and abnormal catalyst overheating. If this occurs, stop the vehicle, turn off the engine and allow it to cool. Service, including a tune up to manufacturer's specifications, should be obtained immediately.

To minimize the possibility of catalytic converter damage:

- Do not shut off the engine or interrupt the ignition when the transmission is in gear and the vehicle is in motion.
- Do not try to start the engine by pushing or towing the vehicle.
- Do not idle the engine with any spark plug wires disconnected or removed, such as when diagnostic testing.
- Do not idle the engine for prolonged periods during very rough idle or malfunctioning operating conditions.
- Do not allow vehicle to run out of fuel.

NOTE: Intentional tampering with emissions control systems can result in civil penalties being assessed against you.

Engine Timing Belt — 2.4L Engine

Replace the engine timing belt at the intervals described in the appropriate maintenance schedule.

Ignition Wiring System — 2.4L Engine

Replace the ignition cables at the intervals described in the appropriate maintenance schedule.

Crankcase Emission Control System

Proper operation of this system depends on freedom from sticking or plugging due to deposits. As vehicle mileage builds up, the PCV valve and passages may accumulate deposits. If a valve is not working properly, replace it with a new valve. **DO NOT ATTEMPT TO CLEAN THE OLD PCV VALVE!**

Check ventilation hose for indication of damage or plugging deposits. Replace if necessary.

Air Cleaner Filter

Under normal driving conditions, replace the air filter at the intervals shown on “Maintenance Schedule A.” If, however, you drive the vehicle frequently under dusty or severe conditions, the filter element should be inspected periodically and replaced if necessary at the intervals shown on “Maintenance Schedule B.”

WARNING!



The air cleaner can provide protection in the case of engine backfire. Do not remove the air cleaner unless it is necessary for repair or maintenance. Make sure that no one is near the engine compartment before starting the vehicle with the air cleaner removed. Failure to do so can result in serious personal injury.

Maintenance-Free Battery

Your vehicle is equipped with a maintenance-free battery. You will never have to add water, nor is periodic maintenance required.

WARNING!

Battery posts, terminals, and related accessories contain lead and lead compounds. Always wash hands after handling the battery.

| | | | |
|--|--------------------------|--|--|
| BATTERY CONDITION INDICATOR | O.K. TO JUMP START |   | <p>DARKENED INDICATOR WITH GREEN DOT</p> <ul style="list-style-type: none"> • BATTERY CHARGE OK • FLUID LEVEL OK <p>DARKENED INDICATOR NO GREEN DOT</p> <ul style="list-style-type: none"> • BATTERY CHARGE LOW • FLUID LEVEL OK |
| | DO NOT JUMP START |  | <p>YELLOW OR BRIGHT INDICATOR</p> <ul style="list-style-type: none"> • BATTERY CHARGE UNKNOWN • FLUID LEVEL LOW <p>(CHARGE MAY STILL BE SUFFICIENT TO START YOUR CAR)</p> |

8000cbee

To determine the battery charge, check the battery test indicator (if equipped) on top of the battery. Refer to the illustration.

CAUTION!

It is essential when replacing the cables on the battery that the positive cable is attached to the positive post and the negative cable is attached to the negative post. Battery posts are marked (+) positive and negative (-) and identified on the battery case. Also, if a “fast charger” is used while battery is in the vehicle, disconnect both vehicle battery cables before connecting the charger to battery. Do not use a “fast charger” to provide starting voltage.

Air Conditioner Maintenance

For best possible performance, your air conditioner should be checked and serviced by an Authorized Dealer at the start of each warm season. This service should include cleaning of the condenser fins and a performance test. Drive belt tension should also be checked at this time.

WARNING!

- Use only refrigerants and compressor lubricants approved by the manufacturer for your air conditioning system. Some unapproved refrigerants are flammable and can explode, injuring you. Other unapproved refrigerants or lubricants can cause the system to fail, requiring costly repairs.
- The air conditioning system contains refrigerant under high pressure. To avoid risk of personal injury or damage to the system, adding refrigerant or any repair requiring lines to be disconnected should be done by an experienced repairman.

Refrigerant Recovery and Recycling

R-134a Air Conditioning Refrigerant is a hydrofluorocarbon (HFC) that is endorsed by the Environmental Protection Agency and is an ozone-saving product. However, the manufacturer recommends that air conditioning service be performed by dealers or other service facilities using recovery and recycling equipment.

NOTE: Air Conditioning systems found to be contaminated with A/C System Sealers, Stop Leak Products, Seal Conditioners, Compressor Oil, or Refrigerants not approved by the manufacturer, voids the warranty for the Air Conditioning system.

Power Steering Fluid Check

Checking the power steering fluid level at a defined service interval is not required. The fluid should only be checked if a leak is suspected, abnormal noises are

apparent, and/or the system is not functioning as anticipated. Coordinate inspection efforts through a certified "DaimlerChrysler Dealership."

WARNING!

Fluid level should be checked on a level surface with the engine off to prevent injury from moving parts, and to insure accurate fluid level reading. Do not overfill. Use only the manufacturer's recommended fluid.

If necessary, add fluid to restore to the proper indicated level. With a clean cloth, wipe any spilled fluid from all surfaces. Refer to Recommended Fluids, Lubricants, and Genuine Parts for correct fluid type.

Driveline And Steering Component Lubrication

U-joints (cardan joints) are sealed and do not require lubrication. Prop shafts, yokes, ball joints and other driveline and steering components may be provided with grease fittings for lubrication. Lubrication of these components at the intervals specified in the appropriate "Maintenance Schedule" in Section 8 is very important, particularly if your vehicle is subjected to off-road or other heavy-duty use. See your authorized dealer for complete service information.

Body Lubrication

Locks and all body pivot points, including such items as seat tracks, doors, swing gate and hood hinges, should be lubricated periodically to assure quiet, easy operation and to protect against rust and wear. Prior to the application of any lubricant, the parts concerned should be wiped clean to remove dust and grit; after lubricating excess oil and grease should be removed. Particular

attention should also be given to hood latching components to insure proper function. When performing other underhood services, the hood latch, release mechanism and safety catch should be cleaned and lubricated.

The external lock cylinders should be lubricated twice a year, preferably in the fall and spring. Apply a small amount of a high quality lubricant such as Mopar® Lock Cylinder Lubricant directly into the lock cylinder.

Windshield Wiper Blades

Clean the rubber edges of the wiper blades and the windshield periodically with a sponge or soft cloth and a mild non-abrasive cleaner. This will remove accumulations of salt or road film.

Operation of the wipers on dry glass for long periods may cause deterioration of the wiper blades. Always use washer fluid when using the wipers to remove salt or dirt from a dry windshield. Avoid using the wiper blades to

remove frost or ice from the windshield. Keep the blade rubber out of contact with petroleum products such as engine oil, gasoline, etc.

Windshield Washers

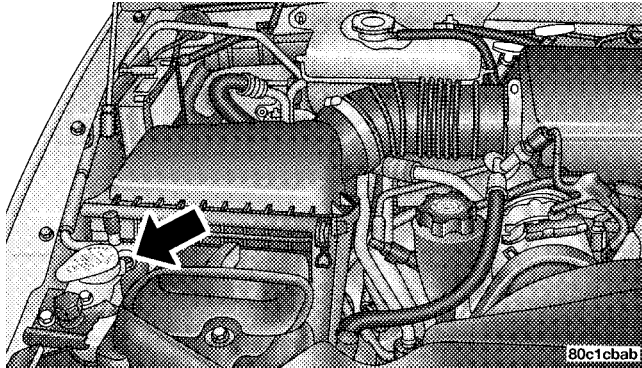

The fluid reservoir for the windshield washers and the rear window washer is shared. It is located in the front of the engine compartment on the passenger side and

should be checked for fluid level at regular intervals. Fill the reservoir with windshield washer solvent (not radiator antifreeze) and operate the system for a few seconds to flush out the residual water.

WARNING!

Commercial windshield washer solvents are flammable. They could ignite and burn you. Care must be exercised when filling or working around the washer solution.

Exhaust System

The best protection against carbon monoxide entry into the vehicle body is a properly maintained engine exhaust system.

If you notice a change in the sound of the exhaust system; or if the exhaust fumes can be detected inside the vehicle;

or when the underside or rear of the vehicle is damaged; have an authorized technician inspect the complete exhaust system and adjacent body areas for broken, damaged, deteriorated, or mispositioned parts. Open seams or loose connections could permit exhaust fumes to seep into the passenger compartment. In addition, inspect the exhaust system each time the vehicle is raised for lubrication or oil change. Replace as required.

Cooling System

WARNING!

You or others can be badly burned by hot coolant or steam from your radiator. If you see or hear steam coming from under the hood, don't open the hood until the radiator has had time to cool. Never try to open a cooling system pressure cap when the radiator or coolant bottle is hot.

Coolant Checks

Check coolant protection every 12 months (before the onset of freezing weather, where applicable). If coolant is dirty or rusty in appearance, the system should be drained, flushed and refilled with fresh coolant.

Check the front of the radiator for any accumulation of bugs, leaves, etc. Clean the radiator by gently spraying water from a garden hose at the back of the core.

Check the engine cooling system hoses for condition and tightness of connection. Inspect the entire system for leaks. Any hoses that show cuts or severe abrasion must be replaced.

Cooling System — Drain, Flush, And Refill

At the intervals shown in the appropriate "Maintenance Schedule," the system should be drained, flushed, and refilled.

If the solution is dirty and contains a considerable amount of sediment, clean and flush with reliable cooling system cleaner. Follow with a thorough rinsing to remove all deposits and chemicals.

Engine Coolant Disposal

Used ethylene glycol based engine coolant is a regulated substance requiring proper disposal. Check with your local authorities to determine the disposal rules for your community. Do not store ethylene glycol based engine coolant in open containers or allow it to remain in puddles on the ground. Prevent ingestion by animals or children. If ingested by a child, contact a physician immediately.

Selection Of Coolant

Use only the manufacturer's recommended coolant, refer to Recommended Fluids, Lubricants, and Genuine Parts for correct coolant type.

CAUTION!

- **Mixing of coolants other than the specified HOAT coolant may result in decreased corrosion protection and engine damage that may not be covered under the new vehicle warranty. If a non-HOAT coolant is introduced into the cooling system in an emergency, it should be replaced with the specified coolant as soon as possible.**
- **Do not use plain water alone or alcohol base antifreeze products. Do not use additional rust inhibitors or antirust products, as they may not be compatible with the radiator coolant and may plug the radiator.**
- **This vehicle has not been designed for use with Propylene Glycol based coolants. Use of Propylene Glycol base coolants is not recommended.**

Adding Coolant

When adding coolant, a minimum solution of 50% recommended ethylene glycol antifreeze coolant in water should be used. Use higher concentrations (not to exceed 70%) if temperatures below -37°F (-38°C) are anticipated.

Use only high purity water such as distilled or deionized water when mixing the water/antifreeze solution. The use of lower quality water will reduce the amount of corrosion protection in the engine cooling system.

Please note that it is the owner's responsibility to maintain the proper level of protection against freezing according to the temperatures occurring in the area where the vehicle is operated.

NOTE: Mixing coolant types will decrease the life of the engine coolant and will require more frequent engine coolant changes.

Cooling System Pressure Cap

The cap must be fully tightened to prevent loss of coolant, and to insure that coolant will return to the radiator from the coolant bottle.

The cap should be inspected and cleaned if there is any accumulation of foreign material on the sealing surfaces.

WARNING!

The warning words DO NOT OPEN HOT on the cooling system pressure cap are a safety precaution. Never add coolant when the engine is overheated. Do not loosen or remove the cap to cool an overheated engine. Heat causes pressure to build up in the cooling system. To prevent scalding or injury, do not remove the pressure cap while the system is hot or under pressure.

Coolant Level

The coolant recovery bottle provides a quick visual method for determining that the coolant level is adequate. The coolant level must be at or above the COLD FULL level on the bottle. The radiator normally remains completely full, so there is no need to remove the radiator cap unless checking for coolant freeze point or replacing coolant. Advise your service attendant of this. As long as the engine operating temperature is satisfactory, the coolant bottle need only be checked once a month.

When additional coolant is needed to maintain the proper level, it should be added to the coolant recovery bottle. Do not overfill.

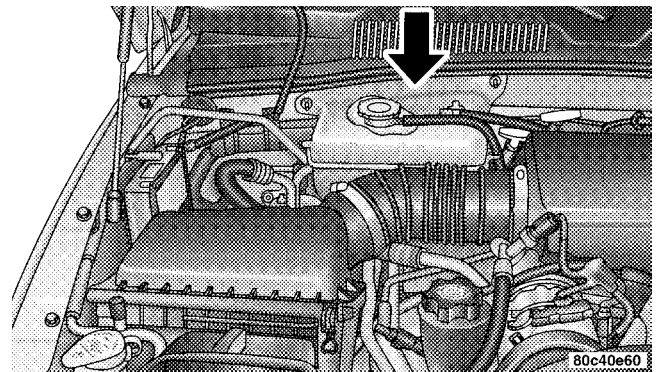

Points To Remember

NOTE: When the vehicle is stopped after a few miles of operation, you may observe vapor coming from the front of the engine compartment. This is normally a result of

moisture from rain, snow, or high humidity accumulating on the radiator and being vaporized when the thermostat opens, allowing hot water to enter the radiator.

If an examination of your engine compartment shows no evidence of radiator or hose leaks, the vehicle may be safely driven. The vapor will soon dissipate.

- Do not overfill the coolant bottle.
- Check coolant freeze point in the system.
- If frequent coolant additions are required, or if the level in the recovery bottle does not drop when the engine cools, the cooling system should be pressure tested for leaks.
- Maintain coolant concentration to 50% ethylene glycol antifreeze (minimum) in water for proper corrosion protection of your engine that contains aluminum components.

- Make sure that the radiator and coolant bottle hoses are not kinked or obstructed.
- Do not change the thermostat for summer or winter operation. If replacement is ever necessary, install **ONLY** the correct type thermostat. Other designs may result in unsatisfactory cooling performance, poor gas mileage, and increased emissions.

Hoses and Vacuum/Vapor Harnesses

Inspect surfaces of hoses and nylon tubing for evidence of heat and mechanical damage. Hard or soft spots, brittle rubber, cracking, tears, cuts, abrasions, and excessive swelling indicate deterioration of the rubber.

Pay particular attention to the hoses nearest to high heat sources such as the exhaust manifold. Inspect hose routing to be sure hoses do not touch any heat source or moving component that may cause heat damage or mechanical wear.

Insure nylon tubing in these areas has not melted or collapsed. Inspect all hose connections such as clamps and couplings to make sure they are secure and no leaks are present. Components should be replaced immediately if there is any evidence of degradation that could cause failure.

Brake System

In order to assure brake system performance, all brake system components should be inspected periodically. Refer to the appropriate "Maintenance Schedule" in Section 8 for suggested service intervals.

WARNING!

Riding the brakes can lead to brake failure and possibly an accident. Driving with your foot resting or riding on the brake pedal can result in abnormally high brake temperatures, excessive lining wear, and possible brake damage. You wouldn't have your full braking capacity in an emergency.

Brake and Power Steering System Hoses

When servicing the vehicle for scheduled maintenance, inspect surface of hoses for evidence of heat and mechanical damage. Hard and brittle rubber, cracking, tears, cuts, abrasion, and excessive swelling suggest deterioration of the rubber. Particular attention should be made to examining those hose surfaces nearest to high heat sources, such as the exhaust manifold.

Inspect all hose clamps and couplings to make sure they are secure and no leaks are present.

NOTE: Often fluids such as oil, power steering fluid, and brake fluid are used during assembly plant operations to ease the assembly of hoses to couplings. Therefore, oil wetness at the hose-coupling area is not necessarily an indication of leakage. Actual dripping of hot fluid when systems are under pressure (during vehicle operation) should be noted before hose is replaced based on leakage.

NOTE: Inspection of brake hoses should be done whenever the brake system is serviced and every engine oil change.

WARNING!

Worn brake hoses can burst and cause brake failure. You could have an accident. If you see any signs of cracking, scuffing, or worn spots, have the brake hoses replaced immediately.

Brake Master Cylinder

The fluid level in the master cylinder should be checked when performing under hood services, or immediately if the "Brake Warning Light" shows system failure.

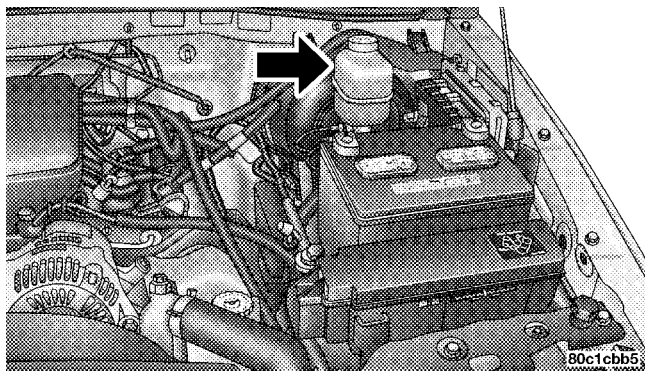

Be sure to clean the top of the master cylinder area before removing the cap. If necessary, add fluid to bring the fluid level up to the requirements described on the brake fluid reservoir. With disc brakes, fluid level can be expected to fall as the brake pads wear. However, low fluid level may be caused by a leak and a checkup may be needed.

Use only manufacturer's recommended brake fluid, refer to Recommended Fluids, Lubricants, and Genuine Parts for correct fluid type.

WARNING!

Use of a brake fluid that may have a lower initial boiling point or unidentified as to specification, may result in sudden brake failure during hard prolonged braking. You could have an accident.

WARNING!

Overfilling the brake fluid reservoir can result in spilling brake fluid on hot engine parts and the brake fluid catching fire.

Use only brake fluid that has been in a tightly closed container to avoid contamination from foreign matter. Do not allow petroleum base fluid to contaminate the brake fluid as seal damage will result.

Automatic Transmission**Selection of Lubricant**

It is important that the proper lubricant is used in the transmission to assure optimum transmission performance. Use only manufacturer's recommended transmission fluid, refer to Recommended Fluids, Lubricants, and Genuine Parts for correct fluid type. It is important that the transmission fluid be maintained at the prescribed level using the recommended fluid.

CAUTION!

Using a transmission fluid other than the manufacturer's recommended fluid may cause deterioration in transmission shift quality and/or torque converter shudder. Using a transmission fluid other than the manufacturer's recommended fluid will result in more frequent fluid and filter changes. Refer to Recommended Fluids, Lubricants, and Genuine Parts for correct fluid type.

Fluid Level Check – 3.7L 42RLE

This fluid level should be checked when the engine is fully warmed up and the fluid in the transmission is heated to its normal operating temperature. Operation of the transmission with an improper fluid level will greatly reduce the life of the transmission and of the fluid.

To check the automatic transmission fluid level properly, the following procedure must be used:

1. The vehicle must be on level ground.
2. The engine should be running at curb idle speed for a minimum of 60 seconds.
3. Fully apply parking brake.
4. Apply the brakes and shift the transmission into P (Park).
5. The fluid **MUST** be checked with the transmission in P (Park) to be sure that the fluid level is accurate.
6. Wipe the dipstick clean and reinsert until seated. Remove dipstick and note reading.

At normal operating temperature (approximately 180° F (82° C), the fluid level is correct if it is in the HOT region

(cross-hatched area) on the oil level indicator. The fluid level indicator should be in the COLD region at 70° F (21° C) fluid temperature.

If the fluid level is low, add sufficient fluid to bring to the proper level. Refer to Recommended Fluids, Lubricants and Genuine Parts for correct fluid type.

Fluid is added through the dipstick tube.

NOTE: To prevent dirt and water from entering the transmission after checking or replenishing fluid, make certain that the dipstick cap is properly reseated.

Special Additives

The manufacturer recommends against the addition of any additives to the transmission. Exception to this policy is the use of special dyes to aid in detecting fluid leaks.

Hydraulic Clutch Fluid — Manual Transmission

The clutch hydraulic system is a sealed maintenance free system. In the event of leakage or other malfunction, the system must be replaced.

Manual Transmission**Selection of Lubricant**

Use only manufacturer's recommended manual transmission fluid, refer to Recommended Fluids, Lubricants, and Genuine Parts for correct fluid type.

Fluid Level Check

Check the fluid level by removing the fill plug. The fluid level should be between the bottom of the fill hole and a point not more than 3/16" (4.76 mm) below the bottom of the hole.

Add fluid, if necessary, to maintain the proper level.

Frequency of Fluid Change

Under normal operating conditions, the fluid installed at the factory will give satisfactory lubrication for the life of the vehicle. Fluid changes are not necessary unless the lubricant has become contaminated with water. If contaminated with water, the fluid should be changed immediately.

Transfer Case**Fluid Level Check**

Inspect the transfer case for fluid leaks. If a fluid leak is evident, the transfer case fluid level can be checked by removing the fill plug (B) located at the back of the transfer case.

The fluid level should be to the bottom edge of the fill hole (A) when the vehicle is in a level position.

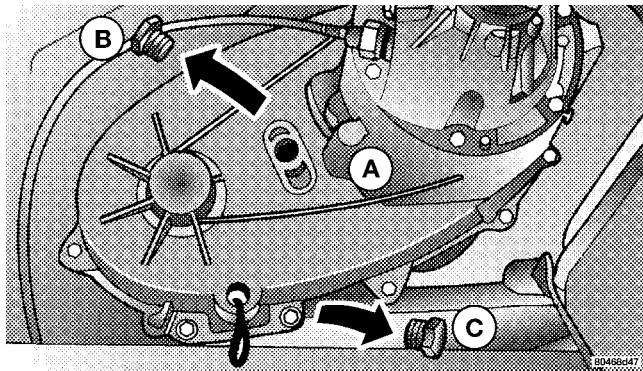

Adding Fluid

Only at filler hole until fluid runs out of the hole, when the vehicle is in a level position.

Drain

First remove fill plug (B), then drain plug (C). Recommended tightening torque for drain and fill plugs is 15–25 ft.lbs. (20–34 N·m).

CAUTION!

When installing plugs, do not overtighten. You could damage them and cause them to leak.

Selection of Lubricant

Use only manufacturer's recommended fluid, refer to Recommended Fluids, Lubricants, and Genuine Parts for correct fluid type.

Front/Rear Axle Fluid

The front axle has a threaded “fill plug” on the cover plate, and a threaded “drain plug” on the bottom side of the carrier.

Fluid Level Check

Lubricant should be 1/2" (1 cm) below the oil fill hole.

Adding Fluid

Add lubricant only at the fill hole and only to the level specified above.

Selection of Lubricant

Use only manufacturer's recommended fluid, refer to Recommended Fluids, Lubricants, and Genuine Parts for correct fluid type.

Appearance Care And Protection From Corrosion**Protection Of Body And Paint From Corrosion**

Vehicle body care requirements vary according to geographic locations and usage. Chemicals that make roads passable in snow and ice, and those that are sprayed on trees and road surfaces during other seasons, are highly corrosive to the metal in your vehicle. Outside parking, which exposes your vehicle to airborne contaminants, road surfaces on which the vehicle is operated, extreme hot or cold weather and other extreme conditions will have an adverse effect on paint, metal trim, and underbody protection.

The following maintenance recommendations will enable you to obtain maximum benefit from the corrosion resistance built into your vehicle.

What Causes Corrosion?

Corrosion is the result of deterioration or removal of paint and protective coatings from your vehicle.

The most common causes are:

- Road salt, dirt and moisture accumulation.
- Stone and gravel impact.
- Insects, tree sap and tar.
- Salt in the air near sea-coast localities.
- Atmospheric fallout/industrial pollutants.

Washing

- Wash your vehicle regularly. Always wash your vehicle in the shade using a mild car wash soap and rinse the panels completely with clear water.
- If insects, tar, or other similar deposits have accumulated on your vehicle, wash it as soon as possible.
- Use Mopar® Auto Polish to remove road film and stains and to polish your vehicle. Take care never to scratch the paint.

- Avoid using abrasive compounds and power buffing that may diminish the gloss or thin out the paint finish.

CAUTION!

Do not use abrasive or strong cleaning materials such as steel wool or scouring powder, which will scratch metal and painted surfaces.

Special Care

- If you drive on salted or dusty roads or if you drive near the ocean, hose off the undercarriage at least once a month.
- It is important that the drain holes in the lower edges of the doors, rocker panels and tailgate must be kept clear and open.

- If you detect any stone chips or scratches in the paint, touch them up immediately. The cost of such repairs is considered the responsibility of the owner.
- If your vehicle is damaged due to an accident or similar cause which destroys the paint and protective coating have your vehicle repaired as soon as possible. The cost of such repairs is considered the responsibility of the owner.
- All wheels and wheel trim, especially aluminum and chrome plated wheels should be cleaned regularly with mild soap and water to prevent corrosion. To remove heavy soil, select a non-abrasive, non-acidic cleaner. Do not use scouring pads, steel wool, a bristle brush, or metal polishes. Only Mopar® Cleaners are recommended. Do not use oven cleaner. Avoid automatic car washes that use acidic solutions or harsh brushes that may damage the wheel's protective finish.
- If you carry special cargo such as chemicals, fertilizers, de-icer salt, etc., be sure that such materials are well packaged and sealed.
- If a lot of driving is done on gravel roads, consider mud or stone shields behind each wheel.
- Use Mopar® Touch Up Paint on scratches or chips as soon as possible. Your authorized dealer has touch up paint to match the color of your vehicle.

Interior Care

Use Mopar® Fabric Cleaner to clean fabric upholstery and carpeting.

Use Mopar® Vinyl Cleaner to clean vinyl or leather upholstery.

Mopar® Vinyl Cleaner is specifically recommended for interior vinyl trim.

Leather Seat Care & Cleaning

Leather is best preserved by regular cleaning with a damp soft cloth. Small particles of dirt can act as an abrasive and damage the leather surface and should be removed promptly with a damp cloth. Stubborn soils can be removed easily with a soft cloth and Mopar® Total Clean. Care should be taken to avoid soaking the leather with any liquid. Please do not use polishes, oils, cleaning fluids, solvents, detergents, or ammonia based cleaners to clean the leather. Application of a leather conditioner is not required to maintain the original condition.

WARNING!

Do not use volatile solvents for cleaning purposes. Many are potentially flammable, and if used in closed areas they may cause respiratory harm.

Glass Surfaces

All glass surfaces should be cleaned on a regular basis with any commercial household-type glass cleaner. Never use an abrasive type cleaner. Use caution when cleaning inside rear windows equipped with electric defrosters. Do not use scrapers or other sharp instruments which may scratch the elements.

When cleaning the rear view mirror, spray cleaner on the towel or rag that you are using. Do not spray cleaner directly on the mirror.

Carpet

Vacuum your carpet regularly to prevent a soil build-up. Shampoo soiled carpet with a reliable upholstery cleaner, using a natural sponge or soft bristle brush. After carpet dries, vacuum it thoroughly.

Seat Belt Maintenance

Do not bleach, dye or clean the belts with chemical solvents or abrasive cleaners. This will weaken the fabric. Sun damage will also weaken the fabric.

If the belts need cleaning, use a mild soap solution or lukewarm water. Do not remove the belts from the vehicle to wash them.

Replace the belts if they appear frayed or worn or if the buckles do not work properly.

Maintenance After Off-Pavement Driving

After extended operation in mud, sand or water, or similar dirty conditions, have your brake drums, brake linings, and axle joints inspected and cleaned as soon as possible. This will prevent any abrasive material from causing excessive wear or unpredictable braking action.

Following off-pavement usage, completely inspect the underbody of your vehicle. Check tires, body structure,

steering, suspension and exhaust system for damage. Check threaded fasteners for looseness, particularly on the chassis, drivetrain components, steering and suspension. Retighten, if required, to torque values specified in the Service Manual. Also check for accumulations of vegetation or brush that could become a fire hazard, or conceal damage to fuel lines, brake hoses, axle pinion seals, and propeller shafts.

CAUTION!

Under frequent heavy-duty driving conditions, change all lubricants and lubricate body components, all driveline joints and steering linkage more often than in normal service to prevent excessive wear.

FUSE PANEL

Interior Fuses

The fuse panel is on the left side of the instrument panel. A label is attached to the fuse panel cover to identify each fuse for ease of replacement.

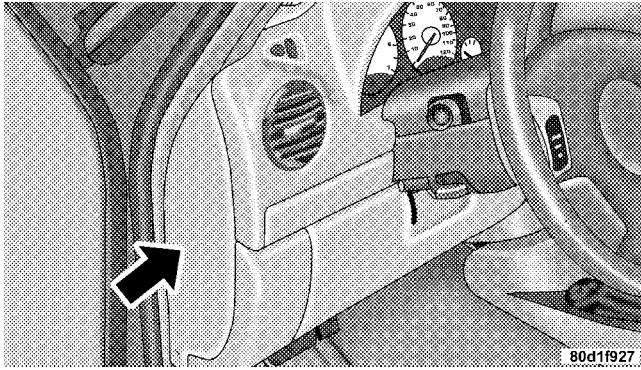

SEE OWNER'S MANUAL FOR DETAILS

| HIGH BEAM | | | DAYTIME RUNNING LIGHTS | | |
|-----------|----|----|------------------------|--|--|
| 1 | 16 | 26 | | | |
| 2 | 17 | 27 | | | |
| 3 | 18 | 28 | | | |
| 4 | 19 | 29 | | | |
| 5 | 20 | 30 | | | |
| 6 | 21 | 31 | | | |
| 7 | 22 | 32 | | | |
| 8 | 23 | 33 | | | |
| 9 | | 34 | | | |
| 10 | | 35 | | | |
| 11 | | 36 | | | |
| 12 | | 37 | | | |
| 13 | | | | | |
| 14 | 24 | 38 | | | |
| 15 | 25 | 39 | | | |

80c9225b

Fuse Panel Description

| Cavity | Fuse | Description |
|--------|---------------|---|
| 1 | 15 Amp Blue | Horn Relay, Power Sunroof Relay, Power Window Relay |
| 2 | 10 Amp Red | Rear Fog Lights (Export Only) |
| 3 | 20 Amp Yellow | Cigar Lighter |
| 4 | 10 Amp Red | Headlight Low Beam Right |
| 5 | 10 Amp Red | Headlight Low Beam Left |
| 6 | 20 Amp Yellow | Body Control Module/Power Door Locks |
| 7 | 10 Amp Red | Left Park Light/Left Tail Lamp/License Plate Lamp |
| 8 | Spare | |
| 9 | 10 Amp Red | Right Park Light/Right Tail Lamp/License Plate Lamp/Cluster |

| Cavity | Fuse | Description |
|--------|---------------|---|
| 10 | Spare | |
| 11 | 15 Amp Blue | Flasher |
| 12 | 15 Amp Blue | Stop Lights |
| 13 | 10 Amp Red | Body Control Module/CMTC/Cluster/Pass. Airbag On,Off Indicator, Auto Daylight Mirror/Light Bar Switch (Renegade Only) |
| 14 | 10 Amp Red | PDC Fuel Pump/AC Clutch, Starter Relay/Engine Controller/Transmission Controller (Diesel Only) |
| 15 | Spare | |
| 16 | 20 Amp Yellow | Power Outlet (Rear) |
| 17 | 15 Amp Blue | Rear Wiper |

322 MAINTAINING YOUR VEHICLE

| Cavity | Fuse | Description |
|--------|---------------|---|
| 18 | 20 Amp Yellow | Radio Choke & Relay |
| 19 | 20 Amp Yellow | Frt Fog Lights/Trailer Tow Stop and Turn Lights |
| 20 | Spare | |
| 21 | 10 Amp Red | Radio |
| 22 | 20 Amp Yellow | Power Sunroof Relay/ Antenna Module (Export Only) |
| 23 | Spare | |
| 24 | 10 Amp Red | PDC Blower Motor |
| 25 | 10 Amp Red | Heated Seat Switches/HVAC Control Head/Trailer Tow Battery Charge |
| 26 | 10 Amp Red | Headlight High Beam Right |
| 27 | 10 Amp Red | Headlight High Beam Left |
| 28 | Spare | |

| Cavity | Fuse | Description |
|--------|-------------|--|
| 29 | 10 Amp Red | Heated Mirrors/Rear Window Defroster Indicator |
| 30 | 15 Amp Blue | Heated Seat Module |
| 31 | Spare | |
| 32 | 10 Amp Red | Wiper Switch/Front and Rear Wipers |
| 33 | 10 Amp Red | SKIM Module/Data Link Connector |
| 34 | 15 Amp Blue | Body Control Module/ Cluster/Interior Lights, Hands Free Module/Radio/ CMTC/ITM Module & Siren (Export Only) |
| 35 | Spare | |
| 36 | 10 Amp Red | Airbag Control Module/ Occupation Classification Module (Right Front Seat) |

| Cavity | Fuse | Description |
|--------|------------|---|
| 37 | 10 Amp Red | Airbag Control Module |
| 38 | 10 Amp Red | ABS Controller/Shifter Assembly |
| 39 | 10 Amp Red | Hazard Flasher (Turn Signals)/Backup Lamp Switch (Manual Transmission Only)/Transmission Range Switch (Automatic Transmission Only) |

Underhood Fuses (Power Distribution Center)

Your vehicle is equipped with an electrical power distribution center located in the engine compartment near the battery. This power center houses plug-in “Cartridge” fuses which replace in-line fusible links. The power center also contains “Mini” fuses and plug-in full and micro ISO relays. A label inside the latching cover of the

center identifies each component for ease of replacement, if necessary. “Cartridge” fuses and relays can be obtained from your authorized dealer.

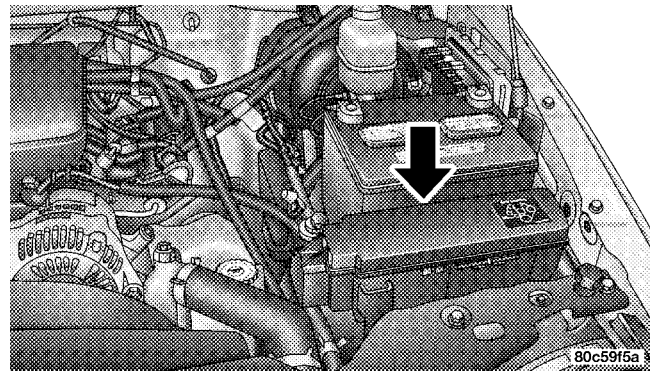

VEHICLE STORAGE

If you are leaving your vehicle dormant for more than 21 days you may want to take steps to protect your battery. You may:

- Remove Cartridge fuse #15 in the Power Distribution Center labeled Ignition-Off Draw (IOD).
- Store the removed IOD fuse in the Power Distribution Center location #11 labeled "IOD Storage."
- Or, disconnect the negative cable from the battery.
- Anytime you store your vehicle, or keep it out of service (i.e. vacation) for two weeks or more, run the air conditioning system at idle for about five minutes in the fresh air and high blower setting. This will insure adequate system lubrication to minimize the possibility of compressor damage when the system is started again.

REPLACEMENT BULBS

| Interior Lights | Bulb Type |
|---|------------------|
| A/C Heater | Not Serviceable |
| Ashtray Receiver Light | 161 |
| Climate Control (Manual A/C) | 74 |
| Front Reading | 192 |
| Rear Cargo Light | 214-2 |
| Lighted Vanity Mirror * | P/N 6501966 |
| Underpanel Courtesy Lights | 906 |
| Instrument Cluster (General Illumination) | 103 |
| Telltale/Hazard Light | 74 |

* Available only from authorized dealers.

| Exterior Lights | Bulb Type |
|---|------------------|
| Backup Lights | 3157 P27/7W |
| Center High-Mounted Stoplight | 921/W16W |
| Fog Lights | 9145 |
| Front Park/Turn Lights | 3157 P27/7W |
| Front Side Marker | 168 |
| Headlights | 9007QL |
| Rear License Plate Light | 168 |
| Rear Stop/Tail Lights | 3157 P27/7W |
| Rear Turn Signal Lights (2) | 3157 P27/7W |
| Underhood Light | 561 |

NOTE: Numbers refer to commercial bulb types that can be purchased from your authorized dealer.

If a bulb needs to be replaced, visit your authorized dealer.

FLUID CAPACITIES

| | U.S. | Metric |
|--|--------------|---------------|
| Fuel (Approximate) | 19.5 Gallons | 74 Liters |
| Engine Oil with Filter | | |
| 2.4 & 3.7 Liter Engine (SAE 5W-30, API Certified Engine Oil) | 5 Qts | 4.7 Liters |
| Cooling System * | | |
| 2.4 Liter Engine (Mopar® Antifreeze/Coolant 5 Year/100,000 Mile Formula) | 10 Qts | 9.5 Liters |
| 3.7 Liter Engine (Mopar® Antifreeze/Coolant 5 Year/100,000 Mile Formula) | 14 Qts | 13.2 Liters |

* Includes heater and coolant recovery bottle filled to MAX level.

RECOMMENDED FLUIDS, LUBRICANTS AND GENUINE PARTS

Engine

| Component | Fluid, Lubricant, or Genuine Part |
|--------------------------|---|
| Engine Coolant | Mopar® Antifreeze/Coolant 5 Year/100,000 Mile Formula HOAT (Hybrid Organic Additive Technology) |
| Engine Oil | Use API Certified SAE 5W-30 Engine Oil. Refer to oil viscosity chart for correct SAE grade meeting DaimlerChrysler Material Standard MS-6395. |
| Oil Filter (2.4L Engine) | Mopar® Oil Filter (P/N 4105409) |
| Oil Filter (3.7L Engine) | Mopar® Oil Filter (P/N 04781452AA) |
| Spark Plugs | Refer to the Vehicle Emission Control Information label in the engine compartment. |
| Fuel Selection | 87 Octane (89 Octane should be used for trailer towing purposes - 3.7L Only). |

Chassis

| Component | Fluid, Lubricant, or Genuine Part |
|---|--|
| Automatic Transmission | Mopar® ATF+4 Automatic Transmission Fluid |
| Manual Transmission | Mopar® Manual Transmission Lubricant (P/N 04874464) |
| Transfer Case | Mopar® ATF+4 Automatic Transmission Fluid |
| Axle Differential (front-rear) | Mopar® SAE 75W-140 (API GL5) Synthetic Gear Lubricant or equivalent. The 8.25 Corporate Rear Axle should use a SAE 75W-90 Gear Lubricant. For trailer towing, the lubricant should be replaced with SAE 75W-140 Synthetic Gear Lubricant. Models equipped with Trac-Lok™ require a friction modifier additive. |
| Brake Master Cylinder | Mopar® DOT 3, SAE J1703 should be used. If DOT 3, SAE J1703 brake fluid is not available, then DOT 4 is acceptable. Use only recommended brake fluids. |
| Power Steering Reservoir | Mopar® ATF+4 Automatic Transmission Fluid |
| Ball Joints, Prop Shafts, U-Joints, Yokes, & Wheel Bearings | Mopar® Multi-Purpose Lube NLGI Grade 2 EP, GC-LB |

MAINTENANCE SCHEDULES

CONTENTS

| | | | |
|---|-----|--------------------------|-----|
| ■ Emission Control System Maintenance | 330 | □ Schedule “B” | 333 |
| ■ Maintenance Schedules | 330 | □ Schedule “A” | 342 |

330 MAINTENANCE SCHEDULES

EMISSION CONTROL SYSTEM MAINTENANCE

The “Scheduled” maintenance services, listed in **bold type** must be done at the times or mileages specified to assure the continued proper functioning of the emission control system. These, and all other maintenance services included in this manual, should be done to provide best vehicle performance and reliability. More frequent maintenance may be needed for vehicles in severe operating conditions such as dusty areas and very short trip driving.

Inspection and service also should be done any time a malfunction is suspected.

NOTE: Maintenance, replacement, or repair of the emission control devices and systems on your vehicle may be performed by any automotive repair establishment or individual using any automotive part which has been certified pursuant to U.S. EPA or, in the State of California, California Air Resources Board regulations.

MAINTENANCE SCHEDULES

There are two maintenance schedules that show the **required** service for your vehicle.

First is Schedule “**B**”. It is for vehicles that are operated under the conditions that are listed below and at the beginning of the schedule.

- Day or night temperatures are below 32°F (0°C).
- Stop and go driving.
- Extensive engine idling.
- Driving in dusty conditions.
- Short trips of less than 10 miles (16.2 km).
- More than 50% of your driving is at sustained high speeds during hot weather, above 90°F (32°C).
- Trailer towing.
- Taxi, police, or delivery service (commercial service).

- Off-road or desert driving.

NOTE: Most vehicles are operated under the conditions listed for Schedule “B.”

Second is Schedule “A”. It is for vehicles that are not operated under any of the conditions listed under Schedule “B.”

Use the schedule that best describes your driving conditions. Where time and mileage are listed, follow the interval that occurs first.

CAUTION!

Failure to perform the required maintenance items may result in damage to the vehicle.

At Each Stop for Fuel

- Check the engine oil level about 5 minutes after a fully warmed engine is shut off. Checking the oil level while the vehicle is on level ground will improve the accuracy of the oil level reading. Add oil only when the level is at or below the ADD or MIN mark.
- Check the windshield washer solvent, add as required.

Once a Month

- Check the tire pressure and look for unusual wear or damage.
- Inspect the battery, and clean and tighten the terminals as required.
- Check the fluid levels of the coolant reservoir, brake master cylinder, and transmission, and add as needed.
- Check all lights and all other electrical items for correct operation.

332 MAINTENANCE SCHEDULES

At Each Oil Change

- Change the engine oil filter.
- Inspect the exhaust system.
- Inspect brake hoses.
- Check the coolant level, hoses, and clamps.
- Inspect manual transmission fluid level — if equipped.
- Rotate the tires at each oil change interval shown on Schedule “A” 6,000 miles (10 000 km) or every other interval shown on Schedule “B” 6,000 miles (10 000 km).
- After completion of off-road operation, the underside of the vehicle should be thoroughly inspected. Examine threaded fasteners for looseness.

Schedule "B"

Follow schedule "B" if you usually operate your vehicle under one or more of the following conditions.

- Day or night temperatures are below 32°F (0°C).
- Stop and go driving.
- Extensive engine idling.
- Driving in dusty conditions.
- Short trips of less than 10 miles (16.2 km).
- More than 50% of your driving is at sustained high speeds during hot weather, above 90°F (32°C).
- Trailer towing.
- Taxi, police, or delivery service (commercial service).
- Off-road or desert driving.

| Miles (Kilometers) | 3,000 (5 000) | 6,000 (10 000) | 9,000 (14 000) | 12,000 (19 000) | 15,000 (24 000) |
|--|------------------|-------------------|-------------------|--------------------|--------------------|
| Change the engine oil and engine oil filter. | X | X | X | X | X |
| Inspect the engine air filter element, replace if necessary. | | | | | X |
| Inspect the brake linings. | | | | X | |
| Drain and refill the front and rear axle fluid‡ | | | | X | |

334 SCHEDULE "B"

| Miles (Kilometers) | 18,000 (29 000) | 21,000 (34 000) | 24,000 (38 000) | 27,000 (43 000) | 30,000 (48 000) |
|--|----------------------------|----------------------------|----------------------------|----------------------------|----------------------------|
| Change the engine oil and engine oil filter. | X | X | X | X | X |
| Inspect the engine air filter element, replace if necessary. | | | | | X |
| Replace the spark plugs. | | | | | X |
| Inspect and replace the PCV valve, if necessary. ◇ | | | | | X |
| Inspect the brake linings. | | | X | | |
| Drain and refill the front and rear axle fluid‡ | | | X | | |
| Inspect the transfer case fluid, add if necessary. | | | | | X |

| Miles (Kilometers) | 33,000 (53 000) | 36,000 (58 000) | 39,000 (62 000) | 42,000 (67 000) | 45,000 (72 000) |
|--|--------------------|--------------------|--------------------|--------------------|--------------------|
| Change the engine oil and engine oil filter. | X | X | X | X | X |
| Inspect the engine air filter element, replace if necessary. | | | | | X |
| Inspect the brake linings. | | X | | | |
| Drain and refill the front and rear axle fluid‡ | | X | | | |
| Inspect the drive belt and replace as needed. | | | | | X |

336 SCHEDULE "B"

| Miles (Kilometers) | 48,000 (77 000) | 51,000 (82 000) | 54,000 (86 000) | 57,000 (91 000) | 60,000 (96 000) |
|---|----------------------------|----------------------------|----------------------------|----------------------------|----------------------------|
| Change the engine oil and engine oil filter. | X | X | X | X | X |
| Inspect the engine air filter element, replace if necessary. | | | | | X |
| Replace the spark plugs. | | | | | X |
| Inspect and replace the PCV valve, if necessary. ◇ | | | | | X |
| Replace the ignition cables (2.4L Only). | | | | | X |
| Inspect the brake linings. | X | | | | X |
| Drain and refill the front and rear axle fluid‡ | X | | | | X |
| Drain and refill the automatic transmission fluid, and replace main sump filter. | | | | | X |
| Inspect the drive belt and replace as needed. Not required if belt was previously | | | | | X |
| Drain and refill the transfer case fluid. | | | | | X |

| Miles (Kilometers) | 63,000 (101 000) | 66,000 (106 000) | 69,000 (110 000) | 72,000 (115 000) | 75,000 (120 000) |
|---|---------------------|---------------------|---------------------|---------------------|---------------------|
| Change the engine oil and engine oil filter. | X | X | X | X | X |
| Inspect the engine air filter element, replace if necessary. | | | | | X |
| Inspect the brake linings. | | | | X | |
| Drain and refill the front and rear axle fluid‡ | | | | X | |
| Inspect the drive belt and replace as needed. Not required if belt was previously replaced. | | | | | X |

338 SCHEDULE "B"

| Miles (Kilometers) | 78,000 (125 000) | 81,000 (130 000) | 84,000 (134 000) | 87,000 (139 000) | 90,000 (144 000) |
|---|-----------------------------|-----------------------------|-----------------------------|-----------------------------|-----------------------------|
| Change the engine oil and engine oil filter. | X | X | X | X | X |
| Inspect the engine air filter element, replace if necessary. | | | | | X |
| Replace the spark plugs. | | | | | X |
| Inspect and replace the PCV valve, if necessary. ◇ | | | | | X |
| Inspect the brake linings. | | | X | | |
| Drain and refill the front and rear axle fluid‡ | | | X | | |
| Inspect the drive belt and replace as needed. Not required if belt was previously replaced. | | | | | X |
| Replace the timing belt (2.4L Only). | | | | | X |
| Inspect the transfer case fluid, add if necessary. | | | | | X |

| Miles (Kilometers) | 93,000 (149 000) | 96,000 (154 000) | 99,000 (158 000) | 102,000 (163 000) | 105,000 (168 000) |
|---|---------------------|---------------------|---------------------|----------------------|----------------------|
| Change the engine oil and engine oil filter. | X | X | X | X | X |
| Inspect the engine air filter element, replace if necessary. | | | | | X |
| Inspect the brake linings. | | X | | | |
| Drain and refill the front and rear axle fluid‡ | | X | | | |
| Inspect the drive belt and replace as needed. Not required if belt was previously replaced. | | | | | X |
| Flush and replace the engine coolant. | | | | X | |

340 SCHEDULE "B"

| Miles (Kilometers) | 108,000 (173 000) | 111,000 (178 000) | 114,000 (182 000) | 117,000 (187 000) | 120,000 (192 000) |
|---|----------------------|----------------------|----------------------|----------------------|----------------------|
| Change the engine oil and engine oil filter. | X | X | X | X | X |
| Inspect the engine air filter element, replace if necessary. | | | | | X |
| Replace the spark plugs. | | | | | X |
| Inspect and replace the PCV valve, if necessary. ◇ | | | | | X |
| Replace the ignition cables (2.4L Only). | | | | | X |
| Inspect the brake linings. | X | | | | X |
| Drain and refill the front and rear axle fluid‡ | X | | | | X |
| Drain and refill the automatic transmission fluid, and replace main sump filter. | | | | | X |
| Inspect the drive belt and replace as needed. Not required if belt was previously replaced. | | | | | X |
| Drain and refill the transfer case fluid. | | | | | X |

Inspection and service should be performed anytime a malfunction is observed or suspected. Retain all receipts.

◇ This maintenance is recommended by the manufacturer to the owner, but it is not required to maintain emissions warranty.

‡Off-highway operation, trailer towing, taxi, limousine, bus, snow plowing, or other types of commercial service or prolonged operation with heavy loading, especially in hot weather, require front and rear axle service indicated with a ‡ in Schedule "B". Perform these services if the vehicle is usually operated under these conditions.

342 SCHEDULE "A"

Schedule "A"

| Miles (Kilometers) [Months] | 6,000 (10 000) [6] | 12,000 (19 000) [12] | 18,000 (29 000) [18] | 24,000 (38 000) [24] | 30,000 (48 000) [30] |
|--|--------------------------|----------------------------|----------------------------|----------------------------|----------------------------|
| Change the engine oil and engine oil filter. | X | X | X | X | X |
| Inspect the engine air filter element, and replace if necessary. | | | | | X |
| Replace the spark plugs. | | | | | X |
| Inspect the brake linings. | | | X | | |
| Inspect the transfer case fluid. | | | | | X |

| Miles (Kilometers) [Months] | 36,000 (58 000) [36] | 42,000 (67 000) [42] | 48,000 (77 000) [48] | 54,000 (86 000) [54] |
|--|----------------------------|----------------------------|----------------------------|----------------------------|
| Change the engine oil and engine oil filter. | X | X | X | X |
| Inspect the brake linings. | X | | | X |

344 SCHEDULE "A"

| Miles (Kilometers) [Months] | 60,000 (96 000) [60] | 66,000 (106 000) [66] | 72,000 (115 000) [72] | 78,000 (125 000) [78] |
|--|-------------------------------------|--------------------------------------|--------------------------------------|--------------------------------------|
| Change the engine oil and engine oil filter. | X | X | X | X |
| Inspect the brake linings. | | | X | |
| Inspect the engine air filter element, and replace if necessary. | X | | | |
| Replace the spark plugs. | X | | | |
| Inspect the ignition cables, and replace if necessary (2.4L Only). | X | | | |
| Inspect and replace the PCV valve, if necessary. ◇ | X | | | |
| Inspect the drive belt and replace, if needed. | X | | | |
| Inspect the drive belt and replace as needed. Not required if previously replaced. | | | X | |
| Flush and replace the engine coolant at 60 months, regardless of mileage. | X | | | |
| Inspect the transfer case fluid. | X | | | |

| Miles (Kilometers) [Months] | 84,000 (134 000) [84] | 90,000 (144 000) [90] | 96,000 (154 000) [96] | 102,000 (163 000) [102] |
|--|-----------------------------|-----------------------------|-----------------------------|-------------------------------|
| Change the engine oil and engine oil filter. | X | X | X | X |
| Inspect the brake linings. | | X | | |
| Inspect the engine air filter element, and replace if necessary. | | X | | |
| Replace the spark plugs. | | X | | |
| Inspect and replace the PCV valve, if necessary. ◇ | | X | | |
| Inspect the drive belt and replace as needed. Not required if previously replaced. | X | | X | |
| Flush and replace the engine coolant if not done at 60 months. | | | | X |
| Inspect the transfer case fluid. | | X | | |

346 SCHEDULE "A"

| Miles (Kilometers) [Months] | 108,000 (173 000) [108] | 114,000 (182 000) [114] | 120,000 (192 000) [120] |
|--|-------------------------------|-------------------------------|-------------------------------|
| Change the engine oil and engine oil filter. | X | X | X |
| Inspect the brake linings. | X | | |
| Inspect the engine air filter element, and replace if necessary. | | | X |
| Replace the spark plugs. | | | X |
| Inspect and replace the PCV valve, if necessary. ◇ | | | X |
| Inspect the ignition cables, and replace if necessary (2.4L Only). | | | X |
| Inspect the drive belt and replace as needed. Not required if previously replaced. | X | | X |
| Flush and replace the engine coolant if not done at 163 000 km (102,000 miles). | | | X |
| Replace the timing belt (2.4L Only). | | | X |
| Drain and refill the transfer case fluid. | | | X |

Inspection and service should be performed anytime a malfunction is observed or suspected. Retain all receipts.

◇ This maintenance is recommended by the manufacturer to the owner, but it is not required to maintain emissions warranty.

IF YOU NEED CONSUMER ASSISTANCE

CONTENTS

| | | | |
|--|-----|--------------------------------------|-----|
| ■ Suggestions For Obtaining Service For Your Vehicle | 348 | ■ Warranty Information | 351 |
| □ Prepare For The Appointment | 348 | ■ Mopar® Parts | 353 |
| □ Prepare A List | 348 | ■ Reporting Safety Defects | 353 |
| □ Be Reasonable With Requests | 348 | □ In Canada | 353 |
| ■ If You Need Assistance | 348 | ■ Publication Order Forms | 354 |

SUGGESTIONS FOR OBTAINING SERVICE FOR YOUR VEHICLE**Prepare For The Appointment**

If you're having warranty work done, be sure to have the right papers with you. Take your warranty folder. All work to be performed may not be covered by the warranty, discuss additional charges with the service manager. Keep a maintenance log of your vehicle's service history. This can often provide a clue to the current problem.

Prepare A List

Make a written list of your vehicle's problems or the specific work you want done. If you've had an accident, or work done that is not on your maintenance log, let the service advisor know.

Be Reasonable With Requests

If you list a number of items, and you must have your vehicle by the end of the day, discuss the situation with the service advisor and list the items in order of priority. At many dealers you may obtain a rental vehicle at a minimal daily charge. If you need a rental, it is advisable to make these arrangements when you call for an appointment.

IF YOU NEED ASSISTANCE

The manufacturer and its dealers are vitally interested in your satisfaction. We want you to be happy with our products and services.

Your selling dealer is best equipped and most anxious to provide prompt resolution for any warranty issue or related matter that you may experience. The manufacturer's dealers have the facilities, factory-trained technicians, special tools, and the latest information to assure your vehicle is fixed correctly and in a timely manner.

The manufacturer has empowered its dealers to make warranty and repair decisions that ensure you are not inconvenienced. There is no need for you to wait for a decision from the manufacturer. If a special circumstance occurs that requires information from the manufacturer, we have asked the dealer's service management to make the contact on your behalf.

This is why you should always talk to your dealer's service manager first. Most matters can be resolved with this process.

- If for some reason you are still not satisfied, talk to the general manager or owner of the dealership. They want to know if you need assistance.
- If your dealership is unable to resolve the concern, you may contact the Manufacturer's Customer Center.

Any communication to the Manufacturer's Customer Center should include the following information:

- Owner's name and address
- Owner's telephone number (home and office)
- Dealership name
- Vehicle identification number
- Vehicle delivery date and mileage

DaimlerChrysler Motors Corporation Customer Center

P.O. Box 21-8004

Auburn Hills, MI 48321-8004

Phone: (800) 992-1997

DaimlerChrysler Canada Inc. Customer Center

P.O. Box 1621

Windsor, Ontario N9A 4H6

Phone —(800) 465-2001

In Mexico contact:

Av. Prolongacion Paseo de la Reforma, 1240
Sante Fe C.P. 05109
Mexico, D. F.
In Mexico (915) 729-1248 or 729-1240
Outside Mexico (525) 729-1248 or 729-1240

Customer Assistance For The Hearing Or Speech Impaired (TDD/TTY)

To assist customers who have hearing difficulties, the manufacturer has installed special TDD (Telecommunication Devices for the Deaf) equipment at its Customer Center. Any hearing or speech impaired customer who has access to a TDD or a conventional teletypewriter (TTY) in the United States can communicate with the manufacturer by dialing 1-800-380-CHRY.

Service Contract

You may have purchased a service contract for your vehicle to help protect you from the high cost of unexpected repairs after your manufacturer's new vehicle limited warranty expires. The manufacturer stands behind only the manufacturer's Service Contracts. If you purchased a manufacturer's Service Contract, you will receive Plan Provisions and an Owner Identification Card in the mail within three weeks of your vehicle delivery date. If you have any questions about your service contract, call the manufacturer's Service Contract National Customer Hotline at 1-800-521-9922.

The manufacturer will not stand behind any service contract that is not the manufacturer's Service Contract. It is not responsible for any service contract other than the manufacturer's Service Contract. If you purchased a service contract that is not a manufacturer's Service Contract, and you require service after your manufacturer's new vehicle limited warranty expires, please refer to your contract documents, and contact the person listed in those documents.

We appreciate that you have made a major investment when you purchased your new vehicle. Your dealer has also made a major investment in facilities, tools, and training to assure that you are absolutely delighted with your ownership experience. You'll be pleased with their sincere efforts to resolve any warranty issues or related concerns.

WARRANTY INFORMATION

See your manufacturer's Warranty Information Booklet for information on warranty coverage and transfer of warranty.

352 IF YOU NEED CONSUMER ASSISTANCE

| DESCRIPTION | 1 Yr/ 12,000 | 2 Yr/ 24,000 | 3 Yr/ 36,000 | 3 Yr/ 50,000 | 3 Yr/ Unimtd | 5 Yr/ 100,000 | 7 Yr/ 70,000 | 8 Yr/ 80,000 |
|--|-----------------|-----------------|-----------------|---|-----------------|------------------|-----------------|-----------------|
| Basic Limited Warranty Coverage | | | | | | | | |
| Special Extended Warranty Coverage | | | | | | | | |
| Powertrain Limited Warranty (\$100 deductible) | | | | 1st Owner & 2nd Owner with Paid Powertrain Transfer | | | | |
| | | | | 2nd Owner if Powertrain Not Transferred and 3rd (And After) Owners | | | | |
| Anti-Corrosion Perforation Limited Warranty: All Panels | | | | | | | | |
| Outer Panels | | | | | | | | |
| Federal Emission Warranty | | | | | | | | |
| Federal Emission Warranty - Specified Components | | | | | | | | |
| California Emission Warranty | | | | | | | | |
| California Emission Warranty - Specified Components | | | | | | | | |

NOTE: Vehicles used as a police vehicle, taxi, limousine, postal delivery vehicle, ambulance or rental vehicle are covered only under the 3 year/36,000 mile Basic Limited Warranty. 8132c269

MOPAR® PARTS

Mopar® fluids, lubricants, parts, and accessories are available from your dealer. They will help you keep your vehicle operating at its best.

REPORTING SAFETY DEFECTS

In the 50 United States and Washington D.C.: If you believe that your vehicle has a defect which could cause a crash or cause injury or death, you should immediately inform the National Highway Traffic Safety Administration (NHTSA) in addition to notifying the manufacturer.

If NHTSA receives similar complaints, it may open an investigation, and if it finds that a safety defect exists in a group of vehicles, it may order a recall and remedy campaign. However, NHTSA cannot become involved in individual problems between you, your dealer, and the manufacturer.

To contact NHTSA, you may either call the Auto Safety Hotline toll free at 1-800-424-9393 (or 366-0123 in Washington DC area) or write to: NHTSA, U.S. Dept. of Transportation, Washington DC 20590. You can also obtain other information about motor vehicle safety from the Hotline.

In Canada:

If you believe that your vehicle has a safety defect, you should contact the Customer Service Department immediately. Canadian customers who wish to report a safety defect to the Canadian government should write to Transport Canada, Motor Vehicle Defect Investigations and Recalls, 2780 Sheffield Road, Ottawa, Ontario K1B 3V9.

PUBLICATION ORDER FORMS

To order the following manuals, you may use either the website or the phone numbers listed below. Visa, Mastercard, American Express, and Discover orders are accepted. If you prefer mailing your payment, please call for an order form.

NOTE: A street address is required when ordering manuals. (No P.O. Boxes).

- *Service Manuals.*

These comprehensive service manuals provide the information that students and professional technicians need in diagnosing/troubleshooting, problem solving, maintaining, servicing and repairing DaimlerChrysler Corporation vehicles. A complete working knowledge of the vehicle, system and/or components is written in straightforward language with illustrations, diagrams and charts.

- *Diagnostic Procedure Manuals.*

Filled with diagrams, charts and detailed illustrations, these practical manuals make it easy for students and technicians to find and fix problems on computer-controlled vehicle systems and features. They show exactly how to find and correct problems the first time, using step-by-step troubleshooting and driveability procedures, proven diagnostic tests and a complete list of all tools and equipment.

- *Owner's Manuals.*

These manuals have been prepared with the assistance of service and engineering specialists to acquaint you with specific Chrysler group vehicles. Included are starting, operating, emergency and maintenance procedures as well as specifications, capabilities and safety tips.

Call Toll Free at **1-800-890-4038 (U.S.)** or **1-800-387-1143 (Canada)**

Or

Visit us on the World Wide Web at:

www.techauthority.daimlerchrysler.com or
www.daimlerchrysler.ca/manuals

INDEX

| | | | |
|--|-----------|---------------------------------------|---------|
| Adding Washer Fluid | 204 | Antenna, Satellite Radio | 193 |
| Air Cleaner, Engine | 297 | Antifreeze (Engine Coolant) | 326 |
| Air Conditioner Maintenance | 299 | Anti-Lock Brake System | 234 |
| Air Conditioning | 200 | Anti-Lock Warning Light | 152 |
| Air Conditioning Controls | 200,201 | Appearance Care | 315 |
| Air Conditioning, Operating Tips | 202 | Arming Theft System | 28 |
| Air Conditioning Refrigerant | 300 | Auto Down Power Windows | 33 |
| Air Conditioning System | 200 | Automatic Dimming Mirror | 76 |
| Air Filter | 297 | Automatic Door Locks | 21 |
| Air Pressure, Tires | 249 | Automatic Transmission | 216,311 |
| Airbag | 46 | Adding Fluid | 312 |
| Airbag Deployment | 55 | Fluid and Filter Changes | 311 |
| Airbag Light | 51,58,157 | Fluid Level Check | 311 |
| Airbag Maintenance | 57 | Fluid Type | 311 |
| Airbag, Window | 47 | Gear Ranges | 217 |
| Alarm | 28 | Shifting | 216 |
| Alarm, Panic | 25 | Special Additives | 312 |
| Alignment and Balance | 253 | Torque Converter | 221 |
| Alterations/Modifications, Vehicle | 8 | Auxiliary Electrical Outlet | 133 |

| | | | |
|---|---------|--|-----------------|
| Auxiliary Power Outlet | 133 | Bulbs, Light | 324 |
| Bar, Light | 103 | Calibration, Compass | 122 |
| Battery | 298 | Capacities, Fluid | 326 |
| Emergency Starting | 279 | Caps, Filler | |
| Keyless Transmitter Replacement | 27 | Fuel | 262 |
| Saving Feature | 102 | Radiator | 305 |
| Belts, Drive | 294 | Car Washes | 316 |
| Body Mechanism Lubrication | 301 | Cargo Area Cover | 137 |
| B-Pillar Location | 244 | Cargo Area Features | 137 |
| Brake System | 308 | Cargo Compartment | |
| Anti-Lock | 152,234 | Light | 99,137 |
| Hoses | 308 | Luggage Carrier | 142 |
| Master Cylinder | 310 | Cargo Light | 99,137 |
| Parking | 232 | Cargo Organizer | 140 |
| Warning Light | 155 | Cargo Tie-Downs | 138 |
| Brake/Transmission Interlock | 216 | Carpeting | 318 |
| Break-In Recommendations, New Vehicle | 68 | Cassette Tape and Player Maintenance | 196 |
| Bulb Replacement | 324 | Cassette Tape Player | 160,162,174,178 |

| | | | |
|-------------------------------------|-------------------------|-----------------------------|---------|
| Catalytic Converter | 295 | Compass | 122 |
| Caution, Exhaust Gas | 68 | Compass Calibration | 122 |
| CD Changer | 164,171,182 | Compass Variance | 123 |
| CD Player | 167,169,174,180,183,186 | Computer, Trip/Travel | 120 |
| CD Player Maintenance | 197 | Console, Overhead | 110 |
| Cellular Phone | 78,198 | Contract, Service | 350 |
| Chains, Tire | 257 | Converter, Catalytic | 295 |
| Changing A Flat Tire | 274 | Cooling System | 303 |
| Charging System Light | 153 | Adding Coolant (Antifreeze) | 305 |
| Chart, Tire Sizing | 241 | Coolant Capacity | 326 |
| Child Restraint | 58,63,65 | Coolant Level | 306 |
| Child Restraint Tether Anchors | 62,63 | Disposal of Used Coolant | 304 |
| Child Safety Locks | 22 | Drain, Flush, and Refill | 303 |
| Cigar Lighter | 135 | Inspection | 303 |
| Climate Control | 198 | Points to Remember | 306 |
| Clock | 158 | Pressure Cap | 305 |
| Clutch Interlocking Ignition System | 210,215 | Radiator Cap | 305 |
| Command-Trac Operation | 222 | Selection of Coolant | 304,326 |
| Compact Disc Maintenance | 197 | Temperature Gauge | 153 |

| | | | |
|---|-----|---|-----|
| Crankcase Emission Control System | 297 | Used Engine Fluids | 294 |
| Cruise Control | 108 | Door Locks | 18 |
| Cruise Light | 155 | Door Locks, Automatic | 21 |
| Cup Holder | 136 | Door Opener, Garage | 125 |
| Customer Assistance | 348 | Doors | 18 |
| Cylinder, Retest Requirements | 102 | Drive Belts | 294 |
| Daytime Running Lights | 102 | Driving | 236 |
| Dealer Service | 289 | Off-Pavement | 236 |
| Defroster, Rear Window | 204 | On Hills | 237 |
| Diagnostic System, Onboard | 287 | On Slippery Surfaces | 237 |
| Dimmer Switch, Headlight | 101 | When to Use Low Range | 236 |
| Dipsticks | | Electric Remote Mirrors | 77 |
| Oil (Engine) | 290 | Electrical Outlet, Auxiliary | 133 |
| Power Steering | 300 | Electrical Power Outlets | 133 |
| Disabled Vehicle Towing | 281 | Electronic Speed Control | 108 |
| Disarming, Theft System | 28 | Electronic Vehicle Information Center | 112 |
| Disposal | | Emergency, In Case of | |
| Engine Oil | 294 | Hazard Warning Flasher | 272 |

| | | | |
|---|---------|--|---------|
| Jump Starting | 279 | Oil Filter | 294 |
| Tow Hooks | 281 | Oil Filter Disposal | 294 |
| Emission Control System Maintenance | 288,330 | Oil Selection | 293,326 |
| Engine | | Overheating | 273 |
| Air Cleaner | 297 | Starting | 210 |
| Block Heater | 212 | Temperature Gauge | 153 |
| Break-In Recommendations | 68 | Timing Belt | 297 |
| Checking Oil Level | 290 | Engine Oil Viscosity Chart | 293 |
| Compartment | 285,286 | Enhanced Accident Response Feature | 56 |
| Compartment Identification | 285,286 | Entry System, Illuminated | 17 |
| Cooling | 303 | Exhaust Gas Caution | 68 |
| Fails to Start | 211 | Exhaust System | 302 |
| Flooded, Starting | 211 | Exterior Finish Care | 316 |
| Fuel Requirements | 259,326 | | |
| Jump Starting | 279 | Filters | |
| Malfunction Indicator | 152 | Air Cleaner | 297 |
| Oil | 290,326 | Engine Oil | 294 |
| Oil Change Interval | 292 | Finish Care | 316 |
| Oil Disposal | 294 | | |

| | | | |
|-------------------------|---------|---------------------------|---------|
| Flashers | | Four-Way Hazard Flasher | 272 |
| Hazard Warning | 272 | Front Axle | 315 |
| Turn Signal | 151 | Fuel | 259 |
| Flat Tire Changing | 274 | Filler Cap | 262 |
| Flooded Engine Starting | 211 | Filler Door | 262 |
| Fluid Capacities | 326 | Gasoline | 259 |
| Fluid Leaks | 70 | Gauge | 157 |
| Fluid Level Checks | 70 | Materials Added | 262 |
| Automatic Transmission | 311 | Octane Rating | 259 |
| Clutch Fluid | 313 | Requirements | 259,326 |
| Engine Oil | 290 | Tank Capacity | 326 |
| Manual Transmission | 313 | Fuel System Caution | 263 |
| Power Steering | 300 | Fuses | 320 |
| Fog Lights | 102 | Garage Door Opener | 125 |
| Folding Rear Seat | 94 | Gas Cap | 262 |
| Four Wheel Drive | 222 | Gasoline | 259 |
| Operation | 222 | Gasoline, Reformulated | 260 |
| Shifting | 225,230 | Gasoline/Oxygenate Blends | 260 |
| Systems | 222,226 | | |

| | | | |
|------------------------|---------|-----------------------------|---------|
| Gauges | | Switch | 101 |
| Coolant Temperature | 153 | Heated Mirrors | 78 |
| Fuel | 157 | Heated Seats | 97 |
| Odometer | 154 | Heater | 198 |
| Speedometer | 151 | Heater, Engine Block | 212 |
| Tachometer | 151 | Holder, Cup | 136 |
| Gear Ranges | 215,217 | Homelink Transmitter | 125 |
| General Information | 256 | Hood Release | 97 |
| Glass Cleaning | 318 | Hoses | 307 |
| Glove Compartment | 135 | Hydraulic Clutch Fluid | 313 |
| Hands-Free Phone | 78 | Identifying Your Engine | 285,286 |
| Hazard Warning Flasher | 272 | Ignition | |
| Head Restraints | 92 | Key | 12 |
| Head Rests | 92 | Wiring System | 297 |
| Headlights | 101 | Illuminated Entry | 17 |
| High Beam | 151 | Inflation Pressure Tires | 249 |
| Lights On Reminder | 102 | Information Center, Vehicle | 112 |
| Passing | 101 | Inside Rearview Mirror | 75 |

| | | | |
|---|-----|--|--------|
| Instrument Cluster | 150 | Keyless Entry System | 23 |
| Instrument Panel and Controls | 149 | Keys | 12 |
| Interior Appearance Care | 317 | Lane Change and Turn Signals | 151 |
| Interior Fuses | 320 | Lap/Shoulder Belts | 35 |
| Interior Lighting | 98 | LATCH (Lower Anchors and Tether for | |
| Interior Lights | 98 | CHildren) | 62,63 |
| Intermittent Wipers | 107 | Lead Free Gasoline | 259 |
| Introduction | 4 | Light Bar | 103 |
| Jack Location | 274 | Lighter, Cigar | 135 |
| Jack Operation | 276 | Lights | 98,324 |
| Jacking Instructions | 276 | Airbag | 58,157 |
| Jump Starting | 279 | Anti-Lock | 152 |
| Key, Programming | 16 | Battery Saver | 102 |
| Key Release Button | 13 | Brake Warning | 155 |
| Key, Replacement | 15 | Cargo | 99,137 |
| Key, Sentry | 14 | Cruise | 155 |
| Key-In Reminder | 14 | Daytime Running | 102 |
| | | Dimmer Switch, Headlight | 99,101 |

| | | | |
|----------------------------|-----|--|---------|
| Dome | 111 | Passing | 101 |
| Fog | 102 | Reading | 111 |
| Four-Wheel Drive Indicator | 152 | Seat Belt Reminder | 157 |
| Fuses | 320 | Sentry Key | 157 |
| Hazard Warning Flasher | 272 | Transfer Case | 155,156 |
| Headlight Switch | 101 | Transmission Warning | 155 |
| Headlights | 101 | Turn Signal | 101,151 |
| Headlights On Reminder | 102 | Warning (Instrument Cluster Description) | 151 |
| Headlights On With Wipers | 101 | Loading Vehicle | |
| High Beam Indicator | 151 | Tires | 244 |
| Instrument Cluster | 101 | Locks | |
| Intensity Control | 99 | Automatic Door | 21 |
| Interior | 98 | Child Protection | 22 |
| Lights On Reminder | 102 | Door | 18 |
| Low Fuel | 157 | Power Door | 21 |
| Malfunction Indicator | 152 | Steering Wheel | 17 |
| Map Reading | 100 | Lower Anchors and Tether for CHildren | |
| Oil Pressure | 155 | (LATCH) | 62,63 |
| Park | 101 | Lubrication, Body | 301 |

| | | | |
|---------------------------------------|---------|--|---------|
| Lug Nuts | 278 | Master Cylinder | 310 |
| Luggage Carrier | 142 | Mini-Trip Computer | 120 |
| Luggage Rack | 142 | Mirrors | 75 |
| | | Automatic Dimming | 76 |
| Maintenance Free Battery | 298 | Electric Remote | 77 |
| Maintenance Procedures | 290 | Heated | 78 |
| Maintenance Schedule | 330 | Outside | 76 |
| Light Duty Schedule "A" | 342 | Rearview | 75 |
| Light Duty Schedule "B" | 333 | Vanity | 78 |
| Schedule "A" | 342 | Modifications/Alterations, Vehicle | 8 |
| Schedule "B" | 333 | Monitor, Tire Pressure System | 113,254 |
| Maintenance, Sunroof | 132 | Mopar Parts | 289,353 |
| Malfunction Indicator Light | 152,288 | Multi-Function Control Lever | 100 |
| Manual, Service | 354 | | |
| Manual Transmission | 213,313 | New Vehicle Break-In Period | 68 |
| Fluid Level Check | 313 | | |
| Lubricant Selection | 313 | Occupant Classification System | 51 |
| Shift Speeds | 215 | Occupant Restraints | 34 |
| Map/Reading Lights | 111 | Octane Rating, Gasoline | 259 |

| | | | |
|---------------------------|---------|---------------------------------------|-----|
| Odometer | 154 | Outside Rearview Mirrors | 76 |
| Trip | 154 | Overhead Console | 110 |
| Off-Pavement Driving | 236,319 | Overheating, Engine | 273 |
| Off-Road Driving | 319 | Owner's Manual | 354 |
| Oil, Engine | 290 | Paint Care | 315 |
| Capacity | 326 | Paint Damage | 315 |
| Change Interval | 292 | Panic Alarm | 25 |
| Checking | 290 | Parking Brake | 232 |
| Dipstick | 290 | Passing Light | 101 |
| Identification Logo | 293 | PCV Valve | 297 |
| Materials Added to | 294 | Pets | 67 |
| Pressure Warning Light | 155 | Phone, Cellular | 78 |
| Recommendation | 293,326 | Phone, Hands-Free | 78 |
| Viscosity | 293,326 | Placard, Tire and Loading Information | 244 |
| Oil Filter, Selection | 294 | Polishing and Waxing | 316 |
| Oil Pressure Light | 155 | Power | |
| Onboard Diagnostic System | 287,288 | Distribution Center | 323 |
| Opener, Garage Door | 125 | Door Locks | 21 |
| Organizer, Cargo | 140 | | |

| | | | |
|----------------------------------|-----------------|---|-----|
| Mirrors | 77 | Rear Swing Gate | 29 |
| Outlet | 133 | Rear Window Defroster | 204 |
| Seats | 93 | Rear Window Features | 203 |
| Steering | 300 | Rear Wiper/Washer | 203 |
| Sunroof | 130 | Rearview Mirrors | 75 |
| Windows | 32 | Reclining Front Seats | 91 |
| Pregnant Women and Seat Belts | 45 | Recommended Fluids, Lubricants and Genuine Parts | 327 |
| Preparation for Jacking | 276 | Recreational Towing | 267 |
| Pretensioners | | Shifting into Transfer Case Neutral (N) | 267 |
| Seat Belts | 43 | Shifting out of Transfer Case Neutral (N) | 269 |
| Programmable Electronic Features | 115 | Reformulated Gasoline | 260 |
| Programming Transmitters | 26 | Refrigerant | 300 |
| Radial Ply Tires | 251 | Reminder, Lights On | 102 |
| Radio | 160,167,174,183 | Reminder, Seat Belt | 44 |
| Radio Broadcast Signals | 158 | Remote Keyless Entry | 23 |
| Radio Operation | 160,167,174,198 | Remote Sound System Controls | 194 |
| Radio, Satellite | 190 | Replacement Keys | 15 |
| Rear Axle | 231,315 | Replacement Parts | 289 |

| | | | |
|---|---------|---|-------|
| Replacement Tires | 252 | Seat Belt Reminder | 44 |
| Reporting Safety Defects | 353 | Seat Belts | |
| Restraint, Head | 92 | Adjustable Upper Shoulder Anchorage | 40 |
| Restraints, Child | 58 | And Pregnant Women | 45 |
| Restraints, Infant | 59 | Child Restraint | 58,65 |
| Restraints, Occupant | 34 | Extender | 45 |
| Retractable Cargo Area Cover | 137 | Inspection | 69 |
| Roof Rack | 142 | Maintenance | 319 |
| Rotation, Tires | 256,258 | Operating Instructions | 36 |
| | | Pretensioners | 43 |
| Safety Checks Inside Vehicle | 69 | Reminder | 157 |
| Safety Checks Outside Vehicle | 70 | Seats | 90 |
| Safety Defects, Reporting | 353 | Adjustment | 90 |
| Safety, Exhaust Gas | 68 | Cleaning | 318 |
| Safety Information, Tire | 239 | Head Restraints | 92 |
| Safety Tips | 68 | Heated | 97 |
| Satellite Radio | 190 | Power | 93 |
| Satellite Radio Antenna | 193 | Rear Folding | 94 |
| Schedule, Maintenance | 330 | Reclining | 91 |

| | | | |
|---|---------|---|-----|
| Security Against Theft | 20,28 | Slippery Surfaces, Driving On | 237 |
| Security Alarm | 28 | Snow Chains | 257 |
| Selection of Oil | 293 | Snow Plow | 270 |
| Selec-Trac Operation | 226 | Spare Tire | 275 |
| Sentry Key | 14 | Spark Plugs | 295 |
| Sentry Key Programming | 16 | Specifications | |
| Sentry Key Replacement | 15 | Fuel | 259 |
| Service Assistance | 348 | Oil | 293 |
| Service Contract | 350 | Speed Control | 108 |
| Service Manuals | 354 | Speedometer | 151 |
| Setting the Clock | 158 | Starting | 210 |
| Shift Speeds, Manual Transmission | 215 | Automatic Transmission | 210 |
| Shifting | 213 | Cold Weather | 211 |
| Automatic Transmission | 216 | Emergency (Jump Starting) | 279 |
| Manual Transmission | 213 | Engine Block Heater | 212 |
| Transfer Case | 225,230 | Engine Fails to Start | 211 |
| Shoulder Belt Upper Anchorage | 40 | Manual Transmission | 210 |
| Shoulder Belts | 35 | Starting Procedures | 210 |
| Signals, Turn | 101,151 | | |

| | | | |
|--|-----|--------------------------------------|---------|
| Steering | | | |
| Power | 300 | Theft System Disarming | 28 |
| Wheel Lock | 17 | Tie Down Hooks, Cargo | 138 |
| Wheel, Tilt | 107 | Tilt Steering Column | 107 |
| Steering Wheel Mounted Sound System | | Timing Belt | 297 |
| Controls | 194 | Tire and Loading Information Placard | 244 |
| Storage | 324 | Tire Identification Number (TIN) | 243 |
| Storage, Vehicle | 324 | Tire Markings | 239 |
| Storing Your Vehicle | 324 | Tire Safety Information | 239 |
| Sun Roof | 130 | Tires | 248 |
| Sunroof Maintenance | 132 | Air Pressure | 249 |
| Supplemental Restraint System - Airbag | 46 | Alignment and Balance | 253 |
| Swing Gate, Rear | 29 | Chains | 257 |
| | | Changing | 274,275 |
| Tachometer | 151 | Flat Changing | 274 |
| Tape Player | 178 | General Information | 248 |
| Temperature Gauge, Engine Coolant | 153 | High Speed | 250 |
| Tether Anchor, Child Restraint | 62 | Inflation Pressures | 249 |
| Theft System Arming | 28 | Jacking | 276 |
| | | Load Capacity | 244,245 |

| | | | |
|-----------------------------------|---------|---|---------|
| Pressure Monitor System | 113,254 | Transfer Case | 222,313 |
| Radial | 251 | Four-Wheel-Drive Operation | 222 |
| Replacement | 252 | Maintenance | 313 |
| Rotation | 256,258 | Transmission | |
| Safety | 70,239 | Automatic | 216,311 |
| Sizes | 241 | Maintenance | 311,313 |
| Spare Tire | 275 | Manual | 213 |
| Spinning | 251 | Shifting | 213 |
| Tread Wear Indicators | 252 | Warning Light | 155 |
| Wheel Nut Torque | 278 | Transmitter Battery Service | 27 |
| Torque Converter Clutch | 221 | Transmitter, Garage Door Opener | 125 |
| Tow Hooks, Emergency | 281 | Transmitter Programming | 26 |
| Towing | 264,281 | Transporting Pets | 67 |
| Disabled Vehicle | 281 | Tread Wear Indicators | 252 |
| Recreational | 267 | Trip Odometer | 154 |
| Trailering | 264 | Turn Signals | 101,151 |
| Trac-Lok Rear Axle | 231 | Underhood Fuses | 323 |
| Trailer Towing | 264 | Universal Transmitter | 125 |
| Minimum Requirements | 266 | | |

| | | | |
|---|-----|---------------------------------------|---------|
| Unleaded Gasoline | 259 | Washer, Adding Fluid | 204 |
| Upholstery Care | 317 | Washers, Windshield | 105,302 |
| Vacuum/Vapor Harnesses | 307 | Washing Vehicle | 316 |
| Vanity Mirrors | 78 | Waxing and Polishing | 316 |
| Variance, Compass | 123 | Wheel Alignment and Balance | 253 |
| Vehicle Identification Number | 7 | Wheel Mounting | 277 |
| Vehicle Loading | 245 | Wheel Nut Torque | 278 |
| Vehicle Modifications/Alterations | 8 | Wind Buffeting | 34 |
| Vehicle Storage | 324 | Window Fogging | 203 |
| Vinyl Trim | 317 | Windows | 32 |
| Warning Flasher, Hazard | 272 | Power | 32 |
| Warning Lights (Instrument Cluster Description) | 151 | Windshield Washers | 105 |
| Warnings and Cautions | 7 | Fluid | 302 |
| Warranty Information | 351 | Windshield Wiper Blades | 301 |
| | | Windshield Wipers | 106 |
| | | Wipers, Intermittent | 107 |