

OPEL Antara



Operation, Safety, Maintenance

Data specific to your vehicle

Please enter your vehicle's data here to keep it easily accessible.

This information is available under the section "Technical data" as well as on the identification plate.

Fuel

Designation

Engine oil

Grade

Viscosity

Tyre pressure

	Tyre size	for load of up to 4 persons		for full load	
Summer tyres	<input type="text"/>	Front <input type="text"/>	Rear <input type="text"/>	Front <input type="text"/>	Rear <input type="text"/>
Winter tyres	<input type="text"/>	Front <input type="text"/>	Rear <input type="text"/>	Front <input type="text"/>	Rear <input type="text"/>

Weights

Permissible Gross Vehicle Weight

- EC kerb weight

= Loading

Your Antara

is an intelligent combination of forward-looking technology, impressive safety, environmental friendliness and economy.

It now lies with you to drive your vehicle safely and ensure that it performs perfectly. This Owner's Manual provides you with all the necessary information to that end.

Make sure your passengers are aware of the possible risk of accident and injury which may result from improper use of the vehicle.

You must always comply with the specific laws of the country that you are travelling through. These laws may differ from the information in this Owner's Manual.

When instructed to consult a workshop, we recommend that you consult an Opel Partner.

All Opel Partners offer first-class service at reasonable prices.

You will receive quick, reliable and individual service.

Experienced mechanics, trained by Opel, work according to specific Opel instructions.

The Owner's Manual should always be kept together with the Service and Warranty Booklet in the vehicle: Ready to hand in the glove compartment.

Make use of the Owner's Manual:

- Its "In brief" section will give you an initial overview.
- The table of contents at the beginning of the Owner's Manual and within the individual chapters will show you where everything is.
- Its index will help you find what you want.
- It will familiarise you with the sophisticated technology.
- It will increase your pleasure in your vehicle.
- It will help you to handle your vehicle expertly.

The Owner's Manual is designed to be clearly laid-out and easily understood.

This symbol signifies:

▶ Continue reading on next page.

* The asterisk signifies equipment not fitted to all vehicles (model variants, engine options, models specific to one country, optional equipment, Opel genuine parts and accessories).

Warning

Text marked  **Warning** provides information on risk of accident or injury. Disregard of the instructions may lead to injuries or endanger life. Inform your passengers accordingly.

Yellow arrows in the illustrations serve as points of reference or indicate some action to be performed.

Black arrows in the illustrations indicate a reaction or a second action to be performed.

Directional data, e.g. left or right, or front or back, in the descriptions always relates to the direction of travel.

We wish you many hours of pleasurable driving

Your Opel Team

Contents

Handling characteristics

All Wheel Drive vehicles have a high centre of gravity due to the increased ground clearance required for off-road use.

As with other vehicles of this type, failure to operate the vehicle correctly may result in loss of control or an accident.

Please read the sections "All Wheel Drive" on page 121 and "Driving hints" on page 127.

In brief	6
Locks, doors, windows	21
Seats, interior	36
Instruments, controls	70
Lighting	94
Infotainment system	101
Climate control	103
Driving and operation	115
Self-help, vehicle care	171
Service, maintenance	206
Technical data	215
Index	228

In brief

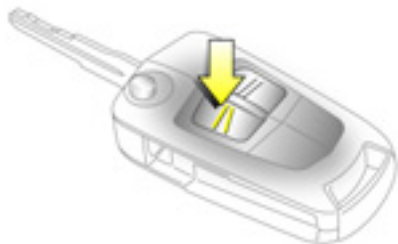

S 13204

**To unlock and open the vehicle:
Press button , pull door handle**

- ▶ Door locks - see pages 30, 72, keys - see page 21,
- electronic immobiliser - see page 22,
- radio frequency remote control - see page 23,
- central locking system - see page 25,
- anti-theft locking system - see page 27,
- anti-theft alarm system - see page 27.

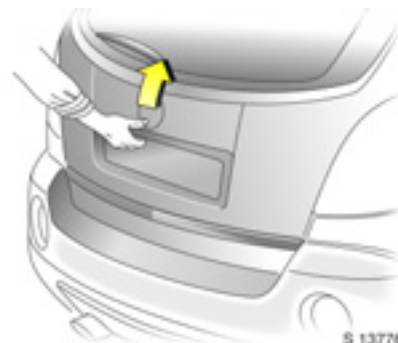

S 13776

**To unlock and open the tailgate:
Press button  on remote control,
operate button above
license plate**

- ▶ Tailgate - see page 26,
- radio frequency remote control - see page 23,
- central locking system - see page 25,
- anti-theft alarm system - see page 27.



S 13335

Front seat adjustment: Pull handle, slide seat, release handle

► Seats - see page 36,
seat position - see page 38.



S 14613

Adjusting front seat backrests: Lift release lever on outboard side of seat

Move seat backrest to suit seating position.

Do not lean on seat backrest whilst
adjusting it.

► Seats - see page 36,
seat position - see page 38.



S13261

Adjusting the lumbar support ✱: Turn handwheel

Adjust lumbar support to suit personal
requirements.

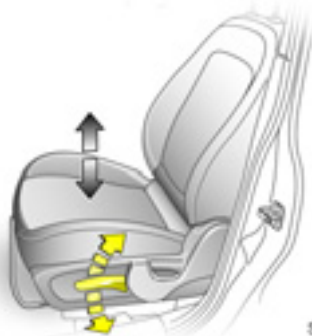

S 14614

Adjusting seat height ✳:
Raise or lower lever on outboard side of seat

Lever pumping action

upward: raises seat
downward: lowers seat

► Seats - see page 36,
seat position – see page 38.

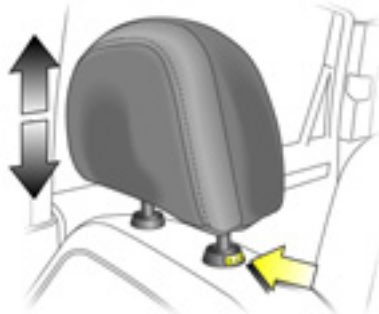

S 13259

Adjusting head restraint height:
Press release button, adjust height, then release

► Head restraints - see page 39,
head restraint position – see page 39.



S 11650

Fitting seat belt:
Draw seat belt smoothly from inertia reel, guide over shoulder and engage in buckle

The belt must not be twisted at any point.
The lap belt must lie snugly against the body.

The backrests must not be tilted back too far (recommended maximum tilting angle approx. 25°).

To release belt, press red button on belt buckle.

► Seat belts – see pages 43 to 47,
airbag systems – see page 52,
seat position – see page 38.



S14522

To adjust interior mirror: Swivel mirror housing

Swivel lever on underside of mirror housing to reduce dazzle at night.

Take care when driving with interior mirror adjusted for night vision. Rear view may be slightly distorted in this position.

► Mirrors - see page 31,
automatic anti-dazzle interior mirror -
see page 32.



S 14523

Electrically adjustable exterior mirrors:

Four way switch in driver's door

Move selector switch to L or R; four way switch adjusts corresponding mirror.

► Further information,
automatic anti-dazzle exterior mirrors -
see page 31,
heated exterior mirrors - see page 105.

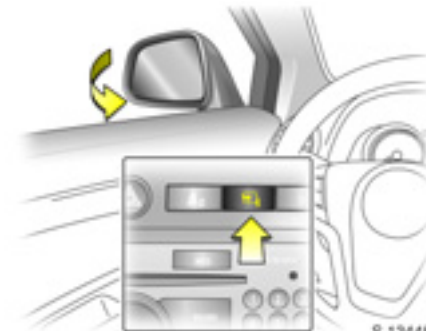



S 13448

Fold in exterior mirrors:

Manually: press lightly.

Electrically ✳: with ignition switch in positions ACC or ON, press button  and both mirrors will fold in.

Press button  again; both mirrors will fold to the driving position.

If a folded-in electric mirror has been folded out manually, pressing button  only folds the other mirror out. Pressing button  again folds both mirrors back in.





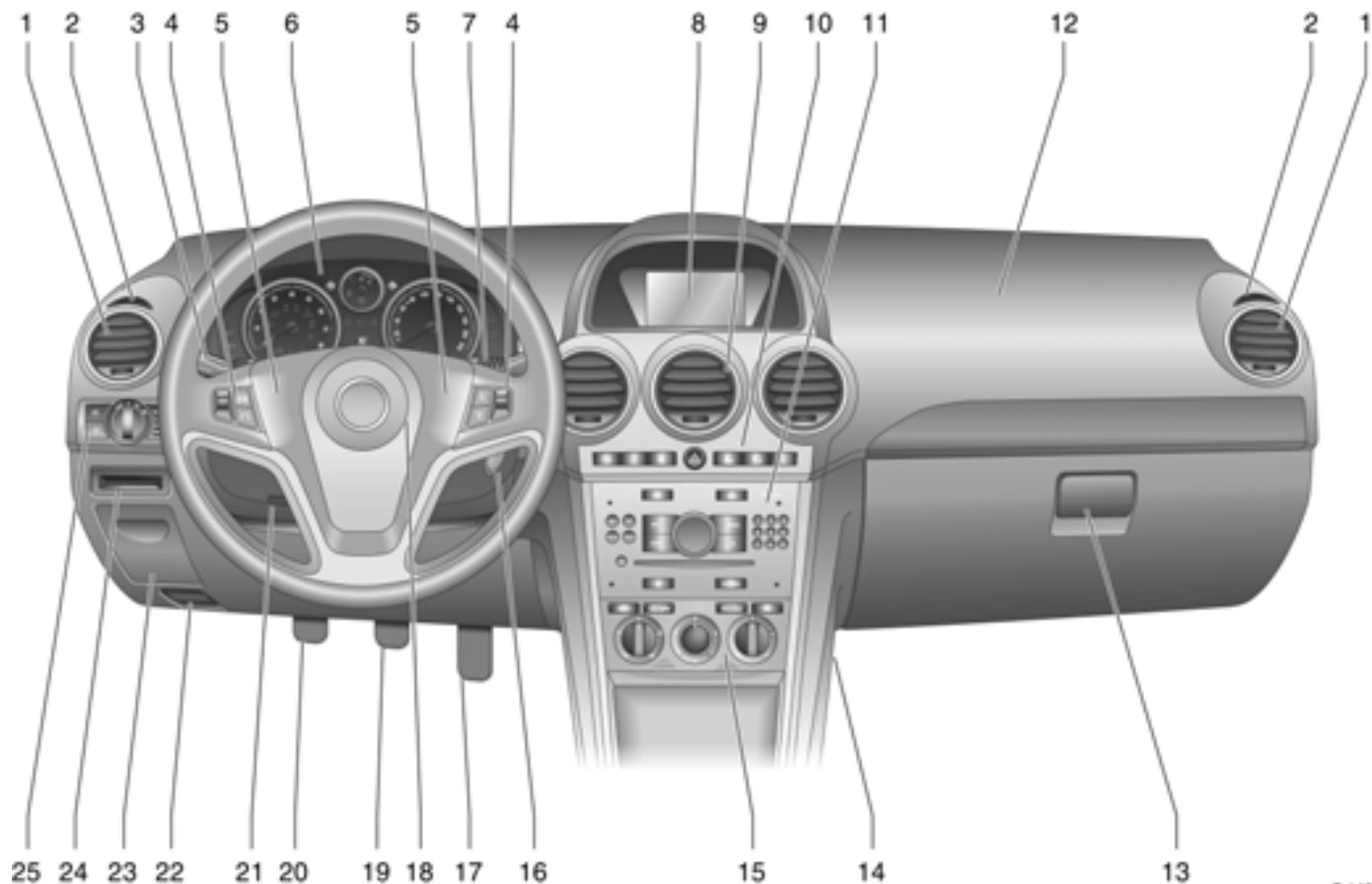





Fold mirrors back into driving position before driving the vehicle.













10 In brief













	Page		Page		Page
1	104	9	104	17	127
Side air vents		Centre air vents		Accelerator pedal	
2	104	10	14	18	52
Door window defroster vents		Hazard warning		Driver's airbag	
3	14	Park pilot *	142	19	127, 146
Headlamp flash and main beam		Descent Control System (DCS)	138	Brake pedal	
turn signal lamps	14	Electronic Stability Control (ESC) ...	136	20	127, 128
Peripheral lighting	98	Front passenger's		Clutch pedal *	
cruise control *	140	seat belt reminder *	46	21	13
4		Fold in exterior mirrors *	30	Steering wheel adjustment	
Infotainment system		Control indicator for		22	171
remote control buttons	101	anti-theft alarm system *	29	Bonnet release	
Trip computer *	81, 88	11	101	23	67
5	15	Infotainment system		Coin storage	
Horn		12	52	24	67
6	70	Front passenger's airbag		Card holder	
Instruments		13	64, 105	25	94
7		Glove compartment		Parking lamps	
Windscreen and tailgate		14	182	dipped beam	14, 95
wipers and washers	15, 16	15	103	automatic dipped beam	
headlamp washers *	16	Climate control		activation *	95
8		16	13	headlamp range adjustment *	97
Central information display for time,		Ignition switch		front fog lamps	96
date, outside temperature,				fog tail lamp	96
Infotainment system,				instrument illumination	98
check control *	91				
Trip computer *	81, 88				

Control indicators

-  **ABS (Anti-lock Brake System):**
see page 148.
-  **Trailer indicator *:**
see page 70.
-  **Brake system:**
see pages 70, 145.
-  **Park pilot *:**
see pages 71, 142.
-  **DCS (Descent Control System):**
see pages 71, 138.
-  **AWD (All Wheel Drive):**
see pages 71, 121.
-  **ESC Active & Warning (Electronic Stability Control):**
see page 136.
-  **ESC Not Ready:**
see page 136.
-  **ESC OFF:**
see page 136.
-  **Automatic headlamp range adjustment *:**
see pages 71, 97.
-  **Coolant temperature:**
see pages 71, 195.

-  **Electronic immobiliser:**
see pages 22, 72.
-  **Door open:**
see page 72.
-  **Engine electronics, transmission electronics *:**
see pages 72, 134.
-  **Airbag systems *, belt tensioners:**
see pages 44, 52.
-  **Tailgate open:**
see page 72.
-  **Driver's seat belt reminder:**
see page 72.
-  **Turn signal lamps:**
see pages 14, 72, 95.
-  **Low fuel level:**
see pages 72, 76, 132, 225.
-  **Front fog lamps:**
see pages 73, 96.
-  **Fog tail lamp:**
see pages 73, 96.
-  **Headlamp main beam:**
see pages 14, 73, 95.
-  **Low windscreen washer fluid:**
see page 73.

-  **Water in diesel fuel filter *:**
see pages 73, 194.
-  **Change engine oil *:**
see page 73.
-  **Preheating for diesel engines *:**
see pages 19, 73.
-  **DPF (Diesel particle filter) *:**
see pages 73, 135.
-  **Cruise control *:**
see page 140.
-  **Engine oil level *:**
see page 73.
-  **Power steering:**
see page 73.
-  **Anti-theft alarm system activation without monitoring of passenger compartment and vehicle tilt *:**
see page 28.
-  **Engine oil pressure:**
see page 74.
-  **Alternator:**
see page 74.
-  **Exhaust emissions:**
see pages 74, 134.
- WINTER Winter program:**
see pages 74, 117.



S 13583

Steering column lock and ignition:

Turn key to position ACC.
To release lock,
rotate steering wheel slightly

Positions:

- LOCK = Ignition off
- ACC = Steering unlocked, ignition off
- ON = Ignition on, with diesel engine: preheating
- START = Start (transmission in neutral)

► Starting - see page 19,
electronic immobiliser - see page 22,
parking the vehicle - see page 20.



S 13777

Steering wheel adjustment:

Move lever down,
adjust height and distance,
move lever up and engage

Adjust steering wheel only with vehicle stationary and steering column lock released.

Push the lever firmly upwards to ensure that the steering wheel is locked in position.

► Airbag systems - see page 52.



S 13208

Exterior lamps

Turn light switch:

- = Off
- ☛☛ = Parking lamps
- ☛☛☛ = Dipped beam or main beam
- AUTO = Automatic dipped beam activation*

Press button:

- ☛☛☛☛ = Front fog lamps
- ☛☛☛☛☛ = Fog tail lamp

► Headlamp warning device - see page 92,
further information - see page 94,
headlamp range adjustment* -
see page 97,
headlamps when driving abroad -
see page 100,
daytime running lamps* - see page 94.



Headlamp flash, main and dipped beam:

- Headlamp flash** = Pull lever towards steering wheel
- Main beam** = Push lever forwards
- Dipped beam** = Pull lever back towards steering wheel

► Main beam, headlamp flash - see page 95.

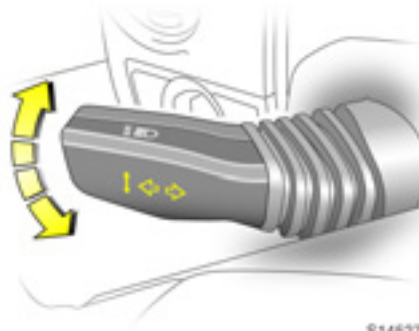

Turn signal lamps:

- Lever in rest position**
- Upwards** = Right turn
- Downwards** = Left turn

► Turn signal lamps - see page 95.



Hazard warning lamps:

- On** = Press 
- Off** = Press  again

► Hazard warning lamps - see page 97.



Activate horn : Press either side of the steering wheel

The horn will sound regardless of ignition switch position.

► Airbag systems - see page 52,
remote control on steering wheel -
see page 101.

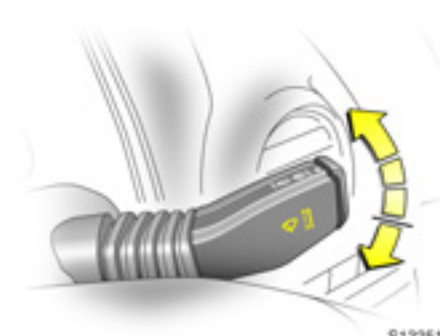

Windscreen wipers: Move lever upwards

- = Off
- = Timed interval wipe
- = Slow
- ≡ = Fast

Press lever down from position ○:
Single swipe.

► Windscreen wipers - see page 92,
adjustable wiper interval - see page 92,
further information - see pages 198, 202,
205.

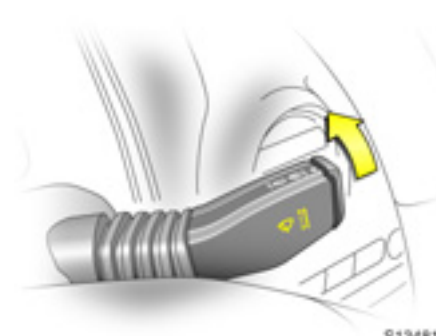

Automatic wiping with rain sensor : Move lever to automatic wiping with rain sensor position --

The rain sensor detects the amount of
water on the windscreen and automatically
regulates the windscreen wipers.

► Windscreen wipers - see page 92,
further information - see pages 198, 202,
205.



S13482

Operating windscreen and headlamp washer systems ✳:
Pull lever towards steering wheel

► Windscreen and headlamp washer systems - see page 93,
 further information - see pages 199, 202, 205.

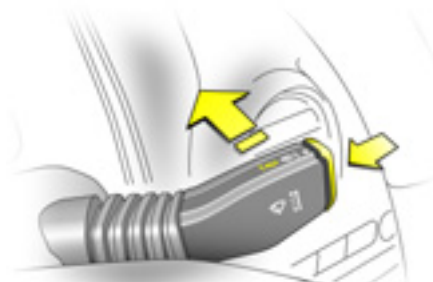

S13483

Tailgate wiper and washer systems:

Wipers on = Push lever forward

Wipers off = Pull lever back towards steering wheel

Wash = Press and hold button

► Tailgate wiper and washer systems - see page 93,
 further information - see pages 198, 199, 202, 205.



S 14532

Heated rear window, heated exterior mirrors ✳:

Press  = On

Press  again = Off

► Air conditioning - see page 109,
 heated rear window, heated exterior mirrors - see page 105.



S 13625

Drying misted up or iced up windows:

Set air distribution to position , set the temperature rotary knob to red and fan to position 4, switch on heated rear window 

Close centre air vents, open side air vents and direct them towards the door windows.

► Heating, ventilation and air conditioning system - see pages 106, 109.

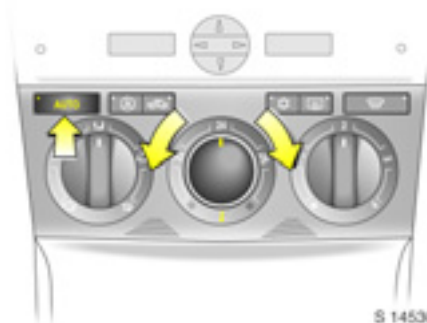

S 14530

To set automatic mode of Electronic Climate Control :
Press AUTO button, set temperature using rotary knob

Open all air vents.

► Electronic Climate Control (ECC) - see page 111.

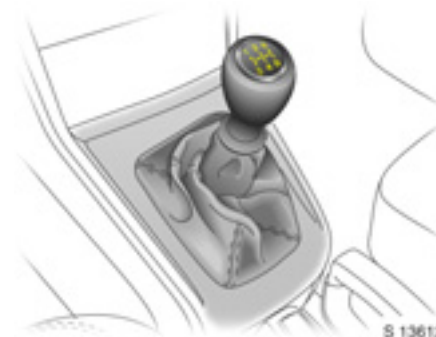

S 13612

Manual transmission:

1 to 5 = 1st to 5th gear

R = Reverse gear

Only engage reverse gear when the vehicle is stationary.



Automatic transmission ⚠:

P = Park position

R = Reverse

N = Neutral (idle)

D = Automatic gear selection

Starting is only possible in **P** or **N**. To move from **P** or **N**, switch on ignition, depress foot brake and press selector lever button.

Engage **P** or **R**: press selector lever button.

P: Only with vehicle stationary, first apply hand brake

R: Only with vehicle stationary.

► Automatic transmission - see page 115.



Manual mode:

+ = Shift to higher gear

- = Shift to lower gear

► Further information - see page 117.

Before starting-off, check:

- Tyre pressures and condition.
- Engine oil level and fluid levels in engine compartment (see page 192).
- All windows, mirrors, exterior lighting and license plates are free from dirt, snow and ice and are operational.
- Objects are securely located and will not be thrown forward in the event of sudden braking.
- Seats, seat belts and mirrors are correctly adjusted.
- All gauges and control indicators.
- Brake operation.



S 13443

Starting the engine:

**Manual transmission in neutral,
Depress clutch and foot brake,
Automatic transmission in P or N,
Do not accelerate**

Petrol engines:

Turn key to START and release it

Diesel engines:

Turn key to ON, when preheating control indicator  extinguishes¹⁾, turn key to START and release it

Key returns automatically to ON position when released.

¹⁾ Preheating system switches on only if outside temperature is low.

Start attempts should not last longer than 15 seconds. If engine does not start, wait 10 seconds before repeating starting procedure.

The increased engine speed automatically returns to normal idling speed as the engine temperature rises.

Drive at a moderate speed, especially in cold weather, until normal engine operating temperatures have been reached.

► Electronic immobiliser - see page 22,
diesel fuel system - see page 171,
further information - see pages 127, 129,
131.

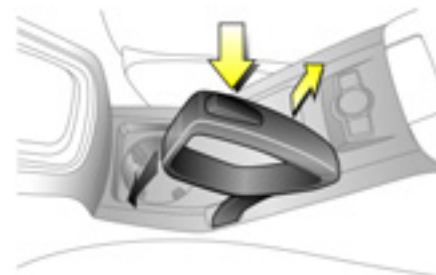

S 12815

Releasing the hand brake:

**Raise lever slightly,
press release button,
lower lever fully**

To reduce operating forces, depress foot brake at the same time.

Do not drive with hand brake on, to avoid damage to brakes on the rear wheels. Do not apply hand brake while vehicle is in motion or as a substitute for the foot brake.

Drive carefully, economically and with the environment in mind. While driving, do not do anything that could distract you.

► Hand brake - see page 147.



Parking the vehicle:
Apply hand brake firmly,
close windows,
switch off engine, remove key,
engage steering column lock,
lock vehicle

► Further information - see pages 22, 128, radio frequency remote control - see page 23, central locking system - see page 25, anti-theft alarm system - see page 27.

Advice when parking:

- Always apply hand brake firmly and as firmly as possible on slopes.
- Push key into ignition switch before removing (vehicles with automatic transmission *: depress foot brake and shift into **P** before removing key). Turn steering wheel until lock is felt to engage (anti-theft protection).

- If the vehicle is parked on a level surface or a hill, select 1st gear before switching ignition off (vehicles with automatic transmission *: move selector lever to **P**). Also turn front wheels away from kerb if parked on an uphill slope.

If the vehicle is parked on a downhill slope, select reverse gear before switching ignition off (vehicles with automatic transmission *: move selector lever to **P**). Also turn front wheels towards kerb.

- Switch off exterior lamps, otherwise the headlamp warning device will sound when the driver's door is opened.
- Cooling fans may run on after the engine has been switched off.
- Do not park on easily ignitable surfaces as hot exhaust system temperatures could cause the surface to ignite.

That was the most important information for your first drive in your Antara in brief.

Your vehicle has still more instruments and controls, possibly also optional equipment.

The remaining chapters of the Owner's Manual contain important information on operation, safety and maintenance as well as a complete index.

Locks, doors, windows

Replacement keys	21
Car Pass.....	21
Key with foldaway key section *	21
Electronic immobiliser.....	22
Radio frequency remote control	23
Central locking system	25
Tailgate	26
Mechanical anti-theft locking system *	27
Anti-theft alarm system *	27
Child safety locks.....	30
Exterior mirrors.....	30
Interior mirror	31
Electric windows.....	32
Sun visors.....	34
Slide/tilt sun roof *	34

Replacement keys

The key is a constituent of the electronic immobiliser. In case of loss, replacement keys can be ordered from your Opel Partner by quoting the key number and Vehicle Identification Number (VIN).

Once a new transmitter is coded, the lost transmitter will not unlock your vehicle.

Ordering keys from an Opel Partner guarantees problem-free operation of the electronic immobiliser.

Keep spare key in a safe place.

Locks - see page 205.

Car Pass

The Car Pass contains all of the vehicle's data and should therefore not be kept in the vehicle.

Have your Car Pass on hand when consulting an Opel Partner.

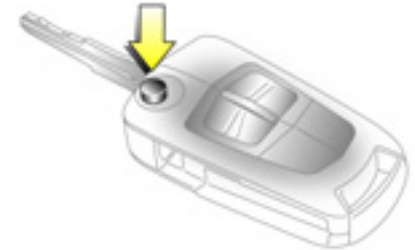

S 13585

Key with foldaway key section *

Press button to extend. Press button to retract; key section audibly engages.



S 13586

Electronic immobiliser

The system checks whether the vehicle may be started using the key that has been inserted. If the key is recognised as "authorised", the vehicle can be started. The check is carried out via a transponder housed in the key.

The electronic immobiliser is automatically activated when the key is turned to LOCK position and removed from the ignition switch.



S 13499

Control indicator for immobiliser

The control indicator illuminates when the ignition is switched on, then extinguishes.

If the control indicator stays illuminated after the ignition is switched on, there is a fault in the immobiliser system.

- Turn key to LOCK position and remove,
- wait approximately two seconds,
- then repeat starting procedure.

If the control indicator fails to extinguish, try to start the engine using the spare key and seek the assistance of a workshop.

Note

The immobiliser does not lock the doors. Therefore, after leaving the vehicle, always lock it and switch on the anti-theft alarm system * - see pages 25, 27.

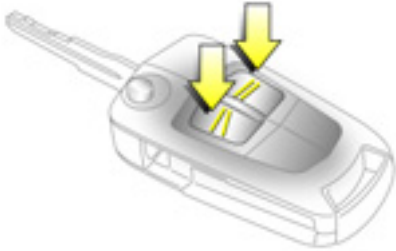

S 13587

Radio frequency remote control

The remote control is used to operate:

- Central locking system,
- Mechanical anti-theft locking system ✱,
- Anti-theft alarm system ✱.

The remote control has a range of approx. 6 metres. The range may be reduced due to environmental conditions or shadowing and reflection of the radio waves.

To operate the remote control, direct the remote control unit at the vehicle.

Treat the remote control unit with care: it should be protected against moisture, kept out of direct sunlight and should not be operated unnecessarily.

Do not place heavy objects on the remote control unit, and avoid dropping it.

The hazard warning lamps come on to indicate that the remote control is operational.

Central locking system
see page 25.

Mechanical anti-theft locking system ✱
see page 27.

Anti-theft alarm system ✱
see page 27.

Fault

If the central locking system cannot be operated with the remote control, this may be due to the following reasons:

- The remote control is out of range.
- The battery voltage of the remote control is too low. Change the battery in the remote control unit.
- The remote control has been repeatedly operated outside the vehicle's reception range (e.g. at too great a distance from the vehicle). The remote control must be reprogrammed. We recommend you consult your Opel Partner.
- The system has been overloaded as a result of repeated operation at short intervals. The power supply is cut-off for a brief period.
- Interference from higher power radio waves from other sources.

Lock or unlock the doors manually using the key or central locking switch - see page 25.

Have cause of fault remedied by a workshop.



Changing battery in remote control unit

Replace the battery in accordance with the information on pages 206 to 212 or when the range of the remote control starts to become reduced.

Key with foldaway key section:
open cover by hand.

Remove used battery, taking care to avoid touching the circuit board to other components.

Ensure the new battery is installed correctly with positive (+) side facing up.

Close cover, ensuring it audibly engages in the key part.

Key with fixed key section:

insert a small screwdriver in the notch on the cover and prise it open.

Remove used battery, taking care to avoid touching the circuit board to other components.

Ensure the new battery is installed correctly with positive (+) side facing down towards the base.

Close cover, ensuring it audibly engages in the key part.

Warning

Used lithium batteries can harm the environment. Make sure that you dispose of old batteries in accordance with environmental protection regulations. Do not dispose with household refuse.

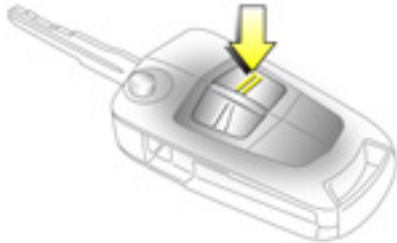



S 13588

Central locking system

For front doors, rear doors, tailgate and tank flap.

To lock:

Press button  on remote control
- or -

With the doors closed, press central locking switch  in driver's door.

The central locking system can be activated with the windows open.

Always ensure that the doors, bonnet, tailgate, sun roof  and windows are properly closed and that there are no passengers left in the vehicle before locking with the remote control.

To unlock:

Press button  on remote control

- or -

Press central locking switch  in driver's door.

If no door is opened within approx. 30 seconds after the vehicle has been unlocked via the remote control, the vehicle is relocked automatically and anti-theft alarm  is reactivated.

When button  is pressed, the instrument panel illuminates for approx. 30 seconds or until ignition switch is turned to the ACC position.

Warning

For safety reasons, the vehicle cannot be locked or unlocked via the remote control (and the anti-theft system  will not be activated) if the key is in the ignition switch.

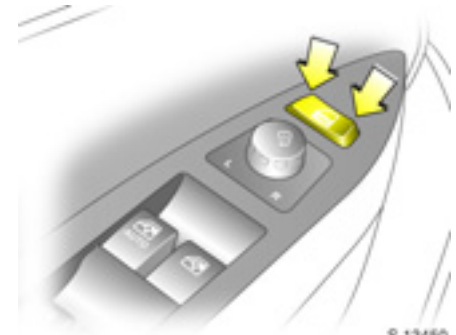

S 13450

Central locking switch

Use the central locking switch to lock or unlock the doors, tailgate and tank flap from inside the vehicle.

Press the right part of the switch to lock or the left part of the switch to unlock.

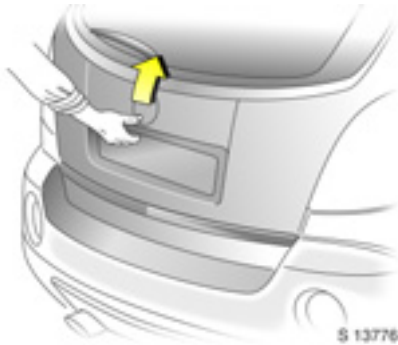

Tailgate

To unlock and open

Press button  on remote control

- or -

Press central locking switch  in driver's door.

The tailgate is unlocked together with the doors and can be opened by operating the button above the license plate and lifting the tailgate.

With the engine running, the tailgate will only unlock when the hand brake is applied or automatic transmission  is in P.

If the tailgate is open when the ignition is switched on, tailgate open control indicator  illuminates in the instrument panel.

Warning

Ensure there are no obstructions and that there is adequate clearance when opening the tailgate.

Do not drive with tailgate open or ajar, e.g. when transporting bulky objects, since toxic exhaust gases could penetrate the vehicle interior.

If driving with tailgate open is necessary, set fan to highest speed, open all air vents, close windows and ensure air recirculation mode is off, to allow entry of outside air.



To close and lock

There is a handle on the inside of the tailgate for closing the luggage compartment.

Close tailgate by pushing it down so it latches securely. Ensure tailgate is fully closed before driving.

To lock tailgate, together with the doors:

Press button  on remote control

- or -

Press central locking switch  in driver's door.

If the ignition is switched on, the tailgate open control indicator  extinguishes in the instrument panel.

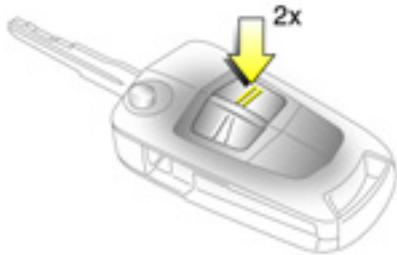

S 13589

Mechanical anti-theft locking system *

Warning

Do not use the system if there are people in the vehicle. The doors cannot be unlocked from inside.

To lock:

All doors and the tailgate must be closed; press button  on remote control again within 3 seconds after locking

- or -

Turn key in driver's door lock towards rear of vehicle again within 3 seconds after locking, then turn it back to the vertical position and remove.

Lock buttons on all doors are positioned such that doors cannot be opened.

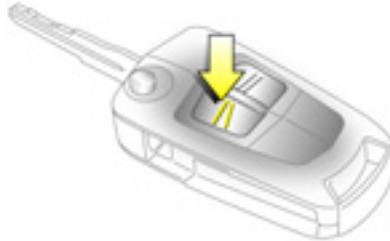

S 13204

To unlock:

Press button  on remote control

- or -

Turn key in driver's door lock towards front of vehicle, then turn it back to the vertical position and remove.

Warning

Unlocking is not possible in any other way, so keep spare key in a safe place.

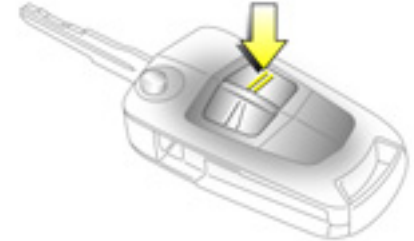

S 13588

Anti-theft alarm system *

The system monitors:

- Front and rear doors.
- Tailgate, bonnet.
- Ignition switch.
- Passenger compartment *
- Vehicle tilt, e.g. if it is raised *
- Siren power supply *

Warning

Do not use the system if there are passengers in the vehicle. The doors cannot be unlocked from the inside when the alarm is activated.

The remote control unit is used to operate the anti-theft alarm system.

To activate

Always ensure that the doors, bonnet, tailgate, sun roof * and windows are properly closed and that there are no passengers left in the vehicle before activating anti-theft alarm system.

Press button  on remote control

- or -

Lock driver's door by turning key in door lock towards rear of vehicle then turn it back to the vertical position and remove;

- Hazard warning lamps flash once,
- All doors are locked,
- Anti-theft system is activated after approx. 30 seconds.



Confirm that the control indicator starts flashing slowly, after illuminating for approx. 30 seconds, to show that the anti-theft system has been activated.



If button  is pressed again, the anti-theft alarm system will activate automatically, bypassing the 30 second delay.



If the hazard warning lamps do not flash on activation or the control indicator flashes quickly, this may indicate that a door, the tailgate or the bonnet is not fully closed.



Activation without monitoring of passenger compartment and vehicle tilt *

Switch on when, for example, animals are to be left in the vehicle.

1. Close tailgate and bonnet.
2. Press button  in the roof lining. Control indicator  illuminates in yellow in the instrument panel.
3. Close doors.
4. Switch on anti-theft alarm system. Control indicator for anti-theft alarm system illuminates. After a 30 second delay, the system is activated without monitoring of the passenger compartment or vehicle tilt.

Control indicator  remains illuminated in the instrument panel until the system is switched off by pressing button  again.



Control indicator for anti-theft alarm system *

The control indicator illuminates to show that the system is operational when the doors are locked with the remote control or the key. When the doors are unlocked with the key or remote control, the control indicator extinguishes.

To deactivate

Press button  on remote control
- or -

Unlock driver's door by turning key in door lock towards front of vehicle, then turn it back to the vertical position and remove:

- Hazard warning lamps flash twice,
- All doors are unlocked,
- Anti-theft system is deactivated.

If the driver's door is not opened, or the engine is not started within 30 seconds of deactivation, all doors are automatically relocked and the system is reactivated.

If the alarm has been triggered, the hazard warning lamps will not flash upon deactivation.

Note

The anti-theft alarm system cannot be deactivated in any other way, so keep a spare key in a safe place.



Changes to the vehicle interior, such as the use of seat covers, could impair the function of passenger compartment monitoring *.

Alarm

While the alarm system is switched on, the alarm can be triggered, indicated by:

- an acoustic signal (horn) and
- a visual signal (exterior lamps).

The number and duration of the alarms are legally established.

The alarm is stopped by pressing  or  on the remote control or by unlocking the driver's door with the correct key. The anti-theft alarm system is deactivated at the same time.

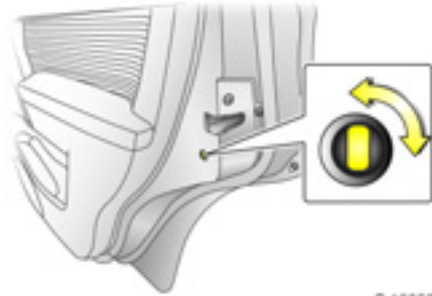

S 12858

Child safety locks

Warning

Use the child safety locks whenever children are occupying the rear seats. Disregard may lead to injuries or endanger life. Vehicle passengers must be informed accordingly.

To engage lock, open door, insert key into child safety lock and turn lock from the vertical to the horizontal position. Door cannot then be opened from inside.

To unlock door while child safety lock is activated, pull up lock button and open door from outside. Do not pull inside door handle while child safety lock is activated.



S 14523

Exterior mirrors

Electrically adjustable exterior mirrors

Adjust with the four way switch in driver's door: move selector switch to L or R; four way switch adjusts corresponding mirror.

The mirror glass swivels in the same direction as the activation of the four way switch.

Heated exterior mirrors * - see page 105.

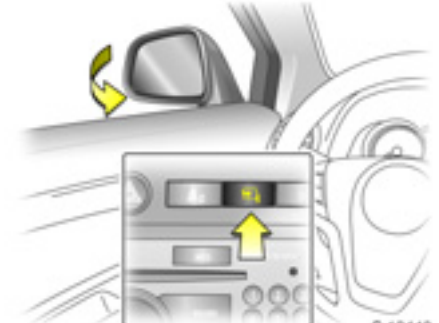

S 13448

Fold in exterior mirrors

Manually: the exterior mirrors can be folded in by pressing lightly on the outside of the mirror housing.

Electrically *: with ignition switch in positions ACC or ON, press button and both mirrors will fold in.

Press button again; both mirrors will fold to the driving position.

If a folded-in electric mirror has been folded out manually, pressing button only folds the other mirror out. Pressing button again folds both mirrors back in.

Fold mirrors back into driving position before driving the vehicle.



S 13687

For the safety of pedestrians, the exterior mirrors will swing out of their normal mounting position in the event of an accident-like impact.

As exterior mirrors are convex, objects are closer than they appear. Use interior mirror to judge size and distance of objects.

Do not scrape ice from exterior mirrors or force them if frozen. Use a de-icer.



S 13590

Automatic anti-dazzle exterior mirrors *
Dazzle is automatically reduced.

Exterior mirrors dim to reduce glare automatically in conjunction with the automatic anti-dazzle interior mirror * - see page 32, Fig. S13260.



S14522

Interior mirror

To adjust interior mirror, swivel mirror housing.

Swivel lever on underside of mirror housing to reduce dazzle at night.

Take care when driving with interior mirror adjusted for night vision. Rear view may be slightly distorted in this position.



S13260

Automatic anti-dazzle interior mirror *
Dazzle is automatically reduced.

With the ignition off, the mirror does not dim.

Press button on mirror housing to turn function on. Button will illuminate. Press button again to turn off.

There are two light sensors in the mirror housing. To avoid interference and loss of function, do not cover the sensors or hang anything on the mirror.

Electric windows

Warning

Care must be taken when operating the electrically operated door windows. There is a risk of injury, particularly for children, and a danger that articles could become trapped. Vehicle passengers must be informed accordingly.

If there are children on the rear seats, press the switch in the driver's door to lock rear window operation. Rear windows can then only be operated via the driver's door switches.

Keep a close watch on the windows when closing them. Ensure that nothing becomes trapped in them as they move.

Before leaving the vehicle, remove the ignition key in order to prevent unauthorized operation.

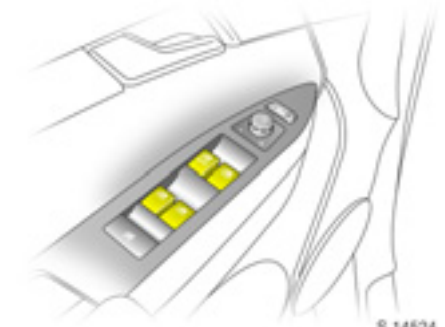

S 14524

Operational with key in ignition switch positions ACC or ON. If key is in LOCK position or removed, windows can be operated for 10 minutes or until driver's door is opened.

Operated via four switches located in the driver's door.

For incremental operation, briefly pull or press the switch.

For automatic * opening or closing, pull or press the switch longer. Pull or press the switch again to stop the movement.

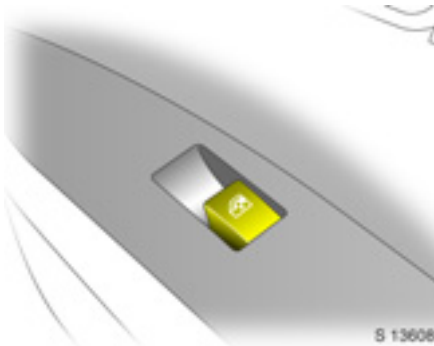

Additional switches are located in the front passenger's door and the rear doors.

The rear windows do not open fully.

Safety function ✱

If the window glass encounters resistance above the middle of the window during automatic closing, it will stop immediately and will be opened again.

In the event of difficulty due to frost or the like, press the relevant window switch several times until the window is closed.



Child safety system for rear windows

Press  switch in driver's door to lock rear window operation.

With the lock on, rear passenger windows can only be operated via the switches in the driver's door.



S 13447

Sun visors

Use the sun visor to protect from glare by pulling it up, down or swivelling it to the side.

Sun visors have vanity mirrors and a ticket holder * on the rear.

When the vanity mirror covers are opened, the sun visor lamp * will illuminate.

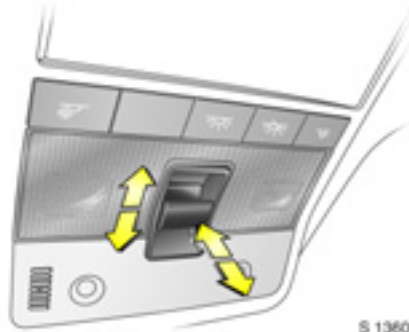

S 13609

Slide/tilt sun roof *

Operated via switch in roof lining when the ignition switch is in positions ACC or ON.

With key in LOCK position in the ignition switch or removed, the slide/tilt sun roof can be adjusted for up to 10 minutes or until a door is opened.

For incremental operation, briefly press the button. For automatic opening or closing, press and hold the switch.

To open

Press switch rearwards; it will open automatically unless the switch is pressed again in another direction, or released.

To close

Press and hold switch forwards. Release switch when sun roof reaches desired position.

To tilt

Press and hold switch upwards. Release switch when sun roof reaches desired position.

To return sun roof to its original position, press and hold switch downwards. Release switch when sun roof reaches desired position.

Note

- If the top of the sun roof is wet, tilt it to allow water to run off before opening the sun roof.
- When carrying a roof load, check the clearance of the sun roof, to avoid damage.

 **Warning**

Care must be taken when operating the sun roof. Do not place any objects or body parts in the sun roof opening.

Keep sun roof clear of debris. Do not place heavy objects on or around sun roof.

When leaving the vehicle unattended, ensure the sun roof is fully closed.

Seats, interior

Front seats	36
Rear seats.....	41
Seat belts.....	42
Child restraint systems *	47
Airbag systems	52
Storage	59
Drink holders	67
Ashtrays *.....	67
Warning triangle ▲*, First aid kit ☹️*	68
Power outlets	68
Assist grips	69



Front seats

▲ Warning

Never adjust seats whilst driving as they could move uncontrollably.

Adjust seat longitudinally

To adjust, pull the handle on the front seat, slide the seat and release the handle.



Adjusting front seat backrests

To adjust, lift the release lever, move seat backrest to suit seating position and lock in position when the lever is released.

Do not lean on the seat backrest whilst adjusting it.



S13261

Adjusting the lumbar support *

To adjust, turn the handwheel whilst relieving the load on the backrest.

Adjust lumbar support to suit personal requirements.

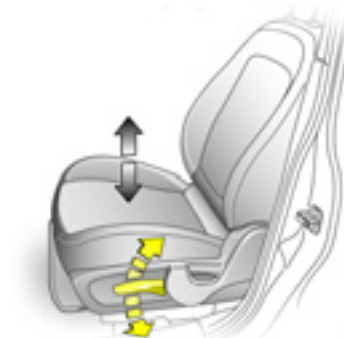

S 14614

Adjusting seat height *

To adjust, operate lever on side of seat.

Lever pumping action

upward: raises seat
downward: lowers seat

Electrically adjustable front seat *

⚠ Warning

Care must be taken when operating electrically adjustable seats. There is a risk of injury, particularly for children and a danger that articles could become trapped.

Keep a close watch on the seats when adjusting them.

Vehicle passengers must be informed accordingly.

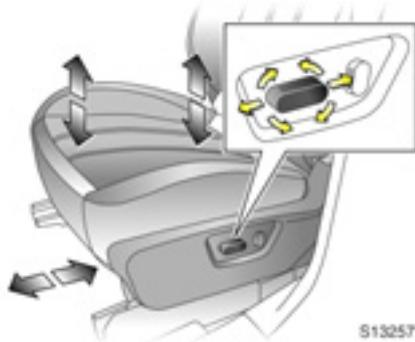

Adjustment

The seat position can be adjusted by means of switches on the outboard side of the seat.

Adjusting the longitudinal position:
Move front switch forwards/backwards.

Height adjustment:
To adjust height of front part of seat cushion, push front part of switch up/down.
To adjust height of rear part of seat cushion, push rear part of switch up/down.

To adjust height of entire seat cushion, push both front and rear parts of switch up/down.



Seat backrest adjustment:
Move upper part of rear switch forwards/backwards.

Operate switch until desired seat position is reached. Seat position - see next column.

After adjusting the seat, adjust height of seat belt - see page 47.

The seat backrest must not be tilted back too far (recommended maximum tilting angle approx. 25°).

Seat position

Adjust driver's seat such that, with the driver sitting upright, the steering wheel is held in the area of its upper spokes with the driver's arms slightly bent.

Slide front passenger's seat as far back as it will go.

The seat backrests must not be tilted back too far (recommended maximum tilting angle approx. 25°).

⚠ Warning

Disregard can lead to injuries which could be fatal. Vehicle passengers must be informed accordingly.

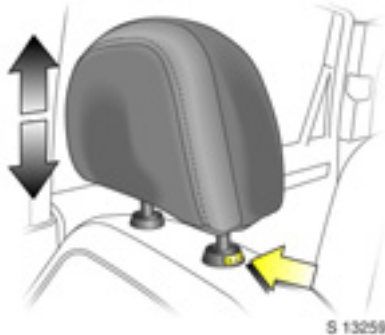

Head restraints

To adjust head restraint height, press release button, adjust height to suit then release the button.

Pull head restraint up to raise. Push head restraint down while pressing the release button to lower the head restraint.

Active head restraints ❄

In the event of a rear-end impact, the active head restraints automatically tilt forwards. The head is more effectively supported by the head restraint and the danger of hyperextension in the area of the cervical vertebra is reduced.

Do not attach objects or components that are not approved for your vehicle to the head restraints. These affect the protective effect of the head restraints and can be propelled through the vehicle in an uncontrolled manner if the driver brakes hard or an accident occurs.



Head restraint position

For maximum protection, the middle of the head restraint should be at eye level. If this is not possible for extremely tall persons, set to highest position, and set to lowest position for extremely small persons.

Warning

Disregard can lead to injuries which could be fatal. Vehicle passengers must be informed accordingly before moving away.

Removing the head restraints

Insert a suitable tool into the small hole in the side of the guide sleeve without the release button and depress the lock. Press the release button on the other guide sleeve and pull up the head restraint.

Stow head restraints securely in luggage compartment.



S 14545

Front seat armrest *

The armrest can be slid forwards. Pull up and hold upper lever and slide the armrest forwards.

To return armrest to its rearmost position, slide it back until it latches into position.

Console box in front armrest - see page 65.



S 13441

Folding down the passenger's seat *

Push front passenger's seat head restraint all the way down - see page 39.

Slide front passenger's seat as far back as it will go.

Fold seat forwards by lifting backrest release lever and folding backrest down onto seat cushion.

To raise the seat, lift backrest release lever and push backrest to upright position.

Push and pull on seat backrest to ensure it is locked, thus avoiding excessive forward movement in the event of a collision.

Warning

If longer objects, e.g. skis, are to be carried on the back of the front passenger's seat backrest, ensure they are not in the area in which the front passenger's airbag inflates or in the area between the seat backrest and the vehicle body. In the event of a collision, such objects may be thrown through the vehicle.

The load must not hinder hand brake operation or gearshifting.

Disregard of these notes can lead to injuries which may be fatal.



Rear seats

To adjust backrests, lift release lever located on top of backrest and move backrest forwards or backwards to desired position.

Do not lean on seat backrest whilst adjusting it or make adjustments while the vehicle is moving.

When folding the rear seat backrests, ensure the seat belts are unbuckled.



Folding rear seat backrests

The luggage compartment can be enlarged by folding the rear seat backrests onto the seat cushions.

To fold rear seat backrests separately, unbuckle all three rear seat belts and ensure front seats are not in reclined position.

Push head restraints all the way down, lift backrest release lever and fold backrest forwards and down onto seat cushion.

Do not allow passengers to sit on folded backrest, or place any unrestrained loads on it.

⚠ Warning

When folding the backrest, use caution - beware of moving parts.

Safety net * - see page 60.

Restoring rear seat backrests

Lift and push backrest up and backwards to restore it to its original position. Ensure backrest latches into place by pushing top of backrest and pulling it forwards again.

⚠ Warning

Ensure that the backrest returns to its correct position - see page 38.

Never adjust the rear seat backrests whilst the vehicle is moving. They could move in an uncontrolled manner when the lever has been pulled.



Rear seat armrest *

The armrest can be folded down.

If the rear centre seat is being used or the rear seat backrests are being folded down, fold armrest upwards.

Console box in rear armrest - see page 65.

Seat belts

Three-stage restraint system

The system comprises:

- Three-point seat belts.
- Belt tensioners, with load limiters, on the front seats.
- Airbag systems for driver, front passenger and rear outboard seat occupants.

The three stages are activated in sequence depending on the seriousness of the accident:

- The automatic seat belt locking devices prevent the belt strap from being pulled out and thus ensure that the vehicle occupants are retained in their seats.
- The front seat belt buckles are pulled downwards. As a result, the seat belts are instantaneously tightened and the occupants are made aware of the deceleration of the vehicle at a very early stage. This reduces stress placed on the body.

■ The airbag system is additionally triggered in the event of a serious accident involving a frontal impact, and forms a safety cushion for the driver and front passenger. In the event of a side impact, the side airbag system * protects the occupants in the front of the vehicle, and the curtain airbag system protects both front and rear outboard seat occupants.

⚠ Warning
<p>The airbag system serves to supplement the three-point seat belts and belt tensioners. The seat belts must therefore always be worn.</p> <p>Disregard of these notes can lead to injuries which may be fatal. Vehicle passengers must be informed accordingly.</p> <p>Be sure to read the descriptions of all the restraint systems on the following pages.</p>

Three-point seat belts

The front and rear seats are equipped with three-point seat belts with automatic retractors and locking devices, allowing freedom of body movement when the vehicle moves at a constant speed, although the spring-tensioned belts are always a snug fit.

The belt has a “vehicle sensitive retractor” which is designed to lock during heavy acceleration or deceleration in any direction.

⚠ Warning
<p>Always wear your seat belt, and that means also in urban traffic and when you are a rear seat passenger. It can save your life!</p> <p>Pregnant women too must always wear a seat belt, keeping the lap belt low and snug on the hips and pelvis (not the waist or abdomen, where actuating belt tensioners could cause serious injury in the event of a collision).</p>

In the event of an accident, persons not wearing seat belts endanger their fellow occupants and themselves.

Control indicator  for driver's seat belt reminder - see page 72.

Control indicator  for front passenger's seat belt reminder * - see page 46.

Seat belts are designed to be used by only one person at a time. They are only suitable for children aged up to 12 or smaller than 150 cm if used in conjunction with a child restraint *.

For children up to 12 years of age, we recommend the Opel child restraint system * - see page 47.

Belt force limiters

Load limiters on the front seats reduce the impact on the seat occupant's body from a tensioning belt, in the event of a severe frontal collision. The belt force is controlled, to reduce the risk of belt-inflicted injury.

Inspection of belts

Periodically inspect all parts of the belt system for damage and to make sure they are functioning properly.

Have damaged parts replaced. After an accident, belts and triggered belt tensioners must be replaced by new ones.

Do not perform any alterations on the belts, their anchorages, the automatic retractors or the belt buckles.

Make sure that belts are not damaged or trapped by sharp-edged objects.



Belt tensioners

The seat belt systems on the front seats incorporate belt tensioners housed in the belt buckles and seat belt retractors.

In the event of frontal collisions or side impacts of a certain severity, belt buckles and seat belt retractors tighten the seat belts; the shoulder and lap belts are instantaneously tightened to fit the occupant's body more snugly.

The belt buckles and seat belt retractors will remain locked after actuation (where some noise will occur and smoke may be released).

Belt tensioners are not designed to activate in the event of rear impacts, minor side impacts, rollovers or minor frontal collisions.

Actuation of belt tensioners

The belt tensioners actuate only once and must be replaced by a workshop after activation.

Warning

The belt tensioners are operational only when control indicator  is unlit.

If the control indicator does not flash briefly when the ignition is on, stays lit, illuminates or flashes whilst driving, the belt tensioners or the airbag systems may not function correctly.

Have both systems inspected by a workshop.

The seat belts remain fully operational even when the belt tensioners have been actuated.



Belt tensioners control indicator

The seat belt tensioners are monitored electronically together with the airbags, and their operational readiness shown by the red control indicator  in the instrument panel.

When the ignition is switched on, the control indicator flashes several times then extinguishes. If it does not flash, stays lit, illuminates or flashes whilst driving, there is a fault with the belt tensioners or in the airbag systems. The systems might not therefore be triggered in the event of an accident (see also page 56).

 Warning
Have the cause of the fault remedied by a workshop.

The system's integrated self-diagnostics allows faults to be quickly remedied.

Important

- Accessories not released for your vehicle type and other objects must not be fixed or placed within the action zone of the belt tensioners, as they may result in injury if the belt tensioners are triggered.
- Do not make any modifications to the components of the belt tensioners, as this may result in unintended actuation of the belt tensioners, rendering the vehicle unroadworthy and causing serious personal injury.

 Warning
Improper handling (e.g. removal or installation) can activate the belt tensioners – risk of injury.

- The belt tensioner and airbag system control electronics can be found in the centre console area. In order to avoid malfunctions, do not store magnetic objects in this area.
- When using the rear seats, ensure that the front seat belt components are not damaged by shoes or other objects. Avoid dirt getting in the retractors.
- The belt tensioners only actuate once, indicated by continuous illumination of control indicator  in the instrument panel. Deployed belt tensioners must be replaced by a workshop.
- When disposing of the vehicle, observe the applicable safety regulations. Take the vehicle to a recycling company for disposal.



S 11650

Using the belts

Fitting the belt

Pull the belt out evenly from the retractor and guide it over the shoulder, making certain that it is not twisted.

Insert the latch plate into the buckle. The seat backrest must not be tilted back too far (the recommended maximum tilting angle is approx. 25°).

The lap belt must not be twisted and must fit snugly across the body. Tension the belt frequently whilst driving by tugging the diagonal part of the belt.



S 11735

Warning

On pregnant women in particular, the lap belt must be positioned as low as possible across the pelvis in order to prevent pressure on the abdomen.

Keep knees pointing straight forward so that driver's side knee bolsters can help prevent submarining under the seat belt in the event of a collision.

Bulky clothing prevents the belt from fitting properly. The belt must not rest against hard or fragile objects in the pockets of your clothing (e.g. ballpoint pens, keys, spectacles) because these could cause injury in the event of a collision. Do not place any objects (e.g. handbags) between the belt and your body.



S 13540

Front passenger's seat belt reminder *

Illuminates for approx. 4 seconds when ignition is switched on.

When the engine is running, if the front passenger's seat is occupied and the belt is not engaged, the control indicator will flash for approx. 90 seconds and then illuminate until the belt is fastened correctly (control indicator will extinguish immediately).

If vehicle speed exceeds approx. 22 km/h (14 mph), the control indicator will flash for approx. 90 seconds along with a warning chime, and then illuminate until front passenger's seat belt is fastened.

Control indicator  for driver's seat belt reminder - see page 72.

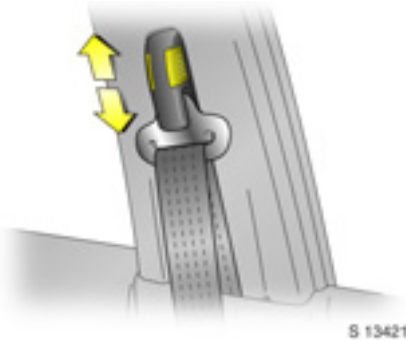

S 13421

Seat belt height adjustment

of front seat belt upper anchorage points

- Do not adjust height whilst driving.
- Squeeze release buttons together and slide adjuster up or down to desired position.
- Ensure sliding height adjuster latches into position.

Height adjuster can also be moved up without squeezing release buttons.

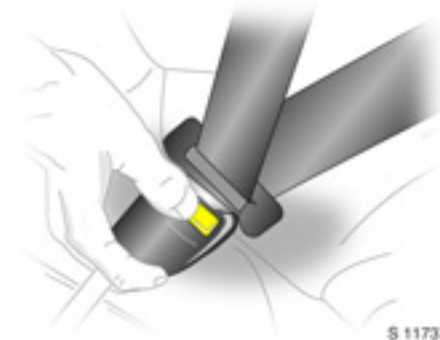

S 11737

Removing the belt

To remove the belt, press the red release button on the belt buckle; the belt will retract automatically.

Guide the belt as it retracts, to prevent personal injury and damage to interior surfaces.

Always ensure you position the release button so that you can unbuckle the seat belt quickly if necessary.

Child restraint systems ❄

Opel child restraint systems are designed specifically for your vehicle and thus provide optimum safety for your child in the event of an impact. The use of an Opel child restraint system is therefore recommended.

If a different child safety seat is used, follow the manufacturer's instructions for fitting and use.

⚠ Warning

Disregard of these instructions may lead to injuries or endanger life.

Selecting the right system

Your child should be transported facing rearwards in the vehicle as long as possible. The child's neck area is still very weak and in an accident they suffer less stress in the semi-prone rearward position than when sitting upright.

Note

- Children under 12 years or under 150 cm tall should only travel in an appropriate child safety seat.
- Never carry a child whilst travelling in the vehicle. The child will become too heavy to hold in the event of a collision.
- When transporting children, use a child restraint system that is suitable for the child's weight, age and height.
- Ensure that the child restraint system to be installed is compatible with the vehicle type.
- You should always observe the instructions on installation and use supplied with the child restraint system.

- Do not stick anything on the child restraint systems and do not cover them with any other materials.
- Only allow children to enter and exit the vehicle at the side facing away from the traffic.
- A child restraint system which has been subjected to stress in an accident must be replaced.
- When the child restraint system is not in use, secure the seat with a seat belt or remove it from the vehicle.
- The covers of the Opel child restraint system can be wiped clean.

The following Opel child restraint systems have been approved for installation in your Antara:

Group, weight and age class ¹⁾	Opel system
0 From birth - 10 kg, 0 - 10 months	Baby Safe
0+ From birth - 13 kg, 0 - 2 years	
I From 9 - 18 kg, 8 months - 4 years	Duo ISOFIX
II From 15 - 25 kg, 3 years - 7 years	Kid
III From 22 - 36 kg, 6 years - 12 years	

¹⁾ We recommend the use of each system until the child reaches the upper weight limit.

If child restraint systems of other manufacture are to be installed, ensure that they conform to the appropriate safety regulations.

Permissible options for fitting a child safety seat

Weight and age class	On front passenger's seat	On outboard rear seats	On centre rear seat
0: up to 10 kg or approx. 10 months	X	U, +	X
0+: up to 13 kg or approx. 2 years	X	U, +	X
I: 9 to 18 kg or approx. 8 months to 4 years	X	U, +, ++	X
II: 15 to 25 kg or approx. 3 to 7 years	X	U	X
III: 22 to 36 kg or approx. 6 to 12 years	X	U	X

- U** = Universal suitability in conjunction with the three-point seat belt.
- +** = Vehicle seat with ISOFIX mounting available. When mounting with ISOFIX, only ISOFIX child restraint systems that have been approved for the vehicle may be used.
- ++** = Vehicle seat with ISOFIX fixings available. For use of ISOFIX and top tether fixings, universal ISOFIX child restraint systems may be used.
- X** = No child restraint system permitted in this weight and age class.

 Warning
Disregard of these instructions may lead to injuries or endanger life.

ISOFIX child restraint systems *

The instructions accompanying the ISOFIX child restraint system are to be expressly followed.

- IL = Suitable for particular ISOFIX child restraint systems specified in the list.

These ISOFIX systems are of the 'vehicle-specific', 'restricted' or 'semi-universal' type.
- IUF = Suitable for ISOFIX forward-facing child restraint systems of universal category approved for use in this weight and age class.
- X = No child restraint system permitted in this weight and age class.

Size class

Description

- A - ISO/F3: Forward-facing child restraint system for children of maximum size in the weight class 9 to 18 kg.
- B - ISO/F2: Forward-facing child restraint system for smaller children in the weight class 9 to 18 kg.
- B1 - ISO/F2X: Forward-facing child restraint system for smaller children in the weight class 9 to 18 kg.
- C - ISO/R3: Rear-facing child restraint system for children of maximum size in the weight class up to 13 kg.

D - ISO/R2:

Rear-facing child restraint system for smaller children in the weight class up to 13 kg.

E - ISO/R1:

Rear-facing child restraint system for young children in the weight class up to 13 kg.

Permissible options for fitting an ISOFIX child safety seat

Weight and age class	Size class	Fixture	On front passenger's seat	On outboard rear seats	On centre rear seat
0: up to 10 kg or approx. 10 months	E	ISO/R1	X	IL	X
0+: up to 13 kg or approx. 2 years	E	ISO/R1	X	IL	X
	D	ISO/R2	X	IL	X
	C	ISO/R3	X	IL	X
I: 9 to 18 kg or approx. 8 months to 4 years	D	ISO/R2	X	IL	X
	C	ISO/R3	X	IL	X
	B	ISO/F2	X	IUF	X
	B1	ISO/F2X	X	IUF	X
	A	ISO/F3	X	IUF	X

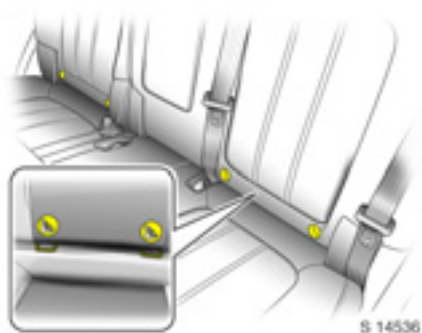

Mounting brackets for ISOFIX child restraint systems

The brackets located between the backrest and seat cushion are used for mounting ISOFIX child restraint systems.

The instructions accompanying the ISOFIX child restraint system are to be expressly followed.

Only ISOFIX child restraint systems approved for the vehicle may be used.

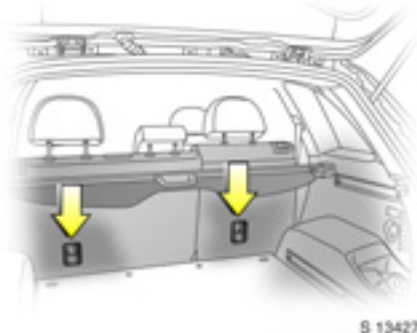

Anchors for Top-Tether child restraint systems

The top tether anchors located on the rear of the backrests are designed to hold child restraints which come equipped with top tether anchor attachments only.

Please be sure to follow the instructions provided with the Top-Tether child restraint system.

For use of ISOFIX and Top-Tether fixings, universal ISOFIX child restraint systems may be used.



Airbag systems

Front airbags

The front airbag system is identified by the word "Airbag" on the steering wheel and above the glove compartment.

The front airbag system comprises:

- an airbag with an inflator in the steering wheel, and a second one behind a trim panel above the glove compartment,
- the control electronics,
- the front impact sensor,
- the airbag system control indicator  in the instrument panel.

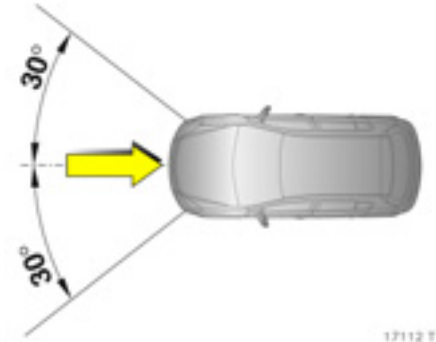

The front airbag system is triggered:

- depending on the severity of the accident,
- depending on the type of impact,
- within the range shown in the illustration,
- independently of the side airbag * and curtain airbag systems.

Examples:

- Impact against a non-yielding obstacle; the front airbags are triggered at low vehicle speeds,
- Impact against a yielding obstacle (such as another vehicle); the front airbags are only triggered at a higher vehicle speed.

When triggered, the driver's and front passenger's airbags inflate in milliseconds and form safety cushions for the driver and front passenger. Forward movement of driver and front passenger is checked and the risk of injuries to the upper body and head thereby substantially reduced.

- No impairment of view will occur, as airbags inflate and deflate so quickly.

⚠ Warning

The front airbag system provides optimum protection when the seat, seat belt, backrest and head restraint are correctly adjusted.

Adjust the driver's seat according to the occupant's height such that, with the driver sitting upright, the steering wheel is held in the area of its upper spokes with the driver's arms slightly bent.

The driver's seat should be as far back as possible without compromising the driver's ability to reach the pedals, steering wheel or controls.

The front passenger's seat should be as far back as possible, with the backrest upright. Do not place the head, body, hands or feet on the cover of the airbag system.

Do not place objects, children or pets in the area in which the airbags inflate.

The front airbag system will not be triggered in the event of:

- the ignition being switched off,
- minor frontal collisions,
- accidents in which the vehicle overturns,
- collisions involving a side or rear impact where it would not be of benefit to the occupants.

⚠ Warning

Seat belts must therefore always be worn. The front airbag system serves to supplement the three-point seat belts.

If you do not wear your seat belt, you risk being seriously injured, or even thrown from the vehicle, in the event of an accident.

The belts help to maintain occupants in the correct seating position for the front airbag system to provide effective protection in the event of an accident.



Side airbags *

The side airbags are identified by the word "Airbag" on the outboard sides of the front seat backrests, and protect front seat occupants in the event of a severe side impact.

The side airbag system comprises:

- an airbag with inflator in the outboard sides of the driver's and front passenger's seat backrests,
- the control electronics,
- the side impact sensors,
- the airbag systems control indicator  in the instrument panel.

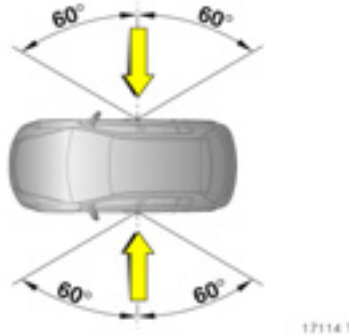

The side airbag system will be triggered:

- depending on the severity of the accident,
- depending on the type of impact,
- within the range shown in the illustration,
- independently of the front airbag system.

When triggered, the side airbag inflates in milliseconds and forms a safety cushion for the driver and/or front passenger in the respective door area. The risk of injury to the upper body and pelvis in the event of a side impact is thereby substantially reduced.

 Warning

There must be no objects in the area in which the airbag inflates or in the area between the seat backrests and the vehicle body.

Do not place hands, arms or other body parts on the covers of the airbag systems.

Important information - see page 57.

The three-point seat belt must always be correctly fitted - see page 43.

The side airbags will not be triggered in the event of:

- the ignition being switched off,
- frontal collisions,
- accidents in which the vehicle overturns, if lateral impact is insufficient for side airbag deployment,
- collisions involving a rear impact,
- collisions involving a side impact outside the passenger cell.

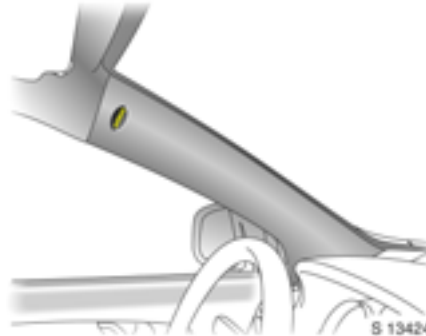

Curtain airbags

The curtain airbag system is identified by the word "Airbag" on the roof frame, and protects front seat and rear outboard seat occupants in the event of a severe side impact.

The curtain airbag system comprises:

- an airbag with inflator in the roof frame above the doors on the driver's and passenger's side respectively,
- the control electronics,
- the side impact sensors,
- the airbag systems control indicator  in the instrument panel.

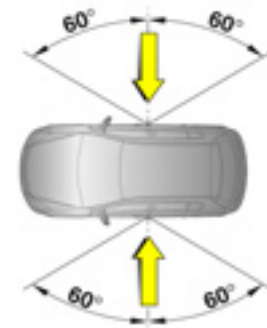

The curtain airbag system will be triggered:

- depending on the severity of the accident,
- depending on the type of impact,
- within the range shown in the illustration,
- together with the side airbag system,
- independently of the front airbag system.

When triggered, the curtain airbag inflates in milliseconds and provides a safety barrier in the head area on the respective side of the vehicle. This reduces the risk of injury to the head considerably in the event of a side impact.

Warning

There must be no objects in the area in which the airbag inflates. Do not place hands, arms or other body parts on the covers of the airbag systems.

Never secure anything to the roof by routing ropes through the doors or windows, to avoid obstructing inflation of the curtain airbags.

Important information – see page 57.

The three-point seat belt must always be correctly fitted – see page 43.

The curtain airbags will not be triggered in the event of:

- the ignition being switched off,
- frontal collisions,
- accidents in which the vehicle overturns, if lateral impact is insufficient for curtain airbag deployment,
- collisions involving a rear impact,
- collisions involving a side impact outside the passenger cell.



Airbag control indicator

The front airbag system, side airbag system and curtain airbag system are monitored electronically together with the belt tensioners, and their operational readiness is shown by the red control indicator in the instrument panel.

When the ignition is switched on, the control indicator flashes several times then extinguishes. If it does not flash, stays lit, illuminates or flashes whilst driving, there is a fault in the airbag systems or with the belt tensioners. The systems might not therefore be triggered in the event of an accident (see also page 45).

 **Warning**

Have the cause of the fault remedied by a workshop.

The system's integral self-diagnosis facility allows faults to be quickly remedied.

 **Warning**

Disregard of these instructions may lead to injuries or endanger life.

Important

- Accessories not released for your vehicle type and other objects must not be affixed or placed in the area in which the airbags inflate, as they could cause injury when the airbags are triggered.
- Do not place any objects between the airbag systems and the vehicle occupants; danger of injury.
- Only use the hooks on the assist grips in the roof frame to hang up light articles of clothing or coat hangers. Do not place any objects in the pockets of the hanging items; risk of injury.
- Do not stick or place anything on the steering wheel, instrument panel, front seat backrests in the vicinity of the airbags and seat areas or cover them with other materials.
- The airbag systems and belt tensioner control electronics can be found in the centre console area. In order to avoid malfunctions, do not store magnetic objects in this area.
- Use only a dry cloth or interior cleaner to clean the steering wheel, instrument panel, front seat backrests, roof frame and seat area of the front seats. Do not use any aggressive cleaning agents.
- Only protective covers which are approved for your vehicle with side airbags* may be fitted on the front seats. When fitting the protective covers, make sure that the airbag units on the outboard sides of the front seat backrests are not covered.
- The airbag systems are triggered independently of each other, depending on the severity of the accident and the type of impact. The side airbag system* and the curtain airbag system are triggered together.
- During off-road driving especially, airbags can also inflate in moderate to severe non-collision situations such as when slamming the undercarriage or other solid components of the vehicle in a dip in the driving surface.
- Each airbag can be triggered only once. Once triggered, an airbag must be replaced immediately by a workshop.

- After airbags deflate, you may notice a burning smell, smoke and white powder in the interior, which is normal. Although they may cause skin or eye irritation, these substances are non-toxic.
- Hazard warning lamps may flash and locked doors may be unlocked automatically when airbags deploy ✱.
- The speeds, directions of movement and deformation properties of the vehicles, and the properties of the obstacle concerned, determine the severity of the accident and triggering of the airbags.
- The degree of damage to your vehicle and the resulting repair costs alone are not indicative that the criteria for triggering of the airbags were met.
- Do not perform any modifications to the components of the airbag systems, as this will render the vehicle unroadworthy.

⚠ Warning

The systems can be triggered abruptly and cause injury if they are handled improperly.

- We recommend having the steering wheel, the instrument panel, all panelling parts, the door seals, handles and the front seats removed by a workshop.
- When disposing of the vehicle, please observe the applicable safety regulations. Take the vehicle to a recycling company for disposal.

⚠ Warning

Child restraint systems as well as other heavy objects must never be carried on the lap of passengers; risk of fatal injury.



17118T

Use of child restraint systems ✱ on front passenger's seat

⚠ Warning

No child restraint system may be installed to the front passenger's seat. Danger to life.

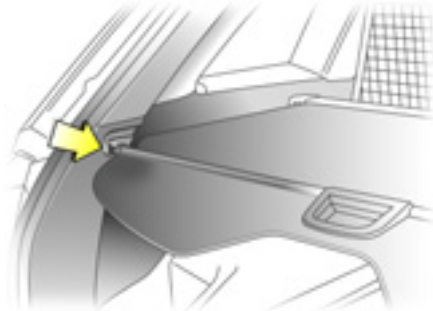

S 13355

Storage

Luggage compartment cover

To close

Pull luggage compartment cover towards rear of vehicle using handle and insert retainers into brackets on either side of luggage compartment.

To open

Remove luggage compartment cover from side brackets. It rolls up automatically.

Notes on loading the vehicle:
See page 63.

Warning

Do not place any heavy or sharp objects on the cover.

Loose objects in the luggage compartment should be secured safely.

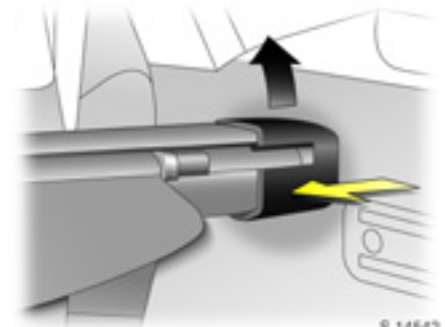

S 14542

To remove

Open luggage compartment cover.

Pull socket on either side of cover towards centre of vehicle, lift and remove cover from the side guides.

Fit in reverse order.

Safety net ✳

The safety net can be mounted behind the rear seats or, if the rear seat backrests are folded, in front of the rear seats.

Passengers must not be transported behind the safety net.

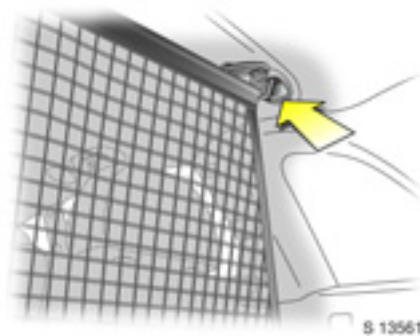

Fitting

There are four installation openings in the roof frame, two located in front of and two behind the rear seats.

When fitting behind the rear seats, remove the luggage compartment cover - see page 59.

When fitting in front of the rear seats, fold down rear seat backrests - see page 41.

Open aperture covers on the roof frame and insert top corners of safety net into large apertures in roof frame and secure by sliding them into the smaller apertures.

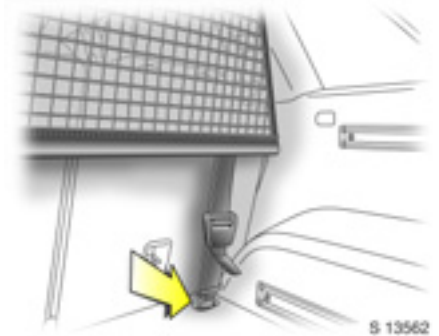

In front of and behind the rear seats on both sides of the vehicle are the hook holders (lashing eyes) for the lower strap hooks.

Hang strap hooks in the two lashing eyes.

Pull on the straps to take up any slack.

⚠ Warning

Do not stack loads higher than the upper end of the safety net.

Avoid applying excessive force to the safety net or hanging heavy items from it.

Do not place loads behind the safety net which have sharp edges that could pass through the net in the event of heavy braking, for example.

Removing

Loosen straps by pulling up strap adjusters and remove the strap hooks from the lashing eyes.

Pull top corners of safety net from the smaller apertures into the larger apertures and remove.

**Lashing eyes**

Lashing eyes are mounted on the luggage compartment floor, to enable loads to be secured in position using lashing straps * or a luggage floor net *. Two lashing eyes are located in front of the rear seats for fitting a safety net * - see page 60.

Designed for carrying small, light items only, the luggage floor net * helps keep loads from moving during sharp turns or quick starts and stops.

To install: attach the four net hooks to the lashing eyes mounted on the luggage compartment floor.

⚠ Warning

Do not carry heavy objects in the luggage floor net. Loose objects in the luggage compartment should be secured safely.

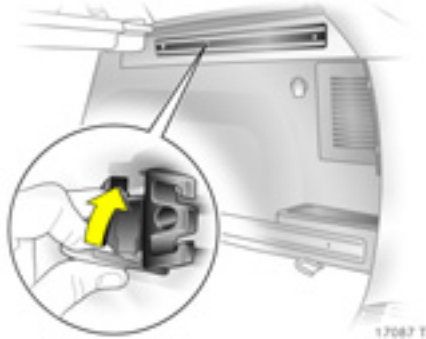

FlexOrganizer *

Flexible system for dividing the luggage compartment or securing loads.

The system consists of:

- adapters
- variable partition net
- mesh pockets for the side walls
- hooks in the luggage compartment

Components are mounted in the two guide rails in the side walls of the luggage compartment by means of adapters or hooks.

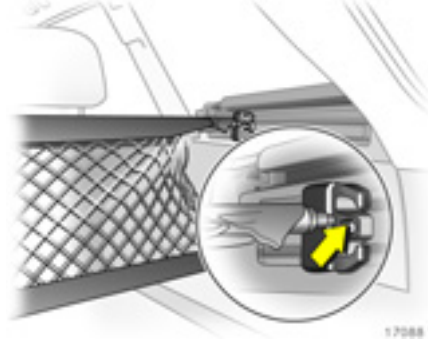

Variable partition net

Insert an adapter in each rail: fold up handle plate, insert adapter in upper and lower groove of rails, move to desired position.

To lock the adapter, swivel the handle plate up. Compress the rods of the partition net slightly and insert in corresponding openings of the adapter. The longer rod must be inserted in the upper adapter.



Hooks and mesh pocket

Insert the hooks in the desired position in the rails: insert the hook in the upper groove on the rail and press in the lower groove. The mesh pocket can be hung from the hooks.

Removing

Press the partition net rods together and remove from the adapters.

Adapter: fold open the retainer, release the adapter from the lower groove and remove from the upper groove.

Release the hooks from the rails.



Luggage compartment storage *
Trays on both sides of the luggage compartment floor.

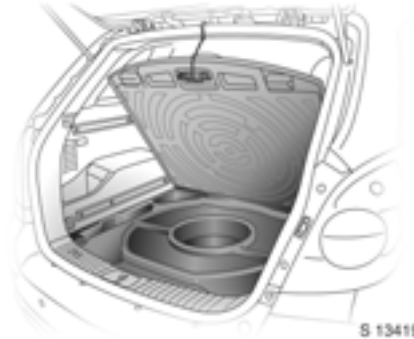

Luggage compartment under floor storage *

To access the under floor storage, push both levers on floor cover towards the handle - see page 176. Pull floor cover upwards by the handle and hang the hook to the upper part of the tailgate opening.

Warning

Do not allow objects to protrude above the top of the under floor storage, to avoid damage to the storage area and the luggage compartment floor.

Notes on loading the vehicle

- Heavy objects in the luggage compartment should be placed as far forward as possible. If objects are to be stacked, the heavier objects should be placed at the bottom.

With rear seats in the folded position, or with safety net * installed behind rear seats, objects must not be stacked higher than the seat backrests.

Unsecured objects in the luggage compartment would be thrown forward with great force in the event of heavy braking, for example.
- Secure heavy objects with lashing straps * attached to the lashing eyes. If heavy loads slip when the vehicle is braked heavily or driven around a bend, the handling of the vehicle may change.
- Secure loose items in luggage compartment using FlexOrganizer * or luggage floor net * to prevent sliding.
- When transporting objects in the luggage compartment, fit safety net * - see page 60.

- Close the luggage compartment cover to prevent the objects from being reflected in the rear window.
- If the backrests are not folded down when transporting objects in the luggage compartment, they must be engaged in their upright position - see page 41.
- Do not allow the load to protrude above the upper edge of the rear seat backrests, or if the rear seat backrests have been folded down onto the seat cushions, above the upper edge of the front seat backrests.
- The warning triangle * and first aid kit * should always be freely accessible.
- No objects should be placed on the luggage compartment cover or the instrument panel. They are reflected in the glass, obstruct the driver's view and will be thrown through the vehicle in the event of heavy braking, for example.
- No objects should be stored in any of the airbag inflation zones, as injuries may be caused when the airbag is triggered.

- The load must not obstruct the operation of the pedals, hand brake and gearshift lever or hinder the freedom of movement of the driver. Do not place any unsecured objects in the interior.
- Bulky objects should not be transported with the tailgate open or ajar, otherwise poisonous exhaust fumes may enter the vehicle.
- Weights, payload and roof load - see page 221.
- Driving with a roof load (see also page 127) increases the sensitivity of the vehicle to crosswinds and has a detrimental effect on vehicle handling owing to the higher centre of gravity of the vehicle.

⚠ Warning

Disregard of these instructions may lead to injuries or endanger life. Vehicle passengers must be informed accordingly.



S 13418

Storage compartments

Glove compartment

To open, pull handle upwards.

The glove compartment will illuminate when opened.

The glove compartment partition can be removed from its groove.

Store the partition in the groove on the far left-hand side of the glove compartment.

⚠ Warning

Do not drive with glove compartment open; risk of injury in the event of heavy braking or a collision.

Glove compartment cooling * - see page 105.



S 12917

Sunglass holder

To open: push the rear part of the front reading lamps cover.

To close: pull up cover and push it until it latches into place.

Do not store heavy items in the stowage compartment.

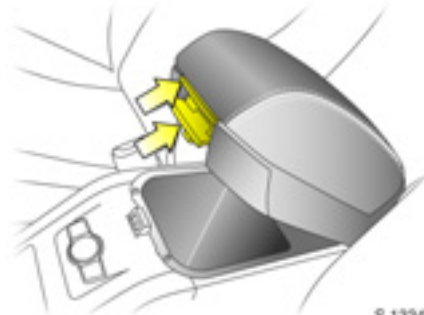

S 13345

Console box in front armrest *

To open: pull up lower lever and lift the lid.

To close: lower lid and push it down until it latches into position.

To use the tray *: ensure armrest is in its rearmost position, pull up on upper lever and lift the lid.

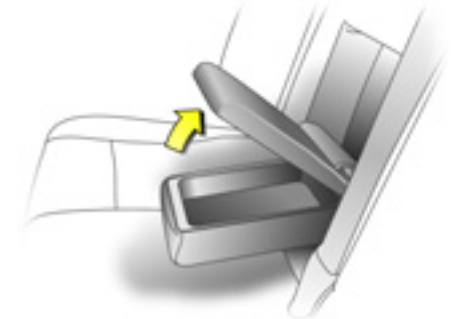

S 13337

Console box in rear armrest *

To open: pull up lid of rear centre armrest.

To close: lower lid and push it down until it latches into position.

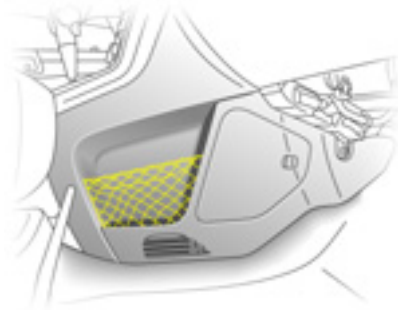

S 13491

Console net *

Located in the front passenger's footwell.



S 13356

Front passenger's seat undertray *

Pull up on front of tray then pull it forwards. Push the tray towards the seat to return it to its original position.



S 12924

Storage compartment *

Located in rear of centre console.

To open: press button above the storage compartment.

Card holder

Located below instrument panel on driver's side. Insert a card into the slot for convenient use.

Coin storage

Open by pulling handle on coin storage door (located below card holder) towards you. Push door firmly to close.



S 13420

Drink holders

Located in the front * and rear of the centre console.

The front drink holder is a fixed size.

The rear drink holder is flexible, allowing different size drink containers to be stored.

To open: press button above rear drink holder.

Ashtrays *

To be used only for ash and not for combustible rubbish.

Warning

Disregard of these instructions may lead to injuries or endanger life. Vehicle passengers must be informed accordingly.

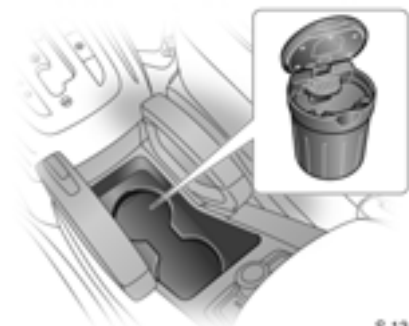

S 13417

Portable front ashtray *

Located in front drink holder.

To open: gently lift up lid. Illuminates depending on outside light conditions.

To empty: rotate upper part of ashtray anti-clockwise and remove.

After use, close lid firmly.

To replace battery: remove screw on ashtray lid and replace with CR2032 (or equivalent) battery.

Warning triangle ▲ *, **First aid kit** ☼ *

Your first aid kit and warning triangle can be accommodated below the floor cover in the luggage compartment.

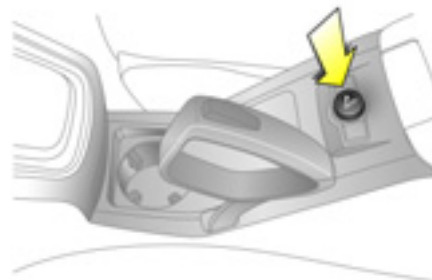

S 13392

Power outlets

Cigarette lighter ⚡

With ignition switch in positions ACC or ON, push the cigarette lighter in all the way.

Heating up ceases once element is glowing; cigarette lighter pops up automatically. Withdraw lighter.



Accessory sockets

Located in the rear centre console between the front seats and in the right-hand side of the luggage compartment ❄.

Operational with ignition switch in positions ACC or ON.

Pull the cap out to use the accessory socket, and replace it when not in use.

The socket for the cigarette lighter can also be used to connect electrical accessories when the ignition is switched on.

Use of accessory sockets while the engine is not running will discharge the battery.

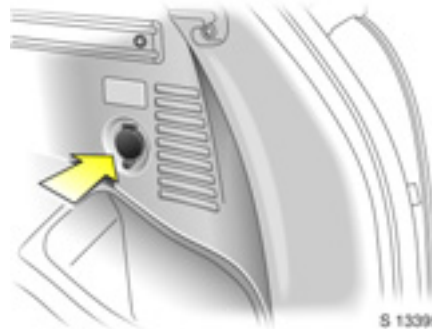

The maximum power requirement of electrical accessories must not exceed 120 watts.

Do not connect any current delivering accessories, e.g. electrical charging devices or batteries.

Connected electrical accessories must comply with the EC standard in terms of electromagnetic compatibility requirements laid down in DIN VDE 40 839, otherwise vehicle malfunctions may occur.

The use of non-authorized accessories may cause damage to the socket.



Assist grips

Located above the driver's door ❄, the front passenger's door and both rear doors.

Pull grip down and hold to assist when entering or exiting the vehicle. Grips swing back up automatically when released.

Rear door assist grips also include coat hangers.

Instruments, controls

Control indicators 70
 Instrument display 75
 Information display 76
 Display of current tyre pressure * 91
 Check control * 91
 Warning buzzers..... 92
 Windscreen wipers..... 92



Control indicators

The control indicators described here are not present in all vehicles. The description applies to all instrument versions.

The colours of the control indicators mean:

- Red Danger, important reminder,
- Yellow Warning, information, fault,
- Green Confirmation of activation,
- Blue Confirmation of activation.



ABS (Anti-lock Brake System)

see page 148.



Trailer indicator *

Illuminates in green when a trailer is connected to the vehicle. Extinguishes when the trailer is disconnected.



Brake system

Illuminates in red when ignition is switched on. Extinguishes after engine is started.

Illuminates when engine is running if hand brake is applied and/or fluid level for brake hydraulics is too low.

Warning

If it illuminates when the hand brake is not applied: stop vehicle; interrupt your journey immediately. Consult a workshop.

Further information - see page 145.

**Park pilot ***

Illuminates in yellow when ignition is switched on, then extinguishes.

If it stays illuminated while driving, there is a fault in the system - see page 142.

**DCS (Descent Control System)**

Both control indicators illuminate when ignition is switched on, then extinguish.

Green; illuminates when DCS is ready for operation. Flashes during driving when DCS is in operation, after pressing the DCS button.

Yellow; flashes to indicate system is not ready for conditions to operate. Illuminates to indicate there is a fault in the system.

If the yellow control indicator flashes or illuminates during driving, friction material needs to cool down: drive the vehicle without braking as much as possible.

Further information - see page 138.

**AWD (All Wheel Drive)**

Illuminates in yellow when ignition is switched on, then extinguishes.

If it flashes during driving, the AWD system is temporarily disabled.

If it illuminates, there is a fault in the system. Consult a workshop as soon as possible.

Further information - see page 121.

**ESC Active & Warning (Electronic Stability Control)**

see page 136.



NOT READY

ESC Not Ready

see page 136.

**ESC OFF**

see page 136.

**Automatic headlamp range adjustment ***

Illuminates in yellow when ignition is switched on, then extinguishes.

Comes on during driving to indicate a fault that requires immediate attention. Consult a workshop as soon as possible.

Further information - see page 97.

**Coolant temperature**

Illuminates in red when ignition is switched on, then extinguishes.

If it illuminates when the engine is running: stop vehicle and switch off engine. Coolant temperature is too high; danger of engine damage. Check coolant level.

 Warning

Allow engine to cool down before removing coolant filler cap.

Further information - see page 195.



Electronic immobiliser

Illuminates in red when ignition is switched on, then extinguishes.

If it remains illuminated after the ignition is on, there is a fault in the immobiliser system; the engine cannot be started - see page 22.



Door open

Illuminates in red when a door is open.



Engine electronics, transmission electronics ✱

Illuminates in yellow when ignition is switched on, then extinguishes.

If it illuminates during driving; there may be a fault in the engine or transmission electronics: interrupt your journey and consult a workshop as soon as possible.

Further information - see page 134.



Airbag systems ✱, belt tensioners

see pages 44, 52.



Tailgate open

Illuminates in red when ignition is switched on, then extinguishes.

Illuminates when tailgate is open or not securely latched.

Tailgate - see page 26.



Driver's seat belt reminder

Illuminates in red when ignition is switched on, then extinguishes.

When the engine is running, if driver's seat belt is not engaged, it will flash for approx. 90 seconds and then illuminate until driver's seat belt is fastened.

If vehicle speed exceeds approx. 22 km/h (14 mph), control indicator will flash for approx. 90 seconds along with a warning chime and then remains illuminated until driver's seat belt is fastened.

Seat belts - see page 43.



Turn signal lamps

The relevant control indicator flashes in green when the turn signal is on.

Rapid flash; failure of a turn signal bulb or the corresponding fuse or failure of a trailer turn signal bulb ✱. Both control indicators flash when the hazard warning lamps are active.

Further information - see pages 14, 95.
Bulb replacement - see page 185.
Fuses - see page 181.



Low fuel level

Illuminates in yellow when ignition is switched on, then extinguishes.

If it illuminates during driving; fuel level low: fill up fuel tank as soon as possible.

Never let the tank run dry.

Erratic fuel supply can cause catalytic converter to overheat - see page 133.

Diesel engines: if the tank has been run dry, bleed the fuel system as described on page 171.

Refuelling - see page 132.
Fuel tank capacity - see page 225.

**Front fog lamps**

Illuminates in green when front fog lamps are switched on - see page 96.

**Fog tail lamp**

Illuminates in yellow when the fog tail lamp is switched on - see page 96.

**Headlamp main beam**

Illuminates in blue when main beam is on and when headlamp flash is operated - see pages 14, 95.

**Low windscreen washer fluid**

Illuminates in yellow when ignition is switched on, then extinguishes.

If it illuminates: windscreen washer fluid level low, add washer fluid as soon as possible - see page 199.

**Water in diesel fuel filter ***

Illuminates in yellow when water level in diesel fuel filter exceeds a specified level. Residual water in the diesel fuel filter will need to be drained - see page 194. Consult a workshop as soon as possible.

**Change engine oil ***

Illuminates in yellow when ignition is switched on, then extinguishes.

Illuminates to indicate that engine oil needs changing within approx. 1000 km (600 miles). Engine power may be decreased.

Once the engine oil has been changed, the engine oil life monitor needs to be reset - see page 194.

**Preheating for diesel engines ***

Illuminated in yellow during preheating.

Preheating system switches on only if outside temperature is low.

If it comes on during driving or if the engine cannot be started, consult a workshop as soon as possible.

Starting the engine - see page 19.

**DPF (Diesel particle filter) ***

Illuminates in yellow when diesel particle filter requires cleaning.

As soon as the road and traffic situation permits it, increase speed to more than 50 km/h (30 mph) for approx. 15 minutes. The control indicator extinguishes as soon as cleaning is complete.

Further information - see page 135.

**Cruise control ***

see page 140.

**Engine oil level ***

Illuminates in yellow when ignition is switched on, then extinguishes.

If it illuminates during driving; oil level low: top up oil to specified level - see page 192.

**Power steering**

Illuminates in yellow when ignition is switched on, then extinguishes.

If it does not illuminate when the ignition is switched on, stays illuminated or illuminates during driving, there is a fault in the system. Consult a workshop as soon as possible.



Anti-theft alarm system activation without monitoring of passenger compartment and vehicle tilt * see page 28.



Engine oil pressure

Illuminates in red when ignition is switched on. Extinguishes after engine is started. Can illuminate intermittently when idling with hot engine; must extinguish when engine speed is increased.

If it illuminates during driving; engine oil pressure may be dangerously low, interrupting engine lubrication and resulting in damage to the engine and/or locking of the driving wheels:

- Move out of the flow of traffic as quickly as possible without impeding other vehicles,
- Depress clutch,
- Move gearshift lever to neutral (automatic transmission to **N**),
- Switch off ignition.

⚠ Warning

When the engine is off, considerably greater force will be required for braking and steering.

Do not remove key until vehicle has come to a standstill, otherwise the steering column lock could engage unexpectedly.

Check engine oil level before consulting a workshop. If the oil level is low, top up using the specified engine oil - see pages 192, 213, 217.

If the oil level is normal, have a workshop check the vehicle's lubricating system.



Alternator

Illuminates in red when ignition is switched on. Extinguishes after engine is started.

If it illuminates during driving: stop vehicle and switch off engine. The battery is not being charged and the engine cooling may be interrupted. The brake servo unit may cease to be effective. Interrupt your journey immediately. Remove key and check drive belt condition and tensioning before consulting a workshop.



Exhaust emissions

Illuminates in yellow when ignition is switched on. Extinguishes after engine is started. Can illuminate briefly when driving; this is normal and does not indicate a system fault.

If it illuminates when the engine is running; fault in emission control system.

The permitted emission limits may be exceeded. Fuel economy and vehicle driveability may be impaired.

The control indicator also illuminates if there is a fault in the diesel particle filter *. Consult a workshop as soon as possible.

If it flashes when the engine is running; for a fault that can lead to destruction of the catalytic converter, see page 134. Consult a workshop as soon as possible.

WINTER

Winter program *

Illuminates in yellow when Winter program for the automatic transmission is enabled - see page 117.



Instrument display

Tachometer

Making use of the tachometer helps to save fuel; it indicates the engine speed in revolutions per minute (rpm).

Red warning zone on right; maximum permissible engine speed exceeded, danger to engine.

If possible, drive in each gear in the low engine speed range (between approx. 2000 and 3000 rpm) and maintain an even vehicle speed to maximise fuel efficiency.



Speedometer

Indicates the vehicle speed.



Odometer

The odometer indicates how far the vehicle has been driven.

Trip odometer

There are two independent trip odometers which indicate how far the vehicle has been driven since the last reset.

Press the trip odometer button once to toggle between **Trip A** and **Trip B**.

To reset a trip odometer, press and hold the trip odometer button.



Fuel gauge

Indicates fuel level when the ignition is on.

After adding fuel and restarting engine, fuel gauge pointer slowly moves to show new fuel level.

When fuel gauge indicates that fuel supply is low, control indicator  illuminates: fill up fuel tank as soon as possible - see page 132.

Never let the fuel tank become empty. Diesel engines: if the tank has been run dry, bleed the fuel system as described on page 171.

Because of the amount of fuel remaining in the tank, the amount of fuel required to fill the tank may be less than the specified tank capacity.



Transmission display *

Display of the selected gear or mode with automatic transmission *.

- P** Park position.
- R** Reverse gear.
- N** Neutral.
- D** Automatic mode.
- 1 to 5** Selected gear in manual mode.



Information display

Board information display

Display of time, outside temperature and date/Infotainment system (when it is on).

An **F** in the display indicates a fault. Have the cause of the fault remedied by a workshop.

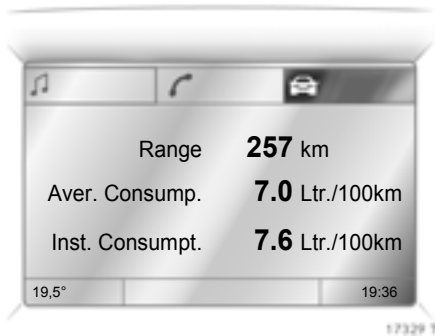

Graphical information display ✱, colour information display ✱

Display of time, outside temperature, and date/Infotainment system (when it is on).

The graphical information display presents the information in monochrome. The colour information display presents the information in colour.

The type of information and how it is displayed depends on the equipment of the vehicle and the settings of the trip computer ✱ and Infotainment system.

Some information appears on the display in an abbreviated form.

Infotainment system – see Infotainment system instruction manual.

An **F** in the display indicates a fault. Have the cause of the fault remedied by a workshop.

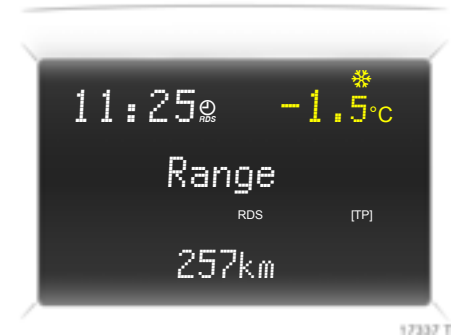

Outside temperature

A fall in temperature is indicated immediately and a rise in temperature after a time delay.

If outside temperature drops to 3 °C, the symbol ✱ illuminates in the board information display as a warning for icy road surfaces. ✱ remains illuminated until outside temperature reaches at least 5 °C.



In vehicles with graphical information display ❄️ or colour information display ❄️, a warning message appears on the display as a warning for icy road surfaces. There is no message below -5 °C.

⚠️ Warning

Caution: the road surface may already be icy, even though the display indicates a few degrees above 0 °C.



Board information display, selecting functions

Functions and settings of some equipment can be accessed via the board information display.

This is done via the menus and the buttons on the Infotainment system or with the left adjuster wheel on the steering wheel. The relevant menu options are then shown on the subsequent row of the display.

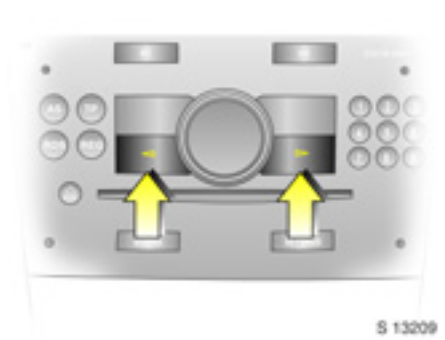

Select menu items using the arrow buttons:

OK button Select marked item, confirm command.



S14617

To select using the left adjuster wheel on the steering wheel:

- Turn up** Previous menu item.
- Turn down** Next menu item.
- Press** Select marked item,
confirm command.

If check control  issues a warning message, the display is blocked from other functions. Acknowledge the message by pressing the **OK** button or the left adjuster wheel. If there are several warning messages, acknowledge them one at a time.

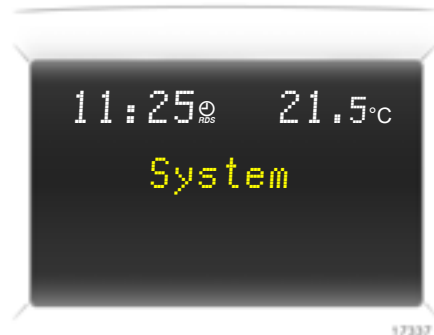

S7337 T

Board information display, system settings

Press the **Settings** button on the Infotainment system. Menu item **Audio** or **System** will appear.

Press the left arrow button to reach menu item **System** and select. The first function of the **System** menu is marked.

Some of the functions appear on the display in an abbreviated form.

The functions are displayed in the following order:

- Time synchronisation
- Time, setting hours
- Time, setting minutes
- Date, setting day
- Date, setting month
- Date, setting year
- Ignition logic
- Language selection
- Setting units of measure

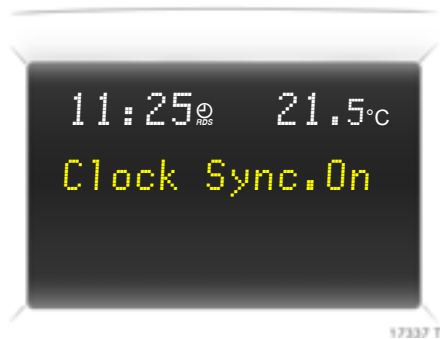

Correcting time

Some RDS¹⁾ transmitters do not send a correct time signal. If the incorrect time is continually displayed, deactivate automatic time synchronisation * and set the time manually – see next column.

The automatic setting is indicated by  in the display.

To correct time with the help of RDS, select the menu item for time synchronisation from the **Settings** menu.

Make the desired setting.

Setting date and time

Select the menu item for time and date setting from the **Settings** menu.

Make the desired setting.

The setting is saved when the menu item is exited.

Ignition logic *

See Infotainment system instruction manual.



Language selection

You can select the display language for some functions.

Select the menu item for language from the **Settings** menu and make the desired setting.

¹⁾ RDS = Radio Data System.



Setting units of measure

You can select which units of measure are to be used.

Select the menu item for units of measure from the **Settings** menu and make the desired setting.

Board information display, trip computer *

The trip computer provides information on driving data, which is continually recorded and evaluated electronically.

Access trip computer vehicle data by pressing the **BC** button on the Infotainment system or the left adjuster wheel on the steering wheel.

Some of the functions appear on the display in an abbreviated form.

Once a function has been selected, the subsequent rows of the trip computer function are displayed.

The functions are displayed in the following order:

- Instantaneous consumption
- Average consumption
- Effective consumption
- Average speed
- Distance travelled
- Range
- Stop watch



Instantaneous consumption

Display changes depending on speed;

Display in l/h below 13 km/h.

Display in l/100 km above 13 km/h.

Average consumption

Display of average consumption.

The measurement can be restarted at any time – see "Resetting trip computer information".

Effective consumption

Displays amount of fuel consumed.

The measurement can be restarted at any time – see "Resetting trip computer information".

Average speed

Display of average speed.

The measurement can be restarted at any time - see "Resetting trip computer information".

Stoppages in the journey with the ignition off are not included in the calculations.

Distance travelled

Displays number of kilometres (miles) driven. The measurement can be restarted at any time – see "Resetting trip computer information".



Range

Range is calculated from current fuel tank content and instantaneous consumption. The display shows average values.

The vehicle updates the range automatically after a brief delay when the vehicle has been refuelled.

If the fuel in the tank will allow less than 50 km (30 miles) of travel, the warning "Range" appears on the display.

If the fuel in the tank will allow less than 30 km (20 miles) of travel, the warning "Refuel!" * appears on the display.

Resetting trip computer information

The following trip computer information can be reset (restart measurements):

- Average consumption
- Effective consumption
- Average speed
- Distance travelled

Select the desired trip computer information.

Reset by pressing the left adjuster wheel on the steering wheel or the **OK** button on the Infotainment system.



Stop watch

Operating using the arrow buttons:

To start, press left arrow button to select menu item **Start** and press **OK** button to start/stop.

To reset, press left arrow button to select menu item **Reset** and press **OK** button.

Operating using the left adjuster wheel on the steering wheel:

To start, select menu item **Start** and press to start/stop.

To reset, select menu item **Reset** and press to confirm command.

Interruption of power supply

If the power supply has been interrupted or if the battery voltage has dropped too low, the values stored in the trip computer will be lost.

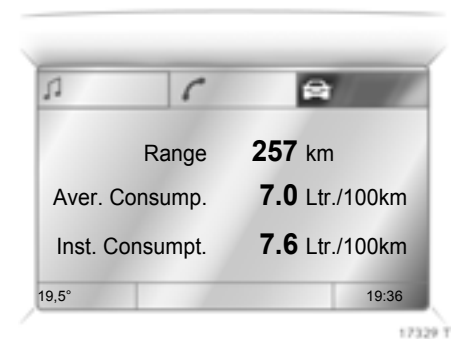

Graphical information display * or colour information display *, selecting functions

The functions and settings of some equipment * can be accessed via the graphical information display or the colour information display.

Functions are selected and executed in the menu on the display using the arrow buttons *, the multifunction knob * on the Infotainment system or the left adjuster wheel on the steering wheel.

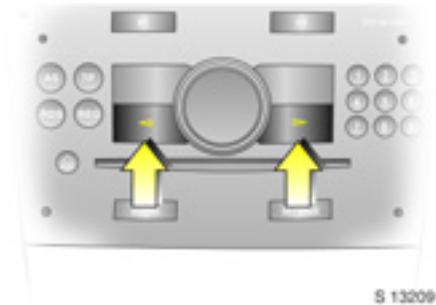

S 13209

To select using the arrow buttons:

Select menu items via menus and with the buttons on the Infotainment system.

If check control  issues a warning message, the display is blocked from other functions. Acknowledge the message by pressing the right or left arrow button. If there are several warning messages, acknowledge them one at a time.



17013 T

To select using the multifunction knob:

Turn Mark menu items or commands, select functions.

Press Select marked item, confirm command.

To exit a menu, turn the multifunction knob left or right to **Return** or **Main** and select.

If check control  issues a warning message, the display is blocked from other functions. Acknowledge the message by pressing the multifunction knob.

If there are several warning messages, acknowledge them one at a time.



S14617

To select using the left adjuster wheel on the steering wheel:

Turn up Previous menu item.

Turn down Next menu item.

Press Select marked item, confirm command.

If check control  issues a warning message, the display is blocked from other functions. Acknowledge the message by pressing the left adjuster wheel. If there are several warning messages, acknowledge them one at a time.

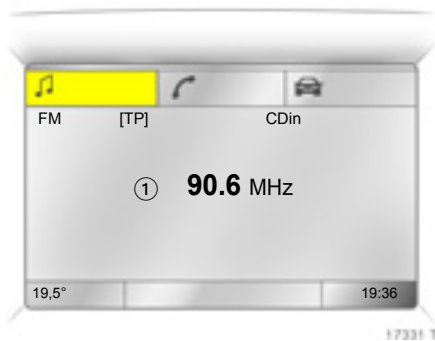

For each functional area there is a main page (Main), which is selected at the top edge of the display:

- Audio
- Navigation *
- Telephone *
- Trip computer *

For audio, navigation * and telephone * functions – see Infotainment system instruction manual.

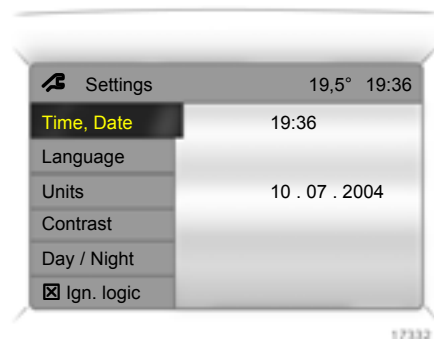

Graphical information display * or colour information display *, system settings

The settings are accessed via the **Settings** menu.

Press the **Main** button * (not found on all Infotainment systems) on the Infotainment system (call up main display).

Press the **Settings** button on the Infotainment system. On Infotainment System CD 30, make sure no menu has been selected.

The **Settings** menu is displayed.

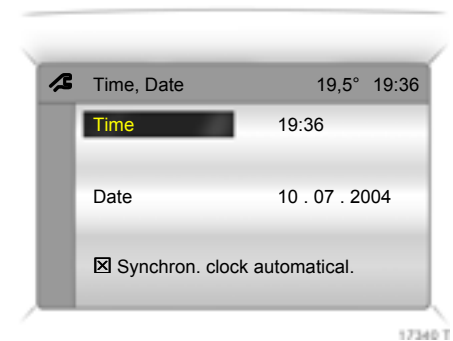

Setting date and time

Select menu item **Time, Date** from the **Settings** menu.

The menu for **Time, Date** is displayed.

Select the menu items required: make the desired setting.

Correcting time ✱

With the navigation system, date and time are set automatically upon receipt of a GPS¹⁾ satellite signal. If the displayed time does not match local time, it can be corrected manually or automatically by receiving an RDS²⁾ time signal ✱.

Some RDS transmitters do not send correct time signals. If the incorrect time is displayed often, deactivate automatic time synchronisation ✱ and set the time manually.

To correct time with the help of RDS, select menu item **Synchron. clock automatical.** from the **Time, Date** menu.

The box in front of **Synchron. clock automatical.** will be ticked: see Fig. 17340 T.

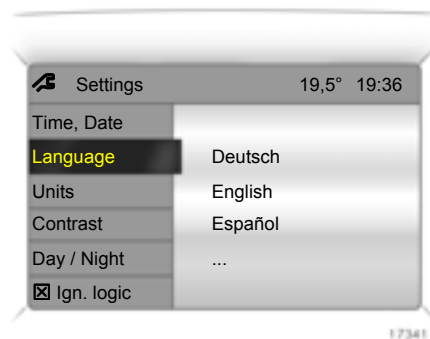
**Language selection**

You can select the display language for some functions.

Select menu item **Language** from the **Settings** menu.

The available languages are displayed.



Select the desired language.

Selections are indicated by a ► in front of the menu item.

In systems with voice output ✱, when the language setting of the display is changed, the system will ask whether the announcement language should also be changed – see Infotainment system instruction manual.

1) **GPS** = **G**lobal **P**ositioning **S**ystem, satellite system for world-wide positioning.
2) **RDS** = **R**adio **D**ata **S**ystem.



Setting units of measure

You can select which units of measure are to be used.

Select menu item **Units** from the **Settings** menu.

The available units are displayed.

Select the desired unit.

Selections are indicated by a ● in front of the menu item.

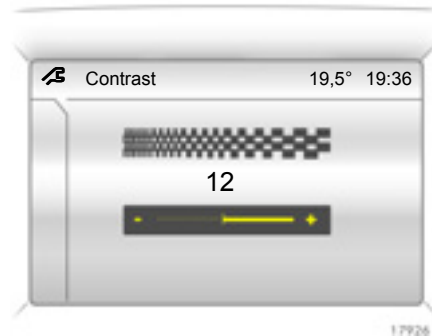

Adjusting contrast *

(graphical information display)

Select menu item **Contrast** from the **Settings** menu.

The menu for **Contrast** is displayed.

Confirm the required setting.

Setting display mode *

The display can be adjusted to suit the light conditions: black or coloured text on a light background or white or coloured text on a dark background.

Select menu item **Day / Night** from the **Settings** menu.

The options are displayed.

Automatic; adapted based on vehicle lighting.

Always day design; black or coloured text on light background.

Always night design; white or coloured text on dark background.

Selections are indicated by a ● in front of the menu item.

Ignition logic *

See Infotainment system instruction manual.

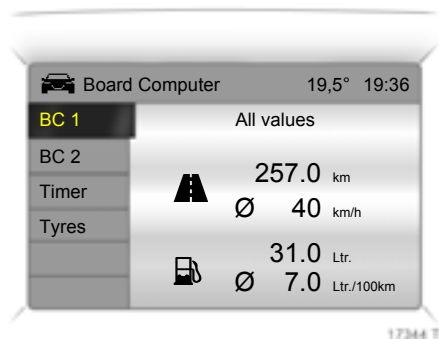

Graphical information display * or colour information display *, trip computer *

The trip computers provide information on driving data, which is continually recorded and evaluated electronically.

The trip computer main page provides information on range, average consumption and instantaneous consumption.

To display other trip computer data, press the **BC** button on the Infotainment system and select the trip computer menu in the display.

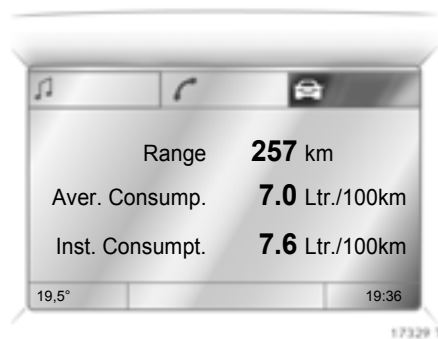

Range

Range is calculated from current fuel tank content and instantaneous consumption. The display shows average values.

After refuelling, the vehicle updates the range automatically after a brief delay.

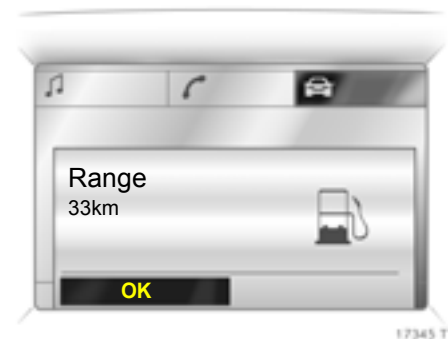

If the fuel in the tank will allow less than 50 km (30 miles) of travel, the warning "Range" appears on the display.

If the fuel in the tank will allow less than 30 km (20 miles) of travel, the warning "Refuel!" * appears on the display.

Acknowledge the menu item as described on page 84.

Instantaneous consumption

Display changes depending on speed;

Display in l/h below 13 km/h.

Display in l/100 km above 13 km/h.

Distance travelled

Displays number of kilometres (miles) driven. The measurement can be restarted at any time - see "Resetting trip computer information".

Average speed

Display of average speed.

The measurement can be restarted at any time - see "Resetting trip computer information".

Stoppages in the journey with the ignition off are not included in the calculations.

Effective consumption

Displays amount of fuel consumed.

The measurement can be restarted at any time - see "Resetting trip computer information".

Average consumption

Display of average consumption.

The measurement can be restarted at any time - see "Resetting trip computer information".

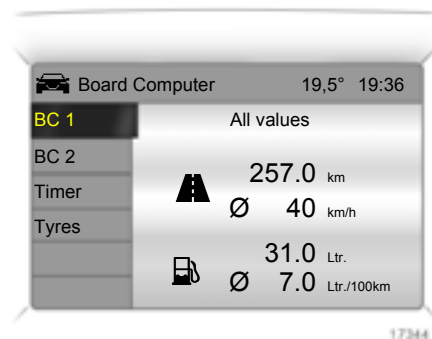
Resetting trip computer information

The following trip computer information can be reset (restart measurements):

- Distance travelled
- Average speed
- Effective consumption
- Average consumption

Select **BC 1** or **BC 2** from the trip computer menu.

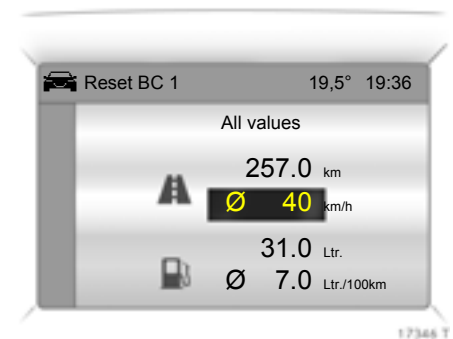

The information of the two trip computers can be reset separately, making it possible to evaluate data from different time periods.

Select the desired trip computer information.

The value for the selected function will be reset and recalculated.

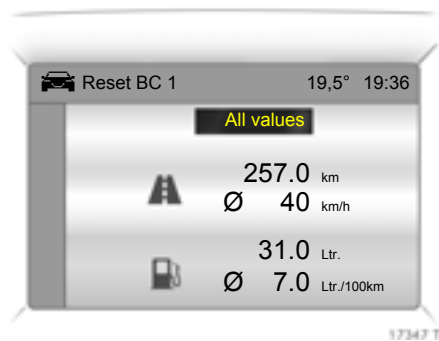

To reset all information of a trip computer, select menu item **All values**.

After resetting, "- - -" is displayed for the trip computer information selected. The recalculated values are displayed after a brief delay.

Interruption of power supply

If the power supply has been interrupted or if the battery voltage has dropped too low, the values stored in the trip computer will be lost.



Stop watch

Select menu item **Timer** from the **Board Computer** menu.

The **Timer** menu is displayed.

To start, select menu item **Start**.

To reset, select menu item **Reset**.

The desired stop watch display can be selected from the **Options** menu *:

Driving Time excl. Stops

The time the vehicle is in motion is recorded. Stationary time is not included.

Driving Time incl. Stops

The time the vehicle is in motion is recorded. The time the vehicle is stationary with the key in the ignition switch is included.

Travel Time

Measurement of the time from manual activation via **Start** to manual deactivation via **Reset**.

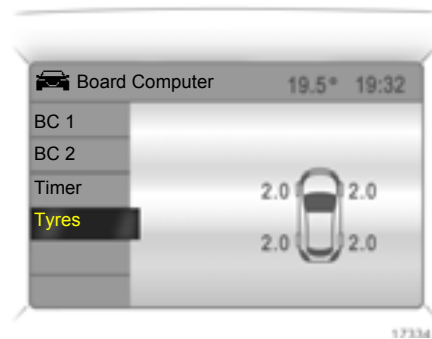

Display of current tyre pressure *

Select menu item **Tyres** from the **Board Computer** menu.

The current pressure of each tyre is displayed.

Further information – see page 144.

Check control *

In vehicles with tyre pressure monitoring system *, if tyre pressure is too low, the display indicates which tyre to check, e.g.:

**Tyre pressure
check rear
right tyre
(value in bar)**

Check tyre pressure at next opportunity using suitable gauge.

Tyre pressure monitoring system * – see page 144.

Tyre pressure – see page 224.

In vehicles with tyre pressure monitoring system *, if there is a major loss of pressure in a tyre, the display indicates the tyre at fault, e.g.:

**Attention!
Rear left tyre
pressure loss
(value in bar)**

Stop immediately and check tyre.

Tyre pressure monitoring system * – see page 144.

Tyre pressure – see page 224.

Warning buzzers

While driving:

- when operating the turn signals.
- if driver's or passenger's seat belt * is not engaged when the seat is occupied and vehicle speed exceeds approx. 22 km/h (14 mph).

When the vehicle is parked and driver's door is opened:

- with exterior lamps switched on.
 - when the key is in the ignition switch.
- Seat belt warning chimes - see pages 46, 72, driving hints - see page 127, save fuel, protect the environment - see page 129.

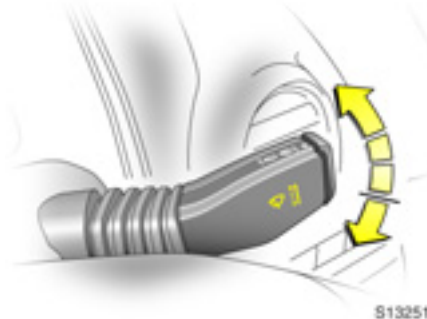

Windscreen wipers

To activate, move lever upwards.

- = Off
- = Timed interval wipe
- = Slow
- == = Fast

Press lever down from position ○: single swipe.

Further information - see pages 198, 202, 205.

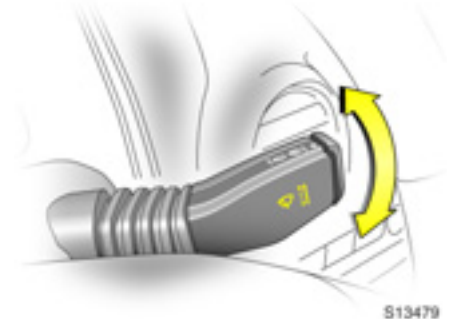

Adjustable wiper interval

To set the wiping interval to a value between 1 and 10 seconds:

Switch on ignition.

Push lever down from position ○.

Wait the desired interval.

Set the lever to adjustable timed interval wiper position --.

The interval remains stored until the next change or the ignition is switched off.

Switching the ignition on and moving the lever to -- sets the interval to 3.5 seconds.

In this mode, wiping frequency is also affected by vehicle speed. As vehicle speed increases, wiping will become more frequent.

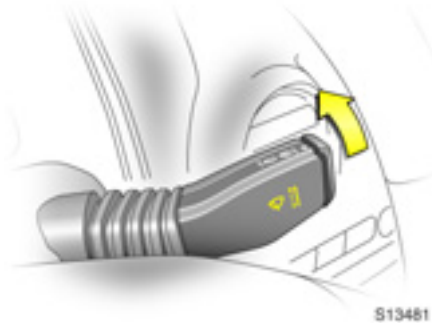

Automatic wiper with rain sensor *

To activate, move lever upwards to automatic wiper with rain sensor position --.

The rain sensor detects the amount of water on the windscreen and automatically regulates the windscreen wipers.

The wipers operate for one cycle to check the system when the ignition switch is turned to ACC.

To turn wipers off, move lever to position O.

Keep the rain sensor area clean by activating the windscreen washer system.

Further information - see pages 198, 202, 205.



Windscreen and headlamp washer systems *

To activate, pull lever towards steering wheel. Washer fluid is sprayed onto the windscreen. If the lever is held longer, the wipers operate for two cycles after the lever has been released and once more after a 3 second delay *.

The headlamp washer system * can only be operated when the headlamps are on. Washer fluid is sprayed onto the headlamps. The headlamp washer system can only be operated again after a short delay. If washer fluid level is low then this delay is increased.

On vehicles fitted with rain sensor *, keep the sensor area clean by activating the windscreen washer system.

Further information - see pages 199, 202, 205.

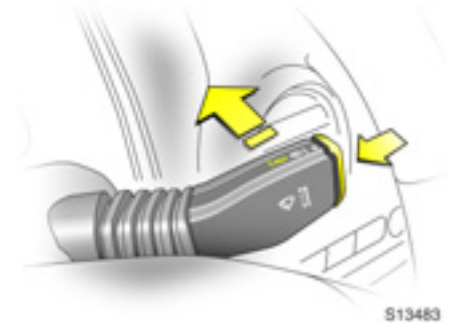

Tailgate wiper and washer systems

Activate wipers and washer as follows:

- Wipers on = Push lever forwards
- Wipers off = Pull lever back towards steering wheel
- Wash = Press and hold button

Washer fluid is sprayed on to tailgate window when the button on the end of the lever is pressed. When the button is released, the washer will stop, but the wipers will continue to swipe for approx. 3 cycles.

Further information - see pages 198, 199, 202, 205.

Lighting

Main beam, headlamp flash	95
Automatic dipped beam activation*	95
Turn signal lamps	95
Front fog lamps 𐄀D	96
Fog tail lamp 𐄀𐄁	96
Reversing lamps.....	96
Centre high-mounted stop lamp.....	96
Hazard warning lamps	97
Headlamp range adjustment 𐄀D	97
Peripheral lighting	98
Instrument illumination, information display illumination.....	98
Interior courtesy lamps.....	98
Battery discharge protection.....	100
Headlamps when driving abroad.....	100



Exterior lamps

Turn light switch:

O	=	Off
𐄀𐄁	=	Parking lamps
𐄀D	=	Dipped beam or main beam
AUTO	=	Automatic dipped beam activation *

In positions 𐄀𐄁 and 𐄀D, the tail lamps, license plate lamps and instrument panel lamps are also on.

Daytime running lamps *

Come on automatically when engine is started.

They will turn off when the parking lamps or dipped beam are on, or when the engine is stopped.

Follow the regulations of the country in which you are driving when using daytime running lamps and front fog lamps.

Driving abroad - see page 100.

Lamps on reminder

If the driver's door is opened when the light switch is in position 𐄀𐄁 or 𐄀D and the ignition is off, a warning chime will sound. If the lamps are then switched off and back on again, the warning chime will not sound.

Wiper activated lighting *

With light switch in **AUTO** position, if windscreen wipers are operated for 8 cycles or more, the exterior lamps illuminate automatically.

Approach lighting *

Depending upon outside light conditions, when you press 𐄀 on the remote control, the hazard warning lamps flash twice and the exterior lamps illuminate for approx. 20 seconds.



S14526

Main beam, headlamp flash

To switch from dipped beam to main beam, push lever forwards.

To switch back to dipped beam, pull lever back towards steering wheel.

To activate the headlamp flash, pull lever towards steering wheel. Main beam is engaged for the duration of activation.

The blue control indicator  is illuminated when main beam or headlamp flash is on.



S 13591

Automatic dipped beam activation

Light switch to **AUTO**; dipped beam comes on automatically when the engine is running, depending on outside light conditions.

For reasons of safety, the light switch should always remain in the **AUTO** position.

To ensure automatic dipped beam activation functions properly, do not cover the light sensor on top of the instrument panel.

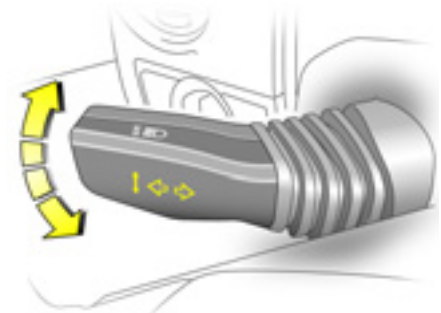

S14527

Turn signal lamps

To activate, press lever up or down lightly.

Lever up = Right turn
Lever down = Left turn

When the steering wheel is turned back, the lever automatically returns to its rest position. This will not happen when making a minor steering manoeuvre such as lane changing.

Tap signal: briefly move lever to resistance point. The turn signal then flashes three times when changing lanes or the like.

Hold the lever if you want the turn signals to flash for longer. When released, the lever will spring back to rest position.

The volume of the turn signal lamps' audible warning is dependent upon vehicle speed.



Front fog lamps D

- On = Press button D , D illuminates in instrument panel.
- Off = Press button D again, D extinguishes in instrument panel.

The front fog lamps can only be switched on when both the ignition and headlamps are on.

With automatic dipped beam activation * , parking lamps and dipped beam come on simultaneously when the front fog lamps are switched on.

Follow the regulations of the country in which you are driving when using front fog lamps.



Fog tail lamp D

- On = Press button D , D illuminates in instrument panel.
- Off = Press button D again, D extinguishes in instrument panel.

The fog tail lamp can only be switched on when the ignition is on and the light switch is in position D , or the front fog lamps are on and the light switch is in position D .

With automatic dipped beam activation * , parking lamps and dipped beam come on simultaneously when the fog tail lamp is switched on.

Reversing lamps

Come on when reverse gear is engaged and ignition is switched on.

Centre high-mounted stop lamp

Comes on when the brakes are applied, acting as a third stop lamp, to supplement the brake lamps.



Hazard warning lamps

To switch on, press button .

To switch off, press button  again.

To aid location of the pushbutton, the red surface is illuminated when the ignition is switched on. When the button is pressed, its control indicator flashes in unison with the hazard warning lamps.



Headlamp range adjustment

Manual headlamp range adjustment *

With dipped beam switched on, adjust headlamp range to suit vehicle load.

Correct adjustment of the headlamp range reduces dazzle for other road users.

Automatic level control system * - see page 143.

Vehicles without level control system

- Front seats occupied = 0
- All seats occupied = 1
- All seats occupied and load in luggage compartment = 2
- Driver's seat occupied and load in luggage compartment = 3

Vehicles with level control system

- Front seats occupied = 0
- All seats occupied = 1
- All seats occupied and load in luggage compartment = 1
- Driver's seat occupied and load in luggage compartment = 2

Automatic headlamp range adjustment *

On vehicles with Xenon headlamps, the range of the headlamps is adjusted automatically based on vehicle load.

If control indicator  for automatic headlamp range adjustment illuminates in the instrument panel while driving, a fault has occurred.

Have the cause of the fault remedied immediately. Consult a workshop.

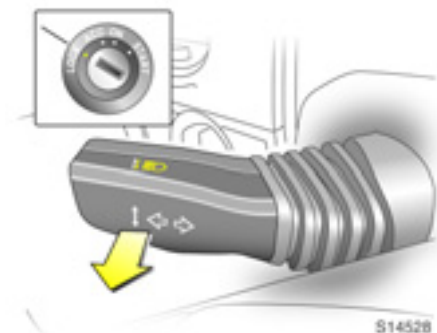

Peripheral lighting

The dipped beam and reversing lamps illuminate for approx. 30 seconds after the driver exits the vehicle and closes the door.

To activate function:

1. Switch off ignition.
2. Remove ignition key.
3. Open driver's door.
4. Pull turn signal lever towards steering wheel.

If the driver's door is left open, the lamps will extinguish after two minutes.

Peripheral lighting can be deactivated by inserting the key in the ignition switch or by pulling the turn signal lever towards the steering wheel again while the driver's door is open.



Instrument illumination, information display illumination

Comes on when ignition is switched on.

Brightness can be adjusted when the exterior lamps are on: turn wheel to the right or left until the desired brightness is obtained.

If driver's door is opened or > is pressed on the remote control, instrument panel lamps will illuminate automatically and stay on for approx. 30 seconds until ignition switch is turned to the ACC position.

Display mode ✱ - see page 87.



Interior courtesy lamps

Front reading lamps, rear interior lamps and luggage compartment lamps function as courtesy lighting and illuminate when the doors or tailgate are opened.

If doors or tailgate remain opened, the lamps stay illuminated for approx. 10 minutes.

Once all doors and the tailgate are closed, the courtesy lamps dim gradually after approx. 10 seconds.

By pressing button ☰ , both front reading lamps and the rear interior lamps illuminate.

Press the button again to turn the lamps off.



S 12875

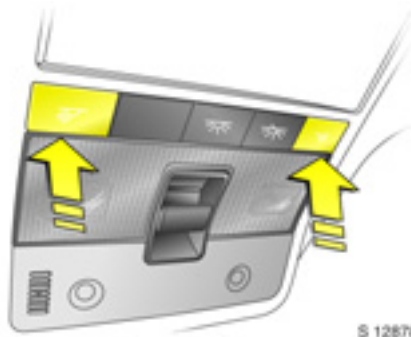

Courtesy lamps can be turned off immediately by pressing button .



S 12878

Front reading lamps

Left and right reading lamps are individually operable. With ignition on:

On = Press button  or 

Off = Press button again

Warning

Avoid using interior lamps while driving in the dark, as they can reduce driver visibility.



S 13429

Rear interior lamps

Press button to turn on left and right rear interior lamps individually.

Press button again to turn the lamp off.



Luggage compartment lamps

Come on when a door or the tailgate is opened.

Front door lamps

Come on when a door is opened.

Once all doors are closed, the front door lamps extinguish after approx. 10 seconds. If the doors are left open, the lamps will stay on for approx. 10 minutes.

Front door lamps can also be turned off immediately by pressing button  in the roof lining.

Ignition switch illumination

Comes on when you open a door.

Ignition switch illumination can also be turned off immediately by pressing button  in the roof lining.

Sun visor lamps*

Come on when vanity mirror covers are opened. See page 34.

Ashtray illumination

The portable front ashtray, located in the front drink holder, illuminates depending on outside light conditions. See page 68.

Glove compartment illumination

Comes on when the glove compartment is opened. See page 64.

Battery discharge protection

To prevent battery from becoming discharged, the external lamps turn off automatically approx. 10 minutes after the ignition is switched off.

Battery discharge protection will not work if the lamps are turned on 10 minutes after the ignition has been switched off; the key cannot be removed from the ignition switch until the battery is recharged.

Headlamps when driving abroad

The asymmetrical dipped beam increases the field of vision on the near side of the lane.

When driving in countries which drive on the opposite side of the road, this causes glare for oncoming traffic.

For temporary periods, to avoid glare the headlamp pattern should be adjusted down to the horizontal position.

Have the headlamps adjusted by a workshop.

Infotainment system

Radio reception *	101
Steering wheel mounted remote control	101
Mobile telephones and radio equipment (CB) *	102
Infotainment and navigation systems *	102

Radio reception *

The radio is operated as described in the operating instructions supplied.

Vehicle radio reception will differ from that obtained with domestic radios.

As the vehicle antenna is relatively near the ground, the broadcasting companies cannot guarantee the same quality of reception as is obtained with a domestic radio using an overhead antenna.

- Changes in distance from the transmitter
 - multi-path reception due to reflection and shadowing
- may cause hissing, noise, distortion or loss of reception altogether.



Steering wheel mounted remote control

Infotainment system functions can be operated by the buttons mounted on the steering wheel.

Further information - see pages 79, 84 and the relevant operating instructions.

Mobile telephones and radio equipment (CB) *

The Opel installation instructions and the operating guidelines provided by the telephone manufacturer must be observed when fitting and operating a mobile telephone. Failure to do so could invalidate the vehicle's operating permit (EU Directive 95/54/EG).

Requirements to ensure trouble-free operation:

- Professionally installed exterior antenna, to obtain the maximum range possible
- Maximum transmission power 10 W.
- Installation of the telephone in a suitable spot (front centre console).
See important notes on page 57.

Obtain advice on predetermined installation locations for the external antenna and equipment holder and ways of using devices with transmission power of more than 10 Watts. We recommend that you consult your Opel Partner, who will have brackets and various installation kits and install them in accordance with regulations.

Operation of a handsfree attachment with no outside antenna, using the mobile telephone standards GSM 900/1800/1900 and UMTS, may take place only if the maximum transmission power of the mobile telephone does not exceed 2 W, in the case of GSM 900, and otherwise 1 W. The operating instructions of the manufacturer of the telephone and handsfree attachment must be noted in all cases.

For reasons of safety, we recommend that you do not use the phone while driving. Even use of a handsfree set can be a distraction while driving. Be sure to observe any country-specific regulations.

Warning

When used in the vehicle interior, mobile telephones and radio equipment (CB) with integrated antenna may cause malfunctions in the vehicle electronics.

Mobile telephones and radio equipment (CB) should only be used with an antenna fitted on the vehicle exterior.

Infotainment and navigation systems *

The systems are operated as described in the instruction manuals supplied.

The navigation system is supplied with a CD or DVD detailing the local territory.

For additional countries/territories, separate CD's are available from your Opel Partner.

Climate control

Heating and ventilation system, air conditioning system	103
Electronic Climate Control (ECC) * ...	103
Air vents	104
Heated rear window, heated exterior mirrors *	105
Heated front seats *	105
Glove compartment cooling *	105
Heating and ventilation system	106
Air recirculation mode	109
Air conditioning system	109
Electronic Climate Control (ECC) * ...	111
Air intake	114
Pollen filter	114
Note	114
Maintenance	114



Heating and ventilation system, air conditioning system

Ventilation, heating and cooling are combined into one unit that is designed to provide comfort regardless of the season, weather or outside temperature.

When cooling is activated, the air is cooled and dehumidified (dried).

The heating unit heats the air as required in all operating modes, depending on the position of the temperature rotary knob. The air supply can be adjusted to suit personal requirements by means of the fan.

Air conditioning system - see page 109.



Electronic Climate Control (ECC) *

Provides the greatest amount of comfort in the vehicle interior, regardless of the weather, outside temperature or season.

To ensure a constant and comfortable climate in the vehicle, the temperature of inflowing air, the air flow rate, air distribution mode, air recirculation mode and air conditioning are automatically adapted based on the climate conditions outside the vehicle and the current temperature of the vehicle interior.

Electronic Climate Control (ECC) * - see page 111.

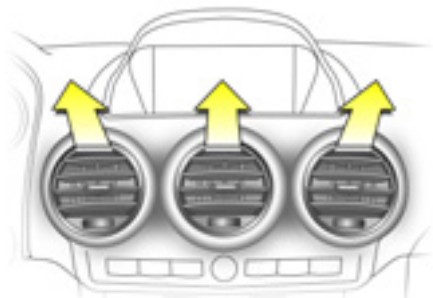



S13256

Air vents

Pleasant ventilation to the head area with unheated or slightly warmed air depending on the position of the temperature rotary knob.

Centre air vents

To open and close air vents, turn horizontal knurled wheel to the left or right.

Open air vents when air distribution rotary knob is set to  or .

The air supply is increased by switching on the fan.



The air flow can be directed as desired by tilting and swivelling the slats up, down and sideways.



S 13456

Side air vents

To open and close air vents, turn horizontal knurled wheel to the left or right.



Open air vents when air distribution rotary knob is set to  or .

Depending upon the position of the temperature rotary knob, cold or heated air will be directed into the vehicle via these air vents.



The air supply is increased by switching on the fan.

The air flow can be directed as desired by tilting and swivelling the slats up, down and sideways.

Door window defroster vents

Air distribution rotary knob set to  or ; cooled or heated air will be directed onto the windscreen and onto the door windows (mainly in the area of the exterior mirrors).

Rear air vents

Operational when air distribution rotary knob is set to ,  or .

Cooled or heated air is directed into the footwell area of the rear passenger compartment.

Keep the area underneath the front seats clear, to allow air flow to the rear passenger compartment.

Additional air vents

Below the windscreen (defroster vents) and in the front footwells.



S 14532

Heated rear window, heated exterior mirrors *

Operational only in ignition switch positions ACC or ON.

Press button  = On

Press button  again = Off

Control indicator in button.

Turn off as soon as vision is clear.

Rear window and exterior mirror heating is switched off automatically after approx. 15 minutes.

To avoid discharging the battery, do not operate when you are just starting the vehicle, or if there is a build up of snow or ice. Operate only with the engine running.

Do not use sharp instruments or abrasive cleaners on rear window or exterior mirrors, and avoid scratching or damaging their heating elements.

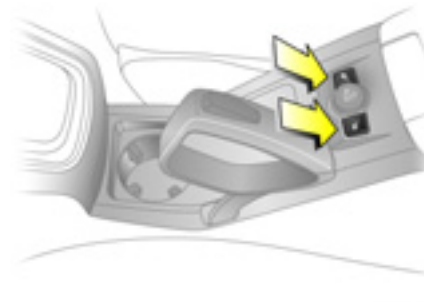

S 13393

Heated front seats *

Operational only in ignition switch positions ACC or ON.

Press switch  on respective side one or more times to set the desired heat output. Control indicator in switch indicates which of the three heating levels is active.

To switch heating off, set heat output to the lowest level and press the switch again. The control indicator will extinguish.

Prolonged use could cause damage to delicate and thin clothing and burn seat occupants.

Avoid subjecting seats to heavy impacts, as this may cause damage to the heating element.

If temperature continues to rise, turn seat heating off and consult a workshop.

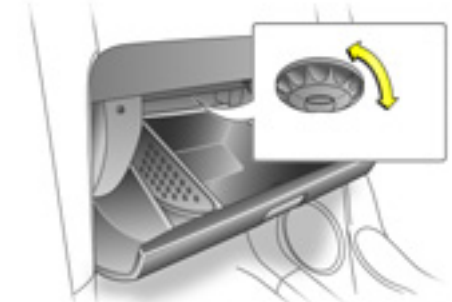

S 13626

Glove compartment cooling *

Cooled air is fed into the glove compartment through an air opening, when the air conditioning is turned on.

Rotate adjustment wheel anti-clockwise to allow the air conditioning to keep the contents of the glove compartment cool.

Rotate adjustment wheel clockwise to close air opening when glove compartment cooling is not required.



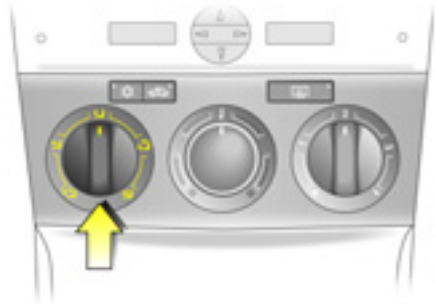

General notes and notes on air intake, pollen filter and maintenance
see page 114.



S 13615

Heating and ventilation system

Left-hand rotary knob: Air distribution

-  To head area via adjustable air vents
-  To head area via adjustable air vents and to footwell
-  To footwell
-  To windscreen, front door windows and footwell
-  To windscreen, front door windows and head area via adjustable air vents



S 13701

Central rotary knob: Temperature

- To red = Warm
- To blue = Cold



S 13617

Right-hand rotary knob: Air flow

Four fan speeds:





-  = Off
- 4** = Maximum air flow

The rate of air flow is determined by the fan. The fan should therefore be switched on during driving.



S 13618



Ventilation

- Turn air recirculation mode  off.
- For maximum ventilation to head area: set air distribution rotary knob to .
- For ventilation to footwell: set air distribution rotary knob to .
- For simultaneous ventilation to head area and footwell: set air distribution rotary knob to .
- Turn temperature rotary knob to blue area for cooling.
- Set fan to desired speed.
- Open adjustable centre and side air vents.

Heating



The amount of heat is dependent on the engine temperature and is thus not fully attained until the engine is warm.

For rapid warming of the passenger's compartment:

- Activate air recirculation mode .
- Set the air distribution rotary knob to  or .
- Turn temperature rotary knob to red area for warm air.
- Set fan to 4.
- Open adjustable side air vents.

Do not use this setting for extended periods, as gradual deterioration in air quality and an increase in humidity may cause windows to mist up.

To obtain a temperature for a "cool head and warm feet" effect:

- Turn air recirculation mode  off.
- Set the air distribution rotary knob to .
- Turn temperature rotary knob to the middle.
- Set fan to desired speed.
- Open adjustable centre and side air vents.

The comfort and general wellbeing of vehicle occupants are to a large extent dependent on a suitable ventilation and heating setting.



Heating the footwell

- Set air distribution rotary knob to .
- Turn temperature rotary knob to red area for warm air.
- Switch on fan.





Window demisting and defrosting

Warning





Failure to follow these instructions could lead to misted or icy windows and accidents stemming from impaired visibility.



To clear misted or icy windows, e.g. due to damp weather, damp clothing or low outside temperatures:

- Set air distribution rotary knob to .
- Turn temperature rotary knob to red area for warm air.

- Set fan to 4.
- Close centre air vents.
- Open adjustable side air vents and direct them towards door windows.
- Switch on heated rear window .

For simultaneous warming of the footwell, set air distribution rotary knob to .

Air conditioning  and air recirculation  are turned on automatically to improve defrosting efficiency when position  or  is selected.

To prevent windows from misting up, do not set air distribution rotary knob to position  or  in extremely humid weather when temperature rotary knob is set to blue area for cooling.



Air recirculation mode

During 'normal' operation, the heating, ventilation and air conditioning system uses outside air. To prevent fumes or unpleasant odours from entering the vehicle when in stationary traffic and when rapid heating or cooling of the passenger compartment is required, press button ; control indicator in the button illuminates and air is recirculated.

Air recirculation mode should only be used for brief periods, due to gradual deterioration in air quality and an increase in humidity, causing windows to mist up. Driving with air recirculation mode on for extended periods may cause vehicle occupants to feel drowsy.

Press button  again to turn air recirculation mode off; control indicator in the button extinguishes and outside air is drawn into the vehicle.



Air conditioning system

As a supplement to the heating and ventilation system, the air conditioning system cools and dehumidifies (dries) inflowing air and removes dust and pollen, to provide maximum comfort under any weather conditions.

If cooling or dehumidification is not required, switch off cooling in order to save fuel.



S 13622

Cooling

Operational only with engine running and with the fan switched on:

Press button  = On

Press button  again = Off

Control indicator in the button illuminates when air conditioning is enabled and extinguishes when the system is switched off.

Cooling switches off automatically at low outside temperatures.

Engine power and performance may be affected when the system is on.

If the fan is switched off, the air conditioning system will not operate.

Once activated, the air conditioning system is operated via the normal heating and ventilation controls.

Even with air conditioning on, if temperature rotary knob is set to warm, the vehicle will still produce warm air in the passenger compartment.

To improve efficiency of the air conditioning, always close the windows, to prevent chilled air from escaping.

Switching on the air conditioning will assist in windscreen demisting. In very hot temperatures, before starting the engine, allow hot air to escape from the vehicle by opening the windows and sun roof .

When the air conditioning system is switched on, at least one of the adjustable centre or side air vents must be open, so that the evaporator does not ice up due to lack of air movement.





Driving in stop-and-go traffic may reduce the effectiveness of the air conditioning system.

Using the air conditioning system when driving up long hills or in heavy traffic can cause engine overheating. If engine coolant temperature warning control indicator  illuminates in instrument panel, turn off air conditioning and allow engine to idle for a few minutes (see page 71).



S 13623

Normal cooling

- Press button  (to switch on air conditioning system).
- Turn air recirculation mode  off.
- Set air distribution rotary knob to position  or .
- Turn temperature rotary knob to blue area for cooling.
- Set fan to desired speed.
- Open air vents as required.



Maximum cooling

Open windows and sun roof ☼ briefly so that warm air can escape rapidly.

- Press button ☼ (to switch on air conditioning system).
- Activate air recirculation mode 🚗.
- Set air distribution rotary knob to 🌀.
- Turn temperature rotary knob all the way to blue area for cooling.
- Set fan to 4.
- Open all air vents.

Electronic Climate Control (ECC) ☼

Provides the greatest amount of comfort in the vehicle interior, regardless of the weather, outside temperature or season.

To ensure a constant and comfortable climate in the vehicle, the temperature of the inflowing air, the air flow rate, air distribution mode, air recirculation mode and air conditioning are automatically adapted based on the climate conditions outside the vehicle and the current temperature of the vehicle interior. Temperature changes due to external influences, such as direct sunlight, are automatically compensated.



When cooling (air conditioning compressor) is active, air is cooled and dehumidified.

The pollen filter removes dust, soot, pollen and spores from the inflowing outside air.



S 14533

Automatic air recirculation

The automatic air recirculation system has an air quality sensor to detect harmful ambient gases, in which case it will switch automatically to air recirculation mode.

Press automatic air recirculation button ; the system provides the optimum settings for almost all conditions. Control indicator in the button illuminates when automatic air recirculation is enabled.

Press button  again to turn automatic air recirculation system off; control indicator in the button extinguishes and outside air is drawn into the vehicle.

The system is only operational when the engine is running.



S 14530

Automatic mode

Basic setting for maximum comfort:

- Press **AUTO** button.
- Open all air vents.
- Set temperature using central rotary knob.

All air vents are actuated automatically in automatic mode. The air vents should therefore always be open - see page 104.

The control indicator in the **AUTO** button illuminates when automatic mode has been selected.

To switch the system off, set fan to .

Temperature preset

The central rotary knob can be used to set the temperature; 22 °C, 24 °C and 26 °C appear on the rotary knob. Intermediate settings are possible.

The selected temperature is maintained.

At the lowest or highest temperature setting, the system works at maximum cooling or heating.



Manual settings

Under certain circumstances (e.g. iced or misted windows), the functions of the system can be modified manually.

System settings can be changed by pressing button (control indicator in button will illuminate) or by adjusting the fan or air distribution rotary knob.

Automatic regulation of temperature, air flow rate, air distribution mode, air recirculation mode and air conditioning is disabled.

To return to automatic mode: press **AUTO** button.

Air distribution mode - see page 106,
air flow rate - see page 106,
air recirculation mode - see page 109,
air conditioning system - see page 109.



Window demisting and defrosting

Warning

Failure to follow these instructions could lead to misted or icy windows and accidents stemming from impaired visibility.

To clear misted or icy windows, e.g. due to damp weather, damp clothing or low outside temperatures:

- Press button , to clear the windscreen.
- Switch on heated rear window .
- Set fan to desired speed.

Air recirculation mode is automatically switched off. Air conditioning switches on.

To switch off window demisting and defrosting, press button again, press **AUTO** button, adjust fan speed or air distribution rotary knob.

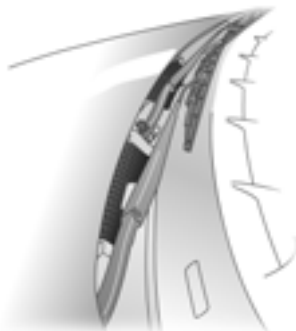

S 13673

Air intake

The air intakes in front of the windscreen in the engine compartment must be kept clear to allow air intake. Remove any leaves, dirt or snow.

Pollen filter

The pollen filter cleans dust, soot, pollen and spores from the air entering from outside. The active carbon layer ✱ eliminates most odours and harmful ambient gases from the air.

Replace the pollen filter at the intervals given on pages 206 to 212.

Note

If the windscreen mists up in damp weather, temporarily set the system as described under "Window demisting and defrosting" - see pages 108, 113.

Cooling is most efficient when the windows are closed. If the interior is extremely hot due to a long period in strong sunlight, briefly open the windows and sun roof ✱ to allow hot air to escape quickly.

When cooling (air conditioning compressor) is switched on, condensation forms, which is expelled from the underside of the vehicle.

When cooling is switched on, at least one of the adjustable centre or side air vents must be open so that the evaporator does not ice up due to lack of air movement.

Cooling switches off automatically at low outside temperatures.

Do not cover the interior temperature sensor (located below the fan switch) or the sunlight sensor (located in front of windscreen defroster vents) as this could cause the Electronic Climate Control (ECC) system ✱ to malfunction.

Maintenance

To ensure continuously efficient performance and prolong the life of the air conditioning system, it must be switched on for a few minutes once a week, irrespective of the weather and time of year.

Electronic Climate Control (ECC) ✱ handles this automatically while driving. Air conditioning compressor operation is not possible at low outside temperatures.

Malfunctions in the system must not be rectified by the owner: consult a workshop.

Driving and operation

Automatic transmission *	115
All Wheel Drive.....	121
Driving hints	127
Save fuel, protect the environment ...	129
Fuels, refuelling	131
I Catalytic converter, exhaust emissions.....	133
Drive control systems	136
Brake system.....	145
Anti-lock Brake System (ABS) (®).....	148
Wheels, tyres	149
Roof racks *.....	153
Flex-Fix system *.....	154
Towing equipment *.....	164
Towing	167

Automatic transmission *

The automatic transmission permits manual gearshifting (**manual mode**) or automatic gearshifting (**automatic mode**) with fully automatic clutch control.

The engine can only be started when the selector lever is in position **P** or **N**. When starting in **P**, turn key in ignition switch to ACC or ON, depress foot brake and press selector lever button before selecting a gear.

Do not accelerate whilst gearshifting. If a gear has been selected and the foot brake is released without accelerating, the vehicle will "creep".

Never operate the brake pedal and accelerator simultaneously.

Warning

Disregard of these instructions may cause damage to the vehicle and lead to injuries or endanger life.

Selecting **D** puts the transmission in automatic mode.

If the selector lever is moved to the left from position **D**, manual mode is activated. Forward gear changes only can then be made manually by tipping the selector lever towards + or -.



Transmission display

Display of mode or current gear.

- P** Park position.
- R** Reverse gear.
- N** Neutral.
- D** Automatic mode.
- 1 to 5** Selected gear in manual mode.



**Selector lever settings,
P, R, N and D (automatic mode)**

- P** Park position. Front wheels locked. Only engage when the vehicle is stationary and the hand brake is applied. "P" appears on the transmission display.
- R** Reverse gear. Only engage when the vehicle is stationary. "R" appears on the transmission display.
- N** Neutral or idle. "N" appears on the transmission display.
- D** Drive position for normal driving in 1st gear to 5th gear. "D" appears on the transmission display.

Selector lever can only be moved out of **P** or **N** with the ignition switched on and the foot brake depressed (selector lever lock).

To engage **P** or **R**, press selector lever button.

Never shift to **P** or **R** while the vehicle is moving.

The engine can only be started when the selector lever is in position **P** or **N**. Depress foot brake or apply hand brake before starting.

Do not accelerate during the selection procedure.



Manual mode

Move selector lever out of position **D** (to the left) into manual gate, then forwards or backwards.

- + Shift to a higher gear.
- Shift to a lower gear.

Tip selector lever in the appropriate direction. It then returns to centre position.

Gearshifting in manual mode can be achieved whilst accelerating.

If the engine speed is too low, the transmission will automatically shift to a lower gear, even in manual mode. This prevents the engine from stalling.

After stopping, 1st gear is automatically selected.

No automatic shifting to a higher gear takes place at high engine speeds.

When upshifting in manual mode, take heed of prevailing road conditions, keeping engine speed below the red zone.

Downshifts must be made in accordance with vehicle speed.

Gears can be skipped by moving the selector lever repeatedly at short intervals.

When starting on slippery surfaces, move selector lever forwards to engage 2nd gear.

The selected gear is displayed in the transmission display.

For safety reasons, kickdown is also available in manual mode - see page 118.

To move back to **D**, push selector lever back to the right.



Winter program

In the event of difficulties starting-off on icy and slippery surfaces, press button ; control indicator **WINTER** is illuminated in the instrument panel and the vehicle sets off in 3rd gear, to reduce slipping and loss of traction.

Winter program is switched off by:

- pressing button  again (control indicator **WINTER** will extinguish in instrument panel),
- turning off the ignition.

If the vehicle is switched to manual mode while Winter program is active, the Winter program is switched off.

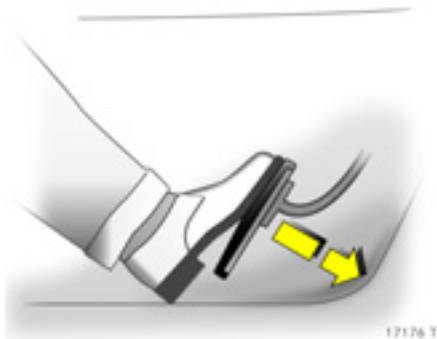

Kickdown

Depress accelerator pedal past the pressure point and hold in position; below certain speeds, the transmission shifts down into a lower gear. Full engine power is available for acceleration.

When the desired speed is reached, ease off the accelerator; the transmission shifts up into a higher gear.

For safety reasons, kickdown is available in both automatic and manual mode.

Engine braking assistance

Automatic mode

The automatic transmission automatically selects the driving programs with the best possible braking effect.

If necessary, lower gears can also be selected in manual mode to increase the braking effect. 1st gear has the greatest braking effect.

Manual mode

In order to utilize the engine braking effect when driving downhill, select drive range **3**, **2** or, if necessary, **1** in good time.

The braking action is most effective in drive range **1**. If drive range **1** is selected at too high a speed, the transmission remains in the current gear until the shift point for drive range **1** is reached, e.g. as a result of deceleration.

Use of the engine braking effect, as opposed to the use of the foot brake when driving downhill, can extend the life of the brakes.

Stopping the vehicle

The selector lever can be left in the current drive range when the engine is running.

In automatic or manual mode, once the vehicle is stationary, first gear engages automatically and the clutch opens.

In position **R**, reverse remains engaged.

When stopping on gradients, engage hand brake or depress brake pedal. Do not hold the vehicle in place with the accelerator.

Switch off engine if stopping for a lengthy period, e.g. in traffic jams.

Parking

Before leaving the vehicle:

- Depress and hold foot brake,
- Apply hand brake,
- Move selector lever to position **P**,
- Turn key to **LOCK** position,
- Remove ignition key,
- Engage steering column lock,
- Lock the vehicle.

When the ignition is switched off, the automatic transmission no longer responds to movements of the selector lever.

Rocking the vehicle

If it becomes necessary to rock the vehicle to free it from water, ice, sand, mud, snow or a dip, observe the following:

Check there are no objects or people in the vicinity before attempting to rock the vehicle.

Turn the steering wheel fully from left to right to clear the area around the front tyres.

Move the selector lever between **R** and a forward gear in a repeat pattern while applying light pressure to the accelerator pedal when the vehicle is in gear.

Do not spin the wheels or race the engine and avoid sudden acceleration.

This applies only in the exceptional circumstances mentioned above.

If the vehicle cannot be released after rocking the vehicle several times, your vehicle may need to be towed.

Towing - see page 174.

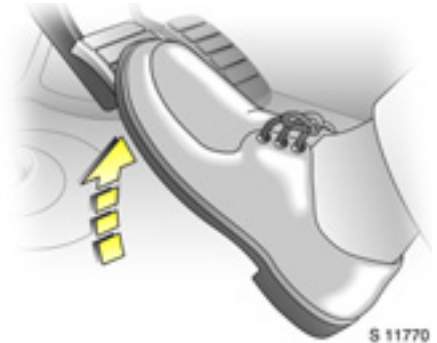
**Manoeuvring the vehicle**

To manoeuvre the vehicle back and forth during attempts to park or in garage entrances, the creeping movement can be utilized by releasing the foot brake.

Never actuate the accelerator and brake pedals simultaneously.



Fault

If a fault occurs in the automatic transmission, control indicator  will illuminate in the instrument panel.

Automatic shifting may be much harsher than normal or, in the case of a serious fault, cancelled altogether.

Consult a workshop as soon as possible to have the cause of the fault eliminated.



Interruption of power supply

The clutch is not disengaged if the vehicle battery is discharged and a gear has been selected. The vehicle cannot move.

If the battery is flat, the selector lever cannot be moved out of position **P** or **N**.

Start the vehicle using jump leads - see page 172.

If the cause of the interruption to the power supply is not a discharged battery, release selector lever:

1. Turn off ignition and remove key.
2. Depress and hold foot brake.
3. Remove cap on console with a suitable screwdriver.
4. Insert ignition key and press gently into shift lock release slot.
5. Shift to neutral (N).
6. Remove key from shift lock release slot.
7. Start engine and shift to chosen gear.
8. Reinstall cap on console.

Have cause of power supply interruption remedied immediately. Consult a workshop.

All Wheel Drive

All Wheel Drive (AWD) is an active-on-demand system that engages automatically, with no action required by the driver. Depending on the driving environment, the vehicle switches between two-wheel drive and four-wheel drive, to give the vehicle more traction and stability when necessary.

If the front wheels begin to slip, the rear wheels will automatically begin to drive the vehicle as required.

More torque is transferred to the wheels that have the most traction, so the vehicle has optimum grip at all times.

There may be a slight engagement noise during hard use.

As well as enabling the vehicle to be driven off-road, this system also enables the vehicle to be driven on normal roads without incurring excessive tyre and drivetrain wear or causing poor control.



All Wheel Drive control indicator

When the ignition is switched on, control indicator  illuminates for approx. 4 seconds. The system is ready for operation when the control indicator extinguishes.

If the control indicator flashes during driving, All Wheel Drive is temporarily disabled.

If it flashes briefly then extinguishes, this is normal and does not indicate a fault.

If the control indicator flashes continuously, there is a fault in the system. Consult a workshop as soon as possible.

On-road driving

The increased traction of All Wheel Drive vehicles offers greater driving control in adverse road conditions, particularly heavy snow and ice. However, All Wheel Drive vehicles are not "skid-proof" and do not decrease stopping distances.

All Wheel Drive vehicles have a higher centre of gravity than conventional vehicles. Always approach curves at an appropriate driving speed. Do not attempt to go as fast through turns as you might in a conventional vehicle.



Strong crosswinds can affect the normal steering of the vehicle. Drive slower under strong crosswind conditions.

Always exercise caution when in slippery conditions (caused by sand, gravel, water, snow or ice on the road), in order to maintain vehicle control.

Use the accelerator to control the vehicle - keep brake pedal use to a minimum.

- Do not slip the clutch.
- Do not spin the wheels.
- Do not make exaggerated or jerky steering movements.

Driving a vehicle in snow and ice should be undertaken with extreme caution:

- Select a gear suitable for the conditions.
- Start the vehicle moving with minimal engine revs, low gear and combined clutch and accelerator control.
- Change to a higher gear as quickly as possible, to keep the engine revs low.
- With automatic transmission , select drive range **D** and press button , to activate the Winter program.

Off-road driving

During off-road driving, you will encounter a variety of driving conditions and circumstances too numerous to list here.

Always use good judgement and common sense. If you feel uncomfortable about tackling a given situation, do not attempt it.

Avoid protruding objects (such as rocks or tree stumps) that may damage the underbody and tyres of your vehicle.

Test the brakes after operating in mud, to clear excess mud from the braking surfaces.

Gripping the steering wheel

Terrain conditions can cause rapid and unexpected movement in the steering, especially rough terrain.

Warning

Be ready to deal with these movements by having a firm grip on the outer rim of the steering wheel with the thumbs outside the spokes, to guard against injury from kickback.

Preparation

The duration, distance and conditions of the off-road activity determine the extent of the preparation that is required. The following are given as guidelines.

Know the area where you will be driving, either by inspection or from terrain maps. Decide your route in advance and ensure that it is a vehicular right of way¹⁾.

Make a thorough check of the vehicle.

Check the following:

- Oil, water, fuel, brake and clutch fluid levels,
- Drive belts,
- Windscreen wipers and washer system,
- Lamps.

Maintenance - see pages 126, 206.

¹⁾ Observe national regulations.

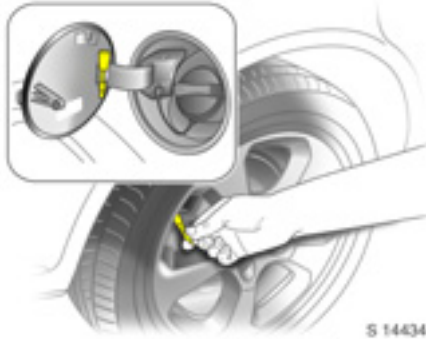

Ensure that tyres (including the spare) are inflated to the correct pressure and are suitable for the prevailing off-road conditions.

Tyre pressures - see page 224.

Check the jack and wheel changing tools, and include a board or plate for supporting the jack on soft ground.

Carry emergency equipment, i.e. tow rope, spade, first aid kit etc., which may be desirable if you intend entering unfamiliar off-road terrain.

A tow rope should be carried, to allow the recovery vehicle to be placed clear of any adverse ground.

Your Opel Partner will assist you in assessing any special requirements.



Secure all loose items and luggage that may cause injury if thrown around the passenger compartment in bumpy conditions. Avoid carrying heavy loads on the roof. Make sure all doors, the tailgate and the bonnet are firmly closed.

Securing items using lashing eyes - see page 61.

The ground clearance, ramp angle, angle of approach and departure and wading depth need to be considered, especially in hilly conditions and when wading, to prevent the vehicle becoming stuck and possibly damaged.

Technical data - see page 215.

Driving through water

Do not exceed the maximum wading depth.

Check the depth of water: choose the lowest entry and departure angles before entering.

Maintain a steady engine speed, to help prevent water from entering the exhaust system, but do not exceed 5 km/h (3 mph), to avoid splashing the water.

Drive with the flow wherever possible, not against it. If you have to drive against the flow, try to drive at an angle to it, so that the leading corner of the vehicle will help deflect water from the engine compartment.

Avoid splashing the water - if the ignition system becomes wet, the engine may stall.

Avoid water entering the air intake system.

Warning

If water enters the air intake system, engine seizure with severe costly damage may result.

Test the brakes after leaving the water - wet brakes are less effective than dry ones.

Perform the service operations for wading, involving checks for water contamination, at the earliest opportunity.

Service checks after wading - see page 126.

Self-help**Recovery and towing**

When recovering or towing a vehicle off-road, observe the following:

- A greater force is required to move a vehicle from or through mud than when on a hard surfaced road.
- Attach a tow rope to the towing eye of the vehicle, not to the axle - see pages 164, 174.
- Where possible, drive both vehicles forward to affect a recovery, using an appropriate gear to avoid wheelspin.
- Avoid the use of reverse gear because of possible resultant wheelspin.
- Stay clear of the tow rope.

 Warning
Breaking ropes can cause serious injury.

Wheel changing

Place a board or plate beneath the jack, to prevent it from sinking into soft ground.

Further information - see page 178.

Cleaning

Clean the vehicle thoroughly and as soon as possible after driving off-road.

Do not let mud remain dry on any part of the vehicle as it becomes abrasive and can damage paint, glass, seals, bearings and brake components.

If left to build up, mud can seriously affect the air flow through and over mechanical components and cause localised overheating and failure of parts, especially in the engine compartment.

Ensure the radiator core and the area between the radiator and intercooler/oil cooler (where installed) is cleaned, to maintain proper cooling air flow.

Check the radiator and cooler cores for blockage (sand, silt etc.).

Check the tyre treads.

Clean and check the mechanical parts of the vehicle, particularly the following areas:

- Driveshafts, including sealing bellows,
- Front brake calipers, pads and discs,
- Front suspension,
- Clutch fork sealing bellows,
- Rear brake calipers, pads and discs,
- Rear suspension,
- Fuel tank and underguard,
- Breathers, axles and fuel tank,
- Load sensing valve,
- Transfer box and underguard,
- Engine oil pan and underguard.

Observe the following:

- Do not spray high-pressure water directly at the vehicle seals.
- The wheels must be removed to clean all mud and stones from the brake calipers and to check brake pad wear.
- The areas on the upper side of the underguards must be cleared of stones, to prevent damage to the engine oil pan and the fuel tank.

Maintenance

Certain maintenance operations, e.g. changes of engine oil, oil filter, air cleaner element and brake pads, are required more frequently for severe operating conditions, e.g. driving on unsurfaced roads, during thick dust or mud accumulation, etc.

If the vehicle is driven off-road to a great extent, the chassis will need regular inspection.

Your Opel Partner will inform you which additional service is required between the normal service intervals, after consideration of the specific operating conditions of your vehicle.

Further information - see page 206.

Service checks after wading

After wading, check for the ingress of water into the following:

- Brake fluid reservoir,
- Air cleaner element,
- Engine,
- Transmission,
- Axles,
- Interior of vehicle.

Renew any lubricating oil or hydraulic fluid that has a milky appearance, indicating contamination with water.

All Wheel Drive summary

Do

- Check fuel and tyres, water and oil levels before venturing off-road.
- Survey on foot before driving off-road, especially when traversing hillsides, wading, driving in deep snow and over ridges.
- Select the correct gear for the conditions.
- Use the engine's power of acceleration and deceleration with the correct gear, to control the vehicle.
- Keep a firm grip on the outer rim of the steering wheel - keep your thumbs away from the spokes.
- Drive carefully and be prepared for emergencies.
- Drive slower under crosswind conditions.
- Approach obstacles and conditions off-road at the correct angles and with sufficient momentum to negotiate the obstacle, but do not put undue strain on the vehicle.
- Use caution - if you are not sure, do not do it.

Don't

- Do not venture off-road unless you are certain that the conditions are capable of being negotiated safely by you and your vehicle.
- Do not take unnecessary risks.
- Do not use the brakes excessively, to maintain steering control.
- Do not change gear on difficult terrain - depressing the clutch may cause the vehicle to stop because of drag on the wheels - or accelerate backwards or forwards when on a hill.
- Do not ride or slip the clutch.
- Do not spin the wheels if stuck in mud, sand or snow - they will only dig in deeper.
- Do not drive at an excessive speed, especially into corners. Your All Wheel Drive vehicle has a higher centre of gravity than conventional vehicles. Sudden changes of direction can lead to loss of control.

Driving hints

The first 1000 km (600 miles)

Drive your vehicle at various speeds. Do not use full throttle. Never allow the engine to labour at low revs.

Make good use of all gears. Depress the accelerator pedal a maximum of around three quarters of the available pedal travel in all gears and drive ranges.

Do not drive faster than three quarters of maximum speed.

Avoid quick starts, sudden acceleration and prolonged high-speed driving, to avoid engine damage and to conserve fuel.

Do not brake unnecessarily hard for the first 200 km (125 miles).

If possible, avoid towing another vehicle.

Never coast with engine not running

Many units may then not function (e.g. brake servo unit, power steering, airbag system). Driving in this manner is a danger to yourself and others.

Brake servo unit

With the engine not running, the brake servo unit is no longer effective once the brake pedal has been depressed once or twice. The braking effect is not reduced, but substantially greater foot pressure is necessary to stop the vehicle.

Power steering

Never leave the steering wheel on full lock when the vehicle is stationary, as this may damage the power steering pump.

If the power steering should fail - e.g. when the vehicle is being towed with the engine switched off - the vehicle can still be properly steered, but considerably greater effort is necessary.

Driving in mountainous terrain or with a caravan/trailer

Electrically driven fan; the fan cooling capacity is not dependent on engine speed. It is not necessary, therefore, when driving uphill to shift down into a lower gear if the vehicle can climb in a higher gear.

Driving in extreme conditions

When driving in hazardous conditions, e.g. in snow, ice, mud, sand or water, drive slowly and cautiously to allow for greater braking distances.

If stuck, use 2nd gear (automatic transmission in drive range 2) to avoid spinning the front wheels.

Use sand, tyre chains or other non-slip materials to provide traction when stuck in snow, mud or ice.

Driving through water

Before attempting to drive through water, check the depth. If the depth is slightly lower than the underbody of your vehicle, do not attempt to drive through it.

Driving too quickly through water can cause water to enter the engine through the air intake, causing severe damage. Drive slowly, in a high engine rpm in as low a gear as possible.

Driving with a roof load

Do not exceed the permissible roof load - see page 221. For safety reasons, distribute the load evenly and secure it tightly with straps so that it cannot slip. Set the tyre pressure to the value given for full load. Do not drive faster than 120 km/h (75 mph). Check and retighten straps at frequent intervals.

Switching off the engine

If the engine temperature is very high, e.g. after driving in mountainous terrain: allow engine to idle for approx. 2 minutes, in order to prevent heat accumulation.

When you switch off, fans in the engine compartment may continue running for a time, to cool the engine.

Vehicles with turbocharger *

In order to protect the turbocharger, after running at high engine speeds or high engine loads, operate the engine briefly at a low load or run in neutral for approx.

30 seconds before switching off.

Save energy – more kilometres/miles

Please observe the running-in hints on the previous page and the tips for energy saving on the following pages.

Good, technically correct and economical driving ensures maximum durability and performance for your vehicle.

Overrun

The fuel supply is automatically shut off during overrun, e.g. when the vehicle is being driven down long gradients or during braking. To enable the overrun cut-off to come into action, do not accelerate or declutch during overrun.

Engine rpm

Under all driving conditions, drive in a favourable engine speed range.

Warming up

Allow engine to warm up while driving. Do not warm it up by letting it run at idling speed. Do not apply full throttle until engine reaches operating temperature.

After a cold start, automatic transmission * does not shift into higher gears until higher engine speeds have been reached. This allows the catalytic converter to quickly reach the temperature required for optimum pollutant reduction.

Correct gear selection

Do not race your engine whilst in neutral or with a low gear selected. Driving too fast in individual gears or drive ranges as well as stop-and-go traffic increase engine wear and fuel consumption.

Change down

When decreasing speed, shift down into the next lowest gear. Do not slip the clutch with a high-revving engine. This is especially important when hill climbing.

Clutch operation *

Always depress the clutch pedal hard to the floor, to prevent shifting difficulties and transmission damage. There must be no mats in the area of the pedals.

When driving, do not use the clutch pedal as a foot rest; this will cause substantial clutch wear.

Pedals

Do not place any objects in the footwell which could slip under the pedals and inhibit the pedal travel.

To ensure the pedal travel is uninhibited, there must be no mats in the area of the pedals.

When driving, do not use the brake pedal as a foot rest; this will cause substantial wear to brake components and cause overheating, resulting in longer braking distances.

Battery care whilst driving

When driving slowly or when the vehicle is stationary, e.g. in slow urban traffic, stop-and-go traffic or traffic jams, turn off all unnecessary electrical loads where possible (e.g. heated rear window, auxiliary headlamps).

When starting the engine, depress the clutch pedal so that transmission resistance is eliminated and the starter motor and battery are relieved.

Save fuel, protect the environment

Trend-setting technology

When developing and manufacturing your vehicle, Opel used environment-friendly and, in the main, recyclable materials. The production methods used to make your vehicle are likewise environmentally-compatible.

Recycling of production wastes keeps the circulation of material closed. Reduction of energy and water requirements also helps to conserve natural resources.

A highly advanced design means that your vehicle can be easily disassembled at the end of its working life, and the individual materials separated for subsequent re-use.

Materials such as asbestos and cadmium are not used. The refrigerant in the air conditioning system is CFC-free.

New painting techniques employ water as a solvent.

End-of-life vehicle recovery

Information on end-of-life vehicle recovery centres and the recycling of end-of-life vehicles is available at www.opel.com.

Drive in an energy and environment-conscious way

- High fuel consumption, noise levels and exhaust emissions are often caused by a driving style that is not energy and environment-conscious.
- You should therefore drive with energy in mind: "more kilometres/miles with less fuel".
- Reduce the noise level and exhaust emissions by adopting an environment-conscious driving style. This is extremely worthwhile and improves quality of life.

Fuel consumption depends to a great extent on your own personal driving style. The following hints are intended to help you consume fuel at a rate that is as close as possible to the specified levels.

Check your vehicle's fuel consumption every time you refuel. This facilitates early detection of any irregularities causing increased fuel consumption.

Warming up

- Full throttle and warming up at idle speed increase wear, fuel consumption, fuel emission, the amount of pollutant in the exhaust and the amount of noise.
- Drive off immediately after starting. Warm up the engine by running it at moderate engine speeds.

Uniform speed

- Hectic driving significantly increases fuel consumption, the quantity of emission and the proportion of pollutant in the exhaust.
- Do not accelerate and brake unnecessarily. Drive at uniform speed. Avoid frequent starting-off and stopping, e.g. at traffic lights, in short distance traffic and in queues of traffic, by means of clever planning. Select roads with good traffic flow.

Idling

- The engine also consumes fuel when idling.
- If you have to wait for more than 1 minute, it is worthwhile switching off the engine. Five minutes of idling corresponds to approx. one kilometre (0.6 miles) of driving.
- Idling for more than 5 minutes can cause excessive temperatures and damage to the exhaust system.

Overrun

- The fuel supply is automatically shut off during overrun, e.g. when the vehicle is being driven down long gradients or during braking - see page 128.
- To enable the overrun cut-off to take effect and save fuel, do not accelerate or declutch.

Correct gear selection

- High revs increase engine wear and fuel consumption.
- Do not race your engine. Avoid driving at high engine speeds.

Driving with an eye on the tachometer saves fuel. If possible, drive at low revs in each gear and at a constant speed. Drive in top gear as much as possible, shift up as soon as possible and do not shift down prematurely.

High speed

- The faster the speed, the higher the fuel consumption and noise level. Driving at full throttle uses up a great deal of fuel and generates excessive noise and high emission levels.
- Slightly releasing the accelerator pedal results in distinct fuel savings with no major loss of speed.

Drive at no more than around three quarters of maximum speed and you will use up to 50% less fuel, without losing a great deal of time.

Tyre pressure

- Inadequate tyre pressure, leading to higher road resistance, costs money in two ways; for more fuel and increased tyre wear.
- Regular checks (every 14 days) pay off.

Electrical loads

- The power consumption of electrical equipment increases fuel consumption.
- Switch off all additional consumers (e.g. air conditioning, heated rear window) when they are no longer required.

Roof racks *

- Roof racks can increase fuel consumption by approx. 1 l/100 km (3.5 gal./1000 miles) due to air resistance.
- Remove them if they are not being used.

Repair and maintenance

- Improper repairs or adjustment and maintenance work can increase fuel consumption. Do not carry out work on the engine yourself.

You may, out of ignorance, infringe environmental laws by not disposing of materials properly.

Appropriate parts might not be recycled.

Contact with some of the materials involved may pose a health hazard.

- We recommend that repairs and maintenance be entrusted to an Opel Partner.

Extreme driving conditions

- Driving up steep gradients, cornering, driving on poor roads, and winter driving all increase fuel consumption.

Fuel consumption increases dramatically in urban traffic and at winter temperatures, especially on short trips when the engine operating temperature is not reached.

- Follow the hints given above to keep fuel consumption to a minimum under such conditions.

Fuels, refuelling

Fuel consumption

Optional equipment (e.g. wide tyres, towing equipment) increases the kerb weight and, in some cases, also the permissible Gross Vehicle Weight.

This in turn increases fuel consumption and reduces the maximum speed of the vehicle.

When the vehicle is new, there is increased friction between the engine and transmission components lasting for several thousand kilometres. This also increases fuel consumption.

Fuel for petrol engines

Commercially available high-quality fuels are suitable (see page 217). Fuel quality has a decisive influence on the power output, driveability and life of the engine. The additives contained in the fuel play an important role in this regard. You should therefore use only high-quality fuels containing additives.

Petrol with too low an octane number can cause pinking. Opel cannot be held liable for resulting damage.

Petrol with a higher octane number can always be used.

A dispensing pump for leaded fuel cannot be inserted in the fuel tank of a vehicle that must be operated on unleaded fuel only.

Use of petrol with an octane rating of 95 will ensure economical driving

Fuel for diesel engines

Diesel engines must be operated only on commercially available diesel fuel meeting the specifications of DIN EN 590.

Marine diesel fuel, fuel oils, diesel fuels, which are entirely or partially plant based such as rape seed oil or bio-diesel, Aquazole and similar diesel-water emulsions must not be used.

The flow and filterability of diesel fuels are insufficient at low temperatures, as a result of crystallized paraffins.

Diesel fuels with improved low-temperature properties are therefore available on the market during the winter months. Make sure that you use winter fuel before the start of the cold weather season.

Use of diesel fuels with manufacturer-guaranteed winter properties eliminates the need for additives.

Fuel filler cap

If replacing the fuel filler cap, be sure to use the original fuel filler cap for your model, to ensure full functionality.

Refuelling

Warning

Care must be taken when dealing with fuel.

Before refuelling, it is absolutely vital to switch off the engine and any heating systems with combustion chambers.

Switch off mobile phones.

Fuel is inflammable and explosive, therefore avoid dealing with fuel near naked flames and doing anything that would generate sparks. No smoking!

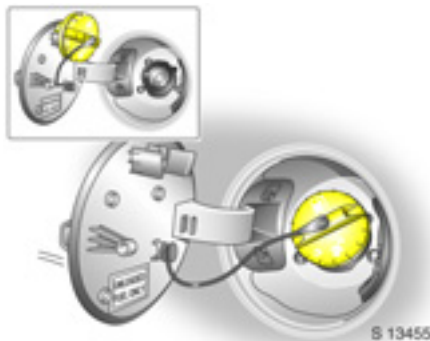

This also applies where the smell of fuel is noticeable. If the smell of fuel vapour occurs in the vehicle itself, have the cause remedied immediately by a workshop.

Ensure suitable fuel is available before driving in foreign countries.



The fuel filler neck with bayonet cap is located on the left rear side of the vehicle.

The tank flap is locked together with the doors - see page 25.

Unlock doors, tailgate and tank flap by pressing button  on the remote control or by pressing central locking switch  in the driver's door.

Open the tank flap by hand.

If, in cold weather, the tank flap does not open, tap it and try again.

To unlock fuel filler cap: turn it anti-clockwise.

If hissing occurs, wait until it stops before completely unscrewing the fuel filler cap. Remove fuel filler cap and place it in its holder on the inside of the tank flap.

The fuel tank has a limiting system which prevents overfilling of the tank.

Correct refuelling is largely dependent on correct operation of the dispensing pump:

- Insert dispensing pump as far as it will go and switch it on.
- After the first automatic cut-off, do not fill the tank any further.

Replace the fuel filler cap and turn it clockwise until you hear several clicks.

Close tank flap.

Wipe off any overflowing fuel immediately.

If fuel is spilt onto the vehicle, rinse the area with clean, cold water as soon as possible, to avoid permanent damage to painted surfaces.

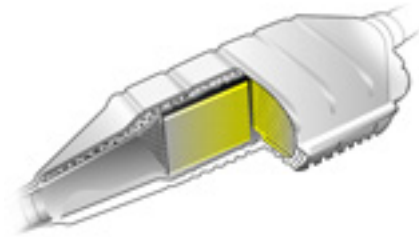

17199 T

Catalytic converter, exhaust emissions

Catalytic converter for petrol engines



Leaded fuel will damage the catalytic converter and parts of the electronic system, thereby rendering them inoperative.

On vehicles with a catalytic converter, the fuel tank filler neck is of a narrow design so that a dispensing pump for leaded fuel cannot be inserted.

Damage to the catalytic converter or the vehicle may result if the following points are not observed:

- If the engine misfires or runs roughly after a cold start, the engine power has reduced significantly or other unusual operating problems occur that indicate a fault in the ignition system, please contact a workshop as quickly as possible. Drive at a slower speed and with less engine revs for a short time, if necessary.
- If unburned fuel enters the catalytic converter, this may result in overheating and irreparable damage to the catalytic converter.

You should therefore avoid frequent cold starts, unnecessarily long use of the starter when setting off, running the tank dry (an irregular fuel supply leads to overheating) and starting the engine by pushing or towing.

- If the control indicator for exhaust emissions  flashes, lift your foot off the accelerator until the control indicator stops flashing and is steadily lit. Contact a workshop immediately. Control indicator  for exhaust emissions - see pages 74, 134.

Catalytic converter for diesel engines

Damage to the catalytic converter or the vehicle may result if the following points are not observed:

Consult a workshop as quickly as possible in the event of irregular engine running, a significant loss of engine power or other unusual malfunctions. If necessary, driving may be continued for a short time at a low speed and with a low engine speed.





Controlling exhaust emission

Through design-related measures, primarily in the fuel injection and ignition systems (in combination with the catalytic converter), the proportion of noxious materials in the exhaust, such as carbon monoxide (CO), hydrocarbons (CH) and nitrogen oxides (NO_x), is reduced to a minimum.



Control indicator for exhaust emissions

Control indicator  illuminates for a few seconds when the ignition is switched on.

If it illuminates when the engine is running, there is a fault in the emission control system or with the diesel particle filter . The permitted emission values may be exceeded. Consult a workshop.

Flashing with the engine running indicates a fault that may damage the catalytic converter. The vehicle's electronic system will switch to an emergency running program so you may continue to drive without causing damage, by slowing down until the flashing stops and the control indicator is steadily lit. Consult a workshop immediately.



Control indicator for engine electronics

Control indicator  illuminates for a few seconds when the ignition is switched on.

If it illuminates when the engine is running, there is a fault in the engine electronics. The electronics switch to the emergency running program, fuel consumption may increase and the driveability of the vehicle may be affected.

In some cases, the fault can be eliminated by switching the engine off and back on again. If the control indicator illuminates again when the engine is running, have the cause of the fault eliminated by a workshop.

Exhaust gases

 **Warning**

Engine exhaust gases contain poisonous carbon monoxide, which has no colour or odour and can be lethal if inhaled.

If exhaust fumes penetrate the vehicle interior, open the windows and consult a workshop immediately.

Do not run engine in enclosed spaces, e.g. in a garage, or sit in a parked vehicle for an extended period with the engine running.

Do not drive with tailgate open. If driving with the tailgate open is necessary, set fan to highest speed, close windows and ensure air recirculation mode is off, to allow entry of outside air.

If the underbody or rear of vehicle is damaged or corroded, you notice a change in the sound of the exhaust system, or whenever you suspect exhaust gases are penetrating the vehicle interior, consult a workshop immediately.

When the vehicle is driven for the first time, wax and oil on the exhaust system may evaporate, producing smoke-like emissions which should not be inhaled. Allow wax and oil to evaporate while the vehicle is in the open air.

Diesel particle filter (DPF) *

The diesel particle filter removes polluting soot particles out of the exhaust.

The system contains a self-cleaning function at certain intervals. The filter is cleaned by burning the soot particles at high temperature. This procedure runs automatically under certain vehicle conditions and can take up to 15 minutes, during which time fuel consumption may increase. The smell and the noise that occur are normal.

The system cannot automatically clean itself under certain vehicle conditions, such as driving short distances.

If control indicator  illuminates, you should continue driving, and as soon as the road and traffic situation permits it, increase speed to more than 50 km/h (30 mph) and diesel particle filter cleaning will start.

Cleaning is quicker at faster speeds and under load. The engine speed should not drop below 2000 rpm. The control indicator extinguishes as soon as cleaning is complete.

We recommend that you do not turn the ignition off during cleaning.

Maintenance

Have all maintenance work carried out at the intervals specified by Opel. We recommend that you entrust this work to your Opel Partner, who has proper equipment and trained personnel available. Electronic testing of systems permits rapid diagnosis and remedy of faults. This way, you can be certain that all components of the vehicle's electrical, injection and ignition systems operate correctly, that your vehicle has a low level of pollutant emission and that the catalytic converter system will have a long service life.

You are thereby making an important contribution towards keeping the air clean and compliance with emissions legislation.



Checking and adjustment of the fuel-injection and ignition systems is part of the scope of a Service. For this reason, you should have all maintenance work carried out at the intervals specified in the chapter "Service, Maintenance" on page 206.

Drive control systems

Electronic Stability Control (ESC)

The Electronic Stability Control improves driving stability when necessary, independently of the type of road surface and the tyre grip. It also prevents the drive wheels from spinning.

The system monitors vehicle movements. As soon as the vehicle starts to swerve (understeers/oversteers), engine output is reduced (the sound of the engine changes) and individual wheels are specifically braked. This considerably improves the driving stability of the vehicle on snow and ice and on wet or slippery road surfaces.

ESC is ready for operation after the ignition is switched on and the ESC control indicators ,  and  illuminate then extinguish after approx. 4 seconds.

When the ESC comes into action, control indicator  flashes in the instrument panel. Some noise or vibration may be apparent.

The vehicle is now in a critical situation; the ESC helps you to keep control of the vehicle and reminds you to match your speed to the road conditions.

Warning

Do not let this special safety feature tempt you into taking risks when driving.

Traffic safety can only be achieved by adopting a responsible driving style.



ESC Active & Warning control indicator

The control indicator illuminates in yellow for approx. 4 seconds when the ignition is switched on. The system is ready for operation when it extinguishes.

Flashing when driving;

The system has come into action. The engine output may be reduced (the sound of the engine changes) and the vehicle may be braked automatically to a small degree.

Illuminated when driving;

Fault in the system. Poor road surface conditions may cause vehicle stability to be impaired.

Have the cause of the fault remedied by a workshop. The system's integrated self-diagnostics allows faults to be quickly remedied.



ESC Not Ready control indicator

The control indicator illuminates in yellow for approx. 4 seconds when the ignition is switched on.

Illuminates to indicate that the system is not ready for conditions to operate.

May illuminate in cold conditions. It should extinguish when the vehicle warms up.





Switching off

Control indicator  illuminates in yellow for approx. 4 seconds when the ignition is switched on.

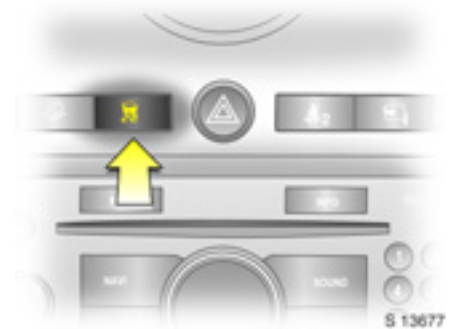
With ESC active, if wheels are slipping on wet, snowy or icy roads, engine speed may not increase when accelerator pedal is depressed. The vehicle may not move.



Turn off ESC function to allow engine rpm to increase, by pressing button . Control indicator  illuminates in the instrument panel.

The ESC function is turned on again by pressing button  again (control indicator extinguishes) or the next time the ignition is switched on.

Hydraulic Brake Assist (HBA)

When the ESC function comes into action and recognises any emergency situations requiring hard braking, it automatically delivers increased braking pressure to the wheels.

Active Rollover Protection (ARP)

If the vehicle moves in an unstable manner, this function helps the vehicle maintain normal stability.

Trailer Stability Assist (TSA) ✱

TSA monitors vehicle movements when towing a caravan or trailer. If the system detects lurching movements, engine power is reduced and the vehicle/trailer combination is selectively braked until the lurching ceases.

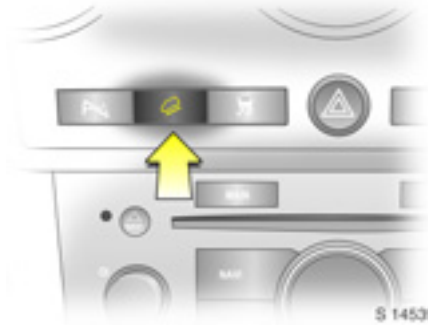

DCS (Descent Control System)

The Descent Control System allows the vehicle to travel at a low speed without depressing the foot brake.

The vehicle will automatically decelerate to a low speed and remain at that speed when DCS button  is pressed.

Use only when descending steep grades while driving off-road. Do not use when driving on normal road surfaces.

Some noise or vibration from the brake system may be apparent when DCS is active.



To activate

At speeds below approx. 50 km/h (30 mph), press DCS button. The green DCS control indicator  will flash in the instrument panel, to show DCS is in operation.

DCS will not activate at speeds above 50 km/h (30 mph), even if the button is pressed.

Unnecessary usage of the DCS function, such as while driving on normal roads, may damage the brake system and the ESC function.

To deactivate

Press DCS button again. The green DCS control indicator  will extinguish.

Depressing the foot brake or accelerator will also cause the DCS function to be deactivated.



Flashing or illumination of the yellow DCS control indicator  reminds the driver that the friction material needs to cool down: drive the vehicle without braking as much as possible.

If the control indicator does not extinguish, have the cause of the fault remedied by a workshop.

Fault

The yellow DCS control indicator  flashes to indicate that the system is not ready for conditions to operate, due to the high temperature (approx. 350 - 400 °C) of friction material, through severe or repeated braking. It will extinguish when the temperature drops below 350 °C.

The yellow DCS control indicator  illuminates when there is a malfunction in the system, due to the extremely high temperature (over 400 °C) of friction material, through severe or repeated braking. It will extinguish when the temperature drops below 350 °C.

These temperatures may differ according to vehicle conditions or outside conditions.

Cruise control *

Cruise control can store and maintain speeds over approx. 30 km/h (20 mph).

Deviation from the stored speed may occur when driving uphill or downhill.

For safety reasons, cruise control cannot be activated until the foot brake has been depressed once.

Cruise control is operated with buttons - SET, + RES and CRUISE on the turn signal lever.

Do not use cruise control if it is not advisable to maintain a constant speed (e.g. in situations presenting a danger to yourself and other road users, in heavy traffic or on winding, slippery or greasy roads).

With automatic transmission, only use cruise control while in **D**.

When cruise control is active, reaction times may be increased, due to the different position of the feet.

Warning

The driver is always responsible for ensuring that vehicle speed is appropriate for the speed limit and driving conditions - even if cruise control is engaged.

Failure to follow the instructions could lead to injuries or endanger life.



Control indicator for cruise control

When driving, control indicator  will illuminate when the system is switched on and the desired vehicle speed is stored.

Illuminated in yellow;
cruise control is ready for operation by pressing the CRUISE button.

Illuminated in green;
cruise control speed is set by pressing the - SET button.

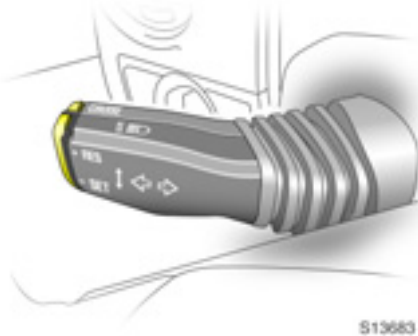

S13683

To activate

Press the **CRUISE** button to turn cruise control on. Accelerate to the desired speed, press the **- SET** button and release it; the current speed is stored and maintained. The accelerator pedal can be released after setting cruise control speed.

Vehicle speed can be increased temporarily for overtaking purposes, by depressing the accelerator pedal. When the accelerator pedal is released, the previously stored speed is resumed.

Increase speed

With cruise control active, press and hold the **+ RES** button and release it when the desired vehicle speed is reached.

To increase the speed in steps of 2 km/h (1.2 mph), tap the **+ RES** button and release it.

When the **+ RES** button is released, the current speed is stored and maintained.

Alternatively, use the accelerator pedal to increase vehicle speed, press the **- SET** button and release it, then release the accelerator pedal.

When the **- SET** button and the accelerator pedal are released, the current speed is stored and maintained.

Decrease speed

With cruise control active, press and hold the **- SET** button and release it when the desired vehicle speed is reached.

To decrease the speed in steps of 2 km/h (1.2 mph), tap the **- SET** button and release it.

When the **- SET** button is released, the current speed is stored and maintained.

To deactivate



Switch off cruise control when not needed, to avoid accidental activation.

Press **CRUISE** button to turn cruise control off.

Control indicator  extinguishes and the vehicle slowly decelerates. To continue driving, depress the accelerator pedal in the usual manner.

For safety reasons, cruise control deactivates under certain driving conditions.

For example:

- If the vehicle speed drops below 30 km/h (20 mph), or
- If the brake pedal is depressed, or
- If the clutch pedal  is depressed, or
- If the automatic transmission  selector lever is in **N**, or
- If the traction control aspect of the Electronic Stability Control (ESC) comes into action, to limit wheel spin.

Resuming the stored speed

Press the **+ RES** button at speeds above 30 km/h (20 mph); the speed selected before cruise control was switched off, is resumed.

The value of the stored speed is deleted when the ignition is switched off or the **CRUISE** button is pressed.

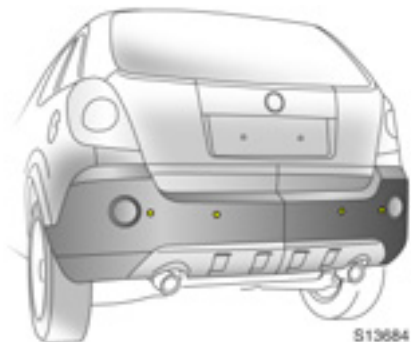

S13684

Park pilot *

The park pilot makes parking easier by measuring the distance between the vehicle and any obstacles to the front and rear and giving an acoustic signal in the passenger compartment.

The system records the distance using four sensors in both the front and rear bumpers.

To activate

The park pilot activates automatically when the ignition is switched on and a forward gear or reverse gear is engaged and the hand brake is released.

The acoustic signal may differ depending on the type of object detected.

If the vehicle approaches an obstacle when in a forward gear or while reversing, a series of signals can be heard in the vehicle interior. The interval between the signals becomes shorter as the distance is reduced. If the distance is less than 30 cm, the signal will be continuous.

Warning

Under certain circumstances, various reflective surfaces on objects or clothing as well as external noise sources may cause the system to fail to detect obstacles.

The park pilot may not recognise sharp objects, thick clothes or sponge-like materials which absorb the frequency.

If the sensors are damaged or covered with snow, dirt or ice, the park pilot may not activate.

For these reasons, care must be taken when reversing, even if the park pilot is operational. This is of particular importance when in the vicinity of pedestrians.

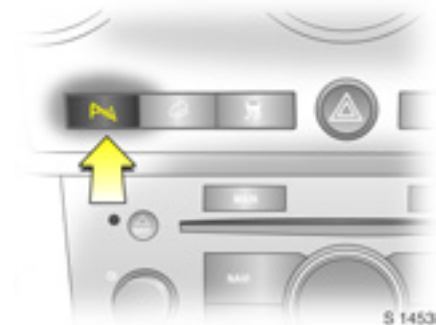

S 14538

To deactivate

The system deactivates automatically when in neutral (automatic transmission *) in **N** or **P** with the hand brake applied. When the vehicle speed is greater than 8 km/h (5 mph), the system also deactivates.

To deactivate the system manually, press button  on the instrument panel. The control indicator in the button will illuminate.

If the button is pressed again, the control indicator in the button will extinguish and the system will be reactivated as soon as a forward gear or reverse gear is engaged and the hand brake is released.



Control indicator for park pilot

Control indicator **P**▲ illuminates while driving if there is a fault in the system.

If the acoustic signal sounds 3 times continuously when there are no obstacles near the front or rear bumper, there is a fault in the system.

Have the cause of the fault remedied by a workshop.

To ensure the safety of other road users and people in the vicinity and to avoid damage to the vehicle, remember:

- The park pilot should only be considered as a supplementary function. Normal precautions should be maintained when reversing. Check the rear view and use the mirrors when reversing.
- Do not push, scratch or otherwise damage the sensors.
- Do not use high-pressure jet cleaners to clean the sensors. Clean only with a soft sponge and clean water.



S 13686

Automatic level control *

Automatic level control makes it possible to keep the height of the vehicle constant when subjected to different loads in the rear (e.g. when passengers are occupying the rear seats or when towing a caravan/trailer). This significantly improves driving conditions.

The vehicle is automatically raised at the rear to its previous unloaded level, increasing spring travel and ground clearance.

Headlamp range adjustment - see page 97.

In the event of malfunctions, do not utilise the vehicle's full load capacity. Have the cause of the fault remedied by a workshop without delay.

Tyre pressure monitoring system *

The tyre pressure monitoring system continually checks the pressure of all four wheels while driving.

A pressure sensor is integrated in each wheel. Once a minute, the pressure of each tyre is sent to a control unit, where it is compared. If the system detects one or more pressure differences, a message appears on the information display.

Current tyre pressures can be shown in the information display.

For the system to be operational, all wheels must be equipped with pressure sensors and all tyres must be filled to the prescribed pressure. The tyre pressure monitoring system automatically detects if the vehicle is being driven with a load of up to 3 persons or a full load.

Once the ignition is switched on, the system is operational and will continuously monitor the tyre pressures at speeds of approx. 40 km/h (25 mph) and above.

Warning

The tyre pressure monitoring system does not replace manual checks with a suitable gauge.

Check tyre pressures at least every 14 days and prior to any long journey: the tyres should be checked when cold. Don't forget to check the spare.

Tyre pressure – see pages 224.

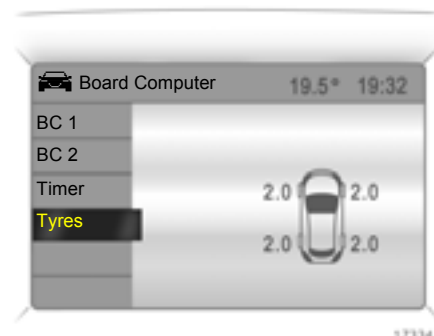

Display of current tyre pressure

Select menu item **Tyres** from the **Board Computer** menu.

The current pressure of each tyre is displayed.

Warning messages

A message is given on the information display to warn of inconsistent tyre pressures. In some versions, the message is displayed in abbreviated form.

For example, the following messages can be displayed:



A graphic indicating the left rear tyre is shown together with the current tyre pressure; slight pressure deviation. Reduce speed. Check pressure at next opportunity with appropriate gauge and correct if necessary.

On the colour information display ✱, this report will appear in yellow.

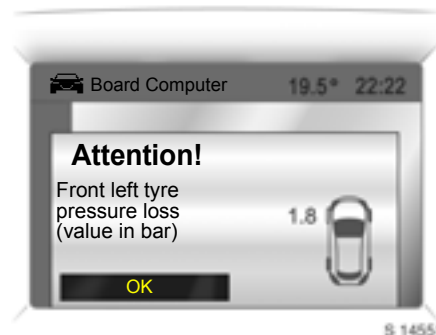

A graphic indicating the front left tyre is shown together with the current tyre pressure; significant pressure deviation or direct pressure loss. Steer out of flow of traffic as quickly as possible without endangering other drivers. Stop and check the tyres.

Mount the spare wheel if necessary – see page 177.

On the colour information display ✱, this report will appear in red.

Acknowledgement of warnings – see page 84.

Brake system

The effectiveness of the brakes is an important factor for traffic safety.

In the interest of effectiveness, do not brake unnecessarily hard during the first 200 km (125 miles) after new disc brake pads have been fitted.

Wear of the brake linings must not exceed a specified limit. Regular maintenance, as detailed on pages 206 to 212, is therefore of the utmost importance for traffic safety.

Have worn brake pads replaced by a workshop. Pads which have been tested and passed ensure optimum brake performance.

Brake pads worn to their minimum thickness may generate a grinding noise. It is possible to continue driving. Have your brake pads replaced as soon as possible. Seek the assistance of a workshop for replacing the brake pads.

Warning

Disregard of these instructions may lead to injuries or endanger life.

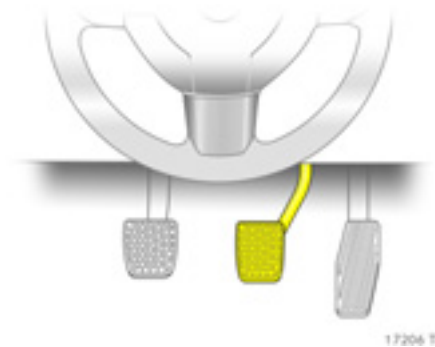

Brake assist

Rapid powerful application of the brake pedal automatically applies maximum brake force amplification to achieve the shortest possible braking distance under full braking (brake assist).

Maintain steady pressure on the brake pedal for as long as full-on braking is to continue. When the brake pedal is released, the maximum brake force amplification is taken away.

Foot brake

The brake system comprises two separate brake circuits.

If one brake circuit should fail, the vehicle can still be braked with the second remaining circuit.

If this happens, the brake pedal must be fully depressed with greater pedal pressure. The distance required for braking will be greater.

If, at any time during driving, the brake pedal can be depressed further than normal, the vehicle repeatedly pulls to one side under braking or brake noise is heard, consult a workshop.

In order to utilise the full pedal travel, particularly in the event of a brake circuit fault, there must be no mats in the area of the pedals - see page 128.

With the engine stopped, the brake servo assistance is discontinued after the brake pedal has been depressed once or twice. The braking effect is not reduced, but increased foot pressure will be necessary. Take extra care when the vehicle is being towed.

Check the brake lamps before starting out on a journey. Shortly after the start of each journey, the brake system should be tested for its effectiveness at low speed and without inconveniencing other road users, especially if the brakes are wet, e.g. after washing your vehicle.

Excessive braking when going downhill can cause brakes to temporarily overheat. Shift to a lower gear rather than continuously applying brakes.

The brake fluid level should be checked regularly - see page 196.

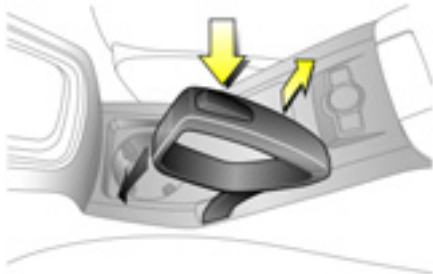

S 12815

Hand brake

Always apply hand brake firmly. On slopes, apply the hand brake as firmly as possible.

The mechanical hand brake acts on the brakes on the rear wheels. It engages automatically when applied.

To release the hand brake, press and hold the button, pull the lever up slightly and lower lever while holding the button in.

To reduce the operating forces of the hand brake, depress the foot brake at the same time.



S 13668

Control indicator (D) for brake system

Illuminates when ignition is switched on. Extinguishes after engine is started.

Illuminates if hand brake is applied and/or fluid level for brake hydraulics is too low.

Brake fluid level - see page 196.

Warning

If it illuminates when the hand brake is not applied: stop vehicle, interrupt your journey immediately.

Check brake fluid level and top-up if necessary before consulting a workshop. Have cause of brake fluid loss remedied.

If the control indicator stays lit, the brakes do not operate as normal or leaks are found in the brake system, do not attempt to drive the vehicle. Have the vehicle towed to a workshop for inspection and repair.

If the control indicator does not illuminate when the ignition is switched on or when the hand brake is applied (with ignition on), stop and consult a workshop.

Anti-lock Brake System (ABS) ^(ABS)

The ABS continually monitors the vehicle's brake system and prevents the wheels from locking, irrespective of the road condition and tyre grip.

It starts to regulate the braking pressure as soon as a wheel shows a tendency to lock. The vehicle remains steerable, even in the event of very heavy braking, e.g. on bends or when swerving to avoid an obstacle. Even in the case of full-on braking, the ABS makes it possible to drive round an obstacle without releasing the brakes.

ABS control is made apparent through a pulse in the brake pedal and the noise of the regulation process.

Warning

For optimum braking, keep the brake pedal fully depressed throughout the braking process, despite the fact that the pedal is pulsating. Do not reduce the pressure on the pedal.

Do not let this special safety feature tempt you into taking risks when driving.

Traffic safety can only be achieved by adopting a responsible driving style.



Control indicator ^(ABS) for ABS

Illuminates in yellow for approx. 4 seconds when the ignition is switched on.

At the same time, the system performs a self-check. When the control indicator extinguishes, the system is ready for operation.

If the control indicator does not illuminate when the ignition is switched on, does not extinguish after approx. 4 seconds, or if it illuminates during driving, there is a fault in the ABS. The vehicle's brake system may remain operational without ABS regulation.

If control indicator ^(ABS) illuminates during driving along with brake system control indicator ^{(D)(P)}, there is a serious fault in the brake system. Have the system checked immediately by a workshop.

Fault

Warning

If there is a fault in the ABS, the wheels may tend to lock in the event of unusually heavy braking. This may cause the vehicle to swerve. The benefits of the ABS are lost.

You can continue driving, provided you drive with care and anticipation.

Have the cause of the fault remedied by a workshop. The system's integrated self-diagnostics allows faults to be quickly remedied.

Wheels, tyres

See page 223 for suitable tyres and restrictions.

Factory-fitted tyres are matched to the chassis and offer optimum driving comfort and safety.

Changing tyre/wheel type

Note the necessary modifications before switching to different tyres or wheels.

Warning

Use of unsuitable tyres or wheels may lead to accidents and render the vehicle unroadworthy.

If wheel rims of a different type are to be installed, the wheel nuts may also need to be changed. We recommend you consult an Opel Partner.

If tyres of a different size to those fitted at the factory are used (this includes winter tyres), the electronic speedometer may possibly need to be reprogrammed, to ensure that the speed displayed is correct.

Vehicles with tyre pressure monitoring system *

When using winter tyres, or when switching to different tyre sizes, sensors for the tyre pressure monitoring system can be fitted at a later date by a workshop, upon request. Otherwise, the system would not indicate tyre pressure deviations.

Tyre pressure monitoring system - see page 144.

Fitting new tyres

New tyres should be fitted in pairs, or, for preference, in sets. Make sure that both tyres on an axle are:

- the same size,
- the same design,
- the same make,
- and have the same tread pattern.

Fit directional tyres such that they roll in the direction of travel. The rolling direction is indicated by a symbol (e.g. an arrow) on the sidewall.

Tyres fitted opposing the rolling direction (e.g. when a tyre is changed) should be refitted as soon as possible. This is the only way to obtain full benefit from the design properties of the tyre.

Observe legal requirements when disposing of tyres.

Some brands of tyres have a beaded edge for alloy wheels, to protect against damage. If wheel trims are used on steel wheels with beaded-edge tyres, the following procedure must be followed:

- Wheel trims and tyres that are approved by Opel for the respective vehicle and comply with all of the relevant wheel and tyre combination requirements must be used.
- If the wheel trims and tyres used are not Opel-approved, the tyres must not have a beaded edge.

Warning

Use of unsuitable tyres or wheel trims could lead to sudden pressure loss and thereby accidents.

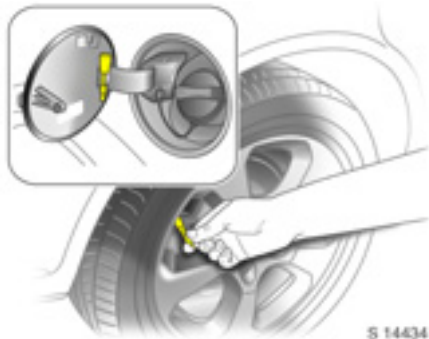

Tyre pressure

Check tyre pressures when cold, at least every 14 days and prior to any long journey. Don't forget to check the spare.

Use the valve cap key ✱ to make unscrewing the valve caps easier. The valve cap key is located on the inside of the tank flap.

Tyre pressures - see page 224.

Increased pressure resulting from tyre warm-up must not be reduced, otherwise the pressure may drop below the permissible minimum when the tyres cool down.



After having checked the tyre pressures, securely tighten the valve caps.

Incorrect inflation pressures will impair safety, vehicle handling, comfort and fuel economy and will increase tyre wear.

If the pressure is too low, this can result in considerable tyre warm-up and internal damage, leading to tread separation and even to tyre blow-out at high speeds.

Hidden tyre damage is not eliminated by subsequently adjusting the inflation pressure.

Warning

Incorrect tyre pressure could lead to a flat tyre.

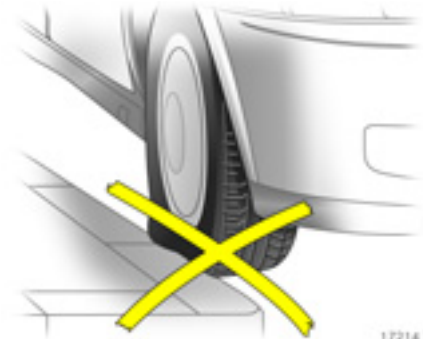

Tyre condition, wheel condition

Driving over sharp edges can lead to hidden tyre damage and wheel damage which is only noticed later on; danger of tyre blow-out.

Drive over edges slowly and at a right angle if possible. When parking, ensure that the tyres are not pressed against the edge of the kerb.

Check tyres regularly for damage (foreign bodies, punctures, cuts, cracks, bulges in sidewalls). Check wheels for damage. In the event of damage or abnormal wear, consult a workshop.

Warning

Damage may lead to tyre blowout.

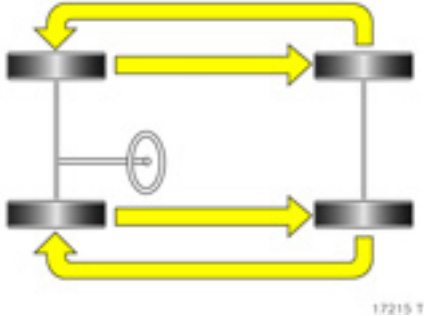

Tread depth

Check tread depth regularly. Should the front tyres show greater wear than the rear tyres, have both front wheels exchanged with the rear wheels so that the tyres with deeper tread are on the front axle.

For information on how to change a wheel - see page 178.

Check the tyre pressures - see page 224.



For safety reasons, tyres should be replaced when their tread depth has worn down to 2 to 3 mm. The legal permissible minimum tread depth (1.6 mm) has been reached when the tread has worn down as far as one of the wear indicators.

A number of wear indicators are spaced at equal intervals around the tyre, within the tread. Their position is indicated by markings on the tyre sidewall.

General information

Note that the danger of aquaplaning is greater if the tyres are worn and if the tyre pressures are not correct.

Tyres age, even if they are used only very little or not at all. A spare wheel which has not been used for six years should be used only in emergencies: drive slowly when using such tyres.

Never fit used tyres the previous history and use of which you do not know.

Tyre designations

Meanings:

e.g. **235/60 R 17 102 H**

235 = Tyre width in mm

60 = Aspect ratio
(tyre height to tyre width in %)

R = Belt type: Radial

17 = Rim diameter in inches

102 = Load index
e.g.: 91 represents 618 kg

H = Speed code

Speed code letters:

Q Up to 160 km/h (100 mph)

S Up to 180 km/h (112 mph)

T Up to 190 km/h (118 mph)

H Up to 210 km/h (130 mph)

V Up to 240 km/h (150 mph)

W Up to 270 km/h (168 mph)

Winter tyres ❄️

See page 223 for restrictions.

Winter tyres improve safety at extremely low outside temperatures and should therefore be fitted on all wheels.

The design of summer tyres means they have limited qualities for winter driving.

If the maximum permissible speed for the winter tyres is less than that of the vehicle, a notice indicating the maximum permissible speed for the tyres must be affixed within the driver's field of vision ¹⁾.

If you use the spare wheel when it is fitted with a summer tyre; the vehicle's driveability may be affected, especially on slippery road surfaces. Obtain a replacement for the faulty tyre as soon as possible, and have the wheel balanced and fitted to the vehicle.

Ensure that winter tyres are inflated to the correct pressure specified by the tyre manufacturer.

If winter tyres are installed that have not been approved for your vehicle, ESC performance may be affected. Consult a workshop regarding availability of approved winter tyres.

Wheel trims ❄️

If the wheel trims and tyres used are not Opel-approved, make sure the tyres do not have a beaded edge - see page 149.

¹⁾ Varies from country to country on account of national regulations.



17217 E

Tyre chains ❄️

See page 223 for restrictions.

Tyre chains must not be used on the temporary spare wheel. If you need to use tyre chains after suffering a flat front tyre, fit the temporary spare wheel on the rear axle and transfer one of the rear wheels to the front axle.

Always use fine-linked chains that add no more than 15 mm to the tyre tread and the inboard sides (including chain lock).

Tyre chains may only be used at speeds of up to 50 km/h (30 mph)¹⁾ or up to the tyre chain manufacturer's recommended maximum speed, whichever is lower.

When travelling on roads that are free of snow, they may only be used for brief periods since they are subject to rapid wear on a hard road and may snap.

Avoid sharp turns, bumps and holes and do not lock the wheels when braking, to avoid damaging the tyre chains.

Retighten the chains after driving for approx. 1 km (0.6 miles). If, at any time, you hear or suspect that the chains are contacting the vehicle, stop and retighten the chains.

Always read the instructions supplied with the tyre chains.

Temporary spare wheel

The temporary spare wheel is designed for use on your vehicle only.

Do not attempt to use the spare tyre on a different wheel, or use a different tyre on the spare wheel, as they will not fit.

For notes on the temporary spare wheel - see page 178.

Ensure the temporary spare wheel is inflated to the correct tyre pressure - see page 224.

Wheel changing - see page 178.

Roof racks ❖

Warning

Disregard of the instructions may lead to injuries or endanger life. Vehicle passengers must be informed accordingly.

For reasons of safety and to avoid damaging the roof, we recommend that you use the Opel roof rack system approved for your vehicle.

Fasten the roof rack to the roof rails following the instructions that accompany the system, ensuring that the roof load is evenly distributed over the side or cross rails. Loads must not be placed on the roof surface.

To prevent damage or loss, check frequently that roof loads are securely fastened.

Driving with a roof load affects the vehicle's centre of gravity; drive carefully in crosswinds and do not drive at high speeds.

Driving hints - see page 127.

¹⁾ Varies from country to country on account of national regulations.



S 14512

Flex-Fix system ❄

The Flex-Fix system allows up to two bicycles to be attached to a pull-out carrier integrated beneath the vehicle floor.

The maximum load is 40 kg.

If not in use, the Flex-Fix system has to be collapsed back beneath the vehicle floor.

There must not be any objects on the bicycles that could become loose during transportation.

A multifunction box ❄ is offered as an accessory for the carrier system. The transportation of other objects is not permitted.



S 14624

Extend Flex-Fix system

Open tailgate - see page 26.

Warning

No persons may remain in the extension zone of the Flex-Fix system while opening; risk of injury.

■ Raise the release lever. The system disengages and travels quickly out from the bumper.



S 14514

Completely pull out the Flex-Fix system until you hear it engage.

Ensure that it is not possible to push in the Flex-Fix system without pulling the release lever again.



S 14568

Pull up license plate holder and fully insert the holder supports into the retainers.

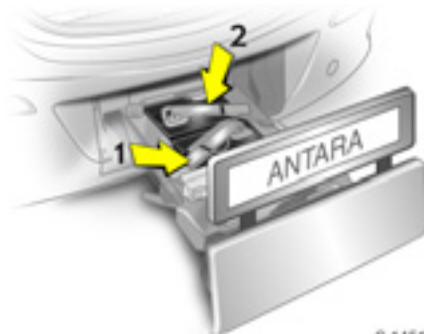

S 14515

Install the tail lamps

Remove the left tail lamp (1), then the right tail lamp (2) from the storage bay.

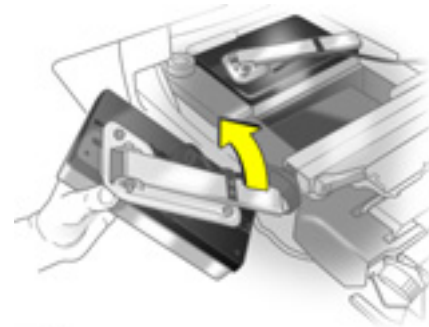

18339 S

Open out the lamp support on the back of the tail lamp all the way.

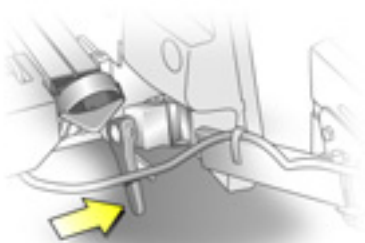

S 14570

Push the clamping lever and insert the lamp support into the retainer until it hits the stop.

Perform this procedure for both tail lamps.



S 14516

Check the cable and lamp position to make sure these are correctly installed and are securely located.



18478 S

Lock the Flex-Fix system

Swivel the left clamping lever (1) outwards first, followed by the right clamping lever (2) until they stop. Both clamping levers must point backwards, otherwise safe functionality is not guaranteed.

Warning

It is only permissible to fit objects to the Flex-Fix system if the system has been correctly engaged. If the Flex-Fix system will not engage correctly, do not fit objects to the system and slide the system back. Contact a workshop for assistance.

Close the tailgate.



S 14517

Unfold pedal crank recesses

Fold one or both pedal crank recesses upwards until the diagonal support engages.

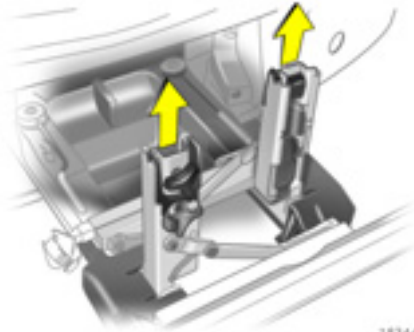

18344 5

Remove the pedal crank mounts from the pedal crank recesses.

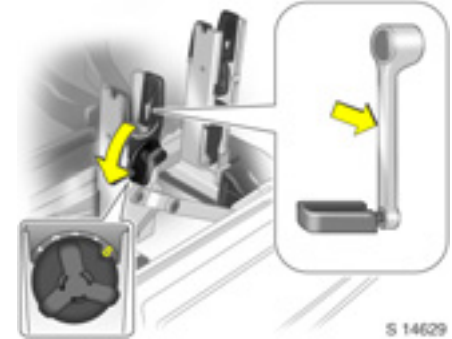

S 14629

Adapting the Flex-Fix system to a bicycle

With the rotary lever on the pedal crank recess, roughly adapt the adjustable pedal crank unit to the protrusion of the pedal crank.

If the bicycle has straight pedal cranks, unscrew the pedal crank unit all the way (position 5), see illustration.

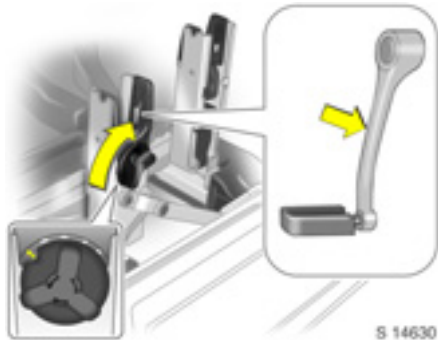

If the bicycle has curved pedal cranks, screw in the pedal crank unit all the way (position 1), see illustration.

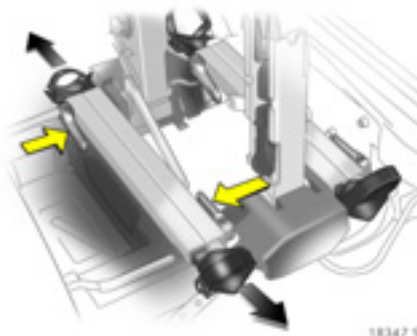

Press the release lever and withdraw the wheel recesses.

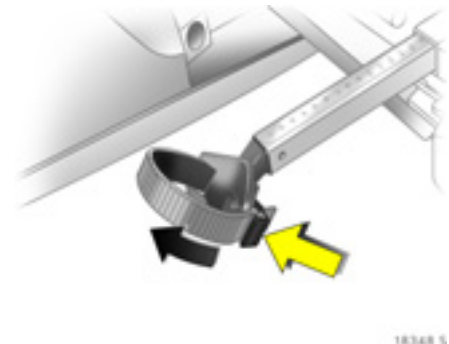

Push the release lever on the strap retainer and remove the strap retainer.



Prepare the bicycle for attachment

Rotate the left pedal (opposite the chain cog) vertically downwards. The pedal on the left pedal crank must be horizontal.

The front bicycle must have its front wheel facing left.

The rear bicycle must have its front wheel facing right.

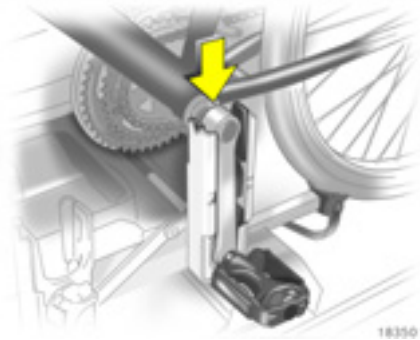

Attaching a bicycle to the Flex-Fix system

Put on the bicycle. The pedal crank here must be placed in the pedal crank recess opening as shown in the illustration.

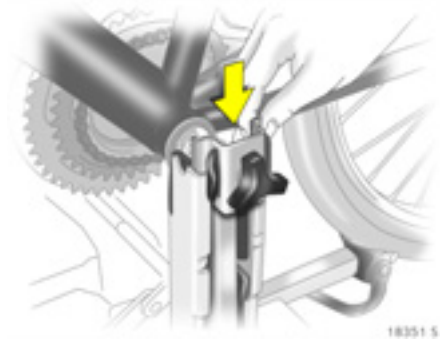

Insert pedal crank mount into outer rail of each pedal crank recess from above and slide downwards as far as it will go, see Fig. 18454 S on page 160.

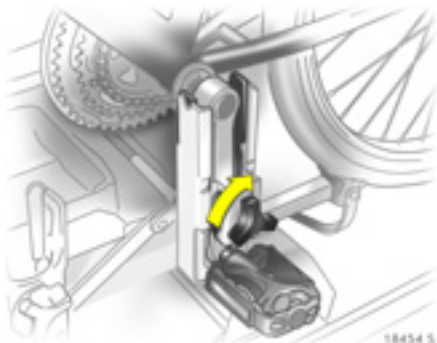

Attach the pedal crank by rotating the attachment screw on the pedal crank mount.



Place the wheel recesses such that the bicycle is more or less horizontal. Here, the distance between the pedals and the tailgate should be at least 5 cm. Setting the wheel recesses - see page 158.

Both bicycle tyres must be in the wheel recesses. In order to prevent damage, neither the pedal bearing housing on the bicycle nor the pedal crank should be touching the pedal crank recess.



Align the bicycle in the longitudinal direction of the vehicle:

Slightly loosen the pedal bearing mount - see page 157, Fig. 14629 S.

Place the bicycle upright using the rotary lever on the pedal crank recess - see page 157, Fig. 14629 S or page 158, Fig. 14630 S.

If the two bicycles obstruct one another, the relative positions of the bicycles can be adapted by adjusting the wheel recesses and the rotary lever on the pedal crank recess until the bicycles no longer touch one another. Make sure there is sufficient clearance from the vehicle.

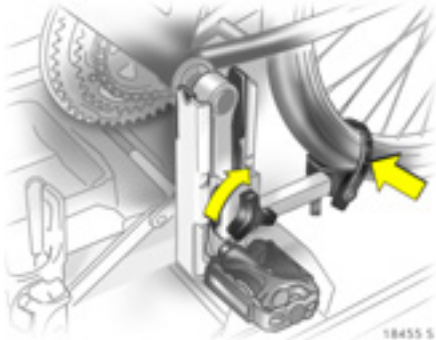

Tighten the attachment screw for the pedal bearing mount to its maximum point.

Secure both bicycle wheels to wheel recesses using strap retainers.

Check the bicycle to make sure it is secure.

The settings for the wheel recesses and the rotary lever on the pedal crank recess should be noted and saved for each bicycle. Correct presetting will facilitate refitting of the bicycle.

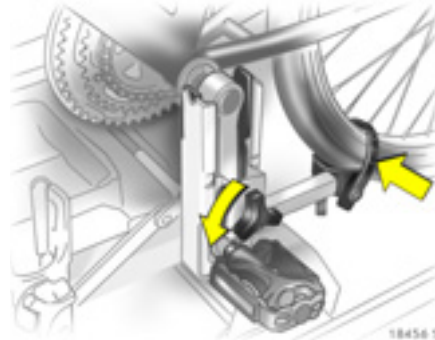

Removing a bicycle from the Flex-Fix system

Undo strap retainers on both bicycle tyres.

Hold on to the bicycle, loosen the attachment screw for the pedal bearing mount, then lift the pedal bearing mount to remove it.

Remove bicycle from the Flex-Fix system.

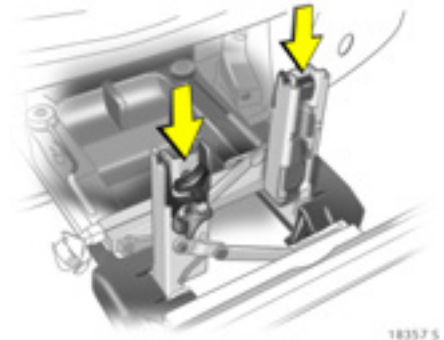

Retracting the Flex-Fix system

Push the pedal crank mounts into the pedal crank recesses.

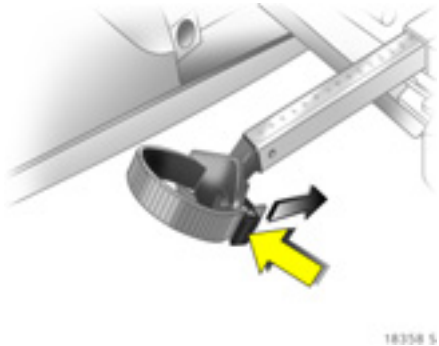

Secure the strap retainer and pull tightly downwards as far as possible.

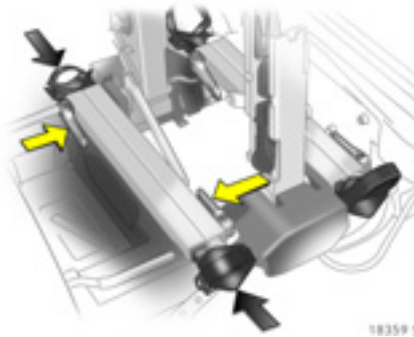

Press release lever and slide in wheel recesses all the way as far as they will go.

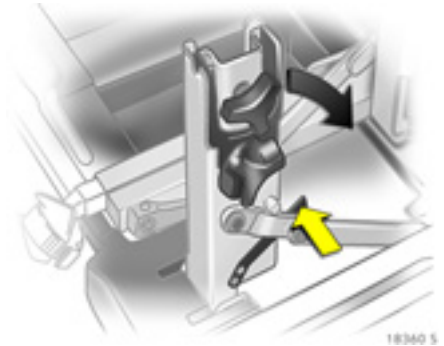

Disengage the locking lever on the diagonal support and fold both pedal crank recesses down.

⚠ Warning

Caution; risk of trapping fingers.

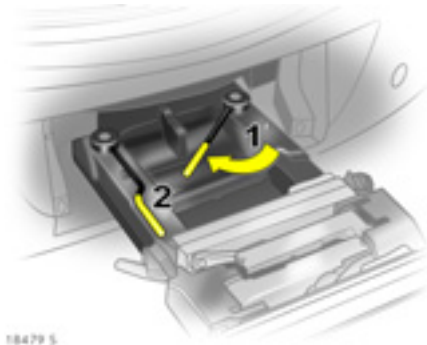

Swivel first the right clamping lever (1), inwards, followed by the left clamping lever (2), until they can be engaged in their respective recesses.

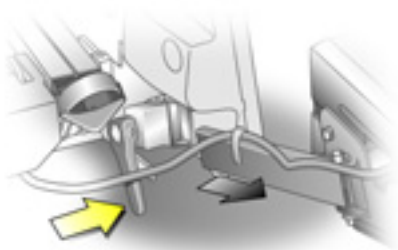

Push the clamping lever and pull both lamp supports out of the recesses.

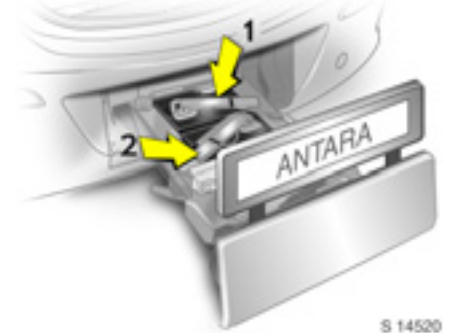

Fold in the lamp supports on the backs of the tail lamps.

First place the right tail lamp (1), then the left tail lamp (2) in their respective recesses and push down as far as possible. Push cables all the way into all guides in order to prevent damage.

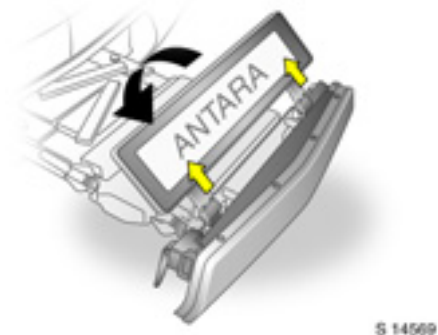

Pull up license plate holder and fold down into horizontal position.



Open the tailgate.

Raise the release lever and push the system into the bumper until it engages.

Ensure release lever returns to original position.

⚠ Warning

If the system cannot be correctly engaged, please contact a workshop for assistance.

Towing equipment ✳

If the vehicle is not equipped with a trailer hitch, we recommend having this retrofitted by a workshop, who will advise you on any possible towed load increases.

The workshop has instructions on how to install the trailer hitch and making any changes to the vehicle that are needed that affect the cooling system, heat shields or other equipment.

⚠ Warning

The coupling ball bar is to be removed when not towing.

Mounting dimensions of towing equipment - see page 227.

Towing equipment with detachable coupling ball bar***Stowage of coupling ball bar**

The coupling ball bar is kept in a bag, fastened with a strap and is stowed below the floor cover in the luggage compartment.

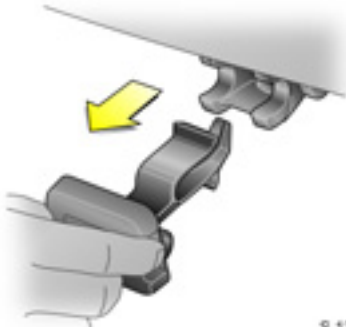

S 13518

Fitting the coupling ball bar

Remove sealing plug from the hole for the coupling ball bar and stow it in the luggage compartment.

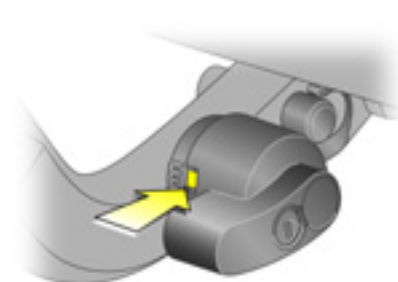

S 13519

Confirm that the colour marking on the lever is red.

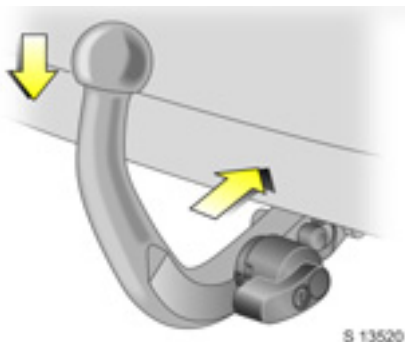

Inserting the coupling ball bar

Insert the coupling ball bar into the coupling housing and push firmly downwards until the coupling ball bar audibly engages.

If it does not engage, repeat fitting procedure.

Do not swing the coupling ball bar to the left or right, or upwards and downwards, to avoid disrupting correct fitting.

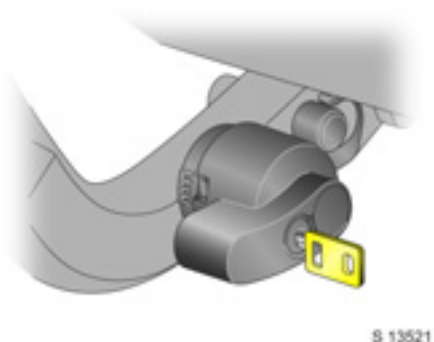

Lock coupling ball bar by turning the supplied key in the lock cylinder of the coupling ball bar.

Remove key.

Important

Check that the coupling ball bar is correctly attached:

- Green marking must be visible on lever.
- Coupling ball bar must be seated firmly in coupling housing.

Coupling ball bar must be locked and key must be removed.

Warning

Towing a caravan/trailer is only permitted with a properly attached coupling ball bar. If the coupling ball bar cannot be properly attached, consult a workshop.

Eye for breakaway stopping cable *

In the case of caravans/trailers with brakes *, attach the breakaway stopping cable to the eye - not the coupling ball bar.



S 13522

Dismounting the coupling ball bar

Unlock coupling ball bar and remove key.

Push lever to the left, towards the coupling ball bar and turn it downwards. Pull coupling ball bar out of coupling housing.

Remove any rust or dirt from area around the coupling housing and coupling ball bar connection before inserting sealing plug in the hole.

Place the coupling ball bar in the bag supplied, fasten it with the strap and stow it below the floor cover in the luggage compartment.

Do not use steam-jet cleaners or other high-pressure cleaners to clean the coupling ball bar.

Towing

Caravan/trailer loads¹⁾

The permissible caravan/trailer loads are vehicle-dependent and engine-dependent maximum values which must not be exceeded.

The actual caravan/trailer load is the difference between the actual gross weight of the caravan/trailer and the actual coupling socket load with the caravan/trailer coupled.

When the caravan/trailer load is being checked, therefore, only the caravan/trailer wheels - and not the jockey wheel - must be standing on the weighing apparatus.

The permissible caravan/trailer loads for your vehicle are given in the vehicle papers. Unless otherwise stated, they are valid for gradients up to max. 12%.

The permissible caravan/trailer load should be fully utilized only by drivers who are adequately experienced in towing large caravans/trailers.

The permitted caravan/trailer load applies up to the specified incline and up to an altitude of 1000 metres above sea level.

Since engine power decreases as altitude increases because of the air becoming thinner, therefore reducing climbing ability, it may not be possible for permissible trailer loads to be fully utilized in mountainous territory.

The permitted towing weight decreases by 10% for every 1000 metres of additional altitude.

The towing weight does not have to be reduced when driving on roads with slight inclines (less than 8%, e.g. on motorways).

The actual caravan/trailer load plus the actual Gross Vehicle Weight must not exceed the maximum permitted towing weight. For example, if the permitted Gross Vehicle Weight is utilised, the caravan/trailer load must only be used until the maximum permitted towing weight is reached.

The maximum permitted towing weight is shown on the vehicle identification plate - see page 215.

¹⁾ Observe national regulations.

Coupling socket load

The coupling socket load is the load exerted by the caravan/trailer on the coupling ball. It can be varied by changing the weight distribution when loading the caravan/trailer.

The maximum permissible coupling socket load for the towing vehicle (80 kg) is stated on the towing equipment identification plate and should always be aimed for, particularly in the case of heavy caravans/trailers. The coupling socket load should never be below 25 kg.

When measuring the coupling socket load, make sure that the drawbar of the loaded caravan/trailer is at the same height as it will be when the caravan/trailer is coupled with the towing vehicle loaded. This is particularly important for caravans/trailers with tandem axle.

Rear axle load during towing

When the caravan/trailer is coupled and the towing vehicle fully loaded (including all occupants), the permissible rear axle load must not be exceeded.

National regulations regarding maximum speeds for vehicles towing a caravan/trailer must be observed.

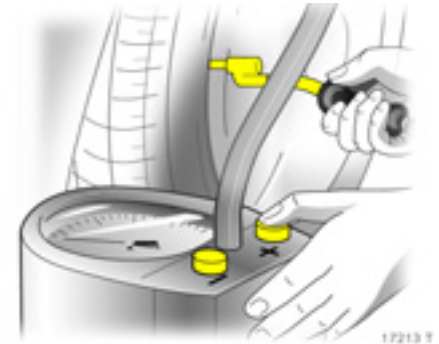

Tyre pressure

Increase the tyre pressure on the towing vehicle to the value specified for full load (see page 224). Also check the pressure of the caravan/trailer tyres.

Driving characteristics, towing tips

In the case of caravans/trailers with brakes ✱, attach the breakaway stopping cable to the eye ✱ or loop around coupling ball bar if no eye is available.

Ensure cable is crossed under the coupling socket to ensure the caravan/trailer nose cannot drop to the ground if it becomes separated from the trailer hitch.

Do not allow the cable to drag along the ground and always allow enough slack to permit full turning. Follow the instructions supplied with the towing equipment.

Before coupling the caravan/trailer, lubricate the ball of the caravan/trailer towing device. However, do not do so if a stabilizer which acts on the coupling ball is being used to damp rolling motions.

Handling is greatly influenced by the loading of the caravan/trailer. Loads should therefore be secured so that they cannot slip and should be placed in the centre of the caravan/trailer if possible, i.e. above the axle.

Opel genuine parts and accessories which can be subsequently fitted aid trailer operation, e.g. large mirrors for wide caravans/trailers.

In the case of caravans/trailers with low directional stability, it is advisable to use a friction-type stabilizer to damp rolling motions.

Do not drive faster than 80 km/h (50 mph), even in countries where higher speeds are permitted.

When driving uphill, do not drive faster than 30 km/h (20 mph) in 1st gear, or 50 km/h (30 mph) in 2nd gear.

Make sure that you have enough room when cornering and avoid sudden manoeuvres.

If the caravan/trailer starts to sway, drive more slowly, do not attempt to correct the steering and brake sharply if necessary.

If it is necessary to apply the brakes fully, depress the brake pedal as hard as possible.

The cooling fan is electrically operated. The fan cooling capacity is not, therefore, dependent on engine speed. It is not necessary, when driving uphill, to shift down into a lower gear if the vehicle can climb in a higher gear.

When coupled to a caravan/trailer, the vehicle requires more braking effort when driving down long gradients, so select the same gear as you would when driving uphill and drive at roughly the same speed.

Automatic transmission in automatic mode will select the driving program with the optimum engine braking effect.

Remember that braking distances for vehicles towing caravans/trailers with and without brakes is always greater than for vehicles not towing a caravan/trailer. For caravans/trailers with brakes, follow the instructions carefully. Do not make any modifications to the brake system.

Always check lamps on caravans/trailers before towing. Ensure national regulations are observed.

The fog tail lamp on the vehicle is deactivated when towing a caravan/trailer.

When reversing, if possible, have someone provide assistance.

Drive slowly and shift down into a lower gear when descending steep gradients rather than holding the foot brake depressed, to avoid overheating and reduced brake efficiency.

Block the wheels of both the caravan/trailer and the vehicle when parking and always apply the hand brake firmly. If possible, do not park on slopes.

Warning

Have someone provide assistance when removing blocks. Always remove blocks from wheels while standing to one side.

Do not remove blocks while standing behind the caravan/trailer; risk of injury and damage to both the vehicle and caravan/trailer.



Parking on inclines

If parking on an incline is unavoidable, depress the foot brake, have someone place wheel blocks under the caravan/trailer wheels and release the foot brake until the blocks have absorbed the load.

Depress foot brake again, apply hand brake, engage first gear on uphill gradients or reverse gear on downhill gradients (automatic transmission  in **P**) and finally, release foot brake.

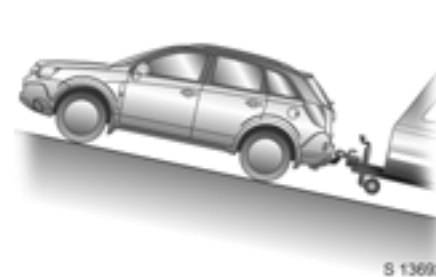

Starting on inclines



Depress the foot brake and hold it down, start the engine, shift into gear and release the hand brake.

Release foot brake and drive slowly until the caravan/trailer is clear of the wheel blocks. Stop the vehicle and have someone pick up the blocks. If possible, the engine speed should not drop during this procedure.

For vehicles with automatic transmission  in automatic mode, apply sufficient throttle.

Before starting-off under extreme conditions (e.g. high combination weight, mountainous terrain with steep inclines), switch off all unnecessary electrical loads (e.g. heated rear window, air conditioning system, heated front seats .

Self-help, vehicle care

- Diesel fuel system, bleeding 171
- Bonnet 171
- Starting 172
- Starting the engine with jump leads* 172
- Towing 174
- Jack and vehicle tools 176
- Warning triangle *,
First aid kit * 177
- Temporary spare wheel 177
- Wheel changing 178
- Electrical system 181
- Fuses and the most important circuits
they protect 182
- Bulb replacement 185
- Opel genuine parts and accessories. 191
- A note on safety 191
- Checking and topping up fluids 191
- Windscreen wipers 198
- Windscreen washer system 199
- Battery 200
- Protection of electronic components 201
- Vehicle storage 201
- Vehicle care 201

 **Warning**

Disregard of the instructions may lead to injuries or endanger life. Vehicle passengers must be informed accordingly.

Diesel fuel system, bleeding

Never let the fuel tank run dry. If control indicator  illuminates, refuel as soon as possible.

It is possible to restart the engine if the tank has been run dry. A delayed start can be expected. Switch on the ignition three times for approx. 15 seconds. Then try to start the engine for no more than 40 seconds. If the engine will not start, wait at least 10 seconds before trying again. If the engine will still not start, consult a workshop.

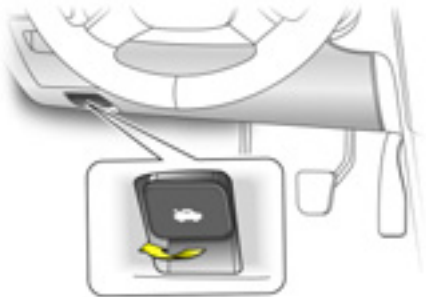

Bonnet

To open the bonnet, pull release lever  located on the left-hand side below the instrument panel.

The bonnet will then be unlocked and will partially open. Return release lever to its original position.

Do not pull release lever while the vehicle is moving.

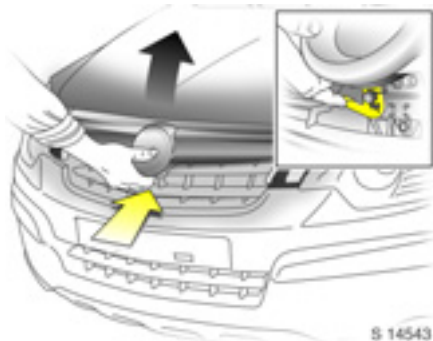

To open completely, locate the safety catch, found slightly left of centre on the underside of the bonnet, push the catch upwards and lift the bonnet gently. The bonnet is held open automatically.

When the bonnet is opened, leaves, dirt or snow on the bonnet can slide down and obstruct the air intake. Remove any leaves, dirt or snow. Air intake - see page 114.

Never drive with bonnet open.

To close bonnet, lower it gradually, allowing it to drop from a height of approx. 30 cm.

Check that the bonnet is locked in position before driving, by pulling at its front edge. If it is not engaged, repeat closing procedure.

Starting

Do not start with quick charger

This prevents damage to electronic components.

Warning

If the vehicle battery requires charging whilst still in the vehicle, ensure there is adequate ventilation in and around the battery compartment, to prevent risk of explosion.

Do not start by pushing or towing

Because your vehicle is fitted with a catalytic converter, it must not be started by pushing or towing - see page 133.

The vehicle can only be started using jump leads - see following pages.

Starting the engine with jump leads ❄

A vehicle with a discharged battery can be started using jump leads and the battery of another vehicle.

Start attempts should be made at intervals of 1 minute and should not last longer than 15 seconds.

Warning

This must be done with extreme care. Any deviation from the following instructions could lead to personal injury or damage resulting from battery explosion, as well as to damage to the electrical systems in both vehicles.

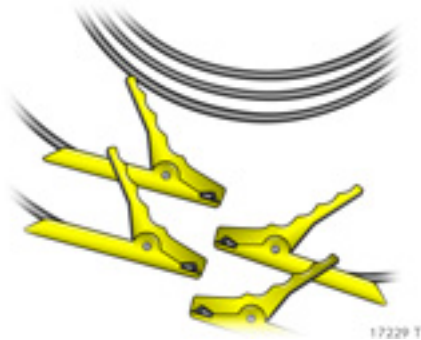

- Never expose the battery to naked flames or sparks.
- A discharged battery can freeze at temperatures of 0 °C. Defrost the battery in a warm room before connecting the jump leads.
- Do not allow battery fluid to contact eyes, skin, fabrics or painted surfaces. The fluid contains sulphuric acid which can cause injuries and damage in the event of direct contact.
- Wear eye protection and protective clothing when handling a battery.

- Use auxiliary battery with same voltage (12 volts). Its capacity (Ah) must not be considerably less than that of the discharged battery. Voltage and capacity information can be found on the batteries.
- Use jump leads with insulated terminals and a width of at least 16 mm² (25 mm² for diesel engines).
- Do not disconnect the discharged battery from the vehicle.
- Switch off all unnecessary electrical consumers. Infotainment system may be damaged if switched on while jump starting.
- Do not lean over the battery during jump starting procedure.
- Do not allow the terminals of one lead to touch those of the other lead.
- The vehicles should not touch while jump starting.
- Apply hand brake.
- Manual transmission in neutral, automatic transmission * in P.

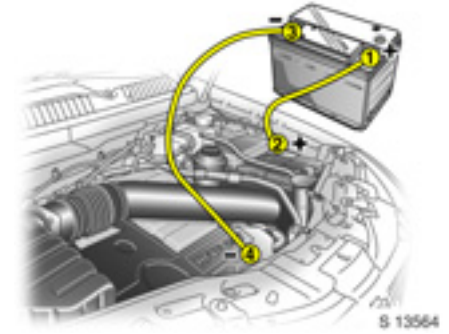

Connect the leads in the order shown in the illustration:

1. Connect one end of the first jump lead to the positive terminal **1** of the battery providing the jump start (identified by "+" sign on battery case or terminal).
2. Connect the other end of the first jump lead to the positive terminal **2** of the discharged battery ("+" sign).
3. Connect one end of the second jump lead to the negative terminal **3** of the battery providing the jump start (identified by "-" sign on battery case or terminal).
4. Connect the other end of the second jump lead **4** to ground on the vehicle with the discharged battery, e.g. on the engine block.

⚠ Warning

Care must be taken to ensure that the leads do not inadvertently contact metal surfaces within the compartment area.

- Do not connect leads to negative terminal of discharged battery.
- The last connection point should be as far away from the discharged battery as possible.
- Route leads so they cannot catch on rotating parts in engine compartment.
- Start the engine of the vehicle providing the jump start.
- After 5 minutes, start the other engine. Start attempts should be made at intervals of 1 minute and should not last longer than 15 seconds.
- After starting, allow both engines to idle for approx. 3 minutes with leads connected.
- In order to avoid excess voltage in the electrical system, before removing a lead, switch on an electrical consumer (e.g. lamps, heated rear window) in the vehicle receiving the jump start.
- Operate discharged vehicle for approx. 20 minutes to allow for recharging.
- Reverse above sequence exactly when removing leads.

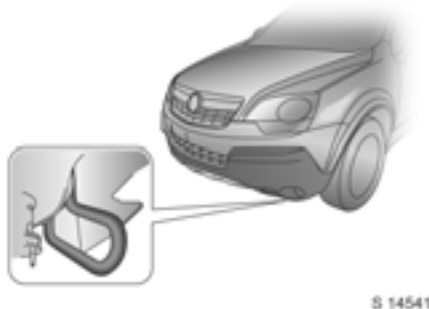

Towing

Towing the vehicle

Attach a tow rope * - or better still a tow rod * - to the front towing eye (located under the front bumper). Do not tow the vehicle from the rear.

The front towing eye must only be used for towing and not recovering the vehicle.

⚠ Warning

Never lift vehicle using the towing eye.

Place gearshift lever in neutral. Switch on the ignition to release the steering column lock and to permit operation of the brake lamps and windscreen wipers.

Drive off slowly and avoid jerky movements. Impermissible tractive forces could damage the vehicles.

⚠ Warning

More brake pedal pressure is necessary when braking since the brake servo unit is operative only when engine is running.

Considerably greater steering force is necessary since this unit is operative only when the engine is running.

Keep tow rope * clear of front bumper, and ensure it is securely fixed to the towing eye at both ends. Pull on the tow rope * to check.

To prevent entry of exhaust fumes from towing vehicle, switch on air recirculation mode (see page 109) and close the windows.

Never let passengers ride in a vehicle that is being towed.

Never tow a vehicle with damaged parts that are not secured to the vehicle or if wheels, brakes or steering are damaged.

Do not tow the vehicle with a tow rope * or tow rod * for extended periods, to avoid damage to the vehicle. Only tow in this manner on hard-surfaced roads.

For vehicles with automatic transmission *: use flatbed or wheel lift equipment only. Towing can cause severe damage to the transmission.

Seek the assistance of a workshop.

Towing service

Entrust your vehicle only to the towing service of your choice and obtain an estimate on towing costs before employing any towing service. This will prevent unnecessary expense and possible insurance problems during claim processing.

Use flatbed equipment whenever possible. If vehicle is to be towed using a wheel lift, tow with all wheels off the road, using a towing dolly.

Never use sling-type equipment to tow the vehicle or tow the vehicle with the front or rear wheels on the road, to avoid causing serious damage to the vehicle.

Place the gearshift lever in neutral (automatic transmission * in **N**), switch on hazard warning lamps, turn key to ignition switch position ACC and release the hand brake before towing the vehicle.

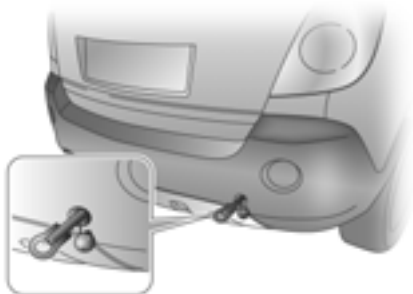

S 13574

Towing another vehicle

In emergency situations only, attach a tow rope * - or better still a tow rod * - to the rear towing eye.

The rear towing eye attachment * is stored below the floor cover in the luggage compartment.

Remove the cover located on the rear bumper by pressing the lower part of the cover.

Screw the rear towing eye attachment anti-clockwise until it is firmly in place.

⚠ Warning

Never lift vehicle using the towing eye.

Drive off slowly and avoid jerky movements. Impermissible tractive forces could damage the vehicles.

To prevent damage, do not take up slack in the tow rope too quickly.

After towing, unscrew the rear towing eye attachment clockwise to remove, and reinstall the cover.

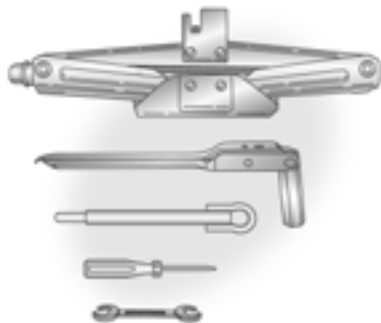

S 13702

Jack and vehicle tools

The jack and vehicle tools have been specially developed for your vehicle and must only be used on that vehicle. Only use jack for changing wheels.

The jack and vehicle tools are located in the luggage compartment below the floor cover.

⚠ Warning

In a sudden stop or a collision, loose items can be thrown around inside the vehicle, causing personal injury and damage to the interior.

Secure the jack and vehicle tools away properly under the floor cover in the luggage compartment.

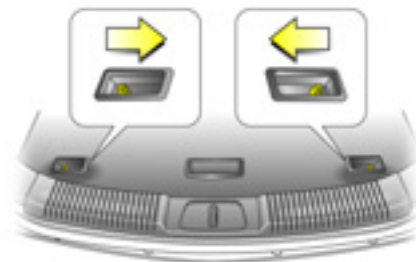

S 13700

To remove the jack and vehicle tools, open the tailgate. Push both levers on the floor cover towards the handle and pull up the floor cover by the handle.

Hang the hook to the upper part of the tailgate opening (see page 63, Fig. S 13419).

Remove wing bolt from the jack by rotating it anti-clockwise and remove the jack and wheel wrench bag.

Remove straps holding the bag containing the wheel wrench. Remove wheel wrench from the bag.

**Warning triangle ▲ ❄️,
First aid kit 🆘 ❄️**

Your first aid kit and warning triangle can be accommodated below the floor cover in the luggage compartment.

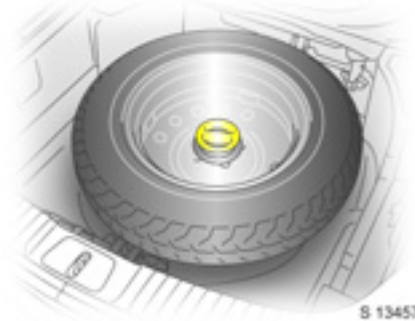
**Temporary spare wheel**

The temporary spare wheel is located in the luggage compartment below the floor cover and is secured with a screw-in retainer.

Push both levers on the floor cover towards the handle and pull up floor cover by the handle (see page 176, Fig. S 13700). Hang the hook to the upper part of the tailgate opening (see page 63, Fig. S 13419).

Remove the retainer by rotating it anti-clockwise, and remove spare wheel from the spare wheel well.

General information

If you use winter tyres ❄️, the spare wheel may still be fitted with a summer tyre.

If you use the spare wheel when it is fitted with a summer tyre, the vehicle's driveability may be affected, especially on slippery road surfaces.

Obtain a replacement for the faulty tyre as soon as possible, and have the wheel balanced and fitted to the vehicle.

Notes on temporary spare wheel

- Using a temporary spare wheel may change the driving behaviour of the vehicle, particularly if using winter tyres ✱. Replace defective tyre as quickly as possible, balance wheel and fit to vehicle.
- Fit only one temporary spare wheel.
- Do not drive faster than 80 km/h (50 mph).
- Take curves slowly.
- Do not use the temporary spare wheel for a lengthy period.
- Replace temporary spare wheel with full specification wheel without delay.
- When temporary spare wheel is fitted, do not take the vehicle through an automatic car wash with guide rails. The temporary spare wheel may get caught on the rails, causing damage to the tyre, wheel and other vehicle parts.
- Tyre chains are not permitted on the temporary spare wheel.
If tyre chains are necessary after a front wheel puncture, fit the temporary spare wheel to the rear and a rear wheel to the front. Check tyre pressure and adjust if necessary - see page 224.
- Follow the temporary spare wheel instructions on pages 153, 181, 223.

Notes on directional tyres ✱

Tyres with a prescribed rotating direction can only achieve their maximum performance if they are fitted in the prescribed rotating direction.

If a tyre or spare wheel is fitted that is rotating in the wrong direction due to a puncture, the following must be noted:

- The handling of the vehicle may be different. Replace defective tyres as soon as possible, have wheel balanced and fitted to the vehicle.
- Do not drive faster than 80 km/h (50 mph).
- Drive particularly carefully on wet and snow-covered road surfaces.
- For more information on tyres with a prescribed rotating direction - see page 149.

Wheel changing

In order to reduce the chance of possible injuries, make the following preparations and note the procedure:

- Park on a level, firm and non-slippery surface.
- Switch on hazard warning lamps and apply hand brake. Engage 1st gear or reverse (automatic transmission ✱ in P).
- Correctly set up warning triangle ✱.
- Ensure all vehicle passengers are out of the vehicle and clear of the vehicle and other traffic.
- Take the spare wheel from under the luggage compartment floor cover - see page 177.
- Before raising the vehicle, turn front wheels to straight-ahead position.

- Remove wheel trim ❄.
- Slacken wheel nuts one turn only before raising the vehicle, but do not totally unscrew or remove the nuts until the wheel is off the ground.
- Never change more than one wheel at a time.
- Block wheel diagonally opposite the wheel to be changed, by placing wedge blocks or equivalent in front and behind the wheel.
- Do not jack-up the vehicle when traffic is too close.
- Use jack only when changing wheels.
- Never exceed jack maximum working load (900 kg).
- If the ground on which the vehicle is standing is soft, a solid board (max. 1 cm thick) should be placed under the jack. Using a thicker board could lead to damage of the jack and the vehicle.

- Do not raise the vehicle more than is necessary to change a wheel.
- No people or animals may be in the vehicle when it is jacked-up.
- Never start or run the engine or crawl under a jacked-up vehicle.
- Before screwing on the wheel nuts when changing a wheel, apply a light coating of grease to the cone of each wheel nut.
- Fully tighten the wheel nuts after lowering the vehicle all the way, ensuring nuts have been tightened to the correct torque (see page 223).
- If conditions are not satisfactory to change a wheel safely, consult a workshop.



1. Prise off the wheel trim ❄.
2. Slacken the wheel nuts by one turn each using the wrench, putting the wrench on as far as possible.



S 13693

3. The location of front and rear jacking points is indicated by notches on the bottom edge of the vehicle, under the doors.

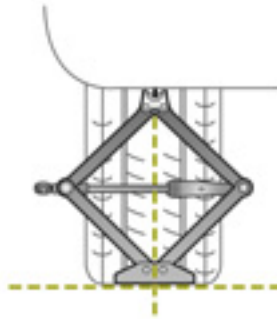

S 13694

4. Before positioning the jack, set it to the necessary height by rotating the eye by hand.
Position jack at the front or rear jacking point located nearest to the wheel concerned so that the jack claw spans the vertical base. Make sure it is properly positioned.
The jack base must be on the ground directly below the jacking point in a manner that prevents it from slipping.

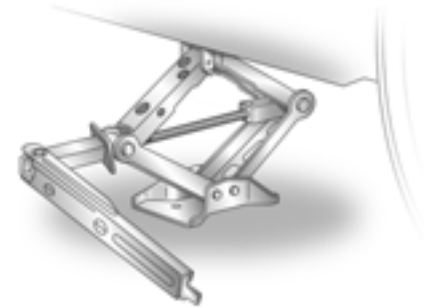

S 13727

5. Attach wrench to eye of threaded rod and turn crank to raise vehicle.
If this is not the case, carefully lower the vehicle immediately and reposition the jack.
Raise the vehicle until the wheel is just clear of the ground.
6. Unscrew wheel nuts completely by turning anti-clockwise and wipe clean with a cloth. Then apply a light coating of grease to the cone of each wheel nut. Do not grease the threads.
Put wheel nuts somewhere where the threads will not be soiled.



7. Change the wheel.
Notes on spare wheel - see page 178.
8. Screw on wheel nuts and tighten slightly by hand until wheel is held against the hub.
9. Rotate wrench anti-clockwise and lower vehicle to the ground.
10. Tighten wheel nuts in a cross wise sequence, putting the wrench on as far as possible.

11. Stow replaced wheel in luggage compartment.
12. Stow the jacking equipment and warning triangle * - see pages 176, 177.
13. Check the tyre pressure of the newly fitted wheel - see page 224. Adjust as necessary.
14. Have the new wheel balanced on the vehicle and have the tightening torque of the wheel nuts checked as soon as possible, and if necessary, corrected. Tightening torque - see page 223.
15. Replace defective tyre on the wheel that was removed.
16. Replace temporary spare wheel with a full specification wheel without delay.

Electrical system

Warning

Electronic ignition systems generate very high voltages. Do not touch the ignition system; high voltage can be fatal.

Fuses

There are two fuse boxes in the vehicle: the instrument panel fuse box is located on the left-hand side of the front passenger's footwell, the engine compartment fuse box is located next to the coolant reservoir.

It is advisable to carry a full set of fuses.

Spare fuses are kept in the engine compartment fuse box.

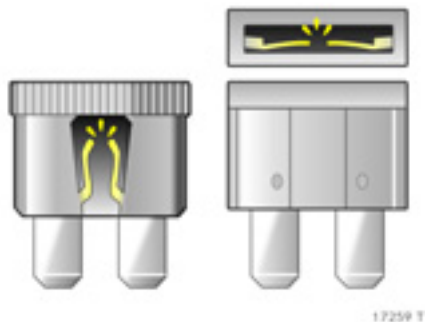

When replacing a fuse, turn off the respective switch and the ignition.

A defective fuse can be recognized by its melted wire. A new fuse should only be installed after the cause of the trouble has been eliminated.

There is a fuse extractor in the engine compartment fuse box. Do not use tools that conduct electricity when changing fuses.

Only install fuses of the specified rating. Each fuse has its rating written on it, in addition the fuses are colour coded.

Fuses, Colour	Fuses, Rating ¹⁾
Grey	2 A
Light brown	5 A
Dark brown	7.5 A
Red	10 A
Light blue	15 A
Yellow	20 A
White	25 A
Light green	30 A
Orange	40 A
Dark blue	60 A

¹⁾ Rating in Amperes.

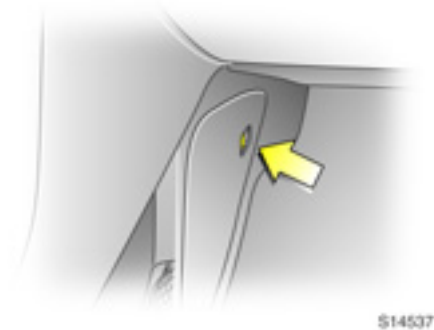

Fuses and the most important circuits they protect

Instrument panel fuse box

Located in the left-hand side of the front passenger's footwell. Release latch to open cover.

To help in replacing fuses, a fuse extractor is located in the engine compartment fuse box.

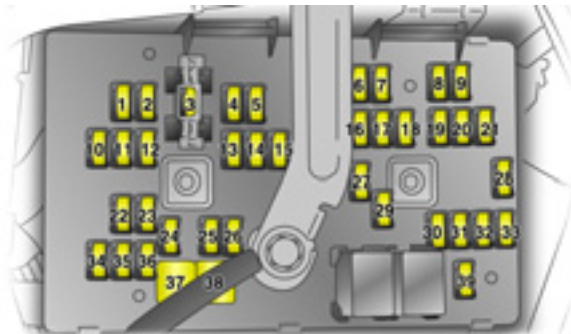

S 13483

Some circuits may be protected by several fuses.

No.	Circuit	Rating
1	Accessory socket	20 A
2	Seat heating	20 A
3	Audio	15 A
4	Trailer	10 A
5	Parking lamp (right side)	10 A
6	Air conditioning	10 A
7	Power steering	10 A
8	Body Control Module	10 A
9	Anti-theft alarm	10 A
10	Central door locking	20 A
11	Turn signal (right side)	15 A
12	Turn signal (left side)	15 A

No.	Circuit	Rating
13	Stop	15 A
14	Headlamp washer	15 A
15	Rear cluster	10 A
16	Air conditioning	15 A
17	Body Control Module	20 A
18	Body Control Module	15 A
19	Ignition switch	2 A
20	Fog tail lamp	10 A
21	Airbag	10 A
22	Front door lock	15 A
23	Accessory socket	20 A
24	Transmission Control Module	15 A
25	Engine	15 A
26	Body Control Module	10 A

No.	Circuit	Rating
27	-	-
28	Windscreen washer	10 A
29	Exterior mirror heating	15 A
30	Instrument cluster	10 A
31	Ignition	10 A
32	Airbag	10 A
33	Steering wheel remote	2 A
34	Folding mirrors	10 A
35	-	-
36	Cigarette lighter	20 A
37	Passenger's electric window	20 A
38	Driver's electric window	20 A
39	Automatic transmission	10 A



S 13579

Engine compartment fuse box

The fuse box is located next to the coolant reservoir in the engine compartment.

Warning

Switch off engine before opening the engine compartment fuse box; risk of injury.

To open, disengage cover and tilt upwards.

To help in replacing fuses, a fuse extractor is located in the engine compartment fuse box.

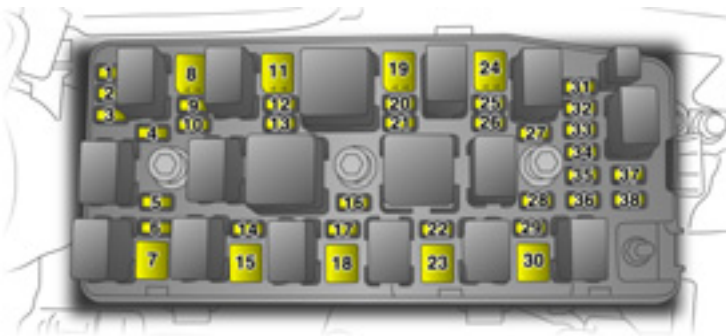

S 13580

Some circuits may be protected by several fuses.

No.	Circuit	Rating
1	Engine 1	15 A
2	Engine 2	15 A
3	Engine Control Module	20 A
4	Engine 3	15 A
5	Air conditioning	10 A
6	Main	10 A
7	Starter	20 A
8	Cooling fan	30 A
9	Fuel pump	15 A
10	All Wheel Drive (AWD)	15 A

No.	Circuit	Rating
11	Cooling fan auxiliary	30 A
12	Stop	15 A
13	Seat heating	20 A
14	ABS module	20 A
15	ABS module	40 A
16	Horn	15 A
17	Wipers	25 A
18	Run	40 A
19	Accessory/Ignition	40 A
20	Sun roof	20 A
21	Anti-theft system	15 A

No.	Circuit	Rating
22	Electric seat	30 A
23	Battery	60 A
24	Defogger	30 A
25	Dipped beam (left side)	15 A
26	Dipped beam (right side)	15 A
27	Parking lamp (left side)	10 A
28	Front fog lamps	15 A
29	Main beam	15 A
30	Rear wipers	20 A
31	-	-
32	Headlamp washer	20 A
33	Transmission Control Module	15 A
34	Trailer/parking lamp (left side)	10 A
35	Spare	25 A
36	Spare	20 A
37	Spare	15 A
38	Spare	10 A

Bulb replacement

Before replacing a bulb, switch off ignition and relevant switch.

Only hold new bulbs at base! Do not touch the bulb glass with bare hands, otherwise fingerprints on the glass evaporate and residue builds up on the reflector eventually resulting in a dull reflector. Inadvertently stained bulbs may be cleaned with a clean lint-free cloth, using alcohol or white spirit.

Replacement bulb must be in accordance with data on base of defective bulb. Do not exceed wattage given on bulb base.

Headlamp aiming

We recommend that headlamp aiming be carried out by a workshop, which will have special equipment.

When aiming your headlamps, the manual headlamp range adjustment * must be set to **0**.

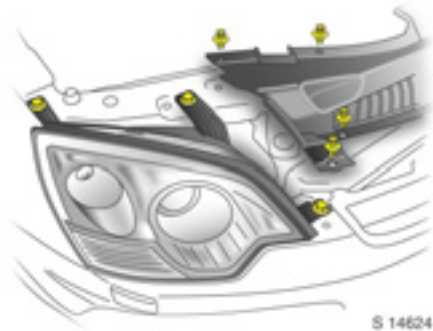

Headlamp removal

For bulb replacement, it is necessary to first remove the headlamp assembly.

1. Switch off ignition and headlamp switch.
2. Open the bonnet, release the 11 retainers and remove the radiator cover.
3. Remove 3 bolts and withdraw headlamp.
4. Depress harness connector tags and disconnect headlamp wiring.
5. Remove the headlamp assembly.

Headlamp assembly installation is the reverse of removal - ensure locating dowel aligns with its socket.

Do not overtighten bolts or retainers.

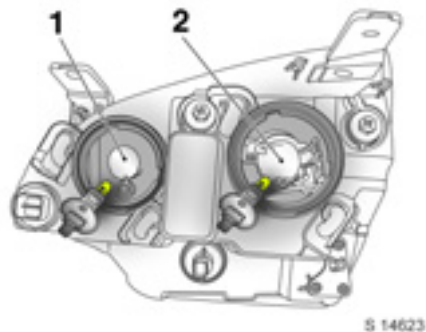

Halogen headlamp system

Dipped and main beam

Main beam 1 (inner bulbs) and dipped beam 2 (outer bulbs).

1. Remove headlamp assembly - see page 185.
2. Remove headlamp cap.
3. Release bulb retaining spring and remove bulb from reflector housing.
4. When fitting a new bulb, ensure the lugs engage correctly with the recesses on the reflector. Do not touch the glass.
5. Engage bulb retaining spring and replace headlamp cap.
6. Reinstall headlamp assembly.

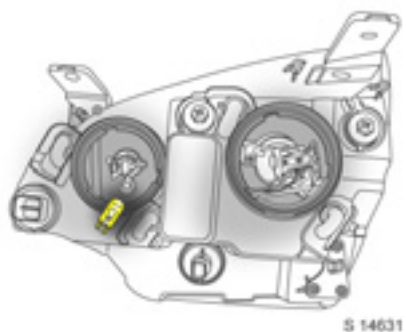

Parking lamps

1. Remove headlamp assembly - see page 185.
2. Remove headlamp cap and withdraw bulb holder (located next to main beam bulb) from lamp assembly.
3. Remove bulb from bulb holder by pulling it straight out.
4. Install new bulb, using a lint-free cloth to hold bulb.
5. Reinstall bulb holder in lamp assembly and replace headlamp cap.
6. Reinstall headlamp assembly.

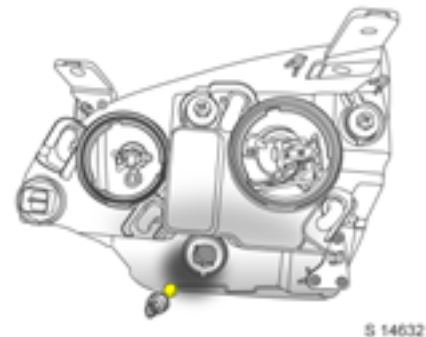

Front turn signal lamps

1. Remove headlamp assembly - see page 185.
2. Rotate bulb holder anti-clockwise and withdraw bulb holder from lamp assembly.
3. Press and rotate bulb anti-clockwise to remove it from bulb holder.
4. Install new bulb into bulb holder by pressing and rotating it clockwise.
5. Reinstall bulb holder in lamp assembly by rotating it clockwise.
6. Reinstall headlamp assembly.

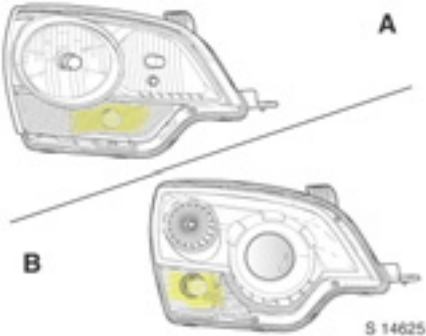

Xenon headlamp system *

Halogen headlamps **A** can be identified from Xenon headlamps **B** by the different lens layout.

⚠ Warning
Xenon headlamps operate at very high voltages. Do not touch; risk of fatal injury. Have dipped beam and main beam repaired by a workshop only.

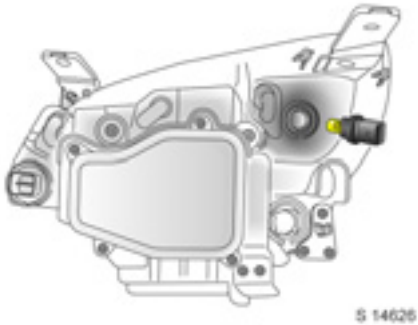

Parking lamps

1. Remove headlamp assembly - see page 185.
2. Rotate bulb holder anti-clockwise and withdraw bulb holder from lamp assembly.
3. Remove bulb from bulb holder by pulling it straight out.
4. Install new bulb, using a lint-free cloth to hold bulb.
5. Reinstall bulb holder in lamp assembly by rotating it clockwise.
6. Reinstall headlamp assembly.

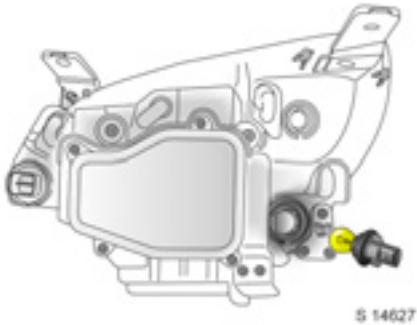

Front turn signal lamps

1. Remove headlamp assembly - see page 185.
2. Rotate bulb holder anti-clockwise and withdraw bulb holder from lamp assembly.
3. Press and rotate bulb anti-clockwise to remove it from bulb holder.
4. Install new bulb into bulb holder by pressing and rotating it clockwise.
5. Reinstall bulb holder in lamp assembly by rotating it clockwise.
6. Reinstall headlamp assembly.

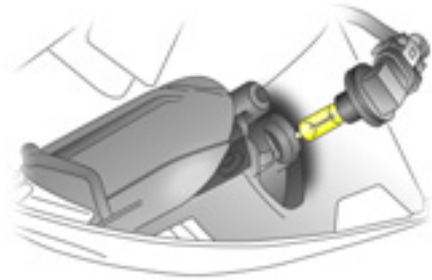

S 13768

Front fog lamps

1. Remove 2 screws from panel on underside of vehicle below front fog lamps and remove panel.
2. Disconnect harness connector from bulb holder and rotate bulb holder anti-clockwise.
3. Remove bulb holder from lamp assembly, rotate bulb anti-clockwise and remove from bulb holder.
4. Install new bulb into bulb holder and rotate it clockwise.
5. Reinstall bulb holder in lamp assembly and reconnect harness connector.
6. Reinstall panel to underside of vehicle using 2 screws removed earlier.



S 13527

Side repeater lamps

1. Using a suitable screwdriver, pry lamp assembly away from wing.
2. Rotate bulb holder anti-clockwise.
3. Remove bulb from lamp assembly by pulling bulb straight out of bulb holder.
4. Install new bulb into bulb holder by pressing it in and rotating the bulb holder clockwise.
5. Push lamp assembly back into aperture.



S 13528

Rear brake, tail, turn signal, reverse lamps and fog tail lamp

1. Open the tailgate and remove 2 screws and lamp assembly.
2. Remove bulb holder by rotating it anti-clockwise.
3. Remove bulb from bulb holder by pressing the bulb in and rotating it anti-clockwise.
4. Install new bulb into bulb holder.
5. Reinstall bulb holder into lamp assembly. Rotate bulb holder clockwise and ensure it is secure.

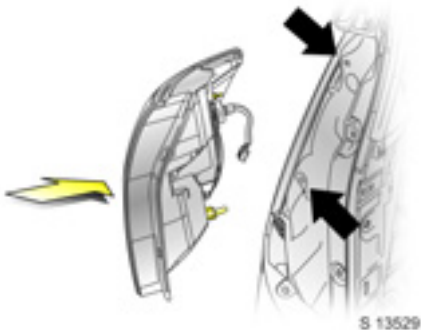

6. Replace lamp assembly by guiding lugs on lamp assembly into their holes (see black arrows in illustration).
7. Replace 2 screws removed earlier and close the tailgate.

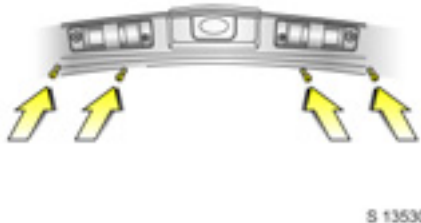

License plate lamps

1. Remove 4 screws (arrowed) and remove lamp covers.
2. Remove bulb holder from lamp assembly by rotating it anti-clockwise.
3. Pull bulb straight out of bulb holder.
4. Install new bulb.
5. Reinstall bulb holder into lamp assembly, rotate bulb holder clockwise and ensure it is secure.
6. Replace lamp covers using 4 screws removed earlier.

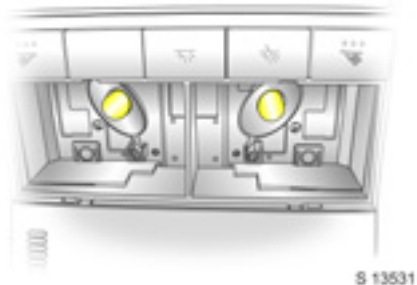

Front reading lamps

1. Using a suitable screwdriver, pry lamp lens away from roof lining.
2. Remove bulb.
3. Install new bulb.
4. Reinstall lamp lens in roof lining.

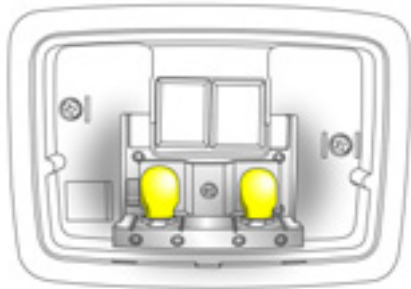

S 13532

Rear interior lamps

1. Using a suitable screwdriver, pry lamp lens away from roof lining.
2. Remove bulb.
3. Install new bulb.
4. Reinstall lamp lens in roof lining.



S 13533

Luggage compartment lamps ❄

1. Using a suitable screwdriver, remove lens from lamp assembly.
2. Remove bulb.
3. Install new bulb.
4. Reinstall lens to lamp assembly.



S 13535

Front door lamps

1. Using a suitable screwdriver, pry lamp lens away from front door trim.
2. Remove bulb.
3. Install new bulb.
4. Reinstall lamp lens to front door trim.

Centre high-mounted stop lamp, instrument panel and glove compartment illumination

We recommend having bulb replacements carried out by a workshop.

Opel genuine parts and accessories

We recommend the use of “Opel genuine parts and accessories” and conversion parts released expressly for your vehicle type. These parts have undergone special tests to establish their reliability, safety and specific suitability for your vehicle. Despite continuous market monitoring, we cannot assess or guarantee these attributes for other products, even if they have been granted approval by the relevant authorities or in some other form.

“Opel genuine parts and accessories” and conversion parts approved by Opel can be obtained from your Opel Partner, who can provide comprehensive advice about permitted technical changes and ensure that the part is installed correctly.



S 11814

A note on safety

To avoid the possibility of injury, only carry out engine compartment checks (e.g. checking the brake fluid level or the engine oil level) when the ignition is switched off.

Warning

The cooling fan may be operated by a thermostich and can therefore start to operate unexpectedly, even when the ignition is switched off; risk of injury.

Electronic ignition systems generate very high voltages. Do not touch the ignition system; high voltage can be fatal.

Never carry out any repairs or adjustment and maintenance work on the vehicle yourself. This especially applies to the engine, chassis and safety parts. You may, out of ignorance, infringe the provisions of the law and, by not performing the work properly, you may endanger yourself and other road users.

Checking and topping up fluids

To aid identification, the engine oil filler cap, the coolant filler cap, the lid of the fluid container for the windscreen washer system and the handle of the engine oil gauge (dipstick) may be coloured yellow.

Engine oil

Information on engine oils - see page 213.

Engine oil level and consumption

It is normal for every engine to consume some oil, and it is sometimes necessary to check and top up the engine oil level between oil changes.

Warning

Do not allow the engine oil level to drop below the minimum level.

For this reason, the engine oil level should be checked every 500 km (300 miles) or before starting a long trip.



The illustrations show checking and replenishing the engine oil in the Z 24, Z 32 petrol engines and the Z 20 diesel engines respectively.

To check the level, remove dipstick from the dipstick tube, wipe it clean and re-insert it as far as it will go. After pulling the dipstick out again, check the oil level, ensuring it is between the lower and upper (or **MIN** and **MAX**) marks.

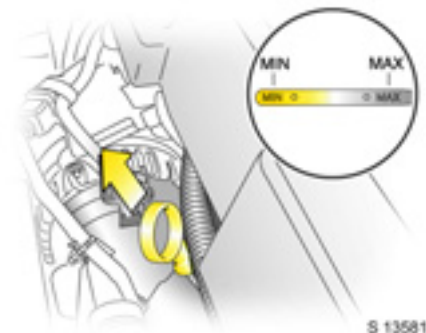

Engine oil level check and topping up

The engine oil level must be checked with the vehicle horizontal and with the engine (which must be at operating temperature) switched off. Wait a few minutes before checking the level to allow the normal oil accumulation in the engine to drain back into the oil pan.

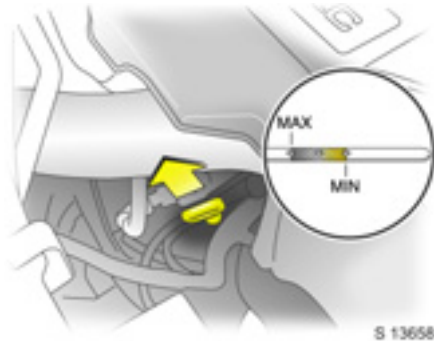

S 13658

Top up if the engine oil level has dropped to the "add oil" lower mark (or **MIN** mark). The oil level must not go above the upper (or **MAX**) mark on the dipstick. This would lead, for example, to increased oil consumption, excessive formation of carbon residue and a possible risk of damage to the catalytic converter or the engine.

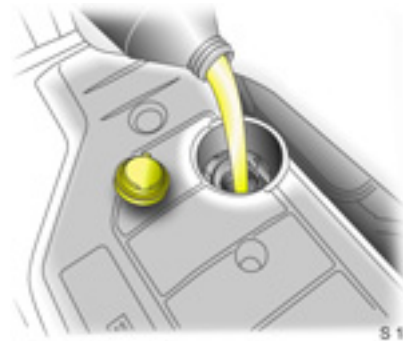

S 13660

When replenishing, attempt to use the same type of engine oil as used at the last oil change.

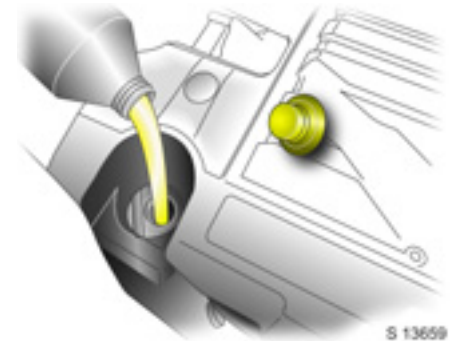

S 13659

Capacities - see page 225.

A stabilization of the engine oil consumption will not take place until the vehicle has been driven several thousand kilometres/miles. Only then can the actual degree of oil consumption be established.

If oil consumption exceeds more than 0.6 litres every 1000 km (600 miles) after this running-in period, consult a workshop.



Engine oil change, oil filter change

Engine oil changes are to be carried out depending on time intervals or kilometre/mileage intervals, since oil loses its lubrication properties not only through engine operation but also through ageing.

We recommend that you use genuine Opel oil filters.

⚠ Warning

Used engine oil filters and empty oil containers should not be disposed of as domestic refuse. We recommend that you entrust oil and oil filter changes to a workshop who is familiar with legal requirements regarding disposal of used oil and can thus help to protect both the environment and your health.

Engine oil is a danger to health; avoid prolonged contact with skin and wash exposed areas thoroughly.

Remember to reset the engine oil life monitor * whenever the engine oil is changed.

Engine oil life monitor *

The engine oil life monitor lets you know when to change the oil. Based on driving conditions, the kilometre/mileage interval at which an oil change will be indicated can vary considerably.

For the system to work properly, it must be reset every time the oil is changed. Consult a workshop.

When the system has calculated that oil life has been diminished, control indicator  illuminates in the instrument panel - see page 73. Engine oil needs changing within approx. 1000 km (600 miles). Engine power may be decreased.



Diesel fuel filter

Drain diesel fuel filter of residual water at every engine oil change.

Place a container underneath the filter housing. Turn drain plug, located on the left of the filter housing, anti-clockwise using a suitable screwdriver, to drain off the water.

The filter is drained as soon as diesel fuel emerges from the port. Retighten the drain plug by turning it clockwise.

With engine switched off, turn ignition key to ON, wait approx. 5 seconds, and turn key to LOCK to perform priming operation. Perform this operation 3 times or more while the engine is switched off, to avoid air entering the fuel line.

Check diesel fuel filter at shorter intervals if the vehicle is subjected to extreme operating conditions such as high humidity (primarily in coastal areas), extremely high or low outside temperatures and substantially varying daytime and night-time temperatures.

If there is water in the diesel fuel filter, control indicator  illuminates in the instrument panel - see page 73. Drain the water immediately.

Coolant

During operation, the system is pressurized. The temperature may therefore rise to over 100 °C.

The antifreeze provides excellent corrosion protection for the cooling and heating system, as well as freeze protection down to -28 °C.

Certain types of antifreeze can lead to engine damage. We therefore strongly recommend the use of antifreeze that has been approved by Opel.

Warning

Antifreeze is a danger to health: it must therefore be kept in the original container and out of the reach of children.

Antifreeze and corrosion protection

Before the start of the cold weather season, have the coolant checked for correct concentration by a workshop. The amount of antifreeze must provide protection down to approx. -28 °C. If the antifreeze concentration is too low, this reduces protection from freezing and corrosion. Top up antifreeze if necessary.

If coolant loss is topped up with demineralised water, have antifreeze concentration checked and more antifreeze added as necessary.

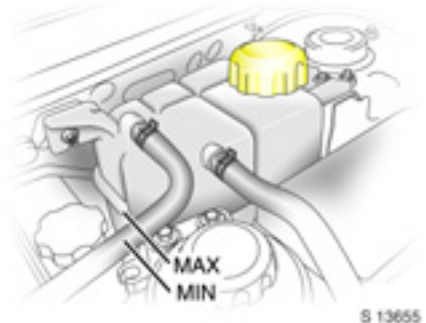

Coolant level

Hardly any losses occur since the cooling system is sealed and it is thus rarely necessary to top up the coolant.

The coolant level in the expansion tank should be between the **MIN** and **MAX** marks when the system is cold.

Warning

Allow engine to cool down before removing coolant filler cap. If steam is visible, move away from the vehicle until the engine is cool.

Remove coolant filler cap carefully so that pressure can escape slowly, otherwise there is a risk of scalding.

When the engine is at operating temperature, coolant level rises. It falls again when the system cools. If it falls below the **MIN** mark when the system is cold, the coolant must be replenished.

Top up antifreeze. If no antifreeze is available, top up with clean tap water. If tap water is unavailable, distilled water can be used.

When you top up with tap water or distilled water, add concentrated antifreeze and possibly mix in antifreeze as well. Have the cause of the coolant loss eliminated by a workshop.

Too low a coolant level can cause engine damage.

When closing, tighten coolant filler cap as far as it will go.

Coolant temperature

Control indicator  illuminates when coolant temperature is too high. Check coolant level:

- Coolant level low:
Top up coolant. Pay attention to the instructions given under "Antifreeze and corrosion protection" and "Coolant level". Have the cause of the coolant loss remedied by a workshop.
- Coolant level OK:
Have the cause of increased coolant temperature remedied by a workshop.

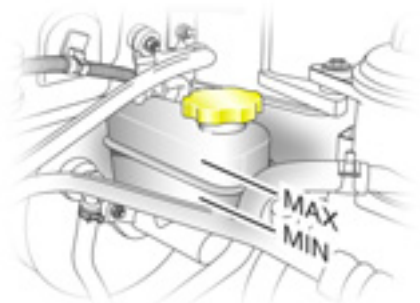

S 13652

Brake fluid

Brake fluid level

Warning

Caution - brake fluid is poisonous and corrosive. Do not allow it to contact eyes, skin, fabrics or painted surfaces; direct contact may cause injuries and damage.

The brake fluid level in the reservoir must not be higher than the **MAX** mark or lower than the **MIN** mark.

Do not overfill the brake fluid reservoir, as this may cause an engine fire due to fluid burning; risk of injury and damage to the vehicle.

Use of some brake fluids could cause damage or impair braking effectiveness. Stay well informed. We recommend that you use Opel-approved high performance brake fluid.

Extreme cleanliness is important, since brake fluid contamination can lead to brake system malfunctions.

If brake fluid level is too low, brake system control indicator  illuminates in the instrument panel - see page 70.

After correcting the brake fluid level, have the cause of the loss remedied by a workshop.

Brake fluid change

As brake fluid is hygroscopic, it absorbs water. Vapour bubbles which impair the braking effect may occur during braking.

The fluid change intervals specified on pages 206 to 212 must therefore be observed.

 Warning
We recommend that you have brake fluid changed by a workshop, who will be familiar with the requirements of the law as regards disposal of brake fluid and can thus help to protect the environment and your health.

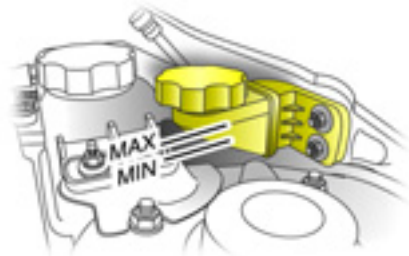

S 13731

Clutch fluid ❄

The clutch fluid does not require any additional maintenance than that detailed on pages 206 to 212.

If the fluid in the reservoir falls below the **MIN** mark, consult a workshop.

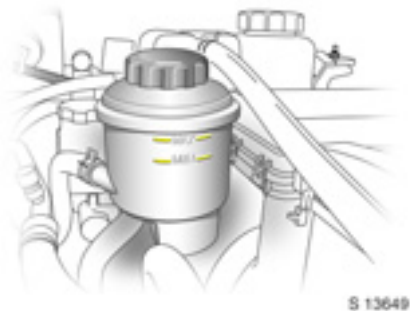

S 13649

Power steering fluid

The power steering fluid does not require any additional maintenance than that detailed on pages 206 to 212.

If the fluid in the reservoir falls below the **MIN** mark, consult a workshop.

Windscreen wipers

Clear vision is essential for safe driving.

Perform regular checks on the wipers to ensure they are operating correctly. We recommend wiper blade replacement at least once a year.

If the windscreen is dirty, operate the windscreen washer system before switching on the wipers or setting the wipers to automatic operation with the rain sensor ❄️. This will avoid wiper blade wear.

Do not switch on the windscreen wipers if the windscreen is dry or obstructed (e.g. with snow or ice), as this could damage the glass, the wiper blades, or the wiper system.

If the wipers become frozen on to the glass, we recommend that they be released with the aid of Opel De-icer Spray.

Smearing wiper blades can be cleaned with a soft cloth and Opel Cleaning Solvent and Antifreeze.

Wiper blades whose lips have become hardened, cracked or covered with silicone must be replaced. This may be necessary as a result of the effects of ice, thawing salt or heat, or the incorrect use of cleaning agents.

Switch off the wipers in car washes – see pages 92 and 202.

Wiper care – see page 205.



17498 T

To ensure proper operation of the rain sensor ❄️, the sensor area must be free from dust, dirt and ice, which is why the windscreen washer system must be operated at regular intervals and the sensor area de-iced. Vehicles with rain sensor can be identified by the sensor area near the top of the windscreen.

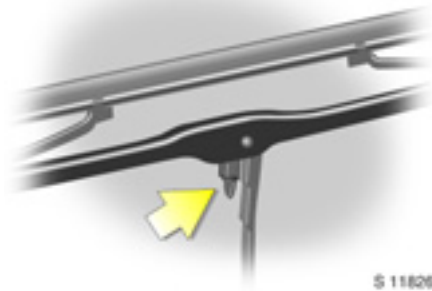

S 11826

Replacing windscreen wipers

Lift wiper arm, press and hold retaining clip and detach wiper blade.

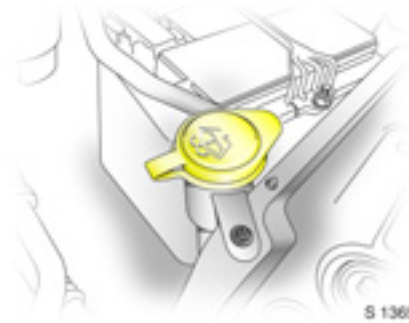

S 13650

Windscreen washer system

Do not spray washer fluid onto windscreen in freezing weather, to avoid ice forming and impairing vision.

The filler opening of the fluid container for the windscreen washer system is located in the front of the engine compartment.

Fill only with commercially available, ready-to-use windscreen washer fluid.

Do not use tap water, as minerals will cause clogging in the system.

In cold weather, do not fill the windscreen washer fluid reservoir more than three-quarters full, to allow enough room for expansion if the fluid freezes, and to prevent damage to the reservoir.

In freezing conditions, use windscreen washer fluid with sufficient antifreezing properties. Do not use coolant antifreeze or tap water, to avoid freezing the solution and damaging the windscreen washer system.

When closing the container, press the lid down firmly all the way round.

If the fluid in the windscreen washer fluid reservoir is too low, control indicator  illuminates in the instrument panel - see page 73. Top up washer fluid as soon as possible.



S 13651

Battery

The battery is maintenance-free.

Warning

We recommend that you have battery changes carried out by a workshop who knows the laws concerning the disposal of used batteries, therefore protecting the environment and your health.

Retrofitted electrical or electronic accessories can place an additional load on the battery or discharge the battery. Consult a workshop regarding technical possibilities, such as fitting a more powerful battery.

Laying up the vehicle for more than 6 weeks can lead to battery discharge, which may reduce the service life of the battery. Disconnect battery from on-board power supply by detaching negative terminal (anti-theft alarm system * is then disabled).

Ensure that ignition is switched off before connecting the battery. Then perform the following actions:

- Set date and time in the information display - see pages 80, 86.
- If necessary, activate the electric windows and sun roof * - see pages 32, 34.

In order to prevent the battery from discharging, some consumers such as the courtesy lamps automatically switch off after a delay.

Warning

Ensure there is adequate ventilation when charging the battery. There is a risk of explosion if gases generated during charging are allowed to accumulate.

Battery acid is poisonous and corrosive. Do not allow it to contact eyes, skin, fabrics or painted surfaces; direct contact may cause injuries and damage.

Avoid dealing with the battery near naked flames and anything that would generate sparks. No smoking!

Charge a disconnected battery every 6 weeks.



S 11814

Protection of electronic components

In order to avoid the breakdown of electronic components within the electrical system, never disconnect the battery with the engine running. Never start the engine while the battery is disconnected (e.g. when using jump leads).

To avoid damaging the vehicle, do not make any modifications to the electrical system, e.g. connecting additional consumers or tampering with electronic control units (chip tuning).

Warning

Electronic ignition systems generate very high voltages. Do not touch the ignition system; high voltage can be fatal.

Disconnecting/connecting the battery from/to the electrical system

Disconnect the battery from the vehicle electrical system before charging: first detach the negative and then the positive lead.

Do not reverse the polarity of the battery, i.e. do not confuse the terminals for the positive and negative leads. When connecting, start with the positive lead and then connect the negative lead.

Vehicle storage

If your vehicle is to be stored for long periods without use, we recommend you consult a workshop for advice.

Vehicle care

In caring for your vehicle, observe all national environmental regulations, particularly when washing your vehicle.

Regular, thorough care contributes to improving the appearance of your vehicle and maintaining its value. It is also a prerequisite for claims made under the warranty, in the event of paint or corrosion damage. In the following pages, we give you tips for vehicle care which, with correct use, will help to ward off unavoidable and harmful environmental influences.

Vehicle care aids *

Vehicle wash:

- Car Shampoo
- Sponges
- Chamois Leather
- Wheel Cleaners
- Engine Cleaners
- Glass Cleaners

Exterior care:

- Touch-up Applicator
- Spray and Touch-up Paint
- Car Polishes/Colour Restorers
- Car Waxes/Sealers
- Alloy Wheel Cleaner
- Alloy Wheel Preserver
- Metallic Paintwork Wax
- Rust Preventative
- Lubricant Sprays
- Lock Cylinder Grease
- De-icer Sprays
- Tar Removal Spray
- Insect Remover
- Window Cleaning Spray
- Cleaning Solvent and Antifreeze

Interior care:

- Interior/Upholstery Cleaner

Washing

The paintwork of your vehicle is exposed to environmental influences, e.g. continuous changes in weather conditions, industrial waste gases and dust or thawing salts, so wash and wax your vehicle regularly. When using automatic car washes, select a program which includes waxing.

Bird droppings, dead insects, resin, pollen and the like should be cleaned off immediately, as they contain aggressive constituents which can cause paint damage.

If using a car wash, comply with the pertinent instructions of the car wash manufacturer. The windscreen wipers and tailgate wipers must be switched off – see pages 92, 93. Remove detachable rod antenna by unscrewing it.

Do not use high-pressure jet cleaners.

If you wash your vehicle by hand, make sure that the insides of the wings are also thoroughly rinsed out. Do not use household dishwashing liquid, to avoid removing wax from the paintwork.

Clean edges and folds on opened doors and flaps as well as the areas they cover.

Thoroughly rinse off and leather-off the vehicle. Rinse leather frequently. Use separate leathers for paint and window surfaces; remnants of wax on the windows will impair vision.

Also wash aluminium trim parts, avoiding the use of abrasive materials such as automotive or chrome polish, steam or caustic soap. Washing with water is normally sufficient.

Observe national regulations.

Waxing

Wax your vehicle regularly, in particular after it has been washed using Car Shampoo and at the latest when water no longer forms beads on the paintwork, otherwise the paintwork will dry out.

Also wax aluminium trim parts, edges and folds on opened doors and flaps as well as the areas they cover.

Polishing

Polishing is necessary only if the paint has become dull or if solid deposits have become attached to it.

Paintwork polish with silicone forms a protective film, making waxing unnecessary.

Plastic body parts should not be treated with wax and polish.

Use Metallic Paintwork Wax on vehicles with a metallic-effect paint finish.

Wheels

Use a pH-neutral wheel cleaning agent to clean the wheels.

Avoid using abrasive materials and brushes that can damage the finish.

Wheels are painted and can be treated with the same agents as the body. For alloy wheels, we recommend the use of Alloy Wheel Preserver.

Paintwork damage

Repair small areas of paint damage such as stone impacts, scratches etc. immediately, using an Opel Touch-up Applicator or Opel Spray and Touch-up Paint before rust can form. If rust has already formed, have the cause remedied by a workshop. Please also pay attention to surfaces and edges beneath the vehicle where rust may have formed unnoticed for some time.

Tar spots

Tar spots must not be removed with hard objects, but instead immediately cleaned off with Tar Removal Spray. Do not use Tar Removal Spray on headlamp and other exterior lamp bezels.

Exterior lamps

Headlamp and other protective lamp bezels are made of plastic. If they require additional cleaning after the vehicle has been washed, clean them with Car Shampoo. Do not use any abrasive or caustic agents, do not use an ice scraper, and do not clean them dry.

Plastic and rubber parts

For additional cleaning of plastic and rubber parts, use a cleaner suitable for vehicle interiors. Do not use any other agent, and in particular do not use solvents or petrol.

Wheels and tyres

Do not use high-pressure jet cleaners on wheels and tyres.

Interior and upholstery

Clean the vehicle interior regularly, including the instrument panel fascia, using Interior/Upholstery Cleaner.

Clean fabric upholstery with a vacuum cleaner and brush. To remove stains, use a cleaner that is suitable for both fabrics and vinyl.

Open Velcro fasteners on clothing could damage seat upholstery. Make sure that Velcro fasteners are closed.

Do not use cleaning agents such as acetone, carbon tetrachloride, paint thinner, paint remover, nail varnish remover, washing powder or bleach to clean fabrics, carpets, the instrument panel or leather trim * in the vehicle interior. Benzine, petrol, naphtha, enamel reducers and lacquer thinners are also unsuitable.

Avoid over-exposure to vapours from cleaning agents and other chemicals when cleaning. Whenever possible, avoid using such cleaning agents in small, unventilated spaces, to avoid inhalation of dangerous vapours. Open the doors.

If the front seats are equipped with side airbags *, do not use chemical solvents or strong detergents on the seat covers.

Do not saturate the seat covers with Interior/Upholstery Cleaner, to avoid contaminating the airbag system, otherwise the side airbags * may not trigger in the event of a collision.

Seat belts

Always keep seat belts clean and dry.

Clean seat belts only with lukewarm water or Interior/Upholstery Cleaner.

Periodically check the seat belts and replace immediately with new seat belts if damage or weakening of the belts has occurred.

Windows

When cleaning the heated rear window, make sure that the heating element on the inside of the window is not damaged. Never place stickers on the inside of the rear window.

Use a soft, lint-free cloth or chamois leather, in conjunction with Window Cleaning Spray and Insect Remover. Do not use sharp instruments or abrasive cleaners.

Opel Cleaning Solvent and Antifreeze is suitable for de-icing windows.

For mechanical removal of ice, use a commercially available sharp-edged ice scraper. Press the scraper firmly against the glass so that no dirt can get under it and scratch the glass.

Windscreen wiper blades

Wax, such as that used in car washes, can cause streaks to form on the windscreen when the wipers are used.

Smearing wiper blades can be cleaned with a soft cloth and Opel Cleaning Solvent and Antifreeze, and replaced if necessary – see page 198. Do not use abrasive cleaners.

Locks

The locks are lubricated with a high-grade lock cylinder grease at the factory. Opel Lock Cylinder Grease prevents the locks from freezing up.

Only use de-icing agents in emergencies, as they have a degreasing effect and will impair the function of the locks. After using a de-icing agent, have the locks re-greased by a workshop.

Engine compartment

Areas of the engine compartment that are painted in the same colour as the vehicle must be looked after like any other painted surface.

It is advisable to wash the engine compartment before and after winter and preserve it with wax. Cover alternator and fluid reservoirs with plastic sheets before washing the engine.

When washing the engine with a steam-jet cleaner, do not direct the steam-jet at components of the Anti-lock Brake System (ABS), the air conditioning system or the belt drive and its components.

Protective wax that has been applied is also removed during the engine wash. For this reason, have the engine, brake system components in the engine compartment, axle components with steering, body parts and cavities thoroughly preserved with protective wax after the wash.

An engine wash can be performed in the spring in order to remove dirt that has adhered to the engine compartment, which may also have a high salt content. Check protective wax layer and make good if necessary.

Underbody

Your vehicle has a factory-applied PVC undercoating in the wheel arches (including the longitudinal members) which provides permanent protection and needs no special maintenance. The surfaces of the vehicle underbody not covered by PVC are provided with a durable protective wax coating in critical areas.

On vehicles which are washed frequently in automatic car washes with underbody washing facility, the protective wax coating may be impaired by dirt-dissolving additives. Check the underbody after washing and have it waxed if necessary. Before the start of the cold weather season, check the PVC coating and protective wax coating and, if necessary, have them restored to perfect condition.

Caution – commercially available bitumen/ rubber materials can damage the PVC coating. We recommend that you have underbody work carried out by a workshop, who knows the prescribed materials and has experience in the use thereof.

The underbody should be washed following the end of the cold weather season to remove any dirt adhering to the underbody since this may also contain salt. Check protective wax coating and, if necessary, have it restored to perfect condition.

Service, maintenance

European service schedule	207
International service schedule.....	209
Additional servicing.....	213
Recommended fluids and lubricants	213

European service intervals

Engine oil change - Z 24 XE only
Due every 15,000 km (10,000 miles).

Main Service

Due every 30,000 km (20,000 miles) or 1 year, whichever occurs first.

International service intervals

Interim Service - except Z 24 XE

Due every 15,000 km (10,000 miles).

Main Service - except Z 24 XE

Due every 30,000 km (20,000 miles) or 1 year, whichever occurs first.

Interim Service - Z 24 XE only

Due every 10,000 km (6,500 miles) or 6 months, whichever occurs first.

Main Service - Z 24 XE only

Due every 20,000 km (13,000 miles) or 1 year, whichever occurs first.

Confirmations

Confirmation of Service is recorded in the spaces provided in the Service and Warranty Booklet. The date and kilometre/mileage reading is completed with the stamp and signature of the Servicing Workshop.

Make sure that the Service and Warranty Booklet is completed correctly as continuous proof of service is essential if any warranty or goodwill claims are to be met, and is also a benefit when you come to sell the vehicle.

Service plan

The European service schedule is valid for the following countries:

Andorra, Austria, Belgium, Cyprus, Czech Republic, Denmark, Estonia, Finland, France, Germany, Greece, Greenland, Hungary, Iceland, Ireland, Italy, Latvia, Lithuania, Luxembourg, Malta, The Netherlands, Norway, Poland, Portugal, Slovakia, Slovenia, Spain, Sweden, Switzerland, United Kingdom.

For all remaining countries the International service schedule applies.

European service schedule

(Antara Z 20 DM, Z 20 DMH, Z 24 XE, Z 32 SE)

Service operations	by year ¹⁾						
	15	1	2	3	4	5	6
	km (x 1000) ¹⁾	30	60	90	120	150	180
miles (x 1000) ¹⁾	10	20	40	60	90	120	150
Controls, lighting, signalling equipment and airbags: visual check steering lock and ignition lock: check		x		x			x
Remote control batteries: replace	Every 2 years						
Windscreen wipers, windscreen washer system: check, correct		x		x			x
Coolant level and antifreeze: check, correct Hoses: check for tightness and secure seating		x		x			x
Brake fluid level: check, correct		x		x			x
Battery terminals: check for secure connections and battery eye		x		x			x
Vehicle system check with TECH2		x		x			x
Pollen filter: replace		x		x			x
● More often for when dust, sand or pollen is in the air	Agreement with customer						
Air cleaner element: replace		x		x			x
⊕ Spark plugs and plug leads: replace	Every 90 000 km/60 000 miles						
Ribbed V-belt: visual check		x		x			x
⊕ Toothed belt and tension roller: visual check		x		x			x
Toothed belt and tension roller: replace - Z 24 XE	Every 8 years/120 000 km/80 000 miles						
Toothed belt and tension roller: replace - Z 20 DM, Z 20 DMH	Every 6 years/90 000 km/60 000 miles						
Power steering system: check for leaks. Fluid level: check, correct		x		x			x
Engine oil and oil filter: replace - fixed interval Z 24 XE ²⁾	x	x	x	x	x	x	x
Z 20 DM, Z 20 DMH, Z 32 SE, except ²⁾		x		x			x

1) Whichever occurs first.

2) On vehicles with oil life monitoring, it may be necessary to change the engine oil earlier (control indicator illuminates).

208 Service, maintenance

Service operations	by year ¹⁾	1	2	3			
	km (x 1000) ¹⁾	15	30	45	60	75	90
	miles (x 1000) ¹⁾	10	20	30	40	50	60
⊕ Diesel fuel filter: drain water ● (If relative humidity is high and/or fuel is of lower quality)		Annually					
Fuel filter: replace and drain water - diesel (grade EN 590)		Every 2 years/60 000 km/40 000 miles					
Parking brake: check and adjust Wheel mounting and suspension front and rear, brake lines, brake pressure hoses, fuel lines and exhaust system: visual check		x		x			x
Corrosion protection: check and record in Service and Warranty Booklet		Annually					
Front and rear wheel brakes: check visually		x		x			x
●⊕ Annual service check if annual mileage exceeds 20 000 km		Annually					
Engine, transmission, PTO, rear differential, A/C compressor: check for leaks		x		x			x
Steering system boots, track rods, final drive: visual check		x		x			x
Track rod end and supporting ball joint: check		x		x			x
⊕ Brake and clutch fluid: change		Every 2 years					
Wheel fastening: loosen and tighten to torque Tyre condition and pressures: check, correct		x		x			x
⊕ Annual service check if annual mileage exceeds 20 000 km		Annually					
First aid kit, tyre repair kit and lashing eyes: visual check		Every 2 years					
Headlamp aiming: check, adjust		x		x			x
Door hinges, door stop, lock cylinder, lock striker, bonnet catch, tailgate hinges and check links: lubricate		x		x			x
Test drive, final check Service interval display and oil life monitor: reset - if applicable		x		x			x

1) Whichever occurs first.

⊕ Additional operations.

● Under extreme operating conditions and if required by country-specific conditions, the intervals are reduced.

International service schedule

(All except Z 24 XE)

Service operations	by year ¹⁾	1	2	3	4	5
	km (x 1000) ¹⁾	15	30	45	60	75
	miles (x 1000) ¹⁾	10	20	30	40	50
Controls, lighting, signalling equipment and airbags: visual check steering lock and ignition lock: check		x	x	x	x	x
Remote control batteries: replace		Every 2 years				
Windscreen wipers, windscreen washer system: check, correct		x	x	x	x	x
Coolant level and antifreeze: check, correct Hoses: check for tightness and secure seating		Annually				
Brake fluid level: check, correct			x			x
Battery terminals: check for secure connections and battery eye		Annually				
Vehicle system check with TECH2		Annually				
Pollen filter: replace			x		x	x
● More often for when dust, sand or pollen is in the air		Annually/15 000 km/10 000 miles				
Air cleaner element: replace			x		x	x
● More often for when dust or sand is in the air		Annually/15 000 km/10 000 miles				
⊕ Spark plugs and plug leads: replace		Every 90 000 km/60 000 miles				
Ribbed V-belt: visual check			x		x	x
⊕ Toothed belt and tension roller: visual check		Annually/15 000 km/10 000 miles				
Toothed belt and tension roller: replace - Z 20 DM, Z 20 DMH		Every 6 years/90 000 km/60 000 miles				
Power steering system: check for leaks. Fluid level: check, correct		Annually				
Engine oil and oil filter: replace		x	x	x	x	x

¹⁾ Whichever occurs first.

210 Service, maintenance

Service operations	by year ¹⁾						
	15	1	45	2	75	3	
km (x 1000) ¹⁾	15	30	45	60	75	90	
miles (x 1000) ¹⁾	10	20	30	40	50	60	
⊕ Diesel fuel filter: drain water ● (If relative humidity is high and/or fuel is of lower quality)	Annually						
Fuel filter: replace and drain water - diesel (grade EN 590)	Every 2 years/60 000 km/40 000 miles						
Parking brake: check and adjust Wheel mounting and suspension front and rear, brake lines, brake pressure hoses, fuel lines and exhaust system: visual check	Every 2 years/60 000 km/40 000 miles						
Corrosion protection: check and record in Service and Warranty Booklet	Annually						
Front and rear wheel brakes: check visually	Every 2 years/60 000 km/40 000 miles						
●⊕ Annual service check if annual mileage exceeds 20 000 km	Annually						
●⊕ Automatic transmission oil: change	Every 4 years/60 000 km/40 000 miles						
Engine, transmission, A/C compressor: check for leaks	Annually						
Steering system boots, track rods, final drive: visual check	Annually						
Track rod end and supporting ball joint: check	Annually						
⊕ Brake and clutch fluid: change	Every 2 years						
Wheel fastening: loosen and tighten to torque Tyre condition and pressures: check, correct	Every 2 years/60 000 km/40 000 miles						
⊕ Annual service check if annual mileage exceeds 20 000 km	Annually						
First aid kit, tyre repair kit and lashing eyes: visual check	Every 2 years						
Headlamp aiming: check, adjust	Every 2 years/60 000 km/40 000 miles						
Door hinges, door stop, lock cylinder, lock striker, bonnet catch, tailgate hinges and check links: lubricate	Every 2 years/60 000 km/40 000 miles						
Test drive, final check Service interval display and oil life monitor: reset - if applicable	x	x	x	x	x	x	

¹⁾ Whichever occurs first.

⊕ Additional operations.

● Under extreme operating conditions and if required by country-specific conditions, the intervals are reduced.

International service schedule

(Antara Z 24 XE)

Service operations	by month ¹⁾	6	12	18	24	30	36
	km (x 1000) ¹⁾	10	20	30	40	50	60
	miles (x 1000) ¹⁾	6.5	13	20	26.5	33	40
Controls, lighting, signalling equipment and airbags: visual check steering lock and ignition lock: check			x		x		x
Remote control batteries: replace	Every 2 years						
Windscreen wipers, windscreen washer system: check, correct		x			x		x
Coolant level and antifreeze: check, correct Hoses: check for tightness and secure seating			x		x		x
Brake fluid level: check, correct			x		x		x
Battery terminals: check for secure connections and battery eye			x		x		x
Vehicle system check with TECH2			x		x		x
Pollen filter: replace	Annually/30 000 km/20 000 miles						
● More often for when dust, sand or pollen is in the air	Agreement with customer						
Air cleaner element: replace	Annually/30 000 km/20 000 miles						
⊕ Spark plugs and plug leads: replace	Every 90 000 km/60 000 miles						
Ribbed V-belt: visual check		x			x		x
⊕ Toothed belt and tension roller: visual check	Annually/30 000 km/20 000 miles						
Toothed belt and tension roller: replace	Every 8 years/120 000 km/80 000 miles						
Power steering system: check for leaks. Fluid level: check, correct			x		x		x
Engine oil and oil filter: replace - fixed interval ²⁾		x	x	x	x	x	x

¹⁾ Whichever occurs first.

²⁾ On vehicles with oil life monitoring, it may be necessary to change the engine oil earlier (control indicator illuminates).

212 Service, maintenance

Service operations	by month ¹⁾	6	12	18	24	30	36
	km (x 1000) ¹⁾	10	20	30	40	50	60
	miles (x 1000) ¹⁾	6.5	13	20	26.5	33	40
Parking brake: check and adjust			x		x		x
Wheel mounting and suspension front and rear, brake lines, brake pressure hoses, fuel lines and exhaust system: visual check							
Corrosion protection: check and record in Service and Warranty Booklet		Annually					
Front and rear wheel brakes: check visually			x		x		x
Engine, transmission, PTO, rear differential, A/C compressor: check for leaks			x		x		x
Steering system boots, track rods, final drive: visual check			x		x		x
Track rod end and supporting ball joint: check			x		x		x
⊕ Brake and clutch fluid: change		Every 2 years					
Wheel fastening: loosen and tighten to torque Tyre condition and pressures: check, correct			x		x		x
First aid kit, tyre repair kit and lashing eyes: visual check		Every 2 years					
Headlamp aiming: check, adjust			x		x		x
Door hinges, door stop, lock cylinder, lock striker, bonnet catch, tailgate hinges and check links: lubricate			x		x		x
Test drive, final check Service interval display and oil life monitor: reset - if applicable			x		x		x

¹⁾ Whichever occurs first.

⊕ Additional operations.

● Under extreme operating conditions and if required by country-specific conditions, the intervals are reduced.

Additional servicing

Additional operations ⊕

Additional work is work that is not required every service but can be performed in conjunction with a regular service.

Time allowances for such work are not included in the scope of regular services and will be charged for additionally. It is more economic if these operations are performed as part of a scheduled service than having them performed separately.

Severe operating conditions ●

Operating conditions are classified as severe when one or more of the following occurs frequently:

- cold starts,
- stop and go,
- trailer/caravan towing,
- gradients and/or high altitudes,
- poor road surfaces,
- sand and dust,
- extreme temperature fluctuations.

Police vehicles, taxis and driving school vehicles are also classified as operating under severe conditions.

Under severe operating conditions, it may be necessary to have certain scheduled service work done more frequently than the scheduled intervals.

For example, if fuel is used that does not comply with required standards, the fuel filter may need more frequent draining or replacement and it may also be necessary to change other components more often (e.g. spark plugs).

It is recommended to seek technical advice on the servicing requirements dependent on the specific operating conditions of your vehicle.

Recommended fluids and lubricants

Only use products that have been tested and approved. Damage resulting from the use of non-approved materials will not be covered by the warranty.

Warning

Operating materials are hazardous and must be handled with the appropriate level of care. If consumed, seek medical attention immediately. Do not inhale fumes and avoid skin contact. Keep out of reach of children. Do not allow operating materials to contaminate the sewage system, surface water, ground water or soil. Dispose of empty containers properly. Always bear in mind that operating materials are hazardous to your health.

Checking and topping up fluids

see page 191.

Engine oil

Engine oil is identified by its quality and also its viscosity. Quality is more important than viscosity when selecting which engine oil to use.

Engine oil quality

European specifications

GM-LL-A-025:	Petrol engines
GM-LL-B-025:	Diesel engines without DPF
ACEA-C3	Diesel engines with DPF

GM	General Motors Europe
LL	Longlife
A or B	Engine oil quality specification
025	Validity index

Opel engine oil meets classifications GM-LL-A-025 and GM-LL-B-025 and is therefore suitable for both petrol and diesel engines.

International specifications

ACEA-A3:	Petrol engines
ACEA-B4:	Diesel engines without DPF
ACEA-C3:	Diesel engines with DPF

The above specification is valid only if the service interval is reduced to that shown for the international service schedule - see pages 209 to 212.

Topping up engine oil

Oils of different manufacturers and brands can be mixed as long as you comply with the specified engine oil criteria (quality and viscosity).

Not every engine oil available on the market meets the quality requirements, always check the required specification and rating is marked on the container.

If engine oil of the required quality is not available, a maximum of 1 litre of ACEA A3/B4 or A3/B3 grade may be used (only once between each oil change). The viscosity should be of the correct rating.

Use of ACEA A1/B1 and A5/B5 engine oil is expressly forbidden, since they can cause long-term engine damage under certain operating conditions.

Engine oil additives

The use of engine oil additives could cause damage and invalidate the warranty.

Engine oil viscosity

SAE 0W-30, 0W-40, 5W-30 or 5W-40

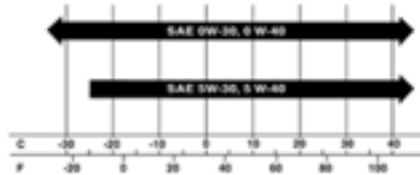

S 17639

The SAE viscosity rating defines the ability of an oil to flow. When cold, oil is more viscous than when hot.

Multigrade oil is indicated by two figures. The first figure, followed by a W, indicates low temperature viscosity and the second figure the high temperature viscosity.

Coolant and antifreeze

Use antifreeze of recommended specification: silicate-free LLC (Long Life Coolant).

The system is factory-filled with coolant designed for frost protection down to approx. -28 °C. This concentration should be maintained all year-round.

Coolant additives intended to give additional corrosion protection or seal against minor leaks can cause function problems. Liability for consequences resulting from the use of coolant additives will be rejected.

Brake and clutch fluid

Only use DOT4 brake fluid.

Warning

Brake fluid is poisonous!

Over time, brake fluid absorbs moisture which will reduce braking effectiveness. The brake fluid should therefore be replaced at the specified interval.

Brake fluid should be stored in a sealed container to avoid water absorption.

Ensure it does not become contaminated with fluids containing mineral oil (oil, petrol, cleaner) as this can damage the seals and sleeves of the brake system.

Warning

Due to its corrosive nature, it must not come in contact with the paintwork. Flush any escaped brake fluid with plenty of water.

Technical data

Vehicle documents, identification plate..... 215

Coolant, brake fluid, oils..... 216

Engine data..... 217

Performance..... 218

Fuel consumption, CO₂ emissions 219

Weights, payload and roof load 221

Tyres 223

Electrical system 225

Capacities 225

Dimensions 226

Mounting dimensions of caravan/trailer towing equipment..... 227

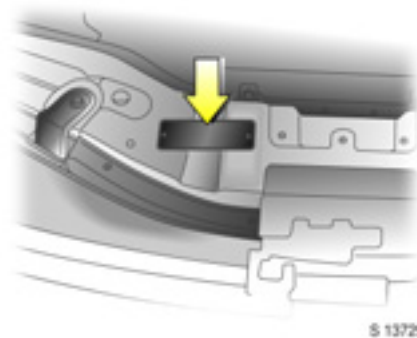

Vehicle documents, identification plate

The technical data is determined in accordance with European Community standards. We reserve the right to make modifications. Specifications in the vehicle documents always have priority over those given in this manual.

The Vehicle Identification Number (VIN) is on the vehicle identification plate, attached to the top of the front panel support, visible when the bonnet is open.

The vehicle identification plate may also list, in kilograms, the Gross Vehicle Weight (GVW), the Gross Train Weight (GTW) and the maximum front and rear axle loads respectively. Observe these limits when using the full load or towing capacity of your vehicle.

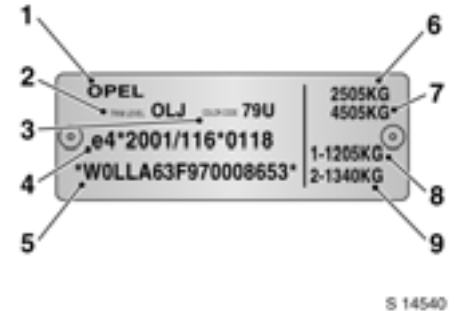

Information on identification plate¹⁾:

- 1 Manufacturer
- 2 Trim level
- 3 Colour code
- 4 Type approval number
- 5 Vehicle Identification Number
- 6 Permissible Gross Vehicle Weight
- 7 Permissible Gross Train Weight
- 8 Maximum permissible front axle load
- 9 Maximum permissible rear axle load

¹⁾ The VIN plate on your vehicle may differ from the illustration shown.

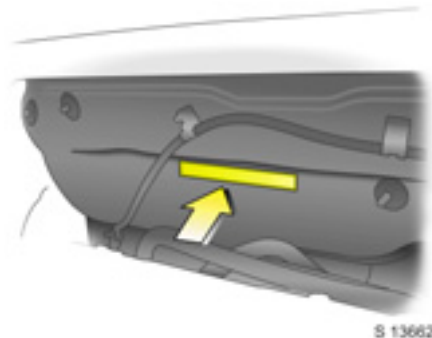

The Vehicle Identification Number (VIN) is also engraved on the top right-hand side of the bulkhead near the centre of the engine firewall.

Engine identifier code and engine number: stamped on the cylinder block under the engine's exhaust manifold (petrol engines), or the intake manifold (diesel engines).

Coolant, brake fluid, oils

Use approved fluids only.

Use of unsuitable fluids could cause serious damage to the vehicle.

Engine oils

Information on engine oils is available on page 213.

Engine data

Sales designation	2.4 Petrol	3.2 V6 Petrol	2.0 Diesel	2.0 Diesel
Engine stamp	Z 24 SE	10 HM	Z 20 S	Z 20 S
Engine identifier code	Z 24 XE	Z 32 SE	Z 20 DMH	Z 20 DM
Number of cylinders	4	6	4	4
Bore dia. (mm)	87.5	89.0	83.0	83.0
Stroke (mm)	100.0	85.6	92.0	92.0
Piston displacement (cm ³)	2405	3195	1991	1991
Max. engine power (kW) at rpm	103 5200	167 6600	110 4000	93 4000
Torque (Nm) at rpm	220 2400	297 3200	320 2000	295 2000
Compression ratio	9.6	10.3	17.5	17.5
Fuel type	Petrol	Petrol	Diesel	Diesel
Cetane requirement (CN)	-	-	49 (D) ¹⁾	49 (D) ¹⁾
Octane requirement (RON) ²⁾ unleaded or unleaded	91 ³⁾⁴⁾ 95³⁾	91 ³⁾⁴⁾ 95³⁾	- -	- -
Max. permissible engine speed, continuous operation (rpm) approx.	6200	6700	4750 ⁵⁾ /4500 ⁶⁾	4750
Engine oil consumption (l/1000 km)	0.6	0.6	0.6	0.6

¹⁾ Standard high-quality fuels: D = Diesel.

²⁾ Standard high-quality fuels, e.g. unleaded DIN EN 228; value printed in bold: recommended fuel.

³⁾ Knock control system automatically adjusts ignition timing according to type of fuel used (octane number).

⁴⁾ Use of 91 RON fuel reduces power and torque. If no unleaded Premium fuel is available, 91 RON can be used, taking care to avoid high engine load or full load as well as driving in mountainous terrain with a caravan/trailer load or high payload.

⁵⁾ Manual transmission.

⁶⁾ Automatic transmission.

218 Technical data

Performance

(approx. km/h / mph)

Engine ¹⁾	Z 24 XE	Z 32 SE	Z 20 DMH	Z 20 DM
Maximum speed ²⁾				
Manual transmission	175/109	-	180/112	174/108
Automatic transmission	-	203/126	178/111	-

¹⁾ Sales designation - see page 217.

²⁾ The maximum speed indicated is achievable at kerb weight (without driver) plus 200 kg payload. Optional equipment could reduce the specified maximum speed of the vehicle.

Fuel consumption, CO₂ emissions

Directive 80/1268/EEC (last changed by 2004/3/EG) has applied for the measurement of fuel consumption since 1996.

The directive is oriented to actual driving practices: Urban driving is rated at approx. $\frac{1}{3}$ and extra-urban driving with approx. $\frac{2}{3}$ (urban and extra-urban consumption). Cold starts and acceleration phases are also taken into consideration.

The specification of CO₂ emission is also a constituent of the directive.

The figures given must not be taken as a guarantee for the actual fuel consumption of a particular vehicle.

All values are based on the EU base model with standard equipment.

The calculation of fuel consumption as specified by directive 2004/3/EG takes account of the vehicle's kerb weight, ascertained in accordance with these regulations. Optional extras may result in slightly higher fuel consumption and CO₂ emission levels than those quoted.

To convert l/100 km into mpg, divide 282 by number of litres/100 km.

Save fuel, protect the environment – see page 129.

220 Technical data

Fuel consumption (approx. l/100 km), CO₂ emission (approx. g/km)

Engine ¹⁾	Z 24 XE	Z 32 SE	Z 20 DMH	Z 20 DM
Manual transmission/Automatic transmission				
urban	13.3/-	- /16.4	8.7/10.9	8.8/-
extra-urban	7.3/ -	- / 8.9	6.8/ 7.3	6.7/-
total	9.6/ -	- /11.6	7.6/ 8.6	7.5/-
CO ₂	229/-	- /278	198/238	200/-

¹⁾ Sales designation – see page 217.

Weights, payload and roof load

The payload is the difference between the permissible Gross Vehicle Weight (see vehicle identification plate on page 215) and the EC kerb weight.

To calculate the EC kerb weight, enter the data from your vehicle below:

■ Kerb weight from page 222 + kg

■ Weight of heavy accessories + kg

The total = kg

is the EC kerb weight.

Optional equipment and accessories increase the kerb weight and in some cases also the permissible Gross Vehicle Weight, which means that the payload will also change slightly.

Note the weights given on the vehicle identification plate.

The combined total of front and rear axle loads must not exceed the permissible Gross Vehicle Weight. For example, if the front axle load is being fully utilized, the rear axle can only bear a load that is equal to the Gross Vehicle Weight minus the front axle load.

See the vehicle identification plate on page 215 or the vehicle documents for permissible axle loads.

Roof load

The maximum permissible roof load is 100 kg.

The roof load is the combined weight of the roof rack and the load.

Driving hints – page 127.

Roof racks, caravan and trailer towing - see page 153, 167.

222 Technical data

Weights (kg), Kerb weights

Model	Engine ¹⁾	Kerb weight ²⁾³⁾	
		Manual transmission	Automatic transmission
Enjoy/Edition	Z 24 XE	1805	-
	Z 32 SE	-	1845
	Z 20 DMH	1845	1865
	Z 20 DM	1845	-
Cosmo	Z 24 XE	1805	-
	Z 32 SE	-	1845
	Z 20 DMH	1845	1865
	Z 20 DM	1845	-

1) Sales designation - see page 217.

2) The Gross Train Weight (GTW), along with the Gross Vehicle Weight (GVW) are shown on the VIN plate - see page 215.

3) With driver (75kg) and all fluids (tank 90% full).

Tyres

Restrictions

Not all tyres available on the market currently meet the structural requirements. We recommend that you consult an Opel Partner concerning suitable tyre makes.

These tyres have undergone special tests to establish their reliability, safety and specific suitability for Opel vehicles.

Despite continuous market monitoring, we are unable to assess these attributes for other tyres, even if they have been granted approval by the relevant authorities or in some other form.

Further information - see page 149.

Winter tyres ❄

Tyres of size 235/55 R 18 are not to be used as winter tyres. Tyres of size 215/70 R 16, 235/60 R 17 and 235/65 R 17 may be used as winter tyres.

Use of the spare wheel may alter vehicle handling. Obtain a replacement for the faulty tyre as soon as possible, and have the wheel balanced and fitted to the vehicle.

Further information - see page 152.

Tyre chains

Restrictions

We recommend the use of Opel-tested fine-mesh tyre chains that add no more than 15 mm to the tyre tread and the inboard sides (including chain lock).

Tyre chains are permitted only on tyres of size 215/70 R 16. We recommend you consult your Opel Partner.

Further information - see page 152.

Wheels

Wheel nut tightening torque: 125 Nm.

Tyre pressures in kPa/bar

The tyre pressures given are valid for cold tyres. The increased tyre pressure resulting from extensive driving must not be reduced.

The tyre pressures specified apply to both summer and winter tyres.

Always inflate the spare wheel to the tyre pressure for full load.

Further information - see pages 149 to 153.

Engine ¹⁾	Tyres	Tyre pressure for load of up to 4 persons		Tyre pressure for full load	
		Front	Rear	Front	Rear
Z 24 XE, Z 20 DMH, Z 20 DM	215/70 R 16, 235/60 R 17, 235/65 R 17, 235/55 R 18	210/2.1	210/2.1	230/2.3	240/2.4
Z 32 SE	215/70 R 16 ²⁾ , 235/60 R 17, 235/65 R 17, 235/55 R 18	210/2.1	210/2.1	230/2.3	240/2.4
All	T 155/90 R 16 (temporary spare) ³⁾	410/4.1	410/4.1	410/4.1	410/4.1

¹⁾ Sales designation - see page 217.

²⁾ Only permitted as winter tyres.

³⁾ For notes on the temporary spare wheel - see pages 153, 178.

Electrical system

Engine ¹⁾		Z 24 XE	Z 32 SE	Z 20 DMH	Z 20 DM
Battery	Voltage	12 V	12 V	12 V	12 V
	Amp hours	60 Ah	70 Ah	90 Ah	90 Ah
Battery for radio frequency remote control		CR 2032 or equivalent	CR 2032 or equivalent	CR 2032 or equivalent	CR 2032 or equivalent

¹⁾ Sales designation - see page 217.

Capacities

(approx. in litres)

Engine ¹⁾	Z 24 XE	Z 32 SE	Z 20 DMH	Z 20 DM
Engine coolant	9.0	10.0	9.0	9.0
Fuel tank	65	65	65	65
Engine oil with filter change	4.7	7.4	6.2	6.2
Engine oil between MIN and MAX on dipstick	1.0	1.0	1.0	1.0
Washer fluid reservoir for windscreen and tailgate washer system	4.0	4.0	4.0	4.0
Washer fluid reservoir for windscreen, headlamp and tailgate washer system	6.7	6.7	6.7	6.7

¹⁾ Sales designation - see page 217.

Dimensions

Overall length (mm)	4576
Width (mm)	1850
Overall height with roof rails (mm)	1747
Wheelbase (mm)	2707
Track width (mm):	
Front	1562
Rear	1572
Turning circle diameter, wall to wall (m)	12.78
Maximum wading depth (mm) (at 5 km/h (3 mph))	450
Approach angle	24°
Ramp angle	17.6°
Departure angle	23°

Mounting dimensions of caravan/ trailer towing equipment

Dimension	mm
A	416
B	507
C	482
D	734
E	1039
F (fully laden)	353
G (at kerb weight)	446

Warning

Only use towing equipment approved for your vehicle. We recommend entrusting fitting of towing equipment at a later date to a workshop.

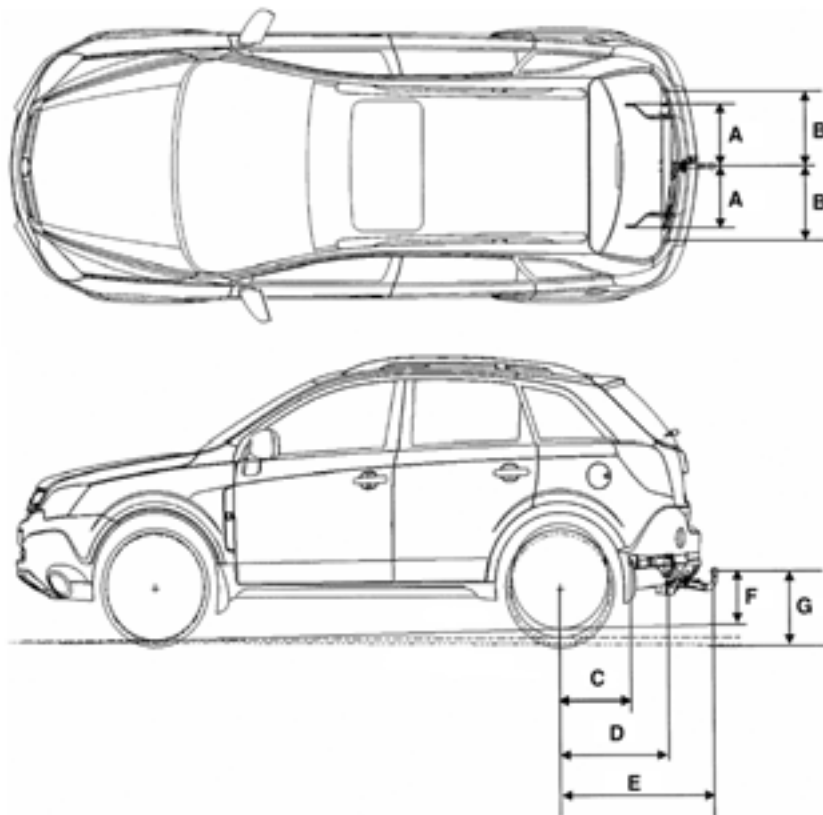

Index

A

ABS 148
 Accessories 45, 57, 69, 169, 191, 200
 Accessory sockets 69
 Active Rollover Protection (ARP) 138
 Air conditioning system 103, 109
 Air distribution 106
 Air intake 114
 Air quality sensor 112
 Air recirculation mode 109
 Air vents 104
 Airbags 42, 52, 54, 55
 Alarm 29
 Alarm system 27
 All Wheel Drive (AWD) 121
 Alternator 74
 Antenna 101, 202
 Antifreeze 195, 214
 Antifreeze protection 195, 199
 Anti-knock quality of fuel 131
 Octane number 217
 Anti-lock Brake System (ABS) 148
 Anti-theft alarm system 27
 Anti-theft locking system 27
 Towing equipment 166
 Approach lighting 94
 Aquaplaning 151
 Armrests 40, 42
 Ashtrays 67
 Illumination 100
 Assist grips 69
 Automatic air recirculation 112
 Automatic anti-dazzle exterior mirrors . 31

Automatic anti-dazzle interior mirror ... 32
 Automatic dipped beam activation 95
 Automatic level control 97, 143
 Automatic transmission 18, 115
 Automatic mode 116
 Engine braking assistance 118
 Fault 120
 Interruption of power supply 120
 Kickdown 117, 118
 Manual mode 117
 Rocking the vehicle 119
 Selector lever 116
 Transmission display 116
 Winter program 117

B

Battery 200
 Interruption of power supply 120
 Battery discharge protection 100
 Before starting-off 18
 Belt force limiters 44
 Belt tensioners 44
 Belts 8, 42, 43, 204
 Bleeding, diesel fuel system 171
 Board information display 76, 78
 Bonnet 171
 Boot, see Luggage compartment 41
 Brake assist 146
 Brake fluid 214
 Brake system 145

- | | | |
|---|--|---|
| Brakes 145 | Clock 76 | Fog tail lamp 73, 96 |
| ABS 148 | Clutch fluid 197 | Front fog lamps 73, 96 |
| Brake assist 146 | Clutch operation 128 | Front passenger's seat belt reminder 46 |
| Brake fluid 196 | CO ₂ emissions 219 | Fuel level 72, 76 |
| Brake lamps 188 | Coin storage 67 | Headlamp main beam 73, 95 |
| Brake servo unit 127 | Cold starts 128, 133 | Park pilot 71, 143 |
| Foot brake 146 | Colour information display 77, 83 | Power steering 73 |
| Hand brake 147 | Console box 65 | Preheating 73 |
| Bulb replacement 185 | Console net 66 | Tailgate 72 |
| Bulbs 185 | Contrast 87 | Trailer 70 |
| C | Control indicators 12, 70 | Transmission electronics 72 |
| Capacities 225 | ABS 70, 148 | Turn signal lamps 72 |
| Car Pass 21 | Airbags 56, 72 | Water in diesel fuel 73, 195 |
| Caravan/trailer towing 127, 167 | All Wheel Drive 71, 121 | Windscreen washer fluid 73, 199 |
| Card holder 67 | Alternator 74 | Winter program 74, 117 |
| Care 201 | Anti-theft alarm system 28, 29, 74 | Coolant 195, 214, 216 |
| Catalytic converter 133, 135, 172 | Automatic headlamp | Coolant level 195 |
| Central locking switch 25 | range adjustment 71, 97 | Coolant temperature 71, 195 |
| Central locking system 25 | Automatic transmission 120 | Cooled glove compartment 105 |
| Centre high-mounted stop lamp | Belt tensioners 45, 72 | Cooling 110, 111 |
| Bulb replacement 191 | Brake system 70, 147, 197 | Correcting time 86 |
| Changing the battery | Change engine oil 73, 194 | Corrosion protection 214 |
| Remote control 24 | Coolant temperature 71, 196 | Coupling socket load 168 |
| Changing tyre/wheel type 149 | Cruise control 73, 140 | Courtesy lamps 98 |
| Changing wheels 178 | Descent Control System 71, 138, 139 | Bulb replacement 189 |
| Chassis number, see Vehicle | Diesel particle filter 73, 135 | Switching off 99 |
| Identification Number 215, 216 | Doors 72 | Cruise control 140 |
| Check control 91 | Driver's seat belt reminder 72 | Curtain airbags 55 |
| Child restraint system 47, 58 | Electronic immobiliser 22, 72 | |
| Child safety locks 30 | Electronic Stability Control 71, 136 | |
| Cigarette lighter 68 | Engine electronics 72, 134 | |
| Cleaning 201 | Engine oil level 73 | |
| Climate control 103 | Engine oil pressure 74 | |
| | Exhaust 74, 134 | |

D

- Dashboard - see Instrument panel 10
- Data 21, 215
- Date 80
- Daytime running lamps 94
- DCS (Descent Control System) 138
- Demisting and defrosting
 - Windows 17
 - With air conditioning system 108
 - With Electronic Climate Control 113
- Descent Control System 138
- Diesel 131
- Diesel fuel filter 194
- Diesel fuel system 171, 194
- Diesel particle filter 73, 135
- Dipped beam 14, 95
 - Bulb replacement 186
- Display 76
- Display mode 87
- Door locks 6, 205
- Doors 72
- Drink holders 67
- Drive control systems 136
- Driving abroad 100
- Driving hints 127

E

- Economical driving 129
- Electric exterior mirrors 9, 30
- Electric sun roof 34
- Electric windows 32
 - Child safety system 33
 - Safety function 33
- Electrical system 181

- Electrically adjustable front seat 37
- Electronic Climate Control 17, 103, 111
- Electronic components 201
- Electronic immobiliser 22
- Electronic Stability Control (ESC) 136
- Engine braking assistance 118
- Engine code 216, 217
- Engine control indicator 134
- Engine data 217
- Engine oil 213
 - Additives 214
 - Topping up 213
 - Viscosity 214
- Engine oil change 194
- Engine oil filter change 194
- Engine oil level and consumption 192
- Engine oil life monitor 73, 194
- Engine oil pressure 74
- Engine oils 192, 216
- Engine speed 75
- Engine wash 205
- Environmental protection 194, 201
- ESC (Electronic Stability Control) 136
- Exhaust control indicator 134
- Exhaust gases 135
- Exhaust system 135
- Exterior lamps 94
- Exterior mirrors 30

F

- Fan 106, 191
- Filling station
 - Capacities 225
 - Engine oil level 192
 - Fuel 131, 217
 - Ignition key 21
 - Opening the bonnet 171
 - Tyre pressure 130, 224
 - Vehicle data 215
 - Windscreen washer system 199
- First aid kit 68, 177
- Flat tyre 177
- Flex-Fix system 154
- FlexOrganizer 62
- Fog tail lamp 96
 - Bulb replacement 188
- Fold in exterior mirrors 9, 30
- Foot brake 146
- Front airbags 52
- Front door lamps 100
 - Bulb replacement 190
- Front fog lamps 96
 - Bulb replacement 188
- Front passenger's seat airbag 52
- Front passenger's seat undertray 66
- Front reading lamps
 - Bulb replacement 189
- Front seat armrest 40
- Fuel 131
- Fuel consumption 129, 131, 219
- Fuel filler cap 132
- Fuel filter 194

Fuel gauge 76
 Fuel system, diesel 194
 Fuse extractor 182
 Fuses 181

G

Gears 17
 Generator, see Alternator 74
 Glasses compartment 65
 Glove compartment 64
 Bulb replacement 191
 Cooling 105
 Lighting 64, 100
 Graphical information display 77, 83
 Gross Vehicle Weight 131, 167, 221

H

Halogen headlamp system 185
 Bulb replacement 185
 Hand brake 19, 147
 Hazard warning lamps 14, 97
 Head restraints 8, 39
 Active head restraints 39
 Head restraint position 39
 Height adjustment 39
 Headlamp aiming 185
 Headlamp flash 14, 95
 Headlamp main beam 14, 95
 Bulb replacement 186
 Control indicator 73, 95
 Headlamp range adjustment 97, 185
 Automatic 97
 Manual 97
 Headlamp switch 13, 94

Headlamp washer system 16, 93, 199
 Antifreeze protection 199
 Capacities 225
 Washer fluid reservoir 199
 Headlamps 13, 94
 Bulb replacement 186, 187
 Daytime running lamps 94
 Driving abroad 100
 Front fog lamps 96
 Warning device 92, 94
 Wiper activated lighting 94
 Heated exterior mirrors 16, 105
 Heated front seats 105
 Heated rear window 16, 105
 Heating 103, 107
 Exterior mirrors 105
 Rear window 105
 Seats 105
 With air conditioning system ... 107, 108
 With Electronic Climate Control 112, 113
 Heating the footwell 108
 Height adjustment
 Head restraints 8, 39
 Seat belts 47
 Steering wheel 13
 High-pressure cleaners 143, 167, 202, 204
 Horn 15
 Hydraulic Brake Assist (HBA) 138

I

Identification plate 215
 Ignition logic 80, 87
 Ignition switch 13
 Illumination 100
 Ignition system 19
 Immobiliser 22
 Information display 76
 Bulb replacement 191
 Illumination 98
 Infotainment system 101, 102
 Inspection system 206
 Instrument display 75
 Bulb replacement 191
 Illumination 98
 Instrument panel 10
 Instruments 70
 Interior lamps 98
 Front reading lamps 99
 Rear interior lamps 99
 Interior mirror 9, 31
 Interruption of power supply ... 83, 90, 120
 Selector lever lock 120
 ISOFIX 50, 51, 52

J

Jack 176
 Jump leads 172

K

Key	21
Extending	21
Ignition lock	13
Locking doors	27, 28
Removing	92
Replacement keys	21
Starting	13, 19
Kickdown	117, 118

L

Language selection	80, 86
Lashing eyes	61
Leather trim	204
Level control system	97, 143
License plate lamps	
Bulb replacement	189
Light switch	13, 94
Lighting	94
Driving abroad	100
Loading	63, 168, 221
Locking doors	25, 28
Locking from the inside	25
Locks	205
Lubricants	191, 216
Luggage compartment	
Bulb replacement	190
FlexOrganizer	62
Lighting	100
Loading	63, 221
Locking	26
Safety net	60
Storage	63
Under floor storage	63

Luggage compartment cover	59
Lumbar support	7, 37

M

Main beam	14, 95
Bulb replacement	186
Control indicator	73, 95

Maintenance

Air conditioning	114
All Wheel Drive (AWD)	126
Antifreeze protection	195
Battery	200
Brake fluid	196
Brakes	145
Catalytic converter	135
Clutch fluid	197
Electronic Climate Control	114
Engine oil	192
Exhaust	135
Fuel consumption	130
Power steering fluid	198
Tyre pressure	150
Tyres	150
Windscreen wipers	198
Manual transmission	17
Mechanical anti-theft locking system ...	27
Mirrors	9, 16, 30, 31, 105
Misted windows	108, 113
Mobile telephones	102
Muffler, see Exhaust system	135

N

Navigation system	86, 102
Neutral	17, 18

O

Octane numbers	217
Odometer	75
Oil	213
Additives	214
Topping up	213
Viscosity	214
Oil change	194
Oil filter change	194
Oil level and consumption	192
Oil life monitor	73, 194
Oil pressure	74
Oils	192, 216
Opel Service	206
Operating temperature	128
Outside temperature	77, 78
Overrun	128

P

Paintwork damage	203
Park pilot	142
Parking	20, 119
Parking lamps	
Bulb replacement	186, 187
Parking on inclines	170
Payload	221
Pedals	128
Performance	218
Peripheral lighting	98
Petrol	131, 217
Pinking	131
Pollen filter	114
Power outlets	68

- Power steering73, 127
 Fluid 198
 Preheating 19, 73
 Pushing, towing 172
- R**
- Radio 101
 Radio equipment (CB) 102
 Radio frequency remote control
 Central locking system 6, 23, 25
 Fault 24
 Radio reception 101
 Rain sensor 15, 93, 198
 Rear interior lamps
 Bulb replacement 190
 Rear lamp cluster 96
 Bulb replacement 188
 Rear seat armrest 42
 Rear seats 41
 Folding backrests 41
 Restoring backrests 42
 Rear window washer system 16, 93, 199
 Rear window wipers 16, 93
 Refuelling 132
 Fuel filler cap 132
 Remote control
 Central locking system 6, 23, 25
 Fault 24
 Replacement keys 21
 Reversing lamps 96
 Bulb replacement 188
 Roof load 35, 64, 127, 153, 221
 Roof racks 130, 153
- Running-in 127
 Brakes 145
- S**
- Safeguard against
 unauthorised use 13, 20, 21
 Safety 191
 Safety accessories 47, 68, 177
 Safety net 60
 Saving energy 129
 Saving fuel 129
 Seat adjustment 7, 36
 Seat belts 8, 42, 43, 204
 Driver's seat belt reminder 72
 Front passenger's seat belt reminder 46
 Height adjustment 47
 Removing 47
 Seat height adjustment 8, 37
 Seat position 38
 Seats 7, 36
 Adjustment 7, 8, 36
 Electric seat adjustment 37
 Folding passenger's seat 40
 Heated seats 105
 Selector lever 18, 116
 Selector lever lock 18, 116
 Self-diagnosis 45
 Self-help 171
 Automatic transmission 120
 Information display 80, 86
 Remote control 24
 Service 206
 Service intervals 206, 207
 Side airbags 54
- Side repeater lamps
 Bulb replacement 188
 Slide/tilt sun roof 34
 Spare keys 21
 Spare wheel 153, 177
 Speed 129, 130
 Fuel consumption 129
 Speedometer 75
 Starting on inclines 170
 Starting the engine 13, 19
 Self-help 172
 Steam-jet cleaners 143, 167, 202, 204
 Steering column lock 13
 Steering wheel adjustment 13
 Steering wheel remote control 101
 Storage 59
 Stowage compartments 64
 Sun roof 34
 Sun visors 34
 Illumination 100
 Sunglass holder 65
 System settings 79, 85
- T**
- Tachometer 75
 Tail and brake lamps
 Bulb replacement 188
 Tailgate 6, 26
 Tailgate washer system 16, 93, 199
 Antifreeze protection 199
 Capacities 225
 Washer fluid reservoir 199
 Tailgate wiper 16, 93

Tank
Fuel gauge 76
Technical data 215
Telephone, see Mobile telephones 102
Temperature regulation 106, 112
Temporary spare wheel 153, 177
The first 1000 km 127
Tightening torque 223
Time 80, 85
Tools 176
Towing 127, 169, 174, 175
Towing equipment 164, 227
Towing eye 174, 175
Towing service 175
Trailer Stability Assist (TSA) 138
Trailer/caravan towing 127, 167
Transmission display 76, 116
Tread depth 151
Trip computer 81, 88
Trip odometer 75
Turn signal lamps 14, 95
Bulb replacement 186, 187
Tyre chains 152
Tyre condition 150
Tyre pressure 150, 168
Tyre pressure monitoring system ... 91, 144
Tyres 223
Directional tyres 178
Pressure 224

U
Units of measure 81, 87
Unleaded fuel 131, 133, 217
Used engine oil 194

V
Valve cap key 150
Vehicle care 201
Vehicle Identification Number 215, 216
Vehicle keys, see Key 21
Vehicle tools 176
Vehicle weights 222
Ventilation 103, 104, 107

W
Warning buzzers 92
Warning messages 79, 84
Warning triangle 68, 177
Washer fluid reservoir 199
Washing the vehicle 202
Weights 221
Wheel condition 150
Wheel trims 152
Wheels, tyres 149
Windows 16, 32, 105
Demisting and defrosting ... 17, 108, 113
Windscreen washer system 16, 93, 199
Antifreeze protection 199
Capacities 225
Washer fluid reservoir 199
Windscreen wipers 15, 92, 198

Winter operation
Battery 128
Coolant, antifreeze 195
Fuel consumption 130
Fuel for diesel engines 131
Heating 103, 109, 111
Locks 205
Tyre chains 152, 223
Window demisting
and defrosting 108, 113
Windscreen wash system,
antifreeze protection 199
Winter tyres 152
Winter program 117
Winter tyres 152

X
Xenon headlamp system 97, 187
Bulb replacement 187