

OPEL Corsa



Owner's Manual

OPEL Corsa



Operation, Safety, Maintenance

Data specific to your vehicle

Please enter your vehicle's data here so that it is readily accessible. Please refer to the sections "Servicing and maintenance" and "Technical data" and the identification plate.

Fuel

Designation

Engine oil

Grade

Viscosity

Tyre pressure

	Tyre size	Front	Rear
Summer tyres	<input type="text"/>	<input type="text"/>	<input type="text"/>
Winter tyres	<input type="text"/>	<input type="text"/>	<input type="text"/>

Weights

Gross vehicle weight rating

- EC kerb weight

= Loading

Introduction

Your vehicle is an intelligent combination of forward-looking technology, impressive safety, environmental friendliness and economy.

It now lies with you to drive your vehicle safely and to see it performs perfectly. This Owner's Manual provides you with all the necessary information to that end.

Make sure your passengers are aware of the possible risk of accident and injury which may result from improper use of the vehicle.

You must always comply with the specific laws of the country that you are in. These laws may differ from the information in this Owner's Manual.

When this Manual refers to a workshop visit, we recommend your Opel Service Partner.

All Opel Service Partners provide first-class service at reasonable prices. Experienced mechanics trained by Opel work according to specific Opel instructions.

The Owner's Manual, infotainment system instructions and the vehicle Service and Warranty Booklet should always be kept ready to hand in the vehicle glove compartment.

Make use of the Owner's Manual

- The "In Brief" section will give you an initial overview.

- The table of contents at the beginning of the owner's manual and within the individual chapters will show you where everything is.

- Its index will help you find what you want.

- Yellow arrows in the illustrations serve as points of reference or indicate some action to be performed.

- Black arrows in the illustrations indicate a reaction or a second action to be performed.

- This Owner's Manual depicts left-hand drive vehicles. Right-hand drive vehicles are operated in the same way.

- The Owner's Manual uses the internal engine codes. The corresponding sales designations are found in the chapter "Technical data".

- Directional data, e.g. left or right, or front or back, in the descriptions always relate to the direction of travel.

Symbols

- ▶ Continue reading on next page.

* signifies equipment not fitted to all vehicles (model variants, engine options, models specific to one country, optional equipment, Genuine Opel Parts and Accessories).

Page references are indicated with ↗ .
↗ means "see page".

⚠ Danger, ⚠ Warning, Caution

⚠ Danger

Text marked ⚠ **Danger** provides information on risk of endangering life. Failure to comply with the instructions could endanger life.

⚠ Warning

Text marked ⚠ **Warning** provides information on risk of accident or injury. Failure to comply with the instructions could lead to injury.

Caution

Text marked **Caution** provides information on possible damage to the vehicle. Failure to comply with the instructions could lead to vehicle damage.

Safe driving!

Adam Opel GmbH

Contents

In Brief	2
Keys, doors, windows, sun roof	26
Seats, Interior	48
Instruments, controls	84
Lighting	108
Infotainment system	118
Climate control	120
Driving and operation	136
Self-help, vehicle care	190
Opel Service, maintenance	231
Technical Data	250
Index	270

In Brief

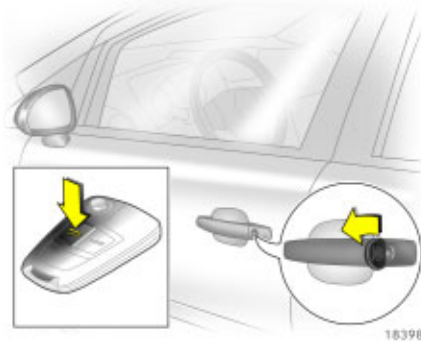

Unlocking the car: Turn the key in the driver's door lock towards the front or press the button \supset

Open the door by pulling on the door handle. To open the tailgate, press in the button under the handle recess and pull the tailgate upwards.

- Key \diamond 26,
- Electronic immobiliser \diamond 27,
- Personalised key \diamond 39,
- Central locking with key \diamond 32,
- Remote control \diamond 31,
- Central locking \diamond 32,
- Anti-theft device \ast \diamond 33,
- Alarm system \diamond 37,
- Child lock \diamond 39.

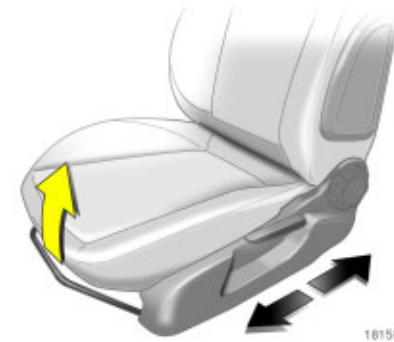

To adjust front seat leg room: Pull handle, slide seat, release handle

Seats \diamond 48, Seat position \diamond 50.



18160 S

**To adjust front seat backrests:
Turn handwheel**

Do not lean on seat backrest whilst adjusting it.

Seats ⇨ 48,
Seat position ⇨ 50,
Folding down the front passenger seat ⇨ 49.



18161 S

Front seat height *: Operate lever on the door side of seat

Pump action of lever

Upwards: Seat higher

Downwards: Seat lower

Seats ⇨ 49, Seat position ⇨ 50.

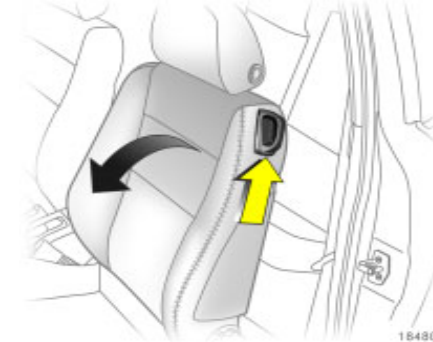

18480 S

To fold the front seat backrests forward *: Lift the locking lever, fold the backrest forward, lower the locking lever, backrest engages folded forward *, slide the seat forward *

To push the seat back to upright, it engages in its original position *. Lift the locking lever *, move the backrest back to upright, lower the locking lever, backrest engages.

Folding the backrest forwards is possible only when the backrest is in an upright position.

Front seats ⇨ 48.

4 In Brief

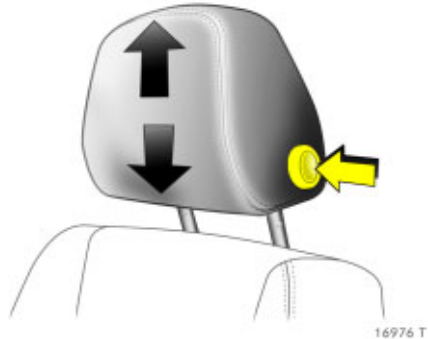

To adjust front seat head restraint height: press button to unlock, adjust height, engage

Head restraint ⇨ 51,
rear head restraint adjustment ⇨ 52,
head restraint position ⇨ 52.



Extend the seat belt and clip it into the buckle

The seat belt must not be twisted and must lie snugly against the body. The backrest must not be tilted back too far (maximum approx. 25°).

To release belt, press red button on belt buckle.

Three-point seat belts ⇨ 59,
Airbag system ⇨ 69,
Seat position ⇨ 50.



To adjust interior mirror by swivelling

Swivel lever on underside of mirror housing to reduce dazzle at night.

Mirrors ⇨ 42,
Autodimming interior mirror ⇨ 44.

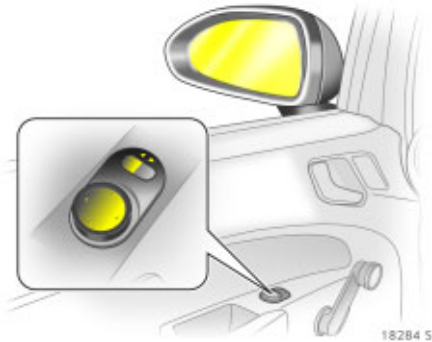

Exterior mirror adjustment

Select the mirror to be adjusted using the rocker switch and adjust using the four-way switch.

- Mirror ⇨ 42,
- Aspherical exterior mirrors ⇨ 42,
- Swinging in exterior mirrors ⇨ 42,
- Heated exterior mirrors ⇨ 13, ⇨ 43.

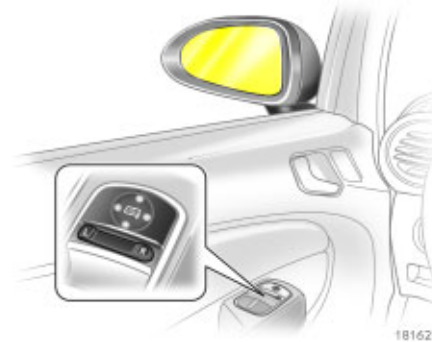

Exterior mirror adjustment on vehicle fitted with electronic windows *

Select the mirror to be adjusted using the rocker switch and adjust using the four-way switch.

- Mirror ⇨ 42,
- Aspherical exterior mirrors ⇨ 42,
- Swinging in exterior mirrors ⇨ 42,
- Heated exterior mirrors ⇨ 13, ⇨ 43.

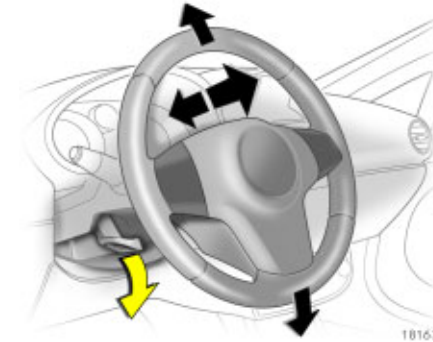

**Steering wheel adjustment:
Swivel lever down, adjust height and distance, swivel lever up, engage**

Adjust steering wheel only when vehicle is stationary and steering column lock is released.

- Airbag system ⇨ 69



<p>1 Side air vents ↗ 120</p> <p>2 Parking lamps, dipped beam ... ↗ 106 Instrument illumination ↗ 112 Fog tail lamp ↗ 108 Fog lamps * ↗ 108 Headlamp range adjustment * ↗ 109</p> <p>3 Turn signal ↗ 11 Headlamp flash dipped beam, main beam ↗ 11 Interior lighting * ↗ 111 Parking lamps * ↗ 112 Cruise control * ↗ 158</p> <p>4 Steering wheel remote control * ↗ 116</p> <p>5 Horn ↗ 12 Driver's airbag ↗ 67</p> <p>6 Instruments ↗ 82</p> <p>7 Windscreen wipers, windscreen washer system, rear window washer system ↗ 12 Trip computer * ↗ 99</p>	<p>8 Centre air vents ↗ 120</p> <p>9 Central information display for time, date, outside temperature, infotainment system *, check control * ↗ 92 Trip computer * ↗ 99 Climate control system * ↗ 126</p> <p>10 Left seat heater * ↗ 48 Steering wheel heater * ↗ 49 Tyre pressure loss monitoring system * ↗ 162 Central locking button ↗ 32 Warning lights ↗ 12 Passenger airbag off switch ↗ 73 Ultrasonic parking sensor ↗ 160 Electronic stability * ↗ 157 Right seat heater * ↗ 48</p> <p>11 Front passenger airbag ↗ 67</p> <p>12 Glove compartment ↗ 80</p>	<p>13 Infotainment system * ↗ 116</p> <p>14 Climate control ↗ 118</p> <p>15 Accessory socket * ↗ 78 Cigarette lighter * ↗ 78</p> <p>16 Ashtray ↗ 79</p> <p>17 Ignition switch with steering wheel lock ↗ 16</p> <p>18 Accelerator pedal ↗ 147, ↗ 148</p> <p>19 Brake pedal ↗ 148, ↗ 163, ↗ 165</p> <p>20 Clutch pedal * ↗ 142</p> <p>21 Steering wheel adjustment ↗ 5</p> <p>22 Releasing the bonnet ↗ 188</p>
--	---	--



8 In Brief

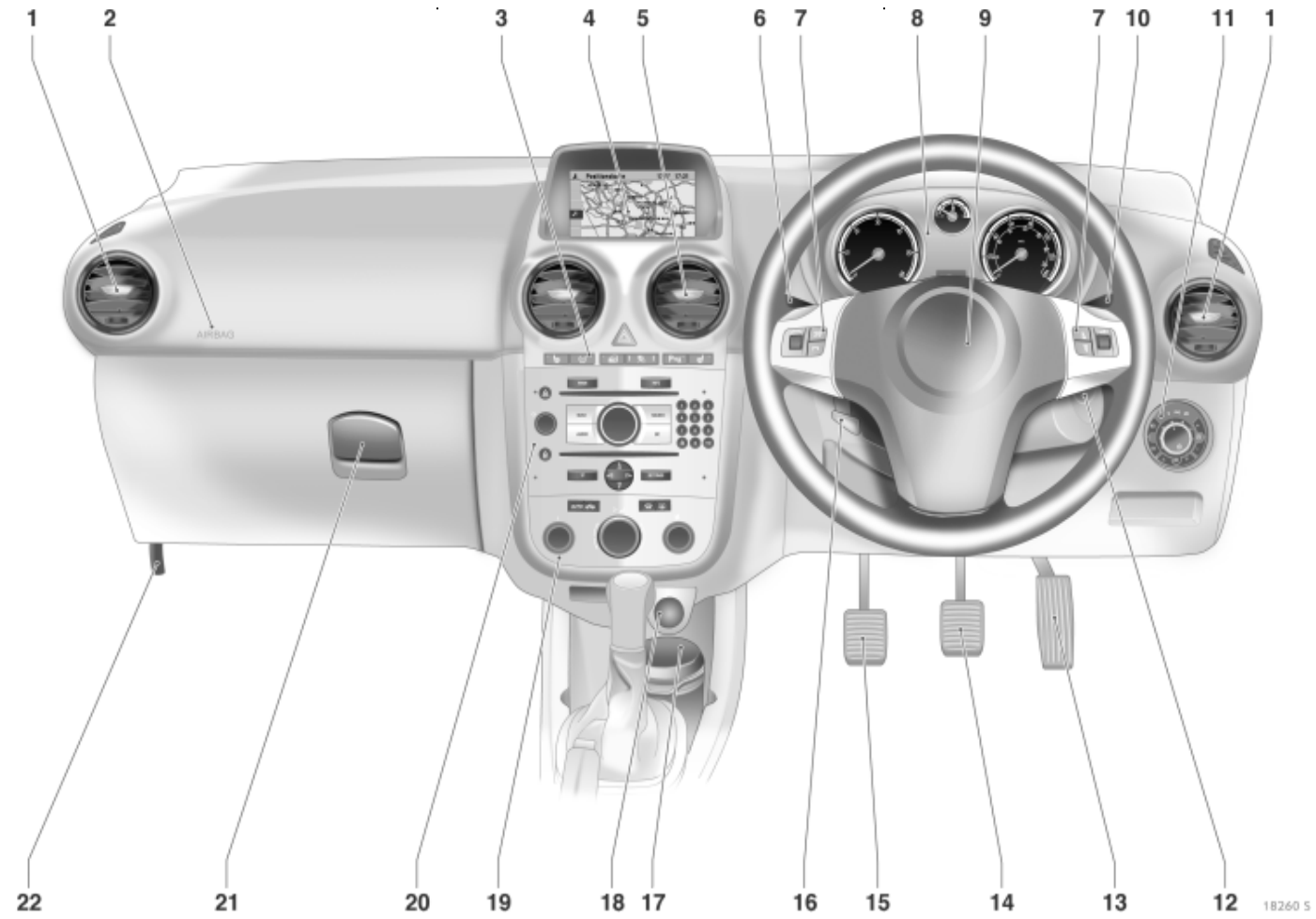

6 In Brief

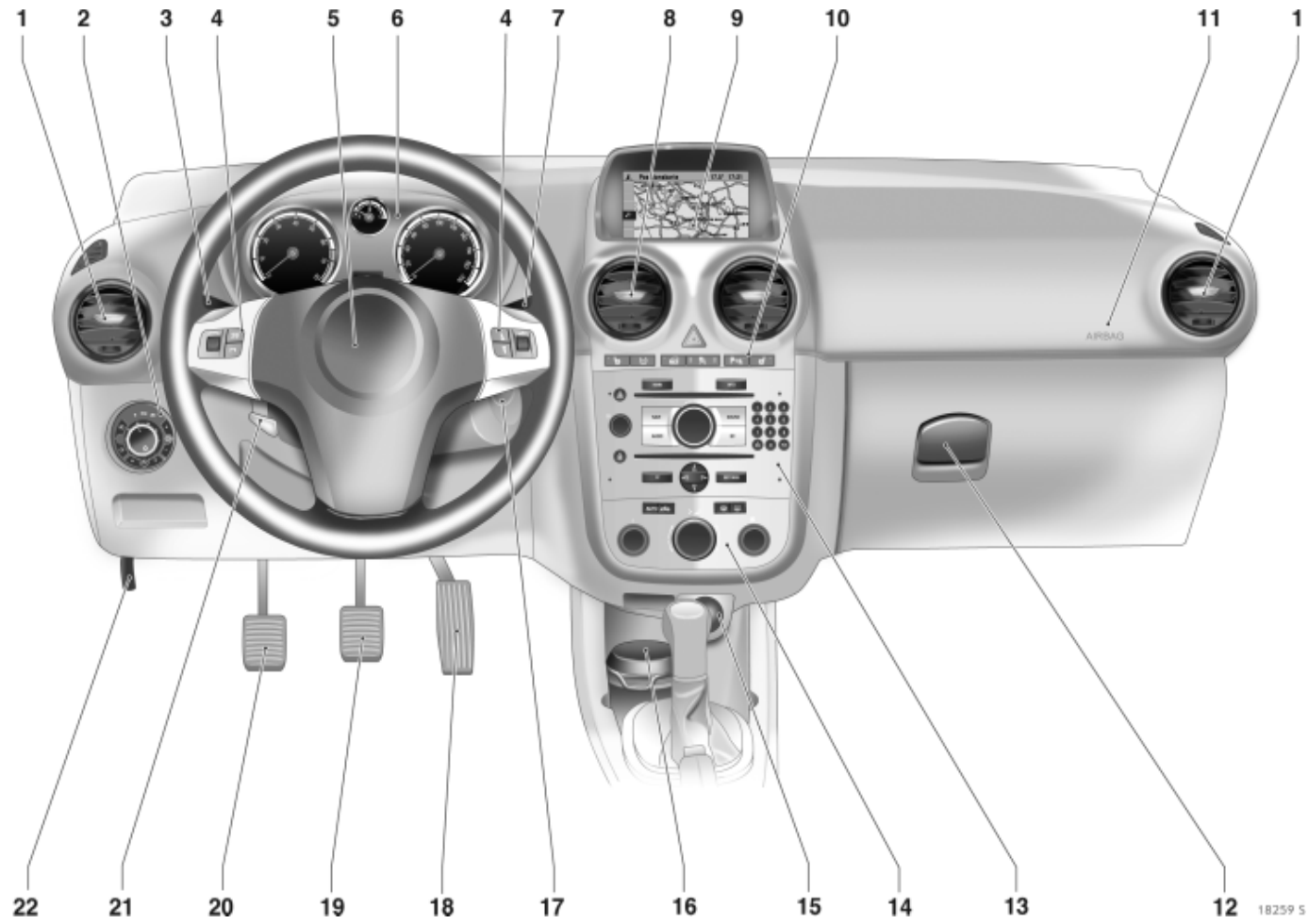

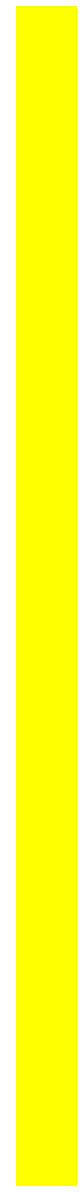

<p>1 Side air vents ↗ 120</p> <p>2 Front passenger airbag ↗ 67</p> <p>3 Left seat heater * ↗ 48 Steering wheel heater * ↗ 49 Tyre deflation detection system * ↗ 162 Central locking button ↗ 32 Warning light ↗ 12 Passenger airbag off switch ↗ 73 Ultrasonic parking sensor ↗ 160 Electronic stability* ↗ 157 Right seat heater * ↗ 48</p> <p>4 Central information display for time, date, outside temperature, infotainment system *, check control * ↗ 92 Trip computer * ↗ 99, Climate control system * ↗ 126</p> <p>5 Centre air vents ↗ 120</p> <p>6 Turn signal ↗ 11 Headlamp flash dipped beam, main beam ↗ 11 Ambient lighting * ↗ 111 Parking lamps * ↗ 112 Cruise control * ↗ 158</p>	<p>7 Steering wheel remote control * ↗ 116</p> <p>8 Instruments ↗ 82</p> <p>9 Horn ↗ 12 Driver's airbag ↗ 67</p> <p>10 Windscreen wipers, windscreen washer system, rear window washer system ↗ 12 Trip computer * ↗ 99</p> <p>11 Parking lamps, dipped beam ↗ 106 Instrument illumination ↗ 112 Fog tail lamp ↗ 108 Fog lamps * ↗ 108 Headlamp range adjustment * ↗ 109</p> <p>12 Ignition switch with steering wheel lock ↗ 16</p>	<p>13 Accelerator pedal ↗ 147, ↗ 148</p> <p>14 Brake pedal ↗ 148, ↗ 163, ↗ 165</p> <p>15 Clutch pedal * ↗ 142</p> <p>16 Steering wheel adjustment ↗ 5</p> <p>17 Ashtray ↗ 79</p> <p>18 Accessory socket * ↗ 78 Cigarette lighter * ↗ 78</p> <p>19 Climate control ↗ 118</p> <p>20 Infotainment system * ↗ 116</p> <p>21 Glove compartment ↗ 80</p> <p>22 Releasing the bonnet ↗ 188</p>
---	--	---





Control indicators

 Deflation detection system *,
 ↗ 84, ↗ 164.

 Ultrasonic parking sensors *,
 fault,
 ↗ 162.

 Adaptive driving light *, fault,
 ↗ 112, ↗ 117.

 Manual transmission
 automated *, starting the
 engine *,
 ↗ 85, ↗ 137.

 Preheating system *,
 Diesel particle filter *,
 ↗ 85.

 Exhaust gases *,
 ↗ 85, ↗ 156.

 Engine electronics, transmission
 electronics *, immobiliser, diesel
 fuel filter *, fault,
 ↗ 27, ↗ 86, ↗ 142, ↗ 148, ↗ 156.

 Engine oil level *,
 ↗ 86, ↗ 242.

 Engine oil pressure,
 ↗ 86.

 Alternator,
 ↗ 87.

 Electro-hydraulic power
 assisted steering,
 ↗ 87.

 Turn signal lamps,
 ↗ 11, ↗ 87.

 Fuel level,
 ↗ 87, ↗ 90.

 Main beam,
 ↗ 11, ↗ 87.

 Coolant temperature,
 ↗ 87, ↗ 244.

 Deactivate front passenger
 airbag systems,
 ↗ 75.

 Winter setting for automatic
 transmission * or automated
 transmission *,
 ↗ 140, ↗ 146.

 Manual transmission
 automated SPORT mode *,
 ↗ 139, ↗ 146.

 Headlamp range adjustment,
 ↗ 75.

 Exterior lights,
 ↗ 88, ↗ 108.

 Fog lamps *,
 ↗ 88, ↗ 110.

 Airbag systems, belt tensioners,
 ↗ 61, ↗ 74.

 Seat belt *,
 ↗ 89, ↗ 62.

 Fog tail lamp,
 ↗ 88, ↗ 110.

 Brake system, clutch system,
 ↗ 89, ↗ 167, ↗ 246.

 Anti-lock brake system,
 ↗ 166.

 Electronic Stability Programme
 (ESP^{Plus}) *,
 ↗ 151.

 Cruise control *,
 ↗ 161.



18164 S

Exterior lights

Rotate

- 0 = Off
- ☛☛ = Parking lamps
- ☛D = Dipped or main beam
- A = Automatic dipped beam activation *

Press

- ☛D = Fog lamps *
- ☛ = Fog tail lamp

Lighting ⇨ 108,
headlamp warning device ⇨ 105.

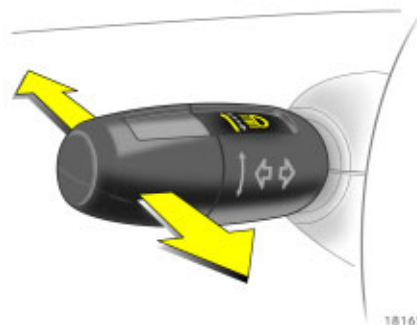

18165 S

Headlamp flash, main beam and dipped beam

- Headlamp flash = Pull stalk towards steering wheel
- Main beam = Push stalk forwards
- Dipped beam = Lever forward again or toward steering wheel

Main beam, headlamp flash ⇨ 109.

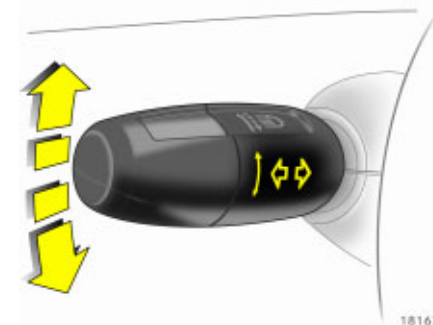

18167 S

Switch turn signal on

- Right = Lever upwards
- Left = Lever downwards

Turn signals ⇨ 109.



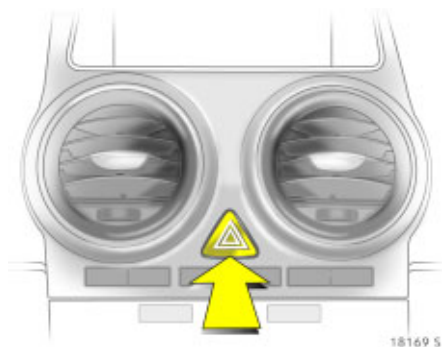

Hazard warning flashers

Operated with the  button.
Hazard warning lamps ⇨ 111.

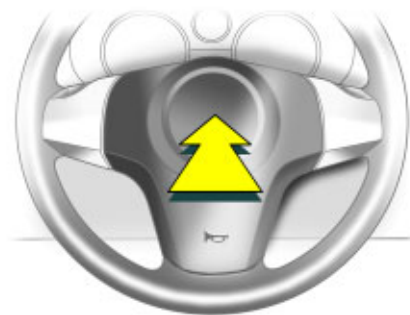



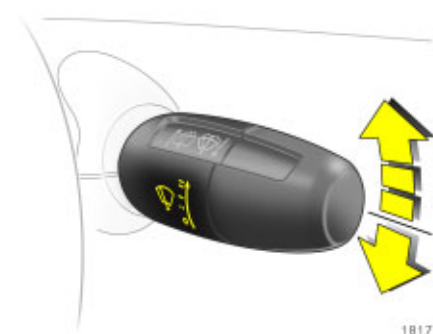

Activate horn:
Press  in centre of steering wheel

Airbag system ⇨ 69,
Steering wheel remote control * ⇨ 118.



Windscreen wiper:
Gently tap lever upwards

-  = Fast
-  = Slow
-  = Timed interval wipe or automatic wiping with rain sensor *
-  = Off

For a single swipe when the windscreen wipers are off, press the stalk down.

Windscreen wipers ⇨ 106,
adjustable intermittent setting ⇨ 106,
further information ⇨ 228, ⇨ 248,
trip computer ⇨ 92.

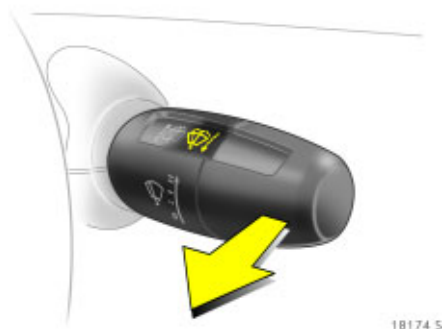

18174 5

Operating windscreen washer system: Stalk toward steering wheel

Windscreen washer system ↗ 248, further information ↗ 228, ↗ 248.



18175 5

Rear window wiper * and Rear window washer system * operation

- Wiper on = Push stalk forwards
- Wiper off = Push stalk forwards again
- Washing = Push lever forward and hold

Rear window wipers and rear window washer system ↗ 107, further information ↗ 228, ↗ 248.



18176 5

Heated rear window, heated exterior mirrors

Operated with the  button.



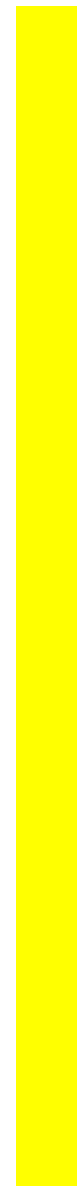

Climate control ↗ 120, heated rear window ↗ 46.





18177 S

To clear fogged or icy windows

Air distribution to , turn rotary switch for temperature and air flow; climate control : Button  must also be pressed; automatic climate control : button  must also be pressed.

Climate control  ↪ 120.



18178 S

To set automatic mode of climate control system

Press **AUTO** button, select temperature with rotary knob, open air vents.

► Climate control system  ↪ 128.

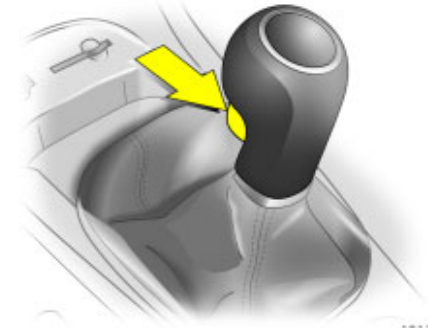

18179 S

Manual transmission

Reverse gear: With vehicle stationary, wait 3 seconds after depressing the clutch, then lift the ring below the gear knob and engage gear.

If the gear does not engage, set the lever in neutral, release the clutch pedal and depress again; then repeat gear selection.

Manual transmission ↪ 144.

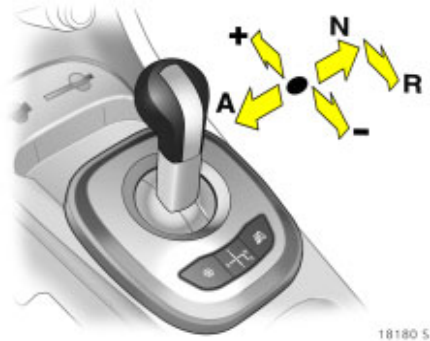

Automated manual transmission *

- N** = Idling
- = Driving position
- +** = Higher gear
- = Lower gear
- A** = Switch between Automatic and Manual mode
- R** = Reverse gear (with selector lever lock)

Always move the selector lever in the appropriate direction right up to the stop. It will automatically return to the neutral position after each operation.

The foot brake must be depressed when starting.

Automated manual transmission * ⇨ 136.

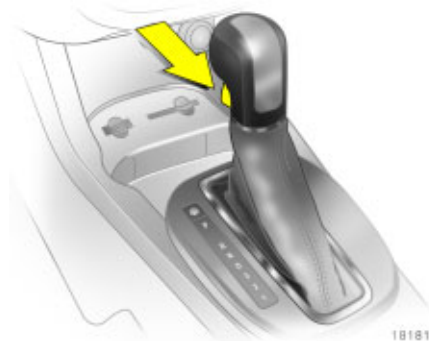

Automatic transmission *

- P** = Park position
- R** = Reverse gear
- N** = Neutral (idling)
- D** = Automatic gear selection
- 3** = 1st to 3rd gear
- 2** = 1st and 2nd gear
- 1** = 1st gear

Only start engine in **P** or **N**. To come out of **P**, turn the ignition, operate the foot break and press the button.

Deactivate the selector lever lock by pressing the button.

► Automatic transmission * ⇨ 144.

Before starting off, check

- Tyre pressure and tyre condition ⇨ 169, ⇨ 264.
- Engine oil level and fluid levels in engine compartment, ⇨ 241 to ⇨ 248.
- All windows, mirrors, exterior lighting and number plates are free from dirt, snow and ice and operational.
- Seats, seat belts and mirrors are correctly adjusted ⇨ 48, ⇨ 58, ⇨ 42.
- Check brake function at low speed, particularly if the brakes are wet.



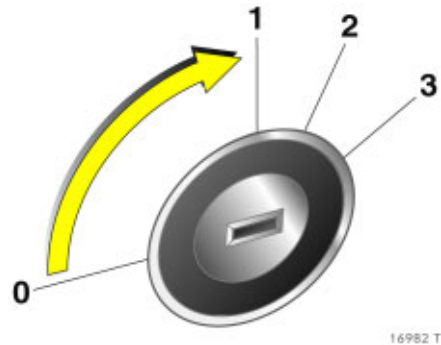



Steering wheel lock and ignition

Turn key to position 1. Move the steering wheel slightly to release the steering wheel lock.

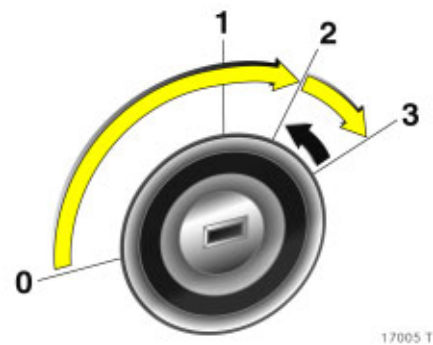
- 0 = Ignition off
- 1 = Steering free, ignition off
- 2 = Ignition on, with diesel engine: pre-heating
- 3 = Starting



Starting the engine

Depress clutch and brake pedals, select *P or N for automatic transmission, *N for manual transmission automated. Do not press the accelerator, in the case of diesel engines, release the key in position 2 until the warning light  goes out, turn the key to position 3 and release once the engine is running.

Before restarting or switching off the engine, turn key back to 0.

To switch on the ignition, only turn the key to 2.

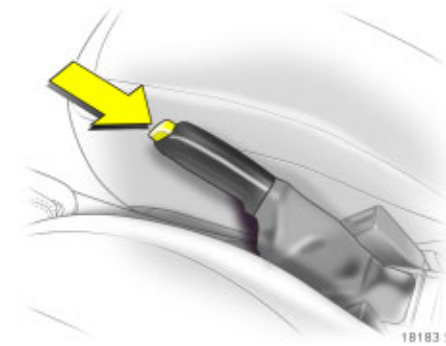

Releasing the hand brake:



Raise lever slightly, press release button, lower lever fully



Hand brake ⇨ 167.



Parking the vehicle

- Apply hand brake firmly without operating release button. On a downhill or uphill slope, apply as firmly as possible. Apply foot brake at same time to reduce operating force.
- Switch off engine and ignition. Turn the ignition key to position 0 and pull it out. Turn the steering wheel until it is clear that the steering lock has engaged (anti-theft protection).



On vehicles with automatic transmission , the key can only be removed when the selector lever is in the P position.

On vehicles with manual transmission automated , control indicator  flashes for a few seconds after the ignition is switched off if the hand brake has not been applied.



- If the vehicle is standing on a level surface or a hill, select first gear before switching the ignition off with manual transmission automated , and with automatic transmission  move selector lever to P. Also turn front wheels away from kerb if parked on an uphill slope.





If the vehicle is parked on a slope, with manual transmission or manual transmission automated,  select reverse gear before switching the ignition off, and with automatic transmission  move selector lever to position P. Also turn front wheels towards the kerb.

- Lock vehicle with key in lock or button  on the remote key fob.

To activate the anti-theft locking system  and anti-theft alarm system , press button  twice.

Advice when parking

- Do not park the vehicle on an easy flammable surface. The high temperature of the exhaust system could ignite the surface.
- Close the windows and sun roof .
- The engine cooling fans may run after the engine has been switched off  241.
- After running at high engine speeds or with high engine loads, operate the engine briefly at a low load or run in neutral for approx. 30 seconds before switching off in order to protect the turbocharger .

Remote control  31,
Central locking system  32,
Anti-theft alarm system   37,
Vehicle decommissioning  249.

Interesting functions

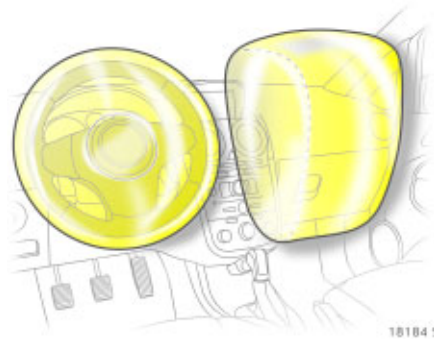

Airbag system

The airbag system consists of several internal systems.

Front airbag system *

The front airbag system will be triggered in the event of a serious accident involving a frontal impact and forms safety cushions for the driver and front passenger *. The forward movement of the driver and front passenger is checked and the risk of injuries to the upper body and head thereby substantially reduced.

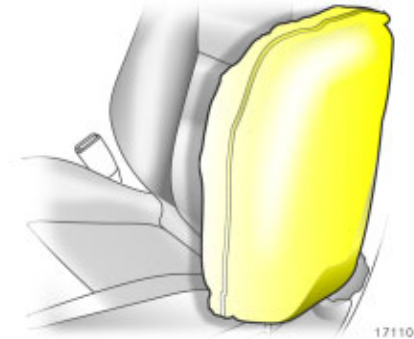

Side airbag system *

The side airbag is triggered in the event of a side-on collision to form a safety cushion for the driver or front passenger in the respective door area. This substantially reduces the risk of injury to the upper body and pelvis.

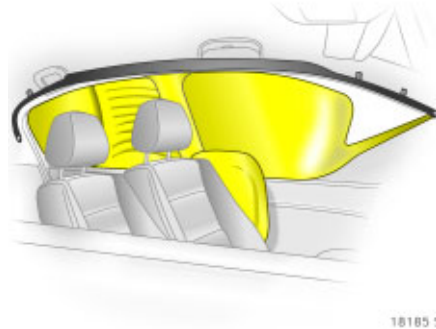

18185 S

Curtain airbag system *

The curtain airbag system triggers in case of a side-on collision and provides a safety barrier in the head area on the respective side of the vehicle. This reduces the risk of injury to the head considerably in case of a side-on collision.

Airbag system ⇨ 69.

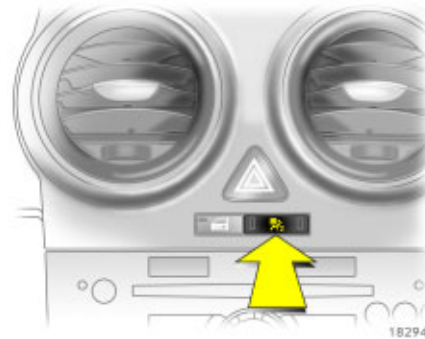

18294 S

Airbag systems which can be deactivated for the front passenger *

The front and side airbag systems * for the front passenger must be deactivated if a child restraint system is to be fitted to the passenger seat. The curtain airbag system *, the belt tensioners and all driver airbag systems remain active when the systems for the front passenger are deactivated. The passenger airbag systems are active in the as-delivered condition.

Airbag systems which can be deactivated ⇨ 75.

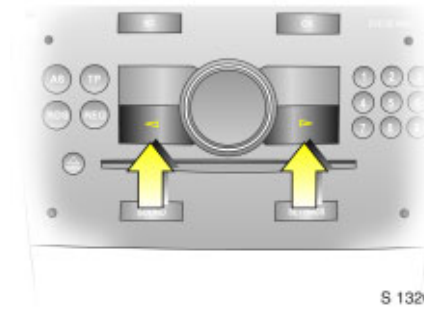

S 13209

Operating menus via the information display *

The menu options are selected via the menus and the arrow keys or the multifunction button of the infotainment system * or the left adjusting wheel * on the steering wheel. The relevant menu options appear on the display.

Selection using arrow keys *: Press right or left arrow key.



Selection using multifunction button *:
rotate and press multifunction button.
To exit a menu, turn the multifunction
button left or right to **Return** or **Main** and
select.



Selection using left adjusting wheel on
steering wheel *:
Rotate and press knurled
wheel.
Information display ⇨ 94.

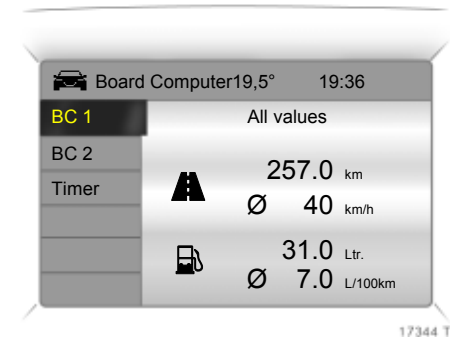

Trip computer *

Functions:

- Range
- Instantaneous consumption
- Distance travelled
- Average speed
- Effective consumption
- Average consumption
- Stop watch

Trip computer * ⇨ 101.



Check control *

The check control software monitors

- Remote control battery.
- Important exterior lighting lamps, including cables and fuses.

Check control * ⇨ 104.

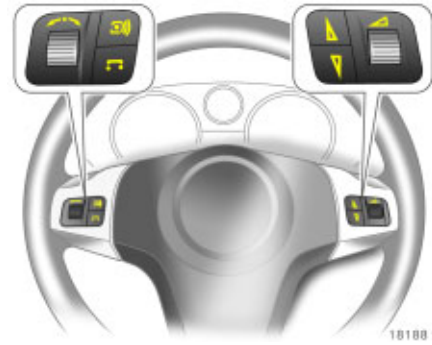

Steering wheel remote control *

The functions of the infotainment system * and the information display can be operated using the buttons and adjusting wheels on the steering wheel.

Further information is available in the infotainment system operating instructions.

Steering wheel remote control * ⇨ 118, Infotainment system ⇨ 118.

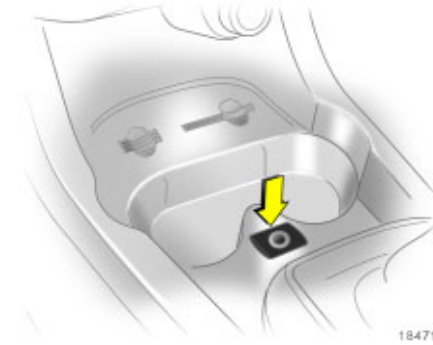

AUX input *

An external audio source such as a portable CD player can be connected via the AUX input with a 3.5 mm jack plug.

AUX input * ⇨ 119.



Ultrasonic parking sensors *

When reverse gear is selected, the park pilot switches itself on automatically.

Manual activation is possible at speed below 25 km/h by using the **P** button in the instrument panel.

An acoustic warning sounds when the vehicle approaches an obstacle behind.

Ultrasonic parking sensors * – page ↻ 162.



Tyre pressure loss monitoring system (DDS = Deflation Detection System) *

If a tyre loses pressure, it grows smaller. It then rotates at a different speed than the other tyres. If the system detects a difference in speed, control indicator (⚠) illuminates red.

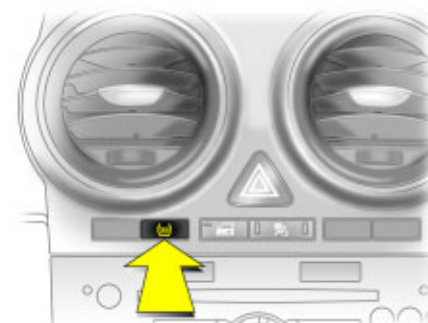

After tyre pressure is corrected or a tyre or wheel is changed, the system must be initialised by pressing the DDS button.

Deflation detection system * ↻ 164.

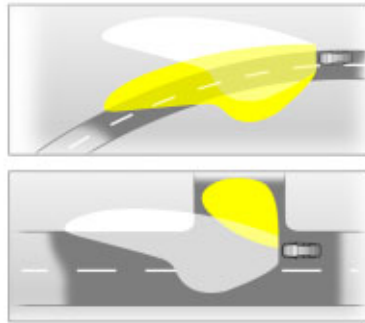

Adaptive Forward Lighting (AFL)*

ensures better illumination of

- bends (curve lighting),
- crossings and narrow bends (cornering light).

Curve lighting (1)

The light beam pivots based on steering wheel position and speed (from approx. 10 km/h).

Cornering light (2)

An additional lamp throws a beam approx. 90° to the left or right, if the steering-wheel is turned approx. 90°, the turn signal is activated and the speed is below approx. 40 km/h.

Reversing function

If the lights are on, reverse gear is engaged, and the turn signal is activated, the cornering light on the appropriate side is switched on.

Adaptive headlight ↻ 112.



Personalised key



If the vehicle is used by a number of drivers, each driver can store his or her own preferred settings and vehicle functions using their key. These settings and functions are then activated when the relevant key is used.

A total of up to five vehicle keys can be programmed separately and used.

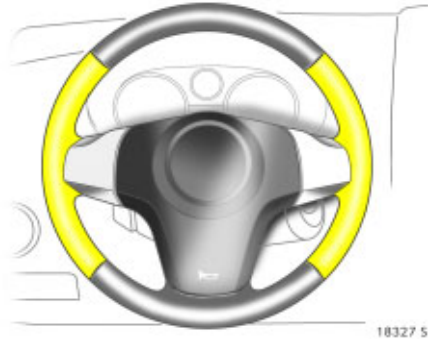
Personalised key ↻ 39.



Heated steering wheel *

Heating of the steering wheel and of the driver's seat is switched on by a single, or repeated (as appropriate) activation of the switch  .

Heating of the steering wheel - the section marked out in the illustration.

Heated steering wheel ⇨ 51.

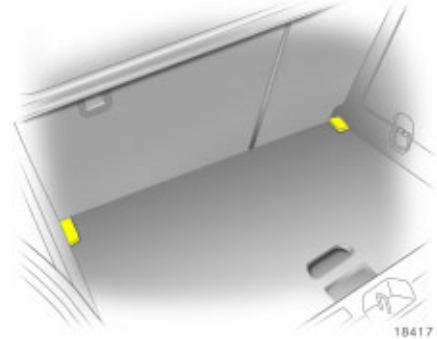

Double load-bay floor *

Double load-bay floor, which can be inserted in the baggage compartment in two positions.

If mounted in the upper position, the space between the load-bay floor and the spare wheel well cover * can be used as a stowage compartment.

In this position, if the rear seat backrests are folded forwards, an almost completely flat load bay is created.

Double load-bay floor ⇨ 82.



Flex-Fix system *

The Flex-Fix system allows two bikes to be attached to a pull-out carrier integrated into the vehicle floor.

If not in use, the Flex-Fix system can be collapsed back into the vehicle floor.

Flex-Fix system ⇨ 174.

Diesel particle filter *

The diesel particle filter system filters harmful soot particles out of the exhaust gases. The system includes a self-cleaning function that runs automatically during driving. The filter is cleaned by burning off the soot particles at high temperature. This process takes place automatically under set driving conditions and may take up to 25 minutes. Fuel consumption may be higher during this period. The emission of smells and smoke during this process is normal.

Under certain driving conditions, e.g. short journeys, the system may not clean itself automatically.



If the filter requires cleaning and previous driving conditions did not enable automatic cleaning, control indicator  flashes.

Further instructions ⇨ 157.

Keys, doors, windows, sun roof

Replacement keys	26
Key with foldaway key section *	26
Car Pass.....	26
Electronic immobiliser.....	27
Central locking system with key activation *.....	28
Remote control *.....	31
Central locking system with remote control *.....	32
Malfunction in remote control.....	35
Malfunction in central locking system.....	35
Luggage compartment.....	36
Anti-theft alarm system *	37
Child safety locks *.....	39
Personalised key	39
Exterior mirrors.....	42
Interior mirror	44
Manual window operation.....	44
Electric windows * on the front doors	45
Sun roof *	46

Replacement keys

The key number is specified in the Car Pass *.

The key is part of the electronic immobiliser.

Locks ⇨ 230.



17027 T

Key with foldaway key section *

Press button to extend. To retract, press button and audibly engage key blade.

Car Pass

The Car Pass contains safety-related vehicle data and should therefore be kept in a safe place.

When the car is taken to a workshop, the Car Pass data is needed in order to perform certain operations.

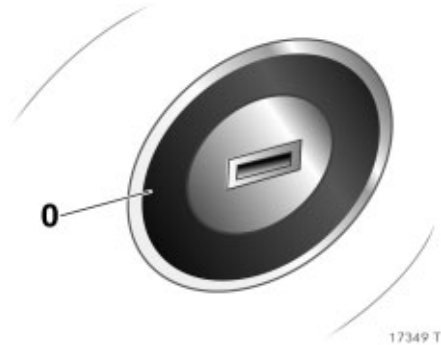

17349 T

Electronic immobiliser

The system checks whether the vehicle is allowed to start with the key used. Once the transponder in the key is recognised, the vehicle can be started.

The electronic immobiliser activates automatically when the key is removed from the ignition switch.



18231 S

Control indicator for immobilizer

Control indicator illuminates briefly when the ignition is switched on.

If the control indicator flashes when the ignition is on, there is a fault in the system; the engine cannot be started. Switch off the ignition and then repeat the start attempt.

If the control indicator continues to flash, please try to start the engine using the second key and contact a workshop.

If control indicator illuminates after the engine has started, there is a fault in the engine electronics or transmission electronics or there is water in the diesel fuel filter.

Note

The immobiliser does not lock the doors. You should always lock the vehicle after leaving it and switch on the anti-theft alarm system.

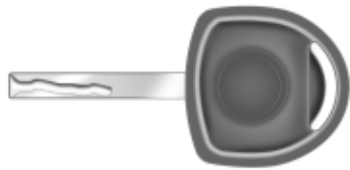

1B407 5

Central locking system with key activation ✳

Used to unlock and lock doors and luggage compartment.

Central locking system with remote control ⇨ 32.

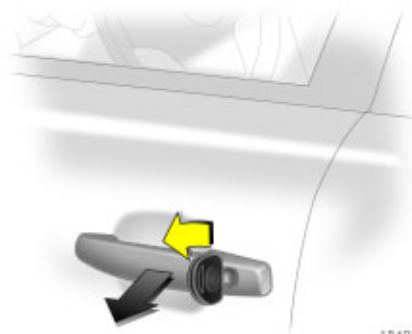

1B408 5

To unlock

Turn the key in the driver's door lock to the front: all doors and the luggage compartment will be unlocked.

Pull handle to open doors.

Fuel filler cap ⇨ 153.



1B158 5

Open luggage compartment

When the central locking system is unlocked, pull the button beneath the lever.

⚠ Warning

Do not drive with the tailgate open or ajar, e.g. when transporting bulky objects, since toxic exhaust gas could penetrate the interior.

After fitting certain accessories, it might not be possible to keep the tailgate in the open position.



18246 5

Close luggage compartment

Close the luggage compartment with the handle on the inside of the tailgate.

Do not operate the button beneath the handle when closing. Otherwise the luggage compartment will once again be unlocked.

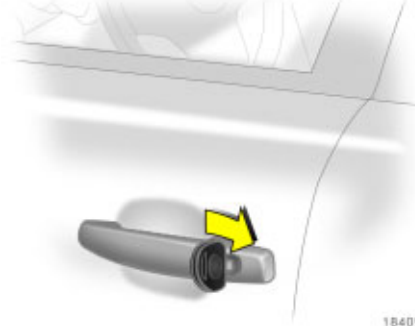

18409 5

To lock

Close doors and luggage compartment.

Turn the key in the driver's door lock towards the rear: all doors and the luggage compartment will be locked.

Fuel filler cap ↗ 153.

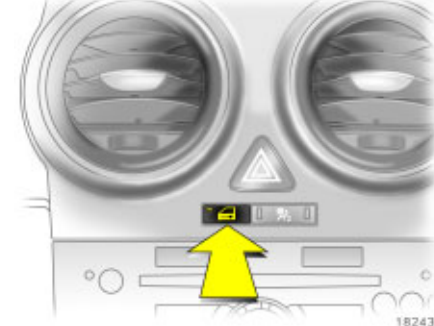

18243 5

Central locking button for locking and unlocking the doors from inside the vehicle

Press button  in the centre console: doors are locked or unlocked.

The LED in the central locking button  comes on for approx. 2 minutes once the vehicle is locked with the key in the driver's door lock.

If the doors are locked from inside using the central locking button while the vehicle is in motion, the LED  stays on.

If the key is in the ignition, locking is only possible if all doors are closed.

30 Keys, doors, windows, sun roof

Malfunction in central locking system

To unlock

Turn the key in the driver's door lock to the front until it stops. Turn the key back and remove it. The other doors can be opened by pulling the handle on the inside of the doors. The luggage compartment and fuel filler cap remain locked.

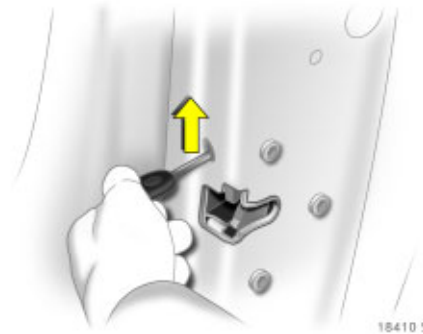

To lock

Put the key in the opening above the lock on the inside of the door and activate the lock audibly by lifting with the key, then close the door. This procedure must be followed for every door. The driver's door can also be locked from the outside using the lock. The unlocked fuel filler cap and tailgate or boot lid cannot be locked.

Note

- If the driver's door is not closed properly, the central locking system will not lock.
- To lock the doors from the inside (e. g. to prevent unwanted entry from outside), press central locking button  in the centre console.
- The doors can also be opened from the inside by pulling the handle even when the central locking system is locked.
- Locked doors unlock automatically in the event of an accident of a certain severity (to allow external help to gain access). The hazard warning lamps and courtesy lamp also come on. For this to occur, the key must be in the ignition switch.
- If the central locking system is overloaded as a result of repeated operation at short intervals, the power supply is cut off for a brief period.

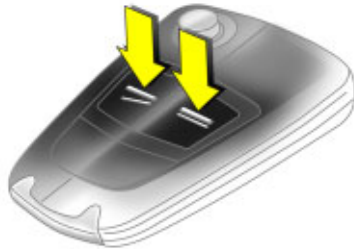

17029 T

Remote control ✱

Depending on the equipment of the vehicle, one of the remote controls depicted on this page will be used.

The remote control is integrated in the key.

Used to operate:

- central locking system,
- mechanical anti-theft locking system ✱,
- anti-theft alarm system ✱.

On cars with electric windows, the windows can be opened and closed from outside using the remote control ✱ ⇨ 45.

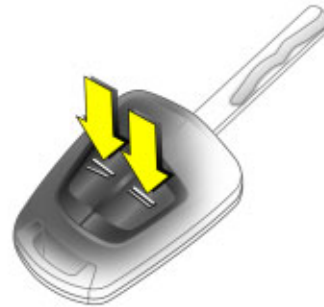

17030 T

The remote control has a range of approx. 5 metres. This range can be affected by outside influences. Aim the remote control at the vehicle to operate. The hazard warning lamps flash to confirm remote control operation.

Handle the remote control with care, protect it from moisture and high temperatures and avoid unnecessary operation.

Fault

If the central locking system cannot be operated with the remote control, it may be due to the following:

- Range exceeded.
- Remote control battery voltage too low. Change battery.
- Frequent, repeated operation of the remote control outside the reception range of the vehicle (e.g. too far from vehicle, remote control is then no longer recognised). Remote control synchronisation.
- If the central locking system is overloaded as a result of repeated operation at short intervals. The power supply is cut off for a brief period.
- Interference from higher-power radio waves from other sources.

Open driver's door with key ⇨ 35.

32 Keys, doors, windows, sun roof

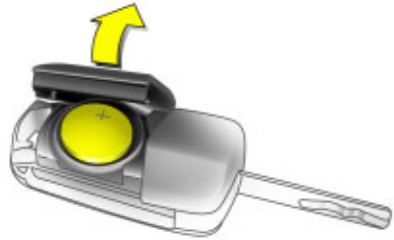

17031 T

Remote control battery replacement

Replace the battery as soon as the range of the remote control begins to shrink.

Batteries do not belong in household waste. They must be disposed of at an appropriate recycling collection point.

Key with foldaway key section

Extend the key ↻ 26. Open the remote control. Replace the battery (battery type CR 20 32), noting installation position. Close the remote control and synchronise.

Key with fixed key section

Have the battery changed in a workshop.

Synchronise remote control

After replacing the battery, unlock the door with the key in the lock ↻ 35. The radio remote control will be synchronised when you switch on the ignition.



18399 S

Central locking system with remote control ✳

Used to unlock and lock doors, luggage compartment and fuel filler flap.

Central locking system with key activation ↻ 28.





16968 T

To unlock

Press button  on radio remote control.

Pull handle to open doors.

Selective unlocking *

You can set the system so that pressing the button  once unlocks just the driver's door, and pressing the button  twice unlocks the entire vehicle.

This function can be activated and deactivated depending on the key used, see "Personalised key", P5 ⇨ 39 ⇨ 41.

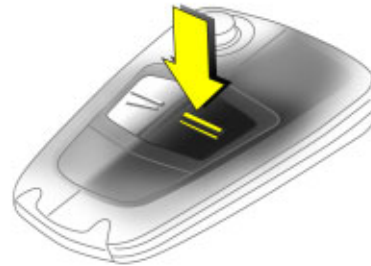

17042 T

To lock

Close doors, luggage compartment and tank flap.

Press button  on radio remote control.

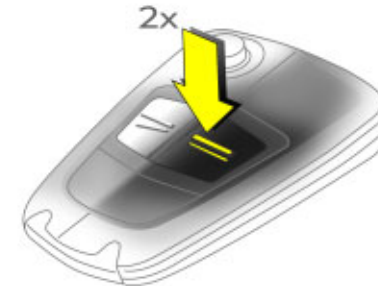

17043 T

Mechanical anti-theft locking system *

⚠ Warning

Do not use the system if there are people in the vehicle! The doors cannot be unlocked from the inside.

All doors must be closed.

If the ignition was on, the driver's door must be opened and closed once so that the vehicle can be secured.

All doors are secured against opening.

Within 10 seconds of locking, press the  button on the remote control again.

The mechanical anti-theft locking system is switched off when the vehicle is unlocked.

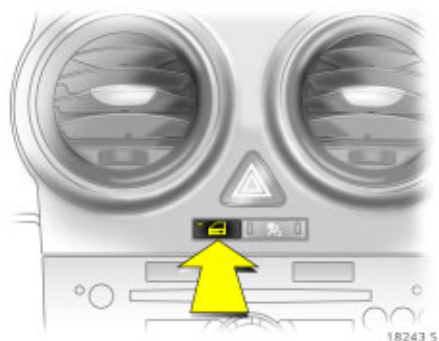

Central locking button for locking and unlocking the doors from inside the vehicle

Press button  in the centre console: doors are locked or unlocked.

The LED in the central locking button  comes on for approx. 2 minutes once the vehicle is locked with the remote control.

If the doors are locked from inside using the central locking button while the vehicle is in motion, the LED  stays on.

If the key is in the ignition, locking is only possible if all doors are closed.

The doors cannot be unlocked with this button when the anti-theft locking system * is activated.

Note

- If the driver's door is not closed properly, the central locking system will not lock.
- The doors lock again automatically a short time after unlocking the vehicle using the remote control if no door is opened in the meantime.
- To lock the doors from the inside (e. g. to prevent unwanted entry from outside), press central locking button  in the centre console.
- The doors can also be opened from the inside by pulling the handle even when the central locking system is locked.
- Locked doors unlock automatically in the event of an accident of a certain severity (to allow external help to gain access). The hazard warning lamps and courtesy lamp also come on. For this to occur, the key must be in the ignition switch.

Fault

If the central locking system cannot be operated with the remote control, it may be due to the following:

- If the central locking system is overloaded as a result of repeated operation at short intervals. The power supply is cut off for a brief period.
- Faulty fuse in fuse box ⇨ 209.

Please contact a workshop to have the cause of the fault remedied.

Opening driver's door with key ⇨ 35.

Automatic locking *

Above a certain speed, the central locking system automatically locks all doors.

This function can be activated and deactivated depending on the key used, see "Personalised key", P4 ⇨ 39 ⇨ 41.

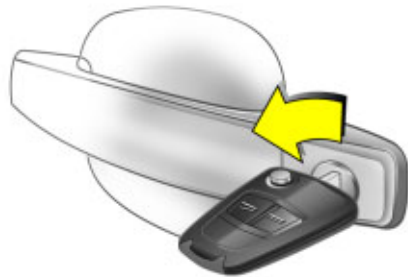

17047 T

Malfunction in remote control

To unlock

Turn the key in the driver's door lock to the front until it stops. Turn the key back and remove it. Open the driver's door. To open the other doors, switch on the ignition and press the central locking button.

To lock

Open passenger door, close driver's door, press central locking switch  in centre console. Central locking system locks all doors. Close passenger door.

Malfunction in central locking system

To unlock

Turn the key in the driver's door lock to the front until it stops. Turn the key back and remove it. The other doors can be opened by pulling the handle on the inside of the doors (not possible if the anti-theft locking system * has been activated). The luggage compartment and fuel filler cap remain locked. To deactivate the anti-theft alarm system *, switch on the ignition  16.



18410 S

To lock

Put the key in the opening above the lock on the inside of the door and activate the lock audibly by lifting with the key, close the door. This procedure must be executed for every door. The driver's door can also be locked from the outside using the lock. The unlocked fuel filler cap and tailgate or boot lid cannot be locked.

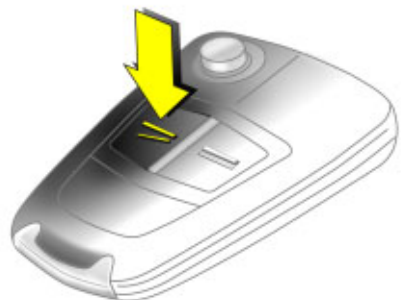

16968 T

Luggage compartment

To unlock

Press button  on the remote control, the luggage compartment and the doors will be unlocked.

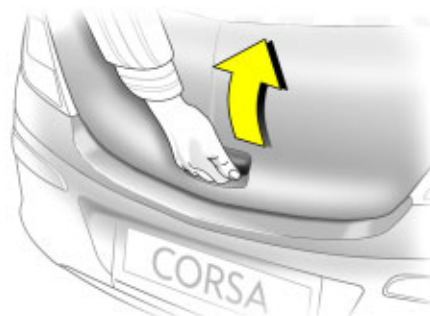

18158 5

To open

The luggage compartment is opened by operating the button beneath the handle.

Warning

Do not drive with the tailgate open or ajar, e.g. when transporting bulky objects, since toxic exhaust gas could penetrate the interior.

After fitting certain accessories, it might not be possible to keep the tailgate in the open position.



18246 5

To close

Close the tailgate using the handle on the inside of the tailgate.

Do not press the release button under the trim strip while closing as this will unlock it again.

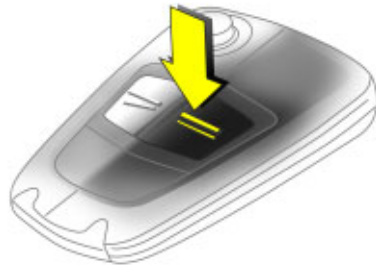

17042 T

To lock
Press button  on radio remote control.

Anti-theft alarm system *
monitors

- Doors, tailgate, bonnet,
- The ignition.

⚠ Warning

Do not use the system if there are people in the vehicle! The doors cannot be unlocked from the inside.

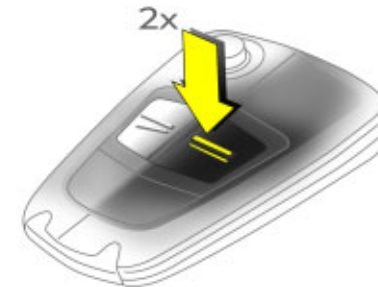

17043 T

To activate
All doors and the bonnet must be closed. Press the remote control button  again at the latest 10 seconds after locking.

If the ignition was switched on, the driver's door must be opened and closed once so that the anti-theft alarm system can be switched on.

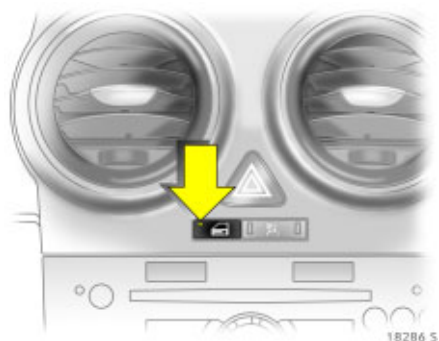

Light emitting diode (LED)

During the first 10 seconds of anti-theft alarm system activation:

- LED comes on = Test, delayed switch-on,
- LED flashes rapidly = Door, tailgate or bonnet open, or system fault.

After the first 10 seconds of anti-theft alarm system activation:

- LED flashes slowly = System switched on.

Contact a workshop for assistance if problems are encountered.



To deactivate

Press button  on remote control

– or –

Switch on ignition.

In the case of a malfunction in the remote control, use the key to unlock the vehicle ⇨ 35.

If the alarm is triggered when the driver's door is opened, deactivate the anti-theft alarm system by switching on the ignition.

Alarm

When triggered, the alarm gives off an acoustic signal (horn) and a visual signal (hazard warning flashers). The number and duration of the alarms are stipulated by legislation.

The alarm can be silenced by pressing a button on the remote control or by switching on the ignition. The anti-theft alarm system is deactivated at the same time.



18287 5

Child safety locks *

⚠ Warning

Use the child safety lock whenever children are occupying the rear seats.

Turn rotary knob at rear door lock from vertical position using key: door cannot be opened from the inside.

Personalised key Store personalised settings or vehicle-specific functions in the vehicle key

If the vehicle is used by a number of drivers, each driver can store his or her own preferred settings and vehicle functions using their key. These settings and functions are then activated when the relevant key is used.

A total of up to five vehicle keys can be programmed separately and used.

Automatically saved settings

The last settings selected

- the climate control system *
- the information display *
- the infotainment system *
- the instrument illumination,

are automatically stored depending on the vehicle key used.

Different settings are stored for each vehicle key. Use of a specific vehicle key will activate the settings associated with it.

The settings are stored once more every time the vehicle is locked.

40 Keys, doors, windows, sun roof

Programmable functions

The vehicle-specific functions P1 to P7 listed in the following table can be activated and deactivated.

The setting selected is automatically stored depending on the vehicle key used.

Different settings are stored for each vehicle key. Use of a specific vehicle key will activate the settings associated with it.

A total of up to five vehicle keys can be programmed separately.

Programming permits the technical prerequisite of the relevant function. To activate and deactivate the functions and set the functions, please see the relevant sections. For page references, see the following table.

Programming:

- Turn the ignition off, the key must be in the ignition lock,



- Pull turn signal stalk and wiper stalk simultaneously to the steering wheel until you hear a confirmation signal (approx. 3 seconds),
- The kilometre display shows **P1**,

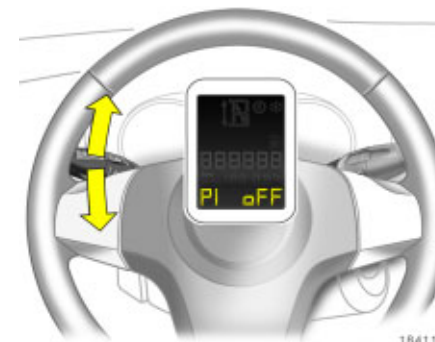

- Push the turn signal stalk (left) up or down and select the desired function **P1 - P7**, see the following table,



- Push the wiper stalk (right) up or down and select status **On** or **OFF**, or input a value for speed (P6) or value for volume (P7),
- Pull turn signal stalk (left) and wiper stalk (right) simultaneously to the steering wheel until you hear a confirmation signal (approx. 3 seconds).

The selected settings are now stored for the key in the ignition lock. To activate and deactivate the functions and set the functions selected, please see the relevant sections. For page references, see the following table.

Repeat the procedure to program additional keys.

Overview of programmable functions

Function designation	Function	Status ex works	Description
P 1	Switch on the external lighting using the remote control (lead-me-to-the-car lighting function)	OFF	↻ 113
P 2	Automatic rear windscreen wiper when reverse gear is selected	OFF	↻ 13
P 3	Lane change indication: three flashes when the lever is moved slightly	On	↻ 11
P 4	Automatic locking	OFF	↻ 34
P 5*	Selective unlocking	OFF	↻ 33
P 6	Speed warning	OFF	↻ 92
P 7	Volume of the acoustic turn signal	3	↻ 110

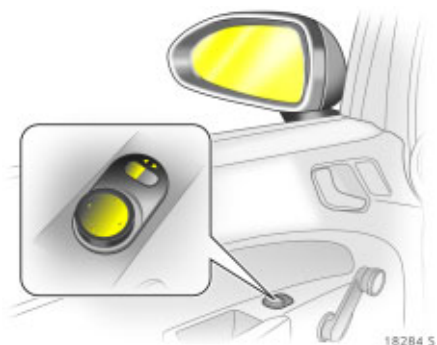

Exterior mirrors

Setting with switches in the driver's door console.

Setting with four-way switch in version with manual window operation

Select the mirror to be adjusted using the rocker switch and adjust using the four-way switch.



Setting with four-way switch in version with electronic window operation

Select the mirror to be adjusted using the rocker switch and adjust using the four-way switch.

Aspherical mirror glass *

The aspherical mirror glass makes the blind angle smaller. The curvature makes objects look smaller, making it more difficult to estimate how far away following vehicles are.

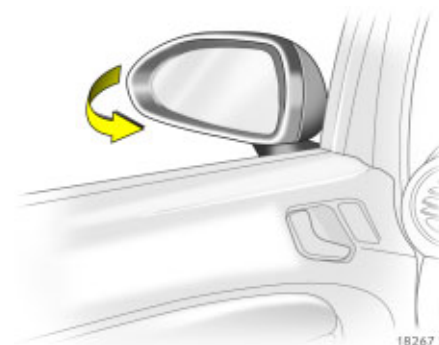

To retract exterior mirrors

The exterior mirrors can be folded in by gently pressing the outer edge of the housing.

Return the mirrors to the driving position before starting off.



18248 S

For the safety of pedestrians, the exterior mirrors will swing out of their normal mounting position if they are bumped with sufficient force. Reposition the mirror by applying slight pressure to the mirror housing.

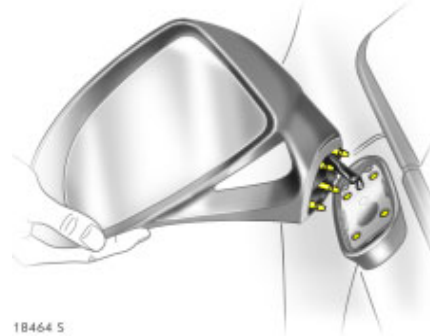

18464 S

For the safety of pedestrians, the exterior mirrors of the Corsa OPC are released from the holder if they are bumped. Fit mirror housing to holder with latching lugs and engage by striking gently.



18206 S

Heated exterior mirrors ❄️

Heating is activated or deactivated by pressing the  button.

Heating works with the engine running and is switched off automatically after a few minutes.



18283 S

Interior mirror

Swivel mirror housing to adjust.

Manual anti-dazzle interior mirror

To reduce dazzle, swivel the lever on the underside of the mirror housing.



18196 S

Automatic anti-dazzle interior mirror*

Dazzling at night is reduced automatically.

The interior mirror does not reduce dazzle when:

- the ignition is switched off,
- reverse gear is engaged or selector lever set to R.

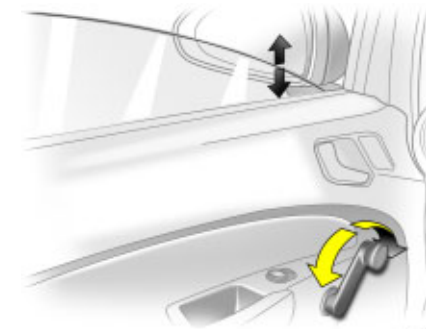

18315 S

Manual window operation

The door windows can be operated using window winders.

Electric windows ✳ on the front doors

⚠ Warning

Take care when operating the electric windows. Risk of injury, particularly to children.
Keep a close watch on the windows when closing them. Ensure that nothing becomes trapped in them as they move.

Operational readiness

The electric windows can be used

- with ignition on,
- within 5 minutes of switching ignition off,
- within 5 minutes of switching ignition key to position 1.

After switching off the ignition, the operational readiness is terminated by opening the driver's door.



18202 5

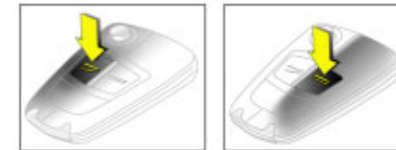
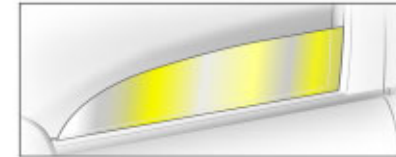

17046 T

Operation

For incremental operation, briefly pull or press the switch. For automatic opening or closing, pull or press the switch longer. Pull or press the switch again to stop the movement.



Safety function

If the window glass encounters resistance above the middle of the window during automatic closing, it is immediately stopped and the window opened again.

In the event of difficulty due to frost or the like, press the relevant window switch several times until the window is closed.

Operating windows from outside ✳

The windows can be opened and closed from outside the vehicle using the remote control.

Hold button  or  on the remote control depressed until all windows have opened or completely closed.



18206 5

Heated rear window *

Heating is activated or deactivated by pressing the  button.

Heating works with the engine running and is switched off automatically after a few minutes.

The heated rear window automatically switches on when the diesel particle filter is being cleaned * depending on the engine.

Overload

If the windows are repeatedly operated at short intervals, the power supply is briefly cut off.

Fault

If the windows cannot be opened and closed automatically, activate the window electronics as follows:

1. Close doors.
2. Switch on ignition.
3. Close the window completely and hold the button depressed at least 5 seconds longer.
4. Open the window completely and hold the button depressed at least 1 second longer.
5. Repeat for each window.

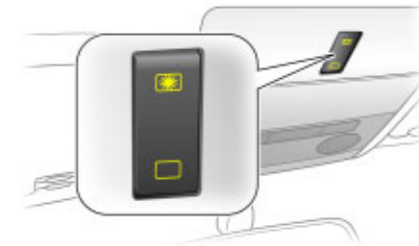

18371 5

Sun roof *

⚠ Warning

Take care when operating the electric sunroof *. Risk of injury, particularly to children.

Keep a close watch on the sun roof when it is being closed. Ensure that nothing becomes trapped.

Operated via a rocker switch in the roof console when the ignition is switched on.

Press the button briefly for activation in steps. Hold down the button for longer for automatic opening.

To raise

With the sun roof closed, press button . The sun roof is raised at the rear.

To open

Press button  again with the sun roof in the raised position. The sun roof opens automatically until it reaches its limit position.

To close

Hold down button  until the sun roof is completely closed.

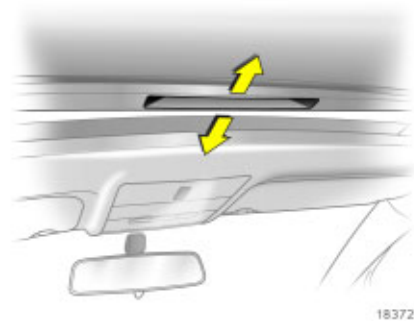

Sunblind

The sun blind can be opened and closed manually whether the sun roof is open or closed.

Note

- If the top of the roof is wet, tilt sun roof, allow water to run off and then open sun roof.
- When using a roof rack , check the free movement of the sun roof in order to avoid damage. It is only permitted to raise the sun roof.

Overload

If the system is overloaded, the power supply is automatically cut off for a short time.

The system is protected by fuses in the fuse box – see page  208.

Fault

If perfect function of the sun roof is not guaranteed. Activate the electronics as follows:

1. Switch on ignition.
2. Close the sun roof and hold button  depressed at least 10 seconds.

Please contact a workshop to have the cause of the fault remedied.

Seats, Interior

Front seats	48
Head restraints	51
Luggage compartment extension * ..	53
Luggage compartment cover	54
Lashing eyes	56
Notes on loading the vehicle	57
Three-stage safety system	58
Three-point seat belts	58
Belt tensioners	60
Seat belt operation	62
Child restraint system *	63
Mounting clips * for ISOFIX child restraint systems	68
Attachment eye * for Top-Tether child restraint systems	68
Airbag system	69
Cigarette lighter *	80
Accessory socket *	80
Ashtray *	81
Drink holder	81
Stowage compartments	82
Sun visors	83



Front seats

⚠ Warning

Never adjust seats while driving. They may make uncontrolled movements.

Adjust longitudinal seat position

Pull handle at front of seat, move seat and then release handle.



Adjusting the backrests

Take the pressure off the backrest and turn the hand wheel on the side.



18161 S

Adjust height of seat ✱
 Operate lever on the door side of seat.
 Pump action of lever
 Upwards = Seat higher
 Downwards = Seat lower

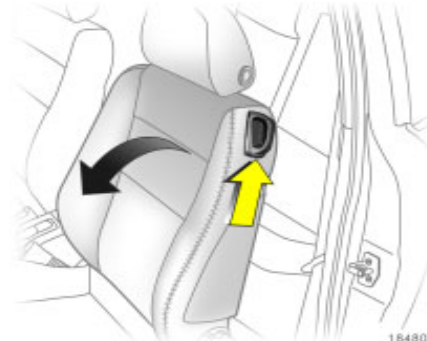

18480 S

Tilting the backrests forward ✱
 To tilt the backrests forward, lift release lever and tilt backrest forward. Lower release lever and backrest engages in lowered position ✱. Slide seat forwards ✱.
 To push the seat back to upright, it engages in its original position ✱. Lift the locking lever ✱, move the backrest back to upright, lower the locking lever, backrest engages.
 Folding the backrest forwards is possible only when the backrest is in an upright position.
 Do not operate handwheel to adjust backrest with backrest tilted forward.

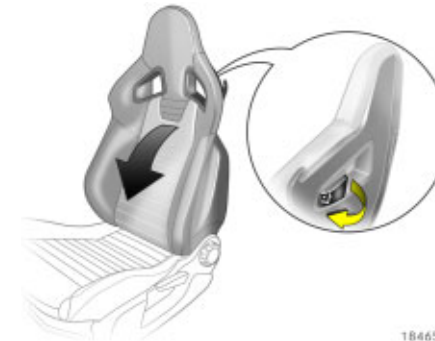

18465 S

Tilting backrests forward, Corsa OPC
 Remove seat belt from belt mount on backrest.
 To tilt the backrest forward, pull release lever on rear of backrest and tilt backrest forward. Release the release lever and backrest engages in the lowered position ✱. Slide seat forward ✱.
 To move the backrest upright, slide seat back and it will engage in its original position ✱. Pull release lever ✱, move backrest upright, release the release lever, backrest engages.
 Folding the backrest forwards is possible only when the backrest is in an upright position.
 Do not operate handwheel to adjust backrest with backrest tilted forward.

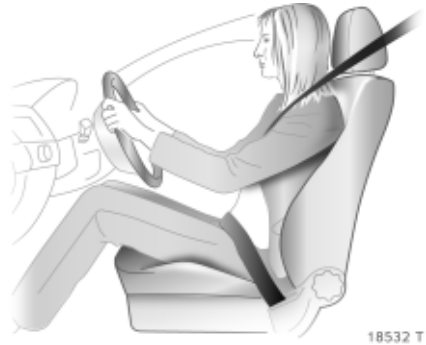

Seat position

⚠ Warning
Only drive with the seat correctly adjusted.

- Sit with your buttocks as far back against the backrest as possible. Adjust the distance between your feet and the pedals so that your legs are slightly angled when pressing the pedals. Slide the passenger seat as far back as possible.

- Sit with your shoulders as far back against the backrest as possible. Set the backrest rake so that you can easily reach the steering wheel with your arms slightly bent. Maintain contact between your shoulders and the backrest when turning the steering wheel. Do not angle the backrest too far back. We recommend a maximum rake of approx. 25°.
- Adjust the steering wheel ↻ 5.
- Set seat height * high enough to have a clear field of vision on all sides and of all display instruments. There should be at least six inches of clearance between your head and the headlining. Your thighs should rest lightly on the seat without pressing into it.
- Adjust the head restraint.
- Adjust the height of the seat belt ↻ 63.

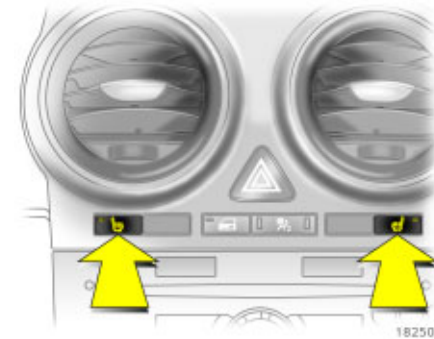

Heated front seats *

Two buttons beneath the centre air vents for the left and right seats.

When the ignition is switched on, the heating of the front seats is activated by pressing the corresponding button .



LED in button  on: relevant front seat heating on.

No LED on: front seat heating is off.

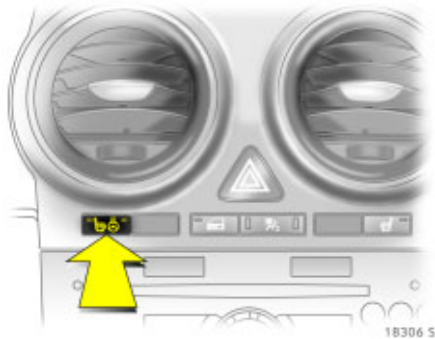

Seat heating is operational when the engine is running.





Heated driver's seat ✱, heated steering wheel ✱

When the ignition is switched on, the heating of the steering wheel and/or the driver seat is activated by pressing the corresponding button   once or several times.

LED  on: heating of the driver seat.

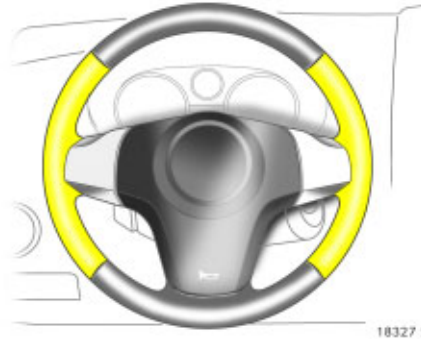
LEDs  and  on: heating of the driver seat and steering wheel.



LED  on: heating of the steering wheel.

No LED on: heating of the driver seat and steering wheel off.

The steering wheel is heated with the engine running in the area shown in the illustration above.

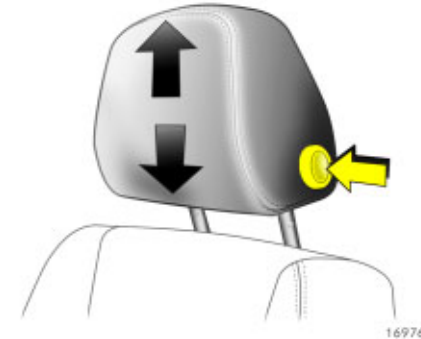

Head restraints

Front head restraint adjustment ✱

To adjust, press button on side and adjust height.

Set height according to body size.



18275 S

Adjusting the rear head restraints *

The height of the head restraints can be set in two positions. To set in the first position, pull the head restraint up, in the second position press the spring marked in the illustration and push the head restraint right up to the top.

To adjust downwards, press the spring marked in the illustration and push the head restraint down.

To fold down the backrests ⇨ 53 or improve visibility when the rear seats are not occupied, push the head restraint all the way down.

If the rear seats are occupied, adjust the rear head restraints accordingly to body size.

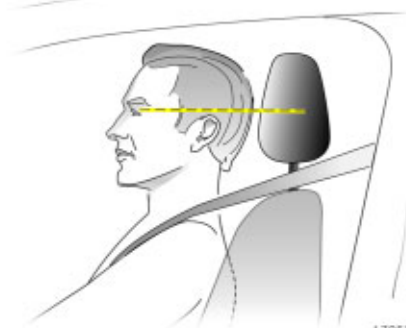

17055 T

Head restraint position

⚠ Warning

Only drive with the head restraint set to the proper position.

The middle of the head restraint should be at eye level. If this is not possible for extremely tall persons, set to highest position, and set to lowest position for small persons.

Active head restraints *

In the event of a rear-end impact, the active head restraints automatically tilt slightly forward. The head is more effectively supported by the head restraint and the danger of injury in the area of the cervical vertebra is reduced.

Note

Only approved objects or components must be attached to the head restraint of the unoccupied front passenger seat.

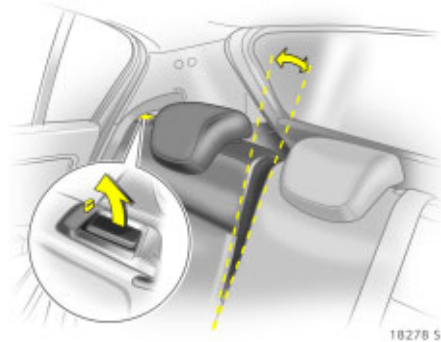

Luggage compartment extension *

Adjust angle of rear backrests

The rear backrest, in a single unit or split *, can also be locked in an upright position for transporting bulky items.

Pull the unlocking handle, pull the backrest forwards to the vertical position and allow to engage.

When unlocking, a red marking appears next to the unlocking lever. The backrest is only engaged correctly when the red bolt is no longer protruding.

If the backrest is split *, unlock the relevant side, and unlock at both sides if it is a single unit.

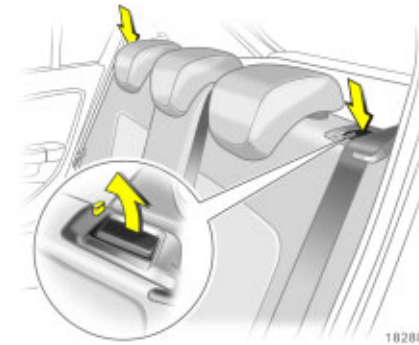

Folding the backrest

Remove luggage compartment cover and push rear headrests down as far as they will go ⇨ 52.

Move the seat belts to protect them against damage by means of side supports on the release lever. When folding the backrests, pull the seat belts along with them.

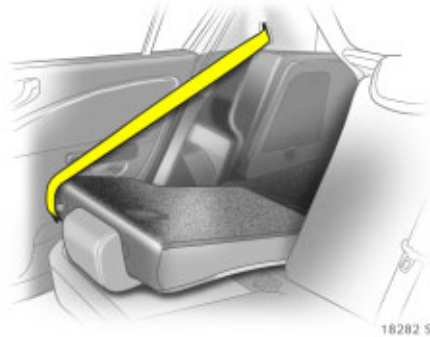

Disengage the backrest (single or split ✱) using the release lever and fold it down onto the seat cushion.

If the backrest is split ✱, unlock the relevant side, and unlock at both sides if it is a single unit.

If the vehicle is to be loaded via a rear door, take the seat belt out of the seat backrest guide, roll it up and insert the latch plate into the side shade retainer.

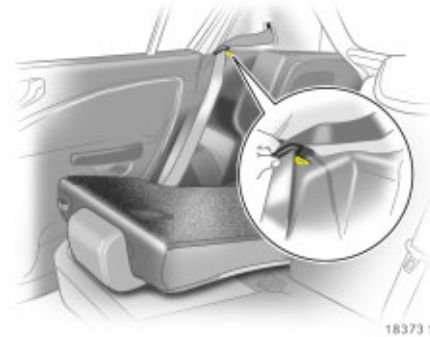

Restoring backrest to an upright position

Move rear seat backrests upright and allow locking mechanisms to audibly engage at both sides. Once the backrests are locked the red mark must no longer protrude.

The rear seat backrests can be locked in two positions.

Do not trap the seat belt when moving the backrest to the upright position.

Install the luggage compartment cover.

Stowage compartment beneath double load-bay floor ✱ ⇨ 82.

Luggage compartment cover

Do not place any heavy or sharp-edged objects on the cover.

To remove, unhook the retaining straps from the tailgate.

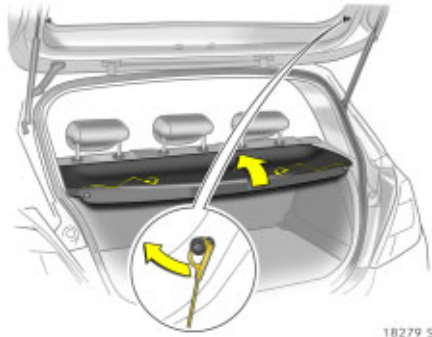

5-door passenger vehicle
Lift the cover backwards as shown in the illustration, until it unlatches, then remove.
Fit in reverse order.

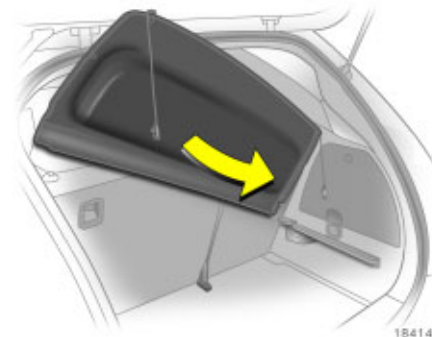

3-door passenger vehicle
Lift the cover backwards as shown in figure 18414 S, until it unlatches, set at an angle, then remove.
Fit in reverse order.

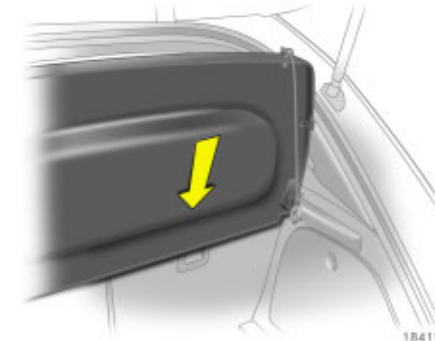

Stowing
When the luggage compartment is fully loaded, stow the luggage compartment cover behind the rear seat backrests:
Lift the cover backwards as shown in figure 18415 S, until it unlatches, then slide down in guides behind the seat backrests.

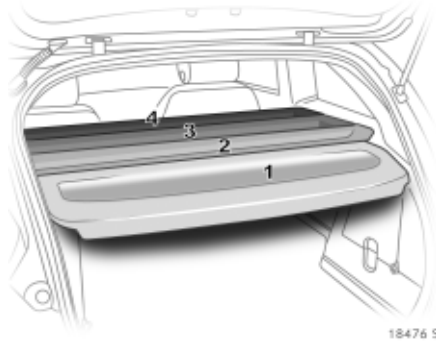

18476 S

Van

The luggage compartment cover consists of four segments which can be individually removed and inserted.

The rear segment (1) has identical functionality (removal and installation) to that of the 3-door passenger vehicle, see previous page.

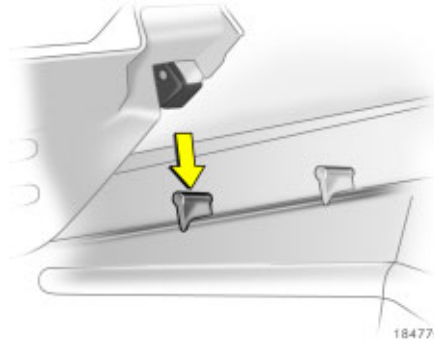

18477s

To remove the three other segments (order 2 to 4) lift at the rear, disengage, twist and remove.

Please install the segments in the order 4 to 1. Engage segments in recesses at the side.

The segments overlap at the connecting points when they are closed.

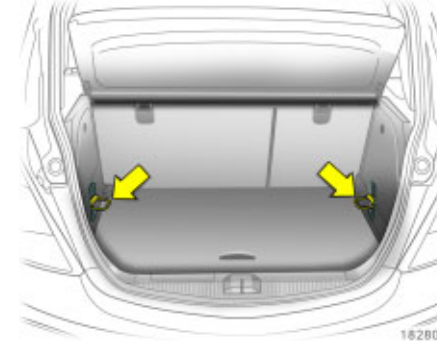

18280 S

Lashing eyes

Lashing eyes are provided to secure objects against sliding B with straps * or netting *.

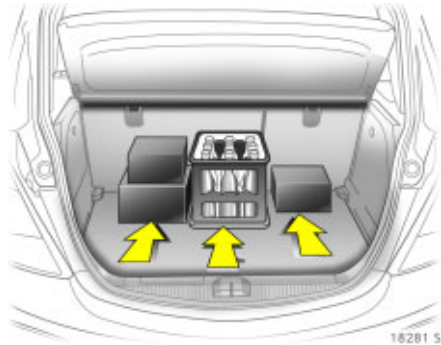

Notes on loading the vehicle

- Heavy objects in the luggage compartment should be placed against the properly engaged rear seat backrests or, if the rear seat backrests are folded down ✱, against the front seat backrests. If objects are to be stacked, the heavier objects should be placed at the bottom.
- Secure heavy objects with straps ✱ attached to lashing eyes.

- If the backrests are not folded down when transporting objects in the luggage compartment, they must be engaged in an upright position ✱ ⇨ 54.
- Do not allow the load to protrude above the upper edge of the backrests.
- The warning triangle ✱ and first-aid kit (cushion) ✱ must always be freely accessible.
- Do not place any objects in front of the rear window or on the instrument panel.
- Items loaded must not prevent operation of the pedals, hand brake and gears or obstruct the freedom of movement of the driver. Do not place loose objects in the interior.
- No objects must be placed in the airbag inflation area, since they could cause injury when the systems are triggered.
- Do not drive with luggage compartment open when transporting bulky objects, for example, since toxic exhaust fumes could penetrate the interior.
- The payload is the difference between the permitted gross vehicle weight (see identification plate ⇨ 250) and the EC kerb weight.
- To calculate the EC kerb weight, enter the data for your vehicle on page ⇨ 259.
- The EC kerb weight includes allowances for the driver (68 kg), luggage (7 kg) and all fluids (tank 90 % full).
- Optional equipment and accessories increase the kerb weight.
- Weights and loads ⇨ 259.
- Driving with a roof load increases the sensitivity of the vehicle to cross-winds and has a detrimental effect on vehicle handling due to the vehicle's higher centre of gravity. Distribute the load evenly and secure it properly with retaining straps. Adjust the tyre pressure to the load conditions. Do not drive faster than 120 km/h. Check and retighten the straps frequently. Observe country-specific regulations.
- The permissible roof load is 75 kg. The roof load consists of the weight of the roof rack plus the load carried.

Three-stage safety system

Comprising:

- Three-point seat belts.
- Belt tensioners at the front seats.
- Airbag systems for driver seat, front passenger seat * and outboard rear seats *.

The three stages are activated in sequence depending on the severity of the accident:

- The automatic seat belt locking devices prevent the belt strap from being pulled out and thus ensure that the vehicle occupants are retained in their seats.
- The front seat belts are pulled down at the belt locks and at the lower, outer attachment points *. This tensions the seat belt so the occupants are slowed down with the vehicle early as the vehicle stops, thus reducing stresses on the body.
- The airbag systems are also triggered in the event of severe accidents and form a safety cushion for the occupants.

⚠ Warning

The airbag systems serve to supplement the three-point seat belts and belt tensioners. The seat belts must therefore always be worn. Disregard of these instructions may lead to injuries or endanger life. Vehicle passengers should be informed accordingly.

Read the instructions supplied with the child restraint system.



18533 T

Three-point seat belts

The seat belts have an automatic retractor, so that the belt is spring tensioned and always lies against the body.

Information on correct seat position ⇨ 50.

The safety belts lock when the vehicle accelerates or decelerates rapidly. This prevents the belt from extending and keeps the occupant in his or her seat.

⚠ Warning

Fasten your seat belt before each trip. In the event of an accident, persons not wearing seat belts endanger their fellow occupants and themselves.

Seat belts are only intended for one person. They are not suitable for anyone under 12 years of age or under 150 cm tall.

For children under the age of 12, we recommend the Opel child restraint system ⇨ 63.

Belt force limiters

In the front seats, stress on the body is reduced by dampened release of the belt during a collision.



Control indicator  indicating that driver's seat belt has not been fastened

When the ignition is switched on, the control indicator  comes on for approx. 15 seconds.

If the driver does not fasten his seat belt within this time, the control indicator flashes  after setting off.

60 Seats, Interior

Checking the seat belts

From time to time, check operation of all seat belt system components and check for damage. Have damaged components replaced. Have seat belts and deployed belt tensioners replaced by an authorised workshop after an accident.

Make sure that seat belts are not damaged or trapped by sharp-edged objects.

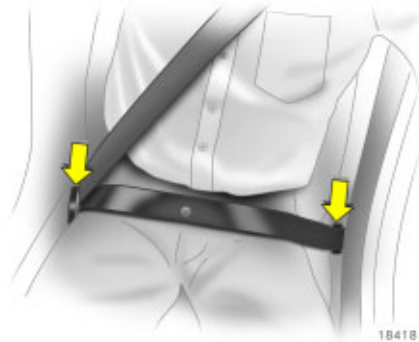

Belt tensioners

The front seat belt systems are pulled down at the belt buckles and the lower, outer attachment points * in the event of an accident of a certain severity. This tensions the seat belts in a uniform manner.



Actuation of belt tensioners

is indicated by illumination of control indicator *, see next column.

Triggered belt tensioners must be replaced by a workshop. Belt tensioners can only be triggered once.



18247 5

Control indicator  for belt tensioners
 The functionality of the belt tensioner systems is monitored electronically together with the airbag systems and indicated via the control indicator . When the ignition is switched on, the control indicator comes on for approximately 4 seconds. If it does not, or if it does not go out after 4 seconds, or if it comes on while driving, there is a fault in the belt tensioner system or the airbag systems  74. The systems might not be deployed in the event of an accident.

In the event of a fault in the belt tensioners, the LEDs flash in the button for switching off the airbag systems, in addition to the control indicator  coming on.

Deployment of the belt tensioners is indicated by continuous illumination of .

 Warning

Have the cause of the fault remedied immediately by a workshop.

The system's integrated self-diagnostics allows faults to be quickly remedied.

Note

■ Do not place or store items within the working range of the seat belt tensioners (near to the buckles or the seatbelt retractor). Do not modify any tensioner or retractor components or the vehicle's operating permit will be invalidated.

 Warning

Incorrect handling (e.g. removal or fitting of seat belts or belt buckles) can cause the belt tensioners to deploy, with risk of injury.

■ The belt tensioner and airbag system control electronics can be found in the centre console area. In order to avoid malfunctions, do not store magnetic objects in this area.

62 Seats, Interior

- When the rear seats are being used it must be ensured that the components of the front seat belts are not damaged by shoes or other objects. Do not allow dirt to penetrate the seat belt inertia reels.
- We recommend that you have the seats removed by a workshop.
- The belt tensioners only deploy once, which can be detected by illumination of the control indicator . Have deployed belt tensioners replaced by a workshop.
- The applicable safety regulations must be adhered to when the vehicle is disposed of. The vehicle should therefore be disposed of by a recycling company.



Seat belt operation

Fitting seat belts

The seat belt must not be twisted and must lie snugly against the body. The backrest must not be tilted back too far (maximum approx. 25°).

Adjust the height so that the belt lies across the shoulder. It must not lie across the throat or upper arm.

Pull the belt out of the reel, guide it across the body (making certain it is not twisted) and engage the latch plate in the buckle. Tension the lap belt frequently whilst driving by tugging the shoulder belt.

With the Corsa OPC Feed seat belt through belt mount on backrest when fastening seat belt.



Warning

On pregnant women in particular, the lap belt must be positioned as low as possible across the pelvis so as not to put too much pressure on the abdomen.

Loose or bulky clothing prevents the belt from fitting snugly. Do not place objects such as handbags or mobile phones between the belt and your body.

Warning

The belt must not rest against hard or fragile objects in the pockets of your clothing.

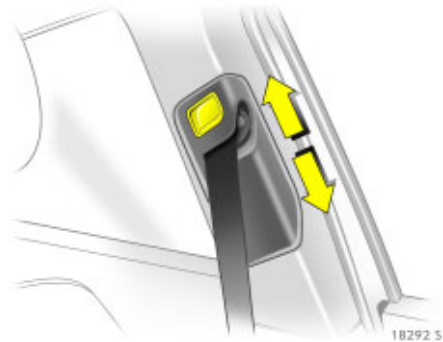

Height adjustment *

Adjusting the height of the upper deflection point of the front seat belts:

1. Unreel seat belt a little.
2. Press down button on adjuster slide.
3. Set desired height.
4. Allow sliding adjuster to audibly latch.

Do not adjust height while driving.

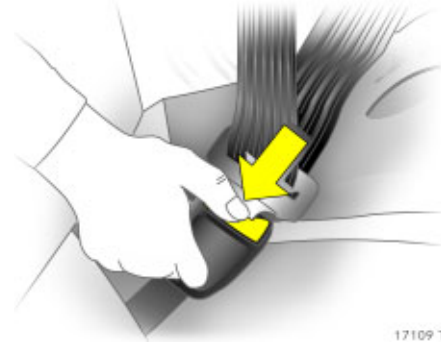

Removing the belt

To release seat belt, press red button on belt buckle.

Three-point seat belts on rear outer seats

When not in use or to fold forward the rear backrests, feed seat belts through belt mount * as shown in figure 18288 S on page 53.

Child restraint system *

Follow the usage instructions for the child restraint system.

Always comply with local or national regulations. In some countries, the use of child restraint systems is forbidden on certain seats.

Selecting the right system

Your child should be transported facing the rear in the vehicle for as long as possible. The very weak cervical vertebrae of a child will be under less stress in an accident if your child is facing the rear and semi-horizontal, than when he is sitting upright.

⚠ Warning

Child restraint systems must not be carried on a passenger's lap. Danger to life.

64 Seats, Interior

Permissible options for fitting a child safety seat

Weight and age class ¹⁾	On front passenger seat	On outer seats * of rear row of seats	On centre seat * of rear row of seats
Group 0: up to 10 kg or approx. 10 months	U ¹ , +	U, +	X
Group 0+: up to 13 kg or approx. 2 years			
Group I: 9 to 18 kg or approx. 8 months to 4 years	U ² , +, ++	U, +, ++	X
Group II: 15 to 25 kg or approx. 3 to 7 years			
Group III: 22 to 36 kg or approx. 6 to 12 years	X	U	X

¹⁾ We recommend the use of each system until the child reaches the upper weight limit.

U¹ = Conditional, only if front passenger airbag system switched off or in version without front passenger airbag.

Place the seat height * in its top position. Push the front passenger seat back as far as possible.

When attaching the child restraint system by means of a three-point seat belt, set the height of the anchorage point for the seat belt to its lowest position.

U² = Conditional, only if front passenger airbag system switched off or in version without front passenger airbag.

Place the seat height * in its top position. Push the front passenger seat back as far as possible.

When attaching the child restraint system by means of a three-point seat belt, the seat belt must run forwards from the anchorage point.

- U = Universal suitability in conjunction with three-point seat belt.
- + = Vehicle seat with ISOFIX mounting available¹⁾. Only the ISOFIX child restraint systems that are approved for the vehicle must be used when mounting with ISOFIX.
- ++ = Vehicle seat with ISOFIX mounting available¹⁾. Universally approved ISOFIX child restraint systems may be used when mounting with ISOFIX and Top-Tether.
- X = No child restraint system permitted in this weight class.

Note

- Children under 12 years or under 150 cm tall should only travel in an appropriate child restraint system.
- When transporting children, use the child restraint systems suitable for the child's weight.
- Ensure correct installation of child restraint system, see the instructions enclosed with the system.
- The covers of the Opel child restraint system can be wiped clean.

- Do not stick anything on the child restraint systems and do not cover them with any other materials.
- Only allow the child to enter and exit on the side of the vehicle facing away from the road.
- A child restraint system which has been subjected to stress in an accident must be replaced.
- Secure or remove child restraint systems that are in the vehicle but not in use.

¹⁾ Not available on the front passenger seat in the Corsa OPC.

66 Seats, Interior

Permitted options for the mounting of ISOFIX child restraint systems

Weight class ¹⁾	ISOFIX size class	Seat device	On front passenger seat	On an outboard seat in the rear row of seats
0: to 10 kg	E	ISO/R1	IL	IL
0+: up to 13 kg	E	ISO/R1	IL	IL
	D	ISO/R2	X	X
	C	ISO/R3	X	X
I: 9 to 18 kg	D	ISO/R2	X	X
	C	ISO/R3	X	X
	B	ISO/F2	IL, IUF	IL, IUF
	B1	ISO/F2X	IL, IUF	IL, IUF
	A	ISO/F3	X	X

¹⁾ We recommend the use of each system until the child reaches the upper weight limit.

- IUF = Mounting possible for universally approved, forward-facing ISOFIX child restraint systems in the specified weight class.
- IL = Mounting possible only with child restraint systems approved for the vehicle in the specified weight class.
- X = No ISOFIX child restraint system approved in this weight class.

ISOFIX size class and seat device

- A – ISO/F3: Forward-facing child restraint system for children of maximum size in the weight class 9 to 18 kg.
- B – ISO/F2: Forward-facing child restraint system for smaller children in the weight class 9 to 18 kg.
- B1 – ISO/F2X: Forward-facing child restraint system for smaller children in the weight class 9 to 18 kg.
- C – ISO/R3: Rear-facing child restraint system for children of maximum size in the weight class up to 13 kg.

- D – ISO/R2: Rear-facing child restraint system for smaller children in the weight class up to 13 kg.
- E – ISO/R1: Rear-facing child restraint system for young children in the weight class up to 13 kg.

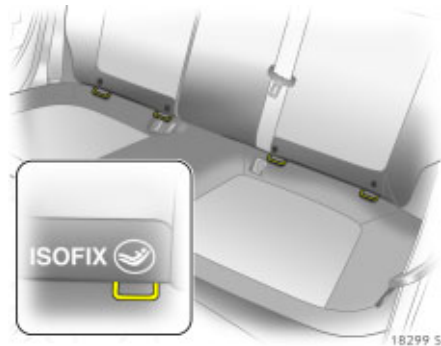

Mounting clips * for ISOFIX child restraint systems

ISOFIX child restraint fixing brackets are fitted to the rear outer seats * and the passenger seat * between the seat face and the back.

The position of the clips can be identified from the symbols on the backrest.

Fasten permitted ISOFIX child restraint systems to the mounting brackets.

Closely follow the installation instructions accompanying the ISOFIX child restraint system.

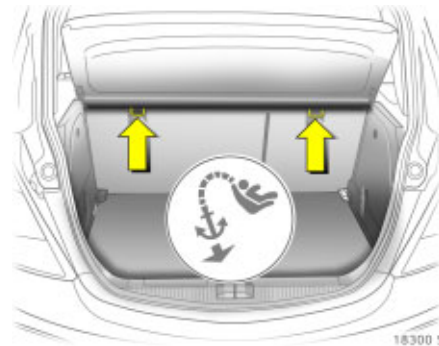

Attachment eye * for Top-Tether child restraint systems

Fit the Top-Tether child restraint system to the locating tabs on the back of the rear seat back and to the passenger seat rail in the rear foot well. The belt must run between the guides on the head restraint.

A symbol is located on the rear roof pillar trim and the attachment points by way of instruction on fitting on the attachment eyes on the rear seats.

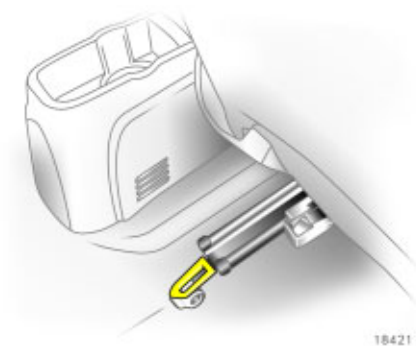

Closely follow the installation instructions accompanying the Top-Tether child restraint system.

Universally approved child restraint systems may be used when securing with ISOFIX and Top-Tether.



18195 S

Airbag system

Front airbag *



The front airbag system consists of one airbag in the steering wheel and one in the instrument panel. These can be identified by the word **AIRBAG**.

The front airbag system comprises:

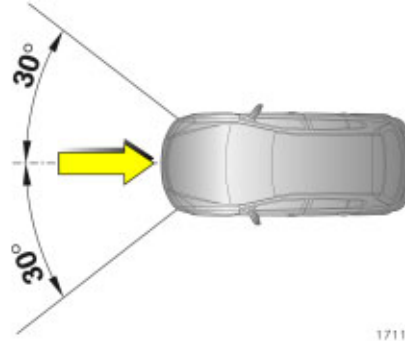
- an airbag with inflator in the steering wheel and a second one in the instrument panel,
- control electronics with impact sensors,
- the control indicator for airbag systems  in the instrument,



17112 T

- the system for deactivating the front and side airbags for the front passenger *
- the control indicator  for deactivated front passenger airbag systems and the LEDs in the button .

The front airbag system will be triggered:

- depending on the severity of the accident,
- depending on the type of impact,
- within the range shown in the illustration,
- independent of the side airbag * and curtain airbag system *.

The ignition must be switched on.

Exception:

The front and side airbags for the front passenger have been deactivated * because a child restraint system is mounted on the front passenger seat.

Deactivation of airbag systems for front passenger *, see page [↔ 75](#).

Mounting of Opel child restraint systems – see pages [↔ 63](#), [↔ 68](#).

Examples of events causing the front airbag system to deploy:

- Impact against a non-yielding obstacle: the front airbags are triggered at low vehicle speed.
- Impact against a yielding obstacle (such as another vehicle): the front airbags are only triggered at a higher vehicle speed.

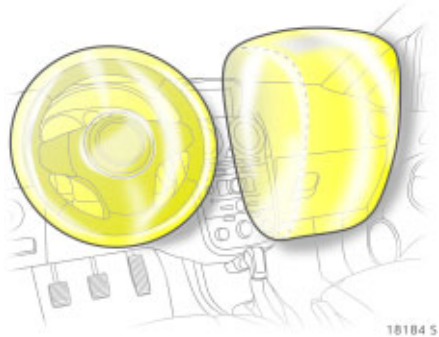

When they are deployed, the front airbags inflate within milliseconds to form a safety cushion for the driver and front passenger*. The forward movement of the front seat occupants is checked, thereby substantially reducing the risk of injury to the upper body and head.

No impairment of view will occur, because the airbags inflate and deflate so quickly that it is often not even noticed in an accident.

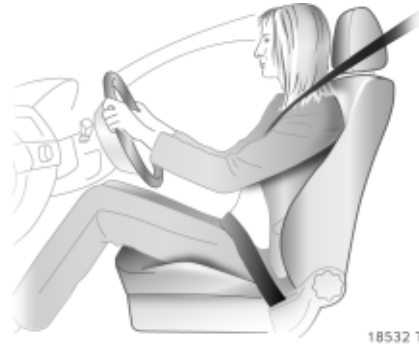

⚠ Warning

Optimum protection is only provided with the seat in the proper position ↗ 50. Keep the area in which the airbag inflates clear of obstructions.

Wear the three-point seat belt properly fastened. The front airbag system is an additional safety device, not a replacement for your seat belt.





The front airbag system will not be triggered in the event of

- the ignition is switched off,
- minor frontal collisions,
- accidents in which the vehicle overturns,
- collisions involving a side or rear impact.

that is to say, if it would not be of benefit to the occupants.

Also, the front airbag system is not deployed for the front passenger when the airbag systems for the front passenger are deactivated ✱.

Deactivated airbag systems for the front passenger ✱ are indicated by constant illumination of the LEDs in the button  and the control indicator .

Deactivating front passenger airbag systems ✱ ⇨ 75.



Mounting Opel child restraint systems ✱ ⇨ 63, ⇨ 68.



Side airbag ✱

The side airbag system consists of an airbag in each front seat backrest. This can be identified by the word **AIRBAG**.

The side airbag system comprises:

- an airbag with inflator in the back of the driver's and front passenger seat respectively,
- the control electronics,
- the side impact sensors,
- the control indicator for airbag systems  in the instrument,
- the system for deactivating the front and side airbags for the front passenger,
- the control indicator  for deactivated front passenger airbag systems.

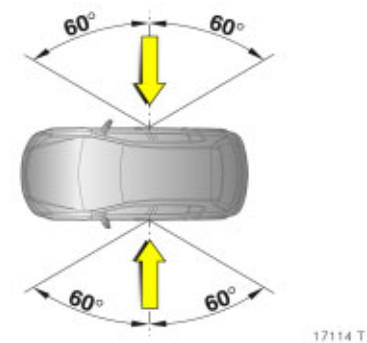

The side airbag system will be triggered:

- depending on the severity of the accident,
- depending on the type of impact,
- within the range shown in the illustration on the centre door pillar of the driver's or front passenger side,
- independently of the front airbag system.

The ignition must be switched on.

Exception:

The front and side airbags for the front passenger were deactivated because a child restraint system is mounted on the front passenger seat.

Deactivating front passenger airbag systems ⇨ 75.

Mounting Opel child restraint systems ⇨ 63, ⇨ 68.

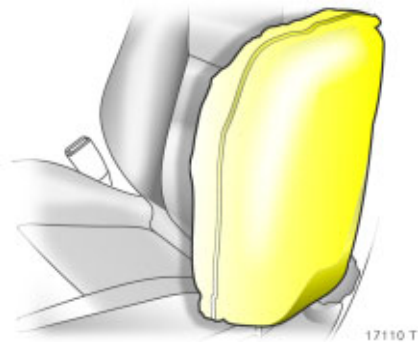

When triggered, the side airbag inflates within milliseconds to form a safety cushion for the driver or front passenger in the respective door area. This substantially reduces the risk of injury to the upper body and pelvis in the event of a side-on collision.



⚠ Warning

Keep the area in which the airbag inflates clear of obstructions.

The side airbag system will not be deployed in the event of

- the ignition is switched off,
- frontal collisions,
- accidents in which the vehicle overturns,
- collisions involving a rear impact,
- side-on collisions outside the passenger cell.

In addition, the side airbag system is not triggered for the front passenger when the airbag systems for the front passenger are deactivated.

Deactivated airbag systems for the front passenger are indicated by the constant illumination of the LEDs in the button  and the control indicator .

Deactivating front passenger airbag systems ⇨ 75.

Mounting Opel child restraint systems ⇨ 63, ⇨ 68.



18293 S

Curtain airbag ✳

The curtain airbag system consists of an airbag in the roof frame on each side. This can be identified by the word **AIRBAG** on the roof pillar.

The curtain airbag system comprises:

- an airbag with inflator in the roof frame on the driver's and front passenger side respectively,
- the control electronics,
- the side impact sensors,
- the control indicator for airbag systems ✳ in the instrument.

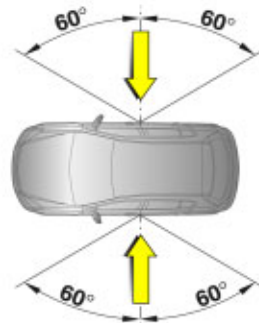

17114 T

The curtain airbag system will be triggered:

- depending on the severity of the accident,
- depending on the type of impact,
- within the range shown in the illustration on the centre door pillar of the driver's or front passenger side,
- together with the side airbag system,
- independent of the deactivated front passenger airbag systems,
- independently of the front airbag system.

The ignition must be switched on.

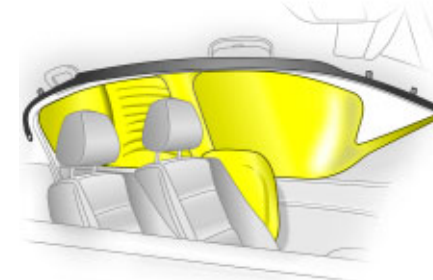

18185 S

When the curtain airbag is triggered it inflates within milliseconds and provides a safety barrier in the head area on the respective side of the vehicle. This reduces the risk of injury to the head considerably in case of a side impact.

74 Seats, Interior

⚠ Warning

Keep the area in which the airbag inflates clear of obstructions.

The curtain airbag system will not be deployed in the event of



- the ignition is switched off,
- frontal collisions,
- accidents in which the vehicle overturns,
- collisions involving a rear impact,
- side-on collisions outside the passenger cell.



Control indicator for airbag systems

The functionality of the airbag systems is monitored electronically together with the belt tensioners and displayed via the control indicator . When the ignition is switched on, the control indicator comes on for approx. 4 seconds. If it does not, or if it does not go out after 4 seconds, or if it comes on while driving, there is a fault in the airbag systems or belt tensioners, see also page [61](#). The systems might not be deployed in the event of an accident.





In the event of a fault in the airbag systems, the LEDs flash in the button  for switching off the airbag systems , the control indicator  also illuminates.

Deployed airbags are indicated by continuous illumination of .

⚠ Warning

Have the cause of the fault remedied immediately by a workshop.

The system's integrated self-diagnostics allows faults to be quickly remedied.

Airbag systems which can be deactivated for the front passenger  

The front and side airbag front passenger airbag systems must be deactivated if a child restraint system is to be fitted on the front passenger seat. The curtain airbag system , the belt tensioners and all driver airbag systems remain active when the front passenger airbag systems are deactivated. The front passenger airbag systems are active in the as-delivered condition.

The button  for activating/deactivating the airbag systems is located among the switches beneath the air vents in the centre console.

LEDs in the button not on: airbag systems for the front passenger are active.

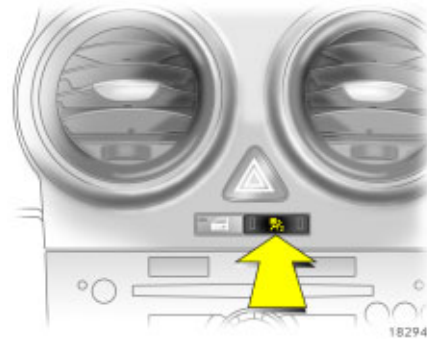

LEDs in the button on: airbag systems for the front passenger are not active.

The setting selected remains in storage even when the ignition is switched on again.





Deactivation

with the vehicle stationary and ignition off:

- switch on ignition, control indicator  flashes, the LEDs in the button display the current status,
- press button  within 15 seconds and hold down,
- after about 2 seconds, you will hear a confirmation buzzer. Release button  after another 4 seconds at the latest.







The airbag systems for the front passenger are now deactivated. To indicate this, both LEDs in the button  and the control indicator  remain on when the ignition is on.

If the LEDs or the control indicator  are not on, the airbag systems for the front passenger will be deployed in the event of an impact.



76 Seats, Interior

Activation

with the vehicle stationary and ignition off:

- Switch on ignition, control indicator  flashes, the LEDs in the button display the current status .
- Press button  within 15 seconds and hold down.
- After about 2 seconds, you will hear a confirmation buzzer. Release button  after another 4 seconds at the latest.







The airbag systems for the front passenger are now activated. To indicate this, LEDs in the button  and the control indicator  must not be on.

If the LEDs or control indicator  are on, the airbag systems for the front passenger will not be triggered in the event of an impact.



Control indicator , front passenger airbag systems which can be deactivated

When the ignition is switched on,  flashes for approx. 15 seconds. The airbag systems for the front passenger can only be activated or deactivated during this time. LEDs illuminated in the button  and illumination of the control indicator  indicate deactivated airbags, but if the LEDs and control indicator  are not on, the airbags are activated.

Starting the engine terminates changing of the setting.

The setting can then only be changed once the ignition has been switched off and then back on again.



18298 5

Warning

When using child restraint systems on the front passenger seat, the airbag system for the front passenger must be deactivated; otherwise triggering of the front or side airbag system * could result in the death of the child. This is particularly true for the fitting of rear-facing child restraint systems on the front passenger seat.

The system for deactivation of the airbag systems for the front passenger can be identified from the sticker on the side of the instrument panel, visible when the front passenger door is open.

Fault

The front and side airbag system * for the front passenger cannot be activated or deactivated if

- the ignition is switched off,
- the engine is running,
- the vehicle is in motion,
- the time limit of 15 seconds is exceeded when the ignition has been switched on,
- the button * is released before the confirmation buzzer is heard,
- the time limit of 4 seconds is exceeded after hearing the confirmation buzzer and button * is kept depressed,
- there is a fault in the airbag system,
- the central locking button is pressed inside the vehicle at the same time.

In these cases, a warning signal sounds and the original setting remains unchanged. The system remains in its original mode. Rectify the cause, if possible. Turn the ignition off and then back on, and repeat the process.

Important

- Placing accessories and objects in the expansion region of the airbag systems is not permitted due to the risk of injury if the components are triggered.
- There must be no objects between the airbag systems and the occupants, risk of injury. No child restraint system * may be fitted on the front passenger seat when the airbag systems are active, could result in fatalities.

Warning

As with any other object, child restraint systems must not be carried on a passenger's lap. Danger to life.

- Use the hooks * on the handles in the roof frame only to hang up light articles of clothing without coat hangers. Do not place any objects in the pockets of the hanging items, risk of injury.
- The airbag system and belt tensioner control electronics can be found in the centre console area. In order to avoid malfunctions, do not store magnetic objects in this area.

78 Seats, Interior

- Do not stick anything on the steering wheel, instrument panel, front seat backrests or roof frame in the vicinity of the airbags. Do not cover any of these areas with other materials.
- Use only a dry cloth or interior cleaner to clean the steering wheel, instrument panel, front seat backrests and roof frame. Do not use any aggressive cleaning agents.
- Only protective covers which are approved for your vehicle with side airbag ✱ may be fitted on the front seats. When fitting the protective covers, make sure that the airbag units on the outboard sides of the front seat backrests are not covered.
- The airbag systems are triggered independently of each other based on the severity of the accident and the type of impact. The side airbag system ✱ and the curtain airbag system ✱ are triggered together.
- The speeds, directions of movement and deformation properties of the vehicles, and the properties of the obstacle concerned, determine the severity of the accident and triggering of the airbags. The degree of damage to your vehicle and the resulting repair costs alone are not indicative that the criteria for triggering of the airbags were met.

- Do not perform any alterations on the components of the airbag system, as this would render the vehicle unroadworthy.

Warning

If handled improperly the airbag systems can be triggered in an explosive manner – risk of injury!

- We recommend having the steering wheel, the instrument panel, all panelling parts, the door seals, the handles and the seats removed by a workshop.
- The applicable safety regulations must be adhered to when the vehicle is disposed of. The vehicle should therefore be disposed of by a recycling company.
- People weighing less than 35 kg should travel in the rear seats only. This ruling does not refer to children who travel in child restraint systems on the front passenger seat with the airbag systems switched off.

Use of child restraint systems ✱ on the front passenger seat

Warning

No child restraint system may be fitted on the front passenger seat when the airbag systems are active, could result in fatalities.

If child restraint systems are to be used on the front passenger seat, the front passenger airbag systems must be deactivated ✱, otherwise child's life may be at risk if the front and side airbag systems are deployed ✱. This is particularly true for rear-facing child restraint systems that are fitted to the front passenger seat.

if the airbag systems for the front passenger are not deactivated, the child restraint system must be fitted in an outer position on the rear seats.



18301 S

The front passenger airbag system * can be recognised by the text **AIRBAG** above the glove compartment.



18431 S

The side airbag system * is identified by the covers on the outboard sides of the front seat backrests.

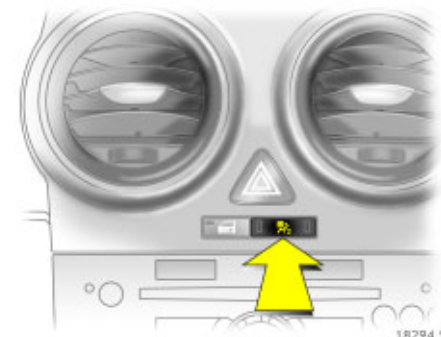

18294 S

Deactivating front passenger airbag systems * → 75.

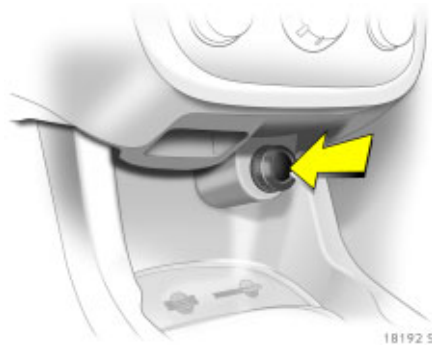

Cigarette lighter *

The cigarette lighter is located in front of the gear lever.

Press in cigarette lighter. Switches off automatically once the element is glowing. Pull out lighter.

Accessory socket *

Some vehicles have an accessory socket for the connection of electrical accessories instead of a cigarette lighter. Use of the accessory socket while the engine is not running will discharge the battery.

Caution

Do not damage the socket by using unsuitable plugs.

Do not exceed the maximum power consumption of 120 watts.

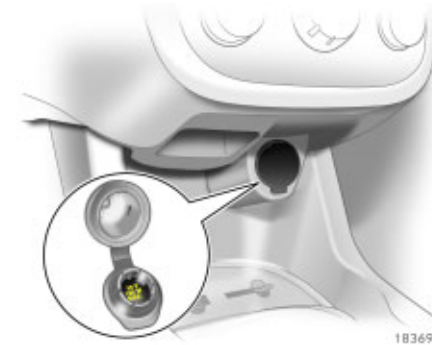

Electrical accessories connected to the socket must comply with the electromagnetic compatibility requirements laid down in DIN VDE 40 839, otherwise vehicle malfunctions may occur.

Do not connect any current-delivering accessories, e.g. electrical charging devices or batteries.

If the tyre repair set is * is in operation, no consumers may be connected to the auxiliary socket.

Ashtray ✱

Caution

To be used only for ash and not for combustible rubbish.
--

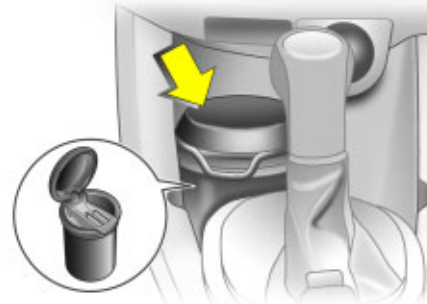

18332 5

Ashtray container
for mobile use in the car.

To use, open cover.



18416 5

Drink holder

located in the centre console in front of the gear lever and behind the hand brake. In the 3-door passenger vehicle, also located at the side behind the rear seat.

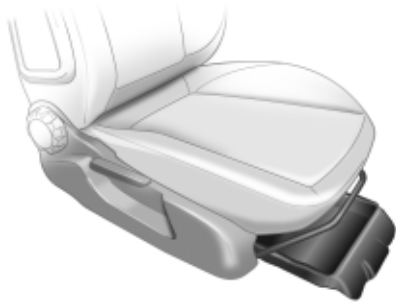

18424 S

Stowage compartments

Stowage compartment * beneath passenger seat

Lift stowage compartment by grasping recessed edge and pull out. Maximum load: 1.5 kg. To close the stowage compartment, push it in and engage.



18289 S

Glove compartment

Pull lever to open.

In the open cover, you will find:

- a card holder in cheque card format,
- pen holder,
- pocket torch holder.

The glove compartment should remain closed while driving.

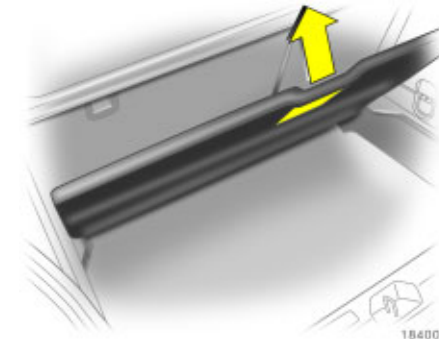

18400 S

Stowage compartment beneath double load-bay floor *

The double load-bay floor can be inserted in the luggage compartment in two positions:

- directly beneath the cover for the spare wheel recess * or the floor cover *, or
- in the upper openings in the luggage compartment.

To remove, lift the load-bay floor using a lever and pull backwards.

To insert, push the load-bay floor forwards in the corresponding guide, then lower.

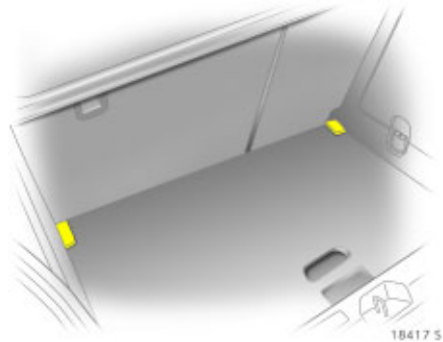

If mounted in the upper position, the space between the load-bay floor and the spare wheel well cover * can be used as a stowage compartment.

In this position, if the rear seat backrests are folded forwards, an almost completely flat load bay is created.

The double load-bay floor is able to withstand a load of no more than 100 kg.

In the model with a tyre repair kit *, the spare wheel recess may be used as an additional stowage compartment.

Sun visors

Use the sun visor to protect from glare by pulling it down and swivelling it to the side.

The mirror covers in the sun visors should be closed while driving.

Instruments, controls

Control indicators	84
Instrument display	90
Trip computer display in instrument panel *	92
Information display in the centre console	94
Warning buzzers.....	105
Windscreen wipers.....	106



18468 5

Control indicators

The control indicators described here are not present in all vehicles. The description applies to all instrument versions.

The colours of the control indicators mean:

- Red Danger, important reminder,
- Yellow Warning, information, fault,
- Green Switch-on confirmation,
- Blue Switch-on confirmation.



Deflation detection system *

Warning light is red or yellow.

Control indicator lights up red

Deflation detected, stop immediately and check tyre pressure

Control indicator lights up yellow

Fault in system. Contact a workshop for assistance.

Deflation detection system ↪ 164

**Ultrasonic parking sensors ***

Control indicator lights or flashes yellow.

Lamps

Fault in system. Have the cause of the fault eliminated by a workshop.

Flashes

Fault due to sensors that are dirty or covered by ice or snow

or

Interference due to external sources of ultra sound (e.g. pneumatic drills, rotary machines). Once the source of interference is removed, the system will operate normally.

Ultrasonic parking sensors ⇨ 162.

**Adaptive Forward Lighting * (AFL)**

Control indicator lights up and/or flashes yellow.

Lamps

Fault in system. Contact a workshop for assistance.

Flashes for 4 seconds after the ignition has been switched on

System converted for driving abroad.

AFL ⇨ 112.

**Manual transmission automated * start engine**

Control indicator lights up yellow.

The engine can only be started if the foot brake is depressed. If the foot brake is not depressed, the control indicator illuminates ⇨ 137.

**Preheating system *, diesel particle filter ***

Control indicator lights up and/or flashes yellow.

Lamps

Preheating activated. Only activates when outside temperatures are low.

Flashes

(in vehicles with diesel particle filter)

Control indicator  flashes if the filter requires cleaning and previous driving conditions did not permit automatic cleaning. Continue driving and if possible do not allow engine speed to drop below 2000 rpm.

The control indicator  goes off as soon as the self-cleaning operation is complete.

Diesel particle filter ⇨ 157.

**Exhaust emission ***

Control indicator lights up and/or flashes yellow.

It illuminates when the ignition is switched on and goes out shortly after the engine starts.

Illuminates when the engine is running

Fault in emission control system. The permissible emission limits may be exceeded. Contact a workshop for assistance immediately.

If it flashes when the engine is running

Fault that could lead to catalytic converter damage. Ease up on the throttle until the flashing stops ⇨ 156. Seek the immediate assistance of a workshop.



18469 5



Engine electronics, transmission electronics*, immobiliser, diesel fuel filter*

Control indicator lights up and/or flashes yellow.

It illuminates for a few seconds when the ignition is switched on.

Illuminates when the engine is running
 Fault in engine electronics or transmission electronics. Electronics switches to emergency running program, fuel consumption may increase and driveability of vehicle may be affected ↻ 156. If the fault is still there when the engine is started again, contact a workshop for assistance.

Lamps together with InSP4 on the service display: Diesel fuel filter needs to be drained of water ↻ 244.

Flashes when the ignition is on
 Fault in the electronic immobiliser system; the engine cannot be started ↻ 27.



Engine oil level*

Control indicator lights up yellow.

The engine oil level is checked automatically.

Illuminates when the engine is running
 Engine oil level too low. Check engine oil level and top up engine oil if necessary ↻ 242.



Engine oil pressure

Control indicator lights up red.

It illuminates when the ignition is switched on and goes out shortly after the engine starts.

Illuminates when the engine is running

Caution

Engine lubrication may be interrupted. This may result in damage to the engine and/or locking of the drive wheels.

1. Depress clutch.
2. Shift manual transmission or manual transmission automated* into neutral; for automatic transmission*, set selector lever to **N**.
3. Move out of the flow of traffic as quickly as possible without impeding other vehicles.
4. Switch off ignition.

Warning

When the engine is off, considerably more force is needed to brake and steer. Do not remove key until vehicle has come to a standstill, otherwise the steering column lock could engage unexpectedly.

Contact a workshop for assistance.



Alternator

Control indicator lights up and/or flashes red.

It illuminates when the ignition is switched on and goes out shortly after the engine starts.

Flashes during or after engine start
Battery voltage too low. Have electrical system tested by a workshop.

Illuminates when the engine is running
Stop and switch engine off. Battery will not be charged. Engine cooling may be interrupted. Effect of brake servo unit may stop in vehicles with diesel engines. Contact a workshop for assistance.



Electro-hydraulic power assisted steering

Control indicator lights up yellow.

Fault in electro-hydraulic power assisted steering system. The power assisted steering may have failed. The vehicle can be steered but considerably more force is required. Contact a workshop for assistance.



Turn signal lamps

Control indicator flashes green.

The control indicator flashes if a turn signal or the hazard warning flashers are activated.

Rapid flashes: A turn signal lamp or the related fuse has failed, failure of turn signal lamp on the trailer ✱.

Change bulbs ⇨ 212. Fuses ⇨ 209.



Fuel level

Control indicator lights up and/or flashes yellow

Lamps
Level in fuel tank too low.

Flashes
Fuel level is used up, fuel immediately.

Never let the tank run dry!

Erratic fuel supply can cause catalytic converter to overheat ⇨ 155.

Diesel engines: Bleed the fuel system after running empty ⇨ 190.



Main beam

Control indicator lights up blue.

It is illuminated when main beam is on and during headlamp flash ⇨ 11, ⇨ 109.



Coolant temperature

Stop, switch off engine.

Caution
Coolant temperature too high.

Coolant temperature too high.

Check coolant level immediately ⇨ 244.

If there is sufficient coolant, consult a workshop.







18469 5

 **Airbag systems which can be deactivated for the front passenger**
Symbol is lit, or flashes in the kilometre display.

Illuminated
together with the LEDs in the button : airbag deactivated ⇨ 76.

Flashes
The system can be activated or deactivated within 15 seconds of switching on the ignition ⇨ 76.

 **Winter setting for automatic transmission  or manual transmission automated **
Symbol lights up on the transmission display if the Winter program is selected ⇨ 140, ⇨ 146.

 **Manual transmission automated SPORT mode **
Symbol lights up on the transmission display if the Sport program is selected ⇨ 139.



Headlamp range adjustment
Symbol is lit in the kilometre display together with the setting.

It comes on for 4 seconds when dipped beam is switched on, as well as when the headlamp range has been adjusted.



Fog lamps 
Control indicator lights up green

This comes on when the front fog lamps are switched on ⇨ 110.



Exterior lights
Control indicator lights up green

Illuminates when the exterior lighting is on ⇨ 108.



Fog tail lamp
Control indicator lights up yellow.

This comes on when the fog tail lamp is switched on ⇨ 110.



Airbag systems ✱, belt tensioners ✱

Control indicator lights up red.

Illuminates when the engine is running

Fault in the airbag or belt tensioner system
⇨ 61, ⇨ 74.



Seat belt ✱

Control indicator lights up or flashes red.

Lamps

It lights up from when the ignition is switched on until the driver's seatbelt is fastened.

Flashes

If the driver's seatbelt has not been fastened when the vehicle starts moving, a warning light flashes.

Fasten seat belt ⇨ 59, ⇨ 62.



Brake system, clutch system

Control indicator lights up or flashes red.

Illuminated

Illuminates when the ignition is switched on if the hand brake is applied ⇨ 167.

Lights up when the hand brake is released when the fluid level for the brake or clutch systems is low ⇨ 246.

Warning

Stop. Do not continue your journey. Consult a workshop.

Flashes

For vehicles with manual transmission automated ✱, the control indicator flashes for a few seconds if the ignition is turned off when the hand brake is not applied.



Anti-lock brake system (ABS) ✱

Control indicator lights up red.

Illuminates while driving

Fault in anti-lock braking system ⇨ 166.



Electronic Stability Programme (ESP^{Plus}) ✱

Control indicator flashes or lights up yellow.

Flashing during driving

System engages actively ⇨ 151, ⇨ 159.

Illuminates while driving

System switched off or fault in system
⇨ 159.



Cruise control ✱

Control indicator lights up or flashes green.

Lamps

Cruise control switched on ⇨ 160.

Flashes

Cruise control was enabled without depressing the brake pedal beforehand
⇨ 160.

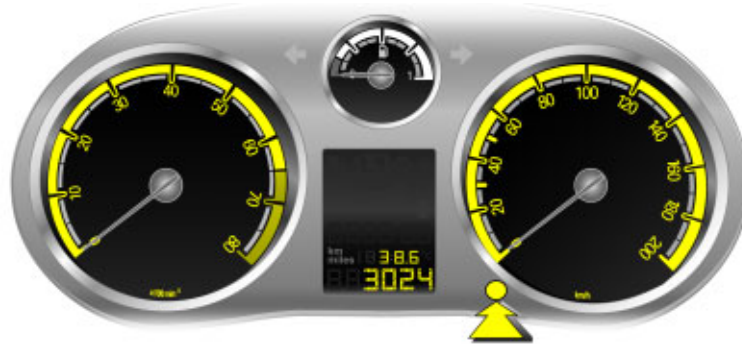

18240 5

Instrument display

On some versions, the pointer of the tachometer, speedometer and fuel gauge briefly moves to its end position when the ignition is switched on.

Tachometer

Displays the engine rpm.

Drive in a low engine speed range for each gear as much as possible.

Caution
If the pointer is in the warning zone, the maximum permitted engine speed is exceeded. Engine at risk.

Speedometer Speed display.



18241 5

Fuel gauge

Fuel tank level display.

If the fuel level is too low, a warning lamp lights up . When the light flashes, refuel as soon as possible.

Never run the tank dry!

Because of the fuel remaining in the tank, the amount of fuel required to fill the tank may be less than the specified tank capacity.



18405 5

Kilometre display

Top line:

Trip odometer

Displays the number of kilometres since the gauge was reset.

To reset, hold down the setting knob for approx. one second when the ignition is on, see previous page.

Bottom line:

Odometer

Records the number of kilometres.



18239 5

Service display

InSP Service interval display. Display of remaining driving distance until next service. For additional instructions ↪ 231.

InSP2 Bulb defective * ↪ 212.

InSP3 Remote control battery voltage too low * ↪ 32.

InSP4 Drain water from diesel fuel filter *. Contact a workshop for assistance.

On vehicles with check control *, a corresponding message is shown on the info display instead of **InSP2** and **InSP3**.

ESPoff Electronic stability * switched off * ↪ 159.



18232 5

Transmission display *

Display of gear selected for automatic transmission * or current gear or mode for manual transmission automated *.

P Automatic transmission park position.

R Reverse gear.

N Neutral.

A Manual transmission automated automatic mode.

D Drive.

1, 2, 3 Selected gear, automatic transmission.

1 - 5 Current gear, manual transmission automated, manual mode.



18401 S

Speed warning

With the "Personalised key" function, **P6**, ↻ 39, ↻ 41, a particular top speed can be assigned to each vehicle key. When this speed is exceeded, a warning buzzer sounds.

This function is programmed in the kilometre display:

- ignition off, key in ignition switch,
- pull turn signal stalk and wiper stalk simultaneously to the steering wheel until you hear a confirmation signal (approx. 3 seconds),
- the kilometre display shows **P1**,
- push down the turn signal stalk (left) until **P6** appears,



18402 S

- push the wiper stalk (right) up until the desired speed appears in increments of 10,
- to reduce the speed or switch off (**OFF**), push the wiper stalk down,
- pull turn signal stalk and wiper stalk simultaneously to the steering wheel until you hear a confirmation signal (approx. 3 seconds).

This function can be programmed differently for each vehicle key.

Personalised key ↻ 39, cruise control ↻ 160.



18406 S

Trip computer display in instrument panel ✳

The trip computer provides information on driving data, which is continually recorded and evaluated electronically.

After switching on the ignition, the last function displayed appears. To select a different function, rotate the rotary switch on the wiper stalk briefly up ↶ or down ↷ and then let go. The functions will be called one after the other.

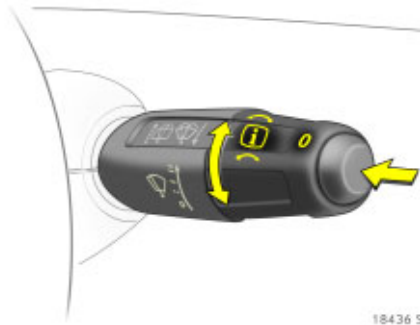

To reset a value or confirm a warning message, press the button **0** on the wiper stalk.



18436 5

Functions:

- Range
- Instantaneous consumption
- Distance travelled
- Average speed
- Effective consumption
- Average consumption
- Stop watch

To select, rotate the rotary switch on the wiper stalk briefly up  or down  for each function and then let go. The functions will be called one after the other.

Range

Range is calculated from current fuel tank content and instantaneous consumption. The display shows average values.

After refuelling, the vehicle updates the range automatically after a brief delay.

When there is insufficient fuel in the tank for more than 30 km, the warning **REFILL** appears on the display.

Confirm the warning message by pressing **0** on the wiper stalk.

Instantaneous consumption

Display of current consumption. At low speeds, consumption per hour is displayed.

Distance travelled

Display of distance travelled. The measurement can be reset at any time.

Average speed

Display of average speed. The measurement can be reset at any time.

Stoppages in the journey with the ignition off are not included in the calculations.



Effective consumption

Display of fuel consumed. The measurement can be reset at any time.

Average consumption



Display of average consumption. The measurement can be reset at any time.

Restart trip computer information

Select the desired trip computer function: rotate the rotary switch on the wiper stalk briefly up  or down  for each function and then let go. To reset a value to zero, hold down the button **0** on the wiper stalk for more than three seconds: this restarts measurement. To reset all functions at the same time, hold down the button **0** for more than 6 seconds.

All trip computer information, apart from range and instantaneous consumption, can be reset.

Stop watch

Select function using rotary switch  or ,

push button **0**: start/stop

for longer than three seconds: reset to zero



Information display in the centre console

Triple information display

Display of time, outside temperature and date/infotainment system (when it is on).

When the ignition is off, the time, date and outside temperature can be presented for 15 seconds by briefly pressing one of the two buttons below the display.

17913 S

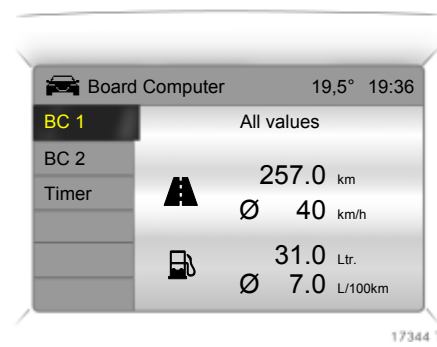

Graphical information display *, Colour information display *

Display of time, outside temperature, date/infotainment system (when it is on) and climate control system *.

The graphical information display presents the information in monochrome. The colour information display presents the information in colour.

17344 T

The information that is displayed and the format thereof depend on the vehicle equipment and the setting of the Infotainment system *, the trip computer * and the climate control system *.

Some information appears in the display in an abbreviated form.

Infotainment system, see Infotainment system instructions. Climate control system ↻ 128.



17913 S

Outside temperature

A fall in temperature is indicated immediately and a rise in temperature after a time delay.

If outside temperature drops below 3 °C, the symbol ❄️ appears in the triple information display as a warning for icy road conditions. When temperature increases to at least 5 °C, the ❄️ symbol goes out.



17338 T

In vehicles with graphical information display ❄️ or colour information display ❄️, a warning message appears in the display as a warning for icy road surfaces. There is no message below -5 °C.



⚠️ Warning

Caution: The road surface may already be icy even though the display indicates a few degrees above 0 °C.



Triple information display

Set date and time





The infotainment system * must be off. Activate setting mode by holding the  button depressed for about 2 seconds. The flashing value is adjusted using the  button. The  button is used to switch to the next unit and to exit setting mode.

17914 S

Automatic time synchronisation *

The RDS signal of most VHF transmitters automatically sets the time. This can be identified by  in the display.

Some transmitters do not send a correct time signal. In such cases, we recommend that you switch off automatic time synchronisation.

Activate setting mode and set it to year setting. Hold the  button depressed about 3 seconds until  flashes in the display and "RDS TIME" appears. The function is activated (RDS TIME 1) or deactivated (RDS TIME 0) with the  button. Exit setting mode using the  button.

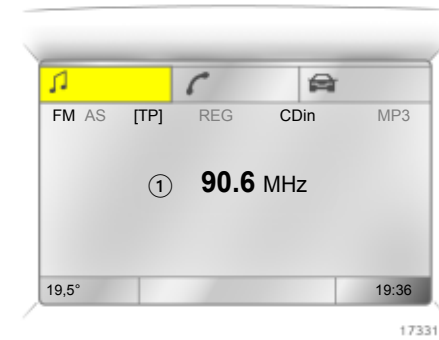

17331 T

Graphical information display * or Colour Information Display * Selecting functions

Functions and settings of the infotainment system * and climate control system * are accessed via the display.

Selections are made via the menus and buttons, the multifunction button * of the infotainment system or the left adjuster wheel * of the steering wheel.

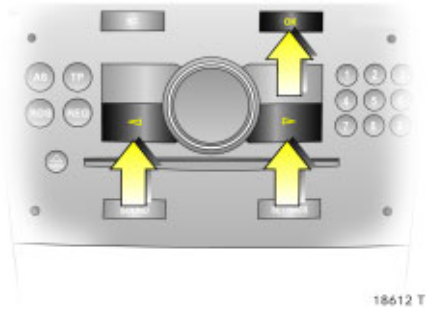

To select with the infotainment system buttons
 Select menu items via the menus and using the infotainment system buttons. The OK button is used to select the marked item or confirm a command.
 To exit a menu, press the right or left arrow button to execute **Return** or **Main**.



To select using the multifunction button
 Turn the multifunction button to highlight menu items or commands and to select function areas.
 Press the multifunction button to select the highlighted item or confirm a command.
 To exit a menu, turn the multifunction button to **Return** or **Main** and select.



Select using the left adjusting wheel * on the steering wheel
 Turn to select a menu item.
 Press the adjuster wheel to select the highlighted item or confirm a command.

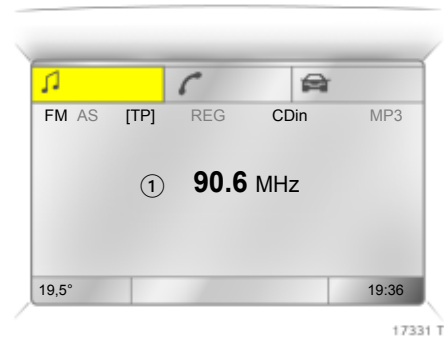

Function areas

For each functional area there is a main page (Main), which is selected at the top edge of the display (not with the Infotainment system CD 30 or the Mobile Phone Portal):

- Audio,
- Navigation ✱,
- Telephone ✱,
- Trip computer ✱.

For Audio, Navigation ✱ and Telephone ✱ functions – see infotainment system instructions.

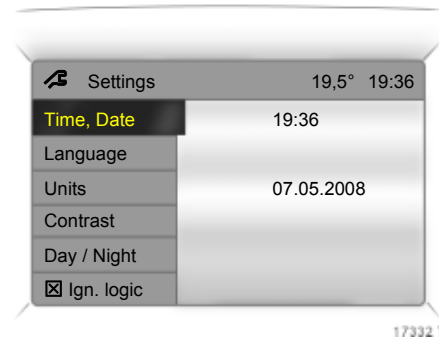

System settings

Press the **Main** button ✱ of the infotainment system.

Press the **Settings** button of the infotainment system. On Infotainment System CD 30, make sure no menu has been selected.

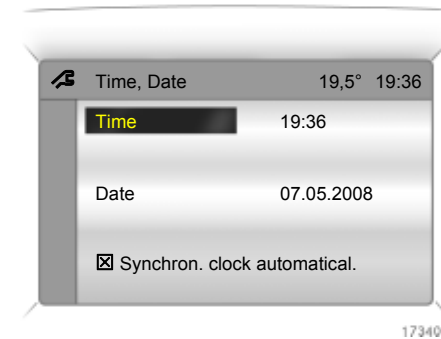

Setting date and time ✱

Select menu item **Time, Date**, from the **Settings** menu.

Select the required menu item and make setting.

Automatic time synchronisation *

The RDS signal of most VHF transmitters automatically sets the time.

Some transmitters do not send a correct time signal. In such cases, we recommend that you switch off automatic time synchronisation.

On infotainment systems with navigation *, time and date are also harmonised upon receipt of a GPS satellite signal.

The function is activated by ticking the field in front of **Synchron. clock automatical.** in the **Time, Date** menu.

**Language selection**

You can select the display language for some functions.

Select menu item **Language** from the **Settings** menu.

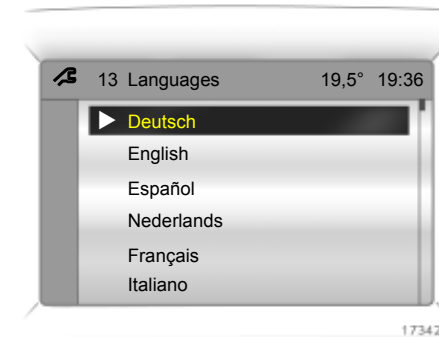

Select the desired language.

Selections are indicated by a ► in front of the menu item.

In systems with language version *, when the language setting of the display is changed, the system will ask if the message language should also be changed - see infotainment system instructions.

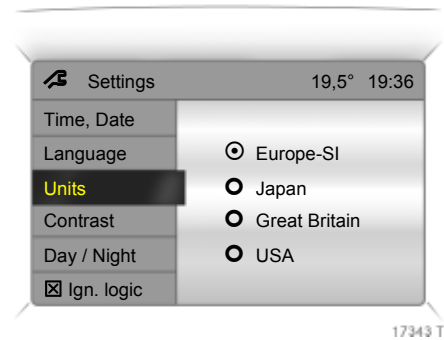

Setting units of measure

Select menu item **Units** from the **Settings** menu.

Select the desired unit.

Selections are indicated by a ● in front of the menu item.

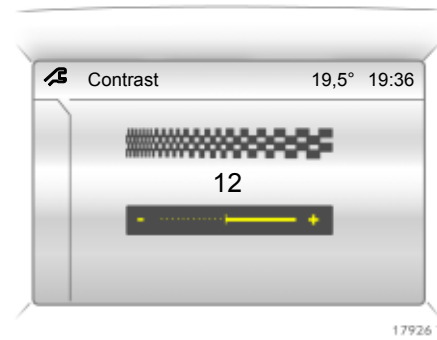

**Adjusting contrast *
(Graphical Information Display)**

Select menu item **Contrast** from the **Settings** menu.

Confirm the required setting.

Setting display mode *

Display brightness is independent of vehicle lighting. Settings are made as follows:

Select menu item **Day / Night** from the **Settings** menu.

Automatic: adapted based on vehicle lighting.

Always day design: black or coloured text on light background.

Always night design: white or coloured text on dark background.

Selections are indicated by a ● in front of the menu item.

Ignition logic *

See infotainment system instructions.

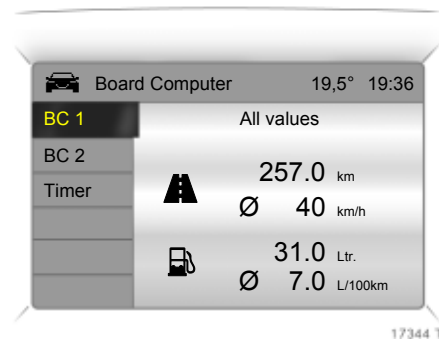

Graphical Information Display * or Colour Information Display *, trip computer *

The main trip computer display provides information about the range, average consumption * and current consumption of **BC 1**.

To display other trip computer data, press the **BC** button on the infotainment system *, select the trip computer menu **Board Computer** on the display or press the left hand adjustment wheel * on the steering wheel.

Select **BC 1** or **BC 2** from the trip computer menu.

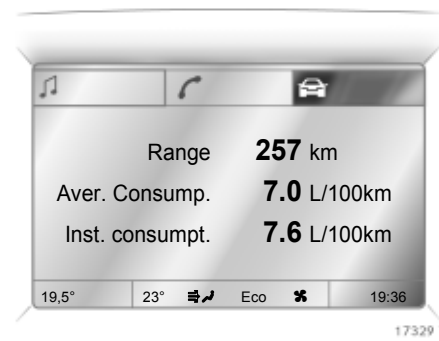

Range

Range is calculated from current fuel tank content and instantaneous consumption. The display shows average values.

After refuelling, the vehicle updates the range automatically after a brief delay.



If the fuel in the tank will allow less than 50 km of travel, the message **Range** appears in the display.

If the fuel in the tank will allow less than 30 km of travel, the message **Please refuel!** * appears in the display.

102 Instruments, controls

Instantaneous consumption

Display of current consumption. At low speeds, consumption per hour is displayed.

Distance travelled

Display of distance travelled. The measurement can be reset at any time.

Average speed

Display of average speed. The measurement can be reset at any time.

Stoppages in the journey with the ignition off are not included in the calculations.

Effective consumption

Display of fuel consumed. The measurement can be reset at any time.

Average consumption

Display of average consumption. The measurement can be reset at any time.

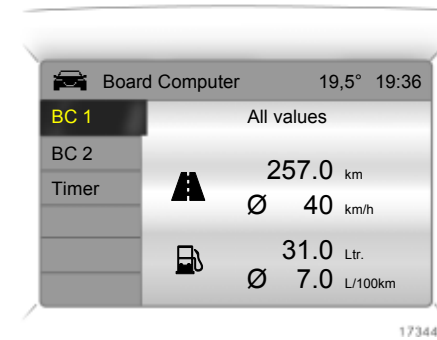

Restart trip computer

The measurement or calculation of the following trip computer information can be restarted:

- Distance.
- Average speed.
- Effective consumption.
- Average consumption.

Select **BC 1** or **BC 2** from the trip computer menu.

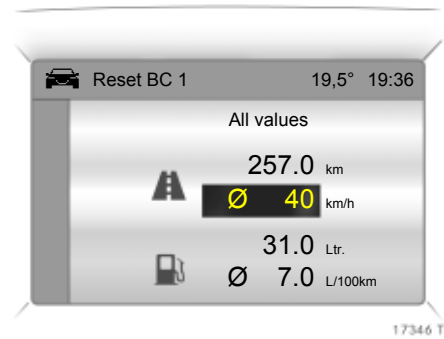

The information of the two trip computers can be reset separately, making it possible to evaluate data from different time periods.

Select the desired trip computer information.

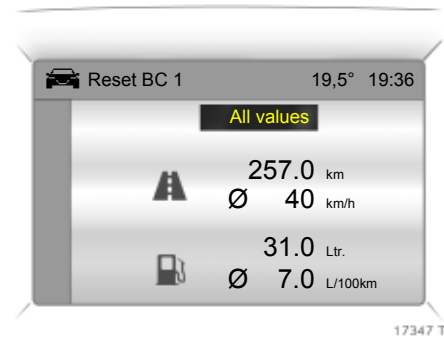

To reset all information of a trip computer, select menu item **All values**.

After resetting, "--" is displayed for the selected trip computer information. The recalculated values are displayed after a brief delay.

104 Instruments, controls

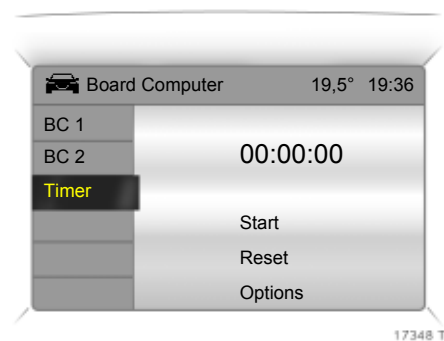

Stop watch

Select menu item **Timer** from the **Board Computer** menu.

To start, select menu item **Start**. To stop, select menu item **Stop**.

To reset, select menu item **Reset**.

The desired stop watch display can be selected from the **Options** menu *:

Driving Time excl. Stops

The time the vehicle is in motion is recorded. Stationary time is not included.

Driving Time incl. Stops

The time the vehicle is in motion is recorded. The time the vehicle is stationary with the key in the ignition switch is included.

Travel Time

Measurement of the time from manual activation via **Start** to manual deactivation via **Reset**.

Check control *

Check control monitors the remote control battery, the brake lamp switch, as well as important exterior lamps, including the cable and fuses.

Warning messages appear on the display. If there are several warning messages, they are displayed one after the other.

Some of the warning messages appear on the display in an abbreviated form.

Acknowledge warning messages as described on page 96, confirm. Unacknowledged warning messages can be re-displayed later.

Warning messages:

**Remote Control
Battery
check**

Remote control battery voltage too low
↪ 32.

**Brakelight switch
check**

Brake light does not come on during braking. Have the cause of the fault eliminated immediately by a workshop.

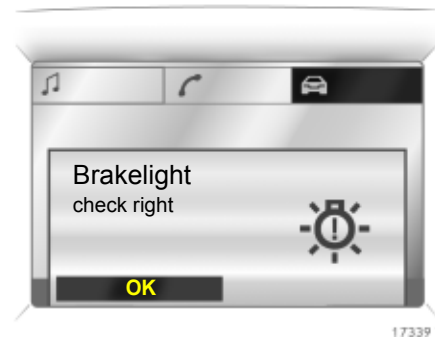

If there is a fault in the lighting system, the respective location of the fault is displayed as text, e.g.:

**Brakelight
check right**

Interruption of power supply
Stored warning messages appear on the display one after the other.

Warning buzzers

When starting the engine or whilst driving:

- If seat belt is not fastened ✱.
- If a door or the luggage compartment has not been closed correctly when you set off.
- Once you have reached a certain speed if the hand brake is applied.
- If the speed programmed at the factory ✱ is exceeded.
- If the car has automated manual transmission ✱ and the driver's door is opened when the engine is running, a gear is engaged and the foot brake is not depressed.
- Warning signal sounded three times if the Flex-Fix system is extended ✱ and reverse gear is selected.

When the vehicle is parked and the driver's door is opened:

- When the key is in the ignition switch ✱.
- With parking lamps or dipped beam on.
- For automated manual transmission ✱, if the hand brake is not applied and no gear is engaged when the engine is switched off.

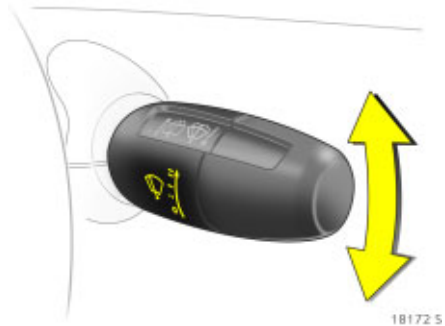

Windscreen wipers

The lever always springs back to its home position.

- ≡ = Fast
- = Slow
- = Adjustable timed interval wipe
- = Off

For a single swipe when the windscreen wipers are off, press the stalk down.

Run through the windscreen wiper stages by pushing the lever past the resistance point and holding. An acoustic signal sounds at ○.

Do not use if the windscreen is icy.

Switch off in car washes.

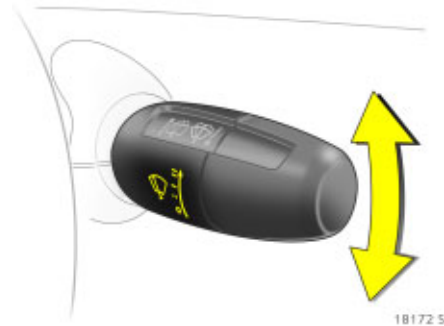

Adjustable wiper interval ✱

Setting wiper interval to a value between 2 and 15 seconds: switch ignition on, move stalk from position ○ downward, wait for required interval, move stalk to --.

After switching on the ignition and moving the stalk up, -- the interval is set to 6 seconds.

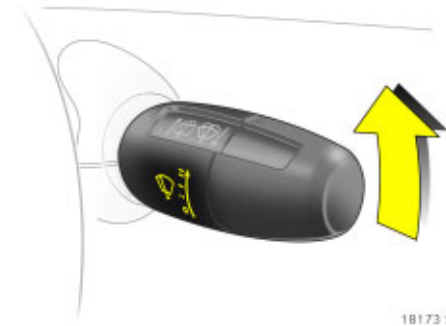

Automatic wiping with rain sensor ✱

-- = Automatic wiping with rain sensor

The rain sensor determines the quantity of water on the windscreen and automatically controls the windscreen wiper.

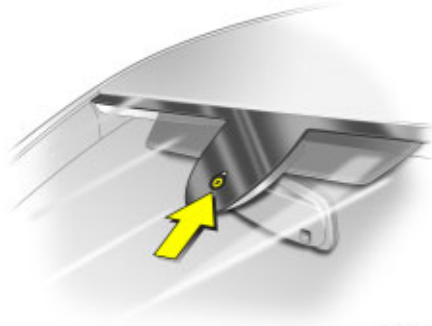

18328 5

Keep the sensor field of the rain sensor free from dust, dirt and ice.



18174 5

Windscreen washer system
Pull stalk towards steering wheel. Screen wash is squirted onto the screen and the wipers move back and forth a few times.



18175 5

Rear window wiper * and rear window washer system *
To switch on, push stalk forwards. The rear window wiper swipes in timed interval mode. Switch off by pushing stalk forwards again.

If the stalk is held forwards, washer fluid is sprayed on the rear window.

Automatic rear window wiper *
The rear window wiper switches itself on automatically when the windscreen wiper is switched on and reverse gear is selected. This function can be activated or deactivated depending on the key that is used, see "Personalised Key", P2 ↗ 39, ↗ 41.

Lighting

Exterior lights	108
Main beam, headlamp flash	109
Automatic dipped beam activation A *	109
Turn signal lamps	109
Fog lamps #D *	110
Fog tail lamp Q#	110
Reversing lamps.....	110
Hazard warning lamps	111
Headlamp range adjustment #D *.....	111
Adaptive Forward Lighting * (AFL) ..	112
Lead-me lighting *	113
Switching on the exterior lighting with the remote control *.....	113
Parking lamps	114
Instrument illumination, Information display illumination.....	114
Courtesy lamp.....	114
Battery discharge protection.....	116
Misted light covers.....	116
Headlamps when driving abroad	117



18197 5

Exterior lights

Turn light switch:

0 = Off

#D = Parking lamps

#D = Dipped or main beam

In positions **#D** and **#D**, the tail lamps and number plate lamps are also on.

Control indicator **#D** ⇨ 88.

If the ignition is switched off when main beam or dipped beam is on, the parking lamps come on.

The parking lamps go off when the ignition key is removed.

Versions with daytime running lights *: Parking lamps are on when the ignition is switched on and the light switch is set to **0** or **A** *. Dipped beam is on when the engine is running.

The daytime running lights switch off when the ignition is switched off.

Follow the regulations of the country in which you are driving when using daytime running lights and fog lamps *.

Driving abroad ⇨ 117.

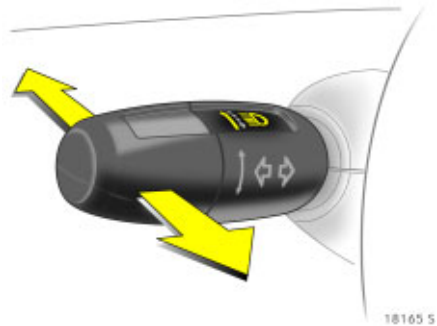

18165 5

Main beam, headlamp flash

Push stalk forward to switch from dipped beam to main beam.

To switch to dipped beam, push stalk forward again or pull towards steering wheel.

To operate the headlamp flash, pull stalk towards steering wheel. The main beam is switched on for as long as the stalk is held in this position.



18198 5

Automatic dipped beam activation A *

Light switch set to **A**: when the engine is running, dipped beam switches on when external light conditions are poor.

The exterior lights switch off when the ignition is switched off.

For reasons of safety, the light switch should always remain in the **A** position.

If visibility is poor (in foggy conditions, for example) turn light switch to **D**.

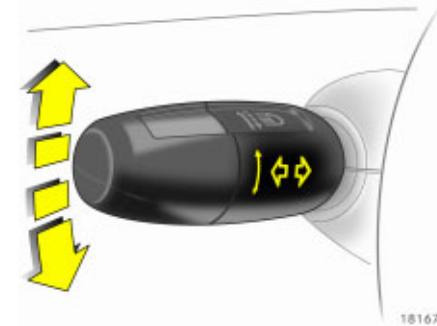

18167 5

Turn signal lamps

Push stalk up or down to activate:

Lever upwards = Right turn signal

Lever downwards = Left turn signal

After operation, the turn signal stalk returns to its starting position.

If the stalk is moved past the resistance point, the turn signal lamp remains on. When the steering wheel moves back toward the straight-ahead position, the turn signal lamp is automatically deactivated.

Move the stalk to the resistance point and hold for the turn signals to flash longer.

Switch the turn signal off manually by moving the stalk slightly.

110 Lighting

Short turn signal *

Push stalk until you feel resistance and release. The turn signal flashes three times, e.g. for changing lanes. This function can be activated or deactivated depending on the key that is used, see "personalised key", P3 ↗ 39, ↗ 41.

Acoustic turn signal *

The volume of the acoustic turn signal can be adjusted. This function can be programmed depending on the key used, see "Personalised key", P7 ↗ 39, ↗ 41.



18199 5

Fog lamps $\#D$ *

The fog lamps can only be switched on when both the ignition and lights are on.

Operated with the $\#D$ button.

Fog tail lamp $\#E$

The fog tail lamp can only be switched on both the ignition and dipped beam/parking lamps are on.

Operated with the $\#E$ button.

The vehicle fog tail lamp are deactivated when towing.

Reversing lamps

The reversing lamps come on when the ignition is on and reverse gear is engaged.

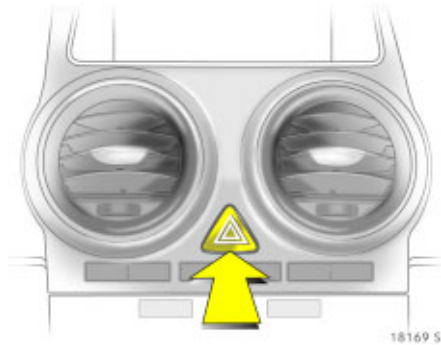

Hazard warning lamps

Operated with the button.

To aid location of the pushbutton, the red surface is illuminated when the ignition switched on. When the button is pressed, its control indicator flashes in time with the hazard warning lamps.

The hazard warning flashers activate automatically if the airbags deploy.



Headlamp range adjustment

Adjust headlamp range to suit the vehicle load to avoid dazzling oncoming traffic. Push button or step-by-step until the required setting is displayed on the kilometre display.

The display shows for 4 seconds, when dipped beam is switched on or every time the beam range is changed, together with the symbol .



- 0 = Front seats occupied
- 1 = All seats occupied
- 2 = All seats occupied and luggage compartment load
- 3 = Driver's seat occupied and luggage compartment load

112 Lighting

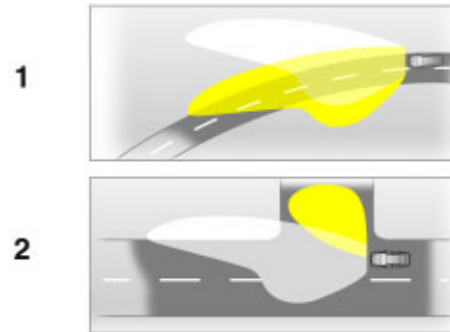

Adaptive Forward Lighting* (AFL)

ensures better illumination of

- bends (curve lighting),
- crossings and narrow bends (cornering light).

Curve lighting (1)

The light beam pivots based on steering wheel position and speed (from approx. 10 km/h).

The headlamps shine at an angle of up to 15° to the right or left of the direction of travel.

Cornering light (2)

An additional light is switched on depending on the steering wheel position (from rotation of approx. 90°), turn signal position and speed (up to approx. 40 km/h).

The light is thrown approx. 90° to the left or right of the car, to a distance of approx. 30 metres.

Reversing function

If the lights are on, reverse gear is engaged, and the turn signal is activated, the cornering light on the appropriate side is switched on. The cornering light stays on for 15 seconds once the turn signal has been switched off.



Control indicator for adaptive driving lamps

Illuminated: Fault in system. The system is not ready for operation.

Contact a workshop for assistance.

If control indicator flashes for approx. 4 seconds after the ignition is switched on, this is a reminder that the headlamps have been set to symmetrical dipped beam; see "Headlamps when driving abroad" ⇨ 117.

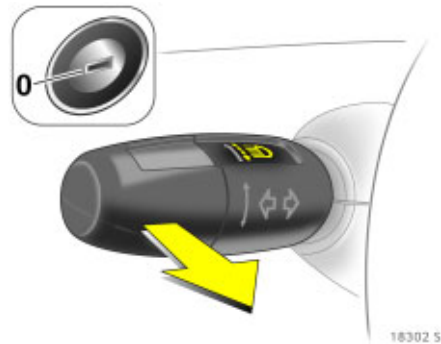

Lead-me lighting *

The dipped beam remains switched on for approx. 30 seconds once you have left the vehicle and closed the driver's door.

To activate

1. Switch off ignition.
2. Remove ignition key.
3. Open driver's door.
4. Pull turn signal stalk toward steering wheel.
5. Close driver's door.

If the driver's door is left open, the lamps will go out after two minutes.

The light is switched off immediately by inserting the key into the ignition or pulling the turn signal stalk towards the steering wheel again.

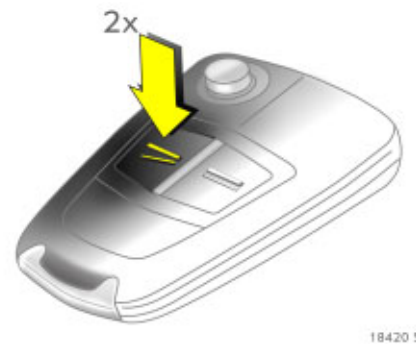

Switching on the exterior lighting with the remote control *

The lead-me-to-the-car light function switches the dipped beam on for approx. 30 seconds.

Program function

This function can be activated and deactivated depending on the key used, see "Personalised key", P1 ⇨ 39 ⇨ 41.

To activate

Press button  on the remote control twice when the vehicle is locked.

Country-specific application *: To switch on the Lead-me-to-the-car light function, press button  on the remote control once the vehicle is locked.

Switching on the ignition or pressing button  on the remote control will deactivate the Lead-me-to-the-car light function early.

114 Lighting

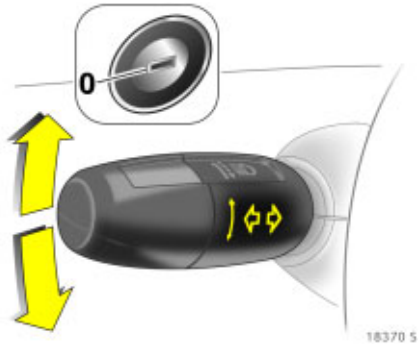

Parking lamps

The front parking lamp and tail lamp of one side of the vehicle can be activated when parking:

1. Set light switch to **0** or **A ***,
2. Ignition off,
3. Move turn signal stalk all the way up (right parking lamp) or down (left parking lamp).

Confirmed by a signal and the corresponding turn signal control indicator.

To switch it off, switch on the ignition or move the turn signal stalk in the opposite direction.



Instrument illumination, Information display illumination

Lights come on when ignition is switched on.

Adjustable brightness when exterior lighting is switched on:

- Brighter = Push button +
- Darker = Push button -

Hold down the button until the required brightness is achieved.

Display mode *↻ 100.

Courtesy lamp

Automatic interior light

Comes on automatically when the vehicle is unlocked with the remote control, when a door is opened or when the key is removed from the ignition switch after the ignition is switched off.

Goes off automatically after a delay when the doors are closed or immediately when the ignition is switched on or the doors are locked.

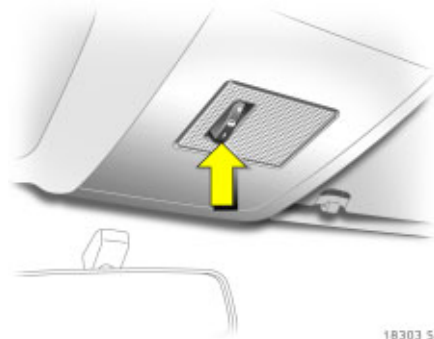

18303 S

Front courtesy lamp

Centre switch position: automatic interior light, see previous page.

To operate manually from inside when the doors are closed:

On = Switch position I

Off = Switch position 0

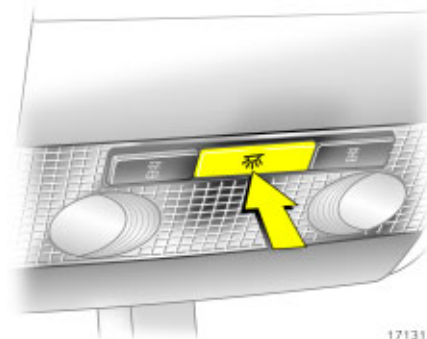

17131 T

Front courtesy lamp with reading lamps *

Automatic interior light, see previous page.

Pressing the button  when the doors are closed.

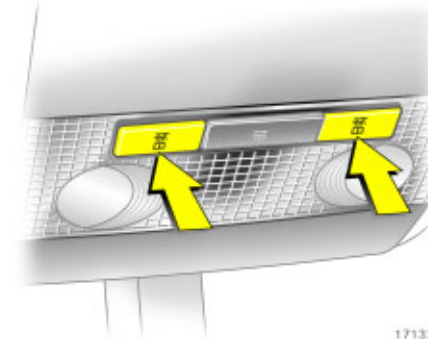

17132 T

Front reading lamps *

Operating using buttons  with the ignition switched on.

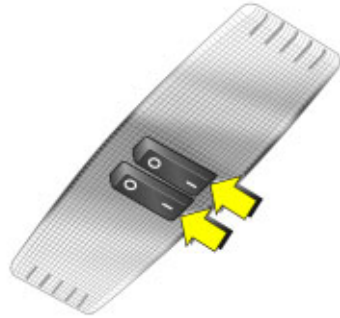

17133 T

Courtesy lamps and rear reading lamps ✱
Operated with switch (1 = on, 0 = off, centre = automatic interior light).

Welcome Light ✱

After unlocking the car, the instrument and switch lighting, the front and rear foot well lighting ✱ and the information display ✱ come on for a few seconds.

Glove compartment lighting ✱

Glove compartment lighting comes on when the lid is opened.

Luggage compartment lighting

The luggage compartment light comes on when the tailgate is open.

Automatically regulated centre console lighting ✱

Spotlight in housing of interior mirror.

Daylight-dependent, automatically regulated centre console lighting with ignition switched on.

Battery discharge protection

To prevent the battery from becoming discharged, the courtesy lamp, reading lamps ✱, luggage compartment lighting and glove compartment lighting ✱ switch off automatically 5 minutes after the ignition is switched off.

Misted light covers

The inside of the light covers may mist up briefly in poor, wet and cold weather conditions, in heavy rain or after washing. The mist disappears quickly by itself; to help, switch on the lights.

Headlamps when driving abroad

The asymmetrical dipped beam increases the field of vision on the passenger side of the lane.

This causes glare for oncoming traffic if the vehicle is driven in countries where traffic drives on the opposite side of the road.

Do as follows to prevent glare:

Vehicles with halogen headlamps

Have headlights converted in a workshop.

Vehicles with Adaptive Forward Lighting* (AFL)

1. Pull and hold stalk for main beam on steering wheel (headlamp flash).
2. Switch on ignition.
3. After approx. 3 seconds, an acoustic signal sounds and then AFL control indicator  flashes approx. 4 seconds.

After the switch, AFL control indicator  flashes for 4 seconds each time the ignition is switched on.

To return to asymmetrical dipped beam, pull and hold the main beam stalk again, switch on the ignition and wait for the acoustic signal. AFL control indicator  will then discontinue flashing.

Control indicator  ↻ 85. ↻ 112.

Infotainment system

Radio reception *	118
Infotainment system *	118
Steering wheel remote control *	118
AUX input *	119
Mobile telephones and radio equipment *	119

Radio reception *

Radio reception may be disrupted by static, noise, distortion or loss of reception due to

- changes in distance from the transmitter,
- multi-path reception due to reflection and
- shadowing.

Infotainment system *

The infotainment system is operated as described in the operating instructions.

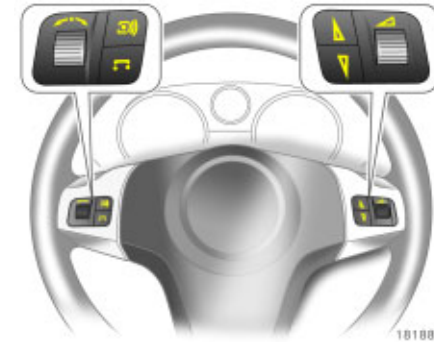

Steering wheel remote control *

The functions of the Infotainment system * and the information display can be operated with the adjusting wheels and buttons on the steering wheel.

Further information ⇨ 97 and the infotainment system instructions.

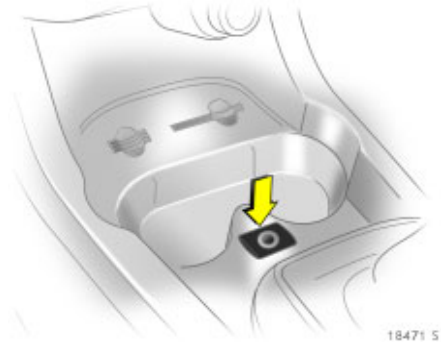

AUX input *

The AUX input is in the centre console in front of the gearshift lever.

An external audio source such as a portable CD player can be connected via the AUX input with a 3.5 mm jack plug.

Keep AUX input clean and dry at all times.

Further information in the infotainment system instructions.

Mobile telephones and radio equipment *

The Opel installation instructions and the operating guidelines provided by the telephone manufacturer must be followed when fitting and operating a mobile telephone. Failure to do so could invalidate the vehicle's operating permit (EU Directive 95 54/EG).

Recommended prerequisites for fault-free operation:

- Professionally installed exterior antenna to obtain the maximum range possible.
- Maximum transmission power 10 Watt.
- Installation of the telephone in a suitable spot (see information ⇨ 77).

Seek advice on predetermined installation points for the external antenna or equipment holder and ways of using devices with a transmission power exceeding 10 watts.

We recommend you contact your Opel Service Partner who will have brackets and various different accessory kits available and can fit them correctly.

Use of a handsfree attachment without external antenna with mobile telephone standards GSM 900/1800/1900 and UMTS is only permitted if the maximum transmission power of the mobile telephone is 2 watts for GSM 900 or 1 watt for the other types.

For reasons of safety, we recommend that you do not use the phone while driving. Even use of a handsfree set can be a distraction while driving. Be sure to observe any country-specific regulations.

⚠ Warning

Mobile phones that do not comply with the above-mentioned mobile phone standard and radio equipment must only be operated using an antenna that is attached to the exterior of the vehicle.

Caution

Mobile phones and radio equipment may cause malfunctions in the vehicle electronics if they are operated in the vehicle without the external antenna unless the above-mentioned regulations are complied with.

Climate control

Heating and ventilation system, air conditioning system *	120
Electronic climate control system *	121
Air vents	122
Heating and ventilation system	123
Air conditioning system *	126
Electronic climate control system *	128
Auxiliary heater	134
Air intake	135
Pollen filter	135
Regular operation	135
Service	135



18203 5

Heating and ventilation system, air conditioning system *

Ventilation, heating and cooling * are combined into one unit that is designed to provide comfort regardless of the season, weather or outside temperature.

When cooling * is activated, the air is cooled and dried.

The heating unit heats the air as required in all operating modes depending on the position of the temperature switch. The air supply can be adjusted to suit requirements by means of the fan.



18204 5

The buttons for cooling ❄️ and air recirculation 🔄 are only found on versions with optional air conditioning system *.

Air conditioning system * ⇨ 126.



18205 5

Electronic climate control system*

Offers the greatest comfort in the vehicle interior regardless of the conditions outside.

To ensure a uniform and comfortable climate in the vehicle, the temperature of inflowing air, air-flow rate and air distribution are automatically adapted based on the climate conditions outside the vehicle and the current temperature of the vehicle interior.

The set values appear on the information display.

Electronic climate control system ⇨ 128.

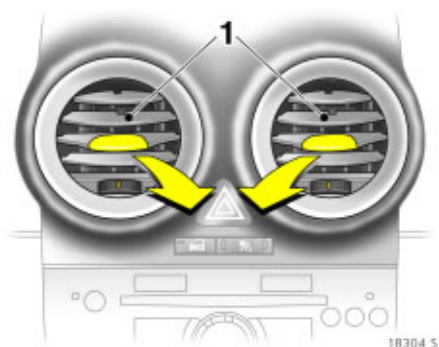

Air vents

At least one air vent must be open while cooling ❄️ (air conditioning compressor) is on in order to prevent the evaporator from icing up due to lack of air movement.

Comfortable ventilation of the interior is based on the position of the temperature switch.

To increase the air supply, set the fan to a higher speed and set the air distribution switch to 🌀 or 🌀.

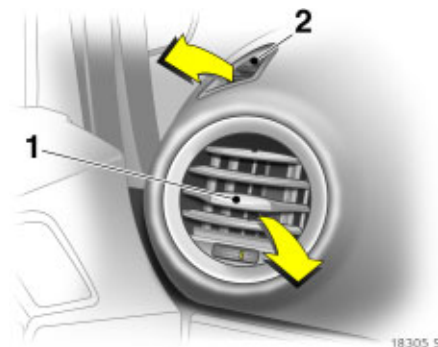

Centre and side air vents (1)

Set the direction of the air flow by turning the adjuster wheel from right to left and raise or lower the horizontal slats.

The side air vents can be directed at the door windows in order to assist the windscreen defroster nozzles (2).

To close the air vent, turn the adjuster wheel left or right to its stop.

Windscreen defroster nozzles (2)

Air distribution switch set to 🌀: Air is directed onto the windscreen and the door windows.

Other air vents

Located beneath the windscreen and in the foot wells.

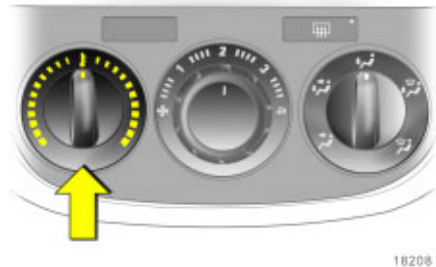

18208 5

Heating and ventilation system

Temperature

Adjusted using left-hand rotary switch.

Turn clockwise = Warm

Turn anticlockwise = Cold

The amount of heat is dependent on the coolant temperature and is thus not fully attained until the engine is warm.

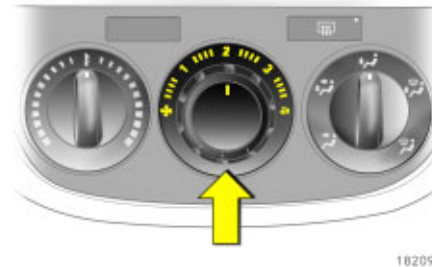

18209 1

Air flow

Adjusted using centre rotary switch.

✖ Off

1 - 4 Selected fan speed

The rate of air flow is determined by the fan. The fan should therefore also be switched on during a journey.



18207 5

Air distribution

Set using right rotary switch.

↗ To headroom via adjustable air vents

↖ To headroom via adjustable air vents, to footwell

↘ To footwell

↙ To windscreen, to front side windows, to footwell

↕ To windscreen and front side windows

Intermediate settings are possible.

Open the air vents when the switch is set to





↖ or ↗.

124 Climate control





18210 5

Ventilation



- Set the temperature to the desired setting.
- Switch fan on, select fan setting according to requirements.
- For maximum ventilation in the head area: set the air distribution switch to , open all air vents, direct the air vent slats  122.
- For ventilation to foot well: Set air distribution switch to .
- For simultaneous ventilation to the head area and the foot well: Set air distribution switch to .

Heating

For rapid warming of the passenger compartment:

- Turn the temperature switch clockwise as far as it will go (warm).
- Set the fan to speed 3.
- Open air vents.
- Set air distribution switch to desired position, preferably position ,  123.

The comfort and general well-being of the vehicle occupants are to a large extent dependent on a suitable ventilation and heating setting.

To achieve temperature layering with the pleasant effect of "cool head and warm feet", set the air distribution rotary switch to  or  and move the rotary temperature switch to any position you like (with temperature stratification effect in the centre zone).



18211 5

Heating the foot well

- Rotate temperature switch to right-hand zone.
- Switch on fan.
- Set air distribution switch to .





18212 5

Window demisting and de-icing

Warning

Disregard of the instructions could lead to misting or icing of the windows and subsequent accidents due to impaired visibility.

Misted or icy windows, e. g. due to damp weather, damp clothing or low outside temperatures:

- Turn the temperature switch clockwise as far as it will go (warm).
- Move fan switch to **3** or **4**.
- Move air distribution switch to .
- To heat footwell at same time, move air distribution switch to .
- Open side air vents as required and direct them towards door windows.
- Switch on heated rear window .

126 Climate control

Air conditioning system *

As a supplement to the heating and ventilation system, the air conditioning system cools and dehumidifies (dries) inflowing air.

If cooling or dehumidification is not desired, switch off cooling in order to save fuel.

Cooling switches off automatically at low outside temperatures.



10213 5

Cooling

Only operate with the engine and fan running. Activate and deactivate with the  button.

When cooling is active (AC compressor) the air is cooled and dehumidified. If cooling or dehumidification is not desired, switch off cooling in order to save fuel.

Cooling switches off automatically at low outside temperatures.

When cooling operates, condensation forms and drips from the underside of the vehicle.



10214 5

Air recirculation system

The air recirculation mode of the ventilation system is activated and deactivated by pressing the  button.

If fumes or unpleasant odours penetrate from outside: temporarily switch on air recirculation system .

To increase cooling at high outside temperatures, switch on the air recirculation system briefly.

⚠ Warning





The air recirculation system minimises the entry of outside air. The humidity increases, and the windows can mist up. The quality of the passenger compartment air deteriorates which may cause the vehicle occupants to feel drowsy.

Air distribution to : the air recirculation system is automatically switched off to speed up window demisting and prevent fogging.



10215 5

Comfort setting

- Set cooling  as desired.
- Air recirculation system  off.
- Set temperature switch as desired.
- Switch on fan at desired speed.
- Set air distribution switch to  or .
- Open air vents as required, and/or direct the air flow.



Temperature switch at lower end of adjustment range: warmer air will flow into the foot well and cooler air into the upper zone, with warmer air coming from the side air vents and cooler air from the centre vents.



10216 5

Maximum cooling

Open windows and sun roof  briefly so that warm air can escape rapidly.

- Cooling  on.
- Air recirculation system  on.
- Turn the temperature switch anticlockwise as far as it will go (cold).
- Move fan switch to 4.
- Set air distribution switch to .
- Open all air vents.

128 Climate control





18217 5

Window demisting and de-icing

Warning

Disregard of the instructions could lead to misting or icing of the windows and subsequent accidents due to impaired visibility.

Misted or icy windows, e. g. due to damp weather, damp clothing or low outside temperatures:

- Cooling  on, the air conditioning compressor automatically switches itself off at low outside temperatures (icing).
- Turn the temperature switch clockwise.
- Move fan switch to **4**.
- Move air distribution switch to .
- Open side air vents as required and direct them towards door windows.
- Switch on heated rear window .

Electronic climate control system *

Provides a the greatest amount of comfort in the interior regardless of the weather, outside temperature or season.

To ensure a constant and comfortable climate in the vehicle, the temperature of the inflowing air, the air-flow rate and the air distribution are changed automatically according to climatic conditions outside the vehicle.

The climate is regulated automatically based on personal settings.

Temperature changes due to external influences, such as direct sunlight, are automatically compensated.

Data is shown on the information display. Setting modifications are briefly shown in the information display, superimposing over the currently displayed menu.

May appear differently depending on the type of display ⇨ 94.

The climate control system settings are stored in the vehicle key when the vehicle is locked, see "Personalised key" ⇨ 39.

Different settings are stored for each remote control. Use of a remote control will activate the settings associated with it.



18205 1

Manual settings such as operating without cooling and air distribution can be selected using the menu ⇨ 132.

When cooling (air conditioning compressor) is active, air is cooled and dehumidified.

The pollen filter removes dust, soot, pollen and spores from the inflowing outside air.



18483 5

When set to automatic mode, the climate control system provides the optimal settings for almost all conditions. If necessary, climate control system settings can be modified manually.

The climate control system is only operational when the engine is running.

If you wish the climate control system * to operate correctly, do not cover the sensor on the instrument panel.

Cooling (air conditioning compressor) switches off automatically at low outside temperatures.

130 Climate control



Automatic mode

Basic setting for maximum comfort:

- Press **AUTO** button.
- Open all air vents.
- Switch on AC compressor ↻ 132.
- Set temperature to 22 °C using left rotary knob.

The temperature can be set higher or lower as desired.

Switching off the air conditioning compressor (**Eco** appears in display) can reduce comfort and affect safety ↻ 132. All air vents are actuated automatically in automatic mode. The air vents should therefore always be open ↻ 122.



Temperature preset

The left rotary knob can be used to set temperatures between 16 °C and 28 °C.

For reasons of comfort, temperature can only be changed in small increments.

If a temperature below 16 °C is set, **Lo** appears in the display: the climate control system runs constantly at maximum cooling power. The temperature is not regulated.

If a temperature above 28 °C is set, **Hi** appears in the display: the climate control system runs constantly at maximum heating power. The temperature is not regulated.

The temperature setting is saved when the ignition is switched off.



The air flow can be increased or decreased by turning the right knob.

To return to automatic mode: press button  or **AUTO**.



Heated rear window  46.

Window demisting and de-icing

Warning

Disregard of the instructions could lead to misting or icing of the windows and subsequent accidents due to impaired visibility.

Misted or icy windows, e. g. due to damp weather, damp clothing or low outside temperatures:

Press  button.  appears in display: control indicator in button illuminates.

Temperature and air distribution are set automatically and the fan runs at a high speed.

132 Climate control

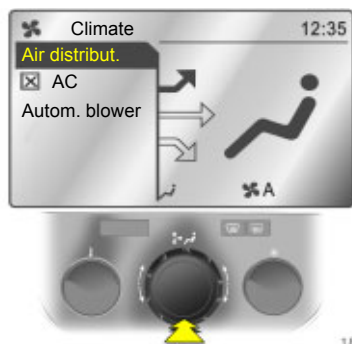

Manual settings

Under certain circumstances (e.g. iced or misted windows), the functions of the climate control system can be modified manually.

Climate control system settings can be changed via the centre knob, the buttons and the menus depicted on the display.

To call up the menu, press the centre knob. The **Climate** menu appears in the display.



Individual menu items are marked by turning the centre knob and selected by pressing it. Selecting certain menus by pressing the knob will open a submenu ✱.

To exit a menu, turn the centre knob left or right to **Return** or **Main** and select.

Manual settings are saved when the ignition is switched off.

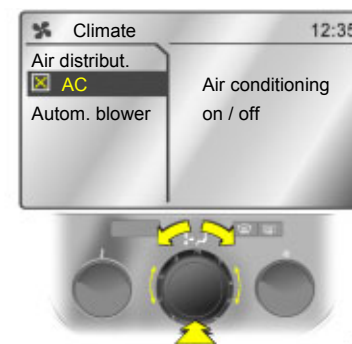

Activating and deactivating cooling system

Find option **Climate** in the menu **AC** and press to select.

Deactivate when cooling or drying is unnecessary (greatest fuel savings): **Eco** appears in the display. The inflowing air is neither cooled nor dehumidified. This restricts the level of comfort offered by the electronic climate control system. This may, for example, cause the windows to mist up.

When cooling operates, condensation forms and drips from the underside of the vehicle.

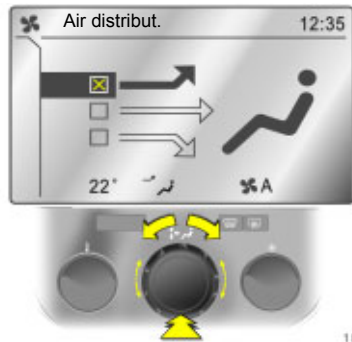

18219 S

Air distribution

Turn the centre knob. The **Air distribut.** menu is activated, showing the possible air distribution settings.

- Up Air distribution towards windscreen and front door windows.
- Middle Air distribution to vehicle occupants via controllable front air vents.
- Down Air distribution towards footwell.

The **Air distribut.** menu can also be called up via the **Climate** menu.

Return to automatic air distribution:
Deactivate corresponding setting or press button **AUTO**.



18485 S

Air flow

Turn right knob right or left. The selected fan speed is indicated with **3** and the number in the display.

At speed **0** both the fan and cooling (air conditioning compressor) are switched off.

To return to automatic mode: Press **AUTO** button.

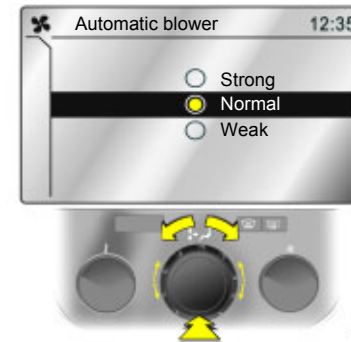

18223 S

Fan control in automatic mode

Fan regulation in automatic mode can be modified.

Select menu item **Automatic blower** from the **Climate** menu and select the desired fan regulation.

134 Climate control



18224 5

Manual air recirculation mode

The air recirculation system prevents the entry of outside air and the air in the passenger compartment is circulated.

Operated with the  button.

Warning

The exchange of fresh air is reduced in air circulation mode. The quality of the passenger compartment air deteriorates which may cause the vehicle occupants to feel drowsy. In operation without cooling the air humidity increases, so the windows may mist up. Consequently, the air circulation system should only be run for short periods of time.

To deactivate manual air recirculation:
Press button  again. The control indicator in the button will go out.

Auxiliary heater

Depending on outside temperature and engine temperature, the passenger compartment of vehicles with Quickheat  electric auxiliary heating is warmed up more quickly.

Diesel-engined vehicles have a fuel-powered auxiliary heater .

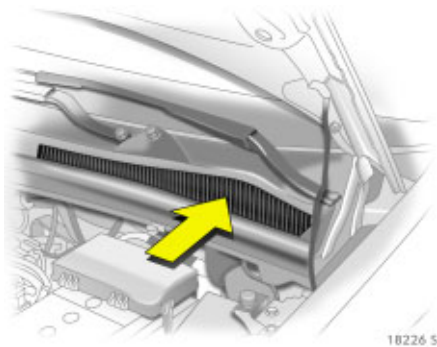

Air intake

The air intakes in the engine compartment in front of the windscreen must be kept free of leaves, dirt and snow in order to provide a supply of air.

Pollen filter

The pollen filter cleans dust, soot, pollen and spores from the air entering from outside. The active carbon layer ✱ eliminates most odours and noxious environmental gases from the air.

Regular operation

For consistently good operation, the air cooling system ✱ must be switched on for several minutes once per month regardless of the weather and the time of year. Operation not possible with the cooling system switched on and when the outside temperature is low.

Service

For optimal cooling performance, we recommend that the climate control system be checked annually, starting three years after initial vehicle registration.

- Functionality and pressure test
- Heating functionality
- Leakage check
- Check of drive belts
- Cleaning of condenser and evaporator drainage
- Performance check

Driving and operation

Manual transmission automated *... 136	136
Manual transmission	144
Automatic transmission *	144
Driving hints	149
Saving fuel, protecting the environment	151
Fuels, refuelling	153
Catalytic converter, exhaust gasses ..	155
Drive Control Systems	159
Hydraulic brake system	165
Anti-lock brake system (ABS ^(ABS))	166
Hand brake	167
Brake assist *	167
Hill Start Assist * (HSA)	167
Wheels, tyres	168
Roof rack *	173
Flex-Fix system *	174
Towing equipment *	184
Caravan/trailer towing	187

Manual transmission automated*

The Easytronic transmission permits manual (**manual mode**) or automatic gear shifting (**automatic mode**), both with automatic clutch control.



Transmission display

Shows the mode and current gear.

The display flashes for a few seconds if **A**, **M** or **R** is activated with the engine running and no foot brake applied.



Starting the engine

Depress the foot brake at the same time as starting the engine. The engine can be started only with the foot brake depressed. "N" is shown in the transmission display. If the foot brake is not depressed, the control indicator  comes on in the instrument, and at the same time "N" flashes in the transmission display, and the engine will not start.

If no brake lights are operational, the engine will not start.

Selecting neutral before starting the engine is not necessary. If a gear is selected, the transmission shifts automatically to neutral (N) when the foot brake is depressed before starting the engine. This may lead to a slight delay in the starting process.



Operation of manual transmission automated using selector lever

Always move the selector lever in the appropriate direction as far as it will go. Upon release, it automatically returns to the centre position. Pay heed to the gear/mode indicator in the transmission display.

Move selector lever toward N
Neutral.



Starting off

Depress the foot brake, release the hand brake and move the selector lever to **A**, **+** or **-**. This will switch the manual transmission automated to automatic and engage first gear (or second gear if the winter program is enabled). "A" appears on the transmission display.

The vehicle begins to "creep" when the foot brake is released.

It is also possible to start off without depressing the foot brake if the accelerator pedal is operated directly after moving the selector lever. If there is no acceleration or the foot brake is not depressed, no gear is engaged and "A" flashes. After a few seconds, the display resumes showing "N". Start off by repeating the previously described procedure.

In Automatic mode, selection of other gears is automatic irrespective of driving conditions.

Move selector lever toward A

Switch between Automatic and Manual mode.

In Manual mode the gears can be shifted manually. The transmission display shows the currently engaged gear.

If the engine speed is too low the manual transmission automated will automatically shift to a lower gear even in Manual mode. This prevents the engine from stalling.



Move selector lever toward + or -

- +** Shift to a higher gear.
- Shift to a lower gear.

If a higher gear is selected when the running speed is too low, or a lower gear when the speed is too high, the gear selection will not take place. This prevents the engine from running at too low or too high revs.

Gears can be skipped by jogging the selector lever repeatedly at short intervals.

If the vehicle is in automatic mode, on movement of the selector lever to + or - the manual transmission automated shifts to manual mode and changes up or down. The gear currently engaged appears on the transmission display.

Move selector lever toward R

Reverse gear. Engage only when vehicle is stationary.

Depress the foot brake, release the hand brake and move the selector lever to **R**. Reverse gear is engaged. "R" appears in the transmission display.

The vehicle begins to "creep" when the foot brake is released.

It is also possible to start off in reverse without depressing the foot brake if the accelerator pedal is operated directly after moving the selector lever. If there is no acceleration or the foot brake is not depressed, no gear is engaged and "R" flashes. After a few seconds, the display resumes showing "N". Start off by repeating the previously described procedure.

Stopping the vehicle

In Automatic or Manual mode, when the vehicle has stopped first gear (with Winter mode engaged, second gear) is engaged automatically and the clutch released. In **R** reverse remains engaged.

A warning buzzer sounds when the driver's door is opened if the engine is running, a gear is engaged and the foot brake is not depressed. The vehicle creeps if the hand brake is not engaged. Move the selector lever to **N** and apply the hand brake.

When stopping on gradients, engage the hand brake or depress the brake pedal. To prevent overheating of the clutch, do not increase engine speed to ensure smooth idling when in gear.

To prevent damage to the automated manual transmission, the clutch is closed automatically at high clutch temperatures.

Switch off engine if stopping for a lengthy period, e.g. in traffic jams or at level crossings.

Electronically controlled driving programmes

- Following a cold start, the operating temperature program automatically increases the engine revolutions to bring the catalytic converter to the required temperature.
- The adaptive program automatically selects the gear according to the driving conditions, e.g. increased load and gradients.



18228 5

Sport programme S

Shift times are reduced when the Sport programme is enabled, and the gears are shifted at higher engine speeds, although not when cruise control is activated.

The Winter program is switched off by:

- pressing button S again,
- turning off the ignition,
- activating the winter program ❄.

If the vehicle is switched to manual mode while the sport programme is active, the sport programme is interrupted. The sport programme resumes upon return to automatic mode.



18229 5

Winter programme ❄

In the event of difficulties starting off on slippery roads, press button ❄ ("A" and ❄ appear on the transmission display). The manual transmission automated switches to automatic mode and the vehicle sets off in second gear.

The Winter programme is switched off by:

- pressing the ❄ button again,
- turning off the ignition,
- when clutch temperature is too high.

Activating the winter programme deactivates the Sport programme, if selected.

If the vehicle is switched to manual mode while the winter programme is active, the winter programme is interrupted. The winter programme resumes upon return to automatic mode.

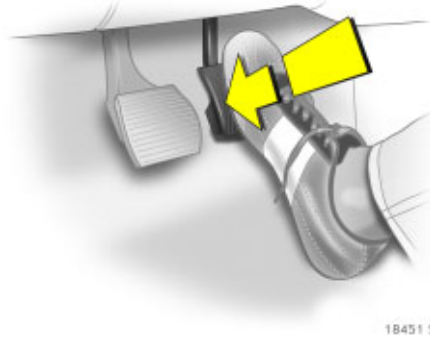

Kickdown

If the accelerator pedal is pressed past the pressure point, the transmission shifts to a lower gear depending on engine speed.

During kickdown no manual gear shifting is possible.

When the engine speed approaches its upper limit, the transmission shifts to a higher gear during kickdown even in Manual mode.

Without kickdown this automatic shift is not effected in Manual mode.

If the SPORT programme is engaged, the driven wheels may spin slightly when starting off with kickdown. This allows for maximum acceleration of the vehicle.

Engine braking

Automatic mode

When driving downhill, the manual transmission automated does not shift into higher gears until a fairly high engine speed has been reached. When braking, the manual transmission automated shifts down in good time.

Manual mode

To utilise the engine braking effect, select a lower gear in good time when driving downhill.

"Rocking the car"

Move selector lever between **R** and **A** (or + or -) while applying light pressure to the accelerator pedal **ONLY** if the vehicle has to be rocked to free it from sand, mud, snow or a hole. Do not race the engine and avoid sudden acceleration.

142 Driving and operation

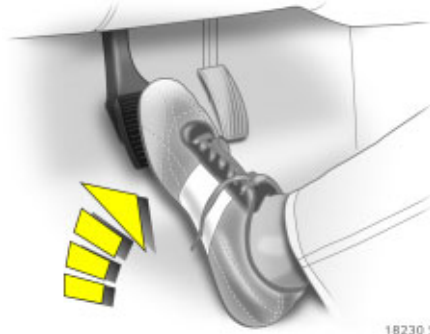

Manoeuvring the vehicle

To manoeuvre the vehicle back and forth during attempts to park or in garage entrances the creeping movement can be utilised by releasing the foot brake.

Never actuate accelerator and brake pedals simultaneously.

To prevent damage, the manual transmission automated deactivates the "creep function" when the temperature of the automatic clutch is extremely high.

Vehicle storage

Apply the handbrake and remove the key from the ignition. The most recently engaged gear (indicator in transmission display) remains engaged. With **N**, no gear is engaged.

When the ignition is switched off the manual transmission automated no longer responds to movement of the selector lever.

Lock the vehicle. Otherwise the battery may become discharged if the vehicle is parked for long periods.

If the hand brake has not been applied, the control indicator (D) flashes for a few seconds after the ignition is switched off.

With the engine off and the hand brake not applied, when the driver's door is opened a warning buzzer sounds and the control indicator (D) flashes; switch on ignition, engage gear, switch off ignition and apply hand brake.



Fault

To prevent damage to the automated manual transmission, the clutch is closed automatically at high clutch temperatures.

Warning light  lights up in the event of a fault. Continued driving is possible, but manual mode can no longer be used for changing gear.

If "F" also appears in the transmission display, continued driving is not possible.

Have cause of fault remedied by a workshop. The system's integrated self diagnostics allow faults to be quickly remedied.

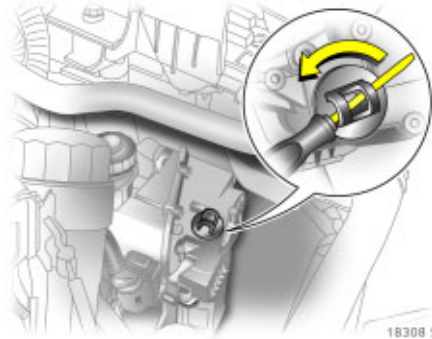

Interruption of power supply
 The clutch is not disengaged if there is an interruption of the power supply when a gear is engaged. The vehicle cannot move. If the battery is flat, start the car using jump leads ↗ 191.

If the cause of the power supply interruption is not a flat battery, contact a workshop for assistance. If the vehicle has to be moved out of flowing traffic, disengage clutch as follows:

1. Apply hand brake and switch off ignition.
2. Open bonnet and engage support.
3. Clean transmission around the cap (see Fig.) so that no dirt can get into the opening when the cap is removed.
4. Rotate cap to slacken and remove by lifting upwards – see figure.
5. Turn the adjusting screw clockwise using a flathead screwdriver (vehicle tools ↗ 198) until clear resistance can be felt. The clutch has now been disengaged.

Caution

Do not turn any further after feeling resistance, since this can damage the manual transmission automated.

6. Fit cleaned cap again. The cap must be in full contact with the housing.

Caution

Towing the vehicle and starting the engine is not permitted when the clutch has been released in this way, although the vehicle can be moved a short distance.

Contact a workshop for assistance immediately.

144 Driving and operation

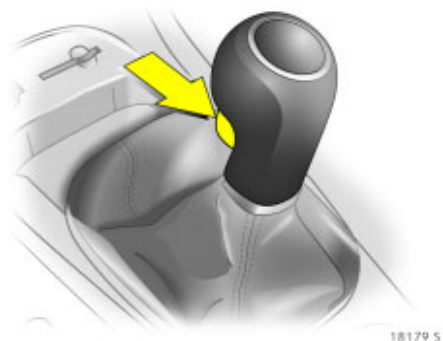

Manual transmission

To engage reverse, with the vehicle stationary wait 3 seconds after declutching and then pull up the button on the selector lever and engage the gear.

If the gear does not engage, set the lever in neutral, release the clutch pedal and depress again; then repeat gear selection.

Do not grind the clutch unnecessarily.

When operating, depress the clutch pedal completely. Do not use the pedal as a foot rest (increases clutch wear).

Automatic transmission *

The automatic transmission * permits automatic shifting.



Transmission display

Display of selected gear.

P Park position.

R Reverse gear.

N Neutral.

D Drive.

3, 2, 1 Selected gear.

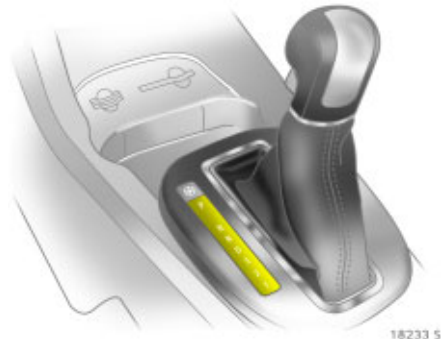

Selector lever positions P, R, N and D

- P** Park position. Front wheels blocked. Engage only when the vehicle is stationary and the hand brake is applied.
- R** Reverse gear. Engage only when vehicle is stationary.
- N** Neutral.
- D** Continuous mode for normal driving conditions in 1st to highest gear.

The selector lever can only be moved from **P** when the ignition is switched on and the foot brake depressed (selector lever lock).

To engage **P** or **R**, push button on selector lever.

The engine can only be started with lever in position **P** or **N**. When position **N** is selected, press foot brake or engage hand brake before starting.

Do not accelerate while engaging a gear. Never depress the accelerator pedal and brake pedal at the same time.

When a gear is engaged, the vehicle slowly begins to creep when the brake is released.

Gears 3, 2, 1

3, 2, 1 Transmission does not shift above the selected gear.

Press button on selector lever to engage **3** or **1**.

Only select **3, 2** or **1** to prevent automatic upshifting or as an aid in engine braking.

146 Driving and operation

Electronically controlled driving programmes

- The automatic neutral shift function automatically shifts to idling when the vehicle is stopped with a forward gear engaged (depending on transmission fluid temperature).
- Following a cold start, the operating temperature programme increases engine speed to quickly bring the catalytic converter to the required temperature.
- The adaptive program automatically adjusts the gear change to the driving conditions, e.g. greater load or gradients.

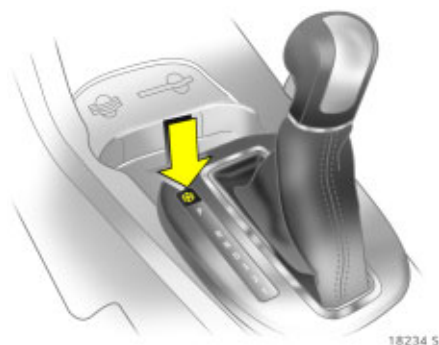

Winter programme ❄️

Activate the Winter programme if you have problems starting off on a slippery road surface.

To activate

Press the ❄️ button with **P, R, N, D** or **3** engaged. The vehicle starts off in 3rd gear.

To deactivate

The Winter programme is switched off by:

- pressing the ❄️ button again,
- manually selecting **2** or **1**,
- turning off the ignition,
- or if the transmission oil temperature is too high.

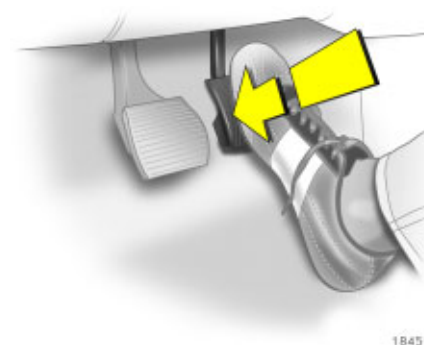

Kickdown

If the accelerator pedal is pressed past the pressure point, the transmission shifts to a lower gear depending on engine speed.

Engine braking

In order to utilise the engine braking effect when driving downhill, select drive range **3**, **2** or, if necessary, **1** in good time.

Gear **1** has the greatest braking effect. If gear **1** is selected at too great a speed the transmission remains in 2nd until the shifting point for 1st gear is achieved by braking, for example.

"Rocking the car"

If it becomes necessary to rock the vehicle to free it from sand, mud, snow or a hole, move the selector lever from **D** to **R** repeatedly. Do not race the engine and avoid sudden acceleration.

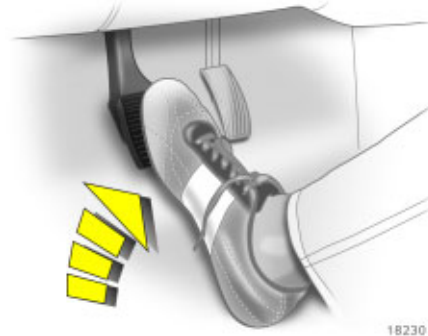

18230 5

Manoeuvring the vehicle

To manoeuvre the vehicle back and forth during attempts to park or in garage entrances, the vehicle's creeping movement can be utilised by releasing the brake pedal.

Never actuate accelerator and brake pedals simultaneously.

Stopping the vehicle

The selector lever can be left in the chosen gear with the engine running.

When stopping on gradients engage hand brake or depress brake pedal. To prevent overheating of the transmission, do not increase engine revolutions to ensure smooth idling while standing if a gear has been selected.

Switch off engine if stopping for a lengthy period, e.g. in traffic jams or at level crossings.

Before leaving the car, apply the hand brake first, then select **P**. Remove the ignition key. Lock the vehicle. Otherwise the battery may become discharged if the vehicle is parked for long periods.

The ignition key can only be removed when the selector lever is in position **P**.



Fault

If there is a fault, warning lamp  lights up. Gear shifting is no longer automatic. It is possible to continue driving.

Have cause of fault remedied by a workshop.

2nd gear is not available. Manual shifting:

- 1 = 1st gear
- 2 = 3rd gear
- 3, D = 4th gear

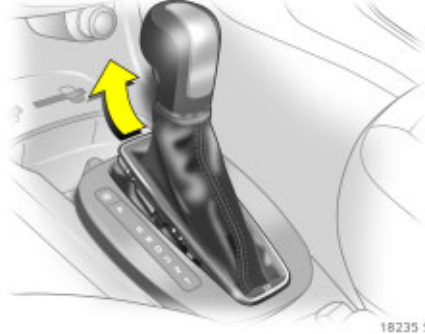

Interruption of power supply

If there is an electrical power failure, the selector lever cannot be moved out of position **P**.

If the battery is flat, start the car using jump leads  191.

If the battery is not the cause of the fault, release selector lever:

1. Apply hand brake.
2. Release selector lever panelling from centre console at front, roll upward and rotate to the left.

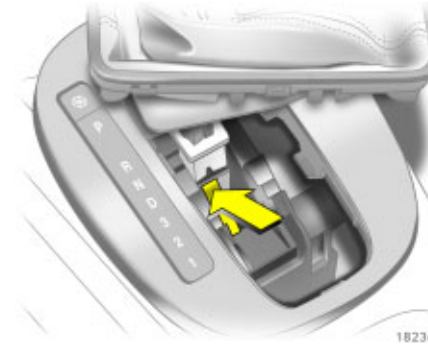

3. Push the yellow catch forward with a screwdriver and move the selector lever out of **P**.

4. Mount selector lever trim on centre console and refit.

Re-selecting **P** locks the system again. Have cause of power supply interruption remedied by a workshop.

Driving hints**The first 1000 km**

Drive your vehicle at various speeds. Do not use full throttle. Never allow the engine to labour at low revs.

Make good use of all gears. Depress the accelerator pedal a maximum of about $\frac{3}{4}$ of the available pedal travel in all gears.

Do not drive faster than three quarters of maximum speed.

Do not brake unnecessarily hard for the first 200 km.

During the first drive smoke may develop because of wax and oil evaporating on the exhaust system. Park the vehicle in the open for a while after the first drive and avoid inhaling the fumes.

Fuel and engine oil consumption is higher than normal during the running-in period.

Never coast with engine not running

Many units will not function in this situation (e.g. brake servo unit, electro-hydraulic power steering). Driving in this manner is a danger to yourself and others.

Brake servo unit

When the engine is not running, the brake servo unit is no longer effective once the brake pedal has been depressed once or twice. Braking effect is not reduced, but significantly greater force is required for braking.

Electro-hydraulic power assisted steering

If the power assisted steering fails when being towed with the engine switched off, the vehicle can still be steered, but considerably more force is required.

Driving in mountainous terrain or with a trailer/caravan

The cooling fan is electrically operated. Its cooling power is therefore independent of the engine speed.

Since a considerable amount of heat is generated at high engine speeds and less at slower speeds, do not shift down when climbing hills whilst the vehicle is still coping with the gradient in the higher gear.

Driving with a roof load

Do not exceed the permissible roof load ⇨ 173, ⇨ 259. For reasons of safety, distribute the load evenly and secure it properly with retaining straps. Adjust tyre pressure to load conditions. Do not drive faster than 120 km/h. Check and re-tighten the straps frequently. Observe country-specific regulations.

Switching off the engine

When you switch off, fans in the engine compartment may continue running for a time to cool the engine.

If the engine temperature is very high, e.g. after driving in mountainous terrain: allow the engine to idle for approximately two minutes in order to prevent heat accumulation.

Vehicles with turbocharged engine

After running at high engine speeds or high engine loads, operate the engine briefly at a low load or run in neutral for approx. 30 seconds before switching off in order to protect the turbocharger.

150 Driving and operation

Save energy – more kilometres

Please observe the running-in hints on the previous page and the tips for saving energy on the following pages.

Good, technically correct and economical driving ensures maximum durability and performance for your vehicle.

Overrun cut-off

The fuel supply is automatically cut off during overrun, e.g. when the vehicle is driven with a gear engaged but no throttle application. Overrun cut-off is deactivated if catalytic converter temperature is high.

Vehicles with turbocharged engine

Flow-generated noises may be audible if the accelerator is released quickly on account of air flow in the turbocharger.

Engine speed

Drive in a low engine speed range for each gear as much as possible.

Warming up

After a cold start, the automatic transmission * or manual transmission automated * in automatic mode shifts into higher gears at higher rpm. This allows the catalytic converter to quickly reach the temperature required for optimum pollutant reduction.

Correct gear selection

Do not race your engine whilst in neutral or with a low gear selected. Driving too fast in individual gears as well as stop-and-go traffic increases engine wear and fuel consumption.

Change down

When decreasing speed, shift down into the next lowest gear. Do not slip the clutch with a high-revving engine. This is especially important when hill climbing.

Cooling fan

The cooling fan is controlled via a thermostatic switch and therefore only runs if necessary.

The cooling fan automatically switches on when the diesel particle filter is being cleaned * depending on the engine.

Pedals

Do not place any objects in the foot well which could slip under the pedals and inhibit the pedal travel.

To ensure the pedal travel is uninhibited, there must be no mats in the area of the pedals.

Battery care

When driving slowly or when the vehicle is stationary, e.g. in slow urban traffic, stop-and-go traffic or traffic jams, turn off all unnecessary electrical loads where possible (e.g. heated rear window, heated front seats, etc.).

Declutch when starting in order to relieve the strain on the starter and the battery.

Saving fuel, protecting the environment

Trend-setting technology

Environmentally friendly and mainly recyclable materials were used when your vehicle was being developed and manufactured. The production methods used to make your vehicle are also environmentally-compatible.

Recycling of production wastes keeps the circulation of material closed. Reduction of energy and water requirements also helps to conserve natural resources.

A highly advanced design means that your vehicle can be easily disassembled at the end of its working life, and the individual materials separated for subsequent re-use.

Materials such as asbestos and cadmium are not used. The refrigerant in the air conditioning system * is CFC-free.

New painting techniques employ water as a solvent.

End-of-life vehicle recovery

Information on end-of-life vehicle recovery centres and the recycling of end-of-life vehicles is available at www.opel.com.

Energy and environment-conscious driving

■ High noise levels and exhaust emissions are often a result of driving without due attention to saving energy and protecting the environment.

■ You should therefore drive with energy in mind: "more miles – less fuel".

Reduce the noise level and exhaust emissions by adopting an environment-conscious driving style. This is extremely worthwhile and improves the quality of life.

Fuel consumption depends to a great extent on your own personal driving style. The following hints are intended to help you consume fuel at a rate that is as close as possible to the specified levels \diamond 256.

Check your vehicle's fuel consumption every time you refuel. This facilitates early detection of any irregularities causing increased fuel consumption.

Warming up

■ Full throttle and warming up at idle speed increase wear, fuel consumption, exhaust emission, the amount of pollutant in the exhaust and the amount of noise.

■ Drive off as soon as possible after starting.

Uniform speed

■ Hectic driving significantly increases fuel consumption, the exhaust emissions, the proportion of pollutant in the exhaust gas and the noise level.

■ Do not accelerate and brake unnecessarily. Drive at uniform speed, watching the road.

Avoid frequent starting off and stopping e.g. at traffic lights, in short distance traffic and in queues of traffic by means of clever planning. Select roads with good traffic flow.

Idling

■ The engine also consumes fuel when idling.

■ If you have to wait for more than one minute, it is worthwhile switching off the engine. Five minutes of idling corresponds to approximately one kilometre of driving.

152 Driving and operation

Overrun

- The fuel supply is shut off automatically on overrun, e.g. when descending steep hills or when braking ↷ 150.
- To enable the overrun cut-off to come into action and save fuel, do not accelerate or declutch during overrun.

Correct gear selection

- High revs increase engine wear and fuel consumption.
- Do not race your engine. Avoid driving at high engine speeds.

Making use of the tachometer helps to save fuel. Drive in a low engine speed range for each gear as much as possible with uniform engine speeds. Drive as often as possible in top gear, select the next higher gear as soon as possible, and only change down when the engine is no longer running perfectly smoothly.

High speed

- The higher the speed, the higher the consumption and the noise level. At top speed, you consume a great deal of fuel and produce excessive noise and exhaust emissions.

- Slightly releasing the accelerator pedal results in distinct fuel savings with no major loss of speed.

Drive at no more than around three quarters of maximum speed and you will use up to 50 % less fuel, without losing a great deal of time.

Tyre pressure

- Inadequate tyre pressure, leading to higher road resistance, costs money in two ways: for more fuel and increased tyre wear.
- Regular checks (every 14 days) pay off.

Electrical loads

- The power consumption of electrical equipment increases fuel consumption.
- Switch off all additional consumers (e.g. air conditioning ❄, heated rear window) when not needed.

Roof racks, ski-holders

- Roof loads can increase fuel consumption by approximately 1l/100 km due to air resistance.
- Remove them if they are not being used.

Repair and maintenance

- Improper repairs or adjustment and maintenance work can increase fuel consumption. Do not carry out work on the engine yourself.

You may out of ignorance infringe environmental laws by not disposing of materials properly.

Appropriate parts might not be recycled.

Contact with some of the materials involved may pose a health hazard.

- We recommend that repair and maintenance be entrusted to your Opel Partner.

Extreme driving conditions

- Driving up steep slopes, cornering, driving on poor roads and driving in ice and snow all increase fuel consumption.

Fuel consumption increases dramatically in urban traffic and at low temperatures, especially on short trips when the engine operating temperature is not reached.

- Following the instructions given above will minimise consumption under these conditions.

Fuels, refuelling

Fuel consumption

Fuel consumption is determined under specific driving conditions – see page ↻ 256.

Special equipment increases the weight of the vehicle. As a result, they can increase fuel consumption and reduce the specified maximum speed.

For the first few thousand kilometres, friction between the engine and transmission components is higher. This increases fuel consumption.

Fuel for petrol engines

Only use unleaded fuel that complies with DIN EN 228.

Fuels with ethanol content greater than 5 % may only be used if the vehicle has been specifically developed and approved for these fuels.

Use fuel with the recommended octane rating (value in bold ↻ 254). Use of fuel with too low an octane rating can reduce engine power and torque and will slightly increase fuel consumption.

Caution
Use of fuel with too low an octane rating could lead to uncontrolled combustion and engine damage.

Fuel for diesel engines

Only use diesel fuel that complies with DIN EN 590. The fuel must have low sulphur content (maximum 50 ppm).

Do not use marine diesel oils, heating oils or entirely or partially plant-based diesel fuels, such as rape seed oil or bio diesel, Aquazole and similar diesel-water emulsions. Diesel fuels must not be diluted with fuels for petrol engines.

The flow and filterability of diesel fuel are temperature-dependent. When temperatures are low, refuel with diesel fuel with guaranteed winter properties.

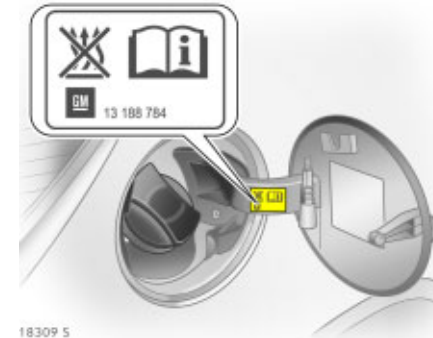

Fuel filler cap

Only a Opel Genuine fuel filler cap provides full functionality. Diesel-engined vehicles have special fuel filler caps.

Refuelling

⚠ Warning
Before refuelling, switch off engine and any external heaters with combustion chambers ❄ (identified by sticker on tank flap). Switch off any mobile phones. Follow the operating and safety instructions of the filling station when refueling.



154 Driving and operation

Warning

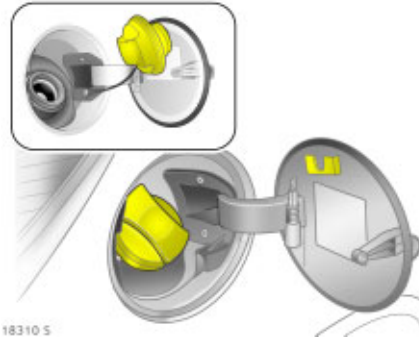
Fuel is flammable and explosive. No smoking. No naked flames or sparks. If you can smell fuel in your vehicle, have the cause of this rectified immediately by a workshop.



Fuel filler neck at right rear side of vehicle.

With a central locking system with remote control , the tank flap is unlocked at the same time as the doors  32.

Open tank flap.

Unlock the fuel filler cap with the ignition key , unscrew, remove and attach to tank flap.

The fuel tank has a limiting system which prevents overfilling of the tank.

Correct filling depends to a large extent on proper operation of the fuel dispensing pump:

1. Fully insert the pump nozzle and switch it on.
2. After automatic switch off, the specified tank capacity is reached after continued, measured filling. Leave the filler nozzle in place until the stop.

To close, place fuel filler cap in position and turn, overcoming the resistance until the ratchet on the cap engages audibly. Lock the fuel filler cap with the ignition key .

Close fuel tank cover.

Caution

Wipe off any overflowing fuel immediately.

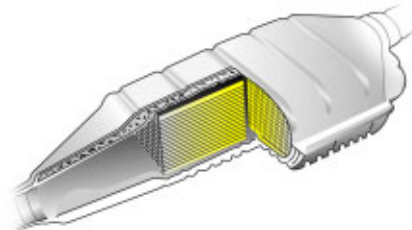

17199 T

Catalytic converter, exhaust gasses

Catalytic converter

The catalytic converter reduces the amount of harmful substances in the exhaust gas, such as carbon monoxide (CO), hydrocarbons, CH) and nitrous oxide (NO_x).

Fuel grades other than those listed on pages 153, 252 (e. g. LRP = Lead Replacement Petrol or leaded fuel) could damage the catalytic converter or electronic components.

Caution
Damage to the catalytic converter or the vehicle may result if the following points are not observed.

- In the event of misfiring, uneven engine running, a clear reduction in engine performance or other unusual problems, have the cause of the fault rectified by a workshop as soon as possible. In an emergency, driving can be continued for a short period, keeping vehicle speed and engine speed low.

This does not apply when the Electronic Stability Program (ESP®^{Plus}*) kicks in ↻ 151.

- If unburnt fuel enters the catalytic converter of a petrol engine, this may result in overheating and irreparable damage to the catalytic converter.

You should therefore avoid unnecessarily long use of the starter when starting off, running the tank dry and starting the engine by pushing or towing.



18182 S

Controlling exhaust emission

Design measures, primarily in the fuel injection system and ignition system zones in combination with the catalytic converter, the amount of hazardous substances in the exhaust emissions, such as carbon monoxide (CO), hydrocarbons (CH) and nitrogen oxides (NO_x), are reduced to a minimum.



Control indicator  for exhaust
Illuminates when the ignition is switched on and during the start attempt. Goes off shortly after the engine starts running.

Illumination whilst the engine is running indicates a fault in the emission control system. The permissible emission limits may be exceeded. Contact a workshop for assistance immediately.

Illumination with the engine running indicates a fault that can cause damage to the catalytic converter. It is possible to continue driving without causing damage by slowing down until the flashing stops and the control indicator illuminates. Contact a workshop for assistance immediately.







Control indicator  for engine electronics
Illuminates for a few seconds after the ignition is switched on.

If it illuminates when the engine is running, there is a fault in engine or transmission electronics. The electronic system switches to an emergency running programme. Fuel consumption may be increased and the driveability of the vehicle may be impaired.

In some cases the fault can be remedied by switching the engine off and starting it again. If the control indicator continues to illuminate whilst the engine is running, contact a workshop for assistance in remedying the cause of the fault.

If it illuminates briefly, but does not recur, it is of no significance.

If  lights up, this could mean that there is water in the diesel fuel filter . A message appears at the same time on the service display  91. Have the fuel filter checked for possible water contamination by a workshop.

If it flashes after the ignition is switched on, there is a fault in the immobiliser system. The engine cannot be started  27.

Engine exhaust

⚠ Warning

Engine exhaust gases contain poisonous carbon monoxide, which is colourless and odourless and could be fatal if inhaled.

If exhaust gases penetrate the vehicle, open windows and contact a workshop for assistance.

Avoid driving with the tailgate open, since exhaust gas can enter the interior of the vehicle.

Diesel particle filter *

The diesel particle filter system filters harmful soot particles out of the exhaust gases. The system includes a self-cleaning function that runs automatically during driving. The filter is cleaned by burning off the soot particles at high temperature. This process takes place automatically under set driving conditions and may take up to 25 minutes. Fuel consumption may be higher during this period. The emission of smells and smoke during this process is normal.



18544 5

Under certain driving conditions, e.g. short journeys, the system may not clean itself automatically.

If the filter requires cleaning and previous driving conditions did not enable automatic cleaning, control indicator  flashes. Continue driving, keeping engine speed above 2000 rpm⁻¹. Shift down if necessary. Diesel particle filter cleaning is then initiated.

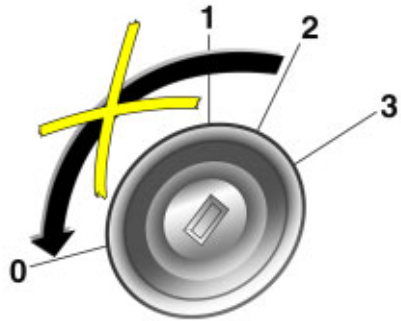

18540 T

We recommend not stopping driving during cleaning, and not switching off the ignition. Cleaning is fastest at high engine revs and high loads.



18545 S

The control indicator  goes off as soon as the self-cleaning operation is complete.

Maintenance

Have all maintenance work carried out at the specified intervals. We recommend that you entrust this work to your Opel Partner, who has proper equipment and trained personnel available. Electronic testing systems permit rapid diagnosis and remedy of faults. This way you can be certain that all components of the vehicle's electrical, injection and ignition systems operate correctly, that your vehicle has a low level of pollutant emission and that the catalytic converter system will have a long service life.

You are thereby making an important contribution towards keeping the air clean and compliance with emissions legislation.

Checking and adjustment of the fuel-injection and ignition systems is included in the inspection. For this reason, you should have all maintenance work carried out at the intervals specified in your Service and Warranty Booklet.

Drive Control Systems

Electronic Stability Program (ESP®^{Plus}) *

ESP®^{Plus} improves driving stability when necessary in any driving situation regardless of the type of road surface or tyre grip. It also prevents the drive wheels from spinning.

As soon as the vehicle starts to swerve (understeer/oversteer), engine output is reduced and the wheels are braked individually. This considerably improves the driving stability of the vehicle on slippery road surfaces.

ESP®^{Plus} is ready for operation as soon as the ignition is switched on and control indicator  goes out.

When the ESP®^{Plus} comes into action,  flashes.

The vehicle is now in a critical situation; ESP®^{Plus} allows you to keep control of the vehicle and reminds you to match your speed to the road conditions.

Warning

Do not let this special safety feature tempt you into taking risks when driving. ESP®^{Plus} does not negate the laws of physics. Adapt speed to the road conditions.



Control indicator

The warning lamp lights up for a few seconds when the ignition is switched on. The system is now ready for operation.

Flashing during driving:

This shows the system has come into action. The engine output may be reduced (the sound of the engine changes) and the vehicle may be braked automatically to a small degree.

Illuminates while driving:

The system is switched off * or a fault is present. Continued driving is possible. However, directional control may deteriorate depending on the road surface conditions.

Switch on ESP®^{Plus} again and have cause of fault remedied by a workshop. The self-diagnosis that is integrated in the system will help you to find a solution quickly.

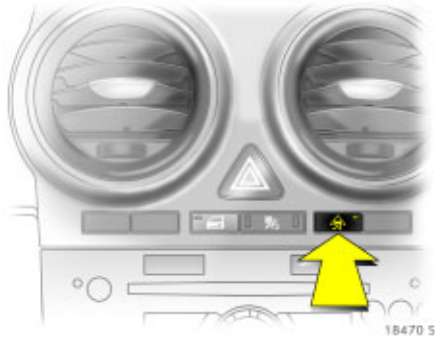

Switching off *

ESP®^{Plus} can be deactivated by pressing button *.

Switching off is indicated by the control indicator lighting up in the instrument. Also appears on the service display **ESPoff** ↻ 91.

Pressing the button again or turning on the ignition switches the ESP®^{Plus} on again.

⚠ Warning

If the vehicle has run-flat tyres * the ESP®^{Plus} must not be deactivated with depressurised tyres.

Cruise control *

Cruise control can store and maintain speeds between 30 and 200 km/h. Deviation from the stored speed may occur when driving up or downhill.

For safety reasons the cruise control system cannot be activated until the foot brake has been operated, otherwise the control indicator flashes .

Cruise control is operated with switch , and button **0** on the turn signal stalk.



Do not use the cruise control if it is not advisable to maintain a constant speed (e.g. in situations presenting a danger to yourself and other road users, in heavy traffic or on winding, slippery or greasy roads).

With automatic transmission *, engage cruise control only in **D**, or with manual transmission automated * in automatic mode only.



⚠ Warning

When the cruise control is active, reaction times may be increased due to the different position of the feet.

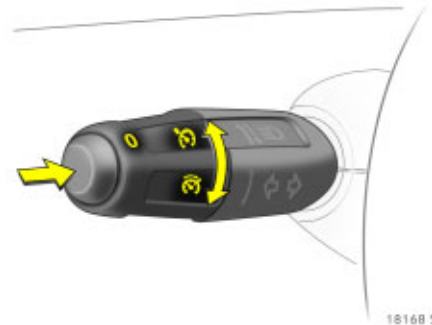

Control indicator 
 When driving, the control indicator  illuminates as soon as the cruise control is switched on.
 If the cruise control is switched on before the brake has been applied once, the control indicator flashes .





To activate
 Turn switch  up and release. The current speed is stored and maintained. The accelerator pedal may be released.
 Vehicle speed can be increased by depressing the accelerator pedal. When the accelerator pedal is released, the previously stored speed is resumed.
Increase
 When cruise control is engaged, turn switch  upwards and hold, or turn briefly several times: continuous or stepwise increase of the speed in 2 km/h increments.
 After releasing, the current speed is stored and maintained.

Decelerate
 When cruise control is engaged, turn switch  downwards and hold, or turn briefly several times: continuous or stepwise reduction of the speed in 2 km/h increments.

After releasing, the current speed is stored and maintained.

To deactivate
 Tap button **0**: this switches the cruise control off. Warning lamp  goes out.

Automatic deactivation:

- Vehicle speed below approx. 30 km/h.
- The brake pedal is depressed.
- The clutch pedal is depressed .
- Selector lever for automatic transmission  or manual transmission automated  in **N**.

Stored speed
 The speed is saved until the ignition is switched off.

To reset the saved speed at over 30 km/h, turn switch  downwards.

162 Driving and operation



Ultrasonic parking sensors ✱

Park pilot makes reverse parking easier by measuring the distance between the back of the vehicle and obstacles to the rear. It is the driver, however, who maintains full responsibility for parking.

The system records the distance using four sensors in the rear bumper.

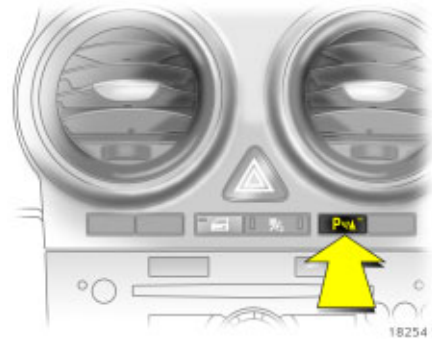

To activate

The park pilot system activates automatically when the ignition is switched on and reverse gear is engaged.

Its operational readiness is indicated by illumination of the LED in the button **PWA** ✱.

If the vehicle approaches an obstacle, a series of acoustic signals sound. The interval between the signals becomes shorter as the vehicle gets closer to the obstacle. When the distance is less than 30 cm, the signal is continuous.

⚠ Warning

Under certain circumstances, various reflective surfaces on objects or clothing as well as external noise sources may cause the system to fail to detect obstacles.

To deactivate

The system deactivates automatically when reverse gear is disengaged.

If the system is switched off with reverse gear engaged, press button **P** with a triangle and asterisk symbol, the LED in the button goes out.

To reactivate, press button **P** with a triangle again.



Control indicator **P** with a triangle

Illuminates:

Fault in system. The system is not operational. Have cause of fault remedied by a workshop. The system's integrated self diagnostics allows faults to be quickly remedied.

Flashes:

The fault is due to sensors obstructed with snow or ice. The sensors must be undamaged and free of dirt, snow and ice.

Interference due to external sources of ultra sound (e.g. pneumatic drills, rotary machines). Once the source of interference is removed, the system will operate normally.

Caravan/trailer towing equipment *,
caravan/trailer towing

When towing, park pilot is automatically deactivated when the trailer cable is plugged into the socket.

Fitting rear load racks *

Rear carriers, e. g. bike carriers, could cause system malfunction.



Deflation detection system (DDS) ❄

The deflation detection system monitors the revolutions of all four vehicles from a speed of approximately 30 km/h. If there is a loss of pressure in one of the tyres, its diameter is reduced, and therefore also the wheel rotation speed. Warning lamp (⚠) lights red.

Stop immediately and check tyre pressure. Fit the spare wheel if necessary ↻ 196, ↻ 200.

Control indicator (⚠)

If control indicator (⚠) lights up red while driving, there is a loss of pressure. Stop immediately and check tyre pressures. A maximum speed of 80 km/h is permitted for tyres run flat ❄ ↻ 171.

Control indicator illumination (⚠) in yellow indicates a fault in the system. Have cause of fault remedied by a workshop. The system's integrated self diagnostics allow faults to be quickly remedied.

The control indicator flashes three times when the system is initialising.

⚠ Warning

The deflation detection system does not replace manual checks with a suitable gauge.

Check tyre pressures at least every 14 days and prior to any long journey; the tyres should be checked when cold. Don't forget to check the spare ❄.

Tyre pressure ↻ 169, ↻ 264.

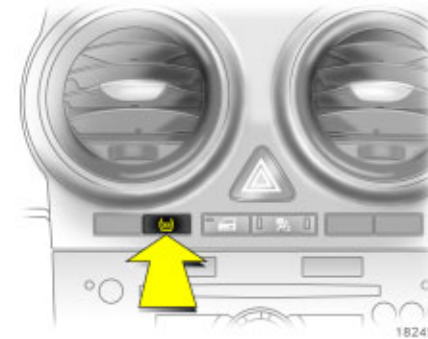

System initialisation

After correcting the tyre pressure or changing a tyre/wheel, the system must be initialised: turn the ignition on, press the **DDS** button for approx. 4 seconds. Control indicator (⚠) flashes three times. The system is operational after driving a certain distance.

Only initialise the system if all tyres have the prescribed pressure.

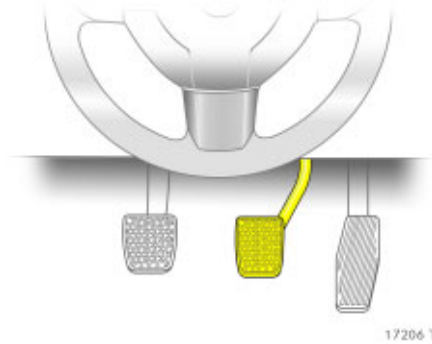

Hydraulic brake system

The foot brake comprises two independent brake circuits.

If a brake circuit fails, the vehicle can still be braked using the other brake circuit. However, the brake pedal must be depressed a considerable way before any braking effect occurs, and much more force is required. The braking distance is longer. Contact a workshop for assistance before continuing to drive.

To ensure that full pedal travel can be utilised, especially in case of a fault in one of the brake circuits, there must be no mats in the vicinity of the pedals ⇨ 150.

When the engine is not running, the support of the brake servo unit disappears once the brake pedal has been depressed once or twice. Braking effect is not reduced, but braking requires significantly greater force. This is especially important to bear in mind when towing.

The brake fluid level should be checked regularly. If the brake fluid level is too low and the hand brake is not applied, control indicator (D) on the instrument panel illuminates ⇨ 89.



Brake system control indicator (D)

The control indicator lights up when the ignition is switched on when the hand brake is applied or when the brake or clutch fluid level is too low. Brake fluid level ⇨ 246.

⚠ Warning

If the control indicator illuminates when the hand brake is released, stop driving immediately. Contact a workshop for assistance.

For vehicles with manual transmission automated ⚙, the control indicator flashes for a few seconds when the ignition is turned off when the hand brake is not applied.

Anti-lock brake system (ABS ^(ABS))

ABS prevents the wheels from locking.

ABS starts to regulate brake pressure as soon as a wheel shows a tendency to lock. The vehicle remains steerable, even during hard braking.

For optimum braking, keep the brake pedal fully depressed throughout the braking process, despite the fact that the pedal is pulsating. Do not reduce the pressure on the pedal.



Control indicator ^(ABS) for ABS

It illuminates for a few seconds when ignition is switched on. Once the control indicator goes out, the system is ready for operation.

If the control indicator does not go out after a few seconds, or if it illuminates while driving, there is a fault in the ABS. The brake system remains operational without ABS regulation.

Adaptive brake lamp *

During full-on braking, all three brake lamps flash for the duration of ABS control.

Self testing

When the engine is started and the vehicle starts off, the system performs a self-check, which may be audible.

Fault

⚠ Warning

If there is a fault in the ABS, the wheels may be liable to lock due to braking that is heavier than normal. The advantages of ABS are no longer available. During hard braking, the vehicle can no longer be steered and may swerve.

Have cause of fault remedied by a workshop. The system's integrated self diagnostics allow faults to be quickly remedied.

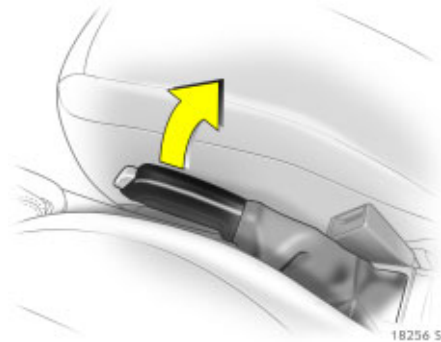

Hand brake

Always apply hand brake firmly without pressing the release button, and apply as firmly as possible on steep slopes.

To release the hand brake pull lever up slightly, press release button, and lower lever all the way down.

To reduce the operating forces of the hand brake, depress the foot brake at the same time.

Brake assist *

If the brake pedal is operated quickly with a powerful push, the vehicle is automatically braked at full braking power in order to achieve the shortest possible braking distance when full-on braking occurs (brake assist).

Maintain steady pressure on the brake pedal for as long as full-on braking is to continue. When the brake pedal is released, the maximum brake force amplification is taken away.

Hill Start Assist * (HSA)

The system helps pull away on inclines. After releasing the footbrake, if the hand brake is not applied the brakes are only released after 2 seconds. As soon as the acceleration is sufficient to prevent rolling back, the brake is released.

Wheels, tyres

Suitable tyres and restrictions ⇨ 264.

Tyres fitted in the factory are adapted to the chassis and provide optimum driving comfort and safety.

Changing tyre/wheel type

If tyres of a different size than those fitted at the factory are used, it may be necessary to reprogram the electronic speedometer and make other vehicle modifications.

After converting to a different tyre size, have the adhesive label with tyre pressures replaced.

⚠ Warning

Use of unsuitable tyres or wheels may lead to accidents and render the vehicle unroadworthy.

Vehicles with run-flat tyres *

When switching wheels, e.g. when switching to winter tyres, use run-flat tyres as there is no spare wheel or tyre repair kit in the vehicle.

Vehicles with engine Z 10 XEP: Run-flat tyres are not permitted for all rear axle applications. We recommend your Opel Partner.

Run-flat tyres * ⇨ 171.

Fitting new tyres

Fit tyres in pairs or in sets, which is even better. Ensure that tyres on one axle are

- the same size,
- the same design,
- the same make,
- and have the same tread pattern.

Fit directional tyres such that they roll in the direction of travel. The rolling direction is indicated by a symbol (e.g. an arrow) on the sidewall.

Tyres fitted opposing the rolling direction (e.g. when a tyre is changed) should be refitted as soon as possible. This is the only way to obtain full benefit from the design properties of the tyre.

Run-flat tyres * must not be combined with conventional tyres.

Pay attention to legal requirements when disposing of tyres.

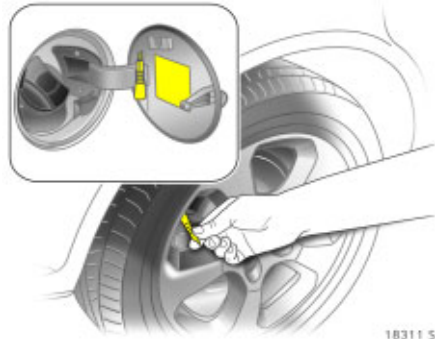

18311 S

Tyre pressure

Check tyre pressure, including the spare wheel, at least every 14 days and prior to any long journey; the tyres should be checked when cold. Don't forget to check the spare wheel.

Remove the valve cap key from the tank flap and use it to unscrew the valve cap.

Tyre pressure ↻ 264 and on the adhesive label on the inside of the tank flap.

The tyre pressure data is for cold tyres. It applies to both summer and winter tyres.

Always inflate the spare wheel to the pressure specified for full load.

Do not reduce tyre pressure when the tyres are warm. Otherwise the pressure may drop below the permissible minimum when the tyres cool down.

After having checked the tyre pressure, tighten the valve caps using the valve cap key.

Incorrect inflation pressures will impair safety, vehicle handling, comfort and fuel economy and will increase tyre wear.

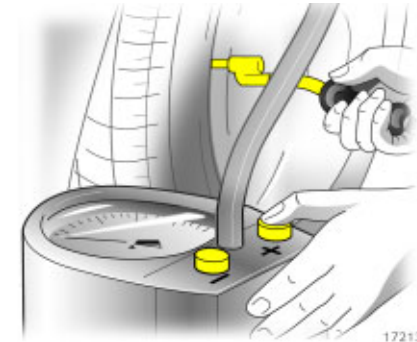

17213 T

⚠ Warning

If the pressure is too low, this can result in considerable tyre warm-up and internal damage, leading to tread separation and even to tyre blow-out at high speeds.

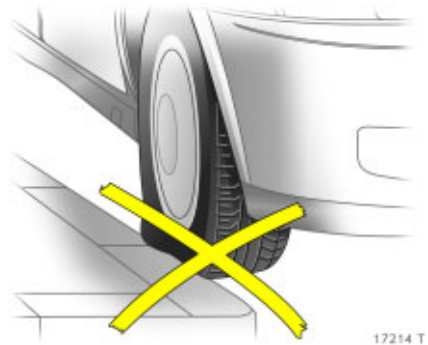

Tyre condition, wheel condition

Drive over edges slowly and at a right angle if possible. Driving over sharp edges can lead to hidden tyre damage and wheel damage. Do not wedge tyres against the kerb.

Regularly check tyres for damage. Seek the assistance of a workshop in the event of damage or unusual wear.



Tread depth

Check tread depth regularly.

For reasons of safety, tyres should be replaced when their tread depth has worn down to 2 to 3 mm (winter tyres: 4 mm).

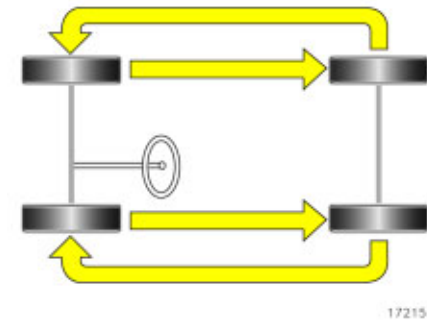

The legally permissible minimum tread depth (1.6 mm) has been reached when the tread has worn down as far as one of the wear indicators (TWI¹⁾). A number of wear indicators are spaced at equal intervals around the tyre within the tread. Their position is indicated by markings on the tyre sidewall.

¹⁾ TWI = Tread Wear Indicator.



If wear in the front is greater than that in the rear, move the rear wheels to the front axle and vice versa.

Correct tyre pressure.

On vehicles fitted with a deflation detection system , initialise the system  164.

General information

- The danger of aquaplaning is greater if the tyres are worn.
- Tyres age, even if they are not used or used infrequently. We recommend tyre replacement every six years at the latest.
- Never fit used tyres the previous history and use of which you do not know.

Tyre designations

Meanings:

e.g. **185/65 R 15 88 T**

- 185** = Tyre width in mm
- 65** = Cross-section ratio
(tyre height to tyre width in %)
- R** = Belt type Radial
- RF** = Type: Run-flat
- 15** = Rim diameter in inches
- 88** = Load-bearing capacity code
e.g.: 88 corresponds to 567 kg
- T** = Speed code letter:

Speed code letters:

- Q** = Up to 160 km/h
- S** = Up to 180 km/h
- T** = Up to 190 km/h
- H** = Up to 210 km/h
- V** = Up to 240 km/h
- W** = Up to 270 km/h

Run-flat tyres (RFT) *

Run-flat tyres have reinforced, self-supporting sidewalls, which ensure that the tyres always have a certain amount of driveability, even when there is no pressure.

Run-flat tyres are permitted only in the case of vehicles with ESP^{Plus} * and a deflation detection system.

⚠ Warning

Even the tyre pressure of run-flat tyres must be checked regularly.

Check tyre pressures at least every 14 days and prior to any long journey; the tyres should be checked when cold.

Depending on the tyre manufacturer, run-flat tyres can be identified from a marking on the tyre wall, e.g. **ROF** = RunonFlat for Dunlop or **SSR** = Self Supporting Runflat Tyre for Continental.

Run-flat tyres can be used only in combination with the alloy wheels issued by Opel: this also applies to winter tyres.

Driving with a damaged tyre

The deflation of a tyre is displayed via the deflation detection system *.

If a tyre has no pressure, continued driving is possible

- at a speed of max. 80 km/h,
- up to a distance of 80 km.

⚠ Warning

When driving with a flat tyre, do not exceed a speed of 80 km/h or a distance of 80 km.

The vehicle will be more difficult to steer and handle and the braking distance will be longer.

Adapt driving style and speed to the conditions at hand.

Do not use a tyre repair kit.

Deflation detection system * ⇨ 164.

172 Driving and operation

Winter tyres ❄️

Notes on fitting new tyres ⇨ 168.

Restrictions ⇨ 171, ⇨ 264.

Winter tyres improve driving safety at temperatures below 7 °C.

The design of summer tyres means they have limited qualities for winter driving.

In accordance with country-specific regulations, affix the speed sticker ❄️ in the driver's field of view.

If you use the spare wheel when it is fitted with a summer tyre, the vehicle's driveability may be affected, especially on slippery road surfaces. Obtain a replacement for the faulty tyre as soon as possible, and have the wheel balanced and fitted to the vehicle.

Wheel covers ❄️

Use of wheel trims and tyres that approved by Opel for the vehicle in question and thereby fulfil all requirements for the wheel and tyre combination.

If the wheel trims and tyres used are not Opel-approved, the tyres must not have a beaded edge.

Wheel trims must not impair brake cooling.

Remove the wheel trims if fitting tyre chains ❄️.

⚠️ Warning

Use of unsuitable tyres or wheel trims could lead to sudden loss of air and thereby accidents.

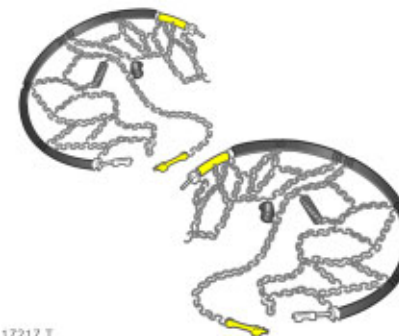

17217 T

Tyre chains

Restrictions and further information ⇨ 264.

Tyre chains are only permitted on the driven wheels (front axle). They must be fitted to the tyres symmetrically in order to achieve a concentric fit.

Always use fine mesh chains that add no more than 10 mm to the tyre tread and the inboard sides (including chain lock).

Remove the wheel trims if using tyre chains
 ⇨ 201.

Tyre chains may only be used at speeds up to 50 km/h. When travelling on roads that are free of snow, they may only be used for brief periods.

⚠ Warning

Damage may lead to tyre blowout.

Tyre chains must not be used on the temporary spare wheel. If you need to use tyre chains after suffering a flat front tyre, fit the temporary spare on the rear axle and transfer one of the rear wheels to the front axle.

Roof rack *

For safety reasons and to avoid roof damage we recommend using the Opel roof rack system that is approved for your vehicle.

Follow the usage instructions for the roof rack.

Remove the roof rack when not in use.

Driving hints ⇨ 149

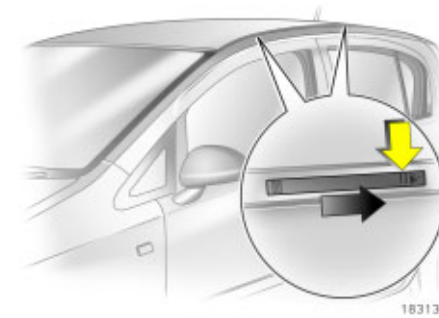

Fitting on model without sun roof *

Push covers for concealing roof rack mounts down and push backwards with a valve cap key. Location of valve cap key ⇨ 169.

Fitting on model with sun roof *

Disengage covers concealing roof rack mounts by pushing sliders in direction of arrow (e.g. with coin) and remove upwards. To close roof rack mounts, first insert covers at front and engage sliders at rear.

Attach roof rack at appropriate points, see enclosed roof luggage rack system instructions.



Flex-Fix system ✳

The Flex-Fix system allows bikes to be attached to a pull-out carrier integrated into the vehicle floor.

The maximum load is 40 kg.

If not in use, the Flex-Fix system can be collapsed back into the vehicle floor.

A multifunction box ✳ is offered as an accessory for the carrier system. The transportation of other objects is not permitted.

There must not be any objects on the bicycles that could become loose during transportation.



Extend Flex-Fix system
Open the tailgate ⇨ 36.

⚠ Warning

No persons may remain in the extension zone of the Flex-Fix system, risk of injury.

Pull release lever up. The system disengages and travels quickly out from the bumper.



Completely pull out the Flex-Fix system until you hear it engage.

Ensure that it is not possible to push in the Flex-Fix system without pulling the release lever again.

⚠ Warning

It is only permissible to fit objects to the Flex-Fix system if the system has been correctly engaged. If the Flex-Fix system will not engage correctly, do not fit objects to the system and slide the system back. Contact a workshop for assistance.

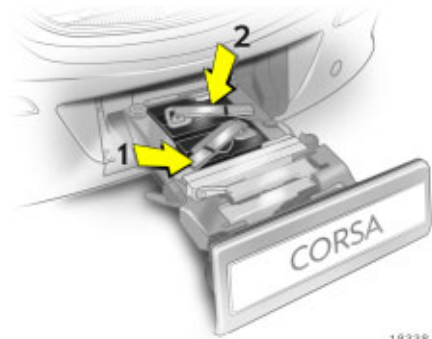

18338 5

Fit the tail lamps
First remove the rear (1), then the front (2) tail lamp from the recesses.

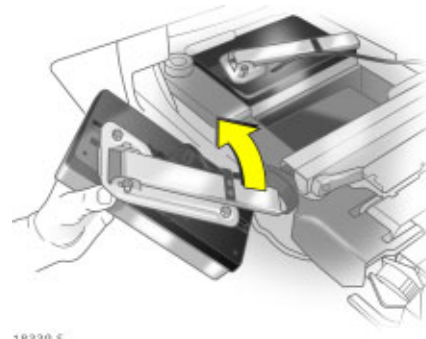

18339 5

Open out the bulb holder on the back of the tail lamp all the way.

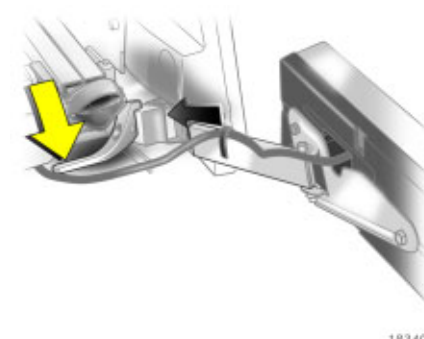

18340 5

Push the clamping lever down and push the bulb holder into the retainer until it hits the stop.
Perform this procedure for both tail lamps.



18341 S

Check the cable and lamp position to make sure these are correct.

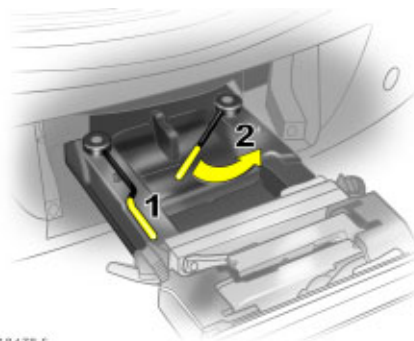

18478 S

Lock the Flex-Fix system
Swivel the left clamping lever (1) back first, followed by the right clamping lever (2) until they stop. Both clamping levers must point backwards, otherwise safe functionality is not guaranteed.
Close the tailgate.

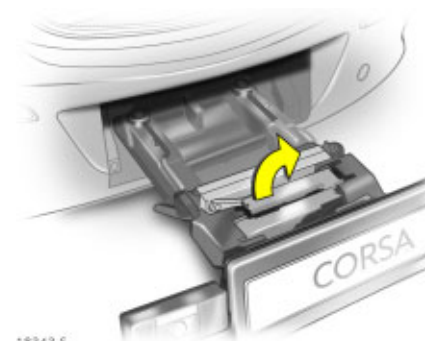

18343 S

Unfold pedal crank recesses
Fold one or both pedal crank recesses upwards until the diagonal support engages.

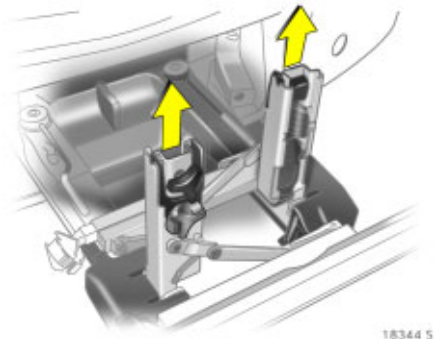

18344 5

Remove the pedal crank mounts from the pedal crank recesses.

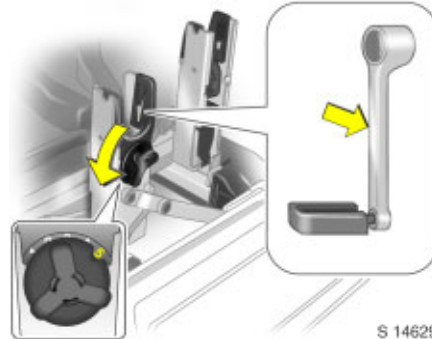

S 14629

Adapting the Flex-Fix system to a bicycle
 With the rotary lever on the pedal crank recess, roughly adapt the adjustable pedal crank unit to the protrusion of the pedal crank.

If the bicycle has straight pedal cranks, unscrew the pedal crank unit all the way (position 5), see illustration.

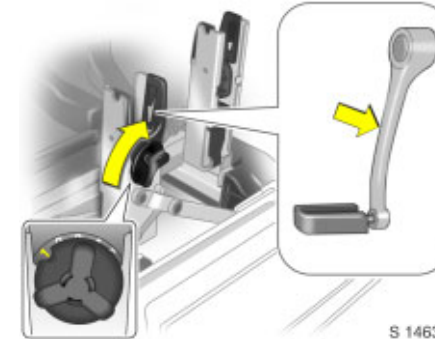

S 14630

If the bicycle has cranked pedal cranks, screw in the pedal crank unit all the way (position 1), see illustration.

178 Driving and operation

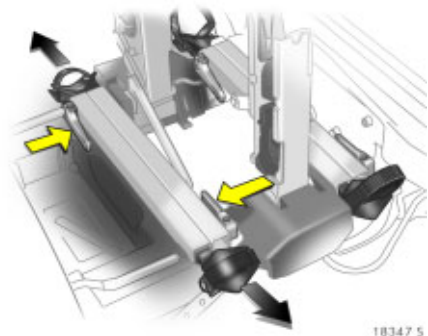

Press the release lever and remove the wheel recesses.

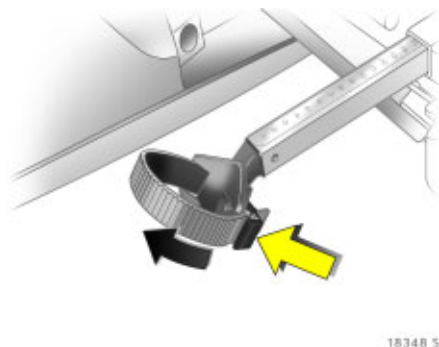

Push the release lever on the strap retainer and remove the strap retainer.



Prepare the bicycle for attachment
Rotate the left pedal (without a chain leaf) vertically downwards. The pedal on the left pedal crank must be horizontal.

The front bicycle must have its front wheel facing left.

The rear bicycle must have its front wheel facing right.

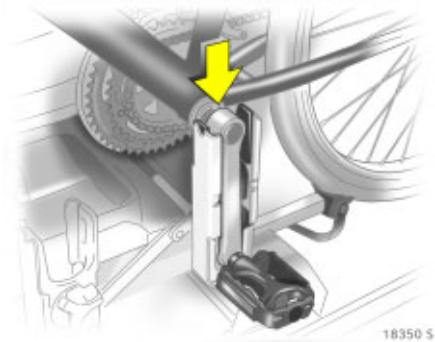

Attaching a bicycle to the Flex-Fix system
Put on the bicycle. The pedal crank here must be placed in the pedal crank recess opening as shown in the illustration.

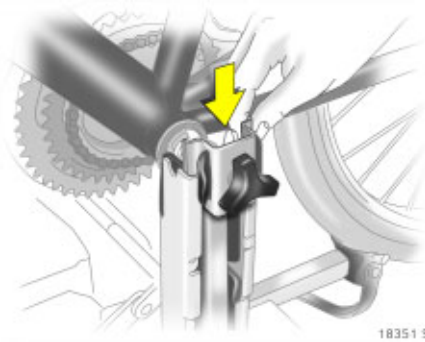

Insert pedal crank mount into outer rail of each pedal crank recess from above and slide downwards as far as it will go, see figure 18454 S.

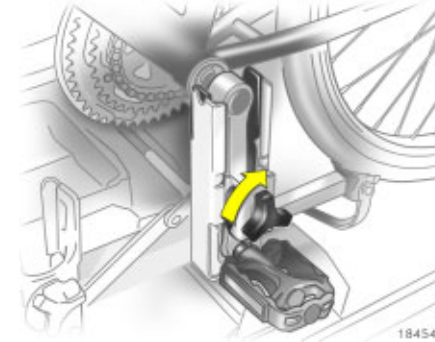

Attach the pedal crank by rotating the attachment screw on the pedal crank mount.

180 Driving and operation



Place the wheel recesses such that the bicycle is more or less horizontal. Here, the distance between the pedals and the tailgate should be at least 5 cm. Setting the wheel recesses ↪ 178.

Both bicycle tyres must be in the wheel recesses. In order to prevent damage, neither the pedal bearing housing on the bicycle nor the pedal crank must not be touching the pedal crank recess.

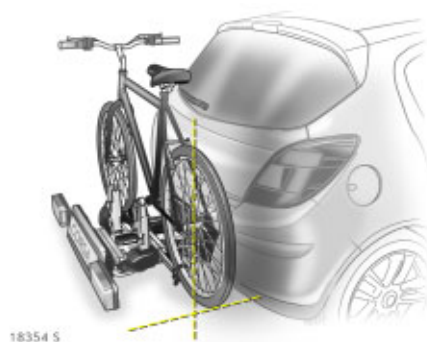

Align the bicycle in the longitudinal direction of the vehicle:
Loosen the locking screw on the crank bearing fixing a little ↪ 177, Fig. S 14629.

Place the bicycle upright using the rotary lever on the pedal crank recess, ↪ 177, Fig. S 14629 or Fig. S 14630.

If the two bicycles obstruct one another, the relative positions of the bicycles can be adapted by adjusting the wheel recesses and the rotary lever on the pedal crank recess until the bicycles no longer touch one another. Here, make sure there is sufficient clearance to the vehicle.

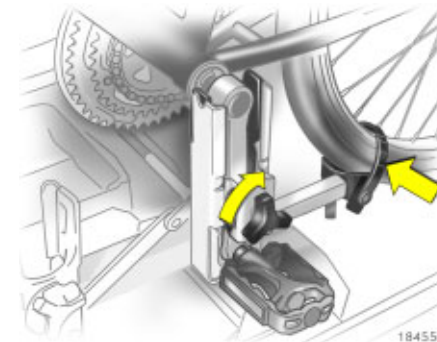

Tighten the attachment screw for the pedal bearing mount to its maximum point.

Secure both bicycle wheels to wheel recesses using strap retainers.

Check the bicycle to make sure it is secure.

The settings for the wheel recesses and on the rotary lever on the pedal crank recess should be noted and saved for each bicycle. Correct presetting will facilitate refitting of the bicycle.

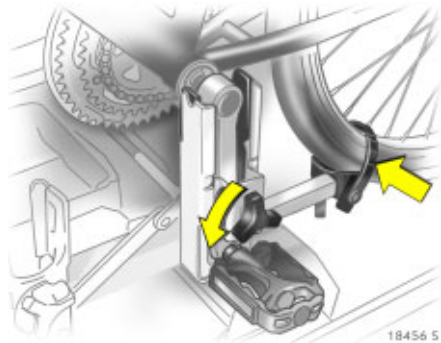

Removing a bicycle from the Flex-Fix system

Undo strap retainers on both bicycle tyres.

Hold on to the bicycle, loosen the attachment screw for the pedal bearing mount, then lift the pedal bearing mount to remove it.

Removing a bicycle from the Flex-Fix system.

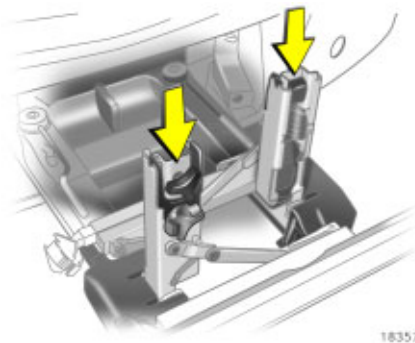

Retracting the Flex-Fix system

Push the pedal crank mounts into the pedal crank recess.

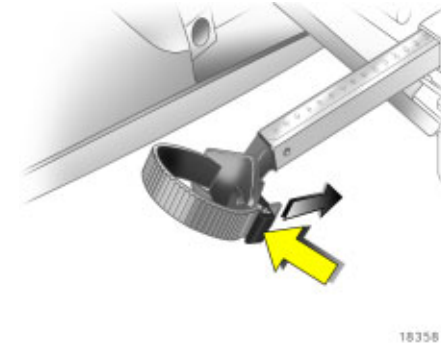

Insert the strap retainer and pull tightly downwards as far as possible.

182 Driving and operation

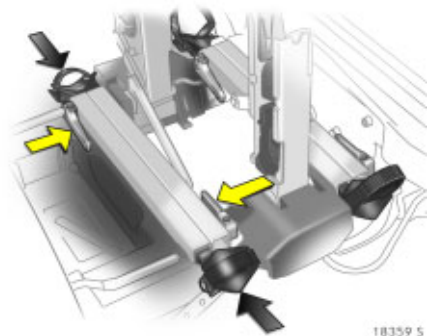

Press release lever and slide in wheel recesses all the way as far as they will go.

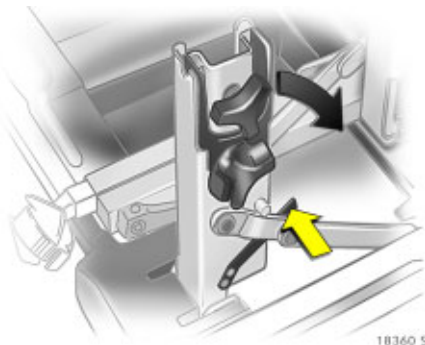

Disengage the locking lever on the diagonal support and fold both pedal crank recesses down.

⚠ Warning

Caution. Risk of pinching.

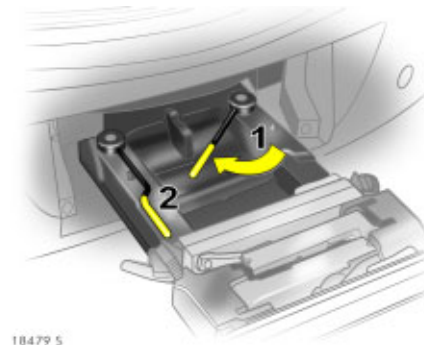

Swivel first the right clamping lever (1) forwards, followed by the left clamping lever (2), until they stop, then engage them. Both clamping levers must be engaged in the recesses.

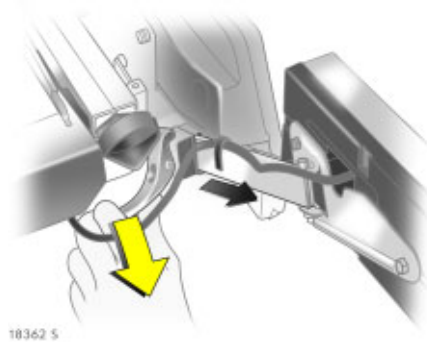

18362 S

Push the clamping lever down and pull both lights out of the recesses.

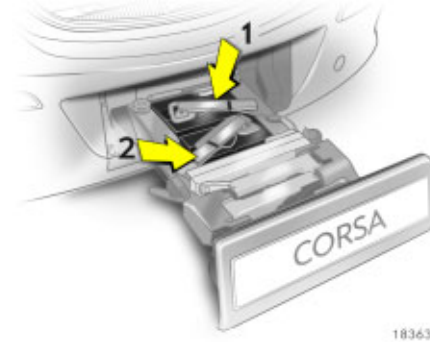

18363 S

Fold in the bulb holders on the backs of the tail lamps.

First place the front (1) tail lamp, then the rear (2) tail lamp in the recesses and push down as far as possible. Push cables all the way into all guides in order to prevent damage.



18364 S

Open the tailgate.

Push the release lever up and push the system into the bumper until it engages.

Release lever must return to original position.

⚠ Warning

If the system cannot be correctly engaged, please contact a workshop for assistance.

184 Driving and operation

Towing equipment ✳

Only use towing equipment that has been approved for your vehicle. Ask a workshop to retrofit towing equipment. It may be necessary to make changes that affect the cooling system, heat shields or other equipment.

Caution
The coupling ball bar is to be removed when not towing.

Mounting dimensions of towing equipment
⇨ 269.

Stowage of coupling ball bar

The coupling ball bar is stowed in a bag in the spare wheel well and secured to the lashing eyes in the luggage compartment
⇨ 187.

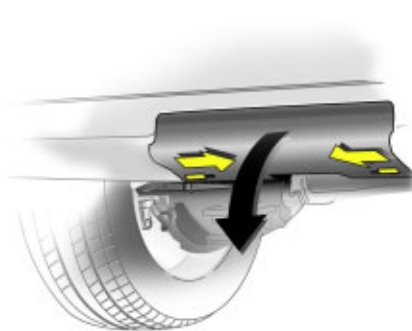

18389 5

Fitting the coupling ball bar
Push both bolts inwards and remove the cover on the bumper.

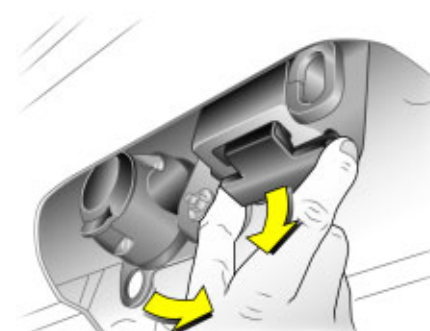

18390 5

Fold down socket. Pull sealing plug out of coupling ball bar opening. Place cover and coupling ball bar in luggage compartment.

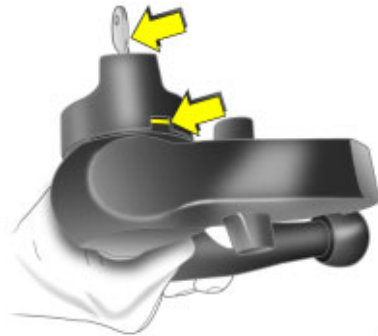

18391 S

Checking the tensioning of the coupling ball bar

- The rotary lever rests on the coupling ball bar.
- Green marking on the rotary lever is not visible.
- Locking pin at the top of the coupling ball bar is set inwards.
- The key is in the lock.

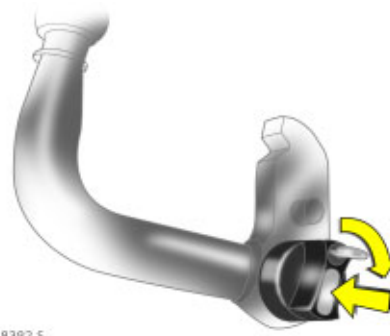

18392 S

Otherwise, the coupling ball bar must be tensioned before it is inserted into the coupling housing:

- Place the key in the lock and unlock the coupling ball bar.
- Push the rotary lever onto the coupling ball bar and rotate right while pressed down until it engages. The key remains in the lock.



18393 S

Inserting the coupling ball bar

Insert the tensioned coupling ball bar in the housing and push firmly upwards until it audibly engages.

The rotary lever moves quickly back into its starting position on its own.

⚠ Warning

Do not touch rotary handle during insertion.

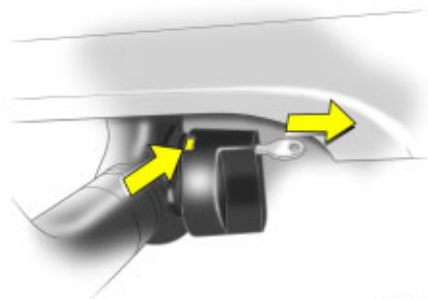

18394 S

Green marking on the rotary lever is visible.
Lock coupling ball bar and remove key.

Check that the coupling ball bar is correctly installed

- Green marking on the rotary lever is visible.
- There must be no gap between the rotary handle and the coupling ball bar.
- The coupling ball bar must be firmly engaged in the opening.
- The coupling ball bar must be locked and the key removed.

⚠ Warning

Towing a caravan/trailer is only permitted with a properly fitted coupling ball bar. If the coupling ball bar cannot be correctly fitted, please contact a workshop for assistance.

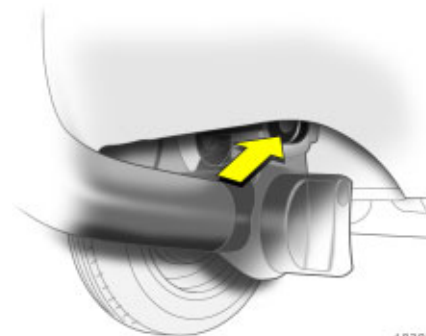

18397 S

Eye for break-away stopping cable
In the case of trailers/caravans with brakes, attach breakaway stopping cable to eye.

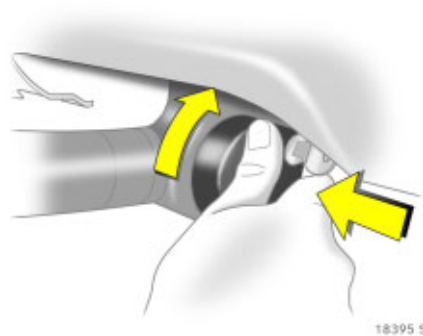

Dismounting the coupling ball bar

Place the key in the lock and unlock the coupling ball bar.

Push the rotary lever onto the coupling ball bar and rotate right while pressed down until it engages. Pull out the ball bar downwards.

Insert sealing plug in opening for coupling ball bar. Close socket ⇨ 184, Fig. 18390 S. Place cover on bumper and push both bolts outwards.

18395 S

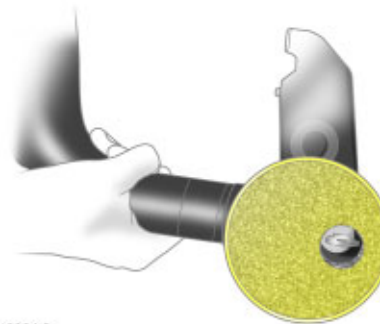

Stowage of coupling ball bar

Fit protective cap * over rotary lever with key.

Stow coupling ball bar in bag and place in spare wheel well, and secure bag to lashing eyes in luggage compartment.

Lashing eyes ⇨ 56

18396 S

Caravan/trailer towing

Caravan and trailer loads¹⁾

The permissible caravan/trailer loads are vehicle and engine-dependent maximum values which must not be exceeded. The actual caravan/trailer load is the difference between the actual gross weight of the caravan/trailer and the actual coupling socket load with the caravan/trailer coupled.

The permissible caravan/trailer loads are specified in the vehicle documents. In general, they are valid for gradients up to maximum 12 %.

¹⁾ Observe national regulations.

188 Driving and operation

The permitted caravan/trailer load applies up to the specified incline and up to an altitude of 1000 metres above sea level. Since engine power decreases as altitude increases because of the air becoming thinner, therefore reducing climbing ability, the permitted towing weight also decreases by 10 % for every 1000 metres of additional altitude. The towing weight does not have to be reduced when driving on roads with slight inclines (less than 8 %, e. g. motorways).

The permissible gross train weight must not be exceeded. This weight is specified on the identification plate ⇨ 250.

Coupling socket load

The coupling socket load is the load exerted by the trailer/caravan on the coupling ball. It can be varied by changing the weight distribution when loading the trailer/caravan.

The maximum permitted coupling socket load (vehicles with engine Z 12 XEP: 45 kg, other versions: 55 kg) of the towing vehicle is noted on the identification plate of the trailer towing device and specified in the vehicle documents. This must always be complied with, particularly when towing heavy trailers. The coupling socket load must never be less than 25 kg.

When measuring the coupling socket load, make sure that the drawbar of the loaded trailer/caravan is at the same height as it will be when the trailer/caravan is coupled with the towing vehicle loaded. Particularly important for trailers/caravans with tandem axle.

Rear axle load during towing

With the trailer attached and the towing vehicle fully loaded, including all the passengers, the permitted rear axle load (specified on identification plate and vehicle documents) for passenger vehicles may be exceeded by 45 kg and the permitted total load may be exceeded by 50 kg.

For vans the permitted rear axle load may be exceeded by 25 kg. The permitted total load may be exceeded by the following amounts with the engines specified below:

Z 10 XEP	30 kg
Z 12 XEP	15 kg
Z 13 DTH	40 kg
Z 13 DTJ	35 kg

Trailer operation is not permitted for vans with tyre size 215/45 R 17.

If the permitted rear axle load is exceeded a maximum speed of 100 km/h applies. If lower national maximum speeds are specified for trailer operation, they must be complied with.

Driving characteristics, towing tips

Before attaching the trailer/caravan, lubricate the ball of the trailer/caravan towing device. However, do not lubricate the ball if a stabiliser, which acts on the coupling ball, is being used to damp hunting.

Check caravan/trailer lighting before starting to drive. The fog tail lamps on the vehicle are deactivated when towing a caravan or trailer.

Trailers with LED turn signals must have a provision enables lamp monitoring for commercial bulbs.

Ultrasonic parking sensors * are deactivated in towing mode.

Handling is greatly influenced by the loading of the trailer/caravan. Loads should therefore be secured so that they cannot slip and be placed in the centre of the trailer/caravan if possible, i.e. above the axle.

For trailers with low directional control and for caravans with a permissible gross vehicle weight of more than 1000 kg, a speed of 80 km/h must not be exceeded; use of a roll damper in accordance with the friction principle is urgently recommended.

If the trailer/caravan starts to sway, drive more slowly, do not attempt to correct the steering and brake sharply if necessary.

If it is necessary to apply the brakes fully, depress the brake pedal as hard as possible.

Remember that the braking distance for vehicles towing caravans/trailers with and without brake is always greater than that for vehicles not towing a caravan/trailer.

When driving downhill, drive in the same gear as if driving uphill and drive at a similar speed.

Adjust tyre pressure to the value specified for full load ⇨ 264.

Starting on inclines

For vehicles with manual transmission, the most favourable engine speed when starting off on an incline is between 2500 and 3000 rpm for petrol engines and between 2000 and 2200 rpm for diesel engines. Hold engine speed constant, engage clutch gradually (let slip), release hand brake and open throttle. If possible, the engine speed should not drop during this procedure.

In vehicles with automatic transmission * and manual transmission automated * it is sufficient to give full throttle in **D** or (in automatic mode) *.

Before starting off under extreme operating conditions, switch off unnecessary consumers.

Self-help, vehicle care

Diesel fuel system, bleeding	190
Bonnet	190
Starting the engine with jump leads *.	191
Towing	193
Warning triangle  *.	196
First-aid kit (cushion)  *.	196
Spare wheel *.	196
Jack  * and vehicle tools *.	198
Changing wheels	200
Tyre repair kit *.	204
Electrical system	208
Fuses and the most important circuits they protect	209
Bulb replacement	212
Halogen headlamp system	212
Adaptive Forward Lighting system *.	216
Front indicator lamps	220
Fog lamps *.	220
Side turn signal lamp	220
Tail lamps	221
Number plate lamp	225
Courtesy lamps	226
Vehicle care	228

Diesel fuel system, bleeding

If the tank is allowed to run dry, the diesel fuel system must be bled. Turn over the ignition three times for 15 seconds at a time. Then start the engine for a maximum of 40 seconds¹⁾. Repeat this process after no less than 5 seconds. If the engine fails to start, seek the assistance of a workshop.

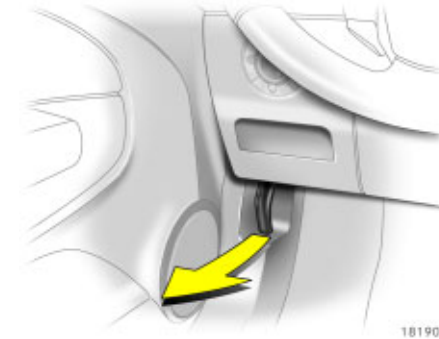

Bonnet

Pull the release lever located on the left side below the instrument panel and push it back to its original position.

¹⁾ For technical reasons only 30 seconds are possible on engines A 17 DTR/Z 17 DTR



Lift the safety catch upwards and open the bonnet.

Any dirt or snow on the bonnet can slide down toward the windscreen when the bonnet is opened and block the air intake
 ⇨ 135.

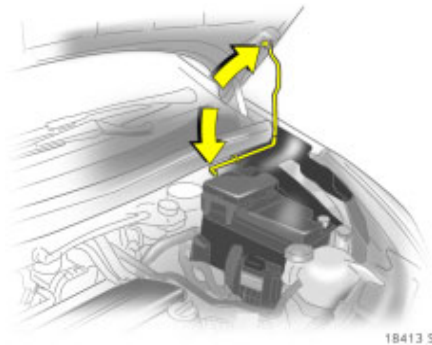

Secure the bonnet support. Before closing the bonnet, press the support into the holder.

Lower the bonnet and allow it to drop into the catch. Check that the bonnet is engaged.

Starting the engine with jump leads*

Do not use a rapid charger or push or tow the vehicle to get it started.

A vehicle with a discharged battery can be started using jump leads and the battery of another vehicle.

⚠ Warning

Starting the engine with jump leads must be carried out with the utmost caution. Any deviation from the following instruction may lead to injury or damage due to the explosion of the batteries and to damage of the electrics in both vehicles.

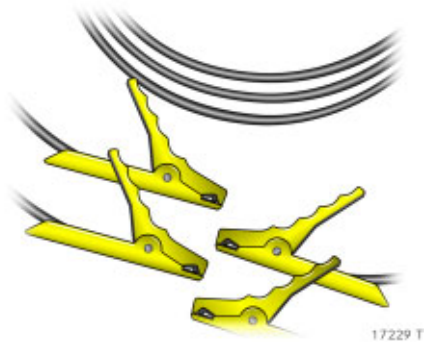

- Never expose the battery to naked flames or sparks.
- A flat battery can freeze at temperatures around 0 °C. Defrost the battery before connecting up jump leads.
- Do not allow battery fluid to come into contact with eyes, skin, fabrics or painted surfaces. The fluid contains sulphuric acid which can cause injuries and damage in the event of direct contact.
- Wear eye protection and protective clothing when handling a battery.

- Use a booster battery with the same voltage (12 volts). Its capacity (Ah) must not be much less than that of the discharged battery.
- Use jump leads with insulated terminals and a cross section of at least 16 mm² (25 mm² for diesel engines).
- Do not disconnect the discharged battery from the vehicle.
- Switch off all unnecessary electrical consumers.
- Do not lean over the battery during jump starting.
- Do not allow the terminals of one lead to touch those of the other lead.
- The vehicles must not come into contact with each other during the jump starting process.
- Apply hand brake. Manual transmission or manual transmission automated * in neutral, automatic transmission * in P.

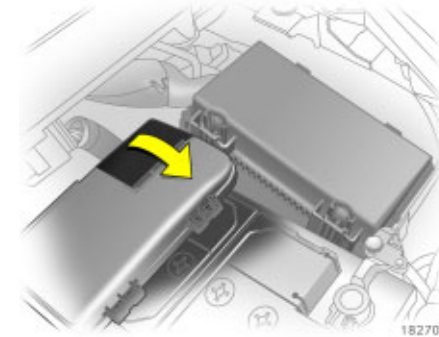

Lead connection order:

1. Connect the red lead to the positive terminal 1 of the booster battery.
2. Connect the other end of the red cable to the positive terminal 2 on the flat battery. The positive terminal has a cover cap on it Undo the cap to access the positive terminal.
3. Connect the black lead to the negative terminal 3 of the booster battery.
4. Connect the other end of the black lead 4 to a vehicle grounding point, such as the engine block or a screw connection in the engine suspension. Connect as far away from the discharged battery as possible.

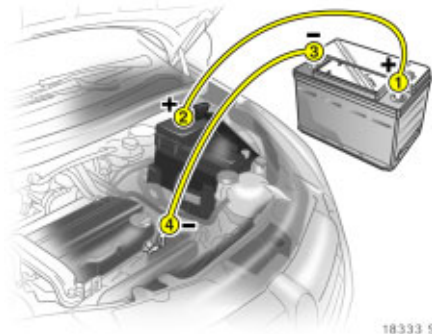

18333 S

Route the leads so that they cannot catch on rotating parts in the engine compartment.

To start the engine:

1. Start the engine of the vehicle providing the jump start.
2. After 5 minutes, start the other engine. Start attempts should be made at intervals of 1 minute not last longer than 15 seconds.
3. Allow both engines to idle for approx. 3 minutes with the leads connected.
4. Switch on electrical consumers (e.g. light, heated rear window) of the vehicle receiving the jump start.
5. Reverse above sequence exactly when removing leads.
6. Close the cover over the positive pole.



18141 S

Towing

Towing your own vehicle

Disengage cap at bottom and remove downwards.



18317 S

The towing eye is in the luggage compartment, on the right beneath the cover.

To open the compartment, disengage the cover and open it.

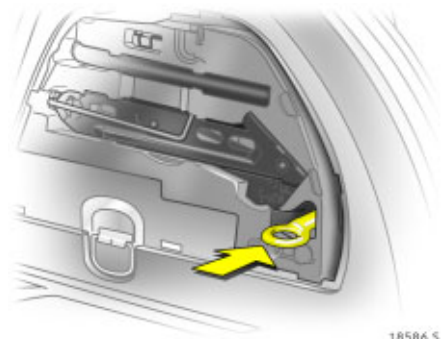

The towing eye is located in a recess.

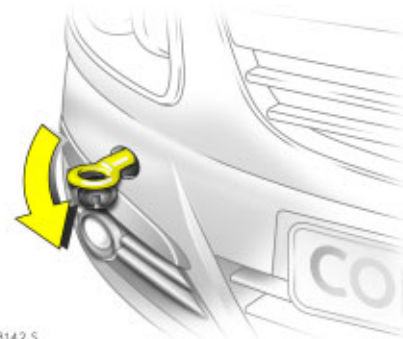

Screw in the towing eye anticlockwise as far as it will go until it stops in a horizontal position.

Attach a tow rope * – or better still a tow rod * – to the eye.

The towing eye may only be used for towing and not for recovery of the vehicle.

Switch on ignition to release steering column lock and to permit operation of brake lamps, horn and windscreen wipers.

Manual transmission or manual transmission automated * in neutral, automatic transmission * in N.

Caution

Drive slowly. Do not drive jerkily. Excessive tractive force can damage the vehicle.
--

When the engine is not running, considerably more force is needed to brake and steer.

To prevent the entry of exhaust fumes from the towing vehicle, switch on the air recirculation * and close the windows.

Contact a workshop for assistance.

Vehicles with automatic transmission * should be towed facing forward only and must not be towed faster than 80 km/h or further than 100 km. If the transmission is defective, or if the above speed or distance is to be exceeded, the front axle must be raised off the ground.

Contact a workshop for assistance.

If the automatic clutch has been manually disengaged in vehicles with manual automated transmission * towing is not permitted ↻ 143. In this case, contact a workshop for assistance immediately.

After towing, unscrew towing eye by rotating clockwise and insert and close the cap.

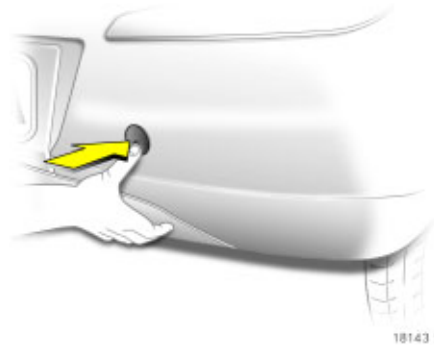

Towing another vehicle

Disengage cap at bottom and remove downwards.

The towing eye is in the luggage compartment, on the right beneath the cover ↻ 198.

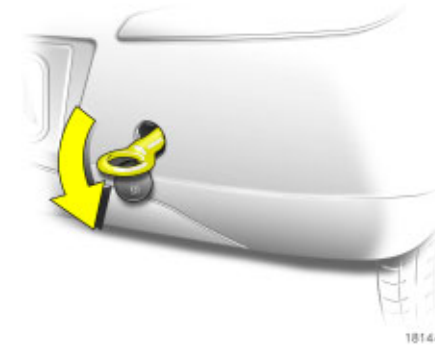

Screw in the towing eye anticlockwise as far as it will go until it stops in a horizontal position.

Attach a tow rope * – or better still a tow rod * – to the eye.

The towing eye may only be used for towing and not for recovery of the vehicle.

Caution

Drive slowly. Do not drive jerkily. Excessive tractive force can damage the vehicle.

After towing, unscrew the towing eye clockwise and refit the cover.

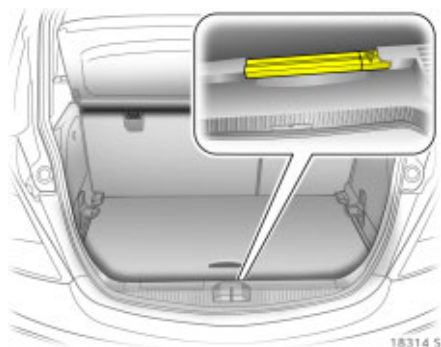

Warning triangle ▲ *

Store warning triangle in rear luggage compartment wall: first fit warning triangle into recess on left and the insert in guide on right.

To remove the warning triangle, lift to the right and pull out to the right.

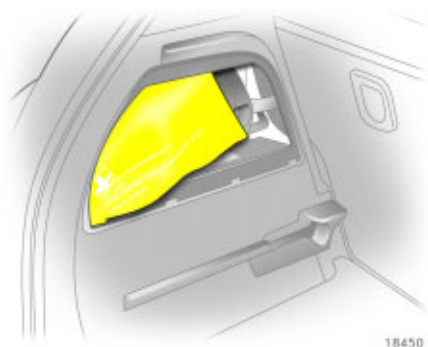

First-aid kit (cushion) ⊕ *

Place the first-aid kit (cushion) in the compartment in the left wall of the luggage compartment.

To open the compartment, disengage the cover and open it.

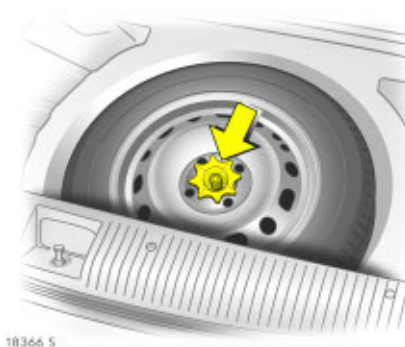

Spare wheel *

Some vehicles are equipped with a tyre repair kit instead of a spare wheel. ⇨ 204.

To remove, lift spare wheel, move to a vertical position and remove from above.

Stowing in the luggage compartment

The spare wheel * is located in the luggage compartment under the floor cover. It is secured using a nut.

In the Corsa van the spare wheel * is screwed down together with the floor cover. To lift the cover, undo the plastic nut. There is a spacer between the spare wheel and the floor cover.

Placing wide wheels in the spare wheel well

The spare wheel well is not designed for all approved tyre sizes. If a wider wheel than the spare wheel is placed in the spare wheel well after replacing a wheel, the floor cover will be resting against the protruding wheel. In vans the spacer * can be omitted if necessary, or the wheel can be bolted down without the floor cover.

Fitting a double load-bay floor * in this case in the upper position ↻ 82.

General information

Depending on the application, the spare wheel is designed as a temporary spare wheel *, note instructions on this page and on pages 173, 197, 264.

On vehicles with alloy wheels * the spare wheel may have a steel rim.

Use of a spare wheel together with winter tyres could alter driving conditions. Have the defective tyre replaced as soon as possible.

Use of a spare wheel that is smaller than the other wheels could alter driving conditions. In many countries, it is only permitted as a temporary spare wheel. Have the defective tyre replaced as soon as possible.

Notes on temporary spare wheel *

- Using a temporary spare wheel may change the driving behaviour of the vehicle, particularly if using winter tyres *. Replace defective tyre as quickly as possible, balance wheel and fit to vehicle.
- Fit only one temporary spare wheel.
- Do not drive faster than 80 km/h.
- Take curves slowly.
- Do not use the temporary spare wheel for a lengthy period.
- Replace temporary spare wheel with full specification wheel without delay.
- Tyre chains are not permitted on the temporary spare wheel. If tyre chains have to be used after a front wheel puncture, fit temporary spare wheel to the rear axle and fit a rear wheel to the front axle. Check tyre pressure and correct if necessary ↻ 264.
- Follow temporary spare wheel instructions on pages 173, 197 and 264.

198 Self-help, vehicle care

Notes on directional tyres *

Fit directional tyres such that they roll in the direction of travel. The rolling direction is indicated by a symbol (e.g. an arrow) on the sidewall.

The following applies to tyres fitted opposing the rolling direction:

- Driving conditions may be altered. Have the defective tyre replaced as soon as possible.
- Do not drive faster than 80 km/h.
- Be especially careful when driving in rain and snow.

Further information on directional tyres
⇨ 168.

Jack ⚠ and vehicle tools ⚠

The jack and the vehicle tools have been specially developed for your vehicle and must only be used on that vehicle. Only use jack for changing wheels.

With versions of the Corsa OPC with sill panelling ⚠ or retrofitted sill panelling ⚠ no jack ⚠ must be used. The vehicle may be damaged.



Vehicles with spare wheel *

The jack and the vehicle tools are in the right-hand compartment in the luggage compartment.

To open the compartment, disengage the cover and open it.

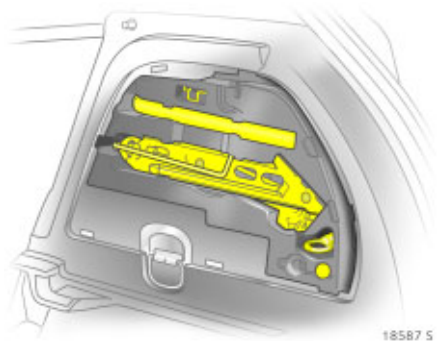

18587 S

The jack and the vehicle tools can be found in the provided recesses.



18426 S

Vehicles with tyre repair kit ✱
The vehicle tools are in the right-hand compartment in the luggage compartment, together with the tyre repair kit.



18425 S

To open the compartment, disengage the cover and open it ↗ 198, Fig. 18317 S.

200 Self-help, vehicle care

Changing wheels

There may be a tyre repair kit instead of a spare wheel ↪ 204.

Make the following preparations and observe the following information:

- Park the vehicle on a level, firm and non-skid surface. The front wheels must be in the straight-ahead position.
 - Switch on hazard warning lights, apply hand brake, automatic transmission * - selector lever in **P**, manual transmission or manual automatic transmission * - engage 1st or reverse gear.
 - Erect warning triangle * as specified. Warning triangle ↪ 196.
 - Remove spare wheel from luggage compartment ↪ 196.
- Never change more than one wheel at once.
 - Use the jack * only to change wheels.
 - If the ground on which the vehicle is standing is soft, a solid board (max. 1 cm thick) should be placed under the jack *.
 - Block the wheel diagonally opposite the wheel to be changed by placing wedge blocks or equivalent in front and behind the wheel.
- No people or animals may be in the vehicle when it is jacked up.
 - Never crawl under a jacked-up vehicle.
 - Do not start the vehicle when it is raised on the jack.
 - Before screwing in the wheel bolts, clean them and lightly coat the taper of each wheel bolt with commercially available grease.

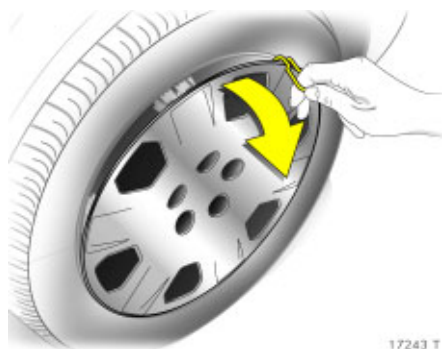

1. Pull off the wheel trim with the hook ✱.
Vehicle tools ⇨ 198.
For wheel trims with visible wheel bolts ✱:
The trim can remain on the wheel. Do not
remove the retaining washers ✱ on the
wheel bolts.



Alloy wheels ✱: Disengage the wheel bolt
caps with a screwdriver and remove.
Protect the wheel by inserting a soft cloth
between the screwdriver and ally wheel.

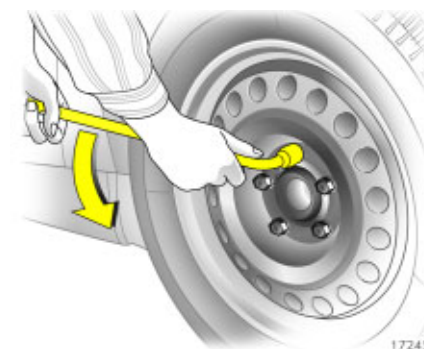

2. Push the wheel bolt wrench ✱ on as far
as possible and slacken the wheel bolts
half a turn.

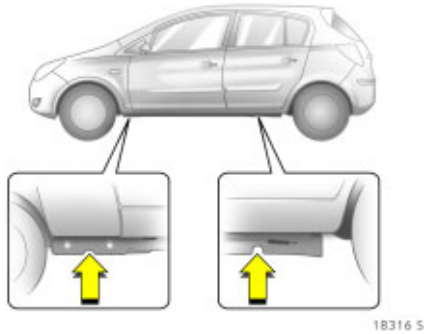

3. The jacking points are marked.
With versions of the Corsa OPC with sill panelling * or retrofitted sill panelling * no jack * must be used. The vehicle may be damaged.

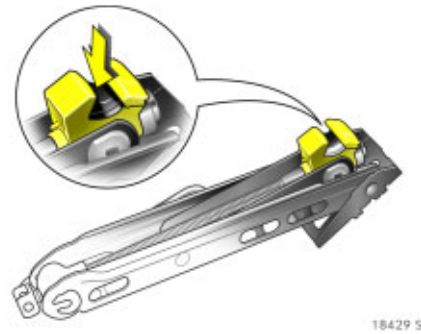

4. Before attaching the jack *, set it to the required height. Fit the jack arm at the front – or rear – in such a way that the jack claw (arrow in figure) goes around the vertical ridge and engages in the recess in the ridge. Ensure that the claw is properly positioned.

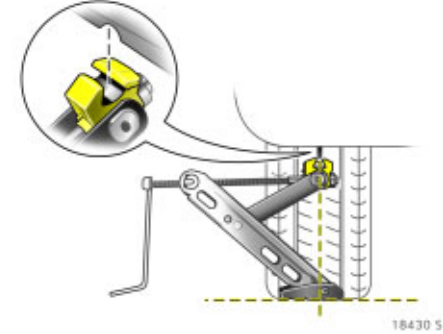

The edge of the jack base * must be planted firmly and vertically in line with the contact point.
Raise vehicle by turning crank handle.
If this is not the case, carefully lower the vehicle immediately and reposition the jack.

5. Unscrew the wheel bolts.

If the wheel bolts have retaining washers ✱, they must not be removed.

6. Change wheel. Notes on spare wheel
 ⇨ 197. Notes on temporary spare wheel
 ⇨ 197.

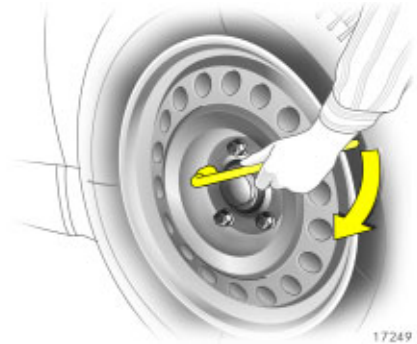

7. Screw in the wheel bolts. Push the wheel bolt wrench ✱ on as far as possible and tighten the wheel bolts slightly.

8. Lower vehicle.

9. Push the wheel bolt wrench ✱ on as far as possible and tighten crosswise. Tightening torque is 110 Nm.

10. Before refitting the wheel trim, clean the wheel around the retaining clips. Valve symbol ✱ on back of wheel trim must point towards valve on wheel.

Align and refit wheel trim or wheel bolt caps ✱.

Alloy wheels ✱: Align and refit wheel bolt caps ✱.

11. Stow removed wheel, tool kit and warning triangle ✱ in the luggage compartment ⇨ 196 to ⇨ 198.

12. Check the tyre pressure of the newly mounted wheel.

13. Have the wheel bolt tightening torque (110 Nm) checked.

14. Replace the faulty tyre on the wheel that was removed.

15. Initialise deflation detection system ✱ ⇨ 164.

Tyre repair kit *

Minor damage to the tyre tread or side wall can be repaired using the tyre repair kit (does not apply to run-flat tyres).

Do not remove the foreign body from the tyre.

Tyre damage exceeding 4 mm or that is on the rim cannot be repaired with the tyre repair kit.

⚠ Warning

Do not drive faster than 80 km/h.
Do not use the temporary spare wheel for a lengthy period.
Steering and handling may be affected.

Important ⇨ 207.

In the event of a flat tyre:

- Switch on hazard warning lights, apply handbrake, engage 1st or reverse gear, in the case of automatic transmission * move selector lever to position P.
- Erect warning triangle * as specified. Warning triangle ⇨ 196.



The tyre repair kit is located in the compartment to the right in the luggage compartment.

To open the compartment, disengage the cover and open it.



1. Remove the sealant bottle and holder with the air tube from the compartment.



17252 T

2. Unwind the air tube from the holder and screw onto the sealant bottle connector.

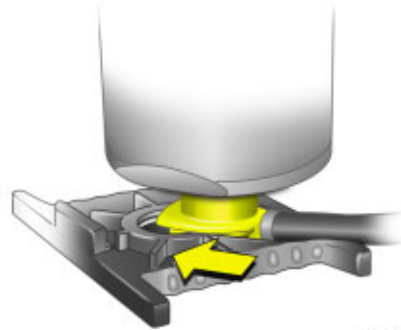

17468 T

3. Place the sealant bottle on the holder as shown in the illustration. Make sure that the bottle does not fall over.



17469 T

4. Remove the valve cap from the defective tyre.
5. Screw the filler hose to the tyre valve.



6. Screw the air tube to the connector on the compressor.

7. Switch on ignition.

To prevent battery discharge, we recommend that you leave the engine running.

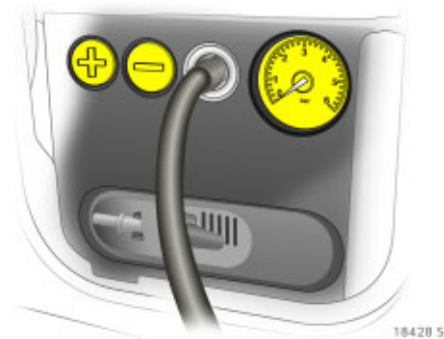

8. Press button **+** on the compressor, the tyre is filled with the sealant.

9. While the sealant bottle drains (approx. 30 seconds) the pressure indicator on the compressor briefly points to 6 bar. Pressure then sinks again.



10. All of the sealant is pumped into the tyre. Afterwards, the tyre is filled with air.

11. The prescribed tyre pressure \varnothing 264, should be attained within 10 minutes. Once the pressure is attained, switch off the compressor by pressing button **+** again.

If the prescribed tyre pressure is not obtained within 10 minutes, remove the tyre repair kit. Move the vehicle one tyre rotation. Reattach the tyre repair kit and continue the filling procedure for 10 minutes. If the prescribed tyre pressure is still not obtained, the tyre is too badly damaged. Seek the assistance of a workshop.

Release excess tyre pressure using button **-**.

Do not operate the compressor for more than 10 minutes, see "Important" \varnothing 207.

12. Dismantle the tyre repair kit. When removing the sealant bottle from the holder, press the ratchet on the holder. Screw the tyre filler tube onto the free connector on the sealant bottle. This prevents the sealant from escaping. Stow the tyre repair kit in the luggage compartment.
13. Wipe away any sealant spill with a cloth.
14. Fold away warning triangle , store in luggage compartment .
15. Apply the sticker on the sealant bottle showing the maximum permitted speed within the line of sight of the driver. Sticker , Fig. 17469 T.

16. Continue driving immediately so that the sealant is distributed evenly inside the tyre. After approx. 10 km (after 10 minutes at the latest), stop and check the tyre pressure. To do this, screw an air tube directly to the tyre valve and compressor.
If tyre pressure is more than 1.3 bar, adjust to the prescribed value. Repeat the procedure until there is no more pressure loss.
If the tyre pressure has dropped below 1.3 bar, the vehicle must not be used. Contact a workshop for assistance.
17. Stow the tyre repair kit behind the cover on the right in the side trim in the luggage compartment. To close, lower the cover and engage in the trim.

Important

The driving comfort of the repaired tyre is severely affected, therefore have this tyre replaced.

If the compressor makes abnormal noises or heats up greatly, switch it off for at least 30 minutes.

The integrated safety valve opens at a pressure of 7 bar.

Protect the compressor from moisture and rain.

The sealant can only be stored for approx. 4 years. After this time, the sealing properties can no longer be guaranteed. Heed the expiration date on the sealant bottle.

Replace the used sealant bottle. Dispose of the bottle as prescribed by applicable laws.

The compressor and sealant can be used from approx. -30 °C.

The adapter  supplied may be used to pump up other objects, such as balls, airbeds, dinghies.

When using the tyre repair kit, no consumer may be connected to the front accessory socket at the same time.

Electrical system

Fuses

Data on the replacement fuse must match the data on the defective fuse.

There are three fuse boxes in the vehicle:

- front left, in the engine compartment,
- in the interior behind the light switch, or, in right-hand drive cars, behind the glove compartment,
- on the left of the luggage compartment, behind a cover.

Before replacing a fuse, turn off the respective switch and the ignition.

A blown fuse can be recognised by its melted wire. Do not replace the fuse until the cause of the fault has been remedied.

Only fit fuses of the specified current rating. Each fuse has its current rating written on it, the ratings are also colour coded.

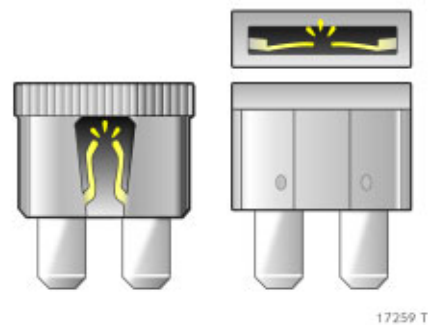

Some functions are protected by several fuses.

There may be fuses inserted with no function.

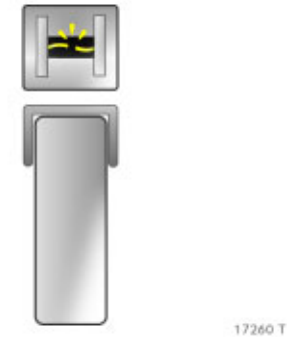

Different versions of fuses are used.

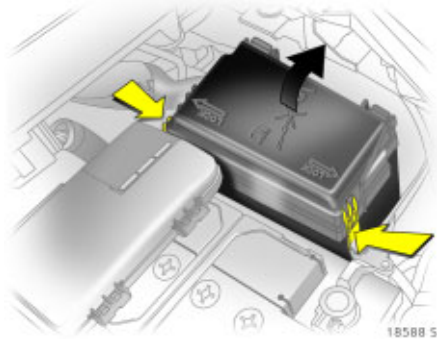

Fuses and the most important circuits they protect

Fuse box in engine compartment

The fuse box is at the front left side of the engine compartment.

To open, disengage the cover, fold cover up and remove.



- | No. | Circuit |
|-----|---|
| 1 | Starter |
| 2 | Air conditioning system |
| 3 | Diesel fuel filter heater |
| 4 | Horn |
| 5 | Manual transmission automated, automatic transmission |
| 6 | Engine control unit |
| 7 | Fog lamps |
| 8 | Engine cooling |
| 9 | Engine cooling |

- | No. | Circuit |
|-----|--|
| 10 | Automated manual transmission |
| 11 | Glow plugs, ignition system |
| 12 | Headlamp range adjustment, Adaptive Forward Lighting |
| 13 | Air conditioning system |
| 14 | Automated manual transmission |
| 15 | Main beam (right) |
| 16 | Main beam (left) |
| 17 | Main relay |
| 18 | Engine control unit |

210 Self-help, vehicle care

No.	Circuit
19	Airbags
20	Main relay
21	Main relay
22	Central control unit
23	Tyre repair kit
24	Fuel pump
25	Anti-lock brake system
26	Heated rear window
27	Anti-lock brake system
28	Interior fan
29	Cigarette lighter
30	Air conditioning system
31	Electric window (left)
32	Electric window (right)
33	Heated exterior mirrors
34	–
35	–



Fuse box in interior

The fuse box is located behind the light switch. Pull the top edge of the panel and fold down.

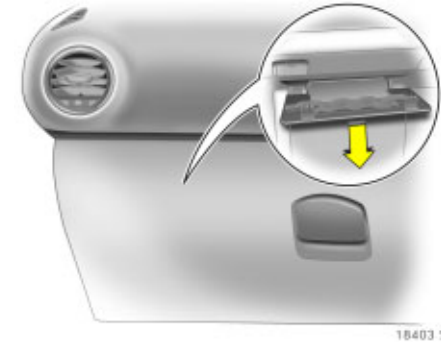

In right-hand drive cars, the fuse box is located behind a cover in the glove compartment. Open the glove compartment and remove the cover. To close, first put on the cover, then lock it into position.

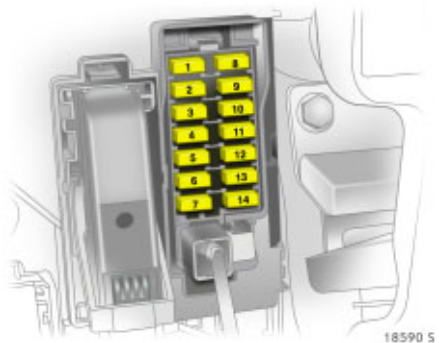

18590 S

No.	Circuit
1	–
2	Instruments, information display
3	Radio
4	Ignition switch
5	Windscreen washer system
6	Unlocking the luggage compartment
7	Central locking system
8	–
9	Courtesy lamp
10	Electric power steering
11	Light switch, brake lamp
12	ABS, brake lamp
13	Heated steering wheel
14	Park pilot, rain sensor, interior mirror

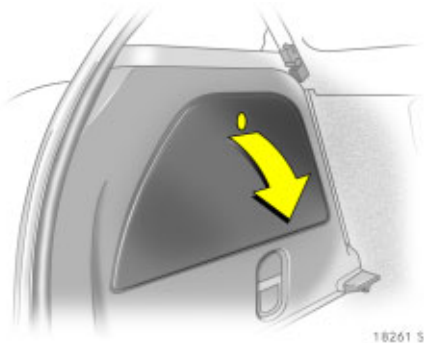

18261 S

Fuse box in luggage compartment
 The fuse box is located behind the cover in the left luggage compartment trim. Remove cover from fuse box.

No.	Circuit
1	Adaptive Forward Lighting
2	–
3	Seat heater (left)
4	Seat heater (right)
5	–
6	–
7	–
8	Flex-Fix system, towing equipment

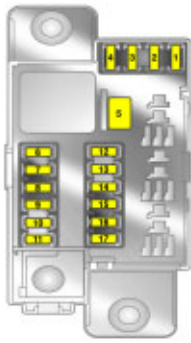

18319 S

No.	Circuit
9	–
10	–
11	–
12	–
13	–
14	–
15	Flex-Fix system, towing equipment
16	–
17	Sun roof

212 Self-help, vehicle care

Bulb replacement

Switch off the ignition and switch off the relevant switch or close the doors.

Only hold a new bulb at the base! Do not touch the bulb glass with your bare hands.

Replace the bulb, checking that the data on the base matches that of the defective bulb.

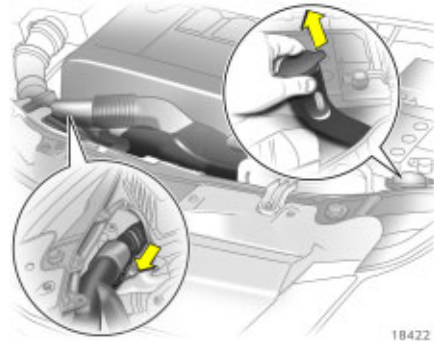

To replace the bulb on the right-hand side, remove the air hose from the air filter.

To replace the bulb on the left-hand side, remove fuse box cover ↗ 209, and also remove windscreen washer system reservoir filler neck from above. Washing fluid may escape if the reservoir is full to the top.

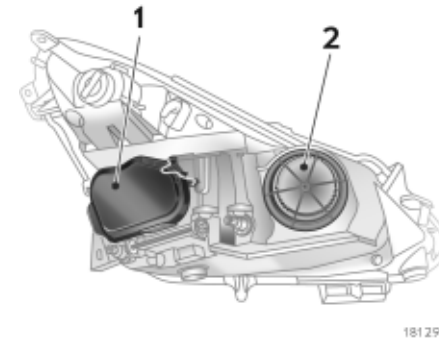

Halogen headlamp system

Headlamp system has separate bulbs for dipped beam 1 (outer bulbs) and main beam 2 (inner bulbs).

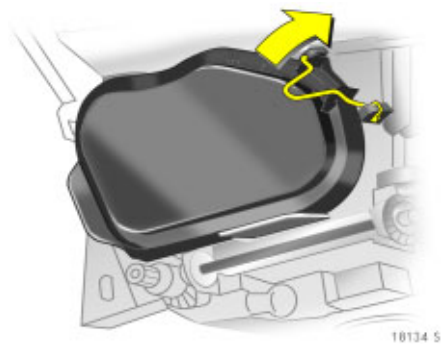

Dipped beam

1. Open bonnet and engage support.
2. Disengage wire clip and remove cover.

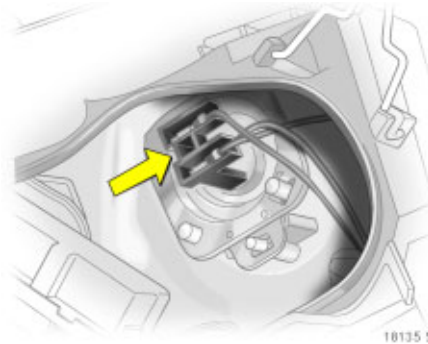

3. Press base to the side and remove from reflector.

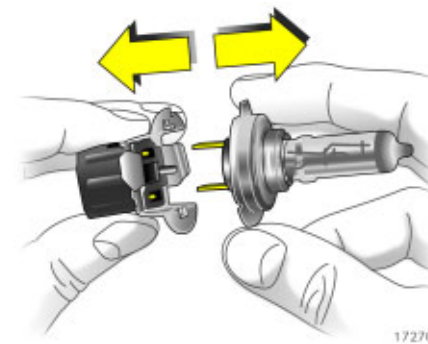

4. Detach plug connector from bulb.
5. Insert new bulb in reflector so that the locating tab of the bulb holder aligns with the reflector recess. Attach the bulb holder so that the locating tab points upwards.
6. Engage bulb.
7. Attach connector to bulb.
8. Put on cover and engage wire clip.

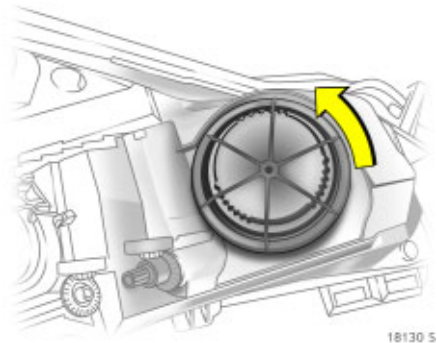

Main beam

1. Open bonnet and engage support.
2. Rotate headlamp cap anticlockwise and remove.
3. Detach plug connector from bulb.

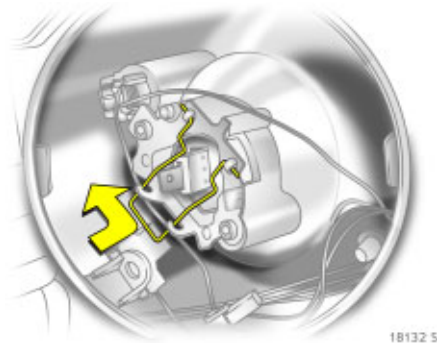

4. Disengage spring wire clip from retaining lugs by moving it and swivelling it to the side.
5. Remove bulb from reflector housing.
6. When fitting the new bulb, insert lugs in the reflector recesses.

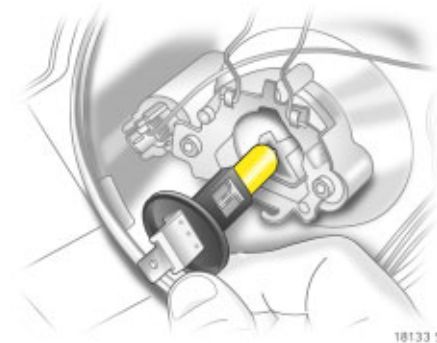

7. Engage spring wire clip, plug connector onto bulb.
8. Fit headlamp cap and rotate clockwise.

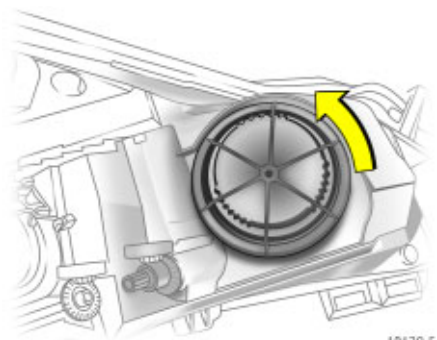

Parking lamps

1. Open bonnet and engage support.
2. Rotate the main beam headlamp cap anticlockwise and remove.

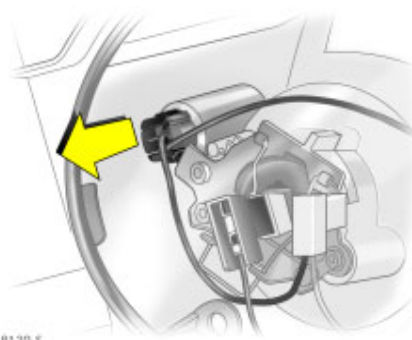

3. Remove parking lamp socket from reflector.

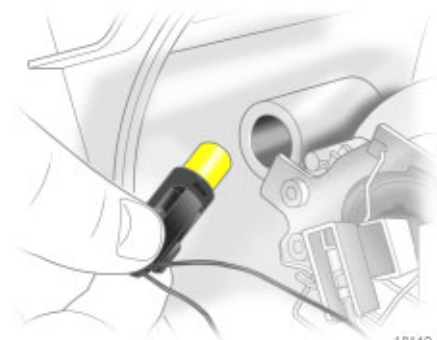

4. Remove bulb from socket.
5. Insert new bulb.
6. Insert socket in reflector.
7. Fit headlamp cap and rotate clockwise.

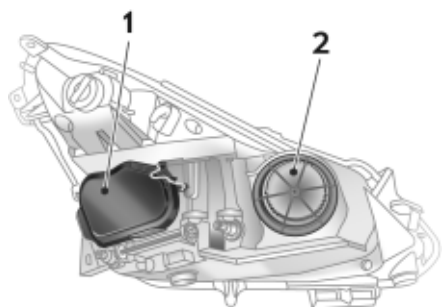

18129 5

Adaptive Forward Lighting system *

Headlamp system has separate systems for dipped beam 1 (outer bulbs) and main beam 2 (inner bulbs). The cornering light is also located behind the cover for the main beam.

Due to the complexity of the procedure, bulb changes should be carried out by a workshop.

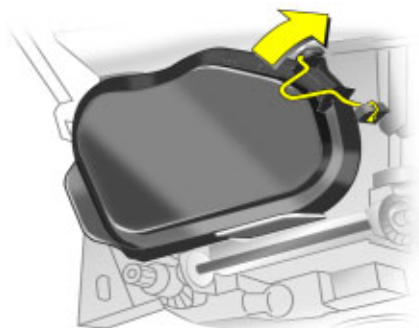

18134 5

Dipped beam

1. Open bonnet and engage support.
2. Disengage wire clip and remove cover.

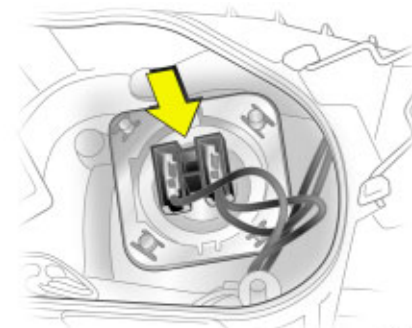

18374 T

3. Press base upwards and remove from reflector.

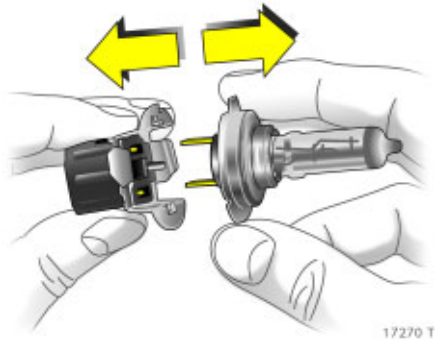

4. Detach plug connector from bulb.
5. Insert new bulb in reflector so that the locating tab of the bulb holder aligns with the reflector recess. Attach the bulb holder so that the locating tab is on the side.
6. Engage bulb.
7. Attach connector to bulb.
8. Put on cover and engage wire clip.

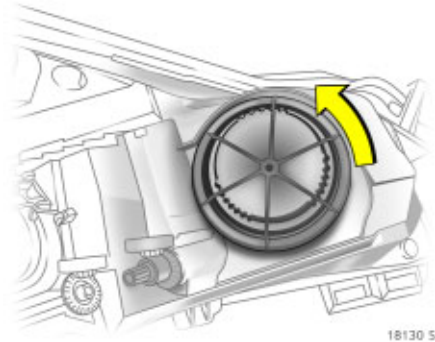

Main beam

1. Open bonnet and engage support.
2. Rotate the main beam headlamp cap anticlockwise and remove.

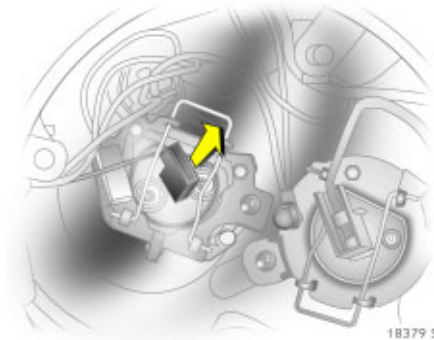

3. Detach plug connector from bulb.

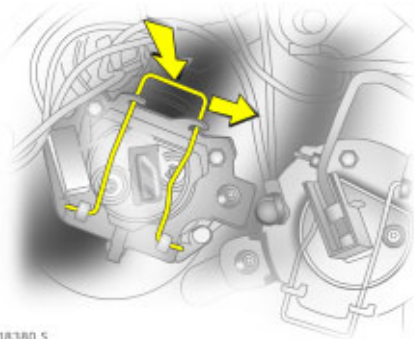

4. Disengage spring wire clip from retaining lugs by moving it and swivelling it to the side.
5. Remove bulb from reflector housing.
6. When fitting the new bulb, insert lugs in the reflector recesses.
7. Engage spring wire clip, plug connector onto bulb.
8. Fit headlamp cap and rotate clockwise.

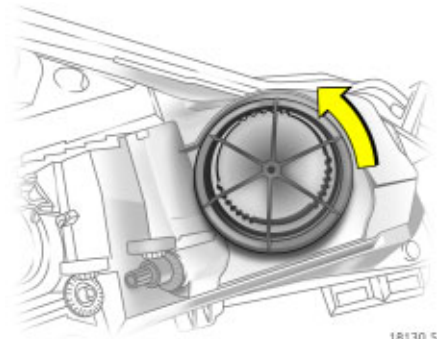

Cornering light

1. Open bonnet and engage support.
2. Rotate the main beam headlamp cap anticlockwise and remove.

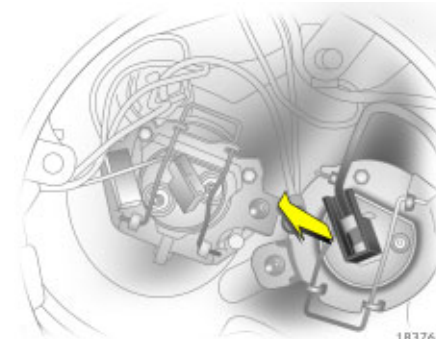

3. Detach plug connector from bulb.

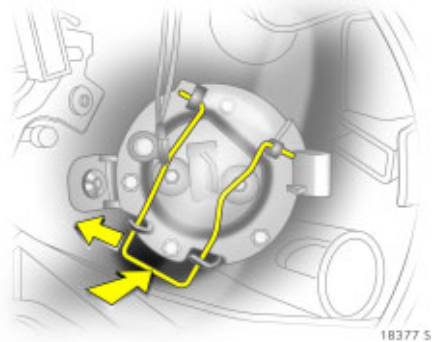

4. Disengage spring wire clip from retaining lugs by moving it and swivelling it to the side.
5. Remove bulb from reflector housing.
6. When fitting the new bulb, insert lugs in the reflector recesses.
7. Engage spring wire clip, plug connector onto bulb.
8. Fit headlamp cap and rotate clockwise.

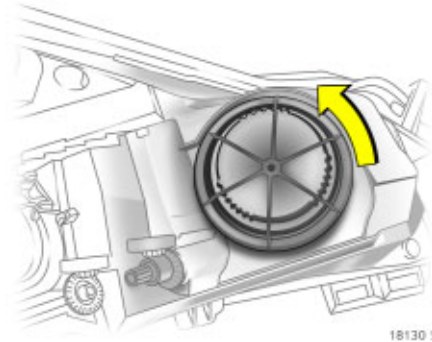

Parking lamps

1. Open bonnet and engage support.
2. Rotate the main beam headlamp cap anticlockwise and remove.

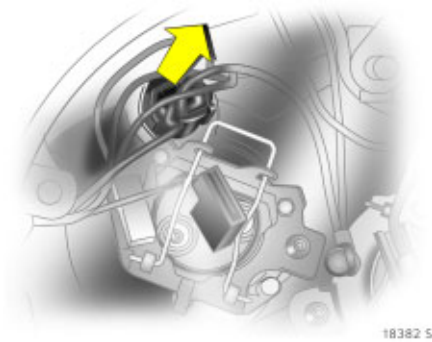

3. Remove parking lamp socket from reflector.

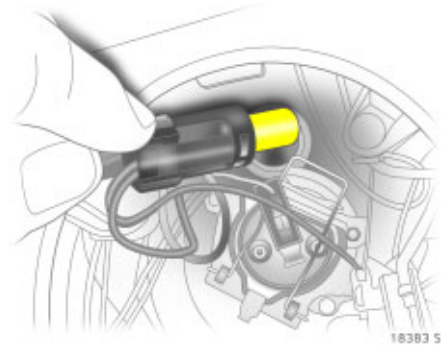

4. Remove bulb from socket.
5. Insert new bulb.
6. Insert socket in reflector.
7. Fit headlamp cap and rotate clockwise.

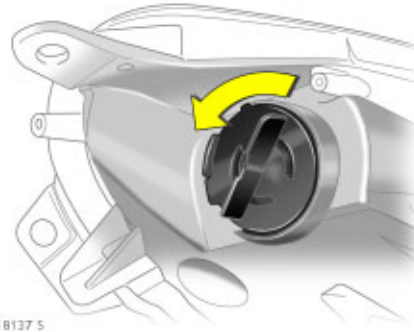

Front indicator lamps

1. Open bonnet and engage support.
2. Rotate bulb holder to left and disengage.

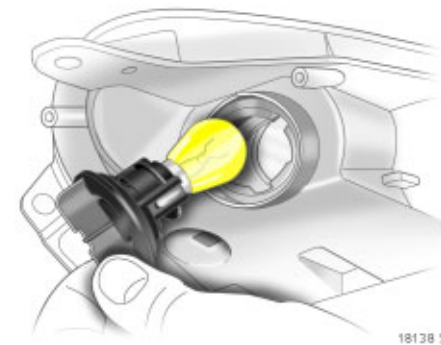

3. Push bulb into holder a little, rotate left and remove.
4. Insert new bulb.
5. Insert lamp holder in reflector, rotate clockwise and engage in position.

Fog lamps *

Have bulb replacement carried out by a workshop.

Side turn signal lamp

Have bulb replacement carried out by a workshop.

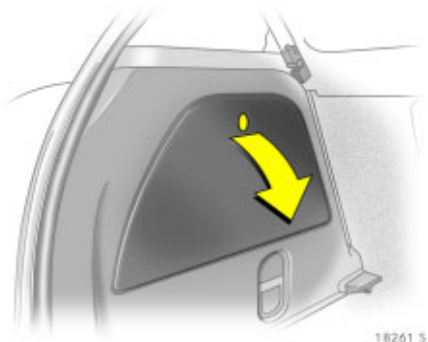

Tail lamps

5-door passenger vehicle

1. Disengage right and left cover in the side luggage compartment trim, then open.

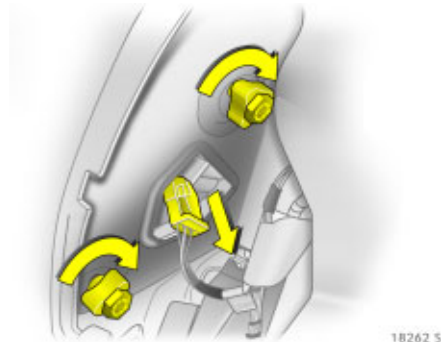

2. Remove plug connector by pressing on bulb holder tab.
3. Hold bulb housing from the outside; unscrew two retaining nuts.

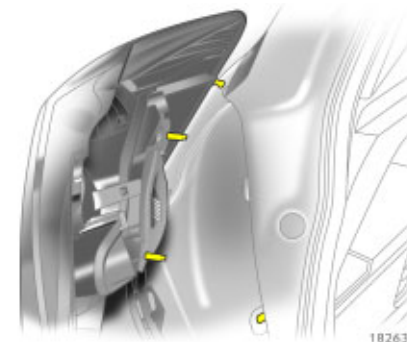

4. Detach bulb housing towards the rear.

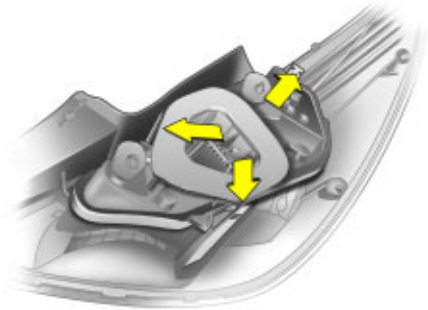

18264 5

5. Gently press the three locking lugs on the outside of the bulb holder outwards and remove bulb holder.

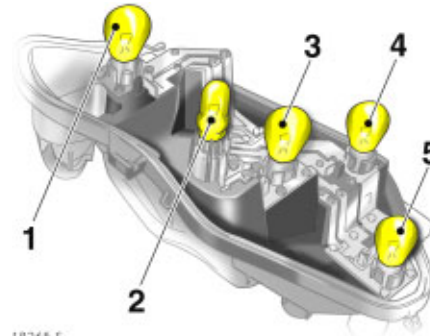

18265 5

Bulbs in bulb carrier

- 1 = Tail lamp
- 2 = Reversing light
- 3 = Turn signal lamp
- 4 = Tail lamp/brake lamp
- 5 = Fog tail lamp (only on one side depending on country-specific regulations)

- 6. Remove bulb from holder, gently pressing the bulb and rotating it.
- 7. Insert new bulb, pressing it gently and rotating it.
- 8. Engage bulb holder in bulb housing, ensuring that it properly engages.

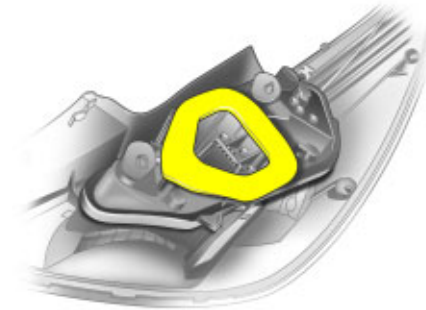

18266 5

9. Ensure that the bulb holder seal is positioned as illustrated.

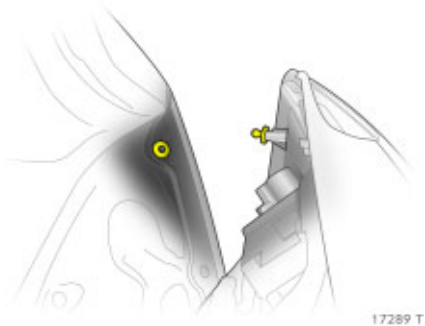

10. Insert bulb housing in vehicle body, engaging the ratchet and bolt in recesses. Tighten attachment nuts by hand. Engage plug connector. Close cover.
11. Carry out the following steps to ensure proper function of the tail lamps:
- Switch on ignition
 - Operate brake
 - Switch on parking lamps

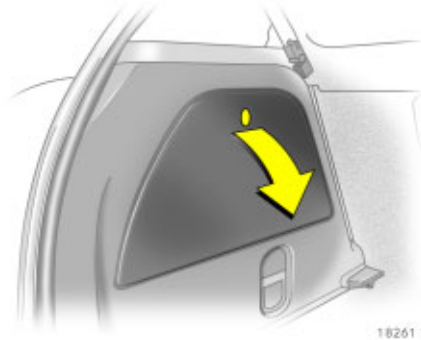

- 3-door passenger vehicle, van**
1. Disengage right and left cover in the side luggage compartment trim, then open.

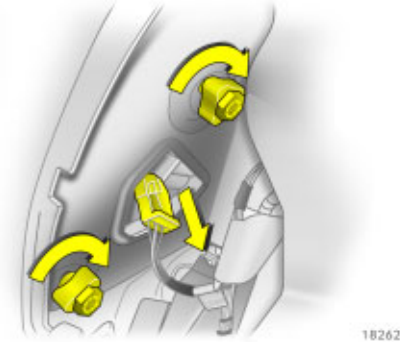

2. Remove plug connector by pressing on bulb holder tab.
3. Hold bulb housing from the outside; unscrew two retaining nuts.

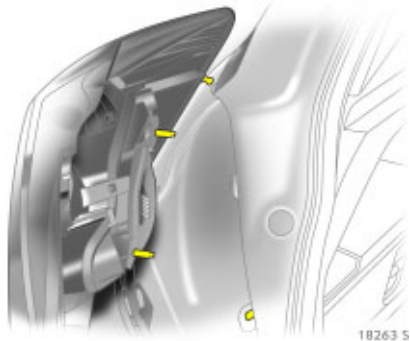

4. Detach bulb housing towards the rear.

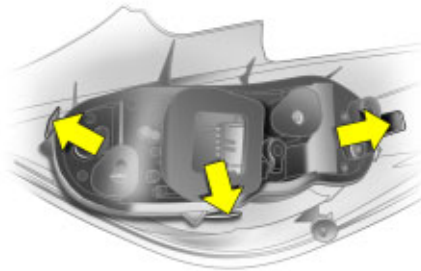

5. Gently press the three locking lugs on the outside of the bulb holder outwards and remove bulb holder.

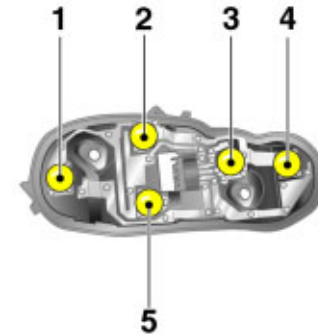

Bulbs in bulb carrier

- 1 = Reversing lamp (right side), rear fog lamp (left side)
- 2 = Tail lamp
- 3 = Turn signal lamp
- 4 = Tail lamp/brake lamp
- 5 = Tail lamp

6. Remove bulb from holder, gently pressing the bulb and rotating it.

7. Insert new bulb, pressing it gently and rotating it.

8. Engage bulb holder in bulb housing, ensuring that it properly engages.



18404 S

9. Ensure that the bulb holder seal is positioned as illustrated. Fit the round seal on the fastening bolt.



17289 T

10. Insert bulb housing in vehicle body, engaging ratchet and bolt in recesses. Tighten attachment nuts by hand. Engage plug connector. Close and lock flap.
11. Carry out the following steps to ensure proper function of the tail lamps:
- Switch on ignition
 - Operate brake
 - Switch on parking lamps

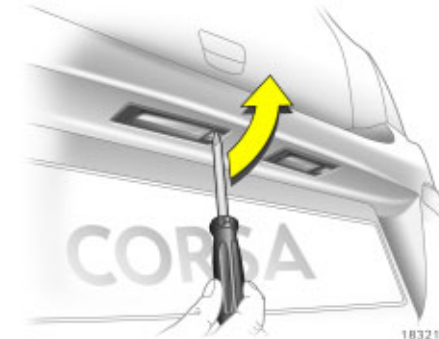

18321 S

Number plate lamp

1. Insert screwdriver vertically in bulb insert as illustrated in figure. Press to the side and release spring.

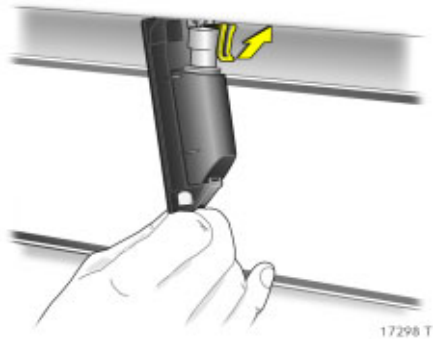

2. Remove bulb housing downward, taking care not to pull on the cable.
3. Lift flap and disconnect plug from bulb socket.



4. Rotate bulb holder to left and disengage.
5. Remove bulb from socket.
6. Insert new bulb.
7. Insert bulb socket into bulb housing and engage by rotating clockwise.
8. Connect plug to bulb socket.
9. Insert and engage bulb housing.

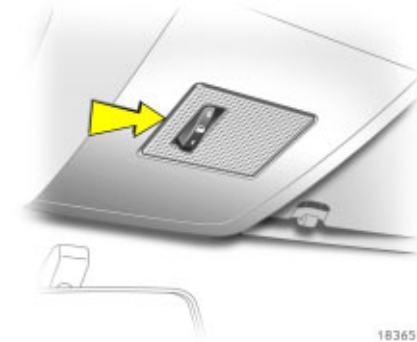

Courtesy lamps

Front courtesy lamp

1. Disengage and remove lens at the position located in the illustration using a screwdriver.
2. Remove bulb from socket.
3. Insert new bulb.
4. Mount lens and engage in position.

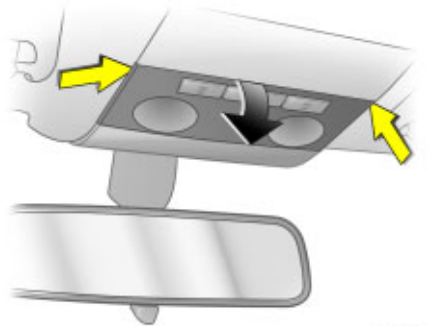

17300 T

Front courtesy lamp with reading lamps ✱

1. Disengage lens by hand at location illustrated in figure, press it downward slightly and remove at a downward angle.
2. Remove bulb from socket.
3. Insert new bulb.
4. Mount lens and engage in position.

**Rear courtesy lamps ✱,
rear reading lamps ✱**

Have bulb replacement carried out by a workshop.

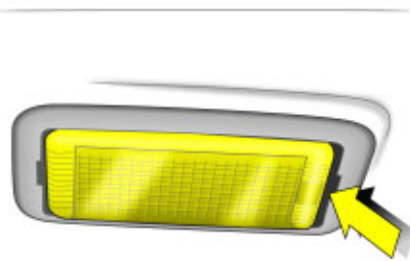

17301 T

Glove compartment lighting, luggage compartment lighting, footwell lighting ✱

1. Prise the lamp out with a screwdriver.



17302 T

2. Press bulb slightly towards spring clip and remove.
3. Insert new bulb.
4. Insert lamp in opening and engage in position.

Instrument illumination, Information display illumination ✱

Have bulb replacement carried out by a workshop.

228 Self-help, vehicle care

Vehicle care

When caring for your vehicle, observe all national environmental regulations, particularly when washing it.

Regular, thorough care helps to improve the appearance of your vehicle and maintain its value over the years. It is also prerequisite for warranty claims for any paint or corrosion damage. The following pages contain tips for vehicle care which, if used properly, will help combat the unavoidable, damaging effects of the environment.

Washing

The paintwork of your vehicle is exposed to environmental influences. Wash and wax your vehicle regularly. When using automatic car washes, select a program that includes waxing.

Bird droppings, dead insects, resin, pollen and the like should be cleaned off immediately, as they contain aggressive constituents which can cause paint damage.

If using a car wash, comply with the car wash manufacturer's instructions. The windscreen wipers and rear window wiper must be switched off. Remove antenna * and roof rack *. Stand on the door sill to reach them more easily.

If you wash your vehicle by hand, make sure that the insides of the wings are also thoroughly rinsed out.

Clean edges and folds on opened doors and flaps as well as the areas they cover.

Thoroughly rinse off and leather-off the vehicle. Rinse leather frequently. Use separate leathers for paint and window surfaces: remnants of wax on the windows will impair vision.

Do not use hard objects to remove spots of tar. Use tar removal spray on painted surfaces.

Polishing and waxing

Wax the vehicle regularly (by the time the water no longer beads at the latest). Otherwise, the paintwork will dry out.

Polishing is necessary only if the paint has become dull or if solid deposits have become attached to it.

Paintwork polish with silicone forms a protective film, making waxing unnecessary.

Plastic body parts should not be treated with wax and polish.

Wheels and tyres

Do not use high-pressure jet cleaners.

Clean wheels with a pH-neutral wheel cleaner.

Wheels are painted and can be treated with the same agents as the body.

Paintwork damage

Rectify minor paintwork damage with a touch-up pen before rust forms. Have more extensive damage or rust areas repaired by a workshop.

Exterior lights

Headlamp and other lamp covers are made of plastic. Do not use any caustic agents, do not use an ice scraper, and do not clean them when dry.

Plastic and rubber parts

Plastic and rubber parts can be cleaned with the same cleaner as used to clean the body. Use interior cleaner if necessary. Do not use any other agent. Avoid solvents and petrol in particular. Do not use high-pressure jet cleaners.

Interior and upholstery

Only clean the vehicle interior, including the instrument panel fascia and panelling, with a dry cloth or interior cleaner.

The instrument panel should only be cleaned using a soft damp cloth.

Clean fabric upholstery with a vacuum cleaner and brush. Remove stains with an upholstery cleaner.

Clean seat belts with lukewarm water or interior cleaner.

Caution

Close Velcro fasteners as open Velcro fasteners on clothing could damage seat upholstery.

230 Self-help, vehicle care

Windows

Use a soft lint-free cloth or chamois leather together with window cleaner and insect remover.

When cleaning the rear window, make sure the heating element inside the window is not damaged.

For mechanical removal of ice, use a sharp-edged ice scraper. Press the scraper firmly against the glass so that no dirt can get under it and scratch the glass.

Clean smearing wiper blades with a soft cloth and window cleaner.

Sun roof ☼

Never clean with solvents or abrasives, fuels, aggressive agents (e.g. paintwork cleaner, solutions containing acetone, etc.), acidic or strongly alkaline agents or scourers.

No stickers may be applied to the sun roof.

Locks

The locks are lubricated with a high-quality locking cylinder grease in the factory. Only use de-icer in urgent cases, since it has a de-greasing effect and affects the operation of the locks. Have the locks re-greased in a workshop after using de-icer.

Engine compartment

Clean painted surfaces in the engine compartment like any other painted surface.

It is advisable to wash the engine compartment before and after winter and preserve it with wax. Cover alternator and brake fluid reservoir with plastic sheets before washing the engine.

When washing the engine with a steam-jet cleaner, do not direct the steam jet at components of the anti-lock brake system, the air conditioning system, the climate control system, belt drive or the fuse box.

After an engine wash, have all engine room components preserved thoroughly by a workshop using protective wax.

Do not use high-pressure jet cleaners.

Underbody

Some areas of the vehicle underbody have a PVC undercoating while other critical areas have a durable protective wax coating.

After the underbody is washed, check the underbody and have more protective wax applied if necessary.

Bitumen/rubber materials could damage the PVC coating. Have underbody work carried out by a workshop.

Before and after winter, wash the underbody and have the protective wax coating checked.

Towing equipment

Do not clean the coupling ball bar with a steam-jet or high-pressure jet cleaner.

Opel Service, maintenance

Scheduled maintenance	231
Service schedule	231
Additional service work.....	238
Recommended fluids and lubricants .	238
Inspection system	240
Genuine Opel Parts and Accessories .	241
Performing work	241
Engine oil	242
Diesel fuel filter	244
Coolant	244
Brakes	245
Brake fluid	246
Windscreen wiper replacement	247
Windscreen washer system.....	248
Battery	248
Protecting electronic components	249
Laying the vehicle up for a long period of time.....	249
Putting the vehicle back into service .	249

Scheduled maintenance

These service intervals apply only under normal driving conditions. If conditions are more arduous ⇨ 238.

Service interval display ⇨ 240.

European service intervals

Every 30000 km or annually, whichever occurs first.

International service intervals

Every 15000 km or annually, whichever occurs first.

Validation

Service is validated using the spaces provided in the Service and Warranty Booklet. The date of service and kilometre reading are added, stamped and signed by the service workshop.

Ensure that the Service and Warranty Booklet is filled in correctly - an uninterrupted service history is important when making guarantee or goodwill claims, and is also an advantage when selling the vehicle on.

Service schedule

The service schedule applies in the following countries: Andorra, Austria, Belgium, Cyprus, Czech Republic, Denmark, Estonia, Finland, France, Germany, Great Britain, Greece, Greenland, Hungary, Iceland, Ireland, Italy, Latvia, Lithuania, Luxembourg, Malta, Netherlands, Norway, Poland, Portugal, Slovakia, Slovenia, Spain, Sweden, Switzerland.

The international service schedule applies in all other countries.

232 Opel Service, maintenance

Service schedule Europe

Service work	after year ¹⁾ km (x1000) ¹⁾	1 30	2 60	3 90	4 120	5 150
Carry out a visual check of all warning lamps, lighting and signalling devices, check steering and ignition locks		x	x	x	x	x
Remote control: replace batteries (check spare key)		every 2 years				
Check windscreen wipers, windscreen washer and headlamp washer systems, adjust if necessary.		x	x	x	x	x
Check coolant and antifreeze levels ²⁾ , top up if necessary, note antifreeze temperature in Service and Warranty Booklet (validation fields).		x	x	x	x	x
Check water-carrying hoses for leaks and make sure that they are secure.		x	x	x	x	x
Check break fluid level ²⁾ , top up if necessary.		x		x		x
Check that the battery terminals and lugs are secure		x	x	x	x	x
Vehicle system check using TECH 2		x	x	x	x	x
Replace pollen filter or active charcoal filter			x		x	
⊕● If the air is particularly polluted, full of dust or sand or pollen, if the air conditioning system smells		Discussion between customer / Opel Partner				
Replace air cleaner element		every 4 years/60000 km				
⊕ Replace spark plugs		every 4 years/60000 km				
Make a visual check of the ribbed belt			x		x	
⊕ Replace ribbed belt Z 13 DTJ, Z 13 DTH, Z 17 DTR		every 10 years/150000 km				
⊕ Check valve clearance, adjust if necessary Z16 LEL, Z 16 LER, Z 17 DTR		every 10 years/150000 km				

¹⁾ Depending on what occurs first.

²⁾ If the loss is too great or there are leaks, carry out remedial work in agreement with the customer.

⊕ Additional work.

● The intervals are shorter where driving conditions are more arduous or country-specific.

Service work	after year ¹⁾ km (x1000) ¹⁾				
	1 30	2 60	3 90	4 120	5 150
⊕ Replace timing belt and tension pulley Z 16 LEL, Z 16 LER, Z 17 DTR	every 10 years/150000 km				
Change engine oil and replace filter	x	x	x	x	x
⊕● Drain water from fuel filter, diesel (if the air humidity is high or the fuel of lower quality)	x	x	x	x	x
Replace fuel filter and drain water, diesel (grade EN590) Z 13 DTJ, Z 17 DTH		x		x	
Replace fuel filter, petrol (grade EN228), outer Z 16 LEL, Z 16 LER	every 4 years/60000 km				
Check handbrake, adjust if necessary (unladen wheels); carry out a visual check of wheel suspension and suspension front and rear, brake lines, brake pressure hose, fuel lines and exhaust system		x		x	
Check external bodywork / underseal, note any damage in the Service and Warranty Booklet.	x	x	x	x	x
⊕● Carry out a visual check on the front and rear wheel brakes ²⁾		x		x	
Annual service check if the annual distance travelled is greater than 20000 km.					
Carry out a visual check of the engine, transmission (AT, MT), check air conditioning compressor for leaks ²⁾	x	x	x	x	x

¹⁾ Depending on what occurs first.

²⁾ If the loss is too great or there are leaks, carry out remedial work in agreement with the customer.

⊕ Additional work.

● The intervals are shorter where driving conditions are more arduous or country-specific.

234 Opel Service, maintenance

Service work	after year ¹⁾ km (x1000) ¹⁾	1 30	2 60	3 90	4 120	5 150
⊕● Remove brake drum, clean, carry out visual check		every 4 years/60 000 km				
Visually inspect steering system boots, track rods, final drive		x	x	x	x	x
Check track rod end and supporting ball joint		x	x	x	x	x
⊕ Change brake and clutch fluids (manual transmission automated)		every 2 years				
Loosen wheel mounting and tighten to 110 Nm						
Grease or apply oil to bolt taper when fitting.						
Check tyre condition and pressure (including spare wheel), correct if necessary.			x		x	
If there is a tyre inflation system, check that the set is complete and the use-by date is still valid. Replace sealant bottle every four years.						
⊕ Annual service check if the annual distance travelled is greater than 20000 km.		every 2 years				
Visually check the first aid kit (that it is where it should be, that it is undamaged and that the use by date is still valid), lashing eyes and warning triangle		every 2 years				
Check headlamp settings (including auxiliary headlamps), adjust if necessary			x		x	
⊕● Lubricate door hinges, check arms, cylinder lock, door latch, bonnet catch, rear panel hinge			x		x	
OPC: check function of central locking system clean door lock from outside and grease		x	x	x	x	x
Test run, final check (check steering and ignition lock, instrument and warning lamps, entire brake system, steering, air conditioning system, engine, bodywork and chassis, reset service/interval display with TECH 2.		x	x	x	x	x
⊕ Germany only: carry out emissions check, main inspection		First time after three years, then every 2 years				
If used commercially to transport passengers, taxis, ambulances, hire cars etc.		annually				

¹⁾ Depending on what occurs first.

⊕ Additional work.

● The intervals are shorter where driving conditions are more arduous or country-specific.

International service schedule

Service work	after year ¹⁾ km (x1000) ¹⁾	1 15	2 30	3 45	4 60	5 75
Carry out a visual check of all warning lamps, lighting and signalling devices, check steering and ignition locks		x	x	x	x	x
Remote control: replace batteries (check spare key)		every 2 years				
Check windscreen wipers, windscreen washer and headlamp washer systems, adjust if necessary.		x	x	x	x	x
Check coolant and antifreeze levels ²⁾ , top up if necessary, note antifreeze temperature in Service and Warranty Booklet (validation fields).		x	x	x	x	x
Check water-carrying hoses for leaks and make sure that they are secure.		x	x	x	x	x
Check break fluid level ²⁾ , top up if necessary.		x		x		x
Check that the battery terminals and lugs are secure		x	x	x	x	x
Vehicle system check using TECH 2		x	x	x	x	x
Replace pollen filter or active charcoal filter			x		x	
⊕● If the air is particularly polluted, full of dust or sand or pollen, if the air conditioning system smells		Discussion between customer/Opel Partner				
Replace air cleaner element		every 4 years/60000 km				
⊕ Replace spark plugs		every 4 years/60000 km				
Make a visual check of the ribbed belt			x		x	
⊕ Replace ribbed belt Z 13 DTJ, Z 13 DTH, Z 17 DTR		every 10 years/150000 km				
⊕ Check valve clearance, adjust if necessary Z16 LEL, Z 16 LER, Z 17 DTR		every 10 years/150000 km				

¹⁾ Depending on what occurs first.

²⁾ If the loss is too great or there are leaks, carry out remedial work in agreement with the customer.

⊕ Additional work.

● The intervals are shorter where driving conditions are more arduous or country-specific.

236 Opel Service, maintenance

Service work	after year ¹⁾ km (x1000) ¹⁾				
	1 15	2 30	3 45	4 60	5 75
⊕ Replace timing belt and tension pulley Z 16 LEL, Z 16 LER, Z 17 DTR	every 10 years/150000 km				
Change engine oil and replace filter	x	x	x	x	x
⊕● Drain water from fuel filter, diesel (if the air humidity is high or the fuel of lower quality)	x	x	x	x	x
Replace fuel filter and drain water, diesel (grade EN590) Z 13 DTJ, Z 17 DTH		x		x	
Replace fuel filter, petrol (grade EN228), outer Z 16 LEL, Z 16 LER	every 4 years/60000 km				
Check handbrake, adjust if necessary (unladen wheels); carry out a visual check of wheel suspension and suspension front and rear, brake lines, brake pressure hose, fuel lines and exhaust system		x		x	
Check external bodywork / underseal, note any damage in the Service and Warranty Booklet.	x	x	x	x	x
⊕● Carry out a visual check on the front and rear wheel brakes ²⁾		x		x	
Annual service check if the annual distance travelled is greater than 20000 km.					
Carry out a visual check of the engine, transmission (AT, MT), check air conditioning compressor for leaks ²⁾	x	x	x	x	x

¹⁾ Depending on what occurs first.

²⁾ If the loss is too great or there are leaks, carry out remedial work in agreement with the customer.

⊕ Additional work.

● The intervals are shorter where driving conditions are more arduous or country-specific.

Service work	after year ¹⁾ km (x1000) ¹⁾	1 15	2 30	3 45	4 60	5 75
⊕● Remove brake drum, clean, carry out visual check		every 4 years/60000 km				
Visually inspect steering system boots, track rods, final drive		x	x	x	x	x
Check track rod end and supporting ball joint		x	x	x	x	x
⊕ Change brake and clutch fluids (manual transmission automated)		every 2 years				
Loosen wheel mountings and tighten to 110 Nm						
Grease or apply oil to bolt taper when fitting.						
Check tyre condition and pressure (including spare wheel), correct if necessary.			x		x	
If there is a tyre inflation system, check that the set is complete and the use-by date is still valid. Replace sealant bottle every four years.						
⊕ Annual service check if the annual distance travelled is greater than 20000 km.		every 2 years				
Visually check the first aid kit (that it is where it should be, that it is undamaged and that the use by date is still valid), lashing eyes and warning triangle		every 2 years				
Check headlamp settings (including auxiliary headlamps), adjust if necessary			x		x	
⊕● Lubricate door hinges, check arms, cylinder lock, door latch, bonnet catch, rear panel hinge			x		x	
OPC: check function of central locking system clean door lock from outside and grease		x	x	x	x	x
Test run, final check (check steering and ignition lock, instrument and warning lamps, entire brake system, steering, air conditioning system, engine, bodywork and chassis, reset service/interval display with TECH 2.		x	x	x	x	x

¹⁾ Depending on what occurs first.

⊕ Additional work.

● The intervals are shorter where driving conditions are more arduous or country-specific.

Additional service work

Additional work ⊕

Additional work is not always necessary at each service, but can be carried out at the same time as a regular service.

The cost of this type of work is not included in the charge for a regular service and will be invoiced separately. It is, however, more cost-effective to have this work done at the same time as a scheduled service rather than have it done separately.

Hard driving conditions ●

Conditions are considered hard when one or more of the following situations occurs more frequently:

- cold start,
- stop and go,
- caravan/trailer towing,
- inclines or steep climbs,
- poor road conditions,
- sand and dust,
- extreme temperature fluctuations.

Police vehicles, taxis and driving school vehicles are classified as being subjected to hard driving conditions.

Engine oil

Engine oil is graded by quality and viscosity. When choosing an engine oil, the quality grade is more important than the viscosity.

With hard driving conditions it might be necessary to carry out certain service work more frequently than the scheduled intervals.

We recommend seeking technical advice with regard to servicing requirements for your particular driving circumstances.

Engine oil for Service schedule Europe

GM-LL-A-025: Petrol engines

GM-LL-B-025: Diesel engines

GM General Motors Europe

LL Long life

Recommended fluids and lubricants

Only use products which have been tested and approved. Damage caused by using operating materials which have not been approved is not covered by the guarantee.

⚠ Warning

Operating materials are dangerous and must be handled carefully. If swallowed, seek medical help immediately. Do not breath in fumes and avoid contact with the skin. Keep away from children.

These materials are forbidden to contaminate waste water, surface water, groundwater or soil. Dispose of empty containers correctly. Always remember that operating materials are dangerous.

A or B Details of engine oil grade

025 Validity code

Opel engine oil is GM-LL-A-025 and GM-LL-B-025 grade and therefore suitable for both petrol and diesel engines.

Engine oil for International service

schedule

- ACEA-A3: Petrol engines
- ACEA-B4: Diesel engines without diesel particulate filter
- ACEA-C3 Diesel engines with diesel particulate filter

Engine oil: top up

Oils from different manufacturers and different brands of oil can be mixed as long as the grades (quality and viscosity) are the same.

Not all the engine oils available on the market are of a suitable quality. Always check that the required specification and classification are given on the cans.

If engine oil of a suitable quality cannot be obtained, use no more than 1 litre of category ACEA A3/B4 or A3/B3 (once between two oil changes). The viscosity must be suitable for requirements.

It is forbidden to use engine oil of grades ACEA A1/B1 and A5/B5. Under certain circumstances, these oils can cause long-term damage to the engine.

Engine oil additives

The use of motor oil additives can lead to damage and will invalidate the guarantee.

Engine oil viscosity

Only use engine oils with viscosity grades 0W-30, 0W-40, 5W-30 or 5W-40.

The SAE viscosity grading system indicates the oil's flowability. Oil is more viscous when cold than when warm.

Multigrade oil has two numbers. The first, followed by a W, indicates the viscosity at low temperatures and the second indicates the viscosity at high temperatures.



Inspection system

In order to guarantee economical and safe vehicle operation and to maintain the value of your vehicle, it is of vital importance that all maintenance work is carried out at the proper intervals.

Fixed service interval

When a service is due, the **InSP** display appears in the odometer display when the ignition is switched on. Have the next service performed by a workshop within one week or 500 km (whichever occurs first).

The service interval display takes account of off-the-road periods during which the battery is disconnected.

Flexible service interval *

The length of the service intervals is based on several parameters stemming from usage. For this reason, various engine-specific data is continually gathered and is used to calculate the remaining distance until the next service.

If the remaining distance is less than 1500 km, **InSP** is displayed with a remaining distance of 1000 km when the ignition is switched on and off. If less than 1000 km remains, **InSP** is displayed for several seconds. Have the next service performed by a workshop within one week or 500 km (whichever occurs first).

Display of remaining distance:

1. Switch off ignition.
2. Briefly press the trip odometer reset button. The odometer reading is shown.
3. Press and hold the reset button for about 2 seconds. **InSP** and the remaining distance are displayed.

Further information on maintenance and the inspection system can be found in the Service and Warranty Booklet, which is in the glove compartment.



Have maintenance work – and repair work on the body and the equipment – carried out professionally by a workshop. We recommend using your Opel partner, who has excellent knowledge of Opel vehicles and has the necessary special tools and up-to-date service instructions from Opel. It is particularly advisable to use an Opel Partner during the warranty period in order to prevent loss of warranty. Further information can be found in the Service and Warranty Booklet.

Separate anti-corrosion service

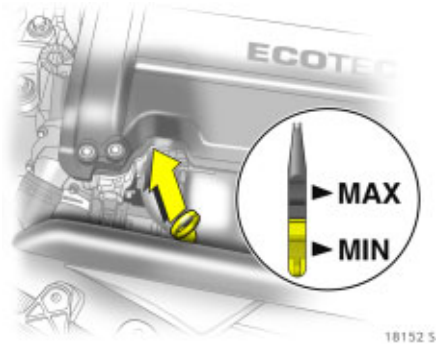
Have this work done at the intervals given in the Service and Warranty Booklet.



Engine oil

In vehicles fitted with engine oil level monitoring , the engine oil level is checked automatically  86. We recommend checking the engine oil level before embarking on long journeys.

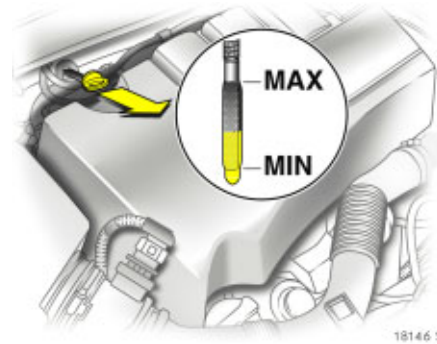

Check with the vehicle on a level surface. The engine must be at operating temperature and switched off for at least 5 minutes.

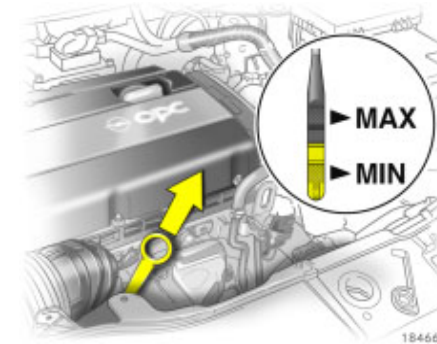

Pull out the dipstick, wipe it clean, insert it to the stop on the handle, pull out and read the engine oil level.

Push the dipstick in as far as it will go and twist it by half a turn.

Different dipsticks are used depending on engine variant.

When the engine oil level has dropped to the **MIN** mark, top up engine oil.

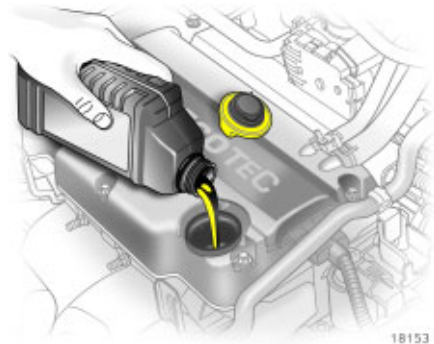

We recommend that you use the same engine oil as was used the last time it was topped up.

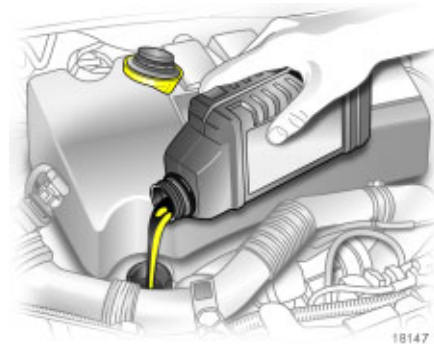

The engine oil level must not exceed the **MAX** mark on the dipstick.

Caution

If there is too much engine oil, the excess must be drained or suctioned out.

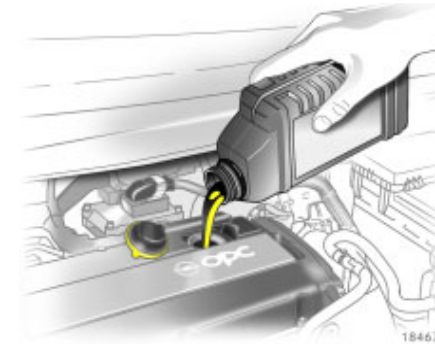

The amount filled must be between the **MIN** and **MAX** marks ↻ 267.

Fit the cap on straight and tighten it.

Diesel fuel filter

On the event of engine oil change, have fuel filter checked for possible water residue by a workshop.

Illumination of  indicates water in the fuel filter .

Have fuel filter checked at shorter intervals if the vehicle is subjected to extreme operating conditions such as high humidity (primarily in coastal areas), extremely high or low outside temperatures and substantially varying daytime and night-time temperatures.

Coolant

The coolant provides anti-freeze protection down to approx. $-28\text{ }^{\circ}\text{C}$.

Caution

Only use approved anti-freeze.

Coolant additives used to give additional protection against corrosion and prevention against small leaks can lead to functional problems. No liability is accepted for damage caused by using coolant additives.

Warning

Antifreeze is a danger to health; it must therefore be kept in the original container and out of the reach of children.

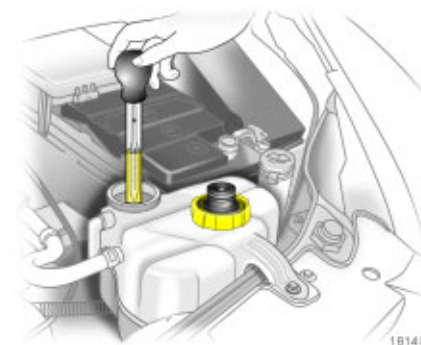

Antifreeze and corrosion protection

Have the concentration of the radiator contents tested by a workshop before winter starts. The amount of antifreeze must provide protection down to approx. $-28\text{ }^{\circ}\text{C}$. A lower antifreeze concentration will reduce the amount of protection from frost and corrosion. Add antifreeze if necessary.

If coolant loss is topped up with water, have concentration checked and add antifreeze if necessary.

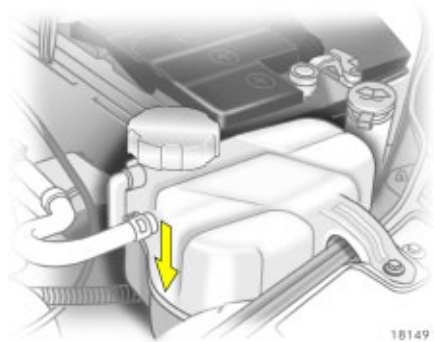

Coolant level

In a closed cooling system, there is hardly any loss.

If the cooling system is cold, the coolant should lie above the **KALT/COLD** mark. Top up if the level is low.

⚠ Warning

Allow the engine to cool before opening the cap. Carefully open the cap, relieving the overpressure slowly.

Top up with anti-freeze. If no anti-freeze is available, fill with clean tap water or distilled water. Have the anti-freeze concentration checked.

Have the cause of coolant loss rectified by a workshop.

Caution

Too low a coolant level can cause engine damage.

Fit the cap on straight and tighten it.

Brakes

A screeching noise indicates that the brake lining is at its minimum thickness. Continued driving is possible. Have the brake lining replaced as soon as possible.

Once new brake lining is fitted, do not brake unnecessarily hard for the first 200 km.

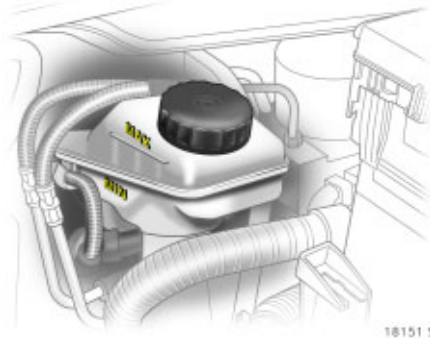

Brake fluid

⚠ Warning

Brake fluid is poisonous and corrosive. Do not allow it to come into contact with eyes, skin, fabrics or painted surfaces.

The brake fluid level must be between the **MIN** and the **MAX** marks.

When topping up, ensure maximum cleanliness as contamination of the brake fluid can lead to function problems in the braking system.

Only use approved high performance brake fluids. Only use brake fluid DOT4.

After correcting the brake fluid level, have the cause of the loss of brake fluid remedied by a workshop.

Brake fluid change

Brake fluid is hygroscopic, i.e. it absorbs water. If the brakes become hot, such as when driving on long downhill stretches, vapour bubbles can occur in the water, which can have an extremely adverse effect on braking power (depending on the proportion of water).

Keep to the specified intervals.

⚠ Warning

Have the brake fluid change performed by a workshop. Please comply with the legal environmental and health regulations – concerning the disposal of brake fluid.

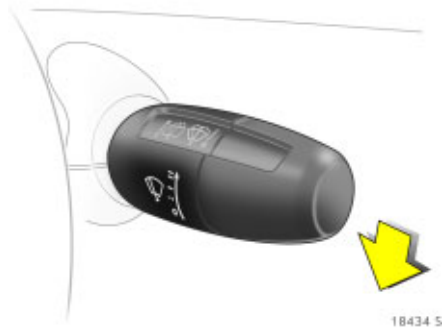

18434 S

Windscreen wiper replacement
Service setting for front windscreen wipers
 (e.g. for changing or cleaning the front wiper blades).

Within 4 seconds of switching off the engine but with the key in the ignition switch, press the windscreen wiper stalk downwards. Release the stalk as soon as the wiper blades are vertical.

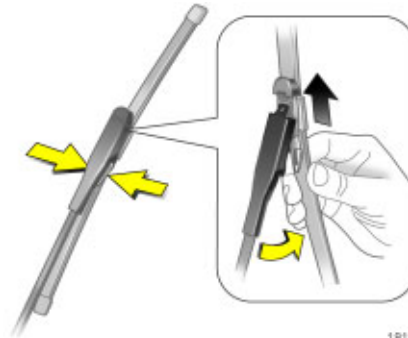

18154 S

Wiper blades on the windscreen
 Activate service setting – see previous column. Raise wiper arm, tilt wiper blade at a 90° to the wiper arm and remove to the side.

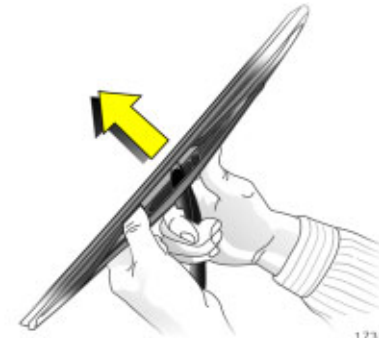

17318 T

Wiper blade on the rear window ✱
 Lift wiper arm. Disengage wiper blade as shown in illustration and remove.

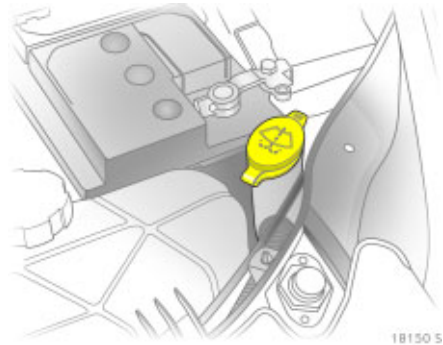

Windscreen washer system

Filler neck of the reservoir for the windscreen washer system at the front left, in front of the battery.

Fill with clean water mixed with cleaner and anti-freeze.

Make sure there is sufficient anti-freeze protection.

When closing the reservoir, press the lid firmly over the beaded edge all the way round.



Battery

The vehicle battery is maintenance-free.

Batteries do not belong in household waste. They must be disposed of at an appropriate recycling collection point.

The retrofitting of electrical or electronic accessories may subject the battery to additional loading and cause it to become discharged. Please seek advice concerning the technical options, such as installing a more powerful battery.

Laying up the vehicle for more than 4 weeks can lead to battery discharge. Disconnect the negative terminal of the vehicle battery.

Ensure the ignition is switched off before connecting or disconnecting the vehicle battery.

Replacing the battery

When the battery is being replaced, please ensure that there are no open ventilation holes in the vicinity of the positive terminal. If a ventilation hole is open in this area, it must be closed off with a dummy cap, and the ventilation in the vicinity of the negative terminal must be opened.

Only use batteries that allow the fuse box to be mounted above the battery.

We recommend that you have the battery replaced by an Opel Partner.

Protecting electronic components

In order to prevent faults in electronic components in the electrical system, never connect or disconnect battery with engine running or ignition switched on. Never start engine with battery disconnected, e.g. when starting using jump leads.

To avoid damaging the vehicle, do not make any modifications to the electrical system, e. g. connecting additional consumers or tampering with electronic control units (chip tuning).

Warning

Electronic ignition systems generate very high voltages. Do not touch the ignition system; high voltage can be fatal.

Laying the vehicle up for a long period of time

If the vehicle is to be laid up for several months, the following work should be undertaken to prevent damage:

- Wash and wax the vehicle ⇨ 228.
- Have the wax in the engine compartment and underbody checked.
- Clean and preserve rubber seals.
- Change engine oil.
- Check antifreeze and corrosion protection ⇨ 244.
- Check coolant level, add antifreeze if necessary ⇨ 245.
- Drain the windscreen washer system.
- Increase tyre pressure to value given for full load ⇨ 264.

- Park the vehicle in dry and well ventilated place. Select first gear or reverse gear, and with automatic transmission * move selector lever to P. Use chocks or something similar to prevent vehicle from rolling.

- Do not apply hand brake.

- Disconnect the clamp from the negative terminal of the vehicle battery.

Putting the vehicle back into service

Perform the following work before recommissioning the vehicle:

- Connect the clamp to the negative terminal of the vehicle battery.
- Check tyre pressure ⇨ 264.
- Top up windscreen washer system ⇨ 248.
- Check engine oil level ⇨ 242.
- Check coolant level ⇨ 245.
- Fit the number plate if necessary.

Technical Data

Vehicle data.....	250
Engine data.....	252
Performance 5-door.....	254
Performance 3-door.....	255
Performance, delivery vehicle.....	255
Fuel consumption, CO ₂ -emissions.....	256
Weights, payload and roof load.....	259
Tyres.....	264
Capacities.....	267
Dimensions.....	268
Trailer hitch installation dimensions ..	269

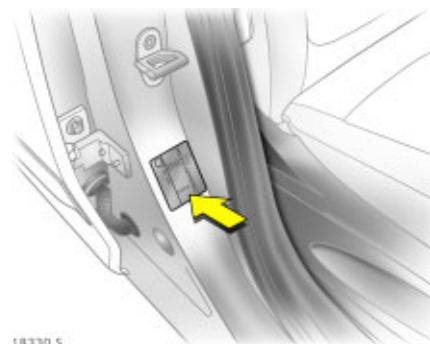

Vehicle data

The technical data is determined in accordance with European Community standards. We reserve the right to make modifications. Specifications in the vehicle documents always have priority over those given in this manual.

The identification plate is affixed to the front right door frame.



Information on identification plate:

- 1 Manufacturer
- 2 Type approval number
- 3 Vehicle identification number
- 4 Gross vehicle weight rating
- 5 Permissible gross train weight
- 6 Maximum permissible front axle load
- 7 Maximum permissible rear axle load
- 8 Vehicle-specific or country-specific data

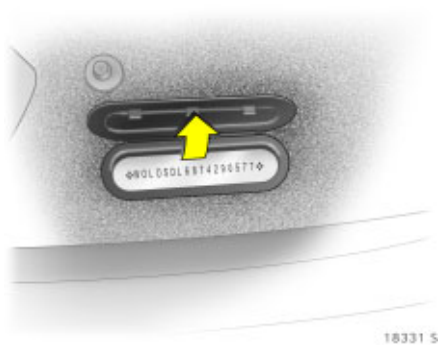

The vehicle identification number is stamped on the identification plate and on the right side of the floor of the vehicle under a cover between the front door and the seat.

Engine code and engine number: stamped on left-hand side of engine on crankcase.

252 Technical Data

Engine data

Sales designation Engine identifier code	1.0 Z 10 XEP	1.2 Z 12 XEP	1.4 Z 14 XEP	1.6 Z 16 LEL	1.6 OPC Z 16 LER
Number of cylinders	3	4	4	4	4
Piston displacement [cm ³]	998	1229	1364	1598	1598
Brake horse power [kW/bhp] at rpm	44 5600	59 5600	66 5600	110 5000	141 5850
Torque [Nm] at rpm	88 3800	110 4000	125 4000	210 1850 to 5000	230 1980 to 5850
Fuel type	Petrol	Petrol	Petrol	Petrol	Petrol
Octane rating RON ¹⁾ recommended possible possible	95 (S)²⁾ 98 (SP) ²⁾ 91 (N) ²⁾³⁾	95 (S)²⁾ 98 (SP) ²⁾ 91 (N) ²⁾³⁾	95 (S)²⁾ 98 (SP) ²⁾ 91 (N) ²⁾³⁾	95 (S) ²⁾⁴⁾ 98 (SP)²⁾ _5)	95 (S) ²⁾⁴⁾ 98 (SP)²⁾ _5)
Max. permissible engine speed, continuous operation (rpm) approx.	6200	6200	6200	6500	6500
Oil consumption [l/1000 km]	0.6	0.6	0.6	0.6	0.6

¹⁾ Standard high-quality fuels, e.g. unleaded DIN EN 228; N = Normal (Regular), S = Super (Premium), SP = Super Plus (Premium Plus); value printed in bold: recommended fuel.

²⁾ Knock control system automatically adjusts ignition timing according to type of fuel used (octane number).

³⁾ Use of 91 RON fuel reduces power and torque. Slight increase in fuel consumption.

⁴⁾ Use of 95 RON fuel reduces power and torque. Slight increase in fuel consumption.

⁵⁾ 91 RON fuel must not be used.

Engine data

Sales designation Engine identifier code	1.3 CDTI Z 13 DTJ	1.3 CDTI Z 13 DTH	1.7 CDTI Z 17 DTR
Number of cylinders	4	4	4
Piston displacement [cm ³]	1248	1248	1686
Brake horse power [kW/bhp] at rpm	55 4000	66 4000	92 4000
Torque [Nm] at rpm	170 1750 to 2500	200 1750 to 2500	280 2300
Fuel type	Diesel	Diesel	Diesel
Cetane requirement [CZ] ¹⁾	49 (D)²⁾	49 (D)²⁾	49 (D)²⁾
Max. permissible engine speed, continuous operation (rpm) approx.	5100	5100	4730
Oil consumption [l/1000 km]	0.6	0.6	0.6

¹⁾ standard high-quality fuels; Diesel DIN EN 590; D = Diesel.

²⁾ A lower value is possible with winter diesel fuels.

254 Technical Data

Performance 5-door

Engine	Z 10 XEP	Z 12 XEP	Z 14 XEP	Z 16 LEL
Top speed ¹⁾ [km/h]				
Manual transmission	150	168	173	210
Manual transmission automated	–	168	–	–
Automatic transmission	–	–	166	–

Engine	Z 13 DTJ	Z 13 DTH	Z 17 DTR
Top speed ¹⁾ [km/h]			
Manual transmission	163 ²⁾	172	195
Manual transmission automated	–	172	–
Automatic transmission	–	–	–

¹⁾ The maximum speed indicated is achievable at kerb weight (without driver) plus 200 kg payload. Optional equipment could reduce the specified maximum speed of the vehicle.

²⁾ Value is different for low-pollution version. Value not available at time of printing.

Performance 3-door

Engine	Z 10 XEP	Z 12 XEP	Z 14 XEP	Z 16 LEL	Z 16 LER
Top speed ¹⁾ [km/h]					
Manual transmission	150	168	173	210	225
Manual transmission automated	–	168	–	–	–
Automatic transmission	–	–	166	–	–

Engine	Z 13 DTJ	Z 13 DTH	Z 17 DTR
Top speed ¹⁾ [km/h]			
Manual transmission	163 ²⁾	172	195
Manual transmission automated	–	172	–
Automatic transmission	–	–	–

Performance, delivery vehicle

Engine	Z 10 XEP	Z 12 XEP	Z 13 DTJ	Z 13 DTH
Top speed ¹⁾ [km/h]				
Manual transmission	150	168	163	172
Manual transmission automated	–	168	–	172
Automatic transmission	–	–	–	–

¹⁾ The maximum speed indicated is achievable at kerb weight (without driver) plus 200 kg payload. Optional equipment could reduce the specified maximum speed of the vehicle.

²⁾ Value is different for low-pollution version. Value not available at time of printing.

256 Technical Data

Fuel consumption, CO₂-emissions

Directive 80/1268/EEC (last changed by 2004/3/EC) has applied for the measurement of fuel consumption since 1996.

The directive is oriented to actual driving practices: Urban driving is rated at approx. $\frac{1}{3}$ and off-road driving with approx. $\frac{2}{3}$ (urban and extra-urban consumption). Cold starts and acceleration phases are also taken into consideration.

The specification of CO₂-emission is also a constituent of the directive.

The figures given must not be taken as a guarantee for the actual fuel consumption of a particular vehicle.

All values are based on the EU base model with standard equipment.

The calculation of fuel consumption as specified by directive 2004/3/EC takes account of the vehicle's kerb weight, ascertained in accordance with the said regulation. Optional extras may result in slightly higher fuel consumption and CO₂-emission levels than those quoted.

Fuel economy, Protecting the environment
↻ 151.

Fuel consumption, CO₂-emissions, passenger car 5-door

Engine	Z 10 XEP	Z 12 XEP	Z 14 XEP	Z 16 LEL
Conventional/sport/manual transmission				
automated/automatic transmission				
urban [l/100 km]	-/ 7.3/-/-	7.7/ 8.0/ 7.6/-	7.7/ 8.0/-/ 8.6	10.5/-/-/-
extra-urban cycle [l/100 km]	-/ 4.6/-/-	4.7/ 5.0/ 4.6/-	4.7/ 5.0/-/ 5.4	6.4/-/-/-
combined [l/100 km]	-/ 5.6/-/-	5.8/ 6.1/ 5.7/-	5.8/ 6.1/-/ 6.6	7.9/-/-/-
CO ₂ [g/km]	-/134/-/-	139/146/137/-	139/146/-/158	189/-/-/-
Engine	Z 13 DTJ	Z 13 DTH	Z 17 DTR	
Conventional/sport/manual transmission				
automated/automatic transmission				
urban [l/100 km]	5.7 ¹⁾ /-/-/-	6.3/-/ 6.1/-	6.3/-/-/-	
extra-urban cycle [l/100 km]	3.8 ¹⁾ /-/-/-	4.1/-/ 4.1/-	4.1/-/-/-	
combined [l/100 km]	4.5 ¹⁾ /-/-/-	4.9/-/ 4.8/-	4.9/-/-/-	
CO ₂ [g/km]	119 ¹⁾ /-/-/-	129/-/128/-	132/-/-/-	

¹⁾ Value is different for low-pollution version. Value not available at time of printing.

258 Technical Data

Fuel consumption, CO₂-emissions, passenger car 3-door

Engine	Z 10 XEP	Z 12 XEP	Z 14 XEP	Z 16 LER	Z 16 LEL
Conventional/sport/manual transmission					
automated/automatic transmission					
urban [l/100 km]	-/ 7.3/-/-	7.7/ 8.0/ 7.6/-	7.7/ 8.0/-/ 8.5	10.5/-/-/-	10.5/-/-/-
extra-urban cycle [l/100 km]	-/ 4.6/-/-	4.7/ 5.0/ 4.6/-	4.7/ 5.0/-/ 5.3	6.4/-/-/-	6.4/-/-/-
combined [l/100 km]	-/ 5.6/-/-	5.8/ 6.1/ 5.7/-	5.8/ 6.1/-/ 6.5	7.9/-/-/-	7.9/-/-/-
CO ₂ [g/km]	-/134/-/-	139/146/137/-	139/146/-/154	190/-/-/-	189/-/-/-
Engine			Z 13 DTJ	Z 13 DTH	Z 17 DTR
Conventional/sport/manual transmission					
automated/automatic transmission					
urban [l/100 km]			5.7 ¹⁾ /-/-/-	6.3/-/ 6.1/-	6.2/-/-/-
extra-urban cycle [l/100 km]			3.8 ¹⁾ /-/-/-	4.1/-/ 4.1/-	4.0/-/-/-
combined [l/100 km]			4.5 ¹⁾ /-/-/-	4.9/-/ 4.8/-	4.8/-/-/-
CO ₂ [g/km]			119 ¹⁾ /-/-/-	129/-/128/-	130/-/-/-

Fuel consumption, CO₂-emissions, delivery vehicle

Engine	Z 10 XEP	Z 12 XEP	Z 13 DTJ	Z 13 DTH
Conventional/sport/manual transmission				
automated/automatic transmission				
urban [l/100 km]	7.3/-/-/-	7.7/ 8.0/ 7.6/-	5.7/-/-/-	6.3/-/ 6.1/-
extra-urban cycle [l/100 km]	4.6/-/-/-	4.7/ 5.0/ 4.6/-	3.8/-/-/-	4.1/-/ 4.1/-
combined [l/100 km]	5.6/-/-/-	5.8/ 6.1/ 5.7/-	4.5/-/-/-	4.9/-/ 4.8/-
CO ₂ [g/km]	134/-/-/-	139/146/137/-	119/-/-/-	129/-/128/-

¹⁾ Value is different for low-pollution version. Value not available at time of printing.

Weights, payload and roof load

The payload is the difference between the permitted gross vehicle weight (see identification plate, page ↻ 250) and the EC kerb weight.

To calculate the kerb weight, enter the data for your vehicle below:

- Unladen weight from table 1 ↻ 260 +..... kg
- Added weight for different specifications are given in table 2 ↻ 263 +..... kg
- Weight of heavy accessories from table 3 ↻ 263 +..... kg
- Total =..... kg

is the EC kerb weight.

Optional equipment and accessories increase the kerb weight, which means that the payload will also change slightly.

Note the weights given in the vehicle documents.

The combined total of front and rear axle loads must not exceed the permissible gross vehicle weight. For example, if the front axle is bearing its maximum permissible load, the rear axle can only bear a load that is equal to the gross vehicle weight minus the front axle load.

With the trailer attached and the towing vehicle fully loaded, including all the passengers, the permitted rear axle load (specified on identification plate and vehicle documents) for passenger vehicles may be exceeded by 45 kg and the permitted total load may be exceeded by 50 kg.

For vans the permitted rear axle load may be exceeded by 25 kg. The permitted total load may be exceeded by the following amounts with the engines¹⁾ specified below:

Z 10 XEP	30 kg
Z 12 XEP	15 kg
Z 13 DTH	40 kg
Z 13 DTJ	35 kg

Trailer operation is not permitted for vans with tyre size 215/45 R 17.

¹⁾ Sales designation – see pages ↻ 252, ↻ 253.

If the permitted rear axle load is exceeded a maximum speed of 100 km/h applies. If lower national maximum speeds are specified for trailer operation, they must be complied with.

See the identification plate or vehicle documents for permissible axle loads.

Roof load

The permissible roof load is 75 kg. The roof load consists of the weight of the roof rack plus the load carried.

Driving instructions ↻ 149. Caravan/trailer towing ↻ 187, roof rack ↻ 173.

260 Technical Data

Table 1, unladen weight¹⁾, passenger car 5-door

Model	Engine	Manual transmission	Easytronic	Automatic transmission
Corsa [kg]	Z 10 XEP	1145	–	–
	Z 12 XEP	1160	1160	–
	Z 14 XEP	1163	–	1188
	Z 16 LEL	1280	–	–
	Z 13 DTJ	1235	–	–
	Z 13 DTH	1265	1265	–
	Z 17 DTR	1320	–	–
	Corsa with air conditioning system or climate control system [kg]	Z 10 XEP	1165	–
Z 12 XEP		1180	1180	–
Z 14 XEP		1183	–	1208
Z 16 LEL		1295	–	–
Z 13 DTJ		1255	–	–
Z 13 DTH		1285	1285	–
Z 17 DTR		1340	–	–
Corsa ECO [kg]		Z 13 DTJ	1210	–
Corsa ECO with air conditioning system [kg]	Z 13 DTJ	1219	–	–

¹⁾ According to EC Directive, including assumed weights for driver (68 kg), luggage (7 kg) and all fluids (tank 90 % full).

Table 1, unladen weight¹⁾, passenger car 3-door

Model	Engine	Manual transmission	Easytronic	Automatic transmission
Corsa [kg]	Z 10 XEP	1100	–	–
	Z 12 XEP	1130	1130	–
	Z 14 XEP	1140	–	1165
	Z 16 LEL	1255	–	–
	Z 13 DTJ	1205	–	–
	Z 13 DTH	1235	1235	–
	Z 17 DTR	1278	–	–
	Corsa with air conditioning system or climate control system [kg]	Z 10 XEP	1120	–
Z 12 XEP		1150	1150	–
Z 14 XEP		1160	–	1185
Z 16 LEL		1270	–	–
Z 13 DTJ		1225	–	–
Z 13 DTH		1255	1255	–
Z 17 DTR		1298	–	–
Corsa OPC [kg]		Z 16 LER	1278	–
Corsa OPC with air conditioning system [kg]	Z 16 LER	1298	–	–
Corsa ECO [kg]	Z 13 DTJ	1163	–	–
Corsa ECO with air conditioning system [kg]	Z 13 DTJ	1175	–	–

¹⁾ According to EC Directive, including assumed weights for driver (68 kg), luggage (7 kg) and all fluids (tank 90 % full).

262 Technical Data

Table 1, unladen weight¹⁾, delivery vehicle

Model	Engine	Manual transmission	Easytronic	Automatic transmission
Corsa delivery vehicle [kg]	Z 10 XEP	1125	–	–
	Z 12 XEP	1140	1140	–
	Z 13 DTJ	1215	–	–
	Z 13 DTH	1245	1245	–
Corsa delivery vehicle with air conditioning system or climate control system [kg]	Z 10 XEP	1145	–	–
	Z 12 XEP	1160	1160	–
	Z 13 DTJ	1235	–	–
	Z 13 DTH	1265	1265	–

¹⁾ According to EC Directive, including assumed weights for driver (68 kg), luggage (7 kg) and all fluids (tank 90 % full).

Table 2, added weight for different specifications

5-door passenger vehicle

Engine	Z 10 XEP	Z 12 XEP	Z 14 XEP	Z 16 LEL	Z 13 DTJ	Z 13 DTH	Z 17 DTR
Enjoy [kg]	7	7	7	7	7	7	7
Sport [kg]	12	12	12	12	12	12	12
Cosmo [kg]	14	14	14	14	14	14	14

3-door passenger vehicle

Engine	Z 10 XEP	Z 12 XEP	Z 14 XEP	Z 16 LEL	Z 13 DTJ	Z 13 DTH	Z 17 DTR
Enjoy [kg]	15	15	15	15	15	15	15
Sport [kg]	21	21	21	21	21	21	21
Cosmo [kg]	14	14	14	14	14	14	14

Weights, table 3, heavy accessories

Accessories	Sun roof	Towing equipment	Flex-Fix system	17-inch wheels on van
Weight [kg]	20	15	23.5	20

Tyres

Not all tyres available on the market currently meet the structural requirements. We recommend that you consult an Opel Partner concerning suitable tyre makes.

These tyres have undergone special tests to establish their reliability, safety and specific suitability for Opel vehicles. Despite continuous market monitoring, we are unable to assess these attributes for other tyres, even if they have been granted approval by the relevant authorities or in some other form.

Further information ⇨ 168.

Wheels

Wheel bolt tightening torque: 110 Nm.

Winter tyres *

Tyres of size 195/60 R 15, 215/45 R 17 and 225/35 R 18 must not be used as winter tyres.

Tyres of size 185/60 R 15 are only approved as winter tyres.

Tyres of size 185/65 R 15 are only approved as winter tyres on vehicles with a sports chassis. We recommend that you contact your Opel partner in order to find out whether your vehicle is equipped with a sports chassis.

If you use winter tyres, the spare wheel * may still be fitted with a summer tyre. If you use the spare wheel the vehicle's handling may be altered. Obtain a replacement for the faulty tyre as soon as possible, and have the wheel balanced and fitted to the vehicle.

Further information ⇨ 172.

Tyre chains *

Tyre chains may be used on the front wheels only.

We recommend the use of tyre chains with a fine mesh that add no more than 10 mm to the running surface and the insides of the tyres (including chain lock).

Tyre chains are not permitted on tyre sizes 195/60 R 15, 215/45 R 17 and 225/35 R 18.

Tyre chains are only approved on tyres of size 185/60 R 15 on vehicles with a sports chassis. We recommend that you contact your Opel partner in order to find out whether your vehicle is equipped with a sports chassis.

Further information ⇨ 172.

Spare wheel *

Depending on the version, the spare wheel will be in the form of a temporary spare wheel *. The vehicle may handle differently if a spare wheel has been fitted.

Replace defective tyre as soon as possible, balance wheel and fit to vehicle.

Please pay attention to the notes on this page and on pages 173, 196.

On vehicles with alloy wheels * the spare wheel may have a steel rim.

The spare wheel can be fitted with a smaller tyre¹⁾ and a smaller rim than the wheels fitted on the vehicle.

Tyre pressure (overpressure)

The specified tyre pressures are valid for cold tyres. The increased tyre pressure resulting from extensive driving must not be reduced. The tyre pressures specified on the following pages apply to both summer and winter tyres.

Always inflate the spare wheel * to the tyre pressure for full load – see tables on the following pages.

Temporary spare wheel tyre pressure * – see tables on the following pages.

Further information ⇨ 168 to ⇨ 172.

¹⁾ Country-specific version: The spare wheel is only to be used as a temporary spare wheel.

Tyre pressure (overpressure)

Passenger vehicle, van		Suspension behaviour when loaded with up to 3 people [kPa/bar]		ECO ¹⁾ when loaded with up to 3 people [kPa/bar]		Tyre pressure when fully laden [kPa/bar]	
Engine	Tyres	Front	Rear	Front	Rear	Front	Rear
Z 10 XEP	185/70 R14, 185/60 R 15 ²⁾ , 185/65 R 15, 195/55 R16, 195/55 RF 16 ³⁾ , 195/60 R 15	200/2.0	180/1.8	270/2.7	250/2.5	260/2.6	320/3.2
Z 12 XEP, Z 14 XEP	185/70 R14, 185/60 R15 ²⁾ , 185/65 R 15, 195/55 R16, 195/55 RF 16, 195/60 R 15, 215/45 R 17	200/2.0	180/1.8	270/2.7	250/2.5	260/2.6	320/3.2
Z 16 LEL, Z 16 LER OPC	195/55 R16 ⁴⁾ , 205/50 R 16, 215/45 R 17	240/2.4	240/2.4	270/2.7	250/2.5	260/2.6	320/3.2
	225/35 ZR 18 ⁵⁾	260/2.6	240/2.4	–	–	280/2.8	320/3.2

- 1) To achieve the smallest amount of fuel consumption possible. Not for use with run-flat tyres.
- 2) Only approved as winter tyres.
- 3) Only for vehicles with a specific rear axle application. We recommend your Opel Partner.
- 4) Only permitted for use as a winter tyre. Wheel chains not permitted.
- 5) Not vehicles with Z 16 LEL engine.

266 Technical Data

Tyre pressure (overpressure)

Passenger vehicle, van		Suspension behaviour when loaded with up to 3 people [kPa/bar]		ECO ¹⁾ when loaded with up to 3 people [kPa/bar]		Tyre pressure when fully laden [kPa/bar]	
Engine	Tyres	Front	Rear	Front	Rear	Front	Rear
Z 13 DTJ	185/70 R14 ²⁾ , 185/65 R 15, 195/55 R16, 195/55 RF 16, 195/60 R 15, 215/45 R 17 ³⁾	200/2.0	180/1.8	270/2.7	250/2.5	260/2.6	320/3.2
	185/60 R15 ⁴⁾	220/2.2	180/1.8	–	–	260/2.6	320/3.2
Z 13 DTJ ECO	175/70 R14	220/2.2	200/2.0	270/2.7	250/2.5	260/2.6	320/3.2
Z 13 DTH	185/65 R 15, 195/55 R16, 195/55 RF 16, 195/60 R 15, 215/45 R 17	220/2.2	200/2.0	270/2.7	250/2.5	260/2.6	320/3.2
	185/60 R15 ⁴⁾	240/2.4	200/2.0	–	–	260/2.6	320/3.2
Z 17 DTR	185/65 R 15, 195/55 R16, 195/55 RF 16, 195/60 R 15, 215/45 R 17	240/2.4	220/2.2	270/2.7	250/2.5	260/2.6	320/3.2
	185/60 R15 ⁴⁾	260/2.6	220/2.2	–	–	260/2.6	320/3.2

¹⁾ To achieve the smallest amount of fuel consumption possible. Not for use with run-flat tyres.

²⁾ Only with 14-inch brake.

³⁾ Not with low-pollution version.

⁴⁾ Only approved as winter tyres.

Capacities

Engine oil

Engine	Z 10 XEP	Z 12 XEP, Z 14 XEP	Z 16 LEL, Z 16 LER	Z 13 DTJ, Z 13 DTH	Z 13 DTJ ECO	Z 17 DTR
Including filter [l]	3.0	3.5	4.5	3.2	3.2	5.4
Between MIN and MAX [l]	1.0	1.0	1.0	1.0	1.0	1.0

Fuel tank

Engine	Z 10 XEP	Z 12 XEP, Z 14 XEP	Z 16 LEL, Z 16 LER	Z 13 DTJ, Z 13 DTH	Z 13 DTJ ECO	Z 17 DTR
Petrol/diesel, nominal capacity [l]	45	45	45	45	40	45

268 Technical Data

Dimensions

	5-door passenger vehicle	3-door passenger vehicle	Corsa OPC, OPC Line
Overall length [mm]	3999	3999	4040
Width [mm]	1737	1713	1713
Width with two exterior mirrors [mm]	1944	1944	1924
Overall height [mm]	1488	1488	1488
Length of luggage compartment floor [mm]	703	703	703
Luggage compartment width [mm]	944	944	944
Height of luggage compartment opening [mm]	538	538	538
Wheelbase [mm]	2511	2511	2511
Turning circle diameter [m]	10.20	10.20	10.20

Trailer hitch installation dimensions

Removable coupling ball bar, passenger vehicle, van

All measurements refer to Opel-approved towing equipment.

⚠ Warning

Only use towing equipment approved for your vehicle. We recommend entrusting retrofitting of towing equipment to your workshop.

Dimension	mm
A	267
B	81
C	700
D	528.5
E	532.5
F	473.5
G	418
H	422
I	9
J	51
K	96
L	255
M	351

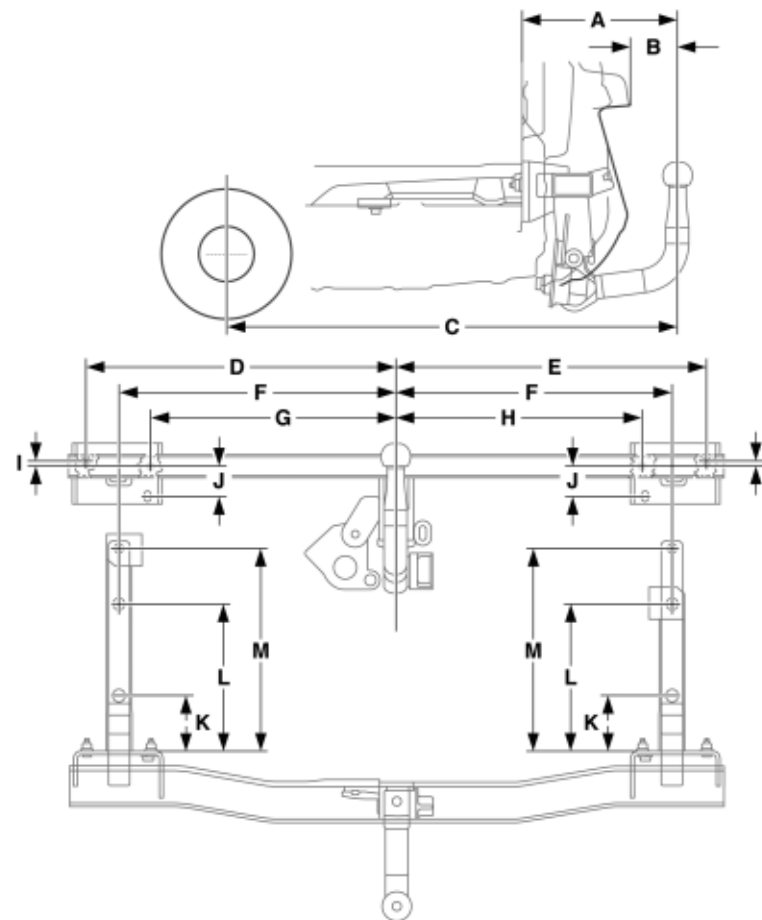

18329 5

Index

A

ABS (Anti-lock Brake System)	166	Antifreeze protection	244, 248
Accessories	63, 196	Anti-theft alarm system	37
Accessory socket	80	Anti-theft locking system	33
Adaptive Forward Lighting (AFL) ..	23, 112	Towing equipment	186
Bulb replacement	216	Anti-theft protection	17
Driving abroad	117	Aquaplaning	170
Adaptive Forward		Ashtray	81
Lighting = AFL	23, 112	Automatic	
Air conditioning system	120, 126	Anti-dazzle interior mirror	44
Air intake	135	Automatic transmission	15
Air recirculation system	126	automatic mode	145
Air vents	122	Driving programme	146
Airbag systems which can		Fault	148
be deactivated	19, 75, 88	Interruption of power supply	148
Airbags	69	Kickdown	146
Alarm system	37	Selector lever	15, 145
Alternator	87	Winter programme	146
Antenna	118, 228	Automatic wiping	106
Antifreeze	244	Auxiliary heater	134

B

Battery	150, 248
Interruption of	
power supply	46, 143, 148
Battery discharge protection	116
Before starting off	15
Belt force limiters	59
Belt tensioners	60
Bleeding, diesel fuel system	190
Bonnet	190
Boot, see Luggage compartment	36, 53
Brake assist	167
Brake lamp	166
Brake system	89
Brakes	
ABS	166
Brake assist	167
Brake fluid	246
Brake lamps	221
Brake servo unit	149
Foot brake	167
Hand brake	167
Bulb replacement	212
Bulbs	212

C

Capacities	267
Car dimensions	268
Car Pass	26
Caravan/trailer towing	149
Care	228
Catalytic converter	158
Central locking system	28, 32
Changing the battery	
Remote control	32, 33
Changing tyre/wheel type	168
Changing wheels	200
Chassis number, see vehicle	
identification number	251
Check control	21, 104
Child restraint system	63
Child safety locks	39
Cigarette lighter	80
Climate control	120
Climate control system	121, 128
Clutch operation	144
CO ₂ -emissions	256
Cold start	150
Colour information display	94
Contrast	100
Control indicator	
ABS (Anti-lock Brake System)	166
Airbag	74
Engine electronics	156
Exhaust	156
Immobiliser	27
Park pilot	163

Control indicators	10, 86
Adaptive Forward	
Lighting (AFL)	85, 112
Belt tensioners	61
Brake system	165
Cruise control	161
DDS	164
Deflation detection system	164
ESP (Electronic Stability Program)	151
Seat belts	59
Coolant	244
Coolant level	245
Coolant temperature	87
Cooling	127
Cornering light	112
Bulb replacement	218
Correcting time	99
Coupling socket load	188
Courtesy lamp	114, 115
Courtesy lamps	
Bulb replacement	226
Cruise control	160
Curtain airbags	73
Curve lighting	23, 112

272 Index

D

- Dashboard, see Instrument panel 6
- Data 26, 250
- Date 96
- Daytime running lights 108
- Decommissioning 249
- Deflation detection system 22, 164
- Deflation Detection System (DDS) 164
- Demisting and defrosting
 - Windows 125
 - With climate control system 131
 - With the air conditioning system 128
- Diesel fuel filter 244
- Diesel fuel system 190, 244
- Diesel particle filter 46, 85, 150, 157
- Dimensions 268
- Dipped beam 11
 - Bulb replacement 213
- Display 91, 92, 94
- Display mode 100
- Door locks 26, 230
- Double load-bay floor 24, 82
- Driving abroad
 - Headlamps 116
- Driving hints 149

E

- Easytronic 15
 - Driving programmes 139
 - Fault 142
 - Interruption of power supply 143
 - Kickdown 141
 - Selector lever 15
 - Sport programme 140
 - Starting off 138
 - Winter programme 140
- Economical driving 151
- Electric sun roof 46
- Electric windows 45
- Electrical system 208, 249, 267
- Electro-hydraulic power
 - assisted steering 87, 149
- Electronic components 249
- Electronic immobiliser 27
- Electronic Stability Program 151
- Engine code 251, 252, 253
- Engine control indicator 156
- Engine data 253
- Engine oil 239, 242
 - Additives 239
 - Top up 239
 - Viscosity 239
- Engine oil consumption 149, 242
- Engine oil level 86, 242
- Engine oil pressure 86
- Engine speed 150
- Engine wash 230
- Environmental protection 228

- ESP (Electronic Stability Program) 151
- Exhaust control indicator 156
- Exhaust gases 157
- Exhaust system 149
- Exterior mirrors 5, 42, 43, 46

F

- Fan 123
- Filling station
 - Engine oil level 242
 - Fuel 252, 253
 - Opening the bonnet 190
 - Tyre pressure 152, 264
 - Vehicle data 250
 - Windscreen washer system 248
- First-aid kit (cushion) 196
- Flat tyre 204
- Flex-Fix system 24, 174
- Fog lamps 110
 - Bulb replacement 220
- Fog tail lamp 110
 - Bulb replacement 221
- Foot brake 167
- Front passenger airbag 69
- Fuel 153, 252, 253
- Fuel consumption 151, 256
- Fuel filler cap 153
- Fuel filter 244
- Fuel gauge 90
- Fuel level 90
- Fuel system, diesel 190
- Fuses 208

G

- Gears 14, 144
- Generator, see Alternator 87
- Glove compartment 82
- Glove compartment lighting
 - Bulb replacement 227
- Graphical information display 94
- Gross vehicle weight 259
- Gross vehicle weight rating 259

H

- Halogen headlamp system 212
 - Bulb replacement 212
 - Driving abroad 117
- Hand brake 16, 17, 167
- Hazard warning lamps 12, 111
- Head restraints 4, 52
- Headlamp flash 109
- Headlamp range adjustment 111
- Headlamp switch 11, 108, 109
- Headlamp washer system 13, 107, 248
- Headlamps 11
 - Daytime running lights 108
 - Driving abroad 117
 - Fog lamps 110
 - Reversing lamps 110
 - Warning device 105
- Headrest height adjustment 4
- Heated exterior mirrors 13, 43
- Heated front seats 50, 51
- Heated rear window 13, 46

- Heating 120, 124
 - Seats 50, 51
 - With climate control system 130
 - With the air conditioning system 128
- Height adjustment
 - Seat belts 63
 - Steering wheel 5
- High-pressure cleaners 230
- Hill Start Assist 167
- Horn 12

I

- Identification plate 250
- Idling 144
- Ignition logic 100
- Ignition system 241, 248, 249
- Immobiliser 27
- Information display 94
- Infotainment system 118
- Inspection system 91, 231
- Instrument display 90
- Instrument illumination 114
 - Bulb replacement 227
- Instrument panel 6
- Instruments 84
- Interior mirror 4, 44
- Interruption of power supply 46, 104
 - Easytronic 143
 - Electric windows 46
 - Selector lever lock 148
- ISOFIX 68

J

- Jack 198, 202
- Jump leads 191

K

- Key
 - Extending 26
 - Locking doors 28, 32
 - Remove 17
 - Starting the engine 16
- Keys 26

L

- Language selection 99
- Lashing eyes 55, 56
- Lead-me-to-the-car light function 113
- Light switch 11
- Lighting 11, 88, 108
 - Driving abroad 117
- Load-bay floor 24, 82
- Loading 187
- Locking doors 28, 32
- Locking from the inside 29, 34
- Locks 230
- Luggage compartment
 - Bulb replacement 227
 - Lighting 116
 - Loading 57, 187, 259
 - Locking 36
- Luggage compartment cover 54, 56

274 Index

M

Main beam 11, 109
 Bulb replacement 214, 217
 Control indicator 87
Maintenance 231
 Air conditioning system 135
 Antifreeze protection 244
 Brake fluid 246
 Brakes 165, 245
 Engine oil 242
 Fuel consumption 152
 Tyre pressure 169
 Tyres 170
Manual transmission –
 see Transmission 14, 144
Mirrors 4, 43, 44
Misted windows 125, 131
Mobile telephone 119
Motorway lighting 112
Muffler, see Exhaust system 157

N

Neutral, transmission 14
Number plate lamps
 Bulb replacement 225
Number plate lighting 225
Number plates 249

O

Octane numbers 252, 253
Oil 239
 Additives 239
 Top up 239
 Viscosity 239
Oil consumption 242
Oil level 242
Oil pressure 86
Oils 242
Opel Service 231
Operating temperature 150
Outside temperature gauge 95
Overrun 152

P

Park pilot 162
Parking 17
Parking lamps 11, 114
 Bulb replacement 215, 219
Parking the vehicle 17
Pedals 150
Performance 254, 256
Peripheral lighting 113
Personalised
 key 23, 33, 34, 39, 92, 107, 110
Petrol 252, 253
Pollen filter 135
Power assisted steering, see
 electro-hydraulic power
 assisted steering 149

Power steering, see electro-hydraulic
 power assisted steering 149
Preheating 85

Q

Quickheat 134

R

Radio 118
Radio equipment (CB) 119
Radio reception 118
Rain sensor 106
Reading lamps 115, 116
Rear lamp cluster 108
 Bulb replacement 221
Rear window
 washer system 13, 107, 228, 248
Rear window wiper 13, 107
Refuelling
 Fuel filler cap 153, 154
Remote control
 Central locking system 2, 31
 Steering wheel 21, 118
Replacement keys 26
Reversing lamps
 Bulb replacement 221
Roof load 57, 149, 152
Roof rack 57, 152, 173, 259
Roof racks 57, 152, 259
Run-flat tyres 171
Running-in
 Brakes 165, 245

S

Safeguard against unauthorised use	16
Safety accessories	63, 196
Saving energy	151
Seat adjustment	2
Seat belts	58, 62
Seat height adjustment	3, 49
Seat position	50
Seats	2
Heated	50, 51
Selector lever	137, 145
Selector lever lock	15, 145
Self-diagnosis	61, 74, 166
Self-help	190
Central locking	34
Electric sun roof	47
Electric windows	46
Information display	96
Remote control	31
Service interval display	240
Service intervals	231
Additional work	238
Hard driving conditions	238
Main inspection	231
Service work	240
Side airbags	71
Signal system	12
Spare keys	26
Spare wheel	196, 197, 200
Speed	151, 152
Fuel consumption	151, 152

Speed warning	92
Speedometer	90
Sport programme	140
Starting the engine	27, 137
Steam-jet cleaners	230
Steering column lock	16, 17
Steering wheel adjustment	5
Steering wheel remote control	21, 118
Stowage compartments	82
Sun roof	46, 230
Sunblind	47
System settings	98

T

Tachometer	90
Tail lamps	108
Bulb replacement	221
Tailgate	36
Tank	
Fuel gauge	90
Technical data	250
Telephone, see Mobile telephone	119
Temperature regulation	123, 130
Tempomat, see cruise control	160
Temporary spare wheel	173, 197
Tightening torque	203, 264
Time	96
To fold backrest	3, 49
Tools	198
Top speed	254
Top-Tether	68
Towing	193
Towing equipment	184, 269

Towing eye	193, 195
Transmission	
Manual transmission	144
Transmission display	91, 136, 144
Transmission, automatic	15
Automatic mode	145
Driving programme	146
Fault	148
Interruption of power supply	148
Kickdown	146
Selector lever	15, 145
Selector lever lock	15
Winter programme	146
Transmission, Easytronic	
Driving programmes	139
Fault	142
Interruption of power supply	143
Kickdown	141
Selector lever	15, 138
Sport programme	140
Winter programme	140
Transmission, manual	14
Tread depth	170
Trip computer	20, 92, 101
Trip odometer	92, 93
Triple information display	94
Turn signal lamps	11
Turn signals	
Bulb replacement	220, 221
Tyre chains	172, 264
Tyre condition	170
Tyre pressure	22, 169, 264
Tyre repair kit	204

276 Index

U

Units of measure 100
Unleaded fuel 155, 252, 253

V

Valve cap key 169, 264
Vehicle care 228
Vehicle decommissioning 249
Vehicle identification number 251
Vehicle keys, see Keys 26
Vehicle recommissioning 249
Vehicle tools 198
Ventilation 120, 124, 133

W

Warning buzzers 105
Warning triangle 196
Washer fluid reservoir,
 windscreen washer system 248
Wheels 168
Wheels, tyres 168, 264
Windows 44
 Demisting
 and defrosting 125, 128, 131
Windscreen washer system 13, 107
 Antifreeze protection 248
 Washer fluid reservoir 248
Windscreen wipers 12
Winter mode
 Starting-off aid 140

Winter operation

Battery 150
Coolant, antifreeze 244
Fuel consumption 152
Fuel for diesel engines 153
Heating 120, 128
Locks 230
Tyre chains 172, 264
Window demisting and defrosting ... 125
Windscreen washer system,
 antifreeze protection 248
Winter programme 140, 146
Winter tyres 172, 264

Opel. Fresh thinking - better cars.

Copyright by ADAM OPEL GmbH, Rüsselsheim, Germany.

The information contained in this document is effective from the date indicated below. Adam Opel GmbH reserves the right to make changes to the technical specifications, features and design of the vehicles in relation to the information contained in this document, as well as changes to the document itself.

Edition: August 2008, ADAM OPEL GmbH, Rüsselsheim.

Printed on chlorine-free bleached paper.

KTA-2656/3-GB 13 255 295 Art.-Nr. 09 927 763 08/2008

