



From <http://www.9ss1.dk/porsche944>

944 944S 944Turbo

Driver's Manual

IMPORTANT

For your own protection and longer service life of your car, please heed all operating instructions and special warnings. Ignoring them could result in serious mechanical failure or even physical injury.

NOTE TO OWNERS

In Canada, this manual is also available in French. To obtain a copy contact your dealer or write to:

Volkswagen Canada Inc.
Porsche Customer Assistance /
Assistance à la Clientèle Porsche
1940 Eglinton Ave. East
Scarborough
Ontario M1L 2M2

NOTE AUX PROPRIETAIRES

Au Canada on peut se procurer un exemplaire de ce Manuel en français auprès du concessionnaire ou du:

PORSCHE



WKD 944021

8 M 6/86

Edition 87

© Dr. Ing. h. c. F. Porsche Aktiengesellschaft
All rights reserved.
Printed in Germany

Your car may have all or some of the components described in this manual. Should you find explanations of a feature or equipment not installed in your car, your Porsche dealer will be glad to assist you. Also check with your dealer on other available options or accessories. Text, illustrations and specifications in this manual are based on the information available at the time of printing.

It has always been Porsche's policy to continuously improve its products. Porsche, therefore, reserves the right to make changes in design and specifications, and to make additions or improvements in its product, without incurring any obligation to install them on products previously manufactured.

Judging by the car you have chosen, you are a motorist of a special breed, and you are probably no novice when it comes to automobiles. Remember however that, as with any vehicle, you should take time to familiarize yourself with your Porsche and its performance characteristics. Always drive within your own unique capabilities as a driver and your level of experience with your Porsche. Ensure that anyone else driving your Porsche does the same. To prevent or minimize injury, always use your safety belts. Never drink alcohol before or while driving.

This Owner's Manual contains a host of useful information. Please read this manual before you drive your new Porsche. Acquaint yourself with your car's features and know how to operate your Porsche more safely. The better you know your Porsche, the more pleasure you will experience driving your new car.

A separate Warranty and Maintenance booklet explains how you can keep your Porsche in top driving condition by having it serviced regularly.

It also contains detailed information about the warranties covering your Porsche. These warranties are:

"Warranty for new Porsche vehicles", "Warranty against corrosion for new Porsche vehicles", "Warranty for new Porsche vehicle emission control system", "Emissions performance warranty" (USA only), and "California emission control system warranty" (California USA only). In order to keep your warranty in effect, you must have the vehicle maintained and serviced as prescribed in the Warranty and Maintenance booklet provided to you at the time of sale.

Always carry your Warranty & Maintenance booklet with you when you take your Porsche to an authorized dealer for service. It provides your Service Adviser with the information he needs and enables him to record each service.

If you sell your Porsche the Owner's Manual and the Warranty & Maintenance booklet should be left in the vehicle to make all operating safety and

maintenance information available to the next owner.

If you change your address or if you bought this Porsche used be sure to send in a "Notice of Address Change"/ "Notice of Used Car Purchase" post card. This card can be found in the Warranty & Maintenance booklet or obtained from your Porsche dealer.

It is in your own interest that we can contact you, should the need arise. In case any adjustments or modifications need to be made to your Porsche to maintain its safety. For your own protection and longer service life of your car, please heed all operating instructions and special warnings. Ignoring them could result in serious mechanical failure or even physical injury.

We wish you many miles of safe and pleasurable driving in your

PORSCHE

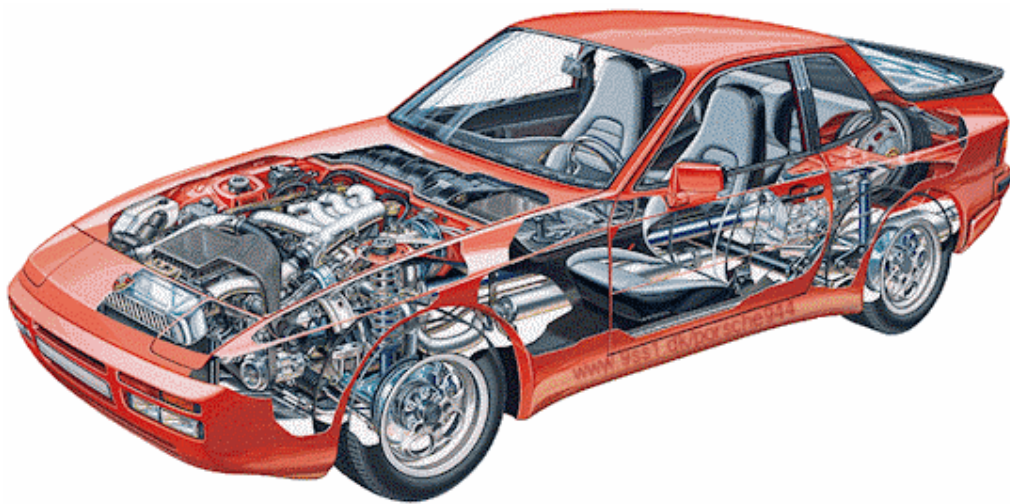

INDEX**A**

ABS 28,39
Acceleration diagram 118-129
Accelerator pedal 55
Air Bag System 20, 21, 38, 39
Air - cleaner 80, 81
- conditioner 44-46
- filter 80,81
Alternator warning light 39
Antifreeze 74,75,110
Antilock, Brake system 28, 39
Anti-theft alarm 11
Ashtray 42, 98
Automatic- garage door 25
- speed control 29
- transmission 53-55
- transmission fluid 78,110,128

B

Battery 90-92
Boost pressure gauge 34
Brake - booster 27
- fluid 39,79,110
- fluid warning light 39
- pads 27,37,47,79,80
- parking 26
- pedal 26, 27
- system 26,27,115
- warning light 37
Break-in hints 47
Bulb replacing 93-98
Buzzer 10,18,24,30

4

Jack 68
- supports 87, 88, 129
K/L
Keys 10-11,86
Kickdown 55
Lane changer 30
Leather 65
License plate light 98
Light switch 30
Lights - ashtray 98
- fog 30, 96, 97
- interior 43, 98
- license plate 98
- parking 30, 37, 93, 94
- turn signal 30,93,94
Locks - doors, wheels 10-13, 86
Loudspeakers 89
Lubricants 110,111
Luggage compartment 57

M/O

Manual transmission 52,122-125
- oil 77,110
Mirrors 22,43
Oil- change 71,72
- consumption 47, 69
- filter changing 71, 72
- pressure gauge 38
- pressure warning light 38
Octane rating 50, 51,106-108
Oxygen Sensor 101,102

P/R

Paint code number

C/D

CASIS 35
Capacities 110
Car care instructions 61-66
Casis 35
Catalytic Converter 50,102
Cautions 67
Central locking 13
Central warning light 37
Cigarette lighter 41
Cleaning 61-66
Clock 40
Clutch pedal 27
Collapsible spare tire 85
Control warning light system 36-39
Coolant Temperature Gauge 36
Cooling system 74-77
Corrosion prevention 65-66
Dashboard 24
Defogging/defrosting 44-46
Dimensions 114
Doors 12,13
Driving hints 8-9, 48, 49

E/F

Electrical system 89-92
Emergency- flasher 41
- starting 92
Emission Control System 100-103
Engine - cooling 74-77
- exhaust 48
- hood 58
- number 6
- oil checking & changing 69-72
- oil 69,110,111,128
-speed, max 34,47,52,106-108

Fan control switch knob 44
Fan, radiator 36, 74
Filling capacities 110
Fog lights 30, 96, 97
Fuel - economy 49
- evaporation control 103
- gauge 37
- recommendation 50, 51
- tank 50,110
Fuses and relays 89,126

G/H

Gas Station Information 126-129
Gasohol 51
Gasoline 50,51
Gear ratio diagram 122-125
Gearshift lever 52-55
Glove compartment 42
Hatchback 56
Headlights 30,95,99
Headlight- dimmer 30
- flasher 30
- switch 30
- washing system 31,32,81,110
Heater/ventilation controls 44-46
Hood - front 58
- rear 56,57
Horn 21,24

I/J

Ignition/steering lock 24
Instrument illumination 30
Instruments 33-40
Interior ligh 43, 98

Parking- brake 26, 37
- lights 30,37,93,94
Performance 116
Power assisted steering 73
Power train 109
Power windows 12
Prop-up roof 59, 60
Radiator fan 36, 74
Rear - hood 56,57
- view mirrors 22
- window defogger 41
- wiper 42
Recirculation Switch 44
Refrigerant 46,110
Relays 89,126
Rims 64,112,113
Roof racks 57,114
Roof, removable 59, 60

S

Safe driving hints 8-9
Safetybelts 17-21,65
Safety belt warning light 18,37
Safety compliance sticker 7
Seat heating System 15
Seats 14-16
Sekuriflex windshield 31, 63, 64
Shift indicator 35
Shift points 52-55
Side marker lights 94
Ski racks 57,114
Snow- chains 83, 84,112,113
- tires 83,84, 111,113
Spare tire, collapsible 85
Spark plugs 106-108
Specifications, engine 106-109

Speedometer 33
Starting procedures 24, 25
Sun visors 43
T/U
Tachometer 34, 35
Technical data 105-125
Tirepressure 82,112,113,129
Tires 47,82-87,112,113
Tool kit 68
Trip odometer 33
Transmission oil 77, 78,110
Trunk 56,57
Turn signal lights 30, 37, 93, 94
Undercoating 65, 66,100
Unleaded fuel 50, 51,106-108,110

V/W

Vehicle identification 6-7
Ventilation 44-46
Voltmeter 38
Warning/indicator lights 35-40
Washer reservoir 81,110
Washing 61-66
Water temperature gauge 36
Weatherstrips 64
Weights 114
Wheel alignment 115
Wheel nuts, lockable 86
Wheels 47,64,82-87,112
Wheel changing 85-88
Windows 12,63,64
Windshield- washer reservoir 81,110
- wiper/washer lever 31

Location of Vehicle Identification Number, Paint and Engine Number
 When ordering spare parts or submitting inquiries, always quote vehicle identification and engine number to assure correct and prompt service.

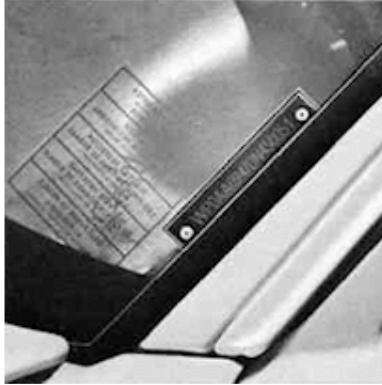

Vehicle Identification number
 In accordance with Federal Safety Regulations, the vehicle identification number of your car is located on the left* windshield pillar and can be seen from the outside.

Throughout this booklet and other Porsche publications applicable to USA vehicles, left is designated as the driver's side of the vehicle, and right as the passenger's side of the vehicle.

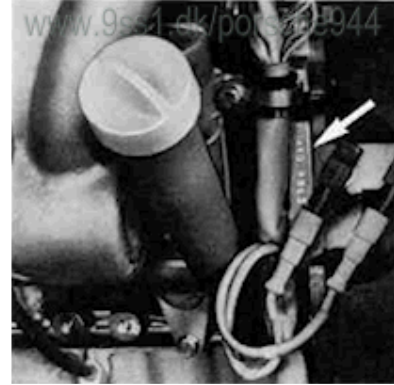

Engine number
 The engine number is stamped on the left side of the crankcase next to the clutch housing.

6



Paint number
 The paint number sticker is on the left side of the engine compartment, to the right of the central electric box.



The **Safety Compliance Sticker** is your assurance that your new Porsche complies with all applicable Federal Motor Vehicle Safety Standards which were in effect at the time the vehicle was manufactured. This sticker is located on the left side of the engine compartment to the left of the central electric box. The sticker also shows the month and year of production and the vehicle identification number of your car as well as the Gross Vehicle Weight Rating and the Gross Axle Weight Rating.



The **Vehicle Identification Label** is located under the luggage compartment carpeting and attached to the rear panel next to the left tail light housing. This label contains the following information:

1. Vehicle Identification Number
2. Vehicle Code
3. Engine and Transmission Code
4. Paint and Interior Code
5. Option Codes

A duplicate of this label is in your Warranty and Maintenance booklet.

7

Dear Porsche Owner

A lot has gone into the manufacture of your Porsche, including advanced engineering techniques, rigid quality control and demanding inspections. These engineering and safety features will be enhanced by **you... the safe driver...** who knows his car and all controls who maintains his vehicle properly who uses his driving skills wisely, and who always drives within his own capabilities and his level of familiarity with his vehicle. You will find helpful hints in this manual on how to perform most of the checks listed on these pages. If in doubt, have these checks performed by your Porsche dealer.

Before going on a trip...

First things first

- Turn the engine off before you attempt any checks or repairs of the vehicle.
- Be sure tires are inflated correctly. Check for damage and tire wear.
- See that wheel bolts are properly tightened and not loose or missing.
- Check engine oil level, add if necessary. Make it a habit to have engine oil checked with every fuel filling.
- Check coolant level to assure sufficient engine cooling.
- Be sure you have a well charged battery.
- Check brake fluid level. If too low, have brake system checked.
- Replenish windshield washer fluid.
- Check if engine hood is latched safely.
- Replace worn or cracked wiper blades.
- See that all windows are clear and unobstructed.
- Keep air intake slots and area between engine hood and windshield free of snow and ice, so that the heater and the windshield wipers work properly.

- Check whether all light lenses are clean.
 - Be sure all lights are working and headlights are aimed correctly.
 - Check under vehicle for leaks.
 - Be sure all luggage is stowed securely.
- Emergency equipment 3
It is good practice to carry emergency equipment in your vehicle. Some of the things you should have are: window scraper, snow brush, container or bag of sand or salt, emergency light, small shovel, first-aid kit, etc.

8

In the driver's seat...

- Check operation of horn.
- Position seat for easy reach of controls.
- Adjust inside and outside rear view mirrors.
- Attach your safety belts.
- Check operation of foot and parking brakes.
- Check all warning and indicator lights when starting the engine.
- NEVER leave car idling unattended.
- Lock doors from inside, especially with children in the car.
- To prevent inadvertent opening of doors from inside or outside, drive with locked doors.

On the road...

- Never drive after you have consumed alcohol.
 - Always have your safety belt attached.
 - Always drive defensively. Expect the unexpected.
 - Use signals to indicate turns and lane changes.
 - Turn on headlights at dusk.
 - Always keep a safe distance from the vehicle in front of you, depending on traffic, road and weather conditions.
 - Reduce speed at night and during inclement weather.
- Driving in wet weather requires caution and reduced speeds, particularly on roads with standing water, as the handling characteristics of the vehicle may be impaired due to tire aquaplaning.
- Also, when crossing stretches of deeper water there is a danger that too high of a speed can cause water to enter the engine combustion chambers through the intake air system and/or water may strike the cooling fan causing cooling system damage. In order to avoid possible en-

gine or cooling system damage when driving through deep water, the vehicle should be driven at a walking speed in first gear.

- Observe speed limits and obey road signs.

- When tired, get well off the road, stop and take a rest. Turn the engine off. Do not sit in the vehicle with engine idling. See WARNINGS on "Engine Exhaust".
- When parked, always set the parking brake. Move the selector lever to "P" (Automatic transmission) or move the gearshift lever to reverse or first gear (Manual transmission). On hills also turn the wheels toward the curb.
- When emergency repairs become necessary, move the vehicle well off the road. Turn on emergency flasher and use other warning devices to alert other motorists. Do not park or operate the vehicle in areas where the hot exhaust system may come in contact with dry grass, brush, fuel spill or other flammable material.
- Make it a habit to have the engine oil checked with every fuel filling.

9

NEVER invite car theft!

An unlocked car with the key in the ignition switch invites car theft.

A steering wheel lock and a buzzer alarm are standard equipment in your Porsche. The buzzer will sound if you open the driver's door while the key is still in the ignition lock. It is your reminder to pull the key out of the ignition lock and to lock the doors.

Always remove the ignition key, especially if children are left unattended in the vehicle. Unsupervised use of any vehicle key may cause serious personal injury. NEVER leave your vehicle unattended with the key in the ignition lock. Take the key and lock the doors.

10

Key number

The key number is impressed on a plastic tag (d) which comes with the keys. Detach this tag and keep it in a safe place. The key numbers of the other keys are embossed on the key heads.

For your protection against theft:

- Record the key number and keep it in a safe place, such as your wallet. Do not keep it in the vehicle.
- If you should lose a key, provide your Porsche dealer with the key number to obtain a duplicate key.

For the lockable wheel nuts, three identical keys (c), plus four wheel nuts with lock sleeve, are included. When taking the vehicle to your Porsche dealer or to a workshop for wheel or tire service, remember to leave one key with the service attendant.

In case of loss, duplicate keys cannot be furnished by your Porsche dealer. Do not leave these keys in the vehicle. Keep them in a safe place.

See "Lockable wheel nuts" for details.

www.9ss1.dk/porsche944

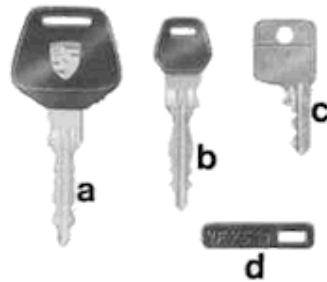

Keys

The vehicle is supplied with three keys fitting all locks. All keys are symmetrical so that there is no wrong way of inserting them in the locks. Two keys (a) are fitted with a battery light which is integrated in the plastic handle and lights up upon pressing the contact button. The third key (b) is flat and should be kept as an "emergency key", for instance, in your purse.

After pulling the plastic head off the flat key, you can snap on a luminous plastic handle available from your Porsche dealer.



www.9ss1.dk/porsche944

WARNING

NEVER remove the key from the steering lock while you are driving or as the car is rolling to a stop. The steering column will lock when you remove the key, and you will not be able to steer the car.

When the key bulb becomes weak, you should install a new battery of the same voltage. Acid leaking from a discharged battery might damage your clothing.

1. Use your finger nail or a small screw driver to carefully lift the key handle cover.
2. Insert a new commercial battery (1.5 V) in the contact button.
3. Assemble key top as shown in the above figure.



Anti-theft alarm

If your Porsche is equipped with an anti-theft alarm system, you will be given an additional set of duplicate keys. Keep one of these keys in a safe place but **not in the car**.

The alarm system can be activated or deactivated with **this key only**.

The lock for the anti-theft alarm system is located behind the door lock on the driver's side.

To **activate** the alarm system, insert the key and turn the lock slot 90° to the right.

To **deactivate** the alarm system, insert the key and turn the lock slot 90° to the left.



When the alarm system is activated, and an attempt is made to open either door, or to lift the engine hood or the rear hatch, the alarm will be triggered and will produce an intermittent high-pitched noise for about 30 seconds.

Should an attempt be made to start the engine, the alarm will also be set off.

However, when the alarm system is activated, it is impossible to start the engine.

11



Doors

To lock, unlock and open doors from the outside

- All doors can be locked with the ignition key.
- The passenger door can be locked without a key by first depressing the locking knob and then closing the door.
- The driver's door can only be locked from the outside with the key. This precaution was taken to prevent locking the driver's door while the key is still inside the car.
- Squeeze trigger in door handle to open door.



To lock, unlock and open doors from the inside

- Lock or unlock door by depressing or raising the locking knob.
- Open door by pulling inside door handle located above the armrest.

Power Windows

To open or close windows, depress the rocker switches located in the door panels. The door window on the passenger's side can also be operated from the driver's side. The power windows are operational when the ignition switch is turned to positions 1 or 2. Information regarding ignition switch posi-



tions will be found in section titled, "Ignition/starter switch with steering lock". When the ignition is turned off or the ignition key removed, the power windows can be operated until one door is opened.

WARNING

- Do not put anything on or near the windows that may interfere with the driver's vision.
- Remove the ignition key to shut off power to the window switches when the vehicle is not attended by a responsible person. Remember, power is still supplied to the window switches until one door is opened.

12



Central Locking

By means of the central locking system both doors are electrically locked or unlocked (locking button lowered or raised) when a door lock is turned with the key. Before locking, make sure that both doors are properly closed.

When the doors are locked, the removable roof is also locked at the same time.

If the roof is open, it is not affected by the central locking system.

Both doors can be individually locked from inside by pressing the locking button. If the locking button is used to unlock one door, the second door is also automatically unlocked.

To prevent you from locking yourself out of the vehicle, it is not possible with the driver's door open to lock the door lock with the locking button.

Emergency operation

Should the central locking fail, both doors can be opened and closed mechanically.



Central Locking Switch

By pressing the central locking switch (A) in the centre console it is possible with the ignition key in position 2 to lock or unlock both doors electrically. As a check, if the doors are locked, a red indicator lamp in the switch lights up.

If one of the doors has been locked manually, the red indicator lamp lights up. By pressing the switch, the door is unlocked; when pressed again, both doors are locked. With the ignition key removed, locking is possible by means of the central locking switch. To unlock, the ignition must be switched on or the locking button raised.

13

Front seats

The correct seating position is all-important for safe and fatigue-free driving. In order to satisfy individual requirements, the seat has infinitely variable adjustment. The rocker switches for the height adjustment are located at the outboard side of the seat. We recommend the following procedure for finding the correct position for the driver's seat:

1. Operate longitudinal adjustment until your leg is fully stretched with the clutch pedal depressed while your foot is bent.
2. Adjust desired fore/aft height.
3. Clasp upper portion of steering wheel. Then adjust backrest inclination so that both shoulders remain in contact with the backrest even with your arms fully stretched.
4. If necessary, correct the longitudinal adjustment.



Seat Adjustment

The seats permit individual longitudinal adjustment. After pulling up the locking lever on the outboard side of the seat, the seat can be repositioned forward or rearward.

WARNING

Do not adjust seats while the vehicle is in motion. The seat may move unexpectedly which could cause sudden loss of vehicle control or personal injury.

Backrest Adjustment

The backrests can be adjusted forward or rearward by pulling up the locking lever on the inboard side of the seat.

WARNING

Front seat passengers should not ride in a moving vehicle with the backrest reclined. Safety belts only offer protection when the backrest is upright and the belts are properly positioned on the body. Improperly positioned safety belts can cause serious personal injury in an accident.

14

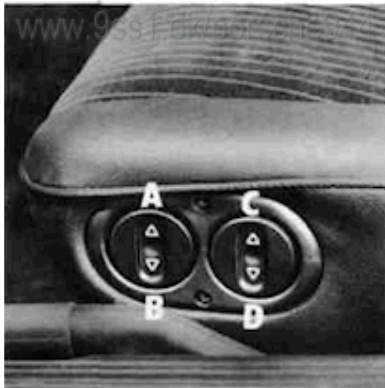

Electric Seat Adjustment

The lifting controls are designed for front and rear vertical adjustment by pressing a rocker switch.

- A Front end up
- B Front end down
- C Rear end up
- D Rear end down



Vehicles with electric backrests and fore-and-aft adjustment are equipped with rocker switches with two additional functions.

- A Move seat forward
- B Move seat rearward
- C Move backrest forward
- D Move backrest rearward

Seat Heating System

The seat heating system is turned on by means of the switch (a); it heats the seat pan and backrest. After appr. 15 minutes, a time relay shuts off the heating automatically. You can also turn it off earlier by pushing the switch downward.



Lumbar Support

The lumbar support is controlled by the rear rocker switch (b) and can be extended/retracted or raised/lowered to any position to support the spine.



Horizontal adjustment



Height adjustment

15



Emergency Adjustment

In the event of a failure of the electrically operated seat adjuster, fore-and-aft adjustment of the seat can be obtained using the Allan key contained in the tool kit. The seat is adjusted by turning the servo motor located at the front on the seat using the Allan key.



Backrest Lock

The backrest is locked to prevent it from tilting forward when you are forced to brake hard. For unlocking, pull up the knob on the left or right side of the backrest.

WARNING

For driver and passenger protection, backrest locks must be engaged at all times while the vehicle is in motion.

16

Safety Belts

WARNING

- For you and your passengers' protection, use safety belts at all times while the vehicle is in motion. Use child safety seats for all small children.
- Safety belts must be properly positioned on the body. Improperly positioned safety belts may cause serious personal injury in case of an accident. Therefore heed all of the following warnings and instructions.
- A combination lap-shoulder belt should not be worn by a person less than 4'11" or 1.5 m in height, because it would not be in its most protective position and therefore may increase the possibility of injury in an accident.
- Persons smaller than 4'11" or 1.5 m in height, and children who are able to sit upright by themselves, should use one of the rear seating positions and the lap belt provided.
- For maximum safety and protection, we recommend that small children travel in the rear seats. Regardless of where small children sit, remember that every state in the US now requires small children to ride in child safety seats.
- When driving in some states and many foreign countries, remember that they require the wearing of safety belts by law.

- Do not strap in more than one person with each belt.
- For maximum effectiveness, the lap belt should be worn low across the pelvic crest.
- Do not wear shoulder part of belt under your arm or otherwise out of position. This would increase the possibility of serious injury in case of an accident.
- Belts should not be worn twisted.
- Do not wear belts over rigid or breakable objects in or on your clothing, such as eye glasses, pens, keys, etc. as these may cause injury.
- Several layers of heavy clothing may interfere with proper positioning of belts.
- Belts must not rub against sharp objects.
- Keep belt buckles free of any obstruction that may prevent secure locking.
- Make sure that belt of the unoccupied passenger seat is fully wound up on its retractor so that the belt tongue is in its stowed position. This reduces the possibility of the tongue hitting a vehicle occupant in case of sudden stop.
- Belts that have been subjected to excessive stretch forces in an accident must be replaced.
- If belts show damage to webbing, bindings, buckles or retractors, they should be replaced.
- If belts do not work properly, see your authorized Porsche dealer.
- Do not modify or disassemble the safety belts in your vehicle.
- The belts must be kept clean as otherwise the retractors may not work properly (see also "Car care instructions").
- Never bleach or dye safety belts.
- Do not allow safety belts to retract until they are completely dry.

17



Safety belt warning system

An audio-visual warning system is interconnected with the driver's safety belt. Every time the ignition is turned on, the seat belt warning light in the left instrument cluster comes on for about 6 seconds to remind driver and passenger to buckle up. If the driver does not fasten the safety belt, the buzzer will continue for the duration of this six second period. The buzzer will go off as soon as the driver has buckled up.

18



Inertia reel retractor

The combination lap/shoulder belt with inertia reel locking mechanism adjusts automatically to your size and movements as long as the pull on the belt is slow. Rapid deceleration during hard braking or a collision locks the belt. The belt will also lock when you drive up or down a steep hill or in a sharp curve. Otherwise the shoulder belt will not inhibit your upper body movement.



- To fasten, grasp belt and pull belt in continuous slow motion across your chest and lap.
- Insert belt tongue into buckle on inboard side of seat. Push down until it securely locks with an audible click. Pull belt to check.
- Pull shoulder section to make sure belt fits snugly across the hips.
- Belts should fit snugly across the pelvis and chest. Make sure any slack is wound on the retractor.



- To unfasten belt, push in release button on buckle. Belt tongue will spring out of buckle.
- To release a locked belt, lean back to take the body pressure off the belt.
- To store lap/shoulder belt, allow belt to wind up on retractor as you guide belt to its stowed position on doorpost.

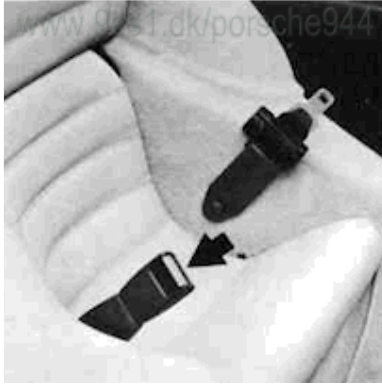

Lap belts for rear seats

The lap belt with inertia reel locking mechanism adjusts automatically to your size and movements as long as the pull on the belt is slow.

Rapid deceleration during hard braking or a collision locks the belt. The belt will also lock when you drive up or down a steep hill or in a sharp curve.

- To fasten lap belt, grasp belt on outboard side of seat and slowly pull across the pelvis. Insert belt tongue into buckle on inboard side of seat and push down until it securely locks with an audible click. Pull belt to check.

- To unfasten belt, push in release button on the buckle.
- To store belt, allow belt to wind up as you guide belt to retractor.

19

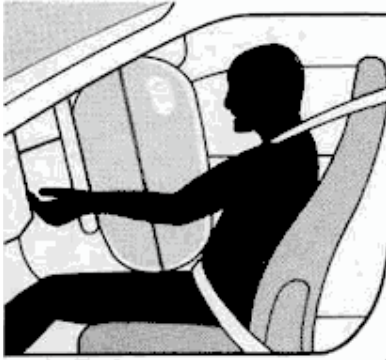

www.9ss1.dk/porsche944

Air Bag System

The "Air Bag" in combination with the safety belt makes up a passive safety system which offers the driver and front seat passenger the greatest known protection from injuries in case of accident.

The air bag system is composed of the following 3 major groups:

- Air bag with gas generator and ignition unit
- Control electronics
- Collision sensors

In case of frontal collision greater than a certain severity, the collision sensors send a signal via the control electronics to the igni-

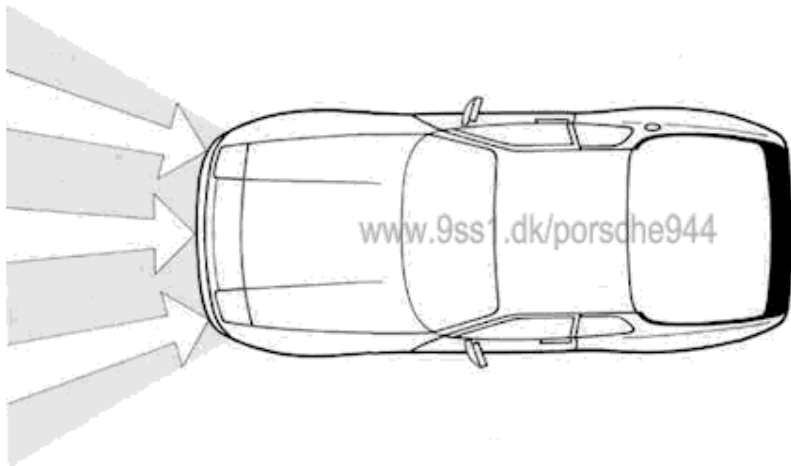

tion mechanism. In the ignition process, a solid propellant in the gas generator is combusted in a fraction of a second. This combustion generates the gas quantity and pressure necessary to fill the air bag. The air bag is located behind the steering wheel center pad on the driver's side, and on the passenger side behind the padding above the glove compartment. Due to the rapid deflation of the air bag after use, there is little danger of obstructed vision. Likewise, the noise of the inflation of the air bag generally goes unnoticed because of the collision noise. The air bag protects the face and upper body, and at the same time dampens the forward motion of the driver and passenger.

Range of Effectiveness

Even if your vehicle is equipped with an air bag, the safety belt must be worn, since the air bag system is only actuated by frontal collisions and at speeds of more than 13 to 19 mph (depending on collision angle). See figure for range of effectiveness.

Below the actuation threshold of the air bag system, and during types of collisions which do not cause the actuation of the system, the seat belts provide the primary protection to the occupants when correctly worn. **Therefore, all persons within the vehicle should always wear safety belts** (in many states, state law requires the use of safety belts). See also the chapter "Safety Belts".

20

Maintenance / Monitor Lights

The air bag system monitors the operational readiness of the igniter, sensors, warning lamp, and control electronics itself.

Any malfunctions which may arise are announced by the monitor lights in the right instrument cluster. Upon activation of the vehicle ignition circuit, the "Air Bag" notation in the instrument cluster lights up for approximately 5 seconds and then goes out again, indicating system readiness.

In the following cases you should immediately consult an authorized Porsche dealer in order to assure the air bag system is functioning properly:

- Illumination of the "Air Bag" light during travel or repeated illumination longer than 5 seconds after the ignition circuit is turned on.
- Illumination fails to light up during ignition circuit activation.

In order to ensure long-term functioning, the air bag system must be inspected by an authorized Porsche dealer after 4, 8 and 10 years from the date of manufacture shown on the safety compliance sticker, and then every 2 years.

WARNING

No changes must be made to the wiring or components of the air bag system. Do not add any additional coverings or stickers to the steering wheel or in the area of the passenger side air bag. Doing so may adversely affect the functioning of the air bag system.

- **Do not undertake any wiring for electrical accessory equipment in the vicinity of the air bag wiring harness. Doing so may disable the air bag system.**
- **The actuation of the air bag requires the immediate inspection of the system and replacement of some parts of the system. See your authorized Porsche dealer.**
- **Defects should be repaired immediately. See your authorized Porsche dealer.**
- **When disposing of a used air bag unit, our safety instructions must be followed. These instructions can be obtained at any authorized Porsche dealer.**

Important:

If you sell your Porsche, notify the purchaser that the vehicle is equipped with an air bag, and refer him or her to the chapter, "Air Bag System", in the owner's manual (safety and disposal rules).

Further information on the air bag system can be found on stickers in the glove compartment, at the interior light, as well as on all air bag components.



Horn Button

In vehicles equipped with an AIR BAG, the horn buttons are mounted in the two upper spokes of the steering wheel (arrow).

21



Rear View Mirrors

Do not put decals or other signs on the windows that may interfere with the driver's vision.
Adjust the outside and inside mirrors before driving. It is important for safe driving that you have good vision to the rear.

Inside day-night mirror

You can adjust the day-night mirror from clear daylight visibility to non-glare visibility at night by moving the lever at the bottom of the mirror forward or rearward.



Heated outside mirrors with remote control

When you turn on the rear window defogger, the outside rear view mirror is also heated. The outside mirrors are adjustable from inside of the vehicle by a four direction switch located on the left door and a rocker switch located on the center console ahead of the gear selection lever. The rocker switch (A) selects either the left or right mirror for adjustment. Push the rocker switch forward to select the left mirror, and rearward to select the right mirror. Then the four direction switch will adjust the selected mirror in any of the four directions.

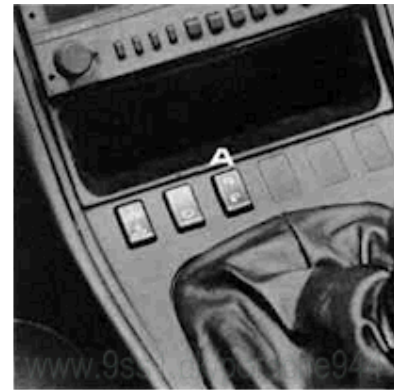

The mirror housing is hinged and can be folded flat against the car in either direction to prevent damage in tight parking spots. If necessary, the outside mirrors can also be adjusted manually.

22

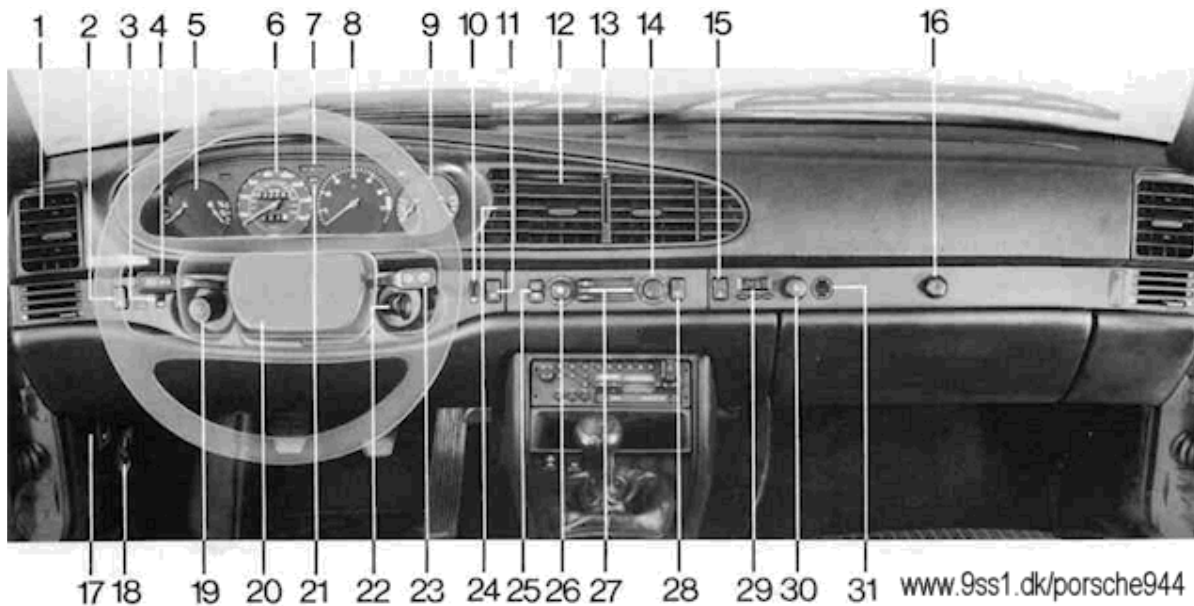

- | | | |
|--|--|---|
| 1 Side-window vents | 10 Intermittent wiper control | 22 Ignition / steering lock |
| 2 Fog light switch | 11 Rear window defogger switch | 23 Wiper / washer lever |
| 3 Instrument illumination dimmer control | 12 Fresh air vents | 24 Trip odometer reset |
| 4 Turn signal / headlight dimmer and flasher switch | 13 Center dashboard vent cut - off slide | 25 Air volume control knob / defroster switch |
| 5 Left instrument cluster / coolant temperature gauge and fuel gauge | 14 Temperature rotary switch | 26 Fan switch |
| 6 Speedometer | 15 Emergency flasher switch | 27 Heating and ventilation control levers - dashboard / floor |
| 7 Central warning light | 16 Glove compartment lock | 28 Air conditioning switch |
| 8 Tachometer | 17 Hatchback release switch | 29 Clock |
| 9 Right instrument cluster / oil pressure gauge and voltmeter | 18 Front hood release | 30 Cigarette lighter |
| | 19 Light switch | 31 Temperature sensor |
| | 20 Horn | |
| | 21 Turn signal indicator | |



Ignition/Starter Switch with Steering Lock

The steering is equipped with an anti-theft ignition lock.

Switch positions

0 The steering is blocked by the steering lock: all circuits wired through the ignition are switched off.

The ignition key can only be withdrawn in the "0" position. The parking lights can be operated in this position by pushing the turn signal indicator lever up and down (also see "Parking lights").

24

1 Position for radio. Steering unlocked. If it is difficult to turn the key, gently move the steering wheel until the key turns freely.

Note: all circuits which are disconnected in position "3" can be switched on. To conserve battery power, switch off other electrical consumers while playing radio in position "1".

2 Ignition on. All electric circuits are operational. With the engine stationary, the central warning light and all individual warning lights located in both combination instruments will light up for a **bulb check**.

3 The starter is operated by turning the ignition key to the right. As soon as the engine starts, release the key. It will spring back to position "2". With the engine running, the central and individual warning lights should go out (see "Central warning light").

To conserve battery power, the electric circuits for headlights, rear window defogger/defroster, temperature control and wiper/washer system are temporarily interrupted during the starting process. The starter should not be operated for more than 10 to 15 seconds at a time. If the engine does not start the first time or stalls at any time, the ignition key must be returned to the "0" position. The non-repeat lock in the switch prevents the starter from being operated when the engine is running and guards against starter damage.

To remove the key and to lock the steering wheel, turn the key back to position "0" and pull out. Turn the steering wheel until it locks.

WARNING

Never remove key from ignition lock or turn key off while vehicle is moving. The steering wheel will lock, causing loss of control.

Instrument panel lights

Warning lights for alternator, oil pressure, and brake system will light up for a bulb check when the ignition is turned on. They should go out after the engine is started. **The brake warning light will go out after the parking brake has been fully released. See "Warning lights" for more details.**

Buzzer

If you leave the key in the ignition/steering lock, the buzzer will sound when the driver's door is opened. This is a reminder to remove the key. For further details see "Starting Procedures" on the following page.

Starting Procedures

WARNING

- Fasten safety belts before driving.
- Never start or let the engine run in an enclosed, unventilated area. Exhaust fumes from the engine contain carbon monoxide, which is a colorless and odorless gas. Carbon monoxide can be fatal if inhaled.
- Never leave engine idling unattended. An unattended vehicle with a running engine is potentially hazardous.
- Do not park or operate the vehicle in areas where the hot exhaust system may come in contact with dry grass, brush, fuel spill or other flammable material.
- Never leave engine idling. When starting engine, be ready to drive immediately. Maintain moderate speed until engine is warm.

Automatic Transmission - Start with selector lever in Park.

Manual Transmission - Start with gearshift lever in Neutral. Temperature sensors on the engine auto-

matically provide the correct fuel/air mixture required for starting.

Therefore, do not depress the accelerator pedal while starting a **cold or a warm engine**. When starting at **very low outside temperatures**, fully depress the clutch pedal, so that the starter only has to crank the engine.

As soon as the engine starts, release the ignition key.

If the engine fails to start after 10 to 15 seconds of cranking, wait about 10 seconds before engaging starter again.

Do not let engine idle to warm it up. After starting, drive vehicle at moderate speeds and with gradual accelerations. Avoid high rpm and full throttle operation until the engine has reached normal operating temperature.

Stopping engine

•Turn key back to position 0.

Do not stop engine immediately after hard or extended driving. Keep engine running at increased idle for about two minutes to prevent excessive heat buildup before turning off engine.

WARNING

- Before you check anything in the engine compartment, let the engine cool down. Hot components can burn skin on contact.
- The radiator fan switches on automatically when the coolant reaches a certain temperature and continues to run (even with ignition off) until the coolant temperature drops. Therefore, never touch the fan blades as they will rotate spontaneously when the thermostat turns the fan on.

If you have an automatic garage door...

The transistorized ignition system in your Porsche may interfere with your electronically operated garage door. To check this: drive your Porsche close to the garage door and run the engine at different speeds.

If the garage door opens or closes without your operating the garage door unit in your car, contact the dealer who installed the automatic garage door to have the frequency and/or coding of the garage door signal modified.

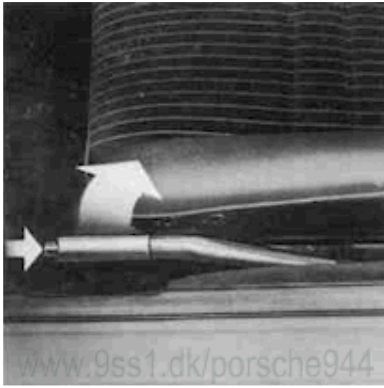

Parking Brake Lever

Parking brake force is mechanically transferred to the rear wheels by means of cables. Use the parking brake only after the vehicle has come to a full stop.

To set parking brake,

- pull the lever all the way up (arrow). With the ignition on, the brake warning light will come on.

To release the parking brake,

- pull the lever slightly up as you depress the release button, and then push the lever all the way down.

The brake warning light on the dashboard will go out after the engine is started and the parking brake is fully released.

WARNING

- **Release the parking brake fully. A partially engaged brake will overheat the rear brakes, reduce their effectiveness and cause excessive wear.**
- **Always set the parking brake when parking your car. Move the selector lever to "P" (Automatic transmission) or move the gearshift lever to reverse or first gear (Manual transmission). On hills also turn the wheels toward the curb.**

Brakes

Functioning of brake system

Your Porsche is equipped with a power assisted hydraulic dual circuit brake system with disc brakes at the front and at the rear. Both circuits function independently. One brake circuit operates the front and the other the rear axle.

In the unlikely event of hydraulic failure of one circuit, push the brake pedal down firmly and hold it in that position. A mechanical linkage activates the second circuit, and you will be able to bring the vehicle to a stop.

26

- Before descending a steep grade, reduce speed and shift transmission into a lower gear or driving position to control speed. Do not ride the brakes or hold pedal down too long or too often. This could cause the brakes to get hot and not function properly.

Brake operation and brake warning light

Make it a habit to check the operation of your brakes before driving. The failure of a brake circuit is indicated by the lighting up of the dual-circuit brake indicator lamp. See also brake fluid warning lamp.

With correctly adjusted brakes the pedal travel to the point of brake actuation should be 13/16" to 19/16" (30 to 40 mm). Whenever the brake pedal travel is greater, have the brake system checked.

Keep in mind that the braking distance increases very rapidly as the speed increases. At 60 mph/100 km/h, for example, it is not twice but four times longer than at 30 mph/ 50 km/h. Tire traction is also less effective when the roads are wet and slippery. Therefore, keep a safe distance from the car in front of you.

Brake Booster

The brake booster assists braking only when the engine is running. When the car is moving while the engine is not running, or if the brake booster is defective, more pressure on the brake pedal is required to bring the car to a halt.

Moisture or road salt on brakes affects braking

WARNING

Driving through water may reduce tire traction. Moisture on brakes from road water, car wash, or coating of road salt may affect braking efficiency. Cautiously apply brakes to test them after being exposed to such conditions. When the vehicle is driven on salted roads for extended periods, the brakes should be hosed down thoroughly about every 2 weeks. An automatic car-wash facility cannot do this job properly. Brakes will dry after a few cautious brake applications.

Brake wear

Our automobiles have excellent brakes, but they are still subject to wear, depending on how the brakes are used. Have the brake system inspected at the intervals recommended in your Warranty & Maintenance booklet.

WARNING

Failure of one brake circuit will impair the braking capability resulting in an increased stopping distance.

If one brake circuit has failed, the other will still operate. However, you will notice an increased pedal travel when you step on the brake. Should you encounter such experience, bring your vehicle safely to a full stop.

Avoid driving the vehicle and instead have it towed to the nearest authorized Porsche dealer.

Brake Pedal

WARNING

The movement of the brake pedal must never be obstructed by a floor mat or any other object. In case one of the two brake circuits fails, increased pedal travel is required to bring your vehicle to a full stop.

Make sure that the size of your floor mat does not hamper the movements of either brake, clutch or accelerator pedals in any way.

Secure the floor mat against sliding into positions that could interfere with the safe operation of your vehicle.

Do not "ride the brakes" by resting your foot on the pedal when not intending to brake. Overheating and premature wear of the brakes will result.

New brake pads or linings Brake pads or linings may not have the highest possible braking efficiency when new. Therefore allow for longer braking distance during the initial 100 to 150 miles or 150 to 250 kilometers of normal city driving; longer if fewer stops are realized.

Clutch Pedal

Due to the hydraulic operation of the clutch, pedal play should be 0.1" or 2.5 mm.

To check the play, depress the clutch pedal. Excessive play or tightness indicate a malfunction of the clutch. Both conditions can lead to severe damage. Contact your Porsche dealer promptly to have the cause located and corrected.

Always depress the clutch pedal fully when changing gears. Do not hold the car on a steep hill with the clutch pedal partially depressed. This will cause premature wear or damage.

27

ABS Brake System (Antilock brake system)

The ABS system represents a major contribution to the enhancement of active safety in your vehicle. This system prevents the wheels from locking in a panic stop on almost all road surfaces.

With ABS system in your vehicle, the following areas are enhanced:

Full steerability, vehicle remains steerable under all braking forces.

Good directional control, no swerving caused by locking of wheels under braking conditions.

Excellent stopping distance, stopping distances are usually reduced because controlled braking is maximized.

Prevention of wheel lock up, no brake-induced sliding and thus no localized tire wear from emergency braking.

The crucial advantage of ABS system over a conventional brake system is in the area of maintaining directional control and maneuverability of the car in emergency situations, including panic braking in turns.

WARNING:

In spite of the improved handling afforded by the ABS system, it still remains the responsibility of the driver to adapt the driving style to the prevailing road and weather conditions, as well as, obeying traffic laws. In no case, should the higher degree of safety offered by ABS be regarded as a

justification for taking greater risks. Other vehicles not equipped with the ABS system may not be able to maintain control, especially on wet or poor road surfaces and thus may be more likely to impact you in the rear. To minimize that risk, use your ABS system to increase your ability to maneuver to avoid dangerous situations and not merely to try to stop in the shortest distance possible.

Driving with the ABS System

A wheel speed sensor is fitted to each of the four wheels. If wheel slippage of either of the front wheels or the rear wheels is sensed during braking, the brake pressure is adjusted automatically until the wheel no longer slips.

The brake pressure is regulated for each front wheel individually and for both rear wheels together.

On a road surface which is slippery on only one side, the rear wheel which is braking on the slippery surface determines the brake pressure which will be applied equally to both rear wheels. This ensures that directional stability is maintained. However, if braking force approaches the wheel locking-up point for all wheels (panic braking) the ABS system will intervene in a way comparable with rapid rhythmic braking. The proper operation of ABS is perceived by the driver as a pulsating brake pedal in conjunction with audible noise and perhaps some vibration. The driver is thereby warned to reduce vehicle speed appropriate for the prevailing road conditions.

If your ABS system should ever malfunction, the ABS system is automatically switched off, but the normal brake system, without ABS, would remain fully operational. Such a malfunction would be indicated by the illumination of the central warning light, as well as the "ANTILOCK" light on the right hand side of the instrument cluster.

If the ABS system becomes inoperative, take your vehicle to your authorized dealer immediately.

Note

The control unit of the ABS brake system is set for standard tire sizes. If non-standard tires are fitted, the control unit may misinterpret the speed of the vehicle, because of the variant data it receives from the sensors on the axles.

If the difference in rolling radius exceeds approx. 17%, the control unit deactivates the ABS system and the ABS warning lamp lights up.

28



- 1 Set accelerator
- 2 Reset
- 3 Cancel

Automatic Speed Control

The automatic speed control allows you to maintain a constant cruising speed of 25 mph (40 km/h) or higher, without actuating the accelerator pedal. Any manual operation, such as accelerating, gearshifting or braking can be done independent of the automatic speed control. The spring loaded control lever operating the automatic speed control is located just below the wiper/ washer lever.

While driving with the automatic speed control set at speeds above 25 mph (40 km/h), do not bring shift lever into the Neutral position as excessive engine rpm will result.

To operate the automatic speed control

Accelerate to the desired cruising speed, push lever toward instrument cluster (arrow 1) and release. This sets the cruising speed and stores it in a memory.

After a second or two, automatic speed control will take over and you can remove your foot from the accelerator pedal. The set cruising speed will be maintained automatically.

WARNING

Do not use the cruise control when it may be unsafe to keep the car at a constant speed. For example, a constant speed may not be safe in heavy traffic, or on winding or slippery roads. With the cruise control system engaged, the engine speed will not return to idle when removing the foot from the accelerator pedal.

Please observe all local and national speed limits.

Passing: If you want to drive faster for a brief moment, for example when passing another vehicle, actuate the accelerator. When you take your foot off the accelerator pedal, the preset speed will automatically be resumed.

Gearshifting: When shifting gears, the automatic speed control is only disengaged as long as the clutch pedal is depressed. The preset speed will be resumed as soon as you take your foot off the clutch pedal.

Braking and stopping: Whenever you apply the brake or come to a stop, the automatic speed control is disengaged. Move the lever down (arrow 2), and the preset speed will be resumed.

Switching system off: To switch off the automatic speed control, move the lever toward you (arrow 3). To resume the preset speed, move the lever down (arrow 2).

To change the preset cruising speed

Increase preset speed:

Accelerate by depressing the accelerator pedal. When the desired speed is reached push lever toward instrument cluster (arrow 1) and take your foot off the accelerator pedal. Now the new cruising speed is set and stored in the memory. As an alternative, you can hold the lever in the front position (arrow 1), without depressing the accelerator pedal. The car will accelerate on its own. When the desired speed is reached, release the lever.

Decrease preset speed:

Apply the brake, which will disengage the automatic speed control. When the vehicle has slowed down to the desired speed, push lever toward instrument cluster (arrow 1) to set the new cruising speed.

As an alternative, disengage the automatic speed control by moving the lever toward you (arrow 3). When the vehicle has slowed down to the desired speed, push lever toward instrument cluster (arrow 1) to register the new cruising speed in the memory.

Note: When driving up a hill, if the engine power is insufficient in a particular gear, the speed control will be disengaged automatically. Shift to a lower gear to avoid stalling the engine.

29



Light Switch

Parking light - 1st position
 Headlights - 2nd position (with ignition key in switch position "1").
 Tail lights, side marker lights, license plate and instrument lights are on in both switch positions.
 The retractable headlights open when turning the switch to the second position.
 When you open the door while the lights are on, the buzzer will sound. It is your reminder to switch off the lights.
 Instrument illumination
 The instrument illumination goes on when the vehicle lights are turned on. Turn the

30

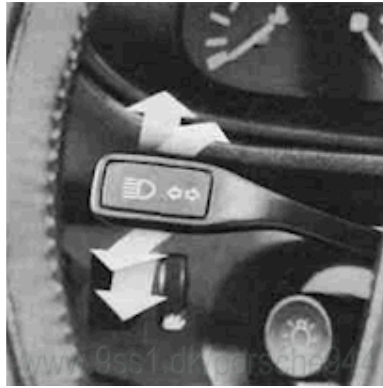

knob to the left of the light switch for infinitely variable brightness control.

Turn Signal/Headlight Dimmer Switch Lever (ignition on)

Lever up - right turn signal
 Lever down - left turn signal
 The turn signal lever turns off automatically when the steering wheel is straightened out after completing a turn.
 If a turn signal fails, the indicator light flashes about twice as fast. The light bulb may have to be replaced.

Lane changer

To indicate your intention when changing lanes on the highway, slightly push the turn signal switch lever up or down to the point of resistance. The lever will return to the OFF position when released.

Headlight dimmer

With the light switch at stage 2, high beam is switched on by pressing the lever towards the instrument panel, and low beam is switched on by pulling the lever towards the steering wheel. When high beams are on, the blue indicator light between the tachometer and the right instrument cluster will light up.
 You can flash signal other motorists by repeatedly pulling and releasing the lever just up to the point of resistance.

Headlight flasher

During daylight, you can flash signal with your foglights (in lieu of horn) by repeatedly pulling and releasing the lever just up to the point of resistance.



Fog lights - with ignition on

Turn on the fog lights by depressing the rocker switch on the dashboard. A green light in the switch glows when the fog lights are turned on.
 Parking lights - with ignition off Lever up - right side parking lights on
 Lever down - left side parking lights on



Windshield Wiper/Washer Lever (with intermittent wiper operation)

The windshield wiper/washer switch has seven positions:
 1 - Low speed
 2 - Normal speed
 3 - High speed
 4 - Intermittent wiper operation
 5 - Windshield washers
 6 - Windshield washers and wipers
 7 - Headlight washers
 The time intervals can be set at the control element to the right of the ignition lock.

Pulling the lever from its basic position towards the steering wheel activates the windshield washer pump in the first stage (switch position 5) and the windshield wipers in the second stage (switch position 6).
 The electric windshield washer system can be operated by pulling the lever toward the steering wheel from any wiper position.
 When the ignition is switched on, the washer nozzles are heated, depending on the outdoor temperature. Nevertheless, a commercial windshield anti-freeze solution should be added to the windshield washer water during cold weather conditions.

Avoid running the wiper blades over a dry windshield to prevent scratching the glass. Spray on washer fluid first. A scratched windshield will reduce visibility. Always loosen blades frozen to glass before operating wipers to prevent damage to wiper motor.

WARNING

Worn or dirty wiper blades will reduce visibility, making driving hazardous. Clean blades regularly to remove road film and carwash wax buildup. Use an alcohol base cleaning solution, a lint free cloth and wipe lengthwise.
Clean all inside and outside window glass regularly. In vehicles without Securiflex windshields use an alcohol base cleaning solution and wipe dry with a lint free or a chamois cloth.

In vehicles with Securiflex windshields, the plastic coating on the inside of the windshield must not have gummed labels put on it or be cleaned using aggressive agents or dry methods. If very dirty, it can be cleaned with benzene. Make certain that the plastic coating is not damaged in cleaning by hard objects such as jewelry or wristwatches.

31



944 / 944 S



944 Turbo



Headlight Washer

To operate the headlight washer, push the washer lever in the direction of the dash-board (switch position 7). The system only operates when the headlights are switched on. A separate pump supplies high-pressure water to the spray nozzles located in front of the headlights on the bumper. The high pressure stream soaks the dirt on the lenses and washes it off. Repeat the wash cycle as necessary to remove heavy dirt accumulation.

Since the system uses a lot of water, a reservoir holding approx. 1,6 U.S. gals, or 6 liters has been installed in the engine compartment. This reservoir also supplies the windshield washer with water. Use windshield washer solvent with anti-freeze all year round, so that both washer systems also function at freezing temperatures.

Do not use engine coolant anti-freeze or any other solution that may damage the car paint.

32

Instruments:
Gauges
Warning Lights
Indicator Lights



944 / 944 S

Speedometer

The speedometer indicates driving speed per hour.

In USA: Miles per hour and Kilometers per hour

In Canada: Kilometers per hour
 The upper odometer records total distance driven and cannot be turned back.



944 Turbo



The trip odometer in the lower part of the speedometer can be turned back to zero by pressing the reset-button, located in the left section of the center dashboard vent. The ignition must be on.



944 / 944 S

Tachometer

The transistorized tachometer operates on the pulse count principle and shows engine speed in revolutions per minute (rpm). The mark at the end of the scale indicates the maximum permissible engine rpm. Before reaching this area, the next **higher** gear should be selected. Earlier shifting saves fuel. Shift to the next **lower** gear when the engine rpm drops below 1500 rpm. The speed limiting governor prevents the engine from being overrevved under load.



944 Turbo

Boost Pressure Gauge

On the 944 Turbo there is a boost pressure gauge in the lower part of the tachometer. This instrument indicates the pressure in the intake manifold.

With the ignition on and the engine stopped, the indicated pressure corresponds to the ambient air pressure (atmospheric pressure) of approx. 1 bar.

Should an excessively high boost pressure occur as a result of a defect, the fuel supply or the ignition is cut off automatically.

34



944 / 944 S

CASIS



Computer Assisted Shift Indicator System (Manual Transmission only)

A computer continually evaluates vehicle data, such as driving speed, engine rpm, engine load and engine temperature.

When the CASIS arrow in the tachometer lights up, it means the engine could operate more economically. The light indicates that you can increase fuel efficiency by shifting into a higher gear. The CASIS light will go out when a higher gear has been engaged, when taking your foot off the accelerator pedal or when accelerating at a higher rate. In fifth gear the CASIS light is inoperative.

During maximum acceleration, the CASIS arrow light will only light up at a point where engine rpm is such that improved acceleration can be obtained by shifting into the next higher gear. This means the CASIS arrow does not indicate any set shift point, but that the computer calculated shift points will depend on the way you drive. The arrow will light up at the lowest speed range when cruising, and at the highest speed range when accelerating with wide open throttle.

How to use CASIS

Drive your Porsche shifting as you normally would.

As soon as the engine reaches uneconomical load range, the CASIS light will remind you to shift into the next higher gear to keep the engine at the same performance level but with lower fuel consumption.

You will get used to CASIS quickly and therefore operate your Porsche with the CASIS arrow light coming on only now and then.

WARNING

Use CASIS to your best advantage but remember that traffic, road and weather conditions must always have priority when shifting gears or changing speeds.

35



Left Instrument Cluster

The left instrument cluster includes the coolant temperature and fuel gauges as well as warning lights for coolant temperature, fuel reserve, brake-lining wear, safety belt, parking light and parking brake. The two arrows at the top are turn signal indicators for vehicles with trailer coupling.



Coolant temperature

Indicator

Needle in lower field - engine is cold
Avoid high speeds and high engine rpm. During cold engine operation, engine

response and power levels will vary from that of a warm engine. Due caution and notice of these engine characteristics will ensure safe operation of the vehicle.

Needle in center field - normal

Under normal driving conditions, needle should remain in center field. The needle may reach the upper field, especially at high engine loads, but should return to "normal" when engine load is reduced.

Needle in upper field - warning

If needle enters the upper field the engine is overheating the warning light comes on. Reduce speed and engine rpm. The needle should return to the center field and the indicator light goes out. If the needle does not return to the center field, and the indicator light does not go out, the **radiator fan** may not be working to provide sufficient engine cooling. Pull off the road and turn off the engine. The fan should still be running for a while. Failure to do so may result in severe damage to the engine.

WARNING

- **Before you check anything in the engine compartment, let the engine cool down. Hot components can burn skin on contact.**
- **The radiator fan switches on automatically when the coolant reaches a certain temperature and continues to run (even with ignition off), until the coolant temperature drops. Therefore, never**

touch the fan blades as they will rotate spontaneously when the thermostat turns the fan on.

• **Be careful if you have to remove the cap from a hot coolant fluid reservoir. Protect your hands, arms and face against scalding. Use a thick rag and open the cap carefully one turn to allow excess pressure to escape before removing the cap.**

If the fan is not working, the fuse for the fan may be burned out, or the relay may be defective. See "Fuses and Relays". After the engine has cooled down, check the coolant level (see "Cooling System"). If the coolant level is low, top it up with water. Check for possible leaks. If the coolant level is normal, proceed to the nearest workshop. Avoid idle speed and stop-and-go driving. But with an inoperative fan, the coolant will heat up again. When the needle enters the upper field, stop again and let the engine cool down before you continue driving.

Coolant system malfunctions should be remedied by the nearest Porsche dealer, as severe engine damage may occur.

36



Fuel Gauge and Fuel Reserve Indicator

When the ignition is turned on, the amount of fuel in the tank is indicated by the fuel gauge in the right part of the dial. If the needle enters the area in the bottom and the fuel reserve indicator lights up, there is only a reserve of about. 2.1 U.S. gal/8 liters left in the tank. Time to refuel at the next gas station.



Brake Pad Warning Light

The brake pad warning light comes on when the ignition is turned on and goes out after the engine has started. If the light stays on when the engine is running or comes on while driving, the brake pads are worn, excessively. **Do not continue to operate the vehicle but have your Porsche dealer check and replace the brake pads.**



Safety Belt

Warning Light

When the ignition is turned on the light will come on for about 6 seconds to remind driver and passenger to buckle up. See "Safety Belts" for more details.



Parking Brake Light

The parking brake light will light up when the ignition is turned on and the parking brake is set. The light goes out when the parking brake is fully released.

Parking Light

The parking light indicator at the bottom in the left instrument cluster lights up when the parking lights are switched on.



Turn Signal Indicator Light

The turn signal indicator light, which is located below the central warning light, will flash at the same frequency as the turn signals. If a turn signal fails, the control light flashes at about twice the normal frequency. Have your dealer check and repair it for you.



High Beam Indicator Light

The high-beam indicator light, which is located at the top between the tachometer and the right instrument cluster, will light up when you switch on the high beams or when you flash signal. The indicator goes out when you switch to low beam.

Central Warning Light

The central warning light comes on after turning on the ignition. This light monitors all functions displayed by the instruments. If one of these functions fails, the central warning light and the pertinent indicator light come on until the malfunction has been corrected. The vehicle should immediately be taken to the nearest authorized workshop.

37



Right Instrument Cluster

The right instrument cluster combines the oil pressure gauge with the oil pressure warning light, the voltmeter with the alternator warning light as well as the brake fluid warning light.



Oil Pressure Gauge

Engine oil pressure is shown in bars. At 5.000 rpm, with the engine at normal operating temperature (approx. 90 °C / 194 °F), the pressure should be approx. 4 bar. A slight drop in oil pressure is normal under certain operating conditions such as prolonged highway driving in hot weather. At idle speed, with the engine oil hot, the oil pressure can sink to 0.5 bar - this does not indicate any loss of engine performance. However, if the oil pressure drops suddenly while you are driving, or if the warning light comes on, pull off the road, **stop the engine and wait for it to cool down**. Check the engine oil level. If the oil level is normal, contact the nearest dealer.

Oil Pressure Warning Light

The oil pressure warning light comes on when the ignition is turned on. It should go out when the engine is started and has reached the correct oil pressure. If the oil pressure warning light **does not light up** when turning the ignition on, or if it **does not go out** after starting the engine, contact your Porsche dealer immediately. If the oil pressure warning light comes on while you are driving, pull off the road and **stop the engine**. Check the oil level to make sure you have enough oil. If oil level is correct and the oil

pressure warning light is still on, do not drive the vehicle as severe engine damage may result. Contact your nearest Porsche dealer for assistance.

An occasional brief flickering of the oil pressure warning light at idle speed and normal engine temperature is no cause for concern if the light goes out upon acceleration.

The oil pressure warning light is not an indicator for low engine oil level. To check the oil level, always use the dipstick.

Make it a habit to have the oil level checked with every fuel filling.



Voltmeter

The voltmeter shows the overall condition of the charging system. The needle should normally stay in the 12-14 volt range when the engine is running. A temporary drop below 12 volts when starting the engine is normal.

38

Alternator Warning Light

The alternator warning light comes on when the ignition is turned on. It should go out after the engine is started.

If the alternator warning light **does not light up** when turning the ignition on, or if it **does not go out** after starting the engine, there is a malfunction in the electrical system. If this is the case, contact your Porsche dealer.

WARNING

If the alternator warning light comes on while you are driving, pull off the road and stop the engine.

Check whether the Polyrib-belt is slipping or broken. The Polyrib-belt not only drives the alternator for battery charging, but also the air conditioner compressor.

If the light just flickers lightly, the Polyrib belt may be loose and is slipping.

The belt should be tightened or replaced before you continue driving.



Brake Fluid Warning

Light

The brake warning light monitors the hydraulic dual-circuit brake system. It lights up when the ignition is turned on and should go out after the engine has been started.

If the brake warning light fails to light up when the ignition is turned on, or if it fails to go out after the engine is started, there may be a malfunction in the electrical system. Let your Porsche dealer locate and correct the condition promptly.

Should the light come on while driving, the brake fluid level in the reservoir could be too low, or one of the dual brake circuits may have failed. In either case, the brakes will function but a much longer distance and a far greater pedal pressure are required to bring the car to a halt. **See "Brakes" for more details.**

Carefully pull off the road and stop. Have your car towed to the nearest dealer for repair. Continued operation of a car with defective brakes is dangerous.

Antilock

The warning light goes on in the event of a malfunction in the ABS system. The system is switched off; the normal brake system remains fully operational. If the light comes on, take your vehicle to your authorized dealer for service immediately.

Air Bag

See "Air Bag System" for details.

39

Clock

Time setting

A. 12 AM, PM or 24.00 h

With the clock in the time readout mode, keep button (2) depressed for 4 seconds - 12 AM, PM or 24.00 flashing. After pushing button (1), either a 12-hour (AM + PM) or a 24-hour setting program can be selected. If you only want to change the display mode, push button (3). The clock then returns to its normal timekeeping function.

B. Hours

Push button (2) a second time - hour display flashes. Set hour by pushing button (1). After pushing button (3)*, the clock returns to the time readout mode with new hour setting.

C. Minutes

Push button (2) once more - minute display flashes. Set minute by pushing button (1). Upon pushing button (3)*, the clock is started - accurate to within 1 second.

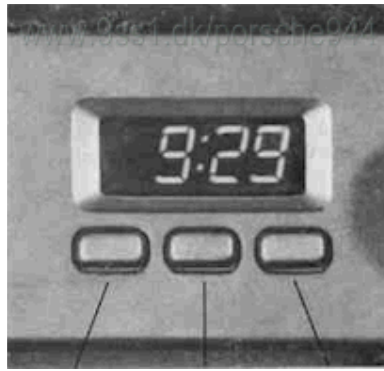

Button (1) Start/Stop Set 12h/24h prog.	Button (2) Reset Stop watch Hour/min select	Button (3) Selector button Time readout Stop watch
--	--	---

Stop watch function

The stop watch can only be set in motion if the clock is in its normal timekeeping mode and **not during setting operations.**

A. Push button (3) - 00:00 display appears;

B. Push button (1) - stop watch is on;

C. Push button (1) a second time - watch stops. (Additional times can be added by pushing button (1) again - stop watch keeps running. Push button (1) once more to stop timing.)

D. Push button (2) - 00:00 display appears;

E. Push button (3) - normal timekeeping mode.

If button (3) is pushed during operation A and B, the setting procedure must be restarted (push button (2)).

40



Cigarette Lighter

Push knob on console in. When ready for use, the lighter will snap back. With the lighter removed, the socket may be used for small appliances, such as shaver, hand vacuum cleaner or air compressor to inflate the collapsible spare tire. Maximum rating of such equipment should not exceed 120 W/12 Volt.

Do not damage the socket by trying to insert plugs of the wrong design.



Rear Window Defogger

The rear window defogger works only with the ignition key in positions 1 and 2.

The rear window defogger, together with the flow through ventilation, will help to keep the inside of the rear window clear of condensation and frost in the winter. Depress the switch to turn on the rear window defogger.

The control light in the switch will light up to remind you that the defogger is switched on. After the rear window has been cleared, switch off the rear window defogger to avoid unnecessary drain on the battery.



Emergency Flasher

If your car is disabled or parked under emergency conditions, depress the HAZARD switch to make all four turn signals flash simultaneously. The light in the switch flashes at the same frequency.

The emergency flasher works independently of the ignition switch position.

WARNING

•Whenever stalled or stopped for emergency repair, move the car well off the road. Turn on the emergency flasher and mark the car with road flares or other warning devices. Do not remain in the car.

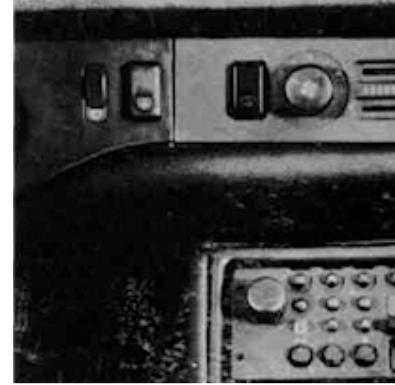

- Do not park or operate the car where the hot exhaust system may come in contact with dry grass, brush, fuel spill or other flammable material.
- Before working on any part in the engine compartment, turn the engine off and let it cool down sufficiently. Hot components can burn skin on contact.
- Remember the coolant fan is thermostatically controlled and may come on at anytime, regardless of ignition switch position.

41



Rear Window Wiper

To operate the wiper, depress the rocker switch (A) on the center console. The rear window must be sufficiently wet to prevent the glass surface from being scratched.



Ashtray

The ashtray is in the center console. To empty the tray, pull it out of its well. Reinsert it so that the light "window" points toward the bulb on the back inside the well.

WARNING

Never use ashtray as waste paper disposal. Fire hazard!



Glove Compartment

Press locking button to open glove compartment. With the car lights turned on, the glove compartment light is automatically switched on when the glove compartment is opened. The compartment is lockable with the ignition key to help prevent theft.

WARNING

Keep glove compartment door closed while driving to prevent injury during a collision.



Overhead Interior Light

Located between the two sun visors the interior light has a three position switch.

Switch Positions

Rearward (a) - on continuously
Center (b) - off
Foreward (c) - on, only with doors open



Sun Visors

To protect driver and passenger from side glare, the sun visors can be moved to the sides after lifting them out of their center mounting.

The make-up mirror on the rear of the visor is fitted with a protective sliding shutter.

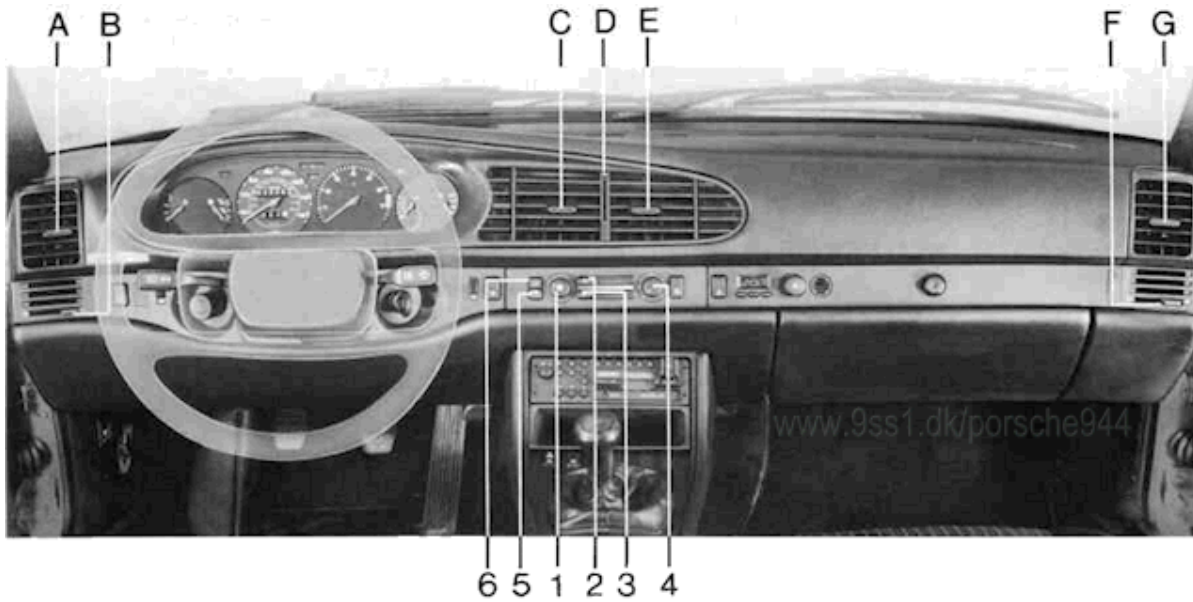

- 1 Fan switch
- 2 Air distribution to windshield
- 3 Air distribution to footwell outlets
- 4 Temperature switch
- 5 Defroster switch
- 6 Recirculation switch

- Heating Ventilation System**
- A Air outlet - left side dashboard vent
 - B Open and close - left side dashboard vent
 - C Air outlet - center dashboard vent, left section
 - D Open and close - center dashboard vent
 - E Air outlet - center dashboard vent, right section
 - F Open and close - right side dashboard vent
 - G Air outlet - right side dashboard vent

44a

Heating and Ventilation

WARNING

- Familiarize yourself thoroughly with the proper use and function of the ventilation/heating, defogging/defrosting and the air conditioning system.
 - For safe driving it is extremely important that you follow the operating instructions in this manual. If in doubt, consult with your Porsche dealer.
 - Maximum heating output and fast defrosting can be obtained only after the engine has reached normal operating temperature.
- Before turning on the air conditioner, move the two air distribution control levers to their center positions, and move the temperature control knob to the extreme counterclockwise position. Should you suspect that the air conditioner is damaged, have it checked promptly. Leaks must be sealed immediately, since loss of refrigerant may result in serious damage to the air conditioner system.

The upper lever (2) controls the air flow to the windshield" right position: open, left position: closed.

The lower lever (3) controls the air flow to the footwell outlets (right position: open -left position: closed).

The center dashboard vent can be opened or closed by operating the lever (D). For closing, the lever is pushed all the way up. For opening, push the lever downward for the desired air volume.

The direction of the air outlet is controlled by means of handles (C, E) on the vents.

The side dashboard vents are opened or closed by means of the lower levers (B, F) (◻ - open, ● - closed). Again, the air outlet direction is controlled by means of handles (A, G) on the vents.

Heater Control

Activation of the heater control system ensures temperature control in the passenger compartment in accordance with the temperature range preset by the temperature knob. The passenger compartment temperature is kept constant under varying climatic conditions.

Fan Control Switch Knob



In order to ensure air circulation even with the vehicle standing or moving at low speed, the fan is running at low speed even at switch position 0. If you desire more air flow, the fan can be switched to steps 1 through 4.

Defroster Switch



Since the effectiveness of the heating depends on the cooling water temperature, the full heating power is not available until the engine has reached its normal operating temperature. To achieve the best defroster effectiveness, the center dashboard vent must be closed entirely (push lever to its extreme top position). Then press the defroster button - indicator light comes on. Independent of the position of the upper and lower levers, high-low temperature switch and the fan control switch knob, the system automatically switches to maximum heating power at fan stage 4 and the full air flow is directed to the windshield and the side dashboard vents.

Recirculation Switch



When you follow a truck or bus to prevent the exhaust gases from entering your car through the fresh air vents, press the recirculation switch. The fresh air supply is then interrupted and air from inside of the vehicle will be recirculated. **The recirculation effect should be utilized for only a short period of time to prevent windshield misting!**

44b

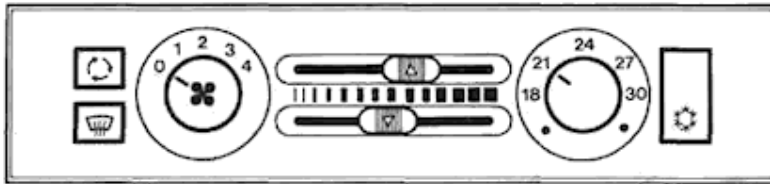

Automatically Controlled



Air Conditioner

The air conditioning system works only when the engine is running. Its refrigerating capacity depends on engine speed. If a high refrigerating capacity is desired, it is necessary to rev up the engine - particularly in city or bumper-to-bumper traffic.

The air conditioning system can be turned on at any air distribution position by pressing the air conditioner switch. When the system is turned on, the air conditioning compressor is activated via a magnetic clutch.

Optimal cooling is achieved when the fan control switch is at position 4, the windows are closed and the lateral as well as the

center dashboard vents are fully opened and the temperature switch is set at maximum cooling power.

When the air conditioning system is on, additional cooled air enters the glove compartment through a vent.

After prolonged exposure to sun, it is recommended that you ventilate the passenger compartment with the windows down and air conditioning on.

Should the air conditioning system fail, i. e. uncooled air flows through the vents while the system is switched on, have it checked in an authorized workshop.

Functioning

The automatic system controls the passenger compartment temperature in accordance with the temperature preset by the temperature knob.

The passenger compartment temperature is kept constant under varying climatic conditions.

Cold and warm air is automatically mixed by means of air flaps operated by a servo motor.

The servo motor is controlled by a passenger compartment temperature sensor, an ambient temperature sensor and a temperature sensor located in the air conditioner.

There are several options to satisfy the requirements of individual comfort with an automatically controlled air-conditioning system:

The upper level (2) is operated to direct the air flow towards the windshield (right position: open; left position: closed).

The lower level (3) can be used to direct the air flow to the footwell outlets (right position: open; left position: closed). The positions of these two levers are infinitely variable and can be set independently of one another.

A higher or lower temperature range can be preselected by means of the temperature control knob.

Air Conditioning System Maintenance

The air conditioning system must be turned on for a short period of time at least once a month. This instruction should be observed particularly during the cold season to ensure proper lubrication of the sealing rings and compressor bearings.

For this purpose, set the temperature control knob at maximum cooling temperature (extreme counterclockwise position).

Check the compressor polyrib belt for proper tension during regular maintenance.

Due to the loss of refrigerant, which is technically inevitable, the refrigerant level in the fluid reservoir should be checked at least once a year.

If gas bubbles are visible over an extended period of time in the inspection window of the fluid reservoir while the air conditioner is running, there is a deficit of refrigerant in the air conditioning system. The brief appearance of gas bubbles is due to technical reasons.

Should the air conditioning system fail, i. e. uncooled air flows through the vents while the system is switched on, have it checked by your Porsche dealer.

**Break-in Hints
for the first 1.000 miles /
1.600 kilometers**

There are no specific break-in rules for your Porsche. However, by observing a few precautions you can help extend the service life and performance of your engine.

During the first 1.000 miles / 1.600 km, all working components of the engine adjust to each other to a certain degree. Therefore: Avoid full throttle starts and abrupt stops. Change speeds frequently. Vary the throttle load.

Do not exceed maximum engine speed of 5.000 rpm (revolutions per minute).

Do not run a cold engine at high rpm or in Neutral.

Do not let the engine labor, especially when driving uphill. Shift to the next proper gear in time (use the most favorable rpm range).

There may be a slight stiffness in the steering, gearshifting or other controls during the break-in period, which will gradually disappear.

Never lug the engine in high gear at low speeds. This rule applies all the time, not just during the break-in period.

Breaking in brake pads

Brake pads do not possess maximum braking efficiency when the car is new. Therefore more pedal force is necessary during the first 100 to 150 miles (150 to 250 km). This also applies to replacement brake pads.

New tires

New tires do not possess maximum traction. They tend to be slippery. Break in new tires by driving at moderate speeds during the first 60 to 120 miles (100 to 200 km), and longer braking distances must be anticipated.

Engine Oil Consumption

During the break-in period oil consumption may be higher than normal.

As always, the rate of oil consumption depends on the quality and viscosity of oil, the speed at which the engine is operated, the climate, road conditions as well as the amount of dilution and oxidation of the lubricant.

Check engine oil level, add if necessary. Make it a habit to have engine oil checked with every fuel filling.

47

Engine Exhaust

WARNING

• **Engine exhaust is dangerous if inhaled.**

- **Never start or let the engine run in a closed garage. Never sit in your car for prolonged periods with the engine on and the car not moving.**
- **Although exhaust fumes from the engine have many components which you can smell, they also contain carbon monoxide, which is a colorless and odorless gas. Carbon monoxide can be fatal if inhaled.**
- **If you smell gas fumes in the vehicle, drive with the windows open but keep the hatchback closed. Have the cause immediately located and corrected.**
- **Because of inherent hazards, we do not recommend transporting objects larger than those fitting safely into the luggage compartment. Keep the hatchback closed while driving to prevent poisonous exhaust gas from being drawn into the vehicle.**
- **Never carry additional fuel containers in your vehicle. Such containers, full or partially empty, may leak, cause an explosion, or result in fire in case of a collision.**

Operating Your Porsche in other Countries

Government regulations in the United States and Canada require that automobiles meet specific emission regulations and safety standards.

Therefore cars built for the U.S. and Canada differ from vehicles sold in other countries.

If you plan to take your Porsche outside the continental limits of the United States or Canada, there is the possibility that

• unleaded fuel may not be available;

• unleaded fuel may have a considerably lower octane rating. Excessive engine knock and serious damage to both engine and catalytic converter could result;

• service may be inadequate due to lack of proper service facilities, tools or diagnostic equipment;

• replacement parts may not be available or very difficult to get.

Porsche cannot be responsible for the mechanical damage that could result because of inadequate fuel, service or parts availability.

If you bought your car abroad and want to bring it back home, be sure to find out about shipping and forwarding requirements, as well as current import and customs regulations.

48

Fuel Economy

Fuel economy will vary depending on where, when and how you drive, optional equipment installed, and the general condition of your car. A car tuned to specifications and correctly maintained, will help you get maximum fuel economy.

- Have your vehicle tuned to specifications.
- Fuel injection should be adjusted to specifications.
- Spark plugs should be clean, properly gapped and fire efficiently.
- Air cleaner should be dirt free to allow proper engine "breathing".
- Battery should be fully charged.
- Wheels should be properly aligned.
- Tires should be inflated at correct pressures.
- Keep a light foot on the accelerator pedal.
- Drive smoothly, avoid abrupt changes in speed as much as possible.
- Avoid jack rabbit starts and sudden stops.
- Do not drive longer than necessary in the lower gears. Shifting up early helps to save fuel.
- Avoid unnecessary idling. Turn the engine off.
- Prolonged "warm up" idling wastes gas. Start the vehicle just before you are ready to drive. Accelerate slowly and smoothly.

- Any additional weight carried in the vehicle reduces fuel economy. Always keep cargo to a minimum and remove all unnecessary items.
 - Organize your trips to take in several errands.
 - Use air conditioner only when needed.
 - All electrical equipment contribute to increased fuel consumption.
- The EPA estimated m.p.g. is to be used for comparison purposes, actual mileage may be different from the estimated m.p.g., depending on your driving speed, weather conditions and trip length. Your actual highway mileage will probably be less than the estimated m.p.g. Please observe all local and national speed limits.



Fuel Filler Cap

The lockable fuel filler cap is on the right side panel of the car. When putting the cap back on, twist it clockwise until it stops with an audible click.

We recommend you turn off the engine when filling the fuel tank.

Fuel tank capacity is listed under "Filling Capacities".

If you lose your fuel filler cap, replace it immediately with a cap of the same design to reduce the possibility of a fire in a collision.

Fuel Recommendation

Your Porsche is equipped with a catalytic converter and must use UNLEADED FUEL ONLY.

944: Minimum octane rating is 91 RON (87 CLC or AKI rating on US fuel pumps).

944 S / 944 Turbo: Minimum octane rating is 95 RON (90 CLC or AKI rating on US fuel pumps).

Federal law prohibits use of leaded fuel in this vehicle.

The use of UNLEADED FUEL ONLY is critically important to the life of the catalytic converter. Deposits from leaded gasolines will ruin the converter and make it ineffective as an emission control device.

Cars with a catalytic converter have a smaller fuel tank opening, and gas station pumps have smaller nozzles. This will prevent accidental pumping of leaded fuel into cars with a catalytic converter.

Unleaded fuels may not be available outside the continental U.S. and Canada. Therefore, we recommend you do not take your car to areas or countries where unleaded fuel may not be available.

Octane ratings

Octane rating indicates a gasoline's ability to resist detonation. Therefore, buying the correct octane gas is important to prevent engine "knock" and possible engine damage. The 91 RON (95 RON) octane rating of your

car is based on the research method. The CLC (U.S. Cost of Living Council octane rating) or AKI (antiknock index) usually displayed on U.S. gasoline pumps is calculated as research octane number plus motor octane number, divided by 2, that is written as:

$$\frac{\text{RON} + \text{MON}}{2} \text{ or } \frac{\text{R} + \text{M}}{2}$$

The CLC or AKI octane rating is usually lower than the RON rating:

91 RON equals 87 CLC or AKI
95 RON equals 90 CLC or AKI

WARNING

•Never carry additional fuel in portable containers in your car. Such containers, full or partially empty, may leak, cause an explosion, or result in fire in case of a collision.

Porsche does not recommend the use of fuel additives.

Do not use any fuel with octane ratings lower than 91 RON or 87 CLC or AKI, 944S/944 Turbo 95 RON or 90 CLC or AKI.

Gasolines containing alcohol

Gasoline containing alcohol is available at gas stations in some areas. The gas pump may not be labeled to identify that alcohol is present in the gasoline. If it is labeled, it may not identify what amount and type(s) of alcohol

are used. We recommend you **DO NOT** use fuels where the alcohol content cannot be identified.

Gasolines containing methanol

DO NOT use fuels containing methanol (methyl alcohol, wood alcohol). The use of fuel containing this type of alcohol can result in vehicle drivability and performance problems and may damage critical parts of your vehicle's fuel and emission control systems.

Gasolines containing ethanol

A mixture of unleaded gasoline and ethanol (ethyl alcohol, grain alcohol) is sold in some areas. This mixture is sometimes called "Gasohol".

You may use gasohol in your

Porsche, provided it contains no more than 10% ethanol, and the octane requirements for your vehicle are met. However, we strongly recommend to switch back to gasoline without ethanol, if you experience any of the following problems with your vehicle:

- Deterioration of drivability and performance.
- Substantially reduced fuel economy.
- Vapor lock and non-start problems, especially at high altitude or at high temperatures.
- Engine malfunction or stalling.

Continued use of gasohol under these conditions may cause costly damage to the fuel system and the emission control system of your vehicle.

**Gearshifting
Manual Transmission**

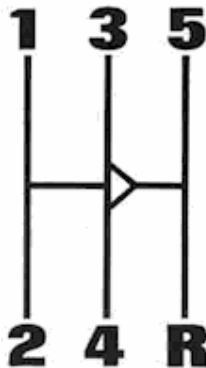

The Porsche transmission with servo-lock synchronization permits rapid and precise shifting of gears. But be sure when changing gears that the clutch pedal is fully depressed to the floor, and that the gearshift lever is completely engaged. The engine speeds for the individual gears are listed on this page.

Reverse

Only shift into reverse when the car has come to a complete stop.

The clutch pedal must be depressed and the vehicle must be stationary before shifting into reverse; only then move the gearshift lever to the right (overcoming the spring resistance) and then to the rear.

Both back-up lights come on when the transmission is put into reverse (with ignition on).

For smooth shifting, observe the following shift points:

The specified maximum rpm figures should not be exceeded when shifting down, as otherwise the engine speed would be too high. This applies to standard gear ratios only.

Maximum downshift points

- 5th to 4th gear
- 944 115 mph/1 80 km/h or 4300 rpm
- 944 S 123 mph/1 98 km/h or 5400 rpm
- Turbo 130 mph/210 km/h or 5000 rpm
- 4th to 3rd gear
- 944 85 mph/1 36 km/h or 4750 rpm
- 944 S 91 mph/1 46 km/h or 5000 rpm
- Turbo 96 mph/1 55 km/h or 4500 rpm
- 3rd to 2nd gear
- 944 58 mph/ 94 km/h or 4500 rpm
- 944 S 61 mph/ 98 km/h or 4600 rpm
- Turbo 65 mph/1 05 km/h or 4250 rpm

2nd to 1st gear

- 944 34 mph/ 55 km/h or 3850 rpm
- 944 S 36 mph/ 58 km/h or 4000 rpm
- Turbo 38 mph/ 62 km/h or 3700 rpm

Minimum upshifting points

- 1st to 2nd gear at 15 mph/24 km/h or 944 2850 rpm
- 944 S 2800 rpm
- Turbo 2850 rpm
- 2nd to 3rd gear at 25 mph/40 km/h or 944 2800 rpm
- 944 S 2750 rpm
- Turbo 2400 rpm
- 3rd to 4th gear at 40 mph/64 km/h or 944 3050 rpm
- 944 S 3000 rpm
- Turbo 2750 rpm
- 4th to 5th gear at 48 mph/77 km/h or 944 2700 rpm
- 944 S 2650 rpm
- Turbo 2300 rpm

Please observe all local and national speed limits!

Controls for Automatic Transmission

The selector lever has 6 positions:

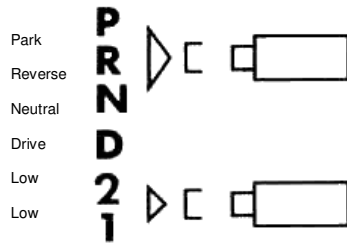

Start in Park

The selector lever has a push button in the handle. The push button must be depressed when selecting the following positions:

- From P to R
- R to P depress push button
- N to R in handle
- 2 to 1

The selector lever can be moved freely between the other positions. The respective position is illuminated in the tachometer as long as the ignition key is in the ignition lock.

Remember the following basic rules:

- ... Apply the parking brake or foot brake before selecting a driving position. When the selector lever is in a driving position, the car may creep even at idle speed. Therefore, do not release the parking brake or foot brake until you are ready to move.
- ... Do not accelerate while selecting a driving position. Wait for positive engagement. At this time the engine must run at idle speed so that no undue stress will be placed on the automatic clutches in the transmission.

... If the selector lever is unintentionally moved into Neutral (N) while driving, take your foot off the accelerator pedal and wait until the engine speed has dropped to idle before selecting a driving position.

Never shift into Reverse (R) or Park (P) when the car is in motion.

... Never get out of the driver's seat when the engine is running and the selector lever is not in the "P" position. **Move the selector lever to "P" and apply parking brake.**

... Always make sure the selector lever is in the "P" position when checking under the hood. Otherwise, any increase in engine speed may set the vehicle in motion, **even with the parking brake applied.**

... A driving position must never be used for holding the vehicle at rest uphill. Always use your foot brakes when stopped on inclines.

Driving the Automatic Transmission

The Automatic Transmission has 3 forward gears and one reverse. In driving positions D and 2 the Automatic Transmission changes gears automatically while driving.

Position D

is the driving position normally used for city and highway driving. It ranges from zero to top speed, and all three gears shift automatically depending on driving speed.

Position 2

is to be used for mountain driving or slow driving, when towing a trailer and also when you want to make use of the engine's braking effect. In "2", only the first and second gears will engage automatically. Therefore, only shift down into position "2" when the speed is below 63 mph or 100 km/h. It is not necessary to let up on the accelerator.

Position 1

is needed on rare occasions. It should only be used up to 25 mph or 40 km/h. In "1" the transmission will stay in first gear and not shift into the second or third gear. **Only shift down into "1" when driving speed is below 25 mph or 40 km/h.**

The reverse position R

Reverse should be selected only when the car has come to a full stop and the engine is running at idle speed.

The back-up lights come on automatically when you engage Reverse (with ignition on).

Starting the engine

is only possible when the selector lever is in **Neutral or Park (N or P)**. As long as one of the driving positions is engaged a safety switch prevents the engine from being started.

Emergency starting

Your Porsche with Automatic Transmission **cannot be started by pushing or towing.** Should the engine fail to start see "Emergency starting with jumper cables" or consult your nearest authorized Porsche dealer.

DO NOT START OR TOW the car without ATF in the transmission, as this will result in serious damage to transmission and torque converter.

Putting the car in gear

With the parking brake or foot brake set, shift into the position you wish to use, usually position D. To accelerate, release the brake and depress the gas pedal.

WARNING

Do not release the brake before you are prepared to move, because power is transmitted to the wheels as soon as a driving position is engaged.

Selecting a driving position while driving is easy. Simply release the accelerator pedal and move the selector lever from the position you are in into the position you want. Then step on the accelerator again.

WARNING

Do not shift to a lower driving position until vehicle speed has dropped below the specified limits. Engine speed will sudden-

ly increase and may cause engine damage and loss of vehicle control.

Stopping

When stopping temporarily, at traffic lights for example, it is not necessary to move the selector lever to Neutral. Simply apply the brakes. To start again release the brake and accelerate.

Parking

When parking your car, apply the parking brake first, and then move the selector lever to position P. To do this, depress the button and push the lever through R to P. The transmission is then mechanically locked. Park may only be engaged when the car is stationary.

Do not remove the key from the ignition steering lock until you have parked the car, because removal of the key locks the steering wheel.

Shift out of the Park position, before releasing the parking brake.

When the car is parked on a steep hill, shifting out of Park may be a little harder. This is due to the weight the car exerts on the transmission.

Neutral

Shift to this position for standing with brakes applied.

Never use Neutral for coasting downhill. You may lose control over the car because of reduced braking and cause serious damage to the transmission when a driving range has to be selected.

CAUTION: While driving with the automatic speed control set (at speeds above 25 mph or 40 km/h), do not bring shift lever into the Neutral position as excessive engine rpm and severe engine damage may result.

Maneuvering

When alternating between forward (D) and reverse (R) (for instance, while maneuvering the car into a tight parking space), only shift into **Reverse or Drive** when the car has come to a full stop and the engine is running at idle speed.

Stuck in snow, mud or sand

When alternating between **Drive and Reverse** in an effort to free the vehicle, depress the accelerator pedal lightly while the transmission is in gear, and release the accelerator pedal while shifting. Do not race the engine and avoid spinning the wheels.

Do not repeat "rocking" back and forth with wheels spinning at high engine speed and heavy throttle, as serious damage may be caused to the automatic transmission and other critical parts.

If you cannot free the vehicle after a few "rocking" attempts, call for help or a tow truck.

Accelerator Pedal

For good fuel economy we recommend smooth and even acceleration. Very fast, racy driving, alternating between full throttle and hard braking, raises the fuel consumption considerably. Also, tires and brake linings wear faster. It is more economical to drive smoothly and at a fairly constant speed.

Accelerator "Kickdown"

When depressing the accelerator pedal you will find resistance near the full throttle position. By applying greater pressure the pedal can be pushed beyond this point to the kick-down position. The transmission will now shift automatically into the next lower gear to give you maximum acceleration, and only shift up again after the engine has reached maximum speed in that particular gear.

WARNING

Be careful when using the kickdown on slippery roads. Rapid acceleration may cause skidding.

Please observe the following when applying the accelerator kickdown:

With the selector lever in D, you can apply the kickdown to make the transmission shift down into second gear when driving below 88 mph or 140 km/h and down to first gear when driving below 47 mph or 75 km/h.

With the selector lever in "2", you can apply the kickdown to make the transmission shift down into first gear when driving below 47 mph or 75 km/h.

As soon as you release the pedal from the kickdown position the next higher gear is automatically engaged.

Please observe all local and national speed limits.

55



Hatchback

(If vehicle is equipped with an anti-theft alarm see "Anti-theft alarm".)

Release switch

To unlock the hatchback, operate the control switch on the left side underneath the dashboard.

If the hatchback does not open of its own accord, it must be raised by hand.

Never operate the switch while the vehicle is in motion.



Lock

The hatchback can also be opened with the ignition/door lock key. Turn key counterclockwise and lift hatchback up.

To close, push hatchback down firmly until both locks snap shut. Pull up on hatchback to make sure it is securely locked.

Keep the hatchback locked at all times to prevent unauthorized access to the vehicle.

Be careful when removing large objects through the rear. Sharp edged objects may damage the defogger wires in the rear window.

WARNING

Because of inherent hazards, we do not recommend transporting objects larger than those fitting safely into the luggage compartment. Keep the hatchback closed while driving to prevent poisonous exhaust gas from being drawn into the vehicle.

56



Luggage Compartment

Luggage and other belongings should be protected from the sun and "inquisitive eyes" by pulling the rolled-up luggage cover from behind the rear seat back and hooking it into the eyelets on the rear cross wall. When unhooked, the cover rolls itself up automatically.

To prevent luggage and other objects from sliding around while the car is in motion, you can secure them with spider straps available through your dealer or other supply firms. The eyelets for this purpose can be found behind the rear seat back and on the luggage compartment floor.

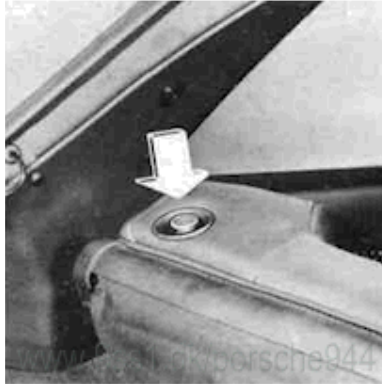

Luggage space

To provide for additional luggage space, press the knob on the left or right side to release the rear seat back. Then tilt forward.

Luggage compartment light

The light is located on the left side of the luggage compartment. The light can be switched on or off, regardless of ignition or vehicle light switch positions.

Roof racks

The installation of commercially available roof racks is not compatible with the roof design of your Porsche.

When installing the **Genuine Porsche Roof-rack** available up till now, the maximum permissible weight load of 75 lbs or 35 kg must not be exceeded.

The **"New Genuine Porsche Roofload Transport System"** provides for maximum permissible weight loads of up to 165 lbs or 75kg.

Your Porsche dealer will be glad to advise you about which type of roof rack can best serve your individual needs and load carrying requirements.

WARNING

Make sure that the load is carefully mounted. Secure it additionally by locking the roof transport system.



Engine Hood

To unlatch the engine hood, pull the release lever on the left underneath the instrument panel.



Opening the hood

Lift hood slightly and pull up on handle (arrow) to disengage safety catch. Then lift up the hood.

Make sure the windshield wipers are not tilted forward.

The engine compartment light on the hood will come on when the vehicle lights are turned on.



Closing the hood

Lower the hood and press it down on the hood latch until you hear an audible click.

WARNING

Should you notice at any time while driving that the hood is not secured properly, please stop at once and close it.



Electric / removable prop-up roof

With the **ignition on**, you can raise (a) or lower (b) the roof at the rear by depressing the front or rear half of the rocker switch in the center console.



Removing roof

Clean the roof prior to removal to avoid scratches and soiling your clothes.

1. Turn the ignition switch to position 1 (see ignition/starter switch section). Depress rear half of rocker switch (a) until the prop-up linkage mechanism unlocks the roof.
2. Loosen front holding clamps.
3. Lift up and remove roof.
4. Store roof in the pouch provided in luggage compartment.



Installing roof

1. From above hold roof at a slight angle and insert in wind deflector grooves and front guides.
2. Lower roof toward rear.
3. Turn the ignition switch to position 1. Depress front half of rocker switch (b) until the prop-up linkage mechanisms has locked the roof.
4. Secure the front holding clamps.



Manual Operation

If the electrical drive mechanism should fail, the roof can be closed manually. The motor for electrical operation is located at the left sidewall of the luggage compartment, behind the carpeting.

1. Remove the clips from the carpet and fold back the carpet.
2. Take off the cover from the adjusting screw.
3. With the spark plug spanner turn the now

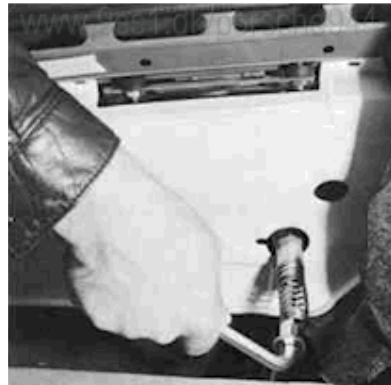

- visible hexagon nut clockwise until the roof is closed.
4. Replace cover for screw.
- Do not operate the rocker switch. Let your Porsche dealer take care of the necessary repair.

Car Care Instructions

Regular and correct care helps to maintain the value of your car and is also a precondition for the long-life guarantee.

The Porsche paint finish is of a high quality baked synthetic enamel. The color and enamel type designation are indicated on the "paint number sticker". When buying touch-up paint, always give the paint and the car's identification numbers to your dealer. A well-cared for Porsche can look like new 10 years later. It all depends on the amount of care the owner is willing to give the car. Your Porsche dealer has a number of car-care products and can advise you which ones to use for cleaning the interior and exterior of your car. Whether you use Porsche recommended products or other commercially available cleaning agents first make sure of their correct application.

WARNING

- Cleaning agents may be poisonous. Keep them out of the reach of children.
- Observe all caution labels.
- Always read directions on the container before using any product.
- Most chemical cleaners are concentrates which require dilution.
- Do not use gasoline, kerosene, naphtha, nail polish remover or other volatile cleaning fluids. They may be toxic, flammable or hazardous in other ways. Only use spot removing fluids in well ventilated areas.
- Do not wash, wax or dry the vehicle with the engine running.
- Do not clean the underside of chassis, fenders, wheel covers, etc., without protecting your hands and arms you may cut yourself on sharp-edged metal parts.
- Moisture and road salt on brakes may affect braking efficiency. Test the brakes after each vehicle washing.

Washing and waxing

The paint on your Porsche is very durable but must be protected from losing its luster due to outside influences. Therefore, wash and wax your Porsche often. The longer the dirt is left on the paint, the greater the risk of damaging the glossy finish, either by scratching if the dirt is rubbed into the paint, or simply by the chemical effect dirt particles have on the paint surface. **Do not wash or wax in direct sunlight. Do not use hot water. Lukewarm to cool water is kinder to the paint.** Pamper your Porsche! Wash it by hand! The mechanical brushes in an Automatic Car Wash may not reach every angle of the vehicle, and some **tracks may cause damage to the underbody.** Use plenty of water, a car-wash and wax solution and a soft sponge or hose brush. Begin by spraying water over the dry surface to remove all loose dirt before applying the car-wash and wax solution. Use plenty of water to rinse the vehicle off. Wipe everything dry with a chamois to avoid water spots.

To guard against corrosion from the inside out, clean drain holes on the bottom of doors, tail gates, hatches etc., after each washing. Then wipe dry thoroughly. Also inspect all weatherstrips to make sure they do not allow water to enter the body panels.

Do not aim the water jet directly at door, hatch or rear lid locks. Tape the key holes to prevent water from seeping into the lock cylinders. Water in lock cylinders should be removed with compressed air. To prevent locks from freezing in the winter, squirt glycerin or lock deicer into the lock cylinders.

Do not use any solution that can damage the body paint.

The underside of the vehicle picks up dirt and road salts used to keep streets and highways free of snow and ice. To guard against corrosion, it is important to remove mud, debris and road salt from the underside with a powerful jet of water. Be sure to include the wheel housings, bumpers, muffler, tailpipe and brackets. This should be done twice a year and is best accomplished after the vehicle has been driven through a heavy rain. Let engine and exhaust system cool down before washing.

Waxing is not really needed when you have used a car-wash and wax solution. If you do not use a car-wash liquid with wax, apply wax to preserve the natural shine of the body paint. To obtain a long lasting finish, apply hard wax. Wax again if water remains on the surface in large patches instead of forming beads and rolling off.

Exterior Care of the finish

Oils contained in the paint are the most important ingredients contributing to the elasticity of the finish. Because these oils diminish gradually due to weather and similar causes, they must be replenished through regular and proper care of the finish. Given proper care, the original finish will retain its luster for many years. Ask your dealer for approved cleaning agents and preservatives. The use of polishes is recommended only after it becomes evident that the normal preservatives no longer accomplish the job.

Dull finishes and plastics

Plastic parts, such as light bulb lenses, decorative strips, panels, etc., will come clean during car washing. Should additional cleaning or spot removal be necessary, use a soft brush or cloth soaked with a mild detergent solution. Then rinse thoroughly and immediately with clear water. **Do not use anything** which could mar the plastic or dull finished surface, such as wax or polish, abrasive detergents or chemical cleaning solvents.

Metal trim

Bright or black anodized trim will come clean when you wash the vehicle. To protect the trim, use car wax.

Touch-up paint

Your dealer has touch-up paint for minor scratches and stone chips. Scratches should be touched up soon after they occur, to prevent corrosion. If corrosion formation becomes visible, however, a simple touch-up job will not suffice. The affected surface must be smoothed with sand paper and covered with an anti-rust primer, before restoring the painted finish.

Tar or oil

Do not allow tar or oil to remain on the paint. Remove as soon as possible with a cloth soaked with a special paint cleaner. If you do not have a tar or oil remover, you may substitute with turpentine. After applying a cleaning fluid, always wash with a lukewarm soap water solution and apply a new wax coat.

Insects

Remove as soon as possible with a lukewarm soap/water solution or apply insect remover.

Tree sap

Remove with a lukewarm soap/water solution. Do not allow tree sap or bird droppings to harden on the paint.

Windows

Keep silicone sprays off the windshield to avoid wiper smear in rain.

Generally, highway dust that settles on the outside of the windshield contains material worn from tires and oil residues. On the inside surfaces of the windshields, particularly in strong sunlight, there are build-ups of dust from the interior decor. These buildups are reinforced by pollution in the air

brought in with the fresh air supply. Use a lukewarm soap/water solution or an alcohol based commercial window cleaning agent for the inside and outside. If a chamois is used for polishing the glass, it should exclusively be used for that purpose.

To assure that windshield washers also function at freezing temperatures, antifreeze must be added to the washer fluids reservoirs beforehand. It is advisable to use window washer solvent with anti-freeze all year round. Follow directions on the can for the right amounts to be used. **Do not use engine coolant anti-freeze or any other solution that can damage the paint.**

In vehicles with Sekuriflex windshields, the plastic coating on the inside of the windshield must not have gummed labels put on it or be cleaned using abrasive agents or dry methods. If very dirty, it can be cleaned with benzine. The use of benzine in a confined environment may be dangerous to your health. Make certain that the plastic coating is not damaged in cleaning by hard objects such as jewelry or wristwatches.

Do not remove ice on the inside of the windshield by any means except warm air from the defroster nozzles. Do not use any deicer sprays, scratching tools, or scrapers!

A foil base must be applied to the windshield prior to application of any labels or stickers such as those used for state registration or inspections. Failure to utilize foil base between sticker or label and the Sekuriflex coating will result in damage to the Sekuriflex coating. Three foil bases were included with the vehicle and additional foil bases may be ordered from any Porsche dealer.

Instructions:

1. Clean the windshield in the area for application.
2. Cut the base of the foil to the required size. Round off the edges.
3. Pull off the protective film.
4. Spray the gummed side of the foil base and the windshield with a soap solution (distilled water and liquid soap or grease-free detergent in a mixing ratio 10:1).
5. Apply the foil base to the windshield and spray it once again.
6. Any liquid and bubbles under the foil base must be brushed out using a flexible plastic scraper.
7. Dry the windshield using a soft cloth.
8. Install label/sticker on the foil base.

63

When removing the label/sticker or the backing foil, first spray the foil with a soapy solution (see point 4).

Wiper blades

Always loosen frozen wiper blades from glass as they may tear otherwise.

Remove all wiper blades periodically and clean them thoroughly with an alcohol base cleaning solution. Use a sponge or soft cloth and wipe lengthwise.

Weatherstrips

To seal properly, weatherstrips around hood, hatch, windows, doors, etc., must be pliable. Spray with silicone or coat with talcum powder or glycerin to retain flexibility of the rubber and to protect against freezing in the winter.

Light alloy wheels

To preserve the decorative appearance of the light aluminium castings, some special care is necessary. Aside from road dirt and salt sprays, brake metal dust will exert corrosive effects.

If left on too long, brake metal dust can cause pitting. Wash the wheels with a sponge or hose brush every other week.

Roads salts should be removed weekly with an acid free cleaning solution.

The acid free cleaning solution must **not** have a pH value greater than 10 (see explanation), in case of doubt, it is recommended to check with the manufacturer of that particular cleaner.

Every three months (after regular cleaning) the wheels should be coated with petroleum jelly. Rub it in firmly with a soft cloth. Never use abrasive or metal polishing cleaning agents.

Explanation of pH value

The pH value is a measurement for the hydrogen-ion concentration in a liquid. This value tells if the liquid reaction is sour (acid) or alkaline (lye solution).

At a pH value of 7, the reaction of the liquid is neutral (that is, chemically clean water), it is not an acid or alkaline. Acids have a pH value under 7, the strength of the acid increases with a lower pH value. Alkaline lies between a pH value of 7 and 14, the strength of the alkaline increases with higher pH values.

For example: a mineral water mixed with carbon dioxide has a pH value of 6-6.5, reaction is also light sour. Battery acid in comparison has a pH value of 1.

or

the pH value for normal soap solution is 8-9, but the soap solution for a dishwasher is approximately 12.5, this would not be suitable for wheel cleaning. Your Porsche dealer can advise you which product to use.

Remember that moisture and road salt on brakes may affect braking efficiency. Test the brakes after each car or wheel wash.

Interior Glass

Use the same cleaning agents as for the exterior and polish dry with a soft cloth or paper towel.

Fabric

Use a vacuum cleaner or a soft bristle brush to remove dust and loose dirt from carpeting, upholstery, headliner and other trim. Dirt stains can usually be removed with lukewarm soap water or an all purpose cleaner solution, or a dry foam cleaner. For greasy, oily and other stubborn stains, use a spot remover. Do not pour the liquid on the fabric. Dampen a clean cloth and rub carefully, starting at the edge and working inward.

Safety belts

Keep belts clean. Very dirty belts may not retract properly. Do not remove belts from the vehicle to be cleaned. **Do not use chemical cleaning agents, bleach or dyes. They contain corrosive properties which will weaken the webbing. Do not allow inertia reel safety belts to retract before they are completely dry.**

For cleaning, use a mild soap water solution. Let belts dry out thoroughly and away from direct sun light.

Plastic, vinyl and leatherette

Use a clean, damp cloth or sponge to keep this trim free from dust. For other spoilage, use a lukewarm all purpose cleaning solution or a mild saddle soap for vinyl and leather trim. Remove water spots and soap traces with a clean, damp cloth or sponge. Use a clean, soft cloth to rub dry. Grease, tar or oil stains can be removed with a clean cloth or sponge soaked with all purpose cleaner or with a solvent type vinyl or leather cleaning agent. Occasionally apply a colorless vinyl or leather preservative to retain the material's luster and pliability.

Leather and leather trim

To keep leather seats and trim beautiful and soft, they should be cleaned and cared for regularly. Clean leather with a soft, white woolen cloth and a mild soapwater solution. Do not use chemical or abrasive cleaning agents. Do not let moisture seep through perforated surfaces to safeguard against corrosion and cracking from underneath. After cleaning, apply a leather preservative re-

commended by Porsche to all dry surfaces with a clean and soft woolen cloth. Let your Porsche dealer advise you on the use of the leather preservation product.

Corrosion protection

The engine compartment, as well as all engine, transmission, front and rear axle assembly surfaces have been treated with a wax based coating at the factory for protection against corrosion.

WARNING

Do not apply additional undercoating or rustproofing on or near the exhaust manifold, exhaust pipes, catalytic converter or heat shields. During driving, the substance used for undercoating could overheat and cause a fire.

Engine Compartment

If it becomes necessary to steam clean or otherwise wash the engine compartment, the wax based protective coating is usually lost. It is therefore important to reapply this protective coating to all engine compart-

ment panels, flanges, cavities, seams and engine assembly surfaces.

When washing the engine compartment, only use commercially available grease cutting solvents made especially for this purpose. Carefully follow directions printed on the container by the manufacturer.

Chassis

The lower body shell of your Porsche is thoroughly protected against corrosion. However, it is recommended to have the underbody inspected twice a year. Any detected damage to the undercoating, due to road hazards, should be repaired promptly. Oil based protective sprays must not be applied. Only tar or wax based anti corrosion protectors are compatible with the factory applied undercoating. Before application, road dirt and oily substances must be removed.

Whenever the lower body shell, axle, transmission or engine assemblies are repaired, the lost anti-corrosion coating of the affected surfaces should be renewed.

Let your Porsche dealer advise and assist you.

Exercise Extreme Caution when Working under the Engine Hood

The engine compartment of any motor vehicle is a potentially hazardous area. If you are not fully familiar with proper repair procedures, do not attempt the adjustments described on the following pages. This caution applies to the entire vehicle.

- Only work on your vehicle outdoors or in a well ventilated area.
- Ensure that there are no open flames in the area of your vehicles at any time when gasoline fumes might be present. Be especially cautious of such devices such as hot water heaters which ignite a flame intermittently.
- Before working on any part in the engine compartment, turn the engine off and let it cool down sufficiently. Hot engine compartment components can burn skin on contact.
- Even after the engine has stopped the radiator fan may continue running until the temperature of the coolant has dropped to a certain level. Therefore, never touch the fan blades as they will rotate spontaneously when the thermostat turns the fan on, even with ignition off.
- Be alert and cautious around engine at all times while the engine is running.

- If work has to be done with the engine running, always set the parking brake, and make sure the shift lever is in either Neutral or Park.
- Exercise extreme caution to prevent neckties, jewelry or long hair from getting caught in the fan blades, the drive belts, or any other moving engine parts.
- Your Porsche is equipped with a transistorized ignition system with breakerless distributor. When the ignition is on, high voltage is present in all wires connected with the ignition system; therefore exercise extreme caution when working on any part of the engine while the ignition is on or the engine is running.
- Always support your car with safety stands if it is necessary to work underneath the car. The jack supplied with the car is not adequate for this purpose.
- When working underneath the car without safety stands but with the wheels on the ground, make sure the car is on level ground, that the wheels are blocked, and that the engine cannot be started. REMOVE THE IGNITION KEY.
- Do not smoke or allow an open flame around the battery or gasoline.
- Keep a fire extinguisher in close reach.

- Incomplete or improper servicing may cause problems in the operation of the car. If in doubt about any servicing, have it done by your authorized Porsche dealer or any other properly equipped and qualified workshop.
- Improper maintenance during the warranty period may affect your warranty coverage.

67



Tool Kit and Car Jack

The tool kit and jack are stored in the luggage compartment under the floor mat.

The car jack must be screwed open a little before it can be removed from the holder.

The **tool kit** contains tools needed for minor emergency roadside repairs, adjustments and wheel changing.

Regulations in some countries require additional tools. Details should be obtained prior to leaving for a foreign country.



WARNING

- **Use the jack only for changing a tire. Never jack up other vehicles or other loads with it.**
- **Follow all warnings and instructions found in this manual for changing a tire.**
- **The jack must never be used as a support to work underneath the vehicle. If the jack is accidentally dislodged, you or bystanders could be seriously injured. When working under the vehicle, always use safety stands specifically designed for this purpose.**

68



944

Engine Oil Level

Engine oil consumption

It is normal for your engine to consume oil. The rate of oil consumption depends on the quality and viscosity of oil, the speed at which the engine is operated, the climate, road conditions as well as the amount of dilution and oxidation of the lubricant. Because of these variables, no standard rate of oil consumption can be established, but drivers should expect an increased oil consumption at high speeds and when the engine is new.

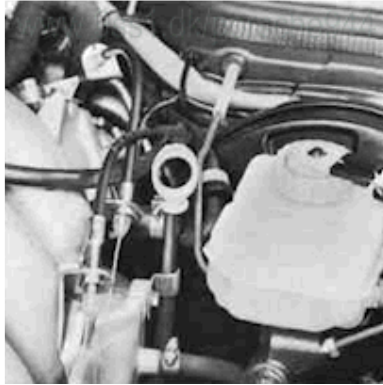

944 S

- The engine in your vehicle depends on oil to lubricate and cool all of its moving parts. Therefore, the engine oil should be checked regularly and kept at the required level.
- Make it a habit to have the engine oil level checked with every fuel filling.
- Lack of sufficient engine oil may lead to severe engine damage.
- The oil pressure warning light is not an oil level indicator.



944 Turbo

Checking oil level

To get a true reading, the car should be on level ground. After turning off the engine, wait a few minutes for the oil to return to the oil sump.

1. Pull out dipstick and wipe it dry with a clean cloth or paper towel.
2. Reinsert dipstick: push it in all the way down for an accurate reading.
3. Pull dipstick out again. The oil level is correct if it is between the "max" and "min" marks on the dipstick.
4. If oil level is below "min" mark, or not showing on dipstick, add oil immediately. The difference between the "max" and "min", marks is about 1 U.S. quart or 1 liter.

69

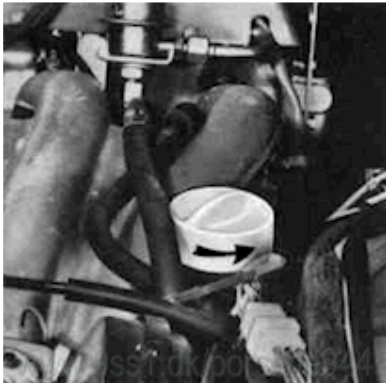

Adding engine oil

Only add the amount of oil that is needed. The correct oil grade and viscosity recommendation is given under "Engine Oils".

1. Remove oil filler cap and remove dipstick.
2. Top up with quality oil labeled "API Service SE or SF".
3. Check oil level with the dipstick. The "max" mark should not be exceeded.
4. Replace cap and tighten securely.

WARNING

The oil filler cap and dipstick must be secure to avoid oil spills and resulting fire hazard.

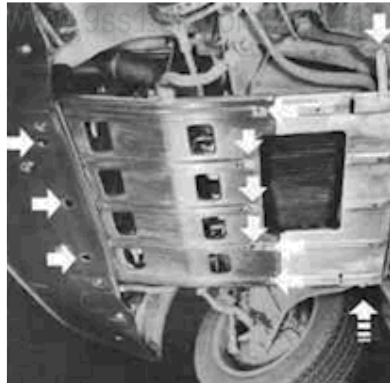

944-Turbo Engine Guard

Before working on the underside of the engine for the 944 Turbo, remove the two-part engine guard.

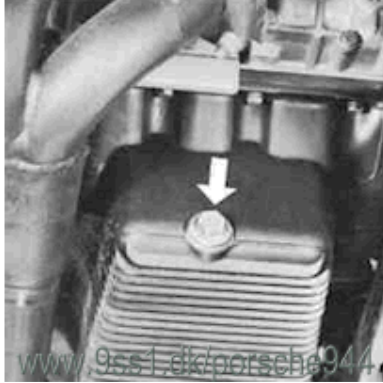
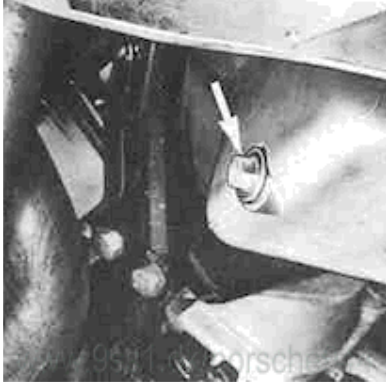

Changing Engine Oil and Filter

High quality-multi-grade oils are suitable for all year round driving. Seasonal oil changes are therefore not necessary. Only if multi-grade oils are not readily available, a single-grade oil of the correct viscosity can be used. Specifications of the various oils to be used are detailed under "Filling Capacities and Engine Oil". **The use of oil additives is not recommended by Porsche.**

WARNING

•When removing oil drain plug with your fingers, keep your arms as high as possible. This will prevent hot oil from running down your arm. Wear eye protection.

•Always use a new gasket when reinstalling the plug. Do not overtighten the plug.

Before changing the engine oil yourself, make sure that the disposal of the engine oil and the oil filter, as special wastes, can be carried out in the proper manner. Under absolutely no circumstance should used oil find its way into the sewage system, soil, rivers, ponds, or other environmentally damaging areas. If there is no possibility of disposing of used oil in the proper manner

(when in doubt, consult local authorities), please have the oil changed by your dealer or a service station.

Oil change intervals specified in the Warranty & Maintenance booklet accompanying the vehicle apply to normal operating conditions and must be adhered to, including intervals for oil filter change.

If you drive mostly short distances, or if you operate the vehicle in dusty areas, or under predominantly stop-and-go traffic conditions, or when temperatures remain below freezing for extended periods, the engine oil should be changed more frequently.

When changing the engine oil and the oil filter, the splash shield under the car has to be removed first.

Drain the oil when the engine is still warm.

71

The oil filter should be changed at the intervals listed in your **Maintenance Schedule**.

1. Unscrew the oil drain plug (arrow), remove the oil filler cap and allow oil to drain completely.
2. Loosen oil filter element with appropriate wrench and remove.
3. Lightly coat new filter seal with engine oil.
4. Screw on filter by hand until gasket contacts, tighten by one further turn and finally recheck tightness of filter with the oil filter wrench.
Specified tightening torque:
20 Nm (14 ftlb).
5. Clean oil drain plug. Always use a new gasket when reinstalling the plug. Do not overtighten the plug. Correct tightening torque is 43 ft. lb. or 60 Nm.
6. Fill the crankcase with the required amount of engine oil labeled "API Service SE or SF" (see "Filling Capacities"). **Do not overfill.**
7. Check oil level with dipstick. Top up if necessary. Reinstall oil filler cap and tighten securely.
8. Run the engine at various speeds for 3-5 minutes and check for leaks.

See Exercise Extreme Caution

72



Power Assisted Steering

The hydraulic assistance system allows effortless steering under all driving conditions. Slight hissing or squeaking sounds during sharp turns (turning steering wheel from lock to lock) are normal and do not indicate a defective steering mechanism.

If the engine is not running, power assisted steering is no longer effective. You can continue to steer the car but more effort will be required to turn the steering wheel.

Checking the fluid level

The hydraulic fluid level should be checked at regular intervals. The fluid reservoir is mounted on the right wheel housing in the engine compartment.

1. Unscrew cap from reservoir and wipe dipstick with a lint free cloth.
2. Let engine run at idle speed. Reinstall cap and unscrew again. The fluid level should be between the upper and lower mark on the dipstick.

- If necessary, top up with ATF-Dextron®.**
3. Reinstall cap and handtighten securely.

Cooling System

Only use additives recommended for aluminium engines and radiators. Your Porsche dealer will be able to advise you.

For year round driving, phosphate-free antifreeze is added at the factory for temperatures down to: -31° F / -35° C

Because of its anti-corrosion properties, antifreeze should also remain in the cooling system for summer operation. Cooling system capacity and specified antifreeze and water ratios are listed under "Filling capacities".

Use any quality phosphate-free anti-freeze containing ethylene glycol, available at your Porsche dealer. **Anti-freeze other than specified by Porsche for aluminium engi-**

nes and radiators may cause corrosion of the cooling system, leading to engine overheating and damage.

Only for topping up coolant, a small amount of anti-freeze containing ethylene glycol and phosphates may be used if recommended anti-freeze is not available.

The anti-corrosion properties and the antifreeze consistency will diminish gradually. We recommend renewing the coolant mixture at least every 2 years.

WARNING

The radiator fan is electrically driven. It is switched on automatically by a thermostat when the coolant reaches 198° F / 92° C.



Even when the engine is turned off, the fan will continue running, until the coolant temperature has dropped to 189° F / 87° C and until the engine itself has cooled down sufficiently.

Checking coolant level in expansion tank

A correctly functioning cooling system requires only minor care. The coolant level should be checked from time to time, and always before going on a longer trip. The **expansion tank** with filler cap opening is located in the engine compartment (see illustration). Since the expansion tank is transparent, the coolant level can be checked visually without removing the filler cap.

When the engine is cold, the coolant level should reach the minimum mark on the expansion tank. When the engine is warm, the coolant level will be above the minimum mark. Since the closed cooling system loses almost no coolant, topping up is normally not required. An obvious loss of coolant indicates leakage. In this case contact your dealer.

WARNING

•Do not open the filler cap when the engine is hot because of the danger of scalding. Allow the engine to cool down. Protect your hands, arms and face.

•Using a thick rag, open the cap carefully and only enough to allow excess pressure to escape before removing the cap.

To avoid damage to the engine, only add cold antifreeze and cold water to the cooling system when the engine is also cold. A warm engine should only be topped up if the coolant level has dropped appreciably below the minimum mark. Too much added coolant will escape through the pressure cap when coolant warms up. If more than about 1.06 U.S qt or 1 liter must be added, the cooling system should be bled.

Winter operation

At the beginning of the winter season, have the coolant checked for anti-freeze concentration.

The ratio between water and anti-freeze necessary to prevent freezing depends on the anticipated outside temperatures. The ratios can be taken from the mixing chart listed under "Filling Capacities" or from the container of the antifreeze manufacturer.

Increasing the anti-freeze in the coolant further than shown on the container is not only uneconomical, it is also detrimental to engine cooling.

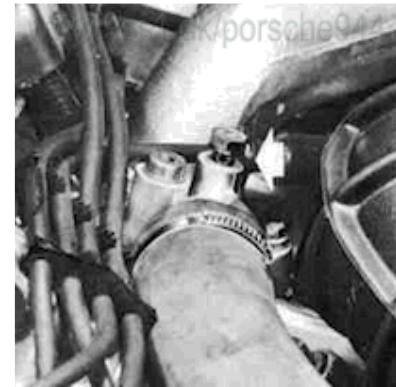
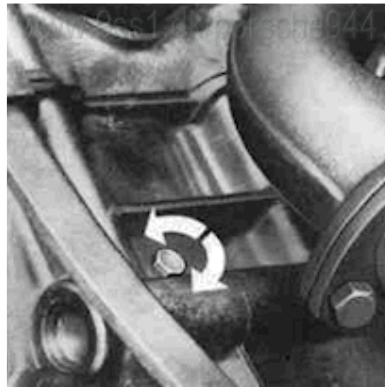
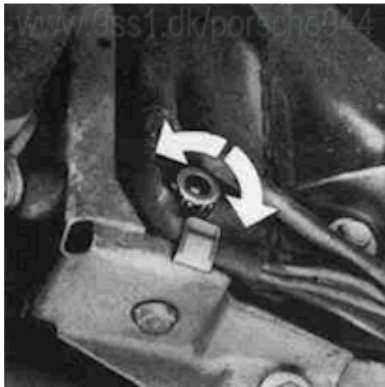

944

Draining the coolant
Engine must be cold

1. Move temperature control lever to "warm".
2. Remove filler cap from expansion tank.
3. Unscrew drain plug on radiator and on engine block (curved arrows). Allow coolant to drain completely.

Bleeding cooling system and topping up coolant

1. Reinstall radiator drain plug. Do not overtighten plug (required torque is 43 in. lb/5 Nm).
2. When reinstalling engine block drain-plug, use a new gasket. Do not overtighten plug (required torque is 14 ft lb/20 Nm).
3. Move temperature control lever to "warm".
4. Unscrew the vent plug (single white arrow) and remove.

5. Remove the expansion tank filler cap and slowly pour coolant into the tank. Stop pouring as soon as fluid runs out of vent plug opening.
6. The expansion tank should only be about half full so as to prevent any overflow once the engine is warm.
7. Screw in the vent plug loosely.
8. Start the engine. Let engine run at increased idle until it has reached operating temperature (the radiator fan will turn on and off).



944 S

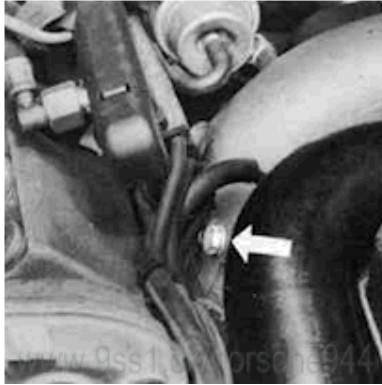

944 Turbo

9. When air bubbles at vent plug disappear, tighten the plug (required torque is 15-18 Nm or 11-13 ft lb).
10. Check coolant level in tank and top up to "max" mark, if necessary.
11. Reinstall the expansion tank filler cap.
After a test drive recheck the coolant level.
See "filling capacities" for amount required.

Manual Transmission oil

Both transmission and final drive are combined in one housing. The lubricant used is hypoid oil. The manual transmission oil should be checked and changed by your Porsche dealer and at the intervals specified in your **Maintenance Schedule**.

77

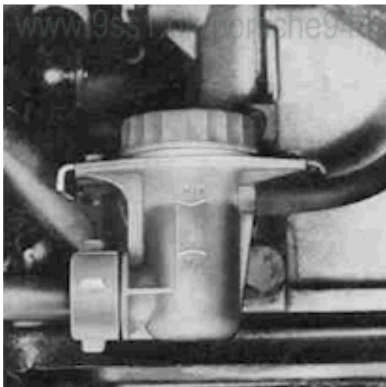

Automatic Transmission Fluid

The torque converter and the transmission are lubricated with Automatic Transmission Fluid (ATF). The final drive requires hypoid oil SAE 90 only.

Do not tow the car or run the engine without ATF in the transmission.

Checking the ATF level

The ATF has to be checked at frequent intervals, for instance, when the engine oil is being checked or at least at the specified intervals (see Maintenance schedule). A correct ATF level is very important for the proper functioning of the transmission. The

reading should be done when the ATF is warm, with the engine idling, the selector lever in Neutral and the parking brake applied. The level of the ATF fluid can be checked visually through the transparent reservoir. This reservoir is located at the rear end of the transmission housing. You have enough ATF if the fluid level is between the Min. and Max. marks. It should never be above or below these marks. The difference between the two marks is 1 U.S. pint or 0.4 liter. If level is too high or too low do not just add or drain ATF. Have your dealer check and correct the cause as soon as possible. For correct ATF specifications, see "Filling Capacities".

Changing the ATF

The ATF and the hypoidoil in the final drive has to be changed at specified intervals (see Maintenance schedule).

78

Brake Fluid Reservoir

The brake fluid reservoir is in the engine compartment. The reservoir has two chambers, the front chamber for one brake circuit and the rear chamber for the second brake circuit and the hydraulic clutch. The fluid level should be checked regularly. If the level drops below the "min" mark on the transparent reservoir, the cause should be located and corrected by your dealer. **To add brake fluid**, unscrew the cap. The vent bore in the cap should be kept clean and open.

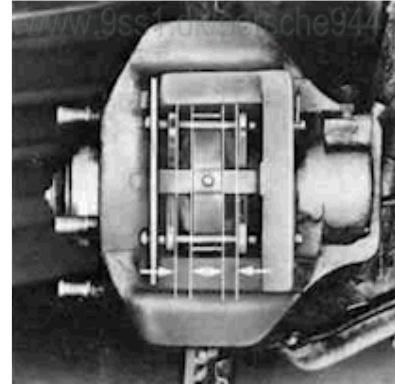
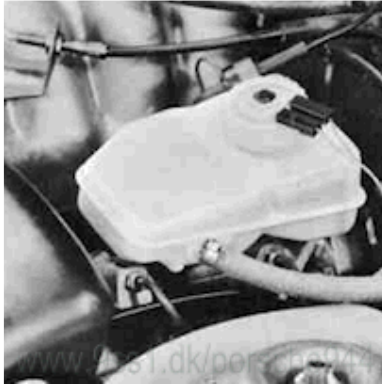

944 / 944 S

WARNING

- Every 2 years the brake fluid has to be replaced. See your Warranty & Maintenance booklet.
- If brake fluid must be added to the reservoir, use only new and unused DOT 3 or DOT 4 brake fluid, that meets SAE specification J1703 and conforms to Motor Vehicle Safety Standard 116.
- Do not use any other brake fluid or brake fluids that have absorbed moisture from the open air, or brake fluid that is dirty. It may cause premature wear or unreliable braking action.

- Do not add or mix DOT 5 silicone type brake fluid with the brake fluid in your vehicle as severe component corrosion may result. Such corrosion could lead to brake system failure.
- The brake warning light does not indicate brake fluid level. Check fluid level between regular maintenance services.
- Brake fluid is poisonous. Brake fluid is also harmful to the paint of your vehicle.

Checking Brake Pads

Brake pad wear will mainly depend upon the degree of usage, and the type of driving you do. Thickness of the pads should be checked during regular maintenance or whenever the wheels are taken off (visual check). The brake pads must be thick enough between the brake pad plate and the cross spring to allow a reserve for further wear (see illustration).

79

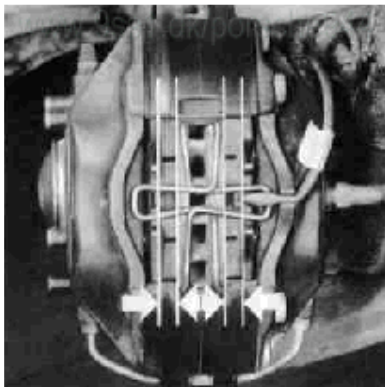

944 Turbo

The permissible wear limit has been reached once the brake pad plate comes to rest against the cross spring (brake pad thickness approx. 0.08 in or 2 mm). We also suggest that the condition of the brake pads be checked prior to going on long trips.



944

Air Filter

A dirty air cleaner not only reduces engine performance, but can lead to premature engine wear. If driving is mostly done in areas where the air is very dusty, the air cleaner must be checked and cleaned frequently, perhaps daily.

The paper filter element must never be cleaned or soaked with gasoline, cleaning solvents or oil.

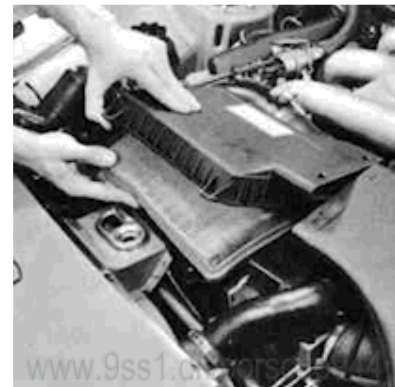

944 Turbo

To clean or replace the filter element 944 / 944 Turbo

1. Loosen hose clamp at filter housing cover (arrow) and pull off hose.
2. Loosen mounting screws with screw driver and lift up filter housing cover. On the 944 Turbo, also remove the air intake funnel.
3. Remove filter element and clean inside of housing with a slightly oiled, lint-free cloth.
4. Replace filter element or shake out dirt to clean.

80

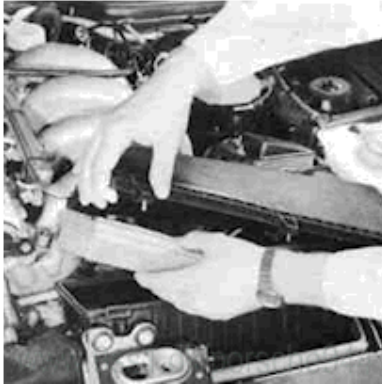

944

5. Press together the housing cover with the air intake funnel (944 Turbo) and carefully place in position. Tighten fastening screws, connect hose and screw down hose clamp.

944 S

1. Unscrew the retaining screws and remove the filter cover.
2. Remove the filter element.
3. Clean the inside of the filter housing with a lightly oiled lint-free cloth.
4. Fit a replacement filter element. Carefully place the housing cover in position and tighten the retaining screws.



Reservoir for Windshield and Headlight Washer System

The transparent reservoir is in the engine compartment. As clear water is usually inadequate for cleaning windshield or headlights, add a cleaning solution, such as windshield washer solvent and antifreeze offered by your dealer. To assure that the system also functions at freezing temperatures, antifreeze must be added to the water beforehand. Follow the instructions on the can for the right amount to be used (also see "Filling Capacities"). **Do not use engine coolant anti-freeze or any other solution that can damage the car paint.**

81

Tires/Wheels

The original equipment tires and wheel rims on your Porsche comply with all applicable Federal Motor Vehicle Safety Standards.

For your driving safety remember the following:

- Wheel rims and wheel bolts are matched to fit your Porsche.
- If you intend to use other than original equipment wheels, be sure that they conform to Porsche specifications for your model.
- The use of wheel rims and wheel bolts that do not meet specifications of the original factory installed equipment will affect the safe operation of your vehicle.
- Before you plan on exchanging wheels, or winter tires already mounted on wheel rims, consult your Porsche dealer. He has the technical information necessary to advise you which wheel rims and wheel bolts are compatible with the original factory installations.

Tire pressures

WARNING

Incorrect tire pressures cause increased tire wear and adversely affect road holding of the vehicle, leading to loss of control. Always use an accurate tire pressure gauge when checking inflation pressures. Do not exceed the maximum tire inflation pressure listed on the tire sidewall. (Also refer to "Technical data"). Cold tire infla-

tion pressure means: when a car has not been driven for at least 3 hours or less than 1 mile. Never let any air out of warm tires to meet cold tire pressure specifications.

Tire traction

WARNING

When driving on wet or slushy roads, a wedge of water may build up between the tires and the road. This phenomenon is known as aquaplaning and may cause partial or complete loss of traction, vehicle control or stopping ability. Reduce speed on wet surface.

Tire Life

Tire life depends on various factors, i.e., roads, traffic and weather conditions, driving habits, type of tires and tire care. Inspect your tires at least every 2.000 miles or 3.000 km for wear and damage. If you notice uneven or substantial wear, wheels might need alignment or tires should be balanced or replaced.

Tires must always remain on same side of vehicle.

After changing, adjust tire pressure and torque wheel nuts diagonally to 94 ft lbs (130 Nm) (see "Changing wheels").

The supposition that tire durability and performance are immune to the effects of storage and age is unfounded. Chemical additives, which make the rubber elastic, lose their effectiveness in the course of time and the rubber becomes brittle and cracks.

Therefore, the tires, especially the collapsible spare tire, should from time to time undergo a visual check. To accomplish this, pump up the collapsible spare tire.

Under no circumstances should tires older than 6 years be used on your Porsche. The age of the tire can be obtained from the "DOT" code number. If, for example, the last three numbers read 125, then the tire was produced in the 12th week of 1985.

Tire wear

The original equipment tires on your Porsche have built-in wear indicators. They are molded into the bottom of the tread grooves and will appear as approximately 1/2 in (12 mm) bands when the tire tread depth is down to 1/2 of an in (1.6 mm).

When the indicators appear in two or more adjacent grooves, it is time to replace the tires. We recommend, however, that you do not let the tires wear down to this extent. Worn tires cannot grip the road surface properly, and are even less effective on wet roads.

In the United States, state laws may govern the minimum tread depth permissible. Follow all such laws.

WARNING

Do not drive with worn tires or tires showing cuts or bruises as they may lead to sudden deflation.

If you notice that tires are wearing unevenly, consult your Porsche dealer. Uneven wear

may not always be due to improper wheel alignment. It can be the result of individual driving habits such as cornering at high speeds. If the tire pressure is not checked and adjusted regularly, abnormal tire wear can also occur.

**Tire care
WARNING**

- Avoid damaging tires and wheel rims. If you must drive over a curb or other obstacle, drive slowly and at an obtuse angle.
- Frequently check tires for uneven wear and damage.
- Remove imbedded material.
- Replace worn or damaged tires immediately.
- Replace missing valve dust caps.
- Keep oil, fuel, brake fluid, etc. away from tires.
- Keep tires inflated correctly.

Tire replacement
In the interest of maximum safety and best all-around car handling, always buy replacement tires that have the same specifications with regard to tire size, design, load carrying capacity, tread pattern, tread depth etc. This also applies to Porsche recommended alternate replacement tires. If you do not use a Porsche recommended replacement tire, make sure that you purchase your new tires from a reputable

tire specially dealer and that the dealer complies with all manufacturers warnings for those tires.

In case of tire damage where it is uncertain whether there is a break in the ply with all its consequences or, tire damage caused by thermal or mechanical overloading due to a loss of pressure or any other prior damage, we recommend that the tire be replaced for safety reasons.

If one faulty tire on an axle is replaced it should be noted that the difference in tread depth on one axle must not be more than 30%.

Tire specifications are imprinted on the sidewall of the tires. If in doubt, check with your Porsche dealer.

When replacing tubeless tires, always install new valve stems. When replacing tires requiring an inner tube, always install new tubes.

New tires do not possess maximum traction. They tend to be slippery. Break new tires in by driving at moderate speed for the first 60-120 miles or 100-200 kilometers.

Wheel balancing

A wheel should always be balanced after a tire repair. Even with regular use a wheel can get out of balance, and should therefore be balanced from time to time. Unbalanced wheels may affect car handling and tire life. When balancing light alloy wheels, use only adhesive balancing weights supplied through the Porsche parts service.

Wheels

If you intend to use other than original equipment wheels, be sure that they conform to Porsche specifications for your model. Check with your Porsche dealer regarding the correct wheel specifications for type and model year.

Removing and storing tires

The driving direction should be clearly marked on all tires before removing them for storage, to make sure they are mounted and run in the same direction as before. Store tires in a cool and dry place. Tires without rims upright! Avoid contact with oil, grease or gasoline. When remounting, put tires with the most tread depth at the front.

Snow tires

For a better grip on snow and ice use radial M + S tires or snow tires with studs. Check with your local Motor Vehicle Bureau for possible restrictions.

Radial ply M+S tires should be inflated with the same cold tire inflation pressures required for the regular radial ply tires. However, do not exceed the maximum tire inflation pressure listed on the tire sidewall.

Snow tires should have the same load capacity as original equipment tires and should be mounted on all four wheels. Snow tires with studs should be run at moderate speeds when new in order to give the studs time to settle.

WARNING

Tires with badly worn treads and studs are very dangerous. Make sure they are replaced immediately.

Do not drive a vehicle equipped with snow tires at prolonged high speed. Snow tires do not have the same degree of traction on dry, wet or snow free roads as a normal tire. Furthermore, snow tires wear rapidly under these conditions.

Snow tires do not fulfill their purpose if the tread depth is less than 5/32 in. / 4 mm.

Comply with all state and local laws governing snow tire and tread depth requirements.

Snow chains

Should snow chains be necessary, they must be mounted on the drive wheels only.

Check with local authorities for possible restrictions.

Use only Porsche-approved snow chains with fine pitch links, so that enough space remains between the chains and the inside of the wheel arches.

Drive wheels must rotate freely with chains mounted to prevent damage to body, axle or brake components. Follow instructions issued by the supplier of the chains. Remove chains as soon as roads are free of ice and snow.

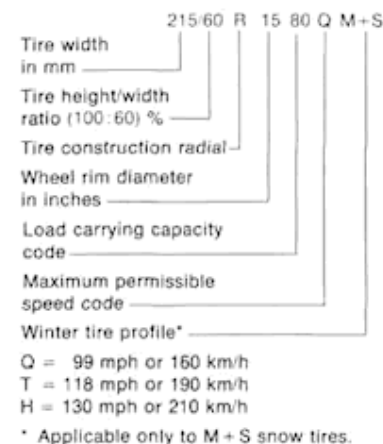

New Tire Identifications

The European tire manufacturers have changed their tire identification system for SR and HR-tires pertaining to maximum permissible speed and maximum load carrying capacity for belted tires. The following is an example only.

During the transition period some tires might show both old and new identification codes, such as: 215/60 SR 15 M+S 80 Q. In this instance, the new codes apply.

The identification codes for VR tires remain unchanged; for example: 205/55 VR 16. (V = maximum permissible speed for radial tires, i.e. over 130 mph or 210 km/h).



Collapsible Spare Tire

The spare tire is stored underneath the luggage compartment cover. Due to tread and space saver design features of the collapsible tire, car handling may be affected.

Therefore, do not drive more than 50 mph (80 km/h) when using the collapsible spare tire. It is for emergency use and short distances only. Remount the original road tire as soon as possible.

Inflating the collapsible tire

WARNING

Do not overinflate your spare tire. Inflate the collapsible tire with the electric air compressor that comes with your Porsche. Do not use other equipment!

1. Mount spare wheel before inflating the tire.
The wheel nuts for the light alloy wheels of the vehicle can be used to mount the spare wheel. This applies to emergency use and short distances only.

2. Attach hose to tire valve. Insert plug of electric cord into cigarette lighter socket.
 3. **The required tire pressure is 36 psi or 2.5 bar/atm (front or rear).** Check pressure with tire pressure gauge.
 4. Disconnect hose and electric cord and store air compressor.

5. Have flat road tire repaired and remounted on car at next service stop. Remember, **the collapsible tire is for emergency use and short distances only.**

When the air is released from the collapsible tire, it will return to its original shape after cooling down for several hours. Store collapsible tire in luggage compartment. **The collapsible spare tire cannot be repaired or mounted on the rims with standard workshop equipment. Repair and remounting must only be done by the tire manufacturer.**

Tire tread depth

As required by law, the tread depth of the collapsible tire is the same as that of the original equipment tire. Replace a worn collapsible spare tire in time.

If air compressor does not work

... Check if tobacco or any other foreign matter is lodged in the cigarette lighter socket. Remove carefully with a wooden pick. Do not use metal object to prevent short circuit.
 ... Check if fuse is blown. Replace with new equivalent fuse.

Maintenance of air compressor

The air compressor is maintenance-free. Do not apply oil or any other lubricant. The air filter should be cleaned periodically to assure maximum efficiency of the unit.

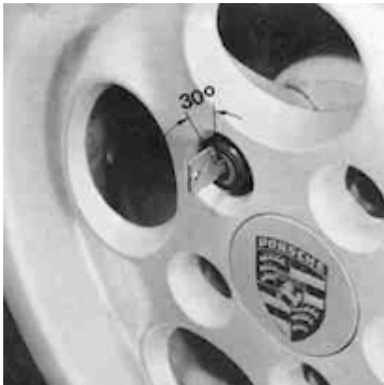

Lockable Wheel Nuts

You can guard against wheel theft by installing lockable wheel nuts on your wheels. Each kit contains three keys and four wheel nuts with lock sleeve. The locking mechanism is identical for all four wheel nuts. When taking the vehicle to your Porsche dealer or to a workshop for wheel or tire service, remember to leave one key with the service attendant. **In case of loss, duplicate keys cannot be furnished by your Porsche dealer. Keep them in a safe place.**

To unlock a wheel

1. Remove protective plastic cap from wheel nut.
2. Insert key all the way and turn left about 30°.
3. Remove lock sleeve together with inserted key.

To lock a wheel

1. Turn the key again approx 30° to the right and remove.
2. Push the lock onto the wheel nut until you can feel it latch.
3. Check whether the sleeve (of the lock) is up against the collar of the wheel nut.
4. Generally it is not necessary to balance the wheels after installing the lockable wheel nuts.

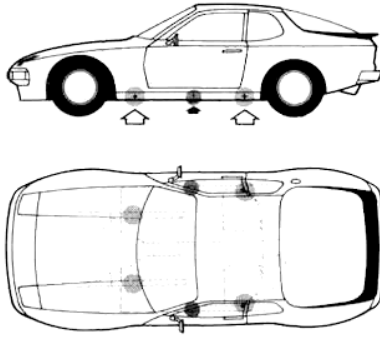

Jack support points

Black arrow: Jackport for car jack
 White arrows: Lift points for workshop hoist or floor jack
front on the inboard side members
rear on the side reinforcement brackets

Jacking at any other place may damage the vehicle or may result in personal injuries.

Changing a Tire

WARNING - Failure to follow these instructions may result in serious personal injuries to you or to bystanders.

- If you have a flat tire, move a safe distance off the road. Turn the emergency flasher on and use other warning devices to alert other motorists.
- Passengers must not remain in the vehicle when it is jacked up.
- Before you change a tire, be sure the ground is level and firm. If necessary, use a board under the jack to ensure that the jack does not sink into the ground.
- Set the parking brake and block the wheels opposite the flat tire on the other side of the vehicle.
- The jack is only to be used for changing

a tire. Do not use it as a support to work under the car.

• Never jack the car up by the body or the bumpers.

Sequence of operations:

1. Loosen all wheel nuts. Do not yet remove nuts.
2. Securely place the jack in the jack support at the indicated point. Place the jack at an angle so that the jack base rests firmly on the ground. If the ground is not firm under the jack, use a board.
3. Raise the car by turning the handle clockwise. Only raise the car as much as is needed to change a wheel.
4. Fully unscrew wheel nuts and remove wheel.

Do not raise the vehicle until you are sure the jack is securely engaged.

5. After you have mounted the spare wheel, insert the wheel nuts and hand tighten them crosswise. Snug wheel nuts with socket wrench and breaker bar.
6. To lower the car, turn the handle counterclockwise till tire touches ground.
7. Then go crosswise from one nut to another tightening them firmly with the socket wrench and breaker bar.
8. Fully lower the vehicle and remove jack.
9. Correct the air pressure of the tire you have just put on. Have flat tire repaired at next service stop.

Correct tightness of the wheel nuts is important. The torque of 94 ft lb (130 Nm) can be obtained with a socket wrench and breaker bar by any person of average strength. If in doubt about the correct tightness of the wheel nuts, have it checked with a torque wrench by your dealer or a service station.

87



Lifting Vehicle

The jack ports are located below the middle of the door underneath the left and right rocker panels, hidden from view.

Lifting with car jack

The car jack must never be used as a support to work underneath the vehicle. If the jack is accidentally dislodged, you could be seriously injured. When working under the vehicle always use safety stands specifically designed for this purpose.

WARNING

• Jacking at any other place may damage the vehicle or may result in personal injuries.

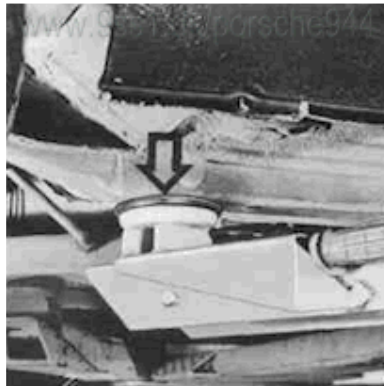

The vehicle should never be lifted or jacked up from underneath the engine oil pan, the transmission housing, or the front or rear axle. This could lead to serious damage.

Lifting with workshop hoist

Make sure there is sufficient clearance between pads and vehicle before driving vehicle onto hoist, especially if the vehicle has a large front panel or spoiler. The vehicle must be lifted only at the lift points illustrated.

The front lift points are located on the inboard side members of the underbody.

The rear lift points are located on the side reinforcement brackets of the underbody.

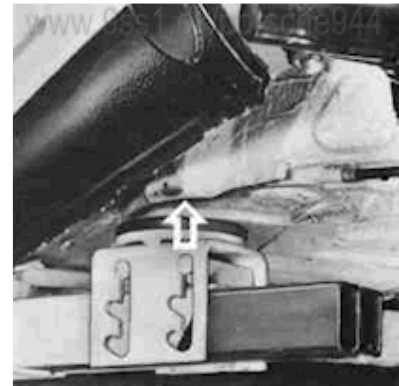

Take care to avoid damaging critical components which are close to the lift points.

WARNING

When removing components such as engine block, transmission housing, fuel tank, wheels, front or rear axle, anchor vehicle to hoist or add corresponding weights to maintain the center of gravity. Otherwise the vehicle might tilt or slip off the hoist, causing serious damage or personal injury.

Lifting with floor jack

The same lift points as illustrated for the hoist also apply when using a floor jack. To avoid damage to the underbody or chassis frame, it is necessary to insert a rubber pad between the floor jack and the lift points.

88

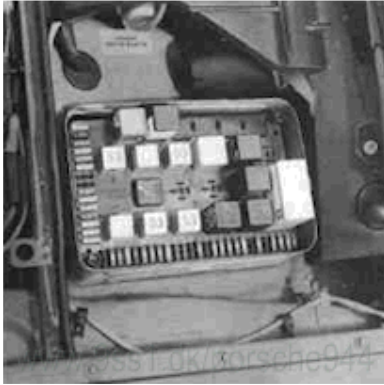

Fuses and Relays

The individual circuits are protected by fuses to prevent damage to electrical leads and components due to short-circuits and overload.

The fuse box with a black plastic cover is located on the left side in the engine compartment directly in front of pivot point for left windshield washer arm.

The use of the fuses and relays is shown in a list on the inside of the cover of the fuses and relays.

Replacing a Fuse

Before replacing a fuse, turn off all electrical components and the ignition; remove

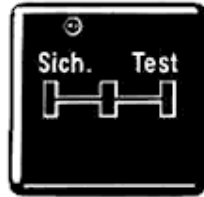

the key. Replacing a fuse or relay with the engine running or the ignition on could cause electrical shock.

A blown fuse indicates an overload in the circuit. When a fuse is blown it is not sufficient to merely replace it. The cause of the short circuit or overload must be located. **Fuses should never be patched up with tin foil or wire as this may cause serious damage elsewhere in the electrical circuit. Open snap-on latches and remove plastic cover.**

To find out whether a fuse is serviceable, pull it out with the plastic pliers specifically provided for this purpose. Insert the fuse at the test point on relay (G 3). If the fuse is in proper condition, the green indicator light will come on.

If it fails to light up, the fuse is defective and must be replaced. Replace black plastic cover.

The central electrical system contains plug in relays for various electrical switching functions.

Defective relays should be tested and replaced by an authorized Porsche dealer.

To prevent damage to the electrical system we recommend having all work - including the installation of electrical accessories - carried out by your authorized Porsche dealer. . ,

Loudspeakers

When installing a radio or booster amplifier, check that the output is compatible with the capacity of the loudspeakers supplied with the vehicle.

Rated capacity in Watt (Sinus)

Front Rear

2x10 2x10

HiFi Audio Package 2 x 25 2 x 25



Battery-12 Volt

The battery is located under the front hood in the cowl area.

A replacement battery should always have the same rating as the original equipment battery. Specifications are printed on the battery housing.

Before work is done on the electrical system, the battery must be disconnected to prevent short circuiting. First disconnect the negative ground wire and then the positive cable. To reconnect battery, reverse the procedure.

Disconnecting the battery while the engine is running will damage the alternator. This also applies to cars equipped with a battery main switch.

Never drive the car with a disconnected battery as this will damage the alternator.

WARNING

•Do not lay tools or other metal objects on the battery as they could cause a short circuit across the battery terminals.

•Do not expose the battery to an open flame or electric spark. Hydrogen gas generated by the battery is explosive.

•Do not let battery acid come in contact with skin, eyes, fabric or painted surfaces.

•If you get electrolyte, which is an acid, in your eyes or on skin, immediately rinse with cold water several minutes and call a doctor.

•Spilled electrolyte must be rinsed off at once with a solution of water and baking soda to neutralize the acid and prevent damage to fabric and metal.

Checking the electrolyte fluid level

The electrolyte fluid level in your battery can be checked by unscrewing and opening the filler vent caps of each cell. The fluid level should meet the indicator mark in each cell. If necessary, top off with distilled water.

How often water must be added depends on operating conditions and on the time of year. Generally, the electrolyte level must be checked more often in the summer than in the winter, and more often when driving long distances.

Only fill up to mark, otherwise the electrolyte will overflow when the battery is being charged and cause damage.

Battery care

•Battery should be securely mounted

•Terminals and connections should be kept clean and properly tightened. Corrosion can be prevented by coating terminals and connections with petroleum jelly or silicone spray

•Vent caps must be securely tightened to prevent spillage

Winter operation

During the winter months, battery capacity tends to decrease as temperatures drop. Additionally, more power is consumed while starting, and the headlights, heater, rear window defogger, etc., are used more frequently. Curtail unnecessary power consumption, particularly in city traffic or when travelling short distances only. Let your Porsche dealer test the battery's capacity before winter sets in. A well charged battery will not only prevent starting problems but will also live longer.

Battery charging

Automotive batteries lose their efficiency when not in use. The charge available in your battery can be measured with a hydrometer. We recommend that battery voltage be tested by your Porsche dealer who has the appropriate equipment. If the car is not driven for prolonged periods, the battery

must be charged at least every 6 weeks. A discharged battery allows rapid formation of sulfates, leading to premature deterioration of the plates.

WARNING

- Charge battery in a well ventilated area. Keep away from open flame or electrical spark. Do not smoke. Hydrogen gas generated by the battery is explosive.
- Electrolyte fluid that may spill during charging should be washed off with a solution of warm water and baking soda to neutralize the acid.
- If you get electrolyte in your eyes or on your skin, immediately rinse with cold water for several minutes and call a doctor.
- Never charge a frozen battery. It may explode because of gas trapped in the ice. Allow a frozen battery to thaw out first.
- Never use a fast charger as a booster to start the engine. This may seriously damage the vehicle's electrical system and the charger.
- Fast charging a battery is dangerous and should only be attempted by a competent mechanic with the proper equipment.

Slow battery charging

WARNING

Heed all warnings and follow instructions that come with your battery charger.

- Disconnect battery cables and remove the battery.
 - All vent caps should be open. If fluid level is low, it should be topped up to the full mark in each cell.
 - Connect charger cables.
- Charger cables must be connected POSITIVE (+) to POSITIVE (+) and NEGATIVE (-) to NEGATIVE (-).**
- Do not connect or disconnect charger cables while charger is operating.
 - Switch on charger.
 - Normally, a battery should be charged at no more than 10 percent of its rated capacity. Rated capacity of the battery in your vehicle is listed on the battery housing.
 - After charging, turn off charger and disconnect charger cables.
 - Tighten the vent caps and reinstall battery.

Emergency Starting with Jumper Cables

WARNING

- Improper use of booster battery to start a vehicle may cause an explosion.
- Lead-acid batteries generate explosive gases. Keep sparks, flame and lighted cigarettes away from batteries.
- Do not charge a frozen battery, thaw it out first. Gas trapped in the ice may cause an explosion.
- No attempt should be made to jump start any vehicle with a low electrolyte level in the battery.
- Check electrolyte level of each cell. If necessary, fill with distilled water to just above plates.
- Make sure the voltage of both batteries is the same.
- The capacity (Ah) of the booster battery should not be lower than that of the discharged battery.
- Vehicle with discharged battery: turn off lights and accessories, remove key, move lever to N or P and set parking brake.
- Vehicle with booster battery should not be running. Disconnect ground cable.
- Remove vent caps from booster battery and discharged battery. Preferably lay a cloth over open vents to reduce explosion hazard.

How to use jumper cables

WARNING

- To avoid serious personal injury and damage to the vehicle, heed all warnings and instructions of the jumper cable manufacturer.
 - The jumper cables must be long enough so that neither vehicles nor cables touch another.
- Improper hook-up of jumper cables can ruin the alternator.**
- Always connect POSITIVE (+) to POSITIVE (+), and NEGATIVE (-) to ground on engine block.**
1. Connect clamp of plus-cable to positive (+) terminal of discharged battery (1).
 2. Connect clamp on opposite end of cable to positive (+) terminal of booster battery (2).
 3. Connect clamp of minus-cable to negative (-) terminal of booster battery (3).
 4. Connect clamp on opposite end of cable to a bare metal part bolted directly to the engine block or to the engine block itself (x) of car with discharged battery. Connect clamp as far away from battery as possible.
 5. Start engine in the usual manner. If engine fails to start, do not continue to crank but contact nearest workshop.
 6. With engine running, remove jumper cables from both cars in exact reverse order: Steps 4 through 1.

7. Reconnect ground cable of booster battery.

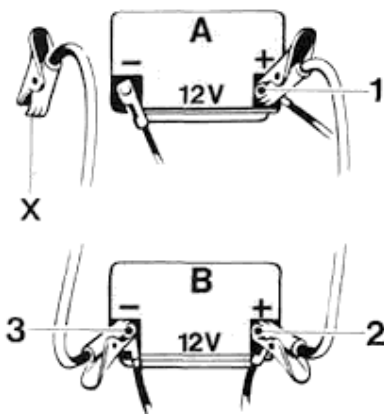

A - Discharged Battery
 B - Booster Battery
 Do not try to start car by pushing or towing. Damage to the catalytic converter, the transmission, and/or other components of the car may result.

Replacing Bulbs



944 / 944 S



944 Turbo

To avoid short circuits, turn off the respective electrical components when changing light bulbs.

Keep bulbs free of grease and dirt. Hold them only with a clean cloth or soft paper. Do not use chemical cleaning agents on the plastic lenses. Plastic lenses should only be cleaned with water or a mild soap/water solution.

We recommend that you have an assortment of spare bulbs in the car.

When traveling abroad don't forget that some countries require spare bulbs as part of the safety equipment.

Front - Turn Signal Lights / Parking Lights

1. Remove the Phillips screws from lamp lens and remove lens.
2. Push bulb into holder and twist to the left (bayonet mount).
3. Remove bulb.
4. Insert new bulb and turn to the right so that it snaps into position.

5. Install lamp lens and tighten the retaining screws evenly, alternating from one to the other.

Do not overtighten screws as this may crack the lens.

6. Check lights.

93

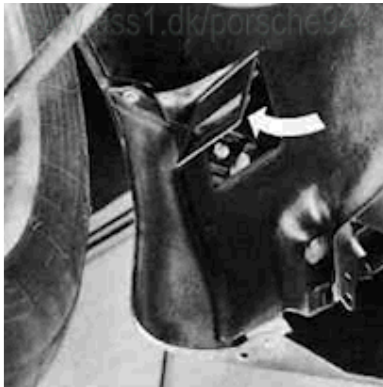

Front



Rear

Rear - Turn Signal Lights / Stop Lights / Parking Lights / Back-up Lights

1. Open hatchback and unsnap carpeting.
2. Remove knurled nut and take off bulb holder
3. Press defective bulb into socket and turn to left (bayonet mount). Discard bulb.
4. Press new bulb into socket, turn to right until it snaps into position.
5. Install bulb holder and tighten knurled nut.
6. Snap carpeting back in place.

Side Marker Lights

To change the bulb, open the flap at the front of the plastic shell beneath the fender. The rear housing is in the stowage well beneath the mat.

1. Unscrew knurled nut and remove the plastic cover.
2. Unclip lamp socket (arrow), remove defective bulb and fit replacement (bayonet mount).
3. Clip socket into place and refit plastic cover.
4. Check that light is functioning correctly.

94

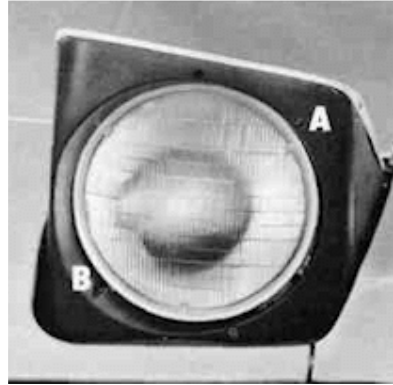
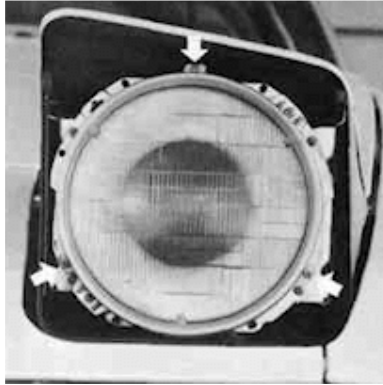

**Sealed Beam Headlights
Replacing light units**

1. Turn on the ignition and depress light switch to the second stop to raise the concealed headlights. Then turn off the ignition.
2. Remove Phillips screw from headlight trim (arrow), take off the plastic cover.
3. Remove only the three recessed screws (arrows) which secure the lamp unit retaining ring, remove retaining ring, and take out sealed beam unit.
4. Disconnect plug from rear of unit.
5. Attach plug to rear of new unit.

6. Insert sealed beam unit and retaining ring, tighten hold-down screws.
7. Check headlight adjustment.
8. Install headlight trim and tighten retaining screw.

Adjusting Headlights

Headlight adjustment should be done with a headlight aiming device under the following conditions:
At curb weight of car (i. e. car ready for use and with full fuel tank).

Driver's seat should be occupied by a person or a weight of approx. 165 lbs (75 kg).
Tire pressure must be correct.
Roll car forward a few feet so that the suspension seeks its normal position.

Headlight adjustment screws

Screw "A" (lateral adjustment)
right turn = beam moves right
left turn = beam moves left
Screw "B" (vertical adjustment)
right turn = beam moves up
left turn = beam moves down



944 Turbo



944 / 944 S



944 / 944 S

Fog Lights

On the 944 Turbo, before adjusting or removing the fog lamp unit, loosen the transparent side parts which are secured with Phillips-head screws.

1. Loosen the Phillips screws (arrows) and pull out the entire light unit.
2. Pull out cable connector plug and unsnap holding clamps.
3. Replace defective bulb. Be sure the new bulb is installed correctly.

4. Refasten holding clamps and plug in cable connection.
5. Reinstall light unit and fasten Phillips screws securely.

Screw "a" (vertical adjustment)



944 Turbo



944 Turbo

6. Check functioning of light and whether light beam is aimed correctly.
 Replace the transparent side parts (944-Turbo)
 Screw "a" (vertical adjustment)
 right turn = beam moves down left turn = beam moves up

97



Interior Light

- Carefully insert small screwdriver at cutout and pry out the whole lamp housing.
- Note:** When removing lamp, retaining clip may fall out.
- Remove defective bulb between contact springs and insert new bulb.
 - Insert one side of the light firmly back into the housing cut-out and press on the other side. Light unit will snap in place.



Ashtray Light

- Remove ashtray by pulling it up.
- Push lamp holder with bulb out of support (towards the front).
- Replace defective bulb with new bulb.
- Check bulb for operation with lights turned on.
- Reinstall ashtray so that light "window" points toward bulb on left side of well.



License Plate Light

- Open hatchback, unsnap carpeting.
- Remove screws and take off bulb holder.
- Replace defective bulb and reinstall bulb holder. Check for proper fit.
- Snap carpeting back in place.

98



Manual Operation of Retractable Headlights

If the retractable headlights do not open, they can be operated manually by turning the knob on the end of the motor drive shaft located in the front of the engine compartment. The connecting rod assembly is designed in such a way that it need only be turned to the left to either close or open the headlights.

WARNING

- Do not turn the knob on the drive shaft as long as the automatic mechanism is operating.
- The motor may turn suddenly and cause injury. Before turning the knob, check first whether the motor will work by turning on the ignition and by depressing the light switch to the second stop.

99

Emission Control System

In the Interest of Clean Air

Pollution of our environment has become a problem that is of increasing concern to all of us. We urge you to join us in our efforts for cleaner air in controlling the pollutants emitted from the automobile.

Porsche has developed an emission control system that controls or reduces those parts of the emission that can be harmful to our environment. Your Porsche is equipped with such a system.

Porsche warrants the Emission Control System in your new car under the terms and conditions set forth in the Warranty & Maintenance booklet.

You, as the owner of the vehicle, have the responsibility to provide regular maintenance service for the vehicle and to keep a record of all maintenance work performed. To facilitate record keeping, have the service performed by authorized Porsche dealers. They have Porsche trained mechanics and special tools to provide fast, efficient service.

WARNING

To assure efficient operation of the Emission Control System:

- Have your vehicle maintained properly and in accordance with the recommendations described in your Warranty & Maintenance booklet. Lack of proper maintenance, as well as improper use of the vehicle, will impair the function of the emission control system and could lead to damage.
- Do not alter or remove any component of the emission control system unless approved by the manufacturer.
- Do not alter or remove any device, such as heat shields, switches, ignition wires, valves, etc., which are designed to protect your vehicle's emission control system.
- Do not continue to operate your vehicle if you detect engine misfire or other unusual operating conditions.

Starting

- Do not leave vehicle engine idling unattended after starting. If warning lights should come on to indicate improper operation, they would go unheeded. Extended idling also produces heat, which could result in overheating or other damage to the vehicle or other property.

Parking

- As with any vehicle, do not park or operate your vehicle in areas where combustible materials, such as dry grass or leaves, can come into contact with a hot exhaust system.

Undercoating

- Do not apply additional undercoating or rust proofing on or near the exhaust manifold, exhaust pipes, catalytic converter or heat shields. During driving the substance used for undercoating could overheat and cause a fire.

How Emission Control Works

When an automobile engine is running, it uses energy generated through the combustion of a mixture of air and fuel. Depending on whether a car is driven fast or slowly or whether the engine is cold or hot, some of the fuel (hydrocarbons) may not be burned completely but be discharged into the engine crankcase or exhaust system. Additional hydrocarbons may enter the atmosphere through evaporation of fuel from the fuel tank. These hydrocarbons (HC), when released into the air, contribute to undesirable pollution. In addition, carbon monoxide (CO) and oxides of nitrogen (NOx) contribute to engine emissions. They, too, are formed during the combustion process and discharged into the exhaust system. To reduce these pollutants, your Porsche is equipped with a precisely calibrated fuel injection system to assure a finely balanced air/fuel mixture under all operating conditions.

Oxygen Sensor

The oxygen sensor, installed in the exhaust pipe continuously senses the oxygen content of the exhaust and signals the information to an electronic control unit. The control unit corrects the air/fuel ratio, so that the engine always receives an accurately metered air fuel mixture.

Crankcase Ventilation

Through Crankcase Ventilation undesirable emissions from the engine crankcase are not permitted to reach the outside atmosphere. These emissions are recirculated from the crankcase to the air intake system. From here the emissions mix with the intake air and are later burned in the engine.

Catalytic converter

The catalytic converter is an efficient "cleanup" device built into the exhaust system of the vehicle. The catalytic converter burns the undesirable pollutants in the exhaust gas before it is released into the atmosphere.

The exclusive use of unleaded fuel is critically important for the life of the catalytic converter. Therefore, only unleaded gasoline without additives must be used.

The catalytic converter will be damaged by

- push or tow starting your vehicle

- misfiring of the engine
- turning off the ignition while the vehicle is moving or

- by other unusual operating conditions.

Do not continue to operate your vehicle under these conditions, as otherwise fuel can reach the catalytic converter. This could result in overheating of the converter.

Federal law prohibits use of leaded gasoline in this car.

The Emission Control System and its other related components are illustrated and described on the following pages.

101

Emission Control System

- 1 Fuel pump
- 2 Fuel filter
- 3 Pressure damper
- 3a Pressure regulator
- 4 Injector
- 5 Auxiliary air valve
- 6 Air flow meter
- 7 Throttle valve switch
- 8 Temperature sensor
- 9 Engine temperature sensor
- 10 Speed sensor
- 11 Reference mark sensor (TDC)
- 12 Control unit
- 13 Ring gear
- 14 Ignition coil
- 15 Distributor
- 16 Relay (fuel pump / control unit)
- 17 Oxygen sensor
- 18 Catalytic converter
- 19 Muffler

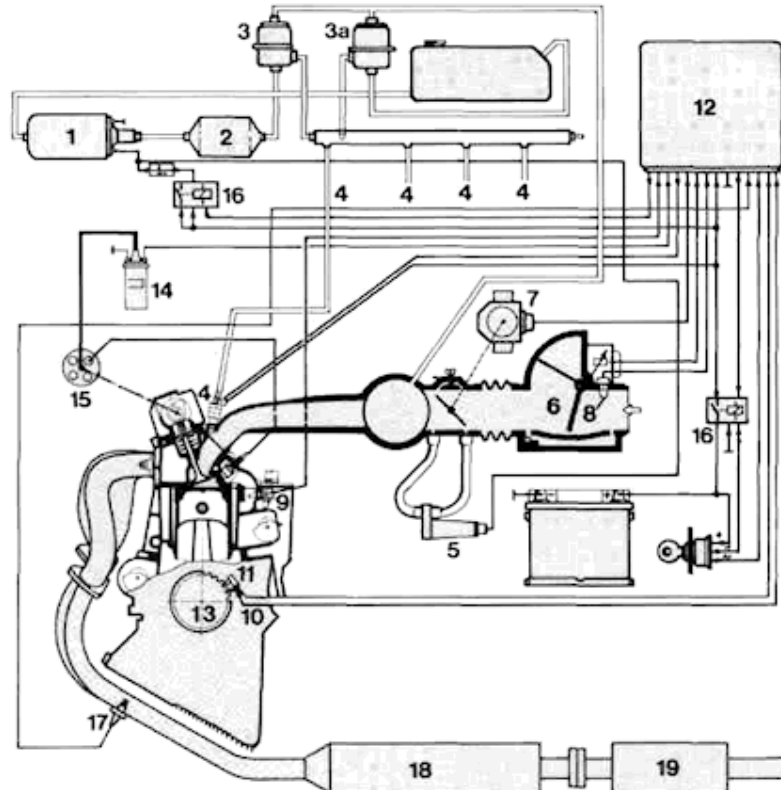

Fuel Evaporation Control

Fuel Tank Venting

The expansion chamber and the roll over valve prevent fuel from escaping to the outside at extreme high outside temperatures and when the car is driven or parked at an incline or in any other nonlevel position. The safety valve works as a restrictor in the tank vent line between the expansion chamber and the canister.

Vapor Control System and Storage

When the fuel tank is filled, vapors are collected in the expansion chamber and filler tube by a vent line leading the vapors via a roll over valve to the activated carbon canister where they are stored as long as the engine does not run. During engine operation, the vapors are stored in the activated carbon canister as long as the control valve I (ON/OFF valve) is in the OFF-position. The control valve I stops purging of the canister during all other operating conditions of the engine if the coolant temperature of the engine is below a defined temperature.

Purge System

Fuel vapors from the carbon canister will be mixed with fresh air taken from the ambient

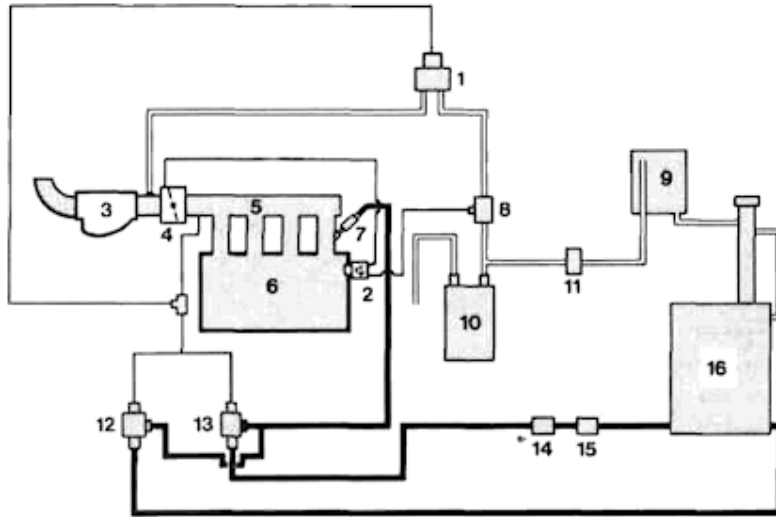

- | | | | |
|----------------------|----------------------------|-----------------------|--------------------|
| 1 Control valve II | 5 Intake manifold | 9 Expansion chamber | 13 Pressure damper |
| 2 Temperature switch | 6 Engine | 10 Charcoal canister | 14 Fuel filter |
| 3 Air flow meter | 7 Injection valve | 11 Roll over valve | 15 Fuel pump |
| 4 Throttle valve | 8 Control valve I (ON/OFF) | 12 Pressure regulator | 16 Fuel tank |

of the carbon canister or fuel vapors from the fuel tank. The vapors will be directed via a control valve I and control valve II to the air intake system housing. The control valve I has the following functions:

To stop purging of the canister during idle (the rich vapor flow from the canister would influence the mixture characteristic).
To allow purging of the canister during all other operating conditions of the engine.
The control valve II controls the vapor flow to the engine.

Engine

944

Number of cylinders	4
Bore	3.94 in. / 100 mm
Stroke	3.11 in. / 78.9 mm
Displacement	151 cu. in. / 2479 cm ³
Compression ratio	9.7:1
SAE net-power	147 hp/ 110 kW at 5800 rpm
SAE net-torque	140 ft lb / 190 Nm at 3000 rpm
Output per liter	59,3 SAE net-hp / 44,4 SAE net-kW
Max. permissible rpm	6500
Fuel octane rating	Unleaded fuel only 91 RON (87 CLC or AKI ((R+M)/2) rating on fuel pumps in U.S.A.)
Spark plugs	Bosch WR 7 DC or Champion RN 9 YC
Electrode gap	0.028 + 0.004 in. / 0.7 + 0.1 mm
Battery capacity	12 volts, 63 Ah
Alternator output	1610W/115A
Firing order	1-3-4-2
Ignition timing	Self-adjusting DME (Digital-Motor-Electronic)
Ignition	Transistorized ignition system with breaker less distributor
Belt for alternator	Polyrib K6 1000 Lw
Belt for servo pump	9.5 x 950 LA
Valve clearance	Hydraulic valve clearance compensation

Engine**944 S**

Number of cylinders	4
Bore	3.94 in. / 100 mm
Stroke	3.11 in. / 78.9 mm
Displacement	151 cu. in. / 2479 cm ³
Compression ratio	10.9:1
SAE net-power	188 hp/ 140 kW at 6000 rpm
SAE net-torque	170 ft lb / 230 Nm at 4300 rpm
Output per liter	75,8 SAE net-hp / 56,5 SAE net-kW
Max. permissible rpm	6800
Fuel octane rating	Unleaded fuel only 95 RON (90 CLC or AKI ((R+M)/2) rating on fuel pumps in U.S.A.)
Spark plugs	Bosch WR 7 DC
Electrode gap	0.028 + 0.004 in. / 0.7 + 0.1 mm
Battery capacity	12 volts, 63 Ah
Alternator output	1610W/115A
Firing order	1-3-4-2
Ignition timing	Self-adjusting DME (Digital-Motor-Electronic)
Ignition	Transistorized ignition system with breaker less distributor
Belt for alternator	Polyrib K6 1000 Lw
Belt for servo pump	9.5 x 950 LA
Valve clearance	Hydraulic valve clearance compensation

107

Engine**944 Turbo**

Number of cylinders	4
Bore	3.94 in. / 100 mm
Stroke	3.11 in. / 78.9 mm
Displacement	151 cu. in. / 2479 cm ³
Compression ratio	8.0:1
SAE net-power	217 hp/ 162 kW at 5800 rpm
SAE net-torque	243 ft lb / 330 Nm at 3500 rpm
Output per liter	87,5 SAE net-hp / 65,3 SAE net-kW
Max. permissible rpm	6500
Fuel octane rating	Unleaded fuel only 90 RON (90 CLC or AKI ((R+M)/2) rating on fuel pumps in U.S.A.)
Spark plugs	Bosch WR 7 DC
Electrode gap	0.028 + 0.004 in. / 0.7 + 0.1 mm
Battery capacity	12 volts, 63 Ah
Alternator output	1610W/115A
Firing order	1-3-4-2
Ignition timing	Self-adjusting DME (Digital-Motor-Electronic)
Ignition	Transistorized ignition system with breaker less distributor
Belt for alternator	Polyrib K6 1000 Lw
Belt for servo pump	9.5 x 950 LA
Valve clearance	Hydraulic valve clearance compensation

108

Engine Design Specifications

Design	4-cylinder, in-line engine, front mount with two balance-shafts
Operating cycle	4-stroke
Lubrication	Pressure oil circulation from oil sump, full flow filter
Cylinder block	Light metal
Cylinder head	Light metal
Valve operation	Overhead camshaft (944 S: 2 overhead camshafts)
Camshaft drive	Spur belt drive
Crankshaft	Forged, 5 main bearings
Fuel injection	AFC (Air Flow Control)

Power Train

Manual transmission	Gear ratio 944	Gear ratio 944 S	Gear ratio 944 Turbo
Gear ratio	3.600:1	3.500:1	3.500:1
1st gear	2.125:1	2.059:1	2.059:1
2nd gear	1.458:1	1.400:1	1.400:1
3rd gear	1.071:1	1.034:1	1.034:1
4th gear	0.730:1	0.829:1	0.829:1
5th gear	3.500:1	3.500:1	3.500:1
Axle ratio	3.889:1	3.889:1	3.375:1
Clutch	Single plate dry disc, hydraulically operated		
Power transmission	Double constant velocity joints and drive shaft		

Automatic transmission

944

Gear ratio 1st gear	2.714:1
2nd gear	1.500:1
3rd gear	1.000:1
Reverse gear	2.429:1
Axle ratio	3.455:1
Clutch	Hydrodynamic torque converter

109

Filling Capacities

Engine oil	With filter change approx. 6.34 (Turbo: approx. 6.87) U.S. qts. or 6 (Turbo: approx. 6.5) liters. Check oil level with dipstick a few minutes after engine has stopped. The difference between the max. and min. marks on the dipstick is approx. 1 U.S. qt. or 1 liter. Only use brand name oil which has been tested and approved by Porsche. Your authorized Porsche dealer will be glad to advise you. Porsche does not recommend the use of oil additives. See also "Engine Oils".		
Cooling system with heating	Approx. 8.2 U.S. qts. or 7,8 liters. Factory filled to -31 °F (-35°C). Only use phosphate-free anti-freeze containing ethylene glycol recommended for aluminum engines and radiators.		
Manual transmission	Approx. 0.53 U.S. gal. or 2.0 liters. Use hypoid oil SAE 80 labeled "For Service API/GL4 or Mil-L 2105".		
Automatic transmission with torque converter	Approx. 1.72 U.S. gal. or 6.5 liters ATF Dexron®. At oil changes 3 U.S. qts. or 2.8 liters are required.		
Differential of automatic transmission	Approx. 1 U.S. qts. or 1 liter hypoid oil SAE 90 according to API classification GL 5 or Mil-L 2105 B.		
Power steering	Approx. 0.63 U.S. qts. or 0.6 liter ATF Dexron®		
Fuel tank	Approx. 21.1 U.S. gals, or 80 liters including a reserve of 2.1 U.S. gals, or 8 liters. Unleaded fuel only! Minimum octane rating 944 91 RON (87 CLC or AKI ((R+M)/2) rating on fuel pumps in U.S.A.), 944 S / 944 Turbo 95 RON (90 CLC or AKI ((R+M)/2) rating on fuel pumps in U.S.A.)		
Brake fluid	Approx. 0.42 U.S. pint or 0.2 liter. Only use brake fluid conforming to specifications SAE J 1703, DOT 3 or DOT 4.		
Windshield and headlight washer system	Approx. 1.59 U.S. gals, or 6.0 liters.		
Refrigerant for air conditioning	Approx. 33.5 oz or 950 g. Refrigerant R 12 (CCl ₂ F ₂)		
Cooling system mixing chart (Approximate values)	Temp, down to	Anti-freeze	Water
Anti-freeze-Water	-13° F (-25° C)	40%	60% 3.1 liters / 3.3 U.S. qts.4.7 liters / 5.0 U.S. qts.
Consult your authorized dealer about the approved anti-freeze mixtures.	-23° F (-30° C)	45%	55% 3.5 liters / 3.7 U.S. qts.4.3 liters / 4.5 U.S. qts.
	-31° F (-35° C)	50%	50% 3.9 liters / 4.1 U.S. qts.3.9 liters / 4.1 U.S. qts.

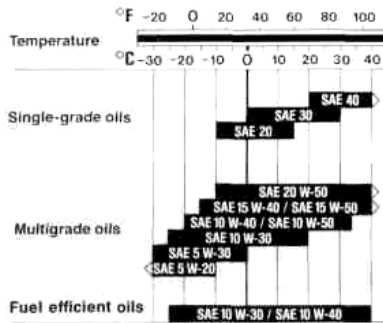

Engine Oils

Use only engine oils which meet the specifications designated by PORSCHE. Your Porsche dealer will be glad to advise you on the correct type of oil for your engine. All current engine oils are compatible with each other, i. e. when making an oil change it is not necessary to flush the engine if you wish to use a different brand or grade of oil. Since, however, each brand of oil has a special composition, you should, if possible, use the same oil brand if it becomes necessary to top up between oil changes. PORSCHE engines have long intervals between oil changes. You can make best use of these long oil change intervals by using multigrade oils since these are largely independent of seasonal fluctuations in temperature.

If your vehicle is used frequently in stop-and-go traffic in winter, the engine will not always be properly warmed up. Condensation from products of combustion may accumulate in the oil. In this case, it is advisable to change the oil in spring so that your engine once again has a 100% efficient engine oil.

Engine oil performance class

Engine oil is not only a lubricant, but also serves to keep the engine clean, to neutralize the dirt which penetrates into the engine through combustion and to protect the engine against corrosion. To perform these functions, the oil is provided with additives which have been specially developed for these functions. So-called mineral oils are produced directly from crude oil. The oils can be further refined (hydrocrack oils) or totally converted through a number of chemical processes (synthetic oils). These oils are structurally more efficient and require fewer additives than simple mineral oils.

The efficiency of an oil is expressed, for example, by the API classifications which are divided into categories "S" and "C". The degrees of quality are expressed by final letters in alphabetical order: The requirements for PORSCHE engines are API class SE/CC to SF/CD.

Viscosity

Like all liquids, engine oil is viscous when cold, and thin-bodied when warm.

The viscosity of an oil is expressed by its SAE class. For cold viscosity (measured at temperatures below 0°C) the SAE class is given as a number and the letter "W" (as in winter); for hot viscosity (measured at 100°C) the SAE class is given only as a number. The viscosity of an oil is, therefore, always the same if it has the same number of an SAE class.

E. g.: A 10 W-30 oil and a 10 W-40 oil have the same viscosity when cold (below 0°C); when hot (at 100°C) the oil with the number 30 is thinner than the oil with the number 40.

Single-grade/multigrade oils

Oils with two viscosities are called multi-grade oils; oils with only one viscosity are termed single-grade oils.

Single-grade oils can only be used for the narrow temperature range identified by their SAE number; multigrade oils cover a wider temperature range (see chart).

Fuel efficient oils

Fuel efficient oils reduce internal friction in the engine. PORSCHE approves only fuel efficient oils which are structurally so stable that they can be used in PORSCHE engines both as summer and winter oils (see chart of areas of application for oils of different viscosity). These conditions are currently fulfilled by synthetic or hydrocrack fuel efficient oils.

111

Tires, Rims

944 / 944 S

Tires, Rims (Rim offset 52,3 mm)	215/60 VR 15 front and rear on rims 7 J x 15 H2 or 205/55 VR 16 on 7 J x 16 H2 front and 225/50 VR 16 on 8 J x 16 H2 rear
Snow tires (Rim offset 52,3 mm)	195/65 R 15 80 Q M + S front and rear on rims 7 J x 15 H2 or 215/60 R 15 80 Q M + S front and rear on rims 7 J X 15 H2 or 205/55 R 16 80 Q M + S front and rear on rims 7 J x 16 H2 or 205/55 R 16 80 Q M + S on rims 7 J x 16 H2 front and 225/50 R 16 80 Q M + S on 8 J x 16 H2 rear The load rating and identification letter for allowable maximum speed (e.g. 80 Q/VR 15) represent minimum requirements.
Collapsible spare tire	165-15 8 PR 89 P on rim 5 1/2 J x 15 H2 Tire pressure always 36 psi (2.5 bar/atm.), front or rear use. Maximum speed is 50 mph (80km/h).
Cold tire pressure	front 29 psi (2.0 bar), rear 36 psi (2.5 bar)
Snow chains	Should snow chains be necessary, they must be mounted on the drive wheels only. Maximum speed is 30 mph (50 km/h). Always use Porsche - approved snow chains.

Important hint:

For tires with **VR quality standard**, there are currently no final standards concerning tire strength at speeds above 210 km/h. For this reason, only use tire makes and types tested by Porsche. If you intend to use other than original equipment wheels, be sure that they conform to Porsche specifications for your model. Check with your Porsche dealer regarding the correct wheel specifications for type and model year.

112

Tires, Rims

944 Turbo

Tires, Rims (Rim offset 52,3 mm)	205/55 VR 16 on rims 7 J x 16 H2 front and 225/50 VR 16 on rims 8 J x 16 H2 rear
Snow tires (Rim offset 52,3 mm)	205/55 R 16 82 Q M+S on rims 7 J x 16 H2 front and rear or 205/55 R 16 82 Q M + S on rims 7 J x 16 H2 front and 225/50 R 16 82 Q M + S on rims 8 J x 16 H2 rear The load rating and identification letter for allowable maximum speed (e.g. 82 Q/VR 16) represent minimum requirements.
Collapsible spare tire	165-15 8 PR 89 P on rim 51/2 J x 15 H2
Cold tire pressure	Tire pressure always 36 psi (2.5 bar/atm.), front or rear use. Maximum speed is 50 mph (80 km/h).
Snow chains	front and rear 36 psi (2.5 bar) Should snow chains be necessary, they must be mounted on the drive wheels only. Maximum speed is 30 mph (50 km/h). Always use Porsche - approved snow chains.

Important hint:

For tires with **VR quality standard**, there are currently no final standards concerning tire strength at speeds above 210 km/h. For this reason, only use tire makes and types tested by Porsche.
If you intend to use other than original equipment wheels, be sure that they conform to Porsche specifications for your model. Check with your Porsche dealer regarding the correct wheel specifications for type and model year.

113

Dimensions

	944 / 944 S	944 Turbo
Length	168.90 in. / 4290 mm	168.90 in. / 4290 mm
Width	68.31 in. / 1735 mm	68.31 in. / 1735 mm
Height	50.20 in. / 1275 mm	50.20 in. / 1275 mm
Wheel base	94.49 in. / 2400 mm	94.49 in. / 2400 mm
Wheel track, front	58.15 in. / 1477 mm	58.15 in. / 1477 mm
Wheel track, rear	57.13 in. / 1451 mm	57.13 in. / 1451 mm
Ground clearance*	4.72 in. / 120 mm	4.72 in. / 120 mm
Tuning circle (curb to curb)	31.17 ft. / 9.5 m	31.17 ft. / 9.5 m
Tuning circle (wall to wall)	33.80 ft./ 10.3 m	33.80 ft./ 10.3 m
Overhang angle, front*	14°	12,5°
Overhang angle, rear*	15°	15°

Weights

	944	944 S	944 Turbo
Curb weight	2778 lbs. / 1260kg	2866 lbs. / 1300 kg	2998 lbs. / 1360 kg
Maximum load capacity	661 lbs. / 300 kg	661 lbs. / 300 kg	650 lbs. / 285 kg
Total permissible weight	3439 lbs. / 1560kg	3527 lbs. / 1600 kg	3626 lbs. / 1645 kg
Maximum axle load, front**	1587 lbs. / 720kg	1609 lbs. / 730kg	1675 lbs./ 760kg
Maximum axle load, rear**	1984 lbs. / 900kg	1984 lbs. / 900 kg	2028 lbs. / 920 kg
Permissible rack load**/**	165 lbs. / 75kg	165 lbs. / 75kg	165 lbs. / 75kg

* At total permissible weight. ** Do not exceed total permissible weight.

*** Applies only if the basic rack of the original Porsche Roof Transport System is used. If old type Porsche ski and luggage racks are used the permissible roof weight is 35 kg (77 lbs.).

The vehicle capacity weight (max. load), the Gross Vehicle Weight Rating (GVWR) and the Gross Axle Weight Ratings (GAWR) for front and rear, are listed on the sticker on the left upper side member in the engine compartment.

The gross vehicle weight rating includes the weight of the basic vehicle plus full tank, oil and coolant, plus max. load which combines passenger (150 pounds / 68 kg per designated position) and luggage weight. Luggage weight is not increased by the use of roof, ski or luggage racks, unless passenger capacity is reduced accordingly.

Wheel Alignment

Wheel camber*	Front	-20' ± 15', maximum difference left to right 20'
	Rear	-1° ± 20', maximum difference left to right 30'
Toe-in*	Front	+ 10' ± 5'
	Rear	0° ± 10', maximum difference left to right 20' at 20° to left and right -1° ± 20'
Toe angle difference*		
Caster*		2,5° + 30' - 15'

* at DIN curb weight

Brake System

Hydraulic dual circuit brake system with
front/rear brake circuits
internally ventilated disc brakes front and rear
Brake power assist
Parking brake acting on rear wheels

Chassis, Suspension

Unitized construction	
Front suspension	Independent coil/shock absorber struts, positive king-pin offset
Rear suspension	Independent - diagonal arm, one torsion bar each
Shock absorbers	Double acting hydraulic shock absorbers, front and rear
Stabilizers	Diameter - front: 20 mm (optional 21,5), Turbo: 22.5 mm or 24 x 3.7 mm rear: 14 mm or 20 mm (optional), Turbo: 18 mm

115

Performance*

	Manual transmission 944	944 S	944 Turbo	Automatic transmission 944
Maximum speed	131 mph (210 km/h)	142 mph (228 km/h)	152 mph (245 km/h)	131 mph (210 km/h)
Acceleration 0-60 mph	8.3 seconds	7.7 seconds	6.1 seconds	9.8 seconds
Time at end 1/4 mile*	16.2 seconds	15.4 seconds	14.4 seconds	17.2 seconds
Time at end 1/4 mile*	30.1 seconds	27.8 seconds	26.0 seconds	17.2 seconds

* At curb weight and half-load capacity, excluding optional equipment and accessories.

Climbing Performance

	Manual transmission 944	944 S	944 Turbo	Automatic transmission 944
1st gear	approx. 61%	approx. 62%	approx. 62%	approx. 36%
2nd gear	approx. 33%	approx. 36%	approx. 49%	approx. 18%
3rd gear	approx. 21%	approx. 22%	approx. 30%	approx. 10%
4th gear	approx. 14%	approx. 14%	approx. 20%	
5th gear	approx. 8%	approx. 9%	approx. 14%	

Full-power Curves

944

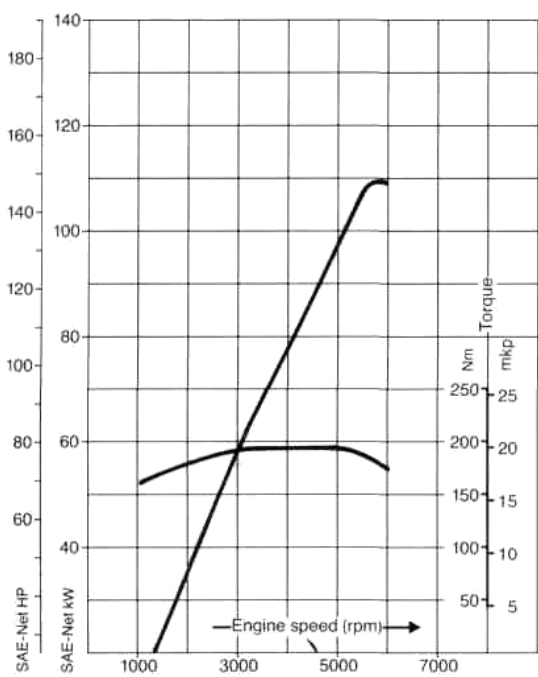

Acceleration Curve
Manual gearbox

944

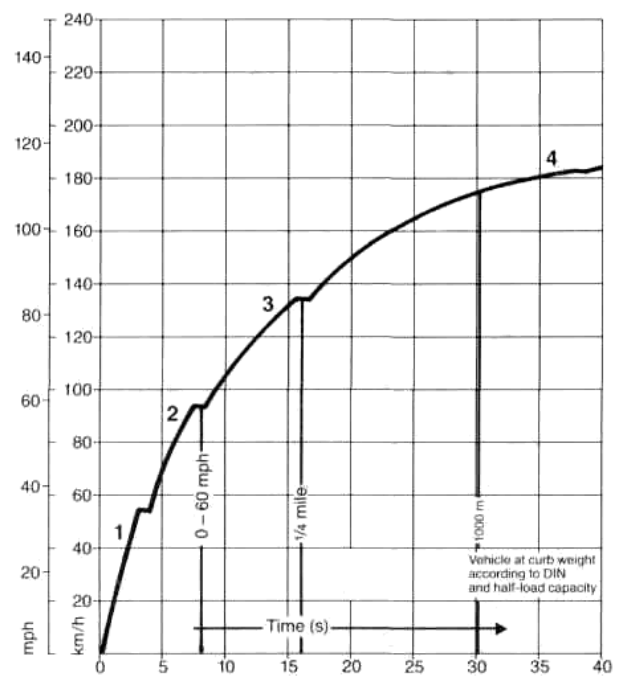

**Acceleration Curve
Automatic**

944

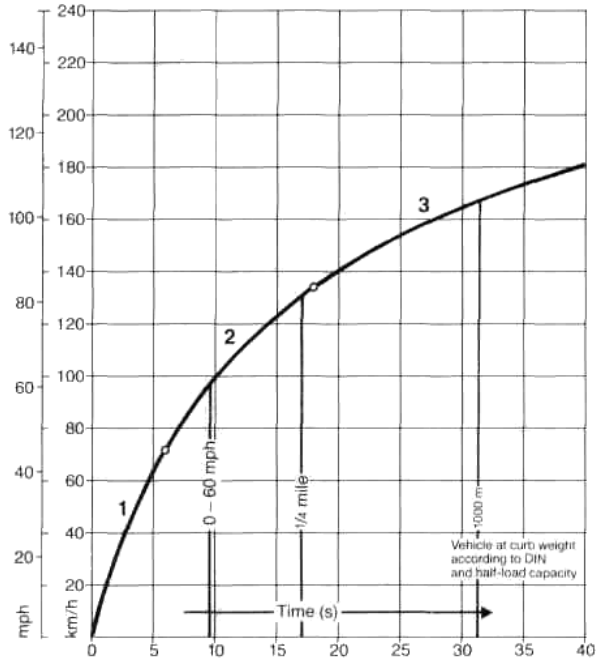

119

Full-power Curves

944S

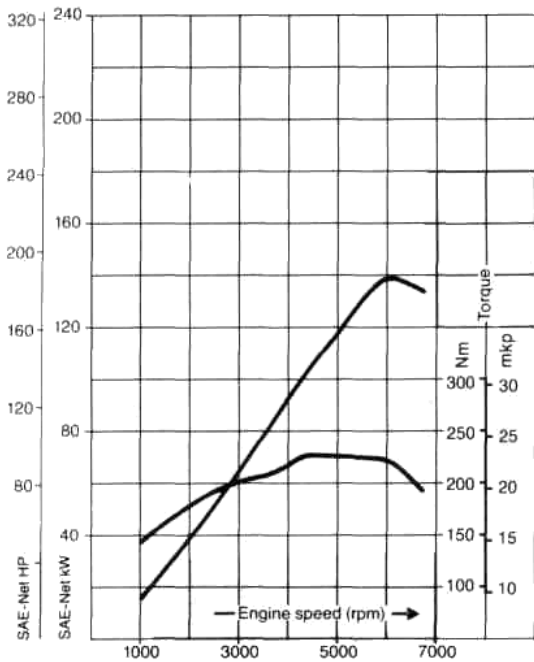

120

**Acceleration Curve
Manual gearbox**

944S

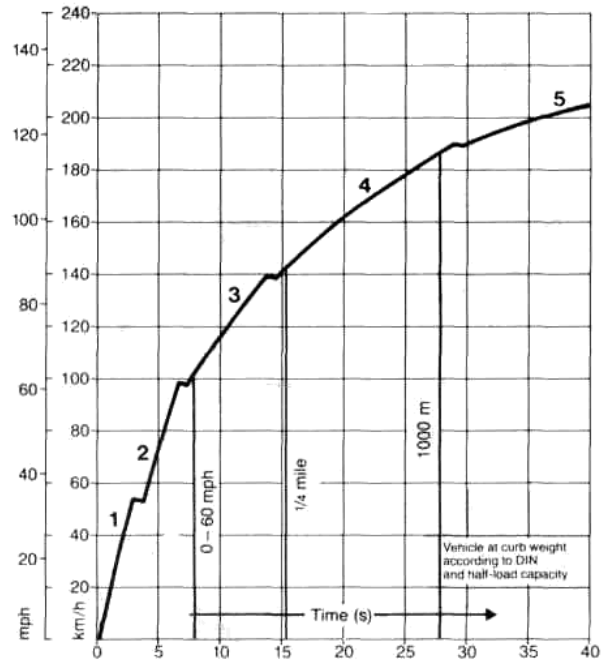

Full-power Curves

944Turbo

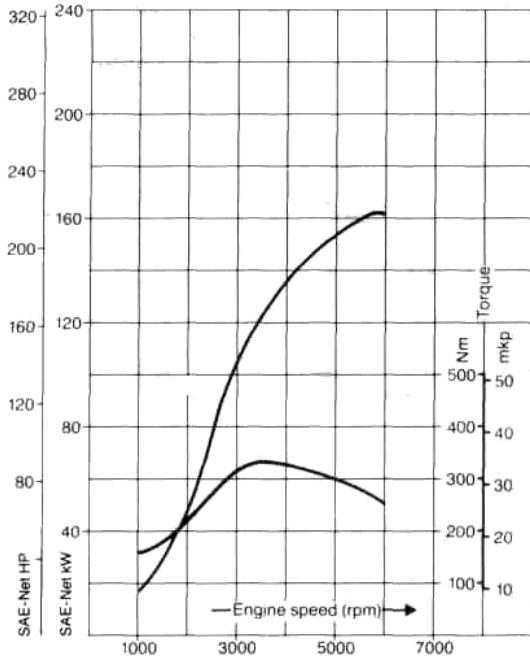

Acceleration Curve
Manual gearbox

944Turbo

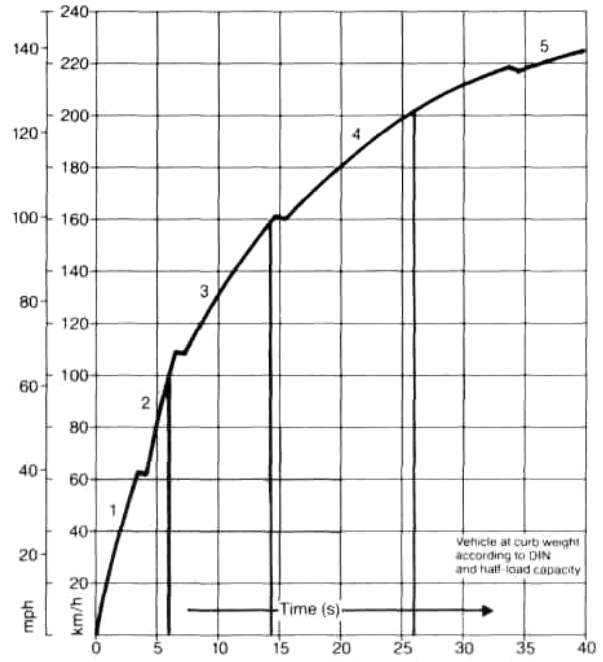

Transmission Diagram
Manual gearbox

944

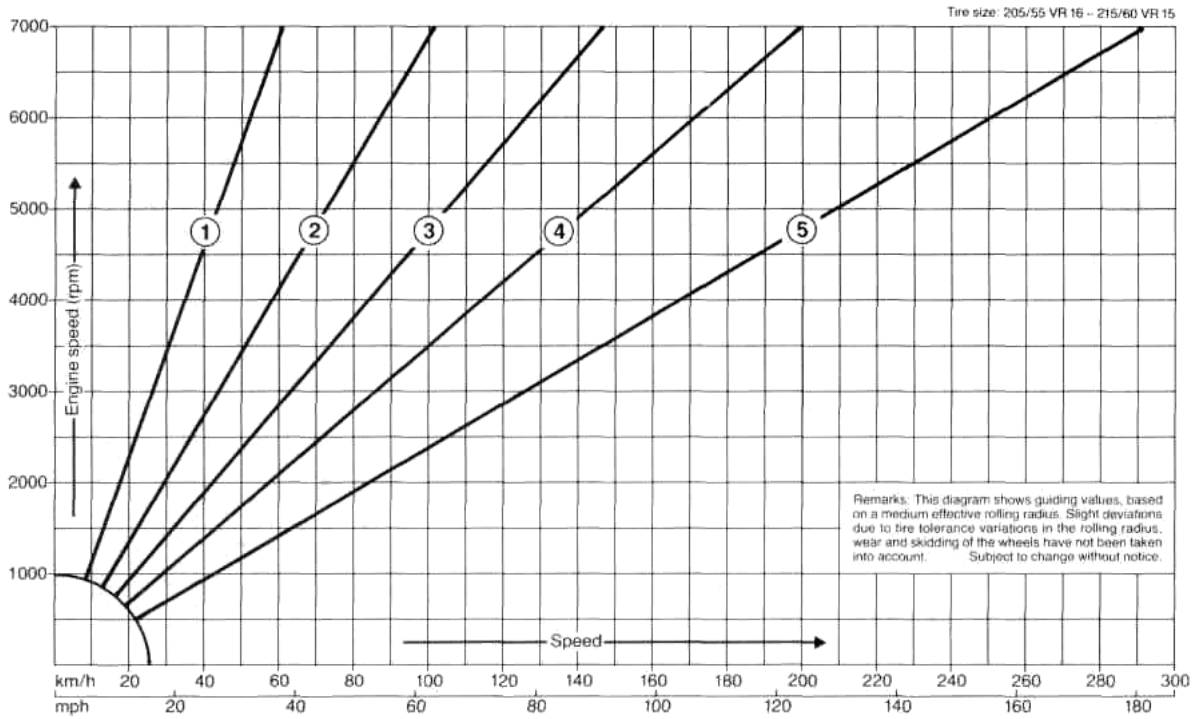

**Transmission Diagram
Automatic**

944

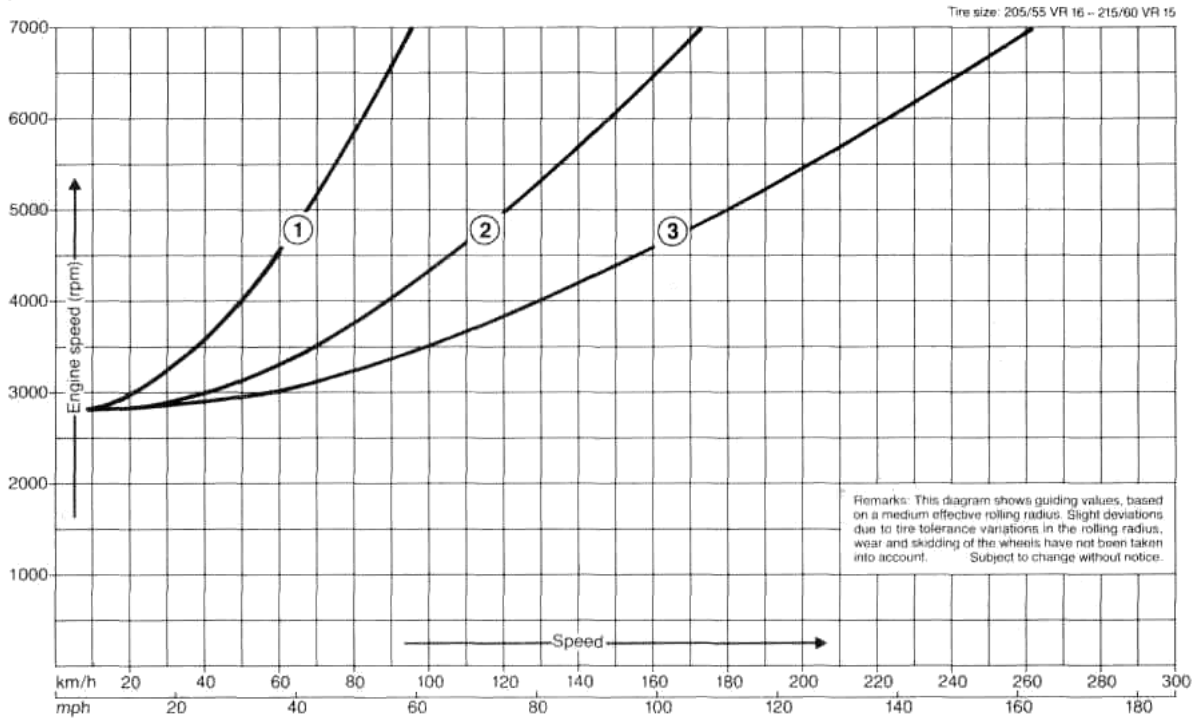

123

**Transmission Diagram
Manual gearbox**

944S

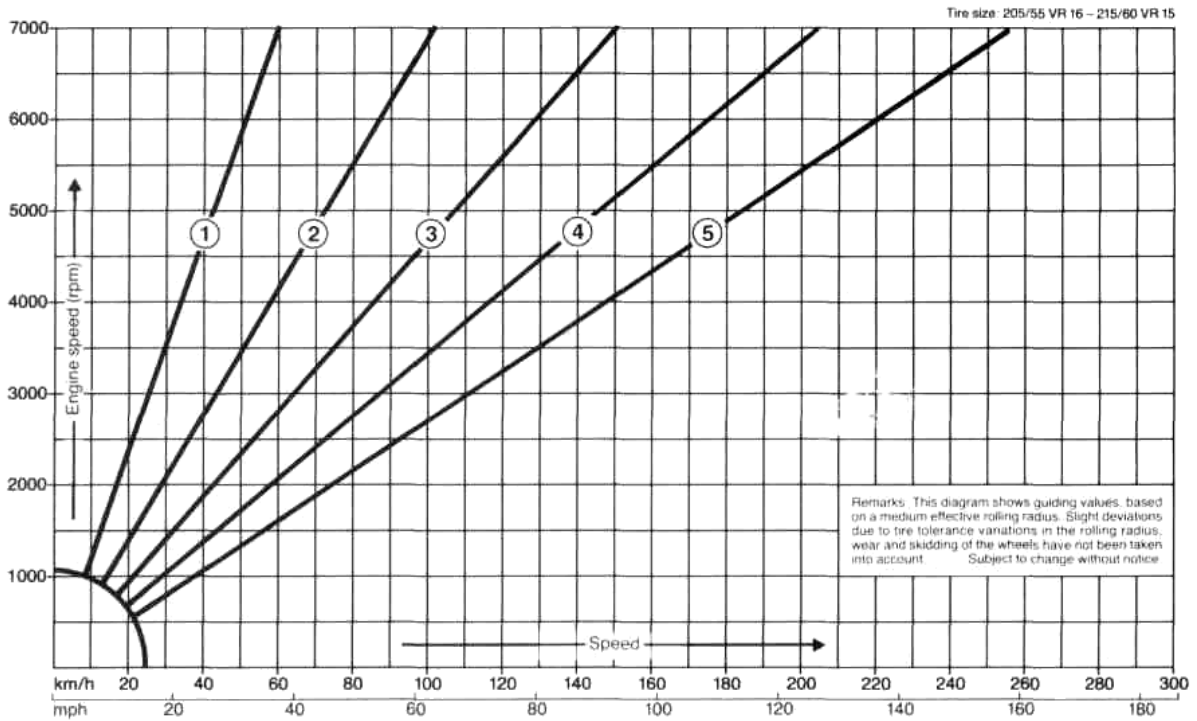

124

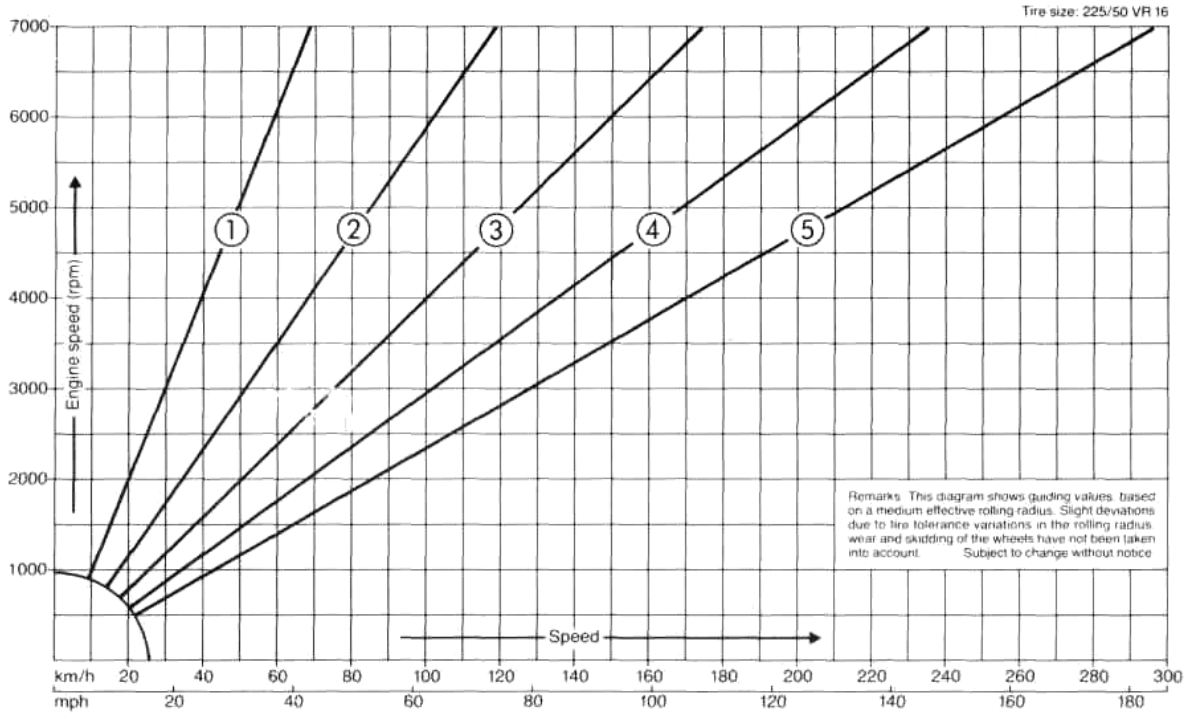

Gas Station Information

Fuses and relays

The fuses are located within the central electric box at the rear left of the engine compartment in front of the pivot point for the left windshield wiperarm (under black plastic cover). **The use of the fuses and relays is shown in a list on the inside of the cover of the fuses and relays.**

Fuel recommendation

944: 91 RON (87 CLC or AKI ((R+M)/2) rating on fuel pumps in U.S.A.) minimum.
944 S / 944 Turbo: 95 RON (90 CLC or AKI ((R+M)/2) rating on fuel pumps in U.S.A.)

UNLEADED FUEL ONLY.

Fuel tank capacity: 21.1 U.S. gals, or 80 liters.

Federal law prohibits use of leaded fuel in this vehicle.

Starting

Manual transmission: Only start in Neutral, clutch pedal depressed.

Automatic transmission:

Start in Park.

Starting cold or hot engine

Just turn ignition key. No need to depress accelerator pedal.

Emergency starting

Car must not be started by pushing or towing.



Seat adjustment
Pull lever in front of seat.

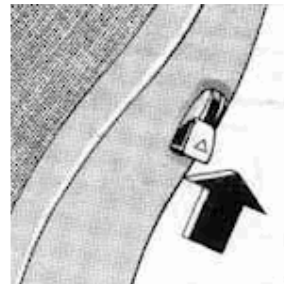

Backrest
Lift lever on side of seatback.



Fuel cap
Located in the right rear panel. To close, turn cap clockwise to stop.

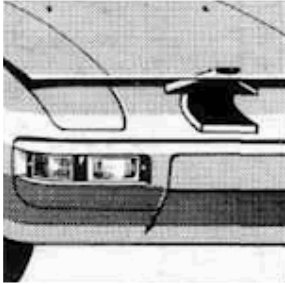

Engine hood release
Pull lever on left underneath dashboard. Disengage safety catch and lift engine hood up.

Battery
In cowl area in engine compartment. Check each cell. Top up with distilled water.

Never disconnect battery while engine is running. It can ruin the alternator.
Before connecting quick-charger, battery must be disconnected.

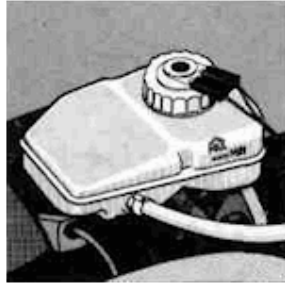

Brake fluid reservoir
Level should be between MIN and MAX marks. Only use new brake fluid according to SAE recommendation J 1703, DOT 3 or DOT 4 and conforming to Motor Vehicle Safety Standard 116. **Do not use silicone base brake fluid (DOT 5).** Even the smallest traces may cause severe corrosion in the brake system.

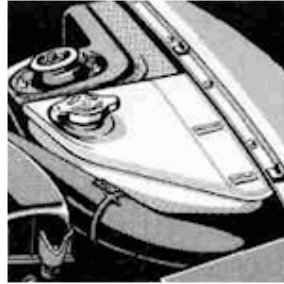

Coolant reservoir
Antifreeze must remain in cooling system all year round. Coolant level should be between minimum and maximum mark when engine is cold. Always add antifreeze and water in ratio specified under "Filling Capacities". Use quality antifreeze containing ethylene glycol.

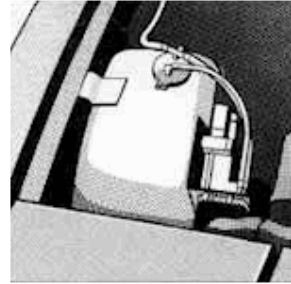

Windshield and headlight washer reservoir
1.6 U.S. gal. or 6.0 liters

127

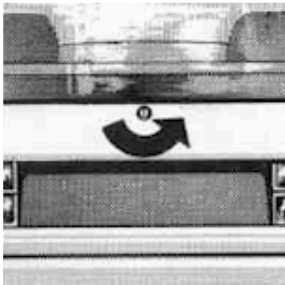

Rear Lid
Unlock by turning door/ignition key counter-clockwise or operating the control switch.



Engine oil dipstick
Check oil level a few minutes after engine has stopped. Level should be between upper and lower marks on dipstick. Difference between marks is approx. 1 U.S. qt. or 1 liter.

WARNING
Before checking anything in the engine compartment, let the engine cool down. The fan blades will rotate spontaneously (even with ignition off) until coolant temperature drops.

Engine oil
Always use quality oil labeled "API" Service "SE or SF". Details under "Engine Oils".
With filter change approx. 6.34 U.S. qts. (6.0 liters)
944 Turbo: approx. 6.87 U.S. qts. (6.5 liters)
Check oil level as described on "Engine oil level".

Manual transmission oil with differential
Hypoid oil SAE 80 according to API classification GL 4 or Mil-L 2105.

Automatic transmission
ATF lubricates torque converter and transmission. Use ATF "Dexron®" only. Quantity at oil change: approx. 3 U.S. qts. or 2.8 liters. Check ATF level visually through transparent reservoir at rear end of transmission housing. Difference between marks approx. 1 U.S. pint or 0.4 liter. Check ATF level when ATF is warm, with engine idling, selector lever in Neutral and car on level ground. For differential use oils API/GI 5 (or Mil-L 2105 B), viscosity SAE 90.

128

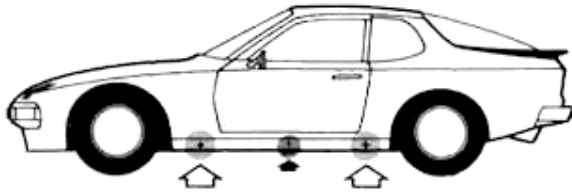

Jack support points

Black arrow: Jackport for car jack
White arrows: Lift points for workshop hoist or floor jack
front on the inboard side members
rear on the side reinforcement brackets

Spare tire

Under luggage compartment cover

Car jack

Behind spare tire wheel well under luggage compartment cover

Use jack only to change a wheel

Never lift car by bumpers

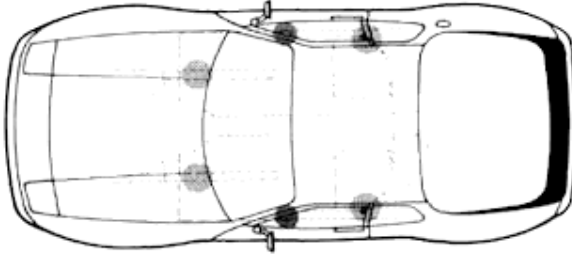

Toolkit

In right-hand storage well beneath carpet.

Tire pressure

Cold tire pressures

29 psi (2.0 bar/atm) - front

36 psi (2,5 bar/atm) - front **Turbo**

36 psi (2,5 bar/atm) - rear

Collapsible spare tire front and rear 36 psi (2.5 bar/atm)