

## Dear Owner,

We would like to thank you for your purchase of a Porsche Cayenne. Judging by the car you have chosen, you are a motorist of a special breed, and you are probably no novice when it comes to automobiles.

Remember however, as with any vehicle, you should take time to familiarize yourself with your Porsche and its performance characteristics. Always drive within your own unique capabilities as a driver and your level of experience with your Porsche. Ensure that anyone else driving your Porsche does the same. To prevent or minimize injury, always use your safety belts. Never consume alcohol or drugs before or during the operation of your vehicle.

This Owner's Manual contains a host of useful information. Please take the time to read this manual before you drive your new Porsche. Become familiar with the operation of your Porsche car for maximum safety and operating pleasure. The better you know your Porsche, the more pleasure you will experience driving your new car. Always keep your Owner's Manual in the car, and give it to the new owner if you ever sell your Porsche.

**A separate Maintenance Booklet** explains how you can keep your Porsche in top driving condition by having it serviced regularly.

**A separate Warranty and Customer Information Booklet** contains detailed information about the warranties covering your Porsche.

### For U.S. only:

If you believe that your vehicle has a fault which could cause a crash, injury or death, you should immediately inform the National Highway Traffic Safety Administration (NHTSA) in addition to notifying Porsche Cars North America, Inc. (Porsche Cars N.A.).

If NHTSA receives similar complaints, it may open an investigation, and if it finds that a safety problem exists in a group of vehicles, it may order a recall and remedy campaign. However, NHTSA cannot become involved in individual problems between you and your dealer, or Porsche Cars N.A.

To contact NHTSA, you may call the Vehicle Safety Hotline toll-free at 1-888-327-4236 (TTY: 1-800-424-9153); go to <http://www.safercar.gov>; or write to: Administrator, NHTSA, 400 Seventh Street, SW., Washington, DC 20590. You can also obtain other information about motor vehicle safety from <http://www.safercar.gov>.

Your car has thousands of parts and components which have been designed and manufactured in accordance with Porsche's high standards of engineering quality and safety.

## Warning!

---

**Any alteration or misuse of the vehicle can lead to accidents and serious or fatal personal injuries.**

**Any alteration of the vehicle may negate or interfere with those safety features built into the vehicle. Modifications may be carried out on your vehicle only if approved by Porsche. Your Porsche is intended to be used in a safe manner obeying the local laws and in the light of driving conditions faced by you, and in accordance with the instructions provided in this Owner's Manual.**

- ▷ Do not misuse your Porsche by ignoring those laws and driving conditions, or by ignoring the instructions in this manual.
- 

**Regularly check your vehicle for signs of damage.**

**Damaged or missing aerodynamic components such as spoilers or underside panels affect the driving behavior and therefore must be replaced immediately.**

Your car may have all or some of the components described in this manual. Should you have difficulty understanding any of the explanations of features or equipment installed in your vehicle, contact your authorized Porsche dealer. He/She will be glad to assist you. Also check with your dealer on other available options or equipment.

Throughout this booklet, left is designated as the driver's side of the vehicle, and right as the passenger's side of the vehicle.

Text, illustrations and specifications in this manual are based on the information available at the time of printing.

It has always been Porsche's policy to continuously improve its products. Porsche, therefore, reserves the right to make changes in design and specification, and to make additions or improvements in its product without incurring any obligation to install them on products previously manufactured.

We wish you many miles of safe and pleasurable driving in your Porsche.

### Important!

---

For your own protection and longer service life of your car, please heed all operating instructions and special warnings. These special warnings use the safety alert symbol, followed by the words **Danger, Warning and Caution**. These special warnings contain important messages regarding your safety and/or the potential for damage to your Porsche. Ignoring them could result in serious mechanical failure, serious personal injury or death.

---

- ▷ Do not alter your Porsche. Any alteration could create dangerous conditions or defeat safety engineering features built into your car.
- ▷ Do not misuse your Porsche. Use it safely, and consistently with the law, according to the driving conditions, and the instructions in this manual.

**Alteration or misuse of your Porsche could cause accidents and serious personal injury or death.**

### Note to owners

In Canada, this manual is also available in French. To obtain a copy contact your dealer or write to:

### Note aux propriétaires

Au Canada on peut se procurer un exemplaire de ce Manuel en français auprès du concessionnaire ou du:

Porsche Cars Canada, Ltd.  
Automobiles Porsche Canada, LTEE

5045 Orbitor Drive  
Building #8, Suite 200  
Mississauga, Ontario  
Canada L4W 4Y4

Telephone number for customer assistance:  
1-800-PORSCHE / Option 3

### Setting and operating vehicle components when driving

#### Warning!

---

**There is a danger of accident if you set or operate the on-board computer, radio, navigation system, telephone or other equipment when driving. This could distract you from the traffic and cause you to lose control of the vehicle resulting in serious personal injury or death.**

- ▷ Operate the components while driving only if the traffic situation allows you to do so safely.
  - ▷ Carry out any complicated operating or setting procedures only with the vehicle stationary.
- 

### Engine Exhaust

#### Danger!

---

**Engine exhaust is dangerous if inhaled. Engine exhaust fumes have many components which you can smell. They also contain carbon monoxide (CO), which is a colorless and odorless gas. Carbon monoxide can cause unconsciousness and even death if inhaled.**

- ▷ Never start or let the engine run in an enclosed, unventilated area. It is not recommended to sit in your car for prolonged periods with the engine on and the car not moving.
-

## California Proposition 65 Warning



### Warning!

Engine exhaust, some of its constituents, and certain vehicle components contain or emit chemicals known to the State of California to cause cancer and birth defects or other reproductive harm.

In addition, certain fluids contained in vehicles and certain products of component wear contain or emit chemicals known to the State of California to cause cancer and birth defects or other reproductive harm.

## Hot Exhaust Pipes



### Warning!

**Risk of burn injury when standing near or coming into contact with the exhaust pipe.**

The exhaust pipe is hot when the vehicle is running and remains hot for some time after the vehicle is turned off.

- ▷ To prevent injury, make a point of noting where your vehicle's exhaust pipe is, avoid placing your legs near the exhaust pipe when loading and unloading cargo in the rear, and closely supervise children around the vehicle during time when the exhaust pipe could be hot. A hot exhaust pipe can cause serious burns.

## Portable Fuel Containers



### Danger!

**Portable fuel containers may leak, whether they are full or partially empty. Fuel leaking from a portable container carried in your vehicle could, in case of an accident, cause a fire or explosion, resulting in serious personal injury or death.**

- ▷ Never carry additional fuel in portable containers in your vehicle.

## Vehicles with SportDesign package



### Caution!

**Risk of damage. On vehicles with Sport-Design package, front, rear, and side member trim are painted and located lower on the vehicle. Off-road driving can seriously damage these trim parts.**

- ▷ When driving off-road, make sure these parts are not damaged.
- ▷ Make sure there is sufficient clearance between obstacles and the underside of the vehicle.
- ▷ Avoid driving through water.
- ▷ Do not use side member trim as a running board.

## Porsche Ceramic Composite Brake (PCCB)

- ▷ Please see the chapter "BRAKES" on Page 163.

The high-performance brake system is designed for optimal braking effect at all speeds and temperatures.

Certain speeds, braking forces and ambient conditions (such as temperature and humidity) therefore might cause brake noises.

Wear on the different components and braking system, such as brake pads and brake discs, depends to a great extent on the individual driving style and the conditions of use and therefore cannot be expressed in actual miles on the road.

The values communicated by Porsche are based on normal operation adapted to traffic. Wear increases considerably when the vehicle is driven on race tracks or through an aggressive driving style.

- ▷ Please consult an authorized Porsche dealer about the current guidelines in effect before such use of your vehicle.

## Dear Porsche Owner

A lot has gone into the manufacture of your Porsche, including advanced engineering, rigid quality control and demanding inspections. These engineering and safety features will be enhanced by you...

### the safe driver...

- who knows her/his car and all controls,
- who maintains the vehicle properly,
- who uses driving skills wisely and always drives within her/his own capabilities and the level of familiarity with the vehicle.

You will find helpful hints in this manual on how to perform most of the checks listed on the following pages. If in doubt, have these checks performed by your authorized Porsche dealer.

## Before driving off...

### Check the following items first

- ▷ Turn the engine off before you attempt any checks or repairs on the vehicle.
- ▷ Be sure the tires are inflated correctly. Check tires for damage and tire wear.
- ▷ See that wheel bolts are properly tightened and not loose or missing.
- ▷ Check engine oil level, add if necessary. Make it a habit to have engine oil checked with every refueling.
- ▷ Check all fluid levels such as windshield washer and brake fluid levels.
- ▷ Be sure the vehicle battery is well charged and cranks the engine properly.
- ▷ Check all doors and lids for proper operation and latch them properly.
- ▷ Check and if necessary replace worn or cracked wiper blades.
- ▷ See that all windows are clear and unobstructed.
- ▷ Check air intake slots and area between engine compartment lid and windshield. Ensure that these areas are free of snow and ice, so the heater and the windshield wipers work properly.

- ▷ If a child will be riding in the vehicle, check child seat/child seat restraint system to ensure that restraints are properly adjusted.
- ▷ Check all exterior and interior lights for operation and that the lenses are clean.
- ▷ Check the headlights for proper aim, and if necessary, have them adjusted.
- ▷ Check under the vehicle for leaks.
- ▷ Be sure all luggage is stowed securely.

### Emergency equipment

It is good practice to carry emergency equipment in your vehicle.

Some of the items you should have are: window scraper, snow brush, container or bag of sand or salt, emergency light, small shovel, first-aid kit, etc.

## In the driver's seat...

- ▷ Check operation of the horn.
- ▷ Position seat for easy reach of foot pedals and controls. To reduce the possibility of injury from the airbag deployment, you should always sit back as far from the steering wheel as is practical, while still maintaining full vehicle control.
- ▷ Adjust the headrest so that the upper edge of the headrest is brought to eye level or higher.
- ▷ Adjust the inside and outside rear view mirrors.
- ▷ Buckle your safety belts.
- ▷ Check operation of the foot and parking brake.
- ▷ Check all warning and indicator lights with ignition on and engine not running.
- ▷ Start engine and check all warning displays for warning symbols.
- ▷ Never leave an idling car unattended.
- ▷ Lock doors from inside, especially with children in the car to prevent inadvertent opening of doors from inside or outside. Drive with doors locked.

## On the road...

- ▷ Never drive after you have consumed alcohol or drugs.
- ▷ Always have your safety belt fastened.
- ▷ Always drive defensively. Expect the unexpected.
- ▷ Use signals to indicate turns and lane changes.
- ▷ Turn on headlights at dusk or when the driving conditions warrant it.
- ▷ Always keep a safe distance from the vehicle in front of you, depending on traffic, road and weather conditions.
- ▷ Reduce speed at night and during inclement weather. Driving in wet weather requires caution and reduced speeds, particularly on roads with standing water, as the handling characteristics of the vehicle may be impaired due to hydroplaning of the tires.
- ▷ Always observe speed limits and obey road signs and traffic laws.
- ▷ When tired, get well off the road, stop and take a rest. Turn the engine off. Do not sit in the vehicle with engine idling. Please see the chapter "ENGINE EXHAUST" on Page 2.

- ▷ When parked, always put the parking brake on **and** put the gearshift lever in neutral or the Tiptronic selector lever in position **P**. On hills also turn the front wheels toward the curb.
- ▷ When emergency repairs become necessary, move the vehicle well off the road. Turn on the emergency flasher and use other warning devices to alert other motorists. Do not park or operate the vehicle in areas where the hot exhaust system may come in contact with dry grass, brush, spilled fuel or other flammable material.
- ▷ Make it a habit to have the engine oil checked with every refueling.

## **Break in hints for the first 2,000 miles (3,000 kilometers)**

The following tips will be helpful in obtaining optimum performance from your new Porsche.

Despite the most modern, high-precision manufacturing methods, the moving parts must still wear in with each other. This wearing-in occurs mainly in the first 2,000 miles (3,000 km).

### **Therefore:**

- ▷ Preferably take longer trips.
- ▷ Avoid frequent cold starts with short-distance driving whenever possible.
- ▷ Avoid full throttle starts and abrupt stops.
- ▷ Do not exceed maximum engine speed of 4,200 rpm (revolutions per minute).
- ▷ Do not run a cold engine at high rpm either in Neutral or in gear.
- ▷ Do not let the engine labor, especially when driving uphill. Shift to the next lower gear in time (use the most favorable rpm range).
- ▷ Never lug the engine in high gear at low speeds. This rule applies at all times, not just during the break-in period.

- ▷ Do not participate in motor racing events, sports driving schools, etc. during the first 2,000 miles (3,000 kilometers).

There may be a slight stiffness in the steering, gear-shifting or other controls during the break-in period which will gradually disappear.

### **Break in brake pads and brake discs**

New brake pads and discs have to be “broken in”, and therefore only attain optimal friction when the car has covered several hundred miles or km. The slightly reduced braking ability must be compensated for by pressing the brake pedal harder. This also applies whenever the brake pads and brake discs are replaced.

### **New tires**

New tires do not have maximum traction. They tend to be slippery.

- ▷ Break in new tires by driving at moderate speeds during the first 60 to 120 miles (100 to 200 km). Longer braking distances must be anticipated.

## **Engine oil and fuel consumption**

During the break-in period oil and fuel consumption may be higher than normal.

- ▷ Please see the chapter “ENGINE DATA” on Page 349.

As always, the rate of oil consumption depends on the quality and viscosity of oil, the speed at which the engine is operated, the climate and road conditions, as well as the amount of dilution and oxidation of the lubricant.

- ▷ Make a habit of checking engine oil with every refueling, add if necessary.

# Table of Contents

## Overview Illustrations..... 10

Driver's cockpit .....	11
Steering wheel and instrument cluster .....	12
Center console, front .....	13

## Opening and Locking ..... 14

Never invite car theft! .....	15
Keys .....	16
Central Locking System .....	17
<b>Brief overview</b> – Opening and locking from outside .....	18
Unlocking and locking from outside .....	19
Opening and locking from inside .....	28
Opening and closing the engine compartment lid .....	29
Malfunctions when opening and closing .....	31

## Seats, Mirrors and Steering Wheel ..... 33

Seat and Headrest .....	34
Front seat with memory .....	37
Easy Entry Function .....	39
Fire Extinguisher .....	40
Heated Seats – Front and Rear .....	40
Safety Belts .....	42
Airbag Systems .....	45
Child Restraint Systems .....	49
LATCH Child Seat System .....	53
Child Restraint Anchorages .....	54
Door Mirrors .....	55
Interior Mirror .....	57

Automatic Anti-Dazzle Mirror .....	57
Steering Wheel .....	58
Multi-Functional Steering Wheel .....	60
Sun Visors .....	62
Make-up mirror .....	62
Sun Blinds, Rear Side Windows .....	62

## Air Conditioning, Parking Heater and Heated Rear Window ..... 63

Opening the Cover Flap of the Air-Conditioning Control Panel .....	64
Overview of Air-Conditioning Systems .....	64
Valid for Every Air-Conditioning System .....	65
<b>Brief Overview</b> – Manual Air-Conditioning .....	66
Manual Air-Conditioning .....	67
<b>Brief Overview</b> – Automatically Controlled 2-Zone Air-Conditioning System .....	69
Automatically Controlled 2-Zone Air-Conditioning .....	70
<b>Brief Overview</b> – Automatically Controlled 4-Zone Air-Conditioning System, Front Control Panel .....	73
<b>Brief Overview</b> – Automatically Controlled 4-Zone Air-Conditioning System, Rear Control Panel .....	74
Automatically Controlled 4-Zone Air-Conditioning .....	75
Vents .....	79
Heated Rear Window .....	80
Parking Heater .....	81

## Windows and Sliding Roofs ..... 86

Power windows .....	87
<b>Brief overview</b> - sliding/lifting roof .....	91
Sliding/Lifting Roof .....	92
<b>Brief overview</b> – Panorama roof system .....	96
Panorama roof system .....	97

## Lights, Turn Signals and Windshield Wipers ..... 103

Light Switch .....	104
Instrument Illumination .....	105
Automatic Headlight Beam Adjustment .....	106
Turn signal/High Beam/Headlight Flasher Stalk .....	106
Emergency flasher .....	107
Interior Lighting .....	107
Comfort Lighting .....	109
Coming Home Function (Auto Shut Off Delay) .....	109
Door-Surrounding Lighting .....	109
<b>Brief overview</b> – Windshield wipers .....	110
Windshield Wiper/Washer Stalk .....	111

## **Multi-Purpose Display and Instruments ..... 115**

Instrument Panel USA Models .....	117
Instrument Panel Canada Models.....	119
Oil Temperature Gage .....	120
Tachometer.....	120
Clock .....	120
Fuel Gage.....	120
Speedometer .....	120
Odometer .....	121
Voltmeter .....	121
Cooling System .....	122
Emission Control.....	123
Operating the multi-purpose display on the instrument panel .....	124
Opening the main menu.....	125
Operating example: Displaying average consumption .....	125
Displaying/resetting average speed .....	127
Displaying range on remaining fuel .....	127
Displaying tire pressure.....	127
Displaying compass .....	127
Displaying navigation information .....	127
Operating the telephone via the multi-purpose display .....	128
Setting speed limit on the multi-purpose display .....	129
Displaying warning messages .....	130
Displaying status of level control.....	131
Displaying status of locks/reduction.....	131
Displaying average consumption .....	132
Setting Tire Pressure Monitoring .....	132

Switching off passenger compartment monitoring on the multi-purpose display .....	142
Synchronous adjustment of door mirrors .....	143
Changing settings for opening and locking the vehicle.....	143
Switching daytime driving lights on/off.....	145
Setting lighting off delay .....	146
Setting the clock.....	146
Setting compass.....	147
Changing language for displays.....	148
Changing units for displays .....	148
Resetting display to factory settings.....	148
<b>Overview of warning messages .....</b>	<b>149</b>

## **Driving and Driving Safety ..... 157**

Ignition Lock/Steering Lock .....	158
Starting and Stopping the Engine .....	160
Parking Brake .....	162
Brakes .....	163
Cruise Control .....	167
Manual transmission, clutch .....	169
Tiptronic S.....	170
Selector Lever Positions .....	171
Driving Programs for On-Road and Off-Road Driving .....	177
Power-Transmission and Running-Gear Control Systems .....	181
Air Suspension with Level Control and Height Adjustment.....	190
Porsche Active Suspension Management (PASM) .....	193
Porsche Dynamic Chassis Control (PDCC).....	194
Off-Road Driving .....	195

## **Luggage Compartment, Loadspace and Storage..... 203**

Folding rear seats forward and returning to upright position .....	204
Loadspace .....	207
Cargo management system .....	208
Luggage Compartment Cover .....	211
Luggage safety net .....	212
Ski Bag .....	214
Roof Transport System.....	216
Off-road roof-mounted Headlights	
Cayenne S Transsiberia .....	217
Car Audio Operation/Tips.....	218
Porsche Communication Management (PCM) .....	220
iPod, USB and AUX.....	221
Storage.....	222
Cupholder.....	226
Ashtray.....	227
Cigarette Lighter .....	228

## **Trailer Hitch ..... 229**

Trailer Coupling.....	230
Loading Information.....	231

## **Parking ..... 236**

Parking Aids .....	237
Swivelling down mirror glass as parking aid..	241
Garage door opener .....	241



**Alarm System and Theft Protection .. 244**

Alarm System and Passenger Compartment Monitoring .....	245
--	-----

**Maintenance and Car Care..... 249**

Exercise Extreme Caution when Working on your Vehicle .....	250
Engine Oil.....	251
Checking Engine Oil Level.....	252
Topping up Engine Oil .....	253
Coolant Level .....	255
Brake-Fluid Level.....	257
Washer Fluid.....	258
Power Steering.....	259
Changing Air Cleaner.....	260
Changing Particle Filter .....	260
Automatic Transmission Fluid.....	260
Manual Transmission Oil.....	260
Wiper Blades .....	261
Emission Control System.....	263
How Emission Control Works .....	264
Fuel Economy.....	265
Operating Your Porsche in other Countries ..	266
Fuel .....	266
Portable Fuel Containers .....	268
Fuel Recommendations .....	269
Fuel Evaporation Control .....	270
Car Care Instructions .....	270

**Minor Repairs..... 279**

Exercise Extreme Caution when Working on your Vehicle.....	280
Tires/Wheels .....	281
Jack.....	291
Tool Kit .....	292
Compressor .....	292
Spacers .....	293
Wheel Bolts .....	293
Changing Wheels .....	294
Flat Tire.....	295
Lifting the Vehicle with a Lifting Platform or Garage lift.....	298
Electrical System .....	312
Battery .....	320
Replacing the remote control battery.....	322
Emergency Starting with Jumper Cables .....	323
Replacing Bulbs .....	326
Headlights .....	327
Tail light .....	336
License Plate Lights .....	338
Headlight Adjustment .....	339
Changing headlights from left to right-hand traffic .....	340
Bulb Chart.....	342
Towing .....	342

**Tire Pressure and Technical Data ..... 346**

Vehicle Identification .....	347
Engine Data .....	349
Tires, Rims, Tracks .....	350
Tire Pressures, Cold (68 °F/20 °C).....	354
Weights .....	356
Ground Clearance .....	357
Capacities .....	359
Dimensions.....	360
Driving Performance.....	361

**Index ..... 362**

# Overview Illustrations

Driver's cockpit .....	11
Steering wheel and instrument cluster .....	12
Center console, front .....	13

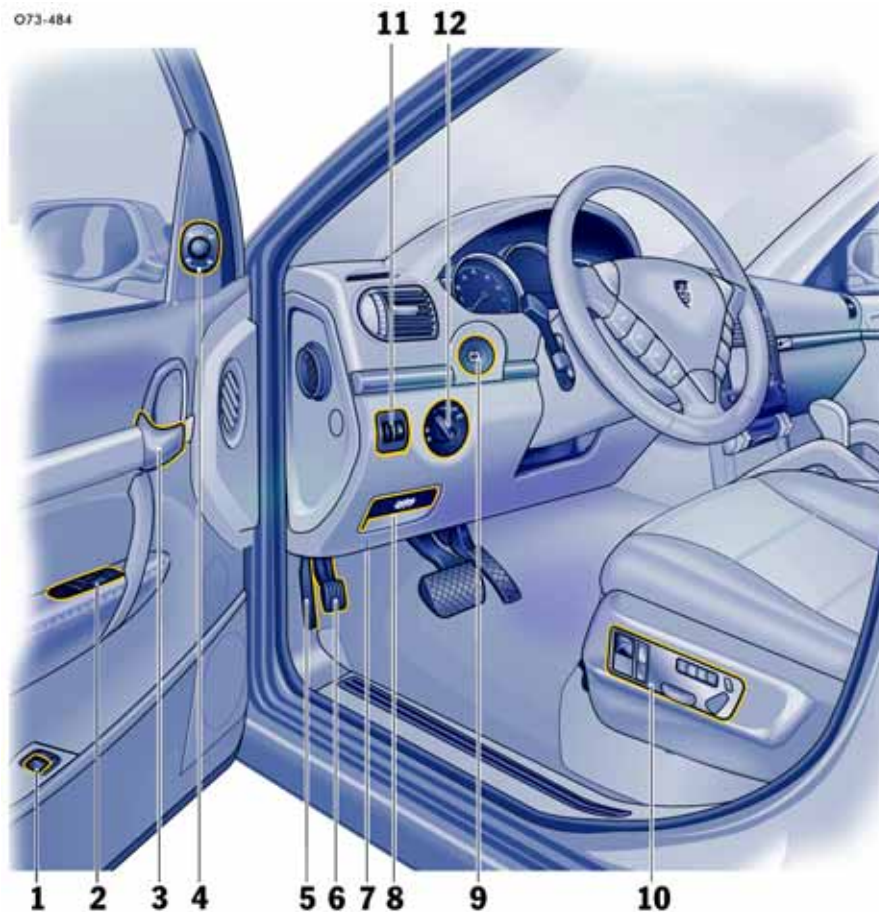

## Driver's cockpit

1. Power Lift Gate  
See Page 23.
2. Power Windows  
See Page 87.
3. Inner door Handle  
See Page 28.
4. Door mirror adjustment  
See Page 55.
5. Engine compartment lid release  
See Page 29.
6. Parking brake  
See Page 162.
7. Diagnostic socket
8. Parking brake release  
See Page 162.
9. Ignition lock/steering lock  
See Page 158.
10. Seat adjustment  
See Page 34.
11. Instrument lighting knob  
See Page 105.
12. Light switch  
See Page 104.

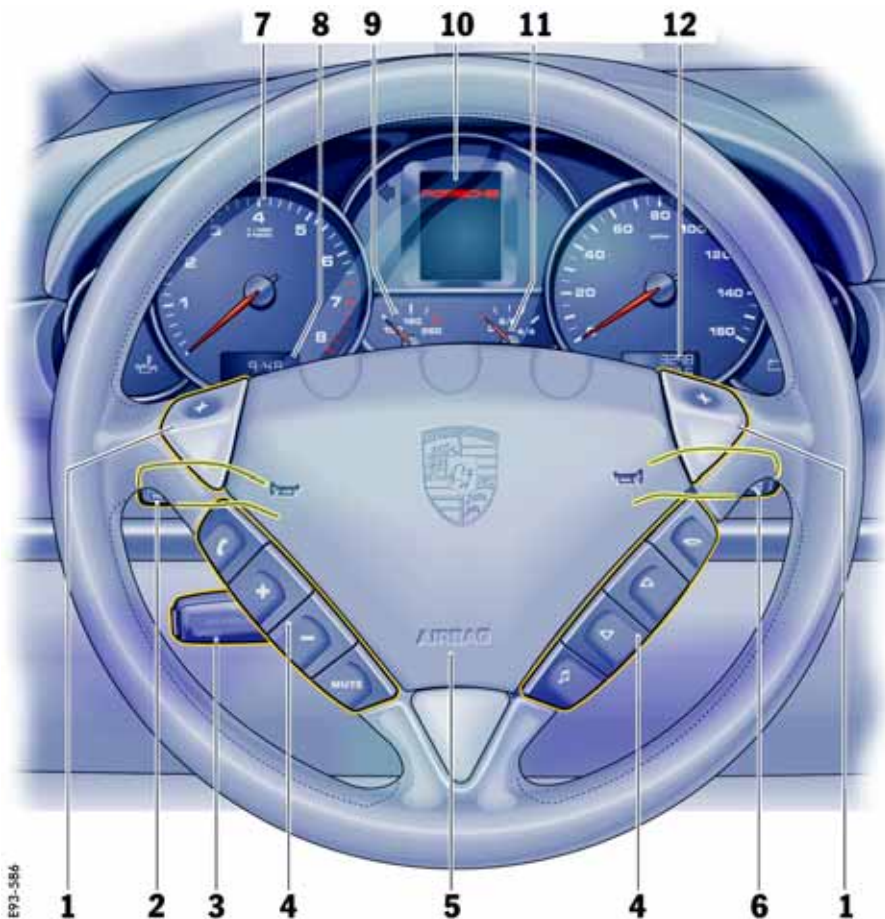

## Steering wheel and instrument cluster

1. Tiptronic rocker switches  
See Page 58.
2. Turn signals  
See Page 106.
3. Cruise control  
See Page 167.
4. Function keys  
See Page 60.
5. Horn  
See Page 58.
6. Windshield wipers  
See Page 111.
7. Tachometer  
See Page 120.
8. Clock  
See Page 123.
9. Cooling system temperature gage  
See Page 122.
10. Multi-purpose display  
See Page 124.
11. Fuel gage  
See Page 120.
12. Odometer  
See Page 121.

EP3-586

## Center console, front



1. Porsche Communication Management (PCM)  
See separate operating instructions.
2. Air conditioner  
See Page 64.
3. Ashtray/cigarette lighter  
See Page 226.
4. Cupholder  
See Page 226.
5. Reduction (Low Range), differential locks  
See Page 177.
6. Sport mode  
See Page 179.
7. Porsche Active Suspension Management (PASM) running-gear setup  
See Page 193.
8. Height adjustment, air suspension  
See Page 190.
9. Armrest, storage trays  
See Page 224.
10. ParkAssistent warning indicator  
See Page 239.
11. Vents  
See Page 79.
12. Glove compartment  
See Page 223.

# Opening and Locking

Never invite car theft! .....	15
Keys .....	16
Central Locking System .....	17
<b>Brief overview</b> – Opening and locking from outside .....	18
Unlocking and locking from outside .....	19
Opening and locking from inside .....	28
Opening and closing the engine compartment lid .....	29
Malfunctions when opening and closing .....	31

## Never invite car theft!

An unlocked car with the key in the ignition lock invites car theft.

A steering wheel lock and a **gong alarm** are standard equipment in your Porsche. The gong alarm will sound if you open the driver's door while the key is still in the ignition lock. It is your reminder to pull the key out of the ignition lock and to lock the doors.

### Warning!

---

**Any uncontrolled movement of the vehicle may result in property damage, serious personal injury or death.**

**Never leave your vehicle unattended with the key in the ignition lock, especially if children and/or pets are left unattended in the vehicle. They can operate power windows and other controls. If the engine is left running, they may accidentally engage the shift lever. Serious personal injury or death could result from loss of control of the vehicle.**

- ▷ Always remove the ignition key.
  - ▷ Always set the parking brake.
  - ▷ Lock the doors with the key or with the remote control.
- 

### Warning!

---

**Risk of a serious accident.**

**The steering column will lock when you remove the key while you are driving or as the car is rolling to a stop. You will not be able to steer the car.**

**Serious personal injury or death could result from loss of control of the vehicle.**

- ▷ Never remove the key from the steering lock while you are driving.
- 

**To protect your vehicle and your possessions from theft, you should always proceed as follows when leaving your vehicle:**

- ▷ Close windows.
- ▷ Close sliding/lifting roof or Panorama Roof System.
- ▷ Remove ignition key (switch ignition off in vehicles that have Porsche Entry & Drive).
- ▷ Engage steering lock.
- ▷ Lock storage tray between the front seats and glove compartment.
- ▷ Remove valuables (e.g. car documents, radio control module, cell phones, house keys) from the car.
- ▷ Lock doors.
- ▷ Lock the glove compartment.
- ▷ Close oddment trays.
- ▷ Cover luggage compartment with the luggage compartment cover.
- ▷ Close rear lid and rear window.



**A** - Car key  
**B** - Release button for key bit

## Keys

Two car keys with integrated remote control are supplied with your Porsche. The car keys are designed as folding keys.

These keys operate all the locks on your vehicle.

- ▷ Be careful with your car keys: do not part with them except under exceptional circumstances.

- ▷ Inform your insurance company of any loss or theft of car keys or if extra or replacement keys have been made.

- ▷ Remove the ignition key, even if leaving the vehicle only briefly.

### Folding out the key bit

- ▷ Press release button **B**.  
The key bit folds out.

### Folding in the key bit

- ▷ Press release button **B** and fold in the key bit.

### Note on operation

The air conditioner settings are stored on the respective key when switching off the ignition and locking the vehicle.

### Emergency operation

- ▷ Please see the chapter "EMERGENCY OPERATION - UNLOCKING THE IGNITION KEY" on Page 159.

## Replacement keys

Car keys can only be ordered through an authorized Porsche dealer. Sometimes, this may take a long time.

You should therefore always keep a spare key on your person. Keep it in a safe place, but under no circumstances in or on the vehicle.

The key codes of new keys have to be "reported" to the vehicle control module by your authorized Porsche dealer. All keys belonging to the vehicle must also be reported again.

### Note

Third parties can continue to operate the mechanical locks using the lost key.





## Panic button

In dangerous situations or when one's own safety is threatened, it is possible to draw attention to the situation by triggering an alarm.

### To trigger an alarm

- ▷ Press button.  
The horn sounds and the emergency flashers flash.

### To stop the alarm

- ▷ Press button again.  
The horn becomes silent and the emergency flashers go out.

## Central Locking System

USA: KR55WK45032

Canada: CAN 267 104 187

This device complies with:  
Part 15 of the FCC Rules  
RSS-210 of Industry Canada.

Operation of this device is subject to the following two conditions:

- It may not cause harmful interference, and
- it must accept any interference received including interference that may cause undesired operation.

### Note

The manufacturer is not responsible for any radio or TV interference caused by unauthorized modifications to this equipment. Such modification could void the user's authority to operate the equipment.



### Warning!

Any changes or modifications not expressly approved by Porsche could void the user's authority to operate this equipment.

Your vehicle is equipped with a central locking system. The following are unlocked or locked together:

- Doors
- Rear lid/rear window
- Filler flap

The central locking system is always activated when the vehicle is unlocked and locked.

On the multi-purpose display of the instrument panel, you can set different variants for locking and unlocking the doors and rear lid. You can open all doors irrespective of the setting made.

The vehicle cannot be locked if the driver's door is not completely closed.

If one of the following components is not completely closed when you try to lock the vehicle the door/lid is not locked:

- vehicle doors
- rear lid
- rear window
- engine compartment lid

The indication by the emergency flasher and by the acoustic signal will be provided after all doors and lids are closed.

## Brief overview – Opening and locking from outside

The Porsche Entry & Drive option can be recognized by the buttons **A** in the door handles.

This brief overview does not replace the information provided in the chapter “Opening and locking from outside”. In particular, warnings are not replaced by this brief overview.



Key

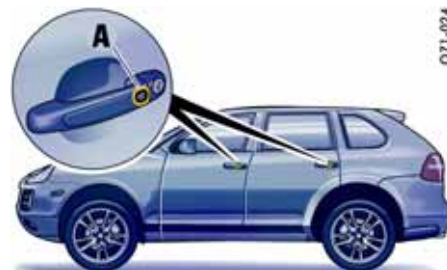

Porsche Entry & Drive

071-024

### What do I want to do?

#### Unlocking

### What do I have to do?

Using the key:  
Press button  on the key **once**.

Press button  on the key **twice**.

With Porsche Entry & Drive:  
Grip door handle fully.

### What happens?

The emergency flasher flashes once.  
The driver's door can be opened.

All vehicle doors and the rear lid can be opened.

The doors and the rear lid  
can be opened.

#### Locking

Using the key:  
Press button  on the key.

With Porsche Entry & Drive:  
Press the button **A** in the handle.

The emergency flasher flashes twice and an  
acoustic signal will sound twice.  
The doors are locked.

#### Locking if persons/animals are remaining in vehicle

(switching off passenger compartment  
monitoring of the alarm system)

- ▷ Please see the chapter “TEMPORARILY  
DEACTIVATING PASSENGER COMPARTMENT  
MONITORING SYSTEM” on Page 246.

#### Switching off alarm

Press button  on the key.



## Unlocking and locking from outside

Depending on your vehicle equipment, you can either unlock and lock it with the car key or without a key by means of Porsche Entry & Drive.

### With the key

Use the buttons on the key to unlock and lock the vehicle.

E71-565



## With Porsche Entry & Drive

On vehicles with Porsche Entry & Drive, you can unlock, lock and start the vehicle without using the key.

You simply have carry the key with you, e.g. in your trouser pocket.

Do not expose the car key to a high level of electromagnetic radiation. This could adversely affect Porsche Entry & Drive.

## Readiness for operation

The Porsche Entry & Drive readiness for operation is switched off for the passenger doors after approximately 30 hours and for the driver's door after approximately 90 hours if the vehicle is not unlocked during this period. In this case:

- ▷ Pull door handle **once**, to reactivate the system.
- ▷ Pull door handle **again**, to open the door.

**or**

- ▷ Press button  on the key to reactivate the system.

## Note on operation

The factory settings of the vehicle are described in this chapter.

You can change the settings and store them on the respective key on the multi-purpose display of the instrument panel.

For further information on the possible settings on the multi-purpose display:

- ▷ Please see the chapter "CHANGING SETTINGS FOR OPENING AND LOCKING THE VEHICLE" on Page 143.



### Note on operation

The vehicle doors are locked automatically after 30 seconds if they are not opened.

If the passenger compartment monitoring system has been switched off (restricted theft protection), this also remains the case after automatic relocking.

The doors can be opened from inside by pulling the inner door handle twice.

## Unlocking and opening doors

### Unlocking driver's door with the key

1. Briefly press button  on the key **once**.  
The emergency flasher flashes once.  
The driver's door is now unlocked.
2. Pull the door handle.

### Unlocking all vehicle doors with the key

1. Briefly press button  on the key **twice**.  
The emergency flasher flashes once.  
The doors are now unlocked.
2. Pull the door handle.

### Unlocking with Porsche Entry & Drive (keyless)

The vehicle can be unlocked if you are in the area of the driver's door with the key.

- ▷ Grip door handle fully. The doors are now unlocked.
- ▷ Pull the door handle.

## Locking doors

### Locking with the key

- ▷ Close the door.
- ▷ Briefly press button  on the key once.  
The emergency flasher flashes twice and an acoustic signal will sound twice.
- ▷ If persons or animals remaining in the car:  
Please see the chapter “TEMPORARILY DEACTIVATING PASSENGER COMPARTMENT MONITORING SYSTEM” on Page 246.

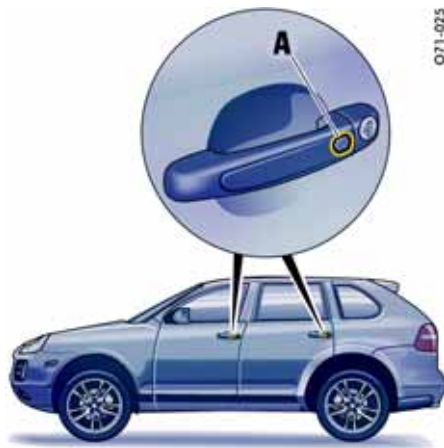

### Locking with Porsche Entry & Drive (keyless)

You must carry the key with you.

- ▷ Close the door.
- ▷ Briefly press the Porsche Entry & Drive locking button **A** in the door handle.  
The emergency flasher flashes twice and an acoustic signal will sound twice.
- ▷ If persons or animals remaining in the car:  
Please see the chapter “TEMPORARILY DEACTIVATING PASSENGER COMPARTMENT MONITORING SYSTEM” on Page 246.

071-025

### Note on operation for locking the doors

The vehicle cannot be locked if the driver's door is open.

### Automatic door locking and automatic door unlocking



**Warning!**

**In an emergency situation where you need to exit the car through an automatically locked door, remember the following procedure to open the door.**

- ▷ Unlock the doors by pressing the central locking button **or**
- ▷ pull the inside door handle **twice** to open the door.

In the multi-purpose display of the instrument panel, you have the option of selecting diverse variants of automatic door locking (AUTO LOCK) and automatic door unlocking (AUTO UNLOCK).

- ▷ For further information:  
Please see the chapter “SETTING AUTO LOCK (AUTOMATIC DOOR LOCKING) AND AUTO UNLOCK (AUTOMATIC DOOR UNLOCKING)” on Page 144.



### Unlocking and opening rear lid (vehicles with spare wheel bracket)

On vehicles with spare wheel bracket, this must be swung to the side before opening the rear lid.

- ▷ For further information on opening the spare wheel bracket: Please see the chapter "OPENING SPARE WHEEL BRACKET" on Page 310.

### Danger!

**Risk of poisoning. Exhaust gases can enter the passenger compartment when the rear lid is open.**

- ▷ Always keep the rear lid closed when the engine is running.
- ▷ Always keep the rear lid closed while driving.

The vehicle doors remain locked after unlocking the rear lid.

The rear lid is locked automatically after 30 seconds if it is not opened.

### Unlocking with the key

- ▷ Press button  on the key.
- ▷ Press the release handle (**arrow**) on the rear lid and open the rear lid.

### Unlocking with Porsche Entry & Drive (keyless)

### Warning!

**Risk of being locked out of vehicles with Porsche Entry & Drive.**

- ▷ Do not leave the key in the vehicle if the vehicle is locked and access is gained through the rear lid. The vehicle is automatically locked when the rear lid is closed.

If the key has been left in the vehicle, the emergency flasher flashes twice **and** a warning signal sounds. The rear lid can be opened again within approx. 30 seconds. After 30 seconds have elapsed, the vehicle can be unlocked again only with the second key.

The rear lid is unlocked if you are in the rear area of the vehicle with the key.

- ▷ Press the release handle (**arrow**) on the rear lid and open the rear lid.



### Locking the rear lid



#### Warning!

**Danger of crushing. The rear lid is automatically pulled into the lock and locked.**

- ▷ Make sure that your fingers are not under the rear lid.
- ▷ Keep foreign objects or limbs away from moving parts (latch striker) of the power closing mechanism.
- ▷ Do not leave children in the car unattended.

The rear lid has a power closing mechanism.

1. Pull down the rear lid by means of the closing handle (**arrow**), and press it gently into the lock.  
The rear lid is automatically pulled closed and locked. (only if rear lid is unlocked)
2. Lock the vehicle.

### Powerliftgate (Rear Lid)



#### Danger!

**Risk of poisoning. Exhaust gases can enter the passenger compartment when the rear lid is open.**

- ▷ Always keep the rear lid closed when the engine is running.
- ▷ Always keep the rear lid closed while driving.

**Danger of injury and damage if the rear lid is automatically opened or closed in an uncontrolled way!**

- ▷ Do not leave children in the car unattended.
- ▷ Open or close the rear lid only when the vehicle is stationary.
- ▷ Never drive with the rear window or rear lid open.  
Exhaust gases can enter the passenger compartment.
- ▷ Open or close the rear lid only when there are no persons, animals or objects within its movement range.
- ▷ Always observe the opening and closing operation so that movement can be stopped at any time in the event of danger.

- ▷ Make sure that there is sufficient clearance behind or above the vehicle (e.g. roof transport systems, garage ceiling).
- ▷ Remove rear rack systems before opening the rear lid automatically.

### **Warning!**

#### **Risk of being locked out of vehicles with Porsche Entry & Drive.**

- ▷ Do not leave the key in the vehicle if the vehicle is locked and access is gained through the rear window. The vehicle is automatically locked when the rear lid is closed.

If the key has been left in the vehicle, the emergency flasher flashes twice **and** a warning signal sounds. The rear lid can be opened again within approx. 30 seconds. After 30 seconds have elapsed, the vehicle can be unlocked again only with the second key.

#### **Acoustic indication during opening/closing of the rear lid**

Opening and closing of the rear lid are indicated by three warning tones.

You can have the warning tones activated/deactivated at your authorized Porsche dealer.



071-027



071-009

#### **Opening the rear lid automatically**

When the vehicle is operated with a trailer, the rear lid can only be opened with the release button on the rear lid.

There are **three** ways of opening the rear lid:

##### **Option 1**

- ▷ Make sure the vehicle is unlocked if your vehicle is not equipped with Porsche Entry & Drive. Then briefly press the release handle on the rear lid.  
The vehicle need not be unlocked on vehicles with Porsche Entry & Drive. You simply have carry the car key with you, e.g. in your trouser pocket.

##### **Option 2**

- ▷ Press the button  on the key for approx. 1 second.  
If the vehicle is locked, the vehicle doors remain locked when the rear lid is opened.





### Interrupting the opening or closing operation in the event of danger

The opening or closing operation is interrupted immediately if one of the following buttons is pressed:

- ▷ Press the button  on the key
- or**
- Release the button in the driver's door
- or**
- Briefly press the button in the rear lid trim panel
- or**
- Briefly press the release button on the rear lid.

Automatic operation can be continued again at any time. To do this, press the corresponding button.

### Option 3

- ▷ Pull and hold the button in the driver's door with the ignition switched on until the rear lid has opened fully. Opening is interrupted if the button is released prematurely.

### Automatically closing the rear lid

Make sure that the load is not in the area of the rear lid when the lid is closed, otherwise the closing operation will be interrupted after contact with the load, and the rear lid will open again by a few inches.

- ▷ Briefly press the button in the rear lid trim panel.

### Detection of obstacles during opening

The rear lid will stop moving if the system detects that the opening is blocked by an obstacle. A warning signal then sounds. When the obstacle has been removed, the rear lid can be opened by pressing

- the button  on the key
- or**
- the button in the driver's door
- or**
- the release button on the rear lid.

## Detection of obstacles during closing



**Warning!**

### Danger of crushing.

- ▷ Despite the presence of this detection system, you are still responsible for keeping yourself and others entirely out of the way of the door as it is closing.

The closing operation is interrupted if closing of the rear lid is blocked by an obstacle.

A warning signal sounds and the rear lid opens again by a few inches.

When the obstacle has been removed, the rear lid can be closed by pressing one of the corresponding buttons.

## Adjusting the opening height of the rear lid

The opening height of the rear lid can be individually adjusted so that the rear lid does not collide with the garage ceiling, for example.

On vehicles with level control, the vehicle height changes depending on the setting of the level control system. For this reason, always adjust the opening height with the vehicle at the highest level setting so that the rear lid cannot accidentally collide with the garage ceiling, for example.

1. Stand behind the vehicle and open the rear lid.
2. Press the button  on the key to stop the automatic opening operation at around 2/3 of the opening height.
3. Now move the rear lid up by hand until the desired opening height is reached. Make sure that there is a sufficient minimum clearance from any obstacle.
4. Press and hold the button in the rear lid trim panel for approx. 3 seconds.  
An acknowledgement signal sounds, and the emergency flasher lights up once.  
The opening height of the rear lid has now been programmed.  
The rear lid can now be closed by briefly pressing the button.

This setting cannot be deleted. If a different setting is required, repeat steps 1 to 4.

## Malfunctions of the rear lid drive

The automatic function is not active if the battery voltage is too low.

If a button is pressed, the rear lid lock is unlocked and a warning signal sounds for 3 seconds. The rear lid can now be opened by hand.

- ▷ Charge the vehicle battery.

## Emergency operation of the rear lid

A warning signal sounds for approx. 3 seconds if the automatic opening or closing operation is interrupted by a fault.

- ▷ Open or close the rear lid by hand.



071-028

## Unlocking and opening rear window

The vehicle doors remain locked after unlocking the rear lid.

The rear window is locked automatically after 30 seconds if it is not opened.

### Unlocking with the key (only on vehicles without Powerliftgate)

- ▷ Press button  on the key for approx. 2 seconds.  
The rear window pops open.

### Unlocking with the key

1. Press button  on the key.
2. Press the release button **A** and open the window.

### Unlocking with Porsche Entry & Drive (keyless)

#### Warning!

#### Risk of being locked out of vehicles with Porsche Entry & Drive.

- ▷ Do not leave the key in the vehicle if the vehicle is locked and access is gained through the rear window. The vehicle is automatically locked when the rear window is closed.

If the key has been left in the vehicle, the emergency flasher flashes twice **and** a warning signal sounds. The rear window can be opened again within approx. 30 seconds. After 30 seconds have elapsed, the vehicle can be unlocked again only with the second key.

#### Danger!

#### Risk of poisoning. Exhaust gases can enter the passenger compartment when the rear window is open.

- ▷ Always keep the rear lid and rear window closed when the engine is running.
- ▷ Always keep the rear lid and rear window closed while driving.

The rear window is unlocked if you are in the rear area of the vehicle with the key.

- ▷ Press the release button **A** and open the window.

### Closing the rear window

Close the rear window and press it into the lock until it can be felt to engage.

#### Note on operation

On vehicles with Porsche Entry & Drive, the rear lid, rear window and spare wheel bracket can no longer be opened when the car key with remote control is out of range.



## Opening and locking from inside

The factory settings of the vehicle are described in this chapter.

You can change the settings and store them on the respective key on the multi-purpose display of the instrument panel.

- ▷ For further information on the possible settings (e.g. Auto Lock and Auto Unlock) on the multi-purpose display:  
Please see the chapter “CHANGING SETTINGS FOR OPENING AND LOCKING THE VEHICLE” on Page 143.

## Locking doors

### Button in the armrest

- ▷ Press the right half of the button in the door panel.  
**All** vehicle doors will be locked.  
The doors can be opened by pulling the inner door handle twice.

### Automatic with Auto Lock

The vehicle is locked automatically when a speed of 6 km/h (4 mph) is exceeded.

## Unlocking doors

### Button in the armrest

- ▷ Press the left half of the button in the door panel.  
If pressed on the front doors, **all** doors will be unlocked.  
If pressed on the rear doors, **only** the relevant door will be unlocked.

### Automatic with Auto Unlock

The vehicle is automatically unlocked when the ignition key is withdrawn or the ignition is switched off.

### Note on operation

If the vehicle was locked by remote control or with the key, it cannot be unlocked with the central locking button.



## Opening doors

### Opening unlocked doors

- ▷ Pull inner door handle once.

### Opening locked doors

- ▷ Pull inner door handle twice.



O71-002

## Securing rear doors

You can secure the rear doors to prevent unintentional opening when driving.

### Switching child lock on and off

The child locks are fitted in the lock area of the rear doors.

The doors cannot be opened from inside when the child locks are engaged.

- ▷ To engage: Turn child lock to position **A**.
- ▷ To disengage: Turn child lock to position **B**.



E91-423



### Switching child protection on/off

The power windows, central locking buttons on the rear doors and the rear control panel for the air conditioning can be disabled by means of the safety button in the armrest of the driver's door.

- ▷ Press the safety button to switch child protection on and off.  
The symbol in the safety button lights up if child protection is active.

## Opening and closing the engine compartment lid

### Opening



**Caution!**

**Risk of damage to engine compartment lid or windshield wipers.**

- ▷ Make sure that the windshield wipers are not pulled out forwards when opening the engine compartment lid.
- ▷ Always switch the windshield wipers off (wiper stalk in position **O**) before opening the engine compartment lid.  
If the wiper arms are not in their final position, they will automatically move to this position when the engine compartment lid is opened. This will happen even if the ignition is off.  
The wiper arms remain in this position until the lid is closed and the wiper system is switched off and then on again.



O71-029

O91-489

1. Pull the release lever (**arrow**).

The engine compartment lid is now unlocked.



2. Unlatch safety catch **A**.
3. Open the lid completely.

## Closing



**Risk of loss of control or an accident, resulting in serious personal injury or death.**

- ▷ Should you notice at any time while driving that one of the lids is not secured properly, please stop immediately in a suitable place and close it.  
The front lid may fly up impairing vision.

1. Lower lid and let it fall into the lock. If necessary, push the lid closed with the palm of your hand in the area of the lock.
2. Check that the lid has correctly engaged in the lock.

When the vehicle is in motion, a message will be displayed on the multi-purpose display of the instrument panel if the lid is not closed properly.

## Malfunctions when opening and closing

### Emergency operation of rear lid

If the rear lid cannot be opened with the radio remote control (e.g., if the battery of the remote control is dead), the emergency operation must be performed:

1. Unlock and open the driver's door with the car key.
2. Switch on the ignition so that the alarm system will not be triggered.
3. Check if the TAILGATE function is activated in the multi-purpose display of the instrument panel.  
Please see the chapter "SETTING REAR LID LOCKING" on Page 144.
4. Press the central locking button in the armrest.

The rear lid is now unlocked and can be opened with the unlocking handle.

### Only one door is unlocked

The setting for locking and unlocking the doors and rear lid has been changed on the multi-purpose display of the instrument panel. You can open all doors irrespective of the setting made.

- ▷ Press button  on the key twice within 2 seconds.

### The vehicle cannot be unlocked

The remote control of the key may

- not function correctly due to radio waves (also radio contact between remote control and vehicle in the case of Porsche Entry & Drive),
  - fail due to a fault,
  - fail due to an exhausted battery.
- ▷ Unlock the vehicle with the unfolded key in the key lock.
  - ▷ If you unlock the vehicle with the key at the door lock, only the driver's door can be opened.  
In order to prevent the alarm system from being triggered, you must switch the ignition on within 15 seconds of opening the door.

### The vehicle cannot be locked

This is recognizable by the fact that the emergency flasher does not flash and there is no locking noise.

The remote control of the key may

- not function correctly due to radio waves (also radio contact between remote control and vehicle in the case of Porsche Entry & Drive),
  - fail due to a fault,
  - fail due to an exhausted battery.
- ▷ Lock the vehicle with the unfolded key at the door lock.

If there is a defect in the central locking system, operating the lock barrel in the driver's door will lock all functioning locking elements of the central locking system.

- ▷ For information on locking the doors by means of the emergency operation:  
Please see the chapter "NOT ALL VEHICLE DOORS ARE LOCKED" on Page 32.
- ▷ Have faults in the central locking system remedied at an authorized Porsche dealer.

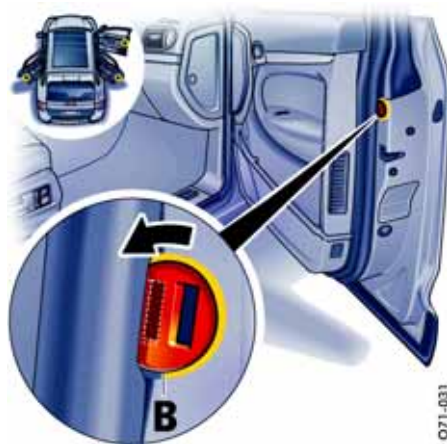
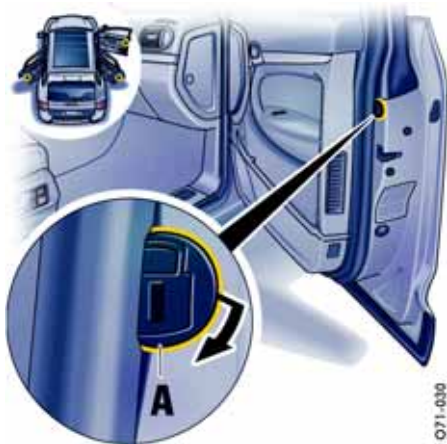

### Not all vehicle doors are locked

The central locking system has failed. The doors must be locked with the emergency locking device.

1. Open the passenger's door.
2. Remove cover **A**.
3. Press red slide **B** with the key bit in the direction of the arrow.  
For information on folding out the key bit: Please see the chapter "FOLDING OUT THE KEY BIT" on Page 16.
4. Fit cover **A** again.
5. Repeat procedure at the rear doors.
6. Close all doors.
7. Lock the driver's door with the key in the door lock.



# Seats, Mirrors and Steering Wheel

Seat and Headrest .....	34
Front seat with memory .....	37
Easy Entry Function .....	39
Fire Extinguisher .....	40
Heated Seats – Front and Rear .....	40
Safety Belts .....	42
Airbag Systems.....	45
Child Restraint Systems.....	49
LATCH Child Seat System.....	53
Child Restraint Anchorages .....	54
Door Mirrors.....	55
Interior Mirror .....	57
Automatic Anti-Dazzle Mirror .....	57
Steering Wheel.....	58
Multi-Functional Steering Wheel.....	60
Sun Visors .....	62
Make-up mirror .....	62
Sun Blinds, Rear Side Windows .....	62

## Seat and Headrest



**The seat may move unexpectedly if you attempt to adjust while driving. This could cause sudden loss of control, resulting in serious personal injury or death.**

- ▷ Do not adjust seats while the vehicle is in motion. The backrest locks must be engaged at all times while the vehicle is in motion.

**Safety belts only offer protection when the backrest is upright and the belts are properly positioned on the body.**

**Improperly positioned safety belts or safety belts worn by passengers in an excessively reclined position can cause serious personal injury or death in an accident.**

- ▷ Do not operate the car with the driver or passenger backrests excessively reclined. Please see the chapter "SEAT POSITION" on Page 36.
- ▷ Porsche recommends the use of L.A.T.C.H. (Lower **A**nchorage and **T**ether for **C**hildren) equipped Porsche child seats.

**Risk of injury if persons or animals are in the movement range of the seat during seat adjustment.**

- ▷ Adjust the seat so that no-one is put a risk.

Your vehicle is equipped with a total of five headrests in the backrests of the front and rear seats. The height of the headrests in the front and back seats is adjustable. All headrests are removable.

All occupants, including the driver, should not operate a vehicle or sit in a vehicle's seat until the headrests and backrests are placed in their proper positions so that the risk of neck injuries is minimized in the event of a crash.

For proper positioning and operation of the headrest, the backrest's inclination should be adjusted such that the headrest is in an upright position. Driver and passengers should be seated upright and in the center of their seats.

### Adjusting headrests



**Improperly positioned headrests can cause serious personal injury or death in an accident.**

- ▷ Adjust the headrest so that the upper edge of the headrest is brought to eye level or higher.
- ▷ Do not drive the vehicle without the headrest in place and properly adjusted.

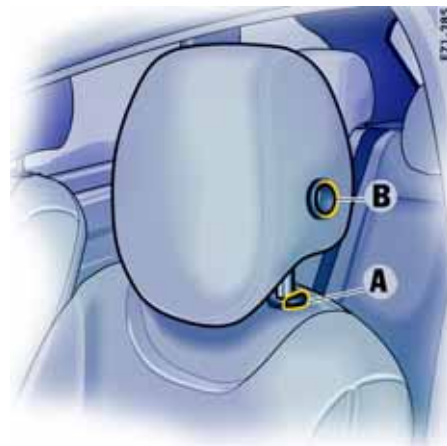

*Example: driver's seat*

### Raising

- ▷ Push headrest upwards until the desired position is reached. Additionally press button **B** on the outer rear seat headrests. Push the middle rear headrest upwards into its locked position.

### Lowering

- ▷ Press button **B** and, at the same time, push the headrest downwards until the desired position is reached. For lowering the middle rear headrest below its locked position press button **A** and, at the same time, push it down fully.

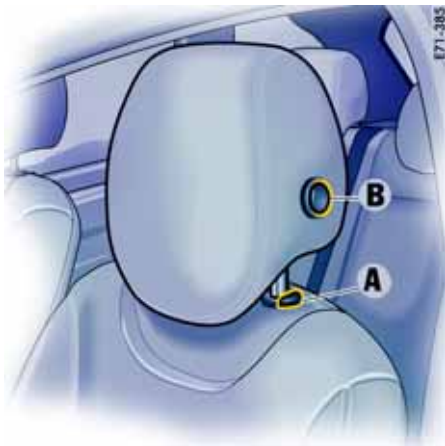

Example: driver's seat

## Removing headrests

### Front seats

- ▷ Press button **A** and, at the same time, completely remove headrest.

### Rear seats - outer headrests

1. Press button **B** and push the headrest all the way down.
2. Press button **A** and, at the same time, pull the headrest completely out.



Example: middle rear headrest for sport seats

## Rear seat - middle headrest

- ▷ Press button **A** and, at the same time, pull the headrest completely out.



**Danger!**

**Driving with removed headrests, improperly positioned headrests or improperly installed headrests can cause serious personal injury or death in an accident.**

- ▷ Adjust the headrests so that the upper edge of the headrest is brought to eye level or higher.
- ▷ Do not drive the vehicle without the headrest in place and properly adjusted.

## Installing headrests

### Front and outer rear headrests

#### Note

The middle headrest of the rear seat bench must only be fitted to the middle seat of the rear seat backrest.

1. Insert the headrests into the guides.
2. Press button **B** and, at the same time, push the headrest downwards until the desired position is reached.

### Rear seat - middle headrest



**Danger!**

**Driving with an improperly installed headrest can cause serious personal injury or death in the event of an accident.**

- ▷ Do not attempt to insert the rear middle seat headrest into either of the rear side seats. The rear middle headrest is designed specifically for the rear middle seat and its safety parameters only.
- ▷ **Vehicles with comfort seats:**  
Insert the headrest into the guides and push it down fully until it is engaged.
- ▷ **Vehicles with sport seats:**  
Insert the headrest into the guides, push it down fully and afterwards push it upwards until it is engaged.

## Seat position

A correct sitting position is important for safe and fatigue-free driving. We recommend the following procedure for adjusting the driver's seat to suit individual requirements:

1. Adjust the seat height to give yourself enough headroom and an unobstructed view outside the vehicle.
2. Adjust the seat until, with the accelerator pedal fully depressed, your leg is straight but your entire foot still rests on the accelerator pedal.
3. Grip the top half of the steering wheel. Set the backrest angle and steering wheel position so that your arms are almost outstretched. However, your shoulders must still rest on the backrest.
4. If necessary, correct the seat fore-and-aft adjustment.
5. Adjust the height of the headrest so that the upper edge is at eye level or higher.



E71-429

## Adjusting the seat

- A Front seat height adjustment.
- B Rear seat height adjustment.



E71-564

- C Fore and aft adjustment.
  - D Backrest angle adjustment.
  - E Lumbar support adjustment.  
To permit a relaxed sitting posture, the backrest curvature is infinitely adjustable in vertical and horizontal directions for individual pelvis and spinal column support.
- ▷ Press the switch in the direction indicated by the arrows until the desired setting is reached.



## Front seat with memory

Personal seat, door mirror, steering wheel and safety belt height adjustments can be stored and recalled on the person buttons **A** and car keys.

### Warning!

**Risk of crushing due to uncontrolled recall of settings.**

- ▷ Cancel automatic adjustment by pressing any of the seat adjustment buttons.
- ▷ Do not leave children in the car unattended.

### Memory options

- Seat adjustment
- Door mirror adjustment

### Comfort memory options

- Seat adjustment
- Door mirror adjustment
- Steering wheel and safety belt height adjustment

### Recalling the settings using the car key or in vehicles that have Porsche Entry & Drive

- ▷ Open the driver's door.  
The stored settings of the driver's seat are recalled automatically.

### Cancelling setting

Automatic settings can be cancelled immediately by pressing any driver's seat setting button.

### Recalling the settings with person buttons 1 - 3 (driver's and passenger's seat)

1. Unlock vehicle and open the driver's door.
2. Press the relevant person button until the stored positions have been reached  
**or**  
Briefly touch the person button if the ignition key is inserted or if the ignition is switched on (in vehicles that have Porsche Entry & Drive).  
The stored positions for each seat are recalled automatically.

### Cancelling setting

Automatic settings can be cancelled immediately by pressing any seat adjustment button.

## Storing driver's seat settings

### Storing settings on a person button and a car key

1. Apply the parking brake.
2. Switch ignition on.
3. Make the required adjustments to the seat, mirror, steering wheel and safety belt.
4. Briefly press the **SET** memory button and, within 10 seconds, hold down one of the person buttons (**1**, **2** or **3**) until an acknowledge tone is obtained.  
The settings are now stored on the desired person button.
5. Withdraw car key or switch ignition off in vehicles that have Porsche Entry & Drive.
6. Press the **SET** memory button within 10 seconds and keep the button depressed until an acknowledge tone is obtained.  
The settings are now assigned to the car key.



**A** - Control switch for door mirror adjustment  
**C** - Passenger mirror setting

### Storing passenger mirror setting as a parking aid

If the passenger's mirror is supposed to swivel downwards when reversing, this can also be stored in the driver's seat setting.

1. Apply the parking brake.
2. Switch ignition on.
3. Press the relevant person button.
4. Engage reverse gear.

5. Set the control switch **A** for the mirror setting to the passenger's side **C**.  
The passenger's mirror swivels downwards.
6. Adjust the passenger's mirror to the required setting.
7. Briefly press the **SET** memory button and, within 10 seconds, hold down the person button on which the setting is to be stored until an acknowledge tone is obtained.

### Storing passenger seat settings

1. Apply the parking brake.
2. Switch ignition on.
3. Adjust seat position and belt height.
4. Briefly press the **SET** memory button and, within 10 seconds, hold down one of the person buttons (**1**, **2** or **3**) until an acknowledge tone is obtained.

### Automatic storage – driver's seat

If settings were changed after the driver's door was opened, these new settings are temporarily stored when the vehicle is locked. This storage is deleted if the vehicle is unlocked with a programmed key and the driver's door is opened. Then the settings of the key used is recalled.



001-470

## Easy Entry Function

The Easy Entry function makes it easier for you to get in and out of the car.

### Warning!

**Risk of crushing if persons are behind the driver's seat when settings are recalled.**

**Risk of damage if the rear seat bench is folded forward when settings are recalled.**

- ▷ Switch off the Easy Entry function if there are persons behind the driver's seat or if the rear seat bench is folded forward.

### Switching Easy Entry function on and off

- ▷ Press switch **A**.

### Entering the vehicle

When the driver's door is opened, the driver's seat moves to the rear.

Once the driver's door is closed and the ignition key is inserted or, in the case of vehicles that have Porsche Entry & Drive, the ignition is switched on, the seat and steering wheel move into the stored position.

### Exiting the vehicle

The steering wheel moves into the frontmost, top position.

- After the ignition key is removed **or**
- After the ignition is switched off and the driver's door is opened on vehicles equipped with Porsche Entry & Drive **or**
- When the steering column is locked.

When the driver's door is opened, the driver's seat moves to the rear.



### Fire extinguisher under the right front seat

- ▷ Take the fire extinguisher out of the drawer under the seat.

#### Note

- ▷ Pay attention to the final control date on the fire extinguisher. If the fire extinguisher is used after its testing interval has elapsed, it may not function properly.
- ▷ Follow the operating instructions on the fire extinguisher.
- ▷ The functional ability of the fire extinguisher should be checked by a specialist workshop every 1 to 2 years.
- ▷ After use, have the fire extinguisher refilled.

## Fire Extinguisher

If the vehicle is equipped with a fire extinguisher, it is mounted underneath the left or right front seat, depending on equipment level.

### Fire extinguisher under the left front seat

- ▷ To remove the fire extinguisher in case of an emergency, hold the fire extinguisher with one hand, and press the PRESS button on the fire extinguisher holder with the other hand (**arrow**).



A - Front seat, left  
B - Front seat, right

## Heated Seats – Front and Rear

The seat heating is ready for operation when the engine is running. The heating power can be infinitely adjusted with the thumb wheel.





- C - Rear seat, left
- D - Rear seat, right

### Switching on

- ▷ Turn thumb wheel until the desired position is reached.

### Switching off

- ▷ Turn thumb wheel to **0**.

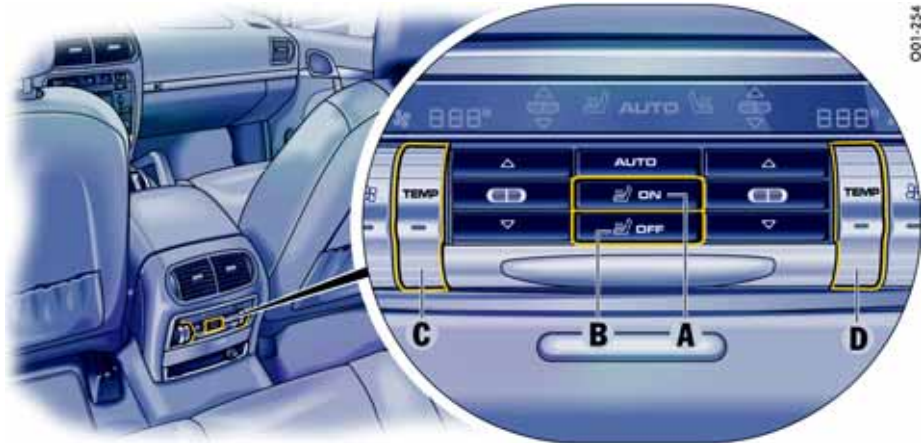

- A - Switches seat heating on
- B - Switches seat heating off
- C - Temperature control for left seat
- D - Temperature control for right seat

### Rear seat heating in vehicles with an four-zone air conditioning system

#### Switching on

- ▷ Press button **A**.

After the seat heating is switched on, the air conditioning display switches to seat heating mode for approx. 10 seconds.

#### Controlling the temperature

- ▷ Move button **C** or button **D** upwards or downwards until the desired position is reached.

#### Switching off

- ▷ Press button **B**.

## Safety Belts



**Always make sure your and your passengers' safety belts are properly fastened while the vehicle is in motion.**

**Failure to follow safety belt warnings may result in serious personal injury or death.**

- ▷ For your and your passengers' protection, use safety belts at all times while the vehicle is in motion.
- ▷ Use appropriate child restraint systems for all small children.

### Proper wearing of safety belts

- ▷ Safety belts must be positioned on the body as to restrain the upper body and lap from sliding forward. Improperly positioned safety belts can cause serious personal injury in case of an accident.
- ▷ The shoulder belt should always rest on your upper body. The shoulder belt should never be worn behind your back or under your arm.
- ▷ For maximum effectiveness, the lap belt should be worn low across the hips.
- ▷ Pregnant women should position the belt as low as possible across the pelvis. Make sure it is not pressing against the abdomen.
- ▷ Belts should not be worn twisted.

- ▷ Do not wear belts over rigid or breakable objects in or on your clothing, such as eye glasses, pens, keys, etc. as these may cause injury.
- ▷ Several layers of heavy clothing may interfere with proper positioning of belts.
- ▷ Belts must not rub against sharp objects or damage may occur to the belt.
- ▷ Two occupants should never share the same belt at the same time.

### Care and maintenance

- ▷ Keep belt buckles free of any obstruction that may prevent a secure locking.
- ▷ Belts that have been subjected to excessive stretch forces in an accident must be inspected or replaced to ensure their continued effectiveness in restraining you. The same applies to belt tensioner systems which have been triggered. In addition, the anchor points of the belts should be checked.
- ▷ If safety belts do not work properly, see your authorized Porsche dealer immediately.
- ▷ If the belts show damage to webbing, bindings, buckles or retractors, they should be replaced to ensure safe operation.
- ▷ Do not modify or disassemble the safety belts in your vehicle.

- ▷ The belts must be kept clean or the retractors may not work properly. Please see the chapter "CAR CARE INSTRUCTIONS" on Page 270.
- ▷ Never bleach or dye safety belts.
- ▷ Do not allow safety belts to retract until they are completely dry after cleaning or this may cause damage to the belt.

---

### Belt tensioner

Depending on the force of a collision, fastened seat belts are automatically tightened in an accident.

#### The belt tensioners are triggered in:

- Front and rear impacts of sufficient severity
- Side impacts (only belt tensioners of the front seats are triggered)
- In cases of vehicle rollover

## Maintenance Notes

The belt tensioner system can be triggered only once; the system must be replaced afterwards.

If there is a fault in the belt tensioner system, the airbag warning light lights up.

Work may be performed on the belt tensioner system only by an authorized Porsche dealer. Smoke is released when the belt tensioners are triggered.

This does not indicate a fire in the vehicle.



## Safety Belt Warning System

An **audio-visual warning** system is interconnected with the driver's safety belt.

Every time the ignition is turned on, the gong will sound for about 6 seconds to remind driver and passenger to buckle up.

In addition, the gong will sound for approx. 90 seconds if vehicle speed exceeds 15 mph/24 km/h.

The safety belt warning lights in the instrument panel and multi-purpose display will go off as soon as the driver has buckled up.



## Fastening the safety belt

- ▷ Assume a comfortable sitting position. Adjust the backrest of the front seat so that the belt always rests on your upper body and runs across the middle of your shoulder.
- ▷ Grasp the belt tongue and pull the belt in a slow, continuous motion across your chest and lap.

## Note on operation

The belt can be blocked if the vehicle is standing at an angle or if the belt is pulled out using a jerking movement.

- ▷ The belt cannot be pulled out while accelerating and slowing down, when cornering and when driving uphill.
- ▷ Insert the belt tongue into the appropriate buckle on the inboard side of the seat, until it locks securely with an audible click.
- ▷ Make sure that belts are not trapped or twisted, and that they are not rubbing on sharp edges.
- ▷ The horizontal section of the belt should always fit snugly across the pelvis. Therefore, after fastening the belt, always pull the diagonal part of the belt upwards. Pregnant women should position the belt as low as possible across the pelvis, and ensure that it is not pressing against the abdomen.
- ▷ Pull on the diagonal section of the belt now and again during the journey to ensure that the horizontal section remains tight.



- ▷ Make sure that the belts and buckles fit correctly on the rear seat bench.

### Releasing the safety belt

- ▷ Hold the belt tongue.
- ▷ Press the red button (**arrow**).
- ▷ Guide belt tongue to the reel.

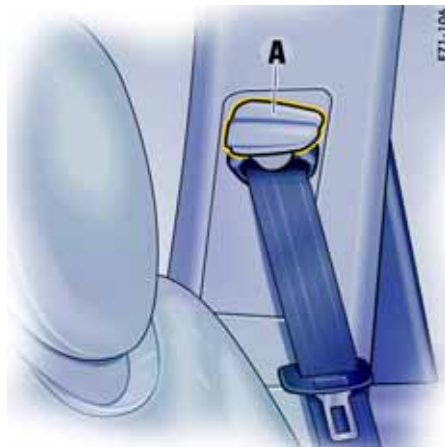

### Safety belt height adjustment

The heights of the belt deflectors for the driver's seat, passenger's seat and the outer rear seats can be adjusted.

Adjust the height of the safety belt so that it runs across the middle of the shoulder, not against the neck.

### Adjusting belt height manually

- ▷ Upward – push belt deflector up.
- ▷ Downward – press button **A** and move belt deflector.



### Adjusting belt height electrically

- ▷ Operate rocker switch **B** in the desired direction until the optimal belt adjustment is reached.

On vehicles with comfort memory, seat belt height adjustment can be stored on the person buttons and vehicle keys and recalled with these.

- ▷ Please see the chapter "FRONT SEAT WITH MEMORY" on Page 37.

## Airbag Systems

The airbags in combination with the safety belts make up a safety system which offers the driver and the passenger the greatest known protection from injuries in case of accident.

Your vehicle is equipped with weight sensing for the passenger's seat in accordance with U.S. Federal/Canadian Motor Vehicle Safety Standard 208.

Even if your vehicle is equipped with airbags, **the safety belts must be worn at all times**, because the front airbag system is only actuated by frontal collisions with an impact of sufficient severity.

Below the deployment threshold of the airbag system, and during types of collisions which do not cause the actuation of the system, the safety belts provide the primary protection to the occupants when correctly worn. **Therefore, all persons within the vehicle must wear safety belts at all times** (in many states, state law requires the use of safety belts).

- ▷ Please see the chapter "SAFETY BELTS" on Page 42.

The **front airbags** are located under the padded steering wheel panel on the driver's side and, on the passenger's side, in the dashboard.

The **side airbags** for the front seats are installed on the side in the seat backrests.

The **head airbags** are installed above the doors in the roof area.



**Danger!**

**To provide optimal occupant protection, airbags must inflate at very high speed. If you are not wearing your safety belt or are too close to the airbag when it is deployed, inflating airbags can result in serious personal injury or death.**

**Improper handling of weight sensing can unintentionally impair switching the passenger's airbag off and on.**

- ▷ Make sure there are no people, animals or objects between the driver or passenger and the area into which the airbag inflates.
- ▷ Sit back as far from the dashboard or steering wheel as is practical, while still maintaining full vehicle control.
- ▷ Always hold the steering wheel by the outer rim. Never rest your hands on the airbag panel.
- ▷ **Always fasten seat belts** because triggering of the airbag system depends on the force and angle of impact.
- ▷ Do not transport heavy objects on or in front of the passenger seat. These could impair the function of the airbag, the seat belts, and weight sensing.
- ▷ Do not hang objects (e.g., jackets, coats, coat hangers) over the backrest.

- ▷ Always keep the lid of the door storage compartment closed. Objects must not protrude out of the door storage compartment. The storage compartment must be closed while driving.
- ▷ No changes must be made to the wiring or components of the airbag system.
- ▷ Do not add any additional coverings or stickers to the steering wheel or in the area of the passenger airbag, side airbags and head airbags. Doing so may adversely affect the functioning of the airbag system or cause harm to the occupants if the airbag system should deploy. Do not use protective seat covers.
- ▷ Do not modify the seat coverings. Do not attach additional cushions, protective coverings, or pillows to the passenger's seat. Do not affix things to the passenger's seat or cover it with other materials. Do not cover the back of the backrest. Do not make changes to the passenger's seat and to the seat base frame.
- ▷ Do not undertake any wiring for electrical accessory equipment in the vicinity of the airbag wiring harnesses. Doing so may disable the airbag system or cause inadvertent inflation.
- ▷ If the warning light comes on, the airbag system should be repaired immediately by your authorized Porsche dealer.

- ▷ Always keep feet in the footwell while driving. Do not put feet on the dashboard or the seat area. Do not lean against the inside of the door or outside the window while the vehicle is moving.
- ▷ Using accessories not approved by Porsche can cause the weight sensing to be impaired.
- ▷ Do not squeeze objects, such as the fire extinguisher, or first aid kit under the seat.
- ▷ Only have seats removed and installed by an authorized Porsche dealer so that weight sensing components will not be damaged.
- ▷ Give your passenger all of the information in this chapter.

---

### Note

Airbag components (e.g. steering wheel, seats) may be disassembled only by an authorized Porsche dealer.

- ▷ When disposing of a used airbag unit, our safety instructions must be followed. These instructions can be obtained at any authorized Porsche dealer.

## Function of the airbag system

Airbags are a supplemental safety system. Your primary protection comes from your safety belts.

The front airbags are triggered during a frontal collision of sufficient force and direction.

In the event of a side impact of corresponding force, the side airbag on the impact side is triggered.

The inflation process generates the amount of gas required to fill the airbags at the necessary pressure in fractions of a second.

Airbags help to protect the head and upper body, while simultaneously damping the motion of the driver and passenger in the impact direction in the event of a frontal impact or side impact.

In order to help provide protection in severe collisions which can cause death and serious injury, airbags must inflate extremely rapidly. Such high speed inflation has a negative but unavoidable side effect, which is that it can and does cause injuries, including facial and arm abrasions, bruising and broken bones. You can help minimize such injuries by always wearing your safety belts.

There are many types of accidents in which airbags are not expected to deploy. These include accidents where the airbags would provide no benefit, such as a rear impact against your vehicle. Other accidents where the airbags are designed not to deploy are those where the risk of injury from the airbag deployment could exceed any protective benefits, such as in low speed accidents or

higher speed accidents where the vehicle decelerates over a longer time. Since airbag deployment does not occur in all accidents, this further emphasizes the need for you and your passengers to always wear safety belts.

Your vehicle is equipped with a crash sensing and diagnostic module. This module will record the use of the seat belt restraint system by the driver and front passenger when the airbags and/or belt tensioner are triggered.

Precondition for activating the restraint systems:

- ▷ Ignition is switched on.

## Advanced Airbag

Your vehicle is equipped with weight sensing for the passenger's seat in accordance with U.S. Federal/Canadian Motor Vehicle Safety Standard 208.

Depending on the weight acting on the passenger's seat, the passenger's airbag will automatically be switched on and off.

Depending on the angle and force of impact, the passenger's airbag which is switched-on will be triggered during a collision.

Precondition for switching the passenger's airbag on and off, depending on weight:

- ▷ Ignition is switched on.

## Seat adjustment for the passenger's seat



**Danger!**

**Safety belts only offer protection when the backrest is upright and the belts are properly positioned on the body. Improperly positioned safety belts can cause serious personal injury or death in an accident.**

- ▷ Do not operate the car with the driver or passenger backrests excessively reclined.

If the seat is in an extreme position (e.g., the backrest is in contact with the rear seat bench), the backrest can warp. Warping of the backrest can lead to malfunctions.

- ▷ Correct the seat adjustment.  
The seat is not jammed and is self-supporting. The backrest is in the upright position.
- ▷ Do not transport a load and objects in the rear footwell or under the passenger's seat.  
If the load or objects are under the seat, they can cause malfunctions.

If the weight on the passenger's seat is reduced significantly, e.g., by supporting weight on the armrest, the passenger's airbag can be switched off.

- ▷ Select an upright seat position, and do not support weight on the armrests or lean out of the window.  
Always keep feet in the footwell while driving. Do not put feet on the dashboard or the seat area. Do not lean against the inside of the door or outside the window while the vehicle is moving.

If the passenger's seat is warped significantly, a message is displayed in the multi-purpose display in the instrument panel:

- ▷ Correct the seat adjustment.
- ▷ Please see the chapter "OVERVIEW OF WARNING MESSAGES" on Page 149.

## Vehicle modifications to accommodate persons with disabilities

Because modifications to your vehicle could compromise your advanced airbag system, please call 1-800-PORSCHE prior to having your vehicle modified.

## Automatic deactivation of the passenger airbags



**Danger!**

**The use of a child restraint system in the front passenger seat can result in serious personal injury or death to the child from an airbag deployment.**

**To reduce risk of injury from an inflating airbag in an accident, Porsche strongly recommends:**

- ▷ Under all normal circumstances, the child seat must be placed in the rear.  
Do not use a child restraint system in the front passenger seat.

Before transporting a child on the passenger seat:

- ▷ Please see the chapter "CHILD RESTRAINT SYSTEMS" on Page 49.
- When a **child weighing up to 29 lbs (13 kg)** is seated in the child restraint system, the front airbag is automatically deactivated on the passenger side.
- When an adult is seated in the front seat the front airbag remains active on the passenger's side.



001-257

### Note

- ▷ After switching on the ignition, the PASSENGER AIRBAG OFF warning light lights up for a few seconds as a check.

### PASSENGER AIRBAG OFF indicator lamp lights up

The passenger's airbag is switched off.

### PASSENGER AIRBAG OFF indicator lamp does not light up

- The passenger's airbag is active and ready for operation.
- If the passenger's seat is not occupied, the PASSENGER AIRBAG OFF indicator lamp will also not light up, even though the passenger's airbag is switched off.

A - PASSENGER AIRBAG OFF indicator lamp

### Note on operation

Although not desired, it can occur in the case of heavier children that the passenger airbags remain active or, in the case of very light adults or young persons, that the passenger airbag is deactivated.

The condition of the passenger airbag system is shown by the indicator lamp **A** in the central console.

- ▷ If in doubt, fasten the child restraint system on the rear bench or transport the passenger on the rear bench.

### Danger!

**Risk of serious personal injury or death due to the passenger airbag triggering unintentionally.**

**When the ignition is on and a child weighing up to 29 lbs (13 kg) is seated in the child restraint system on the passenger seat the indicator lamp „PASSENGER AIRBAG OFF“ must be on.**

**If the “PASSENGER AIRBAG OFF” indicator lamp does not light up, it could indicate a fault in the system.**

**In this case:**

- ▷ Fasten the child restraint system on the rear bench immediately. Do not install any child restraint system on the passenger's seat.
- ▷ Have the fault remedied at your nearest authorized Porsche dealer.





## Warning light

Faults are indicated by a warning light on the tachometer.

- ▷ **In the following cases you should immediately consult an authorized Porsche dealer in order to assure the airbag system is functioning properly:**
- If the warning light does not light up when the ignition is switched on **or**
- If the warning light does not go out once the engine is running **or**
- If the warning light appears while driving.

## Airbag maintenance

In order to ensure long-term functioning, the airbag system must be inspected by an authorized Porsche dealer at the intervals recommended in your Maintenance Booklet.

### Important information

If you sell your Porsche, notify the purchaser that the vehicle is equipped with airbags, and refer them to the chapter, “Airbag Systems”, in the owner’s manual (safety and disposal rules).

Further information on the airbag system can be found on stickers attached to the sun visors, as well as on all airbag components.

For special recommendations on the use of child restraints:

- ▷ Please see the chapter “CHILD RESTRAINT SYSTEMS” on Page 49.

## Child Restraint Systems

Porsche recommends that all infants and children be restrained in child restraint systems at all times while the vehicle is in motion in accordance with applicable laws.

- ▷ Porsche recommends the use of L.A.T.C.H.H. (**L**ower **A**nchorage and **T**ether for **C**hildren) equipped Porsche child seat.

Use only child restraint systems with the LATCH-system recommended by Porsche. These systems have been tested and adjusted to the interior of your Porsche and the appropriate child weight groups. Other systems have not been tested and could entail an increased risk of injury.

You can obtain child seats that are LATCH compatible at your authorized Porsche dealer.

- ▷ Always observe the separate installation instructions for your child seat.

The use of infant or child restraints is required by law in all 50 US states and the Canadian provinces. The child restraint system should be one that complies with U.S. Federal/Canadian Motor Vehicle Safety Standards and should be secured by a lap belt or lap belt portion of a lap-shoulder belt or for child seats equipped with the LATCH system (**L**ower **A**nchorage and **T**ether for **C**hildren, also known as ISOFIX) to the LATCH anchorages.

A statement by the seat manufacturer of compliance with this standard can be found on the instruction label on the restraint and in the instruction manual provided with the restraint.

## Danger!

### Risk of serious personal injury or death to the child.

- ▷ Follow all child restraint instructions and warnings in this manual.
- 
- When using an infant or child restraint system, be sure to follow all manufacturer's instructions on installation and use.
  - Infants and small children should neither be held on the lap, nor should they share a safety belt with another occupant while the vehicle is in motion.
  - Children too big for child restraint systems should use regular safety belts. A shoulder belt can be used providing it does not cross the face or the neck of the child.
  - Choose a child restraint system according to the weight of the child.
  - Child restraint systems that are damaged or have been heavily stressed in an accident must be replaced immediately.
  - Children could be endangered in a crash if their child restraints are not properly secured in the vehicle.
  - Do not affix objects to child restraint systems or cover them with other materials.
- ▷ For maximum safety and protection, do not use a child restraint system in the front passenger seat.

### Direction of installation for child restraint systems

According to accident statistics, children are safer when properly restrained in the rear seating positions than in the front seating positions.

Under all normal circumstances, the child seat must be placed in the rear.

- ▷ Do not use a child restraint system in the front passenger seat.

#### Children up to 29 lbs (13 kg)

Children of this weight must be transported in a restraint system which is fitted **facing backwards**.

#### Children between 20 and 40 lbs (9 and 18 kg)

Children of this weight are transported in child restraint systems **facing forward**.

#### Children between 33 and 55 lbs (15 and 25 kg)

Children of this weight are transported in child restraint systems **facing forward**.

#### Children between 49 and 79 lbs (22 and 36 kg)

Children of this weight are transported in child restraint systems **facing forward**.

### Using child restraint systems in the front passenger seat

## Danger!

**The use of a child restraint system in the front passenger seat can result in serious personal injury or death to the child from an airbag deployment.**

**To reduce risk of injury from an inflating airbag in an accident, Porsche strongly recommends:**

- ▷ Under all normal circumstances, the child seat must be placed in the rear.  
Do not use a child restraint system in the front passenger seat.

---

However, there may be serious situations where it might be necessary to place a child in the front seat so that he/she can be kept under direct observation to prevent an immediate risk to the child (for example, while driving to the doctor or hospital). The following instructions are provided to you solely for that purpose.

- ▷ Seek appropriate advice from your authorized Porsche dealer about the possible installation of a Porsche child restraint system.
- ▷ If a child restraint system must be fastened to the passenger's seat, adjust the passenger's seat as far away from the airbag as possible.

- ▷ If emergency or other serious conditions require a child to be placed in the front seat, exercise extreme caution and defensive driving of your vehicle. You must recognize that any substantial frontal impact could result in the deployment of the passenger airbag, which could lead to serious injury or death of the child.

### **Child restraint system for children weighing up to 29 lbs (13 kg)**

If the child restraint system must be fastened to the passenger's seat in exceptional cases:

- make sure that the PASSENGER AIRBAG OFF indicator lamp lights up.
- adjust the passenger's seat as far away from the airbag as possible

### **Danger!**

---

**Risk of serious personal injury or death due to the passenger airbag triggering unintentionally.**

**When the ignition is on and child weighing up to 29 lbs (13 kg) is seated in the child restraint system on the passenger seat the indicator lamp "PASSENGER AIRBAG OFF" must be on.**

**If the "PASSENGER AIRBAG OFF" indicator lamp does not light up, it could indicate a fault in the system.**

**In this case:**

- ▷ Fasten the child restraint system on the rear bench immediately.
- ▷ Have the fault remedied at your nearest authorized Porsche dealer.

---

### **Child restraint system for children weighing more than 29 lbs (13 kg)**

Your vehicle is equipped with weight sensing for the passenger's seat in accordance with U.S. Federal Motor Vehicle Safety Standard 208. Depending on the weight acting on the passenger's seat, the passenger's airbag will automatically be switched on or off.

- ▷ In case of doubt, fasten the child restraint system on the rear bench.

### **Small adult passengers**

- ▷ Make sure that the PASSENGER AIRBAG OFF indicator lamp does not light up.

### **Danger!**

---

**Risk of serious or mortal injury due to the passenger airbag not triggering.**

**When the ignition is on and the small adult passenger is seated on the passenger seat, the indicator lamp "PASSENGER AIRBAG OFF" must be off.**

**If the "PASSENGER AIRBAG OFF" indicator lamp lights up, it could indicate a fault in the system.**

**In this case:**

- ▷ Carry the passenger on the rear bench until the fault is repaired.
  - ▷ Have the fault remedied at your nearest authorized Porsche dealer.
-

## Automatic locking retractor

The safety belts for the front passenger and the rear bench are equipped with an automatic locking retractor for securing the child restraint system. When activated, this retractor allows you to securely fasten the child restraint system in place so that inadvertent movements will not occur.

### **Danger!**

**The use of a child restraint system on the front passenger seat can result in serious personal injury or death to the child from an airbag deployment.**

**To reduce risk of injury from an inflating airbag in an accident, Porsche strongly recommends:**

- ▷ Under all normal circumstances, the child seat must be placed in the rear.  
Do not use a child restraint system on the front passenger seat.

However, there may be serious situations where it might be necessary to place a child in the front seat so that he/she can be kept under direct observation to prevent an immediate risk to the child (for example, while driving to the doctor or hospital). The following instructions are provided to you solely for that purpose.

- ▷ Seek appropriate advice from your authorized Porsche dealer about the possible installation of a Porsche child restraint system.
- ▷ If a child restraint system must be fastened to the passenger's seat, adjust the passenger's seat as far away from the airbag as possible.

Before transporting a child on the passenger seat:

- ▷ Please see the chapter "CHILD RESTRAINT SYSTEMS" on Page 49.
- ▷ If emergency or other serious conditions require a child to be placed in the front seat, exercise extreme caution and defensive driving of your vehicle. You must recognize that any substantial frontal impact could result in the deployment of the passenger airbag, which could lead to serious injury or death of the child.



**A** - PASSENGER AIRBAG OFF indicator lamp

### **Danger!**

**Risk of serious personal injury or death to the child, when excessive force is acting on the passenger's seat due to the seat belt and the passenger's airbag is switched on unintentionally.**

- ▷ After fastening the child restraint system, do not adjust the seat.
- ▷ Check the condition of the passenger airbag system shown by the indicator lamp **A** in the central console.

## Activating the automatic locking retractor

1. If a child restraint system must be fastened to the passenger's seat, adjust the passenger's seat as far away from the airbag as possible.
2. Fasten child seat.
3. Pull the safety belt retractor completely out. At this point the locking mechanism is activated.
4. Insert the safety belt tongue into the buckle and make certain that it is properly latched. Make no more adjustments to the seat.
5. Allow the safety belt to retract until it is tight on the child restraint system. You may further tighten the belt by pulling on it to allow more of it to retract. Make sure that excessive seat belt forces do not occur by moving the seat with the child seat installed.

## Releasing the safety belt

- ▷ Unbuckle the safety belt latch.

Then make certain that the belt has fully retracted. At this point the automatic locking feature will be disengaged.

Seek appropriate advice from your authorized Porsche dealer about the possible installation of a Porsche child restraint system.



## LATCH Child Seat System

Use only child restraint systems with the LATCH system recommended by Porsche. These systems have been tested and adjusted to the interior of your Porsche and the appropriate child weight groups. Other systems have not been tested and could entail an increased risk of injury.

You can obtain child seats that are LATCH-compatible at your authorized Porsche dealer.

Always observe the separate installation instructions for your child seat.



## Installing a LATCH child seat system

Markings on the right and left for the LATCH child seat anchorage can be found on the backrests of the outer rear seats.

The anchor bars **A** for the LATCH child seat anchorage can be found directly under the markings between backrest and seat cushion.

## Danger!

The use of a child restraint system on the front passenger seat can result in serious personal injury or death to the child from an airbag deployment.

To reduce risk of injury from an inflating airbag in an accident, Porsche strongly recommends:

- ▷ Under all normal circumstances, the child seat must be placed in the rear.  
Do not use a child restraint system on the front passenger seat.
- ▷ Please see your authorized Porsche dealer for correct Porsche Child Seat availability.
- ▷ Porsche recommends the use of a Porsche Child Seat with **Lower Anchorage and Tether for Children** system (LATCH) on the rear seats.

1. Secure the child seat to retaining lugs **A** as outlined in the operating manual for the child seat.
2. Pull the child seat to check that both fastening points are engaged correctly.



## Child Restraint Anchorages

- ▷ Please see the chapter "AUTOMATIC LOCKING RETRACTOR" on Page 52.

If your child restraint seat or seats require the use of a tether strap, you will want to use the anchor points **A** provided behind the rear bench backrests.

To ensure proper installation, see your authorized Porsche dealer.

## Warning!

Child restraint anchorages are designed to withstand only those loads imposed by correctly fitted child restraints. Under no circumstances are they to be used for adults safety belts or harnesses. Such use could result in serious personal injury or death.

- ▷ Do not misuse the child restraint anchorages. Only attach **one** child seat tether per anchorage.
- ▷ They are not designed to withstand loads imposed by adults.

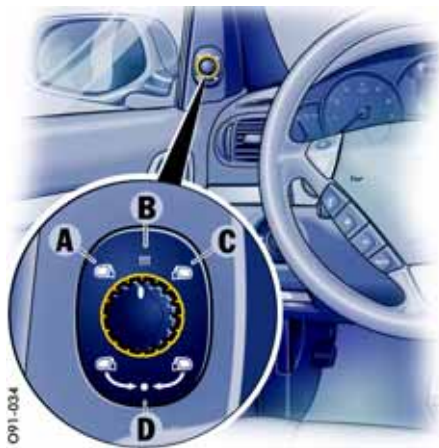

- A** - Door mirror setting – driver's side  
**B** - Heat door mirror  
**C** - Door mirror setting – passenger's side  
**D** - Fold in door mirrors

## Door Mirrors

The convex mirror glass on the passenger's side provides a larger field of view.

### Warning!

**Risk of accident. Vehicles or objects appear smaller in convex mirrors and further away than they are in reality.**

- ▷ Bear this distortion in mind when estimating the distance of vehicles behind you and when reversing into a parking space.
- ▷ Also make use of the interior mirror for judging the distance.

**Risk of damage to the door mirrors when washing the vehicle in a car wash.**

- ▷ Fold in door mirrors before using the car wash.

## Adjusting mirrors

1. Switch ignition on.
2. Select **A** for the driver's side or **C** for the passenger's side by turning the control switch.
3. Move the door mirrors in the appropriate direction by tilting the control switch.

### If the electrical adjustment facility fails

- ▷ Adjust the mirror by pressing on the mirror face.

## Adjusting the door mirrors synchronously

In the multi-purpose display of the instrument panel, you have the option of adjusting the door mirrors synchronously.

- ▷ Please see the chapter “SYNCHRONOUS ADJUSTMENT OF DOOR MIRRORS” on Page 143.

## Folding in door mirror

- ▷ Switch ignition on.
- ▷ Turn control switch to **D**. Both door mirrors fold in automatically.

### If the electrical adjustment facility fails

- ▷ Fold in mirror manually.

## Unfolding door mirrors

- ▷ Switch ignition on.
- ▷ Turn control switch to **A** or **C**. Both door mirrors unfold automatically.

### If the electrical adjustment facility fails

- ▷ Unfold mirrors manually.

## Door mirror heating

The door mirror heater is ready for operation when the ignition is switched on.

### Switching on

- ▷ Turn control switch to **B**.  
Both door mirrors are heated.

### Switching off

- ▷ Change the position of the control switch.

## Storing door mirror settings

On vehicles with seat memory, individual door mirror settings can be stored on the person buttons of the seat memory and vehicle keys and recalled with these.

- ▷ Please see the chapter "FRONT SEAT WITH MEMORY" on Page 37.
- ▷ Please see the chapter "STORING PASSENGER MIRROR SETTING AS A PARKING AID" on Page 38.

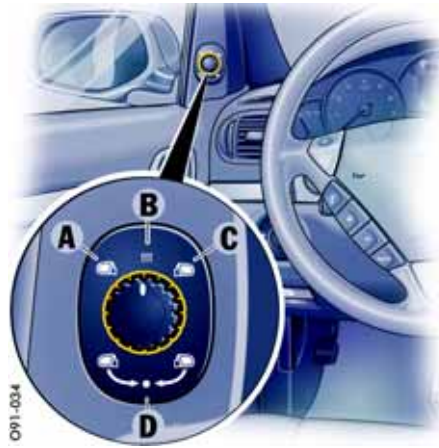

- A - Door mirror setting – driver's side
- B - Heat door mirror
- C - Door mirror setting – passenger's side
- D - Fold in door mirrors

## Swivelling down mirror glass as parking aid

When reverse gear is engaged, the mirror glass on the **passenger's side** swivels down slightly to show the curb area.

## Preconditions

- Vehicle must be equipped with seat memory.
- Control switch must be turned to position **C** (passenger mirror's setting).
- Reverse gear must be engaged.

## Moving mirror glass to its initial position with reverse gear engaged

The mirror glass swivels to its initial position when:

- The car is shifted out of reverse gear **or**
- The position of the control switch for the door mirror setting is changed.





## Interior Mirror

Initial position – lever forward  
 Anti-dazzle setting – lever back

### Note on operation

- ▷ When the interior mirror is being adjusted, anti-dazzle lever **A** must point forward.



**E** - Light-emitting diodes (LED)  
**F** - Button for automatic anti-dazzle operation  
**G** - Light sensors

## Automatic Anti-Dazzle Mirror

Sensors on the front and rear sides of the interior mirror measure the incident light. The mirrors automatically change to anti-dazzle position or revert to their normal state, depending on the light intensity.

### Note on operation

The incident light in the area of light sensors **G** must not be restricted (e.g. by stickers on the windshield).

## Switching off automatic anti-dazzle operation

- ▷ Press button **F**.  
 Light-emitting diode **E** goes out.

### Note on operation

Anti-dazzle operation switches off automatically, if:

- Reverse gear is engaged **or**
- Interior lighting **and/or** reading lights in the front are switched on.

## Switching on automatic anti-dazzle operation

- ▷ Press button **F**.  
 Light-emitting diode **E** lights up.



**Danger of injury. Electrolyte fluid can emerge from broken mirror glass. This fluid irritates the skin and eyes.**

- ▷ If the electrolyte fluid should come into contact with the skin or eyes, immediately rinse it off with clean water.  
 See a doctor if necessary.

**Risk of damage to paintwork and leather and plastic parts, and clothing. Electrolyte fluid can be removed only while it is still wet.**

- ▷ Clean the affected parts with water.

## Horn

- ▷ Press button **B** to operate the horn.

## Airbag unit

Airbag unit **C** is located behind the padded steering wheel boss.

In conjunction with the safety belts, the “airbag” is a safety system designed to provide the driver and passengers with maximum protection from injury in an accident.

- ▷ For further information on the airbag system: Please see the chapter “AIRBAG SYSTEMS” on Page 45.

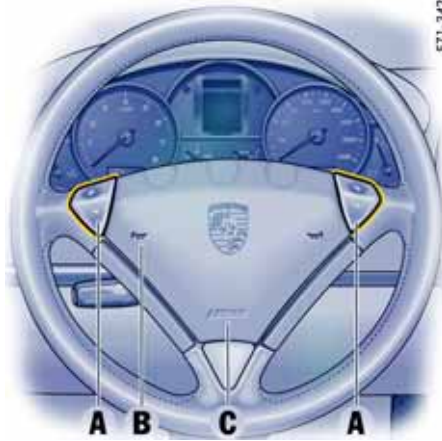

## Steering Wheel

### Tiptronic rocker switches

The Porsche Tiptronic is a six-speed transmission and features an “automatic” and a “manual” gear-shift mode.

You can change temporarily to manual mode using rocker switches **A** on the steering wheel.

- ▷ For further information on gearshifting with Tiptronic S: Please see the chapter “TIPTRONIC S” on Page 170.

## Steering Wheel Heating

The steering wheel heating is switched on and off automatically when the ignition is switched on depending on the interior temperature.

### On vehicles with manual air conditioning

The steering wheel heating **switches itself on** when the following criteria are fulfilled at the same time:

1. Low outside temperature.
2. Low engine temperature.
3. The interior temperature setting in the display of the air conditioning is 10 and more bars.

**or** at the highest level (all bars) of the interior temperature setting on the display of the air conditioning.

The steering wheel heating switches **itself off** again after a warming-up phase, or is switched off if one of the criteria is no longer met.

- ▷ For more information about setting the interior temperature on vehicles with manual air conditioning: Please see the chapter “SETTING TEMPERATURE” on Page 68.

## Steering Wheel Adjustment

### Warning!

**Risk of accident. The steering wheel may move further than desired if you attempt to adjust it when driving.**

**You can lose control of the vehicle, causing serious personal injury or death.**

- ▷ Do not adjust the steering wheel when driving.

**Risk of crushing due to uncontrolled recall of seat memory settings.**

- ▷ Do not leave children in the car unattended.

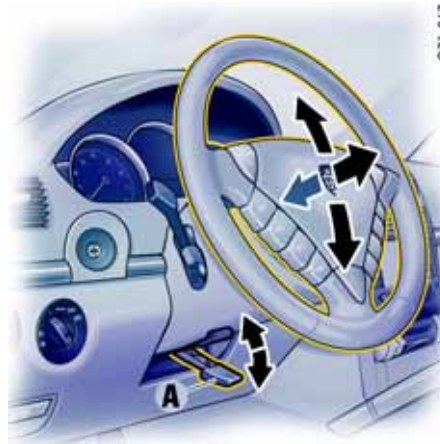

### Manual adjustment

1. Swivel locking lever **A** downwards.
2. Adapt the steering wheel setting to the backrest angle and your seat position. Move the steering wheel in the desired direction.
3. Swivel locking lever **A** back until you feel it engage.



### Electrical adjustment

- ▷ Press control switch **B** in the relevant direction until the desired setting is reached.

The steering wheel setting can be stored in the seat memory.

- ▷ For further information on storing and calling up the steering wheel setting on vehicles with comfort memory: Please see the chapter "FRONT SEAT WITH MEMORY" on Page 37.

## Multi-Functional Steering Wheel



### Warning!

**There is a danger of accident if you set or operate the on-board computer, radio, navigation system, telephone or other equipment when driving.**

**This could distract you from the traffic and cause you to lose control of the vehicle resulting in serious personal injury or death.**

- ▷ Operate the components while driving only if the traffic situation allows you to do so safely.
- ▷ Carry out any complicated operating or setting procedures only with the vehicle stationary.

Depending on the equipment in your vehicle, you can use these function keys to operate the following Porsche communication systems:

- PCM
- Radio
- Telephone,
- TV tuner,
- CD audio, DVD audio, DVD video,

or an iPod or USB storage device connected via the universal audio interface.

### Readiness for operation of multi-functional steering wheel

- With ignition switched on **and**
- With Porsche communication systems switched on.
- ▷ Please read and understand the operating instructions supplied for the Porsche communication systems before operating the function keys.

### Note on operation

The Porsche communication systems cannot be switched on and off using the multi-functional steering wheel.

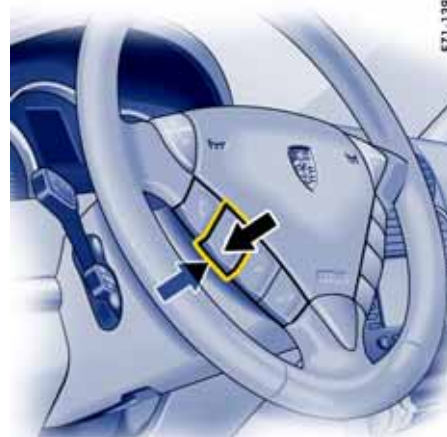

### Operating the function keys

The function keys on the steering wheel (**arrows**) can be operated by pressing and by pulling.

Various functions may require you to press or pull the buttons several times in order to achieve the desired setting.



E71-155

### Steering wheel buttons – lighting

When the light switch is operated, the light switches on automatically. Using the buttons on the back of the steering wheel (**arrow**), the lighting for the function keys and the rocker switches can be switched on and off.

#### Switching lighting off

- ▷ Press button.

#### Switching lighting on

- ▷ Press button again.



E71-240

### Function keys on multi-functional steering wheel

- ▷ Please read and understand the operating instructions supplied for the Porsche communication systems before operating the function keys.

- ↶ **Answer the telephone**
  - Take calls.
- ⏻ **Hang up the telephone**
  - End or reject the call.
- + **Increase the volume of the relevant communication system**
- **Decrease the volume of the relevant communication system**
- MUTE **Switch off the sound**
- ⏭ **Next radio station/title**
  - Select the next radio station or title.
- ⏮ **Last radio station/title**
  - Select the previous radio station or title.
- 🎵 **Source selection**
  - Select available audio source.



## Sun Visors

- ▷ Swing sun visor **A** down to prevent dazzle from the front.
- ▷ If you are dazzled from the side, unclip sun visor **A** from the inner bracket and swivel it round so that it is in front of the door window. You can also swivel sun visor **B** downwards.

### Note on operation

- ▷ Please note that sun visor **B** must be swivelled upwards before swivelling back sun visor **A**. Otherwise, sun visor **B** can no longer be swivelled upwards.



## Make-up mirror

The make-up mirror on the rear of the sun visor can be closed with a sliding cover.



### Risk of injury in an accident.

- ▷ Keep the sliding cover closed while driving.
- ▷ The make-up mirror illumination is switched on automatically when the sliding cover is opened (**arrow**).



## Sun Blinds, Rear Side Windows

The sun blinds in the rear door trim panels can be pulled out and secured in the holders **A**.



### Risk of damage.

- ▷ Pull out sun blinds during the journey only when door windows are closed.

## Retracting sun blinds

- ▷ Disengage the sun blind from holders **A** and carefully guide it back into the retractor roller.

# Air Conditioning, Parking Heater and Heated Rear Window

Opening the Cover Flap of the Air-Conditioning Control Panel .....	64
Overview of Air-Conditioning Systems .....	64
Valid for Every Air-Conditioning System .....	65
<b>Brief Overview</b> – Manual Air-Conditioning .....	66
Manual Air-Conditioning .....	67
<b>Brief Overview</b> – Automatically Controlled 2-Zone Air-Conditioning System .....	69
Automatically Controlled 2-Zone Air-Conditioning .....	70
<b>Brief Overview</b> – Automatically Controlled 4-Zone Air-Conditioning System, Front Control Panel .....	73
<b>Brief Overview</b> – Automatically Controlled 4-Zone Air-Conditioning System, Rear Control Panel .....	74
Automatically Controlled 4-Zone Air-Conditioning .....	75
Vents .....	79
Heated Rear Window .....	80
Parking Heater .....	81



## Opening the Cover Flap of the Air-Conditioning Control Panel

- ▷ Swivel cover flap on the handle downwards (arrow).

## Overview of Air-Conditioning Systems

The following air-conditioning system types may be installed, depending on your vehicle equipment:

### A - Manual air-conditioning system

Air quantity, air distribution and temperature can be set on the control panel of the manual air-conditioning system.

### B - Automatically controlled 2-zone air-conditioning system

The air-conditioning system controls the preselected interior temperature completely automatically. Temperature can be set individually for the left and right air-conditioned areas.

### C - Automatically controlled 4-zone air-conditioning system

The air-conditioning system controls the set interior temperature completely automatically. Temperature, air quantity and air distribution can be set individually for the front left, front right, rear left and rear right air-conditioned areas.

### How do I recognize which is “my” air-conditioning system?

- A - Wide rocker switch and **no** AUTO button
- B - AUTO button **and** REST button present
- C - Button for rear control panel is present

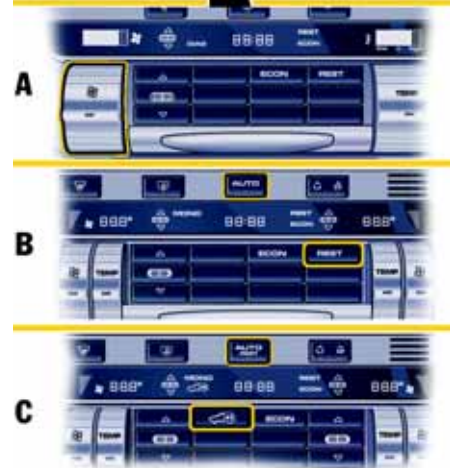



## Valid for Every Air-Conditioning System

### Note on operation

The air conditioner settings are stored on the respective remote control when switching off the ignition and locking the vehicle. The "Air flow OFF" setting is stored for approx. 60 minutes and the "Recirculated air" setting is stored for approx. 20 minutes.

### REST mode

#### Using engine residual heat

The residual heat of the engine can be used to heat the interior up to 20 minutes after the ignition has been switched off.

- ▷ Press button **REST** (manual and 2-zone air-conditioning) or **AUTO** (4-zone air-conditioning) on the front control panel.  
The air-conditioning settings cannot be changed in REST mode.

#### Ending the function

- ▷ Press button **REST** (manual and 2-zone air-conditioning) or **AUTO** (4-zone air-conditioning) on the front control panel.

### Note on operation

If the battery voltage is too low, REST mode is automatically ended.

### ECON mode



---

**Risk of accident due to impaired vision, resulting in serious personal injury or death. The outside air that is flowing in is not dried in ECON mode. The windows may mist up.**

- ▷ Do not switch on ECON mode in damp weather.
- 

In ECON mode, the air-conditioning compressor is switched off and this deactivates the cooling function (e.g. to save fuel).

The air-conditioning compressor is **always** switched off at temperatures below 37.4 °F (3 °C).

#### Switching on ECON mode

- ▷ Press button **ECON**.  
The ECON logo appears on the air-conditioning display panel.  
The air-conditioning compressor is switched off.

#### Switching off ECON mode

- ▷ If the interior temperature is too high, press button **ECON** or press button **AUTO** (2-zone air-conditioning) or button **AUTO** (4-zone air-conditioning).  
The ECON logo disappears from the air-conditioning display panel.  
The air-conditioning compressor is switched on.

### Information on air-conditioning compressor

The air-conditioning compressor:

- May switch off briefly to ensure sufficient engine cooling if the engine is operating under extreme load.
- Switches off automatically at temperatures below approx. 37.4 °F (3 °C) and cannot be switched on, even manually.
- Operates most effectively with windows closed.  
If the car has been in the sun for a long time, however, it is a good idea to ventilate the interior briefly with the windows open.
- Depending on the outside temperature and humidity, condensation can drip from the evaporator and form a pool under the car. This is normal and not a sign of leakage.
- ▷ If uncooled air flows out when the lowest temperature has been set ("LO"), switch off the air-conditioning compressor and have the fault remedied at an authorized Porsche dealer.

## Brief Overview – Manual Air-Conditioning

This brief overview does not replace the information provided in the chapter “Manual Air-Conditioning”. In particular, warnings are not replaced by this brief overview.



### What do I want to do?

### What do I have to do?

#### Setting temperature

Push button **K** up (warmer) or down (colder).

#### Setting air quantity

Push button **E** up (more) or down (less).

#### Setting air distribution

Air to windshield: Press button **F**.  
Air to central and side vents: Press button **H**.  
Air to footwell: Press button **G**.

#### Defrosting windshield

Press button **A**.



C031-200

### Control panel

- A - Windshield defroster
- B - Heated rear window
- C - Recirculated air
- D - Air-conditioning display
- E - Air-quantity button
- F - Air to windshield
- G - Air to footwell
- H - Air to central and side vents
- I - ECON button (air-conditioning compressor off/on)
- J - REST button (engine residual heat)
- K - Temperature button

## Manual Air-Conditioning

Air quantity, air distribution, and temperature can be set on the control panel of the manual air conditioning.

This individual adjustment is shown on the air-conditioning display panel.

Please read the information on:

- **REST mode,**
- **ECON mode and**
- **Air-conditioning compressor on page 65.**



### Defrost windshield

- ▷ Press button . Indicator light in button lights up. The air flows to the windshield and the front side windows. The windshield is demisted or defrosted as quickly as possible.

### Ending the function

- ▷ Press button again.



## Setting temperature

- ▷ The selected temperature is shown in a bar display on the display above the button. The more bars that are displayed, the higher the temperature of the air flowing into the interior.

### Increase temperature

- ▷ Push temperature button **K** up.

### Decrease temperature

- ▷ Push temperature button **K** down.

### Note

- ▷ For maximum cooling, activate recirculated air button .



## Setting air quantity

- ▷ The selected air quantity is shown in a bar display on the display above the button. The more bars that are displayed, the more air flows into the interior.

If the air quantity was reduced so much that "OFF" appears on the display, the outside-air supply is interrupted.

### Increase air quantity

- ▷ Push air quantity button **E** up.

## Decrease air quantity

- ▷ Push air quantity button **E** down.



**Risk of accident due to impaired vision, resulting in serious personal injury or death. If the air quantity is "OFF", the windows may mist up.**

- ▷ Only select air quantity setting "OFF" for short periods.
- ▷ If windows mist up, push air quantity button **E** up to increase air quantity and select the function "Defrost windshield".

## Setting air distribution

### Air to windshield

- ▷ Press button . The air flows to the windshield.

### Air to central and side vents

- ▷ Press button . The air flows from the central and side vents. Vents must be open.

### Air to footwell

- ▷ Press button . The air flows to the footwell.



## Switching recirculating-air mode on



**Risk of accident due to impaired vision, resulting in serious personal injury or death. In recirculating-air mode, the windows may mist up.**

- ▷ Only select recirculating-air mode for short periods.
- ▷ If windows mist up, switch recirculating-air mode off immediately by pressing the recirculating-air button again and select the function "Defrost windshield".

- ▷ Press button . Indicator light in button lights up. The outside-air supply is interrupted and only the inside air is circulated.

## Brief Overview – Automatically Controlled 2-Zone Air-Conditioning System

This brief overview does not replace the information provided in the chapter “Automatically Controlled 2-Zone Air-Conditioning”. In particular, warnings are not replaced by this brief overview.



001-451

What do I want to do?	What do I have to do?
<b>Switching on automatic air-conditioning system</b>	Press button <b>C</b> .
<b>Setting temperature</b>	Left vehicle side: Push button <b>H</b> up (warmer) or down (colder). Right vehicle side: Push button <b>N</b> up (warmer) or down (colder).
<b>Setting air quantity</b>	Push button <b>G</b> up (more) or down (less).
<b>Setting air distribution</b>	Air to windshield: Press button <b>I</b> . Air to central and side vents: Press button <b>K</b> . Air to footwell: Press button <b>J</b> .
<b>Defrosting windshield</b>	Press button <b>A</b> .



001-203

### Control panel

- A - Windshield defroster
- B - Heated rear window
- C - AUTO button (automatic mode)
- D - Recirculated air, automatic recirculated air
- E - Air-conditioning display
- F - Temperature sensor
- G - Air-quantity button
- H - Temperature button for left side
- I - Air to windshield
- J - Air to footwell
- K - Air to central and side vents
- L - ECON button (air-conditioning compressor off/on)
- M - REST button (engine residual heat)
- N - Temperature button, right side

## Automatically Controlled 2-Zone Air-Conditioning

Depending on various factors (e.g. sunlight, air quality), the air-conditioning system controls the preset interior temperature fully automatically.

Temperature can be set individually/separately for the two left and right air-conditioned areas.

You can manually influence the automatic system. This individual adjustment is shown on the air-conditioning display panel.

Please read the information on:

- REST mode,
- ECON mode and
- Air-conditioning compressor on page 65.



### Defrosting the windshield

- ▷ Press button . Indicator light in button lights up. The air flows to the windshield and the front side windows. The windshield is demisted or defrosted as quickly as possible.

### Ending the function

- ▷ Press button  again or
- ▷ Press button **AUTO**.

## Automatic mode

- ▷ Press button **AUTO**. Indicator light in button lights up. Air quantity and air distribution are automatically controlled and variations are compensated.

### Note on operation

If necessary, the automatic system can be manually influenced. This manual setting is retained until the appropriate function button is pressed again or the button **AUTO** is pressed.

## Sensors

To avoid affecting the performance of the air-conditioning system:

- ▷ Do not cover the sun sensor on the dashboard and the temperature sensor **F** in the front control panel of the air-conditioning system.

## Setting temperature

To suit personal comfort, the interior temperature can be adjusted between 61 °F and 85 °F (16 °C and 29.5 °C).

**Recommendation: 72 °F (22 °C)**

The selected temperature is shown on the display above the button.

### Increase temperature

- ▷ Push temperature button up.  
Left side of vehicle: button **H**  
Right side of vehicle: button **N**

### Decrease temperature

- ▷ Push temperature button down.  
Left side of vehicle: button **H**  
Right side of vehicle: button **N**

If “LO” or “HI” appears on the display, the system is operating at maximum cooling or heating power. Automatic mode is switched off.

If the preselected temperature is changed, the air quantity blowing out can adjust automatically in automatic mode.

The desired temperature is reached more quickly this way.

## Setting air quantity

The selected air quantity is shown in a bar display on the display above the button. The more bars that are displayed, the more air flows into the interior.

### Increase air quantity

- ▷ Push air quantity button **G** up.

### Decrease air quantity

- ▷ Push air quantity button **G** down.

Press button **AUTO** to return to automatic mode.

If the air quantity was reduced so much that “OFF” appears on the display, the outside-air supply is interrupted.



---

**Risk of accident due to impaired vision, resulting in serious personal injury or death. If the air quantity is “OFF”, the windows may mist up.**

- ▷ Only select air quantity setting “OFF” for short periods.
  - ▷ If windows mist up, push air quantity button **G** up to increase air quantity and select the function “Defrost windshield”.
-

## Setting air distribution

### Air to windshield

- ▷ Press button .  
The air flows to the windshield.

### Air to central and side vents

- ▷ Press button .  
The air flows from the central and side vents.  
Vents must be open.

### Air to footwell

- ▷ Press button .  
The air flows to the footwell.

## Ending air distribution functions

- ▷ Press the relevant button again **or**
- ▷ Press button **AUTO**.

## Accepting settings for driver's side for the entire vehicle

The MONO function allows temperature settings for the driver's side to be accepted for the entire vehicle.

### Switching MONO function on

The temperature settings for the driver's side can be accepted for the entire vehicle.

- ▷ Press button **AUTO** for 2 seconds.  
The MONO logo appears on the air-conditioning display panel.

### Ending MONO function

- ▷ Press button **AUTO** for 2 seconds **or**
- ▷ Change the settings in the air-conditioned areas.

### Switching automatic recirculating-air mode on

- ▷ Press button  once.  
Indicator light in button lights up.  
Control of the outside-air supply depends on the air quality.

### Note

The recommended operating mode is automatic recirculating-air mode.



## Switching recirculating-air mode on



---

**Risk of accident due to impaired vision, resulting in serious personal injury or death. In recirculating-air mode, the windows may mist up.**

- ▷ Only select recirculating-air mode for short periods.
  - ▷ If windows mist up, end recirculating-air mode by pressing the recirculating-air button again and selecting the function "Defrost windshield".
- 
- ▷ Press button  twice.  
Indicator light in button lights up.  
The outside-air supply is interrupted and only the inside air is circulated.

### Note on operation

When the air-conditioning compressor is switched off manually or automatically, recirculating-air mode ends after approx. 3 minutes.



## Brief Overview – Automatically Controlled 4-Zone Air-Conditioning System, Front Control Panel

This brief overview does not replace the information provided in the chapter “Automatically Controlled 4-Zone Air-Conditioning”. In particular, warnings are not replaced by this brief overview.



001-450

What do I want to do?	What do I have to do?
<b>Switching on automatic air-conditioning system at front</b>	Press button <b>C</b> .
<b>Setting temperature at front</b>	Left side: Push button <b>H</b> up (warmer) or down (colder). Right side: Push button <b>Q</b> up (warmer) or down (colder).
<b>Setting air quantity at front</b>	Left side: Push button <b>G</b> up (more) or down (less). Right side: Push button <b>R</b> up (more) or down (less).
<b>Setting air distribution at front</b>	Air to windshield, left or right side: Press button <b>I</b> or <b>P</b> . Air to central and side vents, left or right side: Press button <b>K</b> or <b>N</b> . Air to footwell, left or right side: Press button <b>J</b> or <b>O</b> .
<b>Defrosting windshield</b>	Press button <b>A</b> .

## Brief Overview – Automatically Controlled 4-Zone Air-Conditioning System, Rear Control Panel

This brief overview does not replace the information provided in the chapter “Automatically Controlled 4-Zone Air-Conditioning”. In particular, warnings are not replaced by this brief overview.

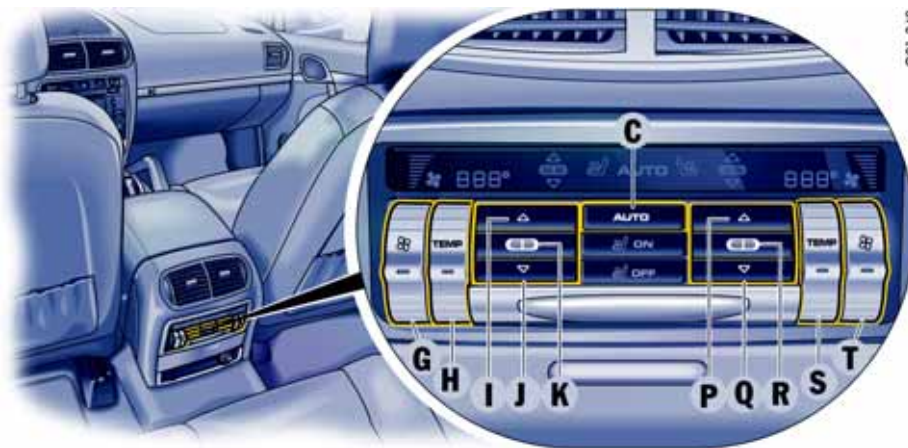

001-249

### What do I want to do?

### What do I have to do?

#### Switching on automatic air-conditioning system at rear

Press button **C**.

#### Setting temperature at rear

Left side: Push button **H** up (warmer) or down (colder).  
Right side: Push button **S** up (warmer) or down (colder).

#### Setting air quantity at rear

Left side: Push button **G** up (more) or down (less).  
Right side: Push button **T** up (more) or down (less).

#### Setting air distribution at rear

Air to side window, left or right side: Press button **I** or **P**.  
Air to central vent, left or right side: Press button **K** or **R**.  
Air to footwell, left or right side: Press button **J** or **Q**.



C001-201

### Control panel, front

- A - Windshield defroster
- B - Heated rear window
- C - AUTO button (automatic mode)  
REST button (engine residual heat)
- D - Recirculated air, automatic recirculated air
- E - Air-conditioning display
- F - Temperature sensor
- G - Air-quantity button, left
- H - Temperature button, left
- I - Air to windshield, left
- J - Air to footwell, left
- K - Air to left central and side vents
- L - Setting for rear air-conditioned areas
- M - ECON button (air-conditioning compressor off/on)
- N - Air to right central and side vents
- O - Air to footwell, right
- P - Air to windshield, right
- Q - Temperature button, right
- R - Air-quantity button, right

## Automatically Controlled 4-Zone Air-Conditioning

Depending on various factors (e.g. ambient temperature, sunlight, air quality), the air-conditioning system controls the preset interior temperature fully automatically.

Temperature, air quantity and air distribution can be set individually/separately for the four air-conditioned areas front left, front right, rear left and rear right.

You can manually influence the automatic system. This individual adjustment is shown on the air-conditioning display panel.

Please read the information on:



- REST mode,
- ECON mode and
- air-conditioning compressor on page 65.



### Defrosting the windshield

- ▷ Press button  on the front control panel. Indicator light lights up. The air flows to the windshield and the front side windows. The windshield is demisted or defrosted as quickly as possible.

### Ending the function

- ▷ Press button  again or
- ▷ Press the button .

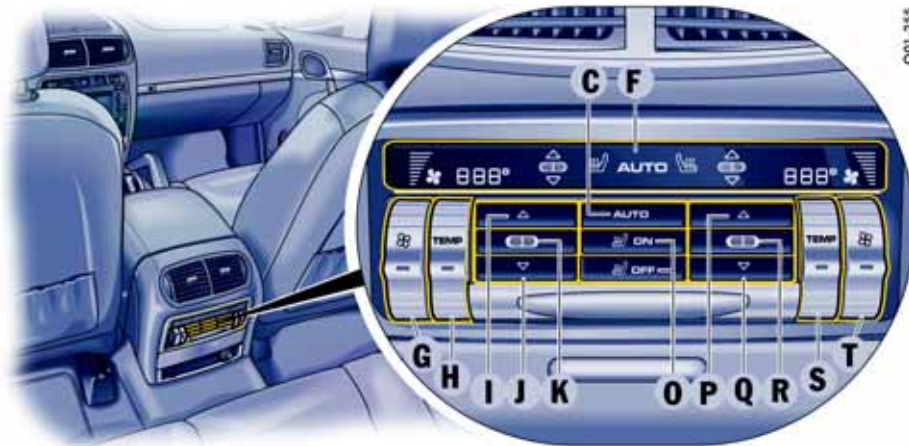

001-255

### Control panel, rear

- C - AUTO button (automatic mode)
- F - Air-conditioning/seat heating display
- G - Air-quantity button, left
- H - Temperature button, left; seat heating, left
- I - Air to vent, left door post
- J - Air to footwell, left
- K - Air to left central vent (center console)
- O - Seat heating off/on
- P - Air to vent, right door post
- Q - Air to footwell, right
- R - Air to right central vent (center console)
- S - Temperature button, right; seat heating, right
- T - Air-quantity button, right

### AUTO Automatic mode

You can switch to automatic mode for the front and rear air-conditioned areas, independently of one another.

- ▷ Press AUTO button **C** on the front or rear control panel.

The indicator light in button **C** of the front control panel and the AUTO indication in the rear display panel are lit.

Air quantity and distribution are automatically controlled and variations are compensated.

### Note on operation

If necessary, the automatic system can be manually influenced.

This manual setting is retained until the appropriate function button is pressed again or the AUTO button **C** is pressed.

### Sensors

To avoid affecting the performance of the air-conditioning system:

- ▷ Do not cover the sun sensor on the dashboard and the temperature sensor **F** in the front control panel of the air-conditioning system.

## Setting temperature

To suit personal comfort, the interior temperature for each of the four air-conditioned areas can be adjusted between 61 °F and 85 °F (16 °C and 29.5 °C).

**Recommendation: 72 °F (22 °C)**

The selected temperature is shown on the display above the button.

### Increase temperature

- ▷ Push temperature button up.  
Left air-conditioned area, front: Button **H**  
Right air-conditioned area, front: Button **Q**  
Left air-conditioned area, rear: Button **H**  
Right air-conditioned area, rear: Button **S**

### Decrease temperature

- ▷ Push temperature button down.  
Left air-conditioned area, front: Button **H**  
Right air-conditioned area, front: Button **Q**  
Left air-conditioned area, rear: Button **H**  
Right air-conditioned area, rear: Button **S**

If “LO” or “HI” appears on the display, the system is operating at maximum cooling or heating power.

If the preselected temperature is changed, the air quantity blowing out can adjust automatically in automatic mode.

The desired temperature is reached more quickly this way.

## Setting air quantity

The air quantity can be selected individually for each of the four air-conditioned areas. The selected air quantity is shown in a bar display on the display above the button. The more bars that are displayed, the more air flows into the interior.

### Increase air quantity

- ▷ Push air quantity button up.  
Left air-conditioned area, front: Button **G**  
Right air-conditioned area, front: Button **R**  
Left air-conditioned area, rear: Button **G**  
Right air-conditioned area, rear: Button **T**

### Decrease air quantity

- ▷ Push air quantity button down.  
Left air-conditioned area, front: Button **G**  
Right air-conditioned area, front: Button **R**  
Left air-conditioned area, rear: Button **G**  
Right air-conditioned area, rear: Button **T**

- ▷ Press AUTO button **C** to return to automatic mode.

If the air quantity on the front control panel was reduced so much that “OFF” appears on the display, the outside-air supply is interrupted.



**Risk of accident due to impaired vision, resulting in serious personal injury or death. If the air quantity is “OFF”, the windows may mist up.**

- ▷ Only select air quantity setting “OFF” for short periods.
- ▷ If windows mist up, push air quantity buttons **G** and **O** up to increase air quantity and select the function “Defrost windshield”.

## Setting air distribution

### Air to windshield and side windows

The air quantity can be selected individually for each of the four air-conditioned areas.

- Front control panel:  
The air flows to the windshield.
- Rear control panel:  
The air flows to the respective side window.
- ▷ Press button .

## Air to central and side vents

- ▷ Press button .
- Front control panel:  
The air flows from the front central and side vents.
- Rear control panel:  
The air flows to the center vents.
- ▷ Vents must be open.

## Air to footwell

- ▷ Press button .  
The air flows to the footwell.

## Ending air distribution functions

- ▷ Press the relevant button again **or**
- ▷ Press the AUTO button **C**.

## Accepting settings for driver's side for the entire vehicle

The MONO function allows the temperature and air quantity settings for the driver's side to be accepted for the entire vehicle.

### Switching on MONO function

- ▷ Press button  in the front control panel for 2 seconds.  
The MONO logo appears on the air-conditioning display panel.

### Ending MONO function

- ▷ Press button  in the front control panel for 2 seconds **or**
- ▷ Change the settings in the air-conditioned areas.

## Switching automatic recirculating-air mode on

- ▷ Press button  on the front control panel once.  
Indicator light in button lights up.  
Control of the outside-air supply depends on the air quality.

### Note

The recommended operating mode is automatic recirculating-air mode.

## Switching recirculating-air mode on



**Risk of accident due to impaired vision, resulting in serious personal injury or death. In recirculating-air mode, the windows may mist up.**

- ▷ Only select recirculating-air mode for short periods.
  - ▷ If windows mist up, end recirculating-air mode by pressing the recirculating-air button again and selecting the function "Defrost windshield".
- 
- ▷ Press button  on the front control panel twice.  
Indicator light in button lights up.  
The outside-air supply is interrupted and only the inside air is circulated.

### Note on operation

When the air-conditioning compressor is switched off manually or automatically, recirculating-air mode ends after approx. 3 minutes.



EV1-423

### Disabling control panel for air-conditioned areas at the rear

Power windows, central locking buttons on the rear doors and rear control panel for the air conditioning can be disabled using the safety button in the armrest of the driver's door.



### Switching child protection on/off

- ▷ Press the safety button to switch child protection on and off.  
The symbol in the safety button lights up if child protection is active.



### Controlling rear air-conditioned areas with the front control panel

- ▷ Press button .  
The Symbol appears on the display.  
The rear air-conditioned areas can be controlled from the front control panel.

### Ending the function

- ▷ Press button  again.

### Note on operation

The function is ended automatically 10 seconds after the last settings are made.

### Rear seat heating

The rear seats can also be heated in vehicles with four-zone air conditioning.

- ▷ For further information on the rear seat heating:  
Please see the chapter "REAR SEAT HEATING IN VEHICLES WITH AN FOUR-ZONE AIR CONDITIONING SYSTEM" on Page 41.



001-202

**A** - Continuous opening and closing  
**B** - Setting vent direction

### Vents

#### ○ Opening vents

- ▷ Rotate thumb wheel **A** upward.

#### ● Closing vents

- ▷ Rotate thumb wheel **A** downward.

## Changing air flow direction

- ▷ Swivel vent fins **B** in the desired direction.

## Note on operation

Fresh air or conditioned fresh air can be delivered from all vents depending on the air distribution setting.

## Fresh-air intake

In order to ensure unhindered air intake:

- ▷ Keep the fresh-air intake between the wind-shield and the engine compartment lid free from snow, ice and leaves.



001-205



## Heated Rear Window

The heated rear window is ready for operation when the ignition is on.

## Switching on

- ▷ Press button **B**.  
Indicator light in button lights up.

Depending on the outside temperature, the heating switches off automatically after approx. 5 to 20 minutes.

The heating can be switched back on again by pressing the switch again.

## Switching off

- Press button **B**.  
Indicator light in button goes out.





0011204

The parking heater is operated using the following buttons on the front air-conditioning control panel:

-  Switch parking heater on and off  
Activate program
- TIMER** Start programming  
Call memories
- +** Set ON times  
Activate heating function
- Set ON times  
Activate ventilating function

- A - “-” button
- B - TIMER button
- C - ON/OFF button
- D - “+” button

## Parking Heater

The parking heater features two functions: parking heating and parking ventilation.

The parking heater is ready for use regardless of the ignition key position.

The parking heater is also used as an auxiliary heater. Operation of the parking heater is therefore clearly audible when outside temperatures are low, even if the parking heater has been manually switched off.

### Danger!

**Risk of poisoning due to carbon monoxide (CO). The parking heater consumes fuel and emits exhaust fumes. Exposure to such fumes can cause unconsciousness, serious personal injury or death.**

- ▷ Switch off the parking heater before refueling.
- ▷ Do not operate the parking heater in enclosed spaces (e.g. a garage).

## Notes on operation

The parking heater runs on fuel, and it therefore cannot be switched on after the reserve warning lights up.

- ▷ For further information on the fuel reserve warning:  
Please see the chapter "FUEL RESERVE WARNING" on Page 120.

The parking heater must be operated at least once per month with the engine cold.

Ignition off: When the parking heater is running, the remaining running time is shown on the display panel.

Operation of the parking heater is clearly audible when outside temperatures are low and the engine is cold.

In certain circumstances, exhaust gases may be visible under the vehicle.



## Switching parking heater on and off

### Switching on

- ▷ Press ON/OFF button .  
The most recently activated parking heating or parking ventilation function is switched on.

### Switching off

- ▷ Press ON/OFF button  again.

### Note on operation

- ▷ After switching off the parking heater using ON/OFF button , wait for at least 2 minutes before you press the button again. The combustion chamber is cleaned.



- E** - Parking ventilation symbol
- F** - ON time symbol
- G** - Memory symbol
- H** - ON time
- I** - Parking heating symbol

## Programming the parking heater

The parking heater has three independent memories for programming the ON times. The ON time, together with the associated parking heating or parking ventilation function, can be programmed in each memory.

Complete programming of the parking heater requires definition of the

- Function **and**
- ON time.

001-471



## Programming function

1. Switch ignition off.
2. Press button **TIMER** on the front air-conditioning control panel.  
The symbols for the parking heating **I** or parking ventilation **E** function flash on the display.
3. Select function.  
Press button **+** for parking heating or button **-** for parking ventilation.

If no other entry is made within **10 seconds**, the display returns to its initial status. However, the selected function is retained and is activated when the parking heater is next turned on.

- ▷ For further information on switching parking heater on and off:  
Please see the chapter "SWITCHING PARKING HEATER ON AND OFF" on Page 82.



## Programming ON times

1. Switch ignition off.
2. Press button **TIMER**.
3. Select function (parking heating or parking ventilation).
4. Select the memory using button **TIMER**.  
The desired memory can be selected by pressing button **TIMER** several times.
5. Set ON time using the **+** and **-** buttons. Pressing the buttons adjusts the time on a minute-by-minute basis. If the button is kept depressed, the time is adjusted faster. ON times are only valid for 24 hours.
6. Press ON/OFF button .  
Displays **F** and **G** flash for approx. 10 seconds. Flashing of the displays can be ended before this time has elapsed by pressing the ON/OFF button  again.  
After ON/OFF button  has been pressed ON time **H**, clock symbol **F** and memory **G** are displayed for 2 minutes.  
The display then goes out.  
The parking heater has now been programmed and the selected memory is active (symbol **G** is lit).

### Note on operation

Only **one** memory can be active at any one time.

## Activating the memory

- The parking heater runs for 30 minutes. It then switches itself off automatically.  
The program must be reactivated for every subsequent run.  
To do this:
1. Switch ignition off.
  2. Press button **TIMER**.
  3. Select function (parking heating or parking ventilation).
  4. Select the memory using button **TIMER**. The ON time that was last saved is displayed.
  5. Press ON/OFF button .  
The program is reactivated.  
Displays **F** and **G** flash for approx. 10 seconds. The ON/OFF button  can be pressed again to switch off the displays before this time has elapsed.  
After the ON/OFF button  has been pressed, the ON time **H**, clock symbol **F** and memory **G** are displayed for 2 minutes.  
The display then goes out.  
The parking heater has now been programmed and the selected memory is active (symbol **G** is lit).

### Note on operation

Only **one** memory can be active at any one time.

## Example:

The parking heater is to activate the parking heating function at 9:48 a.m.

To do this:

1. Switch ignition off.
2. Press button **TIMER** on the front air-conditioning control panel.  
The symbols for the parking heating or parking ventilation function flash on the display.
3. Press button **+**.  
This selects the parking heating function.
4. Select the memory using button **TIMER**.
5. Set ON time to 9:48 a.m. using the **+** and **-** buttons.
6. Press ON/OFF button .  
The parking heater has now been programmed and the selected memory is active.

### Note on operation

If the parking heater is switched on manually prior to program start of an active memory, this will delete the programming.  
The memory must be reactivated if it is needed.  
If the memory is not reactivated, the parking heater will not switch on.

## Parking heater faults

### Initial start-up following period of non-utilization

If you have not used the parking heater for several weeks, the system may require the parking heater to be switched on several times before it actually “starts up”.

- ▷ Please take a break of approximately 5 minutes between each individual switch-on attempt.

### Requirement for initial start-up of the parking heater:

- Cold engine.

Have the parking heater checked by an authorized Porsche dealer in the following cases:

- If the parking heater fails to “start-up” after the 3rd switch-on attempt.
- In the event of faults in the parking heater, no function symbol appears on the display – only the remaining running time is shown. The display flashes on briefly and then goes completely dark.
- In the event of a serious accident, the parking heater switches off automatically for safety reasons. The parking heater is not ready for operation.
- If the temperature rises, the overheating protection switches the parking heater off automatically. The parking heater is not ready for operation.
- The parking heater is switched off automatically if the voltage is too low. The parking heater is temporarily unavailable.

# Windows and Sliding Roofs

Power windows.....	87
<b>Brief overview</b> - sliding/lifting roof.....	91
Sliding/Lifting Roof .....	92
<b>Brief overview</b> – Panorama roof system .....	96
Panorama roof system .....	97

## Power windows



### Warning!

**Risk of injury when the door windows close. This applies especially if the windows are closed with the comfort function.**

**When this function is in operation the window goes up automatically.**

- ▷ Make sure that fingers, hands, arms or other body parts are not in the way when the windows close.
- ▷ Remove the ignition key or switch ignition off in vehicles that have Porsche Entry & Drive to shut off power to the window switches when the vehicle is not attended by a responsible person. Always take the ignition key with you when leaving the vehicle. Uninformed persons could injure themselves by operating the power windows.
- ▷ In case of danger, immediately release the button on the car key or the button in the door handle in vehicles that have Porsche Entry & Drive.
- ▷ Do not leave children in the car unattended.

### Risk of an accident.

- ▷ Do not put anything on or near the windows that may interfere with the driver's vision.

### Note on operation

- ▷ Always keep the side windows closed while driving off-road.

## Readiness for operation of power windows

- With ignition switched on **or**
- A maximum of 10 minutes with door closed and ignition key withdrawn, but only until driver's or passenger door is first opened. The one-touch operation for closing the door windows is available only when the ignition is switched on.

## Opening/closing windows

### Opening window with the rocker switch

- ▷ Press rocker switch until the window has reached the desired position.



**A** - Power window in driver's door  
**B** - Power window in passenger's door  
**C** - Left rear power window  
**D** - Right rear power window

### Note on operation

Rocker switches **A** and **B** in the driver's door have a two-stage function:

- If the switch in question is pressed or pulled to the first level, the front window is opened or closed manually.
- If the switch is completely pressed or pulled to the second level, the front window is opened or closed automatically (one-touch operation). Press or pull again to stop the window in the desired position.



E71-515

Power windows in passenger's door and rear doors

### Closing window with the rocker switch

- Pull rocker switch until the window has reached the desired position.

### One-touch operation for front windows

- ▷ Pull or press rocker switch to its final position in the driver's door. Window moves to its final position. Press or pull again to stop the window in the desired position.

### Note on operation

If a door window is blocked during closing, it will stop and open again by several centimetres. However, this is **not** the case:

- If the rocker switch is pressed again within 10 seconds of the window being blocked **and**
- The windows are closed using the car key in the door lock (comfort function).

The windows close with their full closing force.



**Warning!**

**Risk of serious personal injury. If the rocker switch is pulled again within 10 seconds of the window being blocked, the window will close with its full closing force.**

- ▷ Ensure that no one can be injured when the windows close.

One-touch operation is disabled for 10 seconds after the door window is obstructed.



O91-147

### Disabling power windows in the rear doors

The power windows, central locking buttons on the rear doors and the rear control panel for the air conditioning can be disabled by means of the safety button in the armrest of the driver's door.



### Switching child protection on/off

- ▷ Press the safety button to switch child protection on and off. The symbol in the safety button lights up if child protection is active.





If you unlock the vehicle with the key at the door lock, only the driver's door is unlocked. In order to prevent the alarm system from being triggered, you must switch the ignition on within 15 seconds of opening the door.

On vehicles **with and without** Porsche Entry & Drive

### Opening/closing windows with car key



**Warning!**

**Danger of injury. The window will close with its full closing force.**

- ▷ Ensure that no one can be injured when the windows close.
- ▷ Hold the car key in the door lock in the unlocking or locking position until the windows have reached the desired position.



### Note on operation

The comfort function remains available for approx. 30 seconds after the vehicle has been locked.

### Storing final position of the door windows

The end positions of the door windows are lost when the battery is disconnected and reconnected. The one-touch operation of the windows is disabled.

Perform these procedures for all windows:

1. Close window completely once by pulling rocker switch.
2. Open window completely **again** by pressing rocker switch.

On vehicles **with** Porsche Entry & Drive

### Closing windows with button in door handle



**Warning!**

**Danger of injury. The window will close with its full closing force.**

- ▷ Ensure that no one can be injured when the windows close.
- ▷ Hold the button in the door handle when locking the vehicle until the windows and the Panorama roof system have reached the desired position.

## Brief overview - sliding/lifting roof

This brief overview does not replace the information provided in the chapter “Sliding/lifting roof”. In particular, warnings are not replaced by this brief overview.

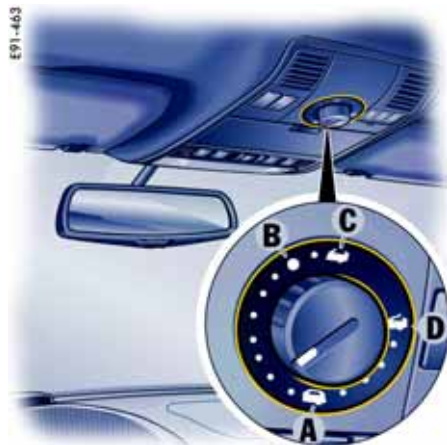

Switch in the roof console

What do I want to do?	What do I have to do?	What do I see?
<b>Opening roof</b>	Turn switch to position <b>C</b> . Or: Turn switch to position <b>B</b> . (noise-optimized position)	Roof opens.
<b>Lifting roof</b>	Turn switch to position <b>D</b> .	Roof is lifted.
<b>Close roof</b>	Turn switch to position <b>A</b> .	Roof closes.

## Sliding/Lifting Roof

The electric sliding/lifting roof is made of single-sheet safety glass. It is equipped with a sliding-roof cover that can be infinitely adjusted manually to protect against the sun.

The sliding/lifting roof is operated using a knob in the roof console.



### Warning!

#### Risk of injury when operating or automatically closing the sliding/lifting roof.

- ▷ Ensure that no one can be injured when the sliding/lifting roof is operated.
  - ▷ Always withdraw ignition key when leaving the vehicle or switch ignition off in vehicles that have Porsche Entry & Drive. Always take the ignition key with you when leaving the vehicle. Uninformed persons (e.g. children) could injure themselves by operating the sliding/lifting roof.
  - ▷ In case of danger, release the knob or car key immediately and operate the sliding/lifting roof in the opposite direction.
- 
- ▷ Always keep the sliding/lifting roof and the side windows closed while driving off-road.

## Readiness for operation of the sliding/lifting roof

- With ignition switched on.
- With ignition key withdrawn until door is first opened, but only for a maximum of 10 minutes.

## Readiness function of the sliding/lifting roof switches off after 10 minutes

If the vehicle is unlocked, the sliding/lifting roof can no longer be operated after 10 minutes (to save the vehicle battery). The power supply is switched back on when the ignition is switched on or the engine started.

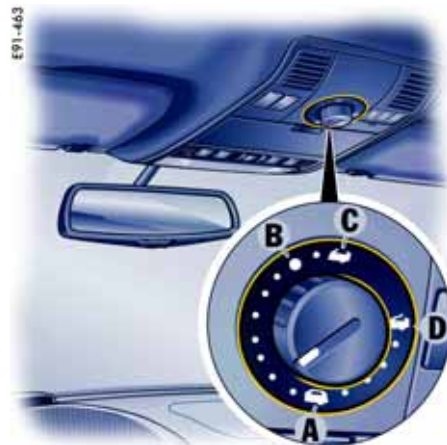

- A** - Closes sliding/lifting roof completely
- B** - Opens sliding/lifting roof to comfort setting
- C** - Opens sliding/lifting roof completely
- D** - Opens sliding/lifting roof in lift position

## Note on operation

Using the automated presetting system, every usable sliding/lifting roof position can be controlled directly with the knob.

## **A - Closing sliding/lifting roof completely**

- ▷ Turn knob to switch position **A**.

### **Note on operation**

The sliding/lifting roof is equipped with a force limiter. If the sliding/lifting roof is obstructed during the closing process, the sliding/lifting roof opens again immediately.

### **Closing the sliding/lifting roof after operation of the force limiter**

- ▷ Remove the obstruction.
- ▷ Turn knob to position **A** again.

## **B - Opening sliding/lifting roof to comfort setting**

- ▷ Turn knob to switch position **B**.

The sliding/lifting roof opens in switch position **B** until it reaches the best position relative to noise. It can be opened fully, however, if you continue to turn the switch beyond the limit to position **C**.

## **C - Opening sliding/lifting roof completely**

- ▷ Turn knob beyond stop position **B** to switch position **C**. Effort is required to turn the knob. Once released, the knob rebounds to position **B**.

## **D - Lifting sliding/lifting roof**

- ▷ Turn knob between switch positions **A** and **D** until it reaches the required position. The roof is lifted completely in switch position **D**.

## **Comfort function on vehicles without Porsche Entry & Drive**

### **Closing the sliding/lifting roof**

- ▷ Hold the car key in the door lock in the locking position until the windows and the sliding/lifting roof have reached the desired position.

## **Comfort function on vehicles with Porsche Entry & Drive**

### **Closing the sliding/lifting roof**

- ▷ Hold the car key in the door lock in the locking position until the windows and the sliding/lifting roof have reached the desired position **or**
- ▷ Hold the button in the door handle when locking the vehicle until the windows and the sliding/lifting roof have reached the desired position.

## Emergency operation of sliding/lifting roof

If the sliding/lifting roof is defective, this can be closed or opened manually.

### Warning!

#### Risk of serious personal injury and damage to the sliding/lifting roof during emergency operation.

- ▷ Ensure that no one can be injured when the sliding/lifting roof is operated.
- ▷ During and after emergency operation, the sliding/lifting roof may no longer be operated with the rocker switch.

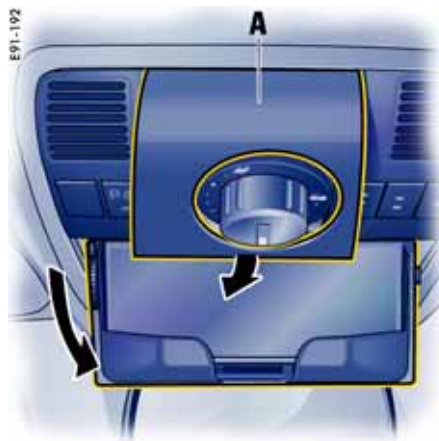

1. Open the glasses case in the roof console (**arrow**).
2. Unclip cover **A**.



3. Fold up armrest.
4. Remove key **B** from the lower storage tray (underneath the rubber mat) in the center console.

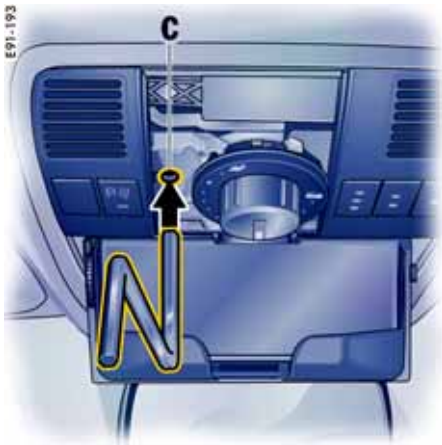

5. Insert the key in opening **C**. This requires a somewhat greater effort.

6. Close sliding/lifting roof  
To close the roof – turn to the right.  
To open the roof – turn to the left.
7. Remove the key and return it to the storage tray.
8. Clip in cover.
  - ▷ Have the fault remedied at an authorized Porsche dealer.

## Brief overview – Panorama roof system

This brief overview does not replace the information provided in the chapter “Panorama roof system”.

In particular, warnings are not replaced by this brief overview.

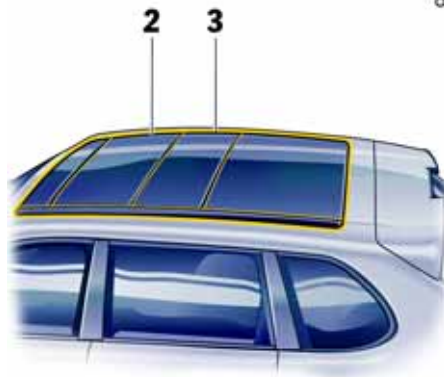

Elements of the Panorama roof system

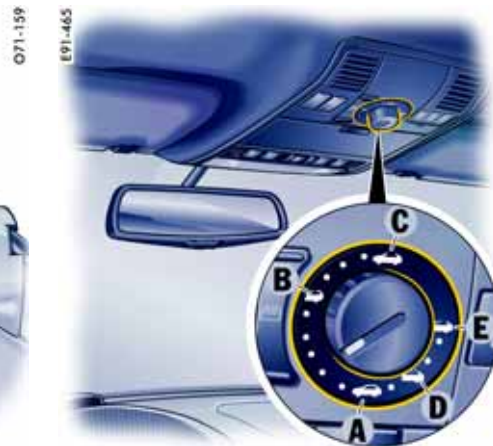

Switch in the roof console

### What do I want to do?

**Open roof completely**  
(roof elements 2 and 3)

**Open roof element 2**

**Open roof element 3**

**Lift roof element 3**

**Close roof**

### What do I have to do?

Turn switch to position **C**.

Turn switch to position **B**.

Turn switch to position **E**.

Turn switch to position **D**.

Turn switch to position **A**.

### What do I see?

Roof elements 2 and 3 open.

Only roof element 2 opens.

Only roof element 3 opens.

Only roof element 3 is lifted.

All opened roof elements are closed.



## Panorama roof system

The Panorama roof system of your Porsche consists of a total of four roof elements.

**Roof element 1** is the draft deflector. This adjusts itself according to the speed, and helps protect from the disturbing effects of the wind when the Panorama roof system is open, especially at high speeds or from turbulent air flow.

Both **roof elements 2 and 3** can be moved by activating the knob in the vehicle's longitudinal direction. **Roof element 3** can also be raised. This allows the interior to be better ventilated.

**Roof element 4** is a fixed glass element and completes the Panorama roof system.

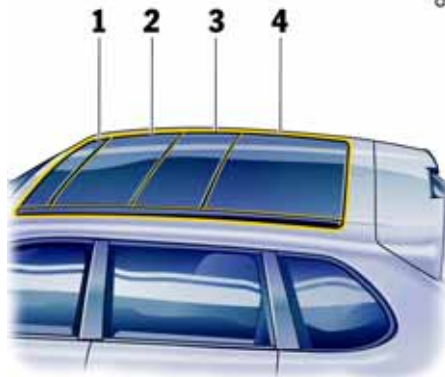

- 1 - Draft deflector
- 2 - Sliding roof element
- 3 - Sliding/lifting roof element
- 4 - Fixed glass element

### Caution!

**Risk of damage when activating the Panorama roof system due to improperly attached roof elements.**

- ▷ Check that the roof elements are securely attached before starting to drive.
- ▷ Make sure there is sufficient clearance between the Panorama roof system and the attached roof elements.

### **Readiness for operation of the Panorama roof system**

- With ignition switched on.
- With ignition key withdrawn until door is first opened, but only for a maximum of 10 minutes.

### **Readiness function of the Panorama roof system switches off after 10 minutes**

If the vehicle is unlocked, the Panorama roof system can no longer be operated after 10 minutes (to save the vehicle battery). The power supply is switched back on when the ignition is switched on or the engine started.



- A - Close Panorama roof system completely
- B - Open sliding roof element completely
- C - Open Panorama roof system completely
- D - Sliding/lifting roof element in lift position
- E - Open sliding/lifting roof element completely

### Note on operation

Using the automated presetting system, every usable roof position can be controlled directly with the knob.

- ▷ Always keep the Panorama roof system and the side windows closed while driving off-road.

### Warning!

#### Risk of injury when operating or automatically closing the Panorama roof system.

- ▷ Ensure that no one can be injured when the Panorama roof system is operated.
- ▷ Always withdraw ignition key when leaving the vehicle or switch ignition off in vehicles that have Porsche Entry & Drive. Always take the ignition key with you when leaving the vehicle. Uninformed persons (e.g. children) could injure themselves by operating the Panorama roof system.
- ▷ In case of danger, operate the knob in the opposite direction or release the car key immediately.

#### A - Closes Panorama roof system completely

- ▷ Turn knob to switch position A.

#### B - Opens sliding roof element completely

- ▷ Turn knob to switch position B.  
**Roof element 2** will be opened completely. The roller blind will open automatically to the selected opening width.

#### C - Opens Panorama roof system completely

- ▷ Turn knob beyond the stop position B to switch position C.  
**Roof elements 2 and 3** will be opened completely. The roller blind will open automatically to the selected opening width.

#### D - Raises sliding/lifting roof element

- Turn knob to switch position D.  
**Roof element 3** will be raised completely. The roller blind does not change position here.

#### E - Opens sliding/lifting roof element completely

- ▷ Turn knob to switch position E.  
▷ **Roof element 3** will be opened completely. The roller blind will open automatically to the selected opening width.

## Comfort function on vehicles without Porsche Entry & Drive

### Opening and closing the Panorama roof system

- ▷ Hold the car key in the door lock in the unlocking or locking position until the windows and the Panorama roof system have reached the desired position.

## Comfort function on vehicles with Porsche Entry & Drive

### Opening and closing the Panorama roof system

- ▷ Hold the car key in the door lock in the unlocking or locking position until the windows and the Panorama roof system have reached the desired position.

### Closing the Panorama roof system

- ▷ Hold the button in the door handle when locking the vehicle until the windows and the Panorama roof system have reached the desired position.

## Force limiter for the Panorama roof system

All roof elements are equipped with a force limiter. If the sliding roof or the sliding/lifting roof element is obstructed during the closing or opening process, the respective roof element opens or closes again immediately.

### Closing a roof element after triggering the force limiter

1. Remove the obstruction.
2. Turn knob to position **A** again.

## Electric emergency closing function



**Risk of injury from the emergency closing function for the Panorama roof system. The force limiter is not available and the roof elements will close with full force.**

- ▷ Ensure that no one can be injured when the Panorama roof system is closing.

If the roof cannot be closed due to dirt, ice, or similar substances:

1. Turn knob to position **A**.
2. Hold the knob in position **A** until all roof elements are completely closed.

## Save final position of the Panorama roof system

After disconnecting/reconnecting the vehicle battery or if the vehicle battery is discharged, or after emergency starting with jumper cables, the final positions of the Panorama roof system are lost.



**Risk of injury when closing the Panorama roof system. The force limiter is not available and the roof elements will close with full force.**

- ▷ Ensure that no one can be injured when the Panorama roof system is closing.
1. Switch ignition off.
  2. Turn knob to position **A**.
  3. Switch ignition on.
  4. Press knob up at its front edge in position **A** and keep pressed.  
The teaching process begins after around 5 seconds. Hold the knob pressed in position until the roller blind and all roof elements have completely stopped moving. The procedure lasts a maximum of 20 seconds.
  5. Release the knob.  
The raised **sliding/lifting roof element 3** closes automatically. The teaching process is then completed.

### Note on operation

If the procedure is interrupted, saving the final positions must be started from the beginning.



### Roller blind

A roller blind is integrated into the Panorama roof system and can be adjusted by activating the rocker switch in the roof console.

### Opening/closing the roller blind

The rocker switch has a two-stage function:

- If the rocker switch is pressed to the first stage, the roller blind opens or closes as long as the rocker switch is being pressed.
- If the rocker switch is pressed completely, the roller blind opens or closes to the final position.

#### Opening the roller blind

- ▷ Press rocker switch to the rear **F**.

#### Closing the roller blind

- ▷ Press rocker switch to the front **G**.

#### Note

If the rocker switch is pressed completely while the roof elements are moving, the roller blind opens or closes to the final position after the roof elements have reached the selected position.

## Roller blind cleaning position

1. Close Panorama roof system and roller blind completely.
2. Turn knob to position **C**. The Panorama roof system opens completely.
3. When the Panorama roof system has reached the final position, hold the rocker switch **G** to the front for longer than 3 seconds, until the roller blind is completely closed.
4. Remove dirt (e.g., leaves).
5. Keep the rocker switch **F** pressed to the rear, until the roller blind is completely closed.
6. Close sliding roof element.

### **Caution!**

**Risk of damage if the Panorama roof system and roller blind are in the roller blind cleaning position while driving.**

- ▷ Close the Panorama roof system completely one time before driving off.

## Emergency operation of the Panorama roof system

Use emergency operation only under exceptional circumstances if the electric emergency closing function cannot be implemented and the end position cannot be stored.

- ▷ Before using emergency operation, please check whether the fuse is defective. After the fuse has been changed, the limit positions of the Panorama roof system will have to be stored again.

### **Danger!**

**Danger of injury and risk of damage when closing the roof.**

- ▷ Ensure that no one is in the way of the roof elements as they are being opened or closed.
- ▷ Do not operate the Panorama roof system with the knob during and after emergency operation

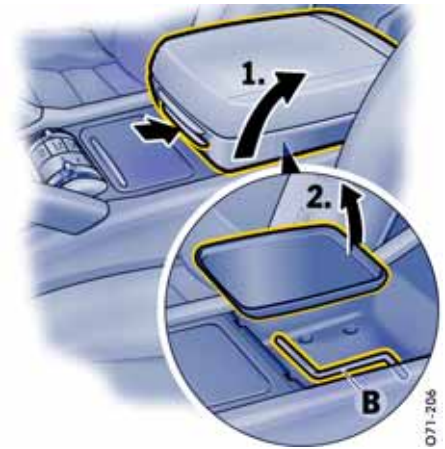

1. Fold up armrest.
2. Remove key **B** from the lower storage tray (underneath the rubber mat) in the center console.

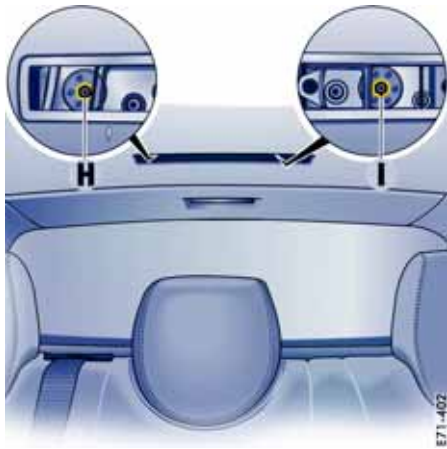

3. Unclip cover.
4. Insert the key in opening **H** or **I** until it can be felt and heard to engage.  
Effort is required to insert the key.  
**H** – Emergency operation for the sliding roof element and the draft deflector  
**I** – Emergency operation for the sliding/lifting roof element

5. Hold the key in this position and turn.  
To close the roof – turn clockwise.  
To open the roof – turn counter-clockwise.

#### **Note on operation**

When using emergency closing for the sliding/lifting roof element, make sure that the roof element is completely closed (center position between sliding and lifting roof position).

6. Remove the key and return it to the storage tray.
7. Clip in cover.

To rule out malfunctions in the system, the final positions of the Panorama roof system must be saved again after emergency operation.

- ▷ Please see the chapter “SAVE FINAL POSITION OF THE PANORAMA ROOF SYSTEM” on Page 99.

# Lights, Turn Signals and Windshield Wipers

Light Switch.....	104
Instrument Illumination .....	105
Automatic Headlight Beam Adjustment.....	106
Turn signal/High Beam/ Headlight Flasher Stalk .....	106
Emergency flasher .....	107
Interior Lighting.....	107
Comfort Lighting .....	109
Coming Home Function (Auto Shut Off Delay) .....	109
Door-Surrounding Lighting.....	109
<b>Brief overview</b> – Windshield wipers .....	110
Windshield Wiper/Washer Stalk .....	111



Light switch **with** driving light assistant



Light switch **without** driving light assistant



## Light Switch

- **Light is switched off.**



## Automatic driving light assistant



## Side lights

License plate light, instrument illumination



## Low beam, high beam

Only when the ignition is switched on



## Fog lights

Only when side lights or low beam are switched on:  
Pull switch to first click.  
Indicator light lights up.



## Rear fog light

Pull switch to second click.  
Indicator light lights up.

## Note on operation

If the ignition key is withdrawn and the door is opened while the lights (not the parking light) are on, an acoustic signal (gong) warns of possible battery discharge.

**In some countries, differences are possible due to provisions of law.**

## Automatic driving light assistant

The driving light assistant is a comfort function. Your Porsche's driving light (low beam) is switched on and off automatically, irrespective of the ambient brightness.

Despite possible support by the driving light assistant, it is the responsibility of the driver to switch on the driving light using the conventional light switch in accordance with the relevant national regulations.

Activating the headlights using the driving light assistant does not therefore absolve the driver of responsibility for the correct operation of the driving light.

The low beam is switched on automatically in the following situations:

- Dusk
- Darkness
- Travelling through tunnels
- Rain (in conjunction with the rain sensor)
- Highway driving



### Note on operation

Fog is not recognized.

- ▷ In the event of fog, the driving light must be switched on manually.

### Warning!

#### Risk of accident due to driving without lights.

- ▷ Always carefully monitor the automatic driving light control.

### Highway function

The light is switched on at speeds of over 87 mph (140 km/h). If you are travelling slower than 40 mph (65 km/h), the driving light is switched off after a delay of approx. 2 minutes, if the external lighting conditions permit.

### Rain function

The driving light is switched on after five seconds of continuous wiper operation.

The driving light is switched off approx. 4 minutes after the wipers have stopped.

### Off delay and door-surrounding lighting

Off delay and door-surrounding lighting are active when the automatic driving light assistant is switched on.

- ▷ Please see the chapter “DOOR-SURROUNDING LIGHTING” on Page 109.

- ▷ Please see the chapter “COMING HOME FUNCTION (AUTO SHUT OFF DELAY)” on Page 109.

### Daytime driving lights

Regulations for switching daytime driving lights on and off vary according to the legal requirements in each country.

The position lights at the front and rear and the low beam headlight come on when the ignition is switched on.

The instrument and switch illumination in the interior of the vehicle remains off.

The daytime driving lights go off when the ignition is switched off. A warning message appears on the multi-purpose display in the instrument panel if the light switch is in position 0 (light switched off). Switch on the light at the light switch if necessary (e.g. when you switch off the ignition at a closed rail crossing).

- ▷ For information on warning messages on the multi-purpose display: Please see the chapter “OVERVIEW OF WARNING MESSAGES” on Page 149.

### USA only:

You can activate/deactivate the daytime driving lights on the multi-purpose display in the instrument panel.

- ▷ Please see the chapter “SWITCHING DAYTIME DRIVING LIGHTS ON/OFF” on Page 145.



A - Instrument lighting knob



### Instrument Illumination

When the light is switched on, the brightness of the instrument illumination can be adjusted by turning thumb wheel **A**.

## Automatic Headlight Beam Adjustment

Vehicles with Bi-Xenon headlights feature automatic headlight beam adjustment.

When the ignition and the low beam are switched on, the level of the headlight beam automatically changes in accordance with the vehicle load. The level of the headlight beam is automatically kept constant during acceleration and braking.

### Checking operation

1. Switch the low beam on.
2. Switch ignition on.

The light beam first dips all the way down and is then adapted to the vehicle load. If this test item is not met, the headlight beam adjustment system must be checked by an authorized Porsche dealer.



### Turn signal/High Beam/Headlight Flasher Stalk

Turn signals, low beam and high beam are ready for operation when the ignition is on.

**1 - Turn signal light, left**

**2 - Turn signal light, right**  
**Move the stalk to the upper or lower pressure point - turn signals flash three times**

**3 - High beam (push forward)**

**4 - Headlight flasher (pull backward)**  
**Lever in center position - low beam (when the light is switched on)**

**5 - Button for voice control**

- ▷ Please see the separate Owner's Manual for Porsche Communication Management (PCM).

### Note on operation

When the high beam is switched on or the headlight flasher is operated, the blue indicator light on the speedometer is lit.

### Parking light

The parking light can only be switched on when the ignition is switched off.

- ▷ Move the lever up or down to switch on the right or left parking light.



## **Emergency flasher**

The emergency flasher is ready for use regardless of the ignition lock position.

### **Switching on and off**

- ▷ Press button **A** to switch on.  
Press button **A** again to switch off.

All turn signal lights and indicator lights on the dashboard flash when the switch is operated.

## **Danger!**

### **Risk of an accident resulting in serious personal injury or death.**

- ▷ Whenever stalled or stopped for emergency repairs, move the car well off the road. Switch on the emergency flasher and mark the car with road flares or other warning devices.
- ▷ Do not remain in the car. Someone approaching from the rear may not realize your vehicle is stopped and cause a collision.

### **Danger of fire.**

- ▷ Do not park or operate the vehicle in areas where the hot exhaust system may come in contact with dry grass, brush, fuel spill or other flammable material.

### **Hot engine compartment components can burn skin on contact.**

- ▷ Before working on any part in the engine compartment, turn the engine off and let it cool down sufficiently.

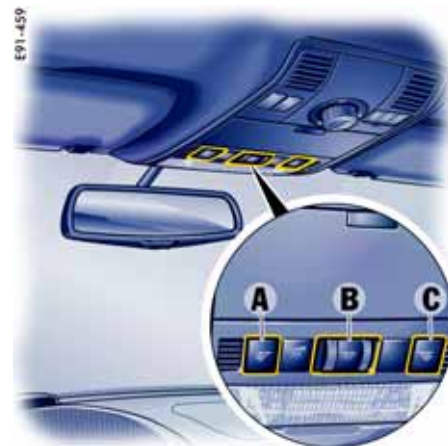

**A, C** - Switch for individual reading lights  
**B** - Switch for interior light

## **Interior Lighting**

### **Reading lights, front**

#### **Switching on**

- ▷ Press button **A** or **C**.

#### **Switching off**

- ▷ Press button **A** or **C**.

## Interior light, front

### Switching on

- ▷ Move switch **B** to the left.

### Switching on and off automatically

- ▷ Move switch **B** to the right.  
The lights are **switched on** when a door is unlocked or opened or when the ignition key is withdrawn from the ignition lock. The lights are **switched off** with a delay of approx. 30 seconds after the door is closed. The light goes out immediately as soon as the ignition key is inserted in the ignition lock or the vehicle is locked.

### Switching off

- ▷ Move switch **B** to center position.



Reading lights, rear left

## Rear reading lights



### Switching on

- ▷ Move toggle switch forward.



### Switching on and off automatically

- ▷ Move toggle switch to center position.  
The lights are **switched on** when a door is unlocked or opened or when the ignition key is withdrawn from the ignition lock. The lights are **switched off** with a delay of approx. 30 seconds after the door is closed. The light goes out immediately as soon as the ignition is switched on or the vehicle is locked.

### 0 Switching off

- ▷ Move toggle switch back.



**A** - Button for dimming the comfort lighting

## Comfort Lighting

The footwell and door panel lighting improve your orientation inside the vehicle when it is dark. These lights are switched on when the vehicle is unlocked and switched off again automatically when the vehicle is locked.

## Dimming (adjusting the brightness of) the comfort lighting

Once the last door is closed, the footwell and door panel lights are dimmed to the set value.

The comfort lighting is dimmed using button **A** in the front roof console.

- ▷ Hold down button **A** until the level of brightness that you require is reached.

## Coming Home Function (Auto Shut Off Delay)

The following lights remain switched on for a certain period to allow you to get out of the vehicle safely and with the best possible view at dusk or in darkness:

- Lights in the door mirrors
- Side marker light
- License plate lights.

### Note on operation

- ▷ Set light switch to **auto**.
- ▷ Please see the chapter "LIGHT SWITCH" on Page 104.

The lights are switched off when the vehicle is locked or, at the latest, after the Coming Home light that has been set on the multi-purpose display has expired.

- ▷ Please see the chapter "SETTING LIGHTING OFF DELAY" on Page 146.

## Door-Surrounding Lighting

The door-surrounding lighting enables passengers to enter the vehicle safely. Obstacles on the ground (e.g. puddles) can be identified more easily.

The area in front of the vehicle is illuminated with the following lights when the vehicle is unlocked by remote control or by Porsche Entry & Drive:

- Low beam
- Lights in the door mirrors
- Side marker light
- License plate lights.

### Note on operation

- ▷ Set light switch to **auto**.
- ▷ Please see the chapter "LIGHT SWITCH" on Page 104.

The door-surrounding lighting switches off after the Coming Home light (light that is used during twilight hours) that has been set on the multi-purpose display has expired or when the ignition is switched on.

- ▷ For information on setting the off delay on the multi-function display:  
Please see the chapter "SETTING LIGHTING OFF DELAY" on Page 146.

## Brief overview – Windshield wipers

This brief overview does not replace the information provided in the chapter “Windshield wiper/washer stalk”.

In particular, warnings are not replaced by this brief overview.



Windshield wiper stalk



Rain sensor rotary switch

### What do I want to do?

#### Automatic wiping at front (rain sensor)

Press the stalk to detent position **1**.

#### Rain sensor adjustment

Adjust rotary switch **A** in the stalk upwards (wipe more often) or downwards (wipe less often).

#### Wiping at front

Slow: Move the stalk to detent position **2**.

Fast: Move the stalk to detent position **3**.

Once: Briefly press stalk to position **4**.

#### Spraying and wiping at front

Pull stalk to position **5** and hold.

#### Wiping at rear

Normal: Press stalk to position **6**.

Once: Briefly move stalk to position **7**.

#### Spraying and wiping at rear

Keep stalk pressed in position **7**.

## Windshield Wiper/Washer Stalk



### Warning!

**Danger of injury when the windshield wipers operate unintentionally.**

**Risk of damage to the engine compartment lid, windshield and wiper system.**

- ▷ Only wipe the windshield when sufficiently wet, otherwise it could be scratched.
- ▷ Loosen frozen wiper blades before driving off.
- ▷ Do not operate headlight washer when it is frozen.
- ▷ Always switch off windshield wipers in car wash to prevent them wiping unintentionally (rain sensor operation).
- ▷ Do not operate headlight washer in car washes.
- ▷ Always switch off windshield wipers before cleaning the windshield to avoid unintentional operation (rain sensor operation).
- ▷ Always hold the wiper arm securely when replacing the wiper blade.

- ▷ Always switch the windshield wipers off (wiper stalk in position **0**) before opening the engine compartment lid. If the wiper arms are not in end position, they will automatically move to this position when the engine compartment lid is opened. This will happen even if the ignition is off.  
The wiper arms remain in this position until the lid is closed and the wiper system is switched off and then on again.



**0 – Windshield wipers off**

**1 – Front windshield wiper – rain sensor operation**

- ▷ Move wiper stalk upwards to the first click.

### Notes on operation

The amount of precipitation which has settled on the windshield is measured. Wiper speed is automatically adjusted accordingly.



### 2 – Front windshield wiper – slow

- ▷ Move wiper stalk upwards to the second click.

### 3 – Front windshield wiper – fast

- ▷ Move wiper stalk upwards to the third click.

At speeds of less than approx. ca. 2.5 mph (4 km/h), rain sensor operation mode is automatically activated if the windshield wiper is switched on. If you exceed a speed of approx. 5 mph (8 km/h), the system switches to the preselected wiper level.

### 4 – Front windshield wiper – one-touch operation

- ▷ Move wiper stalk downwards. The front windshield wipers go through one wipe cycle.

The rain sensor remains switched off if the wiper lever is already in position **1** when the ignition is switched on.

To switch the rain sensor on again:

- ▷ Move wiper stalk to position **0** and then to position **1** – switching on is confirmed by one wipe of the windshield – **or**
- ▷ Operate windshield washer system **5** – switching on is confirmed by three wipes of the windshield – **or**
- ▷ Change the sensitivity of the rain sensor with four-stage switch **A**.

### Changing the sensitivity of the rain sensor

Sensitivity can be set with switch **A** in 4 stages:

- ▷ Adjust rotary switch **A** upwards – high sensitivity.  
The setting is confirmed by one wipe of the windshield.
- ▷ Adjust rotary switch **A** downwards – low sensitivity.



## 5 – Front windshield wipers and washer system

- ▷ Pull wiper stalk towards the steering wheel. The washer system sprays and wipes while the lever is pulled towards the steering wheel. When the wiper lever is released, a few wipes are executed.

### **Headlight washer (on vehicles with Bi-Xenon headlights):**

The washer sprays only while low beam or high beam is switched on.

To activate the headlight washer system, the wiper lever must be pulled for a longer period of time.

The headlight washer can be re-activated at the earliest after five washing cycles.

The spray duration is limited.

### **Maintenance Note**

- ▷ If heavily soiled, repeat wash.
- ▷ Persistent dirt (e.g. insect remains) should be regularly removed.  
Please see the chapter “CAR CARE INSTRUCTIONS” on Page 270.

The **front windshield washer nozzles** are heated when the ignition is on, as a precaution against freezing. However, this does not replace the use of antifreeze.

## 6 – Rear window wiper – intermittent operation

- ▷ Move wiper stalk forwards to the first click. The rear window wiper wipes at preset intervals.

## 7 – Rear window wiper – one-touch operation

- ▷ Push wiper stalk forward briefly. The washer system sprays and the rear window wiper goes through three wipe cycles.

### **Rear window wiper and washer system**

- ▷ Push wiper stalk forwards as far as it will go. The washer system sprays and wipes while the lever is pulled away from the steering wheel. When the wiper lever is released, a few drying wipes are executed.

## Maintenance Note

- ▷ Periodically clean the wiper blades with window cleaner, especially after the vehicle has been washed in a car wash. We recommend the Porsche window cleaner. In the event of heavy soiling (e.g. insect residue), the blades can be cleaned with a sponge or a cloth.

If the wiper blades rub or squeak, this may have the following causes:

- If the vehicle is washed in an automatic car wash, wax residues may adhere to the windshield. These wax residues can be removed only by using window cleaner concentrate.
- ▷ Please see the chapter “WASHER FLUID” on Page 258.
- ▷ Please contact your authorized Porsche dealer for further information.
- The wiper blades may be damaged or worn.
- ▷ Replace damaged or worn wiper blades as soon as possible.



# Multi-Purpose Display and Instruments



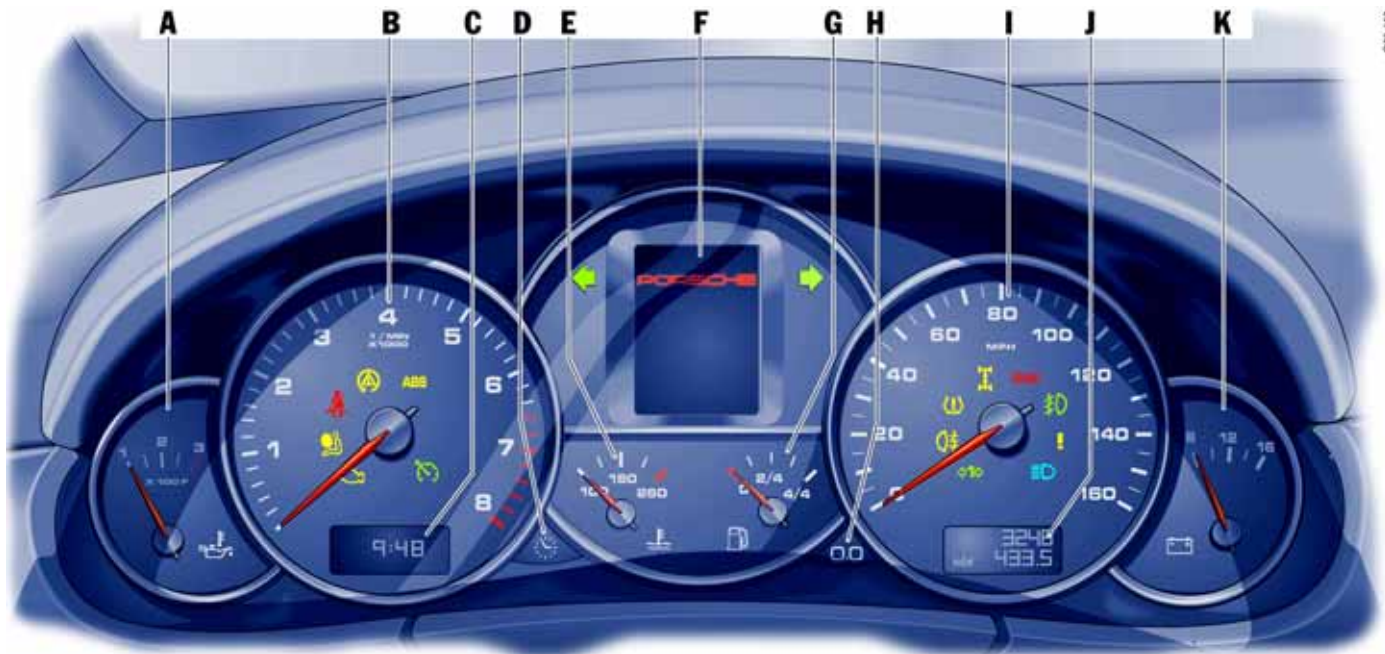



Instrument Panel USA Models .....	117	Switching off passenger compartment monitoring on the multi-purpose display .....	142
Instrument Panel Canada Models.....	119	Synchronous adjustment of door mirrors .....	143
Oil Temperature Gage .....	120	Changing settings for opening and locking the vehicle .....	143
Tachometer.....	120	Switching daytime driving lights on/off.....	145
Clock .....	120	Setting lighting off delay .....	146
Fuel Gage.....	120	Setting the clock.....	146
Speedometer.....	120	Setting compass.....	147
Odometer.....	121	Changing language for displays.....	148
Voltmeter .....	121	Changing units for displays .....	148
Cooling System .....	122	Resetting display to factory settings .....	148
Emission Control.....	123	<b>Overview of warning messages .....</b>	<b>149</b>
Operating the multi-purpose display on the instrument panel .....	124		
Opening the main menu .....	125		
Operating example: Displaying average consumption.....	125		
Displaying/resetting average speed .....	127		
Displaying range on remaining fuel .....	127		
Displaying tire pressure .....	127		
Displaying compass .....	127		
Displaying navigation information.....	127		
Operating the telephone via the multi-purpose display.....	128		
Setting speed limit on the multi-purpose display .....	129		
Displaying warning messages .....	130		
Displaying status of level control .....	131		
Displaying status of locks/reduction .....	131		
Displaying average consumption .....	132		
Setting Tire Pressure Monitoring .....	132		





## Instrument Panel USA Models

- A Oil temperature gage
- B Tachometer
- C Clock
- D Clock setting button
- E Cooling system temperature gage
- F Multi-purpose display
- G Fuel gage
- H Reset button for trip counter display
- I Speedometer
- J Mileage displays
- K Voltmeter









## Warning and indicator lights on the tachometer

-  Emission Control warning light (Check Engine)
-  Airbag warning light
-  Safety belt warning light
-  PSM warning light
-  ABS warning light
-  Cruise control readiness

## Indicator lights in central instrument panel

-  Turn signal indicator light, left
-  Turn signal indicator light, right

## Warning and indicator lights on the speedometer

-  Trailer turn signal Indicator light
-  Rear fog light indicator light
-  Tire pressure warning light
-  Differential locking indicator light
-  Brake warning light
-  Fog light indicator light
-  General warning  
Observe warning message on the multi-purpose display!
-  High beam indicator light







071110



## Instrument Panel Canada Models

- A Oil temperature gage
- B Tachometer
- C Clock
- D Clock setting button
- E Cooling system temperature gage
- F Multi-purpose display
- G Fuel gage
- H Reset button for trip counter display
- I Speedometer
- J Mileage displays
- K Voltmeter







## Warning and indicator lights on the tachometer

-  Emission Control warning light (Check Engine)
-  Airbag warning light
-  Safety belt warning light
-  PSM warning light
-  ABS warning light
-  Cruise control readiness

## Indicator lights in central instrument panel

-  Turn signal indicator light, left
-  Turn signal indicator light, right

## Warning and indicator lights on the speedometer

-  Trailer turn signal Indicator light
-  Rear fog light indicator light
-  Tire pressure warning light
-  Differential locking indicator light
-  Brake warning light
-  Fog light indicator light
-  General warning  
Observe warning message on the multi-purpose display!
-  High beam indicator light



## A - Oil Temperature Gage

A warning message will appear on the multi-purpose display of the instrument panel if the engine oil temperature is too high.

- ▷ Reduce speed and engine load immediately if the red zone is reached.
- ▷ For information on the warning message on the multi-purpose display:  
Please see the chapter "OVERVIEW OF WARNING MESSAGES" on Page 149.

## B - Tachometer

The start of the red zone on the tachometer scale is a visual warning of the maximum permissible engine speed.

If the red zone is reached during acceleration, fuel feed is interrupted in order to protect the engine.

## C - Clock



### Warning!

---

**Risk of loss of control or accident, resulting in serious personal injury or death.**

- ▷ Do not reach through the steering-wheel spokes while driving.
  - ▷ In the event of a sudden turn or airbag deployment, serious personal injury could result if hand is positioned through steering wheel spokes.
- 

Clock **C** is adjusted on the multi-purpose display in the instrument panel:

- ▷ Press button **D**.  
The SETTINGS > CLOCK menu is automatically opened on the multi-purpose display.
- ▷ For information on setting the clock:  
Please see the chapter "SETTING THE CLOCK" on Page 146.



## G - Fuel Gage

When the ignition is on the fuel level is displayed.

- ▷ For information on fuel quality and filling quantities:  
Please see the chapter "CAPACITIES" on Page 359.
- ▷ For information on fuel and refueling:  
Please see the chapter "REFUELING" on Page 268.
- ▷ If the vehicle's inclination changes (e.g. going uphill/downhill), minor deviations in the indication may occur.

## Fuel reserve warning

When the ignition is switched on or the engine is running, the warning light on the multi-purpose display of the instrument panel lights up if less than 3 gallons (12 liters) of fuel remains in the tank or the range on remaining fuel falls below approx. 30 miles (50 km).

- ▷ Fill up at the next opportunity.



### Caution!

---

**A shortage of fuel may cause damage to the emission control system.**

- ▷ Never drive the tank dry.
  - ▷ If the warning lights have come on, do not take turns at high speed.
- 
- ▷ For further information on the emission control system:  
Please see the chapter "HOW EMISSION CONTROL WORKS" on Page 264.

## I - Speedometer

The digital speedometer is integrated on the multi-purpose display of the instrument panel.

An analog display is also located on the right next to the multi-purpose display in the instrument panel.



## J - Odometer

The displays for the total mileage and individual trips are located in the analog speedometer.

The upper display counts the total mileage, the lower display counts the short trips.

After exceeding 6213 miles (9999 kilometers), the short trip counter returns to 0.

### Resetting the short trip counter to “0”

- ▷ Press button **H** for approx. 1 second



## K - Voltmeter

The voltmeter indicates the vehicle electrical system voltage.

Normal range: 12 to 16 volts.

The voltage may drop considerably when the vehicle is being started.

**If the indicator is continually below 12 volts when the engine is running:**

- ▷ Please have the battery charging system checked at an authorized Porsche dealer.

### Battery/alternator

A warning message will appear on the multi-purpose display of the instrument panel if the voltage drops significantly.

- ▷ Stop in a safe place and switch off the engine.
- ▷ For information on the warning message on the multi-purpose display:  
Please see the chapter “OVERVIEW OF WARNING MESSAGES” on Page 149.

### Possible causes

- Defect in the battery charging system
- Broken drive belt



### Warning!

**Risk of engine damage with resultant loss of control and accident, leading to serious personal injury or death.**

**A broken drive belt means there is no power assistance to the steering (more effort is required to steer) and engine cooling fails.**

- ▷ Do not continue driving.
- ▷ Have the fault remedied at your nearest authorized Porsche dealer.

**Danger of steering assistance failing during a long trip in the water if the drive belt slips.**

- ▷ If the steering assistance fails, more effort will be required to steer.



## Cooling System

- ▷ If the cooling system is in any way faulty, consult your authorized Porsche dealer.

### Temperature gage

USA: Display in °F

Canada: Display in °C

### Pointer to the left – engine cold

- ▷ Avoid high engine speeds and heavy engine loading.

### Pointer in the middle – normal operating temperature

The pointer may move up to the red area when engine is heavily loaded and outside temperature is high, but should return to “normal” when engine load is reduced.

### Engine coolant temperature warning

A warning message will appear on the multi-purpose display of the instrument panel if the engine coolant temperature is too high.

- ▷ Switch engine off and let it cool.
- ▷ Check radiator and air passages in front end of car for obstructions.

- ▷ Check coolant level.  
Add coolant if necessary.
- ▷ Please have the fault remedied at an authorized Porsche dealer.
- ▷ For further information on coolant, checking the coolant level and topping up coolant:  
Please see the chapter “COOLANT LEVEL” on Page 255.

### Note on operation

To prevent excessive temperatures, the cooling air guides must not be restricted by covers (e.g. films, “stone guards”).

### Engine coolant level warning

A warning message will appear on the multi-purpose display of the instrument panel if the engine coolant level is too low.

- ▷ Switch engine off and let it cool.
- ▷ Top off coolant.  
Please have the cause of the fault remedied at an authorized Porsche dealer.
- ▷ For further information on coolant, checking the coolant level and topping up coolant:  
Please see the chapter “COOLANT LEVEL” on Page 255.
- ▷ For information on the warning message on the multi-purpose display:  
Please see the chapter “OVERVIEW OF WARNING MESSAGES” on Page 149.



### Risk of engine damage.

- ▷ Do not continue driving if the warning persists even when the engine coolant level is correct.
- ▷ Have the fault remedied at your nearest authorized Porsche dealer.

## Emission Control

### Check engine warning light

The emission control system detects malfunctions early that could, for example, cause increased pollutant emissions or consequential damage. Faults are indicated by a continuously lit or flashing instrument panel warning light. The faults are recorded in the control unit's fault memory.

The warning light in the instrument panel lights up when the ignition is switched on as a bulb check and goes out approx. 4 seconds after the engine starts. If the warning light does not light up, have the bulb replaced promptly.

The warning light in the instrument panel flashes to indicate operating states (e.g. engine misfiring) which might cause damage to certain parts of the emission control system.

- ▷ In this case, immediately reduce the engine load by easing off the accelerator.
- ▷ In order to avoid consequential damage to the engine or emission control system (e.g. catalytic converter), have the fault diagnosed and rectified immediately at the nearest authorized Porsche dealer.

If the warning light in the instrument panel lights up permanently without flashing before and remains on while driving, it suggests:

- a potential engine control problem and the need for system service **or**
  - an improperly fastened tank cap **or**
  - the vehicle was refueled while the engine was running.
- ▷ Stop immediately at a suitable and secure place and check tank cap for proper fastening. If tank cap was fastened correctly, see your authorized Porsche dealer for service as soon as possible.

### Caution!

---

**If the check engine warning light in the instrument panel is flashing, serious catalytic converter damage and power loss will soon occur.**

**Prolonged driving with the check engine warning light on could cause damage to the emission control system. It also could affect fuel economy and driveability.**

- ▷ Have the fault remedied at the nearest authorized Porsche dealer immediately.
-

## Operating the multi-purpose display on the instrument panel

On-board computer information can be displayed on the multi-purpose display. Additional functions are also available in the main menu which allow you to change the settings for your vehicle.

### Warning!

**There is a danger of accident, resulting in serious personal injury or death if you set or operate the multi-purpose display, radio, navigation system, telephone or other equipment while driving. Operating these devices while driving could distract you from traffic and cause you to lose control of the vehicle.**

- ▷ Operate these components while driving only if the traffic situation allows you to do so safely.
- ▷ Carry out any complicated operating or setting procedures only with the vehicle stationary.

It is not possible to describe all details of the functions in this Owner's Manual.

The examples clearly demonstrate the functional principle and clarify the menu structure.

### Note on operation

Depending on the equipment of your vehicle, some information or functions may not be available on the multi-purpose display (e.g. navigation, audio system, compass or tire pressure)

Various menus can only be called up when the vehicle is stationary.

### Note

The multi-purpose display is ready for operation only when the ignition is on.

### Note on operation

By selecting the menu items MAIN MENU > SETTINGS > FACTORY SET, you can reset all individual settings to the basic factory settings.

### Note on operation

Arrows at the top and bottom of the menu indicate additional entries.

- ▷ Press rocker switch **A** up or down.

In the COMFORT menu, the menu scrolls automatically as you approach the end of the list.



### Operating principle

The multi-purpose display is operated by means of the rocker switch **A** and the ENTER button **B** on the windshield wiper stalk.

### Selection or setting

Using the rocker switch **A**, you can move the bar up and down to select menu items, change between display screens and make settings.

### Confirmation

Press the ENTER button **B** to confirm the selected entry. The selected item is then activated.

## Opening the main menu



1. Switch ignition on.
2. Select MAIN MENU.
3. Confirm selection.  
The main menu is displayed.

The main menu contains the following functions:

- ▷ PHONE
- MPH-LIMIT
- VEHICLE INFO
- TYRE PRESS.
- SETTINGS

## Operating example: Displaying average consumption

Select items with rocker switch on the wiper stalk in each case and confirm by pressing the ENTER button.



1. MAIN MENU  
>VEHICLE INFO  
Select and confirm.



2. Select Ø CONSUM.



3. Confirm selection.  
The average consumption is now displayed.

## Returning to starting menu



4. Select BACK.



5. Confirm selection.  
VEHICLE INFO menu appears.



6. Select BACK.



7. Confirm selection.  
MAIN MENU menu appears.



8. Select BACK.



9. Confirm selection.  
Basic display appears.

## Note on operation

Switching the ignition off does not reset the measurements. Values can thus be collected over long periods. Disconnecting the vehicle battery clears the memories.

Further on-board computer functions can be displayed in the PCM. Please follow the separate operating instructions for PCM.

## Menu overview of the multi-purpose display

073-157

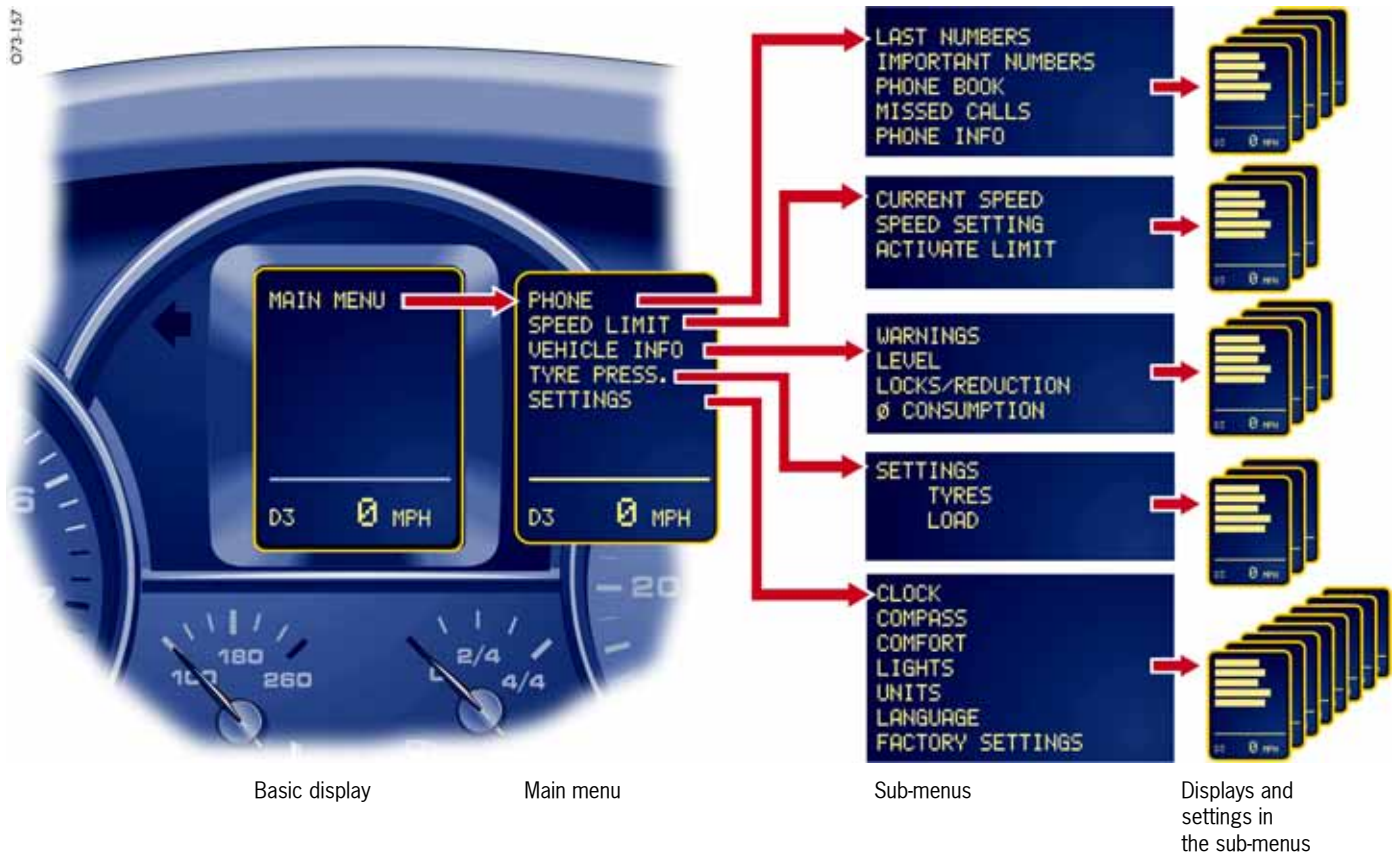

## Displaying/resetting average speed

### Displaying average speed

1. Switch ignition on.
2. Select Ø MPH.  
The average speed is displayed.  
The displayed values are based on the distance travelled since the last reset to “zero”.

### Resetting average speed

3. Select Ø MPH.  
The average speed is displayed.
4. Press the ENTER button for longer than 1 second.

## Displaying range on remaining fuel

1. Switch ignition on.
2. Select remaining range.

The range on remaining fuel is continuously recomputed while driving based on fuel level, current consumption and average consumption.

## Displaying tire pressure

This display is available only in conjunction with the Tire Pressure Monitoring option.

1. Switch ignition on.
2. Select TYRE PRESS.

The current tire pressures at the actually present levels are displayed in the “Tyre pressure” screen of the on-board computer. These values would be identical to those of a pressure gage connected to the four valves. These pressures change while the vehicle is being driven.

- The tire pressures increase as the temperature in the tires rises, e.g. during high-speed motorway driving.
- The tire pressures decrease as the temperatures drop, e.g. during trips in cold regions (such as mountains).

The values displayed therefore do not allow conclusions to be drawn about possible pressure deviations.

- ▷ In order to display pressure deviations from the prescribed pressure, select the menu item TYRE PRESS. in the MAIN MENU.

## Displaying compass

This display is available only in conjunction with the Compass or PCM option.

1. Switch ignition on.
2. Select COMPASS.

## Displaying navigation information

Navigation information can also be displayed on the multi-purpose display.

This display is available only in conjunction with the Navigation (PCM) option.

1. Switch ignition on.
2. Select NAVIGATION.  
The navigation arrows are displayed.

## Operating the telephone via the multi-purpose display

### Note

The telephone function of the multi-purpose display is linked to both the PCM and the multi-functional buttons on the steering wheel as well as the control stalk.

### A SIM card must be inserted in the drawer of the PCM as a prerequisite for telephone operation.

If the link to the network is lost, no PIN is entered, no SIM card is inserted or the telephone is switched off, a corresponding indication will appear.



1. Press the ENTER button.  
The display reverts to the last menu.

### Note

The phone number of an incoming call is shown on the multi-purpose display. The name of the caller is shown only if the caller is stored in the telephone book.

### Notes on operation

If the rocker switch is pressed for longer than one second, the initial letters for which entries exist are shown.

This allows the desired entry to be found more quickly.

- ▷ For information on the operating principle of the multi-purpose display: Please see the chapter “OPERATING PRINCIPLE” on Page 124.

### Accepting, refusing, ending a call

Incoming calls are shown on the multi-purpose display (PHONE INFO must be activated).

Display on display screen

1. Select ACCEPT or REFUSE.
2. Confirm selection.  
After the call is accepted, END appears in the menu.

### Ending a call

3. Select END.
4. Confirm selection.

### Displaying telephone calls on the multi-purpose display

Automatic indication of an incoming call on the multi-purpose display can be switched on or off with the PHONE INFO menu.

1. MAIN MENU
  - > PHONE
  - > PHONE INFO
  - Select and confirm.
2. Select ON or OFF.
3. Confirm selection.  
The selected item is then accepted.

### Displaying last numbers and last-number redial

The LAST NUMBERS menu shows the most recent entries dialed via the respective SIM card.

1. MAIN MENU
  - > PHONE
  - > LAST NUMBERS
  - Select and confirm.
2. Select entry from the list.
3. Confirm selection.



## Displaying important numbers and calling

The IMPORTANT NOS. menu shows the entries stored as important numbers on the SIM card.

1. MAIN MENU  
> PHONE  
> IMPORTANT NOS.  
Select and confirm.
2. Select entry from the list.
3. Confirm selection.

## Displaying telephone book, selecting party and calling

The PHONE BOOK menu shows the entries of the telephone book that are stored on the SIM card.

1. MAIN MENU  
> PHONE  
> PHONE BOOK  
Select and confirm.
2. Select entry from the list.
3. Confirm selection.

## Displaying missed calls, calling back party

The telephone numbers of the rejected calls are shown in the MISSED CALLS menu. The numbers are stored on the SIM card.

1. MAIN MENU  
> PHONE  
> MISSED CALLS  
Select and confirm.
2. Select entry from the list.
3. Confirm selection.

## Setting speed limit on the multi-purpose display

A speed limit can be entered to monitor the driving speed. When it is exceeded, a signal sounds and the multi-purpose display displays the message LIMIT EXCEEDED.

### Note on operation

- ▷ For information on the operating principle of the multi-purpose display:  
Please see the chapter "OPERATING PRINCIPLE" on Page 124.

## Accepting current speed

You can define the current speed as the speed limit in the menu MPH-LIMIT.

1. MAIN MENU  
>MPH-LIMIT  
Select and confirm
2. Select CURRENT MPH.
3. Confirm selection.  
LIMIT ACTIVE is activated automatically and the selected speed limit is shown.



## Presetting speed

You can define a speed limit in the menu MPH-LIMIT.

1. MAIN MENU  
>MPH-LIMIT  
Select and confirm.
2. Select MPH SET.
3. Set desired limit:
  - Press briefly: Limit is set in increments of 1 mph (around 1.6 km/h).
  - Press for longer than 2 seconds: Limit is set in increments of 10 mph (16 km/h).
4. Confirm selection.  
LIMIT ACTIVE is activated automatically.

## Activating or deactivating the limit

1. MAIN MENU  
>MPH-LIMIT  
Select and confirm.
2. Select LIMIT ACTIVE.
3. Confirm selection.
  - LIMIT ACTIVE is activated
  - LIMIT ACTIVE is deactivated
4. Select BACK.
5. Confirm selection.  
Sub-menu MPH-LIMIT is displayed.

Example: Front side light warning message

## Displaying warning messages

All current warnings and information relating to the traffic safety of the vehicle can be displayed in the menu WARNINGS.



### Warning messages indicate possible faults.

- ▷ Go to an authorized Porsche dealer immediately.

**1. MAIN MENU**

>VEHICLE INFO

Select and confirm.

**2. Select WARNINGS.**

**3. Confirm selection.**

NO WARNING is displayed if the vehicle is in perfect condition. Any warning messages which are present are displayed.

**4. Press repeatedly to display the warnings one after the other.**

**5. Confirm selection.**

VEHICLE INFO menu is displayed.

**Note on operation**

- ▷ For information on the operating principle of the multi-purpose display:  
Please see the chapter “OPERATING PRINCIPLE” on Page 124.

## Displaying status of level control

The ground clearance of vehicles equipped with level control is shown in the LEVEL menu.

**1. MAIN MENU**

>VEHICLE INFO

Select and confirm.

**2. Select LEVEL.**

**3. Confirm selection.**

The current level settings are displayed.

**4. Confirm selection.**

VEHICLE INFO menu is displayed.

**Note on operation**

The level control is adjusted by means of the rocker switch behind the gearshift lever in the center console.

For information on level control and height adjustment:

Please see the chapter “AIR SUSPENSION WITH LEVEL CONTROL AND HEIGHT ADJUSTMENT” on Page 190.

## Displaying status of locks/reduction

The selected driving programs for Low Range/High Range as well as the engaged locks can be displayed.

**1. MAIN MENU**

>VEHICLE INFO

Select and confirm.

**2. Select LOCKS/REDUCT.**

**3. Confirm selection.**

The current settings for  
- Longitudinal lock on/off  
- Reduction on/off  
- Transverse axle differential lock on/off are displayed.

**4. Confirm selection.**

VEHICLE INFO menu is displayed.

**Note on operation**

The driving programs are set by means of the rocker switch behind the gearshift lever in the center console.

- ▷ For information on the programs for Off Road and On Road driving and engaging locks/reduction:  
Please see the chapter “DRIVING PROGRAMS FOR ON-ROAD AND OFF-ROAD DRIVING” on Page 177.



## Displaying average consumption

### 1. MAIN MENU

>VEHICLE INFO

Select and confirm.

### 2. Select $\emptyset$ CONSUM.

### 3. Confirm selection.

The average consumption is displayed.

The displayed value is based on the distance travelled since the last reset to “zero”.

## Resetting average consumption

### 4. Select RESET.

### 5. Press the ENTER button for longer than 1 second.

The value is set to “-.-”.

## Note on operation

- ▷ For information on the operating principle of the multi-purpose display: Please see the chapter “OPERATING PRINCIPLE” on Page 124.



## Setting Tire Pressure Monitoring



**Danger!**

**Risk of serious personal injury or death. Driving the vehicle with low tire pressure increases risk of a tire failure and resulting loss of control. Furthermore, low tire pressure increases rate of wear of the affected tires.**

**Despite the advantages offered by Tire Pressure Monitoring, it is not a substitute for proper tire maintenance, and it is still the driver's responsibility to update the settings in the multi-purpose display and maintain the correct tire pressure, even if under-inflation has not reached the level to trigger illumination of Tire Pressure Monitoring low tire pressure message. Low tire pressure reduces the road safety of the vehicle and destroys the tire and wheel.**

- ▷ When a flat tire has been displayed, immediately stop in a suitable place and check the tires for damage. If necessary, remedy the

damage with tire sealant or fit the spare wheel.

- ▷ Do not by any means continue to drive with leaking tires.
- ▷ Sealing the tire with the tire sealant is only an emergency repair so you can drive to the next authorized Porsche dealer. The maximum permitted speed is **50 mph (80 km/h)**.
- ▷ Defective tires must be immediately replaced by an authorized Porsche dealer. **Tire repairs are not permissible under any circumstances.**
- ▷ Do not drive with tires whose tire pressure drops again in a short period of time. Have tires checked by an authorized Porsche dealer.
- ▷ If Tire Pressure Monitoring is defective (e.g. defective wheel transmitters), contact an authorized Porsche dealer immediately and have the damage repaired. The tire pressure will not be monitored by defective Tire Pressure Monitoring. For information on warning messages on the multi-purpose display: Please see the chapter “OVERVIEW OF WARNING MESSAGES” on Page 149.
- ▷ Tire Pressure Monitoring gives a warning about tire damage due to insufficient tire pressure as well as about a gradual loss of pressure due to foreign objects. Tire Pressure Monitoring cannot warn you about tire damage that occurs suddenly (e.g. flat tire due to acute external effects).

- ▷ If a tire pressure message is displayed, correct the tire pressure at the next opportunity.
- ▷ Incomplete entries or selection of the wrong tires on the multi-purpose display affect correct indication of warnings and messages. The settings in the TYRE PRESSURE menu must be updated after wheel changes, use of a spare wheel or changes in vehicle loading.
- ▷ Use only the pressure differences shown in the TYRE PRESSURE menu or from tire pressure messages or warnings when correcting the tire pressure.
- ▷ Tires lose air over time without a tire defect being present. A tire pressure warning will then appear on the multi-purpose display. Correct tire pressure.

---

### Functional description of Tire Pressure Monitoring

Tire Pressure Monitoring continuously monitors tire pressure and tire temperature on all four wheels and warns the driver when the tire pressure is too low.

The display as well as the settings for Tire Pressure Monitoring take place on the multi-purpose display in the sub-menu TYRE PRESSURE.

However, the tire pressure must still be set manually on the wheel.

The deviations in the tire pressures from the required pressures are shown in the sub-menu TYRE PRESSURE.

#### Example:

If the tire pressure display shows “-4 psi (-0.3 bar)”, you must increase the tire pressure by 4 psi (0.3 bar).

The tire pressures to be monitored are fixed in the Tire Pressure Monitoring system and cannot be changed.

The following settings must be made to permit correct monitoring.

#### – Tires

Select the type and size of the tires fitted on the vehicle.

#### – Load

Select the type of loading.

#### Note on operation

Settings can be made only when the vehicle is stationary.

- ▷ For information on tires and wheels: Please see the chapter “TIRES/WHEELS” on Page 281.



### Warning light



#### Warning!

Your vehicle has also been equipped with a TPM malfunction indicator to indicate when the system is not operating properly.

The TPM malfunction indicator is combined with the low tire pressure telltale.

When the system detects a malfunction, the telltale will flash for approximately one minute and then remain continuously illuminated. This sequence will continue upon subsequent vehicle start-ups as long as the malfunction exists.

When the malfunction indicator is illuminated, the system may not be able to detect or signal low tire pressure as intended.

TPM malfunctions may occur for a variety of reasons, including the installation of replacement or alternate tires or wheels on the vehicle that prevent the TPM from functioning properly. Always check the TPM malfunction telltale after replacing one or more tires or wheels on your vehicle to ensure that the replacement or alternate tires and wheels allow the TPM to continue to function properly.

---



## Setting the tire type and size



### Warning!

**Incomplete entries or selection of the wrong tires on the multi-purpose display affect correct indication of warnings and messages.**

- ▷ The settings must be updated in the TYRE PRESSURE menu after changing a wheel, filling with tire sealant or adding air (after previous warning “Flat tyre”).
- ▷ Please see the chapter ““FLAT TYRE” WARNING” on Page 136.

The settings of the multi-purpose display must be updated after changing wheels or tires on the vehicle.

The tire type **and** tire size must be selected even if the settings for the new set of wheels are the same as for the old wheels.

### Note on operation

- ▷ For information on the operating principle of the multi-purpose display; Please see the chapter “OPERATING PRINCIPLE” on Page 124.

1. MAIN MENU  
 >TYRE PRESS.  
   >SETTINGS  
     Select and confirm.

2. Select TYRES.
3. Confirm selection.  
 The TYRE TYPE list is displayed.
4. Select tire type (e.g. SUMMER).  
 The list with the possible tire sizes (e.g. for the selection SUMMER) is displayed.
5. Select tire size (e.g. 18 inch).
6. Confirm selection.  
 The current settings are displayed.

After driving off, the system starts to teach the wheels and wheel positions on the vehicle. During this time, the tire pressure warning light on the speedometer flashes about 60 seconds and lights up thereafter permanently, and no current tire pressure information is available on the displays.

### Note

Information on the tire size and type can be found on the tire sidewall. For further information on the details on the tire sidewall:

- ▷ Please see the chapter “INSCRIPTION ON RADIAL TIRE” on Page 290.

### Note on operation

Before fitting tires approved by Porsche with a size which is not already stored in the multi-purpose display, the missing information should be supplemented in the multi-purpose display.

- ▷ Go to an authorized Porsche dealer immediately.

## Warning!

**Risk of accident due to excessive speed. This could lead to serious personal injury or death.**

- ▷ Always observe the permissible maximum speed of the respective tire.
- ▷ Exceeding maximum tire speed could result in a tire burst, causing loss of control of the vehicle. This could lead to serious personal injury or death. Moreover, Porsche recommends obeying all traffic laws at all times to maintain the safety of yourself and all vehicle occupants.

The speed code letter indicates the maximum permissible speed for the tire.

- ▷ This letter appears on the tire sidewall: Please see the chapter “INSCRIPTION ON RADIAL TIRE” on Page 290.



### Setting vehicle loading and adjusting tire pressure

The tire pressure must be adjusted according to the vehicle load.

A distinction is made between two types of loading:

- Partial load  
up to 3 people and 46 lbs (21 kg) of luggage
- Full load  
more than 3 people and 46 lbs (21 kg) of luggage

1. MAIN MENU  
>TYRE PRESS.  
>SETTINGS  
Select and confirm.
  2. Select LOAD.
  3. Confirm selection.  
The LOAD menu is displayed.  
Select corresponding load type (e.g. FULL LOAD).
  4. Confirm selection.  
The set load status is shown.  
Deviations from the required pressure are shown in the sub-menu MAIN MENU>TYRE PRESSURE>SETTINGS (filling information).
- ▷ Correct the tire pressure according to this information.



## “Flat tyre” warning

The warning threshold for output of this warning message is speed-dependent.

At a speed of below 100 mph (160 km/h), this warning indicates a pressure loss of at least 7 psi (0.5 bar); at a speed of above 100 mph (160 km/h), the warning indicates a pressure loss of at least 6 psi (0.4 bar). The message indicates the wheel in which the pressure loss has been detected. The deviation from the required pressure is displayed for the corresponding wheel. The tire pressure warning light on the speedometer lights up in addition to the warning message. This significant pressure loss is a danger to road safety.

- ▷ The warning message can be acknowledged while driving.  
To do this, press the ENTER button on the wiper stalk. The tire pressure warning light on the speedometer remains lit.  
The measure display SELECTION AFTER WARNING appears only after the ignition is switched back on again.

The display shows: SELECTION AFTER WARNING

1. Stop the vehicle immediately in a suitable place.
2. Check the indicated wheel for damage.
3. Fill the tire or change the wheel, as appropriate.

### - Adding air

**Example:** If the tire pressure display shows “-7 psi (-0.5 bar)”, you must increase the tire pressure by 7 psi (0.5 bar).

On vehicles without air suspension:  
Please see the chapter “CHECKING TIRE PRESSURE WITH A PRESSURE GAGE” on Page 306.

On vehicles with air suspension:  
Please see the chapter “INFLATING TIRES ON VEHICLES WITH AIR SUSPENSION” on Page 308.

or

## - Changing wheel with spare wheel or collapsible spare wheel

For information on jacking up the vehicle: Please see the chapter “LIFTING THE VEHICLE WITH A LIFTING PLATFORM OR GARAGE LIFT” on Page 298.

For information on changing a wheel: Please see the chapter “LIFTING THE VEHICLE WITH A JACK” on Page 299.

or

## - Sealing with tire sealant.

For information on handling and filling the sealant: Please see the chapter “USING TIRE SEALANT” on Page 296.

4. Switch ignition on again.  
The “Flat tyre” warning first appears again on the multi-purpose display. The display changes to SELECTION AFTER WARNING after a few seconds.
5. Select the action which has been carried out on the vehicle on the display with the rocker switch.  
- ADD AIR or  
- WHEEL CHANGE > SPARE WHEEL > Spare wheel type or  
- SEALING SET
6. Press the ENTER button.



## Warning!

**Risk of accident, resulting in serious personal injury or death. The spare wheel and collapsible spare wheel are not equipped with wheel transmitters and are not monitored by Tire Pressure Monitoring.**

- ▷ The spare wheel and collapsible spare wheel must be used only over short distances.

## Warning!

**Risk of accident resulting in serious personal injury or death if a collapsible spare wheel or tire sealant is in use.**

- ▷ Avoid hard acceleration and high cornering speeds.
- ▷ Do not exceed maximum speed of 50 mph (80 km/h).
- ▷ Please observe the safety and operating instructions on the tire compressor.
- ▷ Have the tire or wheel replaced by an authorized Porsche dealer as soon as possible.

## Note

If a collapsible spare wheel or tire sealant is used, a warning reminder appears on the multi-purpose display if the speed limit of 50 mph (80 km/h) is exceeded.

## Note on operation

If you do not confirm a selection or confirm a selection without carrying out the task described for this selection, this will affect correct indication of warnings and messages.

Depending on the selection made, a corresponding message will appear when the ignition is switched on, when driving off or while driving.

For further information on warning messages on the multi-purpose display:  
Please see the chapter “OVERVIEW OF WARNING MESSAGES” on Page 149.



## “Tyre pressure too low” message

This message indicates pressure loss of at least 4 psi (0.3 bar).

The message indicates the wheel in which the pressure loss has been detected. The deviation from the required pressure is displayed for the corresponding wheel.

The message appears only when the vehicle is stationary. It appears for the first time when the ignition is switched off and then each time the ignition is switched on until the tire pressure has been corrected to the required value.

The message is shown for 10 seconds on the multi-purpose display. It can be suppressed immediately by pressing the ENTER button.

- ▷ Check the tire pressure at the next opportunity and fill the tires.

**Example:** If the tire pressure display shows “-4 psi (-0.3 bar)”, you must increase the tire pressure by 4 psi (0.3 bar).

The spare wheel and collapsible spare wheel are not equipped with wheel transmitters and are not monitored by Tire Pressure Monitoring.

### Wheel change (without warning)

The settings of the multi-purpose display must be updated after changing wheels or tires on the vehicle.

Please see the chapter “SETTING THE TIRE TYPE AND SIZE” on Page 134.

### Setting spare wheel/sealant (without warning)

If you have fitted a spare wheel or collapsible spare wheel or used tire sealant without being requested to do so by a “Flat tyre” warning on the multi-purpose display, you must subsequently update the settings in the TYRE PRESSURE sub-menu.

### Setting spare wheel.

1. MAIN MENU  
>TYRE PRESS.  
>SETTINGS  
> TYRES  
> SPARE WHEEL  
Select and confirm.
2. Select SPARE WHEEL.
3. Confirm selection.  
The display automatically returns to the TYRE PRESSURE sub-menu (filling information).  
The required tire pressures are displayed here.  
Select BACK.
4. Confirm selection.  
The basic display appears.



The spare wheel is not equipped with a wheel transmitter and is not monitored by Tire Pressure Monitoring. The tire pressure warning light on the speedometer flashes about 60 seconds and lights up thereafter permanently when the ENTER button is pressed. The value “-” is displayed in the sub-menu TYRE PRESSURE (filling information) at the position of the spare wheel.

The reminder SPARE WHEEL/SEALING SET OPERATION? appears each time the ignition is switched on. For information on spare wheel/sealing set operation: Please see the chapter “NOTE ON SPARE WHEEL/SEALING SET OPERATION” on Page 140.

 **Warning!**

---

**Risk of accident, resulting in serious personal injury or death. The spare wheel is not equipped with a wheel transmitter and is not monitored by Tire Pressure Monitoring.**

- ▷ The spare wheel must be used only over short distances.  
For information on handling and fitting/removing the spare wheel: Please see the chapter “SPARE WHEEL” on Page 309.
- 

**Setting collapsible spare wheel.**

```
1. MAIN MENU
  >TYRE PRESS.
    >SETTINGS
      > TYRES
        > SPARE WHEEL
          Select and confirm.
```

2. Select COLLAP. WHEEL.
3. Confirm selection.  
The required pressure and speed limit for the collapsible spare wheel are displayed.

The collapsible spare wheel is not equipped with a wheel transmitter and is not monitored by Tire Pressure Monitoring. The tire pressure warning light on the speedometer flashes about 60 seconds and lights up thereafter permanently when the ENTER button is pressed. The value “\_” is displayed in the sub-menu TYRE PRESSURE (filling information) at the position of the collapsible spare wheel.

A warning appears on the multi-purpose display if the speed limit of 50 mph (80 km/h) is exceeded.

The reminder SPARE WHEEL/SEALING SET OPERATION? appears each time the ignition is switched on.

For information on spare wheel/sealing set operation: Please see the chapter “NOTE ON SPARE WHEEL/SEALING SET OPERATION” on Page 140.

 **Warning!**

---

**Risk of accident, resulting in serious personal injury or death. The collapsible spare wheel is not equipped with a wheel transmitter and is not monitored by Tire Pressure Monitoring.**

- ▷ The collapsible spare wheel must be used only over short distances.  
For information on handling the collapsible spare wheel: Please see the chapter “COLLAPSIBLE SPARE WHEEL” on Page 305.
- 

 **Warning!**

---

**Risk of accident, resulting in serious personal injury or death if a collapsible spare wheel is in use.**

- ▷ Avoid hard acceleration and high cornering speeds.
  - ▷ Do not exceed maximum speed of 50 mph (80 km/h).
  - ▷ Please observe the safety and operating instructions on the tire compressor.
  - ▷ Have the collapsible spare wheel replaced by an authorized Porsche dealer as soon as possible.
-

## Setting tire sealant/sealing set

### 1. MAIN MENU

>TYRE PRESS.

>SETTINGS

> TYRES

> SPARE WHEEL

Select and confirm.

### 2. Select SEALING SET.

### 3. Confirm selection.

The display automatically returns to the TYRE PRESSURE sub-menu (filling information).

- ▷ Inflate tires according to the displayed pressure differences.

A warning appears on the multi-purpose display if the speed limit of 50 mph (80 km/h) is exceeded.

The reminder SPARE WHEEL/SEALING SET OPERATION? appears each time the ignition is switched on.

For information on spare wheel/sealing set operation: Please see the chapter "NOTE ON SPARE WHEEL/SEALING SET OPERATION" on Page 140.

## Warning!

### **Risk of accident, resulting in serious personal injury or death if a tire repaired with tire sealant is in use.**

- ▷ Avoid hard acceleration and high cornering speeds.
- ▷ Do not exceed maximum speed of 50 mph (80 km/h).
- ▷ Please observe the safety and operating instructions on the tire compressor.
- ▷ Use tires repaired with sealant only over short distances.  
For information on handling and filling the sealant: Please see the chapter "USING TIRE SEALANT" on Page 296.

## **Note on spare wheel/sealing set operation**

Each time the ignition is switched on, the reminder SPARE WHEEL/SEALING SET OPERATION? appears for approx. 10 seconds if a spare wheel type (spare wheel, collapsible spare wheel or sealing set) has been set.

### 1. Select YES or NO:

- YES if a spare wheel, collapsible spare wheel or tire sealant is still being used.
- NO if the spare wheel, collapsible spare wheel or tire sealant has been removed.

### 2. Confirm selection.

The selected item is then accepted.

The current settings are displayed if NO is selected.



- ▷ Set the fitted wheel set with tire type **and** tire size.  
Please see the chapter “SETTING THE TIRE TYPE AND SIZE” on Page 134.

### Note on operation

The reminder SPARE WHEEL/SEALING SET OPERATION? goes out automatically after approx. 10 seconds if no selection is made during this time. The original selection “YES” is then maintained.



## Faults in Tire Pressure Monitoring

In the event of faults, Tire Pressure Monitoring cannot monitor the tire pressure. A distinction is made between partial monitoring and inactive system.

In the case of partial monitoring, the tire pressure warning light on the speedometer flashes about 60 seconds and lights up thereafter permanently.

**No** message is output on the multi-purpose display.

If Tire Pressure Monitoring is not active, the tire pressure warning light on the speedometer flashes about 60 seconds and lights up thereafter permanently. A corresponding message is output on the multi-purpose display.

The warning light goes out as soon as all faults have been remedied.

Tire Pressure Monitoring switches to partial monitoring if:

- there are up to two wheel transmitters not present or faulty (e.g. a spare wheel or collapsible spare wheel is fitted that does not have a wheel transmitter).

In the event of partial monitoring, the value “\_” is displayed in the sub-menu TYRE PRESSURE (filling information) at the position of the faulty or missing wheel transmitter.

Tire Pressure Monitoring is not active in the following cases:

- Tire Pressure Monitoring is faulty,

- at least three wheel transmitters for Tire Pressure Monitoring are faulty or not present,
  - temporarily after changing a wheel,
  - too many wheel transmitters have been detected,
  - there is external interference by other radio sources, e.g. wireless headphones,
  - tire temperatures are too high.
- ▷ For information on messages on the multi-purpose display:  
Please see the chapter “OVERVIEW OF WARNING MESSAGES” on Page 149.

### Notes on tire pressure

#### Pressure increase as the result of temperature increase

In accordance with physical principles, the tire pressure changes as the temperature changes. The tire pressure increases or decreases by around 1.5 psi (0.1 bar) for every 18 °F (10 °C) change in temperature.

#### Tire pressure specifications

The tire pressure must match the prescribed value (required pressure).

You can find information on the tire pressure for cold tires 68 °F (20 °C):

- in the sub-menu TYRE PRESSURE (filling information):  
as a required pressure for each axle if Tire Pressure Monitoring has not yet been taught the corresponding values,
- in the front left door aperture for each wheel,
- in the Technical Data chapter in this Owner's Manual: Please see the chapter "TIRE PRESSURES, COLD (68 °F/20 °C)" on Page 354.

If Tire Pressure Monitoring has been taught the corresponding values, the deviations from the required pressure are shown in the sub-menu TYRE PRESSURE (filling information) independently of the tire temperature. The correct tire pressure adjustment can be made for a wheel on the basis of this display information even if the tires are warm.

Insufficient tire filling pressure can cause tires to overheat when driving and thus be damaged – even invisibly. Hidden tire damage is not eliminated by subsequently correcting the tire pressure.

- ▷ For this reason, always make sure that the tire pressure is correct.
- ▷ For further information on maintenance and care of tires and wheels:  
Please see the chapter "TIRES/WHEELS" on Page 281.

## Switching off passenger compartment monitoring on the multi-purpose display

The passenger compartment monitoring system can be temporarily deactivated in the ALARM sub-menu.

When the doors are locked again, the ultrasound passenger compartment monitoring system is activated once more.

Further important information concerning this topic can be found in a separate chapter:

- ▷ Please see the chapter "TEMPORARILY DEACTIVATING PASSENGER COMPARTMENT MONITORING SYSTEM" on Page 246.

### Notes on operation

- ▷ Comfort settings can be made only when the vehicle is stationary.
- ▷ For information on the operating principle of the multi-purpose display:  
Please see the chapter "OPERATING PRINCIPLE" on Page 124.



## Switching passenger compartment monitoring on/off

The alarm is triggered if motion is detected in the interior with the doors closed (e.g. if a window is broken in a theft).

1. MAIN MENU  
> SETTINGS  
> COMFORT  
> ALARM  
Select and confirm.
2. Select INTERIOR.
3. Confirm selection.
  - Monitoring is activated.
  - Monitoring is deactivated.



## Synchronous adjustment of door mirrors

### Note on operation

Comfort settings can be made only when the vehicle is stationary.

When this function is active, the mirrors move simultaneously and in the same direction.

#### 1. MAIN MENU

- >SETTINGS
- > COMFORT
- > MIRRORS
- Select and confirm.

#### 2. Select SYNCH.

#### 3. Confirm selection.

SYNCHRONOUS ADJUSTMENT is activated.

SYNCHRONOUS ADJUSTMENT is deactivated.

## Changing settings for opening and locking the vehicle

### Note on operation

Comfort settings can be made only when the vehicle is stationary.

You can set different variants of locking and unlocking the doors and the rear lid as well as the check-back signal when locking and unlocking the vehicle and save them on the respective remote control.

#### 1. MAIN MENU

- >SETTINGS
- > COMFORT
- > DOOR OPENING
- Select and confirm.

#### 2. Set the desired function.

#### 3. Switch ignition off.

#### 4. Close the driver's door.

#### 5. Press button on the car key.

The settings are now stored on this car key.

### Note on operation

- ▷ For information on the operating principle of the multi-purpose display: Please see the chapter "OPERATING PRINCIPLE" on Page 124.

## Setting door unlocking

Door unlocking can be set on an individual basis.

#### 1. MAIN MENU

- >SETTINGS
- > COMFORT
- > DOOR OPENING
- > DOORS
- Select and confirm.

#### 2. Select one of the three options:

##### – SINGLE DOOR

Only the driver's door is unlocked.

The door on the access side is unlocked on vehicles equipped with Porsche Entry & Drive.

##### – VEH. SIDE

Both doors on the driver's side are unlocked.

The doors on the access side are unlocked on vehicles equipped with Porsche Entry & Drive.

##### – ALL

All doors are unlocked.

#### 3. Confirm selection.

### Note on operation

If the unlocking button  on the remote control is pressed a second time within 2 seconds, all vehicle doors are unlocked, independent of the affected setting.



## Setting door opening signal

If the function TURN SIGNALS is active, door unlocking and locking is confirmed by the emergency flashers flashing.

If the function HORN is active, door unlocking and locking is confirmed by an acoustic signal.

1. MAIN MENU
  - >SETTINGS
  - > COMFORT
  - > DOOR OPENING
  - > SIGNAL
  - Select and confirm.
2. Select TURN SIGNALS or HORN.
3. Confirm selection.
  - Selection is activated.
  - Selection is deactivated.

## Setting rear lid locking

When the TAILGATE function is active, rear access (rear lid, rear window and spare wheel bracket) is included in the central locking system. Access is possible when the vehicle is stationary and unlocked.

At speeds higher than 4 mph (6 km/h), release is blocked until a door is opened with the vehicle stationary.

When the TAILGATE function is deactivated, access is only possible using button  on the remote control.

1. MAIN MENU
  - >SETTINGS
  - > COMFORT
  - > DOOR OPENING
  - Select and confirm.
2. Select TAILGATE.
3. Confirm selection.
  - Function is activated.
  - Function is deactivated.

### Note on operation

Vehicles with powerliftgate:  
Regardless of the setting in the multi-purpose display, the rear lid can be opened by pulling the button in the driver's door when the vehicle is at a standstill with the ignition switched on. Please see the chapter "POWERLIFTGATE (REAR LID)" on Page 23.

## Setting AUTO LOCK (automatic door locking) and AUTO UNLOCK (automatic door unlocking)

1. MAIN MENU
  - >SETTINGS
  - > COMFORT
  - > DOOR OPENING
  - Select and confirm.
2. Select AUTO LOCK or AUTO UNLOCK.
3. Confirm selection.
  - Selection is activated.
  - Selection is deactivated.

### AUTO LOCK and AUTO UNLOCK variants

You can set 4 different variants of automatic door locking (AUTO LOCK) and automatic door unlocking (AUTO UNLOCK).

Doors locked using AUTO LOCK can **always** be opened by pulling the inner door handle **twice** regardless of the setting for door unlocking.

#### Option 1: AUTO LOCK off and AUTO UNLOCK off

The doors do not lock and unlock automatically.

#### Option 2: AUTO LOCK on and AUTO UNLOCK off

Doors lock automatically when a speed of approx. 4 mph (6 km/h) is exceeded.



### Option 3:

#### AUTO LOCK on and AUTO UNLOCK on

Doors lock automatically when a speed of approx. 4 mph (6 km/h) is exceeded.

On vehicles **without** Porsche Entry & Drive, the doors are unlocked automatically when the ignition key is withdrawn.

On vehicles equipped **with** Porsche Entry & Drive, the doors are unlocked when the ignition is switched off twice.

### Option 4:

#### AUTO LOCK off and AUTO UNLOCK on

The doors do not lock automatically.

If the doors are locked with the central locking system button:

On vehicles **without** Porsche Entry & Drive, the doors are unlocked automatically when the ignition key is withdrawn.

On vehicles equipped **with** Porsche Entry & Drive, the doors are unlocked when the ignition is switched off twice.



## Switching daytime driving lights on/off

### Note on operation

The options in the LIGHTS menu can only be set when the vehicle is stationary.

### USA only:

You can activate/deactivate the daytime driving lights on the multi-purpose display in the instrument panel.

1. MAIN MENU  
> SETTINGS  
> LIGHTS  
Select and confirm.
2. Select DAYTIME DRIVING LIGHTS.
3. Confirm selection.  
 Function ist activated.  
 Function ist deactivated.

### Canada only:

The DAYTIME DRIVING LIGHTS function cannot be deactivated.



## Setting lighting off delay

### Note on operation

The options in the LIGHTS menu can only be set when the vehicle is stationary.

You can set the duration the lights remain on after the vehicle is locked.

1. MAIN MENU  
>SETTINGS  
> LIGHTS  
Select and confirm.
2. Select OFF DELAY.
3. Confirm selection.  
 The set off delay time is now active.
4. Select the time input field.
5. Confirm selection.
6. Set the off delay time (Coming Home function):  
The time is adjusted by pressing the rocker switch. Delay times of 15, 30 or 60 seconds can be set.
7. Confirm selection.

## Setting the clock

1. MAIN MENU  
>SETTINGS  
> CLOCK  
Select and confirm.
2. Select xx:xx SET.
3. Confirm selection.
4. Select hours or minutes display.
5. Confirm selection.  
The desired time can now be set.
6. Set the desired time:  
The time is adjusted in hour or minute increments by pressing the rocker switch.
7. Confirm selection.

### Selecting 12 h mode

8. Select 12 h-MODE.
9. Confirm selection.  
 12 h mode is activated.  
 12 h mode is deactivated.

### Note on operation

There is also a button on the instrument panel to call the CLOCK menu:

- ▷ Please see the chapter "C - CLOCK" on Page 120.

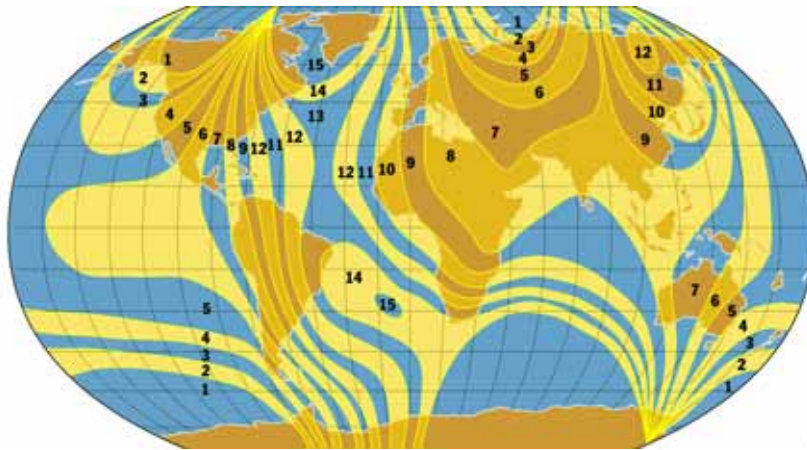

E31-272

## Setting compass

The display is available only for vehicles equipped with Porsche Radio CDR-23 and magnetic field sensor.

If you drive your vehicle across the magnetic field zone set on the multi-purpose display, you must enter your current zone in the COMPASS menu (see illustration).

1. MAIN MENU  
>SETTINGS  
> COMPASS  
Select and confirm.
2. Select SET ZONE xx.
3. Confirm selection.
4. Select zone.  
The setting is changed in increments of 1 by pressing the rocker switch.
5. Confirm selection.

## Calibrating compass

In rare cases, external disturbances may necessitate calibration of the compass. The warning message "CAL." then appears on the multi-purpose display.

- ▷ To calibrate the compass, follow the displayed instruction DRIVE IN A FULL CIRCLE.

The display returns to the main menu after successful calibration.



## Changing language for displays

1. MAIN MENU  
>SETTINGS  
> LANGUAGE  
Select and confirm.

2. Select the desired language.
3. Confirm selection.

### Note

Changing the language will affect the entire multi-purpose display.

## Changing units for displays

1. MAIN MENU  
>SETTINGS  
> UNITS  
Select and confirm.
2. Select the desired category (e.g. SPEEDOMETER).
3. Confirm selection.
4. Select the desired unit (e.g. MPH).
5. Confirm selection.

### Available categories and units

- Speedometer:  
km/h - km, mph - mls
- Consumption:  
l/100 km, km/l, MPG (UK),  
MPG (US)
- Temperature:  
°C - CELSIUS, °F - FAHRENHEIT
- Tire pressure:  
bar, psi



## Resetting display to factory settings

All settings made (Clock, Comfort, Lights, Units, Language) can be reset to the factory settings.

### Note

All personal settings made up to this point will be deleted by resetting to the factory settings.









1. MAIN MENU  
>SETTINGS  
> FACTORY SET  
Select and confirm.
2. Select RESET.
3. Confirm selection.

















## Overview of warning messages





















If a warning message appears, always refer to the corresponding chapters in this Owner's Manual.

















Warning messages are issued only if all measurement preconditions are met.

Therefore, check all fluid levels regularly – in particular, always check the engine oil level after refueling.















Light on instrument panel	Warning message on the multi-purpose display	Meaning/measures
	Steering faulty	Steering lock engaged. Have the fault remedied at an authorized Porsche dealer.
	Ignition lock faulty	Do not continue driving. Have the fault remedied at an authorized Porsche dealer.
	System fault	Have the fault remedied at an authorized Porsche dealer.
	Key not recognised in vehicle	Make sure that you have the remote control with you.
	Turn ignition key to the left for 2 seconds	To lock the steering, turn the ignition key to the left and hold for 2 seconds.
	Key: replace battery	Replace the remote-control battery.
	Move steering wheel	Turn the steering wheel so that the steering wheel lock can engage/disengage.
	Key not found	Make sure that you have the remote control with you.
	Move selector lever to position P	Tiptronic S: The vehicle could roll away. The ignition key can be withdrawn only in Tiptronic selector lever position <b>P</b> .
	Press brake pedal	Apply the brake when starting.
	Move selector lever to position P or N	Tiptronic S: The vehicle can be started only in position <b>P</b> or <b>N</b> .
	Depress clutch	Manual transmission: Depress clutch pedal when starting.



















Light on instrument panel	Warning message on the multi-purpose display	Meaning/measures
	 Immobilizer active	Have the fault remedied at an authorized Porsche dealer.
	 Check left static cornering light	Check bulb.
	 Check right static cornering light	Check bulb.
	 Check dynamic cornering light	Have the fault remedied at an authorized Porsche dealer. If the warning message appears, the high beam indicator light on the speedometer flashes additionally.
	 Check dipped beam	Check bulb.
	 Check trailer lights	Check bulb.
	 Check direction indicators	Check bulb.
	 Check high beam	Check bulb.
	 Check licence plate light	Check bulb.
	 Check fog lights	Check bulb.
	 Check reversing lights	Check bulb.
	 Check front side lights	Check bulb.
	 Check headlight beam adjustment	Have the fault remedied at an authorized Porsche dealer.
	 Daytime driving lights off	Daytime driving lights switch off when the ignition is switched-off. Switch on lights by light switch if necessary.
	 System fault headlamp	Have the fault remedied at an authorized Porsche dealer.















Light on instrument panel	Warning message on the multi-purpose display	Meaning/measures
	Check passenger seat setting	Weight sensing is impaired on the passenger's seat (Advanced Airbag). Correct the seating position, set the backrest upright, do not support weight on the armrests, or lift on the handles.
		Airbag faulty. Have the fault remedied at an authorized Porsche dealer.
	 Seat belt	Fasten seat belt.
	 Caution flat tyre Check tyres	Tire Pressure Monitoring detects a pressure loss of at least 6 psi (0.4 bar) or a larger leak. Stop in a suitable place and check tires. Change wheel if necessary.
	 Check spare wheel required pressure: 3.4 bar/50 psi	Appears about every 6 months. Check if the pressure of the mounted spare wheel matches the required pressure manually, as it is not monitored electronically.
	 Tyre pressure too low Add air	Tire Pressure Monitoring detects a pressure loss of at least 4 psi (0.3 bar). Correct tire pressure at the next opportunity.
	 Collapsible spare wheel/sealing set max. 50 mph (80 km/h)	Observe maximum permitted speed.
	 Collapsible spare wheel Required pressure: 3.5 bar/ 51 psi max. 50 mph (80 km/h)	Information on driving with a collapsible spare wheel after selection in spare wheel menu. Observe maximum speed of max. 50 mph or 80 km/h and required pressure of 51 psi or 3.5 bar.
	 System not active	Tire Pressure Monitoring faulty. Have the fault remedied at an authorized Porsche dealer. Select new set of wheels in the tire pressure menu after changing the wheels.
	 System not active Brief disturbance	External interference (e.g. wireless headphones) or excessive temperature (over 248 °F/120 °C) at the wheel transmitters. Tire Pressure Monitoring will reactivate itself.
	 System not active Too many wheel transmitters	Tire Pressure Monitoring detects more than 4 wheel transmitters (e.g. winter wheels in the luggage compartment) Tire Pressure Monitoring will reactivate itself after the additional wheel transmitters have been removed.





Light on instrument panel	Warning message on the multi-purpose display	Meaning/measures
	 No monitoring System learning	After the tire type and size are selected in the tire pressure menu, Tire Pressure Monitoring re-learns the tires.
	 Wheel change? Make new selection	The tire type and size of the changed tires have not been updated for Tire Pressure Monitoring. The display changes when the vehicle is stationary; Select corresponding tire type <b>and</b> tire size.
	 When vehicle stops: Hit selection	The message appears after driving off if the warning "Flat tyre" has been cleared but the selection on the display SELECTION AFTER WARNING has not been made properly. Make selection on the multi-purpose display when the vehicle is stationary.
	 Engine temperature too high	Coolant or engine oil temperature is too high. Switch engine off and let it cool. Check coolant or engine oil level. Add coolant or engine oil if necessary.
	 Check coolant level	Switch engine off and let it cool. Check coolant level. Add coolant if necessary.
	 Warning battery/generator	Stop in a suitable place and switch engine off. Do not continue driving. Have the fault remedied at an authorized Porsche dealer.
	 Start engine	The battery discharges if the engine is not running and loads are switched on. Start the vehicle or switch the loads off.
	 Electric load Switch-off	Vehicle electrical system is overloaded. Certain loads (e.g. heated rear window, seat heating) will be switched off.
		Stop immediately at a suitable and secure place and check tank cap for proper fastening. If tank cap was fastened correctly, consult your authorized Porsche dealer.
	 Please refuel	
	 Add washer fluid	
	 Oil level monitoring Failure	Have the fault remedied at an authorized Porsche dealer.
	 Check oil level	Check the oil level using the oil dipstick as soon as possible and add engine oil if necessary.



Light on instrument panel	Warning message on the multi-purpose display	Meaning/measures
	 Oil pressure too low	Immediately stop in a suitable place and switch engine off. Do not continue driving. Check engine oil level. Add oil if necessary. Do not continue driving if the warning light comes on even when the oil level is correct. Have the fault remedied at an authorized Porsche dealer.
	 Oil pressure monitoring Failure	Have the fault remedied at an authorized Porsche dealer.
	Service in 1864 mls (3000 km)	Service indicator Bring the vehicle in for service no later than after the distance shown has been covered. Please see the additional information in the "Maintenance" booklet.
	Service now	Service indicator Have your vehicle serviced at an authorized Porsche dealer.
	 Brake pads	Have the brake pads replaced at an authorized Porsche dealer.
<b>BRAKE</b> 	 Warning Brake proportioning	Stop immediately in a suitable place. Do not continue driving. Have the fault remedied at an authorized Porsche dealer.
<b>ABS</b> 	 ABS failure	Drive carefully. Have the fault remedied at an authorized Porsche dealer.
	 PSM failure	Drive carefully. Have the fault remedied at an authorized Porsche dealer.
<b>BRAKE</b> 	 Warning Brake fluid level	Stop immediately in a suitable place. Do not continue driving. Have the fault remedied at an authorized Porsche dealer.
<b>BRAKE</b> 	 Parking brake	Parking brake not released.
	 PSM on	Porsche Stability Management was switched on.

Light on instrument panel	Warning message on the multi-purpose display	Meaning/measures
	 PSM off	Porsche Stability Management was switched off.
	 PHC unavailable	The Porsche Drive-off Assistant (manual transmission) is not available.
<b>BRAKE</b> 	 Brake booster faulty	Greater brake pedal force necessary. Drive carefully to the nearest authorized Porsche dealer.
	 Chassis sport	Current setting of Porsche Active Suspension Management
	 Chassis normal	Current setting of Porsche Active Suspension Management
	 Chassis comfort	Current setting of Porsche Active Suspension Management
	 Chassis system faulty	Handling may be affected. Adapt your speed to the changed conditions. Have the fault remedied at an authorized Porsche dealer.
	 Warning chassis system	The side tilt of the vehicle is significantly greater when cornering. Drive carefully at an appropriate speed to the nearest authorized Porsche dealer.
	 Warning chassis system	Stop at a suitable place. Do not continue driving. Have the fault remedied at an authorized Porsche dealer.
	 Chassis system faulty	Drive carefully to the nearest authorized Porsche dealer.
	 Spare wheel filling	Collapsible spare wheel is being filled by level-control compressor. Do not drive off!
	 Regulation switched off	Level control has been switched off (to jack up the vehicle).
	 Not permissible	The prerequisites for setting the desired level have not been met.
	 Pressure accumulator charging	Level control temporarily unavailable.
	 Four-wheel drive system faulty	Have the fault remedied at an authorized Porsche dealer.

Light on instrument panel	Warning message on the multi-purpose display	Meaning/measures
	 Shift not possible; Speed too high	Tiptronic S: When changing between Low Range and High Range, the limit speed (Low Range program) must not be exceeded.
	 Shift only possible in neutral	Tiptronic S: The Tiptronic selector lever must be in position <b>N</b> when changing between Low Range and High Range.
	 Possible only when stopped in neutral with brake	Manual transmission: The vehicle must be stationary, the brakes must be applied and the gearshift lever must be in the neutral position when changing between Low Range and High Range.
	 Warning parking lock! Apply parking brake!	Do not continue driving. Apply the parking brake. Have the fault remedied at an authorized Porsche dealer.
	Failure sport mode	Have the fault remedied at an authorized Porsche dealer.
	Sport mode only usable without reduction	Sport mode cannot be selected when the off-road driving program (Low Range) is engaged.
 	Limit exceeded.	The set speed limit has been exceeded.
 		Spare wheel is not locked. Danger of injury and damage. Before driving off always lock the spare wheel correctly.
 		Driver's door open All unlocked doors and lids are displayed when the vehicle exceeds 2 mph (3 km/h).
 		Passenger's door open All unlocked doors and lids are displayed when the vehicle exceeds 2 mph (3 km/h).
 		Rear left door open All unlocked doors and lids are displayed when the vehicle exceeds 2 mph (3 km/h).

Light on instrument panel	Warning message on the multi-purpose display	Meaning/measures
		Rear right door open All unlocked doors and lids are displayed when the vehicle exceeds 2 mph (3 km/h).
		Hood open All unlocked doors and lids are displayed when the vehicle exceeds 2 mph (3 km/h).
		Rear lid open. All unlocked doors and lids are displayed when the vehicle exceeds 2 mph (3 km/h).
		Rear window open All unlocked doors and lids are displayed when the vehicle exceeds 2 mph (3 km/h).
	System fault	Several systems may have failed. Have the fault remedied at an authorized Porsche dealer.

# Driving and Driving Safety

- Ignition Lock/Steering Lock ..... 158
- Starting and Stopping the Engine ..... 160
- Parking Brake ..... 162
- Brakes ..... 163
- Cruise Control..... 167
- Manual transmission, clutch ..... 169
- Tiptronic S..... 170
- Selector Lever Positions ..... 171
- Driving Programs for On-Road and  
Off-Road Driving ..... 177
- Power-Transmission and  
Running-Gear Control Systems ..... 181
- Air Suspension with Level Control and  
Height Adjustment ..... 190
- Porsche Active Suspension  
Management (PASM) ..... 193
- Porsche Dynamic Chassis Control (PDCC) .... 194
- Off-Road Driving ..... 195



Ignition lock positions:

- 0** - Initial position
- 1** - Ignition on
- 2** - Start engine
- 3** - Ignition off

## Ignition Lock/Steering Lock



**Caution!**

**Risk of damage. The ignition lock may be damaged if additional weight is attached to the inserted ignition key, e.g. a heavy bunch of keys and/or key tag.**

- ▷ Do not attach a heavy weight to the inserted ignition key.

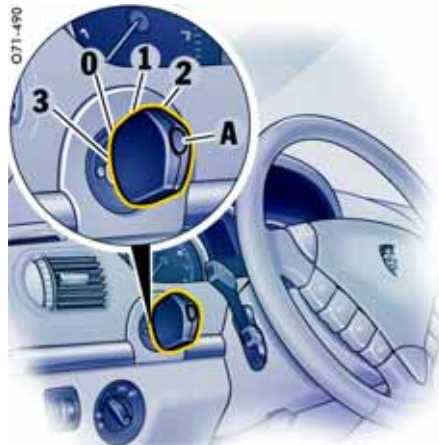

Ignition lock positions with Porsche Entry & Drive:

- 0** - Initial position
- 1** - Ignition on
- 2** - Start engine
- 3** - Ignition off

The ignition lock has a total of four ignition lock positions.

### Note on operation

The car key rebounds to the initial position from every ignition lock position.

For vehicles that have **Porsche Entry & Drive** you do not need to insert the key into the ignition lock again but merely keep it with you.

The ignition key is replaced by a control unit in the ignition lock, which **always** remains in the ignition lock, unless the vehicle is being towed.

### Removing the control unit from the ignition lock

- ▷ Press button **A** and remove the control unit.

### Ignition lock position 0 - Initial position

The ignition key cannot be withdrawn when the ignition is switched on or when the engine is started.

To withdraw the ignition key:

- ▷ Stop the vehicle.
- ▷ **On vehicles with Tiptronic S:**  
Move Tiptronic selector lever to position **P**.
- ▷ Switch ignition off.
- ▷ Withdraw the ignition key.

### Note on operation

The vehicle battery discharges if the ignition key is left inserted.

- ▷ If the vehicle battery is dead, the key can only be pulled out of the ignition lock if the emergency operation is performed:  
Please see the chapter "EMERGENCY OPERATION - UNLOCKING THE IGNITION KEY" on Page 159.

## Ignition lock position 1 - Ignition on

- ▷ Turn ignition key to position 1.

### Note on operation

All electrical equipment can be switched on. The warning lights light up for a lamp check.

- ▷ Please see the chapter “INSTRUMENT PANEL USA MODELS” on Page 117.

If a load is not switched on for 10 minutes after switching on the ignition, the ignition must be switched on again.

Turn the ignition key to ignition lock position 3 (ignition off) first.

## Ignition lock position 2 - Starting engine

- ▷ Turn ignition key to ignition lock position 2.

## Ignition lock position 3 - Ignition off

- ▷ Turn ignition key to ignition lock position 3.
- ▷ For further information on starting and stopping the engine:  
Please see the chapter “STARTING AND STOPPING THE ENGINE” on Page 160.

## Locking the steering column

### Vehicles without Porsche Entry & Drive

The steering column is **automatically locked** when the ignition key is withdrawn from the ignition lock and is **automatically unlocked** when the ignition key is inserted into the ignition lock.

### Vehicles with Porsche Entry & Drive

The steering column is **automatically locked** when the ignition is switched off and the vehicle is locked.

### Manually locking the steering column on vehicles with Porsche Entry & Drive

- ▷ Depress the clutch on vehicles with manual transmission.
- ▷ Once the ignition is switched off, turn the control unit again to ignition lock position 3 and hold it there for **2 seconds**.

The steering column is **automatically unlocked** by turning the control unit from ignition lock position 0.



### Emergency operation - unlocking the ignition key

If the vehicle battery is dead, the key can only be pulled out of the ignition lock if the emergency operation is performed.

1. Turn ignition key counter-clockwise.
2. Press a pointed object, e.g. a ballpoint pen, in the opening **A** next to the ignition lock and keep pressed.
3. Remove ignition key.

## Starting and Stopping the Engine

- ▷ Please see the chapter “IMMOBILIZER” on Page 248.
- ▷ Please see the chapter “EMISSION CONTROL SYSTEM” on Page 263.



**Risk of poisoning. Exhaust gas contains colorless and odorless carbon monoxide (CO), which is toxic even in low concentration. Carbon monoxide can cause unconsciousness and even death if inhaled.**

- ▷ Never start or let the engine run in an enclosed, unventilated area. It is not recommended to sit in your car for prolonged periods with the engine on and the car not moving.

**An unattended vehicle with a running engine is potentially hazardous. If warning lights should come on to indicate improper operation, they would go unnoticed.**

- ▷ Never leave the engine idling unattended.

### Danger of fire.

- ▷ Do not drive or park your car where combustible materials, such as dry grass or leaves, can come into contact with the hot exhaust system.
- ▷ If your car catches on fire for any reason, call the fire department. Do not endanger your life by attempting to put out the fire.

## Starting vehicle

- ▷ Operate footbrake.
- ▷ Fully depress and hold the clutch pedal. Put the gearshift lever in neutral **or on vehicles with Tiptronic S:** move the Tiptronic selector lever to position **P** or **N**.
- ▷ Do not press the accelerator pedal. The engine control module will provide the correct starting mixture.
- ▷ Turn ignition key to ignition lock position **2**.
- ▷ Do not operate the starter longer than approx. 10 seconds. If necessary, repeat the starting procedure after a pause of approx. 10 seconds. Turn the ignition key back to ignition lock position **3** first.

### Notes on operation

The first operation of the starter is ended automatically when the engine starts. If the engine does not start, subsequent starter operations will not be ended automatically.

When the engine is started, the warning lights must go out.

- ▷ Do not warm up the engine when stationary. Drive off immediately. Avoid high revolutions and full throttle until the engine has reached operating temperature.
- ▷ If battery output is insufficient, jump leads can be used to start the engine. Please see the chapter “EMERGENCY STARTING WITH JUMPER CABLES” on Page 323.

### Note on operation

To ensure a good charge condition for the battery and thus its ability to start the engine, all electrical accessories which are not required should be switched off when the ignition is switched on and when engine revolutions are low (in stop and go traffic).



## Stopping

- ▷ Withdraw the ignition key only when the vehicle is stationary, otherwise the steering lock engages and the vehicle cannot be steered.
- ▷ Only switch the ignition off when the vehicle comes to a stop, as there is no steering assistance and brake boost when the engine is switched off.
- ▷ When leaving the vehicle, **always** remove the ignition key and engage the parking brake. Engage the parking lock on vehicles with Tiptronic S (Tiptronic selector lever position **P**). Engage first gear or reverse gear on vehicles with manual transmission. The control unit **always** remains in the ignition lock in vehicles that have **Porsche Entry & Drive**.

### Note on operation

The vehicle battery discharges if the ignition key is left inserted.

## Warning!

---

### **Danger of injury. Hot engine compartment components can burn skin on contact.**

- ▷ Before working on any part in the engine compartment, turn the engine off and let it cool down sufficiently.

### **Risk of burn injury when standing near or coming into contact with the exhaust pipe.**

The exhaust pipe is hot when the vehicle is running and remains hot for some time after the vehicle is turned off.

- ▷ To prevent injury, make a point of noting where your vehicle's exhaust pipe is, avoid placing your legs near the exhaust pipe when loading and unloading cargo in the rear, and closely supervise children around the vehicle during time when the exhaust pipe could be hot. A hot exhaust pipe can cause serious burns.
- 

## Radiator fans

The radiator and radiator fans are in the front of the car.

## Warning!

---

**Danger of injury. After the ignition is switched off, the engine compartment and coolant temperatures are monitored for approx. 30 minutes. During this period, and depending on temperature, the radiator fan may continue to run or start to run.**

- ▷ Carry out work in these areas only with the engine off and exercise extreme caution.
-



## Parking Brake

The parking brake acts on the rear wheels and serves to secure the car while parked.

- ▷ Use the parking brake only after the vehicle has come to a full stop.

## Applying the parking brake

- ▷ Press down firmly on the foot pedal. The warning light in the instrument panel lights up. A message will be displayed on the multi-purpose display of the instrument panel if the parking brake is not released before moving off. If the brake is not fully set, the vehicle may roll without control.
- ▷ Before exiting the vehicle, make sure that the parking brake is fully applied and the vehicle is not moving at all.

### **Danger!**

**Risk of serious personal injury or death. A partially engaged parking brake may allow the vehicle to roll, causing serious personal injury or death to any person in its path.**

- ▷ Engage the parking brake fully.

---

- ▷ Please see the chapter “OVERVIEW OF WARNING MESSAGES” on Page 149.

## **Releasing the parking brake**

- ▷ Press on the footbrake and pull handle **A** of the parking brake. The warning light and the message disappear.

**BRAKE**

### **Parking Brake warning light USA**



### **Parking Brake warning light Canada**

The warning lights will go out after the parking brake is fully released.

The warning lights are not an indicator that the parking brake is fully applied; it is only intended to be a warning to release the parking brake before driving the car.

#### **Caution!**

**A partially engaged brake will overheat the rear brakes, reduce their effectiveness and cause excessive wear.**

- ▷ Release the parking brake fully.
- 
- ▷ When parking your car, press down firmly on the foot pedal.
  - ▷ Move the Tiptronic selector lever to “P” (Tiptronic) or move the gearshift lever to reverse or first gear (Manual transmission).
  - ▷ On hills also turn the front wheels towards the curb.

## **Brakes**

- ▷ Make it a habit to check the operation of your brakes before driving.

Keep in mind that the braking distance increases very rapidly as the speed increases. At 60 mph (100 km/h), for example, it is not twice but four times longer than 30 mph (50 km/h). Tire traction is also less effective when the roads are wet or slippery.

- ▷ Therefore, always maintain a safe distance from the car in front of you.

### **Vehicles without Porsche Ceramic Composite Brake (PCCB)**

Even though the brake discs consist of alloyed grey cast iron, they will unavoidably start to corrode if your car is parked for an extended period. The brakes will tend to “rub” as a result. The nature, extent and effects of corrosion depend on the amount of time the vehicle was parked, whether road salt or grit was spread and whether grease-dissolving agents were used in car washes.

If the braking comfort is noticeably impaired, we recommend having the brake system checked by experts at an authorized Porsche dealer.

## **Brake system function**

Your Porsche is equipped with a power assisted hydraulic dual circuit brake system with disc brakes at the front and rear. Both circuits function independently. One brake circuit operates the front left and rear right wheel and the other operates the front right and rear left wheel.

If one brake circuit has failed, the other will still operate. However, you will notice an increased pedal travel when you apply the brakes. Failure of one brake circuit will cause the stopping distance to increase.

#### **Warning!**

**Risk of an accident, resulting in serious personal injury or death.**  
**In the unlikely event of hydraulic failure of one brake circuit:**

- ▷ Push the brake pedal down firmly and hold it in that position. A mechanical linkage activates the second circuit, and you will be able to bring the vehicle to a stop.
- ▷ After bringing your vehicle to a complete stop, avoid driving the vehicle and instead have it towed to the nearest authorized Porsche dealer for repair.

## Brake system warning light

You can check the functionality of the brake system warning light by switching the ignition to the “On” position and verifying that the warning light illuminates.

**BRAKE**  **Brake warning light USA**

  **Brake warning light Canada**

The warning light in the instrument panel lights up. A message will be displayed on the multi-purpose display of the instrument panel if the brake fluid level is too low, or (if the brake pedal travel has increased) one of the two brake circuits has failed.

A greater braking pressure will be required, stopping distances will be longer and the braking behavior will change, particularly in curves.

With correctly adjusted brakes and a correctly working brake system, the pedal travel to the point of brake application should be 1-3/16 in. to 1-9/16 in. (30 to 40 mm). Whenever the brake pedal travel exceeds this value, have the brake system checked.

## Brake pedal



---

**Risk of an accident, resulting in serious personal injury or death.**  
**Any obstruction of the brake pedal could increase the stopping distance.**

- ▷ Always check the movement of the brake pedal before driving and make sure that it is not obstructed by a floor mat or any other object.
- ▷ Secure the floor mat to prevent it from sliding into positions that could interfere with the safe operation of your vehicle.  
Your Porsche dealer will be glad to offer you floor mats of the correct size including a securing possibility.

---

### Note

In case one of the two brake circuits fails, increased pedal travel is required to bring your vehicle to a full stop.



---

**To avoid overheating and premature wear of the brakes:**

- ▷ Before descending a steep grade, reduce speed and shift the transmission into a lower gear to control speed.
  - ▷ Do not “ride the brakes” by resting your foot on the pedal when not intending to apply brake pressure.
  - ▷ Do not hold the pedal down too long or too often. This could cause the brakes to get hot and not function properly.
-

## Brake booster

**The brake booster assists braking only when the engine is running.**

When the car is moving while the engine is not running, or if the brake booster is defective, more pressure on the brake pedal is required to bring the car to a stop.

Moisture, road salt or grit on brakes affects braking.

Brakes will dry after a few cautious brake applications.



**Warning!**

---

**Risk of an accident, resulting in serious personal injury or death.**

**Driving through water may reduce the traction. Moisture on brakes from road water, car wash, or a coating of road salt or grit may affect braking efficiency.**

- ▷ Cautiously apply brakes to test brakes after exposure to road water, etc.
- 

## Brake wear

Your car has excellent brakes, but they are still subject to wear. The rate at which they wear depends on how the brakes are used.

- ▷ Have the brake system inspected at the intervals recommended in your Maintenance Booklet.

### Brake system warning light

You can check the functionality of the brake system warning light by switching the ignition to the “On” position and verifying that the warning light illuminates.



### Brake wear warning message

A warning message will be displayed on the multi-purpose display of the instrument panel if the brake pads are worn, excessively.

- ▷ Do not continue to operate the vehicle. Have your authorized Porsche dealer inspect or replace the brake pads.
- ▷ Please see the chapter “OVERVIEW OF WARNING MESSAGES” on Page 149.

## Brake pads and brake discs

Wear on the brake pads and brake discs depends to a great extent on the driving style and the conditions of use and therefore cannot be expressed in actual miles on the road.

The high-performance brake system is designed for optimal braking effect at all speeds and temperatures.

Certain speeds, braking forces and ambient conditions (such as temperature and humidity) therefore might cause the brakes to squeal.

## New brake pads or linings

New brake pads have to be “broken in”, and therefore only attain optimal friction when the car has covered several hundred miles or km.

The slightly reduced braking ability must be compensated for by pressing the brake pedal harder. This also applies whenever the brake pads and brake discs are replaced.

### **Warning!**

---

- ▷ Do not obstruct the pedal travel with floor mats or other objects.

The brake booster is ready for operation only while the engine is running.

If the engine is switched off or there is a defect in the brake booster, much greater force has to be applied to the pedal when braking.

- ▷ Please see the chapter “TOWING” on Page 342.

In heavy rain, while driving through water or after leaving a car wash, the braking action may be delayed and increased pressure may be required.

- ▷ For this reason, keep further back from the vehicle in front and “dry” the brakes by applying them at intervals. Make sure that following traffic is not affected.

After a long drive over salted or sanded roads, a coating may form on the brake discs and pads that significantly reduces friction and thus braking action.

- ▷ Even though the brake discs consist of alloyed grey cast iron, they will unavoidably start to corrode if your car is parked for an extended period. The brakes will tend to “rub” as a result.

The nature, extent and effects of corrosion depend on the amount of time the vehicle was parked, whether road salt or grit was spread and whether grease-dissolving agents were used in car washes (not on vehicles with Porsche Ceramic Composite Brake).

To prevent corrosion of the brake discs, “brake them dry” before parking the car (not on vehicles with Porsche Ceramic Composite Brake).

If the braking comfort is noticeably impaired, we recommend having the brake system checked by experts at an authorized Porsche dealer.

- ▷ To relieve the braking system on downhill stretches, change down to a lower gear in enough time to obtain engine braking. If engine braking is insufficient on steep stretches, operate the footbrake at intervals. Continuous braking overheats the brakes and reduces the braking effect.
  - ▷ Please see the chapter “BRAKE-FLUID LEVEL” on Page 257.
-



**A** - SET (Store speed)

**1** - RESUME - Switch on/resume cruise control readiness (pull toward driver)

**2** - OFF - Interrupt (push away from driver)

**3** - + SPEED - Accelerate (raise clockwise)

**4** - - SPEED - Decelerate (lower counter-clockwise)

## Cruise Control

Cruise control maintains any selected speed between 20 and 150 mph (30 and 240 km/h) without you having to use the accelerator. The cruise control is operated with the operating lever on the steering wheel.

### Warning!

**Risk of accident while using cruise control in heavy traffic and consequent personal injury or death, on twisting roads or under unfavorable road conditions (e.g. wintry or wet conditions, varying road surfaces).**

- ▷ Do not use the cruise control under such conditions.
- ▷ Observe all local and national speed limits.

**Risk of an accident, personal injury and loss of control.**

- ▷ Do not reach through the steering-wheel spokes while driving.

### Switching cruise control readiness on

- ▷ Pull back the operating lever to position **1** until it clicks audibly into place.



#### Cruise control readiness

The green indicator light on the tachometer now indicates readiness.

### Maintaining and storing speed

- ▷ Bring the car to the desired speed with the accelerator.
- ▷ Press button **A**.  
The desired speed has now been stored.

### Accelerating (e.g. to overtake)

#### Option 1

- ▷ Increase the speed as usual with the accelerator.  
When you ease off the accelerator, the previously stored value is set again.

#### Option 2

- ▷ Push operating lever upwards into position **3** until the desired speed is reached.  
The speed reached is maintained and stored when the operating lever is released.

#### Option 3

- ▷ Push operating lever slightly upwards into position **3** (a maximum of 10 times).  
The speed is increased by 1 mph (2 km/h), each time the lever is pushed upwards.

#### Note on operation

Cruise control operation is automatically interrupted if the speed is increased by more than approx. 16 mph (25 km/h) for longer than 20 seconds.

## Decelerating

### Option 1

- ▷ Push operating lever down into position **4** until the desired speed is reached.  
The speed reached is maintained and stored when the operating lever is released.

### Option 2

- ▷ Push operating lever slightly downwards into position **4** (a maximum of 10 times).  
The speed is reduced by 1 mph (2 km/h), each time the lever is pushed downwards.

## Interrupting cruise control operation

The speed driven before the interruption remains stored in the memory and can be reactivated by operating the operating lever. Please see the chapter "RESUMING THE STORED SPEED" on Page 168.

- ▷ Push the operating lever forward to position **2** (it doesn't engage) **or**
- ▷ Operate brake or clutch pedal **or**, on vehicles with Tiptronic S, select position **N**.
- ▷ Please see the chapter "TIPTRONIC S" on Page 170.

### Cruise control operation is interrupted automatically:

- If the set vehicle speed is exceeded by more than approx. 16 mph (25 km/h) for longer than 20 seconds.
- If the actual vehicle speed falls by approx. 6 mph (10 km/h) below the set vehicle speed for longer than 5 seconds (e.g. upward slopes).
- If Porsche Stability Management (PSM) intervenes for longer than 0.2 seconds.
- If Low Range is switched on.

## Resuming the stored speed

- ▷ Pull back the operating lever to position **1**.

### Note on operation

The stored speed should only be recalled when traffic conditions and the road surface so permit.

### Switching cruise control readiness off

- ▷ Push forward the operating lever to position **2** until it clicks audibly into place.  
The memory is cleared and the green readiness light goes out.

When the vehicle is parked and the ignition switched off, the memory is cleared.

### Tip on driving

On upward or downward slopes, the set speed cannot always be maintained by cruise control.

- ▷ To obtain sufficient engine braking or a better engine-speed range, therefore, you have to change down to a lower gear.





## Manual transmission, clutch



### Warning!

**Risk of accident, resulting in serious personal injury or death.**

- ▷ Do not obstruct the pedal travel with floor mats or other objects.

### To avoid damage to the clutch and transmission:

- ▷ Always depress the clutch pedal fully when changing gears. Make sure that the gearshift lever is completely engaged.
- ▷ Only shift into reverse when the car has come to a complete stop

---

Floor mats of the correct size and with the appropriate fasteners are available from your authorized Porsche dealer.

The positions of the gears are shown on the shift diagram on the gearshift lever.

- ▷ When shifting gears, always ensure that the clutch pedal is fully depressed and the gear has fully engaged.
- ▷ Select reverse only when vehicle is stationary.
- ▷ Select an appropriately low gear on upward and downward slopes.  
This will ensure optimum use of engine power and engine braking.

When reverse gear is selected and the ignition is on, the reversing lights are lit.

### Permitted engine speed

- ▷ You should change into a higher gear before the needle reaches the red mark on the tachometer, or ease off the accelerator.

If the red zone is reached during acceleration, fuel feed is interrupted.



### Caution!

---

**Risk of engine damage (overrevving) when shifting down to a lower gear.**

- ▷ Take care not to exceed the maximum permitted engine speed when down-shifting.
-

## Tiptronic S

The Porsche Tiptronic is a six-speed transmission and features an “automatic” and a “manual” gear-shift mode.

In **automatic selection mode** (selector lever position **D**), gear changing is automatic. Depending on the driving program, you can change temporarily from automatic to manual mode using the rocker switches on the steering wheel.

In **manual selection mode** (selector lever position **M**), you change gear using the rocker switches on the steering wheel or by pushing the selector lever forward or back.

The functions of selector lever positions **D** and **M** differ in the on-road program, High Range, and in the off-road program, Low Range.

You can change between selector lever positions **D** and **M** as you wish while driving.

The currently selected gear is retained if you change from **D** to **M**.

If you change from **M** to **D**, the gear-changing map suitable for your current driving style is selected and the appropriate gear is selected.

### Note on operation

Take care not to operate the rocker switches on the steering wheel inadvertently, thereby triggering undesired gear changes.



### Changing the selector lever position

The selector lever is locked with the ignition key withdrawn.

The selector lever can be moved from position **P** or **N** only with:

- The ignition switched on
- The brake pedal pressed and
- The release button pressed (**arrow**).

### Release button

The release button (**arrow**) on the front side of the selector lever prevents unintentional gear changes.

The release button must be pressed when shifting to position **R** or **P**.

The selector lever cannot be operated in the event of an electrical fault.

- ▷ Please see the chapter “SELECTOR LEVER EMERGENCY RELEASE” on Page 175.

### Starting

The engine can be started only in selector lever position **P** or **N** with the brake pedal pressed.

### Moving off

- ▷ Select the desired position for moving off (**D**, **M** or **R**) only when the engine is idling and when depressing the brake pedal.
- ▷ Since the car creeps when in gear, do not release the brake until you want to move off.
- ▷ After selecting a gear, do not accelerate until you can feel that the gear is engaged.



Selector lever position

## Indicator for selector lever position and engaged gear

When the engine is running, the selector lever position and engaged gear are indicated.

## Selector Lever Positions

### P – Parking lock

In selector lever position **P**, the driven wheels are mechanically locked.

- ▷ Engage parking lock only when vehicle is stationary.
- ▷ Engage parking lock **after** applying the parking brake and release it **before** releasing the parking brake.
- ▷ Always apply the parking brake before leaving the vehicle.

The ignition key can be withdrawn only in selector lever position **P**.

### R – Reverse

- ▷ Select reverse only if car is stationary and the brake is applied.

### N – Neutral

Selector lever position **N** must be selected for towing or in car washes, for example.

- ▷ Select the desired position for moving off (**D**, **M** or **R**) only when the engine is idling and when depressing the brake pedal.

### D - Automatic selection mode (in the road driving program)

- ▷ Use selector lever position **D** for “normal” driving.  
The gears are shifted automatically according to the accelerator position and speed.

Depending on the way the vehicle is driven and on the resistance (e.g. uphill), the gear-changing points are shifted towards higher or lower engine-speed ranges. Movement of the accelerator, driving speed, longitudinal and lateral acceleration and the road profile all have an influence on the gear-changing characteristic.

When PSM is switched off, transmission gear changes are done at higher engine speeds.

Unwanted upward shifts, e.g. before corners, are prevented by swiftly releasing the accelerator pedal.

Depending on lateral acceleration, upward changes on corners are not made until the engine-speed limit is reached.

During braking, and depending on the amount of deceleration, the Tiptronic changes down earlier. For subsequent cornering, the right gear is engaged when pressure is applied to the brakes before the corner.

The corner is taken in the right gear, and when you accelerate out of the corner you do not have to change down.

### Shifting gear on the steering wheel

By shifting gear with the rocker switches on the steering wheel, you can temporarily change from automatic selection mode **D** to manual selection mode **M**.

Advantages:

- Shifting down before corners and on entering congested areas, on downward slopes (engine braking) or for brief spurts of acceleration.
- Selecting 1st or 2nd gear for moving off.

The manual selection mode remains engaged:

- For cornering (depending on the lateral acceleration) and passing,
- When the vehicle is stationary (e.g. at a junction).

The system leaves manual selection mode:

- automatically after around 8 seconds (unless car is cornering, passing or stationary),
- if you depress the accelerator to kickdown.

### Temporary change-down

Precondition:

- Speed is higher than approx. 33 mph (54 km/h).
- ▷ Depress accelerator quickly. The Tiptronic changes temporarily to the sportiest gear-changing map, i.e. to the highest possible gear-changing points. Correspondingly, the transmission shifts down immediately by one, two or three gears.

### Ending the function

- ▷ Release the accelerator markedly (by approx. 25%).

### Kickdown

The kickdown function is active in selector lever position **D**.

- ▷ For optimum acceleration, e.g. when overtaking, depress the accelerator pedal beyond the full-throttle point (kickdown).

The transmission shifts down depending on the speed of travel and engine speed. Upward shifts occur at the highest possible engine speeds.

These gear-changing speeds remain active until the accelerator is released to approx. 80% of the full-throttle position.

### D - Automatic selection mode (in the off-road driving program)

- ▷ Use selector lever position **D** for “normal” driving. The gears are shifted automatically according to the accelerator position and speed.

The gear-changing points have been adjusted to achieve the best possible vehicle control on difficult terrain.

Depending on the route profile, the gear-changing points are shifted towards higher or lower engine-speed ranges. On steep downhill stretches, upward shifts are prevented until medium engine speeds are reached (at least 2,500 rpm).

When the car is passing, an automatic upshift does not occur when the engine speed limit is reached.

### Shifting gear on the steering wheel

By shifting gear with the rocker switches on the steering wheel, you can temporarily change from automatic selection mode **D** to manual selection mode **M**.

Advantages:

- Shifting down on downward slopes (engine braking) or for brief spurts of acceleration.
- Selecting 1st/2nd or 3rd gear for moving off.

The manual selection mode remains engaged:

- For passing
- Depending on lateral acceleration
- When the vehicle is stationary (e.g. at a junction).

The system leaves manual selection mode:

- Automatically after around 8 seconds (unless car is subject to high lateral acceleration, is passing or stationary),
- if you depress the accelerator to kickdown.

### Kickdown

The kickdown function is active in selector lever position **D**.

- ▷ For optimum acceleration, e.g. when overtaking, depress the accelerator pedal beyond the full-throttle point (kickdown).

The transmission shifts down depending on the speed of travel and engine speed. Upward shifts occur at the highest possible engine speeds.

These gear-changing speeds remain active until the accelerator is released to approx. 80% of the full-throttle position.

### Tip on driving

Unlike in the on-road driving program, an automatic upshift is **not** performed in manual selection mode **M** when the engine-speed limit is reached.



### M - Manual selection mode (in the on-road driving program)



**The kickdown function is not active in manual selection mode “M”.**

**The kickdown function cannot be used to downshift in manual selection mode “M”.**

- ▷ Therefore shift down manually when accelerating (e.g. to overtake).

### Shifting up

- ▷ Press upper part (+) of a rocker switch **A** or
- ▷ Push selector lever **B** forward in the M gate.

### Shifting down

- ▷ Press lower part (–) of a rocker switch **A** or
- ▷ Push selector lever **B** back in the M gate.

Depending on driving speed and engine speed, you can shift up or down at any time. Gear changes which would exceed the upper or lower engine-speed limit are not executed by the control unit.

You can change down two gears by quickly pressing rocker switches **A** or selector lever **B** twice.

If PSM is active and the engine-speed limit is reached, an automatic upward shift is performed or, just before idling speed is reached, a downward shift is performed.

- ▷ Select an appropriately low gear on upward and downward slopes. This will ensure optimum use of engine power and engine braking.

If manual mode fails, the control electronics switch to automatic mode. In this event, the instrument panel will display selector lever position **D**.

- ▷ To remedy the fault, please consult an authorized Porsche dealer.

## M - Manual selection mode (in the off-road driving program)



### Warning!

The kickdown function is not active in manual selection mode "M".

The kickdown function cannot be used to downshift in manual selection mode "M".

- ▷ Therefore shift down manually when accelerating (e.g. to overtake).

### Tip on driving

The kickdown function is **not** active in selector lever position **M**.

Unlike in the road driving program, an automatic upshift is **not** performed when the engine-speed limit is reached.

### Shifting up

- ▷ Press upper part (+) of a rocker switch **A** or
- ▷ Push selector lever **B** forward in the M gate.

### Shifting down

- ▷ Press lower part (-) of a rocker switch **A** or
- ▷ Push selector lever **B** back in the M gate.

Depending on driving speed and engine speed, you can shift up or down at any time. Gear changes which would exceed the upper or lower engine-speed limit are not executed by the control unit.

You can change down two gears by quickly pressing rocker switches **A** or selector lever **B** twice.

The gear is changed down automatically just before idle speed is reached.

- ▷ Select an appropriately low gear on upward and downward slopes.  
This will ensure optimum use of engine power and engine braking.

If manual mode fails, the control electronics switch to automatic mode. In this event, the instrument panel will display selector lever position **D**.

- ▷ To remedy the fault, please consult an authorized Porsche dealer.

## Stopping

- ▷ For a brief stop (e.g. at a traffic light), leave the selector lever in drive position and hold the vehicle with the brake pedal.
- ▷ Do not hold the car on a slope using the accelerator. Use the brake pedal or the parking brake instead.
- ▷ Before leaving the vehicle, always apply the handbrake and move the selector lever to position **P**.

### Tip on driving

In selector lever positions **D** and **M**, the hillholder function makes it easier to move off from a standstill on an upward slope when the engine is running. The driver does not have to apply the brake.

- ▷ Please see the chapter "HILLHOLDER - MOVING-OFF ASSISTANT ON VEHICLES WITH TIPTRONIC S" on Page 187.

## Parking

- ▷ Go easy on the accelerator.
- ▷ When parking or maneuvering in a small space, control the speed by careful use of the foot-brake.

## Driving in winter

In wintry road conditions it is advisable to take steep inclines in manual mode **M**. This prevents the occurrence of gear changes that could cause wheelspin.

## Limp-home mode

### If there is a fault in the transmission:

- An **X** appears instead of the current gear indicator on the multi-purpose display of the instrument panel.  
The transmission no longer shifts.
- ▷ To remedy the fault, immediately consult an authorized Porsche dealer.

### Warning!

---

**Reverse gear lock monitoring is disabled in the emergency running program.  
Damage to the vehicle may result as well as loss of control, if the vehicle is moving forward fast enough to cause rear wheel lockup.**

- ▷ Do not shift into **R** while the vehicle is moving forward.
- 

### Tip on driving

3rd or 5th gear in selector position **D** and reverse gear **R** are now available and will allow you to reach the nearest authorized Porsche dealer.

- ▷ Please go to your authorized Porsche dealer as soon as possible.



### Selector lever emergency release

In the event of an electrical fault, the selector lever lock in position **P** can be manually released (for towing the vehicle, for example).

1. Fold up armrest.
2. Remove key **B** from the lower storage tray (underneath the rubber mat) in the center console.



3. Undo screws **A** with key **B**.
4. Remove trim mounting **F**.
5. Lift trim **C** at rear and carefully pull it off.

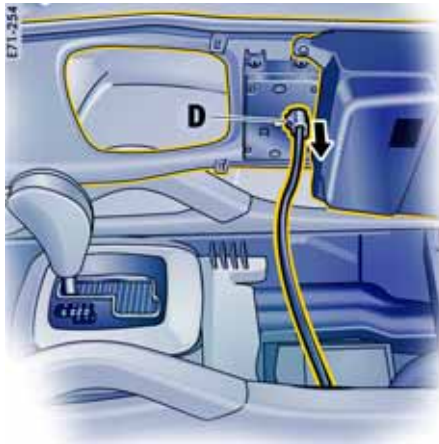

6. Unplug plug connection **D**.



7. Press foam aside.
8. Press locking lever **E** aside (to the left) using a suitable object.
9. Move selector lever to position **N**.
10. Reassemble in reverse order.

**! Danger!**

**Risk of loss of control, resulting in serious personal injury or death.**

- ▷ Ensure that the parking brake of the vehicle is set and that vehicle does not move on its own.





## Driving Programs for On-Road and Off-Road Driving

Two different driving programs with special power-transmission and running-gear control systems (such as ABS, off-road ABS and PSM, etc.) are provided in your Porsche for realising the best possible driving dynamics combined with maximum safety.

- Low Range off-road driving program (with reduction)
- High Range on-road driving program (without reduction)

When the driving program is active, the power transmission and running-gear control systems are automatically adapted to the requirements for off-road or on-road driving.

### Selecting driving program

The particular driving program can be selected using the rocker switch **A**.

The rocker switch **A** is located in the center console of the vehicle. It features a multi-step function and can be operated in both directions.

### Note on operation

The number of differential locks that can be engaged in Low Range depends on the equipment of your vehicle.

### Prerequisites for manual settings

#### Vehicles with manual transmission

- ▷ Stop the vehicle.
- ▷ Apply the brake.
- ▷ Put the gearshift lever in neutral.

### Caution!

**Risk of engine damage (overrevving). In the Low Range program, the gear-shifting points are shifted towards lower engine-speed ranges.**

- ▷ Shift early to prevent overrevving the engine.

### Vehicles with Tiptronic S

- ▷ When selecting the off-road driving program: Reduce speed to below 9.3 mph (15 km/h) or stop vehicle.
- ▷ When selecting the on-road driving program: Reduce speed to below 19 mph (30 km/h) or stop vehicle.
- ▷ Move Tiptronic selector lever to position **N**.

### Danger!

**Risk of accident, resulting in serious personal injury or death due to uncontrolled vehicle movement. The Tiptronic selector lever is blocked during the shifting procedure. Shifting when driving uphill can cause the vehicle to stand still or even roll backwards, if the shifting procedure has not yet been completed. When driving downhill, the vehicle can accelerate unintentionally while shifting.**

- ▷ Increased brake readiness is required.



### Selecting off-road driving program

- ▶ Push rocker switch forward . The vehicle becomes one step more suitable for off-road driving.

### Selecting on-road driving program

- ▶ Pull rocker switch to the rear . The vehicle becomes one step more suitable for on-road driving.

Once the driving program has been selected, the rocker switch springs back to home position.

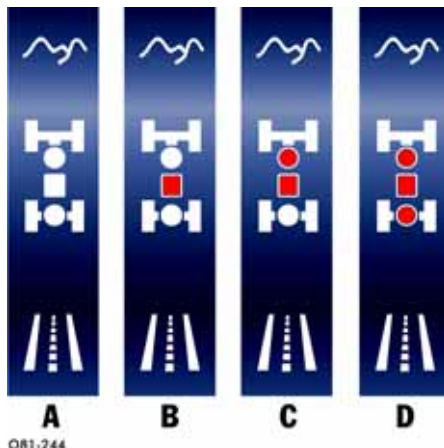

081-244

- A** - High Range on-road driving program (without reduction)
- B** - Low Range off-road driving program (with reduction)
- C** - Center differential lock in Low Range is fully engaged
- D** - Rear differential lock in Low Range is fully engaged

### Display of the selected driving program

The selected driving program is displayed by light-emitting diodes next to the rocker switch (**illustration**).

The corresponding indicator lights on the instrument panel and light-emitting diodes beside the rocker switch **flash several times** during the shifting process.

### Tip on driving center differential lock

When the center differential lock **C** is fully engaged, there is no longer any speed difference between the front and rear axles. If, for example, both wheels at the front axle lose traction on an icy road or soft surface, the rigidly linked drive wheels will permit the car to continue moving nevertheless.

### Tip on driving rear-differential lock

When the rear differential lock **D** is fully engaged, there is no longer any speed difference between the two rear wheels. If, for example, one drive wheel at the rear axle loses traction on an icy road or soft surface, the rigidly linked drive wheels will permit the car to continue moving nevertheless.

### Note on operation

The rear differential lock can be engaged only while the engine is running.

## Note on operation

If the Low Range indicator light next to the rocker switch flashes rapidly **after the ignition is switched on**, there is a fault in the shifting system.

- ▷ Have the vehicle checked immediately.  
Please consult an authorized Porsche dealer.

## Low Range indicator light

If the Low Range indicator light next to the rocker switch flashes when you attempt to operate rocker switch, then at least one condition for shifting has not been met:

### Vehicles with manual transmission

- Vehicle is not stationary.
- Brake is not pressed.
- Gearshift lever is not in neutral.

### Vehicles with Tiptronic S

- Vehicle has exceeded or gone below the limit speed.
- Tiptronic selector lever is not in position **N**.



## Sport Mode

### Function

The sports exhaust system is switched on and a sportier car set-up is obtained when Sport mode is switched on.

Interventions by the Porsche control systems are intentionally shifted towards greater agility and driving performance.

- PASM (Porsche Active Suspension Management) is automatically changed to Sport mode, resulting in a stiffer suspension setup.

- PDCC (Porsche Dynamic Chassis Control) is automatically set to Sport mode, and this further reduces the roll tendency of the vehicle.
- The air suspension automatically changes to the low level setting.
- The Tiptronic S transmission changes to a sportier shift strategy. The gear-changing points are shifted to higher speed ranges. Upward shifts are initiated later, and deceleration shifts are performed earlier. The vehicle moves off in 1st gear.
- The electronic accelerator pedal reacts sooner, and the engine is more responsive to throttle inputs.
- Sporty engine tuning is activated.
- ▷ For further information:  
Please see the chapter “PORSCHE ACTIVE SUSPENSION MANAGEMENT (PASM)” on Page 193.
- ▷ Please see the chapter “PORSCHE DYNAMIC CHASSIS CONTROL (PDCC)” on Page 194.

## Switching Sport mode on and off

Sport mode can be activated when the ignition is switched on and when the on-road driving program High Range (without reduction) is selected.

- ▷ Press SPORT button **E** in the center console. When Sport mode is switched on, the light-emitting diode **F** in the SPORT button is lit.

When Sport mode is switched on, the logo SPORT appears on the multi-purpose display.

After the ignition is switched off, Sport mode is automatically reset to Normal mode.

## Warning messages

A warning appears on the multi-purpose display of the instrument panel in the event of a fault.

- ▷ For information on warning messages on the multi-purpose display: Please see the chapter “OVERVIEW OF WARNING MESSAGES” on Page 149.

## Vehicles with air suspension

If you wish to use the characteristics of Sport mode and the sports exhaust system, but would like a more comfortable running-gear setup, you can:

- switch PASM and PDCC separately to Normal or Comfort mode and/or
- raise the ride height of the vehicle.

- ▷ Press the corresponding PASM button in the center console. The light-emitting diode in the button of the selected running-gear setup lights up.

In addition, the selected running-gear setup is shown on the multi-purpose display of the instrument panel for approx. 12 seconds.

Please see the chapter “PORSCHE ACTIVE SUSPENSION MANAGEMENT (PASM)” on Page 193.

Please see the chapter “PORSCHE DYNAMIC CHASSIS CONTROL (PDCC)” on Page 194.

Press the rocker switch in the center console forward. The corresponding light-emitting diode next to the rocker switch lights up continuously after the adjustment process. The level change is also indicated on the multi-purpose display of the instrument panel.

Please see the chapter “AIR SUSPENSION WITH LEVEL CONTROL AND HEIGHT ADJUSTMENT” on Page 190.

## Power-Transmission and Running-Gear Control Systems

A complex interconnection of all control systems acting in power transmission and in the running gear has been realized in your Porsche. All control systems have been linked with the aim of combining the best possible driving performance with maximum safety. The following systems are involved:

<b>System/designation</b>	<b>Scope</b>
<b>PTM</b> Porsche Traction Management	<ul style="list-style-type: none"><li>– Full-time all-wheel drive</li><li>– Electronically controlled center differential lock</li><li>– Automatic brake differential (ABD)</li><li>– Traction control system (TCS)</li><li>– Reduction gear/Low Range</li></ul>
<b>PTM Plus</b> Porsche Traction Management	In addition to the PTM features, PTM Plus also includes: <ul style="list-style-type: none"><li>– Electronically controlled rear differential lock</li></ul>
<b>PSM</b> Porsche Stability Management	<ul style="list-style-type: none"><li>– Stability management system</li><li>– Anti-lock brake system (ABS)</li><li>– Brake system prefilling</li><li>– Brake booster</li><li>– Traction control system (TCS)</li><li>– Automatic brake differential (ABD)</li><li>– Engine drag torque control (MSR)</li></ul>
<b>Air suspension</b> with level control and height adjustment	<ul style="list-style-type: none"><li>– Fully load bearing air spring struts with integral shock absorbers</li><li>– Air supply system with pressure accumulator</li></ul>
<b>PASM</b> Porsche Active Suspension Management	<ul style="list-style-type: none"><li>– Shock absorber system with adaptive, continuous shock absorber control</li></ul>
<b>PDCC</b> Porsche Dynamic Chassis Control	<ul style="list-style-type: none"><li>– Active chassis control system to stabilize roll tendency of vehicle body when driving</li></ul>

## **Warning!**

---

In spite of the advantages of PTM or four-wheel drive, it is still the driver's responsibility to adapt her/his driving style and maneuvers in line with road and weather conditions, as well as the traffic situation.

The increased safety that is provided should not induce you to take greater risks with your safety. The limits set by the physics of driving cannot be overcome, even with PTM or four-wheel drive.

Risks of accident due to inappropriate speed cannot be reduced by PTM.

---

## **Porsche Traction Management (PTM)**

Porsche Traction Management is a full-time all-wheel control system designed to influence the longitudinal and lateral dynamics. It is closely linked with the Porsche Stability Management (PSM) system:

PTM ensures the best possible power distribution to the four driven wheels at the front and rear axles. The system realizes this optimal traction by intervening in the lock control function of the transfer case and rear differential. PTM is active at all times and, unlike the PSM, cannot be switched off.

## **Advantages of PTM**

- Obvious improvement in traction, driving stability and steering ability of the car.
- Vehicle is more manageable when driven at its performance limits.
- Improved straight-ahead tracking and stability.
- The aforementioned features allow for a sportier setup of the running gear.
- The TCS and ABD provide even better traction for all wheels.

## **Full-time all-wheel drive**

With the four-wheel drive, the drive power is variably distributed to the front and rear wheels. Power distribution and wheel speed compensation between the front and rear axles is realized with a transfer box.

Distribution of the drive power depends on the wheel speed difference between the two axles. The transfer box always controls power distribution in such a way that optimal propulsion is achieved, even on an unfavorable road surface.

Full-time four-wheel drive ensures optimal handling and greater stability.

## **Automatic brake differential (ABD)**

The ABD system controls the front and rear axles separately. If one wheel of an axle starts to spin, it is braked so that the other wheel on the same axle can be driven.

The ABD recognizes different driving states, and it features control strategies adapted to these states. In situations in which little propulsive power is required, such as when the car moves off on a level gravel surface, traction control already becomes active at low engine speeds. If great propulsive power is required, e.g. when moving off on an uphill slope or for rapid acceleration, the ABD is adapted accordingly.

A special off-road program is used in Low Range mode.

## **Traction control system (TCS)**

The traction control system prevents the wheels from spinning by adjusting the engine power, thereby ensuring good lane-holding ability and a stable driving behavior.

## Porsche Stability Management (PSM)

PSM is an active control system for stabilization of the vehicle during extreme driving maneuvers. It operates together with the Porsche Traction Management (PTM) system.

PSM makes use of both the ABD and TCS systems, as well as the known functions of the anti-lock brake system (ABS) and engine drag torque control system (MSR).

### **Warning!**

---

In spite of the advantages of PSM, it is still the driver's responsibility to adapt her/his driving style and maneuvers in line with road and weather conditions, as well as the traffic situation.

The increased safety that is provided should not induce you to take greater risks with your safety. The limits set by the physics of driving cannot be overcome, even with PSM.

Risks of accident due to inappropriate speed cannot be reduced by PSM.

---

## Advantages of PSM

- Best possible traction and lane-holding ability in all driving situations – even on road surfaces with varying friction.
- The system compensates for undesired vehicle reactions (load-alteration effect) when the driver releases the accelerator pedal or brakes on bends. This compensation functions up to the maximum lateral acceleration.
- PSM actively stabilizes the vehicle as required during dynamic driving maneuvers (e.g. rapid steering movements, during lane changes or on alternating bends).
- Improved braking stability on corners and on different or varying road surfaces.
- Improved brake functioning and reduced stopping distance in the event of emergency braking.

## Readiness for operation

PSM is switched on automatically every time you start the engine.

## Function

Sensors at the wheels, brakes, steering system and engine continuously measure:

- Driving speed
- Direction of travel (steering angle)
- Lateral acceleration
- Longitudinal acceleration
- Rate of turn about the vertical axis

PSM uses these values to determine the direction of travel desired by the driver.

PSM intervenes and corrects the course if the actual direction of motion deviates from the desired course (steering-wheel position): It brakes individual wheels as needed. If necessary, PSM additionally influences the engine power or the gear-changing characteristic of the Tiptronic in order to stabilize the vehicle.

The events below inform the driver of PSM control operations and warn him to adapt her/his driving style to the road conditions:

- The multi-functional information light in the instrument panel lights up.
- Light in the PSM Off button flashes.
- Hydraulic noises can be heard.
- The vehicle decelerates and steering-wheel forces are altered as the PSM controls the brakes.
- Reduced engine power.
- The brake pedal pulsates and its position is changed during braking.  
In order to achieve full vehicle deceleration, foot pressure must be increased after beginning of the brake pedal pulsing.

### Examples of PSM control operations

- If the front wheels of the vehicle drift on a corner, engine power is reduced and the rear wheel on the inside of the corner is braked if necessary.
- If the rear of the vehicle swings out on a corner, the front wheel on the outside of the corner is braked.

- Brake system prefilling:  
The brake system is prepared for possible subsequent emergency braking if the accelerator pedal is released suddenly and quickly. The brake system is prefilled and the brake pads are already applied gently to the brake discs.
- Brake booster:  
In the event of an emergency braking operation where the pedal force is insufficient, a brake booster provides the braking pressure necessary for maximum deceleration at all 4 wheels.

### Combined use of PSM and PTM/PTM Plus

In order to ensure optimal stabilization of the vehicle, the center differential lock (PTM) and possibly the rear differential lock (PTM Plus) are also opened when PSM interventions occur.

### Tip on driving

When PSM is switched off, wheel-specific brake interventions and the traction control system (TCS) are also inactive. The automatic brake differential (ABD) remains on.

### Off-road PSM (PSM in Low Range program)

When Low Range is active, an off-road PSM specially matched to off-road driving is activated to enhance traction.

In order to improve driveability on difficult terrain, the response of the off-road PSM is less sensitive in the low speed range when the vehicle is operated in the Low Range off-road driving program.

If the brakes are highly stressed, the automatic brake differential (ABD) switches itself off to protect the brakes. It remains deactivated until the brake system has cooled sufficiently.

### Engine drag torque control

In conditions of excessive slip, the engine drag torque control system prevents all driven wheels from locking up when the car is passing. This is also the case for downshifts on a slippery road.





**During braking**, the vehicle is stabilized even when PSM is switched off.

**One-sided spinning** of the wheels is prevented, even with PSM switched off.

**PSM should always be switched on during “normal” driving.**

However, it can be of advantage to switch off PSM temporarily in exceptional situations:

- On a loose surface or in deep snow
- When “rocking the vehicle free”
- When using snow chains.

**Vehicles with Tiptronic:** When the PSM is switched off the slip monitoring function is also deactivated.



## Multifunctional PSM light

- The multifunctional light on the instrument panel lights up for a lamp check when the ignition is switched on.
  - The light indicates a control operation, including when PSM is switched off (brake control in the event of one-sided wheel spin).
  - In conjunction with the multi-purpose display on the instrument panel, the light indicates that PSM is switched off.
  - Faults are displayed by the light in conjunction with the multi-purpose display of the instrument panel. PSM is out of order.
- ▷ Consult your authorized Porsche dealer.

## Switching off PSM

- ▷ Press PSM OFF button **A**.  
PSM is switched off after a short delay.  
The light-emitting diode in the button is lit up.  
When the PSM is switched off, the multifunctional PSM light on the instrument panel is lit **and** a message appears in the multi-purpose display of the instrument panel.

## Collapsible spare wheel

- ▷ Never switch the PSM off when driving with a collapsible spare wheel.

## Towing

- ▷ For information on towing:  
Please see the chapter "TOWING" on Page 342.

## Tip on driving

When PSM is switched off, wheel-specific brake interventions and the traction control system (TCS) are also inactive.  
The automatic brake differential (ABD) remains on.

## Switching PSM back on

- ▷ Press PSM OFF button **A**.  
PSM is switched on after a short delay.  
The light-emitting diode in the button and the multi-functional PSM light on the instrument panel go out. A message is shown on the multi-purpose display of the instrument panel.

## ABS (Anti-lock Brake System)



In spite of the advantages of ABS, it is still the driver's responsibility to adapt her/his driving style and maneuvers in line with road and weather conditions, as well as the traffic situation.

The increased safety that is provided should not induce you to take greater risks with your safety. The limits set by the physics of driving cannot be overcome, even with ABS.  
Risks of accident due to inappropriate speed cannot be reduced by ABS.

### ABS ensures:

- **Full steering control**  
The vehicle remains steerable
- **Good driving stability**  
No skidding due to locked wheels
- **Optimum braking distance**  
Shorter stopping distances in most cases
- **Lock prevention**  
No flat spots on the tires

## Function

The decisive advantage of ABS is in the driving stability and maneuverability of the vehicle in hazardous situations.

ABS prevents locking of the wheels during full braking, on almost all road surfaces, until shortly before the vehicle stops.

The ABS begins to control the braking process as soon as a wheel shows a tendency to lock. This controlled braking process is comparable to extremely rapid cadence braking.  
The pulsating brake pedal and a "rattling noise" warn the driver to adapt her/his driving speed to the road conditions.

- ▷ If full braking should be necessary, press the brake pedal all the way down throughout the entire braking procedure, regardless of the pulsating pedal. Do not ease up on pressure applied to the pedal.

## Warning light

If the ABS warning lights light up in the instrument panel and on the multi-purpose display of the instrument panel while the engine is running, the ABS has switched off because of a fault.

In this event, the braking system will operate **without lock prevention**, as in cars without ABS.

- ▷ Adapt your driving style to the changed braking behavior.
- ▷ The ABS must be checked immediately at an authorized Porsche dealer. This is necessary in order to prevent the occurrence of further faults whose effects cannot be defined.

The ABS control unit is adjusted for the approved tire dimensions.

The use of tires with non-approved dimensions can lead to different wheel speeds, causing the ABS to switch off.

## Off-road ABS (ABS in Low Range program)

When Low Range is active, an ABS specially matched to off-road driving is activated automatically.

In the event of braking on loose ground, the permissible slip values for ABS braking are increased so that the off-road braking distance is reduced (wheels dig into the surface).

If the driver needs to steer, this off-road driving program is automatically switched off to maintain steerability.

## Hillholder - moving-off assistant on vehicles with Tiptronic S

In Tiptronic selector lever positions **D** and **M**, the hillholder function makes it easier to move off from a standstill on an upward slope when the engine is running. The driver does not have to apply the brake.

The hillholder thus makes moving off on slopes easier.



**Risk of accident, resulting in serious personal injury or death.**  
**The vehicle can roll backwards if the Hillholder is switched off.**

- ▷ Always apply the footbrake on slopes.

## Hillholder is not active:

- In Tiptronic selector lever positions **N** and **R**
- In the limp-home mode **and**
- If not all of the wheels are touching the ground (on difficult terrain, for example).



In spite of the advantages of the hillholder function, it is still the driver's responsibility to adapt her/his driving style and maneuvers in line with situational conditions.

The increased safety that is provided should not induce you to take greater risks with your safety. The limits set by the physics of driving cannot be overcome, even with the hillholder function.

Driving at the limits should be avoided, e.g., on icy slopes or on slippery surfaces. In this and similar cases, the support of the hillholder function is not guaranteed.

## **Porsche Drive-Off Assistant – Moving-off assistant on vehicles with manual transmission**

The Porsche Drive-Off Assistant enables the driver to move off on upward slopes. The vehicle must have sufficient road contact to use this feature.

The Porsche Drive-Off Assistant is available for slopes starting at approximately 5%.

- ▷ Please see the chapter “TRAILER COUPLING” on Page 230.



**Risk of accident, resulting in serious personal injury or death.**

**When moving off on a slippery surface (e.g., on icy or loose surfaces), assistance by the Porsche Drive-Off Assistant is no longer assured. In this case, the vehicle could slip. The limits set by the physics of driving cannot be overcome, even with the Porsche Drive-Off Assistant. The responsibility for moving off on upward slopes is still the driver's, despite the Porsche Drive-Off Assistant.**

- ▷ Always adjust your driving style to the driving conditions and vehicle load, use the footbrake if necessary.

## **Moving off with Porsche Drive-Off Assistant**

1. Hold the vehicle securely with footbrake or parking brake on the slope.  
The engine must be running.
2. Fully depress the clutch pedal.
3. Engage one of the gears used to ascend in the direction of travel (1st gear or reverse).
4. While keeping the clutch pedal depressed, release the footbrake or foot-operated parking brake.  
The vehicle is held on the slope.
5. Move off as usual.

## **Note on operation**

The Porsche Drive-Off Assistant ceases to function:

- By shifting to neutral.
- When changing gears.
- If the engine is not running.



**Risk of accident, resulting in serious personal injury or death.**

**If the Porsche Drive-Off Assistant ceases to function, the vehicle will no longer be held on a slope.**

- ▷ Hold the vehicle with the footbrake.

## Engine Braking Support (Assistance when heading downhill)

The Porsche Down-Hill Assistant is an assistance system which helps the driver at slower downhill driving up to approx. 12 mph (20 km/h), e.g., on steep slopes or on wintry mountain roads.

As long as the gas pedal is not used when traveling downhill, the Porsche Down-Hill Assistant is active and brakes the vehicle.

If road grip is lost on one or more wheels, the system brakes the wheels which have good road contact.

The braking ability of the Engine Braking Support is affected by slippery surfaces (e.g., on icy or loose surfaces), like all brakes.



---

**Risk of accident, resulting in serious personal injury or death. Reduced braking ability on a slippery surface.**

- ▷ Always adjust your driving style to the driving situation.
- 

### Conditions:

- The gas pedal must not be used when travelling downhill.
- The speed must not exceed 12 mph (20 km/h).

- **Vehicles with Tiptronic S:**  
The Tiptronic selector lever position **D**, **M** or **R** must be engaged.
- **Vehicles with manual transmission:**  
The reverse gear or any other gear (1. - 6. ) must be engaged. The clutch pedal must not be used when travelling downhill.

### Tip on driving

The Porsche Down-Hill Assistant is active when driving downhill either forwards or backwards.

## Checks on test stands

### Brake tests

Brake tests must be carried out only in High Range and on plate-type test stands or roller test stands.

The following limit values must not be exceeded on roller test stands:

- Testing speed 4.7 mph (7.5 km/h)
- Test duration 20 seconds

### Parking brake test

Parking brake tests on the brake tester must be performed only with the ignition switched off and the Tiptronic selector lever in position **N** or the gearshift lever in neutral.

## Balancing wheels on the vehicle

During finish balancing of the wheels, the entire vehicle must be lifted and the wheels must be free to turn.

## Dynamometer testing procedure

Some U.S. states and Canadian provinces conduct emissions inspection/maintenance testing involving the use of two-wheel dynamometer. A two-wheeled dynamometer is a treadmill type device upon which a single axle of the car, the driving axle of the vehicle, rotates to simulate vehicle operation on the road while the vehicle remains stationary.

Your Porsche Cayenne has a full-time four-wheel drive system which cannot be disabled. Severe damage to the powertrain can result if tested on a two-wheel dynamometer.



---

**To avoid severe powertrain damage and a possible unexpected movement of the vehicle.**

- ▷ Your Porsche Cayenne vehicle must never be tested on a two-wheel dynamometer.
  - ▷ Advise the emission station of this warning before testing the vehicle.
-



## Air Suspension with Level Control and Height Adjustment

On vehicles with air suspension, the driver can set five different level steps manually. The preselected level is automatically adjusted to suit the vehicle speed. The height of the car is automatically kept constant when the vehicle is loaded.

### Tip on driving

It is not permissible to drive on public roads with the car in the terrain or special terrain setting.

### Note on operation

Frequent level changes can cause the compressor to overheat. In this case, the compressor must cool for several minutes before level adjustment is fully functional again.

### Normal level

The ground clearance at normal level is around 8.5 in. (215 mm) (Cayenne, Cayenne S, Cayenne S Transsylvia) or 7.68 in. (195 mm) (Cayenne GTS).

### Terrain level

This setting is intended for off-road driving, field paths and forest paths, etc.

The vehicle is raised by around 1 in. (26 mm) compared to normal level.

Terrain level can be selected only manually at speeds below around 50 mph (80 km/h). The car is automatically lowered to normal level at speeds exceeding around 50 mph (80 km/h). The car is automatically raised to terrain level when Low Range is activated.

### Special terrain level

This setting is intended only for extremely challenging terrain requiring maximum ground clearance. The vehicle is raised by around 2.2 in. (56 mm) compared to normal level.

The warning light  in the instrument panel comes up when the special terrain level has been reached.

Special terrain level can be selected only at speeds below around 19 mph (30 km/h).

The car is automatically lowered to terrain level at speeds exceeding approx. 19 mph (30 km/h).

### Low level

This level is intended for high-speed driving. Above speeds of around 78 mph (125 km/h), the car is automatically lowered by around 1 in. (24 mm) (Cayenne, Cayenne S, Cayenne S Transsylvia) or 0.4 in. (9 mm) (Cayenne GTS) compared to normal level.

When the speed drops to below around 25 mph (40 km/h), the car is automatically raised to normal level.

### Note

If low level was set manually with the rocker switch in the center console, low level also remains active at speeds below around 25 mph (40 km/h).

## Loading level



**Caution!**

### Risk of damage to running-gear parts, units and the vehicle underbody.

If the car is driven off a curb when at loading level, for example, insufficient ground clearance can cause it to bottom out.

- ▷ Always switch to normal level before moving off.

This setting makes it easier for you to load the luggage compartment.

The car is lowered by around 2.1 in. (54 mm) (Cayenne, Cayenne S, Cayenne S Transsiberia) or 1.3 in. (34 mm) (Cayenne GTS) compared to normal level.

The car is automatically raised to normal level at speeds exceeding around 3 mph (5 km/h).



### Setting level manually

#### Preconditions

- Ignition on.
- Doors are closed.

#### Note on operation

The level last selected is stored in the memory after the ignition is switched off.

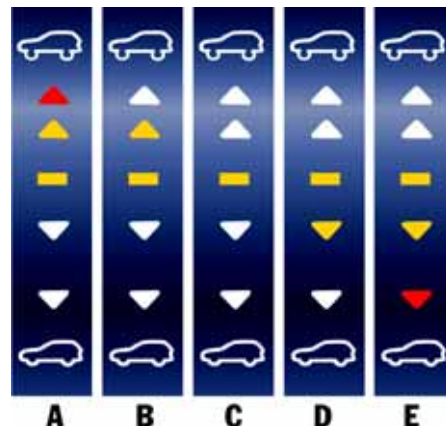

O81-245

**A** - Special terrain level

**B** - Terrain level

**C** - Normal level

**D** - Low level

**E** - Loading level

### Raising the vehicle

- ▷ Briefly press rocker switch forward . The car is raised one level.

### Lowering the vehicle

- ▷ Briefly pull rocker switch to the rear . The car is lowered one level.

### Indication of selected level

The selected level is displayed by light-emitting diodes beside the rocker switch (**illustration**).

The corresponding light-emitting diode beside the rocker switch flashes during the control process. The light-emitting diode is continuously lit after the control process.

The level change is also indicated on the multi-purpose display of the instrument panel.

### Exceptions

Automatic changes from normal level to low level and back are not indicated on the multi-purpose display of the instrument panel.

### Warning message

Various messages are indicated on the multi-purpose display of the instrument panel if there is a system fault or if the compressor switches off due to overload.

- ▷ For further information on warning messages on the multi-purpose display: Please see the chapter “OVERVIEW OF WARNING MESSAGES” on Page 149.
- ▷ Adapt your driving style to the changed conditions.
- ▷ Consult an authorized Porsche dealer in order to remedy a system fault.
- ▷ If the overload-protection function causes the compressor to switch off, wait for a time until it has cooled down. The system will function again as soon as it has cooled sufficiently.

The warning message appears when the control system is switched off and when the collapsible spare wheel is being filled. This does not indicate a fault.

The warning message will go out once these procedures have been completed.

### Raising vehicle with the jack

Whenever it is necessary to jack up the vehicle:

- ▷ Manually set normal level and then switch off level control.

### Switching off level control

1. Switch ignition on.
2. Push rocker switch forward for 5 to 10 seconds.  
A message is shown on the multi-purpose display of the instrument panel.  
The vehicle can now be raised.

### Switching level control back on

1. Switch ignition on.
2. Push rocker switch forward for 5 to 10 seconds **or**
3. Drive forward with the vehicle.  
Level control switches on automatically.

### Transporting the vehicles on car trains, ferries and car transporters

- ▷ Tie the vehicle down only at its wheels.



## Porsche Active Suspension Management (PASM)

Various messages are shown on the multi-purpose display of the instrument panel.

- ▷ For further information on warning messages on the multi-purpose display: Please see the chapter “OVERVIEW OF WARNING MESSAGES” on Page 149.

Three different running-gear setups can be selected with the push of a button:

- comfort
- normal
- sport

If the running-gear setups “comfort” or “normal” have been selected, the system automatically changes the setup to “sport” when the car is driven in a sporty manner.

## Indication of the selected running-gear setup

The light-emitting diode in the button of the selected running-gear setup is lit. In addition, the selected running-gear setup is indicated on the multi-purpose display of the instrument panel for around 12 seconds.

### Warning lights and warning messages

The warning light in the instrument panel comes on if there is a system fault. A warning message is shown on the multi-purpose display of the instrument panel.

- ▷ Adapt your driving style to the changed conditions.
- ▷ To remedy the fault, consult an authorized Porsche dealer.



## Selecting the running-gear setup

1. Switch ignition on.
2. Press the appropriate button.

### Note on operation

The running-gear setup selected last is stored in memory after the ignition is switched off.

## Porsche Dynamic Chassis Control (PDCC)

### Function

Porsche Dynamic Chassis Control (PDCC) is a system for roll stabilization of the vehicle body when driving. Driving comfort and driving safety are improved by active intervention of the anti-roll bars on the front and rear axles.

No separate controls are available for the PDCC system.

After selection of a running-gear setup in Porsche Active Suspension Management (PASM):

- comfort
- normal
- sport

PDCC automatically activates the corresponding on-road driving program.

- ▷ For information on selecting a running-gear setup:  
Please see the chapter “PORSCHE ACTIVE SUSPENSION MANAGEMENT (PASM)” on Page 193.

PDCC automatically activates the off-road driving program if Low Range reduction is switched on.

- ▷ For information on switching Low Range reduction on and off:  
Please see the chapter “DRIVING PROGRAMS FOR ON-ROAD AND OFF-ROAD DRIVING” on Page 177.

### Warning message

A warning message appears on the multi-purpose display of the instrument panel if there is a system fault.

- ▷ For further information on warning messages on the multi-purpose display:  
Please see the chapter “OVERVIEW OF WARNING MESSAGES” on Page 149.
- ▷ Adapt your driving style to the changed conditions.
- ▷ Consult an authorized Porsche dealer in order to remedy the fault.

### Checking hydraulic fluid

Regular checking and changing of the hydraulic fluid takes place as part of servicing.

Further important information on “Maintenance” can be found in a separate chapter.

- ▷ Please see the chapter “CAR CARE INSTRUCTIONS” on Page 270.

## Off-Road Driving

Please read this chapter carefully before driving off road with your Porsche.

The information provided will familiarise you with the special advantages of your vehicle, allowing you to arrive at your destination safely every time.

We recommend practicing on less rugged terrain.

### Vehicles with SportDesign package



---

**Risk of damage. On vehicles with Sport-Design package, front, rear, and side member trim are painted. Off-road driving can seriously damage these trim parts.**

- ▷ When driving off-road, make sure these parts are not damaged.
  - ▷ Make sure there is sufficient clearance between obstacles and the underside of the vehicle.
  - ▷ Avoid driving through water.
  - ▷ Do not use side member trims or rear wheel spoilers as a running board.
- 

### Maintenance Note

Please bear in mind that off-road driving subjects all vehicle components to considerably more wear than normal use, making professional inspection and maintenance after each use a vital precondition for functioning and safety.

Grains of sand, dirt particles and other abrasive materials entering the brakes can cause excessive wear or unpredictable braking action.

### Rules for off-road driving

- ▷ Ensure vehicle is equipped with approved all-terrain tires.
- ▷ Pay attention to the ground clearance of the vehicle.  
Please see the chapter “GROUND CLEARANCE” on Page 357.
- ▷ Activate Low Range.  
Please see the chapter “SELECTING OFF-ROAD DRIVING PROGRAM” on Page 178.
- ▷ Stow or fasten luggage and loads securely.  
Please see the chapter “LOADING INFORMATION” on Page 231.
- ▷ If unknown terrain is obscured from view, examine it on foot first and traverse it with extreme caution.  
This way, obstacles are easier to recognize and damage to the vehicle is avoided.

- ▷ Always drive with the engine running.  
Power steering assistance is provided only with the engine running.
- ▷ Drive slowly and uniformly.
- ▷ Always make sure that the wheels touch the ground.
- ▷ Before driving through water, check the water depth, the condition of the surface beneath it and the speed of the water.
- ▷ Look out for obstacles such as boulders, holes, tree stumps or ruts.
- ▷ Always keep the sliding/lifting roof or Panorama roof system and the side windows closed while driving.
- ▷ Do not depart from marked routes or paths.
- ▷ Respect Nature.  
Always obey off-limits signs.

## Driving systems for off-road driving

Specially adapted driving programs or power-transmission and running-gear control systems are available for off-road driving:

- Off-road program Low Range
- Off-road PSM
- Off-road ABS
- Center differential lock
- Rear differential lock
- ▷ Please see the chapter “POWER-TRANSMISSION AND RUNNING-GEAR CONTROL SYSTEMS” on Page 181.

## Before driving off

### Tires

- ▷ Check tread depth and tire pressure.
- ▷ Check for damage and remove any foreign objects (e.g. stones) from the tread.
- ▷ Replace missing valve caps.

### Rims

- ▷ Replace dented or damaged rims before driving off road.

## Vehicles with SportDesign package



---

**Risk of damage. On vehicles with Sport-Design package, front, rear, and side member trim are painted. Off-road driving can seriously damage these trim parts.**

- ▷ When driving off-road, make sure these parts are not damaged.
  - ▷ Make sure there is sufficient clearance between obstacles and the underside of the vehicle.
  - ▷ Avoid driving through water.
  - ▷ Do not use side member trims or rear wheel spoilers as a running board.
- 

## After driving off road

Off-road driving places a greater burden on the vehicle than does normal driving on roads.

We recommend inspecting the vehicle after off-road driving. Potential damage poses an accident risk and impairs driving comfort. Damage on the car is recognized in good time if the car is checked.



---

**Car damage poses an accident risk for the vehicle occupants and other road users.**

- ▷ In cases of doubt, have your vehicle checked by your authorized Porsche dealer.
  - ▷ Examine tires for signs of damage such as cuts, tears, bulges or foreign objects stuck in the tread.  
Replace a damaged tire if necessary.
  - ▷ Have any damage to your vehicle repaired by an authorized Porsche dealer without delay.
-

## Recommended procedure

- ▷ Deactivate the Low Range off-road driving program.
- ▷ Clean headlights and tail lights and check them for signs of damage.
- ▷ Clean the front and rear license plates.
- ▷ Clean the tire tread with a jet of water and remove any foreign objects.
- ▷ Clean wheels, wheel housings and the underbody with a jet of water.
- ▷ Check whether the car has picked up plant parts or branches.  
These materials increase the risk of fire and can damage fuel lines, brake hoses, boots of the axle joints and drive shafts.
- ▷ After off-road driving, always check the entire floor assembly, tires, body structure, steering system, running gear and exhaust system for signs of damage.

- ▷ After driving for an extended period through mud, sand, water or substances with a similar soiling effect, check the brake discs, brake pads, wheels and axle joints and have them cleaned.
- ▷ If you experience severe vibrations after driving off road, check the wheels for foreign substances.  
These substances can produce an imbalance which might be responsible for the vibrations. Removing these deposits may remedy the problem.

## Uphill driving



---

### **Danger of serious personal injury or death and risk of damage if the vehicle should overturn.**

- ▷ Do not turn around when driving uphill.
  - ▷ If it is not possible to climb a gradient, the car must be backed down in reverse gear.
  - ▷ Do not drive over embankments or slopes at steep diagonal angles.
  - ▷ If the vehicle starts to tilt, immediately steer in the direction of the tilt (line of slope).
  - ▷ When driving uphill, never let the vehicle roll backward when in idle or not in gear.  
Exclusive use of the footbrake is too risky in such situations.
-

### Note on operation

- ▷ Activate the Low Range program before taking extreme upward or downward gradients.

### Tips on driving

- ▷ Do not perform manual gear changes when driving, and try to avoid stopping.
- ▷ Avoid high engine speeds (max. 2,500 rpm).

### Traction on uphill slopes

#### Note on operation

- ▷ Activate the Low Range program and engage differential locks if necessary.

#### Tips on driving

- ▷ When driving uphill, go easy on the accelerator and make sure that wheels have sufficient traction (don't spin).
- ▷ Avoid high engine speeds (max. 2,500 rpm).
- ▷ Drive slowly.

### Driving downhill



---

**There is a danger of serious personal injury or death and risk of damage if the vehicle should overturn.**

- ▷ Do not drive over embankments or slopes at steep diagonal angles.
  - ▷ Drive downhill slowly, with the wheels pointing straight ahead.
  - ▷ If the vehicle starts to tilt, immediately steer in the direction of the tilt (line of slope).
  - ▷ When driving downhill, never let the vehicle roll when in idle.
  - ▷ Use engine braking effect. If the engine braking effect is not adequate, gently apply the foot brake.
- 

### Note on operation

- ▷ Activate the Low Range off-road driving program. The off-road ABS is switched on automatically.

### Tips on driving

- ▷ Do not perform manual gear changes when driving, and try to avoid stopping.
- ▷ Avoid high engine speeds (max. 2,500 rpm).

A special circuit in the off-road ABS permits controlled brief lock-up of the front wheels so that they can dig into the loose surface more effectively. Locked wheels slip and can no longer be steered.

- ▷ When driving down steep hills on unpaved surfaces, brake carefully so that vehicle does not start to slide.

## Obstacles

- ▷ Pay attention to the ground clearance of the car.  
Please see the chapter “GROUND CLEARANCE” on Page 357.

## Note on operation

- ▷ Activate the Low Range program and engage differential locks if necessary.

## Tips on driving

- ▷ Just before reaching the obstacle, ease off the accelerator slightly and use the car's momentum to cross the obstacle. This will prevent the car from jumping over the obstacle and landing on the following downward slope at an excessive speed.
- ▷ Avoid high engine speeds (max. 2,500 rpm).



## Water crossing

- ▷ Pay attention to the ground clearance of the car.  
Please see the chapter “GROUND CLEARANCE” on Page 357.

## ! Danger!

**Danger of drowning if water enters the vehicle. Risk of damage to the engine and accessories if water penetrates.**

- ▷ Before driving through water, check the water depth **A**, water speed and the condition of the surface beneath it.

### **Cayenne, Cayenne S, Cayenne S Transsiberia:**

The water must not be deeper than 19.7 in. (50 cm).

The water must not be deeper than 21.9 in. (55.5 cm) for vehicles with level control and height adjustment.

### **Cayenne GTS:**

The water must not be deeper than 18.7 in. (47.6 cm).

The water must not be deeper than 21.1 in. (53.5 cm) for vehicles with level control and height adjustment.

- ▷ Check the door sills and rubber seals before starting to drive.
- ▷ Do not drive through deep or rapidly flowing water.  
Deep or rapidly flowing water, e.g. mountain streams, can cause the car to deviate from the desired path.
- ▷ Avoid a "bow wave" by driving at an appropriate speed.
- ▷ Never open the doors when driving through water.

### **Soiling can impair the braking action.**

- ▷ Check and clean the brakes if they have been soiled.

### **Danger of steering assistance failing during a long journey in the water if the drive belt slips.**

- ▷ If the steering assistance fails, more effort will be required to steer.

### **Danger of damaging electrical systems**

- ▷ Avoid driving through salt water.
- 

### **Notes on operation**

- ▷ Activate the Low Range program.
- ▷ Switch the air conditioner off.
- ▷ Switch the headlights off.

### **Tips on driving**

- ▷ Avoid high engine speeds (max. 2,500 rpm).
- ▷ Do not perform manual gear changes when driving, and try to avoid stopping. Moving off in the water can be difficult due to the high resistance and the loose surface involved.
- ▷ Start the water crossing at a shallow place at walking speed.
- ▷ After checking the body of water, take the shortest path through it.
- ▷ Never drive into the water at high speed. The resulting “bow wave” could damage the engine and its accessories.
- ▷ Adjust your driving style to the unfamiliar surroundings.
- ▷ Cross the body of water slowly and at a constant speed.
- ▷ Never turn around when crossing a body of water.
- ▷ If it is not possible to cross the body of water, the car must be backed out of it in reverse gear.

The servo pump and alternator can fail if the car is driven through water for an extended period.

- ▷ If the servo pump fails, substantially more force will have to be exerted in order to steer.

### **Maintenance Note**

The car requires a special check after the water crossing.

- ▷ Remove mud from the tire tread.
- ▷ Briefly apply the brakes in order to dry them after driving through the water.



## Crossing obstacles



**Caution!**

**Risk of damage to the underbody and chassis components if obstacles are traversed improperly.**

- ▷ Always bear in mind the ground clearance of your vehicle.
- ▷ Slowly drive over the middle of tree trunks, boulders or other obstacles with one of the front wheels.
- ▷ Cross the obstacle with the rear wheel in the same way.

### Note on operation

- ▷ Activate Low Range and engage differential locks if necessary.



### Tips on driving

- ▷ Have your passenger direct you if necessary.
- ▷ Avoid high engine speeds (max. 2,500 rpm).
- ▷ Drive slowly.

## Driving on sand

### Note on operation

- ▷ Activate Low Range and engage differential locks if necessary.

### Tips on driving

Loose sand is an especially tricky surface for off-road driving.

You can often become stuck in sand within minutes if you do not drive correctly in such situations.

- ▷ Drive at brisk pace and do not stop under any circumstances. This will reduce the chance of the car becoming bogged down.
- ▷ Follow existing tracks – provided that they have not been covered by blown sand, are not too deep and the car's ground clearance is sufficient.  
Pay attention to the ground clearance of the car.  
Please see the chapter "GROUND CLEARANCE" on Page 357.
- ▷ Avoid high engine speeds (max. 2,500 rpm).

When driving on slopes with soft sand on vehicles with Tiptronic S:

- ▷ Use the manual select mode **M** in addition to the Low Range program.

If your vehicle becomes stuck nevertheless:

- ▷ Do not spin the wheels. Instead, use branches, mats or similar items to provide adequate traction so that you can drive out of the critical area.

## Track ruts

Other vehicles leave ruts in many off-road courses or gravel roads.

- ▷ Pay attention to the ground clearance of the car.  
Please see the chapter “GROUND CLEARANCE” on Page 357.



---

### **Risk of damage to the vehicle floor when driving through ruts that are too deep.**

- ▷ Always bear in mind the car's ground clearance.
  - ▷ Do not drive over ruts that are too deep.
- 

### **Note on operation**

- ▷ Activate the Low Range program and engage differential locks if necessary.

### **Tips on driving**

- ▷ In cases of doubt, drive with one wheel on the strip of grass between the ruts.
- ▷ Avoid high engine speeds (max. 2,500 rpm).
- ▷ Drive slowly.

# Luggage Compartment, Loadspace and Storage

Folding rear seats forward and returning to upright position .....	204
Loadspace .....	207
Cargo management system .....	208
Luggage Compartment Cover .....	211
Luggage safety net .....	212
Ski Bag .....	214
Roof Transport System.....	216
Off-road roof-mounted Headlights	
Cayenne S Transsylvberia .....	217
Car Audio Operation/Tips.....	218
Porsche Communication Management (PCM) .....	220
iPod, USB and AUX.....	221
Storage .....	222
Cupholder.....	226
Ashtray.....	227
Cigarette Lighter .....	228

081-232

## Folding rear seats forward

If the luggage safety net is installed, first set up the left seat cushion in a vertical position and fold the left rear seat backrest forward.

**On vehicles with automatically controlled four-zone air conditioning:**



### Safety button

- ▷ Press the safety button in the driver's door armrest before folding the rear seats forward. The rear control panel for the air conditioning ceases to function. This prevents unintentional adjustment of the air conditioning. The symbol in the switch lights up.

1. Move front seats forward.
2. Remove the headrests of the backrest to be folded forward. Please see the chapter "REMOVING HEADRESTS" on Page 35.
3. Pull seat cushion up at loop **A**.



## Folding rear seats forward and returning to upright position

The rear seats are divided and can be folded forward individually to make the loadspace bigger.



**Caution!**

**Risk of damage to seat cushions, backrest, and seat belt if only the backrest is folded forward.**

- ▷ Always fold seat cushions and backrest forward.

073-232



4. Raise seat cushion vertically.



5. Pull release lever **A** and fold the backrest forward.



*Rear seat assembly for comfort seats*

6. Vehicles with comfort seats:  
Insert support bracket of the backrest into the support hook on the seat cushion (**arrow**).

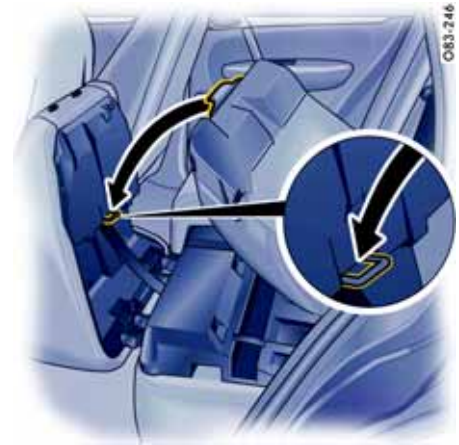

*Rear seat assembly for sport seats*

6. Vehicles with sport seats:  
Insert support bracket of the backrest into the lug on the seat cushion (**arrow**).

**! Caution!**

**Risk of damage to the seat cover if the support bracket of the backrest does not latch into the lug on the seat cushion.**

- ▷ Insert support bracket into the lug.



7. Insert headrest into the receiver in the seat cushion.

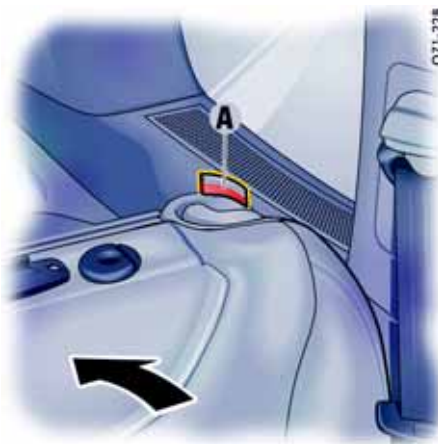

### Positioning rear seats

1. Remove the headrests from the seat cushion.
2. Make sure that the safety belts are not trapped. Raise the backrest until it locks with an audible click. The red "verification flag" **A** must be lowered completely.



### Warning!

**Danger of injury and/or damage as a result of braking or in the event of an accident.**

- ▷ Do not place any objects between the seat cushion and foam part.
- 
3. Fold seat cushion back and press down at the rear. Make sure that the buckles are accessible.
  4. Insert the headrests into the backrest. Please see the chapter "INSTALLING HEADRESTS" on Page 35.

071-068



## Loadspace

The maximum permissible load on the loadspace floor is 400 kg or 880 lbs. The weight must be distributed evenly over the entire loadspace.

- ▷ Please see the chapter "LOADING INFORMATION" on Page 231.

### Opening loadspace floor

1. Pull handle **A** and lift the loadspace floor.

071-069



2. Unclip prop **B** and insert it into receiver **C** in the loadspace floor.

### Note

On vehicles with 19 inch collapsible spare wheel, the prop **B** is omitted.

### Closing loadspace floor

1. Lift the loadspace floor slightly and clip prop **B** into its holder in the vehicle floor.
2. Close the loadspace floor.

071-071



### Tie-down rings

You can secure the load in the luggage compartment against slipping. Tie-down straps or the luggage net can be fastened to tie-down rings **D**.

- ▷ Make sure that all rings are equally loaded when securing a load.

### Note on operation

The tie-down rings are not designed to restrain a heavy load in an accident.

## Cargo management system

The cargo management system is a variable system for securing objects in the luggage compartment.

It is comprised of two telescopic rails integrated in the loadspace, a telescopic bar, four tie-down rings as well as a strap reel and a reversible mat. The reversible mat is provided with an anti-slip structure on the underside.

- ▷ For information on stowing loads and luggage: Please see the chapter "LOADING INFORMATION" on Page 231.



### Inserting and adjusting the telescopic bar

1. Insert the two end elements of the telescopic bar in the openings **A** of the mounting rails.
2. Press the end elements down and push against the load. When the bar is correctly positioned, the load should no longer be able to move.
3. Release the end elements.
4. Check that the elements are locked in position by pushing against them.

### Inserting and adjusting the strap reel

The strap reel is stored in the supplied bag together with the tie-down rings in the luggage compartment or in the spare-wheel well.

1. Take the strap reel out of the bag.
2. Press the button **B** on the end element of the strap reel and pull both elements out to the width of the two mounting rails.





3. Insert the two end elements of the strap reel in the openings **A** of the mounting rails.
4. Press both end elements down and push against the load.
5. Release the end elements.
6. Check that the elements are locked in position by pushing against them.
7. Press button **B** and tension the strap so that the load cannot move.
8. Release button **B**.



### Inserting strap reel on one rail

1. Press button **B** on the end element and pull both elements apart slightly.



2. Insert one end element of the strap reel in the opening **A** of a mounting rail, press down and slide into position.
3. Insert the second element in the same opening **A**, press down and slide in the opposite direction.
4. Check that the elements are locked in position by pushing against them.
5. Press button **B** and place the strap around the item of luggage. Tighten the belt so that the item of luggage cannot move.
6. Release button **B**.

## Inserting and adjusting tie-down rings

Tie-down straps or the luggage net can be fastened to the tie-down rings.

Make sure that all rings are equally loaded when securing a load.

The tie-down rings are not designed to restrain loads in serious accidents.

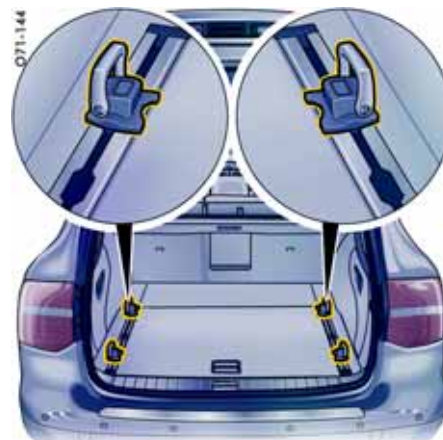

1. Insert the tie-down ring in the opening **A** of the mounting rail.
2. Press button **C** down and slide the tie-down ring in the corresponding direction.
3. Release button **C**.
4. Check that the tie-down ring is locked in position by pushing it.

5. Insert the remaining tie-down rings.

### Note on operation

The opposing tie-down rings must always be inserted in the opposite direction.

## Luggage Compartment Cover

Items in the luggage compartment may be hidden from view by using the luggage compartment cover.

- ▷ Always pull out the luggage compartment cover when transporting objects in the luggage compartment. The luggage compartment cover is not designed to support objects.
- ▷ Do not hang bags or objects on the support brackets **A**. The support brackets could break off.
- ▷ Please see the chapter “LOADING INFORMATION” on Page 231.

### Warning!

**Danger of injury. During braking, direction changes or in an accident, objects can slide into the passenger compartment and endanger the occupants.**

- ▷ Do not place objects on top of the luggage compartment cover.



### Pulling out luggage compartment cover

- ▷ Pull out the cover by the handle and insert it into the guides on the left and right side walls of the luggage compartment.

### Retracting luggage compartment cover

- ▷ Disengage the luggage compartment cover from the guides on the side walls and carefully guide it back into the retractor roller.

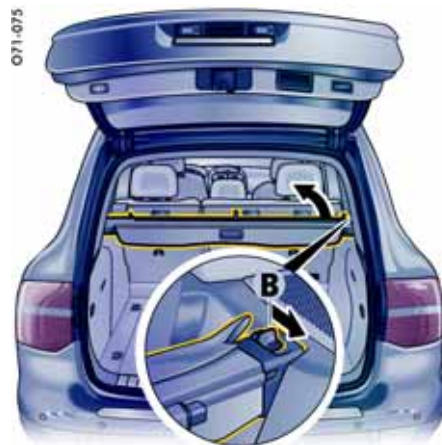

### Remove luggage compartment cover

- ▷ Pull the release **B** back.
- ▷ Lift the cover at the right and remove.



### Installing luggage compartment cover

- ▷ Insert the cover into the receiver on the left side.
- ▷ Press the cover down into the receiver on the right side until it can be heard and felt to engage.  
Release **B** must point forwards.

### Luggage safety net

The luggage safety net can hold back only light-weight items in the event of braking, changes in direction or in an accident.

- ▷ For information on stowing loads and luggage: Please see the chapter "STOWING LOAD IN THE VEHICLE" on Page 233.

#### **Warning!**

**Danger of injury. During braking, direction changes or in an accident, an unsecured load can slip and endanger the occupants.**

- ▷ Always secure the passenger compartment with the luggage safety net.
- ▷ Always fasten the load at the tie-down rings.
- ▷ The load must never project over the top edge of the seat backrest.
- ▷ If the safety net was heavily stressed or damaged during braking or an accident, etc., have the luggage safety net and its bracket checked by an authorized Porsche dealer.



### Maintenance Note

- ▷ If the luggage safety net was heavily stressed or damaged during braking or in an accident etc., have the safety net and its retaining bracket checked by an authorized Porsche dealer.

### Permitted uses

#### A – Variant 1



## Securing passenger compartment with luggage safety net

### Pulling out luggage safety net

- ▷ Pull the luggage safety net out and engage the fastening hooks on the left and right side into the fixing rings on the ceiling. The luggage safety net fastening hooks can be pulled out at the sides.
- ▷ Make sure that the luggage safety net fastening hooks are properly engaged in the fixing rings.

### B – Variant 2

In the case of variant 2, it is necessary to first fold forward the rear seats and open the covers of the luggage safety net fixing points.

For information on folding the rear seats forward:

- ▷ Please see the chapter “FOLDING REAR SEATS FORWARD” on Page 204.



### Removing luggage safety net assembly from the rear seat backrest

1. Open both rear doors.
2. Fold down the left rear seat backrest first, followed by the right rear seat backrest. The seat cushions need not be folded over for this purpose.
- ▷ For information on folding the rear seats forward: Please see the chapter “FOLDING REAR SEATS FORWARD” on Page 204.
3. Push the luggage safety net assembly in the **direction of arrow 1**.
4. Lift the luggage safety net assembly up and off (**direction of arrow 2**).



## Ski Bag

Long objects such as skis can be transported in the passenger compartment, where they can be kept clean and protected against damage.

### Loading ski bag

1. Press release button **A** on the lid of the through-load facility.  
Open the lid downward

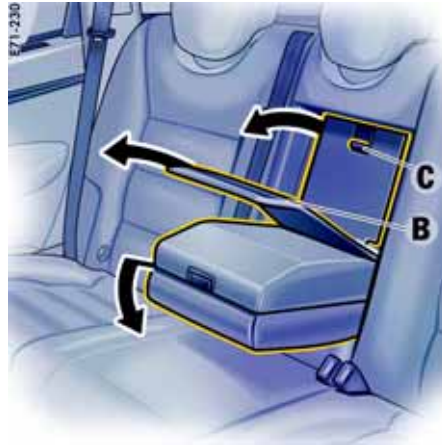

2. Fold down the armrest of the rear seat backrest.
3. Pull protective cover **B** off the Velcro strap at the top and lower it.
4. Press release button **C** on the lid of the through-load facility downwards and fold down the lid.



5. Pull out and unfold the ski bag.
6. Insert objects into the ski bag from the luggage compartment.



### Stowing ski bag

1. Empty ski bag.
2. Pull ski bag into the passenger compartment.
3. Close lid in the luggage compartment.
4. Carefully fold the ski bag and close the lid.
5. Put in the protective cover and secure it with the Velcro strap.

### Note on operation

- ▷ Fold up the ski bag only when it is dry.

### Securing load

- ▷ Secure the stowed objects with tightening belt **D**.
- ▷ Insert belt tongue into the buckle.

## Roof Transport System

- ▷ Please follow the separate instructions for fitting the Roof Transport System.
- ▷ Please see the chapter “LOADING INFORMATION” on Page 231.

Fitting normal commercially available luggage racks is **not** possible.

The **Porsche Roof Transport System** allows the transport of various sports and hobby equipment. Your authorized Porsche dealer will be pleased to tell you about the varied uses of the Roof Transport System.

### Safety Notes!

---

#### **Risk of an accident, loss of control and damage to the vehicle.**

- ▷ Completely remove the Roof Transport System before using an automatic car wash – risk of damage to the vehicle.
- ▷ Do not exceed the permissible roof load, the permissible gross weight and the permissible axle loads. Please see the chapter “WEIGHTS” on Page 356.
- ▷ Distribute load evenly, with heavy items as low as possible. Items of luggage must not project beyond the side of the load area.
- ▷ Fix and secure every item to the basic carrier with a rope or lashing strap (do not use elastic rubber tensioners).
- ▷ Before every trip, and at regular intervals during long trips, check that Roof Transport System and load are secure. Re-tighten if necessary and secure additionally by locking.

When the Roof Transport System is loaded, the maximum speed depends on the nature, size and weight of the load being carried.

- ▷ Adapt your driving style and speed to the changed conditions. Nevertheless, Porsche recommends that you do not exceed the posted speed limit.

Driving, braking and steering behavior change due to the higher center of gravity and the greater wind-resistant area. You should adapt your driving style appropriately.

- ▷ Since fuel consumption and noise are increased with the Roof Transport System fitted, it should not remain on the car if not in use.
-



## Off-road roof-mounted Headlights Cayenne S Transsyberia

- ▷ Please read the separate instructions for fitting and operating the off-road roof-mounted headlights.

### Disclaimer

The off-road roof-mounted headlights provided with your Cayenne S Transsyberia have been designed and manufactured solely for off-road use. The use of these lights while on a public road in your country may not be legal or may be legal only under specified conditions. Check your national, state/provincial and local laws or regulations regarding any restrictions and/or limitations for public highway use prior to installation. It is common in many countries, for example, that such roof-mounted headlights must be hooded or covered while you are on a public road.

Under no circumstances should the electrical circuits for these lights be connected to the circuits for the other lights provided with your vehicle.

### Safety Notes!

- ▷ Completely remove the off-road roof-mounted headlights before using an automatic car wash – risk of damage to the vehicle!
- ▷ Before every trip, and at regular intervals during long trips, check that the off-road roof-mounted headlights are secured to the vehicle properly.
- ▷ With the off-road roof-mounted headlights fitted, do not exceed a maximum speed of 110 mph (180 km/h). Nevertheless, Porsche recommends that you do not exceed the posted speed limit.
- ▷ Driving, braking and steering behaviour change due to the higher center of gravity and the greater wind-resistant area. You should adapt your driving style appropriately.
- ▷ Since fuel consumption and noise are increased when the off-road roof-mounted headlights are fitted, they should not remain on the vehicle when not in use.

### Note on operation

If the engine is not running and the off-road roof-mounted headlights are switched on, the vehicle battery will be discharged.



### Switching the off-road roof-mounted headlights on/off

The off-road roof-mounted headlights are ready for operation when the side lights are switched on.

- ▷ Switch the off-road roof-mounted headlights on and off using the button in the roof console.

## Car Audio Operation/Tips

**For radio operation see your radio manual which is included with your on-board literature.**

### FM reception

A vehicle is not an ideal place to listen to a radio. Because the vehicle moves, reception conditions are constantly changing.

Buildings, terrain, signal distance and noise from other vehicles are all working against good reception.

Some conditions affecting FM may appear to be problems when they are not.

The following characteristics are completely normal for a given reception area, and they do not indicate any problem with the radio itself.

### Note

Electronic accessories should only be installed by your authorized Porsche dealer. Equipment which has not been tested and approved by Porsche may impair radio reception.

### Fading and drifting

FM range is limited to about 25 miles (40 km), except for some high power stations.

If a vehicle is moving away from the desired station's transmitter, the signal will tend to fade and/or drift. This condition is more prevalent with FM than AM, and is often accompanied by distortion.

Fading and drifting can be minimized to a certain degree by careful attention to fine tuning or selection of a stronger signal.

### Static and fluttering

When the line-of-sight link between a transmitter and vehicle is blocked by large buildings or mountains, the radio sound may be accompanied with static or fluttering because of the characteristic of FM.

In a similar effect, a fluttering noise is sometimes heard when driving along a tree-lined road.

This static and fluttering can be reduced by adjusting the tone control for greater bass response until the disturbance has passed.

### Multipath

Because of the reflecting characteristics of FM, direct and reflected signals may reach the antenna at the same time (multipath) and cancel each other out.

As a vehicle moves through these electronic dead spots, the listener may hear a momentary flutter or loss of reception.

### Station swapping

When two FM stations are close to each other, and an electronic dead spot, such as static or multipath area, interrupts the original signal, sometimes the stronger second signal will be selected automatically until the original one returns.

This swapping can also occur as you drive away from the selected station and approach another station of a stronger signal.



## Compact disc player

### Caution!

#### To avoid damage to compact disc player and discs.

- ▷ Use only compact discs labeled as shown, having no dirt, damage or warpage.
- ▷ Never attempt to disassemble or oil any part of the player unit. Do not insert any object other than a disc into the slot. Remember there are no user-serviceable parts inside the compact disc player.
- ▷ Do not allow the disc to sustain any fingerprints, scrapes or stickers on the surfaces. This may cause poor sound quality. Hold the disc only on the edge or center hole.
- ▷ When not in use, take the disc out of the player, put the disc back into its case and store it away from dust, heat, damp and direct sunlight. Leaving the disc on the dashboard in the sun can damage the disc.

- ▷ If the disc gets dirty, clean the disc by wiping the surfaces from the center to the outside in a radial direction with a soft cloth. Do not use a conventional record cleaner or anti-static record preservative. Disc cleaners are available in audio stores.

- ▷ Keep both hands on the steering wheel - use hands-free operation (if available) - pull off the road and park before using a hand-held telephone.

---

### **It is essential to observe the telephone manufacturer's instructions before operating the telephone.**

Any portable telephone or radio transmitter which is used in a Porsche must be properly installed in accordance with the technical requirements of Porsche.

#### **The transmission power must not exceed 10 W.**

The devices must possess a type approval for your vehicle and have an **"e" symbol**.

If you should require equipment with transmission power values greater than 10 W, please consult your authorized Porsche dealer for this purpose. He is familiar with the technical requirements for installing devices of this kind.

The antennas for all radios and telephones with a transmitting antenna must be externally mounted.

The improper installation of radios or telephones or use of a radio or telephone with a transmitting antenna inside the car may cause **the warning lights to come on**.

Improper installation of such equipment can create a discharged battery or excessive current draw from added equipment.

## Car Telephone and Aftermarket Alarms

### **Important legal and safety information regarding the use of cellular telephones**

Some states may prohibit the use of cellular telephones while driving a vehicle. Check the laws and regulations on the use of cellular telephones in the areas where you drive.

### Danger!

#### **Risk of an accident.**

**Severe personal injury or death can result in the event of an accident.**

**Looking away from the road or turning your attention away from your driving can cause an accident and lead to serious personal injury or death.**

When using your cellular telephone, you should always:

- ▷ Give full attention to your driving - pull off the road and park before making or answering a call if traffic conditions so require; and

If aftermarket systems are installed by non-dealer-ship technicians or outside the selling dealer, problems may result. Installation of aftermarket equipment is not covered under the New Car Warranty.

- ▷ Consult your authorized Porsche dealer about the installation of non Porsche approved equipment.

### Reception quality

The reception quality of your car telephone will change constantly when you are driving. Interference caused by buildings, landscape and weather is unavoidable. It may become particularly difficult to hear when using the hands-free function due to external noise such as engine and wind noise.

### Automatic car-wash

- ▷ Unscrew external antennas before using an automatic car-wash.

## Porsche Communication Management (PCM)



**There is danger of accident if you set or operate the on-board computer, radio, navigation system, telephone or other equipment when driving.**

**This could distract you from traffic and cause you to lose control of the vehicle resulting in serious personal injury or death.**

- ▷ Operate the components while driving only if the traffic situation allows you to do so safely.
  - ▷ Carry out any complicated operating or setting procedures only with the vehicle stationary.
  - ▷ If it is necessary to operate these components while the vehicle is in motion, use the function keys on the multi-functional steering wheel.
- 
- ▷ Refer to the separate operating instructions before putting the PCM into operation.

When put into operation for the first time, a distance of approx. 3 miles (5 km) must be driven in order for the navigation system to complete the process of fine calibration. The same applies when the tires are changed (e.g. summer/winter tires) or new tires fitted. Full location accuracy is not yet achieved during the fine-calibration process.

If the vehicle has been transported (e.g. ferry, car train), the system may take a few minutes after being switched on before it determines the current location.

Serious tire slip (e.g. spinning wheels on snow) may result in temporarily inaccurate navigation.

When the battery has been disconnected, it may take up to 15 minutes before the navigation system is operational once more.

### Satellite radio

You must have the satellite radio activated before you can put it into operation. You will need a contract with a provider in order to use this radio.

- ▷ Refer to the separate radio operating instructions before putting into operation.



## iPod, USB and AUX

The iPod, USB and AUX interfaces are located in the storage box between the front seats.

### Note

Do not leave your iPod, USB storage device or an external audio source in the vehicle for extended periods of time because extreme ambient conditions (temperature fluctuations, humidity) can occur in the vehicle.

## iPod

Use the supplied connecting cable to connect one of the iPod models listed:

- iPod 4th generation,
  - iPod 5th generation,
  - iPod nano,
  - iPod nano 2nd generation,
  - iPod mini,
  - iPod photo or
  - more modern iPod models (the operation of more modern iPods cannot be guaranteed on PCM).
- ▷ Please refer to the section “iPod” in the separate PCM operating instructions.

## USB

You can connect a USB storage device to the USB interface.

You can

- play audio data (supported formats: MP3, WMA and AAC-LC),
  - download data from the Sport display and
  - download data from the PCM logbook.
- ▷ Please refer to the section “USB” in the separate PCM operating instructions.

### Note

The LED display of a standard USB storage device is turned away from the driver when connected to the USB interface.

## AUX External audio source

You can connect an external audio source to the AUX interface. This external audio source is then operated on the audio source rather than on the PCM or radio system.

- ▷ Please refer to the section “External audio source” in the separate PCM or radio operating instructions.

## Storage



### Warning!

**Unsecured luggage and heavy objects may come loose during braking, rapid directional changes or in an accident and cause serious personal injury or death.**

- ▷ Do not carry items of luggage or objects in the passenger compartment unsecured.
- ▷ Do not transport any heavy objects in open storage trays.
- ▷ Always keep the storage trays closed while driving.
- ▷ Always protect the passenger compartment with a safety net and a luggage compartment cover.

### Note on operation

An unsecured or incorrectly positioned load can slip out of place or endanger the vehicle occupants during braking, direction changes or in accidents:

- ▷ Please see the chapter "LOADING INFORMATION" on Page 231.

## Storage options

- In the glasses case in the roof console
- In the glove compartment, pen holder
- In the front and rear armrests
- In the drawer underneath the passenger's seat
- In the storage compartments at the sides of the luggage compartment
- In the door trim panel
- In the center console, front and rear
- On the back of the front seats
- Coat hook on the rear grab handles
- Under the load compartment floor
- In the front and rear cupholders



### Glasses case in the roof console

Sunglasses (for example) can be stored in this storage compartment.

#### Opening

- ▷ Press button (**arrow**).

#### Closing

- ▷ Close the lid until it clicks audibly into place.



### Opening

- ▷ Press button **A** and open cover.

### Locking

- ▷ Always lock button **A** with the car key to secure the contents from unauthorized access.

## Glove compartment



### Warning!

**Risk of injury by the glove compartment lid in case of an accident.**

- ▷ Keep the glove compartment closed while driving.

A drawer, designed to hold the welcome kit, is located in the glove compartment.



**B** - Thumb wheel for cooling the glove compartment  
**C** - Holder for pens

### ○ Cooling the glove compartment

- ▷ Rotate thumb wheel **B** leftwards.
- **Switch cooling off**
- ▷ Rotate thumb wheel **B** rightwards.



### Storage trays in the armrest between the front seats

Two storage trays are located in the armrest.

#### Opening the top tray

- ▷ Press button **A** and lift the cover.

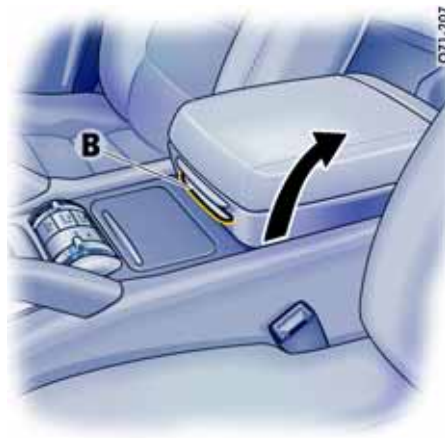

#### Opening the lower tray

- ▷ Press button **B** and lift top tray with the cover closed.



### Storage tray in the rear armrest

One storage tray is located in the armrest.

#### Opening the storage tray in the armrest

1. Fold down the armrest completely.
2. Press button **C** and lift the cover.





### Drawer underneath the right front seat

There is room for the fire extinguisher in the drawer underneath the right front seat.

#### Opening

- ▷ Lift the unlocking handle and pull out the drawer.

#### Closing

- ▷ Close the drawer until it clicks audibly into place.



### Side storage compartments in the luggage compartment

Depending on how the vehicle is equipped, there is an additional storage option in the left-hand storage compartment.

The intermediate base can be removed to increase the size of the drawer.

### Opening the storage compartment

- ▷ Pull off the cover on the handle recess.

### Closing the storage compartment

- ▷ First, insert the cover at the bottom and then close it until it clicks audibly into place.



**Caution!**

### Risk of damage.

- ▷ Because of the heat, the right-hand storage compartment cannot be used as such in vehicles that have air suspension with level control and height adjustment.

## Cupholder

You can place drinks cans and cups in the cupholder.

- ▷ Keep the cupholder closed while driving.

### **Warning!**

**Risk of accident, scalding or damage due to spilling drinks.**

- ▷ Only use cupholder when safe to do so it is.
- ▷ Only use containers which fit.
- ▷ Never put overfull containers in the cupholder.
- ▷ Never place hot drinks in the cupholder.



### **Opening front cupholder**

- ▷ Open shutter **A** (arrow).



### **Removing cupholder insert**

The cupholder insert can be removed for cleaning. Removing the insert makes an additional storage tray available.

- ▷ Open shutter **A**.
- ▷ Press together the cupholder insert at the two engagement recesses **B**.
- ▷ Remove the cupholder insert.



### Opening rear cupholder

- ▷ Press on the cover of the cupholder (arrow).

### Closing rear cupholder

- ▷ Close and engage the cupholder.



### Emptying

- ▷ Move unlocking button **A** to the right; the ashtray insert pops out.
- ▷ Once you have emptied the ashtray, replace the insert and push it down until it clicks audibly into place.

## Ashtray

### Ashtray, front



**Warning!**

#### **Danger of fire.**

- ▷ Never use ashtray for waste paper disposal, as it could pose a fire hazard.

### Opening

- ▷ Press ashtray lid briefly.



### Ashtray, rear

Depending on how the vehicle is equipped, an ashtray can be installed in the rear door panels.

#### Opening

- ▷ Press ashtray lid briefly.

#### Emptying

- ▷ Open ashtray cover and press carefully to the door trim panel.  
The insert is raised slightly.
- ▷ Remove and empty insert.

## Cigarette Lighter

### Warning!

**Danger of fire and burning. The cigarette lighter is ready for use, regardless of the ignition lock position.**

- ▷ Do not leave children in the car unattended.
- ▷ Never touch the heating element or sides of the lighter.
- ▷ Hold the lighter by the knob only.

The cigarette lighter is ready for use regardless of the ignition lock position.

### Lighter, front

- ▷ Press ashtray lid briefly. Ashtray opens independently.
- ▷ Press lighter into the receptacle. When the element is red hot the lighter jumps back to its initial position.



### Lighter, rear

- ▷ Press lighter into the receptacle (**arrow**). When the element is red hot the lighter jumps back to its initial position.

# Trailer Hitch

Trailer Coupling..... 230  
Loading Information..... 231



## Trailer Coupling

### **Warning!**

#### **Risk of accident.**

- ▷ Follow the operating instructions for the trailer recommended by the trailer manufacturer.
- ▷ Do not modify or repair the trailer coupling.
- ▷ Before having new ADAPTER fitted, find out from your authorized Porsche dealer about the current authorization status.
- ▷ Use only ADAPTER makes tested and approved by Porsche.

- ▷ Ensure that all trailer equipment conforms to the appropriate classification for total gross trailer weight and tongue weight.

- ▷ Please see the chapter “WEIGHTS” on Page 356.
- ▷ Please see the chapter “LOADING INFORMATION” on Page 231.

## Retrofitting

Have a trailer coupling retrofitted only by an authorized Porsche dealer. The dealer is familiar with the manufacturer’s specifications and any necessary conversion measures.

## Electrical connection

Your Porsche is equipped with a 7-pin connector **A** for the electrical connection to the trailer.

### **Warning!**

**Risk of accident. Failure to keep an electrical adapter clean may result in corrosion and affect operation of electrical lines, resulting in possible trailer brake system failure.**

- ▷ Periodically inspect and clean adapter as needed.

## Hitching trailer

- ▷ Always turn off the alarm system before you attach a trailer.
- ▷ Follow the operating instructions for the trailer recommended by the trailer manufacturer.
- ▷ Please see the chapter “WEIGHTS” on Page 356.

## Unhitching trailer

If the trailer is equipped with an overrun brake, do not unhitch the trailer when its brake is still applied.

## Loading Information

### Definitions

**The towing capacity** (gross weight of the trailer) is the sum of the trailer's empty weight and the weight of the load.

**The vertical coupling load** is the weight that the trailer drawbar exerts on the trailer coupling of the vehicle.

**The rear-axle load** is the vehicle weight on the rear axle plus the weight of the transported load and the vertical coupling load of the trailer.

**The gross weight of the vehicle and trailer** is the sum of the weight of the towing vehicle and the weight of the trailer.

**The Curb weight** - actual weight of your vehicle - vehicle weight including standard and optional equipment, fluids, emergency tools, and spare tire assembly. This weight does not include passengers and cargo.

**The Gross Vehicle Weight** is sum of the curb weight and the weight of passengers and cargo combined.

**The Gross Vehicle Weight Rating** is the maximum total weight of vehicle, passengers, luggage, hitch, trailer tongue load and optional equipment.

**The Gross Axle Weight Rating** is the maximum load limit for the front or the rear axle. This information is located on the safety compliance sticker located in the driver's side door jamb.

For determining the compatibility of the tire and vehicle load capabilities:

- ▷ Please see the chapter "TIRES, RIMS, TRACKS" on Page 350.

The load capacity coefficient (e.g. "106") is a minimum requirement. For more information:

- ▷ Please see the chapter "INSCRIPTION ON RADIAL TIRE" on Page 290.

**The Gross Combined Weight Rating** is the maximum total weight rating of vehicle, passengers, cargo and trailer.

**The Vehicle Capacity Weight** - Load Limit - is the maximum total weight limit specified of the load (passengers and cargo) for the vehicle. This is the maximum weight of passengers and cargo that can be loaded into the vehicle. This information can be found on the tire pressure plate. If a trailer is being towed, the trailer tongue weight must be included as part of the cargo load.

**The maximum loaded vehicle weight** is the sum of curb weight, accessory weight, vehicle capacity weight and production options weight.

**The load rating** is the maximum load that a tire is rated to carry for a given inflation pressure.

**The maximum load rating** is the load rating for a tire at the maximum permissible inflation pressure.

**The cargo capacity** is the permissible weight of cargo, the subtracted weight of passengers from the load limit.

- ▷ Never exceed the permissible limits.



**Danger!**

**Risk of personal injury or death. Injuries are much more likely in an accident if persons ride in the cargo area.**

- ▷ Persons must ride only on the seats provided for this purpose.
- ▷ Make sure that everybody fastens their safety belts.

**Risk of loss of control, damage to the vehicle and serious personal injury or death.**

- ▷ Never exceed the specified axle loads. Overloading can shorten the service life of the tires and car, as well as lead to dangerous vehicle reactions and long braking distances. Damage due to overloading is not covered by the vehicle warranty.

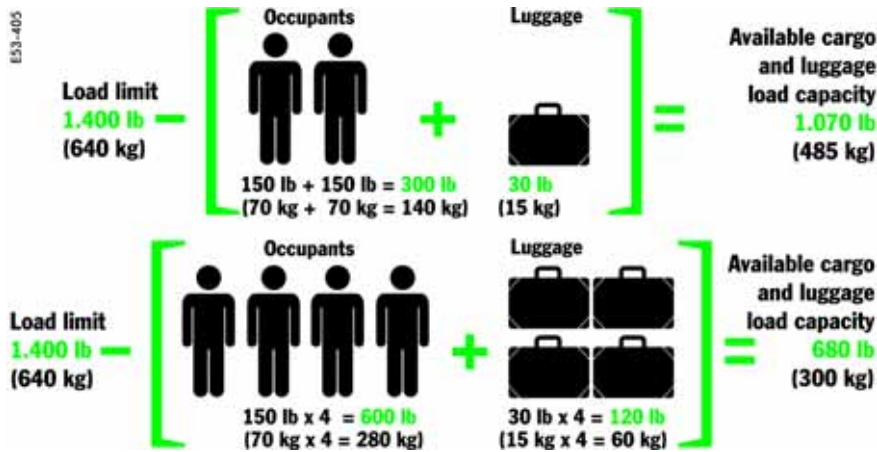

Example for determining the combined weight of occupants and cargo

## Vehicle Load Capacity

- ▶ The combined weight of occupants and cargo should never exceed the weight shown on the tire plate in the vehicle. Please see the chapter "TIRE PRESSURE PLATE" on Page 348.
- ▶ Never exceed the number of passengers shown on the tire pressure plate in the vehicle.

## Determining the combined weight of occupants and cargo:

- ▶ Add the weight of all occupants and then add the total luggage weight (**figure**).

## Steps for determining correct load limit

1. Locate the statement "The combined weight of occupants and cargo should never exceed XXX pounds" on your vehicle's placard (depending on the date of manufacture).
2. Determine the combined weight of the driver and passengers that will be riding in your vehicle.

3. Subtract the combined weight of the driver and passengers from XXX kilograms or XXX pounds.
4. The resulting figure equals the available amount of cargo and luggage load capacity. For example, if the "XXX" amount equals 1400 lbs. and there will be five - 150 lb passengers in your vehicle, the amount of available cargo and luggage load capacity is 650 lbs. [1400 - 750 (5 x 150) = 650 lbs.].
5. Determine the combined weight of luggage and cargo being loaded on the vehicle. That weight may not safely exceed the available cargo and luggage load capacity calculated in Step 4.
6. If your vehicle will be towing a trailer, load from your trailer will be transferred to your vehicle. Consult this manual to determine how this reduces the available cargo and luggage load capacity of your vehicle.



## Stowing load in the vehicle



### Warning!

---

#### **Danger of injury.**

**An unsecured or incorrectly positioned cargo can slip out of place or endanger the vehicle occupants during braking, direction changes or in accidents.**

**Never transport objects which are not secured.**

- ▷ Always transport cargo in the cargo area, never in the passenger compartment (e.g. on or in front of the seats).
- ▷ Support the cargo on the seat backrests whenever possible. Always lock the backrests into place.
- ▷ Place the cargo behind unoccupied seats whenever possible.
- ▷ Stow heavy objects as close to the front of the cargo area as possible, with lightweight objects behind them.
- ▷ The cargo must never project over the top edge of the seat backrest.
- ▷ Always protect the passenger compartment with a luggage safety net and a luggage compartment cover.  
Do not drive with objects on top of the luggage compartment cover.

- ▷ If the rear seats are not occupied, the backrests can be additionally secured with the safety belts. Simply cross the outer safety belts and insert each into the opposite buckle.
- ▷ Make sure that the cargo cannot damage the heating filaments of the rear window and the TV antenna of the side window.

#### **Luggage net**

- ▷ Luggage must be stowed completely covered by the luggage net.  
The luggage net can prevent only lightweight objects from slipping.

#### **Tie-down belts**

- ▷ Do not use elastic belts or straps to tie down cargo.
- ▷ Do not place belts and straps over sharp edges.
- ▷ Observe the directions for use and information for the tie-down equipment.
- ▷ Use only belts with a tear strength of at least 1543 lbs. (700 kg) and a maximum width of 1 in. (25 mm).
- ▷ Cross the belts over the load.

## Driving

- ▷ The car's handling changes depending on the vehicle loading. Adapt your driving style to the changed driving behavior.
  - ▷ Do not exceed the maximum gross weight and the axle load.
  - ▷ Please see the chapter "WEIGHTS" on Page 356.
  - ▷ Never drive with the rear window or rear lid open.  
Exhaust gases can enter the passenger compartment.
  - ▷ Adapt the tire pressure to the load.
  - ▷ Please see the chapter "SETTING VEHICLE LOADING AND ADJUSTING TIRE PRESSURE" on Page 135.
  - ▷ Please see the chapter "TIRE PRESSURES, COLD (68 °F/20 °C)" on Page 354.
-

## Towing a trailer



### Driving with a trailer

- ▷ Always see the permissible towing capacity, vertical coupling load and rear-axle load. Please see the chapter "WEIGHTS" on Page 356.
- ▷ When connected, the trailer must always be horizontal behind the towing vehicle. If necessary, use a trailer with an adjustable drawbar.
- ▷ When the vehicle is driven in the mountains, the engine output decreases as altitude increases. The maximum weights stated are the values at sea level. The total permissible weight of the car-trailer combination must therefore be reduced by 10% for each increment of 3,280 ft. (1,000 meters) altitude. A fractional increment counts as the full 3,280 ft. (1,000 meters). Please take this into consideration when planning your route.

### Distributing the load

- ▷ Distribute the load in the trailer so that heavy objects are as close to the axle as possible. Always safeguard all objects against slipping and tie them down securely.
- ▷ You should make the best possible use of the trailer coupling's rated vertical coupling load when loading the trailer, but never exceed it.

### Tire pressure

- ▷ Select the vehicle tire pressure for full load when towing a trailer.
- ▷ Please see the chapter "TIRE PRESSURES, COLD (68 °F/20 °C)" on Page 354.
- ▷ Check the tire pressure of the trailer's wheels according to the manufacturer's instructions.

### Door mirrors

- ▷ If the width of the trailer obstructs your view of the traffic behind the trailer, you must have additional door mirrors fitted.

### Headlights, lights

- ▷ Always check the headlight adjustment before driving with a trailer. If necessary, correct with the headlight beam adjustment function.
- ▷ Check whether the plug of the trailer is plugged into the towing vehicle and whether all lights function.

## Driving with a trailer

When towing a trailer you must under all circumstances adapt your speed to prevailing road and driving conditions. Towing at excessive speed can result in loss of control. Observe country-specific laws for driving with trailers.

- ▷ Carefully and gradually familiarize yourself with the handling and braking behavior of the car-trailer combination.
- ▷ Do not drive with the towing vehicle empty and the trailer loaded.  
If this unfavorable combination is unavoidable, please drive especially slowly.
- ▷ Bear in mind the different vehicle handling and size in situations such as braking, parking, cornering and overtaking, etc.
- ▷ The driving stability of the car-trailer combination worsens as the speed increases. Therefore, drive especially slowly on downhill stretches and in the case of unfavorable road and weather conditions (such as wind).
- ▷ Drive in an appropriately low gear on downhill stretches in order to make use of the engine braking effect.

- ▷ Slow down immediately if the trailer starts to sway. Do not countersteer; brake if necessary. Never attempt to straighten out the car-trailer combination by accelerating.
  - ▷ Activate Low Range when moving off on steep slopes.
  - ▷ Under no circumstances may people, animals or objects be in the space between the trailer and the towing vehicle when the vehicle is moving.
  - ▷ When reversing, bear in mind that ParkAssist is not active.
  - ▷ Always see the permissible towing capacity, vertical coupling load and rear-axle load. Please see the chapter "WEIGHTS" on Page 356.
- 

## Maintenance Note

- ▷ Please take into consideration that driving with a trailer places markedly greater stress on all vehicle components. Expert inspection and maintenance after every use are indispensable prerequisites for proper functioning and safety.

# Parking

Parking Aids .....	237
Swivelling down mirror glass as parking aid ..	241
Garage door opener.....	241

## Parking Aids

ParkAssist provides a visual and acoustic indication to the driver of the distance between the vehicle and a large obstacle.

ParkAssist is switched on automatically when the ignition is switched on and remains active up to a speed of approx. 9 mph (14 km/h).

ParkAssist is switched off automatically at high speed. ParkAssist is switched on again automatically when the speed drops below approx. 9 mph (14 km/h).

The selector lever position determines activation levels for ParkAssist and the corresponding area that is monitored.

### Tiptronic selector lever position:

- **P** – ParkAssist is **not** activated.
- **R, N** – ParkAssist is activated for the front **and** rear areas.
- **D, M** – ParkAssist is activated for the front area.

### Gearshift lever position:

- **R** – ParkAssist is activated for the front **and** rear areas.
- **In all other gearshift positions** – ParkAssist is activated for the front area.

### Note

On vehicles with manual transmission, the parking assistant is not switched on in the rear area if the vehicle rolls backward without reverse gear engaged.



**Risk of serious personal injury or death. ParkAssist cannot detect small objects such as children and pets. Even when using ParkAssist, the driver is still responsible for taking due care when parking and when assessing obstacles.**

- ▷ Make sure that no persons especially small children, animals or obstacles are within the maneuvering area.



### Switching ParkAssist on and off

- ▷ Switch ParkAssist on and off using button **A** in the roof console.  
When ParkAssist is switched off, the indicator light in the button lights up.

### Note on operation

It is a good idea to switch off ParkAssist when driving off-road and on unpaved surfaces.



Front ultrasound sensors

### Sensors

Six ultrasound sensors in the front and rear bumpers measure the distance to the closest obstacle.

- Range of outer sensors (front and rear): approx. 24 in. (60 cm)
- Range of front middle sensors (**arrow**): approx. 48 in. (120 cm)



Rear ultrasound sensors

- Range of rear middle sensors (**arrow**) (only in vehicles **without** spare wheel bracket): approx. 59 in. (150 cm)
- Range of rear middle sensors (only in vehicles **with** spare wheel bracket): approx. 48 in. (120 cm)

Obstacles cannot be detected in the “blind” sensor area (above and below the sensors).

### Maintenance Notes

- ▷ The sensors must always be kept free of dust, ice and snow in order to ensure that they are fully functional.
- ▷ Do not damage sensors by abrasion or scratching.
- ▷ Maintain sufficient distance when cleaning with steam-jet units. The sensors will be damaged if the pressure is too high.

### Note on operation

The rear ultrasound sensors may not function correctly if tires that have not been recommended by Porsche are fitted on the spare wheel bracket.

If the spare wheel bracket is open, this may impair the function of the rear ultrasound sensors.

In vehicles that have air suspension with level control and height adjustment, the system may not recognize obstacles near the ground at terrain level or special terrain level.



**A** - Front display – left monitoring area  
**B** - Front display – right monitoring area

### Warning indicators, signal tones, distances

The warning indicator for the front area is located on the dashboard.

The warning indicator for the rear area is located in the rooflining at the rear of the loadspace.

The warning indicators for the various monitoring areas (left and right) are subdivided respectively into one green, 4 yellow and 2 red light segments

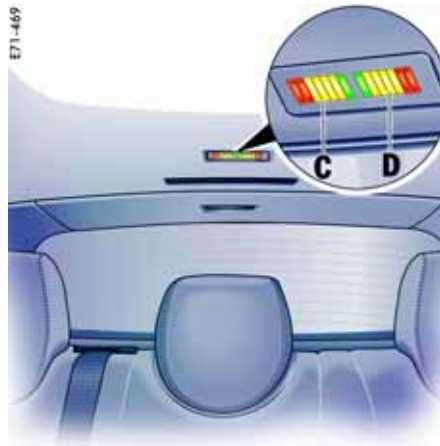

**C** - Rear display – right monitoring area  
**D** - Rear display – left monitoring area

If ParkAssist is activated, the **green light segments** of the active warning indicators are lit up continuously.

If the vehicle approaches an obstacle that has been detected by the sensors, one or more of the yellow or red light segments lights up, depending on the distance to the obstacle.

If the **first yellow light segment** lights up, the obstacle is still 48 in. (120 cm) (to the front) or 48 in. to 59 in. (120 to 150 cm) (to the rear) away.

A brief signal tone sounds when reversing.

An **intermittent tone** sounds when the distance becomes less than approx. 24 in. (60 cm). The **fourth yellow light segment** lights up.

A **continuous tone** sounds when the distance becomes less than approx. 10 in. (25 cm) (on vehicles with trailer coupling: approx. 14 in. (35 cm)). The **second red light segment** lights up.

If the obstacle is approached even closer, the system may not be able to recognize the obstacle any longer.

- ▷ Set the radio volume so that the signal tones are not drowned out.

You can have the volume of the signal tones adjusted to your own requirements at your authorized Porsche dealer.

### Note on operation

If the obstacle is approached even closer after the continuous tone sounds and the second red light segment lights up, the system may not be able to recognize the obstacle any longer.

### Limits of ultrasonic measurement

- ParkAssist cannot detect sound-absorbing obstacles (e.g. winter operation, powder snow),
- Sound-reflecting obstacles (e.g. glass surfaces, flat painted surfaces),
- And very thin obstacles.

Other ultrasound sources (e.g. pneumatic brakes of other vehicles, jackhammers) can interfere with detection of obstacles.

### Fault indication without warning tone

All red light segments of the active warning indicators light up when there is a **temporary fault** in ParkAssist.

### Note

Correct operation is no longer ensured if there is a temporary fault (e.g. caused by ice formation or heavy soiling on the sensors).

The system detects the temporary fault.

All light segments light up until a speed of 9 mph (14 km/h) is reached.

ParkAssist is ready for operation again when the interference has been eliminated.

### Fault indication with warning tone

In the event of a **long-lasting fault** in ParkAssist, the red light segments of the active warning indicators light up **and** a continuous tone sounds for three seconds after a transmission range has been selected.

### Possible causes

- Defect or system fault.
- ▷ Switch ParkAssist off.  
When ParkAssist is switched off, the indicator light in the button lights up.  
Please see the chapter “SWITCHING PARKASSIST ON AND OFF” on Page 237.
- ▷ Please have the fault remedied at an authorized Porsche dealer.

### Driving with a trailer

The ParkAssist rear monitoring area is switched off when the trailer's power supply is plugged in.





A - Control switch for door mirror adjustment  
C - Passenger mirror setting

## Swivelling down mirror glass as parking aid

When reverse gear is engaged, the mirror glass on the **passenger's side** swivels down slightly to show the curb area.

### Preconditions

- Vehicle must be equipped with seat memory.
- Control switch **A** must be turned to position **C** (passenger mirror's setting).
- Reverse gear must be engaged.

### Moving mirror to its initial position

The mirror glass swivels to its initial position when:

- The car is shifted out of reverse gear **or**
- The position of the control switch for the door mirror setting is changed.

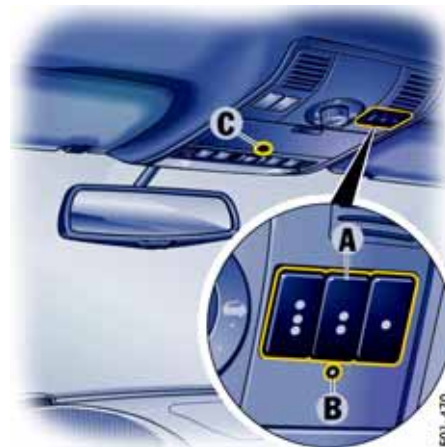

A - Programmable keypad  
B - Light-emitting diode for status identification  
C - HomeLink transmitter

## Garage door opener

The garage door opener of your Porsche replaces up to three original remote controls used to operate various devices.

You have the option of programming each of the buttons on the keypad **A** with functions of the original remote controls if the original remote control is compatible with the HomeLink system. Further information is available from your authorized Porsche dealer.

## Warning!

**Risk of accidents when using the garage door opener if persons, animals or objects are within the range of movement of the equipment that is being operated.**

- ▷ When using the garage door opener, ensure that no persons, animals or objects are within the range of movement of the equipment that is being operated.
- ▷ Observe the safety notes for the original remote control.

## Notes on operation

- ▷ When a button is pressed, the transmitter sends a corresponding signal forwards in driving direction.  
Always position the vehicle in line with the receiver. Otherwise, range restrictions cannot be ruled out.
- ▷ Please read the instructions for the original remote control to find out whether the original remote control has fixed or changeable code.
- ▷ When operating and programming the garage door opener, the ignition must be switched on and the vehicle must be within range of the receiver.

## Assigning garage door opener signal to button

### Notes on assigning signals for fixed-code or changeable code systems

- Several attempts with different distances between the HomeLink transmitter and the original remote control may be necessary.
- The original remote control must transmit continuously during programming. The button on the remote control must be pressed several times in the case of remote controls with standby function.
- The teaching time may be up to 60 seconds.
- ▷ Please refer to the operating instructions for the original remote control.



### Deleting all programmed buttons

- ▷ Keep the two outer buttons of keypad **A** depressed for approximately 20 seconds until LED **B** begins to flash quickly.  
All the programmed buttons are deleted.

### Note

- ▷ Before selling the vehicle, delete the programmed buttons of the HomeLink.



## Programming a button on the keypad



### Caution!

**Risk of damage. When programming a garage door or gate, the door or gate may open and close several times in quick succession, causing the motor to overheat.**

- ▷ Unplug the garage door or gate during the programming procedure to prevent the motor from overheating.

1. Press and hold the desired button on the keypad until light-emitting diode **B** starts to flash slowly (may take up to 20 seconds). Do not release the button before step 3 has been completed.

2. Hold the original remote control approx. 5–30 cm in front of the marked position **C**. Make sure that the battery in the original remote control is new.
3. Press and hold the button on the original remote control until light-emitting diode **B** flashes rapidly. The rapidly flashing LED **B** confirms that the remote control function has been programmed successfully. Only release both buttons when LED **B** flashes.
4. Press the programmed button on keypad **A**. If the light-emitting diode **B** lights up continuously after programming, this means that the system is a fixed-code system. Programming is now completed. If light-emitting diode **B** again flashes rapidly for a short time after programming and then lights up continuously for approx. 2 seconds, this means that the system is a changeable-code system. HomeLink must then be synchronized with the receiver of the garage door opener after programming.

5. Repeat steps 1 to 4 to program the other buttons.

## Synchronization for changeable-code systems

1. To synchronize the system: Press the programming button on the receiver of the garage door opener. Afterwards, you usually have approx. 30 seconds to initiate step 2.

2. Press the previously programmed button on the keypad three times (for approx. 1 second). Changeable-code synchronization is now completed.
3. Repeat steps 1 to 2 to synchronize other signals to the other buttons.

## Note

- ▷ Please consult an authorized Porsche dealer if you have not been able to successfully assign signals to the buttons even though you have carefully followed the instructions in this section and the operating instructions for the original remote control. Your authorized Porsche dealer also has a list of all compatible garage door opener systems.

## Operating the garage door opener

- ▷ Press the corresponding button on keypad **A**. Light-emitting diode **B** lights up continuously during signal transmission with fixed-code systems. In the case of signal transmission for changeable-code systems, light-emitting diode **B** repeatedly lights up rapidly for a short time and then lights up continuously for approx. 2 seconds.

# Alarm System and Theft Protection

Alarm System and  
Passenger Compartment Monitoring ..... 245

## Alarm System and Passenger Compartment Monitoring

USA: KR55WK45032

Canada: CAN 267 104 187

This device complies with:  
Part 15 of the FCC Rules  
RSS-210 of Industry Canada.

Operation of this device is subject to the following two conditions:

- It may not cause harmful interference, and
- it must accept any interference received including interference that may cause undesired operation.

### Note

- ▷ The manufacturer is not responsible for any radio or TV interference caused by unauthorized modifications to this equipment. Such modification could void the user's authority to operate the equipment.

### Warning!

Any changes or modifications not expressly approved by Porsche could void the user's authority to operate this equipment.

### Avoiding false alarms

- ▷ If people or animals are remaining in the locked vehicle or the vehicle is being transported on a train or ship, for example, the passenger compartment monitoring system must temporarily be switched off.
- ▷ Always close the sliding/lifting roof or the Panorama roof system, and all door windows.
- ▷ Do not leave a mobile phone switched on in the glasses case of the roof console.
- ▷ Always turn off the alarm system before you attach or uncouple a trailer. The alarm system could trigger an alarm unintentionally.

### Switching off the alarm system if it is triggered

- ▷ Unlock vehicle doors with the remote control  
**or**
- ▷ Switch ignition on.

### The following alarm contacts are monitored

- Doors
- Engine compartment lid
- Rear lid
- Rear window
- Passenger compartment
- ▷ If one of these alarm contacts is interrupted, the alarm horn sounds for approx. 30 seconds and the emergency flashers flash. After 5 seconds of interruption the alarm is triggered again. This cycle is repeated ten times.

## Switching on

- ▷ Lock the vehicle.  
The alarm system and passenger compartment monitoring system are switched on.
- ▷ Please see the chapter “UNLOCKING AND LOCKING FROM OUTSIDE” on Page 19.

## Switching off

- ▷ Unlock the vehicle.  
The alarm system and passenger compartment monitoring system are switched off automatically.

### Note on operation

If you unlock the vehicle with the key at the door lock, you must switch the ignition on (ignition lock position **1**) within 15 seconds of opening the door in order to prevent the alarm system from being triggered.



### Temporarily deactivating passenger compartment monitoring system

If people or animals are remaining in the locked vehicle or the vehicle is being transported on a passenger train or ship, for example, the passenger compartment monitoring system must be deactivated.

When locked again, the passenger compartment monitoring is activated again.

The rocker switch to switch off the passenger compartment monitoring system is located next to the driver's seat under the seat belt height adjustment.

### Note on operation

You can also temporarily deactivate the passenger compartment monitoring system on the multi-purpose display in the instrument panel:

- ▷ Please see the chapter “SWITCHING OFF PASSENGER COMPARTMENT MONITORING ON THE MULTI-PURPOSE DISPLAY” on Page 142.



## Deactivating passenger compartment monitoring system

1. Apply the parking brake.
2. Remove ignition key.  
On vehicles **with** Porsche Entry & Drive:  
Switch off the ignition.
3. Open the driver's door.
4. Press the rocker switch.  
The rocker switch symbol lights permanently.
5. Lock the vehicle.

Emergency flasher flashes **twice and an acoustic signal will sound twice.**

The vehicle doors, the rear lid and the rear window are locked but the doors can be opened from the inside by pulling the inner door handle twice.

- ▷ Inform any persons remaining in the vehicle that the alarm system will be triggered if the door is opened.

### Note on operation:

If the ignition is switched on after pressing the rocker switch, the passenger compartment monitoring system is activated again. The symbol on the rocker switch will flash.

## Activating the alarm system and the passenger compartment monitoring system

- ▷ Unlock the vehicle and lock it again.

### Fault indication

If the monitoring system could not be deactivated the symbol on the rocker switch will flash (e.g. the rocker switch is pressed with the ignition on).

For deactivating the passenger compartment monitoring:

- ▷ Switch off ignition.
- ▷ Press the rocker switch.
- ▷ Lock the vehicle.

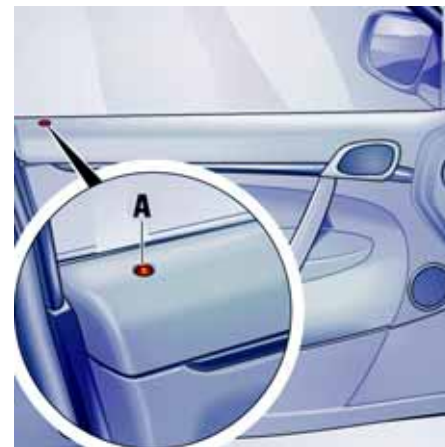

*A - Light-emitting diode for alarm system*

### Function indication

The locking condition of the vehicle is indicated by a rapid flashing of the light-emitting diodes **A** in the front doors.

The light-emitting diodes go out when the vehicle is unlocked.

### **The passenger compartment monitoring is switched on**

- The light-emitting diodes flash for 2 seconds, rapidly, then slowly.

### **The passenger compartment monitoring is switched off**

- The light-emitting diodes flash for 2 seconds, rapidly, then slowly.

### **The passenger compartment monitoring is switched off in the multi-purpose display in the instrument panel**

- The light-emitting diodes flash rapidly for 2 seconds, go out for 28 seconds and then flash slowly.

### **Faults of the central locking system and the alarm system**

- The light-emitting diodes flash rapidly for 2 seconds, shine for 28 seconds and then flash slowly.

### **Immobilizer**

There is a transponder (an electronic component), containing a stored code, in each key. Before the ignition is switched on, the ignition lock checks the code. The immobilizer can be switched off and the engine started only using an authorized ignition key.

#### **Switching off the immobilizer**

- ▷ Insert the ignition key into the ignition lock.

#### **Switching on the immobilizer**

- ▷ Withdraw the ignition key.



# Maintenance and Car Care

Exercise Extreme Caution when Working on your Vehicle .....	250
Engine Oil .....	251
Checking Engine Oil Level .....	252
Topping up Engine Oil .....	253
Coolant Level .....	255
Brake-Fluid Level .....	257
Washer Fluid .....	258
Power Steering .....	259
Changing Air Cleaner .....	260
Changing Particle Filter .....	260
Automatic Transmission Fluid .....	260
Manual Transmission Oil .....	260
Wiper Blades .....	261
Emission Control System .....	263
How Emission Control Works .....	264
Fuel Economy .....	265
Operating Your Porsche in other Countries... ..	266
Fuel.....	266
Portable Fuel Containers .....	268
Fuel Recommendations.....	269
Fuel Evaporation Control.....	270
Car Care Instructions.....	270

## Exercise Extreme Caution when Working on your Vehicle



**Ignoring the following instructions may cause serious personal injury or death.**

- ▷ The engine compartment of any motor vehicle is a potentially hazardous area. If you are not fully familiar with proper repair procedures, do not attempt the adjustments described on the following pages.  
This caution applies to the entire vehicle.
- ▷ Only work on your vehicle outdoors or in a well ventilated area.
- ▷ Ensure that there are no open flames in the area of your vehicle at any time when fuel fumes might be present. Be especially cautious of such devices such as hot water heaters which ignite a flame intermittently.
- ▷ Before working on any part in the engine compartment, turn the engine off and let it cool down sufficiently. Hot engine compartment components can burn skin on contact.
- ▷ Be alert and cautious around engine at all times while the engine is running.

If you have to work on the engine while it is running, always put the parking brake on **and** put the gearshift lever in neutral or the Tiptronic selector lever in position **P or N**.

- ▷ In particular, be very careful to ensure that items of clothing (ties, shirt, sleeves etc.), jewelry, long hair, hand or fingers cannot get caught in the fan, belts or other moving parts. The radiator and radiator fans are in the front of the car.  
The fans can start or continue running as a function of temperature, even with the engine switched off.  
Carry out work in these areas only with the engine off and exercise extreme caution.
- ▷ Your Porsche is equipped with an electronic ignition system. When the ignition is on, high voltage is present in all wires connected with the ignition system; therefore, exercise extreme caution when working on any part of the engine while the ignition is on or the engine is running.
- ▷ Always support your car with safety stands if it is necessary to work under the car. The jack supplied with the car is not adequate for this purpose.  
For vehicles with air suspension with level control and height adjustment switch off level control.  
Please see the chapter "RAISING VEHICLE WITH THE JACK" on Page 192.
- ▷ When working under the car without safety stands but with the wheels on the ground, make sure the car is on level ground, the wheels are blocked, and that the engine cannot be started.  
Withdraw ignition keys (switch ignition off in vehicles that have Porsche Entry & Drive).
- ▷ Do not smoke or allow an open flame around the battery or fuel.  
Keep a fire extinguisher close at hand.
- ▷ Incomplete or improper servicing may cause problems in the operation of the car. If in doubt about any servicing, have it done by your authorized Porsche dealer.  
Improper maintenance during the warranty period may affect your Porsche warranty coverage.
- ▷ Supplies of fluids, e.g. engine oil, washer fluid, brake fluid or coolant, are hazardous to your health.  
Keep these fluids out of children's reach and dispose of them in accordance with the appropriate regulations.
- ▷ Some countries require additional tools and special spare parts to be carried in your vehicle. Please make enquiries before driving abroad.

## Radiator fans

The radiator and radiator fans are in the front of the car.



---

**Danger of injury. The fans can start running as a function of temperature, even with the engine switched off.**

- ▷ Exercise extreme caution when working in the area of the radiator fans.
- 

## Engine Oil

It is important to perform oil changes regularly in accordance with the intervals specified in your **Maintenance Schedule**.

### Engine oil consumption

It is normal for your engine to consume oil. The rate of oil consumption depends on the quality and viscosity of oil, the speed at which the engine is operated, the climate, road conditions as well as the amount of dilution and oxidation of the lubricant.

If the vehicle is used for repeated short trips, and consumes a normal amount of oil, the engine oil measurement may not show any drop in the oil level at all, even after 600 miles (1000 km) or more. This is because the oil is gradually becoming diluted with fuel or moisture, making it appear that the oil level has not changed. The diluting ingredients evaporate out when the vehicle is driven at high speeds, as on an expressway, making it then appear that oil is excessively consumed after driving at high speeds.

If the conditions you drive your vehicle in are dusty, humid, or hot, the frequency of the oil change intervals should be greater.

If the vehicle is driven at a high rate of speed, climatic conditions are warm, and the load is high, the oil should be checked more frequently, as driving conditions will determine the rate of oil consumption.

- The engine in your vehicle depends on oil to lubricate and cool all of its moving parts. Therefore, the engine oil should be checked regularly and kept at the required level.
- Make it a habit to have the engine oil level checked with every refueling.
- The oil pressure warning light is not an oil level indicator. The oil pressure warning light indicates serious engine damage may be occurring when lit, if engine rpm is above idle speed.

## Checking Engine Oil Level

- ▷ Check the oil level regularly. It is best to do this when refueling and before extended journeys.

Further important information concerning “maintenance” can be found in a separate chapter.

- ▷ Please see the chapter “EXERCISE EXTREME CAUTION WHEN WORKING ON YOUR VEHICLE” on Page 250.
- ▷ Please see the chapter “OVERVIEW OF WARNING MESSAGES” on Page 149.

### Warning!

---

**Engine oil is hazardous to your health and may be fatal if swallowed.**

- ▷ Keep engine oil out of children's reach.

**Used engine oil contains chemicals that have caused cancer in laboratory animals.**

- ▷ Always protect your skin by washing thoroughly with soap and water.
- 
- ▷ If you suspect an oil leak in the engine have your authorized Porsche dealer check it out immediately.



## Oil-level warning

If the oil level is too low, this is indicated by the oil level warning light lighting up on the multi-purpose display.

- ▷ Check the oil level using the oil dipstick as soon as possible and add engine oil if necessary.

### Note on operation

- ▷ If the engine compartment lid is opened and oil is not added, the warning message appears again after approximately 100 km.

## Checking the oil level

### Warning!

---

**Danger of injury. The radiator fans can start running as a function of temperature, even with the engine switched off.  
Risk of burning from hot parts in engine compartment.**

- ▷ Exercise extreme caution when working on the engine compartment.
- 

## Conditions for measuring the oil level correctly

- Vehicle must be level.
- Engine must be switched off and at operating temperature.
- Before the oil-level measurement, allow the engine oil to flow back into the oil pan for around 3 minutes.

## Checking oil level with the oil dipstick

1. Withdraw oil dipstick and wipe it with a clean, lint-free cloth.
2. Push oil dipstick fully home, withdraw again and read off the oil level.  
**The oil level must never fall below or exceed the “Min.” and “Max.” marks on the dipstick.**  
The difference between the marks is approx. 1.6 qt. (1.5 liters).
3. Push oil dipstick in as far as the stop.



### Cayenne S, Cayenne GTS, Cayenne S Transsyberia oil dipstick

#### MAX - marking

- ▷ Do not top up engine oil.

#### MIN - marking

- ▷ Top up engine oil immediately.



### Cayenne oil dipstick

#### MAX - marking

- ▷ Do not top up engine oil.

#### A - Normal marking

- ▷ Engine oil can be topped up.

#### MIN - marking

Top up engine oil immediately.

## Topping up Engine Oil

Porsche recommends **Mobil**.

### The right oil for your vehicle

Vehicle	Meets approval <sup>1)</sup>	Viscosity class <sup>2)</sup>
Cayenne S, Cayenne GTS, Cayenne S Transsyberia:	Porsche A40	SAE 0W - 40 <sup>3)</sup> SAE 5W - 40 <sup>4)</sup> SAE 5W - 50 <sup>4)</sup>
Cayenne (V6):	Porsche C30 <b>or</b> VW 504 00	SAE 5W - 30 <sup>3)</sup>

<sup>1)</sup> Generally you can find specifications relating to manufacturer approvals on the oil containers or as a notice displayed by the retailer. You can also ask your authorized Porsche dealer for the current approval status.

<sup>2)</sup> SAE viscosity class – Example: SAE 0W - 40  
Specification 0W = Viscosity specification for low temperatures (winter).  
Specification 40 = Viscosity specification for high temperatures.

<sup>3)</sup> For all temperature ranges.

<sup>4)</sup> For temperature ranges above –25 °C.

### Always observe the following points:

- Use only engine oils approved by Porsche. This is a precondition for optimum and problem-free operation of your vehicle.
- The engine oil is changed regularly during servicing. It is important that the service intervals, particularly the oil change intervals, are observed in accordance with the specifications in the **Maintenance Schedule**. We recommend that you have the engine oil changed at your authorized Porsche dealer.
- Oils approved by Porsche can be mixed with each other.
- Porsche engines are designed so that no oil additives may be used.
- A label located in the engine compartment provides you with details of the most suitable oil for your engine.

Your authorized Porsche dealer will be pleased to advise you.



Engine oil filling point on Cayenne S, Cayenne GTS, Cayenne S Transsylvia

### **Warning!**

**Fire hazard if engine oil comes into contact with hot engine parts.**  
**Risk of damage if engine oil comes into contact with the drive belt.**

- ▷ Exercise great care when adding engine oil.



Engine oil filling point on Cayenne

1. Unscrew cap of the oil filler opening.
2. Add at most half a liter of engine oil at a time.
3. Measure oil level again after a few minutes. **Never exceed the MAX mark on the oil dipstick.**
4. Push oil dipstick in as far as the stop.
5. Carefully close cap of the oil filler opening.

## Coolant Level

The coolant provides year-round protection from corrosion and freezing down to -31 °F (-35 °C) (Nordic countries -40 °F (-40 °C)).

- ▷ Use only anti-freeze authorized by Porsche.
- ▷ Check the coolant level regularly.

Further important information concerning “maintenance” can be found in a separate chapter.

- ▷ Please see the chapter “EXERCISE EXTREME CAUTION WHEN WORKING ON YOUR VEHICLE” on Page 250.

### Checking coolant level/adding coolant

The expansion tank for the coolant is located under the engine-compartment cover in the engine compartment.

When the **engine is cold** and the car is level, the coolant level must lie between the min- and max-marks.



### Checking when engine is cold

1. Remove cover.



2. Open cap of the expansion tank carefully and allow any overpressure to escape. Then unscrew cap completely.
3. Read the coolant level.
4. Top up with coolant if necessary. Do not exceed the max- mark. Only add a mixture of anti-freeze and water in equal parts.  
**Antifreeze in coolant:**  
50% provides anti-freeze protection down to -31 °F (-35 °C).
5. Screw the cap closed firmly and put on the cover.

**Checking the coolant level when a warning messages is shown on the multi-purpose display of the instrument panel**



**Warning!**

**Danger of serious personal injury or death from scalding. Coolant is hazardous to your health, and may be fatal if swallowed.**

- ▷ Do not open the cap of the expansion tank while the engine is hot.
- ▷ Allow the engine to cool down before opening the cap and protect your hands, arms and face from any possible escape of hot coolant.
- ▷ Keep coolant out of children's reach.
- ▷ Also, keep coolant away from your pets. They can be attracted to it should there be a spill, or to used coolant left in an open container. Coolant can be deadly to pets if consumed.

1. Remove cover.
2. If the engine is hot, cover the the expansion tank cap with a cloth. Open cap carefully and allow any overpressure to escape. Then unscrew cap completely.
3. Read the coolant level. Top up with coolant if necessary. Only add a mixture of anti-freeze and water in equal parts.  
**Antifreeze in coolant:**  
50% provides anti-freeze protection down to -31 °F (-35 °C).  
Do not exceed the max-mark.

**Note on operation**

- ▷ If the coolant level exceeds the max-mark when the engine is hot, check the coolant level again when the engine is cold.
4. Screw the cap closed firmly and put on the cover.
  5. Have the cooling system checked by an authorized Porsche dealer.

**Maintenance Notes**

If in an emergency pure water has been added, the mixture ratio must be corrected at an authorized Porsche dealer.

- ▷ Marked loss of coolant indicates leakage in the cooling system. The cause should be remedied at an authorized Porsche dealer immediately.

**Radiator fans**

The radiator and radiator fans are in the front of the car.



**Warning!**

**Danger of injury. The fans can start running as a function of temperature, even with the engine switched off.**

- ▷ Exercise extreme caution when working in the area of the radiator fans.



## Brake-Fluid Level

- ▷ Use only new (unused) Original Porsche brake fluid.

Further important information concerning “maintenance” can be found in a separate chapter.

- ▷ Please see the chapter “EXERCISE EXTREME CAUTION WHEN WORKING ON YOUR VEHICLE” on Page 250.

### Warning!

**Brake fluid is hazardous to your health, and may be fatal if swallowed.**

**Brake fluid also attacks paintwork.**

- ▷ Keep brake fluid out of children's reach.
- ▷ Immediately rinse off spilled brake fluid with clean water.
- ▷ If brake fluid gets into your eye, immediately rinse with clean water for a few minutes. Then see a doctor immediately.
- ▷ Please note all the information on the refill container of the brake fluid.

071-124



071-125



### Checking the brake-fluid level

The reservoir for the hydraulic braking system is located in the engine compartment.

1. Rotate the turn-locks 90° anti-clockwise (**arrow**) with a screwdriver and remove the cover.
2. Check brake-fluid level at the transparent reservoir.  
The fluid level should always lie between the MIN and MAX marks.

A slight decrease in the fluid level due to wear and automatic readjustment of the disc brakes is normal.

If, however, the fluid level falls markedly or below the MIN mark, the braking system may have developed a leak.

- ▷ Please have the braking system checked immediately at an authorized Porsche dealer.

## Changing the brake fluid

Brake fluid absorbs moisture from the air over time. This accumulation of water lowers the boiling point and, under certain operating conditions, can affect the braking performance.

- ▷ Therefore, have the brake fluid changed in accordance with the change intervals stated in the “Maintenance” booklet.

**BRAKE**  **Brake fluid warning light USA**

  **Brake fluid warning light Canada**

The warning light in the instrument panel and the warning message on the multi-purpose display of the instrument panel indicate

- indicate the brake level fluid is too low or,
- in conjunction with large pedal travel could indicate a braking-circuit failure.

### Note on operation

If the warning lights should light up while driving:

- ▷ Stop immediately in a suitable place.
- ▷ Do not continue driving.  
Please have the fault remedied at your nearest authorized Porsche dealer.

071-126



## Washer Fluid

### Warning message on the multi-purpose display

A message is shown on the multi-purpose display of the instrument panel if the washer-fluid level is too low.

In this case, the residual quantity is only around 0.85 quarts (0.8 liter).

- ▷ Add washer fluid at the next opportunity.

The capacity is approx. 7.9 quarts (7.5 liters).

The washer-fluid reservoir for windshield, rear window and headlights is located in the engine compartment.

- ▷ **Summer filling** with water + window cleaner concentrate in the mixture ratio specified on the container.

**Winter filling** with water + antifreeze + window cleaner concentrate in the mixture ratio specified on the container.

Always follow all the instructions on the containers of the additives used.

- ▷ Only use window cleaner concentrate which meets the following requirements:
  - Dilutability 1:100,
  - phosphate-free,
  - suitable for plastic headlights.

We recommend window cleaner concentrates approved by Porsche. Your authorized Porsche dealer will be pleased to advise you.

- ▷ Do not use engine coolant anti-freeze or any other solution that can damage the car's paint, in the washer reservoir.

The washer fluid reservoir for windshield, rear window and headlights is located in the engine compartment.

1. Open cap of washer fluid reservoir.
2. Add washer fluid.
3. Close cap carefully.

## Power Steering

### Warning!

Risk of accident resulting in serious personal injury or death. When the engine is stationary (e.g. when on tow) or the hydraulic system fails, there is no assistance for steering. Therefore, substantially more force will have to be exerted.

- ▷ Exercise great care when on tow.
- ▷ Have the fault remedied at your nearest authorized Porsche dealer.

The flow noise heard at full steering lock is design-related and does not indicate a defect in the steering system.

Further important information concerning “maintenance” can be found in a separate chapter.

- ▷ Please see the chapter “EXERCISE EXTREME CAUTION WHEN WORKING ON YOUR VEHICLE” on Page 250.



### Checking hydraulic fluid

- ▷ Use only hydraulic fluid **authorized by Porsche**.
  - ▷ Check the fluid level with the engine stopped and cold (engine temperature approx. 68 °F or 20 °C).
1. Remove cover **A**.



2. Open the reservoir cap.
3. The fluid level should lie between the MIN and MAX marks on the dipstick. Add hydraulic fluid if necessary.
4. Close cap carefully.
5. Put on cover **A**.
6. Close engine compartment lid.

### Note on operation

- ▷ If the fluid level drops significantly, please have the cause remedied immediately by an authorized Porsche dealer.

## Changing Air Cleaner

Regular replacement of the filter element is part of servicing.

- ▷ In dusty conditions, clean the filter element more frequently and replace if necessary.

Further important information concerning “maintenance” can be found in a separate chapter.

- ▷ Please see the chapter “EXERCISE EXTREME CAUTION WHEN WORKING ON YOUR VEHICLE” on Page 250.

## Changing Particle Filter

The fresh air passing through the particle filter into the passenger compartment is virtually free of dust and pollen.

- ▷ If the outside air is polluted by exhaust fumes, press the recirculating-air button.

A dirty filter can be the cause of reduced air throughput.

- ▷ Have filter replaced by your authorized Porsche dealer.
- ▷ Regular replacement of the filter is part of servicing.

## Automatic Transmission Fluid

The torque converter and the transmission are lubricated with Automatic Transmission Fluid (ATF).

- ▷ Please see the chapter “CAPACITIES” on Page 359.

Do not tow the car or run the engine without ATF in the transmission. The automatic transmission may be damaged by even a tiny speck of dirt, only a clean funnel or spout must be used when adding ATF.

The ATF and transmission oil has to be checked and changed at the intervals listed in your Maintenance Schedule.

We recommend that you have the ATF and transmission oil changed at your Porsche dealer, who has the required lubricants and the necessary filling equipment.

If you suspect an oil leak in the transmission, have your authorized Porsche dealer check it out immediately.

## Manual Transmission Oil

The transmission oil has to be checked and changed at the intervals listed in your Maintenance Schedule.

- ▷ Please see the chapter “CAPACITIES” on Page 359.

We recommend that you have the transmission oil changed at your Porsche dealer, who has the required lubricants and the necessary filling equipment.

If you suspect an oil leak in the transmission, have your authorized Porsche dealer check it out immediately.

## Wiper Blades

### Maintenance Notes

Wiper blades that are in perfect condition are vital for a clear view.

- ▷ Replace the wiper blades twice per year (before and after the cold season) or if wiper performance deteriorates or the blades are damaged.
- ▷ For important information on “service topics”: Please see the chapter “CAR CARE INSTRUCTIONS” on Page 270.

### Caution!

#### **Risk of damage if wiper arm accidentally falls back onto the windshield.**

- ▷ Always hold the wiper arm securely when replacing the wiper blade.

#### **Risk of damage if wiper blades that are frozen in place are loosened improperly.**

- ▷ Thaw the wiper blades before loosening them.

#### **Risk of damage.**

#### **If the wiper blades are not changed properly, they can come loose when the car is moving.**

- ▷ Check whether the wiper blades are seated securely.  
The wiper blade must be pushed onto the wiper arm up to the stop.

- ▷ Periodically clean the wiper blades with window cleaner, especially after the vehicle has been washed in a car wash. We recommend the Porsche window cleaner. If they are very dirty (e.g. with insect remains), they can be cleaned with a sponge or cloth.

If the wiper blades rub or squeak, this may be as a result of the following:

- If the vehicle is washed in an automatic car wash, wax residues may adhere to the windshield. These wax residues can be removed only by using window cleaner concentrate.
- ▷ Please see the chapter “WASHER FLUID” on Page 258.

Please contact your authorized Porsche dealer for further information.

- The wiper blades may be damaged or worn.
- ▷ Replace damaged or worn wiper blades as soon as possible.

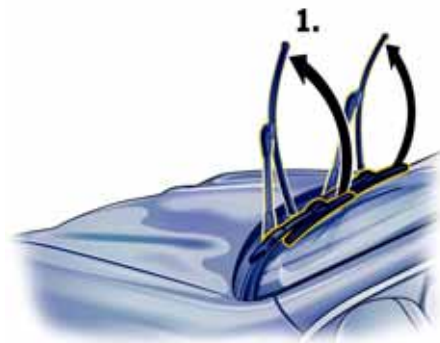

071-234

### Replacing wiper blades at front

- ▷ Apply the parking brake.
  - ▷ Switch the windshield wipers off (wiper stalk in position **0**).
  - ▷ Switch ignition off.
1. Fold windshield wiper arm away from the windshield (**arrow 1**).

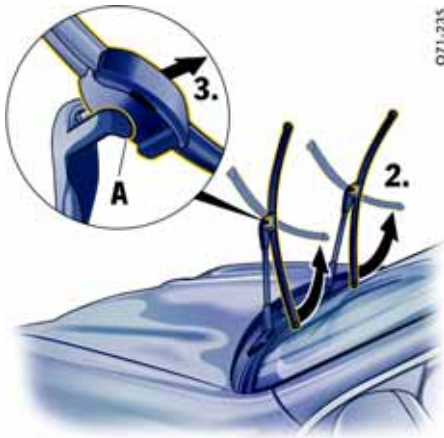

071-235



071-236

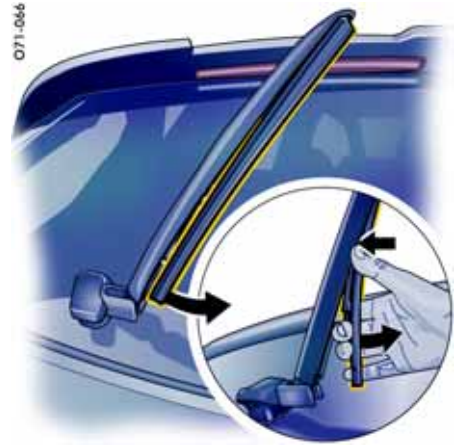

071-066

2. Turn wiper blade at right angle to the wiper arm (**arrow 2**) so that the fixing groove of the wiper blade is released by the retaining clip **A**.
3. Pull off wiper blade towards the windshield (**arrow 3**).
4. Push on new wiper blade.

Make sure that the wiper blade is pushed onto the wiper arm up to the stop.

5. Fold wiper blade back to its original position.  
Make sure that the retaining clip **A** engages fully in the fixing groove of the wiper blade.
6. Carefully fold wiper arm back on to the windshield (**arrow**).

### Changing rear window wiper blade



**Risk of damage if the rear wiper is frozen in place and is loosened improperly.**

- ▷ Thaw the wiper blade before loosening them.
- ▷ Grasp the wiper arm with both hands and separate it from the window.

1. Apply the parking brake.
2. Switch ignition off.
3. Carefully fold the wiper arm away from the rear window until it reaches its locking position (approx. 60°).
4. Carefully unclip the wiper blade from the wiper arm (**arrow**). Hold the wiper arm with your other hand when doing this.
5. Push the new wiper blade onto the wiper arm and snap it into place.
6. Carefully fold wiper arm back on to the rear window.

## Emission Control System

### In the interest of clean air

Pollution of our environment has become a problem that is of increasing concern to all of us. We urge you to join us in our efforts for cleaner air in controlling the pollutants emitted from the automobile.

Porsche has developed an emission control system that controls or reduces those parts of the emission that can be harmful to our environment. Your Porsche is equipped with such a system.

Porsche warrants the Emission Control System in your new car under the terms and conditions set forth in the Warranty Booklet.

You, as the owner of the vehicle, have the responsibility to provide regular maintenance service for the vehicle and to keep a record of all maintenance work performed. To facilitate record keeping, have the service performed by authorized Porsche dealers. They have Porsche trained technicians and special tools to provide fast and efficient service.

### To assure efficient operation of the Emission Control System:

- ▷ Have your vehicle maintained properly and in accordance with the recommendations described in your Maintenance Booklet. Lack of proper maintenance, as well as improper use of the vehicle, will impair the function of the emission control system and could lead to damage.
- ▷ Do not alter or remove any component of the emission control system.
- ▷ Do not alter or remove any device, such as heat shields, switches, ignition wires, valves, etc., which are designed to protect your vehicle's emission control system. In addition to serious engine damage, this can result in a fire if excess raw fuel reaches the exhaust system.
- ▷ Do not continue to operate your vehicle if you detect engine misfire or other unusual operating conditions.

## Parking



**Danger!**

---

### **Danger of fire resulting in serious personal injury or death.**

- ▷ Do not park or operate the vehicle in areas where the hot exhaust system may come in contact with dry grass, brush, fuel spill or other flammable material.
  - ▷ If your car catches on fire for any reason, call the fire department. Do not endanger your life by attempting to put out the fire.
- 

## Undercoating



**Danger!**

---

### **Danger of fire resulting in serious personal injury or death.**

- ▷ Do not apply additional undercoating or rust-proofing on or near the exhaust manifold, exhaust pipes, catalytic converters or heat shields. During driving the substance used for undercoating could overheat and ignite.
- 

## How Emission Control Works

When an automobile engine is running, it uses energy generated through the combustion of a mixture of air and fuel. Depending on whether a car is driven fast or slowly or whether the engine is cold or hot, some of the fuel (hydrocarbons) may not be burned completely, but may be discharged into the engine crankcase or exhaust system. Additional hydrocarbons may enter the atmosphere through evaporation of fuel from the fuel tank. These hydrocarbons (HC), when released into the air, contribute to undesirable pollution.

In addition, carbon monoxide (CO) and oxides of nitrogen (NOx) contribute to engine emissions. They, too, are formed during the combustion process and discharged into the exhaust system.

To reduce these pollutants, your Porsche is equipped with a precisely calibrated fuel injection system to assure a finely balanced air/fuel mixture under all operating conditions.

## Oxygen sensor

The oxygen sensor, installed in the exhaust pipe continuously senses the oxygen content of the exhaust and signals the information to an electronic control unit. The control unit corrects the air/fuel ratio, so the engine always receives an accurately metered air/fuel mixture.

## Crankcase ventilation

Through crankcase ventilation, undesirable emissions from the engine crankcase are not permitted to reach the outside atmosphere. These emissions are recirculated from the crankcase to the air intake system. From here the emissions mix with the intake air and are later burned in the engine.

## Catalytic converters

The catalytic converters are efficient “clean-up” devices built into the exhaust system of the vehicle. The catalytic converters burn the undesirable pollutants in the exhaust gas before it is released into the atmosphere.

**The exclusive use of unleaded fuel is critically important for the life of the catalytic converters. Therefore, only unleaded fuel must be used.**



### **The catalytic converters will be damaged by:**

- push or tow starting the vehicle
  - misfiring of the engine
  - turning off the ignition while the vehicle is moving or
  - driving until the fuel tank is completely empty
  - by other unusual operating conditions.
- ▷ Do not continue to operate your vehicle under these conditions, since raw fuel might reach the catalytic converters. This could result in overheating of the converters. Federal law prohibits use of leaded fuel in this car.

## **Fuel Economy**

**Fuel economy will vary depending on where, when and how you drive, optional equipment installed, and the general condition of your car.**

**A car tuned to specifications and correctly maintained, will help you to achieve optimal fuel economy.**

- ▷ Have your vehicle tuned to specifications. Air cleaner should be dirt free to allow proper engine “breathing”. Battery should be fully charged. Wheels should be properly aligned. Tires should be inflated to the correct pressure.
- ▷ Always monitor your fuel consumption.
- ▷ Drive smoothly, avoid abrupt changes in speed as much as possible.
- ▷ Avoid jack rabbit starts and sudden stops.
- ▷ Do not drive longer than necessary in the lower gears. Shifting into a higher gear early without lugging the engine will help save fuel.
- ▷ Prolonged “warm up” idling wastes gas. Start the vehicle just before you are ready to drive. Accelerate slowly and smoothly.

- ▷ Switch off the engine if stationary for longer periods.
- ▷ Any additional weight carried in the vehicle reduces fuel economy. Always keep cargo to a minimum and remove all unnecessary items.
- ▷ Organize your trips to take in several errands in one trip.
- ▷ All electrical accessories contribute to increased fuel consumption.
- ▷ Only switch on the air conditioning when necessary.
- ▷ Do not drive with the Roof Transport System mounted unless you need it.

**The EPA estimated miles per gallon (mpg) is to be used for comparison purposes, actual mileage may be different from the estimated mpg, depending on your driving speed, weather conditions and trip length. Your actual highway mileage will probably be less than the estimated mpg.**

- ▷ Please see all local and national speed limits.

## Operating Your Porsche in other Countries

Government regulations in the United States and Canada require that automobiles meet specific emission regulations and safety standards. Therefore, cars built for the U.S. and Canada differ from vehicles sold in other countries.

If you plan to take your Porsche outside the continental limits of the United States or Canada, there is the possibility that

- unleaded fuel may not be available;
- unleaded fuel may have a considerably lower octane rating. Excessive engine knock and serious damage to both engine and catalytic converters could result;
- service may be inadequate due to lack of proper service facilities, tools or diagnostic equipment;
- replacement parts may not be available or very difficult to get.

**Porsche cannot be responsible for the mechanical damage that could result because of inadequate fuel, service or parts availability.**

If you purchased your Porsche abroad and want to bring it back home, be sure to find out about shipping and forwarding requirements, as well as current import and customs regulations.

## Fuel



---

**Fuel is highly flammable and harmful to health.**

- ▷ Fire, open flame and smoking are prohibited when handling fuel.
- ▷ Avoid contact with skin or clothing.
- ▷ Do not inhale fuel vapours.

**To prevent damage to the emission control system and engine:**

- ▷ Never drive the tank completely out of fuel.
  - ▷ Avoid high cornering speeds after the warning lights have come on.
- 

To avoid permanent damage to the functionality of the catalytic converters and oxygen sensors, use **only unleaded fuel**.

The engine is designed to provide optimum performance and fuel consumption if **unleaded premium fuel with 98 RON/88 MON** is used.

If unleaded premium fuels with octane numbers of **at least 95 RON/85 MON** are used, the engine's knock control automatically adapts the ignition timing.

The emission control system can be damaged in various ways (e.g. fueling incorrectly, shortage of fuel, tow-starting).

- ▷ Please see the chapter "HOW EMISSION CONTROL WORKS" on Page 264.
- ▷ Please see the chapter "DISPLAYING STATUS OF LEVEL CONTROL" on Page 131.



071-013

## Filler flap

The filler flap is located in the rear right fender.

### Unlocking the filler flap

The filler flap is unlocked by activating the remote control or gripping the outer door handle (on vehicles with Porsche Entry & Drive).

### Opening the filler flap

- ▷ With the vehicle unlocked, press on the rear part of the filler flap (**arrow**). The filler flap pops up and can be opened.



071-014

*Fuel quality label*

### Closing the filler flap

- ▷ Close the filler flap and press on the rear of the filler flap (**arrow**) until it can be felt to engage.

### Locking the filler flap

The filler flap is locked by activating the remote control or the button in the outer door handle (on vehicles with Porsche Entry & Drive).



081-070

## Emergency unlocking

If the electrical release is faulty:

1. Open rear lid.
2. Remove lid of the right storage compartment.
3. Pull emergency release **A** in the **direction of the arrow**.  
The filler flap pops open.

## Refueling

- ▷ **Total capacity approx. 26.4 gallons (100 liters), including approx. 3 gallons (12 liters) reserve.**

### **Danger!**

---

The RF energy from a cellphone can cause a sparking on bare metal, much like aluminum foil in a microwave oven. The spark could ignite gasoline fumes present while refueling. Static discharge from your body can ignite gasoline fumes present when you get back out of the vehicle and touch the fuel nozzle. In either case, resulting fire can cause serious damage to the vehicle, serious injury or death to persons in immediate vicinity.

- ▷ Do not use a cellphone while pumping gas.
  - ▷ Do not re-enter the vehicle while pumping gas.
- 

1. Stop the engine and switch off the ignition.



2. Slowly unscrew the tank cap. Hang the tank cap's plastic strap on the hook **A** on the inside wall of the filler flap.
3. Insert pump nozzle fully into the filler neck with the handle of the pump nozzle facing down.
4. Do not add further fuel once the correctly operated automatic pump nozzle has switched off.  
Fuel could spray or could run over when heated.
5. Replace the tank cap immediately after refueling and turn it until you hear it and feel it engage.

## Maintenance Note

If you lose the tank filler cap, you must replace it only with an original part.

### **Caution!**

---

**Risk of damage. Decorative foils may bleach of they come into contact with fuel.**

- ▷ Wipe off any spilt fuel immediately.
- 

## Portable Fuel Containers

### **Danger!**

---

**Portable fuel containers, full or partially empty, may leak causing an explosion, or result in fire in case of an accident.**

- ▷ Never carry additional fuel in portable containers in your vehicle.
-

## Fuel Recommendations

Your Porsche is equipped with catalytic converters and must use **UNLEADED FUEL ONLY**.

Your engine is designed to provide optimum performance and fuel economy using unleaded premium fuel with an octane rating of **98 RON (93 CLC or AKI)**. Porsche therefore recommends the use of these fuels in your vehicle.

Porsche also recognizes that these fuels may not always be available. Be assured that your vehicle will operate properly on unleaded premium fuels with octane numbers of at least **95 RON (90 CLC or AKI)**, since the engine's "Electronic Octane™ knock control" will adapt the ignition timing, if necessary.

It is important to observe the regular service intervals, and particularly the oil change intervals, specified in your **Maintenance Schedule**.

**The use of UNLEADED FUEL ONLY is critically important to the life of the catalytic converters. Deposits from leaded fuels will ruin the converters and make it ineffective as an emission control device.**

Cars with catalytic converters have a smaller fuel tank opening, and gas station pumps have smaller nozzles. This will prevent accidental pumping of leaded fuel into cars with catalytic converters.

Unleaded fuels may not be available outside the continental U.S. and Canada. Therefore, we recommend you do not take your car to areas or countries where unleaded fuel may not be available.

## Octane ratings

Octane rating indicates a fuel's ability to resist detonation. Therefore, buying the correct octane gas is important to prevent engine "damage".

The RON octane rating is based on the research method. The CLC (U.S. Cost of Living Council octane rating) or AKI (antiknock index) octane rating usually displayed on U.S. fuel pumps is calculated as research octane number plus motor octane number, divided by 2, that is written as:

$$\frac{\text{RON} + \text{MON}}{2} \quad \text{or} \quad \frac{\text{R} + \text{M}}{2}$$

The CLC or AKI octane rating is usually lower than the RON rating:

For example: 95 RON corresponds 90 CLC or "AKI"

- ▷ Do not use fuel additives without Porsche approval.

## Fuels containing ethanol

- ▷ Do not use any fuels containing more than 10 percent ethanol by volume.

We recommend, however, to change to a different fuel or station if any of the following problems occur with your vehicle:

- Deterioration of driveability and performance.
- Substantially reduced fuel economy.
- Vapor lock and non-start problems, especially at high altitude or at high temperature.
- Engine malfunction or stalling.

## Fuel Evaporation Control

### Fuel tank venting

The evaporation chamber and the carbon canister prevent fuel from escaping to the atmosphere at extreme high outside temperatures, when driving abruptly around curves and when the car is parked at an incline or in any other nonlevel position.

### Vapor control system and storage

When the fuel tank is filled, vapors are collected in the evaporation chamber by a vent line leading the vapors to the carbon canister where they are stored as long as the engine does not run.

### Purge system

When the engine is running, the fuel vapors from the canister will be mixed with fresh air from the ambient air of the canister. This mixture will be directed to the intake air housing by the tank vent line, mixed with the intake air and burned during normal combustion.

## Car Care Instructions

- ▷ Please see the chapter “EXERCISE EXTREME CAUTION WHEN WORKING ON YOUR VEHICLE” on Page 250.

**Regular and correct care helps to maintain the value of your car and is also a precondition for the New Vehicle Warranty and the Anti Corrosion Warranty.**

**Your authorized Porsche dealer has specially developed car-care products from the Porsche program available either singly or as complete car-care sets. They will be pleased to help you select suitable products.**

**Whether you use Porsche products or other commercially available cleaning agents first make sure of their correct application.**

A Porsche that is well-cared for can look like new for years. It all depends on the amount of care the owner is willing to give the car.

### Warning!

---

**Risk of serious personal injury or damage to the vehicle or property.**

**Cleaning agents may be hazardous to your health.**

**Most chemical cleaners are concentrates which require dilution. High concentrations might cause problems ranging from irritation to serious injury as well as damage to your vehicle.**

- ▷ Keep cleaning agents out of reach from children.
  - ▷ Observe all caution labels.
  - ▷ Always read directions on the container before using any product. These directions may contain information necessary to avoid personal injury.
  - ▷ Do not use fuel, kerosene, naphtha, nail polish remover or other volatile cleaning fluids. They may be toxic, flammable or hazardous in other ways. Only use spot removing fluids in a well vented area.
  - ▷ Do not clean the underside of chassis, fenders, wheel covers, etc., without protecting your hands and arms as you may cut yourself on sharp-edged metal parts.
- 

Moisture and road salt on brakes may affect braking efficiency.

Test the brakes after each vehicle washing.

## High-pressure cleaning equipment, steam cleaners



### Warning!

#### High-pressure cleaning equipment, steam cleaners or similar can damage the following components:

- Tires
- Logos, emblems
- Painted surfaces
- Widened fenders
- Lock and latch of the removable towing attachment
- Seals of the electrically retractable ball hitch
- Alternator, valve covers
- ParkAssist sensors
- ▷ Please see the operating instructions from the unit manufacturer.
- ▷ Always cover the lid over the brake fluid reservoir prior to cleaning. Never point the cleaning jet directly at the lid.
- ▷ When cleaning with a flat-jet nozzle or the like, maintain a minimum distance of 21 in. (50 cm).

- ▷ Never use high-pressure cleaning equipment, steam cleaners, etc. with a round-jet nozzle. High-pressure cleaning equipment with a round nozzle will damage your vehicle. The tires are particularly susceptible to damage.
- ▷ Do not point the cleaning jet directly at any of the aforementioned components.

#### Decorative foils



### Caution!

#### Risk of damage due to separation of the decorative foils when using high-pressure cleaning equipment, steam cleaners or similar cleaning equipment.

- ▷ Do not use high-pressure cleaning equipment, steam cleaners, etc. to clean decorative foils.

#### Door lock

- ▷ To prevent the door lock from freezing during the cold season, cover the lock barrel with a suitable adhesive tape during washing.

Should the locks freeze, use an ordinary de-icer. In many cases, a well warmed key can help. Never use excessive force.

## Washing

The best protection for the car from the damaging effects of the environment is frequent washing and preservation. The underside of the car should also be thoroughly washed for cinders, salt or sanding at winter's end.

The longer salt, road dust, industrial dust, insect remains, bird excrement, and tree exudations (resin, pollen), etc. are allowed to remain on the bodywork, the more serious is their harmful effect.

New cars should be washed carefully with plenty of clear water to protect the new paint work. Dark paint finishes show up the smallest of surface damage (e.g. scratches) more readily than lighter colors.

Dark colors are also more susceptible to scratching because of the composition of their pigments and require particularly careful paint care.

- ▷ Do not wash your car in bright sunlight or while the bodywork is still hot.
- ▷ When washing by hand, use abundant water, a soft sponge or wash brush and Porsche car shampoo.
- ▷ Begin by spraying the body thoroughly with water to rinse away loose dirt.
- ▷ After washing, rinse the car with plenty of water and then dry with a chamois leather. Do not use the same chamois leather for drying as you use for cleaning the windshield and windows.

## Warning!

**Moisture which gets on the brakes during a car wash can reduce braking efficiency or make the brake pull unevenly which could increase the danger of an accident, causing serious personal injuries or death.**

- ▷ After washing the vehicle, test the brakes and steering and briefly brake the discs dry. When doing so, make sure that vehicles traveling behind you are not affected.

### Automatic car washes

- ▷ Please see the chapter “WIPER BLADES” on Page 261.

Optional add-on parts or parts which project beyond the contours of the vehicle may be damaged by design features (e.g. brushes) of automatic car washes.

### The following parts are particularly susceptible to damage:

- Windshield wipers and rear wiper (always switch them off – wiper stalk in position **0** – to prevent them wiping unintentionally in intermittent or sensor operation).
  - Door mirrors (always fold in).
  - External antennas (always unscrew).
  - Roof Transport System (always remove completely).
  - Off-road roof-mounted headlights (always remove completely).
  - Spoiler.
  - Wheels (the wider the rim and the lower the tire height, the greater the risk of damage).
- ▷ Please consult the operator before using automatic car washes.
  - ▷ Wash and dry by hand all points not reached by a car wash, such as door and lid seams or door sills.

### Note

Automatic car washes spray water at odd angles and high pressures, which are not seen in normal driving. Therefore, water can sometimes find its way into the passengers compartment during or shortly after the car wash.



## Paint

- ▷ Never rub a dusty car with a dry cloth since dust particles are abrasive and could dull and damage the surface finish.

The paintwork of your car is exposed to all types of mechanical and chemical conditions, particularly climatic ones such as bright sunlight, rain, frost and snow. Ultraviolet light, rapid changes in temperature, rain, snow, industrial dust and chemical deposits constantly attack the paint which is only able to withstand such exposure in the long term if it is given regular care and attention.

- ▷ Do not apply silicone polishes to the windshield or window.
- ▷ Do not treat matt-painted components with preservatives or polishes, otherwise the matt effect will be lost.

## Preservation

The paint surface becomes dull over time due to weathering. It is therefore necessary to preserve the paint regularly.

This keeps the paint shiny and elastic. Dirt is prevented from adhering to the paint surface and industrial dust is prevented from penetrating the paint.

Provided it is washed and treated with preservative regularly, the brand new finish of your car will be retained for years to come.

- ▷ Simply apply paint preservative after washing the car and polish it smooth.

## Polishing

Do not resort to using Porsche polish until it becomes evident that the normal preservatives no longer produce the desired finish.

## Removing spots and stains

- ▷ Remove tar stains, grease, oil spots and dead insects etc. as soon as possible with Insect Remover. They can cause discoloration if allowed to remain on the paintwork.
- ▷ Wash the affected area immediately after treating it.

## Minor paint damage

- ▷ Have minor paint damage, such as scratches, scores or chips caused by flying stones, repaired immediately by your authorized Porsche dealer **before** corrosion begins.

However, if there are already traces of corrosion, they must first be removed carefully and thoroughly. Coat the area with a rust-proofing primer and finish off with a top coat. The paint code and color number are found on the data bank in the Maintenance booklet and on the vehicle's data bank.

- ▷ Please see the chapter "DATA BANK" on Page 347.

## Cleaning the engine compartment



---

**Risk of damage, e.g. to the alternator, painted surfaces, and the valve covers.**

- ▷ Never use high-pressure cleaning equipment with a round-jet nozzle.
  - ▷ Always maintain a minimum distance of 21 in. (50 cm).
  - ▷ Always cover the lid over the brake fluid reservoir prior to cleaning with a high-pressure cleaner. Never point the cleaning jet directly at the lid.
  - ▷ Do not point the cleaning jet directly at any of the aforementioned components.
- 

## Note on operation

If the car is driven off-road frequently and after driving on salted or gritted roads:

- ▷ Clean the engine compartment regularly.

## Windows

The road dust which settles on the windshield and windows contains particles of tire rubber and oil residue. The interior trim and upholstery release particles, particularly in strong sunlight, which collect on the insides of the windows. These deposits are augmented by impurities in the air which enters the car through the fresh air vents.

- ▷ Clean all windows regularly, inside and outside, with Porsche window cleaner.
- ▷ Make sure not to damage the TV antenna in the side window when cleaning.
- ▷ If you use a chamois leather for the windows, do not use it for paintwork as it will otherwise pick up a certain amount of preservative or polish and could smear the windows and thus impair vision.
- ▷ Remove dead insects with insect remover.

## Care of wiper blades

Wiper blades that are in perfect condition are vital for a clear view.

- ▷ Replace the wiper blades twice per year (before and after the cold season) or if wiper performance deteriorates or the blades are damaged.
- ▷ For information on replacing the wiper blades: Please see the chapter "WIPER BLADES" on Page 261.
- ▷ Periodically clean the wiper blades with window cleaner, especially after the vehicle has been washed in a car wash. We recommend the Porsche window cleaner. In the event of heavy soiling (e.g. insect residue), the blades can be cleaned with a sponge or a cloth.

If the wiper blades rub or squeak, this may have the following causes:

- If the vehicle is washed in an automatic car wash, wax residues may adhere to the windshield. These wax residues can be removed only by using window cleaner concentrate.
- ▷ Please see the chapter "WASHER FLUID" on Page 258.

Please contact your authorized Porsche dealer for further information.

- The wiper blades may be damaged or worn.
- ▷ Replace damaged or worn wiper blades as soon as possible.

## Undercoating

The underside of your car is durably protected against chemical and mechanical influences.

As it is not possible to exclude the risk of damage to this protective coating in day to day driving, it is advisable to have the underside of the car inspected at certain intervals - preferably before the start of winter and again in spring - and the undercoating restored as necessary.

Your authorized Porsche dealer is familiar with the bodyseal treatment procedures and has the necessary equipment for applying factory approved materials. We recommend that you entrust them with such work and inspections.

Unlike conventional spray oils, undercoating and rust-proofing compounds based on bitumen or wax do not attack the sound-proofing materials applied at the factory.



### Warning!

---

#### **Danger of fire resulting in serious personal injury or death.**

- ▷ Do not apply additional undercoating or rust-proofing on or near the exhaust manifold, exhaust pipes, catalytic converters or heat shields. During driving the substance used for undercoating could overheat and ignite.
- 

- ▷ Before applying fresh underseal, carefully remove deposits or dirt and grease. Once it has dried, the new undercoating compound forms a tough protective coating which provides efficient rust-proofing of the floor panels and components.
- ▷ Always apply a fresh coating of suitable preservative to unprotect areas after cleaning the underside of the body, the transmission, the engine or carrying out repairs to underbody, engine or transmission components.

Effective rust-proofing is particularly important during the cold weather season. If your car is driven frequently in areas where salt has been spread on the roads, the whole engine compartment should be cleaned thoroughly after the winter to prevent salt from causing any lasting damage. A full under-body wash should also be performed at the same time.

## Cleaning headlights, lights, interior and exterior plastic parts, adhesive films

Observe the following points:

- ▷ Use **only** clean water and a little dishwashing detergent or interior window cleaner to clean headlights, lights, plastic parts, adhesive films and surfaces.  
Use a soft sponge or a soft, lint-free cloth.

### Note

An interior window cleaner can also be used to clean plastic surfaces (observe cleaning instructions on the container!).

We recommend the Porsche interior window cleaner.

- ▷ Gently wipe the surface without applying too much pressure.
- ▷ Do not clean when dry.
- ▷ Never use other chemical cleaners or solvents.

Rinse cleaned surfaces with clear water.

## Light alloy wheels

- ▷ Please see the chapter “AUTOMATIC CAR WASHES” on Page 272.

### Danger!

---

**Danger of accident resulting in serious personal injury or death if cleaning agents (e.g. wheel cleaning agents) come into contact with the brake discs. The resulting film on the brake discs can impair braking performance.**

- ▷ Make sure that no cleaning agent comes into contact with the brake discs.
- ▷ If cleaning agent has come into contact with the brake discs, thoroughly clean the brake discs with a strong jet of water.
- ▷ Paying attention to any road users behind you, dry the brake discs by applying the brakes.

Pitting may occur if metallic particles which cause contact corrosion (e.g. brass or copper in brake dust) are allowed to remain on the aluminum too long.

- ▷ If possible, wash the wheels with a sponge or wash brush about every two weeks. In areas where road salt or grit is spread on winter roads or there is a lot of airborne industrial dust, it is best to clean the wheels weekly.  
**The Porsche Light Alloy Wheel Cleaner (ph-value 9.5) can be used for this purpose.**

**If the ph-value of the detergent is incorrect, the protective coating on the wheels will be destroyed.**

**Polishes which dissolve oxides, such as those frequently used for other metals, or abrasive tools or agents are unsuitable because they break down the oxide film of the protective coating and will cause discoloration of the wheel.**

- ▷ Every three months, after cleaning, coat the wheels with a car wax or non-corrosive grease (e.g. vaseline).  
Using a clean cloth thoroughly rub the grease into the surface.

## Stainless steel exhaust tailpipes

Stainless steel exhaust tailpipes can discolor due to soiling, strong heat, and combustion residues.

The original polish can be achieved again using commercially available metal polishing paste or metal polish.

## Cleaning door, roof, lid and window seals

### Caution!

---

**The lubricant coating on the inner door seals may be damaged by unsuitable cleaning and care agents.**

- ▷ Do not use any chemical cleaning agents or solvents.
  - ▷ Do not use any care agents.
- 
- ▷ Wash dirt (e.g. abrasion, dust, road salt or grit) from all seals regularly using warm soapy water. Do not use any chemical cleaning agents or solvents.
  - ▷ When there is a frost hazard, the outer door seals and the lid seals can be protected against freezing into place by a suitable care product.

## Leather care

The natural surface markings of leather, e.g. creases, healed scars, insect sting marks, structural differences and slight variations in shade and grain add to the attractiveness of the high-quality natural leather product.

Observe the following care instructions:



---

**The leather will be damaged by the use of unsuitable cleaning and care agents and by inappropriate treatment.**

- ▷ Do not use caustic cleaners or hard cleaning objects!
  - ▷ Perforated leather must under no circumstances get wet on its reverse side.
- 
- ▷ All types of leather should be cleaned regularly to remove fine dust using a soft, damp, white woollen cloth or a commercially available microfibre cloth.
  - ▷ Remove heavy contamination with a leather cleaner. Please always follow the instructions for use given on the containers. We recommend the Porsche leather care product.
  - ▷ Once cleaned, leather (particularly the heavily stressed leather seats) must be treated only with Porsche leather care product.

## Carpets and mats

- ▷ Use only a vacuum cleaner or a medium stiff brush.
- ▷ Remove stains and spots with Porsche stain remover.

The Porsche range of accessories includes floor-mats to protect the carpets in summer and winter.



---

**Risk of an accident resulting in serious personal injury or death.**

- ▷ Always check the movement of the pedals before driving and make sure that they are not obstructed by a floor mat or any other object.
  - ▷ Secure the floor mat to prevent it from sliding into positions that could interfere with the safe operation of your vehicle – do not lay them loosely in the vehicle. Your Porsche dealer will be glad to offer you floor mats of correct size including a securing possibility.
- 

## Cleaning airbags covers



---

**There is a danger of serious personal injury or death if the airbag system is impaired by improper cleaning work.**

- ▷ Do not make any modifications whatsoever on individual components such as the padded covers of the steering wheel, the passenger side of the dashboard, the front seats, the roof pillars and the rooflinings.
  - ▷ Let your authorized Porsche dealer clean these components.
- 

## Cleaning fabric linings

Fabric linings on pillars, headliner and sun visors, etc., must be treated only using suitable cleaning agents or a suitable dry foam and a soft brush.

## Cleaning Alcantara

- ▷ Do not use a leather care product to clean Alcantara.

For regular care it is sufficient to clean the cover with a soft brush. Heavy abrasion or rubbing when cleaning causes a permanent change in the surface.

## Cleaning when lightly soiled

- ▷ Wet a soft cloth with water or a neutral soap solution and wipe off the dirt.

## Cleaning when heavily soiled

- ▷ Wet a soft cloth with lukewarm water or thinned white spirit and dab the dirt from the outside in.

## Cleaning safety belts

- ▷ Use mild detergent to clean soiled belts.
- ▷ When drying, avoid direct sunlight.
- ▷ Only use suitable cleaning agents.
- ▷ Do not tint or bleach the belts. The belt fabric could be weakened, thus affecting safety.

## Storing your Porsche

If you intend to store your Porsche for a prolonged period, please consult your authorized Porsche dealer. The staff will be glad to advise you on the most suitable and necessary methods.

- ▷ Clean your vehicle thoroughly inside and outside. Clean the engine compartment. The under carriage and chassis components should be free of dirt and salt deposits.
- ▷ Fill up the fuel tank.
- ▷ Change the oil and oil filter, and run the engine for several minutes.
- ▷ Increase the tire pressure to 58 psi (4 bar). It is not recommended to lift the vehicle, due to the possibility of corrosion on shock absorber piston shafts. The vehicle should be moved slightly, approximately every four weeks, to prevent flat spot on the tires.

## Climate control

The air conditioning system should be in good working condition and fully charged.

## Windshield/Headlight washer

- ▷ Check and correct antifreeze/cleaning solution level as necessary.

## Electrical system

- ▷ Remove the battery from the vehicle and store it in a cool dry place, not on a cement floor. When the battery is disconnected, the alarm system is deactivated.
- ▷ Recharge the battery every 3 months. If the battery remains in the vehicle with the cables connected, it is necessary to check, remove and recharge the battery every 2-3 weeks. Do not fast charge the battery.
- ▷ Please see the chapter "CHARGE STATE" on Page 320.

## Vehicle interior

The interior must be dry, especially in the area of the floor carpets. The use of drying agents (Silica-Gel) is recommended in vehicles with leather interior and in areas with high humidity. The recommended amount is 3 fabric bags of 1.1 lbs. (500 grams) each placed on the floor carpets.

- ▷ Windows, doors, lids and roof must be closed. The air vents should be opened.

# Minor Repairs

Exercise Extreme Caution when Working on your Vehicle .....	280
Tires/Wheels .....	281
Jack .....	291
Tool Kit .....	292
Compressor .....	292
Spacers .....	293
Wheel Bolts .....	293
Changing Wheels.....	294
Flat Tire.....	295
Lifting the Vehicle with a Lifting Platform or Garage lift.....	298
Electrical System .....	312
Battery .....	320
Replacing the remote control battery .....	322
Emergency Starting with Jumper Cables .....	323
Replacing Bulbs .....	326
Headlights .....	327
Tail light .....	336
License Plate Lights .....	338
Headlight Adjustment.....	339
Changing headlights from left to right-hand traffic .....	340
Bulb Chart .....	342
Towing .....	342

## Exercise Extreme Caution when Working on your Vehicle



**Ignoring the following instructions may cause serious personal injury or death.**

- ▷ The engine compartment of any motor vehicle is a potentially hazardous area. If you are not fully familiar with proper repair procedures, do not attempt the adjustments described on the following pages.  
This caution applies to the entire vehicle.
- ▷ Only work on your vehicle outdoors or in a well ventilated area.
- ▷ Ensure that there are no open flames in the area of your vehicle at any time when fuel fumes might be present. Be especially cautious of such devices such as hot water heaters which ignite a flame intermittently.
- ▷ Before working on any part in the engine compartment, turn the engine off and let it cool down sufficiently. Hot engine compartment components can burn skin on contact.
- ▷ Be alert and cautious around engine at all times while the engine is running.  
If you have to work on the engine while it is running, always put the parking brake on **and** put the gearshift lever in neutral or the Tiptronic selector lever in position **P** or **N**.

- ▷ In particular, be very careful to ensure that items of clothing (ties, shirt, sleeves etc.), jewelry, long hair, hand or fingers cannot get caught in the engine-compartment blower, fan, belts or other moving parts.  
The radiator and radiator fans are in the front of the car.  
The fans can start or continue running as a function of temperature, even with the engine switched off.  
Carry out work in these areas only with the engine off and exercise extreme caution.
- ▷ Your Porsche is equipped with an electronic ignition system. When the ignition is on, high voltage is present in all wires connected with the ignition system; therefore, exercise extreme caution when working on any part of the engine while the ignition is on or the engine is running.
- ▷ Always support your car with safety stands if it is necessary to work under the car. The jack supplied with the car is not adequate for this purpose.  
For vehicles with air suspension with level control and height adjustment:  
Please see the chapter "RAISING VEHICLE WITH THE JACK" on Page 192.

- ▷ When working under the car without safety stands but with the wheels on the ground, make sure the car is on level ground, the wheels are blocked, and that the engine cannot be started.  
Remove the ignition key.
- ▷ Do not smoke or allow an open flame around the battery or fuel.  
Keep a fire extinguisher close at hand.
- ▷ Incomplete or improper servicing may cause problems in the operation of the car. If in doubt about any servicing, have it done by your authorized Porsche dealer.  
Improper maintenance during the warranty period may affect your Porsche warranty coverage.
- ▷ Supplies of fluids, e.g. engine oil, brake fluid or coolant, are hazardous to your health. Keep these fluids out of children's reach and dispose of them in accordance with the appropriate regulations.
- ▷ Some countries require additional tools and special spare parts to be carried in your vehicle.  
Please make enquiries before driving abroad.



## Notes on minor repairs

### Tool kit

The tool kit is accommodated in the spare-wheel well under the cover of the loadspace floor.

### Note

The tools required for changing a wheel (e.g. jack, wheel bolt wrench, assembly aids, folding wedges) are only supplied with the vehicle if the vehicle comes with a collapsible spare wheel or full-size spare wheel as standard. Your authorized Porsche dealer will be pleased to advise you.

## Tires/Wheels

The original equipment tires and wheel rims on your Porsche comply with all applicable Federal Motor Vehicle Safety Standards.

### For your safety remember the following:

- Wheel rims and wheel bolts are matched to fit your Porsche.
- If you intend to use other than original equipment wheels, be sure that they conform to Porsche specifications for your model. Only tires with the same make and with the same specification code (e.g. “N0”, “N1”...) can be mounted.
- The use of wheel rims and wheel bolts that do not meet specifications of the original factory installed equipment will affect the safe operation of your vehicle and affect warranty coverage.
- Before you plan on exchanging wheels, or snow tires already mounted on the wheel rims, consult your authorized Porsche dealer. Your dealer has the technical information necessary to advise you which wheel rims and wheel bolts are compatible with the original factory installations.



---

### Risk of loss of control and serious personal injury or death.

- ▷ If while driving, your vehicle experiences a sudden vibration or ride disturbance, and/or you suspect that possible damage to your tires or vehicle has occurred, you should immediately reduce your speed without excessive use of the brakes.
  - ▷ Stop the vehicle as soon as possible, and inspect the tires.  
If you cannot determine the cause for the disturbance, have your vehicle towed to the nearest Porsche or tire dealer to have your vehicle or tire(s) inspected.
  - ▷ Continuing to operate the vehicle without correction could result in a loss of control and serious personal injury.
-



Example

## Uniform Tire Quality Grading

Quality grades can be found where applicable on the tire sidewall between tread shoulder and maximum section width.

All passenger car tires must conform to Federal Safety Requirements in addition to these grades.

### Treadwear

The treadwear grade is a comparative rating based on the wear rate of the tire when tested under controlled conditions on a specific government test course. For example, a tire graded 150 would wear one and a half (1-1/2) times as well on the government course as a tire graded 100. The relative performance of tires depends upon the actual conditions of their use, however, and may depart significantly from the norm due to variations in driving habits, service practices and differences in road characteristics and climate.

### Traction AA, A, B, C

The traction grades, from highest to lowest, are AA, A, B, and C and they represent the tire's ability to stop on wet pavement as measured under controlled conditions on specified government test surfaces of asphalt and concrete. A tire marked C may have poor traction performance.



**Warning!**

---

**The traction grade assigned to this is based on braking (straight-ahead) traction tests and does not include cornering (turned) traction, acceleration, hydroplaning or peak traction characteristics.**

---

### Temperature A, B, C

The temperature grades are A (the highest), B and C, representing the tire's resistance to the generation of heat and its ability to dissipate heat when tested under controlled conditions on a specified indoor laboratory test wheel.

Sustained high temperatures can cause the material of the tire to degenerate and reduce tire life, and excessive temperature can lead to sudden tire failure.

The grade C corresponds to a level of performance which all passenger car tires must meet under the Federal Motor Vehicle Safety Standard No. 109.

Grades B and A represent higher levels of performance on the laboratory test wheel than the minimum required by law.



**Warning!**

---

**The temperature grade for this tire is established for a tire that is properly inflated and not overloaded. Excessive speed, underinflation, or excessive loading, either separately or in combination, can cause heat buildup and possible tire failure, resulting loss of control, leading to serious personal injury or death.**

---

## Tire pressures



**Danger!**

---

**Risk of accident.**

**Risk of serious personal injury or death.**

**Driving the vehicle with low tire pressure increases risk of a tire failure and resulting loss of control. Furthermore, low tire pressure increases rate of wear of the affected tires and cause damage.**

- ▷ Always use an accurate tire pressure gage when checking inflation pressures.
  - ▷ Do not exceed the maximum tire pressure listed on the tire sidewall. (Also refer to “Technical data”).
  - ▷ Please see the chapter “TIRE PRESSURE PLATE” on Page 284.
  - ▷ Cold tire inflation pressure means: all tires must be cold, ambient temperature maximum 68°F (20°C), when adjusting the inflation pressure. Avoid sunlight striking the tires before measuring cold pressures, since the pressures would rise from temperature influence.
  - ▷ Valve caps protect the valve from dust and dirt, and thus from leakage. Always screw caps tightly down. Replace missing caps immediately.
  - ▷ Use only plastic valve caps.
  - ▷ For safety reasons, don't use tire inflating bottles.
- 

- ▷ Please see the chapter “TIRE PRESSURES, COLD (68 °F/20 °C)” on Page 354.

Each tire, including the spare (if provided), should be checked monthly when cold and inflated to the inflation pressure recommended by the vehicle manufacturer on the vehicle placard or tire inflation pressure label. (If your vehicle has tires of a different size than the size indicated on the vehicle placard or tire inflation pressure label, you should determine the proper tire inflation pressure for those tires).

As an added safety feature, your vehicle has been equipped with a tire pressure monitoring (TPM) that illuminates a low tire pressure telltale when one or more of your tires is significantly under-inflated. Accordingly, when the low tire pressure telltale illuminates, you should stop and check your tires as soon as possible, and inflate them to the proper pressure. Driving on a significantly under-inflated tire causes the tire to overheat and can lead to tire failure. Under-inflation also reduces fuel efficiency and tire tread life, and may affect the vehicle's handling and stopping ability.

Please note that the TPM is not a substitute for proper tire maintenance, and it is the driver's responsibility to maintain correct tire pressure, even if under-inflation has not reached the level to trigger illumination of the TPM low tire pressure telltale.

For further information on the tire pressure monitoring:

- ▷ Please see the chapter “SETTING TIRE PRESSURE MONITORING” on Page 132.

When tires are warm, the tire pressure is increased.

- ▷ Never let air out of hot tires. This could cause the tire pressure to fall below the prescribed value.

Insufficient tire pressure can cause tires to overheat and thus be damaged – even invisibly. Hidden tire damage is not eliminated by subsequently correcting the tire pressure.

## Overloading



**Danger!**

### Risk of damage to vehicle parts, loss of control and serious personal injury or death.

- ▷ Do not overload your vehicle. Be careful about the roof load.
- ▷ If loading the vehicle also correct the tire pressure. Tire pressure for loaded vehicle can be found on the tire pressure plate and in the chapter technical data.
- ▷ Never exceed the specified axle load. Overloading can shorten the service life of the tires and car, as well as lead to dangerous vehicle reactions and long braking distances. Damage due to overloading is not covered by the vehicle warranty.

- ▷ Please see the chapter "LOADING INFORMATION" on Page 231.



Example of a tire pressure plate

## Tire Pressure plate

### Information on the tire pressure plate

- A Seating capacity  
Maximum number of vehicle occupants, including the driver.

- B Vehicle load limit  
Is the maximum total weight limit specified of the load (passengers and cargo) for the vehicle. This is the maximum weight of passengers and cargo that can be loaded into the vehicle. If a trailer is being towed, the trailer tongue weight must be included as part of the cargo load.  
Please see the chapter "LOADING INFORMATION" on Page 231.
- C Original tire size  
Size of tires mounted at the factory.
- D Recommended cold tire inflation pressure  
These values are for cold tires (68 °F/20 °C).
- E Approved tire sizes
- F Size and tire pressure for the collapsible spare wheel

## Tire traction



**When driving on wet or slushy roads, a wedge of water may build up between the tires and the road. This phenomenon is known as "hydroplane" and may cause partial or complete loss of traction, vehicle control or stopping ability.**

- ▷ Reduce speed on wet surfaces to prevent this.

## Tire life

Tire life depends on various factors, i.e., road surfaces, traffic and weather conditions, driving habits, type of tires and tire care.

- ▷ Inspect your tires for wear and damage before driving off. If you notice uneven or substantial wear, wheels might need alignment or tires should be balanced or replaced.

## Tire wear

The original equipment tires on your Porsche have built-in tire wear indicators. They are molded into the bottom of the tread grooves and will appear as approximately 1/2 in. (12 mm) bands when the tire tread depth is down to 1/16 of an in (1.6 mm).

When the indicators appear in two or more adjacent grooves, it is time to replace the tires. We recommend, however, that you do not let the tires wear down to this extent.

Worn tires cannot grip the road surface properly and are even less effective on wet roads.

In the United States, state laws may govern the minimum tread depth permissible. Follow all such laws.

## Danger!

**Driving on worn tires can result in loss of control of the vehicle and could cause serious personal injuries or death.**

- ▷ Do not drive with worn tires or tires showing cuts or bruises as they may lead to sudden deflation and loss of control which could cause severe personal injury.
- ▷ Specialized high performance tires on high performance sport utility vehicles exhibit more wear than those on a family sedan, or even a high performance sedan. Therefore, it is important to check your tire pressure and condition at least every two weeks.
- ▷ If you notice that tires are wearing unevenly, consult your Porsche dealer.

Uneven wear may not always be due to improper wheel alignment. It can be the result of individual driving habits such as cornering at high speeds. If the tire pressure is not checked and adjusted regularly, abnormal tire wear can also occur.

## Tire care

- ▷ Avoid damaging tires and wheel rims.
- ▷ If you must drive over a curb or other obstacle, drive slowly and at an obtuse angle.
- ▷ Check tires for uneven wear and damage before driving off.
- ▷ Remove imbedded material.
- ▷ Replace worn or damaged tires immediately.
- ▷ Keep oil, fuel, brake fluid, etc. away from tires.
- ▷ Replace missing valve stem caps.
- ▷ Keep tires inflated correctly.
- ▷ Wash tires when washing the vehicle. Also clean inner side of wheels.
- ▷ Do not use abrasive cleaners when washing the wheels.
- ▷ Check wheel rims for corrosion.
- ▷ Remove road salt, if driving in winter.

## Tire damage, puncture

- ▷ Please see the chapter “HIGH-PRESSURE CLEANING EQUIPMENT, STEAM CLEANERS” on Page 271.



**Risk of serious personal injury or death. Driving the vehicle with low tire pressure increases risk of a tire failure and resulting loss of control. Furthermore, low tire pressure increases rate of wear of the affected tires.**

- ▷ Check tires – including sidewalls – regularly for foreign bodies, nicks, cuts, cracks and bulges.
- ▷ After driving off road, examine tires for signs of damage such as cuts, tears, bulges or foreign objects stuck in the tread. Replace a damaged tire if necessary.
- ▷ Cross curb edges slowly and at right angles if possible.  
Avoid driving over steep or sharp curbs.
- ▷ In cases of doubt, have the wheel (particularly the inner side) checked by an authorized Porsche dealer.

In case of tire damage, where it is uncertain whether there is a break in the ply with all its consequences or tire damage caused by thermal or mechanical overloading due to loss of pressure or any other prior damage, we recommend that the tire be replaced for safety reasons.

If one faulty tire is replaced it should be noted that the difference in tread depth on one axle must not exceed 30%. Handling inconsistencies may result.

- ▷ Perform a visual inspection if necessary.

## Tire replacements

- ▷ Use only tire makes and types tested by Porsche.

**If you do not use a Porsche recommended replacement tire, make sure that you purchase your new tires from a reputable tire dealer and that the dealer complies with all manufacturers warnings for those tires.**

**Only tires with the same manufacturer and with the same specification code (e.g. “NO”, “N1”...) should be mounted on the vehicle.**

**Before mounting new tires, check with your Porsche dealer about the current release status.**

Tires should be replaced no less than on one axle at the time. Only tires of the same make and type must be used. Mixed tires are not permissible and will affect vehicle performance, safety, and can affect vehicle warranty.

Porsche dealers can recommend the most current replacement tire options for your vehicle.

Initially, new tires do not have their full traction. You should therefore drive at moderate speeds during the first 60 - 120 miles (100 - 200 km).

**Tires must always remain on the same side of the vehicle.**

When wheels are removed, the direction of rotation and position of each wheel should be marked.

If new tires are installed only on **one** axle, a noticeable change in handling occurs due to the different tread depth of the other tires. This happens especially if only rear tires are replaced. However, this condition disappears as the new tires are broken in.

- ▷ Please adjust your driving style accordingly.

Installation of new tires should only be done by a qualified tire technician.

## Valves

- ▷ Use only plastic valve caps.
- ▷ The rubber valves must be replaced whenever the tires are changed.
- ▷ The fitting and replacement specifications must be observed for metal valves.
- ▷ Only use Original Porsche metal valves.
- ▷ Protect the valve inserts against soiling with valve caps.  
Soiled valve inserts can cause a gradual loss of air.

## Parking at the curb



**Hard impacts against curbs (or traffic islands) are dangerous and may cause hidden tire damage which is not noticeable until later. Such damage can result in accidents at high speeds causing serious personal injury or death. Depending on the force of impact, the edge of the rim can also be damaged.**

- ▷ If you are in doubt, have the wheel checked by an expert, particularly if you suspect damage on the inside.
- ▷ If you must drive over a curb or other obstacle, drive slowly and at an obtuse angle. Exercise care when parking along curbs.

## Maintenance Note

Tire repairs are not permissible under any circumstances.

## Wheel alignment, wheel balancing

As a precaution, have wheels with summer tires balanced in the spring, and those with mud and snow tires before winter. Unbalanced wheels may affect car handling and tire life. Only the specified weights may be used for wheel balancing.

Self-adhesive weights must not come into contact with cleaning agents, since they could drop off. Uneven tread wear indicates wheel imbalance. In this event, the vehicle should be checked at an authorized Porsche dealer.



**If, during a trip, uneven running or vibrations occur that could be caused by damage to tires or the car, the speed must be reduced immediately, but without braking sharply. If you continue your trip without having the cause of the fault remedied, you might lose control of your vehicle which could cause serious personal injury or death.**

- ▷ Stop the vehicle and check the tires.
- ▷ If no cause for the fault can be found, drive carefully to the nearest authorized Porsche dealer.

## Wheels with Tire Pressure Monitoring (TPM) sensors

Before changing wheels, make sure that the wheels are compatible with your vehicle's TPM.

- ▷ Check this with your authorized Porsche dealer.

## Removing and storing tires

- ▷ After changing, adjust tire pressure and torque wheel bolts diagonally. Please see the chapter "CHANGING WHEELS" on Page 294.
- ▷ Store tires in a cool and dry place. Rotate periodically to avoid flat spots.
- ▷ Avoid contact with petrol, oil and grease.

**Tires must always remain on the same side of the vehicle.**

When wheels are removed, the direction of rotation and position of each wheel should be marked.

## Example

FR (front right), FL, RR and RL.

Wheels must always be fitted in accordance with their marking.

The perception that tire durability and performance are not affected by storage and age is unfounded.

Chemical additives, which make the rubber elastic, lose their effectiveness over the course of time and the rubber becomes brittle and cracks.

**Therefore, the tires, especially the spare tire, should be inspected from time to time.**

## Note

Under no circumstances should tires older than 6 years be used on your Porsche.

The age of the tire can be obtained from the "DOT" code number. If, for example, the last three numbers read 1208, then the tire was produced in the 12th week of 2008.

## Snow tires

The installation of Porsche approved winter tires is recommended.

Use Porsche approved winter tires for grip on snow and ice. For optimum performance, studding can be considered.

Check with your local Motor Vehicle Bureau for possible restrictions.

### Danger!

---

**Risk of loss of control and damage to the vehicle as well as serious personal injury or death.**

**The standard tires profile and rubber mixture are optimized for wet and dry driving conditions, and may not prove favorable for snow conditions.**

- ▷ Install winter tires before driving in such conditions.
- 

Before mounting winter tires, consult with your Porsche dealer. He has the technical information necessary to advise you on wheel and tire compatibility.

- ▷ Snow tires should have the same load capacity as original equipment tires and should be mounted on all four wheels.  
Winter tires with studs should be run at moderate speeds when new in order to give the studs time to settle.

### Danger!

---

**Risk of serious personal injury or death. Driving the vehicle with low tire pressure increases increases risk of a tire failure and resulting loss of control. Furthermore, low tire pressure increases rate of wear of the affected tires and cause damage.**

**Tires with badly worn treads and studs are very dangerous and could cause accidents resulting in serious personal injuries or death.**

- ▷ Make sure they are replaced immediately.
  - ▷ Do not exceed the winter tire speed rating.
- 

Snow tires do not have the same degree of traction on dry, wet or snowfree roads as normal tires. Furthermore, snow tires wear rapidly under these conditions.

## Maintenance Note

We recommend fitting winter tires on the vehicle at temperatures below 45 °F (7 °C) since the driving performance of summer tires is reduced at low temperatures. Summer tires may be permanently damaged at extremely low temperatures.

Winter tires do not fulfill their purpose if the tread depth is less than 5/32 in. (4 mm).

**Comply with all state and local laws governing snow tire and tread depth requirements.**

### Danger!

---

**Risk of accident and serious personal injury or death due to excessive speed.**

- ▷ Always check the maximum speed rating on the tire sidewall on any tire on the vehicle.
  - ▷ Never exceed the maximum speed rating of the tires.
- 

## Wheel change

- ▷ When wheels are removed, mark the direction of rotation and position of each wheel.  
Example: FR (front right), FL, RR and RL.
- ▷ Always fit the wheels in accordance with the markings.



## Snow chains



### Warning!

#### Risk of damage to body, axle or brake components.

- ▷ Use only the fine-link snow chains recommended and authorized by Porsche so that sufficient clearance between the wheel well and the chain is assured.
- ▷ Please see the chapter "TIRES, RIMS, TRACKS" on Page 350.
- ▷ Follow instructions issued by the supplier of the chains.

The best possible handling characteristics are achieved when snow chains are fitted on all four wheels of the vehicle. However, it is also possible to fit snow chains on only one axle (preferably the rear axle).

- ▷ Remove spacers if 18 inch tires, snow chains or a collapsible spare wheel are mounted.



### Caution!

#### Risk of damage to wheel housings if the spacers on the rear axle are not removed before fitting the snow chains.

- ▷ 17 mm spacers must always be removed from the rear axle when snow chains are to be fitted.
- ▷ For information on the spacers:  
Please see the chapter "SPACERS" on Page 293.  
Please see the chapter "CHANGING A WHEEL WITH REMOVAL OF 17 MM SPACER" on Page 303.
- ▷ Before fitting chains, remove accumulated ice and snow from the wheel well.
- ▷ Vehicles with snow chains must not be driven faster than **30 mph (50 km/h)**.

Different states and countries have varying statutory requirements regarding maximum speed.

- ▷ Check with local authorities for possible restrictions.
- ▷ Remove chains as soon as the roads are free of ice and snow.



Example of Inscription

## Inscription on radial tire

### A Tire size

**Example: P 255/55R18 109 Y**

- **P** - The tire is designed for Passenger vehicle. This information is not included on all tires.
- **255** - Indication of tire width in mm
- **55** - Indication of tire height to tire width ratio in percent
- **R** - Belt type code letter for radial

- **18** - Indication of rim diameter in inches
- **109** - Load capacity coefficient
- **Y** - Speed code letter
- **XL (Extra Load)** - Tire with increased load rating

### B TIN (Tire Identification Number)

Example: DOT xx xx xxxx xxxx

- **DOT**  
The DOT symbol indicates that the tires comply with the requirements of the US Department of Transportation and provides information about:

- first two-digit code means manufacturer's identification mark.
- second two-digit code means tire size.
- third four-digit code means tire type code.
- fourth four-digit code means date of manufacture.  
If, for example, the last four numbers read 1204, the tire was produced in the 12th week of 2004.

### C Tire ply composition and material

The number of layers in the tread and sidewalls and their material composition.

### D Maximum permissible inflation pressure

The maximum permissible cold inflation pressure to which a tire can be inflated.

- ▷ Do not exceed the permissible inflation pressure.

### E Maximum Load rating

The maximum load in kilograms and pounds can be carried by the tire. If you replace tires always use a tire that has the same maximum load rating as the factory installed tire.

### F Radial

The identification indicates if the tire has radial structure.

### G Term of tubeless or tube tire

Identification for tubeless tires.

## Speed code letter

The speed code letter indicates the maximum permissible speed for the tire.

This code letter is shown on the tire sidewall.

**T** = up to 118 mph (190 km/h)

**H** = up to 131 mph (210 km/h)

**V** = up to 150 mph (240 km/h)

**W** = up to 167 mph (270 km/h)

**Y** = up to 186 mph (300 km/h)

## Tip on driving

Tires with a maximum speed rating that is lower than the specified maximum vehicle speed may be mounted only if they bear an M+S identification on the tire sidewall.

- ▷ Please note that in addition to the winter tires, all-season and all-terrain tires are also subject to speed limits and bear this identification.

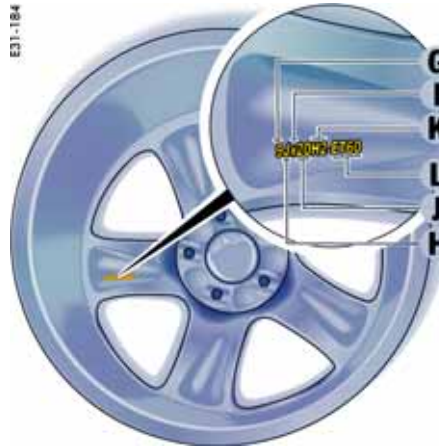

**G** - Rim width in inches

**H** - Rim-flange contour code letter

**I** - Symbol for drop-center rim

**J** - Rim diameter in inches

**K** - Double hump

**L** - Rim offset in mm

## Inscription on light alloy wheels

### Note on operation

- ▷ The information is provided on the spoke. The rim width in inches **G** and the rim offset **L** are visible from the outside. This information can be found near the tire valve.



**A** - Tool box

## Jack

The jack is located in tool box **A** under the load-space floor.

- ▷ Please see the chapter "OPENING LOADSPACE FLOOR" on Page 207.

### Note

The tools required for changing a wheel (e.g. jack, wheel bolt wrench, assembly aids, folding wedges) are only supplied with the vehicle if the vehicle comes with a collapsible spare wheel or full-size spare wheel as standard. Your authorized Porsche dealer will be pleased to advise you.

## Warning!

The jack must be used only to raise the car for wheel changing.

The jack must never be used as a support to work underneath the vehicle. If the jack is accidentally dislodged, you or bystanders could suffer severe personal injury.

- ▷ Never jack up other vehicle or other loads with the jack.
- ▷ Always place the car on stable supports if you have to work under the car. When working under the vehicle, always use safety stands specifically designed for this purpose.

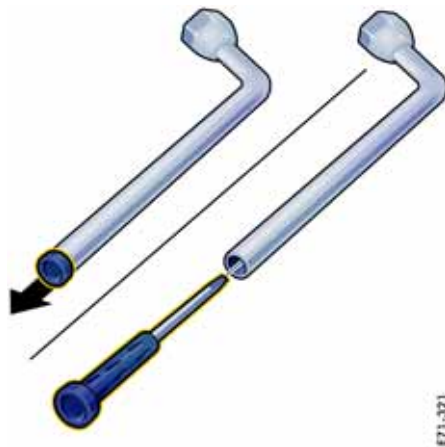

## Tool Kit

Tool box **A** and compressor with pressure tester on non-air suspension vehicles are located under the cargo area.

### Notes on operation

On vehicles with a collapsible spare wheel or full-size spare wheel as standard, the screwdriver is stored in the handle of the wheel bolt wrench.



**A** - Compressor

## Compressor

On vehicles **without** level-control systems, there is an additional compressor with pressure tester under the loadspace floor.

- ▷ Please see the chapter “CHECKING TIRE PRESSURE WITH A PRESSURE GAGE” on Page 306.

On vehicles **with** level control, you can use the compressor of the level-control system to fill the tires.

The bag with the tire filling hose is located under the loadspace floor in the spare-wheel recess.

## Spacers

- ▷ Use the spacers only together with wheels approved by Porsche. Before having spacers fitted, find out about the current approval status.
- ▷ Remove spacers if 18 inch tires, snow chains or a collapsible spare wheel are mounted.

### Danger!

**Risk of accident if the spacers are not removed before mounting 18 inch tires or collapsible spare wheel.**

- ▷ 17 mm spacers are always to be removed before mounting 18 inch tires or a collapsible spare wheel, because the wheel cannot be fitted correctly.

### Caution!

**Risk of damage to wheel housings if the spacers on the rear axle are not removed before fitting the snow chains.**

- ▷ 17 mm spacers must always be removed from the rear axle when snow chains are to be fitted.

## Note on operation

- ▷ To remove or mount the spacers: Please see the chapter “CHANGING A WHEEL WITH REMOVAL OF 17 MM SPACER” on Page 303. Please see the chapter “FITTING THE 17 MM SPACER” on Page 305.



## Wheel Bolts

- ▷ Always clean the wheel bolts before installing.

### Maintenance Notes

- ▷ **Wheel bolts must not be greased.**
- ▷ Replace damaged wheel bolts. Only use the original Porsche wheel bolts specially designed for this vehicle type.

## Tightening torque

Tightening torque of the wheel bolts and wheel nuts **118 ftlb.** (160 Nm).

## Security wheel bolts

The adapter (wrench socket) for the security wheel bolts is located in the tool box.

To loosen or tighten the wheel bolt with anti-theft protection, the adapter must be used between the wheel bolt and the wheel bolt wrench.

- ▷ When positioning the wrench socket, ensure that it engages fully in the teeth of the wheel bolt.

## Note on operation

- ▷ On vehicles with 17 mm spacers on the rear axle, the wheels are secured with steel nuts. There is no anti-theft protection for the wheel nuts.
- ▷ If the wheels have to be removed at the workshop, please do not forget to hand over the socket for the security wheel bolts along with the car key.

## Changing Wheels



**Failure to follow these instructions may result in serious personal injury or death to you or to bystanders.**

### Before changing the wheel

- ▷ If you have a flat tire, move a safe distance off the road. Turn the emergency flasher on and use other warning devices to alert other motorists.
- ▷ Do not park your vehicle where it may contact dry grass, brush or other flammable materials. The hot parts of the exhaust system could set such materials on fire, thereby causing both property damage and severe or fatal physical injury.
- ▷ Passengers must not be in the vehicle when it is jacked up.
- ▷ Before you change a wheel, be sure the ground is level and firm. If necessary, use a board under the jack to ensure that the jack does not sink into the ground.
- ▷ Set the parking brake and block the wheels opposite the flat tire on the other side of the vehicle.

## While operating the jack

- ▷ The jack is only to be used for changing a wheel. Do not use it as a support to work under the car.
- ▷ The car must be jacked up only at the illustrated jacking points. Lifting at any other place may damage the vehicle or may result in personal injury. Never jack the car up by the body or the bumpers.
- ▷ For safety reasons do not use tire inflating bottles. Do not use commercially available sealant bottles. Use only the tire inflating bottle located in the luggage compartment.

## Sequence of operation



### Warning!

**The jack must be used only to raise the car for wheel changing. The jack must never be used as a support to work underneath the vehicle. If the jack is accidentally dislodged, you or bystanders could suffer severe personal injury.**

- ▷ Never jack up other vehicles or other loads with the jack.
  - ▷ Always place the car on stable supports if you have to work under it. When working under the vehicle, always use safety stands specifically designed for this purpose.
- 
- ▷ Please use a suitable knee rest to protect your clothing against soiling.

## Flat Tire

### Note

The tools required for changing a wheel (e.g. jack, wheel bolt wrench, assembly aids, folding wedges) are only supplied with the vehicle if the vehicle comes with a collapsible spare wheel or full-size spare wheel as standard. Your authorized Porsche dealer will be pleased to advise you.

1. Stop the vehicle as far away from the driving lane as possible.  
The car must be parked on a firm and flat surface offering adequate grip.
2. Switch on the emergency flashers.
3. Fully apply the parking brake.
4. Shift into 1st gear or move the Tiptronic selector lever to position **P**.
5. Straighten the front wheels.
6. Withdraw the ignition key to lock the steering and prevent the engine from being started.
7. Have any passengers leave the vehicle.
8. Set up a warning triangle at a suitable distance.



A - Wedges

### Securing the vehicle against rolling

For this purpose, use the two folding wedges **A** secured next to the tool box.

1. You can remove the wedges after undoing the Velcro fastening.

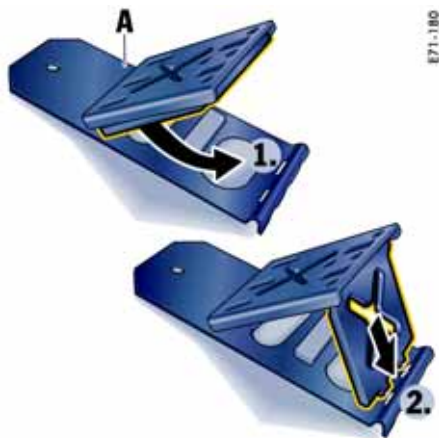

**A** - Folding wedges

2. Unfold the wedges.
3. Lock them in unfolded position.



4. Place one wedge directly in front of and another directly behind the diagonally opposite wheel.



**A** - Filler bottle  
**B** - Filler hose

### Using tire sealant

The tire sealant can be used to seal small cuts, especially in the tire tread.

Sealing the tire with the tire sealant is only an emergency repair, so you can drive to the next workshop. Even with the tire air-tight, it may be used only for short trips in an emergency.



On vehicles **without** level control, the tire sealant and a compressor with pressure tester can be found under the cargo floor in the luggage compartment.

The tire sealant comprises:

- A filler bottle
- A filler hose
- A valve turner
- A spare valve insert
- A set of instructions and
- A sticker with the maximum permissible speed.

### **! Danger!**

#### **Risk of accident, resulting in serious personal injury or death.**

- ▷ Use the tire sealant only in the case of cuts or punctures no larger than 0.15 in. (4 mm).
- ▷ Never use the tire sealant if the rim is damaged.

### **! Warning!**

#### **The sealant is highly flammable and harmful to health.**

- ▷ Fire, naked flame and smoking are prohibited when handling tire sealant.
- ▷ Avoid contact with skin, eyes and clothing due to caustic chemical properties of the tire sealant.
- ▷ Keep tire sealant away from children.
- ▷ Do not inhale vapours, due to consequent harm to personal health resulting in serious personal injury or death.

#### **In case of contact with the sealant:**

- ▷ If sealant gets on the skin or in the eyes, thoroughly rinse the affected part of the body off without delay.
- ▷ Change soiled clothing immediately.
- ▷ Get medical attention immediately in the event of an allergic reaction.
- ▷ If sealant was swallowed, thoroughly rinse out the mouth without delay and drink plenty of water.  
Do not induce vomiting.  
Get medical attention immediately.

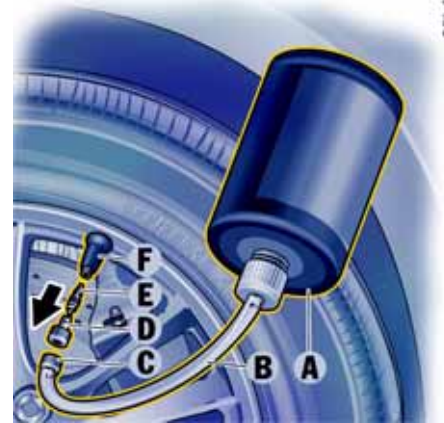

- A** - Filler bottle
- B** - Filler hose
- C** - Plug of the filler hose
- D** - Valve turner
- E** - Valve insert
- F** - Tire valve

#### **Inserting sealant**

1. Leave the object that caused the puncture in the tire.
2. Remove sealant and the enclosed sticker from the luggage compartment.
3. Adhere the sticker in the driver's field of vision.
4. Shake filler bottle **A**.

5. Screw filler hose **B** onto the filler bottle.  
The filler bottle is now open.
6. Unscrew valve cap from tire valve **F**.
7. Remove valve insert **E** from the tire valve with valve turner **D**.  
Keep the valve insert in a clean and dry place.
8. Remove plug **C** of the filler hose **B**.
9. Push filler hose onto the tire valve.
10. Hold filler bottle higher than the level of the tire valve and press it together forcefully until the bottle is completely emptied into the tire.
11. Pull filler hose off the tire valve.
12. Twist the valve insert firmly into the tire valve using the valve turner.
13. Inflate the tire.  
Set the prescribed tire pressure.  
Please see the chapter "TIRE PRESSURES, COLD (68 °F/20 °C)" on Page 354.
14. Screw valve cap onto the tire valve.
15. Check the tire pressure after driving for around 10 minutes.  
If the tire pressure is less than 22 psi (1.5 bar), do not continue driving.  
If a value of more than 22 psi (1.5 bar) is indicated, correct the pressure to the prescribed value.
16. Please consult your authorized Porsche dealer.

The settings for Tire Pressure Monitoring must be update on the multi-purpose display after filling the tire with sealant.

Please see the chapter "SETTING TIRE SEALANT/ SEALING SET" on Page 140.

#### Car care instruction

After drying, any sealant that emerges can be peeled off like a film.

#### Warning!

#### Risk of accident, resulting in serious personal injury or death.

- ▷ Have the tire replaced by a specialist workshop as soon as possible.
- ▷ Avoid hard acceleration and high cornering speeds.
- ▷ Do not exceed maximum speed of 50 mph (80 km/h).
- ▷ Please always observe the safety and operating instructions, which can be found in the separate operating instructions for the sealant and on the compressor.

## Lifting the Vehicle with a Lifting Platform or Garage lift

- ▷ The car must be raised only at the illustrated jacking points.  
Please see the chapter "LIFTING THE VEHICLE WITH A LIFTING PLATFORM OR GARAGE LIFT" on Page 298.  
Please see the chapter "RAISING VEHICLE WITH THE JACK" on Page 192.
- ▷ Lifting at any other place may damage the vehicle or may result in personal injury.

#### Caution!

#### Serious personal injury or death and/or serious damage to the engine or the vehicle may occur, if you lift the vehicle improperly.

- ▷ Never lift the vehicle at any other place than the jacking points.
- ▷ Never lift the vehicle by the engine, transmission or axles.
- ▷ Do not damage any sensitive components in the vicinity of the jacking points.



A - Front jacking points platform lift  
B - Front jacking point garage lift

### Platform lift

- ▷ Before the car is driven on to a lifting platform, it must be ensured that there is enough space between the lifting platform and the vehicle.

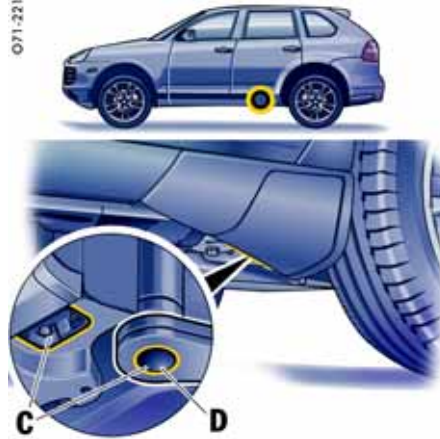

C - Rear jacking points platform lift  
D - Rear jacking point garage lift

### Garage lift

A garage lift may be used **only** at the illustrated jacking points.

Lifting at any other place may damage the vehicle or may result in personal injury.

## Lifting the vehicle with a jack



**Danger of serious personal injury or death.**  
**The car may slip off the jack.**

- ▷ Make sure that no one is in the vehicle when jacking up and changing a wheel.
- ▷ Never jack up the vehicle when it is parked on a surface that slopes up, down or to the side.
- ▷ Use the jack only to raise the car for wheel changing.
- ▷ Always place the car on stable supports if work has to be carried out under the car. The car jack is not suitable for this.

**Danger of injury if the level-control system operates during the wheel change.**

- ▷ Set the car to jacking mode before raising the car. Please see the chapter "RAISING VEHICLE WITH THE JACK" on Page 192.

**Risk of injury and damage if the vehicle is not secured.**

- ▷ Secure the vehicle against rolling.
- ▷ Please see the chapter "SECURING THE VEHICLE AGAINST ROLLING" on Page 295.

## Maintenance Note

The jacking point on the vehicle must be free of dirt.

1. Slightly loosen the wheel bolts of the wheel to be changed.
2. Only set up the jack at the rear jacking point designed for the purpose. The jack foot must be in contact over its whole area and must be positioned directly below the head piece. Use a suitable support if necessary.
3. Hold jack still and wind it up until its head enters the jacking point on the vehicle. Only jack vehicle up until the wheel to be changed is completely off the ground.
4. After lowering the vehicle, remove the jack.



Front jacking point

Access to the jacking points differ according to the respective vehicle equipment.

### Jacking points

- ▷ Set up jack only at the points provided **A** or **C**.



Rear jacking point

The rear jacking point is accessible after removing the covering cap **B** from the sill cover.

Removing covering cap:

- ▷ Pull out covering cap **B** at the bottom at the rear.

Inserting covering cap:

Insert the covering cap **B** in the bottom guides and push in completely until you feel the upper lugs snap into place.



071-007

Vehicles with running board  
Front jacking point

### Jacking points for vehicles with a running board

- ▷ Set up jack only at the points provided **D** or **E**.



071-005

Vehicles with running board  
Rear jacking point



071-008

Vehicles with side member panels  
Front jacking point

### Jacking points for vehicles with side member panels

The jacking points are accessible after removing the plastic covering caps **F** or **H** from the side member panels.

Removing covering cap:

1. Open covering cap **F** or **H** in the side member panel to the front by means of the internal handle recess and pull off (**arrow**).



071-003

Vehicles with side member panels  
Rear jacking point

2. Attach jack only at the points provided **G** or **I**.

Fitting covering cap:

- ▷ Insert the covering cap **F** or **H** completely in the slots of the side member panel with both centring lugs and fold back until it can be felt to engage.



071-020

### Wheel change

1. Remove 1 or 2 wheel bolts (see corresponding figure).



**Caution!**

#### Risk of damage to the brake discs.

- ▷ Always screw in the assembly aids when changing a wheel.



071-021

**Screw in one** assembly aid on vehicles **without** PCCB

2. Screw in assembly aids instead of wheel bolts.



**Screw in two assembly aids on vehicles with PCCB**

3. Remove the remaining wheel bolts.  
For more information on wheel bolts:  
Please see the chapter "WHEEL BOLTS" on  
Page 293.
4. Change wheel.

5. Insert wheel bolts and tighten by hand. Remove assembly aids and screw in remaining wheel bolt.  
Initially tighten bolts in diagonally opposite sequence so that the wheel is centered.
6. Inflate the tire if necessary.  
Please see the chapter "TIRE PRESSURES, COLD (68 °F/20 °C)" on Page 354.  
In vehicles with tire pressure monitoring:  
Please see the chapter "SETTING THE TIRE TYPE AND SIZE" on Page 134.
7. Lower car and remove jack.
8. Tighten wheel bolts in diagonally opposite sequence.

#### **Tire Pressure Monitoring:**

The settings on the multi-purpose display must be updated after a wheel change.

- ▷ Please see the chapter "SETTING TIRE PRESSURE MONITORING" on Page 132.

#### **Maintenance Note**

- ▷ **Immediately after changing a wheel, use a torque wrench to check the prescribed tightening torque of the wheel bolts (118 ftlb./160 Nm).**

### **Changing a wheel with removal of 17 mm spacer**

**! Danger!**

**Risk of accident if the spacers are not removed before mounting 18 inch tires or collapsible spare wheel.**

- ▷ 17 mm spacers are always to be removed before mounting 18 inch tires or a collapsible spare wheel, because the wheel cannot be fitted correctly.

**! Caution!**

**Risk of damage to wheel housings if the spacers on the rear axle are not removed before fitting the snow chains.**

- ▷ 17 mm spacers must always be removed from the rear axle when snow chains are to be fitted.
- ▷ Remove spacers if 18 inch tires, snow chains or a collapsible spare wheel are mounted.
- ▷ It is not necessary to use an assembly aid for mounting a wheel or spare wheel of the same quality.
- ▷ For information on the spacers: Please see the chapter "SPACERS" on Page 293.

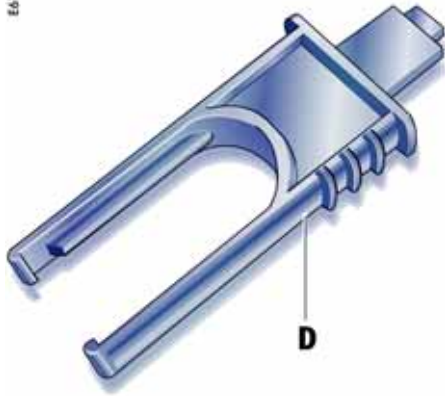

Puller

1. Remove plastic covers from the wheel nuts with the puller **D**.



071-020

2. Remove wheel nuts.

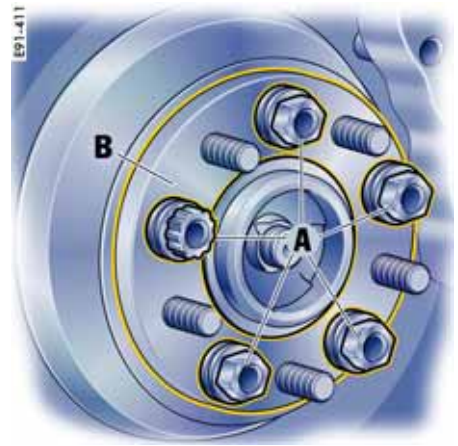

3. Unscrew the wheel bolts **A** with which the spacer **B** is fastened.
4. Remove the spacer **B**.
5. Screw in assembly aid instead of the wheel bolt.
6. Fit wheel.
7. Use the wheel bolts **A** with which the spacer **B** was fastened to mount the wheel. Insert wheel bolts and tighten by hand. Remove assembly aid and screw in remaining wheel bolt. Initially tighten bolts in diagonally opposite sequence so that the wheel is centered.



8. Inflate the tire if necessary.

Please see the chapter "TIRE PRESSURES, COLD (68 °F/20 °C)" on Page 354.

On vehicles with Tire Pressure Monitoring: Please see the chapter "SETTING THE TIRE TYPE AND SIZE" on Page 134.

9. Lower the car and remove the jack.

10. Tighten wheel bolts in diagonally opposite sequence.

### Maintenance Note

▷ **Immediately after changing a wheel, use a torque wrench to check the prescribed tightening torque of the wheel bolts (160 Nm/118 ftlb.).**

▷ Spacer, steel nuts, and plastic covers should be stored together.

### Fitting the 17 mm spacer

1. Remove wheel.
2. Fit the spacer with the wheel bolts **A** used to fasten the wheel.  
Tightening torque: **160 Nm (118 ftlb.)**
3. Fit wheel.  
**To do this** use the original wheel nuts for fastening the wheels.  
Tightening torque: **160 Nm (118 ftlb.)**  
Place plastic covers onto the steel nuts.

### Note

There is no anti-theft protection for the wheel nuts.

### Collapsible spare wheel

The collapsible spare wheel is fastened under the floor in the luggage compartment.

On vehicles with 17 mm spacers:

- ▷ Before fitting a collapsible spare wheel on the **rear axle** always remove the corresponding spacer.  
For information on the spacers:  
Please see the chapter "SPACERS" on Page 293.  
For information about removing the spacers:  
Please see the chapter "CHANGING A WHEEL WITH REMOVAL OF 17 MM SPACER" on Page 303.

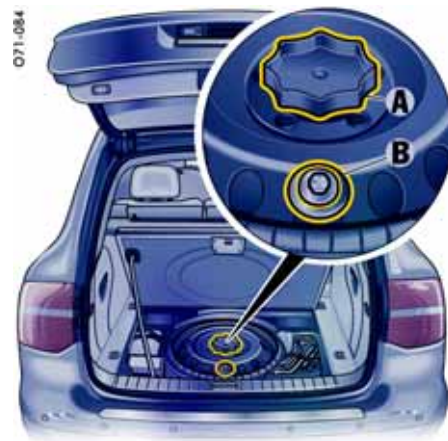

1. Take out rotary knob **A** and put it on bolt **B**.
2. Unscrew the screw and take out the collapsible spare wheel.
3. Mount the collapsible spare wheel on the vehicle before inflating it. Leave the car jacked up. Please see the chapter "LIFTING THE VEHICLE WITH A JACK" on Page 299.
4. Inflate the tire.  
Please see the chapter "TIRE PRESSURES, COLD (68 °F/20 °C)" on Page 354.

## Warning!

---

### Risk of accident.

- ▷ The collapsible spare wheel must be used only over short distances in cases of emergency. For safety reasons, replace the tires **before** the wear indicators appear (webs in the tire grooves, 1/16 in. (1.6 mm) high).
  - ▷ Never deactivate the Porsche Stability Management (PSM) system.
  - ▷ Avoid hard acceleration and high cornering speeds.  
The maximum permitted speed is **50 mph (80 km/h)** and must not be exceeded because of altered driving characteristics and for reasons of wear.  
The tread depth of the spare wheel is subject to the same laws as the original tires.
  - ▷ Do not use a collapsible spare wheel from a different vehicle type.
  - ▷ Do not mount the collapsible spare wheel from your car on a different vehicle.
  - ▷ Only fit **one** collapsible spare wheel on the vehicle at a time.
  - ▷ On vehicles with air suspension, use the tire filling connection **A** only to inflate the collapsible spare wheel.
  - ▷ To avoid damage, do not use automatic car washes when the spare wheel is installed.
- 

### After using the collapsible spare wheel

- ▷ Release air by unscrewing the valve insert.

### Notes on operation

The tire will revert to its original shape only after several hours. Only then can it be stowed in the spare wheel recess in the luggage compartment.

There is a plastic sheet in the tool box to store the damaged wheel.

### Maintenance Note

The collapsible spare wheel must be repaired only by the manufacturer.

- ▷ Please consult your authorized Porsche dealer if the collapsible spare wheel is defective.

### Checking tire pressure with a pressure gage

1. Remove the valve stem cap from the tire.
2. Press the pressure gage onto the valve stem.

### Note on operation

- ▷ Do not press too hard or force the valve stem sideways, or air will escape.  
If the sound of air escaping from the tire is heard, reposition the pressure gage.
3. Read the tire pressure on the gage stem and compare it to the permissible tire pressure. This information can be found on the tire pressure plate in the left door aperture. Please see the chapter "TIRE PRESSURES, COLD (68 °F/20 °C)" on Page 354.
  4. Remove the pressure gage.



O71-127

### Inflating tires on vehicles without air suspension

1. Please follow the operating instructions on the compressor.
2. Screw filler hose of the compressor onto the tire valve.
3. Remove cover **A** of the engine-compartment cover.  
Please see the chapter "CONNECTING JUMPER CABLES" on Page 324.



O71-132

- + = Positive terminal for emergency starting with jumper cables
- = Grounding point for emergency starting with jumper cables

4. Connect clamps of the compressor to the terminals for emergency starting with jumper cables.  
Always observe the following sequence:
  - Open the cap of the positive terminal for emergency starting with jumper cables (+).
  - Connect positive lead (red) to the positive terminal for emergency starting with jumper cables (+).

- Connect negative lead (black) to the negative terminal for emergency starting with jumper cables (-).

### **Warning!**

**Danger of burning. The compressor filler hose can become hot during the inflation process.**

▷ Wear gloves.

5. Switch on compressor.  
The required filling pressure will be reached after a few minutes.
6. Switch off compressor.
7. Check filling pressure with pressure tester.  
Then reduce tire pressure or add more air if necessary. Recheck the filling pressure.
8. Unscrew filler hose of the compressor.

### Reducing filling pressure on vehicles without air suspension

1. Switch off compressor.
2. Open air bleed screw on the filling hose until the correct filling pressure is achieved.

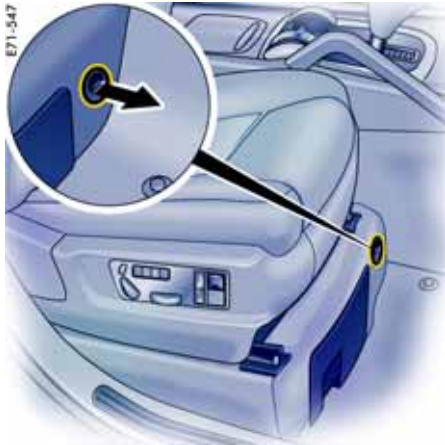

### Inflating tires on vehicles with air suspension

The bag with the tire filling hose is located under the loadspace floor in the spare-wheel recess.

1. Take tire filling hose out of the bag.
2. Remove cover in footwell of right front seat.

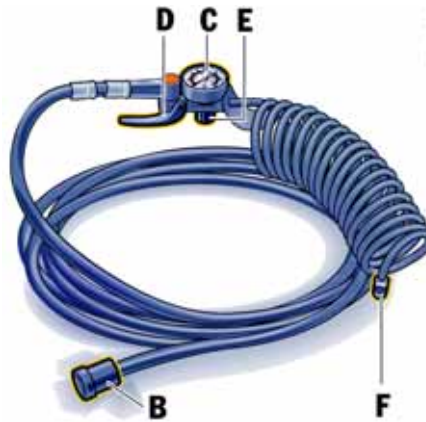

- B** - Screw coupling for compressor connection  
**C** - Pressure tester  
**D** - Hand valve for tire filling  
**E** - Air bleed screw  
**F** - Filler connection for tire valve

3. Screw screw coupling **B** into the compressor connection (in footwell of the front passenger seat).
4. Screw filler connection **F** onto the tire valve.

### Warning!

**Danger of injury and risk of damage if the operating unit is used improperly.**

- ▷ Use this operating unit only to inflate or to bleed air from the tires of this vehicle.

5. Switch ignition on.
6. Press hand valve **D** until the correct tire pressure is achieved. Monitor the tire pressure with pressure tester **C** during the inflation process.
7. Unscrew the screw coupling from the compressor connection.
8. Unscrew filler connection from the tire valve.
9. Stow tire filler hose in the bag.

### Note on operation

The compressor features a protective function against overheating and switches itself off automatically if necessary. The compressor must cool down for a few minutes after automatic deactivation.

### Reducing tire pressure on vehicles with air suspension

- ▷ Open air bleed screw **E** until the correct tire pressure is achieved. Monitor the tire pressure with pressure tester **C** while correcting the tire pressure.

## Spare wheel



**Warning!**

**Risk of accident. The wheel and tire size and the tire quality of the spare wheel and normal wheel may differ.**

**If a spare wheel that differs from the normal tires is used, this may impair the driving behavior.**

- ▷ The spare wheel must be used only over short distances in cases of emergency.  
For safety reasons, replace the tires **before** the wear indicators appear (webs in the tire grooves, 1/16 in. (1.6 mm) high).
- ▷ Never deactivate the Porsche Stability Management (PSM) system.
- ▷ If the tire on the spare wheel is older than 4 years, the spare wheel should be used only in the event of a flat.
- ▷ Avoid hard acceleration and high cornering speeds.  
The maximum permitted speed is **50 mph (80 km/h)** if the mounted spare wheel differs from the other three wheels on the car. This maximum speed must not be exceeded because of altered driving characteristics and for reasons of wear.
- ▷ Do not use a spare wheel from a different vehicle type.
- ▷ Do not mount the spare wheel from your car on a different vehicle.

## Removing spare wheel from bracket



**Warning!**

**Danger of injury if the spare wheel is removed improperly.**

- ▷ Remove the spare wheel only when the spare wheel bracket is locked.
  - ▷ Remove the spare wheel from the spare wheel bracket with care. The wheel is very heavy [approx. 77 lbs. (35 kg)].
- 
1. Unscrew all five wheel bolts.
  2. Remove the top wheel bolt.  
Remove assembly aid from the tool kit and screw in instead of the wheel bolt.  
Remove the remaining wheel bolts.



## Fitting spare wheel on bracket

- ▷ Insert wheel bolts and tighten by hand.  
Remove assembly aid and screw in remaining wheel bolt.  
Initially tighten bolts in diagonally opposite sequence so that the wheel is centered.
- ▷ Please see the chapter "TIRE PRESSURES, COLD (68 °F/20 °C)" on Page 354.
- ▷ After mounting the wheel, tighten all five wheel bolts to **111 ftlb. (150 Nm)**.

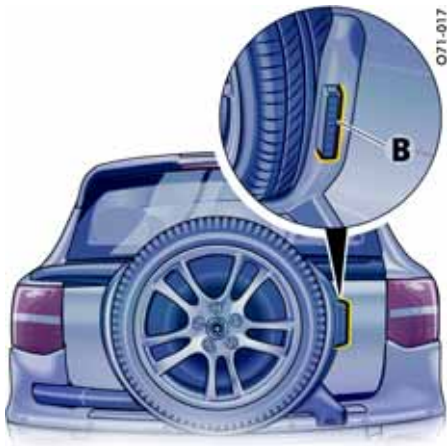

**B** - Button for unlocking the spare wheel bracket

## Opening spare wheel bracket

### Warning!

#### **Danger of injury and risk of accident if the spare wheel bracket is operated improperly.**

- ▷ Make sure that no persons or animals are within the range of movement of the spare wheel bracket. Operate the spare wheel bracket only using button **B**.
- ▷ If the vehicle is inclined to the side, the additional lock **C** on the spare wheel bracket must be operated.

## Precondition

The central locking system must be unlocked.

- ▷ Press button **B** and swing the spare wheel bracket open.

## Notes on operation

- If the opening angle **exceeds 30°**, the spare wheel bracket automatically moves to final position. The rear lid may be opened only when the spare wheel bracket is in final position.
- ▷ If the opening angle is **less than 30°**, the spare wheel bracket automatically moves back to its initial position. However, the spare wheel bracket is not completely engaged yet and must be closed by hand.

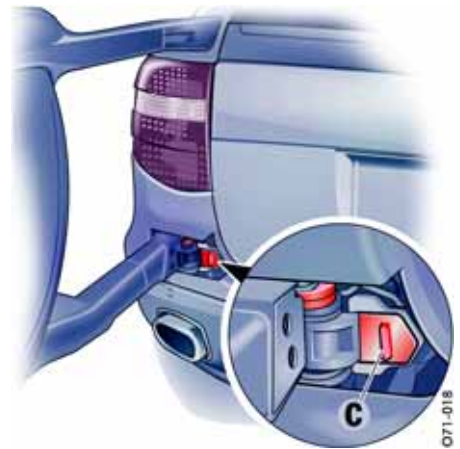

**C** - Additional lock

## Operating the additional lock of the spare wheel bracket if the vehicle is tilted to the side

1. Open spare wheel bracket.
2. Slide additional lock **C** to the left. The spare wheel bracket is mechanically locked. The warning light "rear lid" and a message on the multi-purpose display of the instrument panel warn the driver that the spare wheel bracket is open.

## Closing spare wheel bracket



### Warning!

#### Danger of injury and risk of accident if the spare wheel bracket is operated improperly.

- ▷ Operate the spare wheel bracket only using button **B**.
- ▷ If the vehicle is tilted to the side, more effort will be required to swing the spare wheel bracket.
- ▷ Make sure that no persons or animals are within the range of movement of the spare wheel bracket.

1. Check whether additional lock **C** is engaged. If necessary, slide additional lock **C** to the right.
2. Swing spare wheel bracket closed with force.
3. Check lock and observe indication on the multi-purpose display of the instrument panel. The indicator light must go out when the spare wheel bracket is locked.

### Automatic locking

In the multi-purpose display of the instrument panel, you can set different variants of locking and unlocking the doors and the rear lid as well as the check-back signal when locking and unlocking the vehicle and save them on the respective remote control.

- ▷ Please see the chapter “SETTING REAR LID LOCKING” on Page 144.

071-146

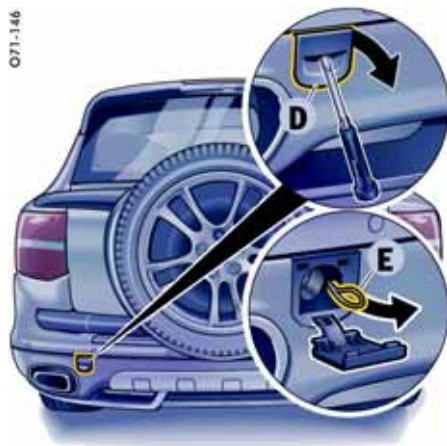

**D** - Towing lug cover (left)

**E** - Emergency release cable

### Emergency release for the spare wheel bracket

If the battery is flat, the only way to open the spare wheel bracket is by using the mechanical emergency release.



### Warning!

#### Danger of injury and risk of accident if the spare wheel bracket is operated improperly.

- ▷ Perform emergency unlocking of the spare wheel bracket only when the vehicle is on a level surface.
- 
1. Remove cover of left towing lug **D**.
  2. Pull emergency release cable **E** in the direction of the arrow. The spare wheel bracket is now unlocked and can be operated.

## Electrical System

In order to avoid damage and faults in electrical or electronic systems, electrical accessories should be installed at your authorized Porsche dealer.

- ▷ Use only accessories authorized by Porsche.

### Warning!

**Risk of short circuit and fire, resulting in serious personal injury or death. Replacing fuses or relays with engine running or the ignition on could cause electrical shock.**

- ▷ Disconnect the negative terminal on the battery during all work on the electrical system.

## Relays

Relays should be checked or changed only by an authorized workshop.



## Sockets

The assignment and number of sockets depend on the respective vehicle equipment.

Electrical accessories can be connected to the 12 V sockets.



## Note on operation

The sockets and thus the connected electrical accessories will function even if the ignition is switched off or the ignition key is withdrawn. If the engine is not running and the accessories are switched on, the vehicle battery will be discharged. Do not operate additional accessories for more than 5 minutes when engine is off.



## Changing fuses

In order to prevent damage to the electrical system due to short circuits and overloads, the individual circuits are protected by fuses.

One fuse box is in the engine compartment. Two additional fuse boxes are located in the outer ends of the dashboard.

1. Switch off the consumer with the defective fuse. Before replacing a fuse, switch off all electrical consumers and remove the ignition key.
2. Open the fuse-box lid.
3. Remove the corresponding fuse from its slot to check it using the plastic gripper. A blown fuse can be identified by the melted metal strip.
4. Replace only with fuses with the same rated current. We recommend using genuine Porsche fuses for replacement.

### Note

If a fuse blows repeatedly, please consult an authorized Porsche dealer immediately, so that the short circuit can be located and corrected.

- ▷ Never try to “repair” fuses: you may cause serious damage to other parts of the electrical system.



Cover of engine-compartment fuse box



Fuse plan and fuse box in engine compartment

### Opening fuse-box lid in engine compartment

1. Rotate the turn-locks of the fuse-box lid 90° anti-clockwise with a screwdriver and remove the cover.
2. Rotate the turn-locks of the fuse-box lid 90° anti-clockwise with a screwdriver and remove the lid.



### Opening fuse-box lid in the dashboard

1. Carefully pry off the plastic cover with a screwdriver (**arrow**) and remove.  
The fuse plan is located on the inside of the cover.



### A - Fuse puller

2. Remove the fuses carefully with the fuse puller **A**.

## Fuse assignment – fuse box in left side of dashboard

No.	Designation	Rating in A
1	Cockpit socket at front centre, centre console sockets at rear right and rear left	20
2	Parking heater radio receiver	5
3	Socket in passenger footwell	20
4	Parking heater	20
5	Sockets in luggage compartment	20
7	Diagnostic socket, rain sensor	5
8	Wiper motor for windshield	30
9	Vehicle electrical system control unit (pump for washer fluid)	15
10	Power window and central locking, rear left door	30
14	Power window and central locking, front left door	30
15	Tail light, right	15
16	Vehicle electrical system control unit (horn)	20
17	Vehicle electrical system control unit (left turn signal light, right side marker light, left low beam)	30
18	Headlight washer system	25
19	Vehicle electrical system control unit (interior light)	5
20	Vehicle electrical system control unit (instrument lighting, fog light left, left additional high beam)	30
22	Rear differential lock, automatic rear lid	30
23	Differential lock	10

No.	Designation	Rating in A
24	Tire Pressure Monitoring	5
26	Engine control unit (engine management, radiator fans, airbag, clutch switch, instrument panel)	10
30	Off-road roof-mounted headlights	15
31	Off-road roof-mounted headlights	15
33	Steering column module	15
34	Passenger compartment monitoring	5
35	Vehicle electrical system control unit (right fog light, right additional high beam, interior light)	30
36	Control unit for power seat controls, left	30
39	Heated rear window relay (control)	5
40	Instrument panel, diagnosis	5
41	Kessy control unit (steering column lock, ignition lock, Porsche Entry & Drive, clutch switch)	15
42	Sliding/lifting roof or Panorama roof system	30
43	Subwoofer	30
44	Electrical seat adjustment, left	30
45	Seat heating, rear	25
47	Rear differential lock	10
49	Servotronic	5
51	Air-quality sensor, diagnostic socket, parking brake	5

No.	Designation	Rating in A
52	Rear wiper	15
53	Vehicle electrical system and rear end control units, low beam switch, steering column	5
54	Headlight beam adjustment, Xenon headlight, left	10
56	Fan, front air-conditioning system	40

No.	Designation	Rating in A
57	Compressor level control	40
RES 1	Spare fuse 1	
RES 2	Spare fuse 2	

### Note

Fuse numbers that are not listed in the table are not assigned in the fuse box.

## Fuse assignment – fuse box in right side of dashboard

No.	Designation	Rating in A
1	Trailer coupling	15
2	ParkAssist	5
3	Trailer coupling	15
5	Trailer coupling	15
6	Porsche Stability Management (PSM)	30
7	Transfer box (center-differential lock), telephone preparation	5
8	Vehicle electrical system control unit (left side marker light, right turn signal, right low beam)	30
10	TV tuner, Rear Seat Entertainment	10
11	Radio or Porsche Communication System (PCM)	10
12	Amplifier for sound package and Bose	30
14	Tail light, left	15
15	Power window and central locking, rear right door	30
18	Heated rear window relay (load)	30
19	Trailer coupling, trailer socket connection point	25
21	Spare wheel release relay (load), horn for alarm system	10
22	Seat heating, front	25
23	Air conditioner 2+2	10
24	Power seat controls and seat memory, front right	30

No.	Designation	Rating in A
25	Air conditioner 2+2, rear	5
27	Level control, Porsche Dynamic Chassis Control (PDCC)	15
29	Transmission control unit, Tiptronic selector lever switch	5
30	Rear lid power closing mechanism relay (control and load)	20
31	Filler flap actuator, rear end control unit (motors)	15
34	Power window and central locking, front right door	30
35	Power seat controls, right	30
36	Roof console, electrical compass	5
38	Porsche Stability Management (PSM)	10
39	Diagnosis	5
40	Transfer box (center-differential lock)	10
41	Trailer coupling control unit	10
42	Roof module	5
43	Reversing light	5
44	Heatable washer nozzles, chassis switch, seat heating potentiometer, Porsche Dynamic Chassis Control (PDCC)	5
46	Rear Seat Entertainment	5
48	Level control	10
49	Anti-dazzle interior mirror	5

No.	Designation	Rating in A
50	Xenon headlight, right	10
51	Tiptronic transmission control unit	15
52	Tiptronic selector lever switch, transmission rewiring	5

No.	Designation	Rating in A
55	Reversing camera control unit	5
56	Porsche Stability Management (PSM)	40
57	Transfer box control unit	40

### Note

Fuse numbers that are not listed in the table are not assigned in the fuse box.

## Fuse assignment – fuse box in engine compartment

Cayenne No.	Cayenne S/Cayenne GTS/ Cayenne S Transsyberia No.	Designation	Rating in A
1	1	Fan	60
2	2	Fan	30
7	7	Ignition coils	15
8	-	Ignition coils	15
-	8	Tank vent valve, air-conditioning compressor, air-conditioning control unit, intake pipe switch-over, crankcase vent	15
9	-	Engine control unit	20
-	9	Quantity control valve, camshaft adjuster, valve lift adjuster	15
10	-	Water run-on pump relay, tank leakage detection, carbon canister shut-off valve, fan, pressure sensor for air conditioner	10
-	10	Cooling air output stages, pressure sensor for air conditioner, tank leakage detection, exhaust flap control valve, oil-level sensor	10
11	-	Oil-level sensor, air-conditioning compressor, air-conditioning control unit, crankcase vent	15
-	11	Engine control unit, fuel valve	15
12	-	Camshaft adjustment, tank vent, fuel valve, variable intake manifold	10
13	13	Fuel pump, right	15
14	14	Fuel pump, left	15
15	15	Engine control unit, main relay	10
17	17	Oxygen sensors ahead of catalytic converter	15
18	18	Oxygen sensors behind catalytic converter	7.5

### Notes

▷ Use the plastic grippers from the fuse boxes in the dashboard to replace the fuses.

Fuse numbers that are not listed in the table are not assigned in the fuse box.

▷ For information on the fuse plan: Please see the chapter “FUSE PLAN AND FUSE BOX IN ENGINE COMPARTMENT” on Page 313.

## Battery



---

### Risk of short circuit and fire, resulting in serious personal injury or death.

- ▷ Observe all warning notes on the battery.
- ▷ Disconnect the negative terminal on the battery during all work on the electrical system.
- ▷ Do not lay tools or other metal objects on the battery as they could cause a short circuit across the battery terminal.

### Hydrogen gas generated by the battery could cause an explosion, resulting in serious personal injury or death.

- ▷ Charge battery in a well ventilated area.
- ▷ Never charge a frozen battery. It may explode because of gas trapped in the ice. Allow a frozen battery to thaw out first.
- ▷ Do not expose the battery to an open flame, electrical spark or a lit cigarette.

### Risk of explosion as a result of static charge, resulting in serious personal injury or death.

- ▷ Do not wipe the battery with a dry cloth.
- ▷ Before touching the battery, discharge any static electricity by touching the vehicle.

### Risk of serious personal injury or death and damage to the fabric, metal or paint.

- ▷ Wear eye protection.
- ▷ Do not allow battery acid to come in contact with your skin, eyes, fabric or painted surfaces.
- ▷ If you get electrolyte, which is an acid, in your eyes or on your skin, immediately rinse with cold water for several minutes and call a doctor.
- ▷ Spilled electrolyte must be rinsed off at once with a solution of baking soda and water to neutralize the acid.

### Battery posts, terminals and related accessories contain lead and lead compounds, chemicals known to the State of California to cause cancer and reproductive harm.

- ▷ Always protect your skin by washing thoroughly with soap and water.

---

The battery is located in the battery box under the left front seat.

## Charge state

A well charged battery will not only prevent starting problems but will also last longer.

### In order to avoid unintended battery discharge

- ▷ Switch off unnecessary electrical loads in city traffic, on short trips or in a line of traffic.
- ▷ Always remove the ignition key from the ignition switch when leaving the vehicle or switch ignition off in vehicles **with** Porsche Entry & Drive.
- ▷ Avoid using the Porsche Communication Management system and the audio system when the engine is not running.

### Maintenance Note

In the cold season, in particular, or if you mainly drive only short distances, it may become necessary to recharge the battery from time to time.



## Battery care

- ▷ Ensure that battery is securely mounted.
- ▷ Keep terminals and connections clean and properly tightened. Corrosion can be prevented by coating the terminals and connections with petroleum jelly or silicone spray.
- ▷ Ensure that vent caps are securely tightened to prevent spillage.

## Checking the electrolyte fluid level (only on low-maintenance batteries)

Generally, the electrolyte level must be checked more often in summer than in the winter, and more often when driving long distances.

- ▷ When adding water, use only clean containers. In no case may alcohol (e.g. window cleaner residues) be permitted to enter the battery.
- ▷ Unscrew and open the filler vent caps of each cell.

With the car on a level surface, the fluid level should meet the indicator mark in each cell.

- ▷ If necessary, top up with distilled water. Do not use acid. Only fill up to the mark, otherwise the electrolyte will overflow when the battery is being charged and cause damage.

## Winter operation

During the winter months, battery capacity tends to decrease as temperatures drop. Additionally, more power is consumed while starting, and the headlights, heater, rear window defogger, etc., are used more frequently.

Let your Porsche dealer test the battery's capacity before winter sets in.

## Vehicle storage

If the car stands for long periods in the garage or workshop, the doors and lids should be closed.

- ▷ Remove the ignition key and, if necessary, disconnect the battery.

## Notes on operation

- ▷ When the battery is disconnected, the alarm system ceases to function. If the vehicle was locked before the battery was disconnected, the alarm will be triggered when the battery is reconnected. To deactivate the alarm system:
  - ▷ Lock the vehicle and unlock it again.

## Alarm system, central locking

The status of the central locking and alarm system is not changed by disconnecting the battery.

## Maintenance Notes

Even if you put your vehicle out of operation, the battery still discharges. The battery will discharge more quickly if your vehicle is not driven on a daily basis over a distance of several miles. The more often you drive your vehicle, and the longer the distance driven on each trip, the more opportunity the vehicle's charging system will have to recharge the batteries.

- ▷ To preserve its efficiency, charge the battery about every 6 weeks.
- ▷ Check the battery acid level and top off with distilled water if necessary.
- ▷ Store a battery that has been removed in a dark, cool place, but not subject to freezing.

## Replacing the battery

The service life of the battery is subject to normal wear; it depends greatly on care, climatic conditions, and driving conditions (distances, loads).

- ▷ Only use an original Porsche battery, with the correct part number, as a replacement. Only this battery meets the specific requirements of the vehicle.
- ▷ Please observe the disposal instructions for batteries.

## Putting vehicle into operation

After the battery is connected or after a **completely discharged** batterie is charged, the PSM warning light lights up on the instrument panel and a message appears on the multi-purpose display of the instrument panel to indicate a fault.

This fault can be remedied with a few simple steps:

1. Start the engine.  
To do this, turn the ignition key or the control unit (on vehicles that have Porsche Entry & Drive) to ignition lock position 2 **twice**.
2. Perform a few steering movements and drive a short distance in a straight line until the PSM warning light goes out and the message is erased from the memory of the multi-purpose display of the instrument panel.
3. If the warnings does **not** go out, then:  
Drive carefully to the nearest authorized Porsche dealer.  
Have the fault remedied by an authorized Porsche dealer.
4. After the warnings disappear:  
Stop the vehicle in a suitable place.
5. Perform adaptation of the power windows:  
Please see the chapter "STORING FINAL POSITION OF THE DOOR WINDOWS" on Page 90.

6. On vehicles with tire pressure monitoring:  
Please see the chapter "SETTING THE TIRE TYPE AND SIZE" on Page 134.
7. On vehicles with Panorama roof system:  
Please see the chapter "SAVE FINAL POSITION OF THE PANORAMA ROOF SYSTEM" on Page 99.

## Replacing the remote control battery

### Note

- ▷ Please dispose of batteries in compliance with any and all government regulations.

### Car key

If the battery in the remote control becomes too weak, a warning will appear on the multi-purpose display in the instrument panel. The battery should be changed in this case.



### Changing the battery

1. Carefully pry out the lid on the back of the key housing with a small screwdriver.
2. Replace battery (observe polarity).  
A replacement battery is available from your authorized Porsche dealer.
3. Replace cover and press together firmly.

## Emergency Starting with Jumper Cables

If the battery is discharged, e.g. in winter or after the car has been parked for a long time, the battery of another car can be used for starting with the help of jumper cables.

Make sure the voltage of both batteries is the same.

The capacity (Ampere hours, Ah) of the booster battery must not be substantially less than that of the discharged battery. The discharged battery must be correctly connected to the vehicle's electrical system.

- ▷ Please see the chapter "BATTERY" on Page 320.

### Note

Do not try to start the car by pushing or towing. Damage to the catalytic converters and other components of the car may result.

### Danger!

#### **Risk of short circuit, damage and explosion, resulting in serious personal injury or death.**

- ▷ Use only jumper cables of adequate diameter cross-section and fitted with completely insulated alligator clips.
- ▷ Follow all warnings and instructions of the jumper cable manufacturer.
- ▷ When connecting jumper cables, make sure that they cannot get caught in any moving parts in the engine compartment. The jumper cables must be long enough so that neither vehicles nor cables touch another.
- ▷ The vehicles must not be in contact, otherwise current might flow as soon as the positive terminals are connected.
- ▷ The cable clamps must not be allowed to contact each other when one end of the jumper cables are connected to a battery.
- ▷ Carefully ensure that tools or conductive jewelry (rings, chains, watch straps) do not come into contact with the positive jumper cable or the positive battery post.
- ▷ Improper hook-up of jumper cables can ruin the alternator.

#### **Danger of caustic burns.**

- ▷ Do not lean over the battery.

#### **Danger of gas explosion.**

- ▷ Improper use of booster battery to start a vehicle may cause an explosion, resulting in serious personal injury or death.
- ▷ Keep sources of ignition away from the battery, e.g. open flame, burning cigarettes or sparking due to cable contact or welding work.
- ▷ A discharged battery can freeze even at 14 °F (–10 °C). Before connecting jumper cables, a frozen battery must be thawed out.



## Connecting jumper cables

Always observe the sequence below:

1. Remove cover **A**.
2. Open the cap of the positive terminal for jump starting(+).
3. Attach the positive lead first to the positive terminal for jump starting (+), then to the positive terminal of the donor battery.
4. Connect the negative lead first to the negative terminal of the donor battery, then to the grounding point for jump starting (-).



+ = Positive terminal for jump starting  
 - = Grounding point for jump starting

5. Run the engine of the donor car at a higher speed.
6. Start the engine.  
 An attempted start using jumper cables should not last more than 15 seconds. Then allow a waiting period of at least one minute.
7. Disconnect the negative jumper cable from the ground point for jump starting (-) first, then from the negative terminal of the donor battery.

8. Disconnect the positive jumper cable from the positive terminal of the donor battery first, then from the positive terminal for jump starting (+).
9. Close the cap of the positive terminal for jump starting (+).

## Battery charging

Automotive batteries lose their efficiency when not in use. The charge available in your battery can be measured with a battery hydrometer. We recommend that the battery voltage be tested by your Porsche dealer who has the appropriate equipment.

If the car is not driven for prolonged periods, the battery must be charged at least every 6 weeks. A discharged battery allows rapid formation of sulfates, leading to premature deterioration of the plates.



---

**Hydrogen gas generated by the battery could cause an explosion, resulting in serious personal injury or death.**

- ▷ Charge battery in a well ventilated area.
  - ▷ Never charge a frozen battery. It may explode because of gas trapped in the ice. Allow a frozen battery to thaw out first.
  - ▷ If you get electrolyte, which is an acid, in your eyes or on your skin, immediately rinse with cold water for several minutes and call a doctor.
- 

## Note

Your authorized Porsche dealer will be pleased to advise you about a suitable charger.

- ▷ Always observe the instructions of the charger manufacturer.
- ▷ When charging the battery, ensure adequate ventilation.
  1. Check the acid level of a low-maintenance battery.
  2. Connect charger to the jump starting points. Only plug into the mains and switch the charger on when it has been correctly connected up.
  3. Switch on the charger.
  4. After charging, switch off and disconnect the charger.
  5. Check the acid level of a low-maintenance battery.

## After charging the battery

After the battery is connected or the **completely** discharged battery is charged, the PSM warning light lights up on the instrument panel and a message appears on the multi-purpose display of the instrument panel to indicate a fault.

This fault can be remedied with a few simple steps:

1. Start the engine.

To do this, turn the ignition key or the control unit (on vehicles that have Porsche Entry & Drive) to ignition lock position 2 **twice**.
2. Perform a few steering movements to the left and to the right when vehicle is standing and drive a short distance in a straight line until the PSM warning light goes out and the message is erased from the memory of the multi-purpose display of the instrument panel.
3. If the warnings does **not** go out, then: Drive carefully to the nearest authorized Porsche dealer. Have the fault remedied by an authorized Porsche dealer.

4. After the warnings disappear:  
Stop the vehicle in a suitable place.
5. Perform adaptation of the power windows:  
Please see the chapter "STORING FINAL POSITION OF THE DOOR WINDOWS" on Page 90.
6. On vehicles with tire pressure monitoring:  
Please see the chapter "SETTING THE TIRE TYPE AND SIZE" on Page 134.
7. On vehicles with Panorama roof system:  
Please see the chapter "SAVE FINAL POSITION OF THE PANORAMA ROOF SYSTEM" on Page 99.

## Replacing Bulbs



---

### **Danger of short circuit.**

- ▷ Always switch off the relevant consumer when changing bulbs.

### **Risk of serious personal injury or death. The headlights are under high voltage when installed.**

- ▷ Exercise extreme caution when working in the area of the headlights.

### **Risk of damage. Bulbs of a higher wattage can damage the light housing.**

- ▷ Only use the bulbs specified in the bulb chart.
- 
- ▷ Bulbs must be clean and free from oil, grease or fingerprints.
  - ▷ Never touch bulbs with your bare hands.  
Use a cloth or soft paper when replacing bulbs.
  - ▷ Always carry spare bulbs with you.  
In certain countries, the carrying of spare bulbs is mandatory.



---

### **Risk of damage to headlights due to excessive temperatures and abrasion.**

- ▷ Attach no coverings (e.g. films, "stone guards") in the area of the headlights.
  - ▷ Use soapy water only to clean light lenses and plastic headlight lenses. In no case may chemical cleaners or other volatile cleaning fluids be used.
  - ▷ To prevent scratches, do not rub with a dry or merely moist cloth, tissue or insect sponges.
-

## Headlights

### Note

The headlights can mist up depending on the temperature and humidity.

- ▷ To ensure optimum ventilation, do not cover the gap between headlight and body.

### Caution!

**Risk of damage to headlights due to abrasion and excessive temperatures.**

- ▷ Do not affix any coverings (e.g. “stone guards” or films) in the area of the headlights.



### Removing headlights

1. Switch off ignition and withdraw the ignition key.
2. Open lid.
3. Press down cover **A** in the engine compartment in the direction of the arrow and remove.
4. Take socket wrench **C** out of the tool kit.
5. Place socket wrench **C** on the release **B** and turn in the direction of the arrow until you feel and hear the headlight being released.



©71-094

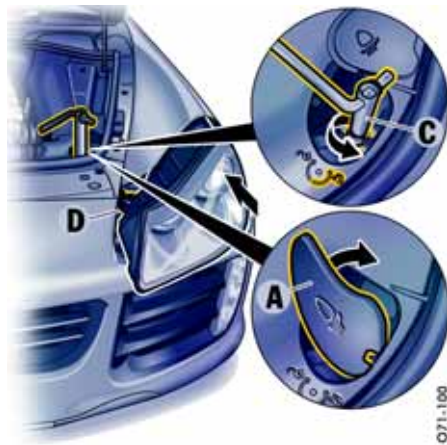

©71-100

6. Pull the headlight forward out of the fender by approx. 4 inch (10 cm).
7. Press back the release tab of the plug **D** and pull plug off.
8. Pull out headlight completely.

**A** - Cover  
**C** - Socket wrench  
**D** - Plug

4. Remove socket wrench **C** and replace in tool kit.
5. Fit cover **A** and fold it down.
6. Close lid.

### Installing headlights

1. Insert headlight in the guide rails, connect plug **D** and then push the headlight fully into the fender.
2. Push headlight to the rear and simultaneously turn socket wrench **C** in the direction of the arrow.  
 The headlight locking device must perceptibly and audibly engage.
3. Check whether the headlight is seated securely.





### Changing bulbs on Halogen headlights

#### Changing bulb for low beam/high beam

1. Remove headlight.  
For information on removing headlights:  
Please see the chapter "REMOVING HEAD-  
LIGHTS" on Page 327.
2. Press down both release tabs **A** and remove  
cover.

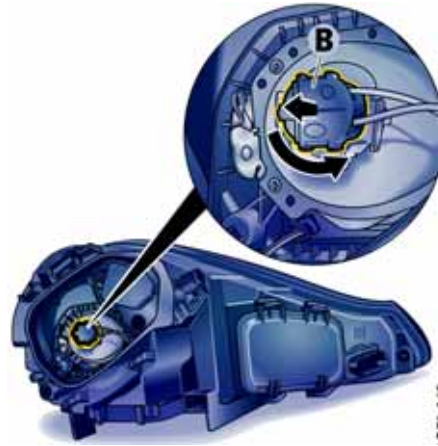

3. Turn bulb socket **B** counter-clockwise and  
remove.

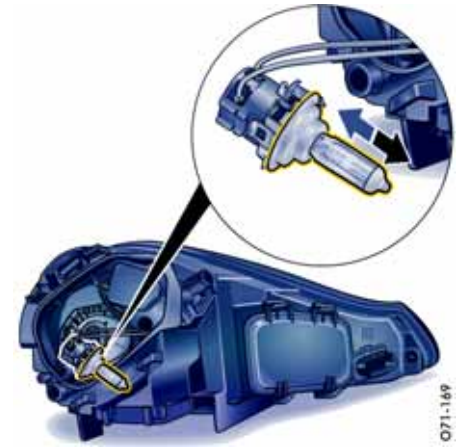

4. Remove defective bulb and replace.
5. Insert bulb socket and turn in clockwise direc-  
tion.  
Make sure that the bulb is installed in the  
correct position.
6. Fit cover on headlight.  
Both release tabs must be fully engaged.
7. Install headlight.  
For information on installing headlights:  
Please see the chapter "INSTALLING HEAD-  
LIGHTS" on Page 328.
8. Check operation of bulbs.

### Changing bulb for additional high beam

- ▷ A Bi-Xenon headlight is used to demonstrate the procedure for changing the bulb for the additional high beam. Please see the chapter “CHANGING BULB FOR ADDITIONAL HIGH BEAM” on Page 331.



### Changing bulbs on Bi-Xenon headlights with cornering light

#### Changing gas discharge lamp for low beam/high beam/dynamic cornering light

1. Remove headlight.  
For information on removing headlights:  
Please see the chapter “REMOVING HEADLIGHTS” on Page 327.
2. Press down both release tabs **A** and remove cover.



3. Turn gas discharge lamp counter-clockwise and remove.

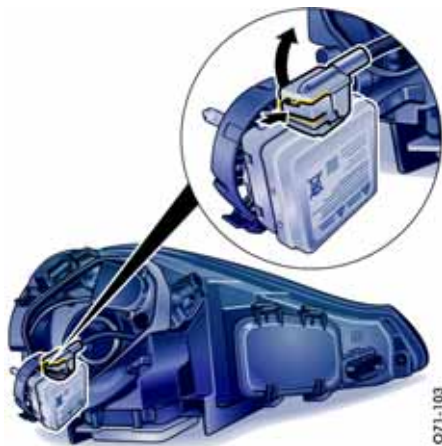

4. Press the release tab on the plug and pull plug off.
5. Connect plug to new gas discharge lamp.
6. Insert gas discharge lamp and turn in clockwise direction. Make sure that the bulb is installed in the correct position.
7. Fit cover on headlight. Both release tabs must be fully engaged.
8. Install headlight.  
For information on installing headlights: Please see the chapter "INSTALLING HEADLIGHTS" on Page 328.
9. Check operation of bulbs.



#### Changing bulb for additional high beam

1. Remove headlight.  
For information on removing headlights: Please see the chapter "REMOVING HEADLIGHTS" on Page 327.
2. Press down both release tabs **A** and remove cover.



3. Turn bulb socket **B** counter-clockwise and remove.

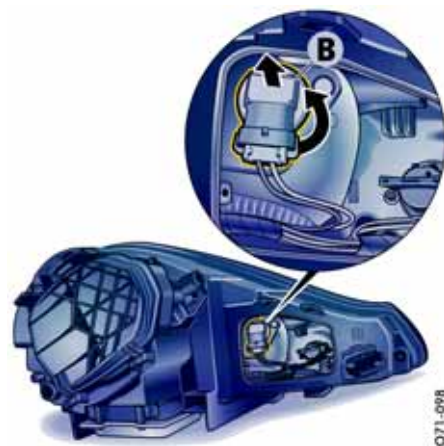
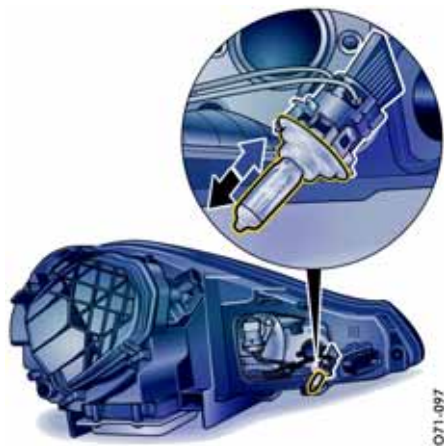

4. Remove defective bulb and replace.
5. Insert bulb socket and turn in clockwise direction. Make sure that the bulb is installed in the correct position.
6. Fit cover on headlight. Both release tabs must be fully engaged.
7. Install headlight.  
For information on installing headlights: Please see the chapter "INSTALLING HEADLIGHTS" on Page 328.
8. Check operation of bulbs.

#### Changing lamp for static cornering light

1. Remove headlight.  
For information on removing headlights: Please see the chapter "REMOVING HEADLIGHTS" on Page 327.
2. Press down both release tabs **A** and remove cover.

3. Turn bulb socket **B** counter-clockwise and remove.

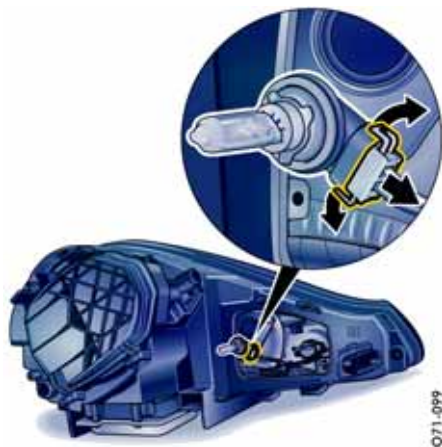

071-099

4. Pull both release tabs on the plug apart, and pull plug out of lamp socket.
5. Replace defective bulb. Make sure that the bulb is installed in the correct position.
6. Fit cover on headlight. Both release tabs must be fully engaged.
7. Install headlight.  
For information on installing headlights: Please see the chapter "INSTALLING HEADLIGHTS" on Page 328.
8. Check operation of bulbs.



071-104

### Changing bulb for turn signal and side marker light Cayenne, Cayenne S, Cayenne S Transsiberia

1. Remove headlight.  
For information on removing headlights: Please see the chapter "REMOVING HEADLIGHTS" on Page 327.
2. Press release tab on the bulb housing in the direction of the arrow and at the same time push forward to the first detent **A**.



071-105

3. Press release tab **A** in direction of arrow again and push forward. Using your other hand, pull the bulb housing completely out of the front apron.



071-106

### Replacing side marker light bulb Cayenne, Cayenne S, Cayenne S Transsyberia

4. Pull bulb socket out of the bulb housing.

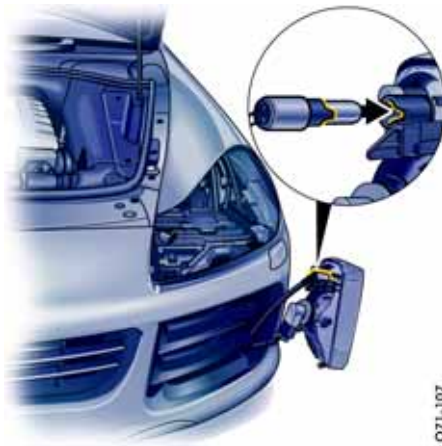

071-107

5. Remove the defective bulb from the socket and replace.  
When inserting the socket in the bulb housing, make sure that the socket has engaged fully.



071-108

### Changing turn signal bulb Cayenne, Cayenne S, Cayenne S Transsyberia

1. Turn socket counter-clockwise and remove.
2. Replace the defective bulb (bayonet fitting).
3. Insert socket and turn in clockwise direction.  
Make sure that the bulb is installed in the correct position.



071-110

### Installing bulb housing Cayenne, Cayenne S, Cayenne S Trassysberia

1. Insert the bulb housing in the front apron. Make sure that the two tabs are inserted correctly in the openings. Push light fully into the front apron until you hear and feel it engage.
2. Check operation of lights.
3. Install headlight.  
For information on installing headlights:  
Please see the chapter "INSTALLING HEAD-  
LIGHTS" on Page 328.



071-433

### Changing bulb for turn signal Cayenne GTS

1. Remove headlight.  
For information on removing headlights:  
Please see the chapter "REMOVING HEAD-  
LIGHTS" on Page 327.
2. Turn socket counter-clockwise and remove.
3. Replace the defective bulb (bayonet fitting).

4. Insert socket and turn in clockwise direction. Make sure that the bulb is installed in the correct position.
5. Check operation of bulb.
6. Install headlight.  
For information on installing headlights:  
Please see the chapter "INSTALLING HEAD-  
LIGHTS" on Page 328.

## Tail light

### Removing tail light

As a result of the design, a relatively large amount of effort is required to remove the tail light. In case of doubt, please contact your authorized Porsche dealer.



1. Switch ignition off.
2. Open rear lid.
3. Remove the two caps **A** with a screwdriver, for example.



4. Unscrew the two fastening screws **B** with the socket wrench from the tool kit.



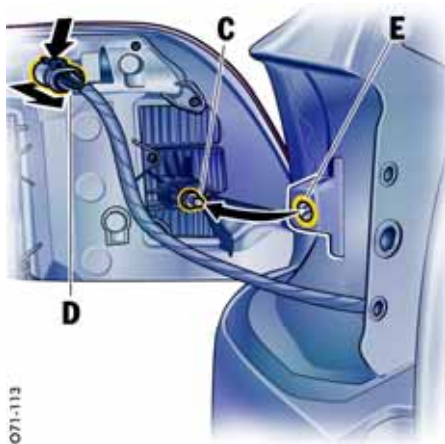

071-113

5. Pull out the light unit to the side in the **direction of the arrow** and additionally pull it out in the area of the ball head **C**.
6. Disengage cable and then press on the plug release (**arrow**) on the plug **D** and pull off the plug.

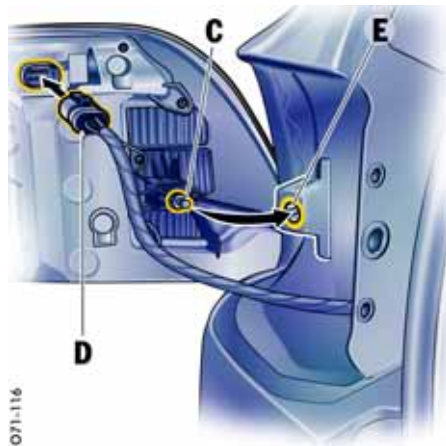

071-116

### Installing tail light

1. Push on plug **D** until the plug is felt to click into place (**arrow**) and secure cable.
2. Insert ball head of tail light **C** into clip nut **E** and fit the light unit into the body (**arrow**).

071-161



3. Screw in the fastening screws **B**.  
When screwing in the fastening screws, make sure that the tail light is flush with the body.
4. Press in caps **A**.
5. Close rear lid.

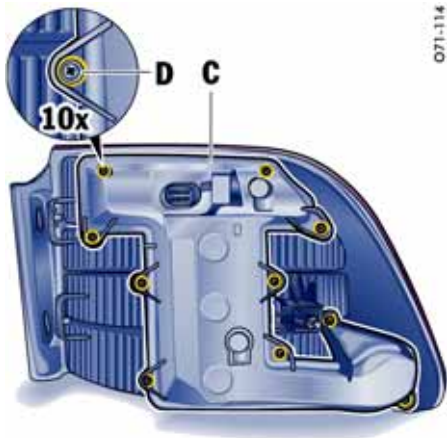

071-114

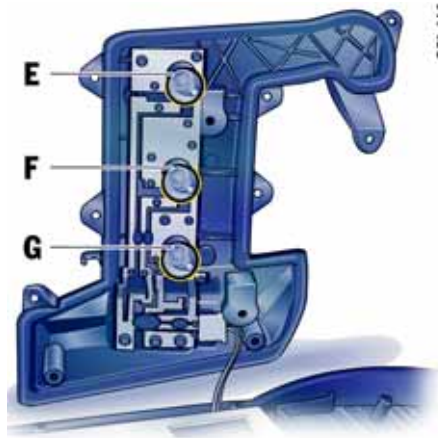

071-115



071-091

## Replacing bulbs at rear

1. Remove tail light.  
For information on removing tail lights: Please see the chapter "REMOVING TAIL LIGHT" on Page 336.
2. Unscrew fastening screws **D** with the cross-head screwdriver from the tool kit.
3. Remove lamp bracket **C**.

**E** - Rear fog light  
**F** - Turn signal light  
**G** - Tail light

4. Replace the defective bulb (bayonet fitting). Insert lamp bracket and screw in fastening screws.
5. Install tail light.  
For information on installing tail lights: Please see the chapter "INSTALLING TAIL LIGHT" on Page 337.
6. Check operation of lights.

## License Plate Lights

### Changing bulb for license plate light

1. Unscrew both screws **A** and remove the light.
2. Push the bulb holder apart and pull the bulb out.
3. Replace defective bulb.
4. Insert light, initially tighten both screws **A** and then screw in uniformly.

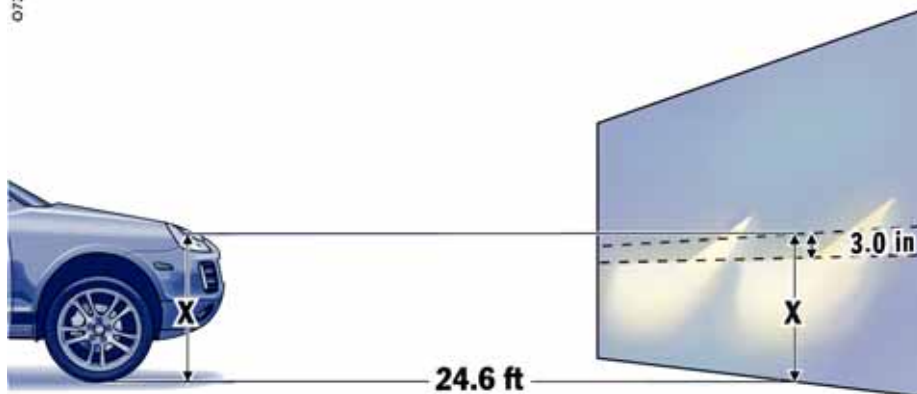

## Headlight Adjustment

- ▷ Check tire pressure and adjust if necessary.
- ▷ Please see the chapter “TIRE PRESSURES, COLD (68 °F/20 °C)” on Page 354.
- ▷ Please see the chapter “REPLACING BULBS” on Page 326.

### Adjustment

The adjustment is made with the vehicle ready to drive and the fuel tank completely filled.

The driver's seat must be loaded by a person or a 165lbs. (75kg) weight and the tire pressures must meet the prescribed values. After being loaded, the car must be rolled a few meters so that the suspension can settle.

For checking the headlight adjustment, the vertical position of the cutoff of the lowbeam (see fig.) has to be projected on a vertical screen (wall) in distance of 24.6 ft. (7.5 m) from the front lens of the headlamp. The correct position of the cutoff is 3.0 in. (7.5 cm) at 24.6 ft. or 7.5 m (0.4°) below a horizontal line, x cm from ground to the center of the headlamp lens.

Lateral adjustment of the headlights should be carried out at a specialist workshop with an optical adjustment unit.

### Distance

Visual aim shall be performed at not less than 24.6 ft. (7.5 m) (this value is a rounded down conversion from the 25-foot distance typical of field aim using a screen). The 24.6 ft. (7.5 m) distance is measured from the headlamp lens to the viewing screen.

### Floor

The surface upon which the vehicle rests is flat and approximately level.

### Screen

The screen upon which headlamp beams are projected is perpendicular to the floor and the vehicle's longitudinal axis, flat, uniformly light in color, unobstructed, and wide and high enough to accommodate the vehicle beam patterns to be aimed.

The screen should be wide enough to provide at least 3.3 ft. (1 m) of space outboard of the vehicle's headlamp spacing.



## Changing headlights from left to right-hand traffic

If you travel to a country where traffic uses the other side of the road, the headlights must be repositioned when you cross the border. The low beam then lights symmetrically and drivers of oncoming vehicles are not dazzled.

On the return journey, do not forget to readjust the headlights.

## Height adjustment for low beam/high beam and additional high beam

1. Switch ignition on.
2. Switch on low beam and/or high beam.
3. Open engine compartment lid.
4. Place allen key (6 mm) on adjusting screw.
5. Adjust low beam in direction of the arrow.



## Repositioning headlights

1. Please see the chapter "REMOVING HEADLIGHTS" on Page 327.  
Remove headlight. Press down both release tabs **A** and remove cover.

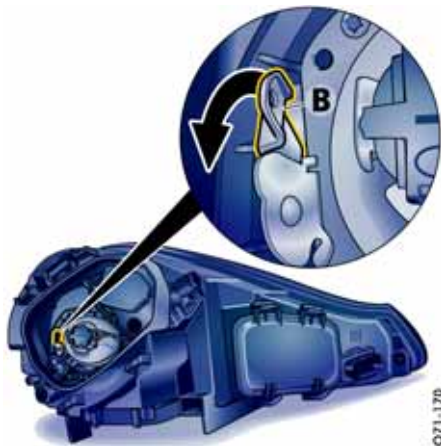

Halogen headlights

2. Push lever **B** down to the stop.

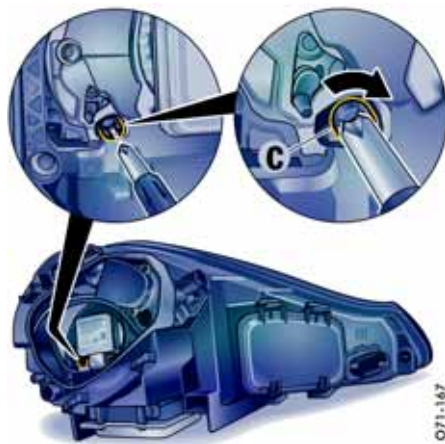

Xenon headlight

3. Turn spindle **C** in clockwise direction to the stop using a crosshead screwdriver.
4. Fit cover on headlight.  
Both release tabs **A** must be fully engaged.
5. Install headlight.  
Please see the chapter "INSTALLING HEADLIGHTS" on Page 328.
6. Reposition the other headlight.

## Bulb Chart

### Exterior lights

	Type, rating
Halogen low beam and high beam	H7
Xenon low beam and high beam	D1S
Side marker lights, front	W5W
Turn signal light, rear	P21W
Turn signal light, front	PY21W
License plate light	C5W
Fog light	H11
Rear fog light	P21W
Back up light	P21W
Additional high beam	H7
Cornering light	H11

### Interior lights

Interior light, front	W5W
Reading light	W5W
Footwell light	W3W
Glove compartment light	W3W
Center console	W3W
Curb lights (doors)	W3W
Warning lights (doors)	W3W
Curb light (rear lid)	W5W
Guard light (rear lid)	W5W
Luggage compartment light	K12V10W

## Towing

Certain state statutes and local ordinances prohibit towing with a chain, rope or even a tow bar. In addition, damage to your vehicle may result from improper procedures. Consult your authorized Porsche dealer for details.

When the turn signal light is set with the ignition on and the emergency warning lights active, only the turn signal light on the corresponding side of the vehicle will light up. After the turn signal light is reset, the emergency warning lights will be switched on again.

### Vehicle towing

Flat bed towing is the preferred type of towing to be used on Porsche vehicles. Under certain circumstances, wheel lifts may be used when the vehicle will not roll.

**The vehicle must be towed with all four wheels off the ground, otherwise damage to the vehicle may result.**

## Towing hook

Depending on the vehicle equipment, the spare-wheel well contains one or two towing hooks.

### Caution!

#### Risk of damage to the vehicle.

- ▷ Use the towing hook only for an emergency to remove the vehicle off the road. The towing hook is to be used only to pull the vehicle onto the flat bed, tractor or towing apparatus if the vehicle will roll freely. Under no circumstances is the vehicle to be secured using the towing hook.
- ▷ Never use the towing hook to tow this or any other vehicle.



#### Screwing in rear towing hook

1. Carefully lever out the appropriate plastic cover **A** in the bumper with the screwdriver. The cover is captive and need not be removed completely.



2. Screw in towing hook **B** as far as the stop (left-hand thread) and tighten hand-tight.



### Screwing in front towing hook

1. Carefully lever out the appropriate plastic cover **A** in the bumper with the screwdriver. Place cover in the vehicle.



2. Screw in towing hook **B** as far as the stop (left-hand thread) and tighten hand-tight.



### Fitting plastic cover at front

First engage the upper locking tabs of the plastic cover, and then press in the bottom tabs and side tab uniformly until the tabs have engaged fully.





### Pulling vehicle onto flat bed

1. Position wooden ramps at the base of the flat bed to reduce the angle of the pull.
2. Reel in the hoist cable and check the underside of the vehicle for any interference.

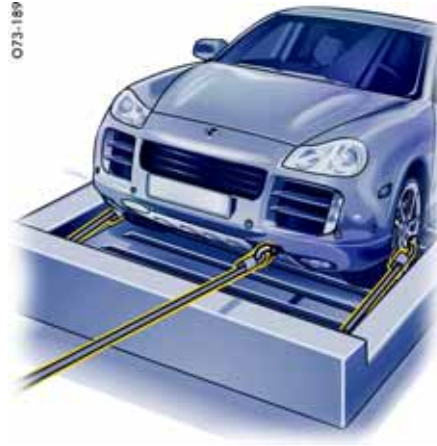

### Tying down vehicle on flat bed

1. Carefully feed towing straps through the opening in the **rear wheels**. Make sure metal parts of straps do not damage rim. Make sure the strap is flat over the rim bead. Make sure brake backing plate is not damaged.
2. Secure straps to rear of flat bed.
3. Reel in hoist cable only far enough to tension tie-down straps.

4. Carefully feed towing straps through the opening in the **front wheels**. Make sure metal parts of straps do not damage rim. Make sure the strap is flat over the rim bead. Make sure brake backing plate is not damaged.
5. Secure straps to front of flat bed.
6. Release tension on hoist cable, but do not disconnect. Use hoist cable as a safety cable.

### Recovering the vehicle

Depending on the vehicle equipment, the spare-wheel well contains one or two towing lugs.

- ▷ When recovering the vehicle, always use two towing lugs if possible. Screw in the towing lugs only at the front or rear. Never screw them in so that one towing lug is at the front and one is at the back.

# Tire Pressure and Technical Data

Vehicle Identification.....	347
Engine Data.....	349
Tires, Rims, Tracks.....	350
Tire Pressures, Cold (68 °F/20 °C) .....	354
Weights.....	356
Ground Clearance.....	357
Capacities.....	359
Dimensions .....	360
Driving Performance .....	361



## Vehicle Identification

When ordering spare parts or making inquiries, please always quote the vehicle identification number.

### Data bank

The data bank is located on the left under the loadspace floor.

This label contains the following information:

1. Vehicle Identification No.
2. Type/Type description
3. Engine code/Transmission code
4. Paint No./Interior
5. Optional equipment

A duplicate of this label is in your Maintenance Booklet.

### Note

The data bank cannot be reordered when lost or damaged.



## Vehicle identification number

In accordance with Federal Safety Regulations, the vehicle identification number of your car is located at the bottom left of the windshield frame and can be seen from the outside and in the luggage compartment on the right in front of the tool box.



### Safety compliance sticker

The safety compliance sticker is your assurance that your new Porsche complies with all applicable Federal Motor Vehicle Safety Standards which were in effect at the time the vehicle was manufactured.

The sticker also shows the month and year of production and the vehicle identification number of your car (perforations) as well as the **Gross Vehicle Weight Rating** and the **Gross Axle Weight Rating**.



### Tire pressure plate

The tire pressure plate is attached to the left-hand-door aperture.

The pressures shown on the tire pressure plate refer to a fully loaded vehicle. In case the combined weight of occupants and cargo does not exceed 260 kg or 573 lbs the pressures for "PARTIALLY LOADED" may be used for greater driving comfort.

- ▷ Please see the chapter "TIRE PRESSURES, COLD (68 °F/20 °C)" on Page 354.
- ▷ Please see the chapter "LOADING INFORMATION" on Page 231.

### For setting "Partially Load":

1. Correct the setting in the multi-purpose display.  
Please see the chapter "SETTING VEHICLE LOADING AND ADJUSTING TIRE PRESSURE" on Page 135.
2. Correct the tire pressure.

## Engine Data

	<b>Cayenne</b>	<b>Cayenne S</b>	<b>Cayenne GTS, Cayenne S Transsyberia</b>
Type	6-cylinder V-engine	8-cylinder V-engine	8-cylinder V-engine
Number of cylinders	6	8	8
Bore	3.5 in. (89 mm)	3.78 in. (96 mm)	3.78 in. (96 mm)
Stroke	3.8 in. (96.4 mm)	3.27 in. (83 mm)	3.27 in. (83 mm)
Displacement	219.5 cu. in. (3598 cm <sup>3</sup> )	293.3 cu. in. (4806 cm <sup>3</sup> )	293.3 cu. in. (4806 cm <sup>3</sup> )
Net-horsepower	213 kW (290 HP)	283 kW (385 HP)	298 kW (405 HP)
at engine speed	6200 rpm	6200 rpm	6500 rpm
Net. torque	273 ftlb. (370 Nm)	369 ftlb. (500 Nm)	369 ftlb. (500 Nm)
at engine speed	3000 rpm	3500 rpm	3500 rpm
Maximum permitted engine speed	6700 rpm	6700 rpm	6700 rpm
Engine oil consumption	up to 1.5 liters/1000 km (1.6 quarts/622 miles)	up to 1.5 liters/1000 km (1.6 quarts/622 miles)	up to 1.5 liters/1000 km (1.6 quarts/622 miles)

## Tires, Rims, Tracks

Cayenne	Tires	Wheel	Rim offset	Track	
		front/rear	front/rear	front	rear
<b>Summer tires</b>	235/65 R 17 108 V XL	7.5 J x 17	2.09 in. (53 mm)	65.2 in. (1655 mm)	65.7 in. (1670 mm)
	255/55 R 18 109 Y XL	8 J x 18	2.24 in. (57 mm)	64.8 in. (1647 mm)	65.4 in. (1662 mm)
	275/45 R 19 108 Y XL	9 J x 19	2.36 in. (60 mm)	64.6 in. (1641 mm)	65.2 in. (1656 mm)
	275/40 R 20 106 Y XL	9 J x 20	2.36 in. (60 mm)	64.6 in. (1641 mm)	65.2 in. (1656 mm)
	275/40 R 20 106 Y XL	9 J x 20/10 J x 20	2.36 in. (60 mm)/ 2.17 in. (55 mm)	64.6 in. (1641 mm)	65.6 in. (1666 mm)
	295/35 R 21 107 Y XL	10 J x 21	1.97 in. (50 mm)	65.4 in. (1661 mm)	66.0 in. (1676 mm)
	295/35 R 21 107 Y XL	10 J x 21	1.97 in. (50 mm)/ 1.77 in. (45 mm)	65.4 in. (1661 mm)	66.4 in. (1686 mm)
<b>Winter tires</b>	235/65 R 17 108 H XL <sup>1)</sup>	7.5 J x 17	2.09 in. (53 mm)	65.2 in. (1655 mm)	65.7 in. (1670 mm)
	255/55 R 18 109 V XL <sup>2)</sup>	8 J x 18	2.24 in. (57 mm)	64.8 in. (1647 mm)	65.4 in. (1662 mm)
	255/50 R 19 107 V XL <sup>3)</sup>	9 J x 19	2.36 in. (60 mm)	64.6 in. (1641 mm)	65.2 in. (1656 mm)
	275/40 R 20 106 V XL <sup>3)</sup>	9 J x 20	2.36 in. (60 mm)	64.6 in. (1641 mm)	65.2 in. (1656 mm)
	275/40 R 20 106 V XL	9 J x 20/10 J x 20	2.36 in. (60 mm)/ 2.17 in. (55 mm)	64.6 in. (1641 mm)	65.6 in. (1666 mm)
<b>All-Season</b>	235/65 R 17 108 V XL <sup>1)</sup>	7.5 J x 17	2.09 in. (53 mm)	65.2 in. (1655 mm)	65.7 in. (1670 mm)
	255/55 R 18 109 V XL <sup>2)</sup>	8 J x 18	2.24 in. (57 mm)	64.8 in. (1647 mm)	65.4 in. (1662 mm)
	275/45 R 19 108 V XL <sup>3)</sup>	9 J x 19	2.36 in. (60 mm)	64.6 in. (1641 mm)	65.2 in. (1656 mm)
<b>Collapsible spare wheel</b>	195/75 - 18	6.5 x 18	2.09 in. (53 mm)		

Cayenne S, Cayenne S Transsyberia	Tires	Wheel	Rim offset	Track	
		front/rear	front/rear	front	rear
<b>Summer tires</b>	255/55 R 18 109 Y XL <sup>4)</sup>	8 J x 18	2.24 in. (57 mm)	64.8 in. (1647 mm)	65.4 in. (1662 mm)
	275/45 R 19 108 Y XL <sup>4)</sup>	9 J x 19	2.36 in. (60 mm)	64.6 in. (1641 mm)	65.2 in. (1656 mm)
	275/40 R 20 106 Y XL	9 J x 20	2.36 in. (60 mm)	64.6 in. (1641 mm)	65.2 in. (1656 mm)
	275/40 R 20 106 Y XL	9 J x 20/10 J x 20	2.36 in. (60 mm)/ 2.17 in. (55 mm)	64.6 in. (1641 mm)	65.6 in. (1666 mm)
	295/35 R 21 107 Y XL	10 J x 21	1.97 in. (50 mm)	65.4 in. (1661 mm)	66.0 in. (1676 mm)
	295/35 R 21 107 Y XL	10 J x 21	1.97 in. (50 mm) 1.77 in. (45 mm)	65.4 in. (1661 mm)	66.4 in. (1686 mm)
<b>Winter tires</b>	255/55 R 18 109 V XL <sup>2)4)</sup>	8 J x 18	2.24 in. (57 mm)	64.8 in. (1647 mm)	65.4 in. (1662 mm)
	255/50 R 19 107 V XL <sup>3)4)</sup>	9 J x 19	2.36 in. (60 mm)	64.6 in. (1641 mm)	65.2 in. (1656 mm)
	275/40 R 20 106 V XL <sup>3)</sup>	9 J x 20	2.36 in. (60 mm)	64.6 in. (1641 mm)	65.2 in. (1656 mm)
	275/40 R 20 106 V XL	9 J x 20/10 J x 20	2.36 in. (60 mm)/ 2.17 in. (55 mm)	64.6 in. (1641 mm)	65.6 in. (1666 mm)
<b>All-Season</b>	255/55 R 18 109 V XL <sup>2)4)</sup>	8 J x 18	2.24 in. (57 mm)	64.8 in. (1647 mm)	65.4 in. (1662 mm)
	275/45 R 19 108 V XL <sup>3)4)</sup>	9 J x 19	2.36 in. (60 mm)	64.6 in. (1641 mm)	65.2 in. (1656 mm)
<b>Collapsible spare wheel</b>	195/75 - 18 <sup>4)</sup>	6.5 x 18	2.09 in. (53 mm)		
	195/65 - 19	6.5 x 19	1.71 in. (43.5 mm)		

Cayenne GTS	Tires	Wheel	Rim offset	Track	
		front/rear	front/rear	front	rear
<b>Summer tires</b>	255/55 R 18 109 Y XL <sup>4)</sup>	8 J x 18	2.24 in. (57 mm)	64.8 in. (1645 mm)	65.7 in. (1669 mm)
	275/45 R 19 108 Y XL <sup>4)</sup>	9 J x 19	2.36 in. (60 mm)	64.6 in. (1641 mm)	65.4 in. (1662 mm)
	275/40 R 20 106 Y XL	9 J x 20	2.36 in. (60 mm)	64.6 in. (1641 mm)	65.4 in. (1662 mm)
	275/40 R 20 106 Y XL	9 J x 20/10 J x 20	2.36 in. (60 mm)/ 2.17 in. (55 mm)	64.6 in. (1641 mm)	65.8 in. (1672 mm)
	295/35 R 21 107 Y XL	10 J x 21	1.97 in. (50 mm)	65.3 in. (1659 mm)	66.2 in. (1682 mm)
	295/35 R 21 107 Y XL	10 J x 21	1.97 in. (50 mm) 1.77 in. (45 mm)	65.3 in. (1659 mm)	66.6 in. (1692 mm)
<b>Winter tires</b>	255/55 R 18 109 V XL <sup>2/4)</sup>	8 J x 18	2.24 in. (57 mm)	64.8 in. (1645 mm)	65.7 in. (1669 mm)
	255/50 R 19 107 V XL <sup>3/4)</sup>	9 J x 19	2.36 in. (60 mm)	64.6 in. (1641 mm)	65.4 in. (1662 mm)
	275/40 R 20 106 V XL <sup>3)</sup>	9 J x 20	2.36 in. (60 mm)	64.6 in. (1641 mm)	65.4 in. (1662 mm)
	275/40 R 20 106 V XL	9 J x 20/10 J x 20	2.36 in. (60 mm)/ 2.17 in. (55 mm)	64.6 in. (1641 mm)	65.8 in. (1672 mm)
<b>All-Season</b>	255/55 R 18 109 V XL <sup>2/4)</sup>	8 J x 18	2.24 in. (57 mm)	64.8 in. (1645 mm)	65.7 in. (1669 mm)
	275/45 R 19 108 V XL <sup>3/4)</sup>	9 J x 19	2.36 in. (60 mm)	64.6 in. (1641 mm)	65.4 in. (1662 mm)
<b>Collapsible spare wheel</b>	195/75 - 18 <sup>4)</sup>	6.5 x 18	2.09 in. (53 mm)		
	195/65 - 19	6.5 x 19	1.71 in. (43.5 mm)		



## **Cayenne, Cayenne S, Cayenne GTS and Cayenne S Transsyberia**

### **Tire and rim sizes**

#### **1, 2, 3) Snow chains and clearance**

#### **4) Porsche Ceramic Composite Brake**

The load capacity coefficient (e.g. "106") and maximum speed code letter (e.g. "T") for permitted top speed are minimum requirements.

When fitting new tires or changing tires: Please see the chapter "TIRES/WHEELS" on Page 281.

Extensive tests are performed before specific tires and wheels are approved by Porsche. Your Porsche dealer has information about approved tires and wheels and is happy to assist you.

By fitting tires which have been approved by Porsche, you can be sure that you have the best possible tires for your Porsche.

The 20 inch and 21 inch tire sizes are designed for on-road use.

Please see the chapter "SNOW CHAINS" on Page 289.

Clearance for tires marked <sup>1)</sup> is only assured with snow chain, part No. 955.044.600.07.

Clearance for tires marked <sup>2), 3)</sup> is only assured with snow chain, part No. 955.044.600.13.

For tires marked with <sup>3)</sup>: Only use snow chains on the rear axle.

Optimal handling characteristics can be achieved only when snow chains are fitted on all four wheels of the vehicle.

It is also possible to fit snow chains on only one axle (preferably the rear axle).

Maximum speed 50 km/h (30 mph).

▷ Observe the respective road traffic regulations.

▷ Use only Porsche-authorized fine-link cross-type or edge chains.

Tires marked with <sup>4)</sup>: Not for vehicles with 20-inch Porsche Ceramic Composite Brake.

## Tire Pressures, Cold (68 °F/20 °C)

These tire filling pressures apply only to the tire makes and types approved by Porsche. Please see the chapter "TIRES/WHEELS" on Page 281.

Partially loaded (up to 3 people and 46 lbs./21 kg of luggage)	Cayenne		Cayenne S, Cayenne GTS, Cayenne S Transsyberia	
	Front axle	Rear axle	Front axle	Rear axle
<b>Tire pressure for summer tires, All-Season tires and winter tires</b>	Front axle	Rear axle	Front axle	Rear axle
235/65 R 17 summer tires and M+S	38 psi (2.6 bar)	43 psi (2.9 bar)	-	-
255/55 R 18 summer tires and M+S			38 psi (2.6 bar)	43 psi (2.9 bar)
255/50 R 19 M+S				
275/45 R 19 summer tires and M+S				
275/40 R 20 summer tires and M+S				
295/35 R 21 summer tires				
<b>Comfort tire pressure for All-Season tires and winter tires</b>	Front axle	Rear axle	Front axle	Rear axle
235/65 R 17 M+S	35 psi (2.4 bar)	39 psi (2.7 bar)	-	-
255/55 R 18 M+S			35 psi (2.4 bar)	39 psi (2.7 bar)
255/50 R 19 M+S				
275/45 R 19 M+S				
275/40 R 20 M+S				
<b>Collapsible spare wheel</b>	Front axle	Rear axle	Front axle	Rear axle
195/75 - 18	51 psi (3.5 bar)			
195/65 - 19				

Fully loaded (more than 3 people and 46 lbs./21 kg of luggage)	Cayenne		Cayenne S, Cayenne GTS, Cayenne S Transsyberia	
	Front axle	Rear axle	Front axle	Rear axle
Tire size				
235/65 R 17 summer and M+S tires	39 psi (2.7 bar)	50 psi (3.4 bar)	-	-
255/55 R 18 summer and M+S tires			39 psi (2.7 bar)	50 psi (3.4 bar)
255/50 R 19 M+S tires				
275/45 R 19 summer and M+S tires				
275/40 R 20 summer and M+S tires				
295/35 R 21 summer tires			51 psi (3.5 bar)	
195/75 - 18 collapsible spare wheel	51 psi (3.5 bar)			
195/65 - 19 collapsible spare wheel	51 psi (3.5 bar)			

- ▷ On vehicles with Tire Pressure Monitoring, the vehicle load must be set in the multi-purpose display of the instrument panel. Please see the chapter “SETTING VEHICLE LOADING AND ADJUSTING TIRE PRESSURE” on Page 135.

**Note**

M+S identification located on All-Season and winter tires.

## Weights

	<b>Cayenne manual transmission</b>	<b>Cayenne Tiptronic S</b>	<b>Cayenne GTS, Cayenne S Transsyberia manual transmission</b>	<b>Cayenne S, Cayenne GTS, Cayenne S Transsyberia Tiptronic S</b>
<b>Empty weight</b>				
Empty weight (depending on equipment)				
per DIN 70020	4762 - 5556 lbs. (2160 - 2520 Kg)	4784 - 5578 lbs. (2170 - 2530 kg)	4905 - 5732 lbs. (2225 - 2600 kg)	4949 - 5776 lbs. (2245 - 2620 kg)
per 70/156/EEC <sup>1)</sup>	4927 - 5720 lbs. (2235 - 2595 kg)	4949 - 5743 lbs. (2245 - 2605 kg)	5071 - 5897 lbs. (2300 - 2675 kg)	5115 - 5941 lbs. (2320 - 2695 kg)
Maximum axle load, front <sup>2)</sup>	3053 lbs. (1385 kg)	3053 lbs. (1385 kg)	3208 lbs. (1455 kg)	3208 lbs. (1455 kg)
Maximum axle load, rear <sup>2)</sup>	3638 lbs. (1650 kg)	3638 lbs. (1650 kg)	3704 lbs. (1680 kg)	3704 lbs. (1680 kg)
Maximum gross weight	6493 lbs. (2945 kg)	6493 lbs. (2945 kg)	6790 lbs. (3080 kg)	6790 lbs. (3080 kg)
<b>Trailer operation Canada/USA</b>				
Maximum gross weight	6493 lbs. (2945 kg)	6493 lbs. (2945 kg)	6790 lbs. (3080 kg)	6790 lbs. (3080 kg)
Maximum axle load, front/rear axle	3053/3803 lbs. (1385/1725 kg)	3053/3803 lbs. (1385/1725 kg)	3208/3803 lbs. (1455/1725 kg)	3208/3803 lbs. (1455/1725 kg)
<b>Roof load</b>				
Maximum roof load <sup>3)</sup>	221 lbs. (100 kg)	221 lbs. (100 kg)	221 lbs. (100 kg)	221 lbs. (100 kg)
when roof rail is fitted <sup>3)</sup>	165 lbs. (75kg)	165 lbs. (75 kg)	165 lbs. (75 kg)	165 lbs. (75 kg)
<b>Towing capacity/vehicle + trailer weight</b>				
Maximum towing capacity, braked (up to a max. 12% slope)	7716 lbs. (3500 kg)	7716 lbs. (3500 kg)	7716 lbs. (3500 kg)	7716 lbs. (3500 kg)
Maximum towing capacity, unbraked	1654 lbs. (750 kg)	1654 lbs. (750 kg)	1654 lbs. (750 kg)	1654 lbs. (750 kg)
Maximum vehicle + trailer weight	14209 lbs. (6445 kg)	14209 lbs. (6445 kg)	14506 lbs. (6580 kg)	14506 lbs. (6580 kg)
Maximum trailer hitch load	617 lbs. (280 kg)	617 lbs. (280 kg)	617 lbs. (280 kg)	617 lbs. (280 kg)

<sup>1)</sup> Empty weight includes 165 lbs. (75 kg) driver and baggage share.

<sup>2)</sup> The maximum gross weight must not be exceeded.

Note: If additional equipment is installed, the useful load will be correspondingly less.

<sup>3)</sup> Use only Original Porsche Roof Transport System.

## Ground Clearance

	Cayenne	Cayenne S, Cayenne S Transsyberia	Cayenne GTS
<b>Steel suspension<sup>1)</sup></b>			
Ramp angle	20.4°	20.4°	18.2°
Overhang angle, front	28.6°	28.6°	25.6°
Overhang angle, rear	22.8°	22.8°	21.1°
Ground clearance (center of axles)	8.58 in. (218 mm)	8.58 in. (218 mm)	7.63 in. (194 mm)
<b>Air suspension – normal level</b>			
Ramp angle	20.0°	20.0°	18.2°
Overhang angle, front	28.5°	28.5°	26.9°
Overhang angle, rear	22.3°	22.3°	21.1°
Ground clearance (center of axles)	8.46 in. (215 mm)	8.46 in. (215 mm)	7.68 in. (195 mm)
<b>Air suspension – low level</b>			
Ramp angle	17.6°	17.6°	17.6°
Overhang angle, front	27.3°	27.3°	27.3°
Overhang angle, rear	20.6°	20.6°	20.6°
Ground clearance (center of axles)	7.52 in. (191 mm)	7.52 in. (191 mm)	7.32 in. (186 mm)
<b>Air suspension – loading level</b>			
Ramp angle	14.8°	14.8°	14.8°
Overhang angle, front	21°	21°	21°
Overhang angle, rear	18.5°	18.5°	18.5°
Ground clearance (center of axles)	6.34 in. (161 mm)	6.34 in. (161 mm)	6.34 in. (161 mm)
<b>Air suspension – terrain level</b>			
Ramp angle	22.1°	22.1°	18.7°
Overhang angle, front	30.2°	30.2°	27.7°
Overhang angle, rear	23.6°	23.6°	21.3°
Ground clearance (center of axles)	9.49 in. (241 mm)	9.49 in. (241 mm)	8.70 in. (221 mm)

	<b>Cayenne</b>	<b>Cayenne S, Cayenne S Transsyberia</b>	<b>Cayenne GTS</b>
<b>Air suspension – special terrain level</b>			
Ramp angle	24.7°	24.7°	21.1°
Overhang angle, front	31.8°	31.8°	29.7°
Overhang angle, rear	25.4°	25.4°	23.3°
Ground clearance (center of axles)	10.67 in. (271 mm)	10.67 in. (271 mm)	9.88 in. (251 mm)

<sup>1)</sup> Not Cayenne S Transsyberia.

## Capacities

Use only fluids and fuels authorized by Porsche. Your authorized Porsche dealer will be pleased to advise you. Your Porsche has been designed so that it is not necessary to mix any additives with oils or fuels.

	<b>Cayenne</b>	<b>Cayenne S, Cayenne GTS, Cayenne S Transsyberia</b>
Engine oil change quantity without oil filter	approx. 6.34 quarts (6.0 liters)	approx. 9.0 quarts (8.5 liters)
Engine oil change quantity with oil filter	approx. 7.29 quarts (6.9 liters) Reference indication is the level on the oil dipstick. Please see the chapter "CHECKING ENGINE OIL LEVEL" on Page 252.	approx. 9.51 quarts (9.0 liters)
Coolant, depending on equipment level	approx. 3.4 – 4.8 U.S. gallons (13 – 18 liters)	approx. 4.8 – 5.5 U.S. gallons (18 – 21 liters)
Manual transmission with compensation	approx. 1.9 quarts (1.8 litres)	approx. 1.9 quarts (1.8 litres)
Automatic transmission with torque converter	approx. 10.04 quarts (9.5 liters)	approx. 9.51 quarts (9.0 liters)
Transfer box	approx. 0.9 quarts (0.85 liter)	approx. 0.9 quarts (0.85 liter)
Front-axle differential	approx. 1.1 quarts (1.0 liter)	approx. 1.1 quarts (1.0 liter)
Rear-axle differential	approx. 1.3 quarts (1.25 liters)	approx. 1.5 quarts (1.4 liters)
Locking rear differential	approx. 1.7 quarts (1.6 liters)	approx. 1.7 quarts (1.6 liters)
Fuel tank	approx. 26.4 U.S. gallons (100 liters), including approx. 3 U.S. gallons (12 liters) reserve	approx. 26.4 U.S. gallons (100 liters), including approx. 3 U.S. gallons (12 liters) reserve
Fuel quality	The engine is designed to provide optimum performance and fuel consumption if unleaded premium fuel with 98 RON/88 MON is used.	If unleaded premium fuels with octane numbers of at least 95 RON/85 MON are used, the engine's "Electronic Oktan™ knock control" automatically adapts the ignition timing.
Power steering	approx. 1.6 quarts (1.5 liters) Pentosin CHF 202 S®	approx. 1.6 quarts (1.5 liters) Pentosin CHF 202 S®
Brake fluid	approx. 1.0 quart (0.95 liter) Use only Original Porsche brake fluid.	approx. 1.0 quart (0.95 liter) Use only Original Porsche brake fluid.
Window/headlight washer system	approx. 7.9 quarts (7.5 liters)	approx. 7.9 quarts (7.5 liters)

## Dimensions

	<b>Cayenne</b>	<b>Cayenne S/ Cayenne S Transsiberia</b>	<b>Cayenne GTS</b>
<b>Length</b>	188.9 in. (4798 mm)	188.9 in. (4798 mm)	188.8 in. (4795 mm)
Length with external spare wheel	198.0 in. (5029 mm)	198.0 in. (5029 mm)	
<b>Width</b>	75.9 in. (1928 mm)	75.9 in. (1928 mm)	77.1 in. (1957 mm)
Width with door mirrors	86.6 in. (2200 mm)	86.6 in. (2200 mm)	86.6 in. (2200 mm)
<b>Height at DIN empty weight</b>	66.9 in. (1699 mm)	66.9 in. (1699 mm)/ 66.8 in (1696 mm)	65.9 in. (1675 mm)
Height at DIN empty weight (rail)	68.5 in. (1741 mm)	68.5 in. (1741 mm)/ 68.5 in (1738 mm)	67.6 in. (1717 mm)
Height at DIN empty weight (basic carrier of Roof Transport System)	70.4 in. (1789 mm)	70.4 in. (1789 mm)/ 70.3 in (1786 mm)	69.5 in. (1765 mm)
Height at DIN empty weight with rear lid open	87.3 in. (2218 mm)	87.3 in. (2218 mm)/ 87.2 in (2215 mm)	86.4 in. (2194 mm)
Max. wading depth	19.7 in. (500 mm) <sup>1)</sup>	19.7 in. (500 mm) <sup>1)</sup>	18.7 in. (476 mm) <sup>2)</sup>
<b>Wheelbase</b>	112.4 in. (2855 mm)	112.4 in. (2855 mm)	112.4 in. (2855 mm)
Overhang, front	36.9 in. (936 mm)	36.9 in. (936 mm)	36.7 in. (933 mm)
Overhang, rear	39.7 in. (1007 mm)	39.7 in. (1007 mm)	39.7 in. (1007 mm)
<b>Turning circle</b>	461 in. (11.7 m)	461 in. (11.7 m)	461 in. (11.7 m)

<sup>1)</sup> Up to 21.9 in. (555 mm) for vehicles with air suspension at special terrain level.

<sup>2)</sup> Up to 21.1 in. (535 mm) for vehicles with air suspension at special terrain level.



## Driving Performance

The specifications refer to a vehicle with DIN curb weight and max. 441 lbs. (200 kg) load without performance-reducing additional equipment (e.g. special tires)

	<b>Cayenne manual transmission</b>	<b>Cayenne Tiptronic S</b>	<b>Cayenne S Tiptronic S</b>
Top track speed	141 mph (227 km/h)	141 mph (227 km/h)	155 mph (250 km/h)
Acceleration 0 - 60 mph (96 km/h)	7.5 seconds	7.9 seconds	6.4 seconds
Acceleration 0 - 62 mph (100 km/h)	8.1 seconds	8.5 seconds	6.8 seconds
Maximum speed when driving with a trailer	Observe country-specific laws for driving with trailers.		

	<b>Cayenne GTS, Cayenne S Transsyberia manual transmission</b>	<b>Cayenne GTS, Cayenne S Transsyberia Tiptronic S</b>
Top track speed	157 mph (253 km/h)	156 mph (251 km/h)
Acceleration 0 - 60 mph (96 km/h)	5.7 seconds	6.1 seconds
Acceleration 0 - 62 mph (100 km/h)	6.1 seconds	6.5 seconds
Maximum speed when driving with a trailer	Observe country-specific laws for driving with trailers.	

# Index

- 2-zone air conditioning
  - Air-conditioning sensors ..... 71
  - Defrosting windshield ..... 70
  - Functional description ..... 70
  - Information on air-conditioning compressor ..... 65
  - Opening the cover flap ..... 64
  - Operating overview ..... 70
  - REST mode ..... 65
  - Setting air distribution ..... 72
  - Setting air quantity ..... 71
  - Setting fan ..... 71
  - Setting temperature ..... 71
  - Sun sensor ..... 71
  - Switching air-conditioning compressor on/off ..... 65
  - Switching automatic mode on/off ..... 71
  - Switching ECON mode on/off ..... 65
  - Switching Mono function on/off ..... 72
  - Switching on automatic recirculating-air mode ..... 72
  - Switching on recirculating-air mode ..... 72
  - Temperature sensor ..... 71
  - Using engine residual heat ..... 65
- 4-wheel drive
  - Functional description ..... 182
  - Warning message on multi-purpose display ..... 154
- 4-zone air conditioning
  - Air-conditioning sensors ..... 76
  - Controlling rear air-conditioned areas with the front control panel ..... 79
  - Defrosting windshield ..... 75
  - Disabling control panel (rear) ..... 79
  - Disabling control panel for air-conditioned areas at the rear ..... 79
  - Functional description ..... 75
  - Information on air-conditioning compressor ..... 65
  - Opening the cover flap ..... 64
  - Operating overview, front ..... 75
  - Operating overview, rear ..... 76
  - REST mode ..... 65
  - Setting air distribution ..... 77
  - Setting air quantity ..... 77
  - Setting fan ..... 77
  - Setting temperature ..... 77
  - Sun sensor ..... 76
  - Switching air-conditioning compressor on/off ..... 65
  - Switching automatic mode on/off ..... 76
  - Switching ECON mode on/off ..... 65
  - Switching Mono function on/off ..... 78
  - Switching on automatic recirculating-air mode ..... 78
  - Switching on recirculating-air mode ..... 78
  - Temperature sensor ..... 76
  - Using engine residual heat ..... 65
- A**
  - ABD (Automatic brake differential)
    - Automatic deactivation ..... 184
    - Functional description ..... 182
  - ABS (anti-lock brake system)
    - Functional description ..... 186
    - Off-road ABS functional description ..... 187
    - Warning light on the tachometer ..... 187
    - Warning message on multi-purpose display ..... 153
  - Additional door mirrors when towing a trailer
  - Additional high beam
    - Changing bulb (Bi-Xenon headlights) ..... 331
    - Changing bulb (halogen headlights) ..... 330
    - Installing headlights ..... 328
    - Removing headlights ..... 327
  - Adhesive films, care instructions ..... 275
  - Adjusting seat position ..... 36
  - Adjusting the opening height of the automatic rear lid ..... 26
  - After driving off-road ..... 196
  - Aftermarket Alarms ..... 219
  - Air cleaner maintenance instructions ..... 260
  - Air conditioner
    - Child lock (4-zone air conditioning) ..... 79
    - Defrosting windshield with 2-zone air conditioning .. 70
    - Defrosting windshield with 4-zone air conditioning .. 75
    - Defrosting windshield with manual air conditioning .. 67
    - Disabling control panel for air-conditioned areas at the rear ..... 79
    - Functional description of 2-zone air conditioning .... 70
    - Functional description of 4-zone air conditioning .... 75
    - Functional description of manual air-conditioning .... 67
    - Information on air-conditioning compressor ..... 65
    - Opening the cover flap ..... 64
    - Operating overview of 2-zone air conditioning ..... 70
    - Operating overview
      - of 4-zone air conditioning, front ..... 75
    - Operating overview
      - of 4-zone air conditioning, rear ..... 76
    - Operating overview of manual air conditioning ..... 67
    - Overview of air-conditioning systems ..... 64
    - Setting air distribution with 2-zone air conditioning . 71
    - Setting air distribution with 4-zone air conditioning . 77
    - Setting air distribution with manual air conditioning. 68
    - Setting air quantity with 2-zone air conditioning ..... 71
    - Setting air quantity with 4-zone air conditioning ..... 77
    - Setting air quantity with manual air conditioning ..... 68
    - Setting fan with 2-zone air conditioning ..... 71
    - Setting fan with 4-zone air conditioning ..... 77
    - Setting fan with manual air conditioning ..... 68
    - Setting temperature with 2-zone air conditioning .... 71
    - Setting temperature with 4-zone air conditioning .... 77
    - Setting temperature with manual air conditioning ... 68
    - Sun sensor for 2-zone air conditioning ..... 71
    - Sun sensor for 4-zone air conditioning ..... 76
    - Switching air-conditioning compressor on/off ..... 65
    - Switching automatic mode on/off
      - with 2-zone air conditioning ..... 71
      - with 4-zone air conditioning ..... 76
    - Switching automatic mode on/off
      - with 4-zone air conditioning ..... 76
    - Switching child protection on/off (4-zone air conditioning) ..... 79
    - Switching ECON mode on/off ..... 65
    - Switching on automatic recirculating-air mode with 2-zone air conditioning ..... 72
    - Switching on automatic recirculating-air mode with 4-zone air conditioning ..... 78
    - Switching on recirculating air-mode with manual air conditioning ..... 68
    - Switching REST mode on/off ..... 65
    - Temperature sensor for 2-zone air conditioning .... 71
    - Temperature sensor for 4-zone air conditioning ..... 76
    - Which system is in my car? ..... 64
  - Air conditioning
    - Fresh-air intake ..... 80
    - Vents ..... 79

Air pressure		Switching on/off .....	246	Automatic anti-dazzle function for interior mirror .....	57
Comfort tire pressure (bar/psi) .....	354	When disconnecting battery .....	321	Automatic anti-dazzle operation .....	57
Data (bar/psi) .....	354	Alcantara		Automatic brake differential (ABD)	
Plate .....	348	Care instructions .....	277	Automatic deactivation .....	184
Warning message on multi-purpose display .....	151	All-Season tires		Functional description .....	182
Air suspension .....	225, 238	Overview .....	350, 351, 352	Automatic headlight beam adjustment	
Compressor connection for inflating tires .....	308	All-Terrain tires		Functional description .....	106
Displaying status of level control		Overview .....	350, 351, 352	Automatic speed control (cruise control)	
on multi-purpose display .....	131	All-wheel drive		Accelerating .....	167
Lowering the car .....	191	Functional description .....	182	Decelerating .....	168
Lowering the car for loading .....	191	Warning message on multi-purpose display .....	154	Functional description .....	167
Overview .....	190	Aluminum rims		Interrupting operation .....	168
Raising the car .....	191	Care instructions .....	276	Storing speed .....	167
Setting loading level .....	191	Inscription .....	291	Switching off .....	168
Setting low level .....	191	Antifreeze .....	255	Switching on .....	167
Setting normal level .....	191	In coolant .....	255	Automatic transmission fluid .....	260
Setting special terrain level .....	191	In washer fluid .....	258	Automatically closing the rear lid .....	25
Setting terrain level .....	191	Anti-freeze content .....	255	AUX interface, installation position .....	221
Warning message on the multi-purpose display .....	192	Anti-lock brake system (ABS)		Average consumption	
Air vents		Functional description .....	186	Displaying/resetting average consumption	
Adjusting .....	79	Off-road ABS functional description .....	187	on multi-purpose display .....	132
Opening/closing .....	79	Warning light on the tachometer .....	187	Avoiding false alarms .....	245
Airbag		Warning message on multi-purpose display .....	153		
Airbag warning light on the tachometer .....	49	Armrest		<b>B</b>	
Automatic deactivation of the passenger airbag .....	47	Opening front storage compartment .....	224	Baby seat	
Care Instructions .....	277	Opening rear storage compartment .....	224	Installing with LATCH system .....	53
Disposal .....	46	Ashtray		LATCH restraint system .....	53
Function .....	46	Front, emptying .....	227	Prescribed installation direction .....	50
Functional description .....	45	Front, opening .....	227	Battery .....	220
Installation location .....	45	Rear, emptying .....	228	After charging .....	325
Passenger airbag warning light .....	48	Rear, opening .....	228	Care .....	321
Unit .....	58	Assembly aid for wheel changes .....	303	Changing in car key .....	322
Air-conditioning compressor		Assistance when driving downhill		Charge state .....	320
Information on air-conditioning compressor .....	65	(Engine Braking Support) .....	189	Charging .....	325
Switching on/off (ECON mode) .....	65	Audio		General information .....	320
Air-conditioning sensors		Tips .....	218	Location .....	320
For 2-zone air conditioning .....	71	Audio interface, installation position .....	221	Procedure after battery connection .....	322
For 4-zone air conditioning .....	76	auto (light switch)		Putting vehicle into operation .....	322
Alarm button .....	17	Functional description, driving light assistant .....	104	Replacing .....	321
Alarm system .....	245	Switching on driving light assistant .....	104	Starting with jumper cables .....	323
Function .....	245	AUTO button		Vehicle electrical system voltage indication .....	121
Function indication .....	247	2-zone air conditioning .....	71	Voltage indication .....	121
Functional description .....	245	4-zone air conditioning .....	76	Warning message on multi-purpose display .....	152
Hitching a trailer .....	230	Automatic (Tiptronic S)		Winter driving .....	321
Persons/animals remaining in the locked vehicle .....	246	Functional description .....	170	Before driving off .....	4, 196
Switching off alarm .....	245	Gear selector .....	171		
Switching off		Rocker switches on the steering wheel .....	58		
passenger compartment monitoring system .....	246	Selector lever .....	171		

Belt tensioner		Breaking in		Button overview	
Functional description.....	42	Engine .....	6	2-zone air conditioning .....	70
Belts .....	42	Engine oil and fuel consumption		4-zone air conditioning, front.....	75
Adjusting belt height.....	44	during break-in period.....	6	4-zone air conditioning, rear .....	76
Belt tensioner functional description	42	Hints .....	6	Manual air-conditioning.....	67
Care instructions .....	278	New brake pads and brake discs.....	6	Parking heater.....	81
Fastening .....	43	New tires .....	6		
Opening .....	44	Brief overview			
Warning light.....	53	2-zone air-conditioning .....	69		
Warning light on the tachometer.....	43	4-zone air-conditioning (front control panel) .....	73		
Bi-xenon.....	330	4-zone air-conditioning (rear control panel) .....	74		
Changing bulb for additional high beam .....	331	Manual air-conditioning .....	66		
Changing bulb for cornering light.....	332	Opening and locking from outside.....	18		
Changing gas-discharge headlight .....	330	Panorama roof system .....	96		
Installing headlights.....	328	Sliding/lifting roof .....	91		
Removing headlights .....	327	Windshield wipers .....	110		
Brake booster.....	165	Bulbs			
Brake booster faulty warning message.....	154	Changing bulb for additional high beam			
Brake fluid		(Bi-Xenon headlights) .....	331		
Change quantity .....	359	Changing bulb for additional high beam			
Changing .....	258	(halogen headlights) .....	330		
Checking level.....	257	Changing bulb for front turn signal (Cayenne GTS)	335		
Warning light on speedometer .....	258	Changing bulb for front turn signal			
Warning message on multi-purpose display .....	153	(Cayenne, Cayenne S, Cayenne S Transsyberia) ..	333		
Brake light		Changing bulb for high beam .....	331		
Changing bulb.....	338	Changing bulb for high beam (halogen headlights)	330		
Installing tail light .....	337	Changing bulb for license plate light .....	338		
Removing tail light .....	336	Changing bulb for low beam .....	329, 330		
Brake pads		Changing bulb for low beam (halogen headlights)	329		
Breaking in new brake pads.....	6	Changing bulb for side light (Cayenne GTS) .....	335		
Warning message on the multi-purpose display ...	153	Changing bulb for side light			
Warning message, brakes .....	165	(Cayenne, Cayenne S, Cayenne S Transsyberia) ..	333		
Brake pedal.....	164	Changing bulb for side light, halogen			
Brake wear		(Cayenne, Cayenne S, Cayenne S Transsyberia) ..	333		
Warning light.....	165	Changing gas-discharge headlight			
Brake wear warning message .....	165	(Bi-Xenon headlights) .....	330		
Brakes.....	163	Chart .....	342		
Applying/releasing parking brake .....	162	Overview .....	342		
Brake pad warning message .....	165	Replacing brake light .....	338		
Brake pedal.....	164	Replacing rear fog light.....	338		
Break in new brake pads.....	6	Replacing rear turn signal light .....	338		
Discs.....	165	Replacing reversing light .....	338		
Pads .....	165, 166	Replacing tail light.....	338		
Parking brake test .....	189				
Test stand .....	189				
Warning light.....	163, 164				
Warning message on the multi-purpose display ...	153				
Break in hints.....	6				
				<b>C</b>	
				Capacities	
				Brake fluid .....	359
				Coolant .....	359
				Engine oil .....	359
				Fuel .....	359
				Overview .....	359
				Washer fluid.....	359
				Car care .....	270
				Airbags .....	277
				Alcantara.....	277
				Cleaning the engine compartment.....	273
				Decorative foils .....	271
				Fabric linings.....	277
				Floor mats .....	277
				Headlights, plastic parts, adhesive films.....	275
				Leather .....	277
				Light alloy wheels .....	276
				Paint.....	273
				Safety belts .....	278
				Seals .....	276
				Seat belts.....	278
				Storing your Porsche.....	278
				Undercoating .....	274
				Use of high-pressure cleaning equipment .....	271
				Washing the vehicle, instructions .....	271
				Wheel bolts.....	293
				Windows .....	274
				Car key (remote control)	
				Changing battery .....	322
				Emergency operation of key in ignition lock.....	159
				Locking the vehicle door .....	21
				Opening/closing Panorama roof system .....	99
				Opening/closing sliding/lifting roof.....	93
				Opening/closing windows	
				(without Porsche Entry & Drive) .....	89
				Unlocking the vehicle door .....	20
				Car Telephone.....	219

Care instructions			
Airbags	277	When disconnecting battery	321
Alcantara	277	Changing bulb for license plate light	338
Carpet	277	Changing wheels	294
Cleaning the engine compartment	273	Check engine (emission control)	
Fabric linings	277	Functional description	123
Floor mats	277	Warning light on the tachometer	123
Headlights, plastic parts, adhesive films	275	Checking hydraulic fluid (power steering)	259
Leather	277	Child restraint anchorages	54
Light alloy wheels	276	Child restraint system	
Paint	273	Installing with LATCH system	53
Safety belts	278	LATCH restraint system	53
Seals	276	Child seat	
Seat belts	278	Installing with LATCH system	53
Storing your Porsche	278	LATCH restraint system	53
Undercoating	274	Prescribed installation direction	50
Use of high-pressure cleaning equipment	271	Child seat bracket	53
Washing	271	Cigarette lighter	228
Wheel bolts	293	Front	228
Windows	274	Rear	228
Cargo	208	Cleaning the engine compartment	273
Cargo management system	208	Clock	
Inserting and adjusting the strap reel	208	Button for setting	123
Inserting and adjusting the telescopic bar	208	Setting on the multi-purpose display	146
Inserting and adjusting tie-down rings	210	Closing	
Overview	208	Automatically closing the rear lid	25
Carpet, care instructions	277	Closing sliding/lifting roof	93
Catalytic converter	264	Locking vehicle door from inside	28
Emission control (Check Engine)	123	Panorama roof system	98
Center armrest		Persons/animals remaining in the vehicle	21
Opening front storage compartment	224	Powerliftgate	23
Opening rear storage compartment	224	Rear window	27
Center differential lock	178	Spare wheel bracket	311
Engaging	178	Vehicle door with Porsche Entry & Drive (keyless)	21
Central locking system		Vehicle door with the car key (remote control)	21
Changing settings via multi-purpose display	143	Closing the rear lid automatically	25
Closing the rear window	27	Clutch	169
Functional description	17	Cockpit	
Locking the rear lid	23	Adjusting illumination	105
Locking vehicle door with Porsche Entry & Drive	21	Clock	123
Locking vehicle door with the car key		Cooling system temperature gage	122
(remote control)	21	Fuel level gage	120
Opening and locking vehicle door from inside	28	Odometer	121
Unlocking and opening rear lid	22	Oil temperature gage	120
Unlocking and opening the rear window	27	Speedometer	120
Unlocking vehicle door with Porsche Entry & Drive	20	Tachometer	120
Unlocking vehicle door with the car key		Voltage indication	121
(remote control)	20	Voltmeter	121
		Warning and indicator lights, overview	117
		Collapsible spare wheel	
		PSM (Porsche Stability Management)	186
		Tire size	350, 351, 352
		Collapsible spare wheel in the luggage compartment	305
		Comfort function	
		Panorama roof system	99
		Comfort lighting	
		Dimming	109
		Comfort tire pressure	
		Data (bar/psi)	354
		Coming Home function	
		Setting lighting off delay	146
		Switching on	109
		Compass	
		Setting on the multi-purpose display	147
		Compressor	307
		Connection (on vehicles without air suspension)	307
		Storage location	
		(on vehicles without air suspension)	292
		Tire filling connection	
		(on vehicles with air suspension)	308
		Control panel	79
		2-zone air conditioning	70
		4-zone air conditioning, front	75
		4-zone air conditioning, rear	76
		Disabling control panel	
		for air-conditioned areas at the rear	79
		Manual air-conditioning	67
		Parking heater	81
		Control systems	
		Overview (PTM, PTM Plus, PSM, PASM, PDCC)	181
		Coolant	
		Antifreeze	255
		Change quantity	359
		Checking level	255
		Cooling system	
		Engine coolant level warning	122
		Engine coolant temperature warning	122
		Temperature gage	122
		Warning on multi-purpose display	122
		Cornering light	330
		Changing bulb (Bi-Xenon headlights)	332
		Installing headlights	328
		Removing headlights	327
		Cornering light, static	332
		Crankcase ventilation	264
		Crossing obstacles	201

Cruise control	
Accelerating .....	167
Decelerating .....	168
Functional description .....	167
Interrupting operation .....	168
Storing speed .....	167
Switching off .....	168
Switching on .....	167
Cupholder	
Closing rear .....	227
Front .....	226
Rear .....	227
Removing insert front .....	226

## D

Data bank for vehicle data .....	347
Daytime driving lights	
Functional description .....	145
Switching on/off .....	145
Decorative foils, instructions for cleaning .....	271
Defrosting windshield	
With 2-zone air conditioning .....	70
With 4-zone air conditioning .....	75
With manual air conditioning .....	67
Differential locks	
Displaying status on the multi-purpose display .....	131
Engaging the center differential lock .....	178
Engaging the rear differential lock .....	178
Digital speedometer .....	120
Dimensions .....	360
Dimmer	
Adjusting brightness of instrument illumination .....	105
Dimming door panel light .....	109
Dimming footwell light .....	109
Dimming the comfort lighting .....	109
Disabling control panel	
for air-conditioned areas at the rear .....	79
Displacement, Technical data .....	349
Display on the multi-purpose display	
Overview of warning messages .....	149
Distance displays	
ParkAssist .....	239

## Door

De-icing door lock .....	271
Locking .....	21
Locking if persons/animals are remaining in vehicle .....	21
Locking with Porsche Entry & Drive (keyless) .....	21
Locking with the car key (remote control) .....	21
Unlocking with Porsche Entry & Drive (keyless) .....	20
Unlocking with the car key (remote control) .....	20
Door lock	
De-icing .....	271
Door locking, automatic .....	21
Door mirrors	
Activating synchronous adjustment .....	55, 143
Activating synchronous mirror adjustment .....	143
Additional door mirrors when towing a trailer .....	234
Adjusting .....	55
Adjusting as parking aid .....	56
Adjusting synchronously .....	55
Door-surrounding lighting .....	109
Driving with a trailer .....	234
Folding in .....	55
Storing setting as parking aid .....	38
Storing settings (memory) .....	56
Switching heating on/off .....	56
Unfolding .....	55
When towing a trailer .....	234
Door opening .....	21
Door trim panel	
Lighting .....	109
Door-surrounding lighting	
Switching on .....	109
Drawer under right front seat	
Opening/closing .....	225
Drinks holder	
Closing rear .....	227
Front .....	226
Rear .....	227
Removing insert front .....	226
Driving	
Load .....	233
Trailer .....	235
Winter .....	175
Driving light assistant	
Switching on light switch .....	104

## Driving off-road

Crossing obstacles .....	201
Downhill driving .....	198
Driving systems for off-road driving .....	196
Engaging the center differential lock .....	178
Engaging the rear differential lock .....	178
Low Range (reduction) indicator light .....	179
Rules for driving .....	195
Sand .....	201
Setting special terrain level .....	191
Setting terrain level .....	191
Switching on Low Range (reduction) .....	178
Track ruts .....	202
Uphill driving .....	197
Water crossing .....	199
Driving performance .....	361
Driving program	
Off road .....	172, 174
Reduced (limp-home mode) .....	175
Road .....	171, 173
Driving programs for on-road and off-road driving .....	177
Driving systems for off-road driving .....	196
Driving with a trailer .....	234, 235
Drop-center rim .....	291
DVD	
Installation location .....	220
Navigation .....	220
Player .....	220

## E

Easy Entry function	
Functional description .....	39
Switching on/off .....	39
Electrical system .....	312
Emergency flasher	
Switching on/off .....	107
Emergency operation	
Of ignition key in ignition lock .....	159
Of rear lid .....	31
Of sliding/lifting roof .....	94
Of the filler flap .....	267
Of the Panorama roof system .....	101
Of the selector lever for Tiptronic S .....	175
Of the spare wheel bracket .....	311
Powerliftgate .....	26
Emergency starting .....	323

Emergency unlocking		Exhaust gas		Fluids and fuels	
Of the filler flap	267	Monitoring warning light	117, 119	Brake fluid	359
Spare wheel bracket	311	Exhaust pipes	3	Coolant	359
Emission control (check engine)		Stainless steel tailpipes, care instructions	276	Engine oil	359
Functional description	123	Exit aid		Fuel	359
Warning light on the tachometer	123	Functional description	39	Hydraulic fluid for power steering	259
Emission Control System	263	Switching on/off	39	Overview	359
Engaging the rear differential lock	178	External audio source, interface	221	Washer fluid	359
Engine				Folding key bit in/out	16
Break in hints	6	<b>F</b>		Folding wedges to prevent rolling	296
Cooling system	122	Fabric linings, care instructions	277	Footbrake	163
Data	349	Factory settings		Warning light	164
Idling	171	Resetting multi-purpose display	148	Footwell lightning	
Starting	160	Faults		Dimming	109
Stopping	161	After charging the battery	325	Four-wheel drive	
Engine Braking Support		Emergency operation of automatic rear lid	26	Functional description	182
(assistance when driving downhill)	189	Emergency operation of ignition key		Warning message on multi-purpose display	154
Engine drag torque control (MSR)		in ignition lock	159	Four-zone air conditioning	
Functional description	184	Emergency operation of rear lid	31	Air-conditioning sensors	76
Engine oil	251	Emergency operation of sliding/lifting roof	94	Controlling rear air-conditioned areas	
Change	253	Emergency operation		with the front control panel	79
Change quantity	359	of the Panorama roof system	101	Defrosting windshield	75
Checking oil level with oil dipstick	252	Emergency operation of the spare wheel bracket	311	Disabling control panel (rear)	79
Choosing the right oil	253	Emergency operation of Tiptronic selector lever	175	Disabling control panel for air-conditioned areas	
Consumption	349	Emergency unlocking of the filler flap	267	at the rear	79
Dipstick	253	Overview of warning messages		Operating overview, front	75
Engine oil pressure	153	on the multi-purpose display	149	Operating overview, rear	76
Filler opening	254	Panorama roof system	99	REST mode	65
General information	253	ParkAssist	240	Setting air distribution	77
Level	252	Parking heater	85	Setting air quantity	77
Oil-level warning on the multi-purpose display	252	Power windows	90	Setting temperature	77
Recommendation	253	Sliding/lifting roof	94	Switching ECON mode on/off	65
Temperature gage	120	When opening and closing	31	Switching Mono function on/off	78
Topping up	254	Filler flap	267	Switching on automatic recirculating-air mode	78
Engine oil level	252	Emergency unlocking	267	Switching on recirculating-air mode	78
Checking	252	Filling pressure		Using engine residual heat	65
Entry & Drive		Plate location	348	Fresh-air intake	80
Locking vehicle door with Porsche Entry & Drive	21	Reducing	307, 308	Front seat	
Opening/closing Panorama roof system		Tires (bar/psi)	354	Adjusting	36
with car key	99	Warning light on speedometer	141	Drawer under the right front seat	225
Unlocking vehicle door with Porsche Entry & Drive	20	Warning message on multi-purpose display	151	Passenger mirror as parking aid	38
Entry aid		Filter		Recalling settings (memory)	37
Functional description	39	Air cleaner maintenance instructions	260	Storing driver's seat settings (memory)	38
Switching on/off	39	Particle filter maintenance instructions	260	Storing passenger's seat settings (memory)	38
Error messages		Fire extinguisher	40	Front seat with memory	37
Displaying	130	Floor mats, care instructions	277	Storing door mirror settings	56
Overview of warning messages				Front seats	34
on the multi-purpose display	149				

Front windshield wipers		Glasses case in the roof console .....	222	Operating washer system.....	113
Adjusting the rain sensor sensitivity .....	112	Glove compartment		Removing .....	327
Changing the sensitivity .....	112	Cooling .....	223	Headrests	
Changing wiper blades .....	261	Locking .....	223	Adjusting .....	34
Switching on rain sensor .....	111	Opening .....	223	Removing and installing.....	35
Windshield wiping plus washer system .....	113	Switching off cooling .....	223	Heated rear window	
Windshield, fast wiping .....	112	Gross weight .....	231	Switching off .....	80
Windshield, slow wiping .....	112	Ground clearance .....	360	Switching on .....	80
Wiping windshield once (one-touch function) .....	112	Data .....	357	Height adjustment	
Fuel				Lowering the car .....	191
Economy .....	265	<b>H</b>		Overview .....	190
Evaporation control.....	270	Halogen		Raising the car .....	191
Fuel level gage .....	120	Changing bulb for high beam .....	330	Warning message on the multi-purpose display ...	192
Fuel reserve warning .....	120	Changing bulb for low beam .....	329	High beam	
General information.....	269	Changing bulb for side light		Changing bulb	
Octane rating.....	269	(Cayenne, Cayenne S, Cayenne S Transsylvia) ..	333	(additional high beam, Bi-Xenon headlights).....	331
Portable fuel containers .....	3	Installing headlights .....	328	Changing bulb (halogen headlights) .....	330
Quality .....	269	Removing headlights .....	327	Changing gas-discharge headlight	
Recommendations .....	269	Handbrake (parking brake)		(Bi-Xenon headlights) .....	330
Refueling.....	268	Applying .....	162	Indicator light .....	117, 119
Tank capacity .....	268, 359	Releasing .....	162	Installing headlights .....	328
Fuel containers, portable .....	3	Warning message on multi-purpose display .....	153	Removing headlights .....	327
Fuel filler opening		Headlight beam adjustment .....	234	Stalk .....	106
Opening filler flap .....	267	Headlight beam adjustment (automatic)		Switch .....	106
Fuel level gage.....	120	Checking operation .....	106	Switching on/off .....	104
Fuel reserve .....	268	Functional description .....	106	High beam, additional .....	331
Function keys on steering wheel.....	60	Headlights .....	327, 330	High Range .....	171, 173
Fuse		Adjusting .....	339	Selecting on-road driving program .....	178
Disabling power windows in the rear doors.....	88	Before driving with a trailer .....	234	High-pressure cleaning equipment, information on use... 271	
Fuse assignment, overview .....	315	Care instructions .....	276	Hillholder (moving-off assistant for Tiptronic S).....	187
Fuses		Changing bulb for additional high beam		HomeLink (garage door opener)	
Changing fuses .....	313	(Bi-Xenon headlights) .....	331	Assigning a signal .....	243
<b>G</b>		Changing bulb for additional high beam		Deleting programmed signals .....	242
Garage door opener		halogen headlights) .....	330	Functional description .....	241
Assigning a signal.....	243	Changing bulb for cornering light		Operating .....	243
Deleting programmed signals .....	242	(Bi-Xenon headlights) .....	332	Synchronisation for changeable-code systems ....	243
Functional description.....	241	Changing bulb for high beam		Horn.....	58
Operating .....	243	(halogen headlights) .....	330	Hot exhaust pipes .....	3
Synchronisation for changeable-code systems ....	243	Changing bulb for low beam, halogen .....	329		
Gear display for Tiptronic S .....	171	Changing bulb for side light (Cayenne GTS) .....	335		
Gear selector (Tiptronic S)		Changing bulb for side light			
Automatic .....	171	(Cayenne, Cayenne S, Cayenne S Transsylvia) ..	333		
Changing selector-lever position .....	170	Changing gas-discharge headlight			
Display on the multi-purpose display .....	171	(Bi-Xenon headlights) .....	330		
Emergency operation .....	175	Changing to left/right-hand traffic .....	340		
Selector-lever positions .....	171	Height adjustment.....	340		
		Installing .....	328		



<b>I</b>			
Identification number location .....	347	Interior light	
Idling .....	171	Switching on/off .....	108
Ignition key		Switching on/off automatically .....	108
Emergency operation .....	159	Interior lighting .....	107
Ignition lock		Interior mirror .....	57
Emergency operation of the key .....	159	Manual anti-dazzle operation .....	57
Functional description .....	158	Switching automatic anti-dazzle function on/off .....	57
Illumination		iPod interface, installation position .....	221
Of steering wheel keys, switching on/off .....	61	<b>J</b>	
Replacing bulbs .....	326	Jack .....	192
Switching on when entering the vehicle .....	109	Information on raising vehicles	
Switching on when leaving the vehicle .....	109	with air suspension .....	192
Immobilizer		Jacking points on the vehicle .....	300
Functional description .....	248	Safety information on raising the vehicle .....	299
Switching on and off .....	248	Storage location in luggage compartment .....	291
Inflation pressure		Jacking points for jack .....	300
Comfort tire pressure (bar/psi) .....	354	Jump lead starting with exhausted battery .....	324
Plate location .....	348	Jump lead starting, external power supply .....	324
Tires (bar/psi) .....	354	Jumper cables .....	323
Warning light on speedometer .....	141	<b>K</b>	
Inserting and adjusting tie-down rings		Key	
(cargo management system) .....	210	Changing battery .....	322
Instrument cluster		Emergency operation, ignition lock .....	159
Adjusting illumination .....	105	Folding key bit in/out .....	16
Clock .....	123	Locking the vehicle door .....	21
Cooling system temperature gage .....	122	Opening/closing Panorama roof system .....	99
Fuel level gage .....	120	Opening/closing sliding/lifting roof .....	93
Odometer .....	121	Unlocking the vehicle door .....	20
Oil temperature gage .....	120	Keys .....	16
Speedometer .....	120	Kickdown .....	172, 173
Tachometer .....	120	<b>L</b>	
Voltage indication .....	121	Language	
Warning and indicator lights, overview .....	117	Setting on the multi-purpose display .....	148
Instrument panel		Large roof	
Adjusting illumination .....	105	Brief overview .....	96
Clock .....	123	Emergency operation .....	101
Cooling system temperature gage .....	122	Functional description .....	97
Fuel level gage .....	120	Malfunctions .....	99
Odometer .....	121	Opening/closing .....	98
Oil temperature gage .....	120	Opening/closing roller blind .....	100
Speedometer .....	120	Opening/closing with car key .....	99
Tachometer .....	120	Roller blind cleaning position .....	101
Voltage indication .....	121	LATCH system .....	53
Voltmeter .....	121	Fastening .....	53
Warning and indicator lights, overview .....	117	Installing a child seat .....	53
		Prescribed installation direction of child seat .....	50
		Leather, care instructions .....	277
		Left-hand traffic (changing headlights) .....	340
		Level control .....	225, 238
		Displaying status on the multi-purpose display .....	131
		Loading level .....	191, 357
		Low level .....	190
		Lowering the car .....	191
		Lowering the car for loading .....	191
		Normal level .....	190
		Overview .....	190
		Raising the car .....	191
		Setting loading level .....	191
		Setting low level .....	191
		Setting normal level .....	191
		Setting special terrain level .....	191
		Setting terrain level .....	191
		Special terrain level .....	190
		Switching on and off .....	192
		Warning message on the multi-purpose display .....	192
		License plate light .....	109
		Lid	
		Luggage compartment .....	23
		Lifting	
		Garage lift .....	298
		Jack .....	299
		Platform .....	298
		Light	
		Headlight flasher .....	106
		Switching daytime driving lights on/off .....	145
		Switching on Coming Home function .....	109
		Switching on when entering the vehicle .....	109
		Switching on when leaving the vehicle .....	109
		Light alloy wheels	
		Care instructions .....	276
		Inscription .....	291
		Light segments .....	239
		Light switch	
		Functional description, auto function .....	104
		Overview .....	104
		Switching on auto position .....	104
		Lighting	
		Switching on when entering the vehicle .....	109



Emergency operation of ignition key in ignition lock .....	159	Mirrors .....	62, 234	Setting units of displays .....	148
Emergency operation of rear lid .....	31	Activating synchronous adjustment of door mirrors .....	143	Setting vehicle loading .....	135
Emergency operation of sliding/lifting roof .....	94	Additional door mirrors when towing a trailer .....	234	Switching daytime driving lights on/off .....	145
Emergency operation, Panorama roof system .....	101	Adjusting door mirrors .....	55	Switching off passenger compartment monitoring .....	142
Emergency operation, spare wheel bracket .....	311	Adjusting door mirrors as parking aid .....	56	Using the telephone .....	128
Emergency unlocking of the filler flap .....	267	Adjusting the door mirrors synchronously .....	55		
Overview of warning messages on the multi-purpose display .....	149	Automatic anti-dazzle function for interior mirror .....	57	<b>N</b>	
Panorama roof system .....	99	Folding in door mirrors .....	55	Navigation system .....	220
ParkAssist .....	240	Interior mirror .....	57	Nearfield lighting .....	124
Parking heater .....	85	Storing door mirror settings (memory) .....	56	Normal level .....	190
Power windows .....	90	Switching automatic anti-dazzle operation on and off .....	57		
Tiptronic selector lever emergency operation .....	175	Switching door mirror heating on/off .....	56	<b>O</b>	
When opening and closing .....	31	Switching on manual anti-dazzle operation .....	57	Octane rating, fuel .....	269
<b>Manual air conditioning</b>		Unfolding door mirrors .....	55	Octane ratings .....	269
Defrosting windshield .....	67	<b>Motion sensor (passenger compartment monitoring)</b>		Odometer	
Information on air-conditioning compressor .....	65	Switching off on the multi-purpose display .....	142	Display .....	121
Opening the cover flap .....	64	<b>Moving-off assistant</b>		Resetting .....	121
Operating overview .....	67	For Tiptronic S (hillholder) .....	187	Off delay	
REST mode .....	65	On vehicles with manual transmission (Porsche Drive-Off Assistant) .....	188	Setting .....	146
Setting air distribution .....	68	<b>Multi-functional steering wheel</b>		Switching on .....	109
Setting air quantity .....	68	Functional description .....	60	<b>Off-road</b>	
Setting fan .....	68	Illumination of steering wheel buttons, switching on/off .....	61	Crossing obstacles .....	201
Setting temperature .....	68	Operating the function keys .....	60	Driving downhill .....	198
Switching air-conditioning compressor on/off .....	65	<b>Multi-purpose display</b>		Driving systems for off-road driving .....	196
Switching ECON mode on/off .....	65	Activating synchronous mirror adjustment .....	143	Engaging the center differential lock .....	178
Switching on recirculating-air mode .....	68	Changing settings for opening and locking the vehicle .....	143	Engaging the rear differential lock .....	178
Using engine residual heat .....	65	Changing settings of central locking system .....	143	Low Range indicator light .....	179
Manual headlight beam adjustment .....	234	Displaying status of level control .....	131	Rules for off-road driving .....	195
<b>Manual transmission</b>		Displaying warning messages .....	130	Sand .....	201
Clutch .....	169	Displaying/resetting average consumption .....	132	Setting special terrain level .....	191
Shift pattern .....	169	Gear display for Tiptronic S .....	171	Setting terrain level .....	191
<b>Maximum permitted engine speeds</b> .....	169	Operating principle .....	124	Switching on Low Range (reduction) .....	178
<b>Measurements, Technical data</b> .....	360	Overview of warning messages .....	149	Track ruts .....	202
<b>Memory</b> .....	37	Resetting to factory settings .....	148	Uphill driving .....	197
Automatic storage .....	38	Setting a speed limit .....	129	Water crossing .....	199
Recalling seat settings .....	37	Setting compass .....	147	<b>Off-road ABS</b> .....	198
Storing driver's seat settings .....	38	Setting language for displays .....	148	Off-road ABS functional description .....	187
Storing passenger's seat settings .....	38	Setting lighting off delay .....	146	<b>Off-road driving</b>	
<b>Minor repairs</b>		Setting the clock .....	146	Crossing obstacles .....	201
In the event of a flat tire .....	295	Setting the tire type and size .....	134	Downhill driving .....	198
Jack in the luggage compartment .....	291	Setting Tire Pressure Monitoring .....	132	Driving rules .....	195
Securing the vehicle against rolling .....	295	Setting tire sealant/sealing set .....	140	Engaging the center differential lock .....	178
Tool kit in the luggage compartment .....	292			Engaging the rear differential lock .....	178
Towing the vehicle .....	342			Low Range (reduction) indicator light .....	179
				Recommendation .....	196
				Rules for driving .....	195

Sand .....	201
Switching off Low Range (reduction) .....	178
Switching on Low Range (reduction) .....	178
Track ruts .....	202
Uphill driving .....	197
Water crossing .....	199
Off-road PSM functional description .....	184
Off-road roof-mounted headlights .....	217
Off-road shifting	
Limit speed .....	177
Oil .....	251
Change quantity .....	359
Checking oil level with oil dipstick .....	252
Choosing the right oil .....	253
Consumption .....	6, 349
Dipstick .....	253
Engine oil pressure .....	153
Filler opening .....	254
General information .....	253
Oil level warning on the multi-purpose display .....	252
Temperature gage .....	120
Topping up .....	254
Oil level	
Checking .....	252
On-board computer	
Activating synchronous mirror adjustment .....	143
Changing settings	
for opening and locking the vehicle .....	143
Changing settings of central locking system .....	143
Displaying status of level control .....	131
Displaying status of locks/reduction .....	131
Displaying warning messages .....	130
Displaying/resetting average consumption .....	132
Gear display for Tiptronic S .....	171
Operating principle .....	124
Overview of warning messages .....	149
Resetting to factory settings .....	148
Setting a speed limit .....	129
Setting compass .....	147
Setting language for displays .....	148
Setting lighting off delay .....	146
Setting the clock .....	146
Setting the tire type and size .....	134
Setting Tire Pressure Monitoring .....	132
Setting tire sealant/sealing set .....	140
Setting units of displays .....	148
Setting vehicle loading .....	135
Switching daytime driving lights on/off .....	145

Switching off passenger compartment monitoring	142
Using the telephone .....	128
Opening and closing	
Automatically closing the rear lid .....	25
Closing the rear window .....	27
Closing the spare wheel bracket .....	311
Engine compartment lid .....	29
Loadspace floor .....	207
Locking vehicle door with the car key (remote control) .....	21
Opening the rear lid automatically .....	24
Opening the spare wheel bracket .....	310
Panorama roof system .....	97
Roller blind for Panorama roof system .....	100
Sliding/lifting roof .....	92
Unlocking and opening rear window .....	27
Unlocking vehicle door with Porsche Entry & Drive .....	20
Unlocking vehicle door with the car key (remote control) .....	20
Opening and closing the engine compartment lid .....	29
Opening and locking	
Closing the rear lid automatically .....	25
Closing the rear window .....	27
Engine compartment lid .....	29
Locking vehicle door with Porsche Entry & Drive .....	21
Locking vehicle door with the car key (remote control) .....	21
Opening and locking vehicle door from inside .....	28
Opening the rear lid automatically .....	24
Unlocking and opening the rear window .....	27
Unlocking vehicle door with car key (remote control) .....	20
Unlocking vehicle door with Porsche Entry & Drive .....	20
Opening the rear lid automatically .....	24
Operating in other countries .....	266
Operating overview	
2-zone air conditioning .....	70
4-zone air conditioning, front .....	75
4-zone air conditioning, rear .....	76
Manual air-conditioning .....	67
Parking heater .....	81
Operating the function keys on steering wheel .....	60
Operating the horn .....	58
Overview of capacities	
Engine oil .....	359
Oxygen sensor .....	264

## P

### Paint

Care instructions .....	273
Polishing .....	273
Preserving .....	273
Removing spots and stains .....	273
Repairing damage .....	273

### Panic button

.....	17
-------	----

### Panorama roof system

Brief overview .....	96
Comfort function .....	99
Emergency operation .....	101
Functional description .....	97
Malfunctions .....	99
Opening/closing with car key .....	99
Opening/closing .....	98
Opening/closing roller blind .....	100
Roller blind cleaning position .....	101

### ParkAssist

.....	235
Distance display, front .....	239
Distance display, rear .....	239
Functional description .....	237
Sensors .....	238
Switching on/off .....	237
When driving with a trailer .....	240

### Parking

.....	175
Applying the parking brake .....	162
Distance display, front .....	239
Distance display, rear .....	239
Locking the vehicle .....	21
ParkAssist, functional description .....	237
Sensors .....	238
Switching ParkAssist on and off .....	237
When towing a trailer .....	240

### Parking aid

.....	56
Distance display, front .....	239
Distance display, rear .....	239
Functional description .....	237
Sensors .....	238
Storing door mirror setting as parking aid .....	38
Switching on/off .....	237
Swivelling down mirror glass .....	56
When driving with a trailer .....	240

Parking brake	PDCS (Porsche Dynamic Chassis Control)	Porsche Traction Management (PTM)
Applying ..... 162	Functional description ..... 194	Functional description ..... 182
Releasing ..... 162	Overview ..... 181	Overview ..... 181
Test stand ..... 189	Warning message on the multi-purpose display .... 194	Porsche Traction Management Plus (PTM Plus)
Warning light ..... 163	Performance, Technical data ..... 349	Overview ..... 181
Warning message on multi-purpose display ..... 153	Person buttons ..... 37	Portable Fuel Container ..... 268
Parking heater ..... 81	Petrol	Potentiometer
Activating the memory ..... 84	Fuel level gage ..... 120	Adjusting brightness of instrument illumination ..... 105
Control panel ..... 81	Fuel reserve warning ..... 120	Power steering ..... 259
Faults ..... 85	General information ..... 269	Checking and adding hydraulic fluid ..... 259
Functional description ..... 81	Octane rating ..... 269	Power windows ..... 87
Programming ..... 83	Portable fuel containers ..... 3	Adjusting after connecting battery ..... 90
Switching on/off ..... 82	Quality ..... 269	Closing windows with button in door handle (Porsche Entry & Drive) ..... 90
Particle filter maintenance instructions ..... 260	Refueling ..... 268	Disabling in the rear doors ..... 88
PASM (Porsche Active Suspension Management)	Tank capacity ..... 268, 359	Malfunctions ..... 90
Functional description ..... 193	Plastic components, care instructions ..... 275	Opening/closing windows with car key (without Porsche Entry & Drive) ..... 89
Overview ..... 181	Porsche Active Suspension Management (PASM)	Opening/closing windows with rocker switch ..... 87
Selecting the running-gear setup ..... 193	Functional description ..... 193	Overview of driver's door control panel ..... 87
Warning light and warning message ..... 193	Overview ..... 181	Overview of passenger's door control panel ..... 87
Passenger airbag	Selecting the running-gear setup ..... 193	Readiness for operation ..... 87
Automatic deactivation of the passenger airbag ..... 47	Warning light and warning message ..... 193	Powerliftgate ..... 23
Warning light in the center console ..... 48	Porsche Ceramic Composite Brake (PCCB)	Closing ..... 25
PASSENGER AIRBAG OFF	General information ..... 3	Opening ..... 24
Warning light in the center console ..... 48	Porsche Communication Management (PCM) ..... 220	Power-transmission and running-gear control systems
Passenger compartment ..... 233	Porsche Drive-Off Assistant	Overview (PTM, PTM Plus, PSM, PASM, PDCS) .... 181
Passenger compartment monitoring system	Moving-off assistant	Pressure tester ..... 308
Deactivating/Activating ..... 247	on vehicles with manual transmission ..... 188	Protection
Function ..... 245	Porsche Dynamic Chassis Control (PDCC)	Child protection ..... 79
Function indication ..... 247	Functional description ..... 194	Disabling control panel for air-conditioned areas at the rear ..... 79
Switching off on the multi-purpose display ..... 142	Overview ..... 181	PSM (Porsche Stability Management) ..... 306
Switching on/off ..... 246	Warning message on the multi-purpose display .... 194	Functional description ..... 183
Passenger mirror	Porsche Entry & Drive	Functional description of off-road PSM ..... 184
Activating synchronous mirror adjustment ..... 143	Locking the vehicle ..... 21	Multi-functional light in the tachometer ..... 185
Additional door mirrors when towing a trailer ..... 234	Opening/closing Panorama roof system	Overview ..... 181
Adjusting ..... 55	with car key ..... 99	Switching off ..... 185
Adjusting as parking aid ..... 56	Switching off readiness for operation ..... 19	Switching on ..... 186
Adjusting synchronously ..... 55	Unlocking the vehicle ..... 20	Warning light on instrument panel after charging the battery ..... 322
Driving with a trailer ..... 234	Porsche Stability Management (PSM) ..... 306	Warning message on the multi-purpose display .... 153
Folding in ..... 55	Functional description ..... 183	PTM (Porsche Traction Management)
Storing setting as parking aid ..... 38	Functional description of off-road PSM ..... 184	Functional description ..... 182
Switching heating on/off ..... 56	Multi-functional light in the tachometer ..... 185	Overview ..... 181
Unfolding ..... 55	Overview ..... 181	PTM Plus (Porsche Traction Management Plus)
When towing a trailer ..... 234	Switching off ..... 185	Overview ..... 181
PCCB (Porsche Ceramic Composite Brake)	Switching on ..... 186	
General information ..... 3	Warning light on instrument panel after charging the battery ..... 322	
PCM (Porsche Communication Management) ..... 220	Warning message on the multi-purpose display .... 153	

## R

Radiator fans .....	251, 256	Switching off .....	178	Opening/closing .....	98
Radio		Switching on .....	178	Opening/closing roller blind .....	100
Tips .....	218	Refueling .....	268	Opening/closing with car key .....	99
Radio remote control .....	16	Relays .....	312	Roller blind cleaning position .....	101
Rain sensor .....	112	Release button .....	170	Roof Transport System .....	216
Adjusting .....	112	Remote control .....	16	Functional description .....	216
Switching on .....	111	Changing battery .....	322	Height .....	360
Reading lights, front		Locking the vehicle door .....	21	Load .....	356
Switching on/off .....	107, 108	Opening/closing Panorama roof system .....	99	Safety notes .....	216
Switching on/off automatically .....	108	Opening/closing sliding/lifting roof .....	93	Roof-mounted headlights .....	217
Rear differential lock .....	178	Unlocking vehicle door .....	20	Running in	
Rear fog light		Reserve .....	268	Tires .....	6
Changing bulb .....	338	REST mode		Running-gear control systems (air suspension)	
Installing tail light .....	337	Using engine residual heat .....	65	Overview (PTM, PTM Plus, PSM, PASM, PDCC)....	181
Removing tail light .....	336	With 2-zone air conditioning .....	65	Running-gear setup	
Switching on .....	104	With 4-zone air conditioning .....	65	Functional description .....	193
Rear lid .....	23	With manual air conditioning .....	65	Selecting .....	193
Closing .....	23	Restraint systems for children		Warning light and warning message .....	193
Emergency operation .....	31	Installing with LATCH system .....	53		
Locking .....	23	LATCH restraint system .....	53	<b>S</b>	
Opening .....	22	Prescribed installation direction .....	50	Safety belts .....	42
Powerliftgate .....	23	Reverse gear .....	169	Adjusting belt height .....	44
Rear reading lights		Swivelling down mirror glass .....	241	Belt tensioner functional description .....	42
Switching on/off .....	108	Swivelling down the mirror glass .....	56	Care instructions .....	278
Switching on/off automatically .....	108	Reversing light		Fastening .....	43
Rear seats		Changing bulb .....	338	Opening .....	44
Adjusting to vertical position .....	206	Installing tail light .....	337	Warning light .....	53
Folding forward .....	204	Removing tail light .....	336	Warning light on the tachometer .....	43
Folding forward and returning to upright position .....	204	Right-hand traffic (changing headlights) .....	340	Safety button in the armrest	
Rear shelf		Rim offset .....	350	Disabling control panel for air-conditioned areas	
Installing .....	212	Rims .....	196	at the rear .....	79
Pulling out .....	211	Diameter .....	291	Disabling power windows in the rear doors .....	88
Removing .....	211	Rim width .....	291	Safety compliance sticker .....	348
Retracting .....	211	Rocker switches .....	172	Safety net .....	212
Rear window		Roll stabilisation		Bracket .....	212
Closing .....	27	Porsche Dynamic Chassis Control (PDCC) .....	194	Permitted uses .....	212
Opening .....	27	Roller blind		Removing from rear seat backrest .....	213
Rear window wiper		Cleaning position .....	101	Securing passenger compartment .....	213
Changing wiper blade .....	262	Opening/closing for Panorama roof system .....	100	Screwdriver, storage location .....	292
Switching on intermittent operation .....	113	Roof console		Sealant/sealing set	
Window wiping plus washer system .....	113	Comfort lighting .....	109	For defective tires .....	296
Wiping rear window once (one-touch function) .....	113	Interior lighting .....	107	Setting on the multi-purpose display .....	140
Rear-axle load .....	231	Switch, overview .....	107	Seals	
Reduction (Low Range)		Roof system (Panorama roof system)		Care instructions .....	276
Displaying status on the multi-purpose display .....	131	Brief overview .....	96	Seat belts	
Indicator light .....	179	Emergency operation .....	101	Care instructions .....	278
		Functional description .....	97		
		Malfunctions .....	99		

Seat heating .....	40	Setting air distribution		Side member panels	
Rear (4-zone air conditioning) .....	41	With 2-zone air conditioning .....	72	Removing cap for jacking point .....	301
Rear (manually controlled air conditioning/ 2-zone air conditioning) .....	41	With 4-zone air conditioning .....	77	Ski bag	
Switching off .....	41	With manual air conditioning .....	68	Loading .....	214
Switching on .....	41	Setting air quantity		Securing .....	215
Seat memory .....	56	With 2-zone air conditioning .....	71	Stowing .....	215
Recall using car key .....	37	With 4-zone air conditioning .....	77	Sliding/lifting roof	
Recall using person buttons .....	37	With manual air conditioning .....	68	Brief overview .....	91
Storing parking aid .....	56	Setting fan		Closing .....	93
Swivelling down mirror glass .....	241	With 2-zone air conditioning .....	71	Emergency operation .....	94
Seat memory (comfort) .....	37	With 4-zone air conditioning .....	77	Functional description .....	92
Seat with memory .....	56	With manual air conditioning .....	68	Lifting .....	93
Swivelling down mirror glass .....	241	Setting interior temperature		Malfunctions .....	94
Seats		With 2-zone air conditioning .....	71	Opening completely .....	93
Adjusting rear seats to vertical position .....	206	With 4-zone air conditioning .....	77	Opening to comfort setting .....	93
Adjusting the front seat .....	36	With manual air conditioning .....	68	Opening/closing with car key .....	93
Child restraint system .....	49	Setting loading level .....	191	Readiness for operation .....	92
Drawer under right front seat .....	225	Setting temperature		Snow chains .....	353
Folding forward at rear and returning to upright position .....	204	With 2-zone air conditioning .....	71	General information .....	289
Front .....	34	With 4-zone air conditioning .....	77	Overview .....	353
Recalling settings (memory) .....	37	With manual air conditioning .....	68	Snow tires .....	288
Storing driver's seat settings (memory) .....	38	Setting units on the multi-purpose display .....	148	Socket (12 V) .....	312
Storing passenger mirror setting as a parking aid (memory) .....	38	Shift pattern		Spacers	
Storing passenger's seat settings (memory) .....	38	Manual transmission .....	169	Fitting .....	305
Securing points in the luggage compartment .....	207	Shifting		General information .....	293
Selecting off-road driving program .....	178	Down .....	173	Removing/fitting .....	303
Selecting on-road driving program .....	178	On the steering wheel .....	172	Spare wheel .....	305
Selection mode		Up .....	173	Collapsible spare wheel in the luggage compartment .....	305
Automatic .....	171	Shifting gears .....	169	Fitting on spare wheel bracket .....	309
Manual .....	173	Shifting up .....	174	General information .....	309
Selector lever		Shock absorber adjustment .....	181	Removing from spare wheel bracket .....	309
Automatic .....	171	Shock absorbers .....	181	Spare wheel/collapsible spare wheel in the luggage compartment .....	305
Tiptronic S .....	171	Short trip counter		Tire size .....	350, 351, 352
Selector lever (Tiptronic S)		Display .....	121	Spare wheel bracket	
Display on the multi-purpose display .....	171	Resetting .....	121	Closing .....	311
Emergency operation .....	175	Side lights		Emergency operation .....	311
Selector lever position (Tiptronic S) .....	170	Changing bulb (Cayenne GTS) .....	335	Opening .....	310
Display on the multi-purpose display .....	171	Changing bulb (Cayenne, Cayenne S, Cayenne S Transsylvia) .....	333	Spare wheel in the luggage compartment .....	305
Sensors		Installing headlights .....	328	Special terrain level .....	190
Air-conditioning sensors for 2-zone air conditioning	71	Removing headlights .....	327	Speed code letter on tire .....	290
Air-conditioning sensors for 4-zone air conditioning	76	Switching on .....	104		
Service indicator on multi-purpose display .....	153	Warning message on multi-purpose display .....	150		
		Side marker light			
		Door-surrounding lighting .....	109		
		Side marker light (Cayenne, Cayenne S, Cayenne S Transsylvia) .....	333		

Speed control (cruise control)		Operating the function keys .....	60	Switching child protection on/off	
Accelerating .....	167	Operating the horn .....	58	Disabling central locking button on the rear doors .	29
Decelerating .....	168	Shifting .....	172	Disabling control panel for air-conditioned areas	
Functional description .....	167	Steering lock .....	158	at the rear (4-zone air conditioning) .....	79
Interrupting operation .....	168	Switching Easy Entry function on/off .....	39	Disabling power windows in the rear doors .....	88
Storing speed .....	167	Switching heating on/off .....	58	Switching ECON mode on/off	
Switching off .....	168	Switching key illumination on/off .....	61	With 2-zone air conditioning .....	65
Switching on .....	167	Tiptronic rocker switches .....	58	With 4-zone air conditioning .....	65
Speed limit .....	290	Stopping .....	174	With manual air conditioning .....	65
Setting on the multi-purpose display .....	129	Engine .....	161	Switching emergency flasher on/off .....	107
Speedometer, digital .....	120	Storage .....	222	Switching front reading lights on/off .....	108
Sport button		Drawer under the right front seat .....	225	Switching Mono function on/off	
Functional description, Sport mode .....	179	Glasses case in the roof console .....	222	With 2-zone air conditioning .....	72
Switching Sport mode on and off .....	180	Glove compartment .....	223	With 4-zone air conditioning .....	78
Sport mode		Storage compartment		Switching off readiness for operation	
Functional description .....	179	at the sides of the luggage compartment .....	225	Vehicles with Porsche Entry & Drive .....	19
Switching on/off .....	180	Storage compartment in the front armrest .....	224	Switching on automatic recirculating-air mode	
SportDesign package .....	3	Storage compartment in the rear armrest .....	224	With 2-zone air conditioning .....	72
Information on risk of damage .....	195	Storage options .....	222	With 4-zone air conditioning .....	78
Sports exhaust system		Storage compartment .....	222	Switching on door-surrounding lighting .....	109
Switching on/off .....	179	At the sides of the luggage compartment .....	225	Switching on fog lights .....	104
Stainless steel exhaust tailpipes .....	276	Drawer under the right front seat .....	225	Switching on parking light .....	106
Stainless steel tailpipes		Glasses case in the roof console .....	222	Switching on recirculating-air mode	
Care instructions .....	276	Glove compartment .....	223	With 2-zone air conditioning .....	72
Starting		In the front armrest .....	224	With 4-zone air conditioning .....	78
Emergency starting with jumper cables .....	323	In the rear armrest .....	224	With manual air conditioning .....	68
Engine .....	160	Storage .....	222	Switching the off-road roof-mounted headlights on/off ...	217
Engine (Tiptronic S) .....	170	Stowing luggage .....	233	Switching the roof-mounted headlights on/off .....	217
With jumper cables .....	323	When towing a Trailer .....	234		
With Tiptronic S .....	170	Strap reel (cargo management system)			
Steam-jet cleaners, information on use .....	271	Inserting and adjusting .....	208		
Steam-jet units .....	238	Strap reel storage location .....	208		
Steering column		Summer tires .....	350		
Locking with Porsche Entry & Drive .....	159	Overview .....	350		
Locking without Porsche Entry & Drive .....	159	Storage .....	287		
Steering column lock		Wheel change .....	302		
With Porsche Entry & Drive .....	159	Sun blind			
Without Porsche Entry & Drive .....	159	Cleaning position (Panorama roof system) .....	101		
Steering lock		Opening/closing for Panorama roof system .....	100		
Emergency operation of the key .....	159	Pulling out/retracting for rear side windows .....	62		
Functional description .....	158	Sun sensor			
Steering wheel .....	58	For 2-zone air conditioning .....	71		
Adjusting .....	59	For 4-zone air conditioning .....	76		
Airbag unit .....	58	Sun visor .....	62		
Heating .....	58	Switching automatic anti-dazzle operation on and off .....	57		
Multi-functional steering wheel .....	61	Switching child lock (rear doors) on/off .....	29		
Multi-functional steering wheel, functional description .....	60				

## T

Tachometer		Display .....	120
Tail light		Changing bulb .....	338
Changing reversing light bulb .....	338	Installing .....	337
Removing .....	336	Removing tail light .....	336
Replacing rear fog light .....	338	Replacing rear fog light .....	338
Replacing turn signal light .....	338	Tailpipes	
Tailpipes		Stainless steel, care instructions .....	276
Tank opening .....	267	TCS (traction control system)	
TCS (traction control system)		Functional description .....	182





Turn signal light	
Changing bulb (Cayenne, Cayenne S, Cayenne S Transsylvia) ..	333
Indicator light .....	117, 119
Turn signal pilot light	
Indicator light .....	117, 119
Turn signal, front	
Changing bulb (Cayenne GTS) .....	335
Changing bulb (Cayenne, Cayenne S, Cayenne S Transsylvia) ..	333
Installing headlights .....	328
Removing headlights .....	327
Turn signal, rear	
Changing bulb .....	338
Installing tail light .....	337
Removing tail light .....	336
Turn signal/high beam/headlight flasher stalk .....	106
Two-zone air conditioning	
Air-conditioning sensors .....	71
Defrosting windshield .....	70
Operating overview .....	70
REST mode .....	65
Setting air distribution .....	72
Setting air quantity .....	71
Setting temperature .....	71
Switching ECON mode on/off .....	65
Switching Mono function on/off .....	72
Switching on automatic recirculating-air mode .....	72
Switching on recirculating-air mode .....	72
Using engine residual heat .....	65

## U

Ultrasonic measurement .....	240
Ultrasound sensors, ParkAssist .....	238
Ultrasound sources .....	240
Undercoating (care instructions) .....	274
Universal audio interface, installation position .....	221
Unlocking	
Opening vehicle door from inside .....	28
Rear lid .....	22
Rear window .....	27
Unlocking and opening rear lid .....	22
Unlocking and opening the rear window .....	27
Unlocking vehicle door with Porsche Entry & Drive (keyless) .....	20
Unlocking vehicle door with the car key (remote control) .....	20

Uphill driving	
Off-road .....	197
Traction .....	198
USB interface, installation position .....	221
Using engine residual heat	
With 2-zone air conditioning .....	65
With 4-zone air conditioning .....	65
With manual air conditioning .....	65

## V

Vehicle	
Battery .....	220
Care .....	270
Charging the battery .....	325
Data bank .....	347
Identification number location .....	347
Keys .....	16
Lowering with level control .....	191
Putting into operation .....	322
Raising vehicle with the jack .....	192
Raising with level control .....	191
Recovering .....	345
Securing the vehicle against rolling .....	295
Storage .....	321
Storing your Porsche .....	278
Towing .....	342
Transporting .....	192

Vehicle door	
Locking from inside .....	28
Locking with Porsche Entry & Drive (keyless) .....	21
Locking with the car key (remote control) .....	21
Unlocking with Porsche Entry & Drive (keyless) .....	20
Unlocking with the car key (remote control) .....	20
Vehicle height, Technical data .....	360
Vehicle key (remote control)	
Changing battery .....	322
Emergency operation of key in ignition lock .....	159
Locking the vehicle door .....	21
Opening/closing Panorama roof system .....	99
Opening/closing sliding/lifting roof .....	93
Opening/closing windows (without Porsche Entry & Drive) .....	89
Unlocking the vehicle door .....	20
Vehicle length, Technical data .....	360
Vehicle width, Technical data .....	360
Ventilation .....	64, 70

## Vents

Adjusting .....	79
Opening/closing .....	79
Vertical coupling load .....	231
Voice control .....	106
Voltage indication .....	121
Voltmeter .....	121
Battery/alternator warning .....	121

## W

Warning - brake booster .....	154
Warning - brake proportioning .....	153
Warning messages	
Displaying on multi-purpose display .....	130
Warning messages on multi-purpose display Overview .....	149
Washer fluid	
Antifreeze .....	258
Filling capacity .....	359
Level .....	258
Topping up .....	258
Washing the vehicle, instructions .....	271
Water crossing .....	199
Water crossing, tips on driving .....	199
Wedges to prevent rolling .....	296
Wedges to secure the vehicle against rolling .....	296
Weights	
Data .....	356
Wheel alignment .....	287
Wheel change .....	288
Wheels	
Adjusting .....	287
Changing .....	294, 302
Comfort tire pressure, data (bar/psi) .....	354
Fitting spare wheel on spare wheel bracket .....	309
Flat .....	295
General information .....	281
Inflating tires on vehicles with air suspension .....	308
Inflating tires on vehicles without air suspension .....	307
Inscription on light alloy wheels .....	291
Inscription on radial tire .....	290
Overview .....	350
Removing spare wheel from spare wheel bracket .....	309
Removing/fitting spacers .....	303
Replacing tires (general information) .....	286
Rim offset .....	350
Security wheel bolt (wrench socket) .....	294

Size.....	350	Windshield wiping plus washer system .....	113
Snow chains (general information).....	289	Windshield, fast wiping .....	112
Spare wheel (general information).....	309	Windshield, slow wiping .....	112
Storage.....	287	Wiping rear window once (one-touch function).....	113
Tire pressure plate.....	348	Wiping windshield once (one-touch function).....	112
Tire pressure, data (bar/psi) .....	354	Winter driving .....	321
Tire sealant.....	296	Winter tires .....	350
Tracks .....	350	General information .....	288
Wheel balancing..... 189, 287		Overview .....	350
Wheel bolt wrench.....	292	Storage.....	287
Wheel bolts (care instructions).....	293	Wheel change.....	302
Winter tires (general information) .....	288	Wiper blades	
Windows		Care instructions.....	274
Adjusting after connecting battery.....	90	Changing (rear).....	262
Care instructions.....	274	Replacing (front).....	261
Closing with button in door handle		With Porsche Entry & Drive .....	19
(with Porsche Entry & Drive).....	90	Working on your vehicle .....	250
Opening/closing with car key		Wrench socket (security wheel bolt).....	294
(without Porsche Entry & Drive).....	89		
Opening/closing with rocker switch.....	87	<b>X</b>	
Windshield		Xenon	
Washer fluid .....	258	Changing bulb for additional high beam	
Windshield washer system		(Bi-Xenon headlights).....	331
Adding washer fluid .....	258	Changing bulb for cornering light	
Antifreeze .....	258	(Bi-Xenon headlights).....	332
Filling capacity.....	359	Changing gas-discharge headlight	
Windshield wiper/washer stalk		(Bi-Xenon headlights).....	330
Rain sensor adjustment.....	112	Installing headlights .....	328
Rear window wiping plus washer system .....	113	Removing headlights.....	327
Switching on intermittent operation			
of rear window wiper .....	113		
Switching on rain sensor .....	111		
Windshield wiping plus washer system .....	113		
Windshield, fast wiping .....	112		
Windshield, slow wiping .....	112		
Wiping rear window once (one-touch function) .....	113		
Wiping windshield once (one-touch function).....	112		
Windshield wipers			
Brief overview .....	110		
Care instructions.....	274		
Changing rear wiper blade .....	262		
Rain sensor adjustment.....	112		
Rear window wiping plus washer system .....	113		
Replacing front wiper blades .....	261		
Stalk.....	111		
Switching on intermittent operation			
of rear window wiper .....	113		
Switching on rain sensor .....	111		