

leon

Owner's manual





### **This owner's Manual**

and the Supplements provided should be read carefully so that you can quickly become familiar with the controls and operation of your vehicle.

As well as care and regular maintenance, correct handling helps maintain the car's value.

**For safety reasons please note also the information on "Accessories, modifications and replacement of parts".**

### **One final request:**

Please pass the complete vehicle wallet on to the new owner of your vehicle if you should sell it, as the vehicle literature belongs to the vehicle.

## You should note these points before reading this Owner's Manual

### Range of equipment

It describes the largest possible range of equipment envisaged at the time of going to press. Some of the equipment may not be available until later or will only be available in certain markets.



Items of equipment marked with this symbol are only available on certain model versions or are only available as optional extras on certain models or are only available in certain markets.

### Environmental notes



*Texts following this symbol and printed in italics are important notes on environmental protection.*

### Contents

On the next few pages you will find a contents list which lists all of the points detailed in this Owner's Manual in order.

### Alphabetical index

At the end of the manual you will find a comprehensive alphabetical index.

You can find desired information quickly by looking for the key in the index.

### Notes on direction

Apart from exceptions, all notes on the direction (left, right, front, rear) in this manual always refer to the vehicle's direction of travel.

Exception: possible specific steering descriptions.

### Warning notes

All blocks of text in bold print, with this colour background and the title "Warning" refer to potential accident or injury risks.

Text in bold print warns against possible damage to the vehicle or notes particularly important information on how to treat your vehicle correctly.

### Official SEAT service

The SEAT Dealers, Workshops and Official Service Centres have the most suitable specific tools and state-of-the-art technology and specialised staff to deal with and repair any problem or fault that may befall your SEAT vehicle, guaranteeing repairs inside or outside warranty, and using only genuine spares.

Do not hesitate to contact your Official SEAT Service Centre for any question that arises in the application or interpretation of the operations and revisions referred to in this manual.

# Contents

---

## Below

we offer a brief summary of the contents of the chapters that this Instructions Manual is divided into.

---

### 1. Safety first

This chapter provides information on your vehicle's passive safety fittings such as seat belts, Air Bags, child seats and safety and head rests.

---

### 2. Handling instructions

This chapter provides information on the layout of the driver's controls, the different seat adjustments, how to create a comfortable atmosphere inside the car, and how to start the engine.

---

### 3. Tips and maintenance

Advice on environmentally friendly driving, care and upkeep of your car and certain breakdowns (such as changing bulbs) that you can do yourself.

---

### 4. Technical data

Numbers, values, dimensions and amounts (fuel consumption, for instance) of your vehicle.



# INDEX

Introduction to the subject . . . . .	1.2
Seat belts . . . . .	1.3
Air Bag system* . . . . .	1.16
Safety for children . . . . .	1.25
Front seats . . . . .	1.32
Head restraints* . . . . .	1.33

## **Introduction to the subject**

---

You will find important information, tips and notes on passive safety in your new LEON in this chapter.

We have detailed everything you need to know about, for example, seat belts, Air Bags, child seats, safety for children and head restraints.

**Please pay particular attention to the notes and warnings in this chapter—in your own interest and in the interest of all passengers.**

**Please drive carefully.**



## Seat belts

### Why have seat belts?

It has been proven that seat belts give good protection in accidents. In most countries, therefore, the wearing of seat belts is required by law.

#### Warning

- The belts should be put on before every journey – even in town traffic. This also applies to rear seats. Pregnant women too should always wear a seat belt. This is the only way to guarantee protection for the unborn child! For more information on this point please see page 1.11.
- The routing of the belt is of major importance to the protective effect of the belt. How the belt should be worn is described on the next pages.

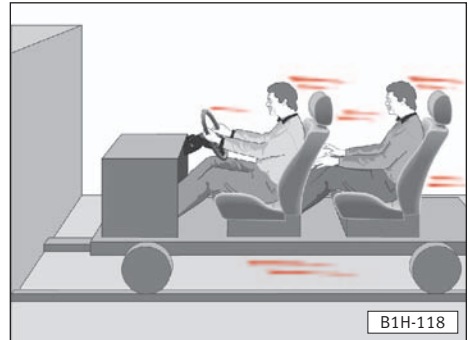

This illustration shows a car driving towards a wall. The vehicle occupants are not belted in.

The physical principle of a frontal crash is easy to explain.

As soon as the vehicle is moving, so-called “kinetic energy” is created by the movement of the vehicle, in the vehicle itself as well as in the vehicle occupants.

The extent of the “kinetic energy” effect depends largely on the speed of the vehicle and on the weight of the vehicle and the vehicle occupants.

The higher the speed and the greater the weight of the vehicle, the more energy must be dispersed should an accident occur.

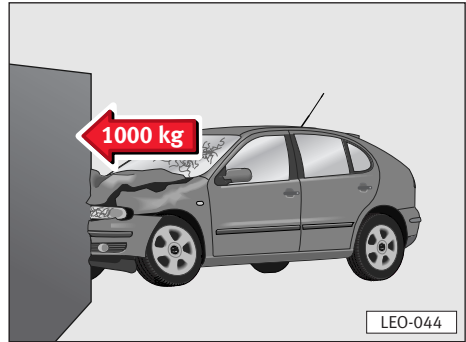
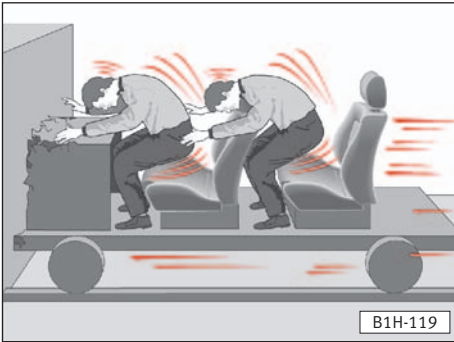

The speed of the vehicle is, however, the more important factor. If, for example, the speed increases from 25 km/h to 50 km/h, the kinetic energy increases fourfold!

As the vehicle occupants in our example are wearing no seat belts, their entire kinetic energy can only be dispersed through the crash into the wall, should a crash occur. The consequences would be severe or possibly even fatal injuries.

If you are driving at a speed of only 30 km/h to 50 km/h, forces which can easily exceed 1000 kg are exerted on the body should an accident occur.

The forces exerted on the body will increase further at higher speeds, e.g. At twice the speed the forces increase fourfold!

Vehicle occupants not wearing their seat belts are thus not “linked” to their vehicle.

In a frontal crash, these people will continue to move forward at the same speed as the vehicle was travelling before the vehicle crashed!

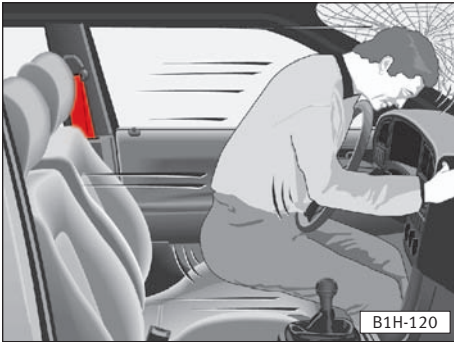

In case of a frontal collision accident, the occupants who are not belted up are thrown forwards and collide with parts of the vehicle interior, e.g. the steering wheel, instrument panel or windscreen.

Vehicle occupants who are not belted in may even be thrown out of the vehicle. This could even lead to serious injuries.

The wide spread opinion that you can protect your body with your hands in the event of a light accident is not correct. Even at low speeds of collision, forces which cannot be deflected act on the body.

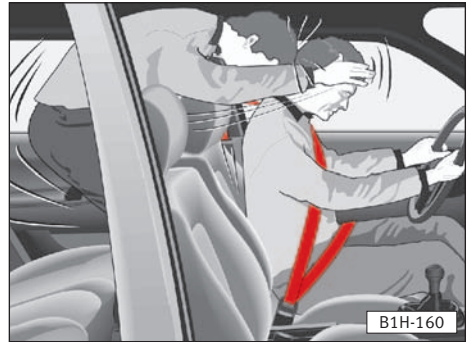

It is also important that occupants sitting in the rear seats are belted in as they can also be thrown out of the vehicle in the event of an accident. Somebody sitting in the rear and not using a seat belt is endangering not only himself but also the occupants of the front seats.

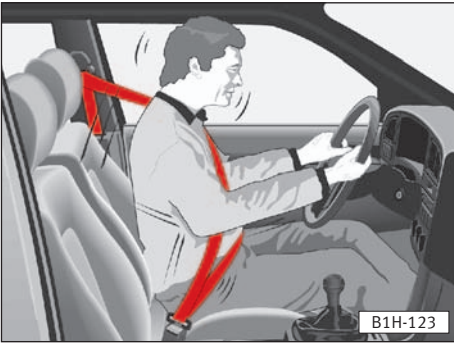

Our examples describe frontal crashes. These physical principles also apply, of course, to other types of accidents and to vehicles with the Air Bag System.

This is why you **must** put on your seat belt before every journey, even if you are only going “just around the corner”. Please also ensure that your passengers are correctly belted in.

You have seen how seat belts function in the case of an accident on previous pages.

Accident statistics have proven that the risk of injury is reduced and the chance of survival in a serious accident is increased if the seat belt is worn properly.

For this reason, the wearing of seat belts is a legal requirement in most countries.

The correct method of wearing the seat belt, and how the Air Bag System functions, is described on the following pages.

### Protecting seat belts

Seat belts which are worn properly contribute to the correct seating position of the vehicle’s occupants. The seat belts help reduce kinetic energy considerably.

They also prevent uncontrollable movements which can also be the cause of severe injuries.

Vehicle occupants who wear their seat belts correctly benefit greatly from the fact that kinetic energy is absorbed by the belt. The vehicle front structure and other passive safety measures, such as the Air Bag System, also guarantee a reduction in kinetic energy. The energy created is thus kept to a low level and the risk of injury reduced.

## Warning notes

- The belts should be put on before each journey – even in town traffic! This also applies to the rear seats.
- The maximum level of protection by the seat belts can only be attained if the belts are worn properly.
- Please ensure that the belts are put on exactly as described in this chapter.

Putting the seat belt on underneath your arm, for example, would considerably increase the risk of injury in the case of an accident!

- The belt must not be twisted or caught, nor should it be allowed to rub on any sharp edges.
- Two people (including children) must never be secured with one belt. It is particularly dangerous to belt your child in when it is sitting on your lap.



- The belt strap should not be worn over hard or breakable articles (glasses, ball pens, etc...), as it may cause injuries.
- Bulky and loose clothing (e.g. an overcoat on top of a jacket), hinder correct fitting and working of the seat belt.
- In order to achieve maximum belt protection occupants must be properly seated; check also the "Front seats" chapter.

Please take notice of the warning notes on the next page.

- You must always keep your feet in the foot well during a journey – never on the dashboard or on the seats.
- The belts must be kept clean as dirt may affect the proper functioning of the retractors (see "Care and maintenance" chapter).
- The slot for the belt tongue must not be blocked with paper or anything similar, as the tongue can otherwise not engage properly.
- You should check your seat belts regularly. If you find any damage on the belt, belt connections, retractor or the locking pieces, the belt must be replaced by a Technical Service Centre.

- The seat belts may not be removed from the vehicle or modified in any way. Do not attempt to remove the seat belts yourself.
- Belts which are stressed and thus stretched in an accident must be replaced by a Technical Service Centre. The belt anchorages should be checked.

**Note**

In some export countries seat belt functions could differ from the 3 point or lap belts described on the next pages

## How are seat belts put on properly?

### Putting 3 point belt on

You must adjust the front seat to your height before fastening the seat belt. See "Front seats" chapter.

For the centre rear seat, it must be taken into account that the back of the seat must be perfectly locked in position for correct functioning of the seatbelt. See page 2.69.

The inertia reel belt gives complete freedom of movement when pulled slowly. Sudden braking, however, will cause the belt to lock.

The mechanism will also lock the belt when accelerating, driving down steep gradients or cornering.

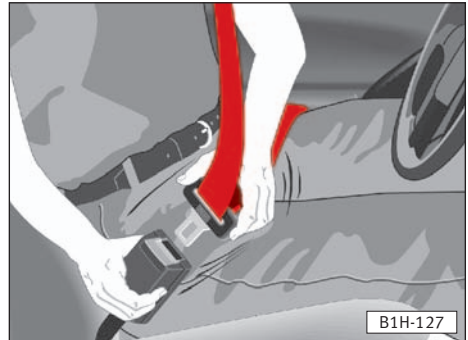

- Pull belt by the tongue slowly and smoothly across the chest and hips.
- Push the tongue into the locking part of the seat until it engages audibly (**pull to test!**).

### Warning

Seat belts can only give their maximum protection in an accident if the backrest is in an upright position and the belt is fitted closely to the body.

### Warning

The tongue must be pressed into locking part designated for that seat and seat belt. The protective effect of the belt will otherwise be negatively affected and the risk of injury increases!

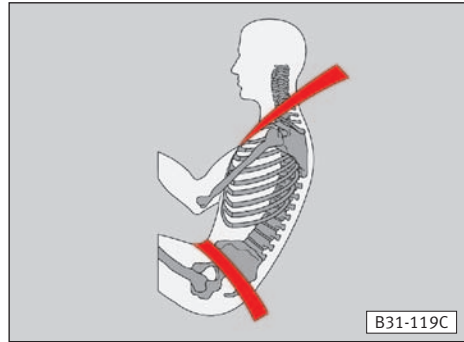
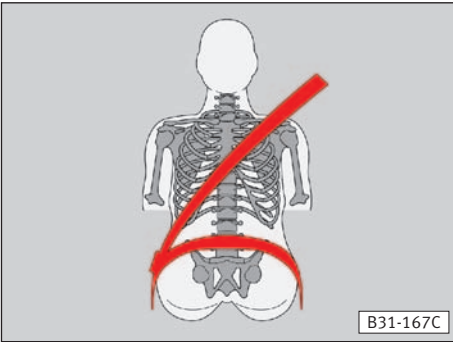

**Warning**

The shoulder part of the belt must run roughly across the centre of the shoulder, on no account against the neck and must also be firmly in contact with the body.

The lap part of the belt must fit tightly across the pelvis— not across the stomach. If necessary, pull the belt tight.

**Warning**

- Please ensure that the seat belt is fitted properly. A seat belt which is worn incorrectly could also cause injury in an accident.
- A seat belt which is worn too loosely could cause injury as your kinetic energy will throw your body further forward in an accident and it will be caught abruptly by the seat belt.



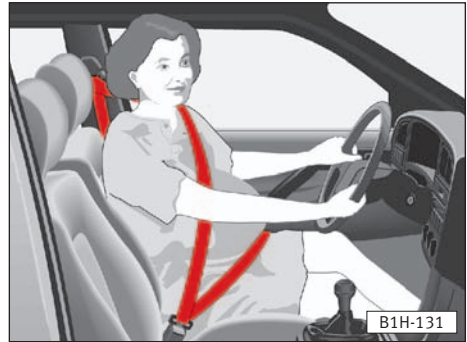
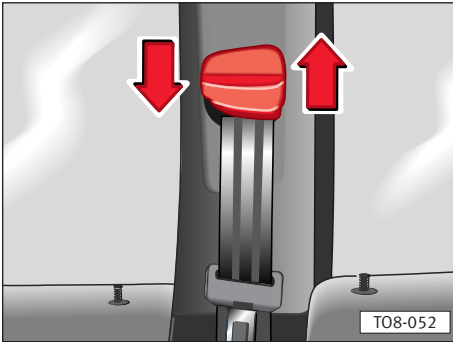

With the aid of the **belt height adjustment** the routing of the shoulder belt for the front and rear seats can be set to fit the body properly.

- To adjust, push the upper relay fitting in the direction shown, hold in this position and move up or down so that the shoulder part of belt runs roughly across the centre of the shoulder as shown in the left-hand illustration – **on no account against the neck.**
- After adjusting, pull the belt with a jerk to ensure that the relay fitting is properly engaged.

#### Note

The seat height adjustment\* can also be used to adjust belt routing on front seats.

#### Warning

**Pregnant women should always wear a seat belt too. The lap part of the belt should be as low as possible across the pelvis so that no pressure is exerted on the abdomen.**

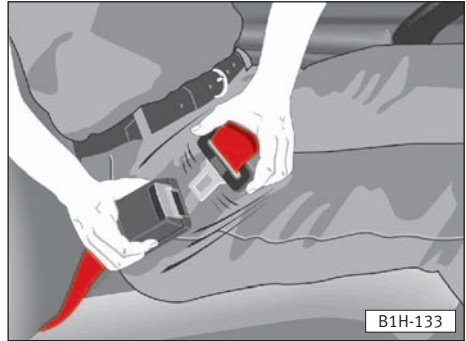
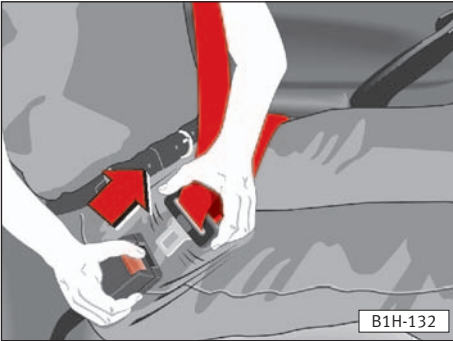

### Taking three point belt off

To release the belt, press the red button in the lock. The tongue will then spring out.

Pass the tongue towards the door by hand so that the retractor can roll the belt up properly. A plastic knob in the belt holds the tongue in a convenient position.

### Lap belt\*

The centre place on the rear seat is fitted with a lap belt.

The belt lock is used in the same way as on the three point inertia reel belts.

For safety reasons a lap belt not being used should always be connected to the buckle.

#### Warning

- The lap part of the belt must fit tightly across the pelvis– not across the stomach. If necessary, loosen the belt.
- Pregnant women should always wear seat belts too. The lap part of the belt should be as low as possible across the pelvis so that no pressure is exerted on the abdomen.

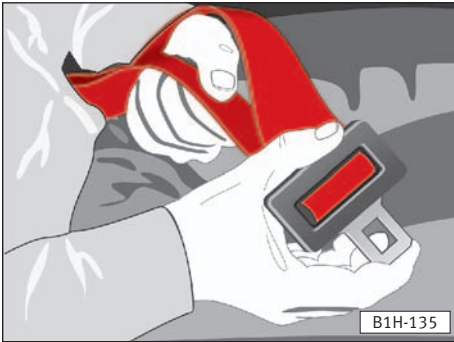

**To lengthen** belt hold the tongue at right angles to belt and pull belt through to the required length – see illustrations.

The belt is easier to adjust if tongue and cap are pressed together.

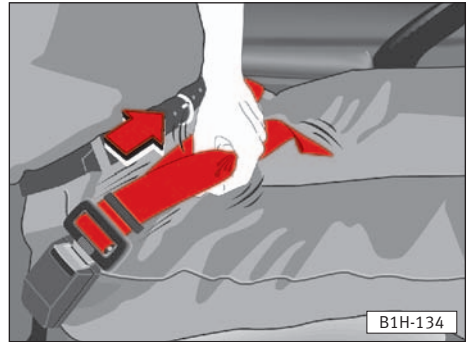

**To shorten** belt it is only necessary to pull the free end of belt.

The surplus belt length is taken up by moving the plastic slide.

### Belt tensioner\*

Safety for the **belted-in** driver and front passenger is increased by the belt tensioners fitted to the inertia reels of the front 3 point seatbelts to supplement the Air Bag.

In case of a severe frontal collision the system is activated by sensors which fire a pyrotechnic charge in the two automatic tightening devices.

This makes the devices roll up and tighten the tensioners.

#### Warning

- **Any repair work on the tensioner system or the removal or installation of system components for other repair work should be carried out by a Technical Service Centre.**

- **The protective function of the belt tensioner is capable of operating only once. If the belt tensioners have been activated at any time, the system must be renewed.**

**If you sell the vehicle, please pass on this Manual to the new owner.**

#### Notes

- Smoke is released when the tensioners are activated. This smoke does not indicate a fire in the vehicle.

- It is of utmost importance to observe the relevant safety regulations when the vehicle or components of the system are scrapped. Technical Service Centres are familiar with these regulations.

## Attach child seat

### Warning

A child seat in which the child sits with its back to the direction of travel may only be used if the passenger side Air Bag has been deactivated by a Technical Service Centre. Otherwise the child would be in great danger.

Ask your Technical Service Centre about the conversion.

As soon as the child seat is no longer needed, the passenger side Air Bag should be made operational again by a Technical Service Centre.

### Child seat safety lock\*

The three point safety belt\* in the middle of the rear of some model versions seat may be blocked constantly. This ensures that the child seat is properly fixed in the car.

### Activating child seat belt lock\*

- Secure your child seat with the belt following the instructions given by the manufacturer.
- Pull out the shoulder part of the belt fully.
- Roll the belt back in until it lies tightly against the child seat. A “clicking” noise will be heard when the belt is rolling in.

The belt can now no longer be pulled out – **pull to test!**

### Deactivating child seat belt lock\*

Press the red button in the lock part. The tongue will be released from the locking part. The child seat belt lock is automatically deactivated when the belt is fully rolled up.

## Air Bag system<sup>1)</sup>

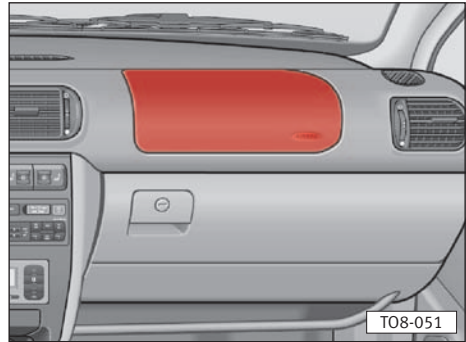

**Supplementing the three-point seat belts, the Air Bag system** offers additional protection for the driver's and passenger's head and chest in a serious frontal collision.

In serious lateral collisions the side Air Bags reduce the risk of injury to the body parts exposed to the danger for the front seat occupants.

The Air Bag system is not a replacement for the seat belt, but it is rather one part of the passive safety concept of the vehicle. Please note that the best possible protection to be offered by the Air Bag system can only be effective when the seat belts are fastened.

**Therefore, the seat belts should always be used, not only for reasons of statutory regulations, but also for safety.**

**Also bear in mind the instructions from the "Seat belts" chapter.**

The **driver's front Air Bag** is located in the central cushioned part of the steering wheel.

The **passenger's front Air Bag** is located in the dash panel above the glove compartment.

Both are marked with "AIR BAG".

### Warning

**The seat belts and Air Bag system only offer maximum protection when seated correctly.**

<sup>1)</sup> This equipment may vary according to the country.

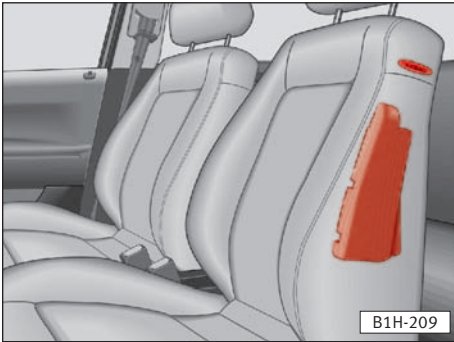

The **side Air Bags** are located on the backside of the front seats (see figure) and are marked with "AIR BAG" on the upper part of the back.

### Components of the system

The system basically consists of:

- an electronic control and monitoring unit (control unit)
- two front Air Bags
- two side Air Bags
- a warning lamp in the instrument panel.

### Air Bag functions are controlled electronically:

- Each time that the ignition is turned on, the Air Bag warning light will light for about 3 seconds.
- If at least one of the Air Bag devices is deactivated, the warning light will flash for approx. 12 seconds.

### There is a defect in the system if

- When switching on the ignition the warning lamp does not light.
- Following the connection of the ignition, the warning light will not go off until after approx. 3 seconds.
- After the ignition is switched on the warning lamp goes out and comes back on.
- The warning lamp lights or flashes while driving.

### Warning

**When a defect is present the system needs to be checked immediately by a Technical Service Centre. Failure to do so will jeopardise proper functioning of the Air Bag in the case of an accident.**

### When are the Air Bags activated?

The Air Bag system is designed so that the driver's side Air Bag and Passenger's side Air Bag are triggered in case of a **serious frontal collision**.

In a **serious side-on collision**, the corresponding side<sup>1)</sup> Air Bag is triggered.

**In certain kinds of accidents, both the front and the side<sup>1)</sup> Air Bags could be triggered.**

The Air Bag system **will not be triggered** in case of light frontal and lateral collisions, rear collisions and **overturning**. In these cases, the vehicles occupants are protected in the conventional way by the seat belts.

It is not possible to define globally when exactly the Air Bag system will be triggered given that the circumstances of each impact may vary enormously.

During inflation, the Air Bag emits a fine dust. This is quite normal and there is no fire risk.

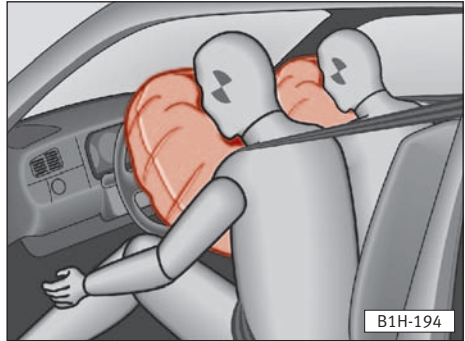

### Frontal Air Bag<sup>1)</sup>

When the system is triggered, the bags are inflated by gas opening in front of the driver and passenger.

The Air Bag inflation is considerably rapid and takes fractions of a second, to offer the best protection in the case of an accident.

**Information about the operation and possible faults of the system may be found on the previous page.**

**Please take notice of the warning notes on the next page**

<sup>1)</sup> This equipment may vary according to the country.



## Warning notes

- It is important to maintain a distance of at least 25 cm from the steering wheel or instrument panel so that the front seat occupants have the best possible effective protection if the system is triggered. The front seats must always be correctly adjusted to the body height.
- If you are not wearing a seat belt or lean forward whilst driving or are sitting in the wrong position, you are open to a higher risk of injury in an accident when the Air Bag System inflates.
- Children must never be allowed to sit unsecured on the front seat whilst the vehicle is in motion. If the Air Bag System is triggered during an accident, children could be seriously injured or killed. For further important points please refer to the chapter on “Safety for children”.
- No persons, animals or objects should be located between the front-seat occupants and the effective range of the Air Bags.
- The protective function of the Air Bag will only be triggered for one accident. If the Air Bag has been triggered, the system must be replaced.

- The steering wheel padded plate and the padded surface of the Air Bag module on the passenger side of dash panel must not have stickers attached, nor should they be covered or re-worked in any other way. These parts should only be cleaned with a dry cloth or a cloth moistened with water. No other items such as, for example, telephone or cup holders should be attached to the Air Bag module.

- No modifications of any kind may be undertaken on the parts of the Air Bag System. All work on the Air Bag system, including the removal and installation of system parts during other repair work (ex.: removing steering wheel), should only be carried out by a Technical Service Centre.

### Note

If the vehicle or individual parts of the Air Bag system is scrapped, one must always observe the relevant valid safety regulations. Technical Service Centres are familiar with these regulations.



## Warning notes

### Warning

- Any repairs to the side Air Bag, such as the removal or assembly of any system component in connection with any other repair work (e.g. removing the front seat), should only be performed by a Technical Service Centre. The correct functioning of the Air Bag system could otherwise be adversely affected.

- If the seatbelt is not worn or an incorrect seating position is adapted (for example leaning to one side) during a voyage, there is a higher risk of injury due to the deployment of the Air Bag in the case of an accident.

- To guarantee a maximum of protection from the lateral Air Bag, a correct seating position should be adapted and the seatbelt should always be worn.

- There should be no person, animal or object between the front passengers and the action zone of the Air Bag. Also, no accessory or any other object should be installed in the deployment area of the lateral Air Bag that may impede its operation or even cause injury to the occupants of the vehicle.

### Side Air Bag<sup>1)</sup>

When the system is triggered, the bags inflate using gas.

The Air Bag inflates in a split second to be able to offer additional protection during an accident.

**On page 1.17 you will find notes on the function and possible defects in the system.**

**Please take notice of the warning notes on the next page.**

<sup>1)</sup> This equipment may vary according to the country.

- Only light articles of clothing should be hung on the coat hooks. No heavy or sharp-edged items should be left in the pockets.

- No excessive pressure should be applied to the sides of the backrest, nor should they be subjected to undue pushing or shoving etc. as the system could be damaged as a result. The side Air Bags would not be triggered should this happen!

- Do not fit seat covers on the driver's or passenger seat. Otherwise, the functioning of the side Air Bag could be limited since it could not come out of the seat back. For further notes refer to the chapter "Accessories, modifications and replacement of parts".

- Any damage to the original seat covers or to the seam in the module area of the side Air Bag must be repaired as soon as possible by any Technical Service Centre.

- The protective function of the Air Bag will only be triggered for one accident. If the Air Bag has been triggered, the system must be replaced.

- If children are leaning to one side or adopt an incorrect position during a voyage, they are automatically exposed to a higher risk of injury in the event of an accident especially if they are seated in the passenger seat. They may be seriously injured or even killed as a result.

## Deactivate Air Bags

**Air Bags must not be deactivated unless there are specific reasons to do so, such as:**

- in the **exceptional case** where it may become necessary to use a child seat in the passenger seat, where the child is facing backwards.
- if it is not possible to keep a minimum distance of 25 cm between the center of the steering wheel and the breastbone even though the driver's seat is in the correct position.
- if handicapped people need special equipment in the steering wheel area.
- if special seats are fitted (i.e. orthopedic seats without side Air Bags).

See the Technical Services for information about which Air Bags may be deactivated in your vehicle.

If you yourself disconnect the passenger Air Bag using the **key lock switch**<sup>1)</sup> (following page), an **"AIR BAG OFF"** warning light will constantly remind you that the Air Bag is deactivated.

**Always activate the Air Bags when possible, to protect the occupants of the vehicle in case of a collision.**

<sup>1)</sup> This equipment will vary according to the country.

## Deactivation of the passenger Air Bag for the installation of a child seat

In the exceptional case where it may become necessary to use a child seat in the passenger seat, where the child is facing backwards, it is essential to deactivate the passenger Air Bag.

We still recommend the installation of the child seat **uniquely on the rear passenger seat**, and to avoid the need to deactivate the passenger Air Bag.

**If use of the child seat has ceased, the passenger Air Bag must be reconnected.**

**Before the use of child seats, please read carefully the section on "Safety for children".**

### Warning!

If in an exceptional case where you may wish to install a child seat in the passenger seat, where the child is facing backwards, it is essential to deactivate the passenger Air Bag. To not do so will put the child at risk of serious or even fatal injury. For any doubt about the deactivation of the passenger Air Bag, consult the Technical Service.

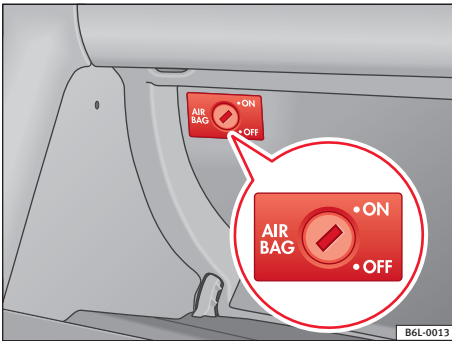

### Key lock switch<sup>1)</sup> for deactivation of passenger Air Bags

By using the key lock switch in the glove box it is possible to deactivate and activate the frontal and lateral passenger Air Bags.

This measure is necessary in the **exceptional** cases where a child seat must be installed in the passenger seat.

In general, child seats **should only be fitted in the rear seats of the vehicle.**

**Reactivate the Air Bags as soon as possible, the prompt reactivation of the Air Bags will offer necessary protection.**

#### Warning!

The key lock switch should only be used with the ignition in the off position. If not, faults may be introduced into the system preventing the triggering of the Air Bag or even an unwanted deployment.

#### Deactivation

- Turn the ignition to the off position
- Turn the key lock switch to the “OFF” position using the ignition key.
- Ensure that when the ignition is switched to the “ON” position, the “**AIR BAG OFF**” warning light always comes on.

#### Warning!

The driver of the vehicle has the responsibility of ensuring the correct position of the switch.

<sup>1)</sup> This equipment varies according to the model.

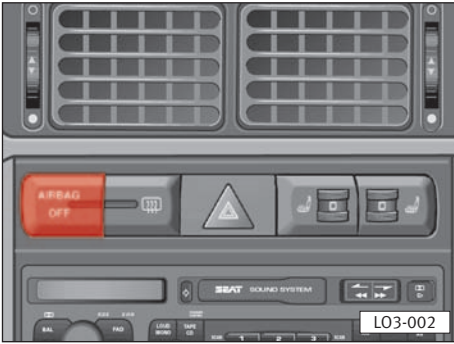

### Warning!

If the “AIR BAG OFF” warning light flashes:

- There is no guarantee that the passenger Air Bags will be triggered in the event of an accident. Warn all passengers.
- Do not place any child seats in the passenger seat, in the event of an accident the Air Bag may be triggered causing serious injury.

### Activation

- Turn the ignition to the off position
- Turn the key lock switch to the “ON” position using the ignition key.
- Ensure that when the ignition is switched on, the “AIR BAG OFF” warning light does not come on.

### “AIR BAG OFF” warning light (Air Bag deactivated)

This warning light will light when the ignition is turned on as long as the passenger Air Bags are deactivated.

**The warning light will flash in case of any anomaly in the Air Bag. In this case a Technical Service must be visited.**

## Safety for children

It is clearly demonstrated by accident statistics that generally children are safer on the back seat than on the passenger's seat. Therefore, children under 12 years of age must normally travel on the rear seats<sup>1)</sup>. Depending on age, height and weight, they have to use a suitable child restraint system or a seat belt. For safety reasons, the child seat must be fit in the center of the rear seat or behind the passenger's seat.

The physical principles apparent in an accident, which are detailed on pages 1.3 to 1.5, naturally also apply to children.

As opposed to adults, the muscle and bone structures of children are not yet fully formed. As such, children are subject to a higher risk of injury.

In order to reduce this risk of injury, children may only be transported in special child restraint systems!

### Warning

- All vehicle occupants, and particularly children, must be belted in during the journey.
- You should never allow your child to stand or kneel whilst the vehicle is in motion. Should an accident occur, your children will be thrown out of the vehicle and could be seriously injured.

- If children lean whilst the vehicle is in motion or adopt an incorrect sitting position, they are subjected to an increased risk of injury. This applies in particular to children seated on the passenger seat when the Air Bag system is triggered during an accident. This could cause serious or fatal injuries.

- A suitable child restraint system can protect your child!

- Do not leave your child unattended in the child seat

- Children under 1.50 m (approx. under 12 years of age) must not use normal seat belts without the child restraint system. This could cause injury to the stomach and neck.

<sup>1)</sup> Different norms may apply to different countries.

Approximate age group		Number of seats		
		Front passenger	Back sides	Central rear
<b>Group 0</b>	< 10 kg (0-9 months)	<b>U</b> (only in exceptional cases). (Slide the front passenger seat as far back as possible and always disconnect the Air Bag)	<b>U</b>	<b>U</b>
<b>Group 0 +</b>	< 13 kg (0-24 months)	<b>U</b> (only in exceptional cases). (Slide the front passenger seat as far back as possible and always disconnect the Air Bag)	<b>U</b>	<b>U</b>
<b>Group I</b>	9-18 kg (9-48 months)	<b>U</b> (only in exceptional cases). (Slide the front passenger seat as far back as possible and always disconnect the Air Bag)	<b>U/L</b>	<b>U</b>
<b>Group II/III</b>	15-36 kg (4-12 years)	<b>X</b>	<b>UF</b>	<b>UF</b>

**U** – Adequate for the universal retention systems officially authorized with this age group. (Universal retention systems are those fixed by the adult safety belt).

**UF** – Adequate for the universal retention systems oriented frontwards officially authorized for use in this age group.

**L** – Adequate for retention systems with ISOFIX anchoring.

**X** – Seat space not adequate for children of this age group.



**Note**

Child restraint systems tested according to ECE-R 44.03 standard are clearly marked with the ECE-R 44.03 test mark (capital E in a circle and a number which indicates the country of the norm, i.e. Spain is number 9).

Only officially approved child restraint systems which are suitable for the child should be used.

The ECE-R<sup>1)</sup> 44.03 standard applies to child restraint systems. This categorizes restraint systems into four classes.

Group 0: 0-10 kg

Group 0+: 0-13 kg

Group I: 9-18 kg

Group II: 15-25 kg

Group III: 22-36 kg

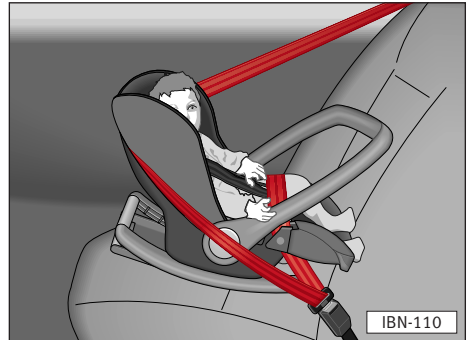
**Group 0/0+**

For babies up to 10 kg/13 kg we recommend child seats which can be adjusted to the horizontal position (see illustration).

**Warning**

If in an exceptional case, a child seat is fitted in the passenger seat where the child is travelling with the back to the direction of travel, the passenger Air Bag must be deactivated either by a Technical Service Centre. Otherwise there is a danger of severe or even fatal injuries. See a Technical Service Centre to deactivate the system.

As soon as the child seat is no longer needed as described in the above paragraph, the passenger-side Air Bag should be made operational again by a Technical Service Centre.

<sup>1)</sup> Regulation of the Economic Commission of Europe.

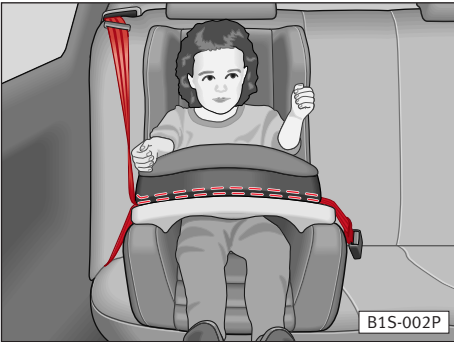

### Group I

For babies and small children weighing between 9-18 kg. Best suited are child seats with safety board – see illustration – or child seats in which the child faces backwards.

#### Warning

If in an exceptional case, a child seat is fitted in the passenger seat where the child is travelling with the back to the direction of travel, the passenger Air Bag must be deactivated either by a Technical Service Centre. Otherwise there is a danger of severe or even fatal injuries. See a Technical Service Centre to deactivate the system.

As soon as the child seat is no longer needed as described in the above paragraph, the passenger-side Air Bag should be made operational again by a Technical Service Centre.

### Group II

For children weighing between 15-25 kg. Best suited are child seats combined with 3-point safety belts.

#### Warning

The shoulder part of the belt must run roughly across the centre of the shoulder, on no account against the neck, and must be firmly in contact with the body.

The lap part of the belt must fit tightly across the pelvis– not across the stomach. If necessary, pull the belt tight.



### Group III

For children weighing between 22-36 kg. and less than 1.50 m (5') tall. Best suited are seat cushions combined with the 3-point seat belt.

#### Warning

**The shoulder part of the belt must run roughly across the centre of the shoulder, on no account against the neck, and must be firmly in contact with the body. The lap part of the belt must fit tightly across the child's hips— not across the stomach. If necessary, pull the belt tight.**

Children more than 1.50 m/5' tall can use the seat belts fitted without seat cushions.

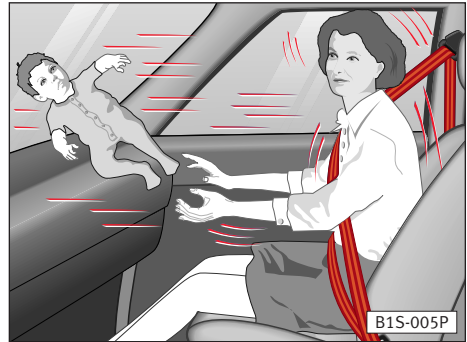

#### Warning

**Never, under any circumstances, should you transport children or infants in the vehicle, by carrying them in arms or seated on somebody's lap.**

When using the belt, the section "Seat belts" should also be noted.

## Notes

- Child retention systems designed for all ages are available for your vehicle from the SEAT Original Accessories Program under the name "Peke"<sup>1)</sup>. These systems mentioned above have been especially designed and approved conforming to the ECE-R 44.03 regulation.
- **For the installation and use, attention must be paid to statutory regulations and the instructions of the restraint system manufacturer.**

### Warning

- Particular care is required if child restraint systems are used which are bolted together with the seat belts fitted in the vehicle. The bolts must be screwed into the hole for the complete length and tightened to 40 Nm.
- Furthermore, the seat belts must be checked for correct routing. The belt must not be able to be damaged by sharply edged fittings.
- Only one child per child restraint system is allowed.

## Attach child seat

### Securing the child seat\*

To attach the child seat you can permanently block the automatic three-point seatbelt\* of the rear central seat available in certain vehicle versions. Hence, a correct attachment of the child seat in the vehicle is guaranteed.

### Warning

If, in exceptional cases, you must carry a child seat in the passenger seat where the child sits with its back to the direction of travel, the passenger Air Bag must be deactivated by a Technical Service Centre. Otherwise, serious injuries or loss of life could occur. If you wish to disconnect the system, contact a Technical Service Centre.

As soon as the child seat is no longer needed as described in the above paragraph, the passenger-side Air Bag should be made operational again by a Technical Service Centre.

<sup>1)</sup> Not available in all countries.

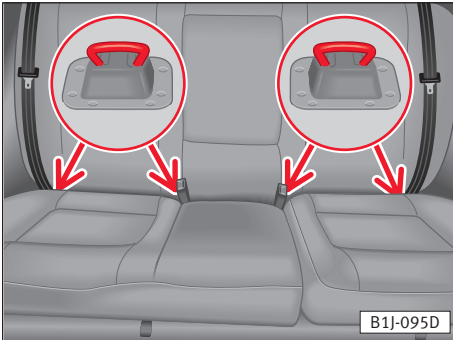

### Attaching child seats with the ISOFIX system

There are four attachment rings (see arrows) on the body work between the chassis and the cushions of the rear seat.

You can use these rings to attach a maximum of two child seats with the ISOFIX system. When you fit the child seat you must be able to hear a "click" on both sides (sound of anchoring). Then, pull the seat to check whether it has been fitted properly (pull test!)

#### Warning

**For safety reasons, carefully read the instructions of child seats with the ISOFIX system and the "Safety for children" chapter.**

## Front seats

The correct adjustment of the seats is important for:

- reaching the controls safely and quickly.
- relaxed low-fatigue body position.
- **maximum protection from the seat belts and the Air Bag System.**

### Warning

● It is important to maintain a distance of at least 25 cm from the steering wheel or instrument panel so that the front seat occupants have the best possible effective protection if the system is triggered. In addition, the front seats and the head restraints must be adjusted to the body height.

Consult the "Front seats" chapter for seat adjustment. Also note on this page the basic adjustment of the driver's and passenger seats.

### Warning

No items must be kept in the footwell, as these could block the pedals in case of sudden braking. Consequently, it would be impossible to brake, change gear or accelerate.

Feet should remain in the footwell when the vehicle is moving, never resting on the instrument panel or seats.

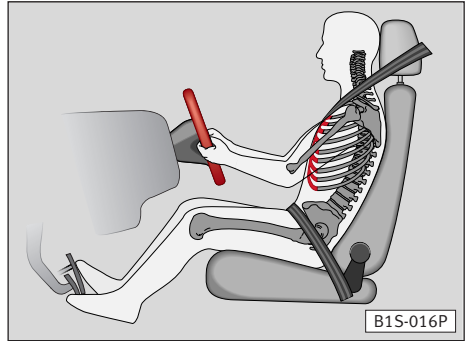

### Driver's seat

We recommend that you position the driver's seat as follows:

- Set the driver's seat forwards/backwards in such a way that the pedals can be fully depressed with a slightly angled leg.
- Set the backrest in such a way that it is fully against your back and that you can reach the upper point of the steering wheel with your arms at a slight angle.

### Front passenger seat

We recommend that you position the front passenger seat as follows:

- Backrest in an upright position.
- Place the feet in the footwell in a comfortable position.
- At the same time push the seat back as far as possible.

## Head restraints\*

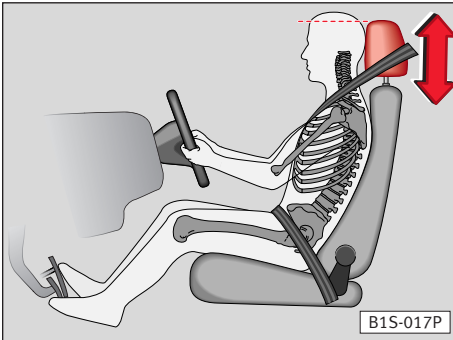

The head restraints are height adjustable and must be set to suit the size of the occupant. Correctly adjusted head restraints together with the seat belts offer effective protection. It is also possible to set the angle of the front head restraints.

### Adjusting height

- Grip sides of head restraint with both hands and pull up or push down.
- The best protection is obtained when the upper edge of the restraint is **at least** at eye level or higher.





# INDEX

## INSTRUMENT PANEL

Table . . . . .	2.2
Instruments . . . . .	2.5
Warning lamps . . . . .	2.13

## OPENING AND CLOSING

Keys . . . . .	2.23
Keys with remote control* . . . . .	2.24
Electronic immobiliser . . . . .	2.25
Doors . . . . .	2.26
Central locking* . . . . .	2.27
Tailgate . . . . .	2.32
Anti-theft alarm system* . . . . .	2.33
Radio-frequency remote control key* . . . . .	2.36
Electric windows* . . . . .	2.39
Sliding/tilting roof* . . . . .	2.43

## LIGHTS AND VISIBILITY

Switches . . . . .	2.45
Sun visors . . . . .	2.48
Indicators and dipped beam lever . . . . .	2.49
Interior lights . . . . .	2.50
Windscreen wipers and washers . . . . .	2.51
Wiper blades . . . . .	2.53
Rear-view mirrors . . . . .	2.55

## SEATS AND LUGGAGE COMPARTMENT

Front seats . . . . .	2.58
Head restraints* . . . . .	2.62
Armrest* . . . . .	2.63
Heated seats* . . . . .	2.64
Adjustable steering column* . . . . .	2.64
Pedals . . . . .	2.65
Luggage compartment . . . . .	2.65
Rear shelf . . . . .	2.67
Rear seat . . . . .	2.68
Roof rack* . . . . .	2.70
Ashtrays . . . . .	2.72
Cigarette lighter/electric socket . . . . .	2.73
Stowage box . . . . .	2.73
Drink can holder* . . . . .	2.74

## CLIMATE CONTROL

Heating and ventilation . . . . .	2.75
Air conditioning* . . . . .	2.78
Climatronic* . . . . .	2.85

## DRIVING

Manual gearbox . . . . .	2.90
Automatic gearbox* . . . . .	2.90
Handbrake . . . . .	2.96
Ignition lock . . . . .	2.97
Starting the engine . . . . .	2.98
Stopping the engine . . . . .	2.100
Cruise control system* . . . . .	2.101

Table

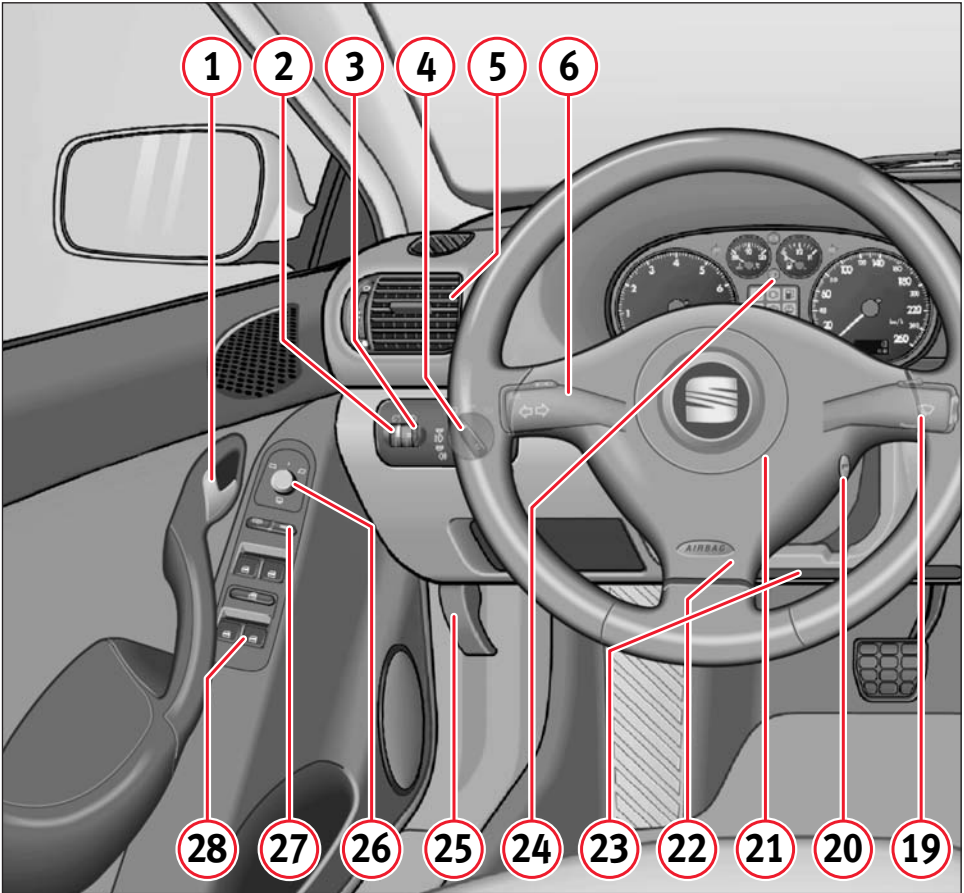

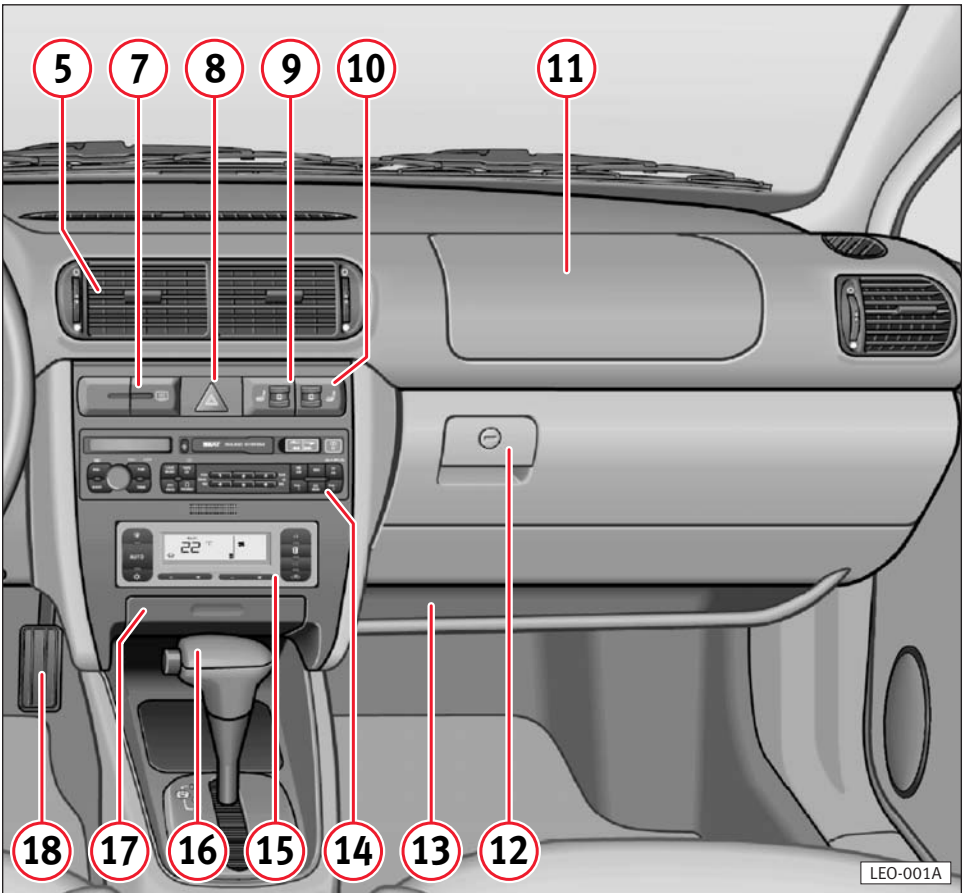

Position	Page
1 – Door handle .....	2.26
2 – Knurled wheel for instrument lighting*.....	2.46
3 – Knurled wheel for light range adjustment* .....	2.46
4 – Light switch .....	2.45
5 – Air vents.....	2.75/2.80/2.85
6 – Indicator/dipped beam lever...	2.49
7 – Heated rear window switch .....	2.46
8 – Hazard warning light switch ....	2.47
9 – Knurled wheel for left seat heating*/ Drink can holder .....	2.64/2.74
10 – Knurled wheel for right seat heating*/ Drink can holder .....	2.64/2.74
11 – Passenger Air Bag* .....	1.16
12 – Glove compartment/ stowage box .....	2.73
13 – Stowage box.....	2.73
14 – Radio/Radio housing <sup>1)</sup> * Radio navigation system <sup>1)</sup> * .....	3.85
15 – Controls for:	
– Heating/ventilation .....	2.76
– Air conditioning* .....	2.79
– Climatronic* .....	2.86
16 – Automatic*/Manual gear lever..	2.90
17 – Ashtray/ lighter.....	2.72/2.73
18 – Pedals.....	2.65
19 – Windshield washer/wipers lever/Multifunction indicator* .....	2.51/2.8

Position	Page
20 – Steering and ignition lock .....	2.97
21 – Driver’s Air Bag/Horn.....	1.16
22 – Steering column adjustment lever* .....	2.64
23 – On board literature compartment.....	2.74
24 – Instrument and warning lamps panel .....	2.13
25 – Bonnet release lever .....	3.35
26 – Electric wing mirror adjustment lever* .....	2.55
27 – Central locking button* .....	2.29
28 – Electric window controls* .....	2.39

- Some of the equipment above-mentioned is only installed on certain model versions or comes as an option.
- Controls on right hand drive models may slightly vary from left-hand drive versions. Nevertheless both versions are fitted with the very same indicator signs.

<sup>1)</sup> An additional instructions manual is delivered for vehicles with a navigation system or factory-fitted radio. If the radio is subsequently fitted, follow indications in the "Accessories, modifications and replacement of parts" chapter.

## Instruments

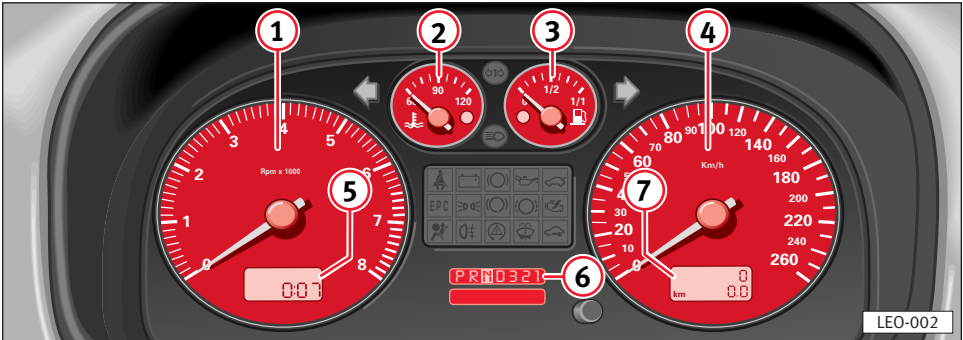

In some model versions or in certain countries, it is possible to insert the ignition key and have the dash panel lights go on without switching the engine on. This function is independent of the vehicle's light connections.

The arrangement of the instruments depends on the model and the engine fitted.

Page

1 – Revolutions counter*	2.5
2 – Coolant temperature .....	2.6
3 – Fuel gauge.....	2.7
4 – Speedometer.....	2.7
5 – Digital clock*.....	2.7
Outside temperature indicator*.....	2.7
Multifunction indicator* .....	2.8
6 – Selector lever position display*.	2.11
7 – Mileage clock with Service interval indicator* .....	2.11/2.12

### 1 – Revolutions counter\*

**On no account must the revolutions counter needle move into the red zone of the scale.**

*✿ Changing up in good time helps to save fuel and keep the noise down.*

Change down a gear at the latest when the engine turn over is no longer smooth.

Avoid high engine revolutions during the running-in period.

## 2 – Coolant temperature

The gauge starts to work when the ignition is switched on.

When the ignition is switched on the warning lamp (c) flashes for a few seconds as a functional check.

### a – Cold

Avoid high engine speeds and do not work engine too hard yet.

### b – Normal

When the vehicle is driven normally the needle should settle down in the central zone.

When engine is working hard and the ambient temperature is high, the needle may move a long way up.

**This is not serious as long as the warning lamp (c) does not flash.**

### c – Warning lamp

If the lamp flashes and a tone is heard at the same time when driving, first check the coolant temperature being displayed.

If the needle is in the normal zone, coolant should be added as soon as possible. See the chapter on “Cooling system”.

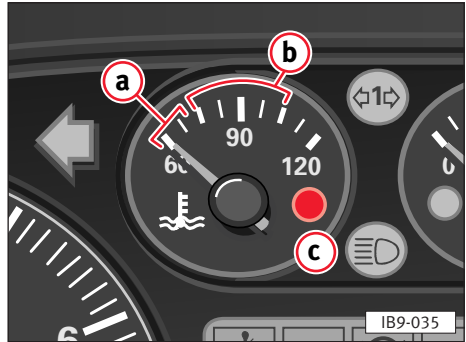

If the needle is in the right half of the indicator, the coolant temperature is too high. **In this case, pull over, switch the engine off, wait until it cools** and then look for the cause of the problem. See the chapter on “Cooling system”.

### Warning

Note warnings in “Cooling system” chapter.

**Additional lights in front of the cooling air intake interfere with the flow of cooling air. At high ambient temperatures and full throttle there is a danger that the engine will then overheat.**

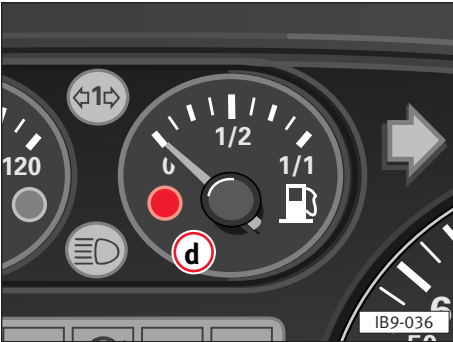

### 3 – Fuel gauge



When the ignition is switched on, the warning light lights up as a functional check.

The tank holds about 55 litres.

When the needle moves to the red reserve zone, warning light **d** lights up at the same time that an acoustic warning signal is produced; this means that approximately 7 litres of fuel remain.

### 4 – Speedometer

The speedometer is fitted with a digital mileage clock and a trip mileage clock, as well as a service interval indicator\*.

During the running in period you must note the instructions in the chapter "The first 1,500 km – and afterwards".

### 5 – Digital clock\*

The digital clock is set by turning a knob that is on the bottom right next to the speedometer.

- The hours are set by turning the button anti-clockwise until it stops. By turning the knob once, you move forward one hour. By turning and holding the knob, the hours move forward continuously.

- The minutes are set by turning the button clockwise until it stops. By turning the knob once, you move forward one minute. By turning and holding the knob, the minutes move forward continuously.

The knob can be used to set the clock to the exact second.

- Turn the knob to the right until the time is set to exactly one minute before the required time.

- Turn the button to the right just as the seconds indicator of an accurately set clock shows one full minute.

- Turning the button to the left sets the clock to the required arrow.

### 5 – Outside temperature indicator\*

The outside temperature is displayed when the ignition is on.

At temperatures from +5 °C to –5 °C, a snowflake symbol is displayed along with the temperature.

**The snowflake symbol is to warn the driver to take extra care when there is a risk of ice forming on the road.**

When the vehicle is stationary or travelling at very low speeds, the temperature displayed may be slightly higher than the actual outside temperature as a result of radiant heat from the engine.

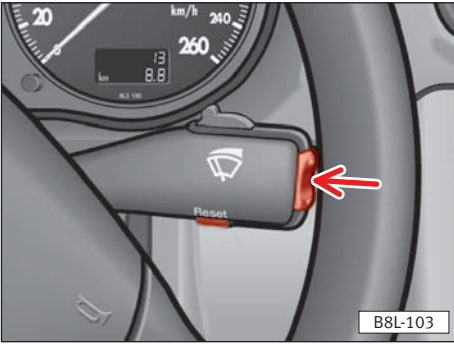

### 5 – Multifunction indicator\*

The multifunction indicator includes:

- Time
- Driving time
- Average speed
- Distance covered
- Autonomy
- Average fuel consumption
- Current consumption

The function selector and the reset key are located in the windshield wiper arm.

With the ignition switched on, repeatedly press the upper or lower part of the function selector and the functions will appear one after the other.

When the ignition is switched on, the function which was selected before switching off the ignition will be activated, unless the ice warning symbol appears with outside temperature of + 5°C and – 5°C.

If the vehicle battery is disconnected, all stored values will be deleted.



---

## Memory

The system is equipped with two memories which function automatically.

**A partial route memory (Multifunction Indicator 1)** gathers the following data between switching the ignition on and off:

Driving time, distance covered and used fuel.

Speed and average fuel consumption are calculated using the above information.

If driving is resumed within two hours from switching off the ignition, the data collected while driving is included in the calculation. If driving is not resumed within two hours, the memory is automatically deleted.

**A total route memory (Multifunction Indicator 2)** collects driving data from any number of partial routes up to a total of 100 driving hours, 10,000 kilometres and a fuel consumption of 1,500 litres. This data is used to calculate average consumption and speed from all partial routes.

If some of the before mentioned data is exceeded, the memory is deleted and the calculation starts over. Contrary to the partial route memory, this memory is not deleted when driving is interrupted for more than two hours.

## Consult memory

To consult data select the memory by pressing the "**Reset**" key for < 2 seconds and from one of the specific Multifunction Indicator 1 or 2 functions.

- Partial route memory - Multifunction Indicator 1
- Total route memory - Multifunction Indicator 2

The following data can be displayed:

- Driving time
- Distance covered
- Average speed
- Average fuel consumption

## Delete memory

Memory data is reset by pressing the "Reset" key for > 2 seconds.

## Indications on screen

The last selected item will be displayed when the ignition is switched on.

## Outside temperature °C

The correct outside temperature takes five minutes to be displayed. When the vehicle is stationary or moving slowly, the indicated temperature may be slightly higher than the real outside temperature due to the engine heat.

### Warning

**In temperatures between +5°C and -5°C the ice warning symbol is displayed next to the outside temperature indication. In case this function was not selected, the screen would automatically display it.**

## Time

The time is displayed even if the ignition is switched off. The clock is set with the right rotary knob below the speedometer (see "digital clock" in the Instructions Manual).

## Driving time

**Multifunction Indicator 1** – Driving time from switching on the ignition or from resetting memory (see "special route memory").

**Multifunction Indicator 2** – Total driving time of all partial routes (see "memory of total route").

The maximum value displayed with either selector position is 99 hours and 59 minutes. If this value is exceeded, the display is reset.

## Average speed Ø km/h

The same applies to "average speed" as to "average fuel consumption".

## Distance covered Km

The same which applies to "distance covered" applies to "driving time" (see below). The maximum displayed distance is 9,999 km.

## Autonomy Km

This function indicates the distance which the vehicle can drive maintaining the same driving style.

Fuel calculation is based on the average fuel consumption during the last 50 kilometers.

After resetting the fuel display (i.e. after disconnecting the battery) the real fuel range will be displayed after approximately 50 kilometers).

---

**Average fuel consumption**      **Ø l/100 km**

Indicates the average fuel consumption, not the consumption at the moment.

After switching on the ignition or after deleting the corresponding memory, the average fuel consumption is displayed after having driven approximately 300 meters. Until that moment, the screen will display lines instead of the function. The figure is updated every 5 seconds.

**Multifunction Indicator 1** – indicates the average fuel consumption of the partial trip.

**Multifunction Indicator 2** – indicates the average fuel consumption of all of the partial trips (see also "memory of total route").

**Note**

The quantity of fuel which has been used is not indicated.

**Current consumption**      **l/100 km**

Indicates the current consumption in l/100 km.

The consumption is calculated in intervals of 2 seconds. When the vehicle is stopped, the consumption is indicated in l/h.

**6 – Selector lever position display\***

The position of the automatic gearbox selector lever is indicated in the display. See "Automatic gearbox" chapter.

**7 – Mileage clock/ Trip mileage**

The upper counter registers the total distance driven and the lower one the short trips.

The last figure of the lower counter indicates 100 m.

The trip mileage can be put back to zero by pressing the reset knob next to the speedometer (partial mileage clock).

## 7 – Service interval indicator\*

If a service is due, the word "Service" will flash for about 20 seconds when the engine is switched on, the vehicle is not moving and the mileage clock reset button is not touched.

The deadline for any service will be displayed 3,000 km in advance.

- **Intermittent service\* for 20 seconds.** Indicates that the time for a new service has elapsed.

- **Service Km 3,000\* for 20 seconds.** Indicates that the next service is due in 3,000 km. Every 100 km the number of km will decrease by 100 km up to the indication "Service".

**After the service has been performed the display needs to be reset.**

The display will be reset by a Technical Service Centre as follows:

- Switch ignition off
- Keep the odometer reset button next to the speedometer pressed down.
- Without releasing the aforementioned button, switch the ignition on. **"SERVICE"** will then appear on the display. Next, turn the button toward the right, for at least one second.
- The display automatically returns to normal mode (total km + partial km), and in this way, the system remains activated for the oil change service.

## Notes

- **Do not zero the display between the service intervals. Otherwise an incorrect reading will appear.**
- **If the battery should be disconnected, the service indicator information will be retained.**
- **If the instrument panel changes due to repair, the service interval display must be reset. This should be carried out by a Technical Service Centre. If the indicator is not reprogrammed, the service work must be done in accordance with the Maintenance and Inspection Plan and not the service interval indicator. Only after a service has been carried out and the indicator has been reset will the service interval indicator regain its validity.**

## Failure indicator

If a failure occurs, "FAIL" would appear either on the instrument panel or the trip meter. The defect should be repaired by a Technical Service Centre as soon as possible.

## Warning lamps

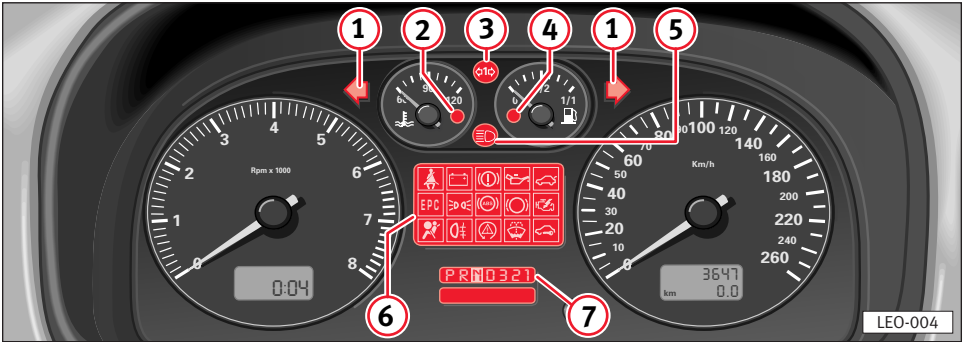

The layout of the warning lamps depends on the model version and engine fitted. The symbols shown here are also on the actual warning lamps.

	Page
1 – Indicators .....	2.15
2 – Coolant temperature/level* .....	2.15
3 – Trailer indicators* .....	2.16
4 – Fuel level* .....	2.16
5 – Main beam .....	2.16
6 – Warning lamps display screen ...	2.16
7 – Upper display: Selector lever position display* .	2.16



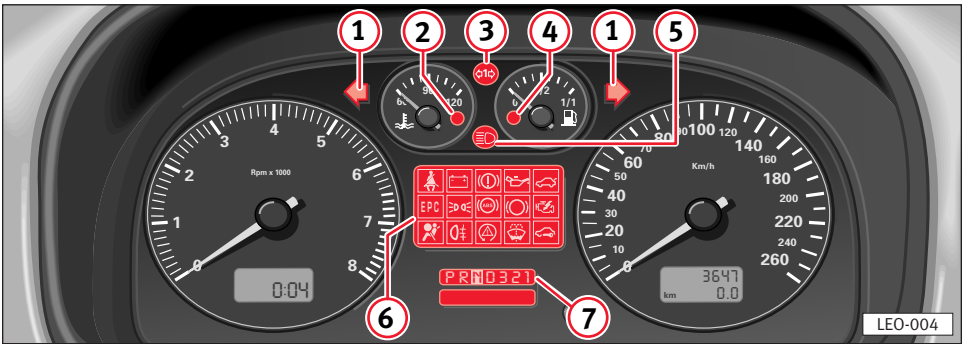

## 1 – Indicators



The pilot light flashes at the same time as the indicator. If a turn signal fails, the warning lamp flashes twice as fast. (Not when towing a trailer).

For more data, see "Indicators and dipped beam lever" chapter.

## 2 – Coolant temperature/level\*



The warning lamp lights up for a few seconds as a functional check when ignition is switched on.

If the lamp does not go out afterwards or lights up or flashes when driving, either the coolant temperature is too high or the coolant level too low. An acoustic signal will sound 3 times as an additional warning:

**Stop the vehicle immediately, switch the engine off** and check the level. If necessary, add coolant. For more information, see the chapter "Instruments".

## Warning notes

- Never open the bonnet of your car if you see steam or coolant coming from the engine compartment – Risk of scalding! Wait until no more steam or coolant can be seen.
- Do not touch the fan. The fan can switch on suddenly – even when the engine is switched off.
- Please note the following points to avoid scalding with hot coolant:
  - Exercise caution when opening the coolant expansion tank! When the engine is hot the cooling system is under pressure – Danger of scalding! Therefore let engine cool down before unscrewing the cap!
  - To protect your face, hands and arms you should cover the cap of the radiator with a large, thick cloth to protect against steam or hot fluid.
- Ensure that the coolant liquid does not drop on the hot exhaust or any other hot engine components. The antifreeze contained in the coolant could ignite.

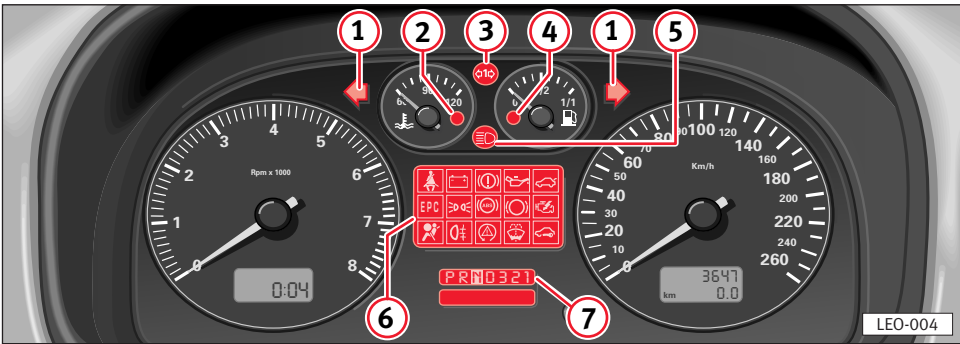

If the level is correct the failure may be due to a fan failure. In this case check the radiator fan fuse and replace if necessary. See "Fuses" chapter.

If the warning lamp does not go out although coolant level and fan fuse are in order, **do not drive on** – call in expert assistance.

If the trouble is located only in the radiator fan, and assuming the coolant level is in order and the temperature warning lamp is off, you may drive on to the nearest Technical Service Centre. In order to make good use of the air stream for cooling, do not let engine idle or drive very slowly.

### 3 – Trailer indicators\*



The warning lamp\* flashes when turn signals are switched on when towing a trailer.

If a turn signal fails on the trailer or vehicle, the warning lamp does not flash.

### 4 – Fuel level\*



When the ignition is switched on, the warning light lights up as a functional check.

The warning lamp comes on when there are about 7 litres left in tank.

### 5 – Main beam



The warning lamp comes on when main beam is on or when the headlight flasher is used.

### 6 – Warning lamps display screen

### 7 – Selector lever position display\*

The automatic gearbox selector lever is shown on the display; See the "Automatic gearbox" chapter.



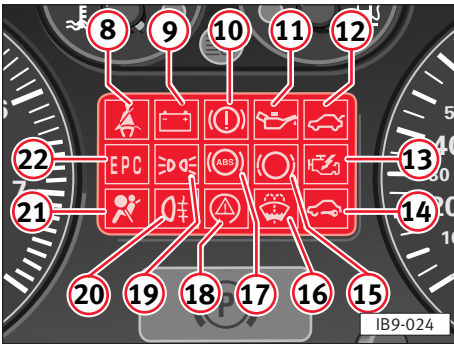

### 8 – Seat belt warning lamp\*



The warning lamp lights up (only for certain countries) for about 6 seconds after ignition as a reminder to fasten your safety belt.

If the seat belt is not fastened, in some countries an acoustic signal will sound after switching on the ignition which will stop after approximately 6 seconds or when the seat belt is fastened.

**Please refer to chapter “Seat belts”.**

### 9 – Alternator



The warning lamp comes on when the ignition is switched on and must go out when the engine is started.

The alternator is driven by a long-life ribbed belt.

If the warning lamp lights during the journey, **stop, switch off engine** and check ribbed belt.

If it is **loose** or broken, **do not drive on** – the coolant pump is no longer being driven. The belt must be checked/ renewed.

If the warning lamp comes on although the V-belt or ribbed belt is not broken or loose, one can normally drive on to the nearest Technical Service Centre.

As the battery will continue to discharge, all electrical consumers which are not absolutely necessary should be switched off.

**10 – Brakes/Hand brake**

The warning lamp comes on when the brake fluid level is too low.

The ignition must be switched on.

On vehicles with ABS\*, the warning lamp will light up for a few seconds when the ignition is switched on or the engine started. If the ABS system\* fails it will also light up together with the ABS warning lamp.

**Warning**

**If the pilot light does not go out or it comes on during the journey, the fluid level in the deposit is too low. Have the brake system serviced immediately at a Technical Service Centre.**

**Meanwhile you will have to press harder on the brake pedal and braking distances will be greater.**

**If the brake system and ABS pilot lights come on at the same time, the rear wheels may lock prematurely while braking. Go immediately to a Technical Service Centre driving very carefully and take precautions.**

**Hand brake**

The pilot light will come on when the hand brake is set and the ignition is switched on. It should go out when the hand brake is taken off.

**11 – Engine oil pressure/level**

The warning light lights up for a few seconds as a functional check when the ignition is switched on.

If the warning lamp is red or yellow or flashes it indicates that the engine oil pressure or level is too low. This warning lamp will also light up if there is a defect in the oil level indicator.

**If lights up or flashes red (insufficient oil pressure)**

Should the warning light flash or light up while driving you will also hear three times an acoustic warning as soon as the engine runs at over 1500 r.p.m. You must stop the car and turn the engine off: check the oil level and top up if necessary. See the "Engine oil" chapter.

If the warning lamp flashes even though the oil level is in order, do not continue driving. Do not even run the engine at idling speed. Call in expert assistance.

If while driving the engine speed decreases below idling speed the oil pressure warning lamp may light up. Increase engine speed by accelerating or changing down gear.

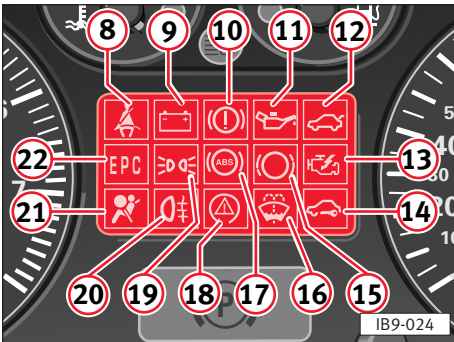

### Lights up yellow (oil level\* too low)

If the pilot light lights up yellow the level is too low. Stop engine and refill oil. See "Engine oil" chapter.

When opening the bonnet the oil level warning is reset. However, if you do not refill oil the warning will reappear after about 100 km.

### Flashes yellow (defective oil level\* indicator)

If the oil level indicator is defective an acoustic signal will sound and the warning lamp will flash several times.

From the moment of the defect to the check-up of the engine the oil level needs to be checked regularly, preferably when filling the tank.

### 12 – Tailgate



The pilot light\* comes on if the tailgate is open or badly closed.

### 13 – Diagnosis\*/ Excess of pollution



This pilot light lights up when the ignition is switched on as a testing device and goes out after a few seconds.

In case of failure due to excessive pollution it will start to flash.

### 14 – Electronic immobilizer



When switching the ignition on, the data from the vehicle key is automatically processed. This procedure is confirmed by the warning lamp lighting up briefly.

If an unauthorized key is used the pilot light will flash continuously. The vehicle cannot be started. See also "Keys with remote control" chapter.

### 15 – Brake wear monitor\*



The pilot light comes on for about 3 seconds as a check when you switch the ignition on. If the pilot light comes on while you are driving you will also hear an alarm.

If when you switch the ignition on the pilot light lights up and you hear the alarm, it means the brake pads are worn. **In this case you should go to a Technical Service Centre to have the front and rear brake pads checked\*.**

## 16 – Windscreen washer water level\*



When the ignition is switched on, this warning light lights up as a functional check.

This warning lamp will light up if the water level in the screen washer reservoir becomes too low.

Add water to the windshield and headlight washers. See "Windshield washer" chapter.

## 17 – Anti-locking brake system (ABS)\*



When the ignition is switched on, this warning light lights up as a functional check.

This warning lamp monitors the **ABS** and **EDL\*** systems.

### Anti-lock Brake System (ABS)\*

The warning lamp comes on for a few seconds when the ignition is switched on or the engine started. The lamp goes out after an automatic test sequence has been completed.

If the ABS warning lamp does not come on when the ignition is switched on, does not go out, or comes on when driving, the system is faulty.

A fault in the ABS system is indicated as follows:

- **Just the ABS warning lamp lights up.** The vehicle can still be braked with normal braking system but without ABS. **The vehicle should be taken to a Technical Service Centre as soon as possible.**

- **ABS warning lamp lights up together with brake system warning lamp.** Not only is the ABS system defective, but a **change in normal braking characteristics can also be expected.**

### Warning

**If there is a fault in the ABS system the rear wheels can lock relatively quickly. In certain circumstances this could make the back end of the car swing violently.**

**If this happens drive with utmost care to the nearest Technical Service Centre to have the fault repaired.**

In versions with an anti-skid regulator in the driving wheels, or an electronic stability programme, the TCS/ESP pilot light will also come on if the ABS fails. For more details see pages 3.11, 3.12 and 3.13.

### Electronic Differential Lock (EDL)\*

The EDL system works in conjunction with the ABS. Failure of the EDL system is indicated by the ABS warning lamp lighting up. **The vehicle should be taken to a Technical Service Centre as soon as possible.**

Further details on EDL are given on page 3.11.

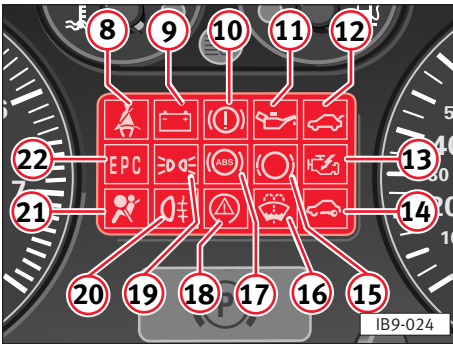

### 18 – Drive wheels spin regulator (TCS)\*



The warning light lights up for a few seconds as a functional check when the ignition is switched on; it should go off after a couple of seconds.

If the TCS works while the vehicle is in motion, the pilot light flashes.

If the system is disconnected or has a fault, the pilot light will stay on.

As the TCS works in combination with the ABS, if the ABS breaks down the TCS pilot light also comes on.

For more information see page 3.11.

### 18 – Electronic Stability Program (ESP)\*



The warning light lights up for a few seconds as a functional check when the ignition is switched on; it should go off after a couple of seconds.

If the ESP works while the vehicle is in motion, the pilot light flashes.

If the system is disconnected or has a fault, the pilot light will stay on.

As the ESP works in combination with the ABS, if the ABS breaks down the ESP pilot light also comes on.

For more information see page 3.13.

### 19 – Parking light/dipped beam



Dipped beam, parking or side light pilot light (green). Works with the ignition off.

**20 – Rear fog light\***

The pilot light will light up as soon as the rear fog light is switched on. For further details see "Switches" chapter.

**21 – Air Bag system<sup>1)</sup>**

When the ignition is turned on, the warning light will remain lit for a few seconds.

If the warning light flashes for about 12 seconds following engagement of the ignition, this means that at least one Air Bag has been disconnected in a Technical Service. See "Deactivation of the Air Bag".

**Therefore if the warning light does not flash or it lights or flashes while the vehicle is in use, it means that there is problem with the Air Bag. Proceed immediately to a Technical Service to solve the problem.**

<sup>1)</sup> This equipment may vary according to the country.

**22 – Preheating system**

(Diesel engines only)

When the engine is **cold** the warning lamp comes on when key is turned to Drive position (ignition on).

If the warning lamp does not come on, there is a defect in the glow plug system – call in expert assistance.

Once the pilot light switched off switch engine on immediately. See "Starting the engine" chapter.

When the engine is **warm** the glow plug lamp does not come on – the engine can be started straight away.

**Note**

If while driving a fault occurs in the diesel engine management system, this is indicated by the warning lamp flashing. The engine must be checked as soon as possible by a Technical Service Centre.

**22 – Electronic accelerator-pedal control (EPC)**

If there is a fault in the accelerator pedal working, a warning light will switch on. Have the fault repaired at a Technical Service Centre.

## Keys

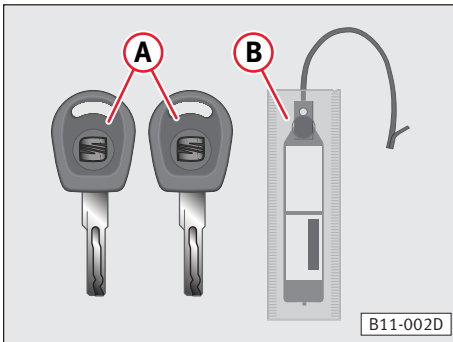

The vehicle is supplied with two keys **A** which fit all locks.

In addition, plastic key chain **B** with the key number is included.

### Warning

- Always take the key from the ignition whenever you leave the vehicle – even if only for a moment. This is particularly important if children are to remain in the vehicle. They might start the engine or some other electrical component, e.g. electric windows. Risk of accident!
- Wait until the vehicle has stopped before taking the key out. Otherwise the steering may block.

### Replacement keys

For reasons of security, replacement keys are only available from SEAT Official Service Centres.

### Key tag

The key tag contains the key number as well as the secret code for the immobilizer, which are needed to obtain replacement keys. With this number you can order a duplicate of your key from a SEAT Official Service Center.

### Note

**You should keep this plastic key chain in a particularly safe place since only with this number can copies of the key be made.**

For this reason you should give the buyer this key tag if you sell the vehicle.

## Keys with remote control\*

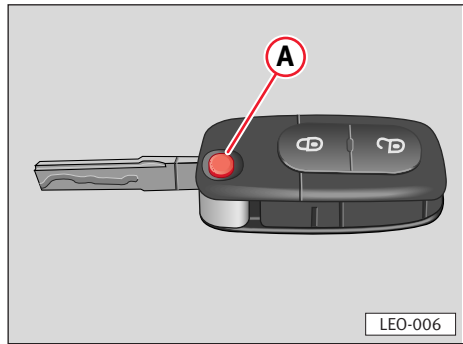
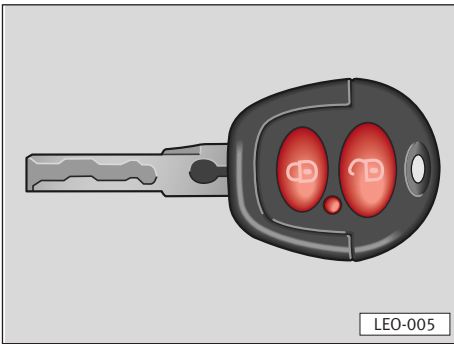

Vehicles with remote control\* have two keys. One is a conventional key (see previous page). The other incorporates a remote control function\* (see "Radio-frequency remote control" chapter).

### Note

In some model versions the remote control key may be folded. Its remote control function is identical to any remote control key. See "Radio-frequency remote control" chapter.

### Foldable key\*

**To unfold** the key sword, press button **A**. It will unfold with a spring.

**To fold** the key sword, press button **A** and guide it with your hand until it is completely folded.



## Electronic immobiliser

---

The immobiliser prevents unauthorised persons from using your vehicle.

A micro-chip is located in the head of the key which automatically deactivates the immobiliser when the key is inserted in the ignition lock.

The system is automatically activated when the ignition is switched off.

### **Note**

The engine can thus only be started with a correctly coded Genuine SEAT key.

Trouble free operation of your vehicle can only be guaranteed when using genuine keys.

## Doors

---

**From the outside of the vehicle**, it may be locked or unlocked using the driver door key.

**Upon opening**, the latch will rise up (for vehicles with central locking).

For vehicles equipped with electric windows and central locking, if the key is maintained in the opening position all of the electric side windows will open.

**Upon closing**, the latch will descend (for vehicles with central locking).

In some vehicle models equipped with electric windows and central locking, if the key is maintained in the locking position on the driver side, any side windows left open as well as the electric sunroof will close.

For vehicles without central locking, the passenger door and the rear doors may be locked from the outside without using a key. Just press the button down and close the door.

The latch on the driver's door may not be pushed down while the door is open (only in vehicles without central locking). This avoids accidentally leaving the keys in the ignition.

**From the inside of the vehicle**, all the doors may be locked by pushing the security buttons down (in vehicles without central locking).

### **Warning!**

**When the doors are locked, any intrusion is impeded, for example while stopped at a red light.**

### **Warning!**

- Exercise extreme caution when closing the windows and the sunroof from the outside of the vehicle.
- Closing from the outside without taking care or observing all the vehicle may cause bruising for other people especially children.
- When locking a vehicle, never leave children unaccompanied inside, as it will make it more difficult to provide assistance if required.

## Central locking\*

When the key is used in the driver's door, all doors and the boot are unlocked at the same time by the central locking system.

The central locking system is fitted with a **locking security system** (double lock): When the vehicle is locked with the key or the remote control from the outside, all of the doors are locked impeding any attempt to force them.

This system may be activated from the **outside** either by using the key or the radio-frequency remote control\*.

### Locking locations of the vehicle

#### Outside:

Driver's door or by using the radio-frequency remote control\*.

#### Inside:

By using the central locking switch located on the handle of the driver's door (simple closure) (see page 2.29).

### Opening

To **open** your vehicle turn the key in the lock of the driver's door to the opening position or use the radio-frequency remote control\*. All of the doors will be unlocked

When the vehicle is opened using the radio-frequency remote control\*, the locking security system as well as the anti theft alarm\* are immediately deactivated. The indicator on the driver's door will stop flashing. This warning light is fitted to vehicles equipped with the locking security system or the anti theft alarm\*.

When the vehicle is opened using the key, the locking security system (double locking) and the anti-theft alarm\* are immediately deactivated.

When the vehicle is opened, the interior lighting will come on for 30 seconds as if a door is open and the indicators will flash twice.

If, for any reason, the central locking ceases to function then, in general, the drivers door and boot may be opened conventionally using the key but neither the locking security system nor the anti theft alarm can be activated.

If the key is maintained in the opening position in the driver's door the electric windows will open, in vehicles equipped with them.

### Notes

If for any reason the central locking ceases to function, neither the rear doors nor the passenger door may be opened.

The lock mechanism of the driver's door, the boot and the ignition locking mechanism all possess a **rotation mechanism** (which will turn freely without the key)\*. When the locking mechanism is operated with any object other than the key, the rotation mechanism is activated. The manipulated cylinder will rotate without opening the vehicle or turning the ignition on.

If the rotation mechanism is activated when the key is inserted then remove the key fully and then reinsert it to open the vehicle. There will be no damage to the locks.

1) This function may vary according to the model and country.

## Locking

● To **lock** your vehicle, **turn the key once** (the double lock is activated) to the locking position in the driver's door lock. All of the doors and the boot will lock. The locking security system (double lock) and the anti theft alarm\* will be immediately activated and the indicator light on the driver's door will begin to flash to indicate this. This warning light is fitted to vehicles equipped with the locking security system or the anti theft alarm\*.

When the vehicle is locked, all of the interior lights that may be on are turned off and the indicator lights flash once.

The activation of the locking security system (double lock) is indicated by the flashing of the indicator light located on the top of the driver's door panel at the level of the window. Also, for vehicles equipped with the anti theft alarm\*, the indicator light will indicate when the alarm is on.

### Warning!

● If the vehicle is closed from the outside by turning the key once to the locking position (double lock), no person –especially children– should remain inside the vehicle due to the fact that the doors cannot be opened from the inside using the door handle or the central locking switch (see central locking switch instructions). If the vehicle is equipped with electric windows, these cannot be opened from the inside either (see the instructions for the electric windows).

● Children should never be left alone inside the vehicle due to the fact that if the doors are accidentally locked, it will be difficult to provide assistance if needed.

● If the key is **turned two consecutive times** to the locking position in less than one second then only the simple locking mechanism is activate for all doors and the boot. The locking security system (double lock) is **not** activated.

If the locking security system (double lock) is not activated then the vehicle may be unlocked **from the inside**. To do this, simply pull the corresponding door handle until the door opens.

● For vehicles<sup>1)</sup> fitted with electric windows or an electric sunroof, when the key is maintained in the locking position the electric windows will close fully followed by the electric sunroof if it is open.

● If the driver's door is **incorrectly closed** or **open** (door "ajar"), the vehicle cannot be locked. In order to lock the doors of the vehicle, the driver's door should be completely closed. If any other door of the vehicle is incorrectly shut then all doors except this door will be locked. If properly closed afterwards, this door will join the locking system of the vehicle.

In the case where the vehicle is opened using the radio-frequency remote control and neither the locks or the doors are used, after 30 seconds the vehicle will automatically be relocked so that it is not accidentally left open.

<sup>1)</sup> This function may vary according to the model and country.

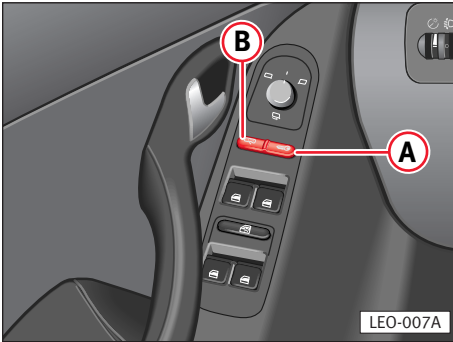

### Notes

If the vehicle is locked using the central locking switch, individual doors may be unlocked. To do this, simply pull the corresponding door handle until the door opens.

### Central locking button\*

The central locking button makes it possible to lock/unlock the whole vehicle from the inside. The button is located in the door release lever on the driver's door (see illustration).

### Locking

By pressing the right hand side of the switch **A** all doors and the boot lid/tailgate are locked. It is now no longer possible to open the doors or boot lid/tailgate. Unwanted access from outside (e.g. at traffic lights) is also prevented in this way.

If the driver's door is **open** it will not be locked. This is to prevent you from locking yourself out.

The locking security system (double lock) and the anti theft alarm\* are **not** activated if the push button is used.

### Automatic Locking

The doors will lock automatically when the vehicle exceeds speeds of 15 km/h.

## Unlocking

Pushing the left part of the locking switch **B** will open all doors.

## Automatic Unlocking

The doors unlock automatically when the key is removed from the ignition.

The button will also function when the ignition is switched off.

### Warning

- If the central locking button in the door release lever on the driver's door is operated, all other doors and the tailgate are locked automatically.

However when the doors are locked outside help in an emergency is hindered, and so children should never be left alone in the vehicle.

- Locking the doors and tailgate prevents intruders from getting in the vehicle, e.g. at traffic lights.

- For vehicles equipped with Air Bags and only in the event of a collision where an Air Bag is detonated, the central locking will unlock all doors automatically to facilitate the evacuation of the vehicle. The vehicle's interior light and the warning lights will remain lit until the key is removed from the ignition and reinserted again.

- Once the vehicle has been locked with the radio wave remote control or with a regular key the central locking knob becomes inactive. It no longer works. For this reason, do not leave anyone in the vehicle, in particular children, since it is not possible to open from the inside or from the outside. Furthermore, the vehicle cannot be unlocked by sticking the hand in the window and pulling the knob from the inside or the central lock command. Therefore, no intruder can unlock the vehicle.

- Take great care when closing the windows and the electric roof\* from the outside!

- If you close from the outside carelessly or without visibility you may cause serious injury especially to children.

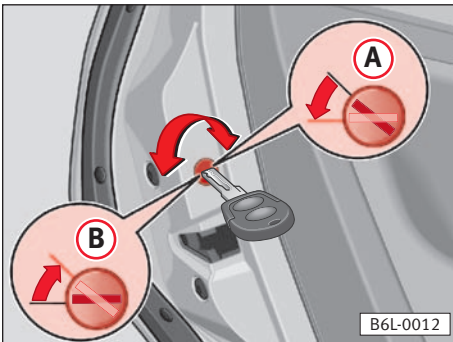

### Child safety

The rear doors also have child-proof catches.

### Child lock

Using the vehicle key, turn the child lock slot in the direction of the arrow (figure **A**). This way, the inside door handle of the affected door is deactivated and the door can only be opened from the outside. The security button must be in the up<sup>1)</sup> position and the vehicle unlocked.

### Removing the child lock

Using the vehicle key, turn the child lock slot in the direction of the arrow (figure **B**). This will reactivate the door handle of the affected door and it may once again be opened from the inside. The security button must be in the up<sup>1)</sup> position and the vehicle unlocked.

<sup>1)</sup> Only vehicles without central locking.

## Tailgate

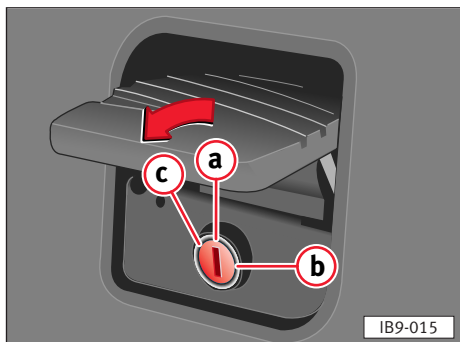

- When the key slot is vertical (**a**) the tailgate/boot lid is locked or unlocked automatically by the central locking system. It can also be locked or unlocked separately with the main key.

- When key slot is horizontal (**b**) the tailgate/boot lid will be locked all the time after closing. It can then only be unlocked with the main key.

To unlock boot lid, insert key and turn as far as possible in the direction of the arrow (**c**). The key cannot be pulled out of the slot in this position.

### Note

The alarm will go off if the boot is opened manually using the key while the alarm is activated.

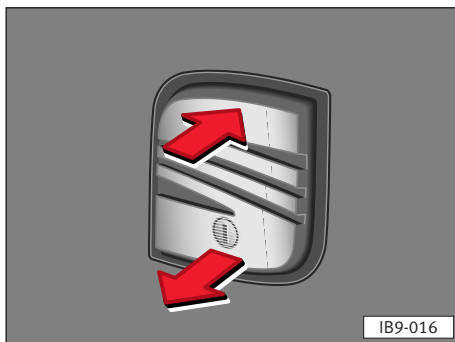

**To open** the tailgate when the key slot is vertical (see illustration), pull the handle and lift the tailgate.

**To close** pull the tailgate down using one of the handles on the interior embellishment and slam it gently.

If the key slot is horizontal it means the tailgate is permanently locked and may only be opened with the main key.

### Warning

- After closing the tailgate always pull it upwards to make sure it is properly closed. Otherwise it may spring open while the vehicle is in motion, even if it has been locked.

- The tailgate must always be properly closed when the vehicle is in motion to prevent exhaust fumes from getting inside.

**Danger of intoxication!**



## Anti-theft alarm system\*

With the anti-theft alarm, break-in attempts and theft of the vehicle are rendered more difficult. The system triggers acoustic and optical warning signals if someone tries to gain unauthorised access to the vehicle.

The alarm system and the locking security system (double lock) are automatically activated when the driver's door is locked. To lock the door either turn the key **once** in the lock towards the locking position or press button **2** on the radio-frequency remote control\*. The system is then activated immediately and the indicator light located on the driver's door will flash along with the flashers indicating that the system have been turned on.

- For vehicles equipped with an additional alarm system\* , if you access the car by using the driver's door key you have 15 seconds to introduce the key into the ignition lock and activate it. Otherwise the alarm will trigger off for 30 sec. and car start up will be deactivated.

You can only turn off the alarm by pressing the "open" key on the remote control.

For cars without radio-frequency remote control keys you must wait for 30 sec. until the alarm cuts off. Then close the door with the key and repeat the previously described process all over again.

The alarm signal will be triggered for 30 seconds if access is attempted via any door that is not the driver's.

### Note

When you lock the car the indicator pilot lights will only come on if the alarm has been properly activated (all security areas have been properly locked).

If a door or the boot are left open when the alarm is connected, they will not be incorporated into the car's protection system. If after you lock the doors or boot, they will be automatically incorporated into the security areas and the indicator signals will show.

If the vehicle is locked and the alarm is activated, you do not need to open the car to deactivate it.

To do this, turn the key twice in the driver's door lock to the lock position or press twice the lock button in the key handle fitted with the radio-frequency remote control.

The alarm will be triggered if, with the vehicle locked, one of

- the doors,
- the bonnet, or
- the boot

is opened or

- the ignition is switched on.

When the alarm is triggered the horn sounds and a flashing signal is activated for about 30 seconds.

**To deactivate the anti-theft alarm turn the key in the opening direction or press the "open" key on the remote control.**

– **two flickers: open and deactivate the alarm**

– **one flicker: lock and activate alarm**

### Notes

- The warning lamp goes out after approx. 28 days. This prevents the battery becoming discharged when the vehicle is not used for a long period. The alarm system remains activated.
- The alarm signal will be triggered a second time if one of the protected parts of the car is interfered with again after the alarm signal has stopped (for instance if the tailgate is opened after one of the doors has been opened).
- The alarm can also be activated and deactivated via the radio wave remote-control\*. Further information can be found under the heading "Radio wave remote control".

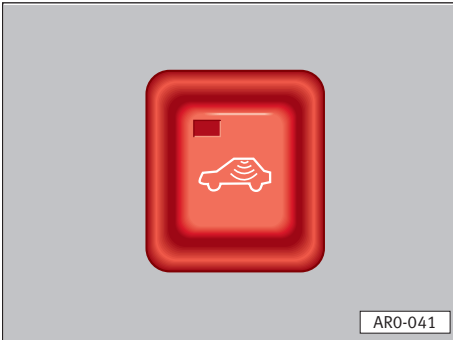

### Volumetric sensor\*

This is a surveillance function or a control incorporated in the anti-theft alarm system which detects through ultrasound unauthorized access to the vehicle interior (i.e. through a window).

This system has two sensors: a transmitter and a receiver.

#### Activate

The volumetric sensor is switched on automatically when the anti-theft alarm is activated whether by locking manually with the key or by remote control.

#### Deactivate

The volumetric sensor is deactivated when:

- 1 – Unlocking the vehicle manually with the key in the door lock or by radio wave remote control.
- 2 – Pressing the button  located in the vehicle's interior behind the driver's door in the lower part for at least one second immediately after having unlocked the driver's door and after having removed the key from the ignition.

#### Note

- If, after deactivating the volumetric sensor, the door is locked with the remote control or manually with the key in the door lock within less than 30 seconds the volumetric sensor is deactivated even though all other anti-theft alarm functions remain activated.
- After this time-span the deactivation of the volumetric sensor is canceled.
- In case of relocking while the alarm was activated without the volumetric sensor function, this relocking will cause a connection of all the alarm functions, except for the volumetric sensor. If it was not disconnected voluntarily it will be reactivated during the following alarm connection.
- If the volumetric sensor caused the alarm to set off this will be indicated by flickering of the pilot light in the driver's door when unlocking the vehicle. This flickering is different than the flickering of the activated alarm.
- If the volumetric sensor has caused the alarm to set off three times the alarm system will no longer go off.
- Other sensors (door opening, luggage compartment, etc.) will continue to set off the alarm.

## Radio-frequency remote control key\*

The following functions can be operated using the radio wave remote control without using the key manually.

- Locking and unlocking the central locking system.
- Connecting and disconnecting the anti-theft alarm system\*.
- Switch on interior light (see "Interior lights" chapter)

The radio wave transmitter with its battery is located in the handle of the key. The radio wave receiver is located inside the vehicle.

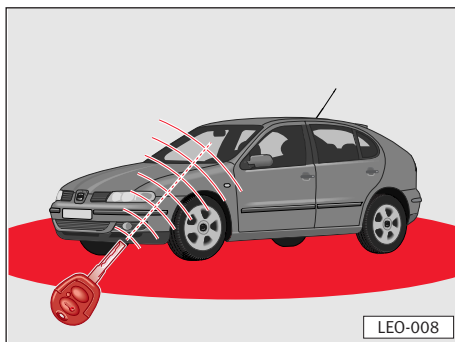

The **effective range** (red area) of the remote control is shown in the illustration. The maximum range depends on various conditions.

The range will reduce as the batteries lose power.

### Note

- The remote control becomes inoperative when the key is in the ignition.

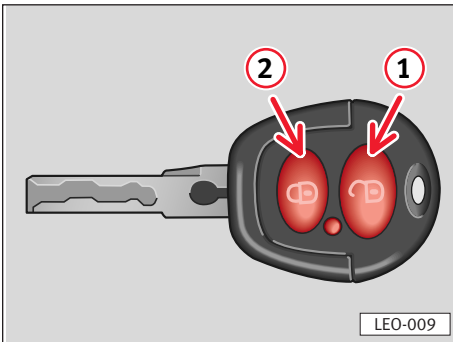

### Opening and closing the vehicle

To **unlock** the vehicle, point the key from within the effective range at the vehicle and briefly press the “open” button (arrow 1). The indicators will flicker. To **lock** the vehicle, briefly press the “close” button (arrow 2). The indicators flicker once.

If you press the “close” button (arrow 2) **twice**, the dead-lock mechanism and anti-theft alarm are **deactivated** and the indicators do not work.

### Selective Unlocking

Press the opening button (arrow 1) once to open only the driver’s door, leaving the rest closed.

Press the opening button (arrow 1) twice to open all doors.

### Notes

When the close or open buttons are pressed a warning lamp will flash in the key. If this lamp does not flash, the battery in the key might be discharged. In this case a Technical Service Centre should check or change the battery.

When the dead-lock mechanism and the anti-theft alarm\* are activated, proceed as follows:

If the vehicle is unlocked by using the open button on the radio-frequency remote control\*, all of the doors and the boot<sup>1)</sup> will be relocked automatically if they are not opened within 30 seconds. However, the locking security system and the anti theft alarm will remain deactivated during these 30 seconds. This function prevents the vehicle being **accidentally open** within range of the radio-frequency remote control.

<sup>1)</sup> The alarm and dead-lock mechanism will remain in the same position as before opening.

## Synchronization

If the vehicle cannot be opened by pressing the radio transmitter button, it could be that the code of the key no longer matches that of the control unit in the vehicle. This can occur when the transmitter button is frequently pressed outside the effective range of the system. **We recommend that a Technical Service Centre take care of this function.**

To synchronize the key again the following procedure must be followed:

- 1- **Both** vehicle keys, the key with the radio transmitter (**A**) and the conventional key (**B**), must be used.
- 2- The synchronization process must be completed within **30 seconds**.
- 3- Use key (**B**) to switch on ignition and key (**A**) to program.
- 4- Make sure that the vehicle is **open** before you proceed to the programming.
- 5- Place key (**B**) in the ignition and switch on.
- 6- Use key (**A**) to lock the driver's door manually.
- 7- Now **unlock** and **lock** manually the driver's door with key (**A**) while pressing button (**1 open**).
- 8- Take the key out of the ignition.

Uncoded keys can be obtained at SEAT Official Service Centers. These keys, however, must be synchronized by a SEAT Official Service Center as the code for the immobilizer also has to be programmed in the head of the key.

## Authorization for use

The radio wave remote control fulfills all norms. Its use has been approved by the corresponding German office (Federal Approvals Office For Telecommunications of The Federal Republic of Germany).

All components have been marked according to current stipulations.

This authorization is the basis for approval in other countries.

## Electric windows\*

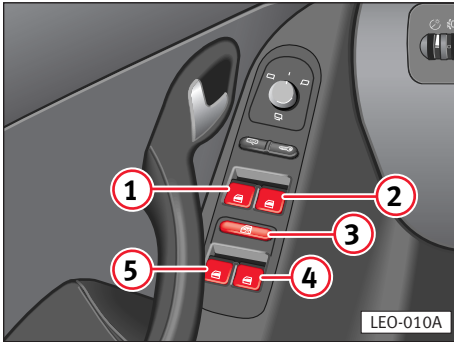

The switches are located in the driver's door (see illustration).

- 1 – Driver's door
- 2 – Front passenger door
- 3 – Safety switch\*
- 4 – Right rear door\*
- 5 – Left rear door.\*

The electric windows can be activated with the ignition on.

With the ignition off, the windows can be activated for 10 minutes. They will stop working when a front door is opened.

The safety switch blocks the buttons of the rear windows. When the switch is pressed again the buttons of the rear doors will become operational.

There are additional controls on the passenger door and the rear doors\* for each window. These controls will only open or close their respective windows.

With the safety switch **3** in the driver's door, the rear electric windows can be deactivated.

- Safety switch **out**:  
The switches in the rear doors can be used.
- Safety switch **in**:  
The switches in the rear doors cannot be used.

Electric windows with an automatic closing function\* are equipped with a **power limiter**.

The windows stop closing automatically should anything block it. **However this power limiter function does not work when the windows are closed from outside with the ignition key.**

#### Warning

- Always remove the ignition key when leaving the vehicle – even if only for a short time. Never leave children alone in the vehicle.

The electric windows are only deactivated when the driver's or passenger doors are opened.

- Watch out when closing the windows! Careless or uncontrolled closing of the windows can cause injuries.

- The driver must warn the other occupants of the risk which careless operation of electric windows entails.

- No one should remain in the vehicle when locked from the outside, as the windows cannot be opened in the event of an emergency.

- Take great care when closing the windows and the electric roof\* from the outside!

- Careless closing from the outside or without visibility can cause serious injury, especially to children.

## Window opening and closing variants with the door keys

### Opening variants

- The window is **opened** by pressing the corresponding door button lightly.

When the button is released the opening process will stop.

- Press the driver's side door button full down to open the window fully and automatically.

When the button is pressed again the window stops immediately.

### Closing variants

- The window is **closed** by pulling the corresponding closing button lightly

When the button is released the closing process will stop.

- Pull the driver's side door button fully to close the window fully and automatically.

When the button is pulled again the window stops immediately.

### Note

The controls of the passenger and rear doors can only be used to open or close the windows. Only the front windows may be opened or closed automatically from the driver's door controls.



---

**The roll-back function\***

- 1 – If the window in the driver or passenger's door is hindered whilst closing through stiffness or by an obstacle (roll-back function), the window will open again immediately.
- 2 – After the window has opened, you must lift and hold the appropriate switch for the affected window again within 5 seconds. If the window is still hindered whilst closing through stiffness or by an obstacle, the window will stop closing.
- 3 – After the window has stopped, you must lift and hold the switch again within 5 seconds in order to close the window.

**The window will now close without power limitation.**

**Note**

If you wait for longer than 5 seconds between the individual steps, the system will reactivate.

**Warning**

- **Take great care when closing the windows! Closing the windows in a careless or uncontrolled manner may cause bruises, especially in children.**
- **The driver must warn the other occupants of the risk which careless operation of electric windows entails.**

### Function of the electric windows with ignition switched off

After the ignition has been switched off, the windows can still be operated for about ten minutes so long as the driver or passenger doors are not opened.

The windows on vehicles with central locking can also be closed or opened from the outside (in cars with a sliding/electric roof you can only close them). For this purpose, the key must be in the lock of the driver's door and held in the locking or open position.

#### Opening

Press the front edge of the respective button.

#### Closing

Lift the front edge of the respective button.

#### Note

If the window in the driver or passenger door is hindered whilst closing through stiffness or by an obstacle (roll-back function), the window will open again immediately.

In this case you can only close the window again after the ignition has been switched on.

#### Notes

The automatic opening/closing, and roll-back functions\* on the driver and passenger door windows will not function after the vehicle battery has been disconnected/reconnected.

To reinstall this function after reconnecting the battery, please note the following points.

- **Lock vehicle** from the outside via the driver's door. When doing this please ensure that all doors and windows are closed completely.
- **Lock the vehicle again** via the driver's door. **Hold the key in the locking position for at least one second.**

This reactivates the system.

#### Warning

- **Be very careful when closing the electric windows and roof from the outside!**
- **Be very careful when closing the windows! Closing from the outside without visibility or in a careless manner can cause serious injury, especially with children.**
- **Children should never remain alone inside the vehicle when it is locked from the outside, as outside help will be hindered in the event of an emergency.**

## Sliding/tilting roof\*

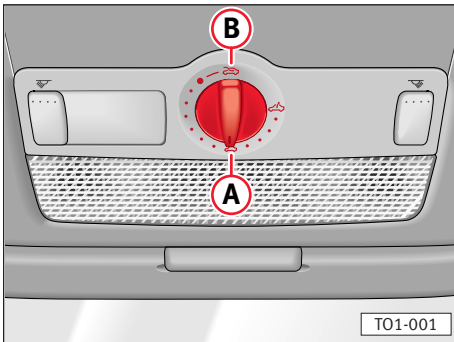

With ignition switched on, the sliding/tilting roof can be opened and closed/lifted and lowered with the rotary switch. Press the switch for emergency or full strength closing.

After the ignition has been switched off, the roof can still be operated so long as the driver or passenger doors are not opened.

### Warning

- Take great care when closing the roof! Closing the roof carelessly or in an uncontrolled manner may cause bruises, especially in children.
- The driver must warn the other vehicle occupants of the risk which careless operation of the roof entails.
- Always remove the ignition key when leaving the vehicle, even only for a moment. Never leave children unattended in the vehicle.

### To open

Turn the switch **clockwise**. There are intermediate opening positions that are shown by notches on the switch. The biggest notch shows the biggest opening advisable for high speed driving with minimum aerodynamic noise.

To completely open the roof keep turning the switch to position **B**. In this position, however, there can be noise due to the wind.

### To close

Turn the switch to rest position or starting position **A**. If you turn it **anti-clockwise** the roof will close completely. If the roof is completely open and you turn the switch anti-clockwise, you can put the roof in the intermediate opening positions represented by the notches.

### To raise

From starting position **A** turn the switch **anti-clockwise**. The roof will be raised according to the notches on the switch.

### To close/lower

Turn the switch **clockwise** until it reaches the rest/starting position **A**.

### Note

The sun screen to prevent intensive sun rays shining in can be slid open or closed by hand with roof open or closed.

You should ensure, especially when the sun screen is closed that the tilting roof is closed when the vehicle is parked or during a sudden rainfall.

### Convenience locking\*

The sliding roof can also be closed when locking the driver's door:

Hold the key in the locking position until the roof is closed.

## Roll back function

The roof has a roll back function to avoid possible injury when closing the roof.

When the roof is closed in a normal way, it will re-open automatically if it encounters any obstacle. **However this will not occur if the emergency or maximum strength lock has been activated.**

### Note

There is an emergency or maximum strength lock which should only be used in case of absolute necessity, e.g. when driving at high speeds or when dirt or ice stop the rails from operating properly. To close press the lower part of the switch and the roof will close forcibly.

### Warning

- Be very careful when closing the roof! Closing from the outside without visibility or in a careless manner can cause serious injury, especially with children.
- The driver should warn the other occupants that careless use of the roof is dangerous.
- Always remove the ignition when leaving the vehicle – even if only for a short time. Never leave children alone in the vehicle.
- When using the maximum strength closure there is a risk of accident or injury. Take extreme care when using this function.

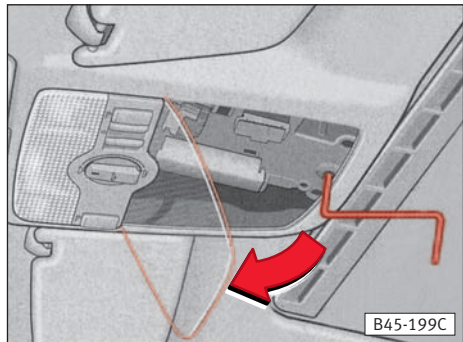

## Emergency operation

If the system should develop a fault the roof can also be closed by hand.

- Remove the plastic cover at rear using a screwdriver.
- Pull crank out of cover retainer, insert it in the opening and close sliding roof.
- Replace crank in retainer, and replace cover.

## Switches

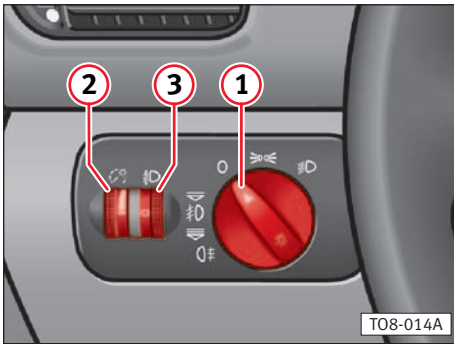

### 1 – Lighting switch



- – Switched off
- ☞☞☞ – Side lights<sup>1)</sup>
- ☞☞☞☞ – Dipped or main beam

The lamps will only function with the ignition on. When the engine is being started and after ignition has been switched off, they automatically switch to the side lights.

Low, high beam and flash light. See "Indicators and dipped beam lever" chapter.

#### Note

If lights are not switched off and the ignition key is removed, a buzzer\* will sound when the driver's door is open.

### Front fog lights\*



With lighting switch in side light or dipped/main beam position pull switch out to first detent.

<sup>1)</sup> In some countries, when the side lights are switched on with the ignition on, the dipped headlights also come on with reduced intensity.

### Rear fog light\*



#### Vehicles without fog lights

Turn lighting switch to dipped/main beam position and pull switch out to stop.

#### Vehicles with fog lights

With lighting switch in dipped/main beam position, pull switch out to 2nd detent.

#### Note

- A warning lamp in the instrument panel lights up when the rear fog light is switched on.
- Due to the amount of dazzle it causes, the rear fog light should only be switched on when the visibility is very poor (e.g. in some E.U. countries, 50 metres).

The electrical system of the factory fitted tow bar\* is wired up so that when towing a trailer fitted with rear fog lights, the rear fog lights on the towing vehicle are automatically switched off.

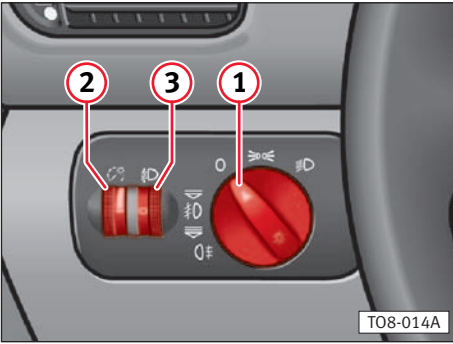

## 2 – Instrument lighting



When the lights are on, the level of the instrument lighting can be set to any intensity by turning the knurled wheel next to the light switch.

## 3 – Headlight range control\*



With the electric adjustment of the headlamp range, headlights can be matched exactly to the load condition of vehicle. This prevents oncoming traffic from being dazzled more than is unavoidable. At the same time the correct headlight beam adjustment provides the best possible visibility for the driver.

The headlights can only be regulated with the dipped headlights switched on.

To lower the beams, turn knurled disc from the basic position (O) downwards.

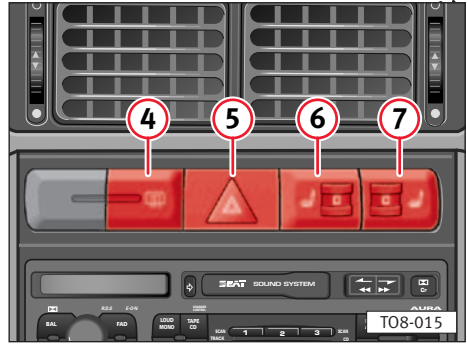

## 4 – Heated rear window



The heating works only when ignition is on. When heater is on a lamp in the switch lights up.

*As soon as window is clear, switch element off. The reduced current consumption helps to reduce fuel consumption – see page 3.20.*

On vehicles with electrically adjustable exterior mirrors the mirrors are heated as long as the rear window heating is switched on.

---

## 5 – Hazard warning lights

The system also works when the ignition is switched off.

Switch on the hazard warning lights if, for example:

- Your vehicle stops because of a technical defect,
- You have an emergency
- You reach the tail end of a traffic jam.

When the hazard warning lights are switched on, all turn signal lights flash simultaneously. The warning lamps for the indicators and a warning lamp in the switch will also flash.

**Observe legal requirements when employing such safety measures.**

## 6 – Seat heating\* for left seat

For further information on its functions see "Heated seats" chapter.

## 7 – Seat heating\* for right seat

For further information on its functions see "Heated seats" chapter.

## Switches in driver's door

### Electric windows

To use the electric windows switches see "Electric windows" chapter.

### Central locking button

To use this switch see "Central locking" chapter.

### Wing mirror adjustment

See "Rear-view mirrors" chapter.

## Sun visors

The sun visors can be pulled out of the side mountings and swung towards the doors.

The vanity mirrors have a sliding cover.

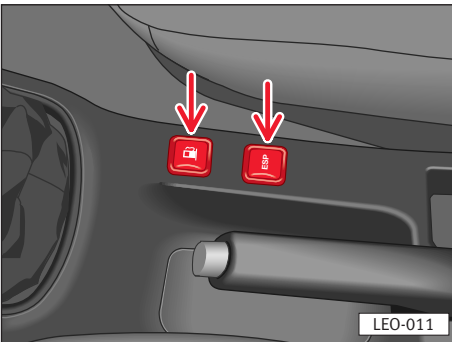

## Switches in the central console

### Unlocking the tank flap

You must press the key to unlock the tank flap. It can only be unlocked when the ignition is off.

### Anti-skidding system of the drive wheels (TCS)\*. Electronic Stability Program (ESP)\*

The TCS or ESP connect automatically when the engine is switched on. If necessary, they may be switched off briefly by pressing corresponding switch.

The pilot light will light up if it is disconnected. See "Warning lamps" chapter.

For further information see pages 3.11, 3.12 and 3.13.



## Indicators and dipped beam lever

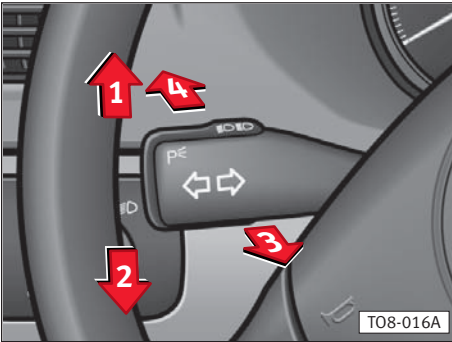

The turn signals only work when the ignition is switched on.

Right turn signals – lever up (1)

Left turn signals – lever down (2)

When the turn signals are switched on the pilot light will light up simultaneously. See "Warning lamps" chapter.

The turn signals switch off automatically when the steering wheel returns to its normal position.

### To signal a lane change

Move the lever up (1) or down (2) to the pressure point and hold in this position – the warning lamp should flash at the same time.

### Headlight flasher

Pull the lever towards the steering wheel (3) – the main beam warning lamp will light up.

### Short or long beams

With the long or short beam connected push the lever towards the steering wheel (4). When main beam is on, the main beam pilot light will light up.

### Parking lights\*

The parking lights only work when ignition is switched off.

Right parking lights – lever up (1)

Left parking lights – lever down (2)

If the ignition key has been removed, a buzzer\* will sound when the driver's door is open.

### Note

**The use of the signals and lighting described here is subject to local regulations.**

## Interior lights

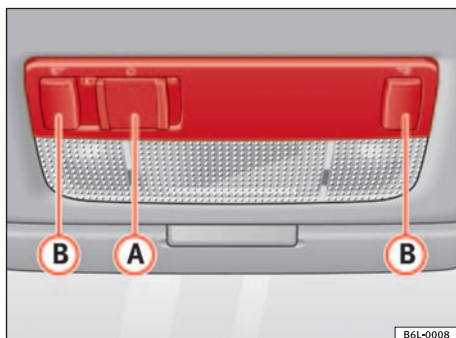

### A – Front interior light

Switch positions:

○ – Off

Left – Light on continuously

Right – Door contact switch

Interior lights with delayed switch off\* remain on for about 30 seconds after doors are closed.

### B – Front reading light\*

The reading light is turned on or off by pressing the appropriate switch B.

### Boot light

The light is on when the tailgate is open (including with lights and ignition off). You must therefore always make sure you close the boot, as well as when you park the car.

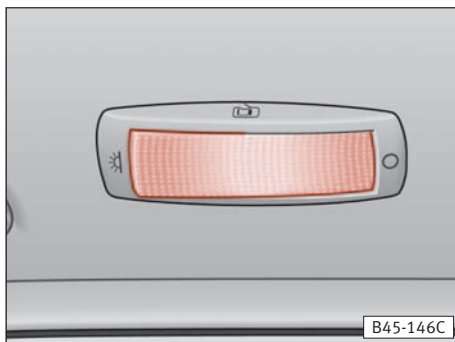

### Rear interior lights

Switch positions:

○ – Off

Intermediate position – Door contact switch

Left – Light on continuously

### Control of interior lights

The interior light is switched on for approx. 30 seconds when the vehicle is unlocked, a door opened or the ignition key removed. The switch must be in the door contact position for this function.

It is however switched off as soon as the vehicle is locked or the ignition switched on.

With the door open, the interior light will remain on for a maximum of ten minutes. This prevents the battery from discharging.

### Glove box light\*

The light in the glove box on the passenger side only comes on when the ignition is on and the lid is open.

## Windscreen wipers and washers

### Warning

The windshield wiper blades must be in perfect condition to ensure good visibility (see "Windscreen wipers" chapter).

Wipers and washers only work when ignition is switched on.

**When it is freezing, check that the wiper blades are not frozen to the glass before switching the wipers on for the first time.**

The heated windscreen washer jets\* are switched on when the ignition is switched on and the amount of heat is regulated automatically according to the outside temperature.

### Note

- Fill container. See "Windscreen washer" chapter.
- Replace wiper blades. See "Wiper blades" chapter.

### Windscreen

#### ● Windscreen wipers off

Lever at position 0.

#### ● Intermittent wipe

Lever at position 1.

Use lever **A** to change the intervals of the intermittent wipe. Four levels are available.

Lever to the right – brief intervals

Lever to the left – long intervals

The intervals of each level are set in function of the time that elapses between each sweep of the wipers.

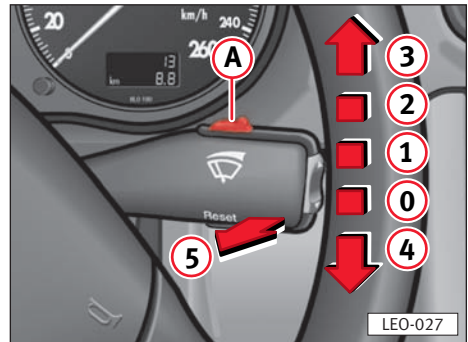

#### ● Wiper slow

Lever at position 2.

#### ● Wiper fast

Lever at position 3.

#### ● Flick wipe

Lever at position 4.

#### ● Automatic wash/wipe facility

To turn on wipers and washer, pull lever towards steering wheel to position 5.

Release lever –

The washer stops and the wipers carry on for about 4 seconds.

#### Rain sensor\*

If the vehicle is fitted with a rain sensor and the intermittent wipe is activated this sensor is in charge of adjusting automatically the duration of the intervals to the amount of rain.

Position **A** of the lever for the windscreen wipers is used to individually adjust the sensitivity of the rain sensor.

After switching off the ignition, the rain sensor needs to be switched on again. To do that the intermittent wipe needs to be switched off and switched on again.

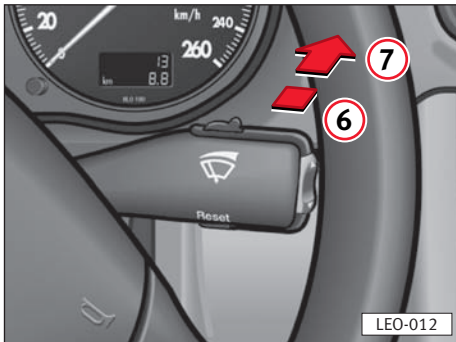

### Headlight washer system\*

When the main or dipped beam is on, the lenses are washed every time the windscreen is washed.

At regular intervals, such as when filling the tank, the dirt on the lenses (insects) should be removed.

### Rear windscreen

#### ● Intermittent wipe

##### Turn on:

Push lever to position **6**.

The wipers wipe approximately every 6 seconds.

##### Turn off:

Move the lever towards the steering wheel. If you turn off the windscreen wiper while wiping, the windscreen wiper will function until the wipe is completed.

#### ● Automatic wash/wipe facility

##### Turn on:

Push the lever forward to position **7**:

The washer/wipe facility keeps working intermittently. To turn off completely move the lever towards the steering wheel.

## Wiper blades

### Warning

- The wiper blades must be in good condition for clear visibility.
- In order to prevent streaks on the windscreen you should clean the wiper blades regularly with a window cleaning product. If the windows are particularly dirty, e.g. insect remains, a sponge or cloth should be used to clean the blades.
- Change the wiper blades once or twice a year for safety reasons. Wiper blades may be purchased from Technical Service Centres.

**When it is freezing, check that the wiper blades are not frozen to the glass before switching the wipers on for the first time.**

If the wiper blades drag, it may be caused by one of the following:

- If the vehicle has been washed in an automatic car wash, residual wax may be left on the windscreen. This wax can only be removed with special detergent. Consult a Technical Service Centre for more information.

The blades will not drag if you use a wax dissolving windscreen cleaner. Grease solvents will not work.

- Damaged wiper blades can also drag. In this case the blades should be renewed.
- The blades are set at an incorrect angle. Have the angle checked and, if necessary, adjusted by a Technical Service Centre.

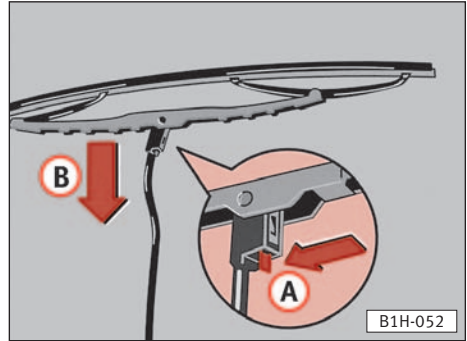

### Changing wiper blades

#### Taking the wiper blade off

- Hinge the wiper arm up and position the blade perpendicular to the wiper arm.
- Press the retaining spring in the direction of arrow **A**.
- Detach the wiper blade in the direction of arrow **B** and then remove from the arm in the opposite direction.

#### Securing the wiper blade

The retaining spring must engage audibly in the wiper arm.

When fitting wiper blades with moulded wind deflectors one should ensure that the deflector is pointing downwards.

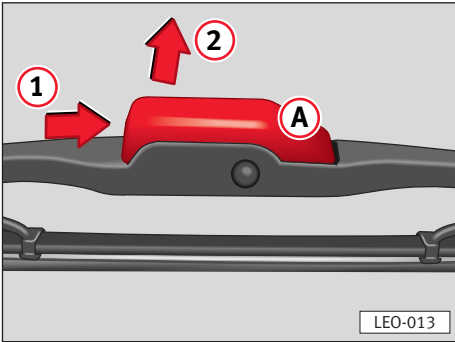

To remove the rear wiper blade, do the following:

Before you follow the aforementioned steps, remove cover **A** by pressing in the direction of arrow **1** and then as indicated by arrow **2**. Proceed as indicated in the before mentioned chapter (change of wiper blades).

## Rear-view mirrors

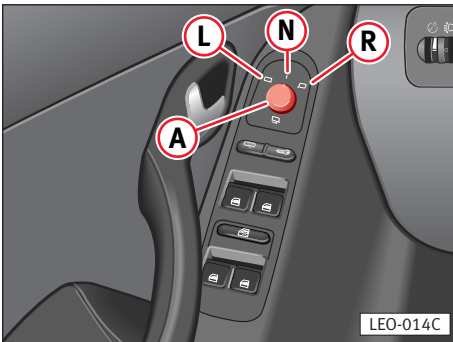

### Adjusting mirrors

The rear view mirrors should always be adjusted properly before moving off so that good vision to the rear is obtained.

### Anti-dazzle interior mirror

The lever on the lower edge of the mirror should be pointing to the rear when the basic setting is made.

To set the anti-dazzle position, pull lever forwards.

**Exterior mirrors controlled mechanically from inside** are adjusted with the knob in the door trim panel.

### Automatic\* anti-dazzle mirror

Adjust interior mirror by hand.

If the ignition is switched on the interior mirror automatically darkens depending on the light from behind (i.e. a headlight).

When you engage the reverse gear or put the selector lever on **R** the mirror returns to its original position (is no longer dark).

### Electrically adjustable mirrors\*

Electrically adjustable mirrors\* are set by pressing the edge of the knob **A** in the driver's door trim.

The surface of the mirror may be angled upwards, downwards, to the left or the right, as required.

With swivel knob **(A)** select the driver or passenger wing mirrors.

**N** – Neutral position

**R** – Driver's mirror

**L** – Passenger's mirror

When you adjust the **left** mirror the right one moves in time, and a separate adjustment of the right mirror should not normally be necessary. If you wish to adjust it separately, activate the right mirror. You should now be able to adjust it.

If the electric adjustment fails, the mirrors can be adjusted manually by pressing on the surface.

**Note for vehicles with convex or aspherical outside mirrors \***

**Convex** (curved outwards) mirrors enlarge the field of view but they make objects look smaller. **These mirrors are only of limited use in estimating how far away a following vehicle is.**

**Aspherical** exterior mirrors have a mirror surface with different curvature. This wide-angle mirror increases the area of vision even more so than conventional convex mirrors. **Their usefulness is also limited when judging the distance to vehicles approaching from behind.**

**Mirror heating\***

The electrically operated outside mirrors are heated as long as the heated rear window is switched on. The ignition must be switched on for this purpose.

**Folding exterior mirrors in**

The exterior mirrors can be folded in.

To do this pull mirror housing towards vehicle.

**Note**

- Before putting the vehicle through an automatic washing plant, the mirrors should be folded in to prevent them from becoming damaged.

**Folding exterior mirrors back**

**Warning**

**When folding the mirror back out ensure that your fingers are not trapped between the mirror and the bracket – Danger of injury!**



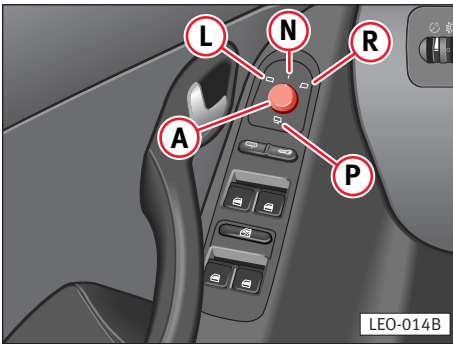

### Note

If the mirror housing is moved by an external force (e.g. knocked when maneuvering) the mirrors must be folded right in electrically. **Under no circumstances must the mirror housing be adjusted by hand** as the operation of the mirror might be affected. To place the mirrors in use position, using control **A**, they will not work for about 15 seconds.

Be careful not to damage the mirrors when using control **A**.

### Electric folding wing mirrors\*

Use control **A** to select the passenger or driver's wing mirror, or the fold-away function, as well as mirror adjustment (see diagram).

**N** – Neutral position

**R** – Driver's wing mirror

**L** – Passenger's wing mirror

**P** – Folding away of wing mirrors

The fold-away position is recommended, for example, when parking or driving in cramped conditions.

To **fold away the wing mirrors**, starting from positions **L**, **R** or **N**, select position **P** with control **A**.

To **unfold the wing mirrors (use position)**, do the opposite, from **P** to **L**, **R** or **N**.

## Front seats

---

The correct adjustment of the seats is important for:

- reaching the controls safely and quickly
- relaxed low-fatigue body position
- **maximum protection from the seat belts and the Air Bag System.**

### Warning

- **For this reason the front seats should not be pushed too close to the steering wheel or the instrument panel.**
- **Your feet should remain in the footwell while the vehicle is in motion – never resting on the instrument panel or seats.**

Please adjust your seat as detailed on the next pages. Please also note the basic positions for the driver's and passenger seats on this page.

### Driver's seat

We recommend that you position the driver's seat as follows:

- Set the driver's seat forwards/backwards in such a way that the pedals can be fully depressed with a slightly angled leg.
- Set the backrest in such a way that it is fully against your back and that you can reach the upper point of the steering wheel with your arms at a slight angle.

### Warning

**No items should be kept in the footwell, as they could block the pedals in the case of a sudden braking manoeuvre.**

**You would no longer be able to brake, change gear or accelerate!**

### Front passenger seat

We recommend that you position the front passenger seat as follows:

- Backrest in an upright position.
- Place the feet in the footwell in a comfortable position.
- At the same time **push the seat back as far as possible.**

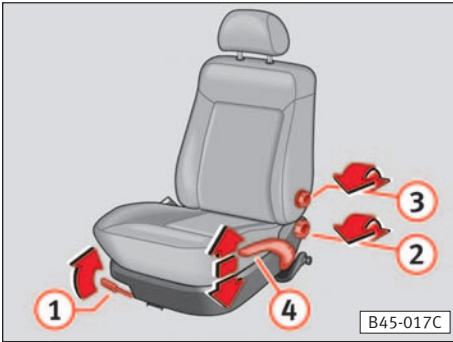

### Driver and front passenger seats (manual adjustment)

#### 1 – To move seat backwards and forwards

Lift lever and move seat. Then release lever and move seat further so that the catch engages.

#### Warning

For safety reasons the driver's seat must only be moved backwards or forwards when the vehicle is stationary.

#### 2 – Adjusting backrest

Take weight off backrest and turn knob by hand.

#### Warning

Do not lower the backrest too far when on the move because the seatbelts are no longer fully effective.

#### 3 – Adjusting lumbar support\*

Turning the wheel will arch the lumbar support cushion to greater or lesser degree. This prevents the fatigue that accompanies long journeys.

#### 4 – Adjusting seat height\*

By “pumping” the lateral lever the seat can be lifted or lowered.

**Lifting:** Lift/pump lever up from base position.

**Lowering:** Press/pump the lever down from the base position.

#### Warning

- For safety reasons the height of the driver's seat must only be adjusted when the vehicle is stationary.

- Be careful when adjusting the seat height! Careless and uncontrolled adjustment can cause injuries.

- The electrical adjustment of the seats will also function when the ignition is off or when the key has been withdrawn fully.

For this reason children should never be left unattended in the vehicle.

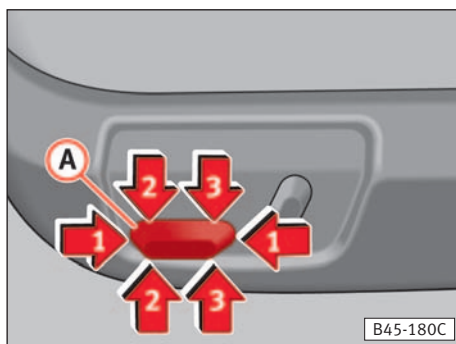
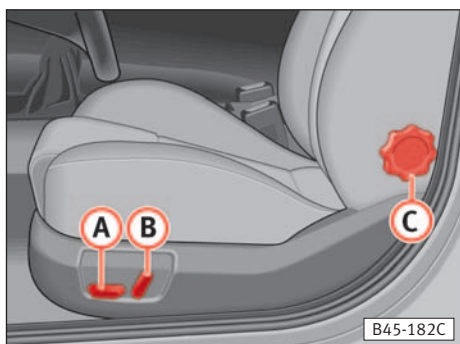

### Driver and front passenger seats (electrical adjustment)\*

The seats are electrically adjusted using the switches **A** and **B**.

The seats can also be adjusted in this way when the ignition is switched off.

Using the handwheel **C** the **lumbar support** is set mechanically. Please also refer to the description (Pos. 3) of the manual adjustment.

### Switch A\*

The seat is adjusted in the corresponding arrow direction by pressing the switch:

- 1** – Seat forwards / back
- 2** – Front seat cushion up / down
- 3** – Rear seat cushion up / down
- 2** and **3** at the same time – Seat up / down

### Warning

- For safety reasons the height of the driver's seat must only be adjusted when the vehicle is stationary.
- Be careful when adjusting the seat height. Careless and uncontrolled adjustment can cause injuries.
- The electrical adjustment of the seats will also function when the ignition is switched off or when the key has been withdrawn completely.

For this reason, children should never be left unattended in the vehicle.

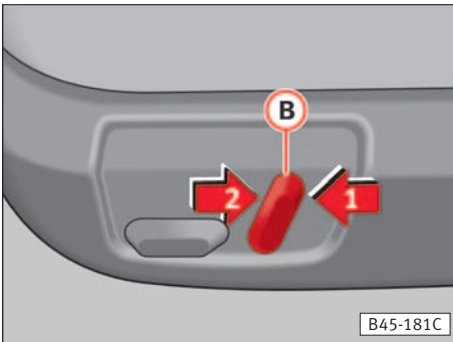

### Switch B\*

The backrest is adjusted in the corresponding arrow direction by pressing the switch:

Arrow 1: Backrest comes forward

Arrow 2: Backrest moves back

### Warning

Do not have the backrest too far forward while the vehicle is in motion as this may affect the effectiveness of the seat belts.

## Head restraints\*

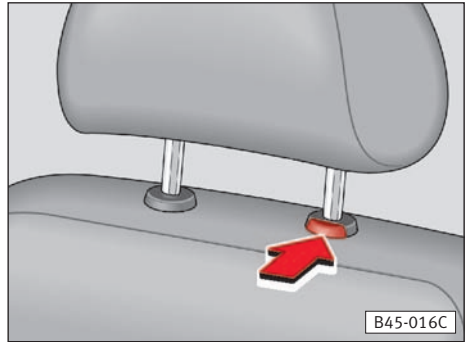
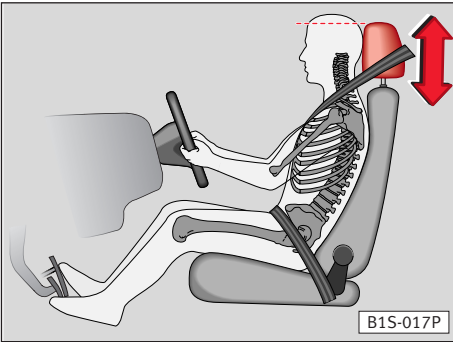

The head restraints are height adjustable and should be set to suit the size of the occupant. Correctly adjusted head restraints together with the seat belts offer effective protection. The front head restraints can also be adjusted to a different angle.

### Adjusting height

- Grip sides of head restraint with both hands and pull up or push down.
- The best protection is obtained when the upper edge of restraint is **at least** at eye level or higher.

### Removing and installing

To remove, pull restraints up to the stop, press button (arrow) and at the same time take restraints out.

To remove the rear head restraint first pull the backrest forwards a little.

To install again, push the restraint rods into the guides until they are heard to engage. You do not need to press the key.

## Armrest\*

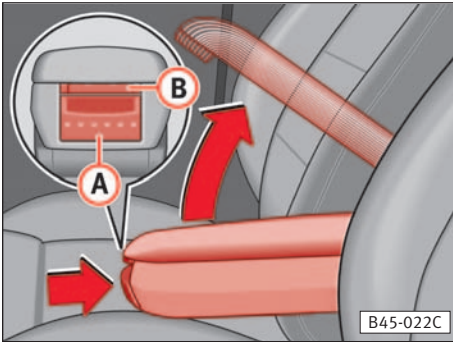

### Front armrest\*

The armrest can be adjusted to several different positions.

To adjust, press the button in the front end of the armrest **A** and fold down the rest. Then raise the rest notch by notch until the desired position has been reached.

There is a stowage compartment in the armrest. To open, press button **B**.

When the armrest is folded down, freedom of movement. For this reason, the armrest should not be folded down when driving in town traffic

## Heated seats\*

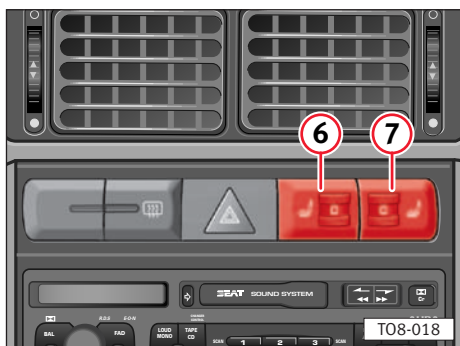

### 6 – Seat heating\* for left seat

The cushion and backrest of the front seats can be heated electrically when the ignition is on.

The heating is switched on and regulated to your comfort with the knurled wheel.

To switch heating off, turn knurled wheel to the basic position (O).

### 7 – Seat heating\* for right seat

The cushion and backrest of the front seats can be heated electrically when the ignition is on.

The heating is switched on and regulated to your comfort with the knurled wheel.

To switch heating off, turn knurled wheel to the basic position (O).

## Adjustable steering column\*

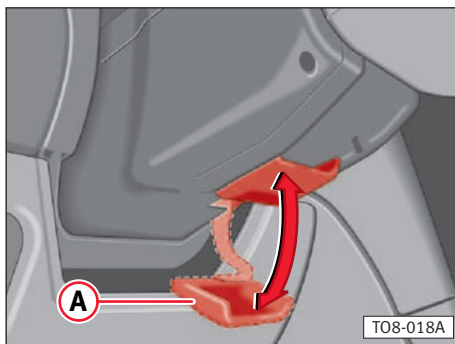

The steering column can be adjusted to suit both reach and height. Press the lever **A** beneath the steering column down and move the steering wheel to the desired position. Then press the lever firmly up again.

### Warning

- The steering column may only be adjusted whilst the vehicle is stationary.
- For safety reasons, the lever must always be firmly pressed up, so that the position of the steering column does not suddenly change while the vehicle is in motion.



## Pedals

---

**The movement of the pedals must not be restricted!**

**For this reason, do not locate any items in the footwell which could roll or slide underneath the pedals.**

Around the pedal area there should not be any foot mats or other additional floor covering materials:

- In the case of defects in the brake system, a greater pedal travel may be necessary.
- It should always be possible to depress the clutch and accelerator pedals fully.
- All pedals must be able to return, unhindered, to their rest positions.

For these reasons, the only foot mats which may be used are those which leave the pedal area completely free and which are prevented from slipping.

### Warning

**Under no circumstances should any items be kept in the footwell, as they could block the pedals in case of a sudden braking manoeuvre.**

**You would no longer be able to brake, change gear or accelerate!**

## Luggage compartment

---

In the interests of good handling ensure that the load (persons and luggage) is distributed evenly. Heavy items should always be carried as near to the rear axle as possible or better still, between the axles.

Stale air escapes through ventilation openings in the side trim\* of the luggage compartment. For this reason, it is best to keep these openings uncovered.

## Warning notes

### Warning

- The permissible payloads and GVW must not be exceeded – see chapter "Technical Data".
- It should be noted that when transporting heavy items the handling will change due to the displacement of the centre of gravity. Driving style and speed must, therefore, be altered to suit.
- The load must be stowed in such a way that no items can fly forward if the brakes are applied suddenly – use the lashing eyes\* if necessary.
- No people or children are to travel in the loading area or the boot. All passengers must wear seat belts. See "Seat belts" chapter.
- Never drive with the boot lid/tailgate open or not properly closed. Exhaust gas could then be drawn into the vehicle interior.

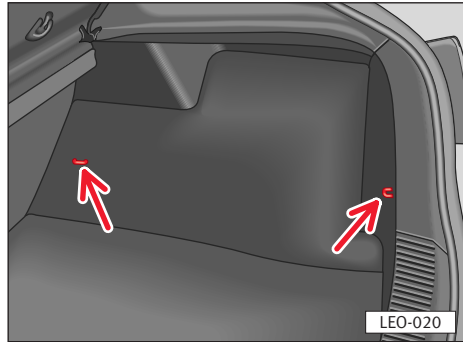

### Lashing eyes\*

On the saloon, four eyelets are provided in the luggage compartment for securing items of luggage. There are two eyelets in the front sides of the luggage compartment, one left and one right. The other two eyelets are near the loading edge (see illustration).

The lashing eyes comply with Standard DIN 75410.

## Rear shelf

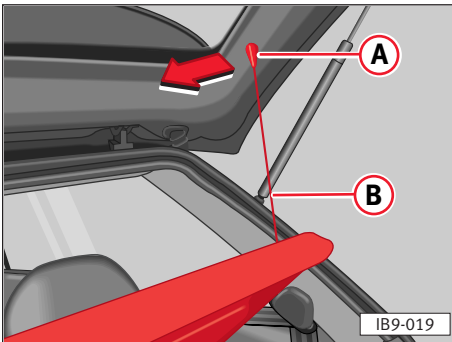

### Removing the shelf

From the rear end of the car, with the tailgate raised, unhitch the stays **B** from their housings **A**. Remove the shelf from its housing, pulling outwards.

The rear shelf can be used to place clothing but care should be taken to avoid reducing visibility through the rear window.

To ensure correct ventilation of the car interior, the slot between the shelf and the rear window must not be obstructed.

#### Warning

**No heavy or hard objects must be stored on the shelf since this could endanger the safety of the occupants of the vehicle in the case of sudden braking.**

**The storage of such heavy or hard objects on the rear shelf could result in damage to the heater elements in the rear window.**

## Rear seat

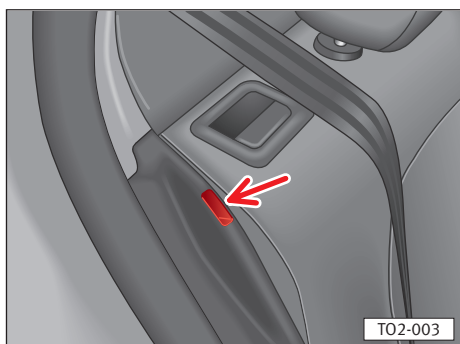

### Increasing boot space\*

You may tip the rear seats forwards to increase the boot space: if it is a split seat each half can be tipped separately.

Headrests must be removed before lowering the back seat\*. To do so you will need to push the back of the seat forward a little. See the "Headrests" chapter.

Place the safety belts through the tongues in the housing provided for this purpose.

The front seats must be placed so that the back seats do not collide with them, to avoid damage.

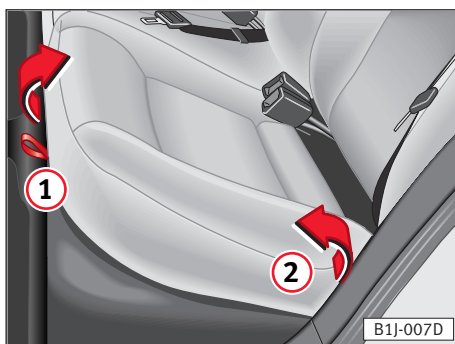

### Folding down the seat

- Pull on the tape (arrow 1) to raise the cushion a little and then pull it forwards as far as possible. Then raise the rear part of the cushion (arrow 2).

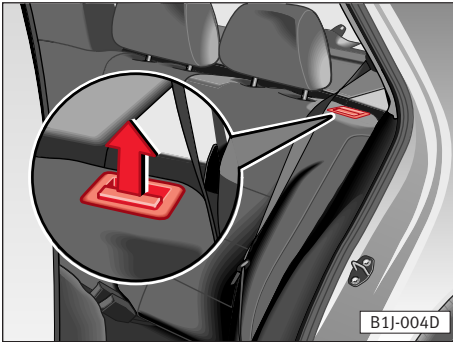

- Pull the release lever on the backrest in the direction of the arrow (or both levers at the same time if the seat is not split) and lower the backrest.

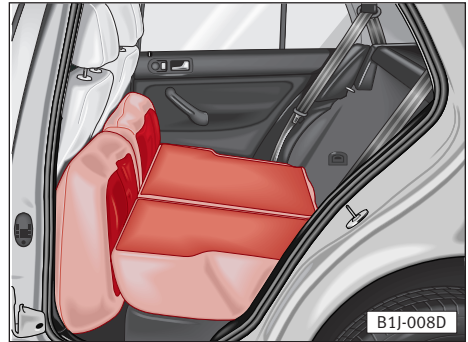

### Raising the seat

- First lift up the backrest.
- Lift the cushion and then push it backwards until it fits into place. When you do, **pull the middle seat belt out, otherwise it will be trapped between the seat and the backrest and you will not be able to use it.**

Also make sure the side belts are not trapped by the backrest.

#### Warning

The rear seat backrest must be properly engaged so that articles in the luggage area do not slide forward if the brakes are applied suddenly.

## Roof rack\*

---

When loads are to be carried on the roof, the following should be noted:

- As the rain channels are moulded into the roof for streamlining reasons, the normal type of roof rack cannot be used. To avoid risks we advise that only the cross bars provided by the factory are used.
- These cross bars are the basis for a complete roof load carrying system. For safety reasons when carrying luggage, bicycles, surf boards, skis and boats, the appropriate special adapters are required.
- The roof rack system must be installed according to the enclosed instructions. Open the plastic covers to secure the feet of the rack to the roof.

When fitting the feet to the roof make sure they fit exactly into the special grooves and properly attach to the appropriate part of the groove.

- Distribute the load evenly. Each cross bar may carry 40 kg if loaded uniformly over the full length. The permissible roof load (including the carrier system) of 75 kg and the permissible gross vehicle weight must not be exceeded. See chapter "Technical Data".

### Warning

- **When carrying heavy or large objects on the roof, bear in mind that the vehicle handling changes due to the displacement of the centre of gravity and the increased area exposed to the wind. Driving style and speed must be adapted to allow for this.**

- If your vehicle has a sliding/lifting sun roof make sure it does not collide with the load.

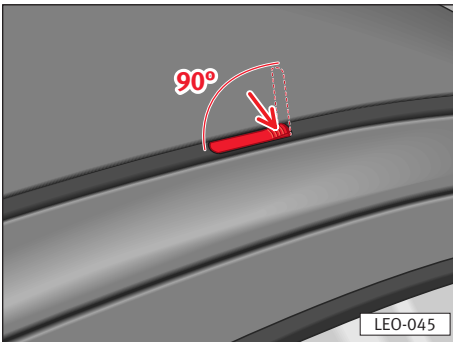

Press forcefully on the cover on the marked side in the direction of the arrow. Lift the aforementioned cover until there is a 90° angle in relation to the roof of the vehicle.

Then place the roof rack\* in the mounting for roof racks (note instructions included in the roof rack\*).

To close proceed in reverse. Ensure that the cover is well closed. It must be flush to the roof channels.

## Ashtrays

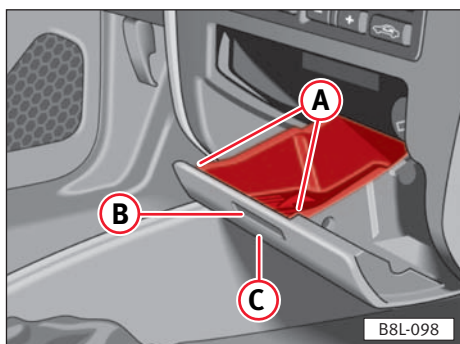

### Front ashtray

#### Opening

Push the front of the ashtray **B**. See figure.

#### Emptying

Take the ashtray by the side grooves (**A**) pulling it upwards.

#### Replacing

Push in.

#### Closing

It can only be closed by pressing on the **lower part of the ashtray (C)**.

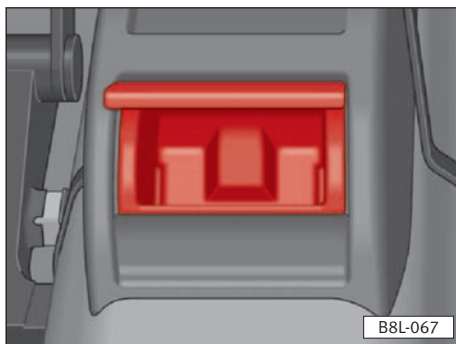

### Rear

#### Opening

Open the lid.

#### Emptying

Remove the inside by pulling it upwards, with the lid open.

#### Replacing

Push in and downwards.



## Cigarette lighter/ electric socket

The cigarette lighter is switched on by pushing in the element. When the heating element glows, the lighter springs out automatically – pull it out immediately and use it.

### Warning

Exercise caution when using the cigarette lighter. It can cause burns.

The cigarette lighter and the socket also work when the ignition is switched off and the key removed.

For this reason children should never be left in the vehicle on their own.

The **12-Volt socket** of the lighter can be used for other electrical accessories with a capacity of up to 120 Watts. When the engine is not running this will however discharge the battery. For further information see “Accessories”.

### Electric socket in the boot\*

The electric socket is located in the wheel area on the left side.

It can be used for electrical accessories with a maximum capacity of 150 W. When the engine is not running, however, it will discharge the battery. For further information see the chapter on “Accessories”.

## Stowage box

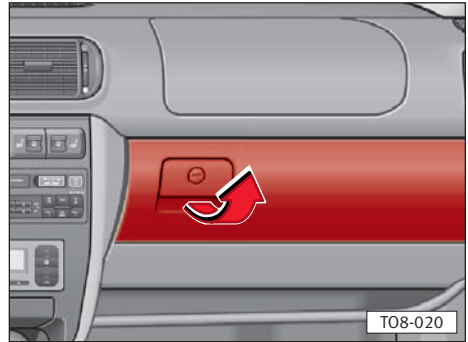

### Warning

For safety reasons the glove compartment lid should always be closed while driving.

Lift the catch in order to open the passenger side glove compartment\*.

### Stowage box with CD-Changer\*

Depending on which car radio they are equipped with, some vehicles have a CD-Changer\* for up to 6 compact disks in the stowage box.

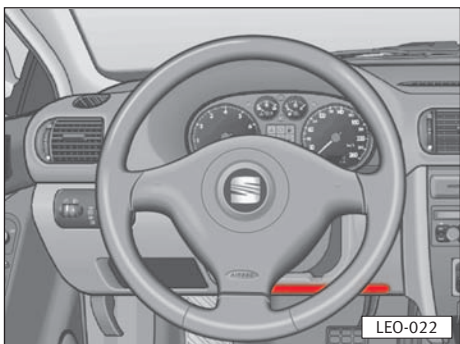

## Drink can holder\*

Located in the central console.

### Opening

Press the edge of the drink can holder and it will spring open.

### Closing

Push the drink can holder closed.

### Warning

The drink can holder should always remain closed while driving to reduce risk in the event of sudden braking or an accident.

## Vehicle wallet storage compartment

This storage box is intended for the vehicle wallet.

### Note

If the vehicle wallet does not fit in this compartment you may store it in the glove compartment on the passenger side or in any of the storage boxes on the doors.

## Heating and ventilation

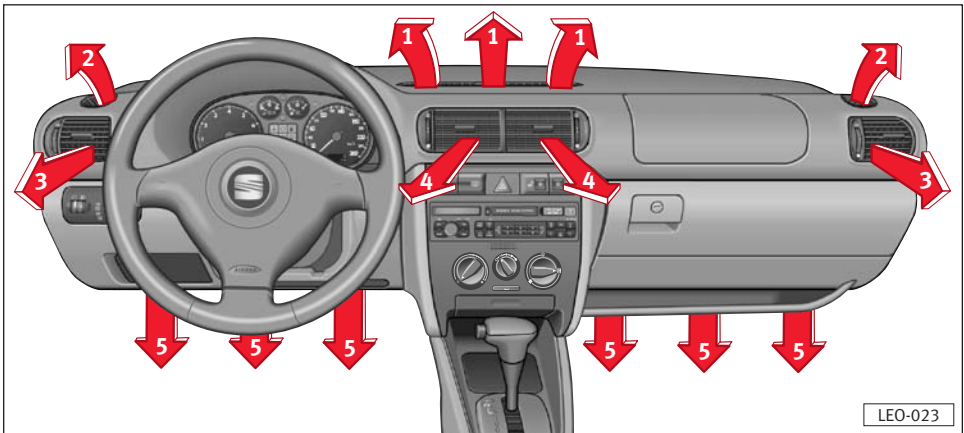

### Warning

- For road safety it is important that all windows are free of ice, snow and mist. Only then can clear vision be guaranteed.

You should therefore familiarise yourself with the correct operation of the heating and ventilation system as well as removing dampness and frost from the windows.

- The highest possible level of heating and quick defrosting of the windows can only be achieved when the engine has achieved its operating temperature.

### Vents

The illustration shows the air vents on the dashboard.

Cooled, heated or unheated air comes out of all the vents.

All vents can be adjusted by swivelling control **C** (see illustration on next page).

Vents **3** and **4** open and close separately, with knurled wheels at the side.

The air flow from the vents can be adjusted horizontally or vertically.

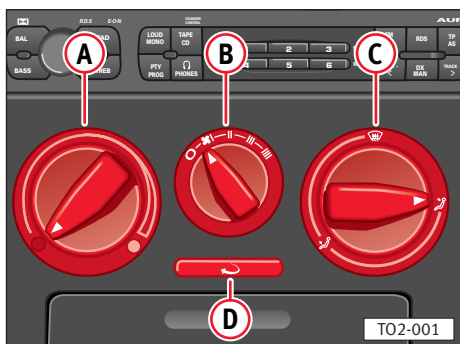

## Controls

### A – Temperature selector

The temperature can be gradually increased by turning the control clockwise.

### B – Blower

Air flow can be adjusted to four speeds. In position O the fan is switched off.

### C – Swivel knob for air distribution

#### Air flow for foot well

Vents 5 are opened.

Vents 3 and 4 must be closed for all the air to go to the feet.

#### Air flow for the windscreen

In this position you cannot connect position D for air recirculation.

Additionally, vents 3 can be used to direct hot air to the side windows.

Vents 1 and 2 are opened.

#### Air flow from the vents

Vents 1, 2 and 5 are closed. The air comes out of vents 3 and 4.

In the above positions there is always some air leaking out of the other vents.

### D – Air recirculation

In this mode, no air is drawn from outside and air is drawn in from the vehicle interior and recirculated.

The air recirculation function stops polluted air from outside entering the vehicle. **You should not drive for too long with this mode switched on.**

**If the windows steam up you should press the air circulation button again immediately to switch it off or select the position .**



## Adjustment instructions

### Defrosting windscreen and side windows

- Rotary switch **B** to stage III.
- Rotary regulator **A** turned fully to right.
- Rotary regulator **C** to ..... 
- Adjust vents **3** so that additional warm air can be directed to the side windows.

### Demisting windscreen and side windows

When the windows mist up due to high air humidity, e.g. when it is raining, we recommend the following settings:

- Rotary switch **B** to stage II or III.
- Rotary regulator **A**, if necessary, into heating range.
- Rotary regulator **C** as required, between  and .
- Additional warm air can be directed to the side windows via vents **3**.

### Heating interior quickly

- Rotary switch **B** to level III.
- Rotary regulator **C** to ..... 
- Turn control **A** as far clockwise as possible.
- Open vents **3**.

### Heating interior comfortably

When the windows are clear and the desired temperature has been reached we recommend the following settings:

- Rotary switch **B** to level II or III.
- Rotary regulator **A** at the desired heat output.
- Rotary regulator **C** to ..... 
- Set vents **3**.

### Ventilation (fresh air operation)

With the following settings, unheated fresh air flows from vents **3** and **4**:

- Rotary switch **B** to desired stage (level IIII for maximum air flow).
- Rotary regulator **A** anti-clockwise to the stop
- Rotary regulator **C** to ..... 
- Vents **3** and **4** open.

If required, regulator **C** can be turned to another position.

## Air conditioning\*

### General notes

- To ensure that the heating and ventilation can work properly, the air inlet in front of the windscreen should be kept free from ice, snow and leaves.
- To prevent the windows from steaming up the fan should always be left on low when you are driving slowly.

- Press button **D** to stop polluted air from outside getting into the vehicle. **Do not drive too fast in this position to stop the windows from steaming up.**

The air and pollen\* filter removes impurities from the air (e.g. pollen, dust, etc.). Only put the rotary switch to **Q** when the air outside is polluted by gases.

- The pollen and dust filter elements should be changed in accordance with the Inspection and Maintenance Plan, to avoid a reduction in heat and de-icing capacity.

### Warning

- For road safety it is important that all windows are free of ice, snow and mist. Only then can clear vision be guaranteed.

You should therefore familiarise yourself with the correct operation of the heating and ventilation system as well as removing dampness and frost from the windows.

- The highest possible level of heating and quick defrosting of the windows can only be achieved when the engine has achieved its operating temperature.

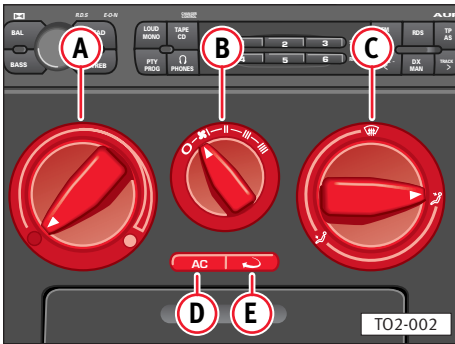

The air conditioner is a combined cooling and heating system which provides the maximum possible comfort all the year round.

The cooling system only works when the engine is running, the ambient temperature is above about +5°C and the ventilator is set to positions I to III.

When the cooling system is switched on it reduces not only the temperature inside the vehicle but also the air humidity making the vehicle occupants feel more comfortable, when there is a high level of humidity.

## Control elements

### A – Temperature selector

**To the right** – increases heat output

**To the left** – decreases heat output

If the air conditioning is connected the cooling capacity is increased if you turn the regulator to the right.

### B – Blower

Air throughput can be adjusted in four stages.

In position 0 the blower is switched off, but air is let in from the outside. If you want to stop polluted (smelly) air coming in from outside press switch E (air circulation).

#### Warning

**As this may make the windows steam up you should not drive for too long in this position.**

### C – Air distribution

#### Air flow for footwell

Vents 5 are opened.

All vents 3 and 4 must be opened to direct all the air flow to the feet.

#### Air flow for the windscreen area

Vents 3 can be used to direct air to the side windows.

Vents 1 and 2 are opened.

#### Air flow of the vents

Vents 1, 2 and 5 are closed. The air comes out of vents 3 and 4.

In the positions mentioned above there is always a leak of air to the remaining vents.

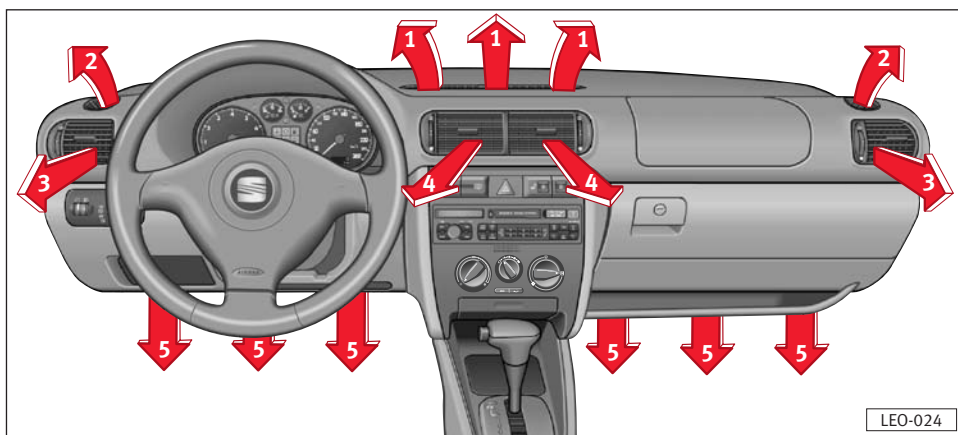

### D – Air conditioner on/off

The system can be switched on by pressing button **D**.

The system is switched off by pressing the button again.

### E – Air recirculation

Air recirculation is connected by pressing button **E**. It is disconnected by pressing the same button again.

Air recirculation may work with or without the air conditioning.

#### Warning

**However, you should only drive in this mode for a short time, as no air is drawn from outside, and the windows may steam up.**

Button **E** may not be used if the rotary regulator **C** is near the position .

### Air vents

Depending on the position of rotary regulators **A**, **B**, **C** and buttons **D** and **E**, heated or unheated fresh air or cooled air flows from all vents.

The vents are controlled by the rotary regulator **C**.

Vents **3** and **4** can be opened or closed separately:

Knurled wheel turned up – vent open.



Knurled wheel turned down – vent closed.

The height of the air flow can be modified by moving the grille of vents **3** and **4**.

The rear footwell vents are supplied together with vents **5**.



### Defrosting windscreen and side windows

- Rotary regulator **B** to level **III**.
- Rotary regulator **C** to ..... 
- Rotary regulator **A** completely to the right
- Close vents **4**.
- Open vents **3**.
- Turn control **B** to level **II** or **III**.
- If necessary, turn control **A** upwards slightly into the heat area.
- If needed, turn rotary regulator **C** to between  and .
- You can also use vents **3** to direct hot air onto the side windows.

### Quick heating of the interior

- Put rotary regulator **B** to position **III**.
- Put rotary regulator **C** to ..... 
- Turn switch **A** clockwise as far as possible.
- Open vents **3**.

### Heating interior comfortably

When the windows are clear and the desired temperature has been reached we recommend the following settings:

- Rotary regulator **B** to level **II** or **III**.
- Turn switch **A** to the required level of heat.
- Put switch **C** to ..... 
- Adjust vents **3** as required.

### Ventilation (fresh air)

With the following settings, unheated fresh air flows from vents **3** and **4**:

- Rotary switch **B** to the required level (level **III** for maximum air flow).
- Regulator **A** as far to the right as possible.
- Rotary switch **C** to ..... 
- Open vents **3** and **4**.

If necessary switch **C** can also be set to other positions.

### Maximum cooling

- Close all windows and sliding/raising roof.
- Switch **B** to speed **IIII**.
- Switch **A** to the left.
- Rotary regulator **C** to ..... 
- Open vents **3** and **4**.
- Connect the air conditioning by pressing switch **D**.
- Press switch **E** to connect air recirculation.

#### Warning

**This running mode draws and uses the air from inside the interior. This mode should only be connected for a short time, as no fresh air is taken from outside.**

**You should not smoke in the car when the air recirculation mode is in operation.**

### Ideal cooling

- Rotary switch **B** to speed **II** or **III** (ideal cooling levels).
- Rotary switch **A** as far to the left as possible. The temperature can then be changed at will by moving the switch to the right.
- Rotary switch **C** to ..... 
- Open vents **3** and **4**.
- Press button **D**.
- Adjust vents **3** and **4** so that the air is blown backwards over the driver's head.

In this mode air is taken from outside and cooled.

## General notes

- When the outside temperature is low the fan will not switch on until the cooling liquid has reached the right temperature, unless the fan is manually switched on .

- The air inlet in front of the windscreen should be kept free from ice, snow and dead leaves to avoid hindrance to the heating or air conditioning systems.

- In automatic gear box versions, the kick-down mechanism briefly switches off the air conditioning compressor when moving down a gear, so the engine can keep up full capacity.

- If the cooling liquid gets too hot the compressor switches off when the engine is subjected to great effort, to guarantee perfect engine cooling.

- At low outside temperatures (less than +5°C) the refrigeration group (compressor) is automatically switched off, and may not even be switched on manually (with **D** key).

- When the compressor is on the inside temperature and humidity of the car is reduced. This stops the windows from steaming up.

- Best results are obtained from the air conditioning if the windows and sun roof\* remain closed.

However if the inside of the car is overheated, e.g. because it has been in the sun, the cooling process can be speeded up by briefly opening the windows.

- When it is very hot or humid, water may condense on the evaporator and drip down to form a puddle under the car. This is perfectly normal and does not mean there is a leak.

- The dust and pollen filter separates impurities from the air (e.g. dust, pollen etc.). If the air is polluted by gases the air recirculation mode should be connected.

- The dust and pollen filter elements\* should be changed in accordance with the Maintenance and Inspection Plan, to prevent a loss in the air conditioning capacity.

- **If you think the air conditioning may be damaged, switch it off and have it checked immediately at a Technical Service Centre.**

**Only then should you switch it on again.**

- **All repairs of SEAT air conditioning modules require specialised information and tools.**

**So make sure you get in touch with your local Technical Service Centre if anything goes wrong.**

### Using air conditioner economically

- In cooling operation the air conditioner compressor places demands on the engine and therefore influences the fuel consumption.
- If the inside temperature is very high after the car has been parked in the sun, we recommend that you open doors or windows briefly to enable the hot air to escape.
- The air conditioner should not be switched on during a journey if the windows or sliding/tilting roof are open.
- If the desired interior temperature can be attained without switching on the air conditioner, the fresh air operation should be selected.

## Climatronic\*

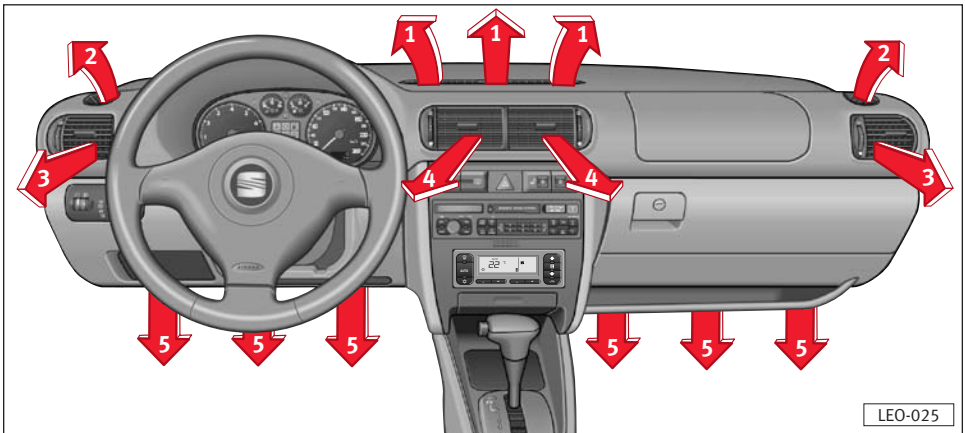

LEO-025

### Warning

- For road safety it is important that all windows are free of ice, snow and mist. Only then can clear vision be guaranteed.

You should therefore familiarise yourself with the correct operation of the heating and ventilation system as well as removing dampness and frost from the windows.

- The highest possible level of heating and quick defrosting of the windows can only be achieved when the engine has achieved its operating temperature.

### Vents

The vents are adjusted automatically or manually, depending on the operating system chosen.

The diagram shows the vents around the instrument panel.

Normal, hot and cold air comes out of the vents.

Vents **3** and **4** may be opened or closed independently by means of the knurled wheels on either side.

They can be directed horizontally or vertically.



The Climatronic\* system automatically provides a uniform temperature inside the vehicle.

To do so it automatically adjusts the temperature of the air released, the fan revolutions (air flow) and the air distribution. This automatic adjustment may be modified manually if necessary.

The illustration shows the controls on the instrument panel. To the left of the screen you can see the temperature and the automatic functions selected, and to the right the manual ones.

### Normal recommended adjustment for all seasons of the year:

After switching the ignition on.

- select the temperature of 22 °C (71 °F) and
- press the AUTO key

With this adjustment you will very quickly achieve a pleasant environment inside the car.

This setting should only be adjusted for your own personal comfort.

## Controls

### Automatic (normal mode)

The temperature, volume and air distribution are automatically adjusted to provide and maintain the required temperature in a short time. Any variation in outside temperature is quickly compensated.

### De-frosting

The windscreen is quickly de-frosted or freed from moisture.

The temperature is automatically regulated. The maximum air flow comes from vents 1 and 2.

### Cooling system on/off

You can switch the cooling system (compressor) off to save fuel. However this may reduce comfort. If the heat inside the car becomes too high, just switch the compressor on again or press AUTO.

### – + Temperature selection

The temperature can be adjusted between 18°C (64°F) and 29°C (84°F). In the extreme positions of “LO” and “HI” there is no temperature adjustment. The device constantly provides maximum heat or cool.

#### The temperature display may be changed from °C to °F as follows:

Press  key and keep it pressed. Then press key + on the temperature selection.

### – + Fan revolutions

This key can be used to increase or lower the automatic number of revolutions (air volume) of the fan. When you press it “man” appears on the right of the display. The revolution speed is shown in segments or bars next to the symbol .

If you press the key when the fan is at its lowest level the system switches itself off.

To **switch on** the air conditioning again you must press the **AUTO** button,  one of the temperature selection buttons or the fan button with the positive symbol.

You do not normally need to disconnect the device from the fan.

### – Air circulation



In this mode no air is drawn from outside, and the inside air is circulated around the car. This stops polluted air from coming in from the outside. Do not have it on this mode for too long.

If the windows steam up disconnect the air circulation mode by pressing the air circulation button again or by selecting a position .

#### Note

If the air conditioner compressor temporarily switches itself off, e.g. because of over exertion of the engine, press the air circulation button again.

#### Air distribution keys

The programmed air distribution may be altered by using buttons ,  and . These buttons may be used in combination or alone. When you press one of these buttons “man” appears on the display.

#### – Air for the windows

If you press this button all the air comes out of vents **1**, **2** and **3**. Unlike the  mode the air volume does not change.

#### – Air from the dashboard and rear central console

All the air from vents **3** and **4** comes out of the dashboard and the rear central console.

#### – Air for the footwell

All the air flow is directed to vents **5** and the vents under the front seats.

If you want to connect automatic air distribution again, you will have to switch off the corresponding functions one by one or press the **AUTO** button, or .

## General notes

- When the outside temperature is low the fan will not switch itself on until the coolant has reached the right temperature, unless the fan is manually switched on .

- The air inlet in front of the windscreen should be kept free of ice, snow and dead leaves to avoid hindrance to the heating or cooling systems.

- In automatic gear box versions, the kick-down mechanism briefly switches off the air conditioning compressor when moving down a gear, so the engine can keep up full capacity.

- If the coolant overheats the compressor switches itself off when the engine is under a great effort, to guarantee perfect engine cooling.

- At low outside temperatures (below +5 °C) the refrigeration group (compressor) is automatically switched off, and cannot be switched on manually .

- With the compressor on both the inside temperature and humidity of the car are reduced. This stops the windows from steaming up.

- Best results are obtained from the Climatronic with the windows and sun roof\* closed.

However if the inside of the car is overheated, e.g. because it has been in the sun, the cooling process can be speeded up by briefly opening the windows.

- When it is very hot or humid outside, water may condense on the evaporator and drip down to form a puddle under the car. This is perfectly normal and does not mean there is a leak.

- The dust and pollen filter separates impurities from the air (e.g. dust, pollen etc.). If the air is polluted by gases the air recirculation mode should be connected.

- The dust and pollen filter elements should be changed in accordance with the Maintenance and Inspection Plan, to prevent a loss in the air conditioning capacity.

- **If you think the Climatronic system may be damaged, switch it off and have it checked immediately at a Technical Service Centre.**

**Only then should you switch it on again.**

- **All repairs of SEAT Climatronic modules require specialised information and tools.**

**So make sure you get in touch with your local Technical Service Centre if anything goes wrong.**



---

## Operating faults

- If the cooling system does not work, it may be due to one of the following:

- temperature is below +5 °C.
- the cooling system compressor has switched itself off temporarily due to the coolant temperature being too high.
- the fuses have blown.

Check the fuse and, if necessary, replace it. If the fuse was not the cause, have the Climatronic checked.

- If the cooling output drops, have the system checked.

## Manual gearbox

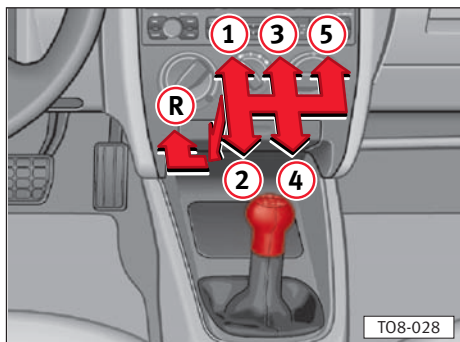

Reverse gear may only be engaged when the vehicle is stationary. When engine is running, depress clutch fully and wait a few seconds before moving gear lever, to prevent grating noises.

When reverse gear is engaged with ignition on, the reversing lights come on.

Some model versions may have 6 gears\*. Its layout is indicated on the selector lever.

### Note

**For safety reasons, do not rest your hand on the gear lever while driving.**

## Automatic gearbox\*

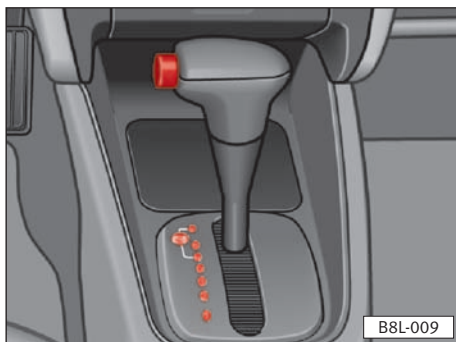

### Driving programmes software

The gearbox management is fitted with several driving programmes. According to the driving style or to the momentary situation, an **economy**, low-consumption, or a more “**sporty**” programme will be selected.

The programme is selected **automatically** depending on the movement of the accelerator pedal.

If the accelerator pedal is moved slowly, or at a normal rate, the gearbox will shift into a higher gear earlier, and down into a lower gear later to **reduce fuel consumption**.

A more “**sporty**” programme is selected when the accelerator pedal moves **fast**. The pedal does not have to be depressed to the point of **kick-down** (see page 2.93). In this mode, the gearbox will shift up later to make full use of the engine power reserves.

The downward shift occurs at a higher rate of revolutions than in the economy programmes.

The gear box is self adapting, and continuously selects the most suitable gear programme. At the same time, the driver can also make the gear box switch to a more “sporty” programme by pressing the accelerator quickly. Depending on road speed, this makes the gearbox shift down early into a lower gear for quicker acceleration (for instance to overtake another vehicle), without having to press the accelerator all the way down to the kick-down position. After the gear box has shifted back up it returns to the original programme, depending on your style of driving.

The gear box adapts the gear shifts for uphill and downhill gradients. This prevents the gearbox from shifting up and down unnecessarily on uphill gradients. On downhill gradients, the gearbox shifts down into a lower gear when the driver presses the brake pedal. This makes use of the braking effect of the engine without having to change down manually.

### Note

Depending on road resistance, for example when trailer towing or on uphill stretches, a programme is automatically selected which provides more power by shifting into a lower gear. This prevents frequent gear changes.

### Selector lever lock

In positions “P” and “N” with the ignition switched on the selector lever is locked. To move the selector lever out of these positions the brake pedal must be depressed and the selector lever button pushed in. This prevents a gear from being engaged inadvertently and the vehicle from unintentionally moving off.

A delay circuit prevents the selector lever from locking when it is moved quickly past the “N” position (for instance from “R” to “D”). This enables for example the vehicle to be “rocked” out of a “bogged down” position. The shift lock only locks the selector lever if it is left in the “N” position for more than about 1 second without the brake pedal being depressed.

At speeds above 5 km/h the selector lever lock is automatically switched-off in position “N”.

### Safety interlock for ignition key.

The key can only be withdrawn with the ignition switched off and the selector lever in position “P” (parking lock).

**When the ignition key is removed, the selector lever is locked in position P.**



### Selector lever positions

In the combi-instrument there is a display that shows the selector lever position currently selected.

#### Warning

**Never shift selector lever to position “R” or “P” whilst the vehicle is in motion. The gears could be damaged – risk of accident!**

### P – Parking lock

The driving wheels are locked mechanically.

The parking lock may only be engaged when the vehicle is stationary. Before moving the lever in or out of the “P” position the lock button in the selector lever handle must be pressed. Before moving the selector lever out of the “P” position with the ignition switched on, the brake pedal must also be depressed.

### R – Reverse gear

The reverse gear should only be engaged when the vehicle is stationary and with the engine idling. Before engaging the position “R” from the positions “P” or “N” the brake pedal must be depressed and the lock button in the selector lever handle must also be pressed.

The reversing lights come on when the selector lever is in the “R” position with the ignition switched on.

### N – Neutral (idling position)

To move the lever out of neutral when stationary or at speeds below 5 km/h and with ignition switched on depress the brake pedal and press the lock button in the selector lever handle.

### D – Normal driving position

The four forward gears are shifted up and down automatically depending upon engine load and road speed.

Under certain driving conditions it is advantageous to engage one of the following described selector lever positions.

### 3 – Position for “hilly” regions

The **1st**, **2nd** and **3rd** gears are shifted up and down automatically depending upon engine load, road speed and selected programme (**E** or **S**). The **4th** gear is not engaged. This increases the engine braking effect when the accelerator pedal is released.

This selector position is recommended in situations where the gearbox alternates frequently between **3rd** and **4th** gears in the “D” position.

## 2 – Position for steep hills

This selector lever position is suitable for long climbs and descents.

The **1st** and **2nd** gears are shifted up and down automatically depending upon engine load and speed. The **3rd** and **4th** gears are not engaged.

## 1 – Position for very steep hills or manoeuvres

This selector lever position is recommended for very steep descents.

To engage this gear, the lock button in the selector lever handle must be pressed in. The vehicle only moves in **1st** gear. The **2nd**, **3rd** and **4th** gears are not engaged. The cruise control\* cannot be used in position “**1**”.

### Note

When changing down manually the selector lever can be moved into gears **3**, **2**, and **1**, but the gearbox will not change down until it is no longer possible to over-rev the engine.

## Kick-down device

The kick-down device gives maximum acceleration. When the accelerator pedal is pressed right down past the full throttle position, depending on road speed and engine speed, the box changes down into a lower gear. The shift into the next higher gear then takes place as soon as the maximum specified engine speed is reached.

### Warning

**Please note that the driving wheels could go into a spin if the kick-down device is applied on roads with black ice.**

**Risk of skidding!**

## Notes on driving

### Starting

The engine can only be started when selector lever is at “**N**” or “**P**”. See also “Starting engine”.

### Selecting a driving range

**When the vehicle is stationary and the engine is running always depress the foot brake when selecting a gear.**

**When the vehicle is stationary do not depress the accelerator when selecting a gear.**

**If the lever is moved accidentally into “N” when driving, release accelerator and let the engine speed drop to idling before selecting a forward gear again.**

### Warning

**When the engine is running it is necessary to hold the vehicle with the foot brake in all gears. Because with an automatic gearbox the transfer of power is not fully interrupted even at idling speed – and the vehicle tends to “creep”.**

When the vehicle is stationary and a gear is engaged, the throttle must not be opened inadvertently on any account (for instance by hand from the engine compartment). Otherwise the vehicle will move immediately – even if the hand brake has been fully applied. Before working on the vehicle with the engine running, apply the handbrake and put the selector lever in “P”.

### Moving off

Select driving range (R, D, 3, 2, 1). **Wait until the gearbox has shifted and the power flow is made to the driving wheels** (light selection jerk perceptible). **Then one can accelerate.**

### Stopping

When the vehicle is stopped for a short period, for example at traffic lights, it is only necessary to apply the brakes. It is not necessary to move selector lever to “N”. The engine should however only be running at idling speed.

### Parking

#### Warning

To prevent the vehicle from rolling away inadvertently, you should always apply the handbrake firmly when the vehicle has come to the complete stop. Also place the gear selector lever in position “P”.

On a gradient the handbrake should be applied firmly first and then the parking lock engaged. This will ensure that the locking mechanism is not too heavily loaded and makes the lock easier to disengage.

### Tow starting

Vehicles with an automatic gearbox cannot be started by towing or pushing the vehicle. See "Tow start/towing" chapter.

When the battery is flat, the engine can be started from the battery of another vehicle by using jumper cables. See "Emergency starting".

### Towing

If a vehicle must be towed instructions in the "Tow start/towing" chapter must be followed strictly.

---

### Emergency program

In case of an electronic failure of the gear-box, emergency programs are activated depending on the type of failure.

- The gear box continues to shift automatically, but strong jerking is noticeable. Consult a Technical Service Centre.
- The gear box no longer shifts automatically.

In this case, you can shift manually. Only the **3rd** gear is available in the positions "**D**", "**3**" and "**2**" of the selector lever.

In the positions "**1**" and "**R**" of the selector lever, the **1st** gear and reverse gear, respectively, are available as customary.

It may happen that the gear oil is overheated when the torque converter has to work harder, especially if **2nd** gear is missing.

In such cases, go to a Technical Service Centre as soon as possible.

## Handbrake

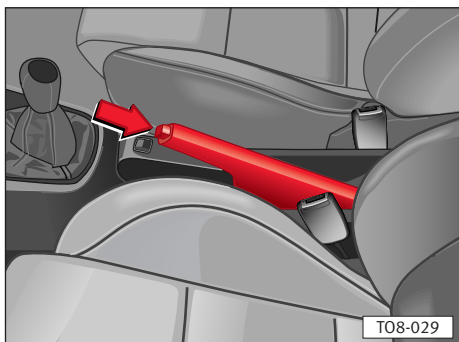

To apply the handbrake pull lever up firmly. On hills the 1st gear or with automatic gearbox the parking lock should also be engaged. The handbrake should always be applied so firmly that it is not possible to drive inadvertently with the handbrake on.

When handbrake is applied with the ignition on, the brake warning lamp comes on.

To release handbrake, pull lever up slightly, press locking knob (arrow) in and push lever right down.

### Warning

- To prevent the vehicle from rolling away inadvertently, you should always apply the handbrake firmly after the vehicle has come to a complete stop.

You should also put the car into gear (manual gearbox) or the gear selector lever in position “P” (automatic gearbox).

- Please note that the handbrake must be released completely after application. If the handbrake is only partly released it could lead to overheating of the brakes and thus negatively affect the function of the brake system. This could also lead to premature rear brake lining wear.



## Ignition lock

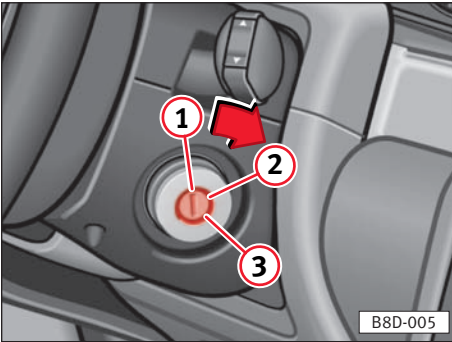

### Electronic engine block

When switching ignition on vehicle and key automatically compare data. This is displayed by a pilot light in the dashboard. See “Warning lamps” chapter.

If the wrong (i.e. false) key is used, the car will not start and the immobiliser pilot light will come on.

### Petrol engines

- 1 – Ignition and engine switched off:  
Steering can be locked.
- 2 – Ignition on
- 3 – Starting engine

### Diesel engines

- 1 – Fuel supply cut off and engine switched off:  
Steering can be locked.
- 2 – Glow plugs / normal running position

To avoid unnecessary strain on the battery, do not use any other major electrical equipment while the glow plugs are pre-heating.

- 3 – Starting engine

### For all vehicles:

#### Position 1:

To lock the steering wheel withdraw the key and turn the wheel until you hear the pin engage.

In vehicles with automatic gearbox the key can only be turned to position 1 and withdrawn when the selector lever is in the “P” position.

#### Warning

**On vehicles with manual gearbox, never remove the key from the steering lock while the vehicle is moving. Otherwise the steering wheel may lock unexpectedly.**

#### Position 2:

If the key is difficult to turn in the lock, move the steering wheel until the key turns freely.

#### Position 3:

Before the starter can be operated a second time the key must be turned back to position 1. This prevents the starter motor from engaging while the engine is running, as this could damage the starter.

### Ignition key lock\*

On vehicles with an automatic gearbox\* after switching off the ignition the ignition key can only be withdrawn if the selector lever is in the “P” position.

When the ignition key has been withdrawn the selector lever is locked in this position.

## Starting the engine

### General notes

#### Warning

When running the engine in confined spaces there is a danger of poisoning.

- Before starting, move gear lever to neutral (with automatic gearbox, selector lever in "P" or "N" position) and apply handbrake firmly.
- On vehicles with a manual gearbox depress the clutch pedal when operating starter so that starter only has to turn engine.
- As soon as engine starts, release the ignition key so that starter can disengage.
- After starting a cold engine it may sound noisy for a moment or two because the oil pressure has to build up in the hydraulic tappets first. This is normal and no cause for alarm.

 ***Do not warm the engine up by running it when the vehicle is stationary. Begin driving the vehicle as soon as possible.***

- Do not over-rev or use full throttle until the engine has reached the normal operating temperature.
- On vehicles with a catalytic converter the engine must not be started by towing the vehicle in excess of 50 m. Otherwise unburned fuel can pass into the converter and lead to damage.
- Before tow starting an engine, an attempt should be made at using the battery of another vehicle as starting help. See "Starting help" chapter.

### Petrol engines

These engines are equipped with a petrol injection system that automatically supplies the correct fuel/air mixture at all ambient temperatures.

When engine **is cold or at operating temperature** do **not** accelerate before or during the starting procedure.

If the engine does not start at once, stop using the starter after 10 seconds. Wait about half a minute and then try again.

If the engine does still not start, this may be due to a blow out of the electric fuel pump fuse. See "Fuses" chapter.

When the engine **is very hot** it may be necessary to accelerate slightly after the engine has started.

---

## Diesel engines

### Glow plug system

After switching to the driving position (ignition on) the required glow plug warm-up time is indicated by a lamp which is controlled by the coolant temperature. See "Warning lamps" chapter.

### Starting a cold engine

Ambient temperature above +5 °C:

The engine can be started without pre-glow. Do not depress throttle during the starting procedure.

Ambient temperature below +5 °C:

- Turn the key in the ignition lock to position **2** the glow plug warning lamp comes on. It goes out when the ignition temperature is reached.

**While the glow plugs are working do not switch on any heavy current consumers because this would place an unnecessary load on the battery.**

If the engine does still not start, this may be due to a blow out of the preheating fuse. See "Fuses" chapter.

- When the warning lamp goes out, start the engine immediately.

Do not depress the accelerator while starting.

If the engine only fires irregularly, continue to operate the starter a few seconds longer (30 seconds at maximum) until the engine runs under its own power.

If the engine does not start, switch the glow plugs on again and try starting it again as described.

### Starting a warm engine

The glow plug lamp does not come on – the engine can be started straight away.

### Starting after running out of fuel

If the tank on vehicles with a diesel engine was empty, starting after filling with diesel fuel can take longer than normal – up to one minute. This is because the fuel system must first be freed of air before starting.

## Stopping the engine

---

- Valid for all engines:

When the engine has been subjected to a heavy engine load for a long time, the engine must not be switched off abruptly. Let it idle for about 2 minutes to avoid overheating.

### Warning

After the engine has been stopped the fan can continue running for a while (up to about 10 minutes) with the ignition switched off. It can also start to run again suddenly after a short time if

- the coolant temperature increases due to heat build-up
- when the engine is hot and the engine compartment is heated additionally by strong sunlight.

Special care must therefore be taken when working in the engine compartment.

- Valid for all versions with catalytic converter\*:

Do not switch off the ignition while the vehicle is in motion with a gear engaged; otherwise unburned fuel may go into the converter, where it would burn and cause overheating, which would damage the converter.

## Cruise control system\*

To relieve the foot on the accelerator pedal this system can hold any speed above around 30 km/h constant, so far as this is permitted by engine output.

### Warning

The cruise control system should not be used in dense traffic and poor road conditions (slippery surfaces, aquaplaning, gravel).

When the system is switched on do not move into neutral without depressing the clutch pedal, otherwise the engine will race and can, under certain circumstances, become damaged.

### Note

On vehicles with an automatic gearbox, the Cruise Control System is only active when the gear selector is in position **D**, **3** or **2**. If any other position (**P**, **N**, **R** or **1**) is selected while driving, the last speed to be stored is deleted and the system is switched off.

### Switching on

The system is **operated** with the sliding switch **A** and the press button **B** on the turn signal/main beam lever.

The system is **switched on** by moving switch **A** to **ON**.

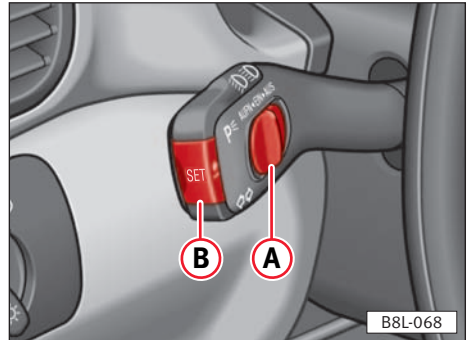

### Storing speed

When the speed to be maintained has been reached the press button **B** (SET) must be pressed briefly. The foot can then be taken off the accelerator pedal.

The speed can also be increased in the normal way with the accelerator pedal. When the pedal is then released the previously programmed speed is resumed.

This however, is not the case when the stored speed is exceeded by more than 10 km/h for a period of more than 5 minutes. The speed must then be stored again.

### Warning

The programmed speed must only be resumed when it is not too high for the existing traffic conditions!

## Altering stored speed

### Reducing/setting

The stored speed can be reduced by pressing button **B**.

By pressing button **B** briefly, the stored speed is reduced by a preset amount. If you press and hold the button, the speed will decrease through automatic deceleration. The speed reached when releasing the button will be stored.

If the button is released at a speed of less than approx. 30 km/h, the memory is deleted. The speed must then, if necessary, be reset using button **B** after the vehicle has accelerated to a speed higher than approx. 30 km/h.

### Accelerating/storing

The stored speed can be **increased** without depressing the accelerator by moving the slide control **A** to **RES**.

By briefly pressing the slide control, the speed is increased by a preset amount. If the switch is moved to the left and held, the speed is increased through automatic acceleration. The speed reached when the switch is released is then saved.

## Switching system off temporarily

### Vehicles with manual gearbox:

The system is **temporarily switched off** when the brake or clutch pedals are used or when the switch **A** is moved to **OFF** (not engaged).

The speed stored at this time will remain in the memory.

To **resume** the previously stored speed push switch **A** fully to the left after the brake or clutch pedals are released.

### Warning

**The programmed speed must only be resumed when it is not too high for existing traffic conditions.**

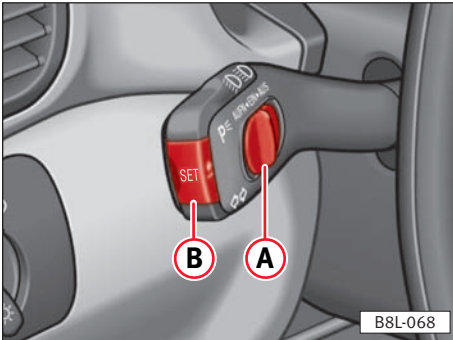

#### Vehicles with automatic gear box:

The system is **temporarily switched off** when the brake or clutch pedals are used or when the switch **A** is moved to OFF (not engaged).

The speed stored at this time will **remain** in the memory.

To **resume** the previously stored speed push switch **A** fully to the left after the brake or clutch pedals are released.

#### Warning

**The programmed speed must only be resumed if it complies with the speed regulations of that moment.**

Furthermore, the system will be **switched off temporarily** if the selector lever is moved to positions **N** or **1**.

The speed stored in the memory at this time **will be deleted**.

#### Storing speed

If no speed was saved before the system was temporarily switched off or if the stored speed was deleted, a new speed can be stored in the following manner:

- Move switch **A** fully to the left and hold until the desired speed has been reached. The speed is stored when the switch is released.

or

- Press button **B** briefly. The current speed is stored

#### Switching the system off completely

#### Vehicles with a manual gear box:

The system is **completely switched off** when switch **A** is moved entirely to the right (OFF engaged) or when the vehicle is stopped and the ignition is switched off.

#### Vehicles with automatic gear box:

The system is **completely switched off** by selecting one of the following positions by moving the selector lever:

- to positions **P**, **N**, **R** or **1**.

or

by switching the ignition off when the vehicle is stationary.





# INDEX

## FILLING THE TANK

Filling the tank . . . . .	3.2
Petrol . . . . .	3.4
Diesel . . . . .	3.5

## INTELLIGENT TECHNOLOGY

Brakes . . . . .	3.7
Four-wheel drive* . . . . .	3.10
Wheelspin control (TCS)* . . . . .	3.11
Electronic Stability Program (ESP)* . . . . .	3.13
Power steering* . . . . .	3.14

## YOUR VEHICLE AND THE ENVIRONMENT

The first 1,500 km – and afterwards . . . . .	3.15
Cleaning the exhaust fumes . . . . .	3.16
Environment-friendly and economical driving . . . . .	3.17
Trailer towing . . . . .	3.21
Driving abroad . . . . .	3.24
Headlight covering . . . . .	3.25

## CARE AND MAINTENANCE

Care of the vehicle . . . . .	3.28
-------------------------------	------

## CHECKING AND REFILLING

Engine bonnet . . . . .	3.35
Engine compartment . . . . .	3.36
Engine oil . . . . .	3.38
Cooling system . . . . .	3.42
Radiator fan . . . . .	3.44
Brake fluid . . . . .	3.45
Battery . . . . .	3.46
Windscreen washer . . . . .	3.51

## SERVICING AND REPLACING

Accessories, modifications and replacement of parts . . . . .	3.52
Spark plugs . . . . .	3.53
Dust and pollen filter* . . . . .	3.54

## IF AND WHEN

First aid kit, warning triangle . . . . .	3.56
On board tools, spare wheel . . . . .	3.57
Wheels . . . . .	3.60
Changing wheels . . . . .	3.66
Fuses . . . . .	3.73
Changing bulbs . . . . .	3.76
Installing a radio . . . . .	3.85
Mobile telephones and radio telephones . . . . .	3.86
Emergency starting . . . . .	3.87
Tow start/towing . . . . .	3.89

## Filling the tank

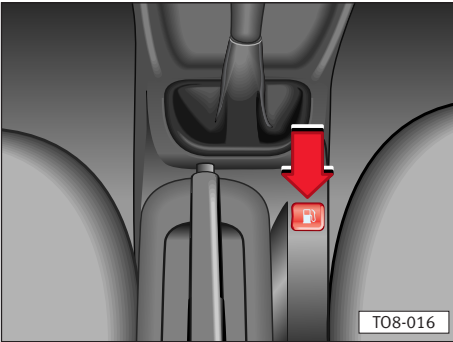

### Unlocking the tank flap

To unlock the tank flap press the button. The unlock function only functions if the ignition is switched off.

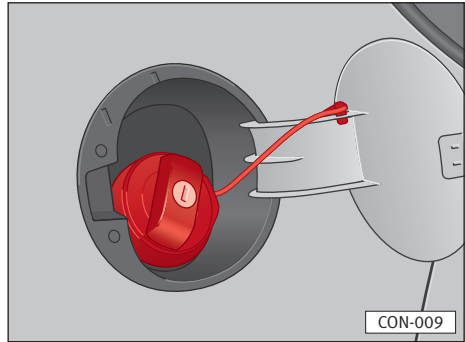

The filler neck is in the rear right-side panel.

You can reach the lockable cap after having opened the tank flap (see illustration).

The tank holds about 55 liters. In four-wheel drive vehicles it holds 62 liters.

***As soon as the correctly operated automatic nozzle switches off for the first time, the tank is full. Do not then try to put more fuel in because the expansion space in the tank will be filled – the fuel can then overflow when it becomes warm.***

After filling the tank, screw cap and close tank flap until it engages. The cap is tied to an anti-loss cord.

---

**Notes**

Any fuel spillage should be wiped off the paint finish immediately, as the paint could otherwise be damaged, especially if it is RME (“biodiesel”) fuel.

**On vehicles with a catalytic converter, never drive until the fuel tank is completely empty. The irregular fuel supply can cause misfiring. This allows unburnt fuel into the exhaust system, which can cause overheating and damage to the catalyst.**

## Petrol

---

In the chapter “Technical Data” and on the inside of the tank flap you will find information on the correct octane rating for your engine.

### General notes

- Unleaded petrol must comply with DIN EN<sup>1)</sup> 228 and leaded petrol with DIN 51 600.
- If, in an emergency, the octane rating of the available petrol is lower than that required by the engine, only drive with medium engine speeds and low engine loading. **High engine loading with full throttle or high revs can cause engine damage.** Fill tank with petrol of the correct octane rating as soon as possible.
- Fuel with a higher octane rating than that required by the engine can be used without limitation. There are, however, no advantages regarding output and consumption.

 ***Even one tankful of leaded petrol will detract from the efficiency of the catalytic converter.***

See chapter “Filling the tank”.

### Petrol additives

The quality of the fuel has a decisive influence upon the running behavior, performance and service life of the engine. The additives which are mixed into the petrol are of particular significance. It is therefore advisable only to use good **quality petrol containing additives.**

1) European Standard.

## Diesel

---

Diesel fuel must correspond to DIN EN<sup>1)</sup> 590. **CZ<sup>2)</sup> no lower than 49.**

### RME fuel (“diester”)

According to norm DIN 51 606<sup>3)</sup>.

Vehicles with diesel engines can also run on **RME fuel** (Rapeseed Methyl Ester).

Ask a Technical Service Centre or automobile club where biodiesel is available.

See chapter "Filling the tank".

### Properties of RME

- RME is chemically produced from vegetable oil (predominantly rapeseed oil) in a process whereby the oil is mixed with methanol and converted, via a catalyst, into RME.
- RME is almost totally sulfur free. The combustion of RME thus emits practically no sulfur dioxide (SO<sub>2</sub>).

- Exhaust gas contains less

– carbon monoxide

– hydrocarbons

– particles (i.e. soot)

than with conventional diesel fuel.

All emission values are lower than legal requirements.

- RME fuel is biodegradable.

- Performance may be slightly lower.

- Fuel consumption may be slightly higher.

- RME can be used in temperatures down to approximately –10 °C.

- Diesel must be added at ambient temperatures of less than –10 °C to prevent deterioration of the biodiesel due to low temperatures. The mixing ratio of diesel to biodiesel must be approximately 50:50.

**If the RME ratio exceeds 50%, too much smoke may be formed.**

- During the summer months, RME may be mixed with diesel at any ratio.

<sup>1)</sup> European Standard.

<sup>2)</sup> Cetan-Zahl (Cetane Number). Measure of diesel fuel ignitability.

<sup>3)</sup> DIN preliminary Standard.

### Driving in winter

When using summer Diesel trouble may be experienced at temperatures below 0 °C because the fuel thickens due to wax separation.

For this reason winter Diesel which is more resistant to cold is sold during the winter in some countries, and this works correctly down to between -15 °C and -22 °C approximately, depending on the brand of fuel used.

The biodiesel available in countries with different climactic conditions usually has different temperature characteristics. Technical Service Centres or service stations in each country can inform you of the specific characteristics of the respective diesel.

### Filter preheating

The vehicle is fitted with a filter preheater. This will ensure that the fuel system will remain operational down to about -25 °C, provided that winter Diesel which is cold resistant down to -15 °C is used.

If, at temperatures below -25 °C the fuel is waxed to such an extent that the engine will not start it is sufficient to place the vehicle in a warm enclosure for a while.

Fuel **additives** (anti-waxing agent), petrol and similar fluids must **not** be mixed with Diesel fuel.

## Brakes

---

### General notes

- Brake lining wear depends to a large extent on the operating conditions and style of driving. On vehicles which are used mainly in town traffic and stop/start conditions or are driven hard it may be necessary to have the thickness of the brake linings checked by a Technical Service Centre in between the intervals given in the Inspection and Service Schedule.
- Change down in good time when driving downhill, in order to make use of the engine braking effect. This relieves strain on the brake system. When the brakes are applied do not keep them on continuously, apply and release alternately.

### What can have a negative effect on the brakes?

#### Wet or gritted road surface

##### Warning

- Under certain conditions e.g. after driving through water, heavy rain falls or after the vehicle has been washed, the brakes could set in later than normal due to damp, or in winter – frozen, brake discs and linings – the brakes must first be dried through careful braking.
- Full braking power might also set in later than normal even when driving on gritted roads if you have not braked for some time – the layer of salt on the brake disks and brake linings must first be worn down whilst braking.

## Overheating of the brakes

### Warning

- Never let the brakes “rub” by pressing the pedal too lightly when you do not really need to brake. This causes the brakes to overheat, leads to longer braking distances and to a higher level of wear.
- Before starting on a long stretch of road in a very hilly area, please reduce your speed, change to a lower gear (manual gearbox) or choose a lower position (automatic gearbox). In this way you will use the braking power of the engine and relieve pressure on the brakes.
- If a front spoiler, full size wheel trims etc., is retrofitted, it is necessary to ensure that the flow of air to the front brakes is not restricted – otherwise the brakes can overheat.

## Servobrake

### Warning

The servo is operated by a vacuum which is only generated when the engine is running. For this reason the vehicle should not be allowed to roll with the engine switched off.

When the brake servo is not working because, for example, the vehicle is being towed or a defect has occurred on the brake servo itself, the brake pedal must be pressed considerably harder to compensate for the absence of servo assistance.

## Anti-locking brake system\*

The ABS plays a major part in increasing the active safety of the vehicle. The big advantage when compared with a conventional brake system is that even when braking hard on a slippery road surface the best possible steerability is retained for the road condition because the wheels do not lock. **Steering control is therefore maintained, giving the best driving stability possible.**

However, one must not expect the ABS system to shorten the braking distance under all conditions. When driving on gravel or on fresh snow covering a slippery surface, i.e. when one should be driving very slowly and carefully, the stopping distance may even be slightly longer.

**Please also refer to the notes on the next page.**



---

### How the ABS\* system works

An automatic check is made when a speed of approx. 6 km/h is reached. When this happens a pumping noise can be heard.

When the turning speed of a wheel reaches a level which is too low for the vehicle speed and it tends to lock, the brake pressure to this wheel is reduced. On the front axle the brake pressure is regulated for each wheel individually, whereas on the rear axle, the pressure is regulated for both wheels at the same time. As a result the braking effect is the same for both rear wheels and the driving stability is retained as far as possible.

**This regulating process makes itself known by movement of the brake pedal and is accompanied by noises.**

This is done deliberately as a warning to the driver that a wheel or the wheels are in the locking range. **So that the ABS can regulate effectively in this range the brake pedal must remain depressed – on no account should it be pumped!**

### Warning

**However the ABS system cannot overcome the physical limits. This must be borne in mind particularly on slippery or wet roads. When the ABS comes into the control range the speed must immediately be adapted to the road and traffic conditions. The increased amount of safety available must not tempt one into taking risks.**

If a defect occurs on the ABS it is indicated by one or two warning lamps.

## Four-wheel drive\*

---

### The concept of four-wheel drives

The four-wheel drive vehicles are fitted with a completely automatic drive on all four wheels.

It automatically distributes the drive power and adapts perfectly to the driving style and specific surface conditions.

#### Warning

**The driving style always needs to be adjusted to suit the road surface and traffic conditions. Increased safety should not encourage one to take unnecessary risks.**

**The braking capacity is limited by the adherence of the wheels and does not differ from a regular vehicle with a two-wheel drive.**

**For this reason, even though on slippery surface the acceleration is good, it should never induce one to drive at excessive speeds.**

**On humid surfaces keep in mind that the front wheels can also suffer from aquaplaning if the speed is excessive. As opposed to vehicles with front wheel drive, the beginning of aquaplaning is not announced by a sudden increase in engine revolutions. We recommend not to drive at excessive speeds and always adjust to the road conditions.**

### Other important notes

#### Winter tyres

With the four wheel drive, the vehicle's drive is good in the winter, even with serial tyres. However, we recommend the use of winter tyres or all-weather tyres on **all four wheels** to further improve driving and braking.

#### Snow chains

Snow chains should be used on four-wheel drives, particularly when it is mandatory. More details on the use of snow chains are indicated in the "Wheels" chapter.

#### Rims/tyre change

**For four-wheel drive versions, all four wheels must have the same tread surface.**

**For further information, see page 3.63.**

## Wheelspin control (TCS)\*

In vehicles with front wheel traction, the TCS lowers the engine power to stop the wheel from spinning when you accelerate. This feature works at any speed in combination with the ABS. If there is an ABS breakdown, the TCS stops working.

Vehicles fitted with TCS\* are also fitted with an electronic differential lock (EDL).

The EDL makes it much easier, or even possible, to pull away, accelerate and climb steep gradients in unfavourable conditions.

The EDL works fully automatically – the driver does not need to do anything at all.

It uses the ABS sensors to monitor the speed of the driving wheels. Up to a speed of about 80 km/h (50 mph), a difference in speed of the drive wheels of approximately 100 rpm caused by a slippery road surface on **one side** is balanced out by slowing down the wheel which is slipping and thereby applying more driving force to the other drive wheel through the differential.

**This control procedure can be detected by the sound it makes.**

**In order to obtain the best possible performance from the EDL, always use the clutch and accelerator pedals according to the road conditions when beginning to drive.**

### Warning

When accelerating on a slippery road surface, e.g. on ice or snow, use the accelerator pedal carefully. The wheels can spin, even with EDL, and thus impair driving stability.

To ensure that the brake disc of the braked wheel does not overheat, the EDL will automatically switch itself off if excessive demands are placed on it. The vehicle remains operational and has the same characteristics as a vehicle without EDL. For this reason, the switching off of the EDL is not noticed.

As soon as the brakes have cooled off, the EDL will switch itself back on again.

If the ABS warning lamp lights up there may be a fault present in the EDL. Take the vehicle to a Technical Service Centre as soon as possible!

### Warning

**The style of driving must always be adapted to suit the road surface and traffic conditions. The increased safety offered by the EDL should not encourage one to take unnecessary risks.**

The TCS connects automatically once the engine is started. If necessary, it can be connected or disconnected by briefly pressing the button located on the central console next to the hand brake.

When the TCS is switched off a pilot light comes on.

You should normally always have the TCS on. Only in exceptional circumstances when you want the wheels to spin should you switch it off. For instance:

- With small emergency wheel,
- When you are using snow chains.
- When driving in deep snow or on a soft surface.
- When the car is stuck, to “rock” it out, and
- To go up slopes where each traction wheel is on a surface with a very different grip (i.e. ice on the left, dry asphalt on the right). The EDS continues to function under these conditions.

Afterwards you should always reconnect this device.

### **Warning**

**Driving style should always be modified to suit the traffic and road conditions. The greater safety provided by the TCS should not lead you to take greater risks.**

### **Note**

For the TCS to work properly all four wheels should be the same. Otherwise engine performance may be reduced.

See also “Changing wheels”.

## Electronic Stability Program (ESP)\*

---

The ESP increases the control over the vehicle in situations such as accelerating or in turns.

The ESP expands the functions of the ABS/TCS and decreases under any circumstance the risk of skidding. This contributes to an improved stability of the vehicle.

The system works in the total realm of speed in relation to the ABS. In case of failure in the ABS, the ESP will also fail.

The ESP connects automatically when the engine is switched on and checks itself.

The ESP warning light lights up when the system is disconnected. See the "Switches" chapter.

The ESP pilot light lights up when the system is disconnected. See "Warning lights" chapter.

The ESP should always be connected. Only in exceptional cases, when the skidding effect is desired under extremely sporty conditions, the system can be disconnected.

Afterwards the system should be reconnected.

The ABS and the EDS remain connected even if the ESP is disconnected.

### Functioning

The electronic stability program encompasses the ABS, EDS and TCS. In addition to all available data for these functions, the ESP control unit needs additional measurements supplied by high precision sensors. The measuring data consists of the speed at which the vehicle turns around its vertical axis, acceleration, pressure on brakes and the turn of the steering wheel.

With the help of the steering wheel sensor and the vehicle's speed, the desired direction is determined and constantly compared to the vehicle's real behavior. When differences occur, such as incipient skidding, the ESP automatically brakes the adequate wheel.

The vehicle stabilizes through the braking force on the wheel. If the vehicle swings out (tendency of the tail to swing out) the brakes will act on the exterior front wheel. In case the swerve is insufficient (tendency to leave the curve) the braking force will be exerted on the interior rear wheel. The braking generates a noise.

### Warning

**The ESP cannot overcome physical limits. This must be borne in mind particularly on wet or icy roads.**

**The driving style must always be adapted to the road and traffic conditions. The increased safety offered by the ESP should not encourage one to take unnecessary risks.**

## Power steering\*

---

Do not keep the steering wheel fully turned more than 15 seconds when the engine is switched on, as the hydraulic oil will be heated to a high temperature by the servo pump.

**This could damage the power steering system.**

Furthermore every time you turn the steering wheel as far as it will go with the engine off, you will hear a series of noises made by the excessive effort of the servo pump. The engine tick over may also be reduced for a short time.

## The first 1,500 km – and afterwards

---

### Running-in

During the first few operating hours the engine internal friction is higher than later on when all the moving parts have bedded down. How well this running-in process is done depends to a considerable extent on the way the vehicle is driven during the first 1500 km.

### Up to 1000 kilometres

the following general rules apply:

- Do not use full throttle
- Do not drive faster than 3/4 of top speed
- Avoid high engine speeds
- Trailer towing should if possible be avoided.

#### Warning

- New tyres must also be “run in” because they do not have maximum adhesion at the start. This must be taken into account by driving carefully during the first 100 km.
- New brake linings must also be run in and do not have the optimum friction properties during the first 200 km. The slightly reduced braking effect can be compensated for by more pressure on the brake pedal. This also applies when new linings have been fitted.

### From 1000 – 1500 km

The speed can be gradually increased to the road or engine maximum.

### During and after the running-in period the following applies:

- Do not overrev the engine when cold – either in neutral or in the gears.

All speeds and revs given are only valid when engine is **properly warm**.

 *Do not drive with unnecessarily high engine revs. Changing up one gear helps to save fuel, decrease noise and pollution. See also the "Driving economically and ecologically" chapter.*

- Do not let engine labour – change down when engine no longer runs smoothly.

### After the running-in period

- On vehicles with a rev counter\* the maximum permissible engine speed is shown by the beginning of the red zone on the rev counter scale. The needle of the counter must not move into this zone.

Extremely high engine revs will be automatically governed.

## Cleaning the exhaust fumes

---

**The perfect functioning of the cleaning system for exhaust fumes** is of great importance for the environment-friendly functioning of your vehicle.

Therefore, keep in mind the following points:

- Versions with a catalytic converter must only use unleaded fuel. See "Filling the tank".
- In vehicles with a catalytic converter never drive until the fuel tank is completely empty. Irregular fuel supply can cause misfiring, thus allowing unburned fuel into the exhaust system which can cause overheating and damage to the catalyst.
- If while driving you experience starting difficulties, loss of power or engine problems the cause could be a failure in the ignition. In this case, fuel may have entered the exhaust system without burning and may be released to the atmosphere. In addition, the catalyst can deteriorate due to overheating. Speed needs to be decreased immediately. See the nearest Technical Service Centre to fix the failure.
- Do not fill the engine with too much oil. See "Checking oil level".
- Do not tow vehicles for more than 50 m when trying to tow start. See "Tow stat/starting" chapter.

### Warning

- **Due to possible high temperatures of the catalyst, do not park in places where the catalyst is easily exposed to inflammable material.**
- **Do not use additional protection for the body or anticorrosive products for sumps and exhaust pipes, catalytic converters or heat shields. The above mentioned material could ignite while driving.**

### Note

Even when the filtering system for exhaust fumes is in perfect working order, under certain circumstances, the fumes may smell like sulphur.

This depends on the percentage of sulfur in the fuel.

Often it is sufficient to change brands or buy super unleaded.



## Environment-friendly and economical driving

Three factors determine the fuel consumption, the burden on the environment and the wear on the engine, brakes and tyres:

- The personal driving style.
- The individual conditions of the use of the car.
- Technical prerequisites.

The fuel consumption can be reduced by 10 to 15 percent by adopting a thoughtful and economic driving style. This chapter will help you lower pollution and save money by following 10 suggestions.

### Suggestion 1



#### *Thoughtful driving style*

The highest fuel consumption takes place during acceleration. If you drive in a thoughtful manner you will have to brake less and, therefore, accelerate less. You can also let the vehicle roll, i.e. when you can foresee that the following traffic light will be red.

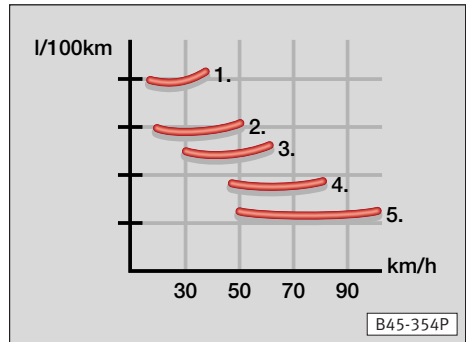

### Suggestion 2



#### *Changing gears saves energy*

Another way to save fuel is to change up as quickly as possible. If you drive with high engine revs the car will use up more energy.

The illustration shows the relation between the consumption (l/100 km) and speed (km/h) in first, second, third, fourth and fifth gear.

The following rules may be helpful. Never drive more than a few meters in first gear. When you reach 2,000 revolutions, you should change up.

If you drive a vehicle with an automatic gearbox, press the accelerator pedal gently. Do not press it to the kick-down position. This way, a consumption oriented program is automatically selected. It changes up as soon as possible and takes longer to change down.

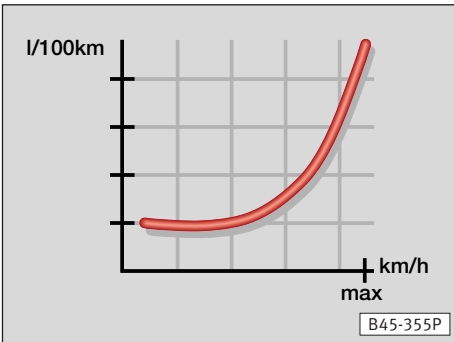

### Suggestion 3



#### ***Avoid driving at maximum speed***

Try not to drive at maximum speed. The increase of fuel consumption, exhaust pollution and noise is disproportionate at high speeds.

The illustration shows the relation between consumption (l/100 km) and speed (km/h).

If only about 3 quarters of top speed is utilized, the fuel consumption will be reduced by about half.

#### **Warning**

**Driving at high speeds decreases road safety.**

### Suggestion 4



#### ***Decrease idling***

It is worth switching off<sup>1)</sup> the engine in traffic jams, at railroad crossings and at traffic lights with a long red light. The savings in fuel after 30-40 seconds with the engine switched off is higher than the fuel used to switch the engine on again.

### Suggestion 5



#### ***Periodic revisions***

Your fuel savings are guaranteed even before going on a trip with the periodic revisions by your Technical Service Centre. The maintenance of the engine is not only a safety and maintenance issue but also a fuel consumption issue.

Poor fine tuning of the engine may increase fuel consumption by up to 10%.

Check the oil level every time you fill up. The oil consumption depends largely on the engine load. Depending on the driving style, the oil consumption can be up to 1.0 l/1000 km.

Another suggestion: You can also lower oil consumption by using synthetic oils.

<sup>1)</sup> Statutory regulations must be respected.

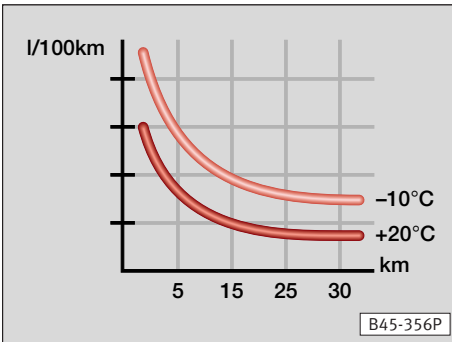

### Suggestion 6

#### **Avoid short drives**

The engine and the catalytic converter must reach its optimum functioning temperature in order to effectively reduce consumption and toxic gas emissions.

The fuel consumption of a cold engine of a normal vehicle right after the start is about 30-40 liters per 100 km. After about one kilometer the consumption decreases to 20 liters. After about **four** kilometers the engine has warmed up and the consumption is normal. For this reason, it is important to avoid short drives and heating the vehicle's engine when the vehicle is not moving. Drive on quickly!

The ambient temperature also counts. The illustration shows the difference in consumption (l/100km) for the same distance (km) at +20°C and -10°C. Your vehicle's consumption is higher in the summer than in the winter.

### Suggestion 7

#### **Check the tyre pressure**

Make sure that the tyres have always adequate pressure. Even half a bar less increases the level of fuel consumption by 5 percent. If the pressure is not correct, the tyres wear out faster due to an excessive deformation and overheating which, in turn, will decrease the driving performance.

Always check the tyre pressure when the tyre is cold.

In addition, do not drive year round with winter tyres. They make more noise and increase fuel consumption by 10 percent. Change to summer tyres on time.

### Suggestion 8

#### **Avoid unnecessary weight**

Apart from driving habits and periodic revisions of your vehicle, there are other ways to reduce fuel consumption:

#### **Avoid unnecessary weight**

Every kilogram increases fuel consumption. For this reason, it is worth checking your boot to avoid unnecessary weight.

Frequently, the roof rack will stay on the roof even though it is no longer needed. Due to greater air resistance, an unloaded roof rack at a speed of 100-120 km/h increases the consumption by approx. 12%.

### **Suggestion 9**



#### ***Save electricity***

The alternator generates electricity while driving. The more electricity is used, the higher the fuel consumption.

The heated rear window, extra lights, the heater fan and air conditioning\* use a large amount of energy. The heated rear window creates a consumption of approx. one liter for every 10 hours.

For this reason, disconnect electrical consumers as soon as they are no longer needed. The alternator generates electricity when the engine is running.

### **Suggestion 10**



#### ***Written check-up***

If you wish to reduce fuel consumption keep a trip book. It is not much work and is worth while since it allows you to detect possible consumption variations (positive or negative) on time and intervene, if necessary. If you detect an increase in consumption you should examine the driving conditions since the last filling.

## Trailer towing

The vehicle is intended mainly for the transportation of persons and luggage. However, it can also be used to tow a trailer if it is fitted with the appropriate technical equipment and the maximum payloads are not exceeded (see chapter “Technical Data”).

Towing a trailer not only demands more from the car, but from the driver too.

You should therefore strictly adhere to the service and running-in instructions on the following pages.

### Technical requirements

- The vehicle is supplied with a factory-fitted towing bracket and all that is technically and legally necessary for trailer towing.

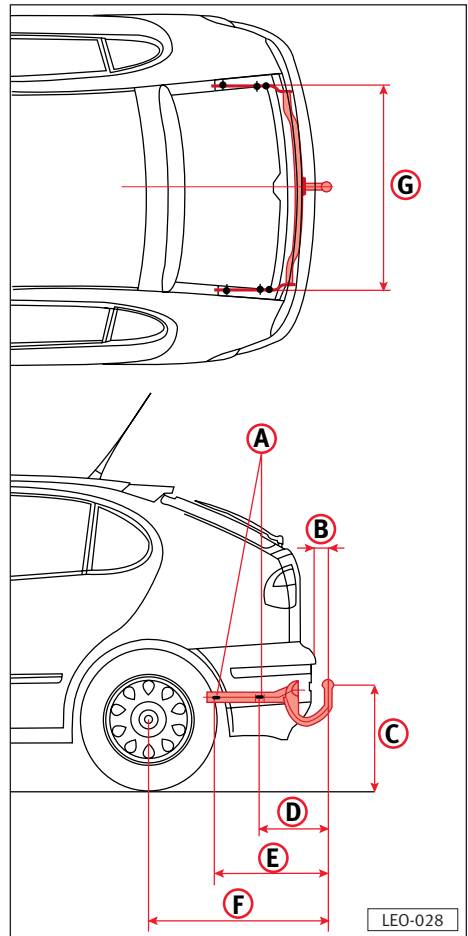

**A** = 4 Attachment points

**B** = 65 mm

**C** = 420 (empty vehicle) /  
350 mm (vehicle with max. load)

**D** = 340 mm

**E** = 552 mm

**F** = 845 mm

**G** = 1014 mm

All measurements are expressed in mm.

### Operations instructions

- The removable ball coupling of the towing bracket\* may be stored in the tool box located inside the spare wheel recess.
- Additional mirrors are required if the traffic behind the trailer is not visible with the exterior mirrors fitted as standard. Both exterior mirrors must be attached to brackets in such a way that a sufficient field of vision to the rear is guaranteed at all times.
- The permitted trailer weight must not be exceeded under any circumstances. See chapter “Technical Data”.

- When using a trailer on mountain routes you must bear in mind that the tow loads given in the “Technical data” chapter are only applicable for slopes of 10% to 12%. If you do not use the full tow load you may drive up steeper slopes.
- The given trailer weights are only applicable for altitudes up to 1000 m above sea level. As the engine output drops due to the decreasing air density, the climbing ability must also be reduced by 10% for each further 1000 m.
- Where possible make full use of the maximum permissible drawbar weight on the ball of the towing bracket but do not exceed it. See chapter “Technical Data”.
- While observing the permissible trailer and drawbar weight, distribute the load in the trailer so that heavy objects are as near as possible to the axle. The objects must also be secured so that they cannot slip about.

---

- The tyre pressures on the towing vehicle must be adjusted for full load conditions, and also check the pressures on the trailer.

- The headlight settings, should be checked with trailer attached before moving off and adjusted as necessary.

On vehicles with headlight beam control it is only necessary to turn the knurled disc on the dash board in the appropriate direction.

### Driving tips

To obtain the best possible handling of vehicle and trailer, the following should be noted:

- Try to avoid driving with an unladen vehicle and a loaded trailer. If this cannot be avoided, only drive slowly to allow for the unfavourable weight distribution.

- As driving stability of vehicle and trailer decreases when the speed increases do not drive at the maximum permissible top speed in unfavourable road, weather or wind conditions – particularly when going downhill.

In any case the speed must be reduced as soon as the trailer shows the slightest sign of snaking. On no account try to stop the snaking by accelerating.

- **For safety reasons one should not drive faster than 80 km/h (50 mph). This also applies in countries where higher speeds are permitted.**

- Always brake in good time. If the trailer has an overrun brake, apply the brakes gently at first then firmly. This will avoid the jerking caused by the trailer wheels locking.

Change down before going down a steep hill so that the engine can act as a brake.

- When a long climb in a low gear with extremely high engine revs must be negotiated at exceptionally high ambient temperatures the coolant temperature gauge must be observed. When the gauge needle moves to the right end of the scale, the road speed must be reduced immediately.

- The cooling effect of the radiator fan cannot be increased by changing down, because the speed of the fan is not dependent on the engine speed. One should therefore not change down even when towing a trailer as long as the engine can cope without the vehicle speed dropping too much.

### General notes

- **During the running in period you should avoid towing a trailer if possible.**

- **It is advisable to have the vehicle serviced between the inspection intervals if it is used frequently for towing a trailer.**

- The trailer and drawbar load figures on the data plate of the towing bracket are for test certification only. The correct figures for the vehicle, which may be lower than the above figures, are given in the vehicle documents and in this manual.

- When using the towing device the car's empty weight is reduced, and as a result its effective load is decreased.

- Observe all statutory requirements regarding the use of a trailer.

## Driving abroad

---

If the vehicle is to be taken abroad, the following must also be borne in mind:

- If the vehicle has a petrol engine and catalytic converter, one must ensure that unleaded petrol will be available during the journey – see page 3.4. The automobile clubs offer information about the unleaded filling station network.

- In some countries it is possible that a vehicle model is sold under conditions where some spare parts are not available or that the Technical Services may only carry out limited repairs.

SEAT importers and distributors will gladly provide information about the technical preparation of your vehicle in addition to necessary maintenance and repair possibilities.

The addresses are given in the SEAT International Assistance Guide which comes with the car documentation.



## Headlight covering

---

When the vehicle is used in a country which drives on the opposite side of the road to the home country, the asymmetric dipped headlights will dazzle oncoming traffic.

To prevent this, the areas of the headlight lenses shown in the illustration must be covered up with an opaque adhesive strip.

When using a sharp object (for example a razor blade) to cut the tape, do not do this directly on the headlights as you may scratch them.

### Warning

**When you drive on the opposite side of the road to your own country, and with your headlights masked, bear in mind that visibility is reduced, and you will have to adapt your driving and speed accordingly for safety reasons.**

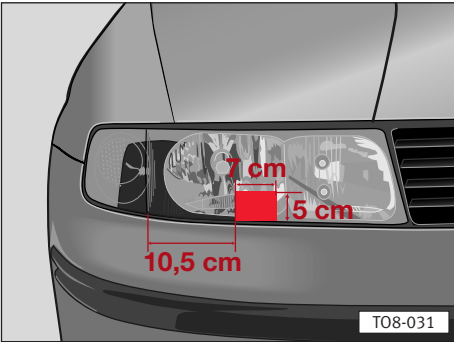

On the right headlamp, if you change from driving on the right hand side to driving on the left hand side of the road.

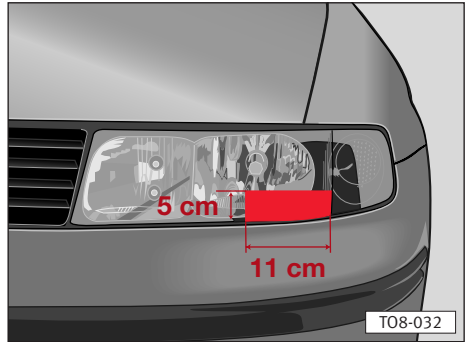

On the left headlamp, if you change from driving on the right hand side to driving on the left hand side of the road.

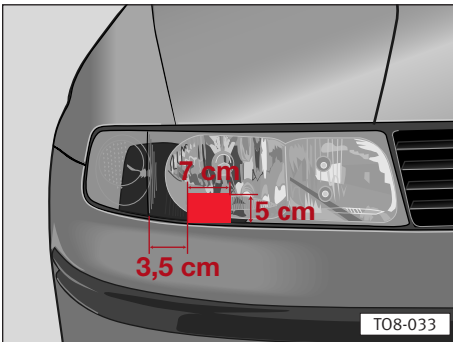

On the right headlamp, if you change from driving on the left hand side to driving on the right hand side of the road.

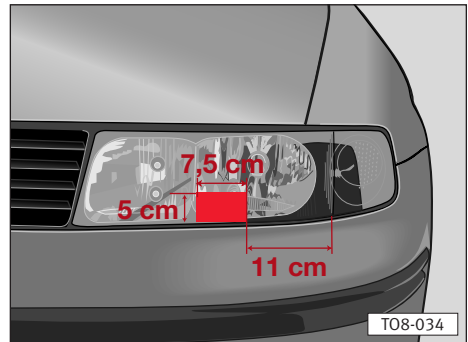

On the left headlamp, if you change from driving on the left hand side to driving on the right hand side of the road.

## Care of the vehicle

---

Regular and expert care helps to maintain the value of the vehicle.

### Warning

- If misused, car care materials can be harmful to health.
- Car care materials must always be stored in a safe place where they are out of reach of children.

 *When buying car care materials one should select products which do not damage the environment. Empty containers which these materials were in do not belong with household waste.*

## Washing

### Warning

**Dampness and ice in the brake system can have a negative effect on the braking power.**

The best protection against environmental influences is frequent washing and use of the right waxing product.

How often this treatment is required depends, amongst other things on how much the vehicle is used, how it is parked (garage, in open under trees etc.), the seasons, weather conditions and environmental influences.

**The longer bird droppings, insects, tree resin, road and industrial grime, tar spots, soot, road salt and other aggressive materials remain on the vehicle paint the more lasting their destructive effect will be. High temperatures e.g. from strong sunlight intensifies the corrosive effect.**

In certain circumstances weekly washing can be necessary, in other conditions monthly washing with appropriate waxing may be fully adequate.

After the period when salt is put on the roads the underside of the vehicle should always be washed thoroughly.

### Automatic car washes

The vehicle paint is so durable that the vehicle can normally be washed without problems in an automatic car wash. However the influence on the Paint depends on the design of the car wash, the filtering of the wash water, the type of wash and care material, etc.

## Notes

- Before going through the car wash, apart from the usual precautions (closing windows and sliding roof).

You do not need to remove the Original roof aerial.

- **If there are special fittings on the vehicle – e.g. spoilers, roof rack, two-way radio aerial – it is best to speak to the car wash operator.**

## Washing the vehicle by hand

 *In the interests of environmental protection the vehicle should only be washed in specially provided wash bays. In some districts, washing cars elsewhere may even be forbidden.*

First soften the dirt with plenty of water and rinse off as well as possible. Then clean the car **with a soft sponge, glove or brush** starting on the roof and going from top to bottom **using only slight pressure especially when cleaning the headlight area.** Paint shampoo, preferably with a neutral pH, should only be used for very persistent dirt. Rinse the sponge or glove out thoroughly at short intervals.

Wheels and sill panels should be cleaned last, using a different sponge if possible.

After cleaning the vehicle, rinse thoroughly with water and leather it off.

## Note

- The vehicle should not be washed in strong sunshine.

- If the vehicle is rinsed with a hose, do not direct the jet of water at the lock cylinders and the door/boot lid/tailgate shut lines – they can freeze up in the winter.

## Washing vehicle with high pressure cleaner

- The operating instructions for the high pressure cleaner must be followed closely – particularly with regard to pressure and working distance.

- Do not use a concentrated jet.

- The water temperature must not be above 60°C.

## Warning

**Tyres must never be cleaned with a concentrated jet! Even at a relatively large working distance and a very short spraying time, damage can occur.**

## Conservation

Regular application of protection products protects the vehicle paintwork to a large extent against the environmental influences listed under “Washing” on the previous page and even against light mechanical damage.

At the latest when water on the clean paint does not form small drops and roll off, the vehicle should be protected by applying a coat of good hard wax. Even when a wax solution is used regularly in the washing water it is advisable to protect the paint with a coat of hard wax at least twice a year.

## Polishing

Should only be done if paint has lost its shine and gloss cannot be brought back with wax. If the polish used does not contain preservative compounds, the paint must be waxed afterwards.

### Note

**Matt painted and plastic parts should not be treated with polish or hard wax.**

## Paint damage

Small marks in the paint such as scratches or stone damage should be touched up immediately with paint before the metal starts to rust.

However, should rust be found at any time it must be removed thoroughly and then the area treated first with an anti-corrosion primer and then the correct paint applied.

The number of the original vehicle paint is given on the data sticker which is inside the boot in the spare wheel housing.

## Windows

Remove snow and ice from windows and mirrors with a plastic scraper only. To avoid scratches due to dirt on the glass, the scraper should only be pushed in one direction and not moved to and fro.

Traces of rubber, oil, wax<sup>1)</sup>, grease or silicone can be removed with a window cleaning solution or a silicone remover.

<sup>1)</sup> This wax residue can only be removed with a special cleaner.

The windows should also be cleaned on the inside at regular intervals.

Do not dry the windows with the leather used for the paintwork because traces of paint cleaner will cause streaks to appear on the glass, which will hinder vision.

To avoid damaging the heating element wires in the rear window do not put stickers over the wires on the inside.

## Door, boot and window seals

The weatherstrips will remain flexible and last longer if they are rubbed lightly with a rubber protective compound from time to time. This will also stop the weatherstrips from freezing on in winter.

## Door lock cylinder

You should only use an appropriate spray, which has lubricating and anti-corrosive qualities, to de-ice the lock cylinder.

## Plastic parts and leatherette

Exterior plastic parts are cleaned with normal washing and interior parts with a damp cloth. If this is not sufficient, **these parts and leatherette may only be cleaned with special plastic cleaners that are free from alcohol and other solvents.**

### Note

The use of liquid air conditioners directly over the air vents of the vehicle may damage the plastic parts if the liquid is accidentally spilled over them.

### Upholstery cloth and textile trim

Upholstery cloth and textile trim on door panels, parcel shelves, luggage compartment covers, headlining etc. must be cleaned with special cleaners or dry foam and a soft brush.

### Natural leather

Leather should, depending on usage, be treated from time to time in accordance with the following instructions. It must be noted that on no account may **solvents, floor wax, shoe polish, spot removers and similar products be used for this purpose.**

To clean leather a cotton or woollen cloth lightly moistened with water should be used for the dirty surfaces.

Dirtier areas may be cleaned with a mild soap solution (2 dessert spoonfuls of neutral soap to 1 litre of water). Make sure that the **leather is not made too wet** and that no water seeps through the seams. After cleaning, wipe dry with a soft cloth.

Furthermore we recommend that, with normal usage, the leather is treated at half yearly intervals with a special leather care agent. Apply one coat and clean off with a soft cloth once it has taken effect.

### Cleaning seat belts

**Keep belts clean. They may not retract properly if very dirty.**

Dirty belts can be cleaned by washing with a mild soap solution without taking the belts out of the vehicle.

#### Note

Inertia reel belts should be completely dry before they are allowed to roll up.

#### Warning

- The seat belts must not be removed for cleaning.
- Do not have the belts cleaned chemically because the cleaning compounds damage the webbing material. Ensure that the belts do not come into contact with corrosive fluids.
- You should check the condition of your seat belts regularly. If you find any damage to the belt webbing, belt connections, the belt retractor or the locking parts, the belt in question must be replaced by a Technical Service Centre.

### Steel wheels

The wheels and the wheel trims should be cleaned thoroughly at regular intervals when the vehicle is being washed. This will prevent brake dust, dirt and road salt from accumulating on the wheel. Persistent ingrained brake dust can be removed with an industrial grime remover. Paint damage should be repaired before rust can form.

### Alloy wheels\*

In order to maintain alloy wheel trims in perfect condition for a long period, regular care is necessary. Above all, road salt and brake pad dust must be washed off thoroughly at least every two weeks, otherwise the surface of the alloy will be damaged. After being washed, the wheels should be treated with an acid-free cleaner for alloy wheels. About every three months it is necessary to give wheels a good rubbing with hard wax. Paint polish or other abrasive solutions must not be used. If the protective paint coat has been damaged, e.g. by stone impact, the damaged spots should be dealt with as soon as possible.

#### Warning

**Please note when cleaning the wheels that dampness, ice and grit can have a negative effect on the braking power.**

### Cleaning and anti-corrosion treatment of engine compartment

#### Warning

- **Before working in the engine compartment note instructions in the "Engine compartment" chapter.**
- **For safety reasons pull out ignition key before reaching into the water box. Otherwise if the windscreen wipers are switched on unintentionally the movement of the wiper link could cause injury.**

The leaves, blossoms etc. which drop into the water box (underneath the engine bonnet in front of the windscreen) should be cleaned out occasionally. This will prevent the water drain holes from becoming blocked and – on vehicles without a dust and pollen filter – foreign bodies entering the vehicle interior via the heating and ventilation system.

The engine compartment and the outside surface of the power unit are given anti-corrosion treatment at the factory.

In the winter when the vehicle is being driven frequently on salted roads, good anti-corrosion treatment is very important. For this reason the entire engine compartment and the plenum chamber should be thoroughly cleaned before and after the salting period and then preserved so that the salt cannot have a damaging effect.



---

**The ignition must be switched off before washing the engine.**

**Do not point the water jet directly at the headlights to avoid damage.**

If the engine compartment is cleaned at any time with grease removing solutions<sup>1)</sup> or if one has the engine washed, the anti-corrosion compound is nearly always removed as well. It is therefore essential to ask for durable preservation of all surfaces, seams, joints and components in the engine compartment to be carried out. This applies also when corrosion protected parts are renewed.

 ***Because when washing the engine petrol, grease and oil deposits are washed off, the dirty water must be cleaned by an oil separator. For this reason engine washing should only be carried out in a workshop or filling station.***

## **Undercoating**

The underside of the vehicle is coated with a special compound to protect it from corrosion and damage.

However, as this protective layer can always become damaged when the vehicle is in use, the protective coating on the underside of the body and on the running gear should be examined at defined intervals - preferably before and after the winter season- and any damage repaired.

### **Warning**

**Never use additional under floor protection or anti-corrosion agents for the exhaust silencer, exhaust pipe, catalysts or heat shields. These substances could ignite whilst the vehicle is in motion.**

<sup>1)</sup> Only the prescribed cleaning products may be used, never use Petrol or Diesel.

### **Note for vehicles with a catalytic converter**

Due to the high temperatures which occur in the afterburning process, additional heat shields are fitted over the catalytic converter. Underbody sealant must not be applied to these shields, the catalytic converter or the exhaust pipes. Removal of the heat shields is also not permissible.

### **Cavity preservation**

All cavities on the vehicle which could be susceptible to corrosion are given permanent protection at the factory.

This coating does not need checking or any subsequent treatment. Should a small amount of wax run out of the cavities at high ambient temperatures it can be removed with a plastic scraper and some white spirit.



***If the wax which has run out is removed with clean petrol, heed the environmental protection regulations.***

## Engine bonnet

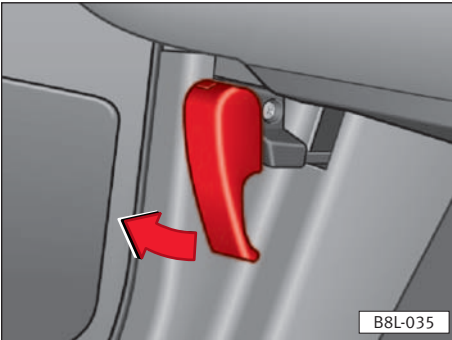

### Unlocking

Pull the lever on the left side panel, under the instrument panel. The bonnet springs up out of its lock.

At the same time, a release lever will appear in the radiator grille. See illustration on the right.

### Note

Before opening the bonnet ensure that the wiper arms are not lifted off the windscreen. Otherwise, damage can occur to the paintwork.

### Opening

Lift bonnet slightly and pull the release grip in the direction of the arrow (see illustration to the right) to release the catch. **Let go of the release grip so it can return to its original position.**

### Warning

Once the bonnet is open do not touch the release grip (located next to the radiator grille) nor other elements of the lock. Otherwise when closing damage could occur to the locking system and the bonnet may open while driving.

**Danger of accident!**

Lift bonnet to the stop. The bonnet is held in position by a gas filled rod.

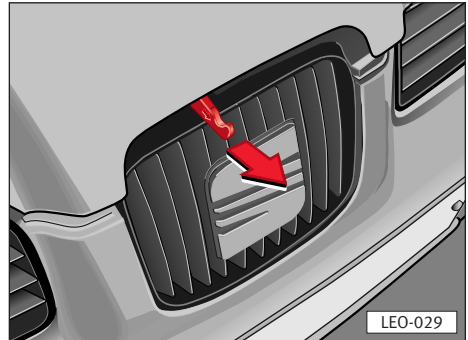

### Closing

Hold the bonnet on the side where the gas filled rod is fitted. Press the bonnet down until the gas filled rod gives way and then engages. **Do not press down if it does not close properly. Open again and press as before.**

### Warning

- For safety reasons, the bonnet must always be properly closed when the vehicle is moving. Always check whether the lock is engaged by pulling up. Furthermore, the bonnet must be flush with the adjacent body panels.
- If you should notice that the lock is not engaged, stop the vehicle immediately and close the bonnet.

## Engine compartment

---

### Warning

Particular care should be taken when working in the engine compartment!

- Switch off engine, remove ignition key.
- Pull handbrake on firmly.
- Move gear lever into neutral or, in automatic gearboxes, in “P” position.
- Allow engine to cool off.
- As long as the engine is at operating temperature:
  - Do not put your hand into the radiator fan, it could switch on suddenly.
  - Do not open the radiator cap because the cooling system is under pressure.
- Never spill any liquids over the hot engine. These liquids could ignite.
- Avoid causing short circuits in the electrical system – particularly at the battery.

- If tests have to be carried out with the engine running, there is an additional danger present from rotating parts – e.g. V-belts, generator, radiator fan etc. – and from the high voltage ignition system.

- If work on the fuel or electrical system is necessary:

- Disconnect the battery from the vehicle electrics

- Do not smoke

- Never work near naked flames

- Always keep a fire extinguisher in the vicinity.

- Attention must be paid to the warnings given in this Manual and to the generally applicable safety regulations.

When topping up fluids do not confuse them with each other under any circumstances, otherwise serious functional defects may occur.



*The ground underneath the vehicle should be checked regularly. If spots caused by oil or other fluids can be seen, the vehicle should be taken to a Technical Service Centre for checking.*

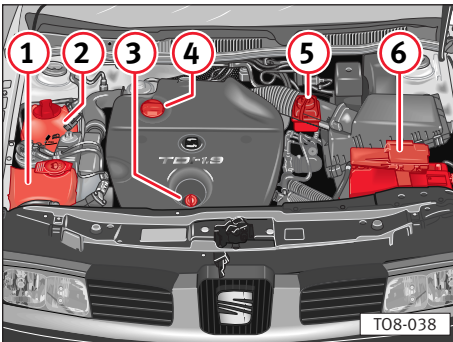

### 81 kW diesel engines

Page

1 – Windscreen washer container.....	3.51
2 – Coolant expansion tank.....	3.42
3 – Engine oil dipstick .....	3.40
4 – Engine oil filler opening .....	3.40
5 – Brake fluid reservoir.....	3.45
6 – Vehicle battery.....	3.46

The layout of the components may vary depending on the engine.

#### Warning

Please take notice of the warning notes on the previous page.

## Engine oil

### Specifications

The engine comes with a special, high quality, multi grade oil that can be used in all seasons of the year except for those regions affected by extreme cold.

As the use of high quality oil is essential for the correct operation of the engine and its long useful life, when topping up or replacement is necessary use only those oils that conform to the requirements of the VW standards.

If it is not possible to find oil conforming to the VW standards then oil conforming to the ACEA or API standards with an appropriate viscosity at atmospheric temperature should be used instead. The use of this type of oil may have some repercussions on the performance of the engine for example, long starting time, increased consumption and a higher emission level.

If a top up is required then different oils may be mixed as long as they all conform to the VW standards.

The specifications (VW standards) set out in the following page should appear on the container of the service oil; the container will display together the different standards for petrol and diesel engines, the oil can be used for both types of engines.

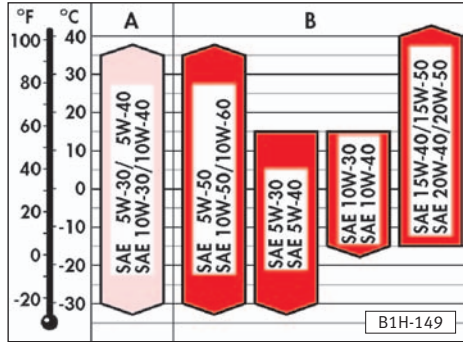

### Oil properties

#### Viscosity

The viscosity class is selected according to the diagram above. If atmospheric temperature falls outside of the described limits for only a short period then an oil change is not necessary.

## Petrol engine

Denomination	Specification	Comments
A – synthetic oil	VW 502 00 VW 500 00	Dated after 1-97
B – mineral oil	VW 501 01	Dated after 1-97
A/B – multi-grade oil	ACEA A2 or A3 or even API SH/SJ	Dated after 1-97

## Diesel engine

Denomination	Specification	Comments
A – synthetic oil	VW 505 01 <sup>1)</sup>	Dated after 1-97
B – mineral oil	VW 505 00	Dated after 1-97
A/B – multi-grade oil	ACEA B2 or B3 or even API CD/CF	Dated after 1-97

### Mono-grade oil

Mono-grade oils cannot be used throughout the whole year due to their limited range of viscosity<sup>2)</sup>.

These oils are only useful in a climate that is constantly very cold or very warm.

### Engine oil additives

No type of additive should be mixed with the engine oil. The deterioration caused by these additives is not covered by the guarantee.

### Note

**Before a long trip, we recommend finding an engine oil that conforms to the corresponding VW specifications and keeping it in the vehicle. In this way the required oil will be available if needed.**

1) Diesel engines that have **fuel injection based on a fuel injector pump** should use **only** oil specification **VW 505 01**. **Avoid the use of any other oil type than VW 505 01 for this engine. Warning! Possible engine damage!**

2) Viscosity: Oil density

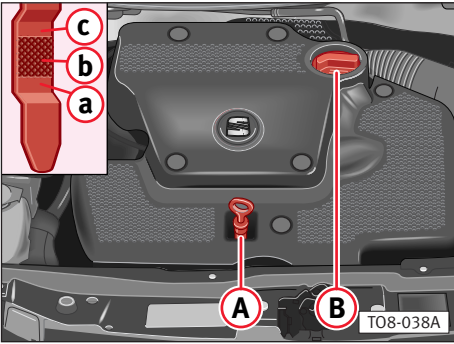

### Checking oil level

Every engine uses a certain amount of oil. The oil consumption can be up to 1.0 litres per 1000 km. The engine oil level must therefore be checked at regular intervals, preferably when filling the tank and before a long journey.

The location of the dipstick **A** can be determined from the illustrations on page 3.37.

The vehicle must be on a level surface when checking the oil level. After stopping engine wait a few minutes for the oil to drain back to the sump.

Then pull the dipstick out, wipe it with a clean cloth and insert again.

Then pull dipstick out again and check the oil level:

- a– Oil **must** be topped up.  
Afterwards it suffices when the oil level is somewhere in area **(b)**.
- b– Oil **can** be topped up.  
It can then happen that the oil level is in area **(c)**.
- c– Oil **must not** be topped up.

When the engine is working hard such as in sustained high-speed motorway cruising in summer, when towing a trailer or when climbing mountain passes, the oil level should be kept at area **(c)** – **not above**.

### Topping up engine oil

Unscrew the cap from oil filler opening **B** and pour oil in 0.5 litres at a time. Then check level with the dipstick.

**On no account should the oil level be above area c. Otherwise oil can be drawn into the engine via the crankcase breather and escape into the atmosphere via the exhaust system. On vehicles fitted with a catalytic converter, the oil could burn inside the converter causing it to become damaged.**

#### Warning

**When topping up the oil, do not spill it onto hot engine components – danger of fire.**

Carefully close the filler cap and push the oil dipstick in as far as possible, this will prevent oil spill when the engine is running.



## Changing engine oil

The engine oil must be changed at the intervals given in the Inspection and Maintenance Plan. We therefore recommend that the oil change be done by a Technical Service Centre.

### Warning

If you want to change the engine oil yourself, you must note the following points:

- Allow the engine to cool down first to avoid the danger of being scalded by hot engine oil.
- Use an appropriate container to drain off the oil. It should be big enough to hold the quantity of oil in your engine.
- Wear protective glasses for your eyes.
- When removing the oil drain plug with your fingers, keep your arm horizontal so that the oil being drained cannot run down your arm.

- If your hands come into contact with engine oil you must wash them thoroughly afterwards.
- Old oil must be stored out of reach of children until it is disposed of in the correct manner.

 *On no account should oil be poured down drains or into the earth.*

*Because of the disposal problems, the necessary special tools and specialised knowledge required, the engine oil and filter changing should preferably be done by a Technical Service Centre.*

### Engine oil additives

No additives should be mixed with the engine oil.

## Cooling system

---

The cooling system is filled at the factory with a permanent coolant which is not changed.

The coolant consists of water and a 40% concentration of our coolant additive **G12+** (glycol-based anti-freeze with anti-corrosion additives). This mixture not only gives the necessary frost protection down to  $-25\text{ }^{\circ}\text{C}$  but also protects the alloy parts in the cooling system against corrosion. In addition it prevents scaling and significantly raises the boiling point of the coolant.

The concentration of the coolant therefore must not be reduced in the summer or in warm countries, by topping up with plain water. **The coolant additive proportion must be at least 40%.**

If greater protection against frost is required, the proportion of **G12+** additive can be increased, but **only up to 60%** (frost protection to approx.  $-40\text{ }^{\circ}\text{C}$ ), otherwise the anti-freeze protection is reduced and furthermore the cooling effect is impaired.

Vehicles for export to cold countries (e.g. Sweden, Norway, Finland) usually have frost protection down to  $-35\text{ }^{\circ}\text{C}$  (50% **G12+**) approximately.

**Other additives can be very detrimental to the anti-corrosion effect in particular.**

**The subsequent corrosion damage can lead to coolant loss resulting in major engine damage.**

### Note

- **Only our G12+ (purple colour) should be used as an antifreeze additive. Observe the notice on the container. The cooling liquid may be purchased in Technical Services.**
- **The antifreeze additive G12+ can be mixed with other additives (G11 and G12).**
- **The additive G12 (red colour) should never be mixed with G11.**

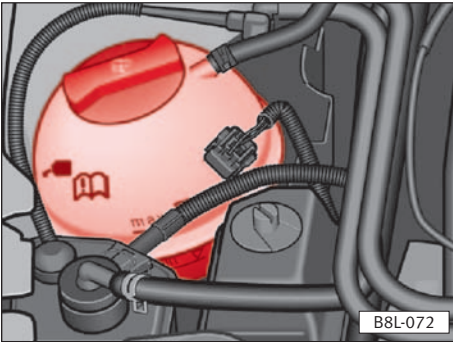

### Checking coolant level

#### Warning

Never open the bonnet if you can see steam or coolant leaving the engine compartment – Risk of scalding! Wait until no more steam or coolant can be seen.

The level can only be checked properly when the engine is not running.

The coolant level must be between the **max** and **min** marks on the expansion tank when engine is cold and can be slightly above the **max** mark when it is warm.

### Coolant losses

Coolant loss normally indicates leaks in the system. In this case the cooling system should be checked by a Technical Service Centre without delay. It is not sufficient merely to add coolant.

In a sealed system losses can only occur if the boiling point of the coolant is exceeded as a result of overheating, and coolant is forced out of the system.

### Topping up coolant

Switch engine off and let it cool down. Then cover expansion tank cap with a cloth and turn cap carefully anti-clockwise and remove.

#### Warning

**Do not remove expansion tank cap when engine is hot – danger of scalding:  
System is under pressure.**

No other coolant may be used if **G12+** is not available. In this case only water can be used and the correct mixture concentration must be restored with the specified coolant additive (see previous page) as soon as possible.

**Please also refer to the further notes on the next page.**

If a lot of coolant has been lost, only add cold coolant after the engine has cooled down. This will prevent engine damage.

**Do not fill above the max mark.**

The excess coolant will be forced out through the pressure relief valve in the cap when engine becomes hot.

**Screw cap on again tightly.**

**Warning**

The coolant additive and the coolant are a danger to health. The additive must therefore only be stored in the original container well out of reach of children. If the coolant has to be drained at any time it must be caught and also stored in a safe place.



*Drained coolant should not normally be reused, it must be disposed of, bearing in mind environmental protection regulations.*

---

## Radiator fan

---

The radiator fan is driven electrically and controlled by a thermostitch from the coolant temperature (also from the engine compartment temperature on some models).

**Warning**

After the engine has been stopped the fan can continue running for a while – even with the engine switched off (up to about 10 minutes). It can also start to run again suddenly after a short time if

- the coolant temperature increases due to heat build up
- when the engine is hot and the engine compartment is heated additionally by strong sunlight.

Special care must therefore be taken when working in the engine compartment.

## Brake fluid

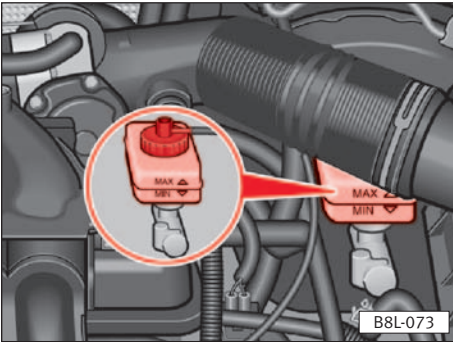

The brake fluid reservoir is on the left hand side of the engine compartment.

On vehicles with ABS\* the reservoir is in the same place but its design is different.

### Note

On vehicles with right-hand drive the reservoir is on the other side of the engine compartment.

### Checking fluid level

The fluid level must always be between the “MAX” and “MIN” marks to ensure perfect operation.

The level of fluid tends to sink slightly when the vehicle is used due to the automatic adjustment of brake linings. This is quite normal.

If the level were to drop rapidly or below the minimum mark **MIN** the brake system may be leaking. The corresponding pilot light lights up if the level is too low (see “Warning lamps” chapter). **Go to a Technical Service Centre immediately and have the brake system checked.**

### Renewing the brake fluid

Brake fluid absorbs moisture. In the course of time it takes in water from the atmosphere. Too high a content of water in the brake fluid system can cause corrosion damage. Furthermore the boiling point of the brake fluid is reduced considerably. **For this reason the brake fluid must be renewed every two years.**

### Warning

**When the brake fluid becomes too old, vapour bubbles can form in the brake system when the brakes are used vigorously. The efficiency of the brakes and thus the vehicle safety are seriously reduced.**

Only our genuine brake fluid should be used (specification according to US FM VSS 116 DOT 4 Standard). The fluid must be new.

### Warning

**Brake fluid is poisonous! It must therefore only be stored in the closed original container out of reach of children.**

**Remember also that brake fluid will attack the paintwork.**

*Because of the disposal problems, the special tools necessary and the specialist knowledge required, brake fluid should preferably be changed at a Technical Service Centre.*

It is advisable to have the fluid change done during an Inspection Service.

## Battery

### Warning notes



Wear eye protection. Do not allow particles containing acid or lead to come into contact with the eyes, skin or clothes.



Battery acid is highly caustic. Always wear protective gloves and glasses. Do not tip battery – acid can spill out of the vents. Should acid come into contact with the eyes, rinse for several minutes using clean running water. Seek medical assistance immediately. Should acid come into contact with skin or clothes, neutralise immediately using an alkaline soap solution and rinse thoroughly. Should acid inadvertently be drunk, seek medical attention immediately.



Keep well clear of naked flame and sparks. Do not smoke. Avoid generating sparks when handling cables and electrical components. Avoid short circuits. Never short battery terminals – danger of injury from high energy sparks.



When battery is being charged, a highly explosive mixture of gasses is produced.



Keep acid and battery out of the reach of children.

- Disconnect positive terminal of battery before doing any work on the electrical system. When changing bulbs it is sufficient to switch off lamp.

- When disconnecting the battery from the vehicle electrical system first disconnect the negative cable and then the positive cable.

The battery must not be disconnected with the engine running, as this will damage the electrical system (electronic components).

- When reconnecting the battery, first connect the positive cable, then the negative. On no account may the cable be interchanged. Risk of cables burning!

Do not disconnect the vehicle battery when the ignition is on or when the engine is running, as the electrical system (electronic components) could otherwise be damaged.

In order to protect the casing from UV radiation, do not expose vehicle battery to direct sunlight.

## Location

The battery is in the engine compartment. Start with the help of another battery. See "Emergency starting" chapter.

## Checking acid level

Take the following warnings of the "Engine compartment" chapter into account before starting any type of work on the engine or the engine compartment.

The acid/electrolyte level should be checked regularly in the following cases:

- high mileage
- in countries with a warm climate
- old battery

The battery is otherwise service-free.

The acid level should always be around the **max.** mark on the longside of the battery. It should never be filled above the **max.** mark nor be allowed to drop below the **min.** mark.

It is recommended that the acid level be checked and corrected by a Technical Service Centre.

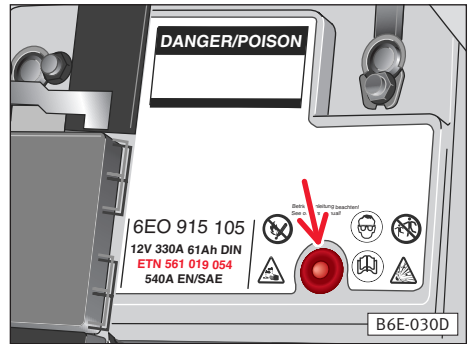

### Battery with a magic eye\*

A round viewing window is located on the upper side of the battery (see arrow). This magic eye will change its color according to the charge condition or the acid level of the battery.

Air bubbles can distort the true color. You should, therefore, tap carefully on the magic eye.

If the display in the viewing window has no color or is light yellow, the acid level in the battery is too low. Distilled water must be added. We recommend that the battery be replaced if it is older than 5 years.

It is recommended that the acid level be checked and corrected by a Technical Service Centre.

The colour displays of green and black are only of use to the Technical Service Centre since it facilitates the diagnosis of the battery.

### Charging the battery

Before charging, switch off the engine and all electrical consumers.

When charging with a low current (e.g. with a small charger) the battery cables need not normally be taken off. The instructions from the battery charger manufacturer must, however, be noted.

In order to connect the positive cable, the cover of the fuse holder on the battery must first be moved to the side. See page 3.50.

Before **quick charging**, that is charging with a high current, both battery cables must be disconnected.

#### Please note the following points:

##### Warning

- **Keep children away from the battery, the battery acid and the charger.**
- **Only charge the battery in a well ventilated room. Do not smoke and allow no naked flames or electric sparks near the battery, as a highly explosive gas is produced whilst the battery is being charged.**
- **Protect your eyes and face. Do not bend over the battery.**
- **Should acid come into contact with the eyes or skin, rinse for several minutes using clear water. You should then seek medical assistance immediately.**

- **Fast charging a battery is dangerous and should only be done at a Technical Service Centre, as special equipment and skills are needed.**
- **Never charge a frozen battery. Risk of explosion! A frozen battery must be thawed before charging.**

**We recommend that batteries should no longer be used after thawing, as the battery housing could have split inside because of ice formation, and the acid may leak out.**

- When charging the battery do not remove caps.
- The main cables of the charger should not be connected until the clips of the charger have been properly secured to the battery terminals:  
red.....= positive  
black, brown or blue.....= negative
- After charging the battery, first switch off the charger and disconnect the main cables. Then disconnect the clips of the charger from the battery.



### What happens when the battery is disconnected and then reconnected ...

After **reconnecting** the battery to the onboard electronics, you should reset the digital clock.

The automatic opening and closing function of the electric windows should also be reactivated.

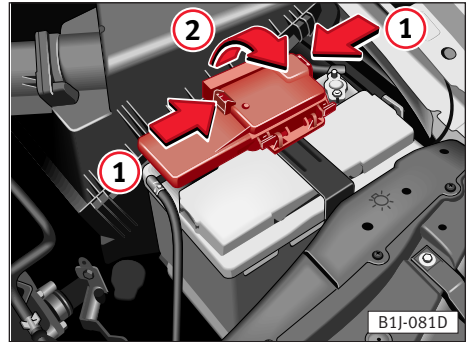

### Removing the battery

- Before removing the battery turn off the ignition and all electrical consumers.
- Press both spring clips in the direction of the arrow 1 and fold the cover of the fuse holder to the side (arrow 2).

**Please also refer to the further notes on the next page.**

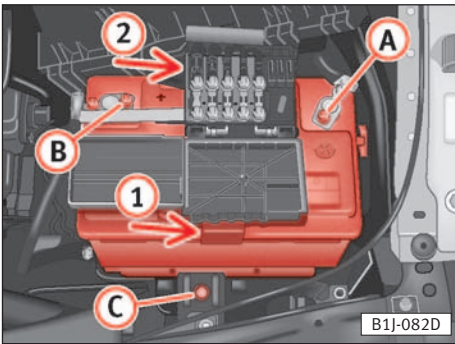

- Then remove the negative cable **A** (normally black, brown or blue).
- Then slightly loosen the nut **B** on the positive terminal.
- First unclip the front retainer (arrow **1**) and then the rear retainer (arrow **2**) from the battery. To do this you must press the retainers away from the battery.
- The fuse holder with the positive cable can now be removed upwards from the battery and placed to the side.
- Then unscrew the battery bracket **C** and remove the battery.

### Renewing the battery

Our batteries have been developed to suit their fitting location. If the battery has to be renewed, the new battery must have the same voltage (12 Volts), shape and safety features such as central degassing and the plugs must be sealed with an O-ring.

New output and capacity should be the same as the old battery. Technical Service Centres have a range of suitable batteries.

*Because of the problem of disposing of the old battery, the renewal should preferably be done at a Technical Service Centre. Batteries contain, amongst other things, sulphuric acid and lead and must on no account be put with normal household waste.*

### Installing the battery

- Switch off the ignition and all electrical consumers before installing the battery.
- Place the battery in the designated installation location. Please ensure that the bracket lug **C** lines up again with the same depth of the clamping strip. Then secure the battery.
- Place the fuse holder together with the positive cable on the battery so that the retainers on the sides of the battery engage.
- Then tighten the nut **B** on the positive terminal.
- Then connect the negative cable **A** to the battery.
- Fold the cover of the fuse holder back and allow both of the spring clips to engage.

## Windscreen washer

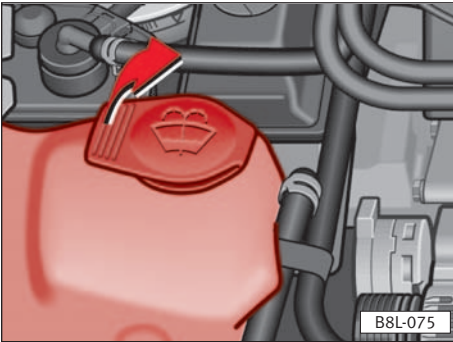

The fluid container is on the right of the engine compartment. The container holds about 3 litres: on vehicles with a headlight washer system\* it holds about 5.5 litres.

### Filling the container

You need to add a window cleaning solution with a wax remover to the water. There are several **appropriate products, containing isopropilic alcohol or methylated spirits** with wax dissolving properties (with anti-freeze additive in winter) on the market, because plain water is not usually sufficient to clean the glass and headlight lenses quickly and thoroughly. The mixing ratios on the window cleaner packaging must be adhered to.

Even when **heated windscreen washer jets\*** are fitted, a window cleaning solution containing anti-freeze should be added to the water in the winter.

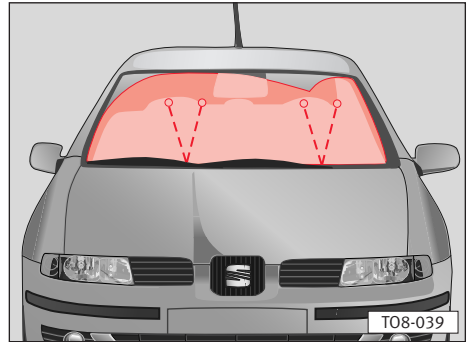

### Note

To avoid a possible error by the fluid level sensor, **the proportion of alcohol and water should be 35% alcohol and 65% water approximately.**

**For additional assistance go to a Technical Service Centre.**

**Under no circumstances should you add coolant anti-freeze or other additives.**

### Adjusting washer jets

The jet for the rear window washer is in the wiper shaft. The water jet should hit the glass in the centre of the wiped area.

The jets for the headlight washer system\* can only be adjusted with a special tool. When adjustment is necessary, contact a Technical Service Centre.

## Accessories, modifications and replacement of parts

Your vehicle is built in accordance with the most modern principles of safety technology and offers therefore a high degree of active and passive safety. To ensure that this remains so the vehicle as supplied by the factory may not be modified without careful thought. The following points must be noted if the vehicle is to be subsequently fitted with accessories, technically modified or have parts renewed later on:

- Always consult a Technical Service Centre **before** purchasing accessories and **before** any modifications are carried out.
- Approved accessories and original SEAT spare parts may be obtained through the Technical Services who will also, naturally, carry out the corresponding assembly in the required conditions.
- Appliances which have been retro-fitted and have a direct influence on the driver's control of the vehicle e.g. cruise control system or electronically controlled shock absorber systems must have the **e**<sup>1)</sup> symbol and be authorised for that vehicle.
- Additionally connected electric consumers e.g. refrigerators, horns, fans etc. which are not directly linked to the control of the vehicle must carry the **CE** symbol<sup>2)</sup>.

1) **e** – European Community authorisation symbol.

2) **CE** – Manufacturer conformity declaration in the European Community.

### Warning

- We inform you that expressly approved SEAT<sup>3)</sup> accessories and Genuine SEAT parts are available for your vehicle. The reliability, safety and suitability of those parts and accessories have been especially adapted for your vehicle.

- Despite continuous market observation we cannot assess or accept responsibility for other products, even in cases where an officially recognised permit has been issued.

- Accessories such as telephone retainers or drinks holders must never be attached to the Air Bag covers or within their area of effectiveness. They could cause injury if the Air Bag is activated during an accident!

- If technical modifications are to be made, our guidelines must be observed. This is to ensure that no damage occurs to the vehicle, the traffic and operating safety is retained and that the modifications are permissible.

3) Not available in all countries.

## Spark plugs

---

The spark plugs are renewed during the SEAT Inspection Service.

If the spark plugs have to be renewed between the Inspection Services, the following should be noted:

- Spark plugs and ignition system are matched to the engine and as such contribute to reducing the levels of exhaust pollutants. To avoid faulty operation, engine damage and even the withdrawal of the type approval due to excessive emissions values or non-suppressed spark plugs, only the Genuine spark plugs for the engine concerned should be used. Important, among other things, are the number of electrodes, the heat value and if necessary the radio suppression.
- The plugs may be, for technical reasons, modified at short notice.

## Dust and pollen filter\*

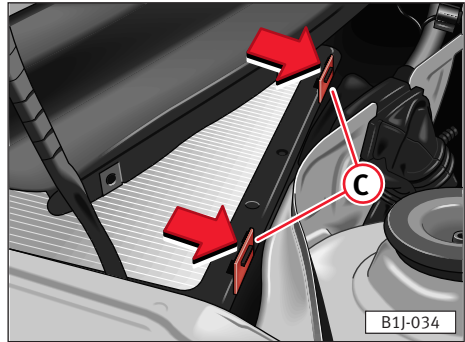
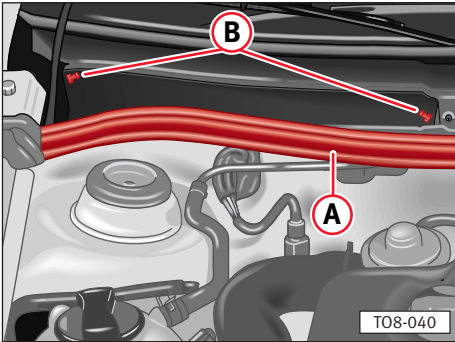

The dust and pollen filter for the heating and ventilation system can be found under the cover on the right in the plenum chamber. **The filter should be changed in accordance with the details given in the Inspection and Service schedule. If the air throughput reduces considerably, the filter should be changed earlier:**

### Removing filter

- Pull up the rubber seal **A** of the plenum chamber to the middle.
- **Carefully** unscrew all screws **B** completely and pull the cover off to the front. Because of their shape they will remain suspended in the cover. Pull the cover outwards.

- Push back spring clips **C** in the direction of the arrow and remove the filter insert.

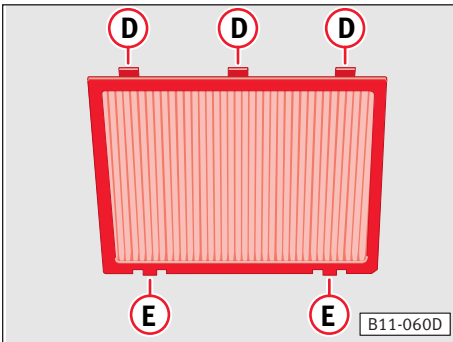

### Installing filter

For greater clarity, the illustration shows the dust and pollen filter already dismantled.

Push the filter into the recesses of the filter unit with the lugs **D** first.

Then press the filter down at the front until the spring clips **C** engage on the lugs **E**.

Screw the cover on tightly and press the rubber seal **A** onto the plenum chamber.

## First aid kit, warning triangle

---

In some countries a luminous hazard warning triangle must be carried in the vehicle to be used in an emergency, as well as a first aid kit and spare bulbs.

The first aid kit can be stored in the spare wheel recess. The warning triangle can be placed at the rear of the boot using rubber bands.

### Note

The first aid kit and warning triangle are **not** delivered with the vehicle as standard fittings.

### Recommendations

- **The first aid kit and warning triangle must fulfil legal requirements.**
- **You should bear in mind the use-by dates of the contents of the first aid kit.**



## On board tools, spare wheel

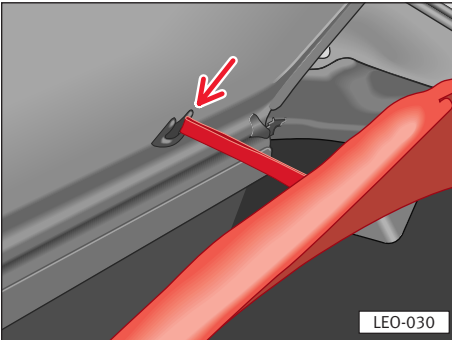

The tools are located in a polystyrene retainer, inside the spare wheel recess secured with a rubber strap.

### Warning

Ensure that the vehicle tools and spare wheel are stowed securely to avoid injuries for the passenger in case of a collision or sudden braking.

### Tool housing

The tools and the spare wheel are stored in the housing under the boot floor covering.

In order to have both hands free to lift out the spare wheel and the on board tools, the floor mat can be hooked to the lower part of the rear shelf.

## Vehicle tools / jack

### Warning

- The jack supplied by the factory is only designed for your vehicle model. On no account should heavier vehicles or other loads be lifted!
- With the vehicle lifted, never start the engine – danger of accident.
- If work has to be done underneath the vehicle, ensure that it is supported on suitable stands.

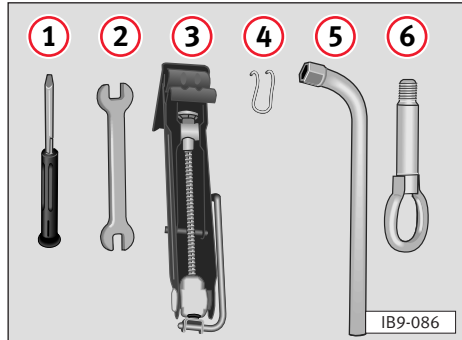

### Vehicles may also have:

- 1 – Screwdriver with box spanner in handle for the wheel bolts. The screwdriver blade is reversible.
- 2 – Open jaw spanner 10 x 13
- 3 – Jack  
Before the jack is placed back into the tool box, the claw must be fully wound back. The crank is then tensioned against the side of the jack.
- 4 – Wire hook\* for wheel trims
- 5 – Wheel bolt spanner
- 6 – Front towing ring

### Note

Never use the box spanner in the handle of the screwdriver to loosen or tighten wheel bolts.

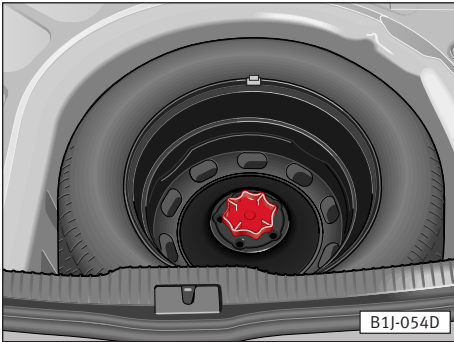

### Spare wheel/Reduced Space Spare Wheel\* (Four-wheel drive vehicles)

The wheel is located in the well under the floor covering in the boot, secured with a plastic nut.

If the wheel has been replaced, secure it with the plastic nut.

Four-wheel drive vehicles are equipped with a reduced space spare wheel<sup>1)</sup> which not only takes up less space than the normal spare wheel in the boot, but also weighs substantially less.

#### Removing the spare wheel

Attach the floor mat to the lower part of the boot cover.

Loosen the retaining strap and remove the polystyrene retainer.

Then turn the hand wheel in an anti-clockwise direction and remove it.

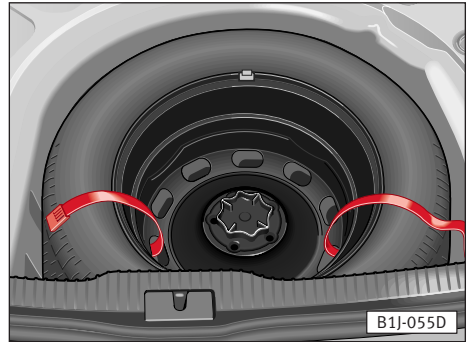

#### Securing the spare wheel

- Place the defective wheel in the housing and secure with the nut.
- Feed the retaining strap through the holes in the rim – see illustration.
- Turn the handwheel in a clockwise direction until the wheel is properly secured.
- Place the polystyrene retainer in the recess and secure it with the retaining strap.
- Remove the floor mat from the luggage compartment cover and replace on the floor of the luggage compartment.

#### Warning

**Ensure that the spare wheel, towing device\* and on board tools are properly secured, so that they cannot injure vehicle occupants if you have to brake suddenly or have an accident.**

<sup>1)</sup> In some countries and in the case of some model versions, a normal spare wheel may be provided instead. When using this wheel, follow the instructions on pages 3.66 to 3.72.

## Wheels

---

### General notes

- New tyres do not give maximum grip straight away and should therefore be run in at moderate speeds and a careful style of driving for about the first 100 km. This will help to make the tyres last longer.
- The tread depth of new tyres can vary due to construction and design features, and depending on version and manufacturers.
- Check tyres for damage from time to time (cuts, splits, cracks and lumps) and remove any foreign bodies embedded in the treads.
- To avoid damage to tyres and wheels drive over curbs and similar obstacles very slowly and as nearly at right angles as possible.

### Warning

**Damage to wheels and tyres is not always easy to see. Unusual vibrations or a pulling to one side could indicate tyre damage. If you suspect damage to a tyre, you should immediately reduce speed. Check all tyres visually for damage (bulges, tears etc.). If no external damage can be seen, drive carefully to the nearest Technical Service Centre and have the vehicle checked over.**

- Keep grease, oil and fuel off the tyres.
- Replace missing dust caps as soon as possible.
- Mark wheels before taking them off so that they rotate in the same direction when put back on again.
- When taken off, the tyres should be stored in a cool, dry and preferably dark place.

Tyres which are not on wheels should be stored in a vertical position.

### Note for tyres where the direction of rotation is stipulated

It is imperative that the designated direction of rotation for tyre treads (which can be determined from the arrow on the side of the tyre) be kept to. The best tyre performance i.e. in aquaplaning, road adhesion, noise and wear is then guaranteed.

### Tyre life

Tyre life depends to a considerable extent on the following factors:

#### Inflation pressure

The inflation pressures are to be found inside the fuel lid.

The inflation pressure is very important particularly at high speeds. Therefore, the pressures should be checked at least once a month and before every long journey.

At this opportunity do not forget the spare wheel:

- The spare wheel with normal tyre should always be inflated to the highest pressure required on the vehicle.
- Always check the pressures when the tyres are cold. When warm, the pressure is higher but do not reduce. If the load changes a great deal the pressure must be altered to suit.

On vehicles with wheel hub caps, valve extensions are fitted. It is not necessary to remove the valve extension piece in order to test and correct the inflation pressure.

**Pressures which are too high or too low shorten tyre life – quite apart from the detrimental influence on vehicle handling.**

#### **Warning**

**At continuous high speeds a tyre in which the pressure is too low flexes more and heats up excessively. This can cause tread separation and tyre blow out.**

*✿ A pressure which is too low increases the fuel consumption and this burdens the environment unnecessarily.*

#### **Mode of driving**

Fast cornering, hard acceleration and violent braking also increase tyre wear.

#### **Balancing wheels**

The wheels on new vehicles are balanced. However when the vehicle is running various influences can cause the wheels to become unbalanced and this causes steering vibration.

As imbalance also increases steering, suspension and tyre wear the wheels should be balanced again. Furthermore a wheel should always be rebalanced when the tyre has been repaired or when a new tyre has been fitted.

#### **Incorrect wheel alignment**

Incorrect wheel alignment not only causes excessive, usually uneven tyre wear, but can also impair the car's safe handling. If unusual tyre wear is noticed, contact a Technical Service Centre.

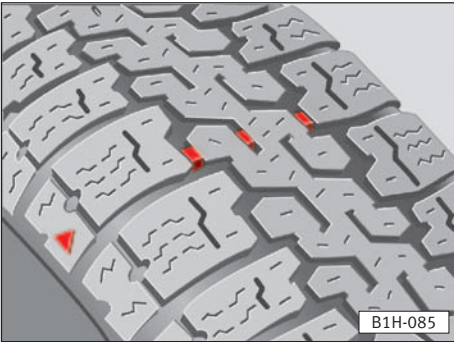

### Wear indicators

At the bottom of the tread of the original tyres there are 1.6 mm high “wear indicators” running across the tread – see fig. There are 6-8 of these indicators – according to make – evenly spaced around the tyre circumference. Marks on the walls of the tyre (for example the letters “TWI” or triangles) show the locations of the wear indicators.

### Warning

- **The tyres must be renewed when they are worn down to the wear indicators.**
- **Worn tyres are detrimental to roadholding particularly at high speeds on wet roads. Furthermore, the vehicle tends to aquaplane sooner.**

### Note

When tread depth is down to 1.6 mm measured in the tread groove next to the wear indicator bar – the official permissible minimum tread depth has been reached (in export countries this figure may differ).

### Renewing wheels/tyres

Wheels and tyres are important design features. The wheels and tyres approved by us should be used. They are specially matched to the model concerned and contribute largely to the excellent roadholding and safe driving characteristics.

**The Technical Services hold up to date information regarding the standard tyres fitted by the manufacturer. Also: Many Technical Services possess a large range of tyres and rims.**

- Fitting and repairing tyres requires expert knowledge and special tools. This work may only be carried out by specialist personnel.

*✿ Because of the problem of disposing of the old tyres, the special tools necessary and the specialist knowledge required, tyre changing should preferably be done by a Technical Service Centre.*

- For safety reasons the tyres should be renewed in pairs and not singly. The tyres with the deepest tread should always be on the front wheels.

- You should only combine radial tyres of the same construction, size (rolling circumference) and, as far as possible, the same tread profile on all four wheels.
- On four-wheel drive vehicles all tyres must be of the same brand. Otherwise, the viscosity would unnecessarily increase the proportion of the rear drive since the axes would be turning at different speeds and this could cause damage.
- If the spare wheel differs from the version fitted on the vehicle (i.e. winter or wide tyres) the spare tyre may only be used briefly and with an appropriately careful style of driving. It must be replaced with the normal wheel as soon as possible.
- Never fit used tyres where their previous history is not known.
- Knowing the tyre lettering and its meaning makes the selection of the correct tyres easier. Radial ply tyres have the following lettering on the sidewall:

e.g. 195 / 65 R 15 91 T	
<b>195</b> =	Tyre width in mm
<b>65</b> =	Height/width ratio in %
<b>R</b> =	Radial construction code letter = <b>Radial</b>
<b>15</b> =	Wheel diameter in inches
<b>91</b> =	Carrying capability code
<b>T</b> =	Speed code letter

**The manufacturing date** is also to be seen on the tyre wall (possibly only on inner side of wheel):

DOT ... 183 ... means that the tyre was produced in the 18th calendar week of 2003.

### Warning

Tyres which are more than 6 years old should only be used in an emergency and then with a particularly careful style of driving.

**If you wish to fit your car with non-standard wheels or tyres please note:**

### Warning

- For technical reasons it is not normally possible to use wheels from other vehicles – in certain circumstances not even wheels from the same vehicle model!

- Using types of wheel and/or tyres which have not been approved by us for your vehicle model can be detrimental to the safety of the vehicle. It can also affect the vehicle under the Construction and Use regulations.

### Warning

Please take notice of the warning notes on the next page.

- Wheels and wheel bolts are matched to each other.

Therefore, whenever wheels are changed to a different version (e.g. alloy wheels or wheels with winter tyres), the corresponding wheel bolts with the corresponding length and taper, must also be used. The security of the wheels and the functioning of the brake system depend on this!

- If wheel trim discs are subsequently installed it is essential to ensure that the air flow remains adequate to cool the brakes.

Technical Service Centres have all the necessary information about the possible conversion of wheels, tyres and wheel trims.

### Wheel bolts

The wheel bolts must be clean and easy to turn – do not grease or oil under any circumstances!

This applies not only to changing a defective wheel but also when replacing summer tyres with winter tyres and vice-versa.

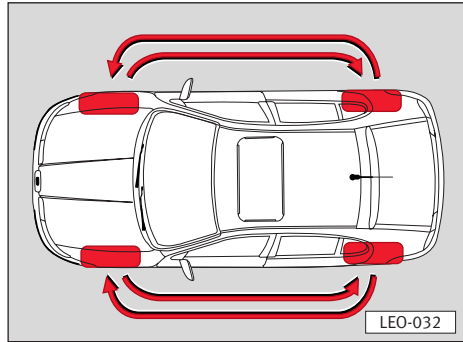

### Changing the wheels round

If the front tyres are worn more than the rear it is advisable to change the wheels round as shown. All tyres will then have approximately the same length of service life.

With certain types of tread wear it can be an advantage to change the wheels diagonally.

### Winter tyres

#### Warning

In winter conditions, winter tyres will significantly improve handling of the vehicle. This also applies to versions with four-wheel drive\*.

Because of their make up (width, rubber mixture, tread formation etc.), summer tyres provide less traction on ice and snow.



When fitting winter tyres note the following:

- For better driving performance, fit winter tyres on all four wheels.
- Winter tyres are no longer fully effective when the tread has worn down to a depth of 4 mm.

The following speed limits are valid for winter tyres:

Code letter Q max. 160 km/h

Code letter T max. 190 km/h

Code letter H max. 210 km/h

### Warning

**The highest permissible speed for your winter tyres must not be exceeded. This could damage the wheel and lead to a serious accident.**

**For this reason, in some countries, vehicles which can exceed this speed must have an appropriate sticker in the driver's field of view. These are available from Technical Service Centres.**

Please note regulations to this effect in your country.

- All-weather tyres can also be used instead of winter tyres.

- If you have a flat tyre the remarks on using the spare wheel on page 3.59 should be noted.

- Do not leave winter tyres fitted for an unnecessary long period because when the roads are free of snow and ice the handling with summer tyres is better.

 ***For environmental reasons summer tyres should be fitted again as soon as possible because normally they are quieter in running, tyre wear is reduced and the fuel consumption is lower.***

### Snow chains

Snow chains may only be fitted on the front wheels. This also applies to vehicles with four-wheel drive\*.

The use of snow chains on the tyres 195/65 R 15 or 175/80 R 14 is allowed.

**Only use thin chains which do not stand clear more than 15 mm (including tensioner).**

When using snow chains wheel trim plates and trim rings must be taken off. In this case, the wheel bolts must then be fitted with caps to protect them.

When driving over roads which are free of snow you must remove the chains. On such roads they are detrimental to vehicle handling, damage the tyres and wear out quickly.

In some countries the maximum permissible speed with snow chains is 50 km/h.

## Changing wheels

### Warning

- In case of a flat tyre or puncture, park the vehicle as far as possible away from the traffic flow. If necessary, switch hazard warning lights on and place the warning triangle in position – note any statutory requirements.

- All vehicle occupants should leave the vehicle and move to a safe area (e.g. behind safety barrier).

- Apply handbrake firmly, engage a gear or place the gear selector in position “P” and chock the opposite wheel with a stone or similar.

- When towing a trailer, the trailer must first be disengaged from the towing vehicle before the wheel is changed.

- Carry out wheel change on as flat a surface as possible.

- Take tools and spare wheel out of luggage compartment.

**When using the reduced space spare wheel\* (in four-wheel drive vehicles), please observe the following points:**

- As the emergency spare is smaller than a normal wheel, the free height of the axle over the spare is lowered by about 30 mm. Try not to use roads with bumps or pot holes to avoid damaging the underbody. Nor should you use an automatic car wash as the underbody may touch the floor.

- The emergency wheels of the different versions of the vehicle have been specially developed for their respective models. So they should not be exchanged or used in a different model. Nor should you use the emergency wheel from another model of car.

- Neither normal tyres nor winter tyres should be fitted onto this wheel.

### Warning!

- The emergency spare\* should only be used temporarily and for a short time, and it must be replaced as soon as possible.

- After fitting the emergency spare, check its pressure, which should be 4.2 bar, as soon as possible.

- You should not drive above 80 km/h. Avoid brusque accelerations, braking, and speeding around bends.

- You must never drive with more than one emergency spare wheel. For technical reasons, snow chains may not be used on spare wheels.

If you have to drive with snow chains and one of the front tyres is punctured, put the spare wheel on the rear axle. Replace the punctured front wheel with the rear wheel you have removed. Put the snow chains on before fitting the wheel.

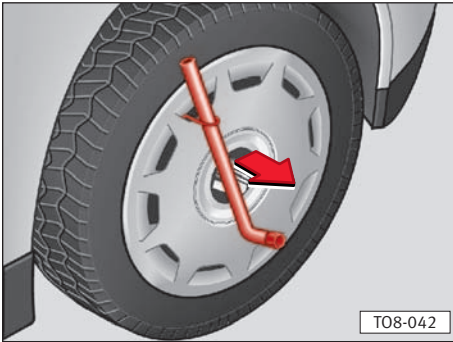

– Remove **centre cover** with the wheel spanner and the wire hook\*. Put the wire hook in one of the recesses of the wheel trim. Pass wheel spanner through hook and lever trim off – see illustration.

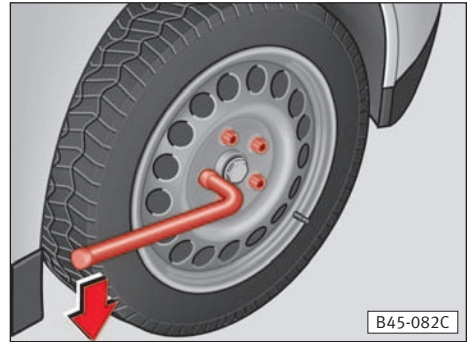

● Push the wheel spanner as far as possible onto the wheel bolt as shown and turn the spanner anti-clockwise. When doing this, grip the spanner as far as possible towards the lever end.

If the bolts cannot be loosened, one can in an emergency, carefully push the spanner down with a foot on the end of the lever. One should ensure that one has a firm stance and a good grip on the vehicle.

Loosen wheel bolts about one turn.

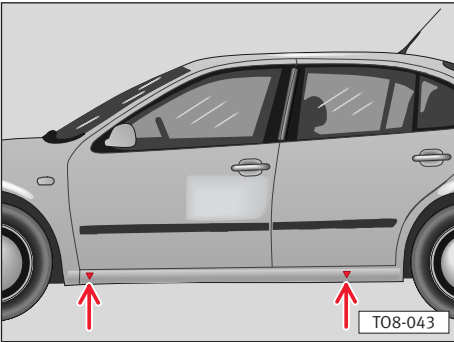

- Depressions under vehicle for jack:

**Warning**

If the jack is not fitted at the points marked or described, damage could be caused to the vehicle. There is also a risk of injury!

- Depressions in the side member at front and rear indicate the points at which the jack must be fitted – see arrows in illustration.
- These marks are about 15 cm and 25 cm from the front and rear wheel arch, respectively.

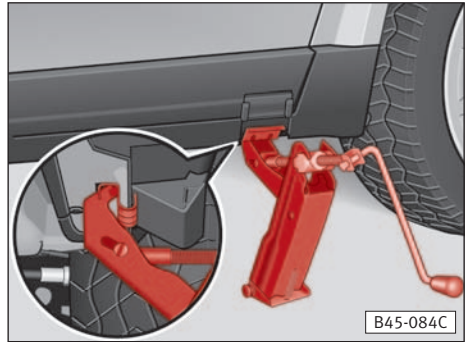

- Place jack under vehicle:

The illustration shows the jack fitted on the rear left hand side.

**Warning**

If the ground under the jack is too soft, the vehicle could slip off the jack.

Ensure, therefore, that the jack is on a solid surface. If necessary, use a large, stable underlay to place under the jack.

If the ground under the jack is slippery, place a non-slip rubber mat underneath.

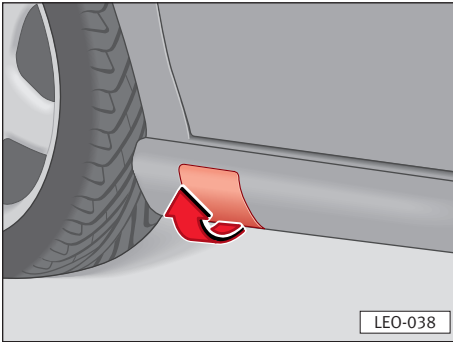

- In vehicles fitted with a plastic cover\*, remove the cover to access the attachment points of the vehicle. For this proceed as follows:

Pull on the cover and remove from its housing in the direction of the arrow.

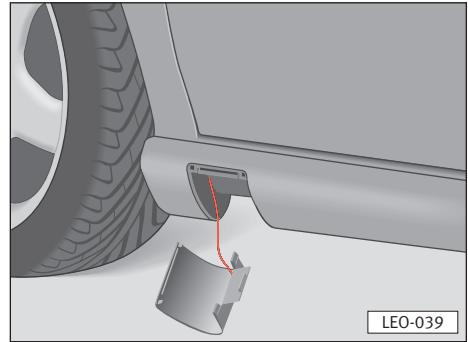

Once the cover is removed it will remain suspended by a rubber band to avoid its loss as shown in the illustration.

- Wind jack arm up by turning the crank in the spindle until the jack just goes under the vehicle.
- The claw of the jack must fit round the vertical rib on the side member so that the jack cannot slip when vehicle is lifted – see illustration on the page 3.68.
- Align jack and at same time wind claw up further until it contacts the vertical rib on side member.
- Lift vehicle until the wheel is just clear of the ground.

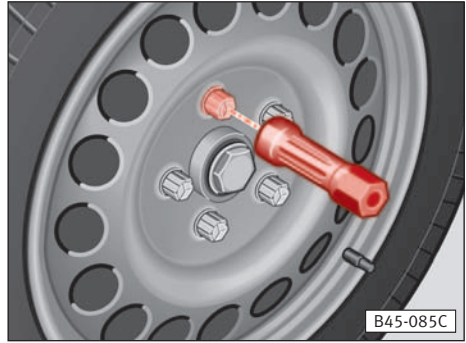

- Remove wheel bolts (**after loosening**), using box spanner in screwdriver handle (see illustration), place them on a clean surface (hub cap, cloth, paper) next to the jack and remove wheel.
- Fit spare wheel, and slightly tighten all bolts using the box spanner in the screwdriver handle.

**The wheel bolts must be clean and easy to turn – do not grease or oil under any circumstances!**

- Lower vehicle and fully tighten bolts in diagonal sequence using wheel spanner.
- Fit the wheel trim again.

When fitting the wheel trim, you must first press on the trim at the valve cut-out and then press on around the full circumference.

- Place defective wheel in spare wheel bracket and secure using handwheel.
- Feed the securing strap through the holes and use it to secure the polystyrene retainer for the vehicle tools.

## Notes

- The box spanner in the screwdriver handle makes handling the wheel bolts easier. The blade should be removed when doing this.

**Never use the box spanner in the handle of the screwdriver to loosen or tighten wheel bolts.**

- **The following points should be noted after changing a wheel:**

- Check the inflation pressure of the replacement wheel as soon as possible.
- Have the tightening torque of the wheel bolts checked with a torque wrench as quickly as possible. The torque for steel and alloy wheels and for the spare wheel is 120 Nm.

**If the wheel bolts are seen to be corroded or too tight when changing the wheel, they must be replaced before checking the torque.**

**Until this has been done, you should only drive at low speeds.**

- The defective wheel should be repaired as soon as possible.

## Warning

**If the vehicle is to be subsequently fitted with wheels or tires differing from those fitted by the factory, it is essential to always note the corresponding indications in the "Accessories, modifications and replacement of parts" chapter.**

## Notes for tyres where the direction of rotation is stipulated

It is imperative that the designated direction of rotation for the tyre treads (which can be determined from the arrow on the side of the tyre) be kept to. The best tyre performance i.e. in aquaplaning, road adhesion, noise and wear are then guaranteed.

If a spare wheel has to be fitted against the stipulated direction of rotation, this measure should only be a temporary one. The best possible tyre performance concerning aquaplaning, noise level and wear are no longer fully guaranteed.

We recommend that you take this into account, especially in wet weather, and adjust your speed to the driving conditions.

In order to use the principle of the direction of rotation fully again, the faulty tyre must be replaced as soon as possible.

If necessary, mount the tyre fitted against the direction of rotation in the stipulated direction.

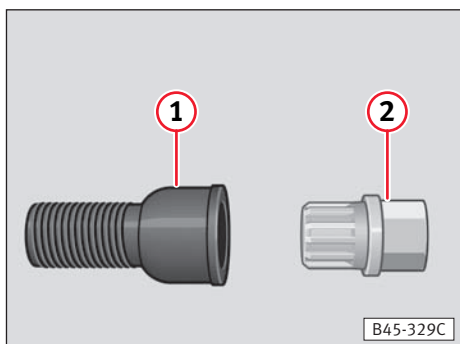

### Code

The code for the wheel bolt is engraved in the front of the adapter.

**Make a note of the code and keep it in a safe place. Only with this code can a replacement adapter be obtained at a SEAT Official Service Center.**

### Anti-theft\* wheel bolts

1 – Anti-theft wheel bolt

2 – Adapter for the wheel bolts

(The adapter is stored with the on board tools.)

### Loosen or tighten wheel bolts

- First, place adapter 2 as far as possible onto the anti-theft wheel 1 bolt.
- Place the wheel spanner (from the on board tools) as far as possible over adapter 2 and loosen or tighten the wheel bolt.
- After the wheel has been changed the adapter needs to be removed from the wheel bolt.

We recommend that you carry the adapter for the wheel bolts in the vehicle and stow it at a location well known to the owner, preferably with the on board tools.



## Fuses

The individual current circuits are protected by fuses.

It is advisable to always carry a few spare fuses on the vehicle.

### Notes

#### Warning

**Never, under any circumstances “repair” the fuses or replace them with more powerful ones, as damage in another part of the electrical system could occur. This could even lead to a fire.**

- If the newly inserted fuse blows again after a short time, the electrical system must be checked by a Technical Service Centre as soon as possible.
- Some of the components listed are only found on certain models or are optional extras.

### Changing a fuse

The fuses are located on the left hand side of the dash panel behind a cover.

On right-hand drive versions, the fuses are on the right hand side of the dash panel behind a cover.

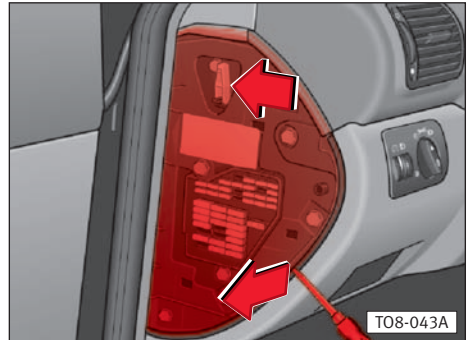

- Switch off the ignition and the component concerned.
- Take the cover off.

To do this, place the flat blade of the screwdriver in the recess on the cover (arrow) and lever off.

- With the aid of the list of fuses (see next pages or the cover of the fuse box) determine which fuse belongs to the component that has failed.
- Remove the appropriate fuse.
- Replace blown fuse – can be recognised by the burnt metal strip – with a fuse of **same** amperage.
- Replace the cover.

**Layout of fuses**

<b>No. Component</b>	<b>A<sup>1)</sup></b>	<b>No. Component</b>	<b>A<sup>1)</sup></b>
1– Heated washer jets, heated mirrors.....	10	23– Side light, left .....	5
2– Indicators .....	10	24– Windscreen washer system, pump .....	20
3– Lights .....	5	25– Heating, air conditioning .....	25
4– Number plate lighting .....	5	26– Heated rear window.....	20
5– Comfort on and off .....	7.5	27– Rear window wiper .....	10
6– Central locking .....	5	28– Fuel pump .....	15
7– Reverse lights .....	10	29– Engine control, petrol engine...	10
8– Telephone.....	5	30– Sliding roof .....	20
9– ABS .....	5	31– Automatic gear box.....	20
10– Petrol engine control unit .....	10	32– Injectors: petrol.....	10
11– Instrument panel.....	5	Engine control, diesel.....	15
12– Supply current, diagnosis, telephone .....	7.5	33– Headlight washers.....	20
13– Brake lights .....	10	34– Engine control, diesel engine... Engine control, petrol engine...	10
14– Interior lighting, central locking/ electric windows.....	10	35– Trailer device connection layout...	30
Interior light .....	5	36– Fog lights, rear fog light .....	5
15– Instrument panel, automatic gear box.....	5	37– Contact .....	10
16– Magnetic clutch, electric water pump .....	10	38– Boot light, Central locking/ electric windows.....	10
17– Free .....	7.5	39– Hazard warning lights.....	15
18– Main beam, right.....	10	40– Horn.....	20
19– Main beam, left.....	10	41– Lighter .....	15
20– Dipped beam, right .....	10	42– Radio .....	15
21– Dipped beam, left.....	10	43– Engine control, petrol engine... Engine control, diesel engine ..	10
22– Side light, right .....	5	44– Heated seat .....	15

1) Amperes.

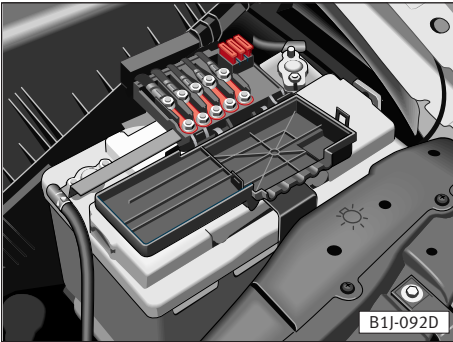

### Fuse box in the engine compartment on the battery

#### Fuses A<sup>1)</sup>

Radiator fan, 1st level .....	30
ABS engine relay.....	30
ABS main relay .....	30

#### Metal fuses<sup>2)</sup>

Alternator .....	150
On board network .....	110
Radiator fan, 2nd level.....	40
Engine distribution system.....	50
Glow plugs .....	50

1) Amperes.

2) These fuses should only be changed at a Technical Service Centre.

#### Fuse colour code:

Beige:	5 Amp
Brown:	7.5 Amp
Red:	10 Amp
Blue:	15 Amp
Yellow:	20 Amp
White	25 Amp
Green:	30 Amp

#### Automatic fuse

All electric windows are protected as a single set via an automatic fuse which breaks the circuit when overloaded (e.g. windows frozen) and completes the circuit again after a few seconds.

## Changing bulbs

Before starting to replace a bulb, you must first always switch off the consumer concerned.

Do not touch the glass part of the new bulb with bare fingers because the finger marks left on the glass evaporate when the bulb becomes hot, the vapour settles on the reflector and dims it.

Always use the same type of bulb. The designation is marked on the base of the bulb or on the glass.

It is advisable to always carry a box of spare bulbs in the vehicle. It should contain at least the following bulbs which are essential for traffic safety.

### Rear light bulbs

Fog light .....	12V/21W
Indicator .....	12V/21W
Rear low beam/ Brake light.....	12V/5 W 12V/21W
Number plate light .....	12V/5W
Reverse light.....	12V/21W

### Main beam bulb without fog light

Dipped beam.....	12V/55W (H7)
Main beam .....	12V/55W (H1)
Indicator .....	12V/21W
Side light.....	12V/5W

### Main beam bulb with fog light

Dipped beam.....	12V/55W (H7)
Fog light.....	12V/55W (H3)
Main beam .....	12V/55W (H1)
Indicator .....	12V/21W
Side light.....	12V/5W

### Warning

**H7 bulbs are pressured and can explode while being changed.**

**For this reason you should always wear gloves and protective glasses when changing an H7 bulb.**

### Note

As a result of the special construction of the engine and the subsequent space requirements, the following bulbs are difficult to replace.

### Main beam

### Side light

### Fog light\*

### Front indicators

For this reason these bulbs should always be changed at a Technical Service Centre. Notwithstanding, here follow instructions on how to change them, except for the fog lights\*.

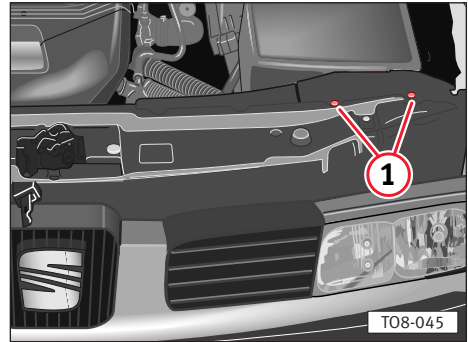
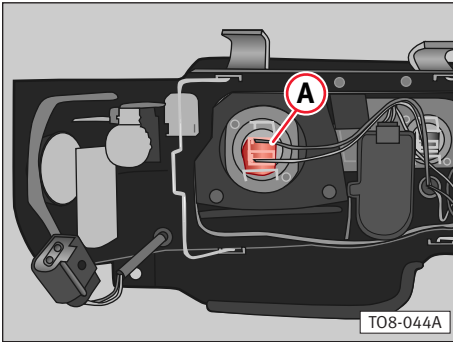

### Warning

When doing work in the engine compartment you must take great care – danger of injury!

For your own safety note the relevant warnings in the "Engine bonnet" and "Engine compartment" chapters/sections.

On some models, before changing the main beam and front indicator bulbs, bear in mind the following:

Remove the air aspiration tube and, depending on the engine, disconnect the battery<sup>1)</sup>.

### Main beam bulbs

The illustration shows the left headlight from the rear.

- A – Dipped beam bulb
- B – Main beam bulb
- C – Side light bulb
- D – Indicator bulb

<sup>1)</sup> Note safety warnings in the "Battery" chapter.

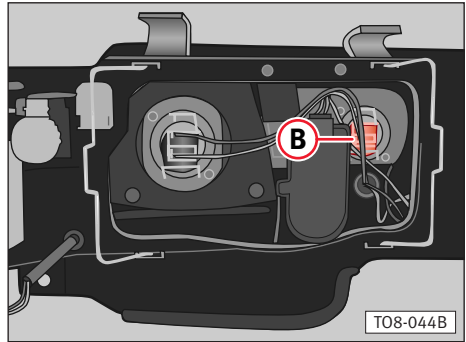
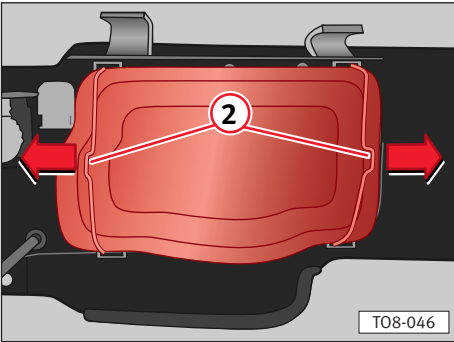

### A – Dipped beam bulb

- Open bonnet.
- Remove cover, loosening screws **1**.
- Unhook spring clips **2** in direction of arrow and fold away.
- Pull out the plug of the bulb cable.
- Release the retaining spring and pull it away.
- Take bulb out and insert new bulb so that the locating lug on the bulb plate engages the recess in the reflector.
- Fold spring clip over the bulb plate until the clip engages.
- Connect plug.
- Place cover into guide.
- Have the headlight beam alignment checked.

### B – Main beam bulb

- Open bonnet.
- Remove cover loosening screws **1**.
- Unhook spring clips **2** in direction of arrow and fold away.
- Pull out the plug of the bulb cable.
- Release the retaining spring and pull it away.
- Take bulb out and insert new bulb so that the locating lug on the bulb plate engages the recess in the reflector.
- Fold spring clip over the bulb plate until the clip engages.
- Connect plug.
- Place cover into guide.
- Have the headlight beam alignment checked.

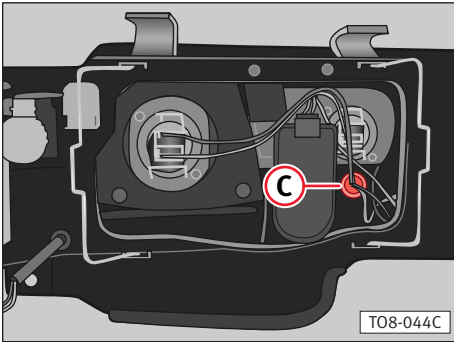

### C – Side light bulbs

- Open the bonnet.
- Remove the cover, loosening screws **1**.
- Unhook spring clips **2** in direction of arrow and fold away.
- Remove bulb holder from the reflector.
- Take bulb out.
- Fit the new bulb.
- Insert bulb carrier into reflector.
- Replace plastic cover.

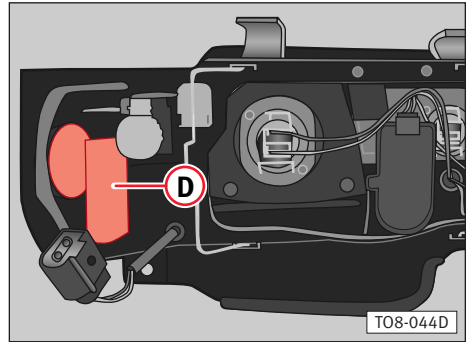

### D – Indicator bulb

- Open the bonnet.
- Remove the cover, loosening screws **1**.
- Unhook spring clips **2** in direction of arrow and fold away.
- Disconnect the connector, pressing the spring tab.
- Turn holder to right and remove it from its housing.
- Turn the bulb to the left and replace it.
- To re-assemble do the same steps in the reverse order.
- Plug in the connector
- Replace the plastic cover.

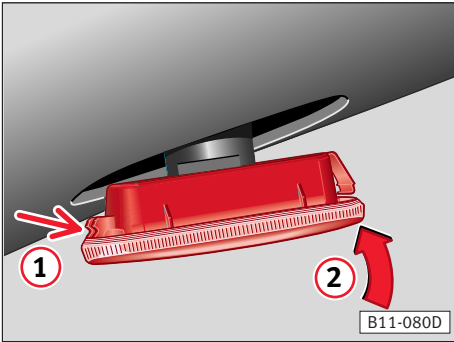

- Slide bulb holder into the indicator guides until the holder engages.
- First place the indicator with retaining lugs (arrow 1) in body opening and then engage the light in the direction of the arrow (arrow 2).

### Side indicators

- Press the indicator to the left or to the right and remove the bulb.
- Pull out bulb holder.
- Pull out the defective glass bulb and insert new one.



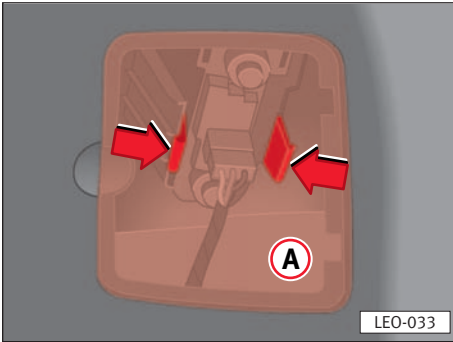

### Rear lights

#### Tailgate lights

#### Fog light

#### Reverse light

- Open tailgate.
- Remove plastic cover **A**.
- Press spring retainers in the direction of the arrows.
- Remove the bulb holder.
- Push on the bulb and turn it to the left.
- Remove the bulb and replace it.
- Replace the lamp holder.
- Replace the plastic cover **A**.

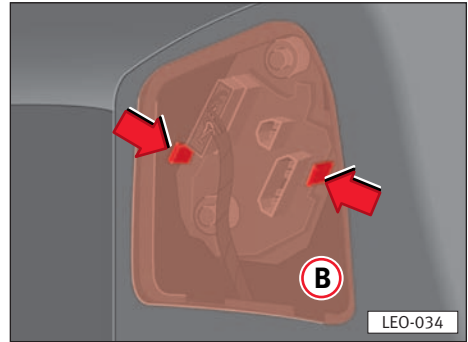

### Body work lights

#### Rear light

#### Brake light

#### Indicator light

- Open tailgate.
- Remove plastic cover **B**.
- Remove the bulb holder, pressing the side retainers.
- Push on the bulb and turn it to the left.
- Remove the bulb and replace it.
- Replace the lamp holder.
- Replace the plastic cover **B**.

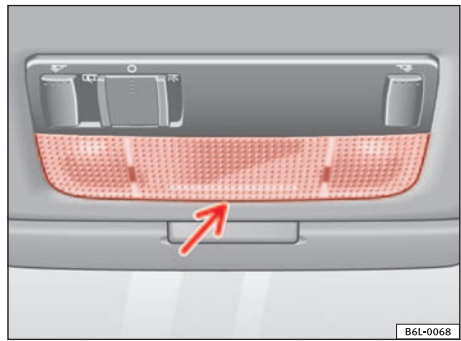
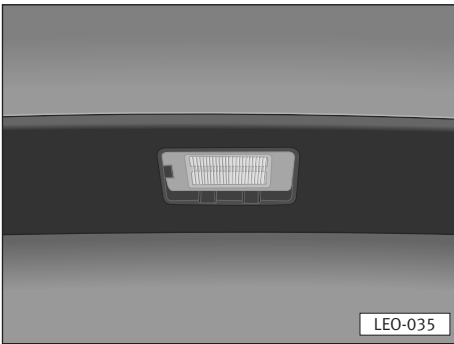

### Number plate light

- To remove the number plate light lever off the side spring retainers with great care to avoid possible breakage.
- Pull defective bulb out of holder and insert the new bulb.
- Insert lens in the tailgate opening, ensure that the rubber seal and the light are correctly positioned (see adjacent light).

### Interior light

- Remove the lens. To do this insert a fine screwdriver into the gap between the housing and lens (arrow) and lever the lens off carefully, to avoid damage.
- Pull out the defective bulb and insert a new one.
- First attach lens to switch trim with both retaining lugs. Then push up at front until both locking plugs engage.

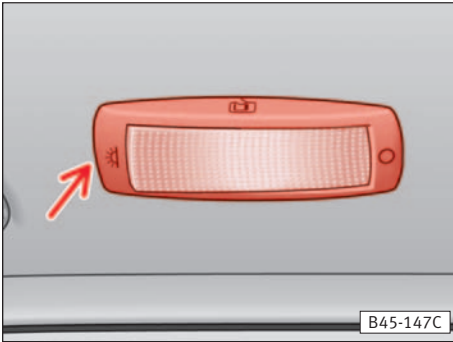

### Rear interior light\*

● Remove complete bulb holder. To do this, insert the flat blade of the screwdriver between the light and the roof trim (arrow) and carefully lever the bulb holder out.

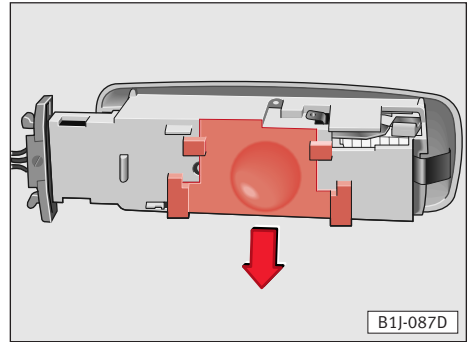

- Move plastic cover in the direction of the arrow and remove.
- Pull out defective bulb and insert new one.
- Slide bulb cover to the side until it engages.
- First insert light carrier from the connector side and then press into the opening of the roof trim.

### Additional brake light\*

Because of the difficulty of the operation, this bulb should only be changed by a Technical Service Centre.

### Glove compartment light

- Insert the screwdriver at the top between the light and the glove compartment and carefully lever the light out. Then take the light out at an angle.
- Change the bulb.
- Insert the light with the switch side at the bottom first and then at the top until it engages.

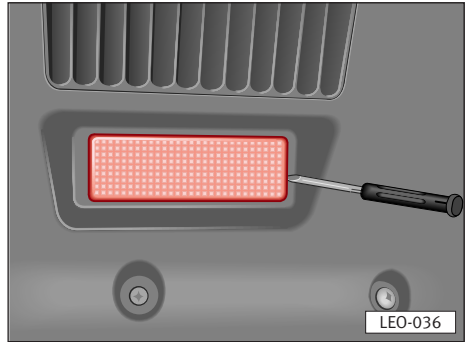

### Luggage compartment light

The luggage compartment light is located on the left side.

- Lever out the luggage compartment light with the flat end of a screwdriver, in the slot as indicated by the arrow in the illustration.
- Change the bulb.
- Refit the light from the switch side. Press upwards until it engages.

## Installing a radio

If a radio is installed or if the factory-provided radio is replaced, including speakers, the following must be noted:

- Connectors\* fitted in the vehicle are for Original SEAT Radios<sup>1)</sup>.
- Radios with different connectors must be connected with adaptor cables.

### Warning

**Never cut a cable and never leave it without insulation. If necessary use an adaptor.**

**Otherwise the cables could be overloaded and cause a short circuit – danger of fire.**

Furthermore, important electronic components could deteriorate or be damaged. In case of a disturbance in the speed signal, for example, it could cause failure in the engine control, automatic gearbox, ABS, etc.

Even if the speed signal is connected to a radio fitted with an automatic volume adjustment by a different manufacturer, a failure of the previously mentioned kind could occur.

To access the original speakers you must remove the entire door panel. Since this operation requires special tools and expertise, we recommend that this be undertaken by a Technical Service Centre.

- The radio and loudspeakers should therefore be fitted by a Technical Service Centre, who are perfectly conversant with all the technical specificities of the vehicles, and have Original Radios<sup>1)</sup> and all the necessary spares from the SEAT Original Parts Program<sup>1)</sup>. Moreover, all work is carried out according to factory standards.

- The radios from the SEAT Original Accessories program<sup>1)</sup> correspond to factory models and guarantee a trouble-free installation. These radios are fitted with advanced technology and are easy-to-use.

- It is also advisable to use speakers, assembly kits, antennas and anti-parasite kits from the Original Accessories program<sup>1)</sup>. These parts have been created for each type of vehicle.

### Roof antenna\*

The vehicle may be fitted with an extendable anti-theft roof antenna\* which can be folded backwards, i.e. at a car wash.

#### To fold

Unscrew rod, bend backwards to the horizontal position and screw in.

#### To use

Proceed in reverse.

<sup>1)</sup> Not for all countries.

## Mobile telephones and radio telephones

---

The installation of mobile telephones should be carried out by a Technical Service Centre.

SEAT has authorised the use of mobile telephones and two-way radios for your vehicle with correctly installed external aerial and maximum broadcast power of 10 Watts.

### Notes

**When using mobile telephones or two-way, faults in the vehicle electrics could occur under the following conditions:**

- no external aerial
- external aerial incorrectly installed
- broadcast power higher than 10 Watts.

**Mobile telephones or two-way radios must not, therefore, be operated inside the vehicle without a separate external aerial or with an aerial which has been incorrectly installed.**

### Warning

**Mobile telephones and two-way radios operated inside the vehicle without a separate external aerial or with an incorrectly installed external aerial can be harmful to health due to the extremely high electromagnetic fields generated.**

Furthermore, optimal range is only achieved with an external aerial.

### Note

**Please take into account the information in the instruction manuals provided along with mobile telephones and radiotelephones!**

If you want to use a mobile telephone or two-way radio with a broadcast power of higher than 10 Watt, please ask a Technical Service Centre. They are aware of the technical possibilities for retro-fitting mobile telephones and two-way radios.

### Warning

**Please concentrate on your driving first of all. Never install telephone retainers on the Air Bag cover or within its range of effectiveness. This would increase the risk of injury should the Air Bag be activated during an accident.**

## Emergency starting

---

If the engine will not start because the battery is flat, **jump leads** can be connected to the battery of another vehicle to start the engine. The following points should be noted:

- Both batteries must be of the 12 Volt variety and the capacity (Ah) of the booster battery must be approximately the same as that of the flat battery.
- The jumper cables must be heavy enough to carry the load. Note cable manufacturer's data.
- Only use jumper cables with insulated clips.

### Warning

**A flat battery can freeze at temperatures of less than 0°C. A flat battery must first be thawed out before attaching the jump leads, as it could otherwise explode.**

- There must be no contact between the vehicles, otherwise current can flow as soon as the plus terminals are connected.
- The flat battery must be properly connected to the electrical system.
- The engine of the boosting vehicle must be running.
- Ensure that the insulated clips have enough contact to metal. This is particularly applicable to clips which are attached to the engine block.

### Colors of jumper cables:

Positive cable: generally red.

Negative cable: generally black, brown or blue.

**Please note instructions on the following page.**

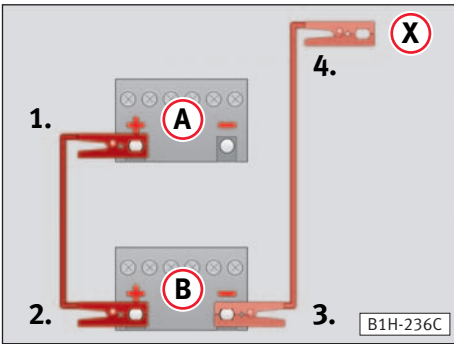

A – Flat battery

B – Boosting battery

The battery is in the engine compartment on the left looking forward.

**The emergency starting cable must be attached in the following order:**

Before the starting cable can be connected to the (+) terminal on the battery of the vehicle, the cover of the fuse holder must first be opened (see page 3.50).

1. One end of (+) cable (usually red) to the (+) terminal of the flat battery A.

2. Other end of the red cable to the (+) terminal of boosting battery B.

3. One end of (–) cable (usually black) to the (–) terminal of boosting battery B.

4. Other end of black cable (X) to a solid metal part bolted to the block or to cylinder block itself.

Do not connect the cable to the flat battery minus terminal. The sparks could ignite the explosive gas flowing out of the battery.

### Warning

- The non-insulated parts of the cable clips must not touch one another on any account. Furthermore the jumper cable attached to the battery positive terminal must not come into contact with electrically conductive vehicle parts – danger of short circuit!

- Route the jumper cables so that they cannot come into contact with rotating parts in the engine compartment.

- Do not stand with your face over the battery – danger of acid burns!

- Keep sources of ignition (naked flames, burning cigarettes etc.) well away from the battery – danger of explosion!

- Start the engine as described in the “Starting engine” section.

- If the engine does not start at once, stop using starter after 10 seconds, wait about half a minute and then try again.

- **With engine running, disconnect cables in reverse sequence to the connection.**



## Tow start/towing

---

### General notes

- Check whether there are any local traffic regulations concerning the towing of vehicles.

- The tow-rope should be slightly elastic to reduce the risk of damage to both vehicles. It is advisable to use synthetic fibre ropes, or ropes of similar elastic material. It is however safer to use a towing bar!

Avoid excessive towing effort and do not jerk. During towing operations on other than surfaced roads there is always the danger that the attachment points will be overloaded and damaged.

- **Before trying to tow start, an attempt should be made to start using the battery of another vehicle – see previous page.**

- When using a tow-rope the driver of the towing vehicle must engage the clutch very gently when moving off and changing gear.

- The driver of the vehicle being towed must ensure that the tow-rope is always taut.

- The emergency lights must be switched on in both vehicles – unless local regulations differ.

- Turn ignition on so that the steering wheel is free and the turn signals, horn, and, if necessary, the windscreen wiper and washer can be used.

- As the brake servo only works when the engine is running, considerably more pressure is required on the brake pedal when the engine is not running.

- More force than usual will be required to turn the steering wheel as the power assisted steering does not work when engine is not running.

- When there is no lubricant in the manual or automatic gearbox, the vehicle may only be towed with driving wheels lifted.

A tow-rope or a towing bar must only be applied at the following points:

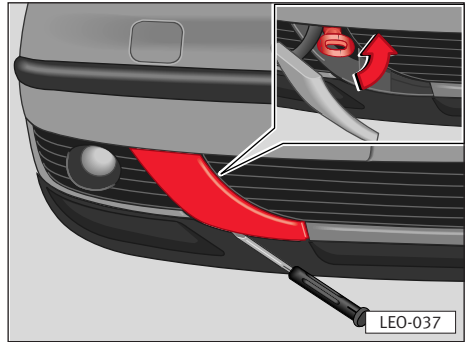
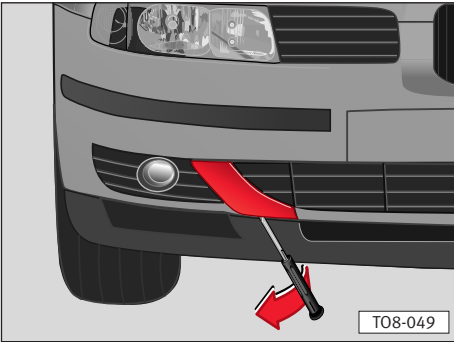

### Front towing eye

To be able to tow the vehicle, the right-hand cover in the lower part of the front bumper must be removed first.

**To remove the cover** insert the flat part of a screwdriver, as in the illustration, carefully lever off and remove the cover.

Screw in the towing eye which is located in the vehicle's tool box. Turn the eye **to the left** with the wheel spanner until the eye is perfectly screwed in.

To remove the towing eye, turn it to the right with the wheel spanner. Place it in its housing, inside the vehicle's tool box.

**To place the cover** put it in its housing and engage it by hitting it lightly with your hand.

### Note

The towing eye needs to be carried in the vehicle at all times.

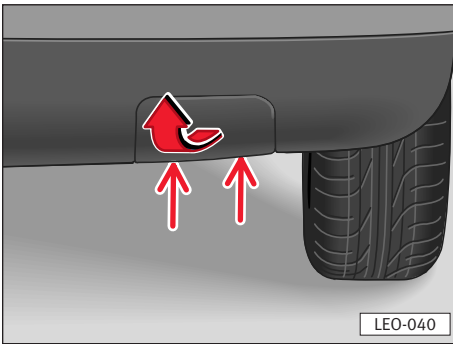

### Rear towing eye

To tow the vehicle first remove the cover on the lower right of the rear bumper.

**To remove cover** insert your fingers in the holes located on the lower part and pull.

Then you can use the eye for towing, as it is in an easily visible position.

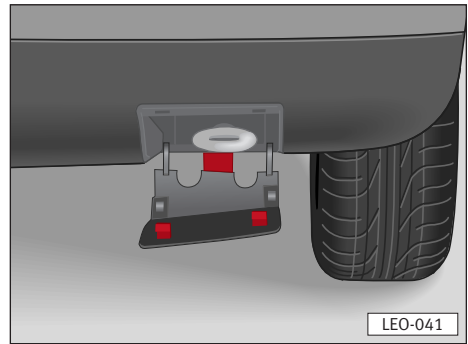

**To replace the cover** place it in its housing, facing first the lower flange and then the two upper clips. Then place the cover by gently hitting the perimeter with your hand.

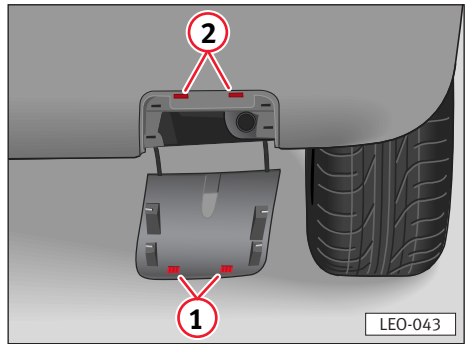
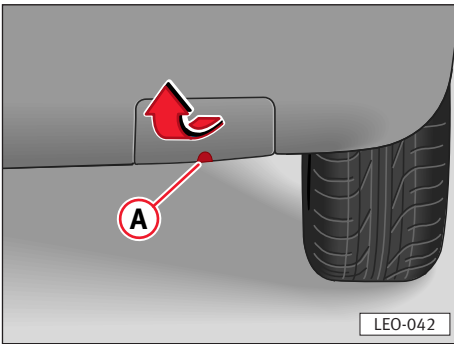

### Rear towing eye (sports version)

#### Remove

Firmly pull the cover down and backwards in the direction of the arrow by inserting your finger into the lower hole **A**.

#### Close

First insert the flanges **1** into their housings **2**. Gently press the edges of the cover with your hand until it is perfectly in place.

## Tow starting

**It is not advisable to tow start a vehicle. We recommend the use of another vehicle's battery. Consult the "Emergency starting" chapter.**

There are various reasons why a vehicle **should not be** tow started:

- When towing there is a danger of colliding with the towed vehicle.
- **In vehicles with a petrol engine, fuel may accumulate in the catalyts<sup>1)</sup> and cause damage.**

**The following points must be noted by the driver of the manual gear vehicle being tow started:**

- Before moving off, engage **2nd** or **3rd** gear, depress and hold clutch.
- Switch ignition on.
- Once both vehicles are moving, release the clutch.
- As soon as engine starts, depress clutch and move gear lever into neutral to avoid running into the towing vehicle.
- **For technical reasons tow starting a vehicle with an automatic gear box is not possible.**

<sup>1)</sup> Does not apply to vehicles with Diesel engine.

## Towing

**When towing** vehicles with an **automatic gearbox**, the following points must be noted in addition to the details on the previous page:

- Selector lever at **"N"**.
- Do not have the vehicle towed faster than 30 mph (50 km/h).
- Do not tow further than 30 miles (50 kilometres).

If the vehicle has to be towed long distances it must be lifted at the front.

Reason: When the engine is not running, the gearbox oil pump is not working and the gearbox is not adequately lubricated for high speeds or long distances.

- With a breakdown vehicle the vehicle may only be suspended at the front.

Reason: If given a rear suspended tow, the drive shafts turn backwards. The planetary gears in the automatic gearbox then turn at such high speeds that the gearbox will be severely damaged in a short time.

## Versions with four-wheel drive

### Manual gearbox

Like any other vehicle, this vehicle can be towed with a bar or a tow rope.

The vehicle can also be towed by a tow truck with a raised front or rear axis.

With this towing procedure:

- you should never exceed 50 km/h
- nor
- should you drive more than 50 km.
- If it is not possible to tow the car or if the car needs to be towed for more than 50 km, suitable transportation arrangements need to be made.

# INDEX

## GENERAL NOTES

General considerations on  
technical data. . . . . 4.2

## WEIGHTS AND MEASUREMENTS

Fixing points for tow bar\* . . . . . 4.4

## VEHICLE IDENTIFICATION DATA

Vehicle identification data . . . . . 4.5

## ENGINE DATA

1.4 16V 55 kW petrol engine . . . . 4.7

1.6 75 kW petrol engine . . . . . 4.8

1.6 16V 77 kW petrol engine . . . . 4.9

1.8 20V 92 kW petrol engine . . . 4.10

1.8 20V 92 kW (automatic  
gearbox) petrol engine . . . . . 4.11

Four-wheel drive 1.8 20V 132 kW  
(6-speed) petrol engine . . . . . 4.12

1.8 20VT 132 kW (6-speed)  
petrol engine . . . . . 4.13

2.0 136 kW petrol engine . . . . 4.14

Four-wheel drive 2.8 VR6 150 kW  
petrol engine . . . . . 4.15

1.9 TDI 66 kW Diesel engine . . . 4.16

1.9 TDI 74 kW Diesel engine . . . 4.17

1.9 TDI 81 kW Diesel engine . . . 4.18

1.9 TDI 96 kW Diesel engine . . . 4.19

1.9 TDI 110 kW (6-speed)  
Diesel engine . . . . . 4.20

## TECHNICAL DATA

Measurements . . . . . 4.21

Capacities . . . . . 4.21

Tyre pressures . . . . . 4.21

## General considerations on technical data

---

Unless otherwise indicated, all technical details provided below apply to vehicles with standard fittings.

These values may be different for special vehicles or vehicles destined for other countries.

Please bear in mind that the data in the car's official documents takes precedence.

### Engine data

The engine fitted in your vehicle is indicated in the data sheet included in the Inspection and Maintenance Plan and in the car's official documents.

### Performance

These values were calculated without extra equipment reducing performance, such as air conditioning, mud flaps, extra wide tyres, etc.

### Fuel Consumption

The consumption and emission levels were calculated using the 93/116/CE measuring standards and take into account the true free-standing weight of the vehicle (weight category). To measure the fuel consumption the vehicle is tested in two different cycles on a rolling bench under the following conditions:

- **Town driving** is measured from a cold start of the engine. Then, driving conditions similar to those of in-town driving are simulated.
- **Intercity driving** the car is accelerated and braked in all gears, just as in normal driving. The driving speed varies between 0 and 120 km/h.

- **Total consumption** is based on a balanced average of 37% of town driving and 63% of intercity driving.

- **CO<sub>2</sub> emission levels** are obtained from the exhaust fumes of the vehicles tested in town and intercity driving on a rolling belt. These fumes are then analysed and the CO<sub>2</sub> emission levels are obtained, among other values.

### Notes

- The consumption and emission levels given in the following tables are correct for unloaded vehicles with basic fittings. If there are extra fittings, the empty weight will increase and, as a result, the weight category, which may slightly increase the consumption and CO<sub>2</sub> levels. Consult a Technical Service Centre to find out the exact specifications of your vehicle.

- Driving style, road and traffic conditions, weather conditions and the condition of the vehicle will, in practice, produce consumption levels different to those indicated.

### Weights

#### Note

These weights are valid for European Union vehicles. Vehicles for other countries may have other weights. At all times it should be taken into account that the data given with the official vehicle document prevails.



**Warning**

- The maximum authorized load and the load on the axle must never be exceeded. See tables on the following pages.
- It must be remembered that when transporting heavy objects, the centre of gravity is displaced. For this reason, speed and driving should be adjusted accordingly.
- When loading luggage always ensure that no loose objects will fly towards the front of the vehicle in the event of sharp braking. If necessary use the lashing rings\* provided.

**Tyre pressure**

The pressure values given here are for cold tyres – do not reduce the high pressure of warm tyres.

**Warning**

**Tyre pressure is of great importance, particularly at high speeds, and should be checked at least once a month.**

**Tow loads****Support loads**

The **maximum** authorised load on the ball bar of the ball joint of the towing system is 75 kg.

The minimum support load must be 4% of the real tow load. However it need not be more than 25 kg. You should use the full authorised load available to you.

**Notes**

These weights are valid for European Union vehicles. Vehicles for other countries may take other weights. At all times it should be taken into account that the data given with the official vehicle documents prevails.

- **For safety reasons do not drive above 80 km/h, not even in countries where travelling at a greater speed is permitted.**
- Due to special versions of certain models and optional extras such as air conditioning, sliding/tilting roof, tow bar and other added features, the free standing weight increases, meaning that the load size is correspondingly reduced.

## Fixing points for tow bar\*

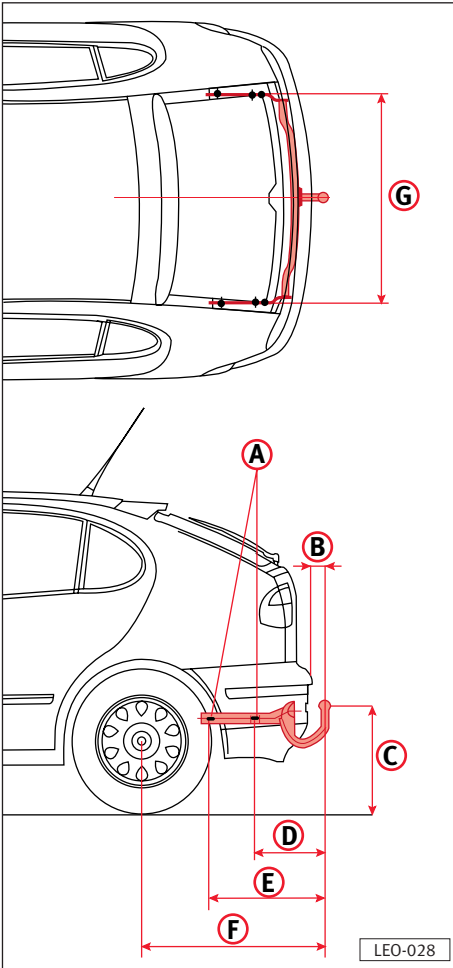

### Warning

**Danger of accident!**

We recommend that you visit a Technical Service Centre for the retrofitting of a tow hook.

**A** = 4 fixing points

**B** = 65 mm

**C** = 420 (empty vehicle)/  
350 mm (fully loaded vehicle)

**D** = 340 mm

**E** = 552 mm

**F** = 845 mm

**G** = 1014 mm

All measurements are in mm.

### Note

For more details see "Trailer towing" chapter.

## Vehicle identification data

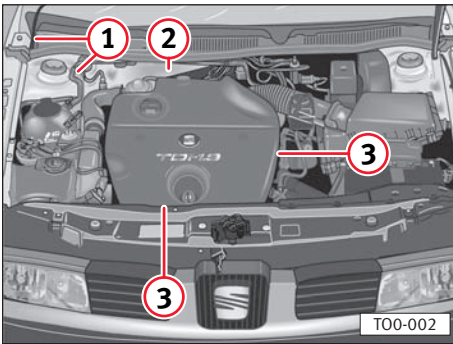

- 1 – Type plate.
- 2 – Vehicle identification number.
- 3 – Engine number.

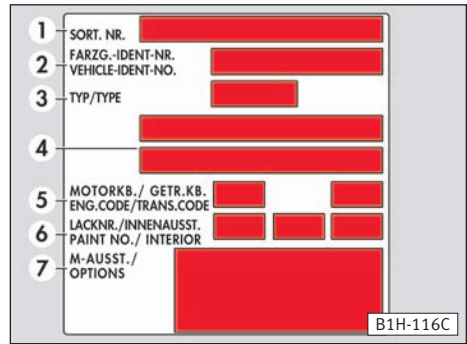

### Data-carrying adhesive

sticker is stuck on the inside rim of the spare wheel or on the floor of the boot.

It carries the following information:

- 1 – Production control bar code.
- 2 – Vehicle identification number.
- 3 – Vehicle model number.
- 4 – Model/engine power.
- 5 – Engine and gearbox lettering.
- 6 – Paint code/inside finish numbers.
- 7 – Optional extras code numbers.

The vehicle data from numbers 2 to 7 are also included in the maintenance and inspection plan.

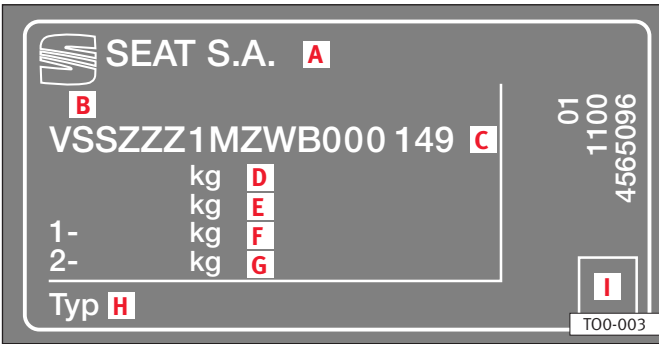

### Data-carrying adhesive

- A – Brand
- B – Countersign for the official approval number
- C – Chassis number
- D – M.A.W.<sup>1)</sup>
- E – M.A.W.<sup>1)</sup> of vehicle (loaded vehicle)
- F – M.A.W.<sup>1)</sup> on front axle
- G – M.A.W.<sup>1)</sup> on rear axle
- H – Type
- I – Emissions coefficient

<sup>1)</sup> Maximum Authorized Weight

## 1.4 16V 55 kW petrol engine

<b>Engine data</b>		
Output kW (HP)	after 1/min	55 (75)/5000
Maximum engine torque	in Nm after 1/min	126/3300
Number of cylinders/Cylinder capacity in cm <sup>3</sup>		4/1390
Compression		10.5 ± 0.3
Fuel		95 ROZ <sup>1)</sup> Super unleaded <sup>2)</sup>
<b>Performance</b>		
Maximum speed	in km/h	170
Acceleration 0-80 km/h	in seconds	9.6
Acceleration 0-100 km/h	in seconds	14.6
<b>Fuel consumption (l/100 km) / CO<sub>2</sub> (g/km)</b>		
Town driving		9.0/216      9.1/218
Intercity driving		5.4/130      5.5/132
Total		6.7/161      6.8/163
<b>Weights</b>		
Maximum authorised weight	in kg	1681
Free standing weight in driving order <sup>3)</sup> (with driver)	in kg	1236
Authorised load on front axle	in kg	855
Authorised load on rear axle	in kg	900
Authorised load on roof	in kg	75 <sup>4)</sup>
<b>Tow weights</b>		
Tow without brake on slopes of up to 12%		600 Kg
Tow with brake on slopes of up to 12%		1000 Kg
<b>Engine oil capacity</b>		
Engine oil capacity with oil filter change		3.5 l.

<sup>1)</sup> Research-Oktan-Zahl: Measurement of the anti-explosive power of petrol.

<sup>2)</sup> If the described fuel is not available then fuel conforming to the standard 91 ROZ<sup>1)</sup> lead free may be used. For more information, see the chapter about fuel.

<sup>3)</sup> Vehicles with basic equipment.

<sup>4)</sup> Maximum load on roof including roof rack (see "Roof rack" chapter).

## 1.6 75 kW petrol engine

<b>Engine data</b>		
Output kW (HP)	after 1/min	75 (102)/5600
Maximum engine torque	in Nm after 1/min	148/3800
Number of cylinders/Cylinder capacity in cm <sup>3</sup>		4/1595
Compression		10.3 ± 0.5
Fuel		95 ROZ <sup>1)</sup> Super unleaded <sup>2)</sup>
<b>Performance</b>		
Maximum speed	in km/h	189
Acceleration 0-80 km/h	in seconds	7.5
Acceleration 0-100 km/h	in seconds	11.3
<b>Fuel consumption (l/100 km) / CO<sub>2</sub> (g/km)</b>		
Town driving		9.9/238
Intercity driving		5.5/132
Total		7.1/170
<b>Weights</b>		
Maximum authorised weight	in kg	1717
Free standing weight in driving order <sup>3)</sup> (with driver)	in kg	1272/1378
Authorised load on front axle	in kg	880
Authorised load on rear axle	in kg	900
Authorised load on roof	in kg	75 <sup>4)</sup>
<b>Tow weights</b>		
Tow without brake on slopes of up to 12%		600 Kg
Tow with brake on slopes of up to 12%		1200 Kg
<b>Engine oil capacity</b>		
Engine oil capacity with oil filter change		4.8 l.

1) **Research-Oktan-Zahl:** Measurement of the anti-explosive power of petrol.

2) If the described fuel is not available then fuel conforming to the standard 91 ROZ<sup>1)</sup> lead free may be used. For more information, see the chapter about fuel.

3) Vehicles with basic equipment.

4) Maximum load on roof including roof rack (see "Roof rack" chapter).

## 1.6 16V 77 kW petrol engine

<b>Engine data</b>		
Output kW (HP)	after 1/min	77 (105)/5700
Maximum engine torque	in Nm after 1/min	148/4500
Number of cylinders/Cylinder capacity in cm <sup>3</sup>		4/1598
Compression		11.5 ± 0.3
Fuel		98 ROZ <sup>1)</sup> Super unleaded <sup>2)</sup>
<b>Performance</b>		
Maximum speed	in km/h	192
Acceleration 0-80 km/h	in seconds	7.2
Acceleration 0-100 km/h	in seconds	10.9
<b>Fuel consumption (l/100 km) / CO<sub>2</sub> (g/km)</b>		
Town driving		9.3/223      9.4/226
Intercity driving		5.5/132      5.6/134
Total		6.9/166      7.0/168
<b>Weights</b>		
Maximum authorised weight	in kg	1717
Free standing weight in driving order <sup>3)</sup> (with driver)	in kg	1272
Authorised load on front axle	in kg	880
Authorised load on rear axle	in kg	900
Authorised load on roof	in kg	75 <sup>4)</sup>
<b>Tow weights</b>		
Tow without brake on slopes of up to 12%		600 Kg
Tow with brake on slopes of up to 12%		1200 Kg
<b>Engine oil capacity</b>		
Engine oil capacity with oil filter change		4.5 l.

<sup>1)</sup> Research-Oktan-Zahl: Measurement of the anti-explosive power of petrol.

<sup>2)</sup> If the described fuel is not available then fuel conforming to the Super 95 ROZ<sup>1)</sup> lead free may be used.  
For more information, see the chapter about fuel.

<sup>3)</sup> Vehicles with basic equipment.

<sup>4)</sup> Maximum load on roof including roof rack (see "Roof rack" chapter).

## 1.8 20V 92 kW petrol engine

<b>Engine data</b>		
Output kW (HP)	after 1/min	92 (125)/6000
Maximum engine torque	in Nm after 1/min	170/4200
Number of cylinders/Cylinder capacity in cm <sup>3</sup>		4/1781
Compression		10.3 ± 0.5
Fuel		95 ROZ <sup>1)</sup> Super unleaded <sup>2)</sup>
<b>Performance</b>		
Maximum speed	in km/h	200
Acceleration 0-80 km/h	in seconds	7.0
Acceleration 0-100 km/h	in seconds	10.3
<b>Fuel consumption (l/100 km)</b>		<b>CO<sub>2</sub> (g/km)</b>
Town driving	10.8	259
Intercity driving	6.4	154
Total	8.0	192
<b>Weights</b>		
Maximum authorised weight	in kg	1766
Free standing weight in driving order <sup>3)</sup> (with driver)	in kg	1321
Authorised load on front axle	in kg	915
Authorised load on rear axle	in kg	910
Authorised load on roof	in kg	75 <sup>4)</sup>
<b>Tow weights</b>		
Tow without brake on slopes of up to 12%		650 Kg
Tow with brake on slopes of up to 12%		1200 Kg
<b>Engine oil capacity</b>		
Engine oil capacity with oil filter change		4.5 l.

1) **Research-Oktan-Zahl:** Measurement of the anti-explosive power of petrol.

2) If the described fuel is not available then fuel conforming to the standard 91 ROZ<sup>1)</sup> lead free may be used. For more information, see the chapter about fuel.

3) Vehicles with basic equipment.

4) Maximum load on roof including roof rack (see "Roof rack" chapter).



## 1.8 20V 92 kW (automatic gearbox) petrol engine

<b>Engine data</b>		
Output kW (HP)	after 1/min	92 (125)/6000
Maximum engine torque	in Nm after 1/min	170/4200
Number of cylinders/Cylinder capacity in cm <sup>3</sup>		4/1781
Compression		10.3 ± 0.5
Fuel		95 ROZ <sup>1)</sup> Super unleaded <sup>2)</sup>
<b>Performance</b>		
Maximum speed	in km/h	197
Acceleration 0-80 km/h	in seconds	8.6
Acceleration 0-100 km/h	in seconds	12.4
<b>Fuel consumption (l/100 km)</b>		<b>CO<sub>2</sub> (g/km)</b>
Town driving	12.1	290
Intercity driving	7.0	168
Total	8.9	214
<b>Weights</b>		
Maximum authorised weight	in kg	1779
Free standing weight in driving order <sup>3)</sup> (with driver)	in kg	1334
Authorised load on front axle	in kg	937
Authorised load on rear axle	in kg	900
Authorised load on roof	in kg	75 <sup>4)</sup>
<b>Tow weights</b>		
Tow without brake on slopes of up to 12%	650 Kg	
Tow with brake on slopes of up to 12%	1200 Kg	
<b>Engine oil capacity</b>		
Engine oil capacity with oil filter change	4.5 l.	

<sup>1)</sup> Research-Oktan-Zahl: Measurement of the anti-explosive power of petrol.

<sup>2)</sup> If the described fuel is not available then fuel conforming to the standard 91 ROZ<sup>1)</sup> lead free may be used. For more information, see the chapter about fuel.

<sup>3)</sup> Vehicles with basic equipment.

<sup>4)</sup> Maximum load on roof including roof rack (see "Roof rack" chapter).

## Four-wheel drive 1.8 20V 132 kW (6-speed) petrol engine

<b>Engine data</b>		
Output kW (HP)	after 1/min	132 (180)/5500
Maximum engine torque	in Nm after 1/min	235/1950-5000
Number of cylinders/Cylinder capacity in cm <sup>3</sup>		4/1781
Compression		9.5 ± 0.5
Fuel		98 ROZ <sup>1)</sup> Super unleaded <sup>2)</sup>
<b>Performance</b>		
Maximum speed	in km/h	224
Acceleration 0-80 km/h	in seconds	5.4
Acceleration 0-100 km/h	in seconds	7.8
<b>Fuel consumption (l/100 km)</b>		<b>CO<sub>2</sub> (g/km)</b>
Town driving	13.1	314
Intercity driving	7.6	182
Total	9.5	228
<b>Weights</b>		
Maximum authorised weight	in kg	1896
Free standing weight in driving order <sup>3)</sup> (with driver)	in kg	1471
Authorised load on front axle	in kg	975
Authorised load on rear axle	in kg	975
Authorised load on roof	in kg	75 <sup>4)</sup>
<b>Tow weights</b>		
Tow without brake on slopes of up to 12%		650 Kg
Tow with brake on slopes of up to 12%		1500 Kg
<b>Engine oil capacity</b>		
Engine oil capacity with oil filter change		4.5 l.

1) **Research-Oktan-Zahl:** Measurement of the anti-explosive power of petrol.

2) If the described fuel is not available then fuel conforming to the Super 95 ROZ<sup>1)</sup> lead free may be used.  
For more information, see the chapter about fuel.

3) Vehicles with basic equipment.

4) Maximum load on roof including roof rack (see "Roof rack" chapter).

## 1.8 20VT 132 kW (6-speed) petrol engine

<b>Engine data</b>			
Output kW (HP)	after 1/min	132 (180)/5500	
Maximum engine torque	in Nm after 1/min	235/1950-5000	
Number of cylinders/Cylinder capacity in cm <sup>3</sup>		4/1781	
Compression		9.5 ± 0.5	
Fuel		98 ROZ <sup>1)</sup> Super unleaded <sup>2)</sup>	
<b>Performance</b>			
Maximum speed	in km/h	229	
Acceleration 0-80 km/h	in seconds	5.7	
Acceleration 0-100 km/h	in seconds	7.7	
<b>Fuel consumption (l/100 km)</b>		<b>CO<sub>2</sub> (g/km)</b>	
Town driving		11.8	283
Intercity driving		6.6	158
Total		8.5	204
<b>Weights</b>			
Maximum authorised weight	in kg	1809	
Free standing weight in driving order <sup>3)</sup> (with driver)	in kg	1364	
Authorised load on front axle	in kg	955	
Authorised load on rear axle	in kg	910	
Authorised load on roof	in kg	75 <sup>4)</sup>	
<b>Tow weights</b>			
Tow without brake on slopes of up to 12%		650 Kg	
Tow with brake on slopes of up to 12%		1500 Kg	
<b>Engine oil capacity</b>			
Engine oil capacity with oil filter change		4.5 l.	

<sup>1)</sup> Research-Oktan-Zahl: Measurement of the anti-explosive power of petrol.

<sup>2)</sup> If the described fuel is not available then fuel conforming to the Super 95 ROZ<sup>1)</sup> lead free may be used.  
For more information, see the chapter about fuel.

<sup>3)</sup> Vehicles with basic equipment.

<sup>4)</sup> Maximum load on roof including roof rack (see "Roof rack" chapter).

## 2.0 136 kW petrol engine

<b>Engine data</b>		
Output kW (HP)	after 1/min	136 (185)/5100-6000
Maximum engine torque	in Nm after 1/min	270/1800-5000
Number of cylinders/Cylinder capacity in cm <sup>3</sup>		4/1984
Compression		10.3 ± 0.5
Fuel		98 ROZ <sup>1)</sup> Super unleaded <sup>2)</sup>
<b>Performance</b>		
Maximum speed	in km/h	221
Acceleration 0-80 km/h	in seconds	5.5
Acceleration 0-100 km/h	in seconds	7.8
<b>Fuel consumption (l/100 km) / CO<sub>2</sub> (g/km)</b>		
Town driving		11.2/269
Intercity driving		6.4/154
Total		8.1/194
		11.4/274
		6.6/158
		8.3/199
<b>Weights</b>		
Maximum authorised weight	in kg	1904
Free standing weight in driving order <sup>3)</sup> (with driver)	in kg	1409/1516
Authorised load on front axle	in kg	1050
Authorised load on rear axle	in kg	896
Authorised load on roof	in kg	75 <sup>4)</sup>
<b>Tow weights</b>		
Tow without brake on slopes of up to 12%		700 Kg
Tow with brake on slopes of up to 12%		1400 Kg
<b>Engine oil capacity</b>		
Engine oil capacity with oil filter change		5.3 l.

1) **Research-Oktan-Zahl:** Measurement of the anti-explosive power of petrol.

2) If the described fuel is not available then fuel conforming to the Super 95 ROZ<sup>1)</sup> lead free may be used.  
For more information, see the chapter about fuel.

3) Vehicles with basic equipment.

4) Maximum load on roof including roof rack (see "Roof rack" chapter).

## Four-wheel drive 2.8 VR6 150 kW petrol engine

<b>Engine data</b>		
Output kW (HP)	after 1/min	150 (204)/6200
Maximum engine torque	in Nm after 1/min	270/3200
Number of cylinders/Cylinder capacity in cm <sup>3</sup>		6/2792
Compression		10.75 ± 0.25
Fuel		98 ROZ <sup>1)</sup> Super unleaded <sup>2)</sup>
<b>Performance</b>		
Maximum speed	in km/h	235
Acceleration 0-80 km/h	in seconds	5.0
Acceleration 0-100 km/h	in seconds	7.3
<b>Fuel consumption (l/100 km)</b>		<b>CO<sub>2</sub> (g/km)</b>
Town driving	15.7	377
Intercity driving	8.2	197
Total	11.0	264
<b>Weights</b>		
Maximum authorised weight	in kg	2010
Free standing weight in driving order <sup>3)</sup> (with driver)	in kg	1585
Authorised load on front axle	in kg	1030
Authorised load on rear axle	in kg	1000
Authorised load on roof	in kg	75 <sup>4)</sup>
<b>Tow weights</b>		
Tow without brake on slopes of up to 12%	650 Kg	
Tow with brake on slopes of up to 12%	1490 Kg	
<b>Engine oil capacity</b>		
Engine oil capacity with oil filter change	4.5 l.	

<sup>1)</sup> Research-Oktan-Zahl: Measurement of the anti-explosive power of petrol.

<sup>2)</sup> If the described fuel is not available then fuel conforming to the Super 95 ROZ<sup>1)</sup> lead free may be used.  
For more information, see the chapter about fuel.

<sup>3)</sup> Vehicles with basic equipment.

<sup>4)</sup> Maximum load on roof including roof rack (see "Roof rack" chapter).

## 1.9 TDI 66 kW Diesel engine

<b>Engine data</b>		
Output kW (HP)	after 1/min	66 (90)/4000
Maximum engine torque	in Nm after 1/min	210/1900
Number of cylinders/Cylinder capacity in cm <sup>3</sup>		4/1896
Compression		19.5 ± 0.5
Diesel fuel		Min 49 CZ <sup>1)</sup> or RME
<b>Performance</b>		
Maximum speed	in km/h	180
Acceleration 0-80 km/h	in seconds	8.7
Acceleration 0-100 km/h	in seconds	12.7
<b>Fuel consumption (l/100 km)</b>		<b>CO<sub>2</sub> (g/km)</b>
Town driving	6.8	184
Intercity driving	4.3	116
Total	5.2	140
<b>Weights</b>		
Maximum authorised weight	in kg	1788
Free standing weight in driving order <sup>2)</sup> (with driver)	in kg	1343
Authorised load on front axle	in kg	945
Authorised load on rear axle	in kg	905
Authorised load on roof	in kg	75 <sup>3)</sup>
<b>Tow weights</b>		
Tow without brake on slopes of up to 12%		650 Kg
Tow with brake on slopes of up to 12%		1400 Kg
<b>Engine oil capacity</b>		
Engine oil capacity with oil filter change		4.3 l.

1) Cetan-Zahl (Cetane Index) = Measurement of fuel combustion power.

2) Vehicles with basic equipment.

3) Maximum load on roof including roof rack (see "Roof rack" chapter).

## 1.9 TDI 74 kW Diesel engine

<b>Engine data</b>		
Output kW (HP)	after 1/min	74 (100)/4000
Maximum engine torque	in Nm after 1/min	240/1800-2400
Number of cylinders/Cylinder capacity in cm <sup>3</sup>		4/1896
Compression		19 ± 0.5
Diesel fuel		Min 49 CZ <sup>1)</sup> or RME
<b>Performance</b>		
Maximum speed	in km/h	188
Acceleration 0-80 km/h	in seconds	8.2
Acceleration 0-100 km/h	in seconds	12.1
<b>Fuel consumption (l/100 km) / CO<sub>2</sub> (g/km)</b>		
Town driving		6.6/178      6.8/184
Intercity driving		4.3/116      4.4/119
Total		5.1/138      5.3/143
<b>Weights</b>		
Maximum authorised weight	in kg	1813
Free standing weight in driving order <sup>2)</sup> (with driver)	in kg	1368/1441
Authorised load on front axle	in kg	982
Authorised load on rear axle	in kg	985
Authorised load on roof	in kg	75 <sup>3)</sup>
<b>Tow weights</b>		
Tow without brake on slopes of up to 12%		650 Kg
Tow with brake on slopes of up to 12%		1400 Kg
<b>Engine oil capacity</b>		
Engine oil capacity with oil filter change		4.3 l.

1) Cetan-Zahl (Cetane Index) = Measurement of fuel combustion power.

2) Vehicles with basic equipment.

3) Maximum load on roof including roof rack (see "Roof rack" chapter).

## 1.9 TDI 81 kW Diesel engine

<b>Engine data</b>		
Output kW (HP)	after 1/min	81 (110)/4150
Maximum engine torque	in Nm after 1/min	235/1900
Number of cylinders/Cylinder capacity in cm <sup>3</sup>		4/1896
Compression		19.5 ± 0.5
Diesel fuel		Min 49 CZ <sup>1)</sup> or RME
<b>Performance</b>		
Maximum speed	in km/h	193
Acceleration 0-80 km/h	in seconds	7.4
Acceleration 0-100 km/h	in seconds	10.7
<b>Fuel consumption (l/100 km)</b>		<b>CO<sub>2</sub> (g/km)</b>
Town driving	6.8	184
Intercity driving	4.3	116
Total	5.2	140
<b>Weights</b>		
Maximum authorised weight	in kg	1779
Free standing weight in driving order <sup>2)</sup> (with driver)	in kg	1334
Authorised load on front axle	in kg	960
Authorised load on rear axle	in kg	895
Authorised load on roof	in kg	75 <sup>3)</sup>
<b>Tow weights</b>		
Tow without brake on slopes of up to 12%		650 Kg
Tow with brake on slopes of up to 12%		1400 Kg
<b>Engine oil capacity</b>		
Engine oil capacity with oil filter change		4.3 l.

1) Cetan-Zahl (Cetane Index) = Measurement of fuel combustion power.

2) Vehicles with basic equipment.

3) Maximum load on roof including roof rack (see "Roof rack" chapter).



## 1.9 TDI 96 kW Diesel engine

<b>Engine data</b>		
Output kW (HP)	after 1/min	96 (130)/4000
Maximum engine torque	in Nm after 1/min	310/1900
Number of cylinders/Cylinder capacity in cm <sup>3</sup>		4/1896
Compression		19 ± 0.5
Diesel fuel		Min 49 CZ <sup>1)</sup> or RME
<b>Performance</b>		
Maximum speed	in km/h	205
Acceleration 0-80 km/h	in seconds	6.8
Acceleration 0-100 km/h	in seconds	9.9
<b>Fuel consumption (l/100 km) / CO<sub>2</sub> (g/km)</b>		
Town driving	7,0/189	7,1/192
Intercity driving	4,3/116	4,5/122
Total	5,2/140	5,4/146
<b>Weights</b>		
Maximum authorised weight	in kg	1813
Free standing weight in driving order <sup>2)</sup> (with driver)	in kg	1368/1441
Authorised load on front axle	in kg	982
Authorised load on rear axle	in kg	985
Authorised load on roof	in kg	75 <sup>3)</sup>
<b>Tow weights</b>		
Tow without brake on slopes of up to 12%	650 Kg	
Tow with brake on slopes of up to 12%	1400 Kg	
<b>Engine oil capacity</b>		
Engine oil capacity with oil filter change	4.3 l.	

<sup>1)</sup> Cetan-Zahl (Cetane Index) = Measurement of fuel combustion power.

<sup>2)</sup> Vehicles with basic equipment.

<sup>3)</sup> Maximum load on roof including roof rack (see "Roof rack" chapter).

## 1.9 TDI 110 kW (6-speed) Diesel engine

<b>Engine data</b>		
Output kW (HP)	after 1/min	110 (150)/4000
Maximum engine torque	in Nm after 1/min	320/1900
Number of cylinders/Cylinder capacity in cm <sup>3</sup>		4/1896
Compression		18.0 ± 0.5
Diesel fuel		Min 49 CZ <sup>1)</sup> or RME
<b>Performance</b>		
Maximum speed	in km/h	215
Acceleration 0-80 km/h	in seconds	6.3
Acceleration 0-100 km/h	in seconds	8.9
<b>Fuel consumption (l/100 km)</b>		<b>CO<sub>2</sub> (g/km)</b>
Town driving	7.2	194
Intercity driving	4.4	119
Total	5.4	146
<b>Weights</b>		
Maximum authorised weight	in kg	1835
Free standing weight in driving order <sup>2)</sup> (with driver)	in kg	1390
Authorised load on front axle	in kg	980
Authorised load on rear axle	in kg	910
Authorised load on roof	in kg	75 <sup>3)</sup>
<b>Tow weights</b>		
Tow without brake on slopes of up to 12%		650 Kg
Tow with brake on slopes of up to 12%		1400 Kg
<b>Engine oil capacity</b>		
Engine oil capacity with oil filter change		4.3 l.

1) Cetan-Zahl (Cetane Index) = Measurement of fuel combustion power.

2) Vehicles with basic equipment.

3) Maximum load on roof including roof rack (see "Roof rack" chapter).

## Leon

<b>Measurements</b>		
Length/Width	4183 mm, 1742 mm	
Height at free standing weight	1439 mm	
Front and rear overhang	882 mm/790 mm 783 mm (four-wheel drive)	
Wheel base	2511 mm 2518 mm (four-wheel drive)	
Turning ratio	10.9 m	
Wheel gauge <sup>1)</sup>	<b>Front</b>	<b>Rear</b>
	1513 mm	1494 mm
	1505 mm	1486 mm
	1500 mm	1481 mm
<b>Capacities</b>		
Fuel tank	55 l. Reserve of 7 l. 62 l. (vehicles with four-wheel drive)	
Windscreen/Headlight washer tank	2.8 l./6.2 l.	
<b>Tyre pressures</b>		
<b>Summer tyres:</b> Tyre pressure is shown on the adhesive on the inside of the fuel cap.		
<b>Winter tyres:</b> The pressure of these tyres is identical to summer tyres. Just add 0,2 bars.		

<sup>1)</sup> This data may vary depending on the type of alloy.



## GENERAL INDEX

**A**

Accessories . . . . .	3.52
Adjustable steering column . . . . .	2.64
Adjusting mirrors . . . . .	2.55
Air conditioning . . . . .	2.78
– air recirculation . . . . .	2.80
– blower . . . . .	2.79
– controls . . . . .	2.79
– temperature selector . . . . .	2.79
– ventilation (fresh air) . . . . .	2.81
Air Bag . . . . .	1.16/2.22
Alloy wheels . . . . .	3.32
Anti-dazzle interior mirror . . . . .	2.55
Anti-freeze . . . . .	3.42
Anti-lock Brake System (ABS) . . . . .	2.20/3.8
Anti-skidding system of the drive wheels (TCS) . . . . .	2.48
Anti-theft alarm system . . . . .	2.33
Anti-theft wheel bolts . . . . .	3.72
Aquaplane . . . . .	3.62
Armrest . . . . .	2.63
Ashtrays . . . . .	2.72
Attach child seat . . . . .	1.15/1.30
Attaching child seats with the ISOFIX system . . . . .	1.31

Automatic car washes . . . . .	3.28
Automatic gearbox . . . . .	2.90
– notes on driving . . . . .	2.93
– reversing lights . . . . .	2.92

**B**

Balancing wheels . . . . .	3.61
Battery . . . . .	3.46
– charging . . . . .	3.48
– magic eye . . . . .	3.47
– renewing . . . . .	3.50
Biodiesel . . . . .	3.5
Boot light . . . . .	2.50
Brake fluid . . . . .	3.45
Brakes . . . . .	3.7

**C**

Capacities . . . . .	4.21
Care of paint . . . . .	3.29
Care of the vehicle . . . . .	3.28
– alloy wheels . . . . .	3.32
– cleaning seat belts . . . . .	3.31
Catalyst . . . . .	3.16
Cavity preservation . . . . .	3.34
Central locking . . . . .	2.27
– locking . . . . .	2.28
– opening . . . . .	2.27

Central locking button . . . . . 2.29

- automatic locking . . . . . 2.29
- automatic unlocking . . . . . 2.30
- unlocking . . . . . 2.30

Cetane Number. . . . . 3.5

Changing bulbs . . . . . 3.76

Changing engine oil . . . . . 3.41

Changing wheels . . . . . 3.66

Changing wiper blades. . . . . 2.53

Checking coolant level . . . . . 3.43

Checking oil level . . . . . 3.40

Child safety . . . . . 2.31

Cigarette lighter . . . . . 2.73

Cleaning and anti-corrosion treatment of engine compartment . . . . . 3.32

Cleaning the exhaust fumes . . . . . 3.16

Climatronic. . . . . 2.85

- air circulation . . . . . 2.87
- controls. . . . . 2.86
- vents . . . . . 2.85

Control of interior lights . . . . . 2.50

Coolant temperature. . . . . 2.6

Cooling system. . . . . 3.42

- additives . . . . . 3.42

Cruise control system . . . . . 2.101

## D

Data-carrying adhesive. . . . . 4.5

Defrosting windscreen and side windows. . . 2.77/2.81/2.86

Diesel . . . . . 3.5

Digital clock . . . . . 2.7

Door, boot and window seals . . . 3.30

Doors . . . . . 2.26

Drink can holder. . . . . 2.74

Driving abroad . . . . . 3.24

Driving in the winter

- care of vehicle. . . . . 3.28
- cooling system . . . . . 3.42
- defrosting windscreen and windows . . . . . 3.30
- diesel . . . . . 3.5
- engine oil . . . . . 3.38
- snow chains . . . . . 3.65
- windscreen washer . . . . . 3.51
- winter tyres . . . . . 3.64

Dust and pollen filter . . . . . 3.54

## E

Economical driving. . . . . 3.17

Electric socket . . . . . 2.73

Electric windows. . . . . 2.39

- roll-back function . . . . . 2.41

Electrically adjustable mirrors . . 2.55

Electronic Differential Lock (EDL) 2.20

Electronic immobiliser . . . . . 2.25

- Electronic Stability Program (ESP) . . . . . 2.48/3.13
- Emergency starting . . . . . 3.87
- Engine bonnet . . . . . 3.35
- Engine compartment . . . . . 3.36
- Engine data . . . . . 4.7-4.20
- Engine number . . . . . 4.5
- Engine oil . . . . . 3.38
- specifications . . . . . 3.38
- Engine oil additives . . . . . 3.41
-  *Environment*
- battery . . . . . 3.50
  - brake fluids . . . . . 3.45
  - care of the vehicle . . . . . 3.28
  - driving and reducing exhaust fumes and noise . . . 3.17
  - engine oil . . . . . 3.41
  - environment-friendly driving . 3.17
  - fuel . . . . . 3.4
  - purification of exhaust fumes. 3.16
  - tyre pressure . . . . . 3.61
  - tyres . . . . . 3.62
  - used oil . . . . . 3.41
  - used tyres . . . . . 3.62
- F**
- Filling the tank . . . . . 3.2
- Filter preheating . . . . . 3.6
- First aid kit . . . . . 3.56
- Fixing points for tow bar . . . . . 4.4
- Foot mats . . . . . 2.65
- Four-wheel drive . . . . . 3.10
- Front fog lights . . . . . 2.45
- Front seats . . . . . 1.32/2.58
- driver’s seat . . . . . 2.58
  - electrical adjustment . . . . . 2.60
  - front passenger seat . . . . . 2.58
  - lumbar support . . . . . 2.59
  - manual adjustment . . . . . 2.59
- Front towing eye . . . . . 3.90
- Fuel gauge . . . . . 2.7
- Fuses . . . . . 3.73
- G**
- Gear layout . . . . . 2.90
- Gear lever . . . . . 2.90
- General considerations on technical data . . . . . 4.2
- Glove box light . . . . . 2.50
- H**
- Hand brake . . . . . 2.18/2.96
- Hazard warning lights . . . . . 2.47
- Head restraints . . . . . 1.33/2.62
- Headlight covering . . . . . 3.25
- Headlight flasher . . . . . 2.49
- Headlight range control . . . . . 2.46
- Headlight washer system . . . . . 2.52

Heated rear window . . . . . 2.46

Heated seats . . . . . 2.64

Heating and ventilation . . . . . 2.75

– air recirculation . . . . . 2.76

– blower . . . . . 2.76

– controls . . . . . 2.76

– temperature selector . . . . . 2.76

– ventilation (fresh air) . . . . . 2.77

– vents . . . . . 2.75

Horn . . . . . 2.4

**I**

Ignition lock . . . . . 2.97

Indicators and dipped beam  
lever . . . . . 2.49

Installing a radio . . . . . 3.85

Instrument lighting . . . . . 2.46

Instruments . . . . . 2.5

Interior lights . . . . . 2.50

**J**

Jack . . . . . 3.58/3.68

Jumper cables . . . . . 3.87

**K**

Key tag . . . . . 2.23

Keys . . . . . 2.23

Keys with remote control . . . . . 2.24

Kick-down device . . . . . 2.93

**L**

Lashing eyes . . . . . 2.66

Lighting switch . . . . . 2.45

Lights . . . . . 2.45

Locking locations of the  
vehicle . . . . . 2.27

Lubricants . . . . . 3.38

Luggage compartment . . . . . 2.65

**M**

Manual gearbox . . . . . 2.90

– reversing lights . . . . . 2.90

Measurements . . . . . 4.21

Mileage clock/Trip mileage . . . . . 2.11

Mirror heating . . . . . 2.56

Mobile telephones and radio  
telephones . . . . . 3.86

Multifunction indicator . . . . . 2.8

**N**

Natural leather . . . . . 3.31

**O**

Octane . . . . . 3.4

On board tools . . . . . 3.57

**P**

Parking lights . . . . . 2.49

Pedals . . . . . 2.65



Petrol . . . . . 3.4  
 – additives . . . . . 3.4  
 – quality . . . . . 3.4  
 Power steering . . . . . 3.14

## R

Radiator fan . . . . . 3.44  
 Radio . . . . . 2.4  
 Radio-frequency remote control  
 key . . . . . 2.36  
 – selective unlocking . . . . . 2.37  
 – synchronization . . . . . 2.38  
 Rain sensor . . . . . 2.51  
 Reading light . . . . . 2.50  
 Rear fog light . . . . . 2.45  
 Rear seat . . . . . 2.68  
 Rear shelf . . . . . 2.67  
 Rear towing eye . . . . . 3.91  
 Rear-view mirrors . . . . . 2.55  
 Replacement keys . . . . . 2.23  
 Replacement of parts . . . . . 3.52  
 Reverse gear . . . . . 2.90/2.92  
 Revolutions counter . . . . . 2.5  
 Roof antenna . . . . . 3.85  
 Roof rack . . . . . 2.70  
 Running-in . . . . . 3.15

## S

Safety for children . . . . . 1.25

Seat belts . . . . . 1.3  
 Selector lever . . . . . 2.92  
 Selector lever positions . . . . . 2.92  
 Service interval indicator . . . . . 2.12  
 Servobrake . . . . . 3.8  
 Short or long beams . . . . . 2.49  
 Side lights . . . . . 2.45  
 Sliding/tilting roof . . . . . 2.43  
 Snow chains . . . . . 3.65  
 Spare parts . . . . . 3.52  
 Spare wheel . . . . . 3.59  
 Spark plugs . . . . . 3.53  
 Speedometer . . . . . 2.7  
 Starting the engine . . . . . 2.98  
 – after running out of fuel . . . . . 2.99  
 – diesel engines . . . . . 2.99  
 – petrol engines . . . . . 2.98  
 Stopping the engine . . . . . 2.100  
 Stowage box . . . . . 2.73  
 Switches . . . . . 2.45  
 Switches in the central console . . . . . 2.48

## T

Table . . . . . 2.2  
 Tailgate . . . . . 2.32  
 – unlock . . . . . 2.32  
 The first 1,500 km . . . . . 3.15  
 Thematic index . . . . . 1.1/2.1/3.1/4.1  
 Tool housing . . . . . 3.57

Tow start. . . . . 3.89

Trailer towing . . . . . 3.21

– attachment points . . . . . 3.21

Turn signals . . . . . 2.49

Type plate. . . . . 4.5

Tyre life. . . . . 3.60

Tyres. . . . . 3.60

– inflation pressure . . . . . 3.60

– running-in . . . . . 3.60

– wear indicators . . . . . 3.62

– where the direction of rotation  
is stipulated . . . . . 3.60

**U**

Undercoating . . . . . 3.33

Unleaded petrol . . . . . 3.4

Unlocking the tank flap . . . . 2.48/3.2

**V**

Vehicle identification data . . . . 4.5

Vehicle identification number. . . 4.5

Vehicle wallet stowage  
compartment . . . . . 2.74

Volumetric sensor. . . . . 2.35

**W**

Warning lamps . . . . . 2.13

– Air Bag . . . . . 2.22

– alternator . . . . . 2.17

– anti-locking brake system  
(ABS) . . . . . 2.20

– brake wear monitor . . . . . 2.19

– brakes/hand brake . . . . . 2.18

– coolant temperature/level. . . 2.15

– diagnosis / excess of  
pollution . . . . . 2.19

– drive wheels spin regulator  
(TCS) . . . . . 2.21

– electronic accelerator pedal  
control (EPC) . . . . . 2.22

– electronic immobilizer. . . . . 2.19

– Electronic Stability Program  
(ESP) . . . . . 2.21

– engine oil pressure/level . . . 2.18

– fuel level . . . . . 2.16

– indicators . . . . . 2.15

– main beam . . . . . 2.16

– parking light/dipped beam . . 2.21

– preheating system. . . . . 2.22

– rear fog light . . . . . 2.22

– seat belt warning lamp . . . . 2.17

– selector lever position. . . . . 2.16

– tailgate . . . . . 2.19

– trailer indicators . . . . . 2.16

– warning lamps display  
screen . . . . . 2.16

– windscreen washer water  
level . . . . . 2.20

Warning triangle . . . . .	3.56	Windscreen washer . . . . .	3.51
Washing . . . . .	3.28	– filling the container . . . . .	3.51
Washing vehicle with high pressure cleaner . . . . .	3.29	Windscreen wipers and washers . . . . .	2.51
Wear indicators . . . . .	3.62	– rear windscreen . . . . .	2.52
Wheel bolts . . . . .	3.70	– windscreen . . . . .	2.51
Wheels . . . . .	3.60	Winter tyres . . . . .	3.64
Wheelspin control (TCS) . . . . .	3.11	Wiper blades . . . . .	2.53
Windows . . . . .	2.39		



SEAT S.A. is permanently concerned about continuous development of its types and models. For this reason we ask you to understand, that at any given time, changes regarding shape, equipment and technique may take place on the car delivered. For this reason no right at all may derive based on the data, drawings and descriptions in this current handbook.

All texts, illustrations and standards in this handbook are based on the status of information at the time of printing. Except for error or omission, the information included in the current handbook is valid as of the date of closing print.

Re-printing, copying or translating, whether total or partial is not allowed unless SEAT allows it in written form.

SEAT reserves all rights in accordance with the "Copyright" Act.

All rights on changes are reserved.

 This paper has been manufactured using bleached non-chlorine cellulose.

© SEAT S.A. - Reprint: 15.10.03



Inglés 1M6012003BA (09.05)

(GT9)