



# OWNER'S MANUAL

Altea



## About this manual

This manual contains a description of the **equipment** supplied with the vehicle at the time this manual was published. Some of the units described herein will not be available until a later date or are only available in certain markets.

**Because this is a general manual for the ALTEA range, some of the equipment and functions that are described in this manual are not included in all types or variants of the model; they may vary or be modified depending on the technical requirements and on the market; this is in no way deceptive advertising.**

The **illustrations** are intended as a general guide and may vary from the equipment fitted in your vehicle in some details.

The **steering indications** (left, right, forward, reverse) appearing in this manual refer to the normal driving movements of the vehicle except when otherwise indicated.

★ The **equipment marked with an asterisk\*** is fitted as standard only in certain versions, and is only supplied as optional extras for some versions, or are only offered in certain countries.

® All **registered marks** are indicated with ®. Although the copyright symbol does not appear, it is a copyrighted mark.

» The section is continued on the following page.

### WARNING

Texts preceded by this symbol contain information on safety. They warn you about possible dangers of accident or injury.

### CAUTION

Texts with this symbol draw your attention to potential sources of damage to your vehicle.

### For the sake of the environment

Texts preceded by this symbol contain relevant information concerning environmental protection.

### Note

Texts preceded by this symbol contain additional information.

This manual is divided into five large parts, which are:

1. Safety
2. Operation
3. Tips
4. Technical data
5. Alphabetical index

At the end of this manual, there is a detailed alphabetical index that will help you quickly find the information you require.

## Foreword

This Instruction Manual and its corresponding supplements should be read carefully to familiarise yourself with your vehicle.

Besides the regular care and maintenance of the vehicle, its correct handling will help preserve its value.

**For safety reasons, always note the information concerning accessories, modifications and part replacements.**

If selling the vehicle, give all of the on-board documentation to the new owner, as it should be kept with the vehicle.

You can access the information in this manual using:

- Thematic table of contents that follows the manual's general chapter structure
- Alphabetical index with many terms and synonyms to help you find information.

### WARNING

**Read and always observe safety information concerning the passenger's front airbag »» page 25, Important information regarding the front passenger's airbag.**



## Table of Contents

<b>Safety</b> .....	5	Electric windows .....	72	Parking aid acoustic system* .....	140
<b>Safe driving</b> .....	5	Sliding/tilting sunroof* .....	74	Cruise speed* (cruise control system - CCS) ...	142
Safety first! .....	5	<b>Lights and visibility</b> .....	75	<b>Towing bracket device</b> .....	144
Advice about driving .....	5	Lights .....	75	Trailer towing .....	144
Proper sitting position for occupants .....	6	Interior lights .....	82	<b>Advice</b> .....	147
Pedal area .....	11	Visibility .....	83	<b>Care and maintenance</b> .....	147
<b>Seat belts</b> .....	11	Windscreen wiper and rear window wiper		Accessories and technical modifications .....	147
The reason why we should wear seat belts .....	11	systems .....	84	Care and cleaning .....	148
How to properly adjust your seatbelt .....	14	Rear vision mirrors .....	86	Care of the vehicle exterior .....	149
Seat belt tensioners .....	16	<b>Seats and head restraints</b> .....	88	Caring for the vehicle interior .....	153
<b>Airbag system</b> .....	17	Adjusting the seat and head restraints .....	88	<b>Checking and refilling levels</b> .....	158
Brief introduction .....	17	Seat functions .....	91	Fuel .....	158
Airbag overview .....	20	Rear seats .....	92	Petrol .....	159
Deactivating airbags .....	23	<b>Transport and practical equipment</b> .....	93	Diesel .....	160
<b>Transporting children safety</b> .....	24	Compartments .....	93	LPG system (Liquefied petroleum gas)* .....	160
Safety for children .....	24	Multi-purpose mobile storage compartment* .....	96	Working in the engine compartment .....	163
Child seats .....	26	Ashtray*, cigarette lighter* and power sockets .....	98	Engine oil .....	166
<b>Operation</b> .....	31	First-aid kit, warning triangle, fire extinguisher .....	100	Cooling system .....	169
<b>Dash panel</b> .....	31	Luggage compartment .....	101	Windscreen washer reservoir .....	171
Overview .....	31	Roof carrier/rack system* .....	104	Brake fluid .....	172
Instruments .....	32	<b>Air conditioning</b> .....	107	Vehicle battery .....	173
Warning lamps .....	35	Heating .....	107	<b>Wheels</b> .....	175
Digital instrument panel display .....	47	Climatic* .....	109	Wheels and tyres .....	175
Instrument panel menus* .....	50	2C-Climatronic* .....	112	Winter service .....	180
<b>Steering wheel controls*</b> .....	57	General notes .....	116	<b>Emergencies</b> .....	181
General information .....	57	<b>Driving</b> .....	117	Vehicle tools, spare wheel .....	181
Audio system .....	57	Power steering (servotronic*) .....	117	Wheel change .....	182
Radio navigation system .....	61	All-wheel drive* .....	117	Tyre repair .....	186
<b>Opening and closing</b> .....	63	Driving with LPG* .....	118	Jump-starting .....	189
Central locking .....	63	Journeys abroad .....	120	Towing and tow-starting .....	191
Keys .....	66	Ignition lock .....	120	Emergency locking and unlocking .....	193
Radio frequency remote control .....	67	Braking and parking .....	123	Changing the wiper blades .....	194
Anti-theft alarm system* .....	68	Manual gearbox .....	126	<b>Fuses and bulbs</b> .....	196
Boot hatch .....	71	Automatic gearbox/DSG automatic gearbox* .....	127	Fuses .....	196
		Run-in and economical driving .....	130	Changing the lights .....	198
		<b>Driver assistance systems</b> .....	134		
		Braking and stability systems .....	134		
		Start-Stop System* .....	138		

<b>Technical specifications</b> .....	207
<b>Technical features</b> .....	207
Important information .....	207
Information on fuel consumption .....	208
Towing a trailer .....	209
Wheels .....	210
Engine specifications .....	211
Dimensions and capacities .....	221
<b>Index</b> .....	223

## Safety

### Safe driving

#### Safety first!

##### WARNING

- This manual contains important information about the operation of the vehicle, both for the driver and the passengers. The other sections of the on-board documentation also contain further information that you should be aware of for your own safety and for the safety of your passengers.
- Ensure that the onboard documentation is kept in the vehicle at all times. This is especially important when lending or selling the vehicle to another person.

### Advice about driving

#### Before setting off

For your own safety and the safety of your passengers, always note the following points before every trip:

- Make sure that the vehicle's lights and turn signals are working properly.
- Check tyre pressure.

- Ensure that all windows provide a clear and good view of the surroundings.
- Make sure all luggage is secured » page 101.
- Make sure that no objects can interfere with the pedals.
- Adjust front seat, head restraint and rear vision mirrors properly according to your size.
- Ensure that the passengers in the rear seats always have the head restraints in the in-use position » page 10.
- Instruct passengers to adjust the head restraints according to their height.
- Protect children with appropriate child seats and properly applied seat belts » page 24.
- Assume the correct sitting position. Instruct your passengers also to assume a proper sitting position. » page 6.
- Fasten your seat belt securely. Instruct your passengers also to fasten their seat belts properly. » page 11.

#### What affects driving safety?

As a driver, you are responsible for yourself and your passengers. When your concentration or driving safety is affected by any cir-

cumstance, you endanger yourself as well as others on the road » , for this reason:

- Always pay attention to traffic and do not get distracted by passengers or telephone calls.
- Never drive when your driving ability is impaired (e.g. by medication, alcohol, drugs).
- Observe traffic laws and speed limits.
- Always reduce your speed as appropriate for road, traffic and weather conditions.
- When travelling long distances, take breaks regularly - at least every two hours.
- If possible, avoid driving when you are tired or stressed.

##### WARNING

**When driving safety is impaired during a trip, the risk of injury and accidents increases.**

#### Safety equipment

Never put your safety or the safety of your passengers in danger. In the event of an accident, the safety equipment may reduce the risk of injury. The following list includes most of the safety equipment in your SEAT:

- Three-point seat belts
- belt tension limiters for the front and rear side seats,



- Belt tensioners for the front seats
- Belt height adjustment for the front seats
- Front airbags
- Side airbags in the front seat backrests
- Head-protection airbags
- Active front head restraints\*
- "ISOFIX" anchorage points for child seats in the rear side seats with the "ISOFIX" system,
- height-adjustable front head restraints,
- rear head restraints with in-use position and non-use position,
- adjustable steering column.

The safety equipment mentioned above works together to provide you and your passengers with the best possible protection in the event of an accident. However, these safety systems can only be effective if you and your passengers are sitting in a correct position and use this equipment properly.

### Safety is everyone's business!

## Proper sitting position for occupants

### Correct sitting position for driver

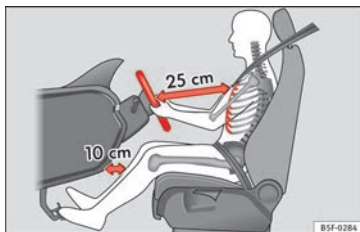

**Fig. 1** The proper distance between driver and steering wheel



**Fig. 2** Correct head restraint position for the driver.

For your own safety and to reduce the risk of injury in the event of an accident, we recom-

mend the following adjustments for the driver:

- Adjust the steering wheel so that there is a distance of at least 25 cm between the steering wheel and the centre of your chest » **Fig. 1.**
- Move the driver seat forwards or backwards so that you are able to press the accelerator, brake and clutch pedals to the floor with your knees still slightly angled » **▲.**
- Ensure that you can reach the highest point of the steering wheel.
- Adjust the head restraint so that its upper edge is at the same level as the top of your head, or as close as possible to the same level as the top of your head » **Fig. 2.**
- Move the seat backrest to an upright position so that your back rests completely against it.
- Fasten your seat belt securely » **page 11.**
- Keep both feet in the footwell so that you have the vehicle under control at all times.

Adjustment of the driver seat » **page 88.**

### **▲ WARNING**

- An incorrect sitting position of the driver can lead to severe injuries.
- Adjust the driver seat so that there is at least 25 cm distance between the centre of



the chest and the centre of the steering wheel » Fig. 1. If you are sitting closer than 25 cm, the airbag system cannot protect you properly.

- If your physical constitution prevents you from maintaining the minimum distance of 25 cm, contact a specialised workshop. The workshop will help you decide if special specific modifications are necessary.

- When driving, always hold the steering wheel with both hands on the outside of the ring at the 9 o'clock and 3 o'clock positions. This reduces the risk of injury when the driver airbag is triggered.

- Never hold the steering wheel at the 12 o'clock position, or in any other manner (e.g. in the centre of the steering wheel). In such cases, if the airbag is triggered, you may sustain injuries to the arms, hands and head.

- To reduce the risk of injury to the driver during sudden braking manoeuvres or an accident, never drive with the backrest tilted far back! The airbag system and seat belts can only provide optimal protection when the backrest is in an upright position and the driver is wearing his or her seat belt correctly.

- Adjust the head restraint properly to achieve optimal protection.

## Adjusting the steering wheel position

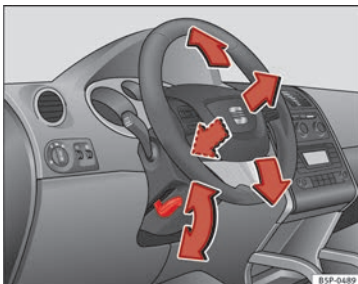

Fig. 3 Adjusting the steering wheel position.

The height and reach of the steering wheel can be freely adjusted to suit the driver.

- Adjust the driver seat to the correct position.
- Push the lever under the steering column » Fig. 3 down » ⚠.
- Adjust the steering wheel until the correct position is set » Fig. 1.
- Then push the lever up again firmly » ⚠.

### ⚠ WARNING

- Incorrect use of the steering column adjustment function and an incorrect seating position can result in serious injury.

- To avoid accidents, the steering column should be adjusted only when the vehicle is stationary.

- Adjust the driver seat or steering wheel so that there is a distance of at least 25 cm between the steering wheel and your chest » Fig. 1. If you fail to observe the minimum distance, the airbag will not protect you. Risk of fatal injury.

- If your physical constitution does not allow you to maintain the minimum distance of 25 cm, contact a Technical Service. The Technical Service will help you to decide if certain specific modifications are necessary.

- If you adjust the steering wheel so that it points towards your face, the driver airbag will not protect you properly in the event of an accident. Make sure that the steering wheel points towards your chest.

- When driving, always hold the steering wheel with both hands on the outside of the ring at the 9 o'clock and 3 o'clock positions. Never hold the steering wheel at the 12 o'clock position, or in any other manner (e.g. in the centre of the steering wheel, or on the inside of the rim). In such cases, if the airbag is triggered, you may sustain injuries to your arms, hands and head.

## Correct sitting position for front passenger

For your own safety and to reduce the risk of injury in the event of an accident, we recommend the following adjustments for the front passenger:

- Move the front passenger seat back as far as possible »» .
- Move the seat backrest to an upright position so that your back rests completely against it.
- Adjust the head restraint so that its upper edge is at the same level as the top of your head, or as close as possible to the same level as the top of your head »» page 9.
- Always keep both feet in the footwell in front of the front passenger seat.
- Fasten your seat belt securely »» page 11.

It is possible to deactivate the front passenger airbag in **exceptional circumstances**.

Adjusting the front passenger seat »» page 89.

### WARNING

- An incorrect sitting position of the front passenger can lead to severe injuries.
- Adjust the front passenger seat so that there is at least 25 cm between your chest and the dash panel. If you are sitting closer

than 25 cm, the airbag system cannot protect you properly.

- If your physical constitution prevents you from maintaining the minimum distance of 25 cm, contact a specialised workshop. The workshop will help you decide if special specific modifications are necessary.
- Always keep your feet in the footwell when the vehicle is moving; never rest them on the dash panel, out the window or on the seat. An incorrect sitting position exposes you to an increased risk of injury in case of a sudden braking or an accident. If the airbag is triggered, you could sustain severe injuries due to an incorrect sitting position.
- To reduce the risk of injury to the front passenger in events such as sudden braking manoeuvres or an accident, never travel with the backrest tilted far back! The airbag system and seat belts can only provide optimal protection when the backrest is in an upright position and the front passenger is wearing his or her seat belt properly. The further the seat backrests are tilted to the rear, the greater the risk of injury due to incorrect positioning of the belt web or to the incorrect sitting position!
- Adjust the head restraint correctly in order to achieve maximum protection.

## Correct sitting position for passengers in the rear seats

To reduce the risk of injury in the event of a sudden braking manoeuvre or an accident, passengers on the rear seat bench must consider the following:

- Sit up straight.
- Adjust the head restraint to the correct position »» page 10.
- Always keep both feet in the footwell in front of the rear seat.
- Fasten your seat belt securely »» page 11.
- Use an appropriate child restraint system when you take children in the vehicle »» page 24.

### WARNING

- If the passengers in the rear seats are not sitting properly, they could sustain severe injuries.
- Adjust the head restraint correctly in order to achieve maximum protection.
- Seat belts can only provide optimal protection when seat backrests are in an upright position and the vehicle occupants are wearing their seat belts correctly. If passengers in the rear seats are not sitting in an upright position, the risk of injury due to incorrect positioning of the seat belt increases.

## Correct adjustment of front seat head restraints

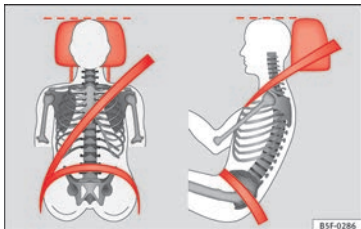

**Fig. 4** Correctly adjusted head restraint as viewed from the front and the side.

Properly adjusted head restraints are an important part of passenger protection and can reduce the risk of injuries in most accident situations.

- Adjust the head restraint so that its upper edge is, as far as possible, at the same level as the top of your head, or at the very least, at eye level » **Fig. 4.**

Adjusting the head restraints » page 88

### Active head restraints\*

Vehicle occupants are pressed into their seats during a rear-end collision. The resulting body pressure on the seat backrest activates the active head restraint\* on the front seat, which moves rapidly forward and up-

ward at the same time. This movement reduces the distance between the occupant's head and the head restraint, thus reducing the risk of injuries such as whiplash.

### ⚠ WARNING

- Travelling with the head restraints removed or improperly adjusted increases the risk of severe injuries. Improper adjustment of the head restraints may cause death in an accident and increase the risk of suffering injuries during abrupt breaking actions or unexpected manoeuvres.
- The head restraints must always be adjusted according to the height of the passenger.

### 📄 Note

The active head restraints\* could also be triggered if a vehicle occupant applies a high level of pressure to the seat backrest (e.g. by "falling" back into the seat when entering the vehicle) or if pressure is applied to a front seat head restraint from the rear. This accidental activation is, however, not dangerous, as the active head restraints will return to the original position immediately and are thus once again ready.

### Examples of incorrect sitting positions

Seat belts can provide optimal protection only when the belt webs are properly posi-

tioned. Incorrect sitting positions substantially reduce the protective function of seat belts and increase the risk of injury due to incorrect seat belt position. As the driver, you are responsible for all passengers, especially children.

- Never allow anyone to assume an incorrect sitting position in the vehicle while travelling » **⚠.**

The following list contains examples of sitting positions that could be dangerous for vehicle occupants. The list is not complete, but we would like to make you aware of this issue.

### Therefore, whenever the vehicle is in motion:

- Never stand in the vehicle.
- Never stand on the seats.
- Never kneel on the seats.
- Never tilt your seat backrest far to the rear.
- Never lean against the dash panel.
- Never lie on the rear bench.
- Never sit on the front edge of a seat.
- Never sit sideways.
- Never lean out of a window.
- Never put your feet out of a window.
- Never put your feet on the dash panel.
- Never put your feet on the surface of a seat. »

- Do not allow anyone to travel in the footwell.
- Never travel without wearing the seat belt.
- Do not allow anyone to travel in the luggage compartment.

#### ⚠ WARNING

- Any incorrect sitting position increases the risk of severe injuries.
- Sitting in an incorrect position exposes the vehicle occupants to severe injuries if airbags are triggered, by striking a vehicle occupant who has assumed an incorrect sitting position.
- Before the vehicle moves, assume the proper sitting position and maintain it throughout the trip. Before every trip, instruct your passengers to sit properly and to stay in this position during the trip » page 6, Proper sitting position for occupants.

### Correct adjustment of rear seat head restraints

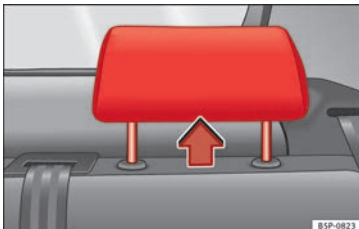

Fig. 5 Head restraints in the correct position.



Fig. 6 Head restraint position warning label.

Properly adjusted head restraints are an important part of passenger protection and can reduce the risk of injuries in most accident situations.

### Rear outer seat head restraints

- The rear outer seat head restraints have 3 positions.
- Two positions for **use** » Fig. 5. In these positions, the head restraints are used normally, and along with the rear seat belts, protect passengers in the rear seats.
- And one position for **non-use**.
- To fit the head restraints in position for use, pull on the edges with both hands in the direction of the arrow.

### Centre rear head restraint

- The centre head restraint only has two positions, **in-use** (head restraint up) and **non-use** (head restraint down).

#### ⚠ WARNING

- Under no circumstances should the rear passengers travel while the head restraints are in the non-use position. See the warning label located on the rear side fixed window » Fig. 6.
- Do not swap the centre rear head restraint with either of the outer seat rear head restraints. Risk of injury in case of an accident!

#### ⓘ CAUTION

Note the instructions on the adjustment of the head restraints » page 90.

## Pedal area

### Pedals

- Ensure that you can always press the accelerator, brake and clutch pedals unimpaired to the floor.
- Ensure that the pedals can return unimpaired to their initial positions.
- Ensure that the floor mats are securely fastened during the trip and do not obstruct the pedals » » ⚠.

Only use floor mats which leave the pedals clear and which are secured to prevent them from slipping. You can obtain suitable floor mats from a specialised dealership. Fasteners\* for floor mats are fitted in the footwells.

If a brake circuit fails, the brake pedal must be pressed down thoroughly in order to stop the vehicle.

### Wearing suitable shoes

Always wear shoes which support your feet properly and give you a good feeling for the pedals.

#### ⚠ WARNING

- If the pedals are obstructed, an accident may occur. Risk of serious injuries.

- Never lay or fit floor mats or other floor coverings over the original floor mats. This would reduce the pedal area and could obstruct the pedals, leading to a risk of accident.
- Never place objects in the driver footwell. An object could move into the pedal area and impair pedal operation. In the event of a sudden driving or braking manoeuvre, you will not be able to operate the brake, clutch or accelerator pedal. Risk of accident!

## Seat belts

### The reason why we should wear seat belts

#### Number of seats

Your vehicle has **five** seats, two in the front and three in the rear. Each seat is equipped with a three-point seat belt.

In some versions, your vehicle is approved **only** for four seats. Two front seats and two rear seats.

#### ⚠ WARNING

- Never transport more than the permitted amount of people in your vehicle.
- Every vehicle occupant must properly fasten and wear the seat belt belonging to his or her seat. Children must be protected with an appropriate child restraint system.

#### Seat belt warning lamp\* 🚨

The control lamp illuminates to remind the driver to fasten his or her seat belt.



Before starting the vehicle:

- Fasten your seat belt securely.



- Instruct your passengers to fasten their seat belts properly before driving off.
- Protect children by using a child seat according to the child's height and weight.

The control lamp  on the instrument panel lights up<sup>1)</sup> if the driver's seat belt is not fastened when the ignition is switched on.

If, when starting to drive, the speed surpasses 25 km/h (15 mph) approx. and no seat belt is worn or it is unfastened during the drive, a warning sound will be heard for a few seconds. The warning light will also flash . The  lamp goes out when the seat belt is fastened with the ignition switched on.

### Seat belt protection



**Fig. 7** Drivers with properly worn seat belts will not be thrown forward in the event of sudden braking

Properly worn seat belts hold the occupants in the proper position. They also help prevent uncontrolled movements that may result in serious injury and reduce the risk of being thrown out of the vehicle in case of an accident.

Vehicle occupants wearing their seat belts correctly benefit greatly from the ability of the belts to absorb kinetic energy. The front part of your vehicle and other passive safety features (such as the airbag system) are also designed to absorb the kinetic energy released in a collision. Taken together, all these features reduce the releasing kinetic energy and consequently, the risk of injury. This is why it

is so important to fasten seat belts before every trip, even when "just driving around the corner".

Ensure that your passengers wear their seat belts as well. Accident statistics have shown that wearing seat belts is an effective means of substantially reducing the risk of serious injury and improving the chances of survival when involved in an accident. Furthermore, properly worn seat belts improve the protection provided by airbags in the event of an accident. For this reason, wearing a seat belt is required by law in most countries.

Although your vehicle is equipped with airbags, the seat belts must be fastened and worn. The front airbags, for example, are only triggered in some cases of head-on collision. The front airbags will not be triggered during minor frontal or side collisions, rear-end collisions, rollovers or accidents in which the airbag trigger threshold value in the control unit is not exceeded.

Therefore, you should always wear your seat belt and ensure that all vehicle occupants have fastened their seat belts properly before you drive off!

<sup>1)</sup> Depending on the model version

## Safety instructions on using seat belts

- Always wear the seat belt as described in this section.
- Ensure that the seat belts can be fastened at all times and are not damaged.

### ⚠ WARNING

- If the seat belts are worn incorrectly or not at all, the risk of severe or fatal injuries increases. The optimal protection from seat belts can be achieved only if you use them properly.
- Fasten your seat belt before every trip - even when driving in town. The other vehicle occupants must also wear the seat belts at all times, otherwise they run the risk of being injured.
- The seat belt cannot offer its full protection if the seat belt is not positioned correctly.
- Never allow two passengers (even children) to share the same seat belt.
- Always keep both feet in the footwell in front of your seat as long as the vehicle is in motion.
- Never unbuckle a seat belt while the vehicle is in motion. Risk of fatal injury.
- The seat belt must never be twisted while it is being worn.
- The seat belt should never lie on hard or fragile objects (such as glasses or pens, etc.)

because this could cause injuries in the case of an accident.

- Do not allow the seat belt to be damaged or jammed, or to rub on any sharp edges.
  - Never wear the seat belt under the arm or in any other incorrect position.
  - Loose, bulky clothing (such as an overcoat over a jacket) impairs the proper fit and function of the seat belts, reducing their capacity to protect.
  - The slot in the seat belt buckle must not be blocked with paper or other objects, as this can prevent the latch plate from engaging securely.
  - Never use seat belt clips, fastening rings or similar items to alter the position of the belt webbing.
  - Frayed or torn seat belts or damage to the connections, belt retractors or parts of the buckle could cause severe injuries in the event of an accident. Therefore, you must check the condition of all seat belts at regular intervals.
  - Seat belts which have been worn in an accident and stretched must be replaced by a specialised workshop. Renewal may be necessary even if there is no apparent damage. The belt anchorage should also be checked.
  - Do not attempt to repair a damaged seat belt yourself. The seat belts must not be removed or modified in any way.
  - The belts must be kept clean, otherwise the retractors may not work properly
- »» page 157.

## Head-on collisions and the laws of physics



**Fig. 8** A driver not wearing a seat belt is thrown forward violently



**Fig. 9** The unbelted passenger in the rear seat is thrown forward violently, hitting the driver wearing a seat belt.

It is easy to explain how the laws of physics work in the case of a head-on collision: When a vehicle starts moving, a type of energy

called “kinetic energy” is created both in the passengers and inside the vehicle.

The amount of “kinetic energy” depends on the speed of the vehicle and the weight of the vehicle and its passengers. The higher the speed and the greater the weight, the more energy there is to be “absorbed” in an accident.

The most significant factor, however, is the speed of the vehicle. If the speed doubles from 25 km/h (15 mph) to 50 km/h (30 mph), for example, the corresponding kinetic energy is multiplied by four.

Because the vehicle occupants in our example are not restrained by seat belts, in the event of crashing against a wall, all of the occupants’ kinetic energy will be absorbed solely by said impact.

Even at speeds of 30 km/h (19 mph) to 50 km/h (30 mph), the forces acting on the body in a collision can easily exceed one tonne (1000 kg). At greater speed these forces are even higher.

Vehicle occupants not wearing seat belts are not “attached” to the vehicle. In a head-on collision, they will move forward at the same speed their vehicle was travelling just before the impact. This example applies not only to head-on collisions, but to all accidents and collisions.

Even at low speeds the forces acting on the body in a collision are so great that it is not possible to brace oneself with one’s hands. In a frontal collision, unbelted passengers are thrown forward and will make violent contact with the steering wheel, dash panel, windscreen or whatever else is in the way

»» Fig. 8.

It is also important for the rear passengers to wear seat belts properly, as they could otherwise be thrown forward violently through the vehicle interior in an accident. Passengers in the rear seats who do not use seat belts endanger not only themselves but also the front occupants »» Fig. 9.

## How to properly adjust your seatbelt

### Fastening and unfastening your seat belt

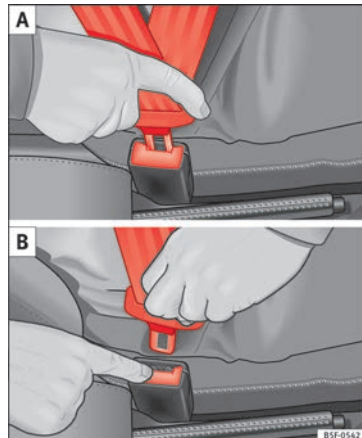
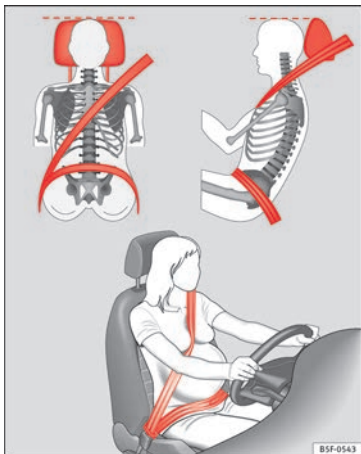

Fig. 10 Positioning and removing the seat belt buckle.





**Fig. 11** Placing the seat belt in the shoulder and pelvis area for pregnant women.

### Fastening the seat belt

The seat belt cannot offer its full protection if the seat belt is not positioned correctly.

- Adjust the seat and head restraint correctly.
- To fasten the belt, take hold of the latch plate and pull it slowly across your chest and lap.
- Insert the latch plate into the buckle for the appropriate seat and push it down until it is

securely locked with an audible click

» **Fig. 10 A.**

- Pull the belt to ensure that the latch plate is securely engaged in the buckle.

The seat belts are equipped with an automatic retractor on the shoulder strap. Full freedom of movement is permitted when the shoulder belt is pulled slowly. However, during sudden braking, during travel in steep areas or bends and during acceleration, the automatic retractor on the shoulder belt is locked.

The automatic belt retractors on the front seats are fitted with seat belt tensioners  
» **page 16.**

### Seat belt release

- Press the red button on the belt buckle  
» **Fig. 10 B.** The latch plate is released and springs out » **△.**
- Guide the belt back by hand so that it rolls up easily and the trim is not damaged.

### Seat belt position

Seat belts offer their maximum protection only when they are properly positioned.

The following features are available to adjust the seat belt in the shoulder region:

- belt height adjustment for the front seats.
- front seat height adjustment\*.

### **△ WARNING**

- The seat belts offer best protection only when the backrests are in an upright position and the seat belts have been fastened properly.
- Never put the latch plate in the buckle of another seat. If you do this, the seat belt will not protect you properly and the risk of injury is increased.
- Never unbuckle a seat belt while the vehicle is in motion. If you do, you increase the risk of sustaining severe or fatal injuries.
- An incorrectly worn seat belt can cause severe injuries in the event of an accident.
- The shoulder part of the seat belt must lie on the centre of the shoulder, never across the neck. The seat belt must lie flat and snugly on the torso » **Fig. 11.**
- The lap part of the seat belt must lie across the pelvis, never across the stomach. The seat belt must lie flat and snugly on the pelvis » **Fig. 11.** Pull the belt tight if necessary to take up any slack.
- For pregnant women, the lap part of the seat belt must lie as low as possible over the pelvis, never across the stomach, and always lie flat so that no pressure is exerted on the abdomen.
- Always engage the retractor lock when you are securing a child seat in group 0, 0+ or 1  
» **page 24.**
- Read and observe the warnings » **page 13.**

## Adjusting the seat belt height

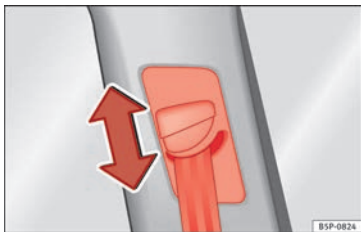

Fig. 12 Location of the belt height adjuster.

Seat belt height adjusters can be used to adjust the position of the seat belt in the front seats at the shoulder depending on a person's height.

- Press the upper part of the shoulder belt guide and hold it in this position »» Fig. 12.
- Move the shoulder belt guide up or down until you have adjusted the seat belt »» page 14.
- After adjusting, pull the shoulder belt sharply to check that the catch on the shoulder belt guide is engaged securely.

## Seat belt tensioners

### How the seat belt tensioner works

During a frontal collision, the seat belts on the front seats are retracted automatically.

The seat belts for the occupants in the front seats are equipped with belt tensioners. Sensors will trigger the belt tensioners only during severe head-on, lateral and rear-end collisions and only if the seat belt is worn. The tensioners retract and tighten the seat belts, reducing the forward motion of the occupants.

The seat belt tensioner can be triggered only once.

The seat belt tensioners will not be triggered in the event of a light frontal, side or rear collision, if the vehicle overturns or in situations where no large forces act on the front, side or rear of the vehicle.

#### Note

- If the seat belt tensioners are triggered, a fine dust is produced. This is normal and it is not an indication of fire in the vehicle.
- The relevant safety requirements must be observed when the vehicle or components of the system are scrapped. Specialised workshops are familiar with these regulations, which are also available to you.

## Service and disposal of belt tensioners

The belt tensioners are components of the seat belts that are installed in the seats of your vehicle. If you work on the belt tensioners or remove and install parts of the system when performing other repair work, the seat belt may be damaged. The consequence may be that, in the event of an accident, the belt tensioners function incorrectly or not at all.

So that the effectiveness of the seat belt tensioner is not reduced and that removed parts do not cause any injuries or environmental pollution, regulations, which are known to the specialised workshops, must be observed.

#### WARNING

- Improper use or repairs not carried out by qualified mechanics increase the risk of severe or fatal injuries. The belt tensioners may fail to trigger or may trigger in the wrong circumstances.
- Never attempt to repair, adjust, remove or install parts of the belt tensioners or seat belts.
- The seat belt tensioner, seat belt and automatic retractor cannot be repaired.
- Any work on the belt tensioners and seat belts, including the removal and refitting of system parts in conjunction with other repair

work, must be performed by a specialised workshop only.

- The belt tensioners will only provide protection for one accident and must be changed if they have been activated.

## Airbag system

### Brief introduction

#### Why wear a seat belt and assume the correct sitting position?

For the inflating airbags to achieve the best protection, the seat belt must always be worn properly and the correct sitting position must be assumed.

The airbag system is not a substitute for seat belts, but it is an integral part of the vehicle's overall passive safety system. Please bear in mind that the airbag system can only work effectively when the vehicle occupants are wearing their seat belts correctly and have adjusted the head restraints properly. Therefore, it is most important to wear the seat belts at all times, not only because this is required by law in most countries, but also for your safety »» page 11, **The reason why we should wear seat belts.**

The airbag inflates in a matter of seconds, so if you are not properly seated when the airbag is triggered, you may sustain fatal injuries. Therefore, it is essential that all vehicle occupants assume a correct sitting position while travelling.

Sharp braking before an accident may cause a passenger not wearing a seat belt to be

thrown forward into the area of the deploying airbag. In this case, the inflating airbag may inflict critical or fatal injuries on the occupant. This also applies to children.

Always maintain the greatest possible distance between yourself and the front airbag. This way, the front airbags can completely deploy when triggered, providing their maximum protection.

The most important factors that will trigger an airbag are: the type of accident, the angle of collision and the speed of the vehicle.

Whether or not the airbags are triggered depends primarily on the vehicle deceleration rate resulting from the collision and detected by the control unit. If the vehicle deceleration occurring during the collision and measured by the control unit remains below the specified reference values, the front, side and/or curtain airbags will not be triggered. Take into account that the visible damage in a vehicle involved in an accident, no matter how serious, is not a determining factor for the airbags to have been triggered.

#### WARNING

- **Wearing the seat belt incorrectly or assuming an incorrect sitting position can lead to critical or fatal injuries.**
- **All vehicle occupants, including children, who are not properly belted can sustain critical or fatal injuries if the airbag is triggered.**

»

Children up to 12 years old should always travel on the rear seat. Never transport children in the vehicle if they are not restrained or the restraint system is not appropriate for their age, size or weight.

- If you are not wearing a seat belt, or if you lean forward or to the side while travelling or assume an incorrect sitting position, there is a substantially increased risk of injury. This increased risk of injury will be further increased if you are struck by an inflating airbag.
- To reduce the risk of injury from an inflating airbag, always wear the seat belt properly » page 11.
- Always adjust the front seats properly.

## Description of airbag system

The airbag system mainly comprises (as per vehicle equipment):

- an electronic control and monitoring system (control unit)
- frontal airbags for driver and passenger,
- side airbags,
- curtain (head) airbags,
- a control lamp  on the dash panel » page 19.
- a key-operated switch for front passenger airbag,

- a control lamp for disabling/enabling the front passenger airbag.

The airbag system operation is monitored electronically. The airbag control lamp will illuminate for a few seconds every time the ignition is switched on (self-diagnosis).

**There is a fault in the system if the control lamp :**

- does not light up when the ignition is switched on » page 19,
- turns off after 4 seconds after the ignition is switched on
- turns off and then lights up again after the ignition is switched on
- illuminates or flashes while the vehicle is moving.

**The airbag system is not triggered if:**

- the ignition is switched off
- there is a minor frontal collision
- there is a minor side collision
- there is a rear-end collision
- the vehicle turns over.

### WARNING

- **The seat belts and airbags can only provide maximum protection if the occupants are seated correctly » page 6, Proper sitting position for occupants.**

- **If a fault has occurred in the airbag system, have the system checked immediately by a specialised workshop. Otherwise, during a frontal collision the system might not trigger correctly or may fail to trigger at all.**

## Airbag activation

The airbags deploy extremely rapidly, within thousandths of a second, to provide additional protection in the event of an accident. A fine dust may develop when the airbag deploys. This is normal and it is not an indication of fire in the vehicle.

The airbag system is only ready to function when the ignition is on.

In special cases of an accident, several airbags may activate at the same time.

In the event of minor head-on and side collisions, rear-end collisions, overturning or roll-over of the vehicle, airbags **do not activate**.

### Activation factors

The conditions that lead to the airbag system activating in each situation cannot be generalised. There are some factors that play an important role, such as the properties of the object the vehicle hits (hard/soft), angle of impact, vehicle speed, etc.

The deceleration trajectory is key for airbag activation.

The control unit analyses the collision trajectory and activates the respective restraint system.

If the deceleration rate is below the predefined reference value in the control unit the airbags will not be triggered, even though the accident may cause extensive damage to the car.

#### The following airbags are triggered in serious head-on collisions

- Driver airbag.
- Front passenger front airbag.

#### The following airbags are triggered in serious side-on collisions

- Front side airbag on the side of the accident.
- Rear side airbag on the side of the accident.
- Curtain airbag on the side of the accident.

#### In an accident with airbag activation:

- the interior lights switch on (if the interior light switch is in the courtesy light position);
- the hazard warning lights switch on;
- all doors are unlocked;
- the fuel supply to the engine is cut.

#### Control lamp for airbag and seat belt tensioner

The control lamp monitors all airbags and seat belt tensioners in the vehicle, including control units and wiring connections.

#### Monitoring of airbag and belt tensioner system

Both the airbag and belt tensioner systems operation is constantly monitored electronically. Each time the ignition is switched on, the control lamp  illuminates for several seconds (self-diagnosis) and the instrument panel display\* shows **AIRBAG/TENSIONER**.

#### The system must be checked when the control lamp :

- does not light up when the ignition is switched on,
- turns off after 4 seconds after the ignition is switched on
- turns off and then lights up again after the ignition is switched on
- illuminates or flashes while the vehicle is moving.

In the event of a malfunction, the warning lamp remains on continuously. In addition, depending on the malfunction, a fault message appears on the instrument panel display for approximately 10 seconds and a short audible warning is given. In this event,

you should have a specialised workshop check the system immediately.

If any of the airbags are disabled by a Technical Service, the warning lamp flashes for several more seconds after verification and will turn off if there is no fault.

#### WARNING

- If there is a malfunction, the airbag and belt tensioner system cannot properly perform its protective function.
- If a malfunction occurs, have the system checked immediately by a specialised workshop. Otherwise, in the event of an accident, the airbag system and belt tensioners may not be triggered, or may not be triggered correctly.

## Airbag overview

### Front airbags

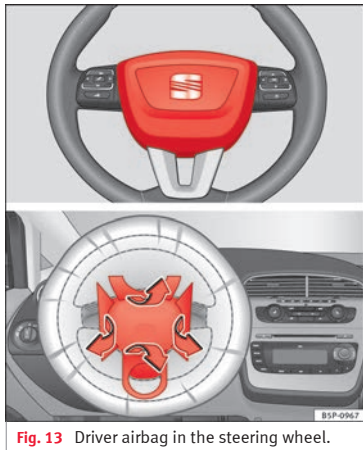

**Fig. 13** Driver airbag in the steering wheel.

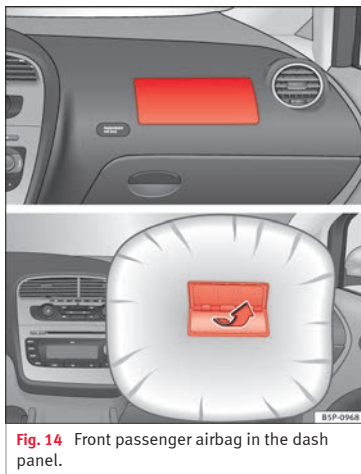

**Fig. 14** Front passenger airbag in the dash panel.

The front airbag for the driver is located in the steering wheel » **Fig. 13** and the airbag for the front passenger is located in the dash panel » **Fig. 13**. Airbags are identified by the word “AIRBAG”.

The airbag covers fold out of the steering wheel and dash panel respectively when the driver and front passenger airbags are triggered » **Fig. 14**. The airbag covers remain connected to the steering wheel or the dash panel.

In conjunction with the seat belts, the front airbag system gives the driver and the front passenger additional protection for the head and chest in the event of a severe frontal collision.

The special design of the airbag allows the controlled escape of the propellant gas when an occupant puts pressure on the bag. Thus, the head and chest are surrounded and protected by the airbag. After the collision, the airbag deflates sufficiently to allow visibility.

#### **⚠ WARNING**

- The seat belts and airbags can only provide maximum protection if the occupants are seated correctly » page 6, Proper sitting position for occupants.
- The deployment space between the front passengers and the airbags must not in any case be occupied by other passenger, pets and objects.
- The airbags provide protection for just one accident; replace them once they have deployed.
- It is also important not to attach any objects such as cup holders or telephone mountings to the surfaces covering the airbag units.
- Do not attempt to modify components of the airbag system in any way.

## Side airbags\*

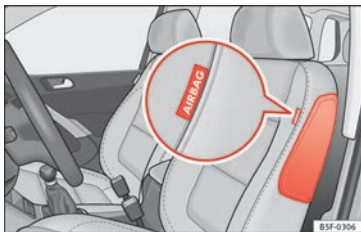

Fig. 15 Side airbag in driver seat.

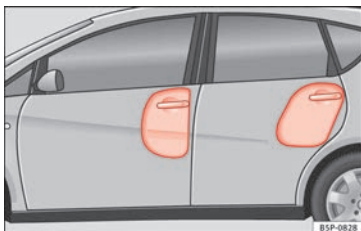

Fig. 16 Inflated side airbag on left side of vehicle.

The side airbags are located in the backrest cushions of the driver seat » Fig. 15 and the front passenger seat and the rear side airbags are mounted in the rear wheel housing. The locations are identified by the text "AIR-BAG" in the upper region of the backrests and in the rear wheel housing lining.

In conjunction with the seat belts, the side airbag system gives the front seat occupants additional protection for the upper body in the event of a severe side collision.

In a side collision, the side airbags reduce the risk of injury to passengers on the front seats to the areas of the body facing the impact. In addition to their normal function of protecting the occupants in a collision, the seat belts also hold the passengers in the front seats and the outer rear seats in a position where these airbags can provide maximum protection.

**⚠ WARNING**

- If you do not wear a seat belt, if you lean forward, or are not seated correctly while the vehicle is in motion, you are at a greater risk of injury if the side airbag system is triggered in an accident.
- In order for the side airbags to provide their maximum protection, the prescribed sitting position must always be maintained with seat belts fastened while travelling.
- Occupants of the outer seats must never carry any objects or pets in the deployment space between them and the airbags, or allow children or other passengers to travel in this position. It is also important not to attach any accessories (such as cup holders) to the doors. This would impair the protection offered by the side airbags.

- The built-in coat hooks should be used only for lightweight clothing. Do not leave any heavy or sharp-edged objects in the pockets.
- Great forces, such as hard blows or kicks, must not be exerted upon the backrest bolster because the system may be damaged. In this case, the side airbags would not be triggered.
- Under no circumstances should protective covers be fitted over seats with side airbags unless the covers have been approved for use in your vehicle. Because the airbag is triggered from the side of the backrest, the use of non-approved seat covers would obstruct the side airbag, seriously reducing the airbag's effectiveness » page 147.
- Any damage to the original seat upholstery or around the seams of the side airbag units must be repaired immediately by a specialised workshop.
- The airbags provide protection for just one accident; replace them once they have deployed.
- Any work on the side airbag system or removal and installation of the airbag components for other repairs (such as removal of the front seat) should only be performed by a specialised workshop. Otherwise, faults may occur during the airbag system operation.
- Do not attempt to modify components of the airbag system in any way.
- The side and head airbags are managed through sensors located in the interior of the front doors. To ensure the correct operation of the side and curtain (head) airbags neither »

the doors nor the door panels should be modified in any way (e.g. fitting loudspeakers). If the front door is damaged, the airbag system may not work correctly. All work carried out on the front door must be done in a specialised workshop.

- In a side collision, the side airbags will not work, if the sensors do not correctly measure the pressure increase on the interior of the doors, due to air escaping through the areas with holes or openings in the door panel.
- Never drive the vehicle if the interior panels have been removed.
- Never drive if the interior door panels have been removed or if the panels have not been correctly fitted.
- Never drive the vehicle if the loudspeakers in the door panels have been removed, unless the holes left by the loudspeakers have been closed properly.
- Always check that the openings are closed or covered if additional loudspeakers or other equipment are fitted inside the door panels.
- Any work carried out to the doors should be made in an authorised specialised workshop.

### Head-protection airbags\*



Fig. 17 Location of head-protection airbags on the left side of the vehicle

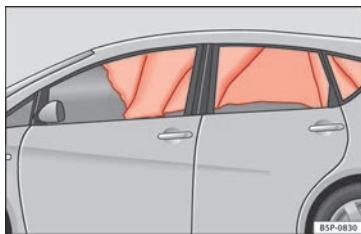

Fig. 18 Deployed head-protection airbags.

The head-protection airbags are located on both sides in the interior above the doors » Fig. 17 and are identified with the text "AIRBAG".

In conjunction with the seat belts, the head-protection airbag system gives the occupants

additional protection for the head and upper body in the event of a severe side collision.

#### ⚠ WARNING

- In order for the head-protection airbags to provide their maximum protection, the prescribed sitting position must always be maintained with seat belts fastened while travelling.
- For safety reasons, the curtain airbag must be disabled in those vehicles fitted with a screen dividing the interior of the vehicle. See a Technical Service to make this adjustment.
- There must be no other persons, animals or objects between the occupants of the outer seats and the deployment space of the head-protection airbags so that the head-protection airbag can deploy completely without restriction and provide the greatest possible protection. Therefore, sun blinds which have not been expressly approved for use in your vehicle may not be attached to the side windows » page 147.
- The built-in coat hooks should be used only for lightweight clothing. Do not leave any heavy or sharp-edged objects in the pockets. Please, do not hang the clothes on coat hangers.
- The airbags provide protection for just one accident; replace them once they have deployed.



- Any work on the head-protection airbag system or removal and installation of the airbag components for other repairs (such as removal of the roof lining) should only be performed by a specialised workshop. Otherwise, faults may occur during the airbag system operation.
- Do not attempt to modify components of the airbag system in any way.
- The side and head airbags are managed through sensors located in the interior of the front doors. To ensure the correct operation of the side and curtain airbags, neither the doors nor the door panels should be modified in any way (e.g. fitting loudspeakers). If the front door is damaged, the airbag system may not work correctly. All work carried out on the front door must be done in a specialised workshop.

## Deactivating airbags

### Front passenger front airbag deactivation



**Fig. 19** In the glove compartment: Switch for activating and deactivating the front passenger airbag



**Fig. 20** Control lamp for deactivated front passenger airbag.

If you fit a rear-facing child seat to the front passenger seat, the front passenger front airbag must be de-activated.

When the front passenger airbag is **deactivated**, only the front airbag is deactivated. All the other airbags in the vehicle remain activated.

### Disabling the front passenger front airbag

- Switch the ignition off.
- Open the glove compartment on the front passenger side.
- Insert the key into the slot of the switch for deactivating the front passenger airbag » **Fig. 19**. About 3/4 of the key should enter, as far as it will go.
- Then turn the key gently to the **OFF** position. Do not force it if you feel resistance, and make sure you have inserted the key fully.
- Check that the control lamp, “OFF”, on the instrument panel » **Fig. 20** remains lit when the ignition is switched on » **△**.

### Activating the front passenger front airbag

- Switch the ignition off.
- Open the glove compartment on the front passenger side.
- Insert the key into the slot of the switch for deactivating the front passenger airbag »

»» **Fig. 19.** About 3/4 of the key should enter, as far as it will go.

- Then turn the key gently to the **ON** position. Do not force it if you feel resistance, and make sure you have inserted the key fully.
- Check that the control lamp on the instrument panel »» **Fig. 20** *does not* light up when the ignition is switched on »» .

#### **WARNING**

- It is the driver's responsibility to ensure that the key-operated switch is set to the correct position.

- You should deactivate the front passenger front airbag only if you have to use a rear-facing child seat in exceptional cases  
»» page 24, Transporting children safety.

- Never install a child seat facing backwards on the front passenger seat unless the front passenger front airbag has been disabled. Otherwise, there is a risk of death.

- As soon as the child seat is no longer needed on the front passenger seat, enable the front passenger front airbag again.

- Only deactivate the front passenger front airbag when the ignition is off, otherwise a fault may occur in the airbag system, which could cause the airbag to not deploy properly or not deploy at all in case of an accident.

- Never leave the key in the airbag deactivation switch as it could get damaged or activate or deactivate the airbag during driving.

- When the front passenger front airbag is deactivated, if the control lamp AIRBAG OFF is not continuously lit up, there may be a fault in the airbag system:

- Have the airbag system inspected immediately by a specialised workshop.

- Do not use a child seat on the front passenger seat! The front passenger front airbag could be triggered in the event of an accident, even if there is a fault in the system and, as a result, a child could sustain serious or fatal injuries.

- It is unpredictable whether the front passenger airbag will deploy in the event of an accident. Warn all your passengers of this.

- When using the ignition key to activate/deactivate the front passenger front airbag, only the front passenger airbag will be activated/deactivated. The side airbag and head airbag on the passenger side will remain active.

## Transporting children safety

### Safety for children

#### Introduction

For safety reasons, as we have learned from accident statistics, we recommend that children under 12 years of age travel in the rear seats. Depending on their age, height and weight, children travelling in the rear seat must use a child seat or a seat belt. For safety reasons, the child seat should be installed in the rear seat, behind the front passenger seat or in the centre back seat.

The physical laws involved and the forces acting in a collision apply also to children »» page 13. But unlike adults, children do not have fully developed muscle and bone structures. This means that children are subject to a greater risk of injury.

To reduce the risk of injuries, children must always use special child restraint systems when travelling in the vehicle.

We recommend the use of child safety products from the SEAT Original Accessories Programme, which includes systems for all ages made by "Peke" (not for all countries).

These systems have been especially designed and approved, complying with the ECE-R44. regulation.

Follow the manufacturer's instructions and observe any statutory requirements when installing and using child seats. Always read and note » page 25.

We recommend you always carry the manufacturer's Child Seat Instruction Manual together with the on-board documentation.

### Important information regarding the front passenger's airbag



Fig. 21 Passenger's side sun visor: airbag sticker.



Fig. 22 On the rear frame of the passenger side door: airbag sticker.

A sticker with important information about the passenger airbag is located on the passenger's sun visor and/or on the passenger side door frame. Read and always observe the safety information included in the following chapters:

- Safety distance with respect to the passenger airbag » page 17.
- Objects between the passenger and the passenger side airbag » **Δ** in Front airbags on page 20.

The passenger side front airbag, when activated, is a serious risk for a child who is facing backward since the airbag can strike the seat with such force that it can cause serious or fatal injuries. Children up to 12 years old should always travel on the rear seat.

Therefore we strongly recommend you to transport children on the rear seats. This is

the safest location in the vehicle. Alternatively, the front passenger airbag can be disabled with a key-operated switch » page 23. When transporting children, use a child seat suitable for the age and size of each child » page 24.

### **Δ** WARNING

- If a child seat is secured to the front passenger seat, the risk to the child of sustaining critical or fatal injuries in the event of an accident increases.
- An inflating front passenger airbag can strike the rear-facing child seat and project it with great force against the door, the roof or the backrest.
- Never install a child seat facing backwards on the front passenger seat unless the front passenger front airbag has been disabled. Risk of potentially fatal injuries to the child! However, if it is necessary, in exceptional cases, to transport a child in the front passenger seat, the front passenger front airbag must always be disabled » page 23, Front passenger front airbag deactivation. If the front passenger seat has a height adjustment option, move it to the highest position.
- For those vehicles that do not include a key lock switch to deactivate the airbag, the vehicle must be taken to a Technical Service.
- All vehicle occupants, especially children, must assume the proper sitting position and be properly belted in while travelling.

»

- Never hold children or babies on your lap, this can result in potentially fatal injuries to the child!
- Never allow a child to be transported in a vehicle without being properly secured, or to stand up or kneel on a seat while travelling. In an accident, the child could be flung through the vehicle, causing possibly fatal injuries to themselves and to the other vehicle occupants.
- If children assume an improper sitting position when the vehicle is moving, they expose themselves to greater risk of injury in the event of a sudden braking manoeuvre or in an accident. This is particularly important if the child is travelling on the front passenger seat and the airbag system is triggered in an accident; as this could cause serious injury or even death.
- A suitable child seat can protect your child!
- Never leave a child alone in the child seat or inside the vehicle because depending on the season, very high temperatures may be reached inside a parked vehicle, which could be fatal.
- Children who are less than 1.5 metres tall must not wear a normal seat belt without a child seat, as this could cause injuries to the abdominal and neck areas during a sudden braking manoeuvre or in an accident.
- Only one child may occupy a child seat  
» page 26, Child seats.

- When a child seat is mounted in the rear seats, the door child-proof lock should be activated » page 66.

## Child seats

### Categorisation of child seats into groups

Use only child seats that are officially approved and suitable for the child.

Child seats are subject to the regulation ECE-R 44. ECE-R stands for: Economic Commission for Europe Regulation.

The child seats are grouped into 5 categories:

**Group 0:** Up to 10 kg (up to around 9 months)

**Group 0+:** Up to 13 kg (up to around 18 months)

**Group 1:** From 9 to 18 kg (up to around 4 years old)

**Group 2:** From 15 to 25 kg (up to around 7 years old)

**Group 3:** From 22 to 36 kg (over around 7 years old)

Child seats that have been tested and approved under the ECE R44 standard bear the test mark on the seat (the letter E in a circle with the test number below it).

Follow the manufacturer's instructions and observe any statutory requirements when installing and using child seats.

We recommend you to always include the manufacturer's Child Seat Instruction Manual together with the on-board documentation.

#### WARNING

**Read and always observe information and warnings concerning the use of child seats**  
» page 25.

### Ways to secure a child seat

You can secure a child seat to the rear seat or front passenger seat in the following ways:

- Child seats in groups **0** to **3** can be secured with a seat belt.
- Child seats for groups **0**, **0+** and **1** can be fastened without seatbelts, using the "ISO-FIX" and Top Tether\* system, using the "ISO-FIX" and Top Tether\* securing rings  
» page 27.

## Transporting children safety

Weight group	Seating position		
	Front passenger seat	Rear side seat	Rear central seat
Group 0 to 10 kg	U*	U	U
Group 0+ to 13 kg	U*	U	U
Group I 9 to 18 kg	U*	U	U
Group II 15 to 25 kg	U*	U	U
Group III 22 to 36 kg	U*	U	U

U: Suitable for universal restraint systems for use in this weight group.

\*: Move the front passenger seat as far back as possible, as high as possible and always disable the airbag.

### **⚠ WARNING**

- When travelling, children must be secured in the vehicle with a restraint system suitable for age, weight and size.
- Read and always observe information and warnings concerning the use of child seats  
» page 25.

### Child seats fastened with the “ISOFIX” and Top Tether\* system

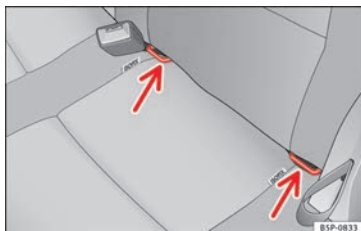

Fig. 23 ISOFIX securing rings.

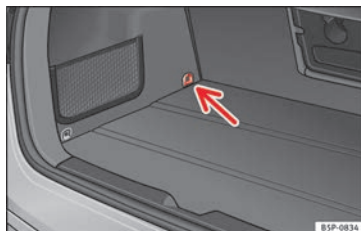

Fig. 24 Top Tether\* securing ring.



Child seats with the “ISOFIX” or Top Tether\* system can be secured quickly, easily and safely on the rear outer seats.

When removing or fitting the child seat, please be sure to follow the manufacturer's instructions.

- Move the rear seat as far to the rear as it will go.
- Press the child seat onto the “ISOFIX” retaining rings until the child seat can be

heard to engage securely. If the child seat is equipped with Top Tether\* anchor points, secure it to the correspondent ring

»» **Fig. 24.** Follow the manufacturer's instructions.

- Pull on both sides of the child seat to ensure that it is secure.

**Two** “ISOFIX” retaining rings are fitted on each rear seat. In some vehicles, the rings are secured to the seat frame and in others

they are secured to the rear floor. Access to the “ISOFIX” rings is between the rear seat backrest and the seat cushioning. The Top Tether\* rings are located at the rear of the backrests of the rear seats (behind the seat backrest or in the boot).

Child seats with the “ISOFIX” and Top Tether\* attachment system are available from Technical Services.

Weight group	Size class	Electrical equipment	Mounting direction	Vehicle Isofix positions
				Rear side seats
Baby carrier	F	ISO/L1	Backward-facing	X
	G	ISO/L2	Backward-facing	X
Group 0 to 10 kg	E	ISO/R1	Backward-facing	IU
Group 0+ to 13 kg	E	ISO/R1	Backward-facing	IU
	D	ISO/R2	Backward-facing	IU
	C	ISO/R3	Backward-facing	IU
Group I 9 to 18 kg	D	ISO/R2	Backward-facing	IU
	C	ISO/R3	Backward-facing	IU
	B	ISO/F2	Forward-facing	IU
	B1	ISO/F2X	Forward-facing	IU
Group II 15 to 25 kg	A	ISO/F3	Forward-facing	IU
	---	---	Forward-facing	---

## Transporting children safety

Weight group	Size class	Electrical equipment	Mounting direction	Vehicle Isofix positions
				Rear side seats
Group III 22 to 36 kg	---	---	Forward-facing	---

- IU: Suitable for ISOFIX universal child restraint systems approved for use in this weight group
- X: ISOFIX position not suitable for ISOFIX child restraint systems for this weight group or size class.

### WARNING

- The retaining rings are designed only for use with “ISOFIX” and Top Tether\* child seats.
- Never secure other child seats without the “ISOFIX”, Top Tether\* system, nor retaining belts or objects to the fastening rings; otherwise this can result in potentially fatal injuries to the child.
- Ensure that the child seat is secured correctly using the “ISOFIX” and Top Tether\* securing rings.

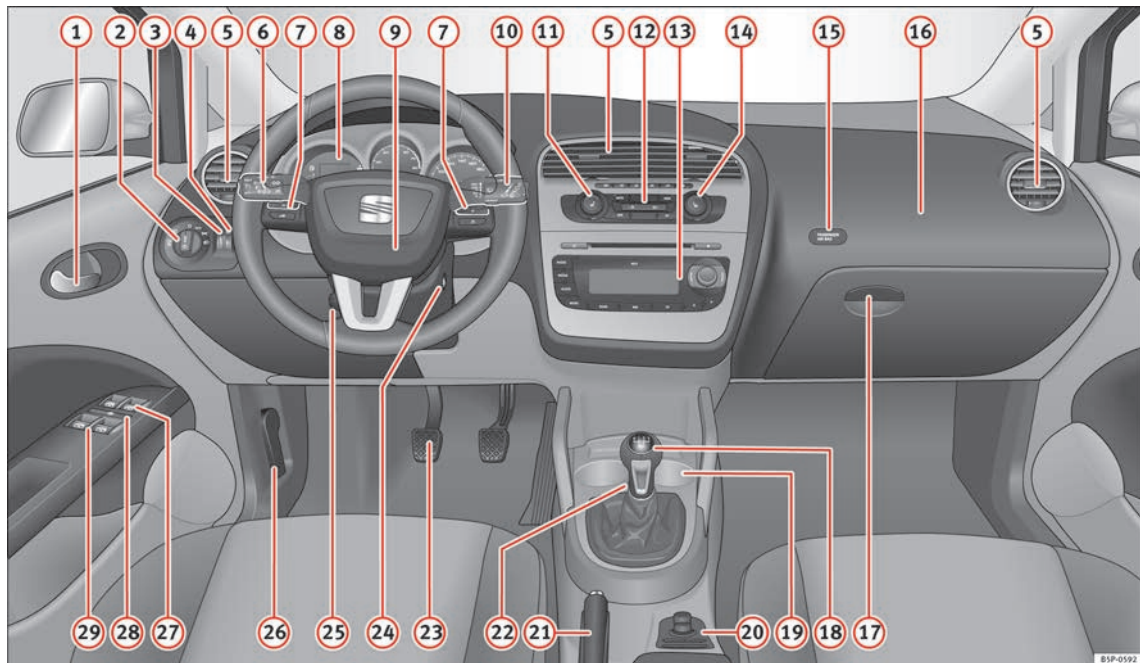

Fig. 25 Dash panel.

85P-0592



# Operation

## Dash panel

### Overview

#### Overview of the dash panel

① Door release lever		⑨ Horn (works only when the ignition is on)/ Driver front airbag	17	– Tyre pressure control*	43
② Light switch	75	⑩ Windscreen wiper lever and operation of the multi-function display*	84, 52	– Park Pilot*	140
③ Lighting control for instrument and switch lighting.	79	⑪ Left seat heating button	91	– Cigarette lighter/Power socket	98
④ Headlight range control	79	⑫ Controls for		– Exterior mirror adjustment	87
⑤ Air vents		– Heating* and ventilation	107	– Start-Stop*	138
⑥ Turn signal and main beam lever and cruise control system*	77, 142	– Climatic*	109	⑫ Handbrake	123
⑦ Controls on the steering wheel	57	– Climatronic*	112	⑬ Hazard warning lights switch	81
⑧ Instrument panel:		⑬ Radio/Navigator*		⑭ Pedals	
– Instruments	32	⑭ Right seat heating button	91	⑮ Ignition lock	120
– Display	47	⑮ Control lamp for front passenger airbag deactivated warning lamp	23	⑯ Steering column control lever*	7
– Control and warning lamps	35	⑯ Front passenger front airbag	17	⑰ Handle for releasing the bonnet	163
		⑰ Glove compartment lever	93	⑱ Button for opening and closing the front windows	72
		⑱ Selector lever	127	⑳ Safety switch* for the rear windows	72
		⑲ Cup holder compartment	95	㉑ Control* for opening and closing the rear windows	72
		⑳ Controls in the centre console:			
		– Central locking	63		
		– ESC	134		

#### Note

**Some of the items of equipment listed here are fitted only on certain model versions or are optional extras.**

## Instruments

## Instrument overview

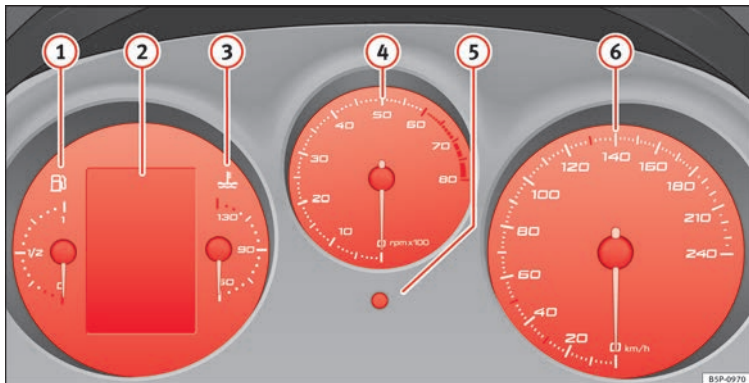

Fig. 26 Detailed view of the dash panel: Dash panel.

- ① Fuel gauge » page 33
- ② Multifunction display » page 47
- ③ Engine coolant temperature display » page 34 or natural gas level indicator in vehicles with natural gas engine (LPG) » page 33
- ④ Rev counter » page 32
- ⑤ Time adjustment button / trip recorder reset button » page 35
- ⑥ Speedometer » page 33

### Rev counter

The rev counter displays the engine speed in revolutions per minute.

The start of the red area » Fig. 26 ④ indicates maximum engine speed working at service temperature. However, it is advisable to change up into a higher gear, move the selector lever to D or lift your foot off the accelerator before the needle reaches the red zone.

### ⓘ CAUTION

To prevent possible engine malfunctions, the rev counter needle should not reach the red zone. The start of the red zone on the dial is different for some engine versions.

### 🌿 For the sake of the environment

Changing up into higher gears sooner, following the recommended gear indications » Fig. 35 will help you to reduce fuel consumption, emissions and also engine noise.

## Speedometer

The speedometer is equipped with a digital odometer and a trip odometer, in addition to a service intervals display.

During the running-in period, the instructions shown on » page 130 should be followed.

## Fuel gauge and reserve indicator



Fig. 27 Instrument panel: fuel gauge

The fuel tank has a capacity of approx. 55 litres.

When the needle reaches the reserve area » Fig. 27 (arrow), the warning lamp will light

<sup>1)</sup> Depending on the version of the model.

<sup>2)</sup> Depending on the model version

up and an audible warning will sound **reminding the driver to refuel**. At this point there are still 7 litres of fuel in the tank.

The following text appears in the dash panel display<sup>1)</sup>:

**PLEASE REFUEL [XXX]**

## LPG gauge\*

✓ Applies to the model: ALTEA / ALTEA XL

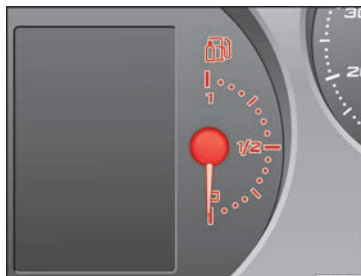



Fig. 28 Instrument panel: gas gauge.

## LPG system filler level display

The LPG tank »  in the spare wheel well has a capacity of 39 litres at an outside tem-

perature of +15 °C (+59 °F) » page 160, **Refuelling with LPG**.

The charge level can be checked on the analogue gas gauge located on the instrument panel » Fig. 28. When the level reaches reserve, a notification text is displayed on the screen. Refill with LPG at the earliest opportunity.

If while driving with LPG a sudden acoustic warning signal is heard, the on-screen message is shown<sup>2)</sup>:

## LPG fault, consult Workshop

This means there is a fault in the LPG system. Take the vehicle to a specialised workshop to check the system.

**Problem:** If the vehicle is left parked for a long time immediately after refuelling, the natural gas level indicator may not accurately indicate the same level shown after refuelling when the vehicle is started up again. This is not necessarily due to a leak in the system.

## WARNING

**LPG is a highly explosive and inflammable substance. It may cause severe burns and other injury.**

»

- Due care must be taken to avoid any risk of fire or explosion.
- When parking the vehicle in a closed area (e.g. in a garage), make sure that there is adequate ventilation, either natural or mechanical, to neutralise the LPG in the event of a leak.

#### Note

- The values shown in the average fuel consumption and distance to empty indications on the multifunction display (MFI)<sup>1)</sup> on the instrument panel display<sup>2)</sup> are approximate values only.
- Two different consumption values are given on the MFI, depending on whether the vehicle is running in gas or petrol mode.
- Please check the fuel level on the fuel level gauge on the instrument panel » page 33.
- If frequent short journeys are made, especially when the outside temperature is low, the vehicle will tend to run on petrol more often than on LPG. Therefore, the petrol tank may empty before the LPG tank.

## Engine coolant temperature gauge

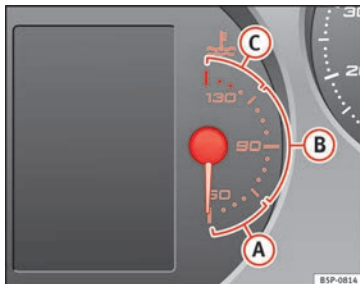

**Fig. 29** Instrument panel: Engine coolant temperature gauge.

### Needle in cold zone **A**

Avoid high engine speeds and heavy engine loads » **Fig. 29**.

### Needle in normal zone **B**

In normal driving conditions, the needle should be in the middle section of the scale. The temperature may also rise when the engine is working hard, especially at high outside temperatures. This is no cause for concern as long as the warning lamp does not

light up and no warning message\* appears on the dash panel display.

### Needle in warning zone **C**

The warning lamp\* » **Fig. 30 2** will light up if the needle is in the warning zone. The following warning message appears on the instrument panel display<sup>3)</sup>. **Stop the vehicle and switch off the engine.** Check the coolant level » page 169 » .

Even if the coolant level is correct **do not continue driving**. You should obtain technical assistance.

### WARNING

**When working in the engine compartment, always observe the safety warnings** » page 163.

### CAUTION

**Accessories in front of the air inlet reduce the cooling effect of the coolant. At high outside temperatures and high engine loads, there is a risk of the engine overheating.**

<sup>1)</sup> Optional equipment

<sup>2)</sup> Depending on the model version

<sup>3)</sup> Depending on the version of the model.

### Setting the digital clock\*

The digital clock is located in the instrument panel display.

– Turn the setting knob » Fig. 26 ⑤ clockwise until the first “click” to set the hour. The hour will flash. To change the hour, press the button.

– Turn the setting knob clockwise to the second “click” to set the minutes. The minutes will flash. To change the minutes, press the button.

## Warning lamps

### Overview of the warning lamps

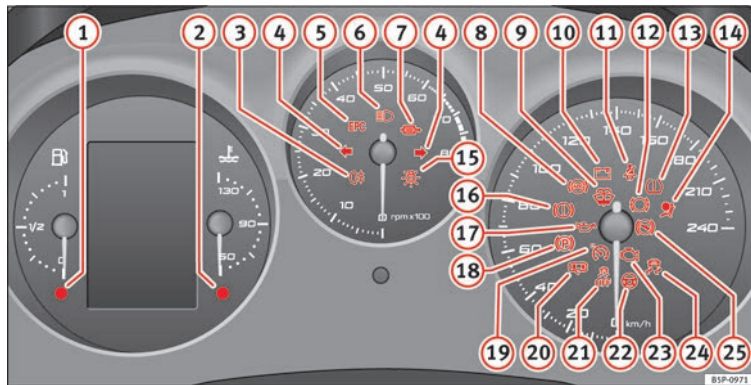







**Fig. 30** Instrument panel warning and control lamps. Some of the items of equipment listed here are fitted only on certain model versions or are optional extras.

Item	Symbol	Meaning of control and warning lamps	Further information
①		Fuel level / reserve	» page 40
②		Coolant level / coolant temperature	» page 40

## Operation

Item	Symbol	Meaning of control and warning lamps	Further information
3		Rear fog light switched on	» page 40
4		Turn signals in operation	» page 41
5	<b>EPC</b>	Engine fault (petrol engine)	» page 41
		Glow plug system (diesel engines)	» page 41
6		Main beam switched on	» page 41
7		Soot accumulation in the diesel engine particulate filter	» page 41
8		ABS system fault	» page 41
9		Windscreen washer fluid level	» page 42
10		Alternator fault	» page 42
11		Fasten seat belts!	» page 11
12		Brake pad worn	» page 42
13		Tyre pressure	» page 43
14		Airbag or belt tensioner system fault or airbag disabled	» page 16 » page 19
15		Bulb defective	» page 44
16		Brake fluid required or brake system fault	» page 44
17		<b>Red:</b> Engine oil pressure	» page 44
		<b>Yellow:</b> <b>If flashing:</b> engine oil sensor faulty <b>If it remains lit:</b> insufficient engine oil	
18		Handbrake on	» page 123

## Dash panel

Item	Symbol	Meaning of control and warning lamps	Further information
19		Cruise speed activated (Cruise control)	»» page 45
20		Door open indicator	»» page 45
21		<b>If it stays lit:</b> ASR switched off	»» page 45 »» page 46 »» page 134
22		Electromechanical steering	»» page 45
23		Fault in the emission control system	»» page 45
24	 <b>ESC</b>	<b>If flashing:</b> the Electronic Stability Control (ESC) is working or the ASR is working <b>If it remains lit:</b> ESC or ASR faulty	»» page 45 »» page 46 »» page 134
25		Selector lever lock (automatic gearbox)	»» page 46

### WARNING

- Failure to observe control lamps and warning messages can result in serious personal injury or damage to your vehicle.
- The risk of an accident increases if your vehicle breaks down. Use a warning triangle to draw the attention of other road users in order to prevent danger to third parties.
- The engine compartment is a dangerous area. Before you open the bonnet to work on the engine or in the engine compartment, switch the engine off and allow it to cool to reduce the risk of burns or other injuries. Read and observe the relevant warnings  
»» page 163.

### Note

- The appropriate control lamp for a fault will light up in vehicles without warning or information messages in the display.
- In vehicles with warning or information messages on the screen, the appropriate control lamp for a fault will light up and a warning or information message will also appear on the screen.

### Overview of control and warning lamps (vehicles with LPG)

✓ Applies to the model: ALTEA / ALTEA XL

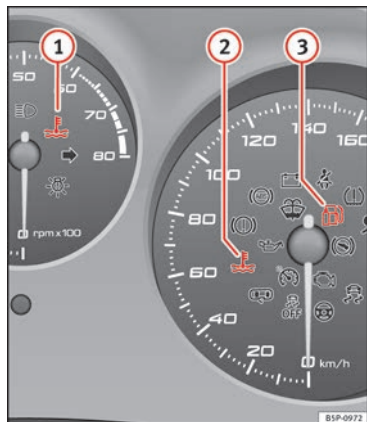

**Fig. 31** Instrument panel control and warning lamps in vehicles with LPG

①		<b>Red:</b> coolant level/coolant temperature	» page 40
②		<b>Blue:</b> cold engine warning	» page 40

③	 (green)	The green lamp lights up when the vehicle is in LPG mode. The lamp goes off when you switch, automatically or manually, to petrol mode.	» page 118
	 (yellow)	The yellow warning lamp lights up when the petrol has reached the reserve level.	

#### WARNING

- Failure to observe control lamps and warning messages can result in serious personal injury or damage to your vehicle.
- The risk of an accident increases if your vehicle breaks down. Use a warning triangle to draw the attention of other road users in order to prevent danger to third parties.
- The engine compartment is a dangerous area. Before you open the bonnet to work on the engine or in the engine compartment, switch the engine off and allow it to cool to reduce the risk of burns or other injuries. Read and observe the relevant warnings » page 163.

#### Note

- The appropriate control lamp for a fault will light up in vehicles without warning or information messages in the display.

- In vehicles with warning or information messages on the screen, the appropriate control lamp for a fault will light up and a warning or information message will also appear on the screen.

### Warning symbols

There are red warning symbols (priority 1) and yellow warning symbols (priority 2).

#### Warning messages, Priority 1 (red)

If one of these faults occurs, the warning lamp will light up or flash and will be accompanied by **three audible warnings**. This is a **danger** warning. Stop the vehicle and switch off the engine. Check the fault and correct it. Obtain professional assistance if necessary.



If several priority 1 faults are detected at the same time, the symbols will be displayed one after the other for about 2 seconds at a time and will continue until the fault is corrected.

No menus will be shown in the display for the duration of a priority 1 warning message.

#### Examples of priority 1 warning messages (red)

- Brake system symbol with the warning message **STOP BRAKE FLUID INSTRUCTION MANUAL** or **STOP BRAKE FAULT INSTRUCTION MANUAL**.



- Coolant symbol  with the warning message **STOP SEE COOLANT INSTRUCTION MANUAL**.
- Engine oil pressure symbol  with the warning message **STOP ENGINE OIL PRESSURE LOW! INSTRUCTION MANUAL**.

### Warning messages, Priority 2 (yellow)

If one of these faults occurs, the corresponding warning lamp lights up and is accompanied by **an audible warning**. Check the corresponding function as soon as possible although the vehicle may be used without risk.

If several priority 2 warning messages are detected at the same time, the symbols are displayed one after the other for about 2 seconds at a time. After a set time, the information text will disappear and the symbol will be shown as a reminder at the side of the display.

**Priority 2** warning messages will not be shown until all **Priority 1** warning messages have been dealt with!

### Examples of priority 2 warning messages (yellow):<sup>1)</sup>

- Fuel warning light with the information text **PLEASE REFUEL**.

- Windscreen washer fluid symbol  with the information text **REFILL WINDSCREEN WASHER FLUID**. Top up the washer fluid level.

### Information messages displayed on the screen\*

Messages <sup>a)</sup>	Description
SERVICE	The service interval has ended. Take the vehicle to a Technical Service.
IMMOBILISER	Immobiliser system active. The vehicle will not start. Take the vehicle to a Technical Service.
ERROR	Instrument panel faulty. Take the vehicle to a Technical Service.
CLEAN AIR FILTER	Warning: The air filter must be cleaned
NO KEY	Warning: Correct key cannot be found in the vehicle.
KEY BATTERY	Warning: Key battery low. Change the battery.
CLUTCH	Warning: Press the clutch to start. In vehicles with manual gearbox and Start-Stop system.
--> P/N	Warning: Place the selector level in position P/N to start. Only in vehicles with automatic gearbox.

Messages <sup>a)</sup>	Description
--> P	Warning: Place the selector lever in position P to stop the engine.
STARTING	Warning: The engine starts automatically. Start-Stop system activated.
START MANUALLY	Warning: The engine must be started manually. Start-Stop system activated
ERROR START-STOP	Warning: Start-Stop system error.
START-STOP IMPOSSIBLE	Warning: Although the Start-Stop system is switched on, the engine cannot be stopped automatically. Not all the necessary conditions are met
START-STOP ACTIVE	Warning: Start-Stop system activated. Vehicle in Stop mode.
SWITCH OFF	Warning: Start-Stop system activated. Switch off the ignition when you leave the vehicle.
STOP TRANSMISSION TOO HOT	Warning: Stop the engine. Gearbox overheated.
BRAKE	Warning: To start the engine, press the brake pedal. Only in vehicles with automatic gearbox.
COASTING FUNCTION	Warning: Coasting mode active. Transmission engaged. Only in vehicles with automatic gearbox.

<sup>1)</sup> Depending on the version of the model.

Messages <sup>a)</sup>	Description
CHECK SAFE-LOCK	Notification of central locking function activated.

<sup>a)</sup> These messages may vary according to the version of the vehicle model.

### Fuel level/reserve

The light comes on when only 7 litres of fuel remain in the tank, and an **acoustic signal** also sounds. It reminds you to fuel up the fuel tank as soon as possible **» page 158**.

The instrument panel displays the following message<sup>1)</sup>: **PLEASE REFUEL!**

### Coolant level\* / temperature (red)

**There is a fault if:**

- The warning symbol does not go out again after a few seconds.
- The warning lamp lights up or flashes while the vehicle is moving, and three **acoustic warning signals** **»**  are emitted.

This means that either the coolant level is too low or the coolant temperature is too high.

### Coolant temperature too high

The instrument panel displays the following message<sup>1)</sup>: **CHECK COOLANT INSTRUCTION MANUAL** **»** page 169.

First look at the coolant temperature gauge. The coolant temperature is too high if the needle is over the warning area on the dial. **Stop the vehicle, switch the engine off and wait for it to cool down.** Check the coolant level.

If the coolant level is correct, the overheating may be caused by a malfunction of the radiator fan. Check the radiator fan fuse and have it replaced if necessary **»** page 196.

If the control lamp lights up again after driving on for a short distance, **stop the vehicle and switch the engine off.** Contact a Technical Service or a specialised workshop.

### Coolant level too low

The instrument panel displays the following message<sup>1)</sup>: **STOP CHECK COOLANT INSTRUCTION MANUAL.**

First look at the coolant temperature gauge. If the needle is in the normal range, top up with coolant at the earliest opportunity **»** .

### WARNING

- If your vehicle is immobilised for technical reasons, move it to a safe distance from traffic. Turn the engine off, turn the hazard lights on and place the warning triangle.
- Never open the bonnet if you can see or hear steam or coolant escaping from the engine compartment. Risk of scalding. Wait until you can no longer see or hear escaping steam or coolant.
- The engine compartment is a dangerous area. Before carrying out any work in the engine compartment, switch off the engine and allow it to cool down. Always note the corresponding warnings **»** page 163.

### Coolant temperature (blue)

 Applies to vehicles with LPG



This lamp lights up when the coolant is below approximately +45 °C (+113 °F). When it exceeds this temperature the lamp turns off.

### Rear fog light

The warning lamp  lights up when the rear fog light is switched on. For further information see **»** page 75.

<sup>1)</sup> Depending on the version of the model.

## Turn signals

Depending on which turn signal is operating, either the left  or right  turn signal lamp flashes. Both control lamps will flash at the same time when the hazard warning lights are switched on.

If any of both turn signals fails, the warning lamp will start flashing twice faster than normal.

For further information on the turn signals, please see **» page 77**.

## Engine management\*

This warning lamp monitors the engine management system for petrol engines.

The warning lamp **EPC** (Electronic Power Control) lights up when the ignition is switched on while system operation is being verified. It should go out once the engine is started.

If there is a fault in the electronic engine management system while you are driving, this warning lamp will light up. Stop the vehicle and seek technical assistance.

## Glow plug system / Engine fault

The warning lamp lights up to show that the glow plugs are preheating the diesel engine.

## The control lamp lights up

If the control lamp  lights up when the engine is started it means that the glow plugs are preheating. When the warning lamp goes off, the engine should be started straight away.

## Control lamp flashes

If a fault develops in the engine management system while you are driving, the glow plug system lamp will flash . Take the vehicle to a specialised workshop as soon as possible and have the engine checked.

## Main beam headlights

The warning lamp  lights up when the main beams are on or when the headlight flasher is operated.





For further information see **» page 77**.

## Soot accumulation in the diesel engine particulate filter

If the control lamp  lights up you should help the filter clean itself by driving in the appropriate manner.

To do this, drive about 15 minutes in fourth or fifth gear (automatic gearbox: S gear range) at a minimum speed of 60 km/h

(37 mph), with the engine running at approximately 2,000 rpm. In this way, the soot build up in the filter is burned. When cleaning is successful, the control lamp turns off.

If the lamp  does not turn off, or the three lamps turn on (particulate filter , fault in the emission control system  and glow plugs ), drive the vehicle to a specialised workshop and have the fault repaired at the earliest opportunity.

### WARNING

- Always drive according to the road weather conditions, the terrain and traffic. Driving recommendations should never lead to illegal manoeuvres in surrounding traffic.
- The diesel engine particulate filter may reach extremely high temperatures; in this case the vehicle should be parked so that it does not enter into contact with highly flammable materials underneath the vehicle. Otherwise there is a risk of fire.

## Anti-lock brake system (ABS)\*

The warning lamp  lights up for a few seconds when the ignition is switched on. It goes out again after the system has run through an automatic test sequence. **»**



**There is a fault in the ABS if:**

- The warning lamp  does not light up when the ignition is switched on.
- The control lamp does not go out again after a few seconds.
- The control lamp lights up when the vehicle is moving.



The vehicle can still be braked in the normal way, without the ABS function. Take the vehicle to a specialised workshop as soon as possible. For further information on the ABS see the **»» page 136**.

If a fault occurs in the ABS, the ESC\* control lamp will also light up.

**Brake system fault**

If the ABS warning lamp  lights up together with the brake warning lamp , there is a fault in the ABS function and in the brake system **»» **.

** WARNING**

- **Before opening the bonnet, read and observe the warnings** **»» page 163, Working in the engine compartment.**
- **If the brake system warning lamp  should light up together with the ABS warning lamp , stop the vehicle immediately and check**

**the brake fluid level in the reservoir** **»» page 172, Brake fluid. If the brake fluid level has dropped below the “MIN” mark you must not drive on. Risk of accident. Obtain technical assistance.**

- **If the brake fluid level is correct, the fault in the brake system may have been caused by a failure of the ABS system. This could cause the rear wheels to lock quickly when you brake. This could cause the rear to break away. Risk of skidding. Stop the vehicle and seek technical assistance.**

**Washer fluid\* **

This warning lamp lights up to indicate that the windscreen washer level is very low.

This serves as a reminder to fill up the reservoir at the earliest opportunity **»» page 171**.

The following message is shown on the instrument panel display\*<sup>1)</sup>: **REFILL WINDSCREEN WASHER FLUID.**

**Alternator **

This warning lamp signals a fault in the alternator.

The warning lamp  lights up when the ignition is switched on. It should go out when the engine has started running.

If the warning lamp  lights up while driving, the alternator is no longer charging the battery. You should immediately drive to the nearest specialised workshop.

You should avoid using electrical equipment that is not absolutely necessary because this will drain the battery.

**Worn brake pads **

If the  symbol lights up, have the front brake pads (and, for safety reasons, the rear pads as well) inspected by a specialised workshop.

<sup>1)</sup> Depending on the version of the model.

## Tyre pressure (L)



Fig. 32 Centre console: tyre monitoring system button.

The tyre pressure monitoring system controls tyre speed and the frequency spectrum of each tyre.

The tyre monitoring lamp<sup>1)</sup> compares wheel revolutions and with it, using the ESC, the wheel diameter of each wheel. If the diameter of a wheel changes, the tyre control lamp (L) lights up. The wheel diameter changes when:

- Tyre pressure is insufficient.
- The tyre structure is damaged.
- The vehicle is unbalanced because of a load.

- The wheels of one axle are under more pressure (for example, driving with a trailer or on steep slopes).
- The vehicle is fitted with snow chains.
- The temporary spare wheel is fitted.
- The wheel on one axle is changed.

### Tyre pressure adjustment

Following the modification to tyre pressure or after changing one or more wheels, the button » Fig. 32 must be pressed down while the ignition is on until an audible warning is heard and the warning lamp goes out.

If the wheels are under excessive load (for example, driving with a trailer or heavy load), tyre pressure must be increased to the recommended value for a full load (see the sticker on the inside of the fuel flap). If the tyre monitor system button is pressed down, the new tyre pressures are confirmed.

### The tyre pressure control lamp (L) lights up

If the tyre pressure of one or more wheels is much lower than the value set by the driver, the tyre control warning lamp lights up » (L).

### The tyre pressure control lamp (L) flashes

If the tyre pressure control lamp flashes, this indicates a fault. Go to the nearest specialised workshop.

#### ⚠ WARNING

- When the tyre pressure monitoring lamp lights up, reduce speed immediately and avoid any sudden manoeuvre or braking. Stop when possible, and check the tyre pressure and status.
- The driver is responsible for maintaining correct tyre pressures. For this reason, tyre pressure must be regularly checked.
- Under certain circumstances (e.g. when driving in a sporty manner, in winter conditions or on a dirt track) the tyre monitoring lamp may light up or function incorrectly.

#### i Note

If the battery is disconnected, the yellow warning lamp (L) lights up after turning the ignition on. This should turn off after a brief journey.

<sup>1)</sup> Depending on the model version

**Brake system\*** **Situations in which the warning lamp lights up** 

- the brake fluid level is too low  
» page 172.



The instrument panel displays the following message<sup>1)</sup>: **STOP BRAKE FLUID INSTRUCTION MANUAL.**

- there is a fault in the brake system.

The instrument panel displays the following message<sup>1)</sup>: **BRAKE SYSTEM FAULT INSTRUCTION MANUAL.**

This warning lamp can light up together with the ABS system warning lamp.

** WARNING**

- **Before opening the bonnet, read and observe the warnings on » page 163.**
- **If the brake warning lamp does not go out, or if it lights up when driving, the brake fluid level in the reservoir » page 172, Brake fluid is too low. Risk of accident. Stop the vehicle and do not drive on. Obtain technical assistance.**
- **If the brake warning lamp lights up  together with the ABS lamp  this could be due to an ABS fault. This could cause the rear**

**wheels to lock quickly when you brake. This could cause the rear to break away. Risk of skidding. Stop the vehicle and seek technical assistance.**

**Handbrake** 

This lamp lights up when the handbrake is applied.

If you drive faster than 6 km/h (4 mph) with the handbrake on, the following message will appear on the instrument panel display<sup>1)</sup>: **HANDBRAKE ON.** You will also hear an acoustic warning signal » page 123.

**Bulb defect\*** 

The  warning lamp lights up when there is a fault in the turn signals, headlights, side lights and fog lights, e.g. in the left headlight.

The instrument panel displays the following message<sup>1)</sup>: **LEFT FULL BEAM FAULTY.**

**Engine oil pressure** 

If this warning lamp is red it indicates that the engine oil pressure is too low.

If this warning symbol starts to flash, and is accompanied by three **audible warnings**, switch off the engine and check the oil level. If necessary, add more oil » page 166.

The instrument panel displays the following message<sup>1)</sup>: **STOP ENGINE OIL PRESSURE INSTRUCTION MANUAL.**

If the warning lamp flashes although the oil level is correct, *stop* driving. Do not even run the engine at idle speed! Obtain technical assistance.

**Checking the oil level** 

If the warning lamp is yellow  the engine oil level should be checked as soon as possible. Top up the oil » page 168 at the next opportunity.

**Oil level sensor faulty\*** 

If the  yellow warning lamp flashes, take the vehicle to a specialised workshop to have the oil level sensor checked. Until then it is advisable to check the oil level every time you refuel.

<sup>1)</sup> Depending on the version of the model.

**Cruise speed (cruise control)\*** 

The warning lamp  comes on when the cruise control system is switched on. For further information on the cruise control system, see **» page 142**.

**Indicator for open doors or boot\*** 

This warning lamp lights up if one of the doors is open.

The warning light  should go off when all the doors are closed correctly.

The system also works when the ignition is switched off. It should disappear approximately 15 seconds after the vehicle has been locked.

**Electromechanical steering\*** 

For vehicles with power steering, the level of steering assistance depends on the vehicle's speed and on the steering angle.

The warning lamp should light up for a few seconds when the ignition is switched on. It should go out once the engine is started.

If the battery is disconnected, the indicator remains lit, even with the engine running.

The warning light only goes off after a distance of approx. 50 m.

There is a fault in the electromechanical steering system if the lamp does not go out or lights up while the vehicle is in motion. The warning lamp may appear in two different colours to indicate faults. If the light is red, it indicates a minor fault. If the light is yellow, it indicates a minor fault. If the light is red, seek assistance from a specialised workshop immediately, as the power steering is not working; in this case you should not keep driving. Stop the vehicle and seek technical assistance. The power steering does not work if the battery is flat or if the engine is off (e.g. for towing). You should take into account that you will need considerably more power than normal to steer the vehicle if the power steering is not working correctly or at all.

For those vehicles fitted with ESC\*, the “Steering manoeuvre recommendation” **» page 134** function is included.

**Emission control system\*** **Control lamp**  **flashes:**

When there is misfiring that can damage the catalytic converter. Reduce speed and drive carefully to the nearest specialised workshop to have the engine checked.



The instrument panel displays the following message<sup>1)</sup>: **EXHAUST GAS SEE WORKSHOP**.

**The control lamp**  **lights up:**

If a fault has developed during driving which has reduced the quality of the exhaust gas (e.g. lambda probe fault). Reduce speed and drive carefully to the nearest specialised workshop to have the engine checked.

The instrument panel displays the following message: **EXHAUST GAS SEE WORKSHOP**.

**Electronic Stability Control (ESC)\***

There are two control lamps for the electronic stability control. The lamp  provides information concerning function and  disconnection status.

Both warning lamps light up together when the ignition is switched on and should turn off after approximately 2 seconds. This is the time taken for the function check.

This programme includes the ABS, EDL and ASR. This also includes the brake assistance system (BAS), automatic cleaning of the brake discs and the trailer stability programme (TSP).

<sup>1)</sup> Depending on the version of the model.

### The warning lamp has the following functions:

- It flashes whilst driving when the ASR/ESC is activated.
- It will light up if there is a fault in the ESC.
- As the ESC operates in conjunction with the ABS, the ESC light will also come on if a fault should occur in the ABS.

If the ESC control lamp  stays on after the engine is started, this may mean that the control system has temporarily switched off the ESC. In this case the ESC can be reactivated by switching the ignition off and then on again. If the control lamp goes out, this means the system is fully functional.

### The lamp provides information about the disconnection status of the system:

- It stays lit when the ASR is disconnected when pressing the  switch.

### Differential lock fault (EDL)\*



The EDL operates along with the ABS in vehicles equipped with Electronic Stability Control (ESC)\*.

A malfunction in the EDL is indicated by the ABS control lamp . Take the vehicle to a

specialised workshop as soon as possible. For further information on the EDL see **»» page 135, Electronic differential lock (EDL)\***.

### Traction control system (ASR)\* /

The traction control system prevents the driven wheels from spinning when the vehicle is accelerating.

There are two warning lamps for the traction control system:  and . Both warning lamps light up together when the ignition is switched on and should turn off after approximately 2 seconds. This is the time taken for the function check.

### The lamp has the following function:

- It flashes when the ASR is working if the vehicle is moving.

If the system is deactivated or if it has any fault, the warning lamp will remain lit. The warning lamp will also light up if a fault should occur in the ABS because the ASR operates in conjunction with the ABS. For further information, see **»» page 137**.

### The lamp provides information about the disconnection status of the system:

- It stays lit when the ASR is disconnected when pressing the ASR OFF switch.

By pressing it again, the ASR function is reactivated and the warning lamp switched off.

### Speed selector lever lock

The brake pedal must be depressed when this warning lamp lights up. This is necessary when the automatic gearbox\* selector lever is moved out of the positions **P** or **N**.

### Electronic immobiliser\* "Safe"

This warning lamp flashes if an unauthorised key is used.

Inside the key there is a chip that deactivates the electronic immobiliser automatically when the key is inserted into the ignition. The electronic immobiliser will be activated again automatically as soon as you pull the key out of the ignition lock.

The instrument panel displays the following message<sup>1)</sup>: **IMMOBILISER**. The vehicle cannot be used in that case **»» page 121**.

<sup>1)</sup> Depending on the version of the model.



The engine can, however, be started if the appropriate coded SEAT genuine key is used.

### Note

**A perfect operation of the vehicle is ensured if genuine SEAT keys are used.**

## Digital instrument panel display

### Display (without warning or information texts)



**Fig. 33** Detailed view of the instrument panel: screen with different indicators.

The display on the dash panel shows the mileage and trip odometer as well as the selector lever position.

- 1 Digital clock display »» page 35. On the right of the display: selector lever position

tion display for the automatic gearbox\*. The current position of the selector lever or the gear which is engaged (for tiptronic)\* is highlighted.

- 2 Outside temperature.
- 3 Odometer or flexible service interval display\*.

### Displayed categories\*

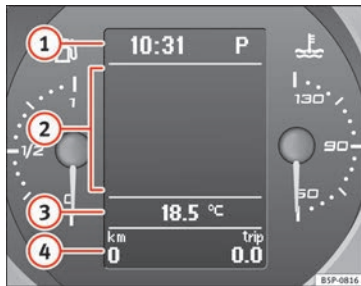
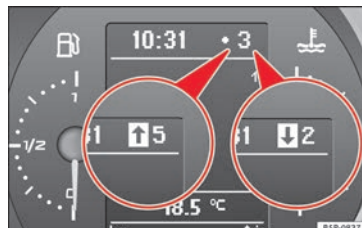

**Fig. 34** Digital dash panel display.

- 1 Clock: "Setting the time". On the right of the display: selector lever position display for the automatic gearbox\*. The current position of the selector lever or the gear which is engaged (for Tiptronic) is highlighted.
- 2 There are optional and automatic displays in this field.

- **Optional indicators:** e.g. those on the multifunction display (MFI).
  - **Automatic indicators:** Information and warning messages.
  - Menus providing further information and which can be used to make diverse settings are also shown: "Dash panel menu".
- 3 Outside temperature.
  - 4 Odometer or flexible service interval display.

### Recommended gear display\*



**Fig. 35** Gear display.

Use the gear display to save fuel. If you are driving in the correct gear, a dot will be shown next to the gear display. If you are not in the correct gear, an arrow will appear next »»

to the gear display indicating whether you should change up or down.

**Note**

**The gear change indication should not be taken into account when quick acceleration is required (for example when overtaking).**

## Odometer

The left-hand counter in the display registers the total amount of distance covered by the vehicle.

The right-hand counter registers the short journeys. The last digit indicates steps of 100 metres. The trip recorder counter may be reset by holding down the reset button for a few seconds.

## Flexible service interval display

Vehicles with **Service intervals dependent on time/distance travelled** already have certain service intervals set. The intervals are calculated individually in vehicles with **LongLife service**.

The service interval display only indicates the dates of services that include engine oil change. The dates of all other services, such as the Inspection Service or brake fluid

change, appear in the sticker on the door pillar or in the Maintenance Programme.

A **Service pre-warning** will appear in the odometer if a service is due soon. A “spanner” symbol appears and the display “km” with the distance that can be driven until the next service appointment is due. This signal changes after around 10 seconds. A “clock symbol” appears and the number of days until the service appointment should be carried out. The following message is shown in the instrument panel display\*:

**Service in**  
**[XXXX]**  
**km**  
 or  
**[XXXX]**  
**days**

The service message will disappear approximately 20 seconds after the ignition is switched on or the engine is running. The normal display can be resumed by briefly pressing the reset button on the trip counter or by pressing the **[OK]** button on the steering wheel controls.

With the ignition on, you can **check the current service message** at any moment in the **Vehicle status** menu or turning the reset button to access the service display.

An **overdue service** is indicated by a minus sign in front of the mileage or day information.

## Indications for vehicles with LongLife service

Technical progress has made it possible to considerably reduce servicing requirements. With the LongLife System, SEAT ensures that your vehicle only has an Interval Service when it is necessary. The length of the Interval Services (max. 2 years) is determined by factors such as conditions under which the vehicle is used and personal driving style.

The service pre-warning will first appear 20 days before the date on which the service is due. The distance travelled is rounded off to the nearest 100 km and the time to full days. The current service message can only be consulted 500 km after the last service. Until that time, only dashes are displayed.

**Note**

- If you reset the display manually, the next service interval will be indicated after 15,000 km or one year and will not be calculated individually.
- Do not reset the display between service intervals as the display will otherwise be incorrect.

- In LongLife Service vehicles, if the battery is disconnected for a long period, the days remaining until the next service cannot be calculated. Therefore, the service message displays on the instrument panel may be incorrect. Take into account the maximum authorised service intervals.

 Note

In the case of screens without warning or information messages, faults are indicated exclusively by the control lamps.

### Warning or information message in the display

The system runs a check on certain components and functions when the ignition is switched on and while the vehicle is moving. Functional faults are indicated by symbols with warning or information messages in the display. An audible warning is given in certain cases.

#### Warning symbols

There are red warning symbols (priority 1) and yellow warning symbols (priority 2).

#### Information text

In addition to warning messages given on a fault, you will receive information in the display on procedures or will be asked to carry out certain tasks.

### Warning messages, Priority 1 (red)



If one of these faults occurs, the warning lamp will light up or flash and will be accompanied by **three audible warnings**. This is a **danger** warning. Stop the vehicle and switch off the engine. Check the fault and correct it. Obtain professional assistance if necessary.

If several priority 1 faults are detected at the same time, the symbols will be displayed one after the other for about 2 seconds at a time and will continue until the fault is corrected.

No menus will be shown in the display for the duration of a priority 1 warning message.

#### Examples of priority 1 warning messages (red)

- Brake system symbol  with the warning message **STOP BRAKE FLUID INSTRUCTION MANUAL** or **STOP BRAKE FAULT INSTRUCTION MANUAL**.

- Coolant symbol  with the warning message **STOP SEE COOLANT INSTRUCTION MANUAL**.
- Engine oil pressure symbol  with the warning message **STOP ENGINE OIL PRESSURE LOW! INSTRUCTION MANUAL**.

### Warning messages, Priority 2 (yellow)

If one of these faults occurs, the corresponding warning lamp lights up and is accompanied by **an audible warning**. The function should be checked as soon as possible.

If several priority 2 warning messages are detected at the same time, the symbols are displayed one after the other for about 2 seconds at a time. After a set time, the information text will disappear and the symbol will be shown as a reminder at the side of the display.

**Priority 2** warning messages will not be shown until all **Priority 1** warning messages have been dealt with!

#### Examples of priority 2 warning messages (yellow):<sup>1)</sup>

- Fuel warning light with the information text **PLEASE REFUEL**. **»**

<sup>1)</sup> Depending on the version of the model.

- Windscreen washer fluid level symbol  with the information message **ADD WINDSCREEN WASHER FLUID**. Refill the windscreen washer tank **»»** page 171.

## Instrument panel menus\*

### Example of menu use

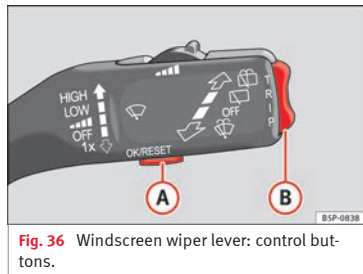

**Fig. 36** Windscreen wiper lever: control buttons.

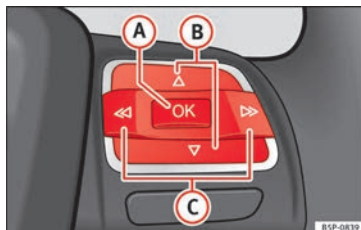

**Fig. 37** Controls on the steering wheel: control buttons.

The setting of a speed warning will be used as an example of how to use the menus. This is a good idea if you are, for example, using winter tyres which are not suited for the top speed of the vehicle.

#### 1. Open the main menu with the MFI lever

- Switch the ignition on.
- Hold down button **(B)** for 2 seconds to return to the main menu from another menu. It may be necessary to repeat this operation until the main menu is displayed.

#### 2. Open the menu “Configuration” with the MFI lever

- To choose an option from the menu, press the upper or lower end of the rocker switch. The selected option is displayed between two lines and there will also be a triangle on the right.

- Select menu **Configuration**.

- Press button **(A)** on the windscreen wiper lever. The **Configuration** menu is opened.

#### 2. Access the “Configuration” menu with the steering wheel controls

- To access the “Configuration” menu, press button **(C)** **»»** **Fig. 37** until the menu is displayed. Now you are in this menu.

#### 3. Open the main menu “Winter tyres”

- Select option **Winter tyres** using switch **(B)**.
- Press the button **(A)**. The menu **Winter tyres** is opened.

#### 4. Program a speed limit warning

- Use button **(B)** to select the option **+10 km/h** or **-10 km/h** and press button **(B)** to either increase or decrease the speed displayed.

#### 5. To activate and deactivate the speed limit warning

- Use switch **(B)** to select the menu point **On / Off** and press the button to switch the speed warning on or off. If the speed warning is deactivated, three dashes will be displayed ---.

#### 6. To close the menu “Winter tyres”

- In the menu select **Back**.

The function “Winter tyres” sends an optical and an acoustic signal when the vehicle reaches the set speed.

### Example menu “Winter tyres”

In the menu Winter tyres	Function
	Name of menu displayed
X km/h	The current set speed is displayed
or ---	or dashes will appear if the function is deactivated
On / Off	If the function is activated or deactivated
+10 km/h	The set value increases by 10 km/h
-10 km/h	The set value decreases by 10 km/h
Back	The menu “Winter tyres” is closed and the last displayed menu is shown.

#### Note

**For electronic and vehicle equipment one or more of these menus will be displayed.**

## Main menu

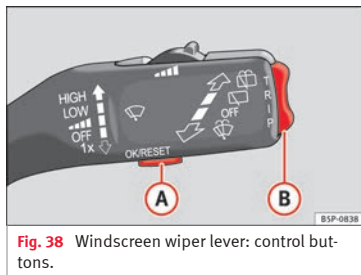

**Fig. 38** Windscreen wiper lever: control buttons.

The menu provides access to the different display functions (only with the MFI lever).

### Open main menu

- Switch the ignition on.
- Press and hold button **(B)** for at least 2 seconds. It may be necessary to repeat this operation until the main menu is displayed.

### Select a menu from the main menu

- To choose an option from the menu, press the upper or lower end of rocker switch **(B)**. The selected option is displayed between two horizontal lines.
- Press button **(A)** to select the entry.

Example of menu use »» page 50

Main menu	Function
<b>Multifunction display</b>	Change to the multifunction display (MF): “Multifunction display (MF)”
<b>Audio</b>	This menu displays the available information for the active audio source (radio station, CD audio track / MP3 / USB / iPod / Bluetooth audio <sup>1)</sup> / call information <sup>2)</sup> .
<b>Navigation</b>	This menu is only available if the vehicle is fitted with a navigation system. The navigation system must be switched on. When the route guidance is activated, the turning arrows and proximity bars are displayed. The appearance is similar to the Navigation system. If the route guidance is not activated, the direction of travel (compass) and the name of the street along which you are driving are shown.
<b>Telephone</b>	This menu is only available in vehicles with a radio unit and if the vehicle is fitted with the telephone function. In vehicles fitted with a radio navigation system, this menu is available in the central unit (navigator) »» Booklet Navigation system..
<b>Vehicle condition</b>	This menu displays current warning or information texts: “Vehicle status menu” This option flashes when one of these texts is displayed.

»»

Main menu	Function
<b>Configuration</b>	This option allows the time, the speed warning when using winter tyres, units, language, independent heating, the Light and visibility menu and the Convenience menu to be reset.

a) Only in vehicles fitted with a radio navigation system.

### Note

**For electronic and vehicle equipment one or more of these menus will be displayed.**

## Multifunction display menu (MFI)

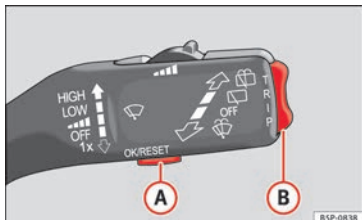

**Fig. 39** Windscreen wiper lever: control buttons.

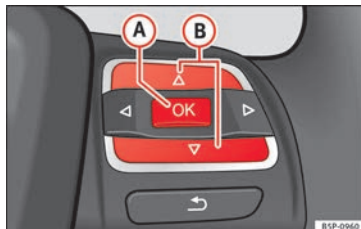

**Fig. 40** Controls on the steering wheel: control buttons.

The multifunction display (MFI) shows you information on the journey and fuel consumption. It has two automatic memories: **1 - Trip memory** and **2 - Total memory**. The selected memory is shown on the upper right hand section of the display at all times.

### Open the multifunction display menu

- Select the **Multifunction display** menu from the main menu »» page 51 and press the **OK** button on the windscreen wiper lever or the multifunction steering wheel\*.

### Selecting a memory

- To change from one memory to another, briefly press button **A** »» Fig. 36 »» page 50 on the windscreen wiper lever or the **OK** button on the multifunction

steering wheel »» Fig. 37 »» page 50 while the ignition is switched on.

### Resetting a memory



- Select the memory where you wish to erase the values.
- Hold down button **A** on the windscreen wiper lever or the **OK** button on the multifunction steering wheel\* for at least 2 seconds.

The **trip memory 1** collects the travel and consumption data from the moment the ignition is switched on until it is switched off. If the journey is continued within two hours of switching off the ignition, the new values will be added to the existing trip recorder memory. The memory will automatically be deleted if the journey is interrupted for more than 2 hours.

The **total memory 2** collects the journey data for any number of individual journeys (even if the ignition is switched off for longer than 2 hours) up to a total of 19 hours and 59 minutes of travel time or 1,999 km (1,250 miles) of distance travelled. The memory will automatically be deleted if one of the named values is reached.

### On-screen display

The following data can be viewed on the multifunction display using rocker switch **B** »» Fig. 36 »» page 50 on the windscreen wiper

lever or by pressing button  or  **Fig. 37** on the multifunction steering wheel\*:

- Distance
- Average speed
- Driving speed
- Speed warning at --- km/h
- Journey duration
- Current fuel consumption
- Average fuel consumption
- Operating range
- Outside temperature

#### Distance travelled in km (miles)

The display shows the distance travelled since the ignition was switched on.

The maximum display value in both memories is 1,999 km. The memory will automatically be deleted once this value has been reached.







#### Average speed in km/h (mph)

After starting the ignition, the average speed will be shown after a distance of approximately 100 metres has been travelled. Until then dashes will appear in the display. The display will be updated every five seconds while the vehicle is in motion.

#### km/h (mph) - Driving speed

Driving speed is digitally shown in the display.

#### Speed warning at --- km/h

This function may help you to keep within the speed limits. Press the  button on the windscreen wiper lever  or the multifunction steering wheel\* to select the current speed. The instrument panel display gives the selected speed, for example, **Speed warning 120 km/h**. You have 5 seconds to reset the speed to between 30 km/h (18 mph) and 250 km/h (155 mph) using rocker switch  or buttons  or  on the multifunction steering wheel\*. Press the  button or wait 5 seconds until the speed is stored and the warning is activated. If the set speed is exceeded, an audible warning is heard and a warning message is displayed until the speed is reduced to at least 4 km/h (2 mph) below the stored speed. The function is switched off by pressing the  button again. **Speed warning --- km/h (miles)** is now displayed on the instrument panel.

#### Trip duration in h and min

The display shows the amount of time which has elapsed since the ignition was switched on.

The maximum display value in both memories is 19 hours and 59 minutes. The memory

will automatically be deleted once this value has been reached.

#### Current fuel consumption in l/100 km or l/hour

The display will show the current fuel consumption in litres/100 km whilst the vehicle is in motion or in litres/hour when the vehicle is in a stationary position with the engine running.

Using this display you can see how your driving style affects fuel consumption **» page 117**.

#### Average fuel consumption in l/100 km

The average fuel consumption will be shown after a distance of approximately 100 metres has been travelled. Until then dashes will appear in the display. The display will be updated every five seconds while the vehicle is in motion. The amount of fuel used will not be shown.

#### Km (miles) - Fuel range

The fuel range is calculated using the figures for tank content and current fuel consumption. This shows how far the vehicle can travel using the same conditions as a reference.

#### Personal selection of display

The driver can establish which displays are shown on the instrument panel display as required: **»**

- Select the submenu **Multifunction Display Data** from the **Configuration** menu  
» page 54.

- The displays can be activated or deactivated individually by marking the required option and pressing the **OK** button on the windscreen wiper lever or the multifunction steering wheel\*.

## Outside temperature indicator

The measurement margin ranges from -45 °C (-49 °F) to +58 °C (+136.4 °F). At temperatures lower than +4 °C (+39.2 °F), an “ice crystal symbol” is displayed and a “warning” is sounded if the vehicle is moving at more than 20 km/h (12 mph) (ice warning). This symbol flashes first for around 10 seconds and remains lit as long as the outside temperature does not rise above +4 °C (+39.2 °F) or +6 °C (+42.8 °F) if it was already lit.

### WARNING

**There could be black ice on the road surface even if the “snowflake symbol” is not shown. For this reason you should not rely exclusively on this display - Risk of accident!**

### Note

- There are different instrument panels; therefore the multifunction display may vary.
- When the vehicle is stationary or travelling at very low speeds, the temperature dis-

played may be slightly higher than the actual outside temperature as a result of the heat radiated from the engine.

- Vehicles with a multifunction steering wheel\* do not have buttons on the windscreen wiper lever. The multifunction display can only be controlled from the buttons on the multifunction steering wheel\*.

## Vehicle status menu

### Open Vehicle Condition menu

- Select the option **Vehicle status** from the main menu: “Main menu” and press button **OK** on the windscreen wiper lever **A**  
» **Fig. 38.** or
- Press button **▶** or **◀** on the multifunction steering wheel\* » **Fig. 37** until the **Vehicle Status** menu is displayed.

Priority 2 warning messages and information texts: “Information and warning messages on the screen” will automatically disappear from the screen after a time and will be stored in the **Vehicle status** menu.

The warning and information texts may be viewed in this menu. If there is no warning or information message, the option **Vehicle status** is not displayed. If there are several messages, each one is shown for a few seconds.

Example of menu use » page 50.

### Note

If there are no warning messages, this menu is not available.

## Configuration menu

### Open Configuration menu

- Select the option **Configuration** from the main menu: “Main menu” and press button **OK** **A** » **Fig. 36** on the windscreen wiper lever. or
- Press button **▶** or **◀** on the multifunction steering wheel\* » **Fig. 37** until the **Configuration** menu is displayed.

Example of menu use » page 50.

Displayed on the screen	Function
<b>Multifunction display data.</b>	This menu is used to establish the data in the multifunction display menu to be displayed on the instrument panel » page 52
<b>Convenience</b>	The convenience set-up mode is used to make the settings for the convenience functions in the vehicle.
<b>Lights and visibility</b>	From this menu it is possible to alter the vehicle lighting settings.



Displayed on the screen	Function
Time	The hours and minutes of the clock and the navigation system can be changed. Choose between 12 and 24-hour format and change to summer time.
Winter tyres	The menu allows the setting of a speed at which an optical and acoustic warning will be given by the system. You can use this function, for example, if you have fitted winter tyres which are not suited for the top speed of your vehicle. Please see the section "Wheels and tyres".
Language	The display texts and the navigation system texts can be seen in different languages.
Units	This option allows you to select the units for displaying temperature, fuel consumption values and distances.
sel. speed	The instrument panel also displays the speed in another different unit of measurement (mph or km/h) to that given on the speedometer.
Inter. Service	Consult service messages and reset service interval display here.
Factory settings	The manufacturer's predefined values for the functions of this menu are restored.
Back <sup>a)</sup>	This returns to the main menu.





<sup>a)</sup> Only if the windscreen wiper lever is used (MF).

### Note

- For electronic and vehicle equipment one or more of these menus will be displayed.
- SEAT dealerships are able to programme other functions or change the existing functions depending upon the vehicle equipment.
- The Configuration menu is only accessible when the vehicle is at a standstill.

## Convenience menu

### Open menu Convenience

- Choose the option **Configuration** from the main menu and press the button   **»» Fig. 36** on the windscreen wiper lever.
- Press button  or  on the multifunction steering wheel\* **»» Fig. 37** until the **Configuration** menu is displayed.
- Choose the option **Convenience** from the main menu and press the button  on the windscreen wiper lever.

Example of menu use **»» page 50**

Displayed on the screen	Function
Central locking.	One door: Individual unlocking activated. Auto lock: The doors are automatically locked when the vehicle is travelling at more than approx. 15 km/h (10 mph). Auto unlock: the doors are unlocked when the key is removed from the ignition.
Elec. window control	Opening and closing electric windows: this determines whether to open or close all the windows when the vehicle is unlocked or locked. The open function can also be activated for the driver door only.
Exterior mirror adjust.	If synchronised adjustment is selected, when the driver side exterior mirror is adjusted, the passenger exterior mirror is also moved.
Factory settings	The predefined factory values for the functions of this menu are restored.
Back	This returns to the Configuration menu.

### Note

- For electronic and vehicle equipment one or more of these menus will be displayed.

## Lights and visibility menu

### Open Lights and visibility Menu

- Select the option **Configuration** from the main menu: “Main menu” and press button **(OK) (A)** » page 50 on the windscreen wiper lever. **or**
- Press button **(▶)** or **(◀)** on the multifunction steering wheel\* » **Fig. 37** until the **Configuration** menu is displayed.
- Select the option **Lights & visibil.** from the menu and press button **(A)** on the windscreen wiper lever.

Example of menu use » page 50.

Displayed on the screen	Function
<b>Coming Home/ Leaving Home</b>	This option permits the adjustment of the time during which the headlamps remain lit after the vehicle is locked, as well as connecting and disconnecting this function.
<b>Indicator conf.</b>	The convenience turn signal function can be activated or deactivated here. With convenience mode activated, the turn signal will blink at least three times when turned on for a lane change.
<b>Factory settings</b>	The predefined factory values for the functions of this menu are restored.

Displayed on the screen	Function
<b>Back</b>	This returns to the Configuration menu.
<b>Note</b>	
<b>For electronic and vehicle equipment one or more of these menus will be displayed.</b>	

## Steering wheel controls\*

### General information

The steering wheel includes a multifunction module from where it is possible to control the audio, telephone and radio navigation functions, and the automatic gearbox\*, without requiring the driver to be distracted from driving.

## Audio system

### Steering wheel audio version controls

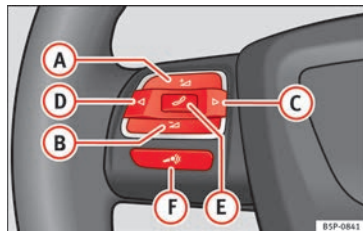

Fig. 41 Steering wheel controls.

There are three versions of the multifunction module:

- Audio version, to control the available audio functions from the steering wheel.
- Audio + Telephone version, to control the available audio functions and the telephone system from the steering wheel.

Both versions may be used to control the audio system (radio, Audio CD, mp3 CD, iPod<sup>1)</sup> /USB<sup>1)</sup> /SD<sup>1)</sup>) and the radio navigation system, in which case they also control the navigation system.

- Version for automatic gearbox\*  
» page 129.

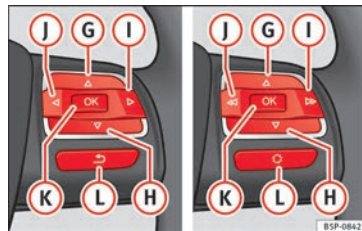

Fig. 42 Steering wheel controls (depending on version of model).

<sup>1)</sup> If fitted in the vehicle.

## Operation

Button	Radio	CD/MP3/USB*/iPod*	AUX»» table on page 59
<b>A</b>	Volume up	Volume up	Volume up
<b>B</b>	Volume down	Volume down	Volume down
<b>C</b>	Search for next station	Next track Hold down: fast forward	No function specified
<b>D</b>	Search for last station	Previous track Hold down: quick rewind	No function specified
<b>E</b>	No function specified	No function specified	No function specified
<b>F</b>	Mute	Pause	Mute
<b>G</b> <sup>a)</sup>	Operates on instrument panel display	Operates on instrument panel display	Operates on instrument panel display
	Next preset <sup>b)</sup>	Next track <sup>b)</sup>	No function specified <sup>b)</sup>
<b>H</b> <sup>a)</sup>	Operates on instrument panel display	Operates on instrument panel display	Operates on instrument panel display
	Previous preset <sup>b)</sup>	Previous track <sup>b)</sup>	No function specified <sup>b)</sup>
<b>I</b> <sup>a)</sup>	Next preset	Change folder	No function specified
	Change menu on instrument panel	Change menu on instrument panel	Change menu on instrument panel
<b>J</b> <sup>a)</sup>	Previous preset	Change folder	No function specified
	Change menu on instrument panel	Change menu on instrument panel	Change menu on instrument panel
<b>K</b>	Operates on instrument panel	Operates on instrument panel	Operates on instrument panel
<b>L</b> <sup>a)</sup>	Change source	Change source	Change source
	Operates on instrument panel	Operates on instrument panel	Operates on instrument panel

<sup>a)</sup> Depending on the model version

<sup>b)</sup> Only if the panel is in Audio menu.

## Steering wheel audio version + telephone controls

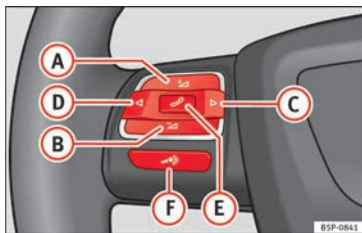

Fig. 43 Steering wheel controls.

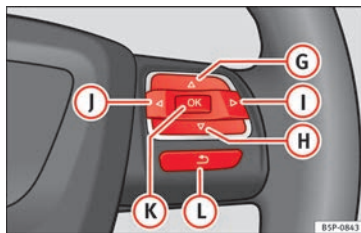

Fig. 44 Steering wheel controls (depending on version of model).

Button	Radio	CD/MP3/USB*/iPod*	AUX	TELEPHONE
A	Volume up	Volume up	Volume up	Volume up
B	Volume down	Volume down	Volume down	Volume down
C	Search for next station	Next track Hold down: fast forward	No function specified	No function specified
D	Search for last station	Previous track Hold down: quick rewind	No function specified	No function specified
E	Access telephone menu on instrument panel	Access telephone menu on instrument panel	Access telephone menu on instrument panel	Make call Accept incoming call End call Hold down: reject incoming call
F	Enable voice recognition	Enable voice recognition	Enable voice recognition	Activate voice control/ Interrupt current message/ Deactivate voice control



## Operation

Button	Radio	CD/MP3/USB*/iPod*	AUX	TELEPHONE
<b>G</b>	Next preset <sup>a)</sup>	Next track <sup>a)</sup>	No function specified	Previous option in the menu/ list/ selection shown on instrument panel <sup>b)</sup>
<b>H</b>	Previous preset <sup>a)</sup>	Previous track <sup>a)</sup>	No function specified	Next option in the menu/ list/ selection shown on instrument panel <sup>b)</sup>
<b>I</b>	Change menu on instrument panel	Change menu on instrument panel	Change menu on instrument panel	Change menu on instrument panel
<b>J</b>	Change menu on instrument panel	Change menu on instrument panel	Change menu on instrument panel	Change menu on instrument panel
<b>K</b>	Operates on instrument panel	Operates on instrument panel	Operates on instrument panel	Confirm
<b>L</b>	Operates on instrument panel	Operates on instrument panel	Operates on instrument panel	Back to last-opened menu

<sup>a)</sup> Only if the panel is in audio menu.

<sup>b)</sup> Only if the instrument panel is in the "TELEPHONE" menu. Examples of use: agenda, call list, select numbers, select letters, main menu.

## Radio navigation system

### Steering wheel audio version + telephone controls

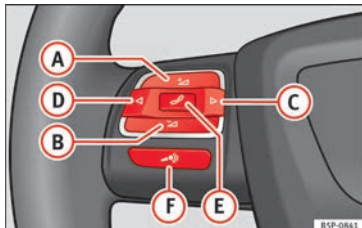

Fig. 45 Steering wheel controls.

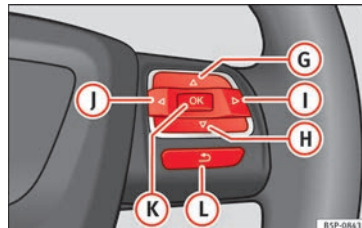

Fig. 46 Steering wheel controls (depending on version of model).

Button	Radio	CD/MP3/USB*/iPod*	AUX	NAVIGATOR	TELEPHONE
A	Volume up	Volume up	Volume up	Volume up	Volume up
B	Volume down	Volume down	Volume down	Volume down	Volume down
C	Search for next station	Next track Hold down: fast forward	No function specified	No function specified	No function specified
D	Search for last station	Previous track Hold down: quick rewind	No function specified	No function specified	No function specified

»

## Operation

Button	Radio	CD/MP3/USB*/iPod*	AUX	NAVIGATOR	TELEPHONE
<b>E</b>	No function specified	No function specified	No function specified	No function specified	Accept incoming call (press briefly) Reject incoming call (press and hold down) End ongoing call /establish call (press briefly) Switch to private mode (press and hold down) Redial last number (press and hold down) <sup>a)</sup>
<b>F</b>	Activation of voice recognition for mobile phone connected to the system (if the phone has this function)* / MUTE	Activation of voice recognition for mobile phone connected to the system (if the phone has this function)* / MUTE	Activation of voice recognition for mobile phone connected to the system (if the phone has this function)* / MUTE	Activation of voice recognition for mobile phone connected to the system (if the phone has this function)* / MUTE	Activation of voice recognition for mobile phone connected to the system (if the phone has this function)* / MUTE
<b>G</b>	Next preset <sup>b)</sup>	Next track <sup>b)</sup>	No function specified	Operates on instrument panel	Operates on instrument panel/no function specified
<b>H</b>	Previous preset <sup>b)</sup>	Previous track <sup>b)</sup>	No function specified	Operates on instrument panel	Operates on instrument panel/no function specified
<b>I</b>	Change menu on instrument panel	Change menu on instrument panel	Change menu on instrument panel	No function specified	Change menu on instrument panel
<b>J</b>	Change menu on instrument panel	Change menu on instrument panel	Change menu on instrument panel	No function specified	Change menu on instrument panel
<b>K</b>	Operates on instrument panel	Operates on instrument panel	Operates on instrument panel	Operates on instrument panel	Operates on instrument panel/no function specified
<b>L</b>	Operates on instrument panel	Operates on instrument panel	Operates on instrument panel	Operates on instrument panel	Operates on instrument panel/no function specified

<sup>a)</sup> For a more detailed description of how to use this button, please refer to the radio navigation system user handbook (SEAT Media System)

<sup>b)</sup> Only if the panel is in audio menu.



## Opening and closing

### Central locking

#### Basic functions

The central locking system enables you to lock and unlock all doors and the rear lid by just pushing the button.

#### Description

Central locking can be activated by using any of the following options:

- **the key**, by inserting it into the driver door cylinder and rotating it manually,
- **the central lock button** in the vehicle interior »» page 65.
- **the radio frequency remote control**, using the buttons on the key »» page 67.

Various functions are available to improve the vehicle safety:

- “Safe” locking system
- Selective unlocking system\*
- Automatic speed-dependent locking and unlocking system\*
- Self-locking system to prevent involuntary unlocking
- Emergency unlocking system

#### Unlocking the vehicle\*

- Press button  »» Fig. 50 on remote control to unlock all the doors and rear lid.

#### Locking the vehicle\*

- Press button  »» Fig. 50 on the remote control to lock all doors and the rear lid or turn the key in the door to lock all doors and the rear lid.

#### WARNING

- Never leave children or disabled persons in the vehicle. In case of emergency, they may not be able to leave the vehicle or manage on their own.
- Never allow children to play in or around the vehicle. A locked vehicle can be subjected to extremely high and low temperatures, depending on the time of year, thus causing serious injuries/illness. It could even have fatal consequences. Close and lock both the rear lid and all the other doors when you are not using the vehicle.
- Always take your car keys with you when you leave the vehicle. Misuse of the keys, for example, by children, may result in serious damage and accident.
  - The engine may accidentally be started and be out of control.
  - If the ignition is switched on, the electric equipment could be activated with risk of

injury, for example, in the electric windows.

- The doors can be locked using the remote control key. This could become an obstacle for assistance in an emergency situation.
- Always take the key with you when you leave the vehicle.
- Never remove the key from the ignition if the vehicle is in motion. The steering lock could suddenly engage, and you would not be able to steer the vehicle.

#### Note

- While the driver door is open, the vehicle cannot be locked with the remote control. This avoids the user from forgetting his key inside the vehicle.
- If the driver door is unlocked with the key shaft, only the driver door is unlocked, the rest of the doors remain locked. When the ignition is switched on, the door “deadlock” function is deactivated (although the doors remain locked) and the central lock button is activated. See »» page 68.
- If the central locking or anti-theft alarm are faulty, the driver door control lamp remains lit for approx. 30 seconds after the vehicle locks.
- For anti-theft security, only the driver door is fitted with a lock cylinder.

## “Safe” security system\*

This is an anti-theft device which consists of a double lock for the door locks and a deactivation function for the boot in order to prevent forced entry.

### Activating the “deadlock”

- Press *once* the locking button  on the remote control. **or**
- Turn the key *once* in the driver door lock to lock. A warning lamp in the driver door flashes to indicate the “deadlock” is working. The warning lamp flashes for approx. 2 seconds at short intervals and then more slowly.

### Deactivating the “deadlock” when the vehicle is locked

- Press the lock button  on the remote control *twice* within 2 seconds. The vehicle is locked without activating the “deadlock”. The driver door warning lamp flashes for approx. 2 seconds and then goes out. It flashes again after around 30 seconds.

The doors can be unlocked and opened from the inside if the “deadlock” has not been activated. You will have to pull the door release lever once. When the “deadlock” is off, the anti-theft alarm\* **»» page 68** remains active. The vehicle interior monitoring system\* and the anti-tow system are deactivated\*.

### WARNING

**Nobody should remain in the vehicle if the “deadlock” system mechanism has been activated. It is not possible to open the doors from the inside. Locked doors could delay assistance in an emergency. People could become trapped inside in an emergency.**

## Selective unlocking system\*

This system allows to unlock either just the driver door or all the vehicle.

**Using the remote control**, press the unlock button on the remote  once. The “Safe” system for all the vehicle is deactivated, only the driver door is unlocked and both the alarm and the warning lamp are also turned off.

### Unlocking all doors and the luggage compartment

The unlock button on the remote control must be pressed twice  so that all doors and the luggage compartment can be opened.

Press twice within 2 seconds to deactivate the “Safe” system for all vehicle, to unlock all doors and to use the luggage compartment. The warning lamp and the alarm (only vehicles fitted with one) are turned off.

## Automatic speed-dependent locking and unlocking system\*

This is a safety system which prevents access to the vehicle from the outside when it is running (e.g. when stopped at a traffic light).

### Locking

The doors and boot will lock automatically if the speed of 15 km/h (9 mph) is exceeded.

If the vehicle is stopped and one of the doors is opened, when the vehicle moves off again and exceeds a speed of 15 km/h (9 mph), the unlocked door(s) will lock once more.

### Unlocking

The driver door automatically unlocks when the key is removed from the ignition.

Each door can be unlocked and opened independently from the inside (for example, when a passenger gets out). To do it, simply operate the lever inside the door.

### WARNING

**The door handles must not be operated when the vehicle is running: the door would open.**

### Automatic locking system for involuntary unlocking\*

It is an anti-theft system and prevents the unintentional unlocking of the vehicle.

If the vehicle is unlocked and none of the doors (including the boot) are opened within 30 seconds, it re-locks automatically. This function prevents the vehicle from remaining unlocked if the unlock button is pressed by mistake.

### Emergency unlocking system

If the airbags are triggered during an accident, the vehicle is unlocked, except for the luggage compartment. It is possible to lock the vehicle from inside with the central locking, after turning the ignition off and back on again.

If the doors must be locked from the outside, see "Emergency locking of the doors".

### Unlocking and locking - Manual personalisation

#### Activating selective unlocking

With the driver door open, turn the key to unlock for approx. 3 seconds.

#### Deactivating selective unlocking

With the driver door open, turn the key to lock for approx. 3 seconds.

The turn signal lamps flash to confirm activation or deactivation.

#### Activation of automatic locking

Press the lock button  on the central locking button for 3 seconds.

#### Deactivation of automatic locking

Press the unlock button  on the central locking button for 3 seconds.

The lock button lamp flashes to confirm activation or deactivation.



### Central lock button



**Fig. 47** Detailed view of the centre console: central locking button.

The central lock button allows you to lock and unlock the vehicle from the inside.

#### Locking the vehicle

– Press the button   .

#### Unlocking the doors

– Press button .

The central lock button also works with the ignition switched off, except when the "safe" system is activated.

Please note the following if you lock your vehicle with the central lock button:



- Locking the doors and rear lid prevents access from the *outside* (for safety reasons, e.g. when stopped at a traffic light).
- The driver door and/or front passenger door cannot be locked if any of the vehicle doors (except the boot) are open. This avoids the user from forgetting his key inside the vehicle.
- Repeated operation of the central locking will deactivate the central lock button for 30 seconds. Once this time has passed, the button if operative again.
- There is a danger of leaving the key inside the vehicle if the vehicle is locked by the central locking button when the driver door is closed and any of the rear doors open. On closing any of the rear doors, the vehicle locks and the keys remain inside it.

- All doors can be unlocked separately from inside the vehicle. Do this by pulling the door release lever *once*.

### **⚠ WARNING**

- If the vehicle is locked, children and disabled people may be trapped inside it.
- The central lock button is not operative in the following cases:
  - When the vehicle is locked from the outside (with the remote control or the key).
  - While the ignition is not activated after unlocking the door lock cylinder with the key.

### **i Note**

- Vehicle locked, amber button 
- Vehicle unlocked, red button 

### Childproof lock



**Fig. 48** Childproof lock on the left hand side door.

The childproof lock prevents the rear doors from being opened from the inside. This system prevents minors from opening a door accidentally while the vehicle is running.

This function is independent of the vehicle electronic opening and locking systems. It only affects rear doors. It can only be activated and deactivated manually, as described below:

#### Activating the childproof lock

- Unlock the vehicle and open the door in which you wish to activate the childproof lock.
- With the door open, rotate the slot in the door using the ignition key, clockwise for the left-hand side doors and anti-clockwise for the right-hand side doors » **Fig. 48**.

#### Deactivating the childproof lock

- Unlock the vehicle and open the door whose childproof lock you want to deactivate.
- With the door open, rotate the slot in the door using the ignition key, clockwise for the right-hand side doors, and anti-clockwise for the left-hand side doors » **Fig. 48**.

Once the childproof lock is activated, the door can only be opened from the outside. The childproof lock can be activated or deactivated by inserting the key in the slot when the door is open, as described above.

## Keys

### Set of keys



**Fig. 49** Set of keys.

The set of keys belonging to your vehicle consists of the following items:

- one remote control key » Fig. 49 A with folding key bit,
- one key without remote control B,
- a plastic key tab\* C.

### Duplicate keys

If you need a replacement key, go to a Technical Service with your vehicle identification number.

#### ⚠ WARNING

- An incorrect use of the keys can cause serious injuries.
- Never leave children or disabled persons in the vehicle. In case of emergency, they may not be able to leave the vehicle or manage on their own.
- An uncontrolled use of the key could start the engine or activate any electric equipment (e.g. electric windows), causing risk of accident. The doors can be locked using the remote control key. This could become an obstacle for assistance in an emergency situation.
- Never forget the keys inside the vehicle. An unauthorised use of your vehicle could result in injury, damage or theft. Always take the key with you when you leave the vehicle.
- Never remove the key from the ignition if the vehicle is in motion. Otherwise, the steer-

ing could suddenly block and it would be impossible to steer the vehicle.

#### ⚠ CAUTION

There are electronic components in the remote control key. Avoid wetting and hitting the keys.

## Radio frequency remote control

### Locking and unlocking the vehicle

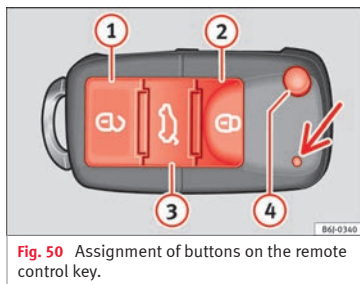

Fig. 50 Assignment of buttons on the remote control key.

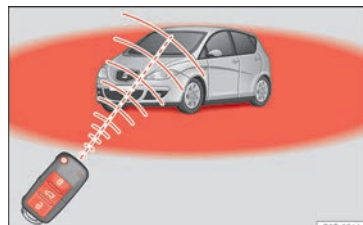

Fig. 51 Range of the radio frequency remote control.

The radio frequency remote control key is used to lock and unlock the vehicle from a distance.

By using button 4 » Fig. 50 on the control, the key shaft is released.

Unlocking the vehicle 6 » Fig. 50 1.

Locking the vehicle 6 » Fig. 50 2.

Unlocking the rear lid. Press button 6 » Fig. 50 3 until all the turn signals on the vehicle flash briefly. When the unlocking button 6 » Fig. 50 3 is pressed, you have 2 minutes to open the door. Once this time has passed, it will lock again.

Moreover, the battery indicator on the key » Fig. 50 (arrow), will flash.

The remote control transmitter and the batteries are integrated in the key. The receiver »

is inside the vehicle. The maximum range depends on different factors. The range is reduced as the batteries start to lose power.

### Selective unlocking\*



When the button  »» Fig. 50 , is pressed once, the driver door is unlocked, all others remain locked.

Press the button  »» Fig. 50  twice to unlock all doors.

### WARNING

Read and observe the relevant warnings »»  in Set of keys on page 67

### Note

- The radio frequency remote control can be programmed by means of pressing the unlocking button once; as a result, only the driver door will unlock. When the button is pressed once more, all doors and the rear lid will be unlocked.
- The radio frequency remote control functions only when you are in range »» Fig. 51 (red area).
- If the vehicle is unlocked using the   button, it will lock again automatically if any of the doors or the rear lid are not opened within 30 seconds after unlocking it. This function prevents the vehicle from remaining unlocked if the unlock button is pressed by mistake.

- If the vehicle cannot be opened and closed using the radio frequency remote control, the remote control key will have to be re-synchronised »» page 68.

### Changing the battery

If the battery indicator does not flash when the buttons are pushed, the battery must be replaced.

### CAUTION

The use of inappropriate batteries may damage the radio frequency remote control. For this reason, always replace the dead battery with another of the same size and power.

### For the sake of the environment

Used batteries must be disposed of at an appropriate waste facility or through an authorised service, given that their components can affect the environment.

### Synchronising the remote control key

If it is not possible to unlock or lock the door with the remote control, it should be re-synchronised.

- Press the  »» Fig. 50 button on the remote control.

- Then close the vehicle using the key shaft **within one minute.**

It is possible that the vehicle could no longer be opened and closed with the remote control if the button  is repeatedly pressed outside of the effective range of the radio frequency remote control. The remote control key will have to be resynchronised.

Spare remote control keys are available at your Technical Service, where they must be matched to the locking system.

Up to four remote control keys can be used.

## Anti-theft alarm system\*

### Description of anti-theft alarm system\*

The anti-theft alarm makes it more difficult to break into the vehicle or steal it. Audible and visible alarms are triggered if the vehicle is opened using the key, or if unauthorised access to the vehicle is forced.

The anti-theft alarm system is automatically switched on when locking the vehicle. The system is then primed.

- The turn signal light will flash twice on opening and deactivating the alarm.

- The turn signal light will flash once on closing and activating the alarm.

### When does the system trigger an alarm?

The system triggers an alarm if the following unauthorised actions are carried out when the vehicle is locked:

- Opening the vehicle mechanically using the key and with the ignition off.
- A door is opened.
- Opening the bonnet.
- The rear lid is opened.
- Ignition switched on with a non-validated key.
- Movements in the driving compartment (vehicles with interior monitoring).
- Undue manipulation of the alarm.
- Battery handling.

The acoustic signals sound and the turn signals flash for approx. 30 seconds. This cycle may be repeated up to 10 times depending on the country.

### Opening the doors mechanically (emergency opening)

If the radio frequency remote control function fails, you will have to use the key to unlock the vehicle. This is done as follows:

- Use the lock on the driver door to unlock the vehicle. The anti-theft alarm system remains active, but an alarm is not triggered immediately.
- Switch on the ignition within 15 seconds. When the ignition is switched on, the electronic immobiliser recognises a valid vehicle key and deactivates the anti-theft alarm system. If you do not switch on the ignition within 15 seconds, the alarm is triggered (in certain markets, such as the Netherlands, there is no 15-second waiting time and the alarm is activated immediately after opening the door).

### Opening all the doors in manual mode

In vehicles without an alarm, when opening the driver door manually, all doors are opened.

### How to switch the alarm off

When the vehicle is unlocked via the unlocking button of the radio frequency remote control or when the key is inserted in the ignition lock.

#### Note

- **After 28 days, the indicator light will be switched off to prevent the battery from draining if the vehicle has been left parked for a long period of time. The alarm system remains activated.**

- **If, after the audible warning turns off, another monitored area is accessed (e.g. the boot hatch is opened after a door has been opened), the alarm is triggered again.**
- **The anti-theft alarm is not activated when the vehicle is locked from within using the central locking button .**
- **If the vehicle battery is run down or flat then the anti-theft alarm will not operate correctly.**
- **Vehicle monitoring remains active even if the battery is disconnected or not working for any reason.**
- **The alarm is triggered immediately if one of the battery cables is disconnected while the alarm system is active.**

### Interior monitoring\*

This is a monitoring or control function incorporated in the anti-theft alarm\* which detects unauthorized vehicle entry by means of ultrasound.

The system consists of 3 sensors, 2 emitters and a receptor.

### Activation

- It is automatically turned on with the anti-theft alarm, when the vehicle is locked mechanically with the key and when the button  on the remote control is used. ➤

**Deactivation**

– Press the button  on the remote control twice. It only deactivates the interior monitor. The alarm system remains activated.

**False alarms**

Interior monitoring will only operate correctly if the vehicle is completely closed. Please observe related legal requirements.

**The following cases may cause a false alarm:**

- Open windows (partially or fully).
- Panoramic/tilting sunroof open (partially or completely).
- Movement of objects inside the vehicle, such as loose papers, items hanging from the rear vision mirror (air fresheners), etc.

**⚠ WARNING**

- The “deadlock” system remains deactivated if the interior monitor is deactivated.
- For those vehicles in which a separation screen is fitted, the alarm will not function correctly due to interference with the sensor.

**i Note**

- If the alarm has been triggered by the interior monitor, this will be indicated by a flashing of the warning lamp on the driver door

**when the vehicle is opened. This flashing will be different to that for an activated alarm.**

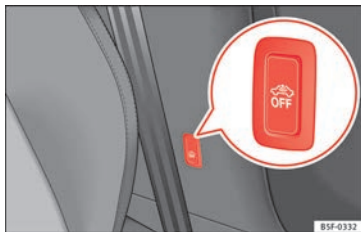
**Deactivating vehicle interior monitoring systems<sup>1)</sup>**

**Fig. 52** interior monitor button.

With the vehicle locked, any movement in the interior (e.g. pets) will set off the alarm. Deactivate interior monitor systems to prevent the alarm from going off unintentionally.

- To switch off the vehicle interior monitor, switch off the ignition and press button  **Fig. 52**. The indicator on the button will light up.
- When the vehicle is now locked, the vehicle interior monitor is switched off until the next time the door is opened.

If the anti-theft security system “deadlock”\*  page 64 is switched off, the interior monitor automatically turns off.

**⚠ WARNING**

**Observe the safety warnings  in “Safe” security system\* on page 64.**

<sup>1)</sup> Only available in certain markets.



## Boot hatch

### Unlocking and locking



Fig. 53 Rear lid: opening from the outside.



Fig. 54 Close-up of the inside trim of the rear lid: hand grip

The rear lid opening system operates electrically. It is activated by using the handle on the rear boot lid.

### Opening the rear lid



- Pull on the release lever and lift the rear lid » Fig. 53. The rear lid will automatically open.

### Closing the rear lid

- Hold the rear lid by one of the two handles on the interior lining and close it, pushing slightly.

This system may or may not be operative, depending on the situation of the vehicle.

If the rear lid is locked then it cannot be opened, however if it is unlocked then the opening system is operative and the rear lid may be opened.

To lock/unlock, press the button  or the button  on the remote control key.

A warning appears on the instrument panel display if the rear lid is open or not properly closed.\* An audible warning is also given if it is opened while the vehicle is moving faster than 6 km/h (4 mph)\*.

### WARNING

- **Always close the rear lid properly. Risk of accident or injury.**
- **Do not close the rear lid by pushing it down with your hand on the rear window. The glass could smash. Risk of injury!**

- **Ensure the rear lid is locked after closing it. If not, it may open unexpectedly while driving.**
- **Never allow children to play in or around the vehicle. A locked vehicle can be subjected to extremely high and low temperatures, depending on the time of year, thus causing serious injuries/illness. It could even have fatal consequences. Close and lock both the rear lid and all the other doors when you are not using the vehicle.**
- **Closing the rear lid without observing and ensuring it is clear could cause serious injury to you and to third parties. Make sure that no one is in the path of the rear lid.**
- **Never drive with the rear lid open or half-closed, exhaust gases may penetrate into the interior of the vehicle. Danger of poisoning!**
- **If you only open the rear lid, do not leave the key inside. The vehicle cannot be opened if the key is left inside.**

## Electric windows

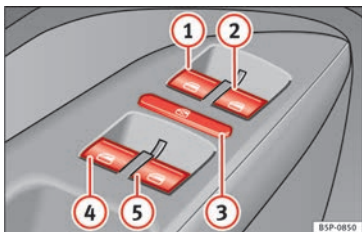

### Opening or closing the electric windows



**Fig. 55** Detail of the driver door: controls for the front and rear windows.

The front and rear electric windows can be operated by using the controls on the driver door.

### Opening and closing the windows

- Press the button  to open the window.
- Pull the button  to close the window **»»** .

Always close the windows fully if you park the vehicle or leave it unattended **»»** .

You can use the electric windows for approx. 10 minutes after switching off the ignition if neither the driver door nor the front passen-

ger door has been opened and the key has not been removed from the ignition.

### Buttons on the driver door

- 1 Button for window in front left door
- 2 Button for window in front right door

### Buttons for rear windows\*

- 3 Safety switch for deactivating the electric window buttons in the rear doors
- 4 Button for window in rear left door
- 5 Button for window in rear right door

### Safety switch \*

Safety switch **3** on the driver door can be used to disable the electric window buttons in the rear doors.

Safety switch not pressed: buttons on rear doors are activated.

Safety switch pressed: buttons on rear doors are deactivated.

### WARNING

- **Incorrect use of the electric windows can result in injury.**
- **Never close the rear lid without observing and ensuring it is clear, to do otherwise could cause serious injury to you and third parties. Make sure that no one is in the path of a window.**

- **Always take the vehicle key with you when you leave the vehicle.**
- **Never leave children or disabled persons in the vehicle, particularly if they have access to the keys. An uncontrolled use of the key could start the engine or activate any electric equipment (e.g. electric windows), causing risk of accident. The doors can be locked using the remote control key. This could become an obstacle for assistance in an emergency situation.**
- **The electric windows will work until the key has been removed from the ignition and one of the front doors has been opened.**
- **If necessary, use the safety switch to disable the rear electric windows. Make sure that they have been disabled.**

### Note

**If the window is not able to close because it is stiff or because of an obstruction, the window will automatically open again **»»** page 73. If this happens, check why the window could not be closed before attempting to close it again.**

### One-touch opening and closing

One-touch opening and closing means you do not have to hold down the button.

**One-touch closing**

- Pull up the window button briefly up to the second position. The window closes fully.

**One-touch opening**

- Push down the window button briefly up to the second position. The window opens fully.

**Restoring one-touch opening and closing**

- Close all windows.
- Use the key to lock the vehicle from outside and hold the key in the lock position for at least one second. The one-touch function is now ready for operation.

The buttons » Fig. 55 ① and ② have two levels for opening the window and two for closing it. This makes it easier to open and close windows to the desired position.

One-touch closing does not work when the ignition has been switched off, even if the key is in the ignition.

The automatic open and close function will not work if the battery has been temporarily disconnected, or if the battery is flat. The function then has to be reactivated.

The one-touch function and roll-back function will not work if there is a malfunction in the electric windows. Contact a specialised workshop.

**Roll-back function**

The roll-back function reduces the risk of injury when the electric windows close.

- If a window is obstructed when closing automatically, the window stops at this point and lowers immediately » .
- If this happens, check immediately (within 10 seconds) why the window could not be closed before attempting to close it again. After 10 seconds the normal automatic function resumes.
- If the window is still obstructed, the window will stop at this point.
- If there is no obvious reason why the window cannot be closed, try to close it again within 5 seconds.

If you wait longer than 10 seconds, the window will open again fully when you operate one of the buttons. One-touch closing is reactivated.

The one-touch function and roll-back function will not work if there is a malfunction in the electric windows. Contact a specialised workshop.

** WARNING**

- **Incorrect use of the electric windows can result in injury.**
- **Always take the ignition key with you when leaving the vehicle, even if you only intend to**

be gone for a short time. Please ensure that children are never left alone inside the vehicle.

- **The electric windows will work until the key has been removed from the ignition and one of the front doors has been opened.**
- **Never close the rear lid without observing and ensuring it is clear, to do otherwise could cause serious injury to you and third parties. Make sure that no one is in the path of a window.**
- **Never allow people to remain in the vehicle when you close the vehicle from the outside. The windows cannot be opened even in an emergency.**

** Note**

The roll-back function is deactivated if the windows are closed from the outside of the vehicle using the ignition key for convenience closing » page 73.

**Convenience opening and closing\*****Using the door lock**

- Hold the key in the door lock of the driver door in either the locking or the unlocking position until all windows are either opened or closed.
- Release the key to interrupt this function. »

### Using the remote control

- Push the lock or unlock button on the remote control for approximately 3 seconds. All windows which function electrically will be either opened or closed.
- Release the unlock button to interrupt the function.
- Once the windows are completely closed, the turn signals will flash.

## Sliding/tilting sunroof\*

### Opening and closing the sliding/tilting roof

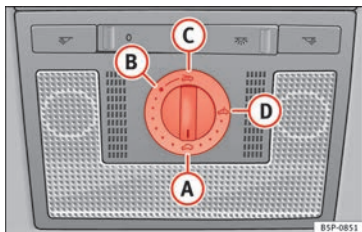

**Fig. 56** Roof lining description: sliding/tilting sunroof rotary knob.

The sliding/tilting sunroof is opened and closed using the rotary knob when the ignition is switched on.

### Closing the sliding/tilting sunroof

- Turn the rotary button to position **A** **»» Fig. 56 »» ⚠**.

### Opening the sliding/tilting sunroof

- Turn the rotary button to position **B**. The sunroof opens to the convenience position where wind noise is reduced.
- To open the roof further, turn the switch to position **C** and hold the switch in this position until the roof opens to the desired position.

### Tilting the sliding/tilting sunroof

- Turn the rotary button to position **D**.

Always close the sliding/tilting sunroof fully if you park the vehicle or leave it unattended **»» ⚠**.

The sliding/tilting sunroof can be operated for up to about 10 minutes after the ignition has been switched off, provided the driver door and the front passenger door are not opened.

### Sun visor

The sun visor is opened together with the sliding/tilting sunroof. If required, it can be closed by hand when the sunroof is closed.

### **⚠ WARNING**

- **Incorrect use of the sliding/tilting sunroof can result in injury.**
- **Never close the sliding/tilting sunroof without checking there are no obstructions, to do otherwise could cause serious injury to you and others. Make sure that no one is in the path of the sliding/tilting sunroof.**
- **Always take the vehicle key with you when you leave the vehicle.**
- **Never leave children or disabled persons in the vehicle, particularly if they have access to the keys. Unsupervised use of a key could mean that the engine is started or that electrical equipment is used (e.g. electric sliding/tilting sunroof). Risk of accident! The doors can be locked using the remote control key. This could become an obstacle for assistance in an emergency situation.**
- **The sliding/tilting sunroof continues to function until one of the front doors is opened and the key removed from the ignition.**

### Convenience closing\*

#### Using the door lock

- Hold the key in the door lock of the driver door in the locking position until the sliding/tilting sunroof is closed.
- Release the key to interrupt this function.

### Using the remote control

- Push the lock button on the remote control for approximately 3 seconds. The sliding/tilting sunroof is closed.
- Release the unlock button to interrupt the function.
- When the sliding/tilting sunroof has closed completely, the turn signals flash once.

**Note**

The sliding/tilting sunroof rotary knob remains in the last position selected if the roof is closed using convenience closing from outside the vehicle and will have to be re-positioned the next time you drive.

### Roll-back function of the sliding/tilting sunroof\*

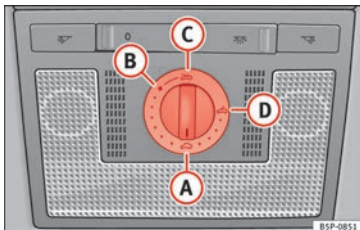

**Fig. 57** Roof lining description: sliding/tilting sunroof rotary knob.

The sliding/tilting sunroof has a *roll-back function* which prevents larger objects getting trapped when the roof is closed. The roll-back function does not prevent fingers getting pinched against the roof opening. The sliding/tilting sunroof stops and opens again immediately if it is obstructed when closing.

If the sliding/tilting sunroof has been opened again by the roll-back function, it can be closed only by pressing the rotary button at the front in position **A** » **Fig. 57** until the sliding/tilting sunroof has closed fully. **Please note that the sunroof will now close without the roll-back function.**

## Lights and visibility

### Lights

#### Switching lights on and off



**Fig. 58** Detailed view of the dash panel: lights, front fog lights and rear fog light switch.

#### Switching on the side lights

- Turn the light switch » **Fig. 58** to position .



#### Switching on dipped beam headlights

- Turn the light switch to position .





#### Switching off the lights

- Turn the light switch to position 0.

**Switching on front fog lights\***

- Pull the switch out of position  or  to the first stop. The symbol  of the light control lights up.

**Switching on the rear fog lights (vehicles with front fog lights)**

- Pull the switch out of position  or  to the second stop  . A control lamp lights up on the dash panel.

**Switching on the rear fog lights (vehicles with no front fog lights)**

- Pull the light switch from position  to the last stop. A control lamp lights up in the dash panel.

**WARNING**

Never drive with just the side lights on. Risk of accident. The side lights are not bright enough to illuminate the road ahead and to ensure that other road users are able to see you. Always use your dipped beam headlights if it is dark or if visibility is poor.

**Note**

- The dipped beam headlights will only work with the ignition on. The side lights come on automatically when the ignition is turned off.
- If the lights are left on after the key has been taken out of the ignition lock, an audible warning will sound while the driver door

remains open. This is a reminder to switch the lights off.

- The rear fog light is so bright that it can dazzle drivers behind you. You should use the rear fog light only when visibility is very poor.
- If you are towing a trailer equipped with a rear fog light on a vehicle with a factory-fitted *towing bracket*, the rear fog light on the vehicle will automatically be switched off.
- The use of the lighting described here is subject to the relevant statutory requirements.
- Depending on weather conditions (very cold or wet), the front and rear lights and the indicators may be temporarily misted. This has no influence on the useful life of the lighting system. The lights will soon demist when they are switched on.

**Automatic lighting\***

Fig. 59 Automatic lighting.

**Activation**

- Rotate the switch to the **AUTO** position. It will light up.

**Deactivation**

- Turn the light switch to **0**.

**Automatic lighting**

If automatic headlight control is switched on, dipped beam headlights are automatically switched on by a photosensor if you drive into a tunnel, for example.

The rain sensor switches on the dipped beam headlights when the windscreen wipers have been operating continuously for a few seconds and it switches the lights off when the continuous or interval wipe is switched off for some minutes  page 84.

When the automatic dipped beam headlight control is on but the dipped beam headlights are off, the warning lamp **AUTO** lights up on the light control **»» Fig. 59**. If the automatic control switches on the dipped lights, the instrument and control lighting is also switched on.

### ⚠ WARNING

• Even if the automatic headlight control is switched on, the dipped beam headlights will not be switched on with fog. Therefore, the dipped beam must be switched on manually.

### 📄 Note

• For those vehicles with the automatic headlight system, when the key is removed from the ignition, the audible warning will only sound if the light control is in the position  $\Rightarrow$  or  $\Leftarrow$  if the vehicle is not fitted with the coming home function.

• If the daylight driving automatic light function is switched on, the front fog lights or rear fog light cannot be switched on in addition.

• The use of the lighting described here is subject to the relevant statutory requirements.

• Do not put stickers on the windscreen in front of the sensor. This may cause disruptions or faults in the automatic lighting system.

• To avoid damage to the tail lights, the lights mounted on the rear lid go off when the rear lid is opened (depending on the country).

### Turn signal and main beam headlight lever

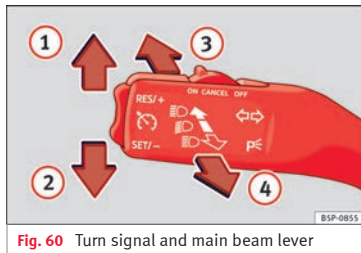

**Fig. 60** Turn signal and main beam lever

The turn signal and main beam headlight lever has the following functions:

#### Switching on the turn signals

- Move the lever all the way up **»» Fig. 60 ①** to indicate **right**, and all the way down **②** to indicate **left**.

#### Signalling a lane change

- Push the lever up **①** or down **②** to the point where you incur resistance and then release it. The turn signal will flash several

times. The corresponding control lamp will also flash.

#### Switching main beam on and off

- If the dipped lights are on, push the lever forward **»» Fig. 60 ③** to switch on the main beam headlights.
- Push the lever towards the steering wheel **»» Fig. 60 ④** to switch off the main beam.

#### Headlight flashers

- Pull the lever towards the steering wheel **④** to operate the flasher.

#### Switching on parking lights $p<$



- Switch the ignition off and remove the key from the lock.
- Move the turn signal lever up or down to turn the right or left-hand parking lights on, respectively.

### ⚠ WARNING

The main beam can dazzle other drivers. Risk of accident! Never use the main beam headlights or the headlight flasher if they could dazzle other drivers.

### 📄 Note

• The **turn signals** only work when the ignition is switched on. The corresponding warning lamp  $\Leftarrow$  or  $\Rightarrow$  flashes in the instrument **»»**

panel. The control lamp  flashes when the turn signals are operated, provided a trailer is correctly attached and connected to the vehicle. If a turn signal bulb is defective, the control lamp flashes at double speed. If the trailer turn signal bulbs are defective, the control lamp  does not light up. Change the bulb.

- The **main beam headlights** can only be switched on if the dipped beam headlights are already on. The warning lamp  then comes on in the instrument panel.
- The **headlight flasher** comes on for as long as you pull the lever – even if no other lights are switched on. The warning lamp  then comes on in the instrument panel.
- When the **parking lights** are switched on, the headlight and the tail light on the corresponding side of the vehicle light up. The parking lights will only work if the key is removed from the ignition. If said light is on, an audible warning will be emitted while the driver door is open.
- If the turn signal lever is left on after the key has been taken out of the ignition lock, an acoustic signal sounds when the driver door is opened. This is intended as a reminder to switch off the turn signal, unless you wish to leave the parking light on.

### Daytime driving lights\*

Daytime running lights are signalling devices for improving road safety. The lights are built

into the headlights and come on each time the ignition is turned on if the light switch is in position **0** or **AUTO**. It is automatically switched off when the side lights are turned on.

### Automatic control of the dipped beam in combination with the daytime running lights

If the *dipped beam control* and the *daytime running lights* are activated at the same time, the dipped beams and the instrument panel lighting will automatically come on as required (e.g. when entering a tunnel) and the daytime running lights will switch off. When the automatic dipped beam control switches off the dipped beams (e.g. when coming out of a tunnel), the daytime running lights come back on.

#### WARNING

The side lights or daytime driving lights are not bright enough to illuminate the road ahead and to ensure that other road users are able to see you.

- Always use your dipped beam head lights if it is raining or if visibility is poor.
- The rear lights do not come on with the daytime driving light. A vehicle which does not have the rear lights on may not be visible to other drivers in the darkness, if it is raining or in conditions of poor visibility.

#### Note

Please observe any relevant legal requirements which may apply in your country.

### Nordic country solution

✓ Only available in certain countries or as an optional extra

The so-called “Nordic country solution” is an alternative solution to daytime running lights in vehicles without this function. It consists of simultaneously connecting the dimmed dipped beams, the sidelights and the licence plate lights.

The aforementioned lights are switched on each time the ignition is turned on if the light switch is in position **0** or **AUTO**. Depending upon the model, the control lamp  on the light control switch or the instrument panel lighting will indicate that the lights are on.

### Activation of the Nordic country solution

- Remove the key from the ignition, move the turn signal lever upward (right turn signal), press it back to flash position and hold it there.
- Insert the key and switch on the ignition, holding it in this position for 3 seconds. Then, switch off the ignition. The Nordic country solution is now activated and the corresponding lights can come on.



### Deactivation of the Nordic country solution

- Remove the key from the ignition, press the turn signal lever down (left turn signal), press it back to flash position and hold it here.
- Insert the key and switch on the ignition, holding it in this position for 3 seconds. Then, switch off the ignition. The Nordic country solution is now deactivated and the corresponding lights will not come on.

### Coming Home/Leaving Home function\*

The Coming Home function is controlled manually. The Leaving Home function is controlled with a photosensor.

If the Coming Home or Leaving Home function is connected, the front side and dipped lights, the tail lights and the number plate light will light up to provide assistance.

#### Coming home function

The Coming Home function is activated by switching off the ignition and briefly flashing the lights. When the driver door is opened, the Coming Home lighting comes on. If the driver door is already open when the lights are flashed briefly, the Coming Home lighting comes on **immediately**.

When the last door of the vehicle or the rear lid is closed, the Coming Home function

starts and the switching off the headlights is delayed.

The Coming Home lighting switches off in the following cases:

- On completion of the time period established for the delay in switching off the lights after all the vehicle doors and the rear lid have been closed.
- If, 30 seconds after being connected, any doors or the rear lid remain open.
- If the light switch is turned to position **0**.
- If the ignition is switched on.

#### Leaving home function

The Leaving Home function is activated when the vehicle is unlocked if:

- the light control is in position **AUTO** and
- the photosensor detects “darkness”.

The Leaving Home lighting switches off in the following cases:

- If the time period for the delay in switching off the headlights has ended
- If the vehicle is locked again.
- If the light switch is turned to position **0**.
- If the ignition is switched on.

#### Note

The setting for the delay in switching off the headlights in the Coming Home and Leaving Home function can be changed or the function can be connected or disconnected in the menu Lights and visibility »» page 56.

- If the ignition key is removed while the lights are on, the lights flash briefly and the driver door opens, no audible warning is heard, since with the Coming Home function on, the lights are automatically switched off after a period of time (except when the light switch is in position  $\Rightarrow \leftarrow$  or  $\Rightarrow \leftarrow$ ).

### Instrument and switch lighting / Headlight range control

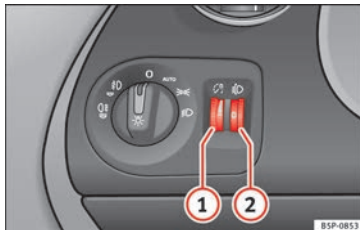

Fig. 61 Dash panel: Instrument panel and control dimmers and headlight range control. »

### Instrument and switch lighting ①

When the headlights are switched on, the brightness of the instrument panel and controls can be adjusted by turning the thumb wheel » **Fig. 61 ①**.

The instrument lighting (dials and needles), the centre console illumination and the illumination of the displays are regulated by a photodiode incorporated in the instrument panel.

The instrument lighting (dials and needles) is switched on when the ignition is on and the **vehicle lights are off**. The instrument lighting is dimmed automatically as the daylight starts to fade. It goes out completely when ambient light is very low. This function is intended to remind the driver to switch on the dipped beam headlights in good time when light conditions become poor.

### Headlight range control ②

By using the electrical headlight range control, ② you can adjust the headlight range to the load level that is being carried in the vehicle. This way, it is possible to avoid dazzling oncoming traffic more than necessary. At the same time, by using the correct headlight settings, the driver has the best possible lighting for the road ahead.

The headlights can only be adjusted when the dipped beam is switched on. To lower the

beam, turn the thumb wheel down ② from the basic setting 0.

### Dynamic headlight range control

Vehicles with **gas discharge lamps** (“xenon lamps”) are equipped with **dynamic headlight range control**. This means that the headlights will be adjusted to suit the load level of the vehicle and “nodding movements” when pulling off and braking are automatically compensated for.

Vehicles with gas discharge bulbs do not have headlight range control.

### Adaptive headlights\* (for driving round bends)

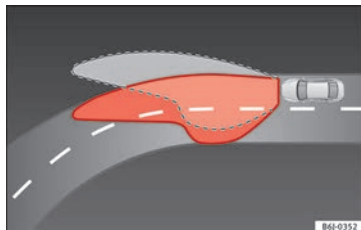



**Fig. 62** Cornering lighting using adaptive headlights.

When driving around bends, the headlights will light the most important areas of the road.

### Dynamic cornering lights\* (AFS)

**Dynamic cornering lights** only operate if the vehicle is travelling at more than 10 km/h (6 mph) and the dipped headlights are on. When taking a bend, the road is illuminated better with directional gas discharge bulbs than with conventional fixed headlights.

A fault in the system is indicated via the flashing of the control lamp  on the instrument panel. At the same time, a text message with information or instructions to perform necessary operations may appear on the instrument panel display. Take the vehicle to a specialised workshop and have the fault repaired.

If the control lamp  lights up on the instrument panel but all the bulbs are operating correctly » **page 198**, there may still be a fault in the dynamic curve lighting system (AFS). Take the vehicle to a specialised workshop and have the fault repaired.

### WARNING

**If the “automatic dipped beam control” is switched on, the dipped beam headlights will not be switched on in fog. They should be switched on manually using the light switch. The driver is personally responsible for the**

correct use of lights in all situations. “Automatic headlight control” is merely a system to support the driver. Where necessary, switch on the lights manually using the light switch.

### Fog lights with cornering function\*

✓ Applies to the model: ALTEA / ALTEA XL

When the turn signal is switched on to turn or on very tight bends, the right or left fog light automatically comes on to function as a **cornering light**. The cornering light only operates if the dipped beam lights are on.

### **WARNING**

**Read and observe the relevant warnings »» ⚠**  
in Adaptive headlights\* (for driving round bends) on page 80

### Hazard warning lights ⚠

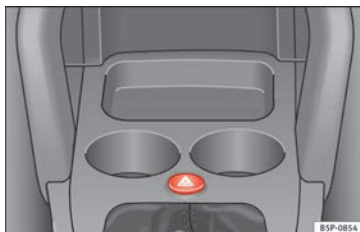

**Fig. 63** Dash panel: switch for hazard warning lights.

The hazard warning lights are used to draw the attention of other road users to your vehicle in emergencies.

If your vehicle breaks down:

1. Park your vehicle at a safe distance from moving traffic.
2. Press the button to switch on the hazard warning lights »» ⚠.
3. Switch the ignition off.
4. Apply the handbrake.
5. For a manual gearbox, engage 1st gear; for an automatic gearbox, move the gear lever to **P**.
6. Use the warning triangle to draw the attention of other road users to your vehicle.

7. Always take the vehicle key with you when you leave the vehicle.

Switch on the hazard warning lights to warn other road users, for example:

- reaching the tail end of a traffic jam,
- there is an emergency
- your vehicle breaks down due to a technical fault,
- you are towing another vehicle or your vehicle is being towed.

All turn signals flash simultaneously when the hazard warning lights are switched on. The two turn signal turn signal lamps ⇄ ⇄ and the turn signal lamp in the switch ⚠ will flash at the same time. The hazard warning lights also work when the ignition is switched off.

### Emergency braking warning

If the vehicle brakes suddenly and continuously at a speed of more than 80 km/h (50 mph), the brake light flashes several times per second to warn the vehicles driving behind. If you continue braking, the hazard warning lights will come on automatically when the vehicle comes to a standstill. They switch off automatically when the vehicle starts to move again.

»»

**⚠ WARNING**

- The risk of an accident increases if your vehicle breaks down. Always use the hazard warning lights and a warning triangle to draw the attention of other road users to your stationary vehicle.
- Never park where the catalytic converter could come into contact with inflammable materials under the vehicle, for example dry grass or spilled petrol. This could start a fire!

**i Note**

- The battery will run down if the hazard warning lights are left on for a long time, even if the ignition is switched off.
- The use of the hazard warning lights described here is subject to the relevant statutory requirements.

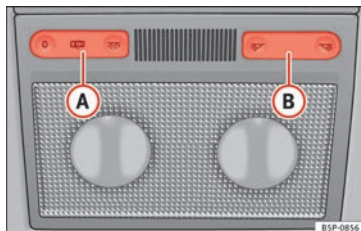
**Interior lights****Front interior lights and reading lights**

**Fig. 64** Interior roof trim: front interior lighting option 1.

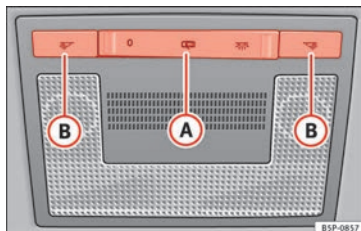

**Fig. 65** Interior roof trim: front interior lighting option 2.

Switch **A** **>>> Fig. 64** or **>>> Fig. 65** is used to select the following positions:

**Courtesy light position **

Rocker switch in flat position (not activated). The interior lighting is automatically switched on when the vehicle is unlocked or the key removed from the ignition. It goes out approximately 20 seconds after the doors are closed. The interior lights are switched off when the vehicle is locked or when the ignition is switched on.

**Interior light switched on **

Push the switch to the position .

**Turning off the interior light 0**

Press the switch to position **0** **>>> Fig. 64** or **>>> Fig. 65**.

**Switching on the reading light **

Press the corresponding button **B** **>>> Fig. 64** or **>>> Fig. 65** to switch on the reading light.

**Switching the reading lights off **

Press the corresponding button to switch the reading light off.

**i Note**

**If not all the vehicle doors are closed, the interior lights will be switched off after approx. 10 minutes, providing the ignition key has been removed and the courtesy light position selected. This prevents the battery from discharging.**

## Rear interior lights and reading lights\*

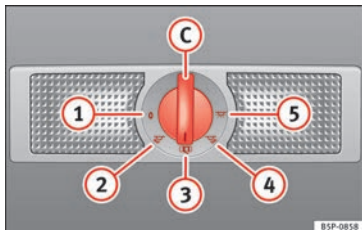

**Fig. 66** Interior roof trim: rear interior lights and reading lights.

The switch » **Fig. 66 C** is used to select the following positions:

### Interior light switched off 0

In switch position » **Fig. 66 1**, the interior and reading lights are switched off.

### Switching on the reading light

Turn the switch to position **2** (left reading light) or to position **4** (right reading light).

### Courtesy light position

Turn the control to position **3**. The interior lighting is automatically switched on when the vehicle is unlocked or the key removed from the ignition. The light goes out approximately 20 seconds after the doors are

closed. The interior lights are switched off when the vehicle is locked or when the ignition is switched on.

### Interior lights or both reading lights switched on

Turn the control to position **5**.

#### Note

If not all the vehicle doors are closed, the interior lights will be switched off after approx. 10 minutes, providing the ignition key has been removed and the courtesy light position selected. This prevents the battery from discharging.

## Visibility

### Sun visors

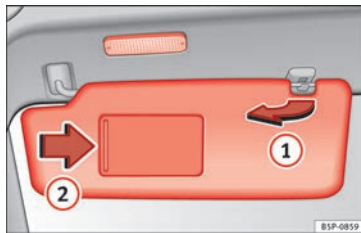

**Fig. 67** Sun visor on the driver side.

The sun visors for the driver and the front passenger can be pulled out of their mountings in the centre of the vehicle and turned towards the doors » **Fig. 67 1**.

The vanity mirrors in the sun visors have covers. When you open the cover **2**, a lamp in the roof lights up.

The light\* in the roof lining will go out when the vanity mirror cover is pushed back or the sun visor is pushed back up.

#### Note

The roof lighting will go out approximately ten minutes after the ignition key has been removed. This prevents the battery from discharging.

### Sun blind\*

✓ Applies to the model: ALTEA XL/ALTEA FRETRACK

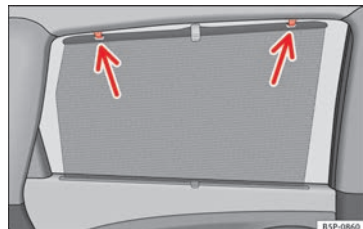

**Fig. 68** Rear door blind.

### Rear window sun blind\*

- Pull out the visor and hook it onto the hooks at the top of the door frame  
»» Fig. 68.

## Windscreen wiper and rear window wiper systems

### Windscreen wipers

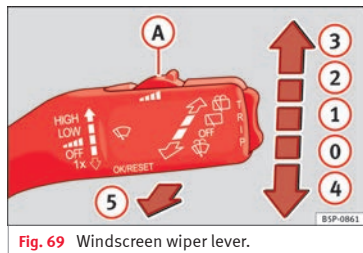

Fig. 69 Windscreen wiper lever.

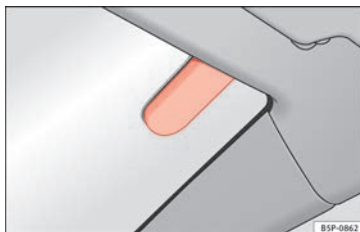

Fig. 70 Rain sensor on the windscreen seen from the interior.

The windscreen wiper lever »» Fig. 69 has the following positions:

#### Initial position 0

Rest, windscreen disconnected.

#### Intermittent wipe / automatic wipe with rain sensor\*

- Move the lever up to position 1.
- With switch A adjust the wipe interval or sensitivity of the rain sensor\*.

Switch A has 4 positions.

The rain sensor\* is part of the intermittent wipe function. You will have to switch the rain sensor back on if you switch off the ignition. This is done by switching the wiper interval wipe function off and back on.

#### Slow wipe

- Push the lever up to position 2.

#### Continuous wipe

- Push the lever up to position 3.

#### Short wipe

- Move the lever down to position 4 to give the windscreen a *short* wipe. The wiper will start to move faster if you keep the lever pressed down for longer than two seconds.

#### Automatic wash/wipe

- Pull the lever towards the steering wheel, position 5. The wash function will start immediately and the wipers will start with a slight delay. The wash and wiper systems will function at the same time at speeds of over 120 km/h (75 mph).
- Release the lever. The wipers will keep running for approximately 4 seconds.

#### Heated windscreen in the wiper blade area\*

In some countries and in some versions, it is possible to heat the windscreen in the area of the windscreen wiper blades in order to aid de-icing in this area. The function is switched on by pressing the heated rear window key .

### ⚠ WARNING

- Worn and dirty wiper blades reduce visibility and safety levels while driving.
- In cold conditions, you should not use the wash/wipe system unless you have warmed the windscreen with the heating and ventilation system. The windscreen washer fluid could otherwise freeze on the windscreen and obscure your view of the road.
- The rain sensor may not detect enough rain to switch on the wipers. If necessary, switch on the wipers manually when water on the windscreen impedes visibility.
- Always note the corresponding warnings  
»» page 194.

### ⓘ CAUTION

In icy conditions, always check that the wiper blades are not frozen to the glass before using the wipers for the first time. If you switch on the windscreen wipers when the wiper blades are frozen to the windscreen, you could damage both the wiper blades and the wiper motor.

### ℹ Note

- The windscreen wipers will only work when the ignition is switched on.
- In certain versions of vehicles with alarms, the windscreen wiper will only work when the ignition is on and the bonnet closed.

- When in use, the wipers do not go as far as the rest position. When the lever is moved to position 0, they are totally hidden.
- If the vehicle stops when wiper speed ② »» Fig. 69 or ③ is selected, the next speed down will be selected automatically. The set speed will be resumed when the vehicle pulls away.
- The windscreen will be wiped again after approximately five seconds once the “automatic wash/wipe system” has been activated, provided the vehicle is moving (drip function). If you activate the wipers less than 3 seconds after the drip function, a new wash sequence will begin without performing the last wipe. For the “drip” function to work again, you have to turn the ignition off and then on again.
- When the “interval wipe function” is on, the intervals are directly proportional to the speed. This way, the higher the vehicle speed the shorter the intervals.
- The wiper will try to wipe away any obstacles that are on the windscreen. The wiper will stop moving if the obstacle continues to block its path. Remove the obstacle and switch the wiper back on again.
- Before removing any objects that may be trapped in the side areas of the windscreen, always move the wiper arms to the service position (horizontal).
- The heat output of the heated jets is controlled automatically when the ignition is switched on, depending upon the outside temperature.

- Do not put stickers on the windscreen in front of the rain sensor\*. This may cause sensor disruption or faults.

### Rear window wiper



Fig. 71 Windscreen wiper lever: rear window wiper.

### Switching on the interval wipe

- Press the lever forward to position ⑥  
»» Fig. 71. The wiper will wipe the window approximately every 6 seconds.

### Switching off the interval wipe function

- Pull the lever back from position ⑥ toward the steering wheel. The wiper will continue to function for a short period if you switch off whilst the wipers are in motion. »»

### Switching on automatic wipe

- Press the lever fully forwards to position ⑦ » Fig. 71. The rear wash function will start immediately and the wiper will start a few seconds later. The rear window wash system will function as long as you hold the lever in this position.
- Release the lever. The wiper then wipes for approximately 4 seconds, and then in intervals again.
- Release the lever. The washer system stops and the wipers function.

#### ⚠ WARNING

- Worn and dirty wiper blades reduce visibility and safety levels while driving.
- Always note the corresponding warnings on » page 194.

#### ⚠ CAUTION

In icy conditions, always check that the wiper blade is not frozen to the glass before using the wiper for the first time. If you switch on the wiper when the wiper blade is frozen to the glass, this could damage both the wiper blade and the wiper motor.

#### i Note

- The windscreen wiper will only function when the ignition is switched on and the rear lid is closed.

- In reverse gear, with the windscreen wipers switched on, the rear windscreen wiper will make one wipe.

### Headlight washer\*

The headlight washers clean the headlight lenses.

The headlight washers are activated automatically when the windscreen washer is used and the window wiper lever is pulled towards the steering wheel for at least 1.5 seconds – provided the dipped beam headlights or main beams are switched on. Clean off stubborn dirt (insects, etc.) from the headlights at regular intervals, for instance, when filling the fuel tank.

#### i Note

- To ensure that the headlight washers work properly in winter, keep the nozzle holders in the bumper free of snow and remove any ice with a de-icer spray.
- To remove water, the windscreen wipers will be activated from time to time, the headlight washers will be activated every three cycles.

## Rear vision mirrors

### Interior rear vision mirror

It is dangerous to drive if you cannot see clearly through the rear window.

### Manual anti-dazzle function for interior rear vision mirror

In the basic mirror position, the lever at the bottom edge of the rear vision mirror should be at the front. Pull the lever to the back to select the anti-dazzle function.

### Automatic anti-dazzle interior rear vision mirror\*

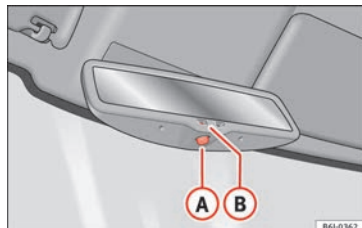

Fig. 72 Automatic anti-dazzle interior rear vision mirror.



### Switching off the anti-dazzle function

- Press button **A** » Fig. 72. Control lamp goes off.

### Switching on the anti-dazzle function

- Press button **A** » Fig. 72. The control lamp lights up.

### Anti-dazzle function

The anti-dazzle function is activated every time the ignition is switched on. The green warning lamp lights up in the rear vision mirror housing.

When the anti-dazzle function is enabled, the interior rear vision mirror will darken **automatically** according to the amount of light it receives. The anti-dazzle function is cancelled if reverse gear is engaged.

#### Note

- The automatic anti-dazzle function will only work properly if the sun blind\* for the rear window is retracted and there are no other objects preventing light from reaching the interior rear vision mirror.
- If you have to stick any type of sticker on the windscreen, do not do so in front of the sensors. Doing so could prevent the anti-dazzle function from working well or even from working at all.

### Exterior mirrors

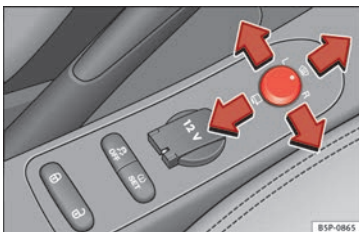

Fig. 73 Exterior mirror controls.

The exterior mirrors can be adjusted using the rotary knob in the centre console.

#### Basic setting of exterior mirrors

1. Turn knob » Fig. 73 to position **L (left exterior mirror)**.
2. Turn the rotary knob to position the exterior mirror so that you have a good view to the rear of the vehicle.
3. Turn the knob to position **R (right exterior mirror)**.
4. Swivel the rotary knob to position the exterior mirror so that you have a good view to the rear of the vehicle » **△**.

#### Heating the exterior mirrors\*

- Turn the knob forward » Fig. 73 so that the heated rear vision mirrors warm up and the

heated windscreen\* in the wiper blade rest area is activated » page 84.

- Exterior mirror heating is not activated in temperatures above approximately +20 °C (+68 °F).

#### Folding in exterior mirrors\*

- Turn the control » Fig. 73 to position **☰** to fold in the exterior mirrors. You should always fold in the exterior mirrors if you are driving through an automatic car wash. This will help prevent damage.

#### Folding exterior mirrors with convenience closing\*

- The exterior mirror will fold back automatically with convenience closing (with the remote or the key).
- To unfold it again, open the door and switch on the ignition.

#### Folding exterior mirrors back out to the extended position\*

- Turn the knob to another position to fold the exterior mirrors back out » **△**.

#### Synchronised mirror adjustment

1. Turn the control to the position **L (left exterior mirror)**.
2. Turn the rotary knob to position the exterior mirror so that you have a good view to »

the rear of the vehicle. The **right exterior mirror** will be adjusted at the same time (synchronised).

#### WARNING

- Convex or spherical mirrors increase the field of vision however the objects appear smaller and further away. If you use these mirrors to estimate the distance to vehicles behind you when changing lane, you could make a mistake. Risk of accident.
- If possible, use the rear vision mirror to estimate distances to vehicles behind you.
- Make sure that you do not get your finger trapped between the mirror and the mirror base when folding back the mirrors. Risk of injury!

#### For the sake of the environment

The exterior mirror heating should be switched off when it is no longer needed. Otherwise, it is an unnecessary fuel waste.

#### Note

- If the electrical adjustment ever fails to operate, the mirrors can be adjusted by hand by lightly pressing the edge of the mirror glass.
- In vehicles with electric exterior mirrors, the following points should be observed: if, due to an external force (e.g. being knocked while manoeuvring), the adjustment of the mirror housing is altered, the mirror will have to be fully folded electrically. Do not readjust

the rear vision mirror housing by hand, as this will interfere with the mirror adjuster function.

- The rear vision mirrors can be adjusted separately or simultaneously, as described above.
- The folding function on the exterior mirrors is not active at speeds over 40 km/h (25 mph).

## Seats and head restraints

### Adjusting the seat and head restraints

#### The importance of correct seat adjustment

Proper seat adjustment optimises the level of protection offered by seat belts and airbags.

Your vehicle has **five** seats, two in the front and three in the rear. Each seat is equipped with a three-point seat belt.

The driver seat and the front passenger seat can be adjusted in many ways to suit the physical requirements of the vehicle occupants. The correct seat position is very important for:

- a fast and easy operation of all controls on the instrument panel,
- a relaxed posture which does not cause drowsiness,
- a safe driving »» page 5,
- ensuring that the seat belts and airbag system provide maximum protection »» page 11.

#### WARNING

- If the driver and passengers assume improper sitting positions, they may sustain critical injuries.

- Never transport more than the permitted amount of people in your vehicle.
- Every vehicle occupant must properly fasten and wear the seat belt belonging to his or her seat. Children must be protected with an appropriate child restraint system »» page 24, Transporting children safety.
- The front seats and all head restraints must always be adjusted to body size and the seat belt must always be properly adjusted to provide you and your passengers with optimum protection.
- Always keep your feet on the footwell when the vehicle is moving; never rest them on the dash panel, out of the window or on the seat. This is also applied to passengers. An incorrect sitting position exposes you to an increased risk of injury in case of a sudden braking or an accident. If the airbag is triggered, you could sustain severe injuries due to an incorrect sitting position.
- It is important for the driver and front passenger to keep a distance of at least 25 cm from the steering wheel and dash panel. Failure to respect the minimum distance means that the airbag will not protect you. Risk of fatal injury. The distance between the driver and the steering wheel or between the front passenger and the dash panel should always be as great as possible.
- Adjust the driver or front passenger seat only when the vehicle is stationary. This also applies to the forwards/backwards adjustment of the rear seats. Otherwise, your seat could move unexpectedly while the vehicle is

moving. This could increase the risk of an accident and therefore, injury. In addition, while adjusting your seat, you will assume an incorrect sitting position. Risk of fatal accidents.

- Special guidelines apply to installing a child seat on the front passenger seat. When installing a child seat, please observe the warnings described in »» page 24, Transporting children safety.

### Adjustment of the front seats



Fig. 74 Front left seat controls

The control elements in »» Fig. 74 are mirrored for the front right-hand seat.

#### ① Adjusting the seat forwards and backwards

- Pull up the grip and move the seat forwards or backwards.

- Then release the grip ① and move the seat further until the catch engages.

#### ② Adjusting the seat height\*

- Pull the lever up or push down (several times if necessary) from its home position. This adjusts the seat height in stages.

#### ③ Adjusting the backrest angle

- Take your weight off the backrest and turn the hand wheel.

#### ④ Adjusting the lumbar support\*

- Take your weight off the backrest and turn the hand wheel to adjust the lumbar support.

As you make the adjustments, the curvature of the cushioned area of the lumbar region becomes more or less acute. In this way, it adapts to the natural curvature of the spine.

#### **⚠ WARNING**

- Never adjust the driver or front passenger seat while the vehicle is in motion. While adjusting your seat, you will assume an incorrect sitting position. Risk of fatal accidents. Adjust the driver or front passenger seat only when the vehicle is stationary.
- To reduce the risk of injury to the driver and front passenger in case of a sudden braking or an accident, never drive with the backrest tilted towards the rear. The maximum

»

protection of the seat belt can be achieved only when the backrests are in an upright position and the driver and front passenger have properly adjusted their seat belts. The further the backrests are tilted to the rear, the greater the risk of injury due to improper positioning of the belt web!

- Exercise caution when securing the seat height into forwards/backwards position. Injuries can be caused if the seat height is adjusted without due care and attention.

### Correct adjustment of head restraints

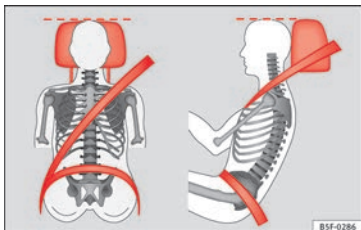

**Fig. 75** Front and side view: head restraints and seat belts correctly adjusted.

Properly adjusted head restraints are an important part of passenger protection and can reduce the risk of injuries in most accident situations.

- Adjust the head restraint so that the top is at the same level as the top of your head, at the very least, at eye level » **Fig. 75.**

Adjusting the head restraints » page 90

### **⚠ WARNING**

- Travelling with the head restraints removed or improperly adjusted increases the risk of severe injuries.
- Improperly adjusted head restraints could lead to death in the event of a collision or accident.
- Incorrectly adjusted head restraints also increase the risk of injury during sudden or unexpected driving or braking manoeuvres.
- The head restraints must always be adjusted according to the height of the passenger.

### Removing or adjusting head restraints

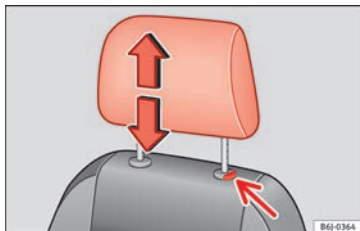

**Fig. 76** Adjusting and removing the head restraints.

#### Adjusting height (front seats)

- Press the button on the side and pull upwards to the desired position.
- To lower the head restraint, press the button and push head restraint downwards.
- Make sure that it engages securely into one of its positions.

#### Adjusting height (rear seats)

- Press the button on the side and pull upwards to the desired position.
- To lower the head restraint, press the button and push head restraint downwards.
- Make sure that the head restraint engages securely in one of its positions. » **page 10**

### Angle adjustment (front seats)

- Press the head restraint forward or back to the required position.

### Removing the head restraint

- Push the head restraint up as far as it will go.
- Press the button » Fig. 76 (arrow).
- Pull head restraint out of fitting without releasing the button.

### Fitting the head restraint

- Insert the head restraint into the guides on the backrest.
- Push head restraint down.
- Adjust the head restraint to suit body size » page 10 and » page 9.

#### **⚠ WARNING**

- Never drive if the head restraints have been removed. Risk of injury.
- Never drive if the head restraints are in an unsuitable position, there is a risk of serious injury.
- After refitting the head restraint, you must always adjust it properly for height to achieve optimal protection.
- Please observe the safety warnings in » page 90, Correct adjustment of head restraints.

## Seat functions

### Heated seats\*

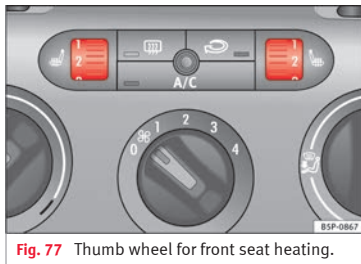

Fig. 77 Thumb wheel for front seat heating.

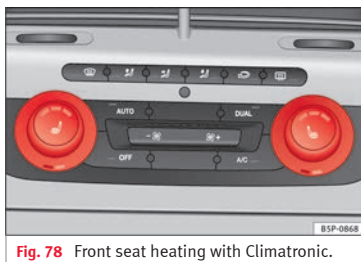

Fig. 78 Front seat heating with Climatronic.

The front seat cushions and backrests can be heated electrically.

### Front seat heating for vehicles without Climatronic

- Turn the appropriate thumb wheel » Fig. 77 to switch on the seat heating. The seat heating is switched off in the 0 position.

### Front seat heating for vehicles with Climatronic

- Press the button to switch on seat heating.
- Press once to set seat heating at maximum level (level 3).
- Press twice to set seat heating at medium level (level 2).
- Press three times to set seat heating at minimum level (level 1).
- When the button is pressed four times, the heating goes off and the LED goes out (level 0).

The seat heating only works when the ignition is switched on. The left thumb wheel controls the left seat and the right thumb wheel the right seat.

#### **ⓘ CAUTION**

To avoid damaging the heating elements, please do not kneel on the seat or apply sharp pressure at a single point to the seat cushion and backrest.

## Rear seats

### Seat adjustment

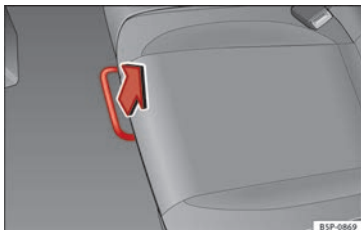

Fig. 79 Unlock bar on rear seat

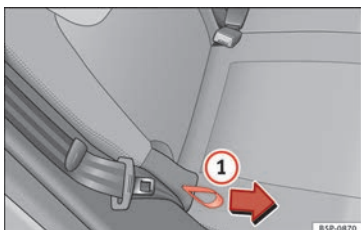

Fig. 80 Rear seat backrest angle adjustment.

The seats may be moved forwards or backwards independently. This movement range can be 1/3 or 2/3 of the seat. There are various possible positions.

### Adjusting reach

- In the seated position, unlock the lever in the direction of the arrow » Fig. 79.
- Move the seat cushion forwards or backwards to the desired position.

### Adjusting the backrest angle

- Hold the backrest at the top. Pull the loop on the side of the seat » Fig. 80 ① in the direction of the arrow and hold it in this position. Push the backrest to the required position and release the loop.

### ⚠ WARNING

- Adjust the seat only when the vehicle is stationary. Otherwise, your seat could move unexpectedly while the vehicle is moving. This could increase the risk of an accident and therefore, injury.
- Do not push the backrests down when the seat is moved to prevent damage to the centre console.
- Ensure that the seat, once moved, is fixed in position.

### i Note

- In order to maintain the maximum luggage compartment space, put the backrests in position normal, without moving.
- In order to maintain the maximum space without putting the backrests down, move the seats forward to the desired position.

### Folding and lifting the seat backrest

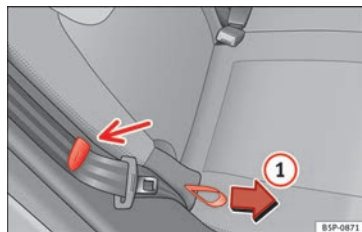

Fig. 81 Folding the rear seat backrests down.

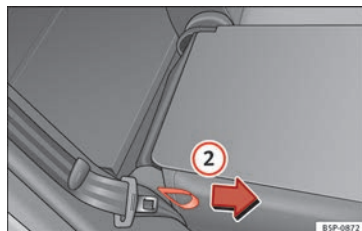

Fig. 82 Lifting the rear seat backrests.

### Folding the backrest forwards

- Pull the loop on the side of the seat » Fig. 81 ①.

In this position the backrest is locked.

### Converting the table to a seat

- Pull the loop on the side of the seat  
»» Fig. 82 ② in the direction of the arrow  
and lift the seat backrest until it is in place.

When folding and lifting the backrest, make sure to place the side seat belts in the trim clip »» Fig. 81 to prevent them from being damaged by becoming trapped in the backrest lock.

#### ⚠ WARNING

- You should check that the backrest has engaged properly in position after the loop is released.
- For safety reasons the locking system loops on the seats may not be used to secure any items.
- After locking the seat backrest into position ensure that the seat belts protrude from the seat.

## Transport and practical equipment

### Compartments

#### Storage compartment on the front passenger side

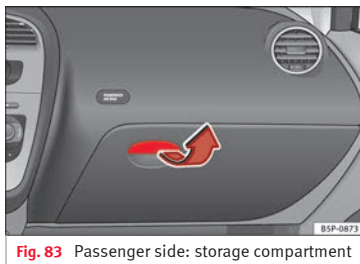

Fig. 83 Passenger side: storage compartment

The compartment can be opened by pulling the lever »» Fig. 83.

#### ⚠ WARNING

Always keep the storage compartment cover closed while the vehicle is in motion in order to reduce the risk of injury caused by a sudden braking or by an accident.

#### Front centre armrest with storage compartment

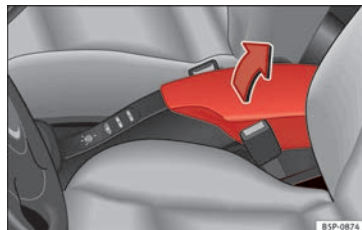

Fig. 84 Front armrest with storage compartment.

There is a storage compartment in the armrest.

- To open the storage compartment, lift the armrest up in the direction of the arrow »» Fig. 84 and then lift the cover.
- To access the CD changer\* or the lower storage compartment, pull on the armrest cover without pressing on the button.
- To close the storage compartment, push the armrest down.

#### ⚠ WARNING

Always keep the storage compartment closed while the vehicle is in motion to reduce the »»

**risk of injury from the armrest during a sudden braking manoeuvre or in the event of an accident.**

### Note

The CD changer is located in this compartment.

### Storage compartment under the front seats\*



**Fig. 85** Storage compartment under the front seats.

There is a storage compartment with a cover under each front seat.

The drawer\* » **Fig. 85** is opened by pushing the button and moving the cover back.

There are two open positions of 15 and 60 degrees depending on the pressure applied to the cover. In the 60 degree position, the

cover will collapse if too much pressure is applied.

To close the drawer, press the cover until it locks into position.

### WARNING

- The drawers will hold a maximum weight of 1.5 kg.
- Do not drive with the drawer cover open. There is an injury risk for passengers if the cargo is released in case of sudden braking or an accident.

### Folding table\*



**Fig. 86** Folding tray on the front left seat.

Folding trays are fitted to the rear of the front seat backrests.

– To open the tray, open it up in the direction of the arrow » **Fig. 86**.

### WARNING

- The folding trays may not be folded down whilst the vehicle is in motion and anyone is seated on the second row of seats. There is a risk of injury during a sudden braking manoeuvre! The tray must therefore be closed and properly secured whilst the vehicle is in motion.
- Do not put hot drinks in the drink holders. During normal or sudden driving manoeuvres, sudden braking or an accident, the hot drink could be spilled. Danger of scalding.

### CAUTION

When driving, do not leave open cans in the cup holders. The drink might be spilt on braking, for example, and could damage the vehicle.

### Roof storage compartment\*

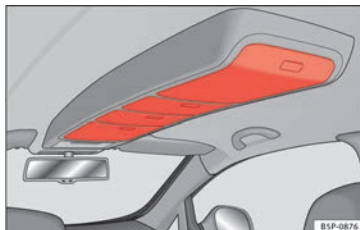

**Fig. 87** Roof storage compartments.



There are four storage compartments in the roof.

- Press the button on the cover to open these compartments » **Fig. 87**. The cover will then open.
- To close the cover, press it up until it engages.

#### **WARNING**

Always keep the storage compartment cover closed while the vehicle is in motion to reduce the risk of injury during a sudden braking manoeuvre or in the event of an accident and to prevent any items from being thrown through the vehicle interior.

### Front drinks holders

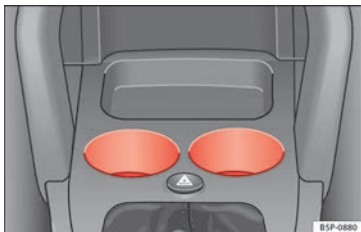

**Fig. 88** Front drink holders.

In the centre console, in front of the gear lever, there are two drink holders » **Fig. 88**.

#### **WARNING**

- Never place hot drinks in the drink holders. During sudden or normal driving manoeuvres, when braking suddenly or in case of an accident, the hot drink could spill. Risk of scalding.
- Never use rigid cup materials (for example, glass or ceramic), since they could cause injury in the case of an accident.

### Rear cup holder\*/armrests\*

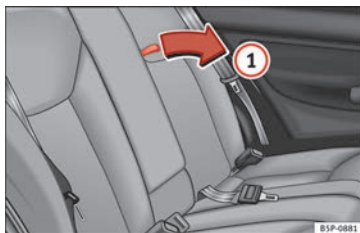

**Fig. 89** Opening the rear cup holder.



**Fig. 90** Rear cup holder in the armrest.

### Opening and closing the armrest\*/drink holder\*

- To open, pull the loop in the direction of the arrow » **Fig. 89 ①**.
- To close, lift the cup holder\*/armrest\* in the direction of the arrow » **Fig. 90 ②**.

#### **WARNING**

Ensure that the load in the luggage compartment is correctly secured with the net\* when travelling with the armrest down » page 104.

### Other storage compartments

Other storage compartments can be found:

- in the centre console,
- in the door trims (front and rear),

»

- in the side trims of the luggage compartment,
- in the spare wheel recess in the luggage compartment (only on vehicles with an optional anti-puncture kit\*.

The clothes hooks are located on the rear roof handles.

### ⚠ WARNING

- Do not store loose objects on the dash panel. These objects could be flung through the passenger compartment when the vehicle is moving (e.g. while accelerating, braking or cornering) and distract the driver.
- Ensure that no objects can fall from the centre console or other storage compartments into the driver footwell while the vehicle is moving. In the event of a sudden braking manoeuvre, you will not be able to use the brake, clutch or accelerator. Risk of accident.
- Clothing hung on the coat hooks must not restrict the driver's view. Risk of accident. The coat hooks are intended only for use with light articles of clothing. Do not leave any hard, sharp or heavy objects in hanging articles of clothing. During sudden braking manoeuvres or accidents, especially those involving airbag deployment, these objects could injure the vehicle occupants.

## Multi-purpose mobile storage compartment\*

### General information

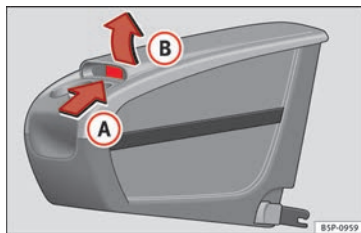

Fig. 91 Mobile storage compartment. Opening.

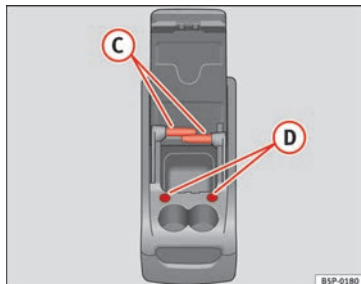

Fig. 92 Mobile storage compartment. Functions.

This storage compartment may only be placed in the central area of the rear seat.

### Opening

- Lift the cover **B**, in area **A** » Fig. 91.

### Closing

- Push the cover down, until it clips into place.

### Uses of the mobile storage compartment

- The front open glove compartment may be used to store small objects that will not damage passengers in the event that the objects are flung around the interior of the vehicle.
- The cup holders are used for holding drink cans or cups.
- The elastic belt on the side may be used for keeping papers and magazines.
- The tables may be used as a support for writing.

To use the table **C** » Fig. 92, it must be removed from its compartment in the side of the mobile storage compartment and fitted into slot **D** » Fig. 92 on the front section of the mobile storage compartment.

The table in the right-hand compartment is fitted into the left-hand slot of the front of the mobile storage compartment and the table in the left-hand compartment is fitted in the right-hand slot.

The tables have two positions for use and cannot be interchanged.

### ⚠ WARNING

- The mobile storage compartment supports a maximum load of 5 kg. Do not overload.
- Do not drive when the cover of the mobile storage compartment is open.
- Do not drive when the tables are set up for use.
- When the vehicle is moving and when the tables are not in use, keep them stored inside the mobile storage compartment with the cover closed.
- Never place hot drinks in the cup holders. The drink may spill and cause burns when the vehicle is moving.
- Do not leave cans in the cup holders when the vehicle is in motion, there is a danger that the can may be flung around the vehicle and cause injury.
- Make sure that the mounting plate is properly fixed onto the cushion frame.
- When the plate is not in use, store inside the storage compartment.
- When the mobile storage compartment is not in use, it should always be properly fastened using the storage net in the boot.

### 📄 Note

- Check that the mobile storage compartment is fitted correctly, pulling it forward by

the front storage compartment and checking that both safety clips are securely fastened to both rings.

## Mounting and removal

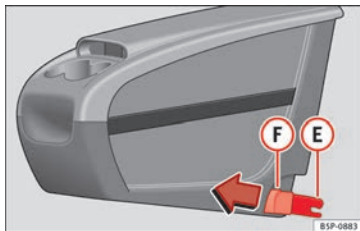

Fig. 93 Mobile storage compartment. Mounting.

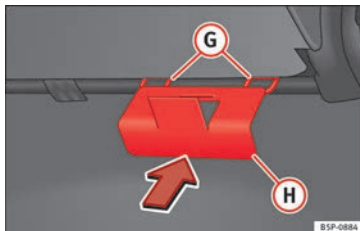

Fig. 94 Mobile storage compartment mounting plate.

## Mounting the mobile storage compartment

- Fold down the small section of the rear seat backrest in order to access the back of the large backrest.
- Fit the mobile storage compartment mounting plate (H) » Fig. 94 from the inside of the vehicle, through the rear part of the seat. It should be fitted between the backrest and the seat, in the central seat area.
- Push the plate until it clips the cushion frame. The rings of the mobile storage compartment mounting plate appear at the front of the seat.
- If it is difficult to make the plate clip, tilt the rear backrest of the large section forwards slightly and then lean the backrest backwards to make the fitting of the mobile storage compartment onto the mounting plate easier.
- Place the mobile storage compartment onto the foam of the central seat.
- Set both mounting pieces together (E) » Fig. 93, with both mounting rings (G) » Fig. 94 and press hard until both the clips completely connect with the rings.

## Removing the mobile storage compartment

- Pull each of the buttons » Fig. 93 (F) on the clips (red buttons) forwards, until they snap out of place.

- Fold the larger seat down and remove the mobile storage compartment mounting plate.

### Ashtray\*, cigarette lighter\* and power sockets

#### Front ashtray\*

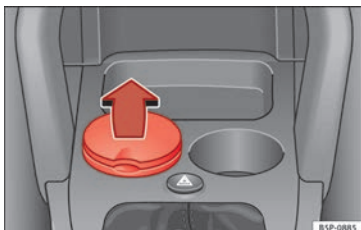

**Fig. 95** Ashtray located in the front cup holder.

#### Opening and closing the ashtray

- To open the ashtray, lift the cover »» **Fig. 95**.
- To close, push the cover down.

#### Emptying the ashtray

- Extract the ashtray and empty it.

#### **⚠ WARNING**

Never put paper in the ashtray. Hot ash could ignite the paper in the ashtray and cause a fire.

#### Cigarette lighter\*



**Fig. 96** The cigarette lighter is located in the power socket of the front centre console.

- Press on the cigarette lighter »» **Fig. 96** to activate it »» **⚠**.
- Wait for the lighter to spring out.
- Pull out the cigarette lighter and light the cigarette on the glowing coil.

#### **⚠ WARNING**

• Improper use of the cigarette lighter can lead to serious injuries or start a fire.

- Using the lighter carefully. Carelessness or negligence when using the cigarette lighter can cause burns and serious injuries.
- The lighter only works when the ignition is turned on or the engine is running. To avoid the risk of fire, never leave children alone inside the vehicle.

## Power sockets



Fig. 97 Power socket, front centre console.

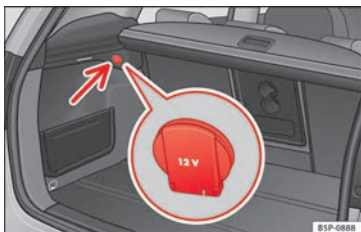

Fig. 98 Altea XL/Freerack model: power socket in boot.

Electrical accessories may be connected to the 12 volt power socket in the front centre console » Fig. 97 and in the luggage compartment\*. The appliances connected to each power point must not exceed a power rating of 120 Watt.

### WARNING

The power sockets and the connected accessories will only operate when the ignition is on or when the engine is running. Improper use of the sockets or electrical accessories can lead to serious injuries or cause a fire. To avoid the risk of injury, never leave children alone inside the vehicle.

### Note

- The use of electrical appliances with the engine switched off will cause a battery discharge.
- Before using any electrical accessories, see the instructions in » page 147.

## Auxiliary audio input (AUX-IN)\*



Fig. 99 Auxiliary audio connection.

– Lift the AUX cover » Fig. 99.

– Insert the plug as far as possible (see Radio manual).

## AUX RSE connection\*



Fig. 100 AUX RSE connection.

This connector may be used as an audio input (red and white connectors) or audio and video connector (red, white and yellow connectors). For more details about the use of this audio and video source, see the RSE manual.

## MEDIA-IN\* connector

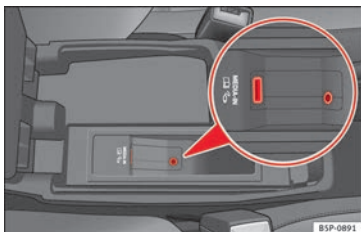
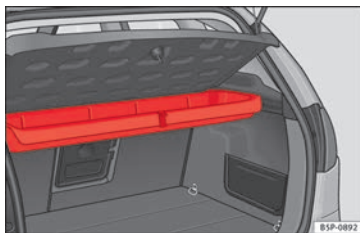

**Fig. 101** Connection in central armrest compartment.

For information concerning the use of this equipment, please see the Radio handbook.

## First-aid kit, warning triangle, fire extinguisher

### Warning triangle\* and first-aid kit\*



**Fig. 102** Altea: warning triangle storage under the rear shelf.

The warning triangle\* can be stowed under the rear shelf in a storage compartment **»» Fig. 102** or in the storage compartment located on the boot floor, under the carpet, depending on the version.

The first aid kit can be stowed in the storage compartment under the carpet on the boot floor, or in the storage compartment in the boot side lining, depending on the version.

#### Note

- The warning triangle and the first aid kit do not belong to the standard vehicle equipment.

- The first aid kit must comply with legal requirements.
- Observe the expiry date of the contents of the first aid kit. After it has expired you should purchase a new one.
- Before purchasing accessories and spare parts, see the instructions in **»»** page 147.

### Fire extinguisher\*

The fire extinguisher\* can be attached to the luggage compartment carpet with Velcro.

#### Note

- The fire extinguisher does not belong to the standard vehicle equipment.
- The fire extinguisher must comply with legal requirements.
- Make sure the fire extinguisher works. They should therefore be checked. The sticker on the fire extinguisher will inform you of the next date for checking.
- Before purchasing accessories and spare parts, see the instructions in **»»** page 147.

## Luggage compartment

### Loading the luggage compartment

All luggage and other loose objects must be safely secured in the luggage compartment. Unsecured objects which shift back and forth could impair the driving safety or driving characteristics of the vehicle by shifting the centre of gravity.

- Distribute the load evenly in the luggage compartment.
- Place heavy objects as far forward as possible in the luggage compartment.
- Place the heavy objects first.
- Secure heavy objects to the fitted fastening rings » page 103.

#### **⚠ WARNING**

- Loose luggage and other objects in the luggage compartment could cause serious injuries.
- Always stow objects in the luggage compartment and secure them on the fastening rings.
- Use suitable straps to secure heavy objects.
- During sudden manoeuvres or accidents, loose objects can be thrown forward, injuring vehicle occupants or passers-by. This increased risk of injury will be further increased

if a loose object is struck by an inflating air-bag. If this happens, objects can be transformed into “missiles”. Risk of fatal injury.

- Please note that the centre of gravity may shift when transporting heavy objects; this may affect vehicle handling and lead to an accident. Therefore, it is essential to adjust your speed and driving style accordingly, to avoid accidents.
- Never exceed the allowed axle weights or allowed maximum weight. If said weights are exceeded, the driving characteristics of the vehicle may change, leading to accidents, injuries and damage to the vehicle.
- Never leave your vehicle unattended, especially when the rear lid is open. Children could climb into the luggage compartment, closing the door behind them; they will be trapped and run the risk of death.
- Never allow children to play in or around the vehicle. Close and lock all the doors and rear lid when you leave the vehicle. Before you lock the vehicle, make sure that there are no adults or children in the vehicle.

#### **ⓘ CAUTION**

Hard objects on the boot cover could chafe against the wires of the heating element in the rear window and cause damage.

#### **i Note**

- Air circulation in the vehicle helps reduce fogging of the windows. Used air escapes

through ventilation slits in the side trim of the luggage compartment. Ensure that these ventilation slits are never covered.

- Straps for securing the load to the fastening rings are commercially available.

### Rear shelf

- ✓ Applies to the model: ALTEA

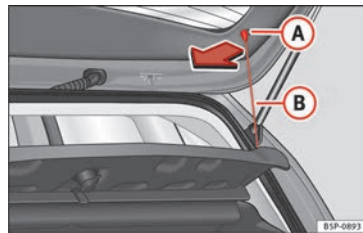

Fig. 103 Rear shelf.

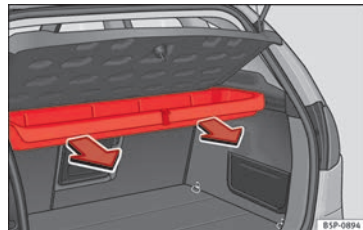

Fig. 104 Removing the storage compartment. »

## Removing the shelf

- Unhook the loops » Fig. 103 (B) from housings (A).
- Extract the shelf from its slot, in its rest position and pull outwards. The storage compartment should remain closed.

## To remove the storage compartment

- Pull outwards until the compartment is freed from the pivot point » Fig. 104.

### ⚠ WARNING

Do not place heavy or hard objects on the rear shelf, because they will endanger the vehicle occupants in case of sudden braking.

### ⚠ CAUTION

- Before closing the rear lid, ensure that the rear shelf is correctly fitted.
- An overloaded luggage compartment could mean that the rear shelf is not correctly seated and it may be bent or damaged.
- If the luggage compartment is overloaded, remove the tray.

### 📄 Note

- Ensure that, when placing items of clothing on the luggage compartment cover, rear visibility is not reduced.

- If the vehicle is fitted with a storage compartment\*, it should only be used to store the emergency triangles\* and light objects.

## Retractable rear shelf

✓ Applies to the model: ALTEA XL/ALTEA FREETRACK

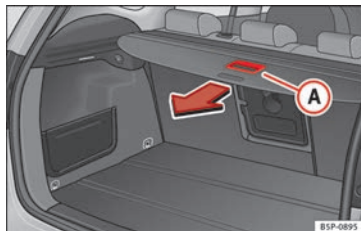

Fig. 105 Operating the storage compartment shelf.

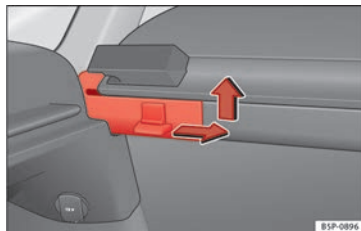

Fig. 106 Removing the storage compartment shelf.

## Using the rear shelf

- Use the handle (A) to pull the shelf back until you hear a “click” » Fig. 105.
- Press the area marked “PRESS”, and the cover is retrieved automatically.

## To remove the rear shelf

- Press the side pin in the direction of the arrow, lift the cover and remove it » Fig. 106.
- Installation is done in the reverse order.

### ⚠ WARNING

Do not place heavy or hard objects on the rear shelf, because they will endanger the vehicle occupants in case of sudden braking.

### ⚠ CAUTION

- Before closing the rear lid, ensure that the rear shelf is correctly fitted.
- An overloaded luggage compartment could mean that the rear shelf is not correctly seated and it may be bent or damaged.
- If the luggage compartment is overloaded, remove the tray.

### 📄 Note

- Ensure that, when placing items of clothing on the luggage compartment cover, rear visibility is not reduced.



## Fastening rings\*

There can be four fastening rings in the luggage compartment for fastening luggage and other objects.

- Always use suitable and undamaged straps to secure luggage and other objects to the fastening rings»» **⚠ in Loading the luggage compartment on page 101.**
- Pull up the fastening rings to attach the straps.

During a collision or an accident, even small and light objects can build up so much energy that they can cause very severe injuries. The amount of “energy” depends on the speed of the vehicle and the weight of the object. The most significant factor, however, is the speed of the vehicle.

Example: An object weighing 4.5 kg is lying unsecured in the vehicle. During a frontal collision at a speed of 50 km/h (30 mph), this object generates a force corresponding to 20 times its weight. This means that the effective weight of the object increases to about 90 kg. Imagine the injuries that may result from said “object” if it hits any passenger when flying through the passenger compartment. This increased risk of injury will be further increased if a loose object is struck by an inflating airbag.

### **⚠ WARNING**

- If pieces of baggage or other objects are secured to the fastening rings with inappropriate or damaged retaining cords, injuries could result in the event of braking manoeuvres or accidents.
- Never secure a child seat on the fastening rings.

## Cargo separation net\*

✓ Applies to the model: ALTEA XL/ALTEA FREETRACK

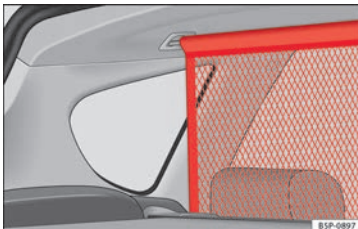

Fig. 107 Separation net.

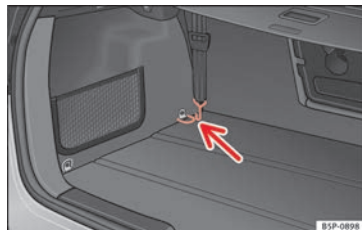

Fig. 108 Fastening rings for the separation net.

The separation net prevents loose objects in the boot from being thrown forward into the passenger compartment (e.g. when braking suddenly).

- Pull the net from underneath between the backrest and the folding tray and fit it to the slots in the roof, first the right then the left»» **Fig. 107.**
- Hook the belts into the front fastening rings to tense the net»» **Fig. 108.**

### Storage in the boot floor\*



Fig. 109 Variable storage in the boot floor.



Fig. 110 Boot floor partition.

There is a variable storage compartment\* in the boot floor.

- Lift the boot floor and fold it back all the way » Fig. 109.
- Fit the separator (A) » Fig. 110, into the side grooves depending on the size of the objects to be transported. The on-board

tool kit and the spare wheel are located underneath the luggage compartment.

- Secure objects in the luggage compartment with suitable straps on the fastening rings.

#### Note

- The maximum weight capacity of the variable boot floor is 100 kg distributed evenly over the whole floor.

### Luggage compartment net\*

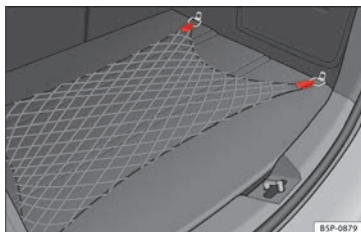

Fig. 111 Boot storage net.

There is a storage net in the luggage compartment for securing objects.

- Use the fastening rings located on the side of the boot to attach the retaining net » Fig. 111.

#### Note

- Do not exceed the maximum authorised weight for the vehicle » page 207.

## Roof carrier/rack system\*

### Introduction

Please observe the following points if you intend to carry loads on the roof:

- For safety reasons, only luggage racks and accessories supplied by SEAT official services are recommended.
- It is essential that you strictly follow the assembly instructions included with the bars, being especially careful to position the boot cover bars on the special housings; you must also respect their position according to the direction of travel indicated in the assembly manual. Not following these instructions may cause marks on the bodywork and the longitudinal bars.
- Pay special attention to the tightening torque of the attachment bolts and check them following a short journey. If necessary, re-tighten the bolts and check them at regular intervals.
- Distribute the load evenly. A maximum load of 40 kg is permitted for each roof rack system support bar, the load must be

distributed evenly along the entire length. However, the maximum load permitted for the entire roof (including the support system) of 75 kg must not be exceeded nor the total weight recommended for the entire vehicle. See the “Technical Data” » page 207 section.

- When transporting heavy or large objects on the roof, any change in the normal vehicle behaviour due to a change in the centre of gravity or an increased wind resistance must be taken into account. For this reason, a suitable speed and driving style must be used.
- On vehicles fitted with a sliding/tilting sun-roof\*, make sure it does not hit the load on the roof upon opening.

### Attachment points

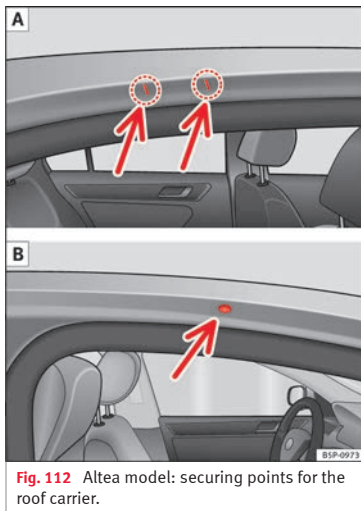

**Fig. 112** Altea model: securing points for the roof carrier.

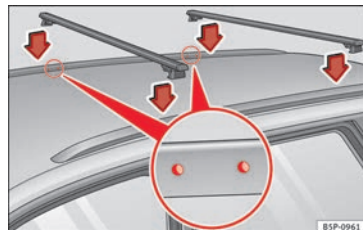

**Fig. 113** Altea XL/Altea Freetrack model: securing points for the roof carrier.

Install and remove following the instructions given.

### Securing the base supports and roof carrier system (Altea)

Location of the basic roof carrier attachment points » **Fig. 112**.

- **A:** marks for securing on the rear section.
- **B:** hole for securing on the front section.

### Securing the base supports and roof carrier system (Altea XL/Altea Freetrack)

Always secure the base supports and roof carrier system correctly.

The roof carrier system must always be installed exactly according to the instructions provided. »

The position holes are located on the inner side of the rail »» **Fig. 113.**

 CAUTION

Follow the instructions given in the manual.

## Air conditioning

### Heating

#### Operating instructions

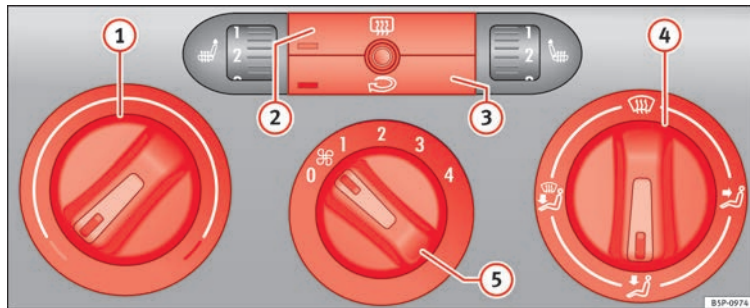

Fig. 114 Heating controls on the dash panel.

- Use the knobs » Fig. 114 ① and ④ and control ⑤ to set the temperature, air distribution and blower speed.
- To switch a function on or off, press the appropriate button ② or ③. When the function is activated, the display window in the lower left of the button is lit.

#### Temperature

With the regulator ① the heating level is determined. The desired temperature inside the vehicle cannot be lower than the ambient temperature. Maximum heat output, which is

needed to defrost the windows quickly, is only available when the engine has reached its operating temperature.

#### Heated rear window

This function ② will be switched off automatically approximately 20 minutes after being switched on. It can also be switched off sooner by pushing the button.

#### Air recirculation mode

Air recirculation mode ③ prevents strong odours in the outside air from entering the vehicle interior, for example when passing through a tunnel or in queuing traffic » .

With low outside temperatures, the air recirculation increases the effectiveness of the heating system by heating the air inside the vehicle rather than the air from outside. »

### Air distribution

Control **4** for setting the flow of air in the required direction.

 Air distribution towards the windscreen. If the windscreen air output is on and air recirculation mode is pressed, it is activated. When the recirculation mode is on, if the air distribution towards the windscreen mode is selected, the recirculation mode is deactivated. For safety reasons, the air recirculation mode should not be connected.

 Air distribution to the upper body

 Air distribution towards the footwell

 Air distribution towards the windscreen and the footwell

### Blower

The air flow can be set at four speeds with the control **5**. The air flow should always be set at the lowest speed when driving slowly.

#### WARNING

• For road safety all windows must be clear of ice, snow, and condensation. This is essential to ensure good visibility. Please familiarise yourself with the correct operation of the heating and ventilation system, including the anti-fog/defrost functions for the windcreens.

• In air recirculation mode, no cold air from the outside enters the vehicle interior. The windows can quickly fog over if the heating is switched off. Therefore, never leave the air recirculation mode switched on for a long time (risk of accident).

#### Note

Please observe the general notes  
»» page 116.

## Climatic\*

## Controls

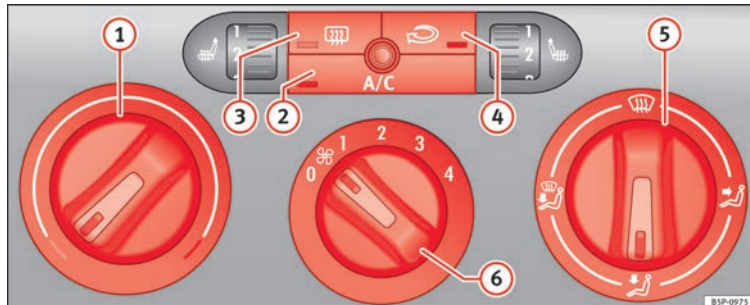

Fig. 115 On the dash panel: Climate controls.

The Climatic or semi-automatic air conditioning system only works when the engine is running and the blower is switched on.

- Use the knobs » Fig. 115 ① and ⑤ and control ⑥ to set the temperature, air distribution and blower speed.
- To switch a function on or off, press the appropriate button ②, ③ or ④. When the function is activated, the display window in the lower corner of the button is lit.

- ① Temperature selector » page 110
- ② A/C button – Cooling system on/off » page 110

- ③ button – Heated rear window The heating will be switched off automatically approximately 20 minutes after switching on. It can also be switched off beforehand by pushing the button.
- ④ button – Air recirculation mode » page 111
- ⑤ Air distribution control » page 110
- ⑥ Blower switch. There are four speed settings for the air flow. The air flow should always be set at the lowest speed when driving slowly.

**WARNING**

For road safety all windows must be clear of ice, snow, and condensation. This is essential to ensure good visibility. Please familiarise yourself with the correct operation of the heating and ventilation system, including the anti-fog/defrost functions for the wind-screens.

**Note**

Please observe the general notes » page 116.

## Heating and cooling the interior

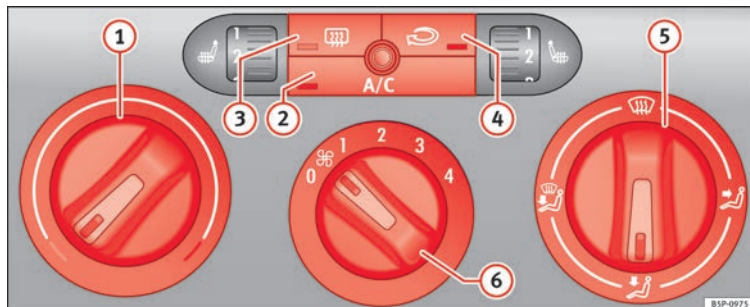

Fig. 116 On the dash panel: Climate controls.

### Interior heating

- Turn the temperature selector » Fig. 116 ① clockwise to select the desired temperature.
- Turn the blower switch to one of the settings 1-4.
- Set the air distribution control to the air flow configuration desired: (towards the windscreen), (towards the chest), (towards the footwell) and (towards the windscreen and footwell areas).

### Interior cooling

- Switch on the air conditioner using the button » Fig. 115 .

- Turn the temperature selector anticlockwise until the desired cooling output is reached.
- Turn the blower switch to one of the settings 1-4.
- Use the air distribution regulator to guide the airflow in the required direction (to the windscreen), (to the upper body), (to the footwell) and (to the windscreen and to the footwell).

### Heating

Maximum heat output, which is needed to defrost the windows quickly, is only available when the engine has reached its operating temperature.

### Air conditioner

When the air conditioning system is switched on, not only the temperature, but also the air humidity in the vehicle interior is reduced. This improves comfort for the vehicle occupants and prevents misting of the windows when the ambient air humidity is high.



If the air conditioning system cannot be switched on this may be caused by the following reasons:

- The engine is not running.
- The blower is switched off.
- The outside temperature is lower than approximately +3 °C (+37 °F).



- The air conditioning system compressor has been temporarily switched off because the engine coolant temperature is too high.
- The air conditioner fuse is faulty.
- Another fault in the vehicle. Have the air conditioner checked by a specialised workshop.

### Air recirculation mode

Air recirculation mode » **Fig. 116**   prevents strong odours or contaminated air from

the outside from entering the vehicle, for example when passing through a tunnel or in a traffic jam.

With low temperatures outside, the air recirculation increases the effectiveness of the heating system by warming the air inside the vehicle rather than the cold air from outside.

With high outside temperatures, the air recirculation increases the effectiveness of the air conditioning system by cooling the air inside the vehicle rather than the ambient air.

If the windscreen air output is on and air recirculation mode is pressed, it is activated.

When the recirculation mode is on, if the air distribution towards the windscreen mode is selected, the recirculation mode is deactivated. For safety reasons, the air recirculation mode should not be connected.

#### **WARNING**

**In air recirculation mode, no cold air from the outside enters the vehicle interior. If the air conditioning system is switched off, the windows can quickly mist over. Therefore, never leave the air recirculation mode switched on for a long time (risk of accident).**

## 2C-Climatronic\*

### Controls

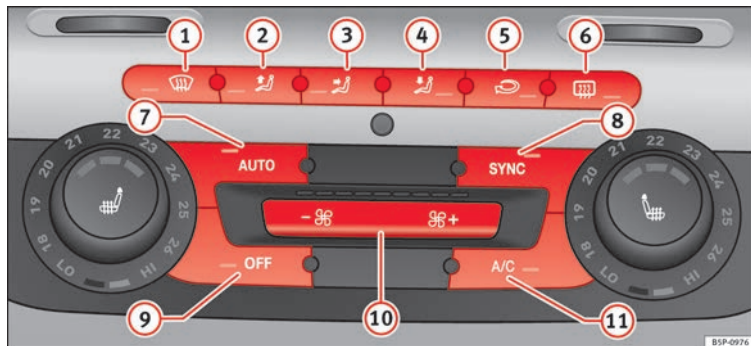

**Fig. 117** On the dash panel: 2C Climatronic controls.





The air conditioner controls the temperature when the engine is running and the blower is switched on.

- Turn the temperature control knobs  
 » **Fig. 117** to adjust the temperature on the left-hand or right-hand side respectively.
- The functions will be switched on when its buttons are pressed. When these functions are activated, they are indicated on the radio display. In addition, all these functions are lit with LEDs. Press the button again to switch off the function.

The temperature can be adjusted separately for the left and right sides of the vehicle interior.

- ① Button  – defrost function for the windscreen. The air drawn in from outside the vehicle is directed at the windscreen. The air recirculation mode, if switched on, will be switched off as soon as the defrost function is switched on. At temperatures over +3 °C (+37 °F), the cooling system will be switched on automatically in order to dehumidify the air. The button is lit in

yellow and the symbol appears on the radio or navigator display.

- ②  button – Upward air distribution
- ③  button – Central air distribution
- ④  button – Downward air distribution
- ⑤  button – Manual air recirculation mode
- ⑥  button – Heated rear window The heating will be switched off automatically approximately 20 minutes after switching on. However, it may be turned off by pushing the button. The button lights up

yellow and the symbol appears in the display.

- 7 **AUTO** button – Automatic temperature, ventilation and air distribution control » page 113
- 8 **SYNC** button – Dual zone synchroniser
- 9 **OFF** button – Switches the 2C-Climatronic on and off » page 114
- 10 Blower control » page 114
- 11 **A/C** button – To switch on the cooling system

#### **WARNING**

For road safety all windows must be clear of ice, snow, and condensation. This is essential to ensure good visibility. Please familiarise yourself with the correct operation of the heating and ventilation system, including the anti-fog/defrost functions for the wind-screens.

### Viewing Climatronic information

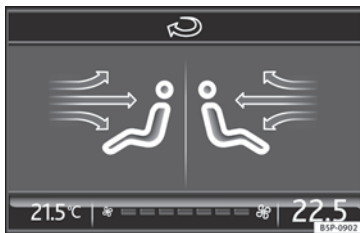

**Fig. 118** Navigation display with information about Climatronic.

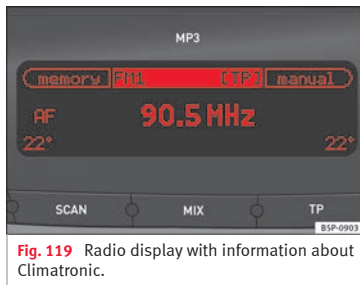

**Fig. 119** Radio display with information about Climatronic.

Information about the Climatronic system can be displayed on the radio or radio and navigation screen mounted at factory.

The LEDs on the Climatronic controls indicate that the selected function has been activated.

In addition, the radio or radio and navigation displays mounted at factory briefly display the current Climatronic settings if any of them have been modified.

The symbols used on the radio or radio and navigation displays are the same as the symbols used for the Climatronic controls.

### Automatic mode

In automatic mode air temperature, air flow and distribution are automatically regulated so that a specified temperature is attained as quickly as possible and then maintained.

The temperature can be adjusted separately for the left and right sides of the vehicle interior.

#### Switching on automatic mode

- Press the **AUTO** » **Fig. 117** button. “AUTO High” is shown on the radio display (high fan speed).
- Press the **AUTO** button again » **Fig. 117**. “AUTO Low” is shown on the radio display (low fan speed).

Depending upon the version and finish, the vehicle may include: »

A pleasant temperature is quickly reached in automatic mode at a temperature of +22 °C (+72 °F). Therefore, we recommend you not to change this adjustment, except as necessary to suit individual preferences or particular circumstances. It is possible to select interior temperatures from +18 °C (+64 °F) to +26 °C (+80 °F). These are approximate temperatures and the actual temperature may be slightly higher or lower depending on outside ambient conditions.

Climatronic maintains a constant temperature. The temperature of the air supplied to

the interior, the blower speed and the air distribution are regulated automatically. The system also considers the sunlight radiation, so there is no need for manual readjustment. Therefore, **automatic mode** almost always provides the best comfort for the vehicle occupants throughout the year.

Automatic mode is switched off whenever an adjustment is made using the buttons for the air distribution, fan or (🌀) or the air recirculation button (🔄). The temperature will continue to be regulated within the parameters manually selected by the user.

### Note

There are two automatic modes:

- **Automatic mode LO:** this calculates the air flow for two people.
- **Automatic mode HI:** this calculates the air flow for more than two people.

## Manual mode

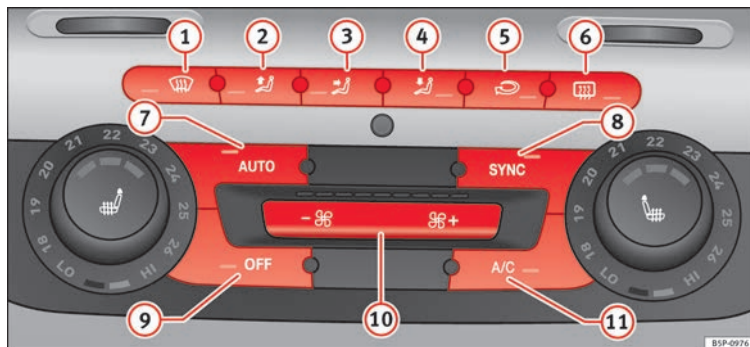

Fig. 120 On the dash panel: 2C Climatronic controls.

In manual mode you can adjust the air temperature, air flow and distribution as required.

### Switching on manual mode

– To enter manual mode, press one of the buttons **»» Fig. 120 ①** to **⑤** or press the air flow control **⑩**. The selected function is shown on the radio or navigator display.

### Temperature

There are separate temperature selectors for the left and right sides of the vehicle interior. The selected temperature is displayed above the selector. It is possible to select interior temperatures from +18 °C (+64 °F) to +26 °C (+80 °F). These are approximate temperatures and the actual temperature may be slightly higher or lower depending on the outside ambient conditions.

If you select temperatures below +18 °C (+64 °F), the indication: **LO** will appear on the screen. In this setting the system runs at maximum cooling output and the temperature is not regulated.

If a temperature above +26 °C (+80 °F) is selected, the screen will show **HI**. In this setting the system runs at maximum heating output and the temperature is not regulated.

### Blower

The fan may be adjusted freely using the controls **⑩**. Always have the blower running at a low setting to ensure a constant flow of fresh air into the vehicle. Pushing the button **⚙** to the minimum -1, turns the Climatronic off.

### Air distribution

The air distribution is adjusted using the buttons **⬅**, **➡** and **⬇**. It is also possible to open and close some of the air vents separately.

### Switching the air conditioning on and off

When the **A/C** button is on (LED lit), the air conditioning system is on.

When the **A/C** button is off (LED off), the air conditioning system is off.

When the **A/C** button is off, the air conditioning system is switched off to save fuel. The temperature continues to self-regulate. The set temperature can only be reached if it is higher than the outside temperature.

### Driver and passenger temperature control

The **SYNC** button controls the synchronisation of the 2 Climatronic climate zones.

When the **SYNC** button is off (LED off), the Climatronic climate zone is personalised. For example: driver side temperature +22 °C

(+72 °F) and passenger side temperature +24 °C (+73.89 °C).

When the **SYNC** button is on (LED lit), the Climatronic climate zone is synchronised. For example: driver side temperature +22 °C (+72 °F) and passenger side temperature +22 °C (+22.22 °C).

If the **SYNC** button is on and the passenger side temperature is changed, the function is automatically deactivated.

### Air recirculation mode

– Press the button **↻** **»» Fig. 120 ⑤** to switch air recirculation mode on or off. It is switched on if the following symbol appears in the display **↻**.

Air recirculation mode prevents strong odours or contaminated air from the outside from entering in the vehicle, for example when passing through a tunnel or in a traffic jam.

With low outside temperatures, the air recirculation increases the effectiveness of the heating system by heating the air inside the vehicle rather than the air from outside.

With high outside temperatures, the air recirculation increases the effectiveness of the air conditioning system by cooling the air inside the vehicle rather than the ambient air. **»»**

If the windscreen air output is on and air recirculation mode is pressed, this remains active. When the recirculation mode is on, if the air distribution towards the windscreen mode is selected, the recirculation mode is deactivated. For safety reasons, the air recirculation mode should not be connected.

#### WARNING

**In air recirculation mode, no cold air from the outside enters the vehicle interior. If the air conditioning system is switched off, the windows can quickly mist over. Therefore, never leave the air recirculation mode switched on for a long time (risk of accident).**

#### General notes

##### Pollution filter

The pollution filter (a combined particulate filter and active carbon filter) serves as a barrier against impurities in the outside air, including dust and pollen.

For the climate control system to work with maximum efficiency, the pollution filter must be replaced at the specified intervals in the Maintenance Programme.

If the filter loses efficiency prematurely due to use in areas reaching very high pollution levels, the pollen filter must be changed more frequently than stated in the Service Schedule.

##### Air conditioner

When the air conditioning system is switched on, not only the temperature, but also the air humidity in the vehicle interior is reduced. This improves comfort for the vehicle occupants and prevents misting of the windows when the ambient air humidity is high.

If the air conditioning system cannot be switched on this may be caused by the following reasons:

- The engine is not running.
- The  button is switched off.
- The outside temperature is lower than approximately +3 °C (+37 °F).
- The air conditioning system compressor has been temporarily switched off because the engine coolant temperature is too high.
- The air conditioner fuse is faulty.
- Another fault in the vehicle. Have the air conditioner checked by a specialised workshop.

#### CAUTION

- **If you suspect that the air conditioner is damaged, switch it off with the  button to prevent further damage and have it checked by a specialised workshop.**
- **Repairs to the air conditioner require specialist knowledge and special tools. Therefore, we recommend you to take the vehicle to a specialised workshop.**

#### Note

- **If the humidity and temperature outside the vehicle are high, condensation can drip off the evaporator in the cooling system and form a pool underneath the vehicle. This is normal and does not indicate a leak.**
- **Keep the air intake slots in front of the windscreen free of snow, ice and leaves to ensure heating and cooling are not impaired, and to prevent the windows from misting over.**
- **The air from the vents flows through the vehicle interior and is extracted by slots designed for this purpose. Therefore, do not cover these slots with items of clothing or other objects.**
- **The air conditioner operates most effectively with the windows and the sliding/tilting sunroof\* closed. However, if the temperature inside the vehicle is excessive because of the sun, the air inside can be cooled faster by opening the windows for a short time.**
- **Do not smoke while air recirculation mode is on, as smoke drawn into the air conditioning system leaves residue on the evaporator, producing a permanent unpleasant odour.**
- **It is advisable to turn on the air conditioning at least once a month, to lubricate the system gaskets and prevent leaks. If a decrease in the cooling capacity is detected, a Technical Service should be consulted to check the system.**

## Driving

### Power steering (servotronic\*)

Power steering assists the driver by reducing the force needed to turn the steering wheel. In cars equipped with servotronic\* power steering the degree of power assistance is regulated *electronically* according to road speed.

The power *steering* will keep on working even if the *servotronic\** device fails. The degree of power assistance will, however, no longer adapt to different speeds. If the electronic regulating system is not working properly, this is most noticeable when turning the steering wheel at low speeds (for instance when parking), as more effort will be required than usual. The fault should be corrected by a specialised workshop as soon as possible.

Power steering does not work if the engine is off. In this case the steering wheel requires much more force to turn.

Turning the steering to its limit when the vehicle is stationary will place an excessive load on the power steering system. Turning the steering wheel to its limit places a load on the system, which causes noise. It will also reduce the idling speed of the engine.

#### ⚠ CAUTION

**When the engine is running, do not turn the steering wheel to its limit for more than 15 seconds. Otherwise, there is a risk of damaging the power steering.**

#### i Note

- If the power steering should fail at any time or the engine is switched off (for instance when being towed), the vehicle can still be steered. However, more effort will be required to turn the steering wheel.
- If the system is leaking or malfunctioning, please take the car to a specialised workshop immediately.
- The power steering system requires a special hydraulic fluid. The container is located in the engine compartment (front left). The correct fluid level in the reservoir is important for the power steering to function properly. The hydraulic fluid level is checked at the Inspection Service.

### All-wheel drive\*

On all-wheel drive models, the engine power is distributed to all four wheels

#### General notes

The all-wheel drive system operates completely automatically. The propulsion force is distributed among the four wheels and adap-

ted to the driving style and the road conditions.

The all-wheel drive is specially designed to complement the superior engine power. This combination gives the vehicle exceptional handling and performance capabilities, both on normal roads and in more difficult conditions, such as snow and ice.

#### Winter tyres

Thanks to its all-wheel drive, your vehicle will have plenty of traction in winter conditions, even with the standard tyres. Nevertheless, we still recommend that winter tyres or all-season tyres should be fitted on all four wheels when winter road conditions are expected, mainly because this will give a better braking response.

#### Snow chains

On roads where snow chains are mandatory, this also applies to cars with all-wheel drive.

#### Changing tyres

On vehicles with all-wheel drive, all four tyres must have the same rolling circumference  
» page 179.

#### ⚠ WARNING

- Even with all-wheel drive, you should always adjust your speed to suit the conditions. Do not let the extra safety features

tempt you into taking any risks when driving. Failure to follow this instruction could result in an accident.

- The braking capability of your vehicle is limited by the tyres' grip. Vehicle behaviour is no different from a vehicle without four-wheel drive. So do not be tempted to drive too fast on icy or slippery roads just because the vehicle still has good acceleration in these conditions. Failure to do so could result in an accident.
- On wet roads bear in mind that the front wheels may lose contact with the road and start to float (aquaplaning) if the vehicle is driven too fast. If this should happen, there will be no sudden increase in engine speed when aquaplaning begins to warn the driver, as with a front-wheel drive vehicle. For this reason and for that mentioned above, always choose a driving speed suitable for the road conditions. Failure to follow this instruction could result in an accident.

### Driving with LPG\*

✓ Applies to the model: ALTEA / ALTEA XL



**Fig. 121** Centre console: gas system control switch.

Your SEAT vehicle has a bivalent engine able to run on either LPG or petrol. The LPG tank »» page 160, Refuelling with LPG is in the spare wheel well »» ⚠.

### Connecting LPG operating mode

- Press the **GAS** button.

After checking the system, the engine automatically switches from petrol to LPG provided the following conditions are met:

- There is enough LPG in the tank.
- The engine coolant has reached the necessary temperature for LPG operation.
- The outside temperature is suitable for LPG to work.

- The engine speed is always above 1,200 rpm.
- The LPG system check has been completed and the established waiting time has elapsed (this operation may take several minutes).
- No fault was detected during the system check.

The **green** LPG gauge control lamp will light up.

### Connecting petrol operating mode

- Press the **GAS** button.

The **green** control lamp will go out on the LPG level indicator.

Petrol operating mode connects automatically when the engine is started or when any of the LPG operating mode conditions are not met. As soon as the necessary conditions are met again, the LPG operating mode reconnects.

### LPG system fault

Message in the instrument panel display	How to proceed
<b>Error: LPG Visit the workshop!</b>	Have the system checked immediately by a specialised workshop.



Message in the instrument panel display	How to proceed
Gas operating mode currently impossible. See the manual!	Check that all conditions for LPG operating mode have been met » page 118. If so, have the system checked immediately by a specialised workshop.
Petrol operating mode currently impossible. See the manual!	Have the system checked immediately by a specialised workshop.

### LPG quality and consumption

Quality requirements for LPG are regulated for all Europe in DIN EN 589 and permit the use of LPG throughout Europe without any problems.

LPG is a mixture of propane and butane.

A difference is drawn between winter gas and summer gas. Winter gas has a higher proportion of propane gas. As a result, the driving range of winter gas may be lower (due to increased consumption) than that of summer gas.

The vehicle's engine management adapts automatically to the LPG used. Therefore, both types of LPG can be mixed in the tank, without the need for comprehensive draining before applying a different quality LPG.

### LPG and safety

If you smell gas or suspect that there is a leak in the LPG system. » » ⚠

- Stop the vehicle immediately.
- Switch the ignition off.
- Open all the doors to properly ventilate the vehicle.
- Extinguish cigarettes immediately.
- Move away from the vehicle or switch off objects that may cause sparks or a fire.
- If you continue to smell gas, do not continue driving!
- Seek specialist assistance. Have the fault repaired.

#### ⚠ WARNING

LPG is a highly explosive and flammable substance. It may cause severe burns and other injury.

- Due care must be taken to avoid any risk of fire or explosion.
- When parking the vehicle in a closed area (for example in a garage), make sure that there is adequate ventilation, either natural or mechanical, to neutralise the LPG in the event of a leak.

#### ⚠ WARNING

Failure to act when you can smell gas in the vehicle or when refuelling can cause serious injuries.

- Carry out the necessary operations.
- Leave the danger zone.
- If necessary, warn the emergency services.

#### 📄 Note

- The LPG system must be subject to regular inspections at a specialised workshop in accordance with the Maintenance Plan.
- The engine is always started with petrol, even when LPG was being used when it was switched off. For this reason the tank should never be drained of petrol completely.
- If frequent short journeys are made, especially when the outside temperature is low, the vehicle will tend to run on petrol more often than on LPG. Therefore, the petrol tank may empty before the LPG tank.
- If while driving the system switches automatically to petrol operating mode because the LPG tank is almost empty, the next few times the engine starts up, and depending on the outside temperature and driving style, it may automatically switch briefly to LPG operating mode to use up what is left in the tank.
- When the system automatically switches to petrol operating mode because the LPG tank is almost empty, you can revert to gas operating mode by pressing the » » Fig. 121 (GAS) »

button while driving slowly and with low acceleration. This procedure can be repeated several times while driving carefully until all the LPG left in the tank has been used up.

- Vehicles that display information or warning messages on the dash panel may show information related to LPG operation.
- The notification LPG mode not possible may be displayed.

## Journeys abroad

To drive abroad, the following must be taken into consideration:

- For vehicles fitted with a catalytic converter ensure that unleaded petrol is available for the journey. See the chapter “Refuelling”. Automobile organisations will have information about service station networks selling unleaded fuel.
- In some countries, your vehicle model may not be available, and therefore some spare parts may not be available or technical services can only carry out limited repairs.

SEAT importers and distributors will gladly provide information about the technical preparation that your vehicle requires and also about necessary maintenance and repair possibilities.

## Adhesive strips for headlights

If you have to drive a right-hand drive vehicle in a left-hand drive country, or vice versa, the asymmetric dipped beam headlights will dazzle oncoming traffic.

To prevent dazzling, you must apply stickers to certain parts of the headlight lenses. Further information is available at any Technical Service.

In vehicles with adaptive headlights, the rotation system must previously be disconnected. To do this, please go to a specialised workshop.

## Ignition lock

### Ignition key positions



Fig. 122 Ignition key positions.

## Ignition switched off, steering lock 0

In this position » Fig. 122, the ignition and the engine are OFF and the steering may be locked.

For the **Steering lock** to operate without the ignition key, turn the steering wheel until it locks with an audible sound. You should always lock the steering wheel when you leave your vehicle. This will help prevent vehicle theft » ⚠.

## Switching the ignition or the glow plug system on 1

Turn the ignition key to this position and release it. If the key cannot be turned or it is difficult to turn from position 0 to position 1, move the steering wheel from one side to the other to release it.

## Starting 2

The engine is started when the key is in this position. Electrical devices with high power consumption are switched off temporarily at the same time.

Each time that the vehicle is restarted, the ignition key must be turned to position 0. The **repetitive start prevention lock** of the ignition prevents possible damage to the starter motor if the engine is already running.

**⚠ WARNING**

- The ignition key must **NOT** be removed from the lock until the vehicle comes to a standstill. Otherwise, the steering could be immediately blocked- Risk of accident!
- Always remove the key from the ignition when leaving the vehicle, even if only for a short period. This is especially important if children or disabled people are left alone in the vehicle. They could accidentally start the engine or work electrical equipment such as the electric windows, resulting in an accident.
- Unsupervised use of the key could start the engine or any electrical system, such as the electric windows. This could result in serious injury.

**ⓘ CAUTION**

The starter motor will only work when the engine is stopped (ignition key position ②).

**Electronic immobiliser**

The electronic immobiliser prevents unauthorised persons from driving the vehicle.

Inside the key there is a chip that deactivates the electronic immobiliser automatically when the key is inserted into the ignition.

The electronic immobiliser will be activated again automatically as soon as you pull the key out of the ignition lock.

The engine can only be started using a genuine SEAT key with its correct code.

**ⓘ Note**

A perfect operation of the vehicle is ensured if genuine SEAT keys are used.

**Starting petrol engines**

The engine can only be started using a genuine SEAT key with its correct code.

- Move the gearbox lever to the neutral position and depress the clutch pedal thoroughly and hold it in this position for the starter to turn the engine on.
- Turn the ignition key to the starting position » page 120.
- Let go of the ignition key as soon as the engine starts; the starter motor must not run on with the engine.

After starting a very hot engine, you may need to slightly press down the accelerator.

When starting a cold engine, it may be a little noisy for the first few seconds until oil pressure has built up in the hydraulic valve compensators. This is quite normal, and no cause for concern.

If the engine does not start immediately, switch the starter off after 10 seconds and try again after half a minute. If the engine still does not start, the fuel pump fuse should be checked » page 196, Fuses.

**⚠ WARNING**

- Never start or run the engine in unventilated or closed rooms. The exhaust gases contain carbon monoxide, an odourless and colourless poisonous gas. Risk of fatal accidents. Carbon monoxide can cause loss of consciousness and result in death.
- Never leave the vehicle unattended if the engine is running.
- Never use “cold start sprays”, they could explode or cause the engine to run at high revs. Risk of injury.

**ⓘ CAUTION**

- When the engine is cold, you should avoid high engine speeds, driving at full throttle and over-loading the engine. Risk of engine damage.
- The vehicle should not be pushed or towed more than 50 metres to start the engine. Unburnt fuel could enter the catalytic converter and damage it.
- Before attempting to push-start or tow a vehicle in order to start it, you should first try to start it using the battery of another vehicle. Note and follow the instructions in » page 189, Jump-starting.

### For the sake of the environment

**Do not warm-up the engine by running the engine with the vehicle stationary. Start off immediately, driving gently. This helps the engine reach operating temperature faster and reduces emissions.**

### Starting diesel engines

The engine can only be started using a genuine SEAT key with its correct code.

- Move the gearbox lever to the neutral position and depress the clutch pedal thoroughly and hold it in this position for the starter to turn the engine on.
- Turn the ignition key to position **» Fig. 122 ①**. The warning lamp  will light for engine pre-heating.
- When the lamp turns off, turn the ignition key to position **②** to start the engine. Do not press the accelerator.
- Release the ignition key as soon as the engine starts. The starter motor should not turn at the same time.

When starting a cold engine, it may be a little noisy for the first few seconds until oil pressure has built up in the hydraulic valve compensators. This is quite normal, and no cause for concern.

If there are problems starting the engine, see the **» page 189**.

### Glow plug system for the diesel engine

To avoid unnecessary discharging of the battery, do not use any other major electrical equipment while the glow plugs are pre-heating.

Start the engine as soon as the glow plug warning lamp **» page 41** goes out.

### Starting a diesel engine after the fuel tank has been completely run dry

If the fuel tank has been completely run dry, it may take longer than normal (up to one minute) to start a diesel engine after refuelling. This is because the fuel system must eliminate air first.

### WARNING

- Never start or run the engine in unventilated or closed rooms. The exhaust gases contain carbon monoxide, an odourless and colourless poisonous gas. Risk of fatal accidents. Carbon monoxide can cause loss of consciousness and result in death.
- Never leave the vehicle unattended if the engine is running.
- Never use “cold start sprays”, they could explode or cause the engine to run at high revs. Risk of injury.

### CAUTION

- When the engine is cold, you should avoid high engine speeds, driving at full throttle and over-loading the engine. Risk of engine damage.
- The vehicle should not be pushed or towed more than 50 metres to start the engine. Unburnt fuel could enter the catalytic converter and damage it.
- Before attempting to push-start or tow a vehicle in order to start it, you should first try to start it using the battery of another vehicle. Note and follow the instructions in **» page 189, Jump-starting**.

### For the sake of the environment

**Do not warm-up the engine by running the engine with the vehicle stationary. You should drive off as soon as you start the engine. This helps the engine reach operating temperature faster and reduces emissions.**

### Switching off the engine

- Stop the vehicle.
- Turn the ignition key to position **» Fig. 122 ①**.

After switching the engine off, the radiator fan may run on for up to 10 minutes. The fan may also turn on again if coolant temperature increases from accumulated heat in the

engine compartment or due to its prolonged exposure to solar radiation.

#### WARNING

- Never switch the engine off until the vehicle is completely stationary.
- The brake servo works only when the engine is running. With the engine switched off, more strength is needed to brake. As normal brake operation cannot be performed, risk of accidents and serious injury may exist.
- The steering lock can be immediately blocked once the key is removed from the ignition. The vehicle cannot be steered. Risk of accident.

#### CAUTION

When the engine has been running under a heavy load for a long period, heat can accumulate in the engine compartment and cause engine damage. For this reason, idle the engine for approximately 2 minutes before switching it off.

## Braking and parking

### Braking capacity and distance

The following factors impair braking capacity:

#### New brake pads

New brake pads do not provide optimal performance during the first 400 km; first they must be “run in”. However, the reduced braking capacity may be compensated by pressing on the brake pedal a little harder. Avoid overloading the brakes during run-in.

#### Wear

The rate of wear on the **brake pads** depends a great deal on how you drive and the conditions in which the vehicle is operated. Negative factors are, for instance, city traffic, frequent short trips or hard driving with abrupt starts and stops.

#### Wet roads or road salt

In certain conditions, such as in heavy rain, or after washing the vehicle or driving through water, the full braking effect can be delayed by moisture (or in winter by ice) on the discs and brake pads. In this case the brakes should be “dried” by pressing the brake pedal several times.

The effectiveness of the brakes can also be temporarily reduced if the vehicle is driven for some distance without using the brakes when there is a lot of salt on the road in winter. In this case, the layer of salt on the brake discs and pads has to wear off before braking.

#### Corrosion

There may be a tendency for corrosion to form on the discs and dirt to build up on the brake pads if the vehicle is used infrequently or the brakes are not used very often.

If the brakes are not used frequently, or if rust has formed on the disks, it is advisable to clean off the pads and disks by braking firmly a few times at a moderately high speed **»»** .

#### Faults in the brake system

If the brake pedal travel should ever increase *suddenly*, this may mean that one of the two brake circuits has failed. Drive immediately to the nearest specialised workshop and have the fault repaired. Drive there slowly and remember that you will have to apply more pressure on the brake pedal and allow for longer stopping distances.

#### Low brake fluid level

Malfunctions can occur in the brake system if the brake fluid level is too low. The brake fluid level is monitored electronically.

#### Brake servo

The brake servo increases the pressure you apply to the brake pedal. It works only when the engine is running. **»»**

### ⚠ WARNING

- Apply the brakes heavily to clean the brake system only in a suitable traffic situation. Do not put other road users in danger: there is risk of causing an accident.
- Ensure the vehicle does not move while in neutral, when the engine is stopped. Failure to follow this instruction could result in an accident.
- If the brake fluid loses its viscosity and is subjected to heavy use, vapour bubbles can form in the brake system. This reduces the efficiency of the brakes.
- If a brake system circuit fails, the braking distance will be increased considerably. Contact a specialised workshop immediately and avoid unnecessary journeys.

### ⓘ CAUTION

- Never let the brakes “drag” by leaving your foot on the pedal when it is not necessary to brake. This overheats the brakes, resulting in longer stopping distances and greater wear.
- Before driving down a long, steep gradient, it is advisable to reduce speed and select a lower gear. This makes use of engine braking and relieves the brakes. If you still have to use the brakes, it is better to brake firmly at intervals than to apply the brakes continuously.

### ⓘ Note

- If the brake servo is out of action, for example when the car is being towed, you will have to press the brake pedal considerably harder than normal to make up for the lack of servo assistance.
- If you wish to equip the vehicle with accessories such as a front spoiler or wheel covers, it is important that the flow of air to the front wheels is not obstructed, otherwise the brakes can overheat. Before purchasing accessories please observe the relevant instructions » page 147, Technical modifications.

## Operating the handbrake

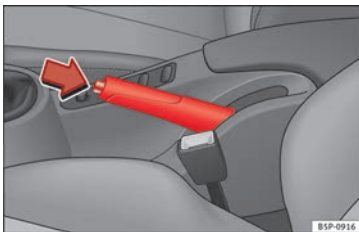

Fig. 123 Handbrake between the front seats.

The handbrake should be applied firmly to prevent the vehicle from accidentally rolling away.

Always apply the handbrake when you leave your vehicle and when you park.

### Applying the handbrake

- Pull the handbrake lever up firmly  
» Fig. 123.

### Releasing the handbrake

- Pull the lever up slightly and press the release knob in the direction of the arrow  
» Fig. 123 and guide the handbrake lever down fully » ⚠.

Always pull the handbrake *all the way up*, so there is less risk of driving off with it still engaged » ⚠.

The handbrake warning lamp ⚠ lights up when the handbrake is applied and the ignition switched on. The warning lamp turns off when the handbrake is released.

If you drive faster than 6 km/h (4 mph) with the handbrake on, the following message\* will appear on the instrument panel: **HANDBRAKE ON**. You will also hear an audible warning.

### ⚠ WARNING

- **Never use the handbrake to stop the vehicle when it is in motion. The braking distance is considerably longer, because braking is only applied to the rear wheels. Risk of accident!**

- If the handbrake is only partially released, this will cause the rear brakes to overheat, which can impair the function of the brake system and could lead to an accident. This also causes premature wear on the rear brake pads.

#### ⓘ CAUTION

Always apply the handbrake before you leave the vehicle. Put it in 1st gear as well.

## Parking

The handbrake should always be firmly applied when the vehicle is parked.

Always note the following points when parking the vehicle:

- Use the brake pedal to stop the vehicle.
- Apply the handbrake.
- Put it in 1st gear.
- Switch the engine off and remove the key from the ignition. Turn the steering wheel slightly to engage the steering lock.
- Always take your keys with you when you leave the vehicle »» ⚠.

### Additional notes on parking the vehicle on gradients:

Turn the steering wheel so that the vehicle rolls against the kerb if it started to roll.

- If the vehicle is parked facing **downhill**, turn the front wheels so that they point *towards the kerb*.
- If the vehicle is parked facing **uphill**, turn the front wheels so that they point *away from the kerb*.
- Secure the vehicle as usual by applying the handbrake firmly and putting it in 1st gear.

#### ⚠ WARNING

- Take measures to reduce the risk of injury when you leave your vehicle unattended.
- Never park where the hot exhaust system could ignite inflammable materials, such as dry grass, low bushes, spill fuel etc.
- Never allow vehicle occupants to remain in the vehicle when it is locked. They would be unable to open the vehicle from the inside, and could become trapped in the vehicle in an emergency. In the event of an emergency, locked doors will delay assistance to vehicle occupants.
- Never leave children alone in the vehicle. They could set the vehicle in motion, for example, by releasing the handbrake or the gearbox lever.

- Depending on weather conditions, it may become extremely hot or cold inside the vehicle. This can be fatal.

### Hill driving assistant\*

This function is only included in vehicles with ESC.

The hill driving assistant helps the driver to move off and upward on a hill without rolling backward.

The system maintains brake pressure for approximately 2 seconds after the driver takes his foot off the brake pedal to prevent the vehicle from rolling backward when starting off. During these 2 seconds, the driver has enough time to release the clutch pedal and accelerate without the vehicle moving and without having to use the handbrake, making starting off easier, more comfortable and safer.

These are the basic operation conditions:

- being on a ramp or hill/slope,
- closed doors,
- vehicle completely stationary,
- engine running and foot on the brake,
- besides having a gear engaged or being in neutral for manual gear change and with the selector lever at position **S**, **D** or **R** for an automatic gearbox.

This system is also active when reversing uphill.

#### **⚠ WARNING**

- If you do not start the vehicle immediately after taking your foot off the brake pedal, the vehicle may start to roll back under certain conditions. Depress the brake pedal or use the hand brake immediately.
- If the engine stalls, depress the brake pedal or use the hand brake immediately.
- When following a line of traffic uphill, if you want to prevent the vehicle from rolling back accidentally when starting off, hold the brake pedal down for a few seconds before starting to move.

#### **i Note**

The official service or a specialist workshop can tell you if your vehicle is equipped with this system.

## Manual gearbox

### Driving with a manual gearbox

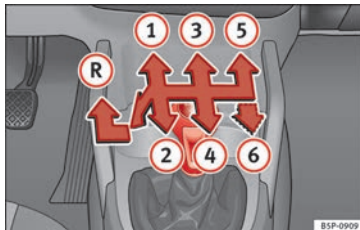

**Fig. 124** Detailed view of the centre console: gear shift pattern of a 5- or 6-speed manual gearbox.

### Engaging the reverse gear

- The vehicle should be stationary with the engine idling. Press the clutch down thoroughly.
- Place the gearbox lever into neutral and push the lever downwards.
- Slide the gearbox lever to the left, and then into the reverse position shown on the lever.

The reverse gear can only be engaged when the vehicle is stationary. When the engine is running and before engaging this gear, wait about 6 seconds with the clutch pressed

down thoroughly in order to protect the gearbox.

The reverse lights switch on when the reverse gear is selected and the ignition is on.

#### **⚠ WARNING**

- When the engine is running, the vehicle will start to move as soon as a gear is engaged and the clutch released.
- Never select the reverse gear when the vehicle is in motion. Risk of accident.

#### **i Note**

- Do not rest your hand on the gear lever while driving. The pressure of your hand could cause premature wear on the selector forks in the gearbox.
- When changing gear, you should always depress the clutch fully to avoid unnecessary wear and damage.
- Do not “slip” the clutch to hold the vehicle on a hill. This causes premature wear and damage to the clutch.
- Do not leave your foot on the clutch pedal; although the pressure may seem insignificant, it can cause the premature wear of the clutch plate. Use the foot rest when you do not need to change gear.



## Automatic gearbox/DSG automatic gearbox\*

### Selector lever positions



**Fig. 125** Centre console: selector lever for automatic gearbox/DSG automatic gearbox.

### Selector lever positions indicated on the cover

- P** Parking position (lever locked).
- R** Reverse position.
- N** Neutral position (lever locked). This position is similar to the neutral position for manual gearboxes).
- D** Drive position (economic driving programme).
- S** Sports driving position.
- +/- Tiptronic driving position (this programme is similar to the operation of a manual gearbox).

### Driving programmes

The automatic gearbox / DSG gearbox has three programmes.

#### Selecting the economy programme

- This programme selects a higher gear earlier rather than remain in a lower gear.
- Put the selector lever into position **D** to drive forwards.
- Put the selector lever into position **R** to reverse. This position is shared by all programmes for reversing.

#### Selecting the sport programme

- Move the lever to position **S**.

If you select sport programme **S**, the programme is designed for sport mode, that is, a programme which changes up at higher engine speeds to use the full power of the engine. This programme is not recommended for use on the motorway or in the city.

#### Selecting the manual programme (Tiptronic)

This programme allows driving similar to a manual gearbox.

This programme may be accessed using the selector lever or from the steering wheel controls when this option is fitted » page 129.

### Selector lever locking



**Fig. 126** Centre console: automatic gearbox selector lever.

The selector lever lock prevents gears from being engaged inadvertently, which would cause the vehicle to move.

#### Releasing the selector lever lock

- Start the vehicle.
- Press and release the brake pedal, at the same time press the button on the selector lever.

The lock can only be engaged when the vehicle is stationary or at a speed of less than 5 km/h (3 mph). It is automatically switched off at higher speeds in position **N**.

For rapid gear changes (e.g. from **R** to **D**) the lever will not lock. If the lever remains in position **N** for more than one second it will lock. With the automatic lock, the lever is



prevented from passing from **P** and **N** to any other gear without first pressing the brake pedal.

The selector lever must be put in the position **P** in order to remove the key.

### Driving with automatic gearbox/DSG automatic gearbox\*



**Fig. 127** Centre console: automatic gearbox selector lever.

The gearbox changes gear ratios automatically as the vehicle moves.

#### Starting

- Start the engine with the selector lever in position **P** or **N**.

#### Driving

- Press and hold the brake pedal.

- Holding down the lock button (button on the selector lever), select **R** or **D**.
- Release the lever and wait a little for the gearbox to engage the gear (a slight movement can be felt).
- Release the brake and press the accelerator »» » ⚠.

#### Stopping briefly

- If stopping for a short time, keep the vehicle stationary by pressing the foot brake hard to prevent the vehicle moving backwards on a slope or “creeping” forwards, e.g. at traffic lights. The selector lever does not need to be put into the positions **P** or **N** for this.
- Do not press the accelerator.

#### Parking

- Press and hold the brake pedal until the vehicle comes to a standstill »» » ⚠.
- Apply the handbrake.
- By pressing the lock button down, move the selector lever to **P** and release the lock button.

#### Driving up and down hills

- Press the selector lever from position “D” to the right into the tiptronic selector gate.

- Lightly press the selector lever back to change down.

#### Holding the car on a hill

- The brake must be always pressed down to prevent the vehicle from “rolling backwards” »» » ⚠. Do not try to prevent the vehicle from “rolling backwards” by increasing the engine speed while a range of gears is selected.

#### Starting the vehicle up hills

- Apply the handbrake.
- With a selected gear, accelerate slowly and at the same time, release the handbrake.

The steeper the slope, the lower the needed gear. This increases the braking effect of the engine. For example, when driving down a very steep slope in third gear. If the engine brake effect is not enough, the vehicle will speed up. The automatic gearbox automatically changes up to prevent the engine over-revving. Use the foot brake to reduce speed and change into 3rd gear using Tiptronic\* »» » ⚠.

Your vehicle has an automatic interlock which prevents the selector lever from being put into a position for driving forwards or in reverse from positions **P** or **N** if the brake pedal is not depressed.

The ignition key cannot be removed unless the selector lever is in position **P**.

### Control lamp “Pressing brake pedal”

When the warning lamp next to the selector lever lights up, press the brake pedal. This is necessary when the automatic gearbox selector lever is moved out of positions **P** or **N**. A text message or instructions to perform necessary operations may appear on the instrument panel.

#### WARNING

- As a driver, you should never leave your vehicle if the engine is running and a gear range is engaged. If you have to leave your vehicle while the engine is running, you must apply the parking brake and put the selector lever in position **P**.
- If the engine is running and if **D** or **R** is engaged, you will need to hold the car on the foot brake. The car will creep forward as the power transmission is not fully interrupted even when the engine is idling.
- Never accelerate when moving the selector lever or you may cause an accident.
- Never move the selector lever to **R** or **P** when driving. Risk of accident!
- Before driving down a long, steep slope, it is advisable to reduce speed and change into a lower gear.

- If you stop the vehicle up hill, always hold the foot brake strongly depressed down to stop it from rolling back.
- Never allow the brake to rub and do not use the brake pedal too often or for long periods. Constant braking will cause the brakes to overheat and will considerably reduce the brake effect. This increases the braking distance and could cause the brake system to fail.
- Never allow the car to roll down a gradient with the gear in neutral **N**, or in selector lever position **D**, even if the engine is not running.

#### CAUTION

- If you stop the vehicle up hills, do not attempt to stop it from rolling back by depressing the accelerator when a gear has been selected. Otherwise, the automatic gearbox may overheat causing damage. Pull the hand-brake up or fully depress the brake pedal to prevent the vehicle from rolling away.
- If you allow the vehicle to roll when the engine is not running, or with the selector lever in position **N**, a lack of lubrication in the automatic gearbox will damage it.

### Changing gear in Tiptronic mode\*

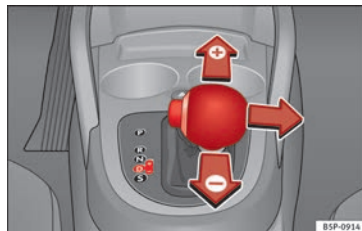

Fig. 128 Changing gear with Tiptronic.





Fig. 129 Steering wheel with paddle shifters for automatic gearbox.



The Tiptronic system allows the driver to select gears manually.

### Changing gear with the selector lever

- Press the selector lever from position **D** to the right into the tiptronic selector gate. »

- Lightly press the selector lever forward »» Fig. 128  to change up to a higher gear.
- Lightly press the selector lever backward »» Fig. 128  to change down to a lower gear.

### Changing gear with the steering wheel paddle levers\*

- Press the right paddle lever  towards the steering wheel to change up »» Fig. 129.
- Press the left paddle  towards the steering wheel to change down »» Fig. 129.

Using the paddle levers on the steering wheel, you can access manual driving mode regardless of the pre-selected driving mode.

### General information about driving in tiptronic mode

When accelerating, the automatic gearbox / DSG automatic gearbox goes into a higher gear a little before the engine reaches its maximum permitted revolutions.

If a lower gear is selected, the automatic gearbox / DSG automatic gearbox will only change down when the engine cannot go over its maximum permitted revolutions.

If “tiptronic” is selected whilst the vehicle is in motion and the automatic gearbox / DSG automatic gearbox is in third gear and selec-

tor lever position **D**, “tiptronic” mode will then also be in third gear.

### Changing gears in the normal or sport programme using the steering wheel paddle levers

If the paddle levers »» Fig. 129 are used in the normal or sport programme, the system switches temporarily to “tiptronic” mode. To exit “Tiptronic” mode again, press the right paddle shifter  toward the steering wheel for approximately one second. You will also leave “Tiptronic” mode if the paddle levers are not moved for a certain time.

#### Note

- The gearbox controls on the steering wheel can operate with the selector lever in any position and with the vehicle in motion.

### Kick-down feature

This feature allows maximum acceleration.

If you press the accelerator down thoroughly, the gearbox automatically changes down, depending on speed and engine speed, into a lower gear to take full advantage of give the vehicle maximum acceleration.

The gearbox does not change gear until the engine reaches the maximum determined engine speed for the gear.

#### WARNING

You could lose control of the vehicle if you accelerate on slippery road surfaces. Risk of serious injury.

- Be particularly careful when using the kick-down features on slippery road surfaces. With a fast acceleration, the vehicle could lose traction and skid.
- You should use the kick-down feature only when traffic and weather conditions allow it to be used safely.

## Run-in and economical driving

### Running in a new engine

The engine needs to be run in over the first 1,500 km.

#### Up to 1,000 kilometres

- Do not drive at speeds of more than 2/3 the maximum speed.
- Do not accelerate hard.
- Avoid high engine revolutions.
- Do not tow a trailer.

### From 1,000 to 1,500 kilometres

- Speeds can be *gradually* increased to the maximum road speed or maximum permissible engine speed (rpm).

During its first few hours of running, the internal friction in the engine is greater than later on, when all the moving parts have bedded in.



For the sake of the environment

If the engine is run in gently, its life will be increased and its oil consumption reduced.

### Environmental friendliness

Environmental protection is a top priority in the design, choice of materials and manufacture of your new SEAT.

#### Constructive measures to encourage recycling

- Joints and connections designed for easy dismantling
- Modular construction to facilitate dismantling
- Increased use of single-grade materials.
- Plastic parts and elastomers are marked in accordance with ISO 1043, ISO 11469 and ISO 1629.

### Choice of materials

- Use of recycled materials.
- Use of compatible plastics in the same part if its components are not easily separated.
- Use of recycled materials and/or materials originating from renewable sources.
- Reduction of volatile components, including odour, in plastic materials.
- Use of CFC-free coolants.

**Ban on heavy metals, with the exceptions dictated by law (Annex II of ELV Directive 2000/53/EC):** cadmium, lead, mercury, hexavalent chromium.

### Manufacturing methods

- Reduction of the quantity of thinner in the protective wax for cavities.
- Use of plastic film as protection during vehicle transport.
- Use of solvent-free adhesives.
- Use of CFC-free coolants in cooling systems.
- Recycling and energy recovery from residues (RDF).
- Improvement in the quality of waste water.
- Use of systems for the recovery of residual heat (thermal recovery, enthalpy wheels, etc.).
- Use of water-soluble paints.

### Catalytic converter

#### To maintain the useful life of the catalytic converter

- Use only unleaded petrol with petrol engines, as lead damages the catalytic converter.
- Do not let the fuel get too low in the tank.
- For engine oil changes, do not replenish with too much engine oil » page 168, **Topping up engine oil** .
- Never tow the vehicle to start it, use jump leads if necessary » page 189.

If you notice misfiring, uneven running or loss of power when the vehicle is moving, reduce speed immediately and have the vehicle inspected at the nearest specialised workshop. In general, the exhaust warning lamp will light up when any of the described symptoms occur » page 35. If this happens, unburnt fuel can enter the exhaust system and escape into the environment. The catalytic converter can also be damaged by overheating.

#### WARNING

The catalytic converter reaches very high temperatures! Risk of fire!

- Never park where the catalytic converter could come into contact with dry grass or flammable materials under the vehicle.

- Do not apply additional underseal or anti-corrosion coatings to the exhaust pipes, catalytic converter or the heat shields on the exhaust system. These materials could catch fire when the vehicle is being driven.

#### ⓘ CAUTION

Never run the fuel tank completely dry because the irregularity of the fuel supply may cause ignition problems. This allows unburnt fuel to enter the exhaust system, which could cause overheating and damage the catalytic converter.

#### 🌿 For the sake of the environment

Even when the emission control system is working perfectly, there may be a smell of sulphur from the exhaust gas under some conditions. This depends on the sulphur content of the fuel used. Quite often the problem can be solved by changing to another brand of fuel.

### Diesel engine particulate filter\*

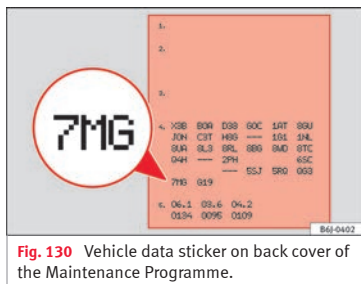

Fig. 130 Vehicle data sticker on back cover of the Maintenance Programme.

Your vehicle is fitted with a DPF (Diesel particulate filter) if the vehicle data sticker (back cover of the “Maintenance Programme”) lists the PR code 7GG or 7MG » Fig. 130.

The diesel engine particulate filter eliminates most of the soot from the exhaust gas system. Under normal driving conditions, the filter cleans itself. If this is not possible (for example, multiple short trips) the filter will be obstructed by soot and the diesel engine particulate filter warning lamp will light up. This does not represent a fault, it is a warning that indicates that the filter has not been able to regenerate automatically and that you must perform a cleaning cycle, as indicated in » page 41.

#### ⚠ WARNING

- The diesel engine particulate filter may reach extremely high temperatures; the vehicle should be parked so that the exhaust pipe does not come into contact with flammable materials underneath the vehicle. Otherwise there is a risk of fire.

#### ⓘ CAUTION

- Your vehicle is not designed to use biodiesel fuel. Never, under any circumstances refuel with biodiesel. The use of biodiesel fuel could damage the engine and the fuel system. The addition of biodiesel to diesel by the diesel producer in accordance with standard EN 590 is authorised and will not cause damage to the engine or the fuel system.
- Using diesel fuel with a high sulphur content may significantly reduce the useful life of the diesel particulate filter. Your Technical Service will be able to tell you which countries have diesel with a high sulphur content.

### Economical and environmentally friendly driving

Fuel consumption, environmental pollution and wear to the engine, brakes and tyres depends in large part on your driving style. By adopting an economical driving style and anticipating the traffic situation ahead, you can easily reduce fuel consumption by 10-15%.

Some tips on how to help you reduce pollution while saving money are listed below.

### Drive anticipating the traffic situation

A vehicle uses most fuel when accelerating. When you anticipate situations, you have to brake less often and, thus, accelerate less. If it is possible, let the vehicle roll with a **gear engaged**, for example, if you see a red light ahead. The braking effect achieved in this way helps to reduce the wear of brakes and tyres; emissions and fuel consumption are reduced to zero (disconnection due to inertia).

### Change gear early to save energy

An effective way of saving fuel is to change up *quickly* through the gears. Running the engine at high rpm in the lower gears uses an unnecessary amount of fuel.

**Manual gearbox:** shift up from first to second gear as soon as possible. We recommend that, whenever possible, you change to a higher gear upon reaching 2000 rpm. Follow the “recommended gear” indication that appears on the instrument panel » [page 47](#).

### Avoid driving at high speed

We advise you not to drive at the top speed permitted by the vehicle. Fuel consumption, exhaust emissions and noise levels all in-

crease very rapidly at higher speeds. Driving at moderate speeds will help to save fuel.

### Avoid idling

It is worthwhile switching off the engine when waiting in a traffic jam, at level crossings or at traffic lights with a long red phase. The fuel saved after only 30 - 40 seconds is greater than the amount of fuel needed to restart the engine.

The engine takes a long time to warm up when it is idling. Mechanical wear and pollutant emissions are also especially high during this initial warm-up phase. It is therefore best to drive off immediately after starting the engine. Avoid running the engine at high speed.

### Periodic maintenance

Periodic maintenance work guarantees that, before beginning a journey, you will not consume more than the required amount of fuel. A well-serviced engine gives you the benefit of **improved fuel efficiency** as well as maximum reliability and an enhanced resale value.

A badly serviced engine can consume up to 10% more fuel than necessary.

### Avoid short journeys

To reduce the consumption and emission of polluting exhaust gases, the engine and the

exhaust gas filtration systems should reach the optimum **operating temperature**.

With the engine cold, fuel consumption is proportionally higher. The engine does not warm up and fuel consumption does not normalise until having driven approximately *four* kilometres. This is why we recommend avoiding short trips whenever possible.

### Maintain the correct tyre pressures

Bear in mind that keeping the tyres at an adequate pressure saves fuel. If the tyre pressure is just one bar (14.5 psi / 100 kPa) too low, fuel consumption can increase by as much as 5%. Due to the greater rolling resistance, under-inflation also increases tyre **wear** and impairs handling.

The tyre pressures should always be checked when the tyres are *cold*.

Do not use **winter tyres** all year round as they increase fuel consumption by up to 10%.

### Avoid unnecessary weight

Given that every kilo of **extra weight** will increase the fuel consumption, it is advisable to always check the luggage compartment to make sure that no unnecessary loads are being transported.

A roof rack is often left in place for the sake of convenience, even when it is no longer needed. At a speed of 100 km/h (62 mph) »

and 120 km/h (75 mph) your vehicle will use about 12% more fuel as a result of the extra wind resistance caused by the roof rack even when it is not in use.

### Save electricity

The engine activates the alternator, which produces electricity. With the need for electricity, fuel consumption is also increased. Because of this, always turn off electrical devices when you do not need them. Examples of devices that use a lot of electricity are: the fan at high speeds, the rear window heating or the seat heaters\*.

**slope. Fuel consumption will be “zero” and the brakes will not suffer.**

## Driver assistance systems

### Braking and stability systems

#### Electronic Stability Control (ESC)\*



**Fig. 131** Detailed view of the centre console: ESC switch.

This Electronic Stability System reduces the risk of skidding and improves the vehicle's stability and ability to hold the road.

Electronic Stability Control (ESC) includes the electronic differential lock (EDL), the traction control system (TCS), the brake assist system (BAS) and the trailer stabilisation programme (TSP). The ESC works together with the ABS. Both control lamps will light up if the ESC or ABS systems are faulty.

The ESC system is started automatically when the engine is started.

#### Note

- If you vehicle has *Start-Stop*, it is not recommended to switch this function off.
- It is recommended to *close the windows* when driving at more than 60 km/h
- Do not drive with your foot resting *on the clutch pedal*, as the pressure can make the plate spin, more fuel will be used and it can burn the clutch plate lining, causing a serious fault.
- Do not hold the vehicle on a hill with the clutch, use the foot brake or hand brake, using the latter to start. The fuel consumption will be lower and you will prevent the clutch plate from being damaged.
- On descents, use the engine brake, changing to the gear that is more suitable for the



The ESC system is always active and cannot be switched off. The ESC switch only switches the ASR off.

The ASR can be deactivated when wheel spin is desirable.

For example:

- When driving with snow chains.
- When driving in deep snow or on loose surfaces.
- When the vehicle is stuck, to rock it backwards and forwards.

Press the button to switch the ASR back on when you no longer need wheel spin.

### Electronic Stability Control (ESC)\*

The ESC reduces the risk of skidding by braking the wheels individually.

The system uses the steering wheel angle and road speed to calculate the changes of direction desired by the driver, and constantly compares them with the actual behaviour of the vehicle. When irregularities occur, for example, if the vehicle begins to skid, the ESC brakes the appropriate wheel automatically.

The forces acting on the braked wheel bring the vehicle back to a stable condition. If the vehicle tends to oversteer (the rear end slides out), the system will act on the front wheel on the outside of the turn.

### Steering manoeuvre recommendations

This is a complementary safety function included in the ESC. This function aids the driver to better stabilize the vehicle in a critical situation. For example, in case of sudden braking on a surface with varied adherence, the vehicle will tend to destabilise its trajectory to the right or to the left. In this case, the ESC recognises the situation and assists the driver with a counter steering manoeuvre from the power steering.

This function simply provides the driver with a recommended manoeuvre in critical situations.

The vehicle does not steer itself with this function, the driver has full control of the vehicle at all times.

#### WARNING

- Remember that not even the ESC can defy the laws of physics. This should be kept in mind, particularly on slippery and wet roads and when towing a trailer.
- Always adapt your driving style to suit the condition of the roads and the traffic situation. The greater safety provided by the ESC should not encourage you to run any risks.

#### CAUTION

- To ensure that the ESC works correctly, all four wheels must be fitted with the same tyres. Any differences in the rolling radius of

the tyres can cause the system to reduce engine power when this is not desired.

- Any modifications made to the vehicle (for example, to the engine, brake system, running gear or to the combination of wheels and tyres) may affect the operation of the ABS, EDL, ESC and ASR.

### Electronic differential lock (EDL)\*

EDL helps the vehicle to start moving, accelerate and climb a gradient in slippery conditions where this may otherwise be difficult or even impossible.

It uses the ABS sensors to monitor the speed of the driven wheels. In case of an EDL fault, the warning light for ABS lights up **» page 41.**

At speeds of up to approximately 80 km/h (50 mph), it is able to balance out differences in the speed of the driven wheels of approximately 100 rpm/min caused by a *partially* slippery road surface. It does this by braking the wheel which has lost traction and distributing more driving force to the other driven wheel via the differential.

To prevent the disc brake of the braking wheel from overheating, the EDL cuts out automatically if subjected to excessive loads. The vehicle will continue to function normally **»**

without EDL. For this reason, the driver is not informed that the EDL has been switched off.

The EDL will switch on again automatically when the brake has cooled down.

### WARNING

- When accelerating on a slippery surface, for example on ice and snow, press the accelerator carefully. Despite EDL, the driven wheels may start to spin. This could impair the vehicle's stability.
- Always adapt your driving style to suit road conditions and the traffic situation. Do not let the extra safety afforded by EDL tempt you into taking any risks when driving, this can cause accidents.

### CAUTION

Modifications to the vehicle (e.g. to the engine, the brake system, running gear or any components affecting the wheels and tyres) could affect the efficiency of the EDL

»» page 147.

### Hydraulic Brake Assist (HBA)\*

The function (Hydraulic Brake Assist HBA) is only included in vehicles with ESC.

In an emergency, most drivers brake in time, but not with maximum force. This results in unnecessarily long braking distances.

This is when the brake assist system comes into action. When pressing the brake pedal rapidly, the assistant interprets it as an emergency. It very quickly builds up the full brake pressure so that the ABS can be activated more quickly and efficiently, thus reducing braking distance.

Do not reduce the pressure on the brake pedal, since the brake assist system switches off automatically as soon as you release the brake.

### Emergency braking warning

If the vehicle is braked suddenly and continuously at a speed of more than 80 km/h, the brake light flashes several times per second to warn vehicles driving behind. If you continue braking, the hazard warning lights will come on automatically when the vehicle comes to a standstill. They switch off automatically when the vehicle starts to move again.

### WARNING

- The risk of accident is higher if you drive too fast, if you do not keep your distance from the vehicle in front, and when the road surface is slippery or wet. The increased accident risk cannot be reduced by the brake assist system.
- The brake assist system cannot defy the laws of physics. Slippery and wet roads are dangerous even with the brake assist system!

**Therefore, it is essential that you adjust your speed to suit the road and traffic conditions. Do not let the extra safety features tempt you into taking any risks when driving.**

### Anti-lock brake system (ABS)

The anti-lock brake (ABS) system prevents the wheels from locking during braking and is an important part of the vehicle's active safety system.

### How the ABS works

If one of the wheels turns too slowly in relation to the vehicle's speed, and is close to locking, the system will reduce the braking pressure to this wheel. The driver is made aware of this control process by a **pulsating of the brake pedal** and audible noise. This is a deliberate warning to the driver that one or more of the wheels is tending to lock and the ABS control function has intervened. In this situation it is important to keep the brake pedal fully depressed so the ABS can regulate the brake application. Do not "pump".

If you brake hard on a slippery road surface, the best possible control is retained as the wheels do not lock.

However, ABS will not necessarily guarantee shorter braking distances in *all* conditions. Braking distance could even be further if you

brake on gravel or on fresh snow on a slippery surface.

#### WARNING

- The anti-lock brake system cannot defy the laws of physics. Slippery and wet roads are dangerous even with ABS! If you notice that the ABS is working (to counteract locked wheels under braking), you should reduce speed immediately to suit the road and traffic conditions. Do not let the extra safety features tempt you into taking any risks when driving.
- The effectiveness of ABS is also determined by the tyres fitted » page 175.
- If the running gear or brake system is modified, the effectiveness of the ABS could be severely limited.

### Drive wheel traction control system (ASR)

The traction control system prevents the driven wheels from spinning when the vehicle is accelerating.

#### Description and operation of the traction control system during acceleration (ASR)

On front-wheel drive vehicles, the ASR system intervenes, reducing engine power and preventing the driven wheels from slipping during acceleration. The system works in the

entire speed range in conjunction with ABS. If a failure occurs in the ABS, the ASR will also stop working.

TCS helps the car to start moving, accelerate and climb a gradient in slippery conditions where this may otherwise be difficult or even impossible.

The ASR automatically switches on when the engine is started. If necessary, it may be turned on or off by briefly pushing the button on the centre console.

When the ASR is switched off, the  OFF warning lamp will light up. The ASR should normally be left on. Only in exceptional circumstances, when slipping of the wheels is desired, should it be disconnected.

- With compact temporary spare wheel.
- When using the snow chains.
- When driving in deep snow or on soft terrain.
- When the vehicle is bogged-down, to free it by “rocking.”

The ASR should be switched on again as soon as possible.

#### WARNING

- Remember that not even the ASR can defy the laws of physics. This should be kept in mind, particularly on slippery and wet roads and when towing a trailer.

- Always adapt your driving style to suit the condition of the roads and the traffic situation. The greater safety provided by the ASR should not encourage you to run any risks.

#### CAUTION

- To ensure that the ASR works correctly, identical tyres should be fitted on all four wheels. Any differences in the rolling radius of the tyres can cause the system to reduce engine power when this is not desired.
- Any modifications made to the vehicle (for example, to the engine, brake system, running gear or to the combination of wheels and tyres) may affect the operation of the ABS and ASR.

### XDS\*

When taking a curve, the driveshaft differential mechanism allows the outer wheel to turn at a higher speed than the inner wheel. In this way, the wheel that is turning faster (outer wheel) receives less drive torque than the inner wheel. This may mean that in certain situations the torque delivered to the inner wheel is too high, causing the wheels to spin. On the other hand, the outer wheel is receiving a lower drive torque than it could transmit. This causes an overall loss of lateral grip on the front axle, resulting in understeer or “lengthening” of the trajectory. »

The XDS system can detect and correct this effect via the sensors and signals of the ESC.

Via the ESC, the XDS will brake the inside wheel and counter the excess driving torque of that wheel. This means that the driver's desired trajectory is much more precise,

The XDS system works in combination with the ESC and is always active, even when ASR traction control is disconnected.

### Brake servo

The brake servo increases the pressure you apply to the brake pedal. It works **only when the engine is running**.

If the brake servo is not functioning, e.g. due to a malfunction, or if the vehicle is being towed, you will have to press the brake pedal considerably harder to make up for the lack of servo assistance.

#### WARNING

The braking distance can also be affected by external factors.

- Never let the vehicle coast with the engine switched off. Failure to follow this instruction could result in an accident. The braking distance is increased considerably when the brake servo is not active.
- If the brake servo is not working, for example when the vehicle is being towed, you will

have to press the brake pedal considerably harder than normal.

## Start-Stop System\*



### Description and operation

The Start-Stop function stops the engine when the vehicle is stopped and starts it automatically when required.

- When the vehicle is stopped, put it in neutral and release the clutch pedal. The engine will stop.
- When the clutch pedal is pressed, the engine starts again.
- The instrument panel display shows information about the status of the Start-Stop function »» Fig. 133.

### Start-Stop function conditions

- The driver seat belt must be buckled.
- The bonnet must be closed.
- The engine must be at operating temperature.
- The steering wheel must be straight.
- The vehicle must not be on a steep gradient.
- The vehicle must not be in reverse.
- A trailer must not be connected.

• The temperature of the passenger compartment must be within comfort limits (button   »» Fig. 120 should be selected).

- The windscreen de-mist function must be off.
- If **not**, it requires an increase in airflow  »» Fig. 120 for more than three presses.
- The temperature must not be set to **HI** or **LO**.
- The driver door must be closed.
- The diesel particulate filter must not be in regeneration mode, for diesel engines.
- The battery charge must not be low for the next start.
- Battery temperature must be between -1 °C (+30 °F) and +55 °C (+131 °F).
- The Parking aid system (Park Assist\*) must not be activated.

### Start-Stop function interruption

In the following situations, the Start-Stop function will be interrupted and the engine will automatically start:

- The vehicle starts moving.
- The brake pedal is pressed several times in a row.
- The battery has been discharged excessively.
- The Start-Stop System is manually deactivated.

- The windscreen de-mist function is turned on.
- The temperature of the passenger compartment exceeds comfort limits (button **A/C** **11** » Fig. 120 should be selected).
- If in an increase in airflow **10** » Fig. 120 is required for more than three presses.
- Temperature setting **HI** or **LO** is selected.
- The engine coolant temperature is insufficient.
- The alternator is faulty, for example the V-belt has ruptured.
- If any of the conditions described in the previous section are not fulfilled.

#### ⚠ WARNING

Never allow the vehicle to move with the engine off for any reason. You could lose control of your vehicle. This could cause an accident and serious injury.

- Power steering does not work when the engine is not running. That is why it is much more difficult to turn the steering wheel.
- Turn off the Start-Stop system when driving through water (fording streams, etc.).

#### **i** Note

- For vehicles with the Start-Stop function and a manual gearbox, when the engine is started, the clutch must be pressed.

- When the conditions for the Start-Stop function are not fulfilled, the instrument panel displays the Start-Stop indicator dimmed.
- If the steering wheel is turned more than 270°, Stop will not function; however, the angle of steering wheel turn does not affect starting the vehicle.

### Activating and deactivating the Start-Stop function



Fig. 132 The Start-Stop function button.

Every time the ignition is switched on, the Start-Stop function is automatically activated.

#### Manually deactivating the Start-Stop function

- Press the **A** » Fig. 132 located in the centre console. When the Start-Stop function is

deactivated, the pushbutton indicator lights.

- If the Start-Stop function is operating then the engine starts immediately.

#### Switching the Start-Stop function on manually

- Press the **A** » Fig. 132 located in the centre console. The indicator on the button will go out.

### Driver messages

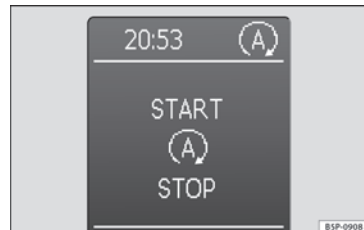

Fig. 133 Display on the instrument panel during Start-Stop function operation.

When the engine is turned off by the Start-Stop function, this is displayed on the instrument panel.

**Note**

There are different versions of the dash panel; the display of indications on the screen may differ.

## Parking aid acoustic system\*

### General notes

Various parking aid systems are available to help you when parking or manoeuvring in tight spaces, depending on the equipment fitted on your vehicle.

The SEAT Parking System\* gives an audible warning if there are any obstacles behind your vehicle.

When you are parking, the SEAT Parking System Plus\* warns you acoustically and optically<sup>1)</sup> about obstacles “in front of” and “behind” the vehicle.

**Note**

To ensure the acoustic parking aid works properly, the sensors must be kept clean and free of snow and ice.

### SEAT Parking System: description

The Parking System is an acoustic parking aid.

Sensors are located in the rear bumper. When the sensors detect an obstacle, you are alerted by audible warnings. The measuring range of the sensors starts at approximately:

Rear	Side	0.60
	Centre	1.60

The audible warnings sound with increasing frequency as you approach the obstacle. When the vehicle is less than 0.30 m away from the obstacle, the warning tone will sound continuously. Do not drive on!

The volume of the warning beeps will gradually decrease after about 4 seconds if the vehicle remains at a constant distance from a detected obstacle (it does not affect the permanent acoustic signal).

The parking aid is switched on automatically when reverse gear is engaged. You will hear a brief confirmation tone.

**WARNING**

- The parking aid is not a replacement for driver awareness. The driver is personally re-

sponsible for safe parking and other manoeuvres.

- The sensors have blind spots in which obstacles are not registered. Always look out for small children and animals because the system will not always detect them. Always pay attention when reversing to avoid accidents.
- Always keep a close eye on the area around the vehicle and make full use of the rear vision mirrors.

**CAUTION**

Please note that low obstacles detected by the system may no longer be registered by the sensors as the car moves closer, so the system will not give any further warning. Certain kinds of obstacles (such as wire fences, chains, thin painted posts or trailer draw bars, etc) may not always be detected by the system, so take care not to damage the vehicle in such cases.

**Note**

Please refer to the notes on towing » page 141.

<sup>1)</sup> Vehicles with a navigation system.

## SEAT Parking System Plus\*: description

The Parking System Plus is an acoustic and optical parking aid.

Sensors are located in the front and rear bumpers. When the sensors detect an obstacle, you are alerted by audible and optical warnings. The measuring range of the sensors starts at approximately:

Front	Side	0.90
	Centre	1.20
Rear	Side	0.60
	Centre	1.60

The audible warnings sound with increasing frequency as you approach the obstacle. When the vehicle is less than 0.30 m away from the obstacle, the warning tone will sound continuously. Stop moving immediately!

The volume of the warning beeps will gradually decrease after about 4 seconds if the vehicle remains at a constant distance from a detected obstacle (it does not affect the permanent acoustic signal).

## Activating/deactivating



**Fig. 134** Centre console: Switch for parking aid.

### Activate

- Connects the radio navigator.
- Press the switch **PWA** on the centre console **»» Fig. 134** or on the gear indicator. You will hear a brief confirmation tone and the LED on the switch will light up.

### Deactivating

- Drive forward faster than 10 km/h (6 mph), or
- Press the switch **PWA** or
- Switch the ignition off.

### Segments in the optical display

Some colour segments in front and behind and an audible warning enable the driver to assess the distance with respect to an obsta-

cle. The amber colour segments combined with a discontinuous beep indicate the presence of an obstacle. As the vehicle gets closer to the obstacle, the colour of the segment changes to red and the acoustic signal beeps continuously. When the penultimate segment is displayed, this means that the vehicle has reached the collision zone. Stop moving immediately! **»» ⚠ in SEAT Parking System: description on page 140.**

### Note

- Please refer to the notes on towing **»» page 141.**
- There is a slight delay in the picture display.

## Towing bracket

In towing mode, the rear parking aid sensors are not enabled when you select reverse gear or press the switch **PWA**. This function may not be guaranteed on towing brackets that are not factory fitted. This results in the following restrictions:

### SEAT Parking System\*

No warning is given.

### SEAT Parking System Plus\*

There is no rear distance warning. The system will still give a warning when obstacles are **»»**

detected while driving forward. The optical display changes to towing mode.

### Fault messages

If you hear a long beep for a few seconds and the LED on the switch P<sub>va</sub>\* starts flashing when you switch on the parking aid, a system fault has occurred. Contact a SEAT official service or specialised workshop.

#### Note

If the fault is not corrected before you switch off the ignition, it will only be indicated by the flashing LED on the switch P<sub>va</sub> the next time you switch on the parking aid.

## Cruise speed\* (cruise control system - CCS)

### Description

The CCS is able to maintain the set speed in the range from approx. 30 km/h (19 mph) to 180 km/h (112 mph).

Once the speed setting has been saved, you may take your foot off the accelerator.

#### WARNING

It could be dangerous to use the cruise control system if it is not possible to drive at constant speed.

- Do not use the cruise control system when driving in dense traffic, on roads with lots of bends or on roads with poor conditions (with ice, slippery surfaces, loose grit or gravel), as this could cause an accident.
- Always switch the cruise control system off after using it in order to avoid involuntary use.
- It is dangerous to use a set speed which is too high for the current road, traffic or weather conditions. Risk of accident.

#### Note

The cruise control cannot maintain a constant speed when descending downhill. It will increase due to its own weight. Use the foot brake to slow the vehicle.

### Switching the cruise control system on and off

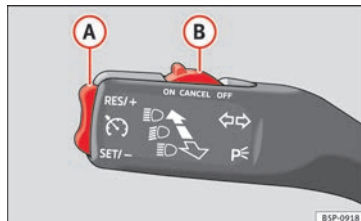

**Fig. 135** Turn signal and main beam headlight lever: switch and rocker switch for the cruise control.

#### Switching on the cruise control system

- Push the switch **» Fig. 135 (A)** to the left to **ON**.

#### Switching off the cruise control system

- Either push the switch **(B)** to the right to **OFF** or turn the ignition off when the vehicle is stationary.

When cruise control is on and a speed is programmed, the indicator  on the dash panel is lit.<sup>1)</sup>

If the cruise control system is *switched off*, the  symbol is switched off. The system will

<sup>1)</sup> Depending on the model version



also be switched off fully when the **1st** gear is engaged.\*

### Setting speed\*

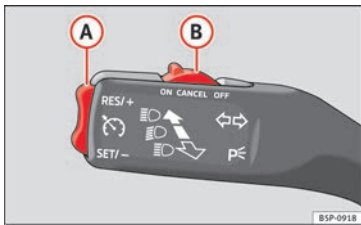

**Fig. 136** Turn signal and main beam headlight lever: switch and rocker switch for the cruise control.

- Press the lower part **SET/-** of the rocker switch **»» Fig. 136 (A)** once briefly when you have reached the speed you wish to set.

When you release the rocker switch, the current speed is set and held constant.

### Adjusting set speed\*

The speed can be altered without touching the accelerator or the brake.

### Setting a higher speed

- Press the upper part **RES/+** of the rocker switch **»» Fig. 136 (A)** to increase the speed. The vehicle will continue to accelerate as long as you keep the rocker switch pressed. When you release the switch, the new speed is stored.

### Setting a lower speed

- Press the lower part **SET/-** **»» Fig. 136 (A)** of the rocker switch to reduce the speed. The vehicle will automatically reduce its speed for as long as you keep the switch pressed. When you release the switch, the new speed is stored.

When you increase speed with the accelerator and then release the pedal, the system will automatically restore the set speed. This will not be the case, however, if the vehicle speed exceeds the stored speed by more than 10 km/h (6 mph) for longer than 5 minutes. The speed will have to be stored again.

Cruise control is switched off if you reduce speed by depressing the brake pedal. You can reactivate the control by pressing once on the upper part of the rocker switch **RES/+** **»» Fig. 136 (A)**.

### Switching off cruise control temporarily\*

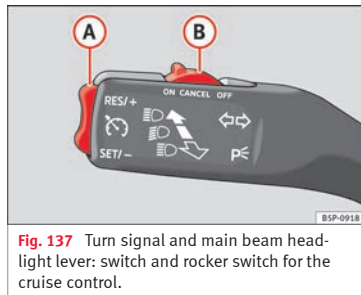

**Fig. 137** Turn signal and main beam headlight lever: switch and rocker switch for the cruise control.

The cruise control system will be switched off in the following situations:

- if the brake pedal is depressed,
- if the clutch pedal is depressed,
- if the vehicle is accelerated to over 180 km/h (112 mph),
- when the ESC or ASR is used.
- when the lever **(B)** is moved to the position **CANCEL** without reaching the **OFF** position. Once the **CANCEL** operation is complete, when the lever is released it returns to its initial position.

To resume cruise control, release the brake or clutch pedal or reduce the vehicle speed to less than 180 km/h (112 mph) and press **»»**

once on the upper part of the rocker switch RES/+ » » Fig. 137 (A).

### Complete system deactivation\*

#### Vehicles with a manual gearbox

The system is **completely turned off** by moving the control (B) » » Fig. 137 all the way to the right (OFF engaged), or when the vehicle is stationary, by switching off the ignition.

#### Vehicles with automatic gearbox/DSG automatic gearbox

To completely disengage the system, the selector lever must be placed in one of the following positions: **P, N, R** or **1** or with the vehicle stopped and the ignition turned off.

## Towing bracket device

### Trailer towing

#### Instructions to follow

Your vehicle may be used to tow a trailer when fitted with the correct equipment.

If the car is supplied with a **factory-fitted** towing bracket it will already have the necessary technical modifications and meet the statutory requirements for towing a trailer. If you wish to **retrofit** a towing bracket, consult » » page 146.

#### Connectors

Your vehicle is fitted with a 12-pin connector for the electrical connection between the trailer and the vehicle.

If the trailer has a **7-pin plug** you will need to use an adapter cable. It is available at any Technical Service.

#### Trailer weight/drawbar load

Never exceed the authorised trailer weight. If you do not load the trailer up to the maximum permitted trailer weight, you can then climb correspondingly steeper slopes.

The maximum trailer weights listed are only applicable for **altitudes** up to 1000 m above sea level. With increasing altitude the engine

power and therefore the vehicle climbing ability are impaired because of the reduced air density. The maximum trailer weight has to be reduced accordingly. The weight of the vehicle and trailer combination must be reduced by 10% for every further 1000 m (or part thereof). The gross combination weight is the actual weight of the laden vehicle plus the actual weight of the laden trailer. When possible, operate the trailer with the maximum permitted **drawbar load** on the ball joint of the towing bracket, but do not exceed the specified limit.

The figures for **trailer weights** and **drawbar loads** that are given on the data plate of the towing bracket are for certification purposes only. The correct figures for your specific model, which may be *lower* than these figures for the towing bracket, are given in the vehicle documentation or in » » chapter **Technical Data**.

#### Distributing the load

Distribute loads in the trailer so that heavy objects are as near to the axle as possible. Loads carried in the trailer must be secured to prevent them moving.

## Tyre pressure

Set tyre pressure to the maximum permissible pressure shown on the sticker on the inside of the fuel tank flap. Set the tyre pressure of the trailer tyres in accordance with the trailer manufacturer's recommendations.

## Exterior mirrors

Check whether you can see enough of the road behind the trailer with the standard rear vision mirrors. If this is not the case, you should have additional exterior mirrors fitted. Both exterior mirrors should be mounted on hinged extension brackets. Adjust the mirrors to give sufficient vision to the rear.

### WARNING

**Never transport people in a trailer. This could result in fatal accidents.**

### Note

- Towing a trailer places additional demands on the vehicle. We recommend additional services between the normal inspection intervals if the vehicle is used frequently for towing a trailer.
- Find out whether special regulations apply to towing a trailer in your country.

## Ball coupling of towing bracket\*

Depending on the model version, the spherical head on the trailer hook may be stored in the tool box.

The ball coupling is provided with instructions on fitting and removing the ball coupling of the towing bracket.

### WARNING

**The towing bracket ball coupling must be stored securely in the luggage compartment to prevent them being flung through the vehicle and causing injury.**

### Note

- By law, the ball coupling must be removed if a trailer is not being towed if it obscures the number plate.

## Driving tips

Driving with a trailer always requires extra care.

## Weight distribution

The weight distribution of a loaded trailer with an unladen vehicle is very unfavourable. However, if this cannot be avoided, drive extra slowly to allow for the unbalanced weight distribution.

## Speed

The stability of the vehicle and trailer is reduced with increasing speed. For this reason, it is advisable not to drive at the maximum permissible speed in an unfavourable road, weather or wind conditions. This applies especially when driving downhill.

You should always reduce speed immediately if the trailer shows the slightest sign of **snaking**. Never try to stop the “snaking” by increasing speed.

Always brake in due course. If the trailer has an **overrun brake**, apply the brakes *gently at first* and then, firmly. This will prevent the jerking that can be caused by locking of trailer wheels. Select a low gear in due course before going down a steep downhill. This enables you to use the engine braking to slow down the vehicle.

## Reheating

At very high temperatures and during prolonged slopes, driving in a low gear and high engine speed, always monitor the coolant temperature gauge » page 31.

## Electronic Stability Control\*

The ESC\* system helps to stabilise the trailer in case of skidding or rocking.

### Fitting a towing bracket\*

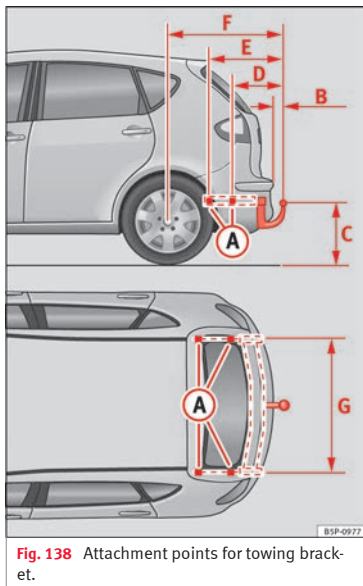

**Fig. 138** Attachment points for towing bracket.

If a towing bracket is to be fitted after the vehicle is purchased, this must be completed according to the instructions of the towing bracket manufacturer.

The attachment points for the towing bracket **A** are on the lower part of the vehicle.

The distance between the centre of the ball coupling and the ground should never be lower than the indicated value, even with a fully loaded vehicle and including the maximum drawbar load.

Elevation values for securing the towing bracket:

	ALTEA	ALTEA XL	ALTEA FREE-TRACK
<b>B</b>	65 mm (minimum)		
<b>C</b>	350 mm to 420 mm (fully laden vehicle)		
<b>D</b>	357 mm	344 mm	
<b>E</b>	569 mm	531 mm	
<b>F</b>	875 mm	1,044 mm	
<b>G</b>	1040 mm		

### Fitting a towing bracket

- Driving with a trailer involves an extra effort for the vehicle. Therefore, before fitting a towing bracket, please contact a Technical Service to check whether your cooling system needs modification.

- The legal requirements in your country must be observed (e.g. the fitting of a separate control lamp).

- Certain vehicle components, e.g. the rear bumper, must be removed and reinstalled. The towing bracket securing bolts must be tightened using a torque wrench, and a power socket must be connected to the vehicle electrical system. This requires specialised knowledge and tools.

- Figures in the illustration show the elevation value and the attachment points which must be considered if you are retrofitting a towing bracket.

### **⚠ WARNING**

**The towing brackets should be fitted at a specialised workshop.**

- If the towing bracket is incorrectly installed, there is a serious danger of accident.
- For your own safety, please observe the tow bracket manufacturer's instructions.

### **ⓘ CAUTION**

- If the power socket is incorrectly installed, this could cause damage to the vehicle electrical system.

### **i Note**

**For the sports model (Altea FR), fitting of a trailer bracket is not recommended due to the design of the bumpers.**

## Advice

### Care and maintenance

#### Accessories and technical modifications

##### Accessories, modifications and spare parts

Your vehicle is designed to offer a high standard of active and passive safety.

Before purchasing accessories and parts, and before making technical changes to your vehicle, we recommend that you consult your Technical Service.

SEAT dealerships will be happy to provide you with the latest information about the use, legal requirements and recommendations from the manufacturer regarding accessories and spare parts.

We recommend you use only **SEAT Approved Accessories®** and **SEAT Approved Spare Parts®**. This way, SEAT can guarantee that the product in question is suitable, reliable and safe. SEAT Technical Services have the necessary experience and facilities to ensure that parts are correctly and professionally installed.

Despite a continuous observation of the market, SEAT is not able to assess the reliability, safety and suitability of parts that **SEAT has not approved**. For this reason, SEAT cannot assume responsibility for any non-genuine parts used, even if these parts have been approved by an official testing agency or are covered by an official approval certificate.

Any **retro-fitted equipment** which has a direct effect on the vehicle and/or the way it is driven, such as a cruise control system or electronically-controlled suspension), must be SEAT-approved for use in your vehicle and bear the **e** mark (the European Union's authorisation symbol).

If **any additional electrical devices** are fitted which do not serve to control the vehicle itself (e.g. refrigerator box, laptop or ventilator fan), these must bear the **CE** mark (European Union manufacturer conformity declaration).

##### WARNING

**Accessories, for example telephone holders or cup holders, should never be fitted on the covers or within the working range of the airbags. Otherwise, there is a danger of injury if the airbag is triggered in an accident.**

##### Technical modifications

Modifications must always be carried out according to our specifications.

Unauthorised modifications to the electronic components or software in the vehicle may cause malfunctions. Due to the way the electronic components are linked together in networks, other indirect systems may be affected by the faults. This can seriously impair safety, lead to excessive wear of components, and also invalidate your vehicle registration documents.

SEAT Technical Services cannot be held liable for any damage caused by modifications and/or work incorrectly performed.

For this reason, we recommend having all work performed by a SEAT Technical Service using **SEAT®** Original Spare Parts.

##### WARNING

**Any type of work or modification performed incorrectly on your vehicle can lead to malfunctions and can cause accidents.**

##### Roof aerial\*

The vehicle may be fitted with a foldable\* and anti-theft\* aerial that may be positioned parallel to the roof.

##### To fold down

Unscrew the rod, position parallel to the roof and tighten once again. »

### To return to working position

Continue in the reverse order to the previous instruction.

#### ⓘ CAUTION

If an automatic car wash tunnel is used, before entering the tunnel, put the aerial down parallel to the roof and do not tighten to avoid damage.

### Mobile phones and two-way radios

First consult your Technical Service if you wish to use a mobile telephone or a two-way radio with a transmitting power output in excess of 10 watts. Here you will receive information concerning the technical possibilities for retrofitting this equipment.

Mobile telephones and two-way radios should be only fitted by a specialised workshop, for example a SEAT dealership.

#### ⚠ WARNING

- Always concentrate primarily on driving. If you are distracted while driving you could have an accident.
- Never attach the telephone mountings to the surfaces covering the airbag units or within the range of the airbags. There is a high danger of injury if the airbag is triggered.

#### ⓘ Note

Please observe the operating instructions of your mobile telephone/two-way radio.

## Care and cleaning

### General information

#### Vehicle maintenance

Regular care and washing help to **maintain the value** of the vehicle. This may also be one of the requirements for acknowledging warranty claims in the event of bodywork corrosion or paint defects.

The best way to protect your vehicle against the harmful effects of the environment is through correct maintenance and *frequent* washing. The longer substances such as insect remains, bird droppings, resinous tree sap, road dirt, industrial deposits, tar, soot or road salt and other aggressive materials remain on the vehicle, the more damage they do to the paintwork. High temperatures, for instance in strong sunlight, further intensify the corrosive effect.

After winter, a period when salt is put on the roads, it is important to have the **underside** of the vehicle washed thoroughly.

### Products for vehicle maintenance

Car-care products are available in your Technical Services. Keep the product instructions until you have used them up.

#### ⚠ WARNING

- Car-care products can be toxic. Because of this, they must always be kept closed in their original container. Keep them out of the reach of children. Failure to comply could result in poisoning.
- Always read and observe the instructions and warnings on the package before using car-care products. Improper use could cause health problems or damage the vehicle. The use of certain products may produce noxious vapours; they should be used in well ventilated areas.
- Never use fuel, turpentine, engine oil, nail varnish remover or other volatile fluids. These are toxic and highly flammable. Risk of fire and explosion.
- Before washing your vehicle, or carrying out any maintenance, switch the engine off, apply the handbrake firmly and remove the key from the ignition.

#### ⓘ CAUTION

Never attempt to remove dirt, mud or dust if the surface of the vehicle is dry. Never use a dry cloth or sponge for cleaning purposes. This could damage the paintwork or the windows of your vehicle. Soak dirt, mud or dust with plenty of water.

### For the sake of the environment

- When purchasing products for your vehicle maintenance, select the ones which are not harmful to the environment.
- The waste from car-care products should not be disposed of with ordinary household waste. Observe the disposal information on the package.

## Care of the vehicle exterior

### Automatic car wash tunnel

The vehicle paintwork is so durable that the vehicle can normally be washed without problems in an automatic car wash tunnel. However, the paintwork wear depends to a large extent on the kind of the car wash tunnel, the brushes used, its water filtering and the type of cleaning and preservative products.

Before going through a vehicle wash, be sure to take the usual precautions such as closing the windows and sunroof.

If the vehicle has special accessories such as spoilers or a roof rack or two-way radio aerial, etc., it is advisable to consult the car wash tunnel operator.

After washing, **the brakes** could take some time to respond as the brake discs and pads

could be wet, or even frozen in winter. “Dry” the brakes by braking several times.

#### WARNING

**Water, ice and salt on the brake system can reduce braking effectiveness. Risk of accident.**

#### CAUTION

**Before putting the vehicle through the car wash, do not tighten the aerial if it is folded because it can be damaged.**

### Washing by hand

#### Vehicle washing

- First soften the dirt and rinse it off with water.
- Clean your vehicle from top to bottom with a soft sponge, a glove or a brush. Use very light pressure.
- Rinse the sponge or glove often with clean water.
- Special car shampoo should only be used for very stubborn dirt.
- Leave the wheels, sill panels etc. until last, using a different sponge or glove.
- Rinse the vehicle thoroughly with water.

– Dry the vehicle surface gently with a chamois leather.

– In **cold temperature**, dry the rubber seals and their surfaces to prevent them from freezing. Apply silicone spray to the rubber seals.

#### After washing the vehicle

– After washing, avoid sudden and sharp braking. “Dry” the brakes by braking several times **»»** page 123, Braking capacity and distance.

#### WARNING

- Wash your vehicle with the ignition switched off.
- Protect your hands and arms from cuts on sharp metal edges when cleaning the underbody, the inside of the wheel housings etc. Risk of injury.
- Water, ice and salt on the brake system can reduce braking effectiveness. Risk of accident.

#### CAUTION

- Never remove dirt, mud or dust if the vehicle surface is dry. Never use a dry cloth or sponge for cleaning purposes. This could scratch the paintwork or glass on your vehicle.

»»

- **Washing the vehicle in low temperatures: when washing the vehicle with a hose, do not direct water into the lock cylinders or the gaps around the doors, rear lid, or sunroof. Risk of freezing.**

#### For the sake of the environment

To protect the environment, the vehicle should be washed only in specially provided wash bays, to prevent toxic, oil-laden waste water from entering the sewer system. In some places, washing vehicles outside wash bays is prohibited.

#### Note

Do not wash the vehicle in direct sunlight.

### Washing the vehicle with a high pressure cleaner

Be particularly careful when using a high pressure cleaner!

- Always observe the instructions for the high-pressure cleaner, particularly those concerning the **pressure** and the **spraying distance**.
- Increase the spraying distance for soft materials and painted bumpers.

- Do not use a high pressure cleaner to remove ice or snow from windows  
»» page 151.
- Never use concentrated jet nozzles (“rotating jets”) »» .
- After washing, avoid sudden and sharp braking. “Dry” the brakes by braking several times »» page 123.

#### WARNING

- **Never wash tyres with a concentrated jet (“rotating nozzle”). Even at large spraying distances and short cleaning times, damage can occur to the tyres. This may cause an accident.**
- **Water, ice and salt on the brake system can reduce braking effectiveness. Risk of accident.**

#### CAUTION

- **Do not use water hotter than +60 °C (+140 °F). This could damage the vehicle.**
- **To avoid damage to the vehicle, keep a sufficient distance from sensitive materials such as flexible hoses, plastic, soundproofing material, etc. This also applies to bumpers painted in the colour of the bodywork. The closer the nozzle is to the surface, the greater the wear on the material.**

### Vehicle paint maintenance

Regular waxing protects the paintwork.

You need to apply wax to your vehicle if water does not form small drops and run off the paintwork when it is *clean*.

Good quality *hard wax products* are available at your Technical Service.

Regular wax applications help to protect the paintwork from environmental contaminants.  
»» page 148. It also protects against minor scratches.

Even if a **wax solution** is used regularly in the vehicle washing tunnel, it is advisable to protect the paint with a hard wax coating at least twice a year.

### Polishing the paintwork

Polishing is only necessary if the paint has lost its shine, and the gloss cannot be brought back by applying wax. Polishing products can be purchased in your Technical Service.

The vehicle must be waxed after polishing if the polish used does not contain wax compounds to seal the paint »» page 150, **Vehicle paint maintenance**.



**ⓘ CAUTION**

To prevent damage to the paintwork:

- Do not use polishes and hard wax on painted parts with a matt finish or on plastic parts.
- Do not polish your vehicle in a sandy or dusty environment.

**Caring for plastic parts**

If normal washing fails to clean plastic parts, clean them with approved **solvent-free** plastic cleaning and care products.

**ⓘ CAUTION**

- The use of liquid air freshener directly over the air vents of the vehicle may damage plastic parts if the liquid is accidentally spilled.
- Cleaning products which contain solvents will damage the material.

**Cleaning windows and exterior mirrors****Cleaning windows**

- Moisten the windows with commercially available, alcohol based glass cleaner.
- Dry the windows with a clean chamois leather or a lint-free cloth.

**Removing snow**

- Use a small brush to remove snow from the windows and mirrors.

**Removing ice**

- Use a de-icer spray.

Use a clean cloth or chamois leather to dry the windows. The chamois leathers used on painted surfaces are not suitable to clean windows because they are soiled with wax deposits which could smear the windows.

If possible, use a de-icing spray to remove ice. If you use an ice scraper, push it in one direction only without swinging it.

Use window cleaner or a silicone remover to clean rubber, oil, grease and silicone deposits off.

Wax deposits can only be removed with a special cleaner available at your Technical Service. Wax deposits on the windscreen could cause the wiper blades to judder. Adding a window cleaner that dissolves wax to the windscreen washer fluid prevents wiper blades from juddering, but wax deposits are not removed.

**ⓘ CAUTION**

- Never use warm or hot water to remove snow and ice from windows and mirrors. This could cause the glass to crack!

- The heating element for the rear window is located on the inner side of the window. To prevent damage, do not put stickers over the heating elements on the inside of the window.

**Cleaning windscreen wiper blades**

Clean wiper blades improve visibility.

1. Use a soft cloth to remove dust and dirt from the windscreen wiper blades.
2. Use window cleaner to clean the windscreen wiper blades. Use a sponge or a cloth to remove stubborn dirt.

**Care of rubber seals**

If rubber seals are well looked after, they will not freeze so quickly.

1. Use a soft cloth to remove dust and dirt from the rubber seals.
2. Apply a specialist care product to the rubber seals.

The rubber strips on the doors, windows, etc. will remain pliable and last longer if they are treated with a suitable rubber care product from time to time (for example silicone spray).



Caring for rubber seals will also prevent premature ageing and leaks. The doors will be easier to open. If rubber seals are well looked after, they will not freeze so quickly in winter.

### Door lock cylinder

The door lock cylinders can freeze up in winter.

To de-ice the lock cylinders you should only use spray with lubricating and anti-corrosive properties.

### Cleaning chrome parts

1. Clean chrome parts with a damp cloth.
2. Polish chrome parts with a soft, dry cloth.

If this does not provide satisfying results, use a specialist **chrome cleaning product**. Chrome cleaning products will remove stains from the surface.

#### ⓘ CAUTION

**To prevent scratching chrome surfaces:**

- **Never use an abrasive cleaning product on chrome.**
- **Do not clean or polish chrome parts in a sandy or dusty environment.**

### Steel wheel rims

- Clean steel wheel rims regularly using a separate sponge.

Use an industrial cleaner to remove brake dust. Any damage to the paint on steel wheel rims should be repaired before starting to rust.

#### ⚠ WARNING

- **Never wash tyres with a cylindrical jet. Even at large spraying distances and short cleaning times, damage can occur to the tyres. This may cause an accident.**
- **Water, ice and salt on the brake system can reduce braking effectiveness. Risk of accident. Directly after washing, avoid sudden and sharp braking. "Dry" the brakes by braking several times »» page 123.**

### Alloy wheel rims

#### Every two weeks

- Wash salt and brake dust from alloy wheels.
- Use an acid free detergent to clean the wheel rims.

#### Every 3 months

- Apply a hard wax compound to the wheels.

Alloy wheels require regular attention to preserve their appearance. If road salt and brake dust are not often removed, the aluminium finish will be impaired.

Always use an acid-free detergent for alloy wheel rims.

Car polish or other abrasive agents should not be used for maintaining the rims. If the protective coating is damaged, e.g. by flying stones, the damaged area should be repaired immediately.

#### ⚠ WARNING

- **Never wash tyres with a cylindrical jet. Even at large spraying distances and short cleaning times, damage can occur to the tyres. This may cause an accident.**
- **Water, ice and salt on the brake system can reduce braking effectiveness. Risk of accident. Directly after washing, avoid sudden and sharp braking. "Dry" the brakes by braking several times »» page 123.**

### Underbody protection

The vehicle underbody is coated to protect it from chemical and mechanical damage.

The protective coating can be damaged when driving. We recommend that you check the protective coating under the body and on the

running gear, and retouch it if necessary, before and after the winter season.

We recommend that you go to your Technical Service to carry out repair work and additional anti-corrosion work.

#### WARNING

**Do not apply underseal or anti-corrosion coatings to the exhaust pipes, catalytic converter or the heat shields on the exhaust system. The heat of the exhaust system or the engine could cause them to ignite. Risk of fire.**

### Cleaning the engine compartment

Take special care when cleaning the engine compartment.

#### Anti-corrosion treatment

The engine compartment and the surface of the power unit are given anti-corrosion treatment at the factory.

Good corrosion protection is particularly important in winter when the vehicle is frequently driven on salted roads. To prevent the salt corroding the vehicle, the entire engine compartment should be thoroughly cleaned before and after winter.

**Technical Services** have the proper products for cleaning and preservation as well as the

necessary workshop equipment. For this reason, we recommend having this work performed by them.

The anti-corrosion protection is usually removed if the engine compartment is cleaned with grease removing solutions, or if you have the engine cleaned. On commissioning this work, ensure that all surfaces, seams, joints and components in the engine compartment are given anti-corrosion treatment.

#### WARNING

- **When working in the engine compartment, always observe the safety warnings**  
» page 163.
- **Before opening the bonnet, switch the engine off, apply the handbrake firmly and always remove the key from the ignition.**
- **Allow the engine to cool before you clean the engine compartment.**
- **Do not clean, for example, the vehicle underbody, wheel arches or wheel trims without protecting your hands and arms. You may cut yourself on sharp-edged metal parts. Failure to comply could result in injury.**
- **Moisture, ice and salt on the brake system may affect braking effectiveness. Risk of accident. Directly after washing, avoid sudden and sharp braking.**
- **Never touch the radiator fan. It is temperature-controlled and could start automatically, even when the key is removed from the ignition!**



#### For the sake of the environment

**Fuel, grease and oil deposits can be removed when the engine is washed. The polluted water must be cleaned in an oil separator. For this reason, engine washing should be carried out only by a specialised workshop or a petrol station.**

## Caring for the vehicle interior

### Introduction

The dye used in many modern garments, for example dark jeans, is not always sufficiently colour-fast. Seat upholstery (material and leather), especially when light-coloured, may visibly discolour if the dye comes out of clothing (even when used correctly). This is not an upholstery defect but indicates that the dye in the item of clothing is not sufficiently colour-fast.

The longer stains or dirt remain on the vehicle surfaces, especially the fabrics covering the padded upholstery, the more difficult it becomes to clean and maintain them. If stains and dirt are left for a long time, it may be that they are impossible to remove.



#### WARNING

**Car-care products may be toxic and hazardous. Using unsuitable car-care products or,**



using them in the wrong way, may cause accidents, serious injury, burns or intoxication.

- Keep your car-care products in their original containers.
- Read the instructions.
- Never keep car-care products in empty food containers, bottles or other similar containers. Other people may confuse them.
- Keep all car-care products out of the reach of children.
- Some products may give off harmful vapours during use. Therefore, they should be used outdoors in well-ventilated places.
- Never use fuel, turpentine, engine oil, nail-varnish remover or any other volatile product for washing, maintenance or cleaning. These are toxic and highly flammable.

#### WARNING

Unsuitable maintenance and cleaning of vehicle components may impair proper operation of safety equipment and cause serious injury.

- Maintain and clean vehicle components according to the manufacturer's instructions.
- Only use approved or recommended cleaning products.

#### CAUTION

- Cleaning products which contain solvents have a corrosive effect and may damage the material irreparably.

- Stains and dirt containing aggressive substances or solvents attack the material and may damage it irreparably, even when they are cleaned quickly.

- Dirt and stains should not be allowed to dry and should be cleaned as quickly as possible.

- In the case of stubborn stains, take the vehicle to a specialised workshop to avoid damage.

### Treating your upholstery

To treat and maintain your seat upholstery, keep the following in mind **»»** :

Before entering the vehicle, close any Velcro fasteners that might snag on the upholstery or trim fabric. Any open Velcro fasteners may damage the trim or upholstery fabrics.

To prevent damage, avoid direct contact between sharp decorative objects and the upholstery and trim fabrics. Decorative objects include zips, rivets and rhinestones on clothing and belts.

From time to time, clean the dust that gathers in the perforations, folds and seams so that the surfaces of the seats are not damaged by its abrasive effect.

Make sure clothes are colour-fast to avoid them running and staining the upholstery. This is especially important if the upholstery is light in colour.

#### CAUTION

If you ignore this checklist, which is important for maintaining your seat upholstery, the fabric may be damaged or stained.

- Consult the checklist and carry out the operations it describes.

#### Note

SEAT recommends you take the vehicle to a specialised workshop to treat any stains on the upholstery caused by the discolouration of clothing.

### How to clean the upholstery, trim fabrics and Alcantara®

#### Cleaning the fabric on heated seats and electrically adjustable seats or seats with airbag components

There may be important airbag components and electrical connections inside the driver seat, passenger seat and possibly the outer rear seats. If these seats and seat backrests are damaged, or are cleaned and are treated incorrectly, or if they get wet, the vehicle electric system may be destroyed and the airbag system damaged **»»** .

Electric and heated seats contain components and electrical connections that may be damaged if the seats are cleaned or incorrectly treated **»»** . Similarly, damage may be

caused at other points in the vehicle's electrical system.

For this reason, bear the following indications in mind for cleaning:

- Do not use high-pressure or steam cleaning equipment or cold aerosols.
- Do not use cream detergents or detergent-based solutions for delicate garments.
- Prevent the fabric from getting wet at all times.
- Only use cleaning products approved by SEAT.
- If in doubt, take the vehicle to a professional cleaning company.

#### **Cleaning the fabric on unheated seats, non-electrically adjustable seats and seats without airbag components**

- Before using any cleaning products, consult and keep in mind the instructions of use, indications and warnings on the container.
- Use a vacuum cleaner (with the brush attachment) on the trim and seat fabrics, the Alcantara® upholstery of the seats and the carpet.
- Do not use high-pressure or steam cleaning equipment or cold aerosols.
- For general cleaning, use a soft sponge or an ordinary lint-free microfibre cloth »» ①.

- Clean Alcantara® surfaces with a slightly damp cotton or woollen cloth, or a standard lint-free microfibre cloth »» ①.

If the dirt on the trim and upholstery fabrics is only superficial, you can use a standard foam cleaner.

If the upholstery and trim are very dirty, before cleaning them we recommend you find out about the most suitable cleaning options from a professional cleaning company. If necessary, cleaning should be done by a specialised firm.

#### **Stain removal**

When removing stains, it may be necessary to clean the whole surface and not just the stain itself. Especially if the surface has been dirtied through normal use. If you only clean the stained area, that part may then look lighter than the rest. If in doubt, take the vehicle to a professional cleaning company.

#### **⚠ WARNING**

**If there is a fault in the airbag system, it is likely that the airbag will not deploy correctly, not deploy at all, or do so unexpectedly, which could cause serious or fatal injuries.**

- **Have the system checked immediately by a specialised workshop.**

#### **ⓘ CAUTION**

**If the upholstery on electrically operated seats or seats with airbag components gets soaked, the vehicle's electric system and certain other components may be damaged.**

- **If the seat gets soaked, take the vehicle immediately to a specialised workshop to be dried and for the system components to be inspected.**
- **Do not use steam cleaning equipment as the dirt becomes more encrusted and fixed in the material.**
- **High-pressure cleaning equipment and cold aerosols may damage the upholstery.**

#### **ⓘ CAUTION**

- **Brushes should only be used to clean the mats and floor mat! Other fabrics may be damaged if cleaned with a brush.**
- **If cream detergents or detergents for delicate garments are applied with a damp cloth or sponge, they may, for example, leave rings when dry because of the surfactant components they contain. Generally, such rings are very difficult or almost impossible to remove.**

#### **ⓘ CAUTION**

- **Do not let water soak into Alcantara® carpet under any circumstances.**
- **Do not use leather cleaning products, solvents, wax polish, shoe cream, stain removers or similar products on Alcantara®.**

»

- **Never use brushes for cleaning damp material as they could damage the surface.**

### Cleaning and maintenance of natural leather upholstery

Consult a professional cleaning workshop if you have any doubts on cleaning and maintaining the leather equipment in your vehicle.

#### Maintenance and treatment

Nappa natural leather is delicate because it has no additional protective layer.

- After cleaning, regularly apply a conditioner with sun-screen and impregnating action. These products nourish the leather, soften it and make it more breathable, as well as rehydrating it. They also provide it with a protective film.
- Clean the leather every two or three months and remove stains as they appear.
- Treat the leather regularly (about twice a year) with a suitable maintenance product.
- Apply as few cleaning and maintenance products as possible, always using a dry, lint-free cotton or woollen cloth. Do not apply cleaning and maintenance products directly to the leather.

- Remove recent ball-point pen and ink stains, lipstick, shoe cream and similar stains as soon as possible.
- Maintain the colour of the leather. To do this, use a special cream especially coloured for leather to achieve the same overall colour, if necessary.
- Afterwards, go over it with a soft cloth.

#### Cleaning the vehicle

SEAT recommends using a slightly damp cotton or woollen cloth for general cleaning purposes.

Generally, the leather should never be soaked at any point, nor should water penetrate the seams.

**Before cleaning** the leather upholstery, bear in mind the following recommendations »» page 154, **Cleaning the fabric on heated seats and electrically adjustable seats or seats with airbag components.**

#### ⓘ CAUTION

- **On no account use solvents, wax polish, shoe cream, stain removers or similar materials on leather.**
- **If the stain remains on the leather for long, it will soak in and be impossible to remove.**
- **In the event of spilt liquids, dry immediately with an absorbent cloth to prevent the liquid penetrating through the leather or seams.**

- **If the vehicle is left standing in the sun for long periods, the leather should be protected against direct sunlight to prevent it from fading.**

#### ⓘ Note

**The leather will usually change colour slightly with use.**

### Cleaning synthetic leather upholstery

Before cleaning synthetic leather upholstery, bear in mind the following recommendations »» page 154, **Cleaning the fabric on heated seats and electrically adjustable seats or seats with airbag components**

Only use water and neutral cleaning products to clean synthetic leather upholstery.

#### ⓘ CAUTION

**Do not use solvents, floor wax, shoe cream, stain removers or similar products on synthetic leather. These will stiffen the material, causing it to crack prematurely.**

### Cleaning plastic parts and the instrument panel

- Use a clean, damp cloth to clean plastic parts and the dash panel.

- If this does not provide satisfactory results, use a special **solvent-free** plastic cleaning product.

**⚠ WARNING**

Never clean the dash panel and the airbag module surface with cleaners containing solvents. Solvents cause the surface to become porous. If the airbag triggered, plastic parts could become detached and cause injuries.

**ⓘ CAUTION**

Cleaning products which contain solvents will damage the material.

### Wooden trim cleaning\*

- Clean the wooden trim with a water-moistened clean cloth.
- If this does not provide satisfactory results, use a *gentle* soap solution.

**ⓘ CAUTION**

Cleaning products which contain solvents will damage the material.

### Cleaning the radio and climate controls

To clean the radio and/or climate controls, use a soft damp cloth. For more resistant dirt, a neutral soap solution may be used.

### Seat belts cleaning

A dirty belt may not work properly. Check all seat belts regularly and keep them clean.

#### Seat belts cleaning

- Pull the dirty seat belt right out and unroll it.
- Clean dirty seat belts with a *gentle* soap solution.
- Allow it to dry.
- Do not roll the seat belt up until it is dry.

If large stains form on the belts, the automatic belt retractor will not work correctly.

**⚠ WARNING**

- Do not use chemical cleaning agents on the seat belts, as this can impair the strength of the webbing. Ensure that seat belts do not come into contact with corrosive fluids.
- Check the condition of the seat belts at regular intervals. If you notice that the belt webbing, fittings, retractor mechanism or buckle

of any of the belts is damaged, the belt must be replaced by a specialised workshop.

- Do not attempt to repair a damaged seat belt yourself. The seat belts must not be removed or modified in any way.

**ⓘ CAUTION**

After cleaning, allow seat belts to dry completely before rolling them up. Otherwise, the belt retractors could become damaged.

## Checking and refilling levels

### Fuel

#### Refuelling

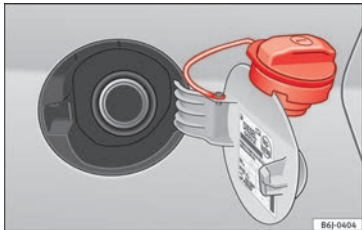

Fig. 139 Tank flap open.

The tank flap is released manually and is located at the rear of the vehicle on the right.

The tank holds approximately 55 litres. For all-wheel drive vehicles, the tank capacity is approximately 60 litres.

Vehicles using LPG have two fuel tanks: one for LPG and another for petrol » page 160.

#### Opening the fuel tank cap

- Lift the lid.
- Hold the cap firmly with one hand, then insert the key into the lock and rotate 180° to the left.

- Unscrew the cap, turning it anticlockwise.

#### Closing the fuel tank cap

- Screw the tank cap to the right until it “clicks”.
- Turn the key in the lock, without releasing the cap, clockwise through 180°.
- Remove the key and close the flap until it clicks into place. The tank cap is secured with an anti-loss attachment

If the automatic filler nozzle is operated correctly, it will switch itself off as soon as the tank is full. Never attempt to fill beyond this point, as this will fill the expansion chamber. Fuel may leak out if ambient conditions are warm.

The correct fuel grade for your vehicle is given on a sticker on the inside of the fuel tank flap. Here you will find further information on fuel.

#### **⚠ WARNING**

- **Fuel is highly flammable and can cause serious burns and other injuries.**
  - Never smoke or come into contact with sparks when filling the fuel tank of the vehicle or a spare fuel canister with fuel. This is an explosion hazard.
  - Follow legal requirements for the use of spare fuel canisters.

- For safety reasons we do not recommend carrying a spare fuel canister in the vehicle. The canister could be damaged in an accident and leak.

• If, in exceptional circumstances, you have to carry a spare fuel canister, please observe the following:

- Never fill the spare fuel canister inside the vehicle or on it. An electrostatic charge could build up during filling, causing the fuel fumes to ignite. This could cause an explosion. Always place the canister on the ground to fill it.
- Insert the fuel nozzle into the mouth of the canister as far as possible.
- If the spare fuel canister is made of metal, the filling nozzle must be in contact with the canister during filling. This helps prevent an electrostatic charge building up.
- Never spill fuel in the vehicle or in the luggage compartment. Fuel vapours are explosive. Danger of death.

#### **ⓘ CAUTION**

- Fuel spills should be removed from the paintwork immediately.
- Never run the tank completely dry. Irregular fuel supply can cause misfiring. As a result, unburnt fuel could enter the catalytic converter and cause damage.



- When filling the fuel tank after having run it completely dry on a vehicle with a diesel engine the ignition must be switched on for at least 30 seconds before starting the engine. Subsequently, when you start the engine it may take longer than normal to start firing (up to one minute). This is due to the fact that the fuel system has to purge itself of air before starting.

### For the sake of the environment

Do not try to put in more fuel after the automatic filler nozzle has switched off; this may cause the fuel to overflow if it becomes warm.

## Petrol

### Petrol types

The recommended fuel types are listed on a sticker inside the fuel tank flap.

Only **unleaded petrol conforming to standard DIN EN 228** may be used for vehicles with catalytic converters (EN = “European Standard”).

Petrol types are categorised according to their **octane number**, e.g. 91, 95, 98 RON (RON = “research octane number”). You may use petrol with a higher octane number than the one recommended for your engine. How-

ever, this has no advantage in terms of fuel consumption and engine power.

### CAUTION

- Petrol with standard EN 228 may be mixed with small quantities of ethanol. However, the so-called “bioethanol fuels” available at commercial establishments with reference E50 or E85, which contain a high percentage of ethanol, may not be used, as they will damage the fuel system.
- Even one tankful of leaded fuel would permanently impair the efficiency of the catalytic converter.
- High engine speed and full throttle can damage the engine when using petrol with an octane rating lower than the correct grade for the engine.

### For the sake of the environment

Just one full tank of leaded fuel would seriously impair the efficiency of the catalytic converter.

### Petrol additives

The quality of the fuel influences the behaviour, power and service life of the engine.

This is why the petrol you use should carry suitable additives already included by the petrol industry, free of metals. These additives will help to prevent corrosion, keep the

fuel system clean and prevent deposits from building up in the engine.

If good-quality petrol with metal-free additives is not available or engine problems arise, the necessary additives must be added when refuelling.

Not all petrol additives have been shown to be effective. The use of unsuitable petrol additives may cause significant damage to the engine and the catalytic converter. Metal additives should never be used. Metal additives may also be contained in petrol additives for improving anti-detonation ratings or octane ratings.

SEAT recommends “genuine Volkswagen Group fuel additives for petrol engines”. These additives can be bought at SEAT Authorised Services, where information on how to use them can also be obtained.

### CAUTION

Do not refuel if the filler indicates that the fuel contains metal. LRP (lead replacement petrol) fuels contain high concentrations of metal additives. Using them may damage the engine!

## Diesel

### Diesel\*

**Diesel fuel** must conform to DIN EN 590 (EN = “European Standard”). It must have a cetane number (CN) of at least 51. The cetane number indicates the ignition quality of the diesel fuel.

Notes on refuelling » page 158.

### Biodiesel\*

#### ⚠ CAUTION

• Your vehicle is not designed to use biodiesel fuel. Never, under any circumstances refuel with biodiesel. The use of biodiesel fuel could damage the engine and the fuel system. The addition of biodiesel to diesel fuel by the diesel manufacturer in accordance with standard EN 590 or DIN 51628 is authorised and will not cause damage to the engine or the fuel system.

• The diesel engine has been designed to be used exclusively with diesel fuel conforming to standard EN 590. Never refuel or use petrol, kerosene, fuel oil or any other type of fuel. If you accidentally fill up the vehicle with the wrong type of fuel, do not start the engine. Seek assistance from specialised personnel. The composition of these fuels may severely damage the fuel system and the engine.

### Winter operation

#### Winter-grade diesel

When using “summer-grade diesel fuel”, difficulties may be experienced at temperatures below 0 °C (+32 °F) because the fuel thickens due to wax separation. For this reason, “winter-grade diesel fuel” is available in some countries during the cold months. It can be used at temperatures as low as -22 °C (-8 °F).

In countries with different climatic conditions the diesel fuel generally sold has different temperature characteristics. Check with the Technical Services or filling stations in the country concerned regarding the type of diesel fuels available.

#### Filter pre-heater

Your vehicle is fitted with a fuel filter glow plug system, making it well equipped for operation in winter. This ensures that the fuel system remains operational to approx. -24 °C (-11 °F), provided you use winter-grade diesel which is safe to -15 °C (+5 °F).

However, if the fuel has waxed to such an extent that the engine will not start at temperatures of under -24 °C (-11 °F), simply leave the vehicle in a heated area for a while.

#### ⚠ CAUTION

Do not mix fuel additives, the so-called “thinners”, or similar additives with diesel fuel.

## LPG system (Liquefied petroleum gas)\*

### Refuelling with LPG

✓ Applies to the model: ALTEA / ALTEA XL

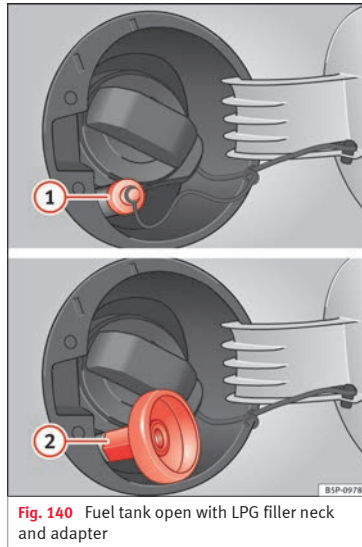
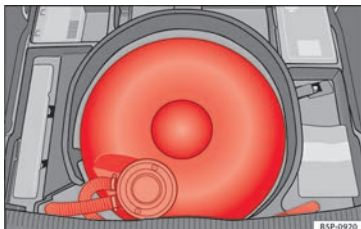

Fig. 140 Fuel tank open with LPG filler neck and adapter



**Fig. 141** LPG tank in spare wheel well

Before refuelling, turn off the engine and switch off the ignition and mobile telephone  
» **⚠**.

Read carefully the instructions on how to use the LPG pump.

### Opening the fuel tank cap

The LPG filler neck is behind the fuel cap, next to the petrol filler neck.

- The tank flap is located on the rear right-hand side of the vehicle.
- Open the fuel tank flap.

### Refuelling

- Remove the plug from the gas filler mouth  
» **Fig. 140** **①**.
- Screw the required adapter **②** onto the LPG gas filler neck.

- Refuel as indicated in the pump instructions.
- The fuel tank will be *full* when the pump compressor automatically cuts the supply.
- If you wish to finish refuelling sooner, release the button on the pump to stop the flow.

### Closing the fuel tank cap

- Unscrew the adapter from the gas filler neck **②**.
- Screw the cap onto the gas filler neck **①**.
- Close the fuel tank flap. The cover should be flush with the bodywork.

### **⚠** WARNING

**Incorrect handling of LPG can cause explosions, fire, serious burns and other injuries.**

- **LPG is a highly explosive and inflammable substance.**
- **Small quantities of LPG may leak out after refuelling. If LPG comes into contact with the skin there is a risk of freezing.**

### **i** Note

- **The vehicle includes one adapter for the country in question, the most common one. We generally recommend that you carry all the adapters in your vehicle, as some countries use more than one type of filling system.**

- **If the outside temperature is very high, the protection against overheating for the LPG pump may disconnect automatically.**
- **If the outside temperature is very high, the pressure of the LPG tank may be equal to or greater than that of the gas tank of the LPG pump. In this case, refuelling will be physically impossible.**
- **The filling nozzles of LPG pumps can differ in the way they are operated. If you do not know, ask a qualified employee at the petrol station to do the refuelling.**
- **Noises heard when refuelling are normal and do not indicate the presence of a fault in the system.**

## Adapter for the

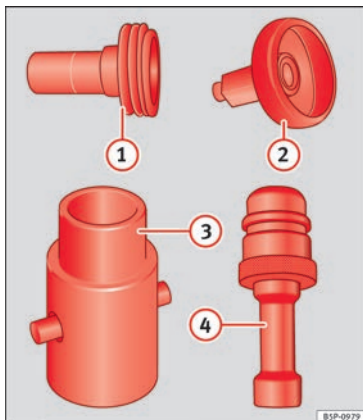

**Fig. 142** General table of LPG filler neck adapters

An adapter is required due to the existence of a range of pumps with different nozzles.

- ① ACME adapter (adapter for Europe)
- ② Dish Coupling Adapter (adapter for Italy)
- ③ Bayonet adapter
- ④ EURO adapter (adapter for Spain)

The supply includes the adapter for the country in question, the ACME ①, the Dish Cou-

pling ②, the bayonet ③ or the EURO adapter ④.

The filler systems and corresponding adapters vary according to country. As petrol stations abroad do not always have the necessary adapters for your LPG system, we recommend you purchase the appropriate adapter before travelling abroad. Check that the adapters are suited to your filling system.

### **i** Note

The four most common types of adapter in Europe are the ACME adapter ①, the Dish Coupling adapter ②, the bayonet adapter ③ and the EURO adapter ④. We generally recommend that you carry all four adapters in your vehicle, as some countries use more than one type of filling system. The introduction of a single system (Euronozzle) throughout Europe is being studied.

## Fixed adapter

✓ Applies to the market: Spanish

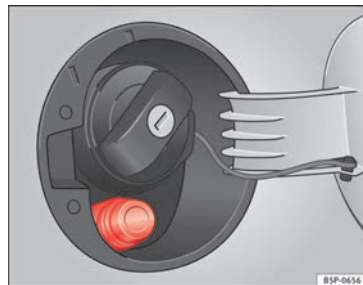

**Fig. 143** Fuel tank flap open with EURO-type connector.

The end of the filling tube has a EURO-type connector so that you can refill LPG without having to use an additional adapter  
»» **Fig. 143.**

## LPG fuel

LPG is an alternative vehicle fuel and is a blend of propane and butane.

The success of LPG is due to the strict regulations concerning exhaust gas emissions. Compared to other fossil fuels, LPG is characterised by its reduced emissions.

### LPG quality and consumption

Quality requirements for LPG are regulated for all Europe in DIN EN 589 and permit the use of LPG throughout Europe.

A difference is drawn between winter gas and summer gas. Winter gas has a higher proportion of propane gas. As a result, the driving range of winter gas may be lower (due to increased consumption) than that of summer gas.

### LPG supplier network

The number of LPG pumps is constantly increasing.

Lists of existing LPG pumps may be found on Internet.

### LPG safety

A series of collision tests performed on this vehicle while running with LPG have confirmed its high level of safety.

The safety of the LPG system guarantees operation without risk. The following safety measures have been adopted:

- The LPG tank has a solenoid valve which closes automatically when the engine is switched off (ignition off) or when running on petrol.

- A solenoid type main valve disconnects the supply of gas to the engine compartment when the engine is switched off or running on petrol.
- A safety valve in the LPG tank with pipes to the outside prevents the gas from entering the vehicle interior.
- All anchorage points and materials have been designed to ensure the maximum possible levels of safety.

The condition of the LPG system should be checked regularly to guarantee safe driving conditions » » ⚠. These checks are included in the Maintenance Programme.

#### ⚠ WARNING

- If there is a smell of gas or a suspected leak, stop the vehicle immediately and switch off the ignition. Open the doors to ventilate the vehicle. Do not carry on driving! Take the vehicle to a specialised workshop and have the fault repaired.
- Immediately extinguish any cigarettes and remove from the vehicle any objects which might produce a spark or cause a fire, and switch off immediately if gas is smelt or a leak is detected.
- LPG tanks are subject to pressure and must be checked regularly. The owner of the vehicle must check that these services are performed correctly.

- When parking the vehicle in a closed area (e.g. in a garage), make sure that there is adequate ventilation, either natural or mechanical, to neutralise the LPG in the event of a leak.

#### Note

For any fault in the LPG system, please refer to the SEAT web page, which lists the workshops authorised to repair these faults.

## Working in the engine compartment

### Safety instructions on working in the engine compartment

Before starting any work on the engine or in the engine compartment:

1. Switch off the engine and remove the key from the ignition.
2. Apply the handbrake.
3. Move the gear lever to neutral or the selector lever to position P.
4. Wait for the engine to cool down.
5. Keep children away from the vehicle.
6. Raise the bonnet » » page 165.

»

You should not do any work in the engine compartment unless you know exactly how to carry out the jobs and have the correct tools! Have the work carried out by a specialised workshop if you are uncertain.

All service fluids and consumables, e.g. coolant, engine oil, spark plugs and batteries, are under constant development. SEAT provides a constant flow of information to Technical Services concerning modifications. For this reason, we recommend you have service fluids and consumables replaced by a Technical Service. Please observe the relevant instructions » page 147. The engine compartment of the vehicle is a hazardous area.

» 

#### WARNING

All work on the engine or in the engine compartment, e.g. checking and refilling fluids, involves the danger of injury and burns, accidents and even fire.

- Never open the bonnet if you see steam, smoke or coolant escaping from the engine compartment. Otherwise, there is a risk of sustaining burns. Wait until no more steam or coolant is emitted, then allow the engine to cool before carefully opening the bonnet.
- Switch off the engine and remove the key from the ignition.
- Apply the handbrake and move the gear lever to neutral or selector lever to position P.
- Keep children away from the vehicle.

- Never touch hot engine parts. There is a risk of burns.
- Never spill liquids on a hot engine or on a hot exhaust gas system. This is a fire hazard.
- Avoid causing short-circuits in the electrical system, particularly at the points where the jump leads are attached » page 190. The battery could explode.
- Never touch the radiator fan. It is temperature controlled and could start automatically, even when the engine has been switched off and the key removed from the ignition!
- Never cover the engine with additional insulating materials such as a blanket. Risk of fire!
- Do not unscrew the cap on the coolant expansion tank when the engine is hot. If the coolant is hot, the cooling system will be pressurised!
- Protect face, hands and arms by covering the cap with a large, thick cloth to protect against escaping coolant and steam.
- Always make sure you have not left any objects, such as cleaning cloths or tools, in the engine compartment.
- If you have to work underneath the vehicle, you must use suitable stands additionally to support the vehicle, there is a risk of accident!. A hydraulic jack is insufficient for securing the vehicle and there is a risk of injury.
- If any work has to be performed when the engine is started or with the engine running, there is an additional, potentially fatal, safety risk from the rotating parts, such as the drive

belts, alternator, radiator fan, etc., and from the high-voltage ignition system. You should also observe the following:

- Never touch the electrical wiring of the ignition system.
- Ensure that jewellery, loose clothing and long hair do not get trapped in rotating engine parts. Danger of death. Before starting any work remove jewellery, tie back and cover hair, and wear tight-fitting clothes.
- Never accelerate with a gear engaged without taking the necessary precautions. The vehicle could move, even if the handbrake is applied. Danger of death.
- If work has to be carried out on the fuel system or on electrical components, you must observe the following safety notes in addition to the above warnings:
  - Always disconnect the battery from the on-board network. The vehicle must be unlocked when this is done, otherwise the alarm will be triggered.
  - Do not smoke.
  - Never work near naked flames.
  - Always have a fire extinguisher on hand.

#### CAUTION

When topping up service fluids, make sure not to mistake them. Using the wrong fluids could cause serious malfunctions and engine damage!

### For the sake of the environment

Service fluids leaks are harmful to the environment. For this reason you should make regular checks on the ground underneath your vehicle. If you find spots of oil or other fluids, have your vehicle inspected in a specialised workshop.

### Opening the bonnet

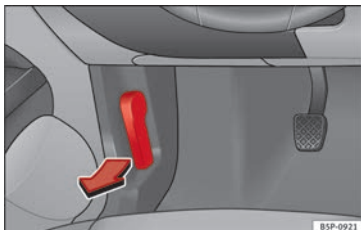

**Fig. 144** Detail of footwell area on driver side: lever for unlocking the bonnet

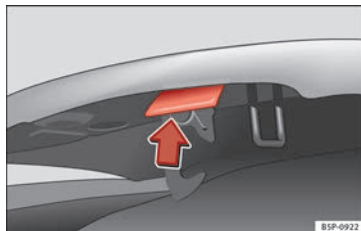

**Fig. 145** Handle for releasing the bonnet.

The bonnet is released from inside the vehicle.

Before opening the bonnet ensure that the windscreen wipers are in rest position.

- To release the bonnet, pull the lever under the dash panel »» Fig. 144 in the direction indicated (arrow). The bonnet will be released by a spring action »» ⚠.
- Lift the bonnet using the release lever (arrow) and open the bonnet.
- Release the bonnet stay and secure it in the fixture designed for this in the bonnet.

#### WARNING

##### Hot coolant can scald!

- Never open the bonnet if you see steam, smoke or coolant escaping from the engine compartment.

- Wait until no more steam, smoke or coolant is emitted from the bonnet, then carefully open the bonnet.
- When working in the engine compartment, always observe the safety warnings »» page 163.

### Closing the bonnet

- Slightly lift the bonnet.
- Release the bonnet stay and replace it in its support.
- At a height of approximately 30 cm let it fall so it locks.

If the bonnet does not close, do not press downwards. Open it once more and let it fall as before.

#### WARNING

If the bonnet is not closed properly, it could open while you are driving and completely obscure your view of the road. Risk of accident.

- After closing the bonnet, always check that it is properly secured. The bonnet must be flush with the surrounding body panels.
- If you notice that the bonnet latch is not secured when the vehicle is moving, stop the vehicle immediately and close the bonnet properly. Risk of accident.

## Checking fluid levels

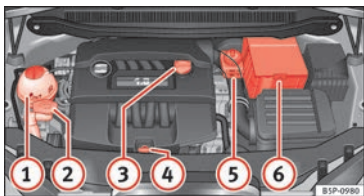

**Fig. 146** Diagram for the location of the various elements.

From time to time, the levels of the different fluids in the vehicle must be checked. Never fill with incorrect fluids, otherwise serious damage to the engine may be caused.

- ① Coolant expansion tank
- ② Windscreen washer reservoir
- ③ Engine oil filler cap
- ④ Engine oil dipstick
- ⑤ Brake fluid reservoir
- ⑥ Vehicle battery (underneath the cover)

The checking and refilling of service fluids are carried out on the components mentioned above. These operations are described in the »» page 163.

## Overview

You will find further explanations, instructions and restrictions on the technical specifications as of »» page 207.

## Engine oil

### General notes

The engine comes with a special, multi-grade oil that can be used all year round.

Because the use of high-quality oil is essential for the correct operation of the engine and its long useful life, when topping up or changing oil, use only those oils that comply with VW standards.

The specifications (VW standards) set out on the following page should appear on the container of the service oil; when the container displays the specific standards for petrol and diesel engines together, it means that the oil can be used for both types of engines.

We recommend that the oil change indicated in the Maintenance Programme be performed by a technical service or a specialised workshop.

The correct oil specifications for your engine are listed in the »» page 167, **Oil properties**.

## Service intervals

Service intervals can be flexible (LongLife service) or fixed (dependent on time/distance travelled).

If the PR code that appears on the back of the Maintenance Programme booklet is PR Q16, this means that your vehicle is programmed with the LongLife service. If it lists the codes Q11, Q12, Q13, Q14 or Q17, the interval service is dependent on time/distance travelled.

### Flexible service intervals (LongLife service intervals\*)

Special oils and processes have been developed which, depending on characteristics and individual driving profiles, allow for greater intervals between oil change services (LongLife service intervals).

Because this oil is essential for extending the service intervals, it **must only** be used observing the following indications:

- Avoid mixing it with oil for fixed service intervals.
- Only in exceptional circumstances, if the engine oil level is too low »» page 167 and LongLife oil is not available, it is permitted to top up (once) with oil for **fixed service intervals** »» page 167 (up to a maximum of 0.5 litres).



### Fixed service intervals\*

If your vehicle does not have the “LongLife service interval” or it has been disabled (by request), you may use oils for **fixed service intervals**, which also appear in **»» page 167, Oil properties**. In this case, your vehicle must be serviced after a fixed interval of 1 year/15 000 km (10 000 miles) (whatever comes first) **»» Booklet Maintenance Programme**.

- In exceptional circumstances, if the engine oil level is too low **»» page 167** and you cannot obtain the oil specified for your vehicle, you can put in a small quantity of oil conforming to the specification ACEA A2 or ACEA A3 (petrol engines) or ACEA B3 or ACEA B4 (diesel engines) (up to 0.5 l).

### Vehicles with a diesel particulate filter\*

The Maintenance Programme states whether your vehicle is fitted with a diesel particulate filter.

Only VW 507 00 engine oil, with reduced ash formation, may be used in diesel engines equipped with particulate filter. Using other types of oil will cause a higher soot concentration and reduce the life of the DPF. Therefore:

- Avoid mixing this oil with other engine oils.
- Only in exceptional circumstances, if the engine oil level is too low **»» page 167** and

you cannot obtain the oil specified for your vehicle, you can use a small quantity of oil (once) conforming to the VW 506 00, VW 506 01, VW 505 00, VW 505 01 or ACEA B3/ACEA B4 specification. (up to 0.5 l).

### Oil properties

Engine type	Specification
Petrol without flexible service interval	VW 502 00/VW 504 00
Petrol with flexible service interval (LongLife)	VW 504 00
Diesel. Engines without Particulate filter (DPF)	VW 505 01/VW 506 01/VW 507 00
Diesel. Particulate Filter Engines (DPF). With or without flexible service interval (with and without LongLife) <sup>a)</sup>	VW 507 00

<sup>a)</sup> Only use recommended oils, otherwise you may damage the engine.

### Engine oil additives

No type of additive should be mixed with the engine oil. The deterioration caused by these additives is not covered by the warranty.

### Note

**Before a long trip, we recommend finding an engine oil that conforms to the corresponding VW specifications and recommend keeping it in the vehicle. This way, the correct engine oil will always be available for a top-up if needed.**

### Checking the engine oil level

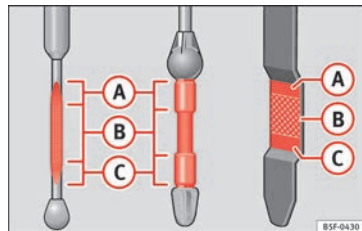

**Fig. 147** Engine oil dipstick.

The engine oil dipstick indicates the level of the oil.

### Checking oil level

- Park the vehicle in a horizontal position.
- Briefly run the engine at idle speed until the operating temperature is reached and then stop.
- Wait for about two minutes.

»»

- Pull out the dipstick. Wipe the dipstick with a clean cloth and insert it again, pushing it in as far as it will go.
- Then pull it out once more and check the oil level »» Fig. 147. Top up with engine oil if necessary.

#### Oil level in area **A**

- Do **not** add oil »» **I**.

#### Oil level in area **B**

- You **can** add oil, but keep the level in this zone.

#### Oil level in area **C**

- Oil **must** be added. **Afterwards**, the oil level should be in the lined area **B**.

Depending on how you drive and the conditions in which the vehicle is used, oil consumption can be up to 0.5 l/1000 km. Oil consumption is likely to be higher for the first 5,000 km. For this reason the engine oil level must be checked at regular intervals, preferably when filling the tank and before a journey.

#### **WARNING**

Any work carried out in the engine compartment or on the engine must be carried out cautiously.

- **When working in the engine compartment, always observe the safety warnings** »» page 163.

#### **CAUTION**

If the oil level is above the area **A** do not start the engine. This could result in damage to the engine and catalytic converter. Contact a Technical Service.

#### Topping up engine oil



Fig. 148 In the engine compartment: Engine oil filler cap

Before opening the bonnet, read and observe the warnings »» **Δ** in Safety instructions on working in the engine compartment on page 163.

- Unscrew cap from engine oil filler opening »» Fig. 148.

- Top-up oil in small amounts, using the correct oil.

- To avoid over-filling with engine oil, you should top-up using small quantities, wait a while and check the oil level before adding any more oil.

- As soon as the oil level is in area **B**, carefully close the cap.

The position of the oil filler opening is shown in the corresponding engine compartment illustration »» page 166.

Engine oil specification »» page 166.

#### **WARNING**

Oil is highly inflammable! Ensure that no oil comes into contact with hot engine components when topping up.

#### **CAUTION**

If the oil level is above the area **A** do not start the engine. This could result in damage to the engine and catalytic converter. Contact a specialised workshop.

#### For the sake of the environment

The oil level must never be above area **A**. Otherwise oil can be drawn in through the crankcase breather and escape into the atmosphere via the exhaust system.

### Changing engine oil

The engine oil must be changed at the intervals given in the service schedule.

We recommend that you have the engine oil changed by a Technical Service.

The oil change intervals are shown in the Maintenance Programme.

#### WARNING

**Only change the engine oil yourself if you have the specialist knowledge required!**

- Before opening the bonnet, read and observe the warnings » page 163, Safety instructions on working in the engine compartment.
- Wait for the engine to cool down. Hot oil may cause burn injuries.
- Wear eye protection to avoid injuries, such as acid burns, caused by splashes of oil.
- When removing the oil drain plug with your fingers, keep your arm horizontal to help prevent oil from running down your arm.
- Wash your skin thoroughly if it comes into contact with engine oil.
- Engine oil is poisonous! Used oil must be stored in a safe place out of the reach of children.

#### CAUTION

**No additives should be used with engine oil. This could result in engine damage. Any damage caused by the use of such additives would not be covered by the factory warranty.**

#### For the sake of the environment

- Because of disposal problems and the special tools and specialist knowledge required, we recommend that you have the engine oil and filter changed by a Technical Service.
- Never pour oil down drains or into the ground.
- Use a suitable container when draining the used oil. It must be large enough to hold all the engine oil.

## Cooling system



### Engine coolant specifications

The engine cooling system is supplied from the factory with a specially treated mixture of water and, at least, 40 % of the additive **G 13** (TLVW 774 J). The engine coolant additive is recognisable by its purple colour. This mixture of water and additive gives the necessary frost protection down to -25°C (-13 F) and protects the light alloy parts of the cooling system against corrosion. It also prevents

scaling and considerably raises the boiling point of the coolant.

To protect the engine cooling system, the percentage of additive must *always* be at least 40 %, even in warm climates where anti-freeze protection is not required.

If greater frost protection is required in very cold climates, the proportion of additive can be increased. However, the percentage of additive should not exceed 60%, as this would reduce frost protection and, in turn, decrease cooling capacity.

When the coolant is topped up, use a mixture of **distilled water** and, at least, 40 % of the G 13 or G 12 plus-plus (TL-VW 774 G) additive (both are purple) to obtain an optimum anti-corrosion protection » . The mixture of G 13 with G 12 plus (TL-VW 774 F), G 12 (red) or G 11 (green-blue) engine coolants will significantly reduce the anticorrosion protection and should, therefore be avoided » .

#### WARNING

**If there is not enough anti-freeze in the coolant system, the engine may fail leading to serious damage.**

- Please make sure that the percentage of additive is correct with respect to the lowest expected ambient temperature in the zone where the vehicle is to be used.
- When the outside temperature is very low, the coolant could freeze and the vehicle

»

would be immobilised. In this case, the heating would not work either and inadequately dressed passengers could die of cold.

#### ⚠ CAUTION

The original additives should never be mixed with coolants which are not approved by SEAT. Otherwise, you run the risk of causing severe damage to the engine and the engine cooling system.

- If the fluid in the expansion tank is not purple but is, for example, brown, this indicates that the G 13 additive has been mixed with an inadequate coolant. The coolant must be changed as soon as possible if this is the case! This could result in serious faults and engine damage.

#### ♻ For the sake of the environment

Coolants and additives can contaminate the environment. If any fluids are spilled, they should be collected and correctly disposed of, with respect to the environment.

## Checking the coolant level and topping up

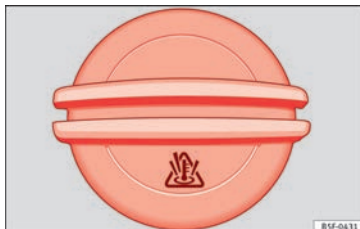

**Fig. 149** Engine compartment: coolant expansion tank cap.

Top up coolant when the level is below the MIN (minimum) mark.

Before opening the bonnet, read and observe the warnings » **⚠** in **Safety instructions on working in the engine compartment** on page 163.

### Opening the coolant expansion tank

- Switch off the engine and allow it to cool.
- To prevent scalding, cover the cap on the coolant expansion tank with a thick cloth and carefully unscrew the cap » **⚠**.

### Checking coolant level

- Look into the open coolant expansion tank and read off the coolant level.

- If the level is below the “MIN” mark, top up with coolant.

### Topping up coolant

- Only use **new** coolant liquid.
- Do not fill above the “MAX” mark.

### Closing the coolant expansion tank

- Screw the cap on again *tightly*.

The position of the coolant expansion reservoir is shown in the corresponding engine compartment illustration » **page 166**.

Make sure that the coolant meets the required specifications » **page 169**. Do not use a different type of additive if additive G12+ is not available. In this case use only water and bring the coolant concentration back up to the correct level as soon as possible by putting in the specified additive » **page 169**.

Always top up with *new* coolant.

Do not fill above the “MAX” mark. Otherwise the excess coolant will be forced out of the cooling system when the engine is hot.

The coolant additive G12+ (dyed purple) may be mixed with G12 (dyed red) and also with G 11.

**⚠ WARNING**

Any work carried out in the engine compartment or on the engine must be carried out cautiously.

- When working in the engine compartment, always observe the safety warnings »» page 163.
- When the engine is warm or hot, the cooling system is pressurised! Do not unscrew the cap on the coolant expansion tank when the engine is hot. This is a burn injury risk.

**ⓘ CAUTION**

- When mixed with other additives the colour of G12 will change to brown. If this occurs you should have the coolant changed immediately. Failure to do so will result in engine damage!
- If a lot of coolant fluid has been lost, wait for the engine to *cool*. This avoids damaging the engine. Large coolant losses are an indication of leaks in the cooling system. See a specialised workshop immediately and have the cooling system checked. Otherwise, there is a risk of engine damage.

**Windscreen washer reservoir****Topping up washer fluid** 🚿

**Fig. 150** In the engine compartment: Cap of windscreen washer reservoir

The **windscreen washer** and the **headlight washers** are supplied with fluid from the windscreen washer fluid container in the engine compartment. The container holds approx. 3 litres; in vehicles with headlight washers\* it holds approx. 5.5 litres.

The reservoir is located on the right-hand side of the engine compartment.

Plain water is not enough to clean the windscreen and headlights. We recommend that you always add a product to the windscreen washer fluid. Approved windscreen cleaning products exist on the market with high detergent and anti-freeze properties, these may be added all-year-round. Please follow the dilution instructions on the packaging.

**⚠ WARNING**

Any work carried out in the engine compartment or on the engine must be carried out cautiously.

- When working in the engine compartment, always observe the safety warnings »» page 163.

**ⓘ CAUTION**

- Never put radiator anti-freeze or other additives into the windscreen washer fluid.
- Always use approved windscreen cleansing products diluted as per instructions. If you use other washer fluids or soap solutions, the tiny holes in the fan-shaped nozzles could become blocked.

## Brake fluid

### Checking the brake fluid level



**Fig. 151** Engine compartment: brake fluid reservoir cap

– Read off the fluid level at the transparent brake fluid reservoir. It should always be between the “MIN” and “MAX” marks.

The position of the brake fluid reservoir is shown in the corresponding engine compartment illustration » page 166. The brake fluid reservoir has a black and yellow cap.

The brake fluid level drops slightly when the vehicle is being used as the brake pads are automatically adjusted as they wear.

However, if the level goes down noticeably in a short time, or drops below the “MIN” mark, there may be a leak in the brake system. A display on the instrument panel will warn you if the brake fluid level is too low » page 35.

### **⚠ WARNING**

**Before opening the bonnet to check the brake fluid level, read and observe the warnings » page 163.**

### Changing the brake fluid

The Maintenance Programme indicates brake fluid change intervals.

We recommend that you have the brake fluid changed by a Technical Service.

Before opening the bonnet, please read and follow the warnings » **⚠ in Safety instructions on working in the engine compartment on page 163** in section “Safety notes for working in the engine compartment”.

In the course of time, brake fluid becomes hygroscopic and absorbs water from the ambient air. If the water content in the brake fluid is too high, the brake system could corrode. This also considerably reduces the boiling point of the brake fluid. Heavy use of the brakes may then cause a vapour lock which could impair the braking effect.

Be sure to always use the correct brake fluid. Only use brake fluid that expressly meets the VW 501 14 standard.

You can buy VW 501 14 standard brake fluid at a SEAT dealership or a SEAT Official Service. If none is available, use only high-quality

brake fluid that meets DIN ISO 4925 CLASS 4 standards, or USA Standards FMVSS 116 DOT 4.

Using any other kind of brake fluid or one that is not of a high quality may affect operation of the brake system and reduce its effectiveness. Never use a brake fluid if the container does not state that it complies with VW 501 14, DIN ISO 4925 CLASS 4 standards, or USA standards FMVSS 116 DOT 4.

### **⚠ WARNING**

**Brake fluid is poisonous. Old brake fluid impairs the braking effect.**

- **Before opening the bonnet to check the brake fluid level, read and observe the warnings » page 163.**
- **Brake fluid should be stored in the closed original container in a safe place out of reach of children. There is a toxic risk.**
- **Perform the brake fluid change according to the Maintenance Programme. Heavy use of the brakes may cause a vapour lock if the brake fluid is left in the brake system for too long. This would seriously affect the effectiveness of the brakes and the safety of the vehicle. This may cause an accident.**

### **ⓘ CAUTION**





**Brake fluid damages the vehicle paintwork. Wipe off any brake fluid from the paintwork immediately.**

### For the sake of the environment

The brake pads and brake fluid must be collected and disposed of according to the applicable regulations. The SEAT Technical Service network has the necessary equipment and qualified personnel for collecting and disposing of this waste material.

## Vehicle battery

### Warnings on handling the battery

	Wear eye protection
	Battery acid is extremely corrosive. Wear protective gloves and eye protection!
	Fires, sparks, open flames and smoking are prohibited!
	A highly explosive mixture of gases is released when the battery is under charge.
	Keep children away from acid and batteries!

### WARNING

Always be aware of the danger of injury and chemical burns as well as the risk of accident or fire when working on the battery and the electrical system:

- Wear eye protection. Protect your eyes, skin and clothing from acid and particles containing lead.

- Battery acid is extremely corrosive. Wear protective gloves and eye protection. Do not tilt the batteries. This could spill acid through the vents. Rinse battery acid from eyes immediately for several minutes with clear water. Then seek medical care immediately. Neutralise any acid splashes on the skin or clothing with a soapy solution, and rinse off with plenty of water. If acid is swallowed by mistake, consult a doctor immediately.

- Fires, sparks, open flames and smoking are prohibited. When handling cables and electrical equipment, avoid causing sparks and electrostatic charge. Never short the battery terminals. High-energy sparks can cause injury.

- A highly explosive mixture of gases is released when the battery is under charge. The batteries should be charged in a well-ventilated room only.

- Keep children away from acid and batteries.

- Before working on the electrical system, you must switch off the engine, the ignition and all electrical devices. The negative cable on the battery must be disconnected. When a light bulb is changed, you need only switch off the light.

- Deactivate the anti-theft alarm by unlocking the vehicle before you disconnect the battery! The alarm will otherwise be triggered.

- When disconnecting the battery from the vehicle on-board network, disconnect first the negative cable and then the positive cable.

- Switch off all electrical devices before re-connecting the battery. Reconnect first the positive cable and then the negative cable. Never reverse the polarity of the connections. This could cause an electrical fire.

- Never charge a frozen battery, or one which has thawed. This could result in explosions and chemical burns. Always replace a battery which has frozen. A flat battery can also freeze at temperatures close to 0 °C (+32 °F).

- Ensure that the vent hose is always connected to the battery.

- Never use a defective battery. This could cause an explosion. Replace a damaged battery immediately.

### CAUTION



- Never disconnect the battery if the ignition is switched on or if the engine is running. This could damage the electrical system or electronic components.

- Do not expose the battery to direct sunlight over a long period of time, as the intense ultraviolet radiation can damage the battery housing.

- If the vehicle is left standing in cold conditions for a long period, protect the battery from “freezing”. If it freezes it will be damaged.

## Checking the electrolyte level

The electrolyte level should be checked regularly in high-mileage vehicles, in hot countries and in older batteries.

- Open the bonnet and open the battery cover at the front »»  in **Safety instructions on working in the engine compartment on page 164** »»  in **Warnings on handling the battery on page 173**.
- Check the colour display in the "magic eye" on the top of the battery.
- If there are air bubbles in the window, tap the window gently until they disperse.

The position of the battery is shown in the corresponding engine compartment diagram »» **page 166**.

The "magic eye" indicator, located on the top of the battery changes colour, depending on the charge state and electrolyte level of the battery.

There are two different colours:

- Black: correct charge status.
- Transparent/clear yellow: the battery must be replaced. Contact a specialised workshop.

## Charging and changing the vehicle battery

The battery is maintenance-free and is checked during the inspection service. All work on the vehicle battery requires specialist knowledge.

If you often drive short distances or if the vehicle is not driven for long periods, the battery should be checked by a specialised workshop between the scheduled services.

If the battery has discharged and you have problems starting the vehicle, the battery might be damaged. If this happens, we recommend you have the vehicle battery checked by a Technical Service where it will be re-charged or replaced.

### Charging the battery

The vehicle battery should be charged by a specialised workshop only, as batteries using special technology have been installed and they must be charged in a controlled environment.

### Replacing a vehicle battery

The battery has been developed to suit the conditions of its location and has special safety features.

Genuine SEAT batteries meet the maintenance, performance and safety specifications of your vehicle.

### WARNING

- We recommend you use only maintenance-free or cycle free leak-proof batteries which comply with standards T 825 06 and VW 7 50 73. This standard applies as of 2001.
- Before starting any work on the batteries, you must read and observe the warnings »»  in Warnings on handling the battery on page 173.

### For the sake of the environment

**Batteries contain toxic substances such as sulphuric acid and lead. They must be disposed of appropriately and must not be disposed of with ordinary household waste.**



## Wheels

### Wheels and tyres

#### General notes

##### Avoiding damage

- If you have to drive over a kerb or similar obstacle, drive very slowly and at a right angle.
- Keep grease, oil and fuel off the tyres.
- Inspect the tyres regularly for damage (cuts, cracks or blisters, etc.). Remove any foreign objects embedded in the treads.

##### Storing tyres

- When you remove the tyres, mark them in order to maintain the same direction of rotation when they are installed again.
- When removed, the wheels and/or tyres should be stored in a cool, dry and preferably dark location.
- Store tyres in a vertical position if they are not fitted on wheel rims.

##### New tyres

New tyres must be run in » page 130.

The tread depth of new tyres may vary, according to the type and make of tyre and the tread pattern.

##### Concealed damage

Damage to tyres and rims is often not readily visible. If you notice unusual vibrations or the vehicle pulling to one side, this may indicate that one of the tyres is damaged. They should be checked immediately by a Technical Service.

##### Tyres with directional tread pattern

An arrow on the tyre sidewall indicates the direction of rotation on tyres with directional tread. Always observe the direction of rotation indicated when fitting the wheel. This guarantees optimum grip and helps to avoid aquaplaning, excessive noise and wear.

#### WARNING

- **New tyres do not have maximum grip during the first 500 km (300 miles). Drive particularly carefully to avoid possible accidents.**
- **Never drive with damaged tyres. This may cause an accident.**
- **If you notice unusual vibrations or if the vehicle pulls to one side when driving, stop the vehicle immediately and check the tyres for damage.**

#### Checking tyre pressure

The correct tyre pressure can be seen on the sticker on the inside of the fuel tank flap.

1. Read the required tyre inflation pressure from the sticker. The values refer to Summer tyres. For winter tyres, you must add 0.2 bar (2.9 psi / 20 kPa) to the values given for summer tyres.
2. The tyre pressures should only be checked when the tyres are cold. The slightly raised pressures of warm tyres must not be reduced.
3. Adjust the tyre pressure to the load you are carrying.

##### Tyre pressure

The correct tyre pressure is especially important at high speeds. The pressure should therefore be checked at least once a month and before starting a journey.

The sticker with the tyre pressure values can be found on the inside of the fuel tank flap. The tyre pressure values given are for cold tyres. Do not reduce the slightly raised pressures of warm tyres » .

#### WARNING

- **Check the tyre pressure at least once per month. Checking the tyre pressure is very important. If the tyre pressure is too high or too low, there is an increased danger of accidents - particularly at high speeds.**
- **A tyre can easily burst if the pressure is too low, causing an accident!**

»

- **At continuously high speeds, a tyre with insufficient pressure flexes more. In this way it becomes too hot, and this can cause tread separation and tyre blow-out. Always observe the recommended tyre pressures.**

- **If the tyre pressure is too low or too high, the tyres will wear prematurely and the vehicle will not handle well. Risk of accident!**

 For the sake of the environment

**Under-inflated tyres will increase fuel consumption.**

## Tyre pressure monitoring

The tyre pressure monitoring system constantly checks the pressure of the tyres.

The system uses the speed sensors of the ABS wheels. It operates by analysing the speed and frequency spectrum of each wheel.

For optimum performance, use genuine SEAT tyres. In addition, check and adjust tyre pressures regularly.

Whenever the tyre pressure is changed or one or more tyres are changed, the system should be reset by pressing the SET button on the centre console.

The system warns the driver in the event of a loss of pressure by means of symbols and

messages in the instrument panel display. The system operates via the ESC » page 134.

Note that tyre pressure also depends on tyre temperature. Said pressure increases around 0.1 bar (2.9 psi/10 kPa) for each +10 °C (+50 °F) in tyre temperature increase. The tyre heats up while the vehicle is being driven and the tyre pressure will rise accordingly. Therefore, you should only adjust the tyre pressure when they are cold (i.e. approximately at ambient temperature).

To ensure that the tyre pressure monitoring system works reliably, you should check and, if necessary, adjust the tyre pressures at regular intervals and store the correct pressures (reference values) in the system.

A tyre pressure information label is attached to the inside of the fuel tank flap.

### WARNING

- **Never adjust tyre pressure when the tyres are hot. This may damage or even burst the tyres. Risk of accident!**

- **An insufficiently inflated tyre flexes a lot more at high speeds and causes significant heating of the tyre. Under these conditions, the tyre bead may be released or the tyre may burst. Risk of accident!**

 For the sake of the environment

**Under-inflated tyres lead to increased fuel consumption and tyre wear.**

## Significant tyre pressure loss

The tyre symbol (⚠) is displayed and indicates that the tyre pressure of at least one tyre is insufficient.

- Stop the vehicle.
- Switch the ignition off.
- Check the tyre(s).
- Change the wheel if necessary.

## Tyre useful life



Fig. 152 Tyre tread wear indicators.

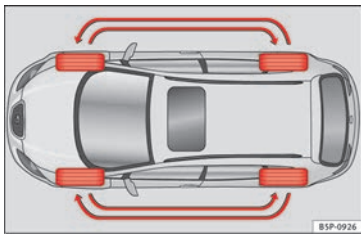

Fig. 153 Diagram for changing wheels

The useful life of tyres is dependent on tyre pressure, driving style and fitting.

### Wear indicators

The original tyres on your vehicle have 1.6 mm high “tread wear indicators” **» Fig. 152**, running across the tread. De-

pending on the make, there will be 6 to 8 of them evenly spaced around the tyre. Markings on the tyre sidewall (for instance the letters “TWI” or other symbols) indicate the positions of the tread wear indicators. The minimum tread depth required by law is 1.6 mm (measured in the tread grooves next to the tread wear indicators). Worn tyres must be replaced. Different figures may apply in export countries **» »** **▲**.

### Tyre pressure

Incorrect tyre pressure causes premature wear and could cause tyre blow-out. For this reason, the tyre pressure should be checked at least once per month **» page 175**.

### Driving style

Fast cornering, heavy acceleration and hard braking all increase tyre wear.

### Changing wheels around

If the front tyres are worn considerably more than the rear ones it is advisable to change them around as shown **» Fig. 153**. The useful life of all the tyres will then be about the same time.

### Wheel balance

The wheels on new vehicles are balanced. However, various factors encountered in normal driving can cause them to become unbalanced, which results in steering vibration.

Unbalanced wheels should be rebalanced, as they otherwise cause excessive wear on steering, suspension and tyres. A wheel must also be rebalanced when a new tyre is fitted.

### Incorrect wheel alignment

Incorrect wheel alignment causes excessive tyre wear, impairing the safety of the vehicle. If tyres show excessive wear, you should have the wheel alignment checked by a Technical Service.

### **▲ WARNING**

**There is a serious danger of accidents if a tyre bursts during driving!**

- The tyres must be replaced at the latest when the tread wear indicators are worn **» page 177**. Failure to follow this instruction could result in an accident. Worn tyres do not grip well at high speeds on wet roads. There is also a greater risk of “aquaplaning”.
- At continuously high speeds, a tyre with insufficient pressure flexes more. This causes it to overheat. This can cause tread separation and tyre blow-out. Risk of accident. Always observe the recommended tyre pressures.
- If tyres show excessive wear, you should have the running gear checked by a Technical Service.
- Keep chemicals such as oil, fuel and brake fluid away from tyres.
- Damaged wheels and tyres must be replaced immediately!

**»**

 For the sake of the environment

**Under-inflated tyres will increase fuel consumption.**

## Run-flat tyres

Run-flat tyres allow you to continue driving even with a punctured tyre, in the majority of cases.

In vehicles that are factory-fitted with run-flat tyres<sup>1)</sup> the loss of tyre pressure is indicated on the instrument panel.

### Driving with run-flat tyres (emergency running)

- Leave the ESC/ASR (Electronic Stability Control), or switch it on »» page 137.
- Continue driving carefully and slowly (80 km/h [50 mph] maximum).
- Avoid sudden manoeuvres and sharp turns.
- Avoid driving over obstacles (e.g. kerbs) or potholes.
- Pay attention if the ESC/ASR activates often, if smoke comes from the tyres or there is a smell of rubber, the vehicle vibrates or there are clattering noises. If any of these occur, stop the vehicle.

The run-flat tyres have a tag on the side of the tyre, with the description: “DSST”, “Eufofia”, “RFT”, “ROF”, “RSC”, “SSR” or “ZP”.

The sides of this type of tyre are reinforced. When the tyres lose air they are supported on the sides (emergency driving).

The loss of pressure in the tyre is shown on the instrument panel. You can then drive a maximum of 80 km (50 miles) and if the circumstances are favourable (e.g. low load), even more.

The damaged tyre should be changed as soon as possible. The rim should be checked in a specialised workshop to detect possible damage and replace it if necessary. We recommend you contact your technical service. If more than one tyre is being used under emergency conditions, this reduces the distance that can be travelled.

### Starting driving in emergency conditions

When loss in tyre pressure is displayed on the instrument panel, this means that at least one tyre is being driven in emergency conditions »» .

### End of emergency operation

Do not drive on if:

- smoke is coming from one of the tyres,

- there is a smell of rubber,
- the vehicle vibrates,
- there is a rattling noise.

### When is it no longer possible to continue driving even using run-flat tyres?

- If one of the tyres has been severely damaged in an accident, etc. If a tyre has been badly damaged there is a risk that parts of the tread can be thrown off and cause damage to the fuel lines, brake pipes or fuel filler.
- It is also advisable to stop driving if severe vibrations occur, or if the wheel starts overheating and gives off smoke.

### WARNING

**When driving in emergency conditions, the driving quality of the vehicle is considerably impaired.**

- **The maximum permitted speed of 80 km/h (50 mph) is subject to road and weather conditions. Please observe related legal requirements.**
- **Avoid sharp turns and rapid manoeuvres, and brake earlier than usual.**
- **Avoid driving over obstacles (e.g. kerbs) or potholes.**
- **If one or more tyres are being driven in emergency conditions, the driving quality of**

<sup>1)</sup> Depending upon version and country.

**the vehicle is impaired and there is a risk of accident.**

**Note**

- **The run-flat tyres do not “deflate” on losing pressure because they are supported on the reinforced sides. Therefore defects in the tyre cannot be detected with a visual inspection.**
- **Snow chains must not be used on front tyres used in emergency conditions.**

## New tyres and wheels

New tyres and wheels have to be run in.

The tyres and wheel rims are an essential part of the vehicle's design. Those approved by SEAT are specially matched to the characteristics of the vehicle and make a major contribution to good road-holding and safe handling »» ⚠.

**Note for Italy:** A SEAT Service Centre should be consulted whether different sized wheels or tyres to those originally fitted by SEAT may be fitted, as well as the combinations allowed between the front axle (axle 1) and back axle (axle 2).

Tyres should be replaced at least in pairs and not individually (i.e. both front tyres or both rear tyres together). A knowledge of tyre designations makes it easier to choose the cor-

rect tyres. Radial tyres have the tyre designations marked on the sidewall, for example:

**195/65 R15 91T**

This contains the following information:

- 195 Tyre width in mm
- 65 Height/width ratio in %
- R Tyre construction: **Radial**
- 15 Rim diameter in inches
- 91 Load rating code
- T Speed rating

The tyres could also have the following information:

- A direction of rotation symbol
- “Reinforced” denotes heavy-duty tyres.

The manufacturing date is also indicated on the tyre sidewall (possibly only on the inner side of the wheel).

“DOT... 1103...” means, for example, that the tyre was produced in the 11th week of 2003.

We recommend that work on tyres and wheels be carried out by a Technical Service. They are familiar with the procedure and have the necessary special tools and spare parts as well as the proper facilities for disposing of the old tyres.

Any technical service has full information on the technical requirements when installing or changing tyres, wheels or wheel trims.

On vehicles with **all-wheel drive**, all four tyres must always be fitted with tyres of the same type, make and tread pattern, as otherwise the driveline can be damaged by continuous differences in the wheel speeds. For this reason, the spare wheel should have the same wheel dimensions as the normal wheels so that it will fit if there is a puncture. You may also use the factory-supplied compact temporary spare wheel.

**⚠ WARNING**

- **We recommend that you use only wheels and tyres which have been approved by SEAT for your model. Failure to do so could impair vehicle handling. Risk of accident.**
- **Avoid running the vehicle on tyres that are more than 6 years old. If you have no alternative, you should drive slowly and with extra care at all times.**
- **Never use old tyres or those with an unknown “history of use”.**
- **If wheel trims are retrofitted, you must ensure that the flow of air to the brakes is not restricted. This could cause the brake system to overheat.**
- **All four wheels must be fitted with radial tyres of the same type, size (rolling circumference) and the same tread pattern.**

»»

### For the sake of the environment

**Old tyres must be disposed of according to the laws in the country concerned.**

### Note

- For technical reasons, it is not generally possible to use the wheels from other vehicles. This can also apply to wheels of the same model. The use of wheels or tyres which have not been approved by SEAT for use with your model may invalidate the vehicle's type approval for use on public roads.
- If the spare tyre is not the same as the tyres that are mounted on the vehicle (e.g. winter tyres) you should only use the spare tyre for a short period of time and drive with extra care. Refit the normal road wheel as soon as possible.

## Wheel bolts

The design of wheel bolts is matched to the rims. If different wheel rims are fitted, the correct wheel bolts with the right length and correctly shaped bolt heads must be used. This ensures that wheels are fitted securely and that the brake system functions correctly.

In certain circumstances, you should not use wheel bolts from a different vehicle, even if it is the same model » page 147.

After the wheels have been changed, the tightening torque of the wheel bolts should be checked as soon as possible with a torque wrench » . The tightening torque for steel and alloy wheels is 120 Nm.

### WARNING

**If the wheel bolts are not tightened correctly, the wheel could become loose while driving. Risk of accident.**

- The wheel bolts must be clean and turn easily. Never apply grease or oil to them.
- Use only wheel bolts which belong to the wheel.
- If the tightening torque of the wheel bolts is too low, they could loosen whilst the vehicle is in motion. Risk of accident! If the tightening torque is too high, the wheel bolts and threads can be damaged.

### CAUTION

**The prescribed tightening torque for wheel bolts for steel and alloy wheels is 120 Nm.**

## Winter service

### Winter tyres

In winter conditions winter tyres will considerably improve the vehicle's handling. Sum-

mer tyres (width, rubber compound, tread pattern) provide less grip on ice and snow.

**Winter tyres must be inflated to a pressure of 0.2 bar (2.9 psi/20 kPa) higher than the pressures specified for summer tyres (see sticker on fuel tank flap).**

Winter tyres must be fitted on all four wheels.

Information on permitted **winter tyre sizes** can be found in the vehicle's registration documentation. Use only radial winter tyres. All tyre sizes listed in the vehicle documentation also apply to winter tyres.

Winter tyres lose their effectiveness when the tread is worn down to a depth of 4 mm.

The speed rating code » page 179, **New tyres and wheels** determines the following **speed limits** for winter tyres: » 

Q	max. 160 km/h
S	max. 180 km/h
T	max. 190 km/h
H	max. 210 km/h

In some countries, vehicles which can exceed the speed rating of the fitted tyre must have an appropriate sticker in the driver's field of view. These stickers are available from your technical service. The legal requirements of each country must be followed.

Do not have winter tyres fitted for unnecessarily long periods. Vehicles with summer tyres

handle better when the roads are free of snow and ice.

If you have a flat tyre, please refer to the notes on the spare wheel » page 179, **New tyres and wheels.**

#### WARNING

**The maximum speed for the winter tyres must not be exceeded. Otherwise, this could lead to damage and risk of accident.**

#### For the sake of the environment

**Fit your summer tyres again as soon as possible. They are quieter, do not wear so quickly and reduce fuel consumption.**

### Snow chains

Snow chains are only permitted on front wheels and only for tyres 195/65R15 and 205/55R16. These tyres may only be fitted with fine-pitch link chains which do not protrude more than 15 mm » page 210.

Other tyres may use fine-pitch links which do not protrude more than 9 mm, including tension device.

Remove wheel hub covers and trim rings before fitting snow chains. For safety reasons, cover caps, available at any technical service, must then be fitted over the wheel bolts.

**All-wheel drive:** where snow chains are compulsory, this normally also applies to all-wheel drive vehicles. Snow chains may only be fitted to the **front** wheels (also on vehicles with all-wheel drive).

#### WARNING

**Snow chains should be correctly tightened in accordance with the manufacturer's instructions. This will prevent the chains coming into contact with the wheel housing.**

#### CAUTION

**Remove the snow chains to drive on roads without snow. Otherwise they will impair handling, damage the tyres and wear out very quickly.**

#### Note

- **In some countries, the maximum permitted speed with snow chains is 50 km/h (31 mph). The legal requirements of each country must be followed.**
- **We recommend that you ask your technical service for information about appropriate wheel, tyre and snow chain size.**

## Emergencies

### Vehicle tools, spare wheel

#### Vehicle Tools

The vehicle tools are located under the floor panel in the luggage compartment.

- Lift the cover of the luggage compartment, by pulling it up with a finger in the fitting.
- Take the vehicle tools out of the vehicle.

The vehicle tool kit includes:

- Jack.\*
- Hook for removing wheel covers\* or wheel trims\*
- Box spanner for wheel bolts.\*
- Towing ring.
- Adapter for the anti-theft wheel bolts\*

Some of the items listed are only provided in certain model versions, or are optional extras.

#### WARNING

- **The factory-supplied jack is only designed for changing wheels on this model. On no account attempt to use it for lifting heavier vehicles or other loads. Risk of injury.**
- **Use the jack only on a firm, level ground.** »

- Never start the engine when the vehicle is on the jack. Risk of accident.
- If work is to be carried out underneath the vehicle, this must be secured by suitable stands. Otherwise, there is a risk of injury.

#### Note

The jack does not generally require any maintenance. If required, it should be greased using universal-type grease.

### Compact spare wheel\* (temporary spare wheel)



**Fig. 154** Luggage compartment. Accessing the spare wheel.

The compact spare wheel (temporary spare wheel for vehicles without the anti-puncture kit) should only be used when strictly necessary.

The temporary spare wheel is stored under the floor panel in the luggage compartment and is attached by a thumbnut.

#### How to use the temporary spare wheel

Should you ever have a punctured tyre, the compact temporary spare wheel is only intended for temporary use until you can reach a workshop. The standard-size road wheel should be replaced as soon as possible.

Please note the following restrictions when using the temporary spare wheel. This temporary spare wheel has been specially designed for your vehicle, thus, it cannot be replaced by a temporary spare wheel from another vehicle.

No other type of tyre (normal summer or winter tyre) may be fitted on the compact temporary spare wheel rim.

#### Snow chains

For technical reasons, snow chains must **not** be used on the compact temporary spare wheel.

If you have a puncture on one of the *front wheels* when using snow chains, fit the compact temporary spare wheel in place of one of the rear wheels. You can then attach the snow chains to the wheel taken from the rear and use this wheel to replace the punctured front wheel.

#### WARNING

- The tyre pressures must be checked and corrected as soon as possible after fitting the temporary spare wheel. The pressure of the spare wheel sized 125/70R16 125/70R18 135/90R16 should be 4.2 bar (61 psi/420 kPa). For other sizes, check the label on the fuel cap. Failure to follow this instruction could result in an accident.
- Do not drive faster than 80 km/h (50 mph), since higher speeds can cause an accident.
- Avoid heavy acceleration, hard braking and fast cornering. Risk of accident.
- Never use more than one temporary spare wheel at the same time, risk of accident.
- No other type of tyre (normal summer or winter tyre) may be fitted on the compact temporary spare wheel rim.

## Wheel change

### Preparation work

- If you have a flat tyre or puncture, park the vehicle as far away from the flow of traffic as possible. Choose a location that is as level as possible.
- All vehicle occupants should leave the vehicle. They should wait in a safe area (for instance behind the roadside crash barrier).



- Switch off the engine. Switch on the hazard warning lights.
  - Apply the **handbrake** firmly.
  - Engage the **first gear**, or put the selector lever to position **P** for those vehicles with an automatic gearbox.
  - If you are towing a trailer, unhitch it from your vehicle.
  - Take the **vehicle tools** and the **spare wheel** out of the luggage compartment.
- Remove the **wheel cover**. Also refer to » **Fig. 155**.
  - Slacken the **wheel bolts**.
  - **Raise** the vehicle with the jack at the corresponding area.
  - **Remove** the wheel and **put on** the spare one.
  - **Lower** the vehicle.
  - Tighten the wheel bolts **firmly** with the box spanner.
  - Replace the **hub cap**.

### ⚠ WARNING

Put the hazard warning lights on and place the warning triangle in position. This is for your own safety and also warns other road users.

### ⓘ CAUTION

If you have to change the tyre on a gradient, block the wheel opposite the wheel being changed by placing a stone or similar object under it to prevent the vehicle from rolling away.

### 📄 Note

Please observe related legal requirements.

## Changing a wheel

Change the wheel as described below:

### After changing a wheel

- Put the tools back in their storage location.
- Place the wheel with the defective tyre in the luggage compartment and secure it.
- Check the tyre pressure of the newly fitted tyre as soon as possible.
- Have the tightening torque of the wheel bolts checked as soon as possible with a torque wrench. The prescribed torque must be 120 Nm.

### 📄 Note

- If you notice that the wheel bolts are corroded and difficult to turn when changing a

wheel, they must be replaced before having the wheel bolt tightening torque checked.

- For safety reasons, drive at moderate speeds until the wheel bolt tightening torque has been checked.

## Wheel trims



**Fig. 155** Changing a wheel: remove the wheel trim.

The wheel trims must be removed to gain access to the wheel bolts.

### Removing

- Insert the **extraction hook** from the tools into the designated ring, located in one of the bolt hole covers of the wheel cover » **Fig. 155**.

- Pull off the **hub cap**.

### Wheel covers\*

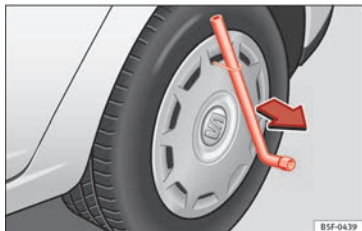

**Fig. 156** Changing a wheel: remove the wheel cover.

The wheel covers must be removed for access to the wheel bolts.

### Removing

- Remove the wheel cover using the wire hook » **Fig. 156**.
- Hook this into one of the cut-outs of the wheel cover.

### Fitting

- Fit the wheel cover onto the wheel rim by pressing it firmly. Put pressure initially on the point of the cut-out for the valve. Then press the wheel cover onto the steel rim so that it engages all round.

### Loosening the wheel bolts

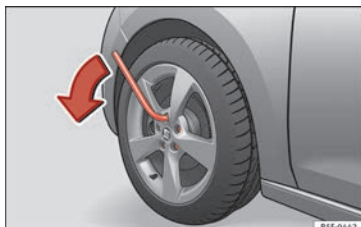

**Fig. 157** Changing a wheel: loosen the wheel bolts.

The wheel bolts must be loosened before raising the vehicle.

### Loosening

- Fit the **box spanner** as far as it will go over the wheel bolt.
- Grasp the box spanner by the end turn it about one full turn to the **left** » **Fig. 157**.

### Tightening

- Fit the box spanner as far as it will go over the wheel bolt.
- Grasp the box spanner close to the end and turn the bolt to the right until it is secured.
- An adapter is required to unscrew or tighten the anti-theft wheel bolts.

### ⚠ WARNING

Loosen the wheel bolts (only about one turn) before raising the vehicle with the jack, otherwise there is a risk of accident.

### i Note

- If the wheel bolt is very tight, you may be able to loosen it by pushing down the end of the spanner carefully with your foot. Hold on to the vehicle for support and take care not to slip.

## Lifting the vehicle

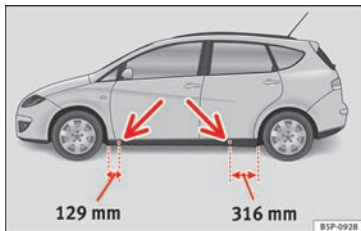

Fig. 158 Jack position points

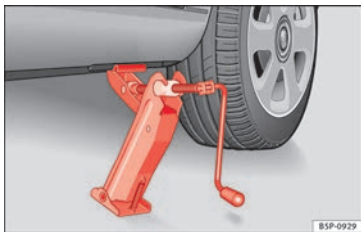

Fig. 159 Fitting the jack.

In order to remove the wheel, the vehicle must be raised with a jack.

- Locate the jacking point under the door sill closest to the punctured wheel » Fig. 158.
- Place the jack under the jacking point and turn the crank until the arm of the jack is di-

rectly below the vertical rib under the door sill.

- Align the jack so that the arm of the jack fits around the rib under the door sill and the movable base plate of the jack is flat on the ground » Fig. 159.
- Raise the vehicle until the defective wheel is just clear of the ground.

Recesses at the front and rear of the door sills mark the jacking points » Fig. 158. There is only one jacking point for each wheel. Do not fit the jack anywhere else.

An **unstable surface** under the jack may cause the vehicle to slip off the jack. Therefore, it must be fitted on solid ground offering good support. Use a large and stable base, if necessary. On a hard, slippery surface (such as tile) use a rubber mat or similar to prevent the jack from slipping.

### ⚠ WARNING

- Take all precautions so that the base of the jack does not slip. Failure to follow this instruction could result in an accident.
- The vehicle can be damaged if the jack is not applied at the correct jacking points. There is also a risk of injury since the jack can slip off suddenly if it is not properly engaged.

## Jack position points for vehicles with sill panel trim\*



Fig. 160 Plastic sill panel trim with jack anchor cover.

### Vehicles with plastic sill panel trim, with cover\*

- Remove the cap **A** to access the anchor point for the vehicle jack » Fig. 160.
- Pull on the cover and remove it from its allotment in the direction of the arrow » Fig. 160.
- Once the cover has been released, it will remain connected to its strap so that is not lost.

## Removing and fitting the wheel

Change the wheel as described below after loosening the wheel bolts and raising the vehicle with the jack.

### Removing a wheel

- Unscrew the wheel bolts using the box spanner and place them on a clean surface.

### Fitting a wheel

- Screw on the wheel bolts in position and tighten them loosely with a box spanner.

The wheel bolts should be clean and easily screwed. Before fitting the spare wheel, inspect the wheel condition and hub mounting surfaces. These surfaces must be clean before fitting the wheel.

If tyres with a specific direction of rotation are fitted, note the direction of rotation.

## Anti-theft wheel bolts\*

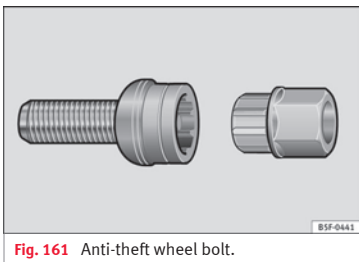

Fig. 161 Anti-theft wheel bolt.

A special adapter is required to turn the anti-theft wheel bolts.

- Insert the adapter onto the wheel bolt and push it on as far as it will go » Fig. 161.
- Fit the box spanner as far as it will go over the adapter.
- Loosen or tighten the wheel bolt as appropriate.

### Code

The code number of the anti-theft wheel bolt is stamped onto the front part of the adaptor.

The code number should be noted and kept in a safe place, as it is only by using the code number that a duplicate adaptor can be obtained from the SEAT Official Services.

## Tyres with directional tread pattern

A directional tread pattern can be identified by arrows on the sidewall that point in the direction of rotation. Always note the direction of rotation indicated when fitting the wheel. This is important so that these tyres can provide maximum grip and avoid excessive noise, tread wear and aquaplaning.

If, in an emergency, you have to mount the spare wheel so it rotates in the wrong direction, you must drive extremely carefully. The tyre will not give optimum performance. This is particularly important when driving on wet roads.

To benefit from the advantages of tyres with this type of tread pattern, the defective tyre should be replaced as soon as possible so that all tyres again rotate in the correct direction.

## Tyre repair

### TMS (Tyre Mobility System)\*

The Anti-puncture Kit\* (Tyre Mobility System) will reliably seal punctures caused by the penetration of a foreign body of up to about **4 mm** in diameter. **Do not remove foreign objects, e.g. screws or nails, from the tyre.**

After inserting the sealant residue in the tyre, you must again check the tyre pressure about 10 minutes after starting the engine.

You should only use the tyre mobility set if the vehicle is parked in a safe place, you are familiar with the procedure and you have the necessary tyre mobility set! Otherwise, you should seek professional assistance.

### The tyre sealant must not be used in the following cases:

- If the wheel rim has been damaged.
- In outside temperatures below -20 °C (-4 °F).
- In the event of cuts or perforations in the tyre greater than 4 mm.
- If you have been driving with very low pressure or a completely flat tyre.
- If the sealant bottle has passed its use by date.

#### **⚠ WARNING**

Using the tyre mobility system can be dangerous, especially when filling the tyre at the roadside. Please observe the following rules to minimise the risk of injury:

- Stop the vehicle safely as soon as possible. Park it at a safe distance from surrounding traffic to fill the tyre.
- Ensure the ground on which you park is flat and solid.

- All passengers and particularly children must keep a safe distance from the work area.
- Turn on the hazard warning lights to warn other road users.
- Use the tyre mobility system only if you are familiar with the necessary procedures. Otherwise, you should seek professional assistance.
- The tyre mobility set is intended for temporary emergency use only until you can reach the nearest specialised workshop.
- Replace the repaired tyre with the tyre mobility set as soon as possible.
- The sealant is a health hazard and must be cleaned immediately if it comes into contact with the skin.
- Always keep the tyre mobility set out of the reach of small children.
- Never use an equivalent jack, even if it has been approved for your vehicle.
- Always stop the engine, apply the hand-brake lever firmly and engage gear if using a manual gearbox, in order to reduce the risk of vehicle involuntary movement.

#### **⚠ WARNING**

A tyre filled with sealant does not have the same performance properties as a conventional tyre.

- Never drive faster than 80 km/h (50 mph).
- Avoid heavy acceleration, hard braking and fast cornering.

- Drive only during 10 minutes at a maximum speed of 80 km/h (50 mph) and subsequently check the tyre.

#### **♻ For the sake of the environment**

Dispose of used or expired sealant observing any legal requirements.

#### **i Note**

- A new bottle of sealant can be purchased at SEAT dealerships.
- Take into account the separate instruction manual from the tyre mobility set\* manufacturer.

### Contents of the tyre mobility system\*

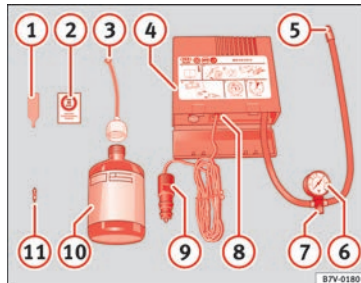

**Fig. 162** Standard representation: contents of the tyre mobility system.

The tyre mobility set is located underneath the floor covering in the boot. It includes the following components »» Fig. 162:

- ① Tyre valve remover
- ② Sticker indicating maximum speed “max. 80 km/h” or “max. 50 mph”
- ③ Filler tube with cap
- ④ Air compressor
- ⑤ Tube for inflating tyres
- ⑥ Warning provided by tyre pressure monitoring system<sup>1)</sup>
- ⑦ Air bleed screw<sup>2)</sup>
- ⑧ ON/OFF switch
- ⑨ 12 volt connector
- ⑩ Bottle of sealant
- ⑪ Spare tyre valve

The **valve insert remover** ① has a gap at the lower end for a valve insert. The valve insert can only be screwed or unscrewed in this way. This also applies to its replacement part ⑪.

## Sealing and inflating a tyre

### Sealing a tyre

- Unscrew the tyre valve cap.
- Use the enclosed extractor to unscrew the valve insert »» Fig. 162 ① and place the valve insert on a clean surface.
- Vigorously shake the sealant bottle »» Fig. 162 ⑩ for several seconds.
- Screw the inflator tube »» Fig. 162 ③ securely into the sealant bottle in a clockwise direction. The seal on the mouth of the bottle moves automatically.
- Remove the lid from the filling tube »» Fig. 162 ③ and screw the open end of the tube into the tyre valve.
- Hold the tyre sealant can upside down and fill the **complete** contents of the can into the tyre.
- Remove the tyre sealant bottle from the valve.
- Screw the valve insert into the tyre valve again with the corresponding tool »» Fig. 162 ①.

### Inflating the tyre

- Securely screw the tyre inflator tube »» Fig. 162 ⑤ of the compressor into the tyre valve.
- Check whether the air bleed screw »» Fig. 162 ⑦ is closed.
- Start the vehicle engine and leave it running.
- Attach the connector »» Fig. 162 ⑨ to one of the vehicle's 12 volt sockets »» page 99.
- Connect the air compressor with the ON/OFF switch »» Fig. 162 ⑧.
- Keep the air compressor running until it reaches 2.0 to 2.5 bar (29-36 psi / 200-250 kPa) »» ⚠. **Maximum operation time 8 minutes** »» ①.
- Disconnect the air compressor.
- If it is not possible to achieve an air pressure of 2.0 to 2.5 bar (29-36 psi / 200-250 kPa), unscrew the tyre inflator tube from the tyre valve.
- Move the vehicle some 10 metres forward or backward so that the sealant is evenly distributed in the tyre interior.
- Securely screw the compressor tyre inflator tube into the tyre valve and repeat the inflation process.

<sup>1)</sup> It can also be integrated in the compressor.

<sup>2)</sup> In its place, the compressor may have a button.

- If the indicated pressure still cannot be reached, the tyre is too badly damaged. The tyre cannot be sealed with the anti-puncture kit. Do not continue driving. You should obtain professional assistance »» ⚠.
- Disconnect the air compressor and unscrew the flexible inflator tube from the tyre valve.
- When the tyre pressure is between 2.5 and 2.0 bars, immediately continue driving without exceeding 80 km/h (50 mph).
- After **10 minutes**, Check the pressure again »» page 189.

### ⚠ WARNING

When inflating the wheel, the air compressor and the inflator tube may become hot.

- Protect hands and skin from hot parts.
- Do not place the hot flexible inflator tube or hot air compressor on flammable material.
- Allow them to cool before storing the device.
- If it is not possible to inflate the tyre to at least 2.0 bars (29 psi / 200 kPa), the tyre is too badly damaged. The sealant is not in a good condition to seal the tyre. Do not continue driving. Seek specialist assistance.

### ⓘ CAUTION

Switch off the air compressor after a maximum of 8 operational minutes to prevent it from overheating! Before switching on the air

compressor again, let it cool for several minutes.

### Check after 10 minutes of driving

Screw the inflator tube »» Fig. 162 ⑤ again and check the pressure on the gauge ⑥.

#### 1.3 bar (19 psi / 130 kPa) and lower:

- **Stop the vehicle!** The tyre cannot be sealed sufficiently with the tyre mobility set.
- You should obtain professional assistance »» ⚠.

#### 1.4 bar (20 psi / 140 kPa) and higher:

- Set the tyre pressure to the correct value again.
- Carefully resume your journey until you reach the nearest specialised workshop without exceeding 80 km/h (50 mph).
- Have the damaged tyre replaced.

### ⚠ WARNING

Driving with an unsealed tyre is dangerous and can cause accidents and serious injury.

- Do not continue driving if the tyre pressure is 1.3 bar (19 psi / 130 kPa) and lower.
- Seek specialist assistance.

## Jump-starting

### Jump leads

The jump lead must have a sufficient wire cross section.

If the engine fails to start because of a discharged battery, the battery can be connected to the battery of another vehicle to start the engine.

### Jump leads

Jump leads must comply with standard **DIN 72553** (see cable manufacturer's instructions). The wire cross section must be at least 25 mm<sup>2</sup> for petrol engines and at least 35 mm<sup>2</sup> for diesel engines.

### ⓘ Note

- The vehicles must not touch each other, otherwise electricity could flow as soon as the positive terminals are connected.
- The discharged battery must be properly connected to the on-board network.

## How to jump start: description

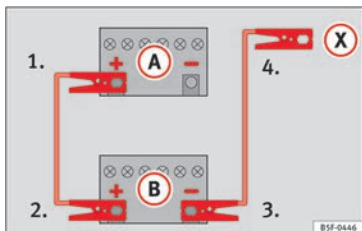

Fig. 163 Diagram of connections for vehicles without Start-Stop system.

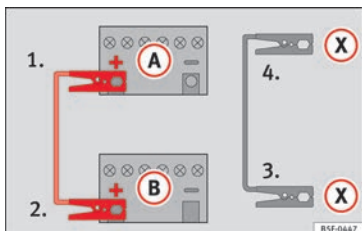

Fig. 164 Diagram of connections for vehicles with Start-Stop system.

### Jump lead terminal connections

1. Switch off the ignition of both vehicles  
» » ⚠.

2. Connect one end of the *red* jump lead to the positive (+) terminal of the vehicle with the flat battery (A) » » Fig. 163.
3. Connect the other end of the *red* jump lead to the positive terminal (+) in the vehicle providing assistance (B).
4. **For vehicles without Start-Stop system:** connect one end of the *black* jump lead to the negative terminal (-) in the vehicle providing assistance (B) » » Fig. 163.
- **For vehicles with Start-Stop system:** Connect one end of the *black* jump lead (X) to a suitable ground terminal, a solid piece of metal in the engine block, or to the engine block itself » » Fig. 164.
5. Connect the other end of the *black* jump lead (X) to a solid metal component bolted to the engine block or to the engine block itself of the vehicle with the flat battery. Do not connect it to a point near the battery (A).
6. Position the leads in such a way that they cannot come into contact with any moving parts in the engine compartment.

### Starting

7. Start the vehicle's engine with the boosting battery and let it run at idling speed.
8. Start the engine of the vehicle with the flat battery and wait 2 or 3 minutes until the engine is "running".

### Removing the jump leads

9. Before you remove the jump leads, switch off the dipped beam headlights (if they are switched on).
10. Turn on the heater blower and heated rear window in the vehicle with the flat battery. This helps minimise voltage peaks which are generated when the leads are disconnected.
11. When the engine is running, disconnect the leads in reverse order to the details given above.

Connect the battery clamps so they have good metal-to-metal contact with the battery terminals.

If the engine fails to start, switch off the starter after about 10 seconds and try again after about a minute.

### ⚠ WARNING

- Please note the safety warnings referring to working in the engine compartment » » page 163, Working in the engine compartment.
- The battery providing assistance must have the same voltage as the flat battery (12 V) and approximately the same capacity (see imprint on battery). Failure to comply could result in an explosion.
- Never use jump leads when one of the batteries is frozen. Danger of explosion! Even



after the battery has thawed, battery acid could leak and cause chemical burns. If a battery freezes, it should be replaced.

- Keep sparks, flames and lighted cigarettes away from batteries, danger of explosion. Failure to comply could result in an explosion.
- Observe the instructions provided by the manufacturer of the jump leads.
- Do not connect the negative cable from the other vehicle directly to the negative terminal of the flat battery. The gas emitted from the battery could be ignited by sparks. Danger of explosion.
- Do not attach the negative cable from the other vehicle to parts of the fuel system or to the brake line.
- The non-insulated parts of the battery clamps must not be allowed to touch. The jump lead attached to the positive battery terminal must not touch metal parts of the vehicle, this can cause a short circuit.
- Position the leads in such a way that they cannot come into contact with any moving parts in the engine compartment.
- Do not lean on the batteries. This could result in chemical burns.

 Note

The vehicles must not touch each other, otherwise electricity could flow as soon as the positive terminals are connected.

## Towing and tow-starting

### Tow-starting

We recommend that you do **not** tow-start your vehicle. Jump-starting is preferable  
» page 189.

#### However, if your vehicle has to be tow-started:

- Engage 2<sup>nd</sup> or 3<sup>rd</sup> gear.
- Keep the clutch pressed down.
- Switch the ignition on.
- Once both vehicles are moving, release the clutch.
- As soon as the engine starts, press the clutch and move the gear lever into neutral. This helps to prevent driving into the towing vehicle.

 **WARNING**

The risk of accidents is high when tow-starting. The vehicle being towed can easily collide with the towing vehicle.

 **CAUTION**

When tow-starting, fuel could enter the catalytic converter and damage it.

### General notes

Please observe the following points if you use a tow rope:

#### Notes for the driver of the towing vehicle

- Drive slowly at first until the tow rope is taut. Then accelerate gradually.
- Begin and change gears cautiously. If you are driving an automatic vehicle, accelerate gently.
- Remember that the brake servo and power steering are not working in the vehicle you are towing. Brake sooner than normal and pressing the pedal gently.

#### Notes for the driver of the towed vehicle

- Ensure that the tow rope remains taut at all times when towing.

#### Tow rope or tow bar

It is easier and safer for the vehicle to be towed using a tow bar. You should only use a tow-rope if you do not have a tow-bar.

A tow rope should be slightly elastic to reduce the loading on both vehicles. It is advisable to use a tow rope made of synthetic fibre or similarly elastic material.

Attach the tow rope or the tow bar only to the towline anchorages provided or a towing bracket.



## Driving style

Towing requires some experience, especially when using a tow rope. Both drivers should be familiar with the technique required for towing. Inexperienced drivers should not attempt to tow.

Do not pull too hard with the towing vehicle and take care to avoid jerking the tow rope. When towing on an unpaved road, there is always a risk of overloading and damaging the anchorage points.

The ignition of the vehicle being towed must be switched on to prevent the steering wheel from locking and also to allow the use of the turn signals, horn, windscreen wipers and washers.

The brake servo only works when the engine is running. When not running, you must apply considerably more pressure to the brake pedal.

As the power assisted steering does not work if the engine is not running, you will need more strength to steer than you normally would.

- The vehicle must not be towed faster than 50 km/h (31 mph).

## Towing vehicles with an automatic gearbox

- Put the selector lever into position “N”.
- Do not drive faster than 50 km/h (31 mph).

- Do not tow further than 50 km.
- If a breakdown vehicle is used, the vehicle must be towed with the front wheels raised.

### Note

- Observe legal requirements when towing or tow-starting.
- Switch on the hazard warning lights of both vehicles. However, observe any regulations to the contrary.
- For technical reasons, vehicles with an automatic gearbox must not be tow-started.
- If there is no lubricant in the gearbox as the result of a fault, you must raise the driven wheels while the vehicle is being towed.
- If the vehicle has to be towed more than 50 km, the front wheels should be raised during towing, and towing should be carried out by a qualified person.
- The steering wheel is locked when the vehicle has no electrical power. The vehicle must then be towed with the front wheels raised. Towing should be carried out by a qualified person.
- The towline anchorage should always be kept in the vehicle. Please refer to the notes on » page 191, Tow-starting.

## Towline anchorages



**Fig. 165** Fitting the front towline anchorage to the front right section of the vehicle.

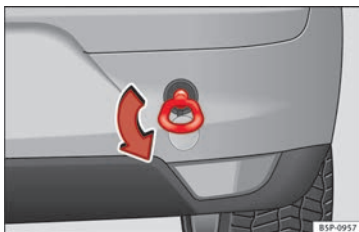

**Fig. 166** Fitting the towline anchorage to the rear of the vehicle.

## Front towline anchorage

- Take the towline anchorage from the on-board tool set.
- Remove the cover by pressing down on its left-hand side.

- Bolt the anchorage to its limit to the *left*, in the direction of the arrow »» Fig. 165.

#### Rear towline anchorage

- Take the towline anchorage from the on-board tool set.
- Remove the cover by pressing down on its right-hand side.
- Bolt the anchorage to its limit to the *left*, in the direction of the arrow »» Fig. 166.

After use, unscrew the towline anchorage and put it back in the vehicle tool kit. Replace the cover on the bumper. The towline anchorage should always be kept in the vehicle.

## Emergency locking and unlocking

### Emergency manual locking

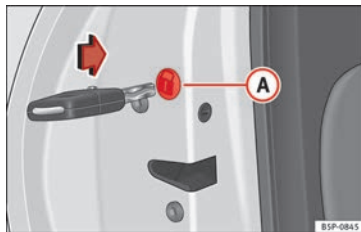

Fig. 167 Emergency door locking.

This permits mechanical locking of the doors in case of central locking system failure.

#### Locking the driver door manually

Insert the key in the door lock cylinder and rotate in a clockwise direction for the left hand side door and anticlockwise for the right hand side door.

Once the door has been closed it can no longer be opened from the outside.

#### Manual (emergency) locking of the remaining doors

Open the door and remove the cap **A** »» Fig. 167 printed with a lock image. This

will expose a circular element with a groove in the centre. Insert the key into the groove and rotate the element clockwise for the right hand side doors and anticlockwise for the left hand side doors.

Replace the cap and close the door. Once the door has been locked it can no longer be opened from the outside.

#### Unlocking the manually (emergency) locked driver door

Insert the key in the door lock cylinder and rotate anticlockwise for the left hand side doors and clockwise for the right hand side doors.

The door lock is released and the door may be opened using the exterior door handle.

#### Unlocking the remaining manually (emergency) locked doors

First the driver door must be unlocked to gain entry to the vehicle. Operate the internal door handle for the required door. If the childproof lock is activated on the rear doors, when the interior door release lever is operated the door is unlocked but does not open. The door must be opened from the outside.

#### **i** Note

**Once the vehicle is open, if you wish to lock it manually, repeat the previous instructions.**

## Emergency boot hatch opening



**Fig. 168** Rear lid: emergency opening.

This allows the vehicle to be opened if the central locking does not work (for example, if the battery is flat)

There is a groove in the luggage compartment allowing access to the emergency opening mechanism.

### Opening the rear lid from inside the luggage compartment

- Insert the key in the groove and unlock the locking system, turning the key from right to left, as shown by the arrow » **Fig. 168**.

## Changing the wiper blades

### Changing windscreen wiper blades



**Fig. 169** Windscreen wipers in the service position.

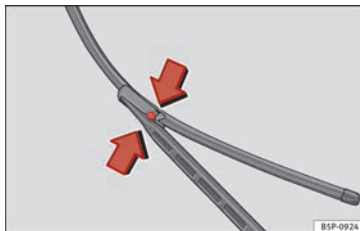

**Fig. 170** Changing the windscreen wiper blades

Perfect wiper blade condition is essential for clear vision. Damaged wiper blades should be replaced immediately.

To change the blades it is necessary to move the wipers from the rest position into the service position.

### Service position (for changing wiper blades)

- Ensure that the wiper blades are not frozen.
- Turn the ignition on and off and then (within approximately 8 seconds), push the windscreen wiper lever out of the short wipe position. The windscreen wipers will move to the service position.

### Changing the windscreen wiper blades

- Lift the wiper arm away from the windscreen.
- Push the side buttons, free the blade and pull in the direction of the arrow » **Fig. 170**

### Fitting the wiper blade

- Insert a blade of identical length and design into the wiper arm.
- Slide the blade until it clicks into position.
- Push the wiper arms back against the windscreen.

The windscreen wiper arms return to their original position when the ignition is turned on and the windscreen wiper lever is operated, or when driving faster than 6 km/h.

If the **windscreen wipers scratch**, they should be replaced if they are damaged, or cleaned if they are soiled.

If this does not produce the desired results, the setting angle of the windscreen wiper arms might be incorrect. They should be checked by a specialised workshop and corrected if necessary.

### **⚠ WARNING**

**Do not drive unless you have good visibility through all windows!**

- Clean the windscreen wiper blades and all windows regularly.
- The wiper blades should be changed once or twice a year.

### **ⓘ CAUTION**

- Damaged or dirty windscreen wipers could scratch the windscreen.
- Never use fuel, nail varnish remover, paint thinner or similar products to clean the windows. This could damage the windscreen wiper blades.
- Never move the windscreen wiper or windscreen wiper arm manually. This could cause damage.
- To prevent damage to the bonnet and the windscreen wiper arms, the latter should only be lifted off the windscreen when in service position.

### **ⓘ Note**

- The windscreen wiper arms can be moved to the service position only when the bonnet is properly closed.

### Changing the rear wiper blade

✓ Applies to the model: ALTEA

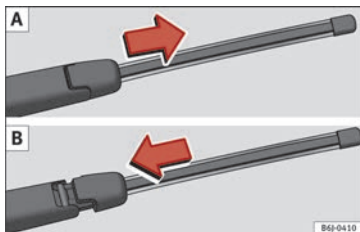

**Fig. 171** Changing the rear window wiper blade.

Perfect rear wiper blade condition is essential for clear rear vision. Damaged wiper blades should be replaced immediately.

### Removing the wiper blade

- Lift the wiper arm away from the glass
- Slide the blade adapter in the direction of the arrow and remove the blade »» **Fig. 171 A**.

### Fitting the wiper blade

- With one hand, hold the top end of the wiper arm.
- Place the blade as shown in »» **Fig. 171 B** and slide the adapter along until it engages.

Check the condition of the wiper blade regularly. Change as required.

If the **windscreen wiper scrapes**, it should be replaced if damaged, or cleaned if soiled.

If this is not sufficient, refer to a specialised workshop.

### **⚠ WARNING**

**Do not drive unless you have good visibility through all windows!**

- Clean the windscreen wiper blades and all windows regularly.
- The wiper blades should be changed once or twice a year.

### **ⓘ CAUTION**

- A damaged or dirty window wiper could scratch the rear window.
- Never use fuel, nail varnish remover, paint thinner or similar products to clean the window as they may damage the blades.
- Never move the windscreen wiper by hand. This could cause damage.

## Changing the rear wiper blade

✓ Applies to the model: ALTEA XL/ALTEA FREETRACK

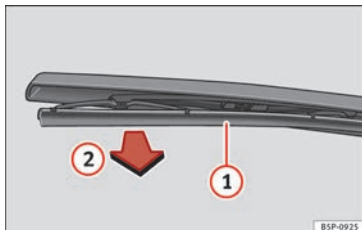

**Fig. 172** Changing the rear window wiper blade.

Perfect rear wiper blade condition is essential for clear rear vision. Damaged wiper blades should be replaced immediately.

### Removing the wiper blade

- Lift the rear wiper arm.
- Release the blade **1** by pulling it in the direction of the arrow **2**.

### Fitting the wiper blade

- Insert the wiper blade onto the windscreen wiper arm until it clicks into place.

Check the condition of the wiper blade regularly. Change as required.

If the **windscreen wiper scrapes**, it should be replaced if damaged, or cleaned if soiled.

If this is not sufficient, refer to a specialised workshop.

#### ⚠ WARNING

**Do not drive unless you have good visibility through all windows!**

- Clean the windscreen wiper blades and all windows regularly.
- The wiper blades should be changed once or twice a year.

#### ⓘ CAUTION

- A damaged or dirty window wiper could scratch the rear window.
- Never use fuel, nail varnish remover, paint thinner or similar products to clean the window as they may damage the blades.
- Never move the windscreen wiper by hand. This could cause damage.

## Fuses and bulbs

### Fuses

#### Introduction

Due to the constant updating of vehicles, fuse assignments based on equipment and the use of the same fuse for various electrical components, it is not possible to provide an up-to-date summary of the fuse positions for the electrical components at the time this manual was printed. For detailed information about the fuse positions, please consult a technical service.

In general, a fuse can be assigned to various electrical components. Likewise, an electrical component can be protected by several fuses.

Only replace fuses when the cause of the problem has been solved. If a newly inserted fuse blows after a short time, you must have the electrical system checked by a specialised workshop as soon as possible.

#### Additional information and warnings:

- Working in the engine compartment  
» page 163.

**⚠ WARNING**

The high voltages in the electrical system can give serious electrical shocks, causing burns and even death!

- Never touch the electrical wiring of the ignition system.
- Take care not to cause short circuits in the electrical system.

**⚠ WARNING**

Using unsuitable fuses, repairing fuses or bridging a current circuit without fuses can cause a fire and serious injury.

- Never use a fuse with a higher value. Only replace fuses with a fuse of the same amperage (same colour and markings) and size.
- Never repair a fuse.
- Never replace a fuse by a metal strip, staple or similar.

**⚠ CAUTION**

- To prevent damage to the vehicle's electric system, before replacing a fuse turn off the ignition, the lights and all electrical elements and remove the key from the ignition.
- If you replace a fuse with higher-rating fuse, you could cause damage to another part of the electrical system.
- Protect the fuse boxes when open to prevent the entry of dust or humidity as they can damage the electrical system.

**i Note**

- One component may have more than one fuse.
- Several components may run on a single fuse.

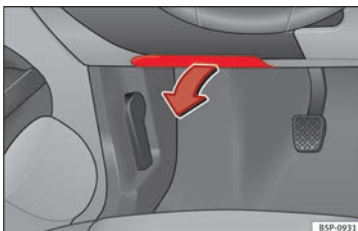
**Vehicle fuses**

**Fig. 173** Left side of dash panel fuse box cover

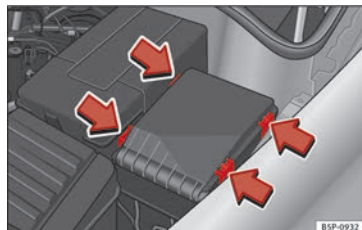

**Fig. 174** In the engine compartment: fuse box cover

Only replace fuses with a fuse of the same amperage (same colour and markings) and size.

**Identifying fuses situated below the driver-side dash panel by colours**

Colour	Amp rating
Purple	3
Light brown	5
Brown	7.5
Red	10
Blue	15
Yellow	20
White or transparent	25
Green	30

Colour	Amp rating
Orange	40

### Opening and closing the fuse box situated below the dash panel

- *Opening*: fold the cover down »» Fig. 173.
- *Closing*: push back the cover it in until it clicks into place.

### To open the engine compartment fuse box

- Open the bonnet  $\Delta$  »» page 163.
- Press the locking tabs in the direction indicated by the arrows to release the fuse box cover »» Fig. 174.
- Then lift the cover out.
- To **fit** the cover, place it on the fuse box. Push the locking tabs down, in the opposite direction to that indicated by the arrows, until you hear them click into place.

#### ⓘ CAUTION

- **Always carefully remove the fuse box covers and refit them correctly to avoid problems with your vehicle.**
- **Protect the fuse boxes when open to avoid the entry of dust or humidity. Dirt and humidity inside fuse boxes can cause damage to the electrical system.**

#### ⓘ Note

**In the vehicle, there are more fuses than those indicated in this chapter. These should only be changed by a specialised workshop.**

### Replacing a blown fuse

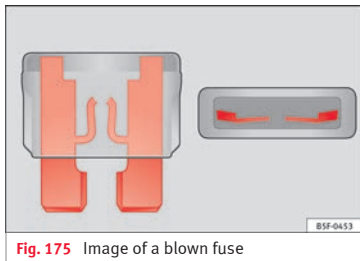

Fig. 175 Image of a blown fuse

#### Preparation

- Switch off the ignition, lights and all electrical equipment.
- Open the corresponding fuse box »» page 197.

#### Identifying a blown fuse

A fuse is blown if its metal strip is ruptured »» Fig. 175.

Point a lamp at the fuse. This will make it easier to see if the fuse is blown.

#### To replace a fuse

- Remove the fuse.
- Replace the blown fuse by one with an *identical* amperage rating (same colour and markings) and *identical* size »» ⓘ.
- Replace the cover again or close the fuse box lid.

#### ⓘ CAUTION

**If you replace a fuse with higher-rating fuse, you could cause damage to another part of the electrical system.**

## Changing the lights

### General notes

Before changing any bulb, first turn off the failed device.

Do not touch the glass part of the bulb with your bare hands. The fingerprints left on the glass will vaporise as a result of the heat generated by the bulb, reducing bulb life and causing condensation on the reflector surface, thus reducing effectiveness.

A bulb must only be replaced by one of the same type. The type is indicated on the bulb, either on the glass part or on the base.

It is highly recommended to keep a box of spare bulbs in the vehicle. At the very least,



the following spare bulbs, which are essential for road safety, should be kept in the vehicle.

### Main headlights

Dipped beam - H7

Main beam - H1

Position - W5W

Turn signal - PY21W

### Xenon headlights<sup>1)</sup> /adaptive\*

Dipped and full beam - D1S<sup>2)</sup>

Daylight - P21W SLL

Position - W5W

Turn signals - PY21W

### Front fog light

Front fog light - H3

<sup>1)</sup> On this type of headlight, the bulb changes must be made by the technical service, given that complex elements must be removed from the vehicle and the incorporated automatic control system must be re-set.

<sup>2)</sup> The Xenon bulbs discharge 2.5 times the light flux and have an average lifespan of 5 times more than that of halogen bulbs, this means that, except due to unusual circumstances, there is no need to change the bulbs for the whole life of the vehicle.

<sup>3)</sup> Electronically controlled single filament bulb for Stop/side bulbs. If the bulb blows it will not work in either position or Stop.

### Upper tail light (ALTEA)

Stop/Position - P21W<sup>3)</sup>

Turn signal - R10W

### Lower tail light (ALTEA)

Fog light - P21W

Reverse light - P21W

### Fixed tail light (ALTEA XL / ALTEA FREETRACK)

Stop/Position - P21W<sup>3)</sup>

Turn signal - P21W

### Mobile tail light (ALTEA XL / ALTEA FREETRACK)

Fog light (driver side) - P21W

Reverse (passenger side) - P21W

Position - W5W

### Side turn signal

Side turn signal - W5W

### Number plate light

Number plate light - C5W

#### Note

- Depending on weather conditions (cold or wet), the headlights, the fog lights, the tail lights and the turn signals may be temporarily misted. This has no influence on the useful life of the lighting system. By switching on the lights, the area through which the beam of light is projected will quickly be demisted. However, the edges may continue to be misted.

- Please check at regular intervals that all lighting (especially the exterior lighting) on your vehicle is functioning properly. This is



not only in the interest of your own safety, but also that of all other road users.

- Due to difficulty of access to some of the bulbs, any replacement work should be done by a technical service. However, the following is a description of how to change the lamps except for the fog lights\* and interior lamps.

### Main headlight bulbs

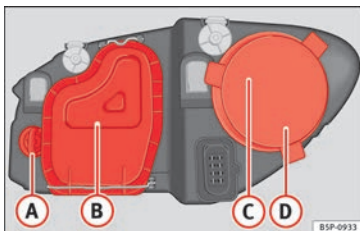

Fig. 176 Main headlight bulbs.

- A** Turn signal
- B** Dipped beam headlights
- C** Main beam headlights
- D** Side light

### Turn signal bulbs

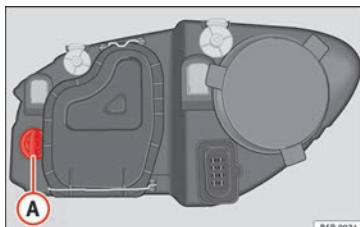

Fig. 177 Turn signal bulb.

- Raise the bonnet.
- Rotate the bulb holder »» Fig. 177 **A** to the left and pull.
- Remove the bulb by pressing on the bulb holder and turn it anti-clockwise at the same time.
- Installation involves all of the above steps in reverse sequence.

### Dipped lights

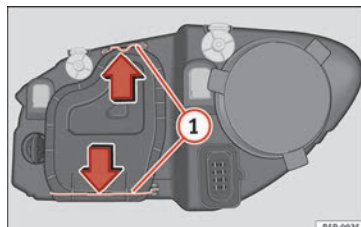

Fig. 178 Dipped beam headlights.

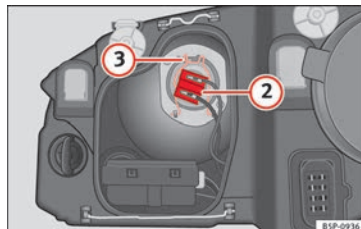
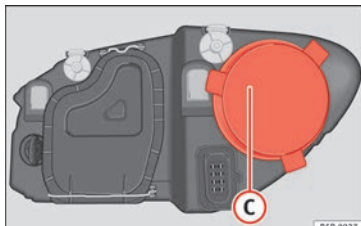

Fig. 179 Dipped beam headlights.

- Raise the bonnet.
- Move the loops »» Fig. 178 **1** in the direction of the arrow and remove the cover.
- Remove connector »» Fig. 179 **2** from the bulb.

- Unclip the retainer spring »»» **Fig. 179** ③ pressing inwards to the right.
- Extract the bulb and fit the replacement so that the lug on the base fits into the recess on the reflector.

### Main beam lights



**Fig. 180** Main beam headlight.

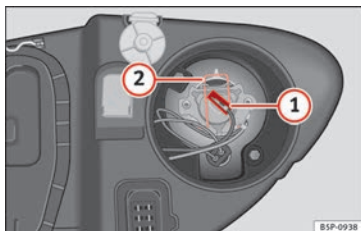

**Fig. 181** Main beam headlight.

- Raise the bonnet.
- Remove the cover »»» **Fig. 180** ③ by pulling on this.
- Remove connector »»» **Fig. 181** ① from the bulb.
- Press the spring »»» **Fig. 181** ② inwards and to the right.
- Extract the bulb and fit the replacement so that it sits correctly into the cut-out on the reflector.
- Installation involves all of the above steps in reverse sequence.

### Side lights

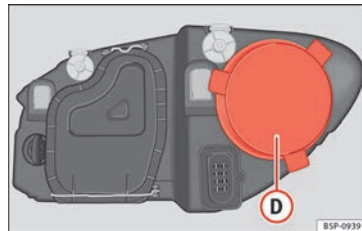

**Fig. 182** Side light.

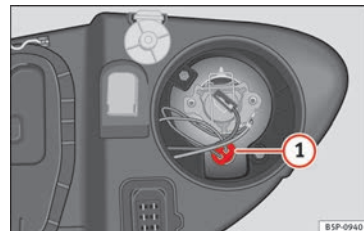

**Fig. 183** Side light.

- Raise the bonnet.
- Remove the cover »»» **Fig. 182** ④ by pulling on this.
- Extract the bulb holder »»» **Fig. 183** ① outwards.
- Replace the bulb by pulling it out and inserting the replacement.
- Installation is done in the reverse order.

## Side lights/ brake lights

✓ Applies to the model: ALTEA

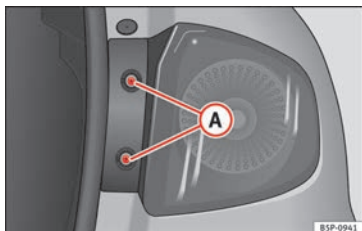

Fig. 184 Side lights and brake lights.

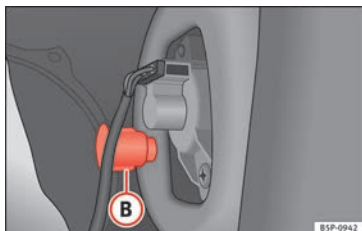

Fig. 185 Side lights and brake lights.

- Open the rear lid.
- Remove the bolts » Fig. 184 (A).
- Remove the cover of the luggage compartment lateral panel.

- Unscrew the plastic fitting » Fig. 185 (B) securing the tail light. Inserting a screwdriver under the plastic fitting may help to loosen it.
- Partially remove the tail light from its casing taking care not to pull on the cable.
- Remove the bulb holder connector.
- Unscrew the bolts » Fig. 186 (C) from the bulb holder and pull on this.
- Press on the bulb and rotate to the left then fit the replacement.
- To refit follow the steps in reverse order, taking special care when fitting the bulb holder. The metal contacts of the bulb holder ends should be correctly fitted with respect to the rear light contacts.

## Turn signal light

✓ Applies to the model: ALTEA

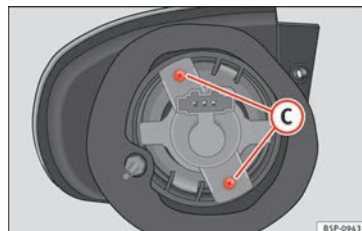

Fig. 186 Turn signal light.

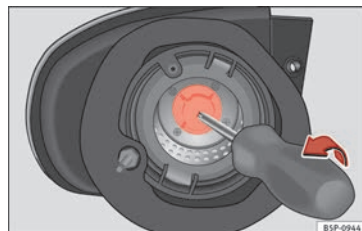

Fig. 187 Turn signal light.

- Remove the lamp from its housing » page 202.
- Unscrew the bolts » Fig. 186 (C) from the bulb holder and pull on this.

- Pull out the turn signal bulb holder using a screw driver in the direction of the arrow »» **Fig. 187.**
- Fit the replacement bulb by pressing it down and rotating to the left.
- Installation involves all of the above steps in reverse sequence.

### Reverse light/rear fog light

✓ Applies to the model: ALTEA

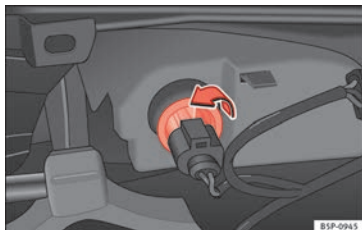

**Fig. 188** Lamp on interior side of bumper.

- Rotate the bulb holder to the left and remove it in the direction of the arrow »» **Fig. 188.**
- Replace the bulb by pressing on it and rotating at the same time to the left

### Turn signal, side and brake lights on the body

✓ Applies to the model: ALTEA XL/ALTEA FREETRACK



**Fig. 189** Lights on the vehicle body.

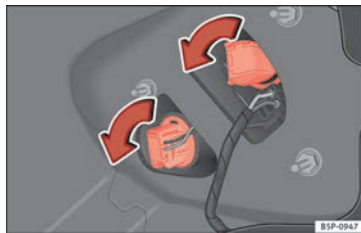

**Fig. 190** Lights on the vehicle body.

- Open the cover of the luggage compartment side panel »» **Fig. 189.**
- Turn the bulb holder to the left »» **Fig. 190.**

- Remove the blown bulb and change it for a new one.
- To refit follow the steps in reverse order, taking special care when fitting the bulb holder.

## Position light, fog light and reverse light on the rear lid

✓ Applies to the model: ALTEA XL/ALTEA FREETRACK



Fig. 191 Lights on the boot.

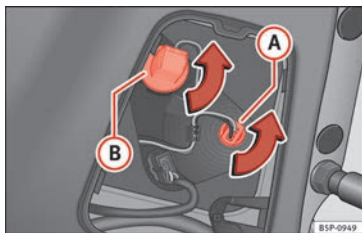

Fig. 192 Side light.

### Side light **A**

- Open the rear lid.
- Pull the cover off.

- Take the lampholder out pressing on the securing pins and extract it outwards.
- Remove the blown bulb and replace it with another.
- To refit follow the steps in reverse order, taking special care when fitting the bulb holder.

### Fog light and reverse lights **B**

- Open the rear lid.
- Pull the cover off.
- Turn the bulb holder to the left.
- Remove the blown bulb and replace it with another.
- Installation involves all of the above steps in reverse sequence.

## Side turn signals

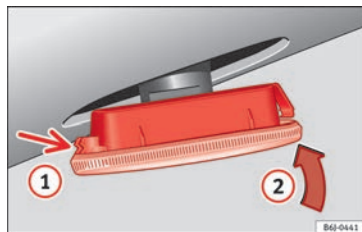

Fig. 193 Side turn signal.

- Press the turn signal to the left or to the right to remove the bulb.
- Remove the bulb holder from the turn signal.
- Remove the failed glass bulb and replace with a new bulb.
- Insert the bulb holder in the turn signal guide until it clicks into place.
- First place the turn signal in the opening in the bodywork, fixing the tabs » Fig. 193, arrow **1**.
- Insert the bulb as shown by the arrow **2** » Fig. 193.

## Luggage compartment lights

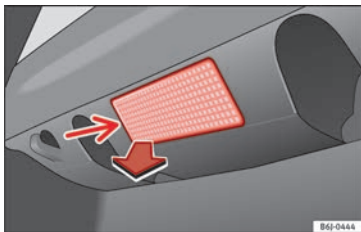

Fig. 194 Boot light.

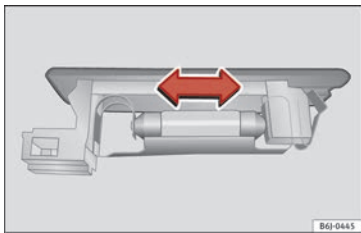

Fig. 195 Boot light.

- Extract the bulb by pressing on its inside edge -arrow- using the flat side of a screwdriver »» Fig. 194.
- Press the bulb sideways and remove it from its housing »» Fig. 195.

## Registration light

✓ Applies to the model: ALTEA

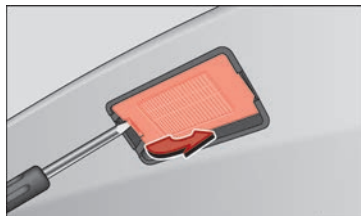

Fig. 196 Number plate light.



Fig. 197 Number plate light.

- Remove the bulb, carefully using the flat side of a screwdriver as a lever inserted in the crack as shown by the arrow »» Fig. 196.
- Remove the bulb, moving it outward and in the direction of the arrow »» Fig. 197.

## Registration light

✓ Applies to the model: ALTEA XL/ALTEA FREETRACK



Fig. 198 Number plate light.

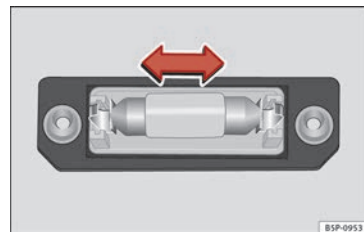
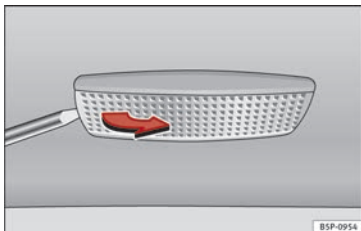

Fig. 199 Number plate light.

- Unscrew the screws to remove the bulb »» Fig. 198.
- Remove the bulb, moving it outward and in the direction of the arrow »» Fig. 199.
- Installation involves all of the above steps in reverse sequence.

## Sun visor light



**Fig. 200** Removing the sun visor light.

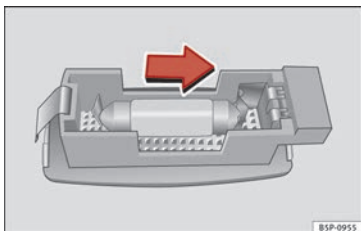

**Fig. 201** Removing the sun visor light.

- Carefully remove the lamp, using the flat side of a screwdriver, as shown in the figure »» **Fig. 201**.
- Remove the bulb, moving it outward and in the direction of the arrow »» **Fig. 201**.



## Technical specifications

### Technical features

### Important information

#### Important

The information in the vehicle documentation always takes precedence over the information in this Instruction Manual.

All technical specifications provided in this documentation are valid for the standard model in Spain. The vehicle data card included in the Maintenance Programme or the vehicle registration documents shows which engine is installed in the vehicle.

The figures may be different depending whether additional equipment is fitted, for different models, for special vehicles and for other countries.

#### Abbreviations used in the Technical Specifications section

Ab- bre- via- tion	Meaning
kW	Kilowatt, engine power measurement.
PS	Pferdestärke (horsepower), formerly used to denote engine power.

Ab- bre- via- tion	Meaning
rpm	Revolutions per minute - engine speed.
Nm	Newton metres, unit of engine torque.
litres per 100 km	Fuel consumption in litres per 100 km (70 miles).
g/km	Carbon dioxide emissions in grams per km (mile) travelled.
CO <sub>2</sub>	Carbon dioxide
CN	Cetane number, indication of the diesel combustion power.
RON	Research octane number, indication of the knock resistance of petrol.

## Vehicle identification data

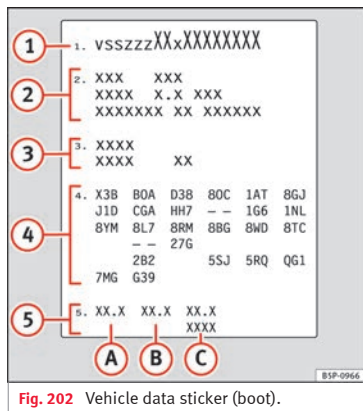

Vehicles for certain export countries do not have an identification plate.

### Identification plate

The identification plate is located on the left rib inside the engine compartment.

### Vehicle data

The data sticker is placed on the inside of the spare wheel well, in the boot and on the rear cover of the Maintenance Programme.

The following information is provided on the vehicle data sticker: » **Fig. 202**

- 1 Vehicle identification number (chassis number)
- 2 Vehicle type, model, displacement, engine type, finish, engine power and gearbox type
- 3 Engine code, gearbox code, external paint code and internal equipment code
- 4 Optional extras and PR numbers
- 5 Consumption values (l/100 km) and CO<sub>2</sub> emissions (g/km)
  - A Urban cycle consumption
  - B Out-of-town consumption
  - C Combined consumption and CO<sub>2</sub> emissions

### Chassis number

The chassis number can be read from outside the vehicle through a viewer in the windscreen » **Fig. 203**. This is located on the left-hand side of the vehicle in the lower corner of the windscreen. It is also located on the right hand side of the engine compartment.

## Information on fuel consumption

### Fuel consumption

The consumption and emission details shown on the vehicle data sticker differ from one vehicle to another.

Vehicle fuel consumption and CO<sub>2</sub> emissions can be consulted on the vehicle data sticker in the spare wheel well, inside the boot and on the rear cover of the Maintenance Programme.

The fuel consumption and CO<sub>2</sub> emission values refer to the weight category assigned to your vehicle according to the engine and gearbox combination, as well as the specific equipment fitted, and is only used to compare between the different models.

The fuel consumption and CO<sub>2</sub> emissions do not depend only on the performance of the

vehicle, they can also differ from the established values depending on other factors such as driving style, road conditions, traffic conditions, environmental conditions, load and number of passengers.

### Calculation of fuel consumption

The consumption values have been calculated based on measurements performed or supervised by certified CE laboratories according to the latest version of directives 715/2007/EC and 80/1268/CEE (for more information consult the European Union Publications Office at EUR-Lex: © European Union, <http://eur-lex.europa.eu/en/index.htm>) and are valid for the kerb weight indicated for the vehicle.

#### Note

**In practice, and considering all the factors mentioned here, consumption values can differ from those calculated in the current European regulations.**

### Weights

Kerb weight refers to the basic model with a fuel tank filled to 90% capacity and without optional extras. The figure quoted includes 75 kg to allow for the weight of the driver.

For special versions and optional equipment fittings or for the addition of accessories, the weight of the vehicle will increase »» .

#### WARNING

- **Please note that the centre of gravity may shift when transporting heavy objects; this may affect vehicle handling and lead to an accident. Always adjust your speed and driving style to suit road conditions and requirements.**
- **Never exceed the gross axle weight rating or the gross vehicle weight rating. If the permissible axle load or the permissible total weight is exceeded, the driving characteristics of the vehicle may change, leading to accidents, injuries and damage to the vehicle.**

## Towing a trailer

### Trailer weights

#### Trailer weight

The trailer weights and drawbar loads approved are selected in intensive trials according to precisely defined criteria. The approved trailer weights are valid for vehicles in the EU and generally, for maximum speeds of 80 km/h (50 mph) (in certain circumstances up to 100 km/h (62 mph)). The figures may be different in other countries. All data in the

official vehicle documentation takes precedence over these data at all times »» .

### Drawbar loads

The *maximum* permitted drawbar load on the ball joint of the towing bracket must not exceed **75 kg**.

In the interest of road safety, we recommend that you always tow approaching the maximum drawbar load. The response of the trailer on the road will be poor if the drawbar load is too small.

If the maximum permissible drawbar load cannot be met (e.g. with small, empty and light-weight single axle trailers or tandem axle trailers with a wheelbase of less than 1 metre), a minimum of 4% of the actual trailer weight is legally required for the drawbar load.

#### WARNING

- **For safety reasons, you should not drive at speeds above 80 km/h (50 mph) when towing a trailer. This also applies in countries where higher speeds are permitted.**
- **Never exceed the maximum trailer weights or the drawbar load. If the permissible axle load or the permissible total weight is exceeded, the driving characteristics of the vehicle may change, leading to accidents, injuries and damage to the vehicle.**

## Wheels

### Tyre pressure, snow chains, wheel bolts

#### Tyre pressures

The sticker with the tyre pressure values can be found on the inside of the fuel tank flap. The tyre pressure values given there are for *cold* tyres. Do not reduce the slightly raised pressures of warm tyres »» ⚠.

#### Snow chains

Snow chains may be fitted only to the *front wheels*.

Consult the section “wheels” of this manual.

#### Wheel bolts

After the wheels have been changed, the **tightening torque** of the wheel bolts should be checked as soon as possible with a torque wrench »» ⚠. The tightening torque for steel and alloy wheels is **120 Nm**.

#### ⚠ WARNING

- Check the tyre pressure at least once per month. Checking the tyre pressure is very important. If the tyre pressure is too high or too low, there is an increased danger of accidents - particularly at high speeds.

- If the tightening torque of the wheel bolts is too low, they could loosen while the vehicle is in motion. Risk of accident! If the tightening torque is too high, the wheel bolts and threads can be damaged.

#### Note

**We recommend that you ask your Technical Service for information about appropriate wheel, tyre and snow chain size.**

## Engine specifications

### Petrol engine 1.6 75 kW (102 PS)

#### Engine specifications

Power output in kW (PS) at rpm		Maximum torque (Nm at rpm)		No. of cylinders/dis- placement (cm <sup>3</sup> )	Fuel	
LPG	Petrol	LPG	Petrol		LPG	Super 95 RON <sup>a)</sup> /Normal 91 RON <sup>b)</sup>
72 (98)/5,600	75 (102)/5,600	144/3,800	148/3,800	4/1,595	LPG	Super 95 RON <sup>a)</sup> /Normal 91 RON <sup>b)</sup>

a) Research Octane Number = Anti-detonation rating of the petrol.

b) Slight power loss.

Performance	ALTEA (LPG)	ALTEA (Petrol)	ALTEA XL (LPG)	ALTEA XL (Petrol)
Top speed (km/h)	178	181	178	181
Acceleration 0-80 km/h (seconds)	9.2	8.9	9.3	9.0
Acceleration 0-100 km/h (seconds)	13.8	13.2	14	13.4
<b>Weights (in kg)</b>				
Gross vehicle weight	1,951	1,951	2,039	2,039
Weight in running order (with driver)	1,456	1,456	1,495	1,495
Gross front axle weight	965	967	970	971
Gross rear axle weight	1,000	980	1,085	1,025
Permitted roof load	75	75	75	75
<b>Maximum trailer weights (in kg)</b>				
Trailer without brakes	720	720	740	740

## Technical specifications

Performance	ALTEA (LPG)	ALTEA (Petrol)	ALTEA XL (LPG)	ALTEA XL (Petrol)
Trailer with brakes, gradients up to 8%	1500	1,500	1,500	1,500
Trailer with brakes, gradients up to 12%	1,200	1,200	1,200	1,200

**Petrol engine 1.2 77 kW (105 PS) Start-Stop**
**Engine specifications**

Power output in kW (PS) at rpm	Maximum torque (Nm at rpm)	No. of cylinders/displacement (cm <sup>3</sup> )	Fuel
77 (105)/5,000	175/1,550-4,100	4/1,197	Super 95 RON <sup>a)</sup> /Normal 91 RON <sup>b)</sup>

a) Research Octane Number = Anti-detonation rating of the petrol.

b) With a slight power loss

Performance	ALTEA	ALTEA XL
Top speed (km/h)	184	184
Acceleration 0-80 km/h (seconds)	7.3	7.5
Acceleration 0-100 km/h (seconds)	11.3	11.6
<b>Weights (in kg)</b>		
Gross vehicle weight	1,880	1,939
Weight in running order (with driver)	1,360	1,395
Gross front axle weight	970	980
Gross rear axle weight	980	1,025
Permitted roof load	75	75
<b>Maximum trailer weights (in kg)</b>		
Trailer without brakes	680	690
Trailer with brakes, gradients up to 8%	1,500	1,500
Trailer with brakes, gradients up to 12%	1,200	1,200

### Petrol engine 1.4 92 kW (125 PS)

#### Engine specifications

Power output in kW (PS) at rpm	Maximum torque (Nm at rpm)	No. of cylinders/displacement (cm <sup>3</sup> )	Fuel
92 (125)/5,000	200/1,500-4,000	4/1,390	Super 95 RON <sup>a)</sup> /Normal 91 RON <sup>b)</sup>

a) Research Octane Number = Anti-detonation rating of the petrol.

b) With a slight power loss

Performance	ALTEA	ALTEA XL	ALTEA FREETRACK
Top speed (km/h)	194	194	188
Acceleration 0-80 km/h (seconds)	6.9	7.0	7.2
Acceleration 0-100 km/h (seconds)	10.3	10.5	10.8
<b>Weights (in kg)</b>			
Gross vehicle weight	1,959	2,022	2,032
Weight in running order (with driver)	1,439	1,478	1,488
Gross front axle weight	1,008	1,004	1,010
Gross rear axle weight	987	1,036	1,035
Permitted roof load	75	75	75
<b>Maximum trailer weights (in kg)</b>			
Trailer without brakes	710	730	740
Trailer with brakes, gradients up to 8%	1,500	1,500	1,500
Trailer with brakes, gradients up to 12%	1,300	1,300	1,300



### Petrol engine 1.8 118 kW (160 PS)

#### Engine specifications

Power output in kW (PS) at rpm	Maximum torque (Nm at rpm)	No. of cylinders/displacement (cm <sup>3</sup> )	Fuel
118 (160)/4,500-6,200	250/1,500-4,500	4/1,798	Super 95 RON <sup>a)</sup> /Normal 91 RON <sup>b)</sup>

a) Research Octane Number = Anti-detonation rating of the petrol.

b) With a slight power loss

Performance	ALTEA	ALTEA XL
Top speed (km/h)	210	210
Acceleration 0-80 km/h (seconds)	5.8	6.0
Acceleration 0-100 km/h (seconds)	8.4	8.6
<b>Weights (in kg)</b>		
Gross vehicle weight	2,015	2,069
Weight in running order (with driver)	1,495	1,525
Gross front axle weight	1,062	1,068
Gross rear axle weight	994	1,043
Permitted roof load	75	75
<b>Maximum trailer weights (in kg)</b>		
Trailer without brakes	740	750
Trailer with brakes, gradients up to 8%	1,500	1,500
Trailer with brakes, gradients up to 12%	1,400	1,400

**Petrol engine 2.0 155 kW (211 PS)**
**Engine specifications**

Power output in kW (PS) at rpm	Maximum torque (Nm at rpm)	No. of cylinders/displacement (cm <sup>3</sup> )	Fuel
155 (211)/5,300-6,200	280/1,700-5,200	4/1,984	Super 95 RON <sup>a)</sup> /Normal 91 RON <sup>b)</sup>

a) Research Octane Number = Anti-detonation rating of the petrol.

b) With a slight power loss

Performance	ALTEA FREETRACK Front-wheel drive	ALTEA FREETRACK Four-wheel drive
Top speed (km/h)	220	218
Acceleration 0-80 km/h (seconds)	5.5	5.3
Acceleration 0-100 km/h (seconds)	7.7	7.6
<b>Weights (in kg)</b>		
Gross vehicle weight	2,150	2,205
Weight in running order (with driver)	1,606	1,661
Gross front axle weight	1,115	1,140
Gross rear axle weight	1,055	1,085
Permitted roof load	75	75
<b>Maximum trailer weights (in kg)</b>		
Trailer without brakes	750	750
Trailer with brakes, gradients up to 8%	1,650	1,650
Trailer with brakes, gradients up to 12%	1,400	1,650

### Diesel engine 1.6 TDI CR 66 kW (90 PS) with/without DPF

#### Engine specifications

Power output in kW (PS) at rpm	Maximum torque (Nm at rpm)	No. of cylinders/displacement (cm <sup>3</sup> )	Fuel
66 (90)/4,200	230/1,500-2,500	4/1,598	Diesel according to standard DIN EN 590, min. 51 CN <sup>a)</sup>

a) Cetane Number (cetane index) = Measure of the combustion power of the diesel

Performance	ALTEA	ALTEA XL
Top speed (km/h)	172	172
Acceleration 0-80 km/h (seconds)	9.1	9.3
Acceleration 0-100 km/h (seconds)	13.8	14.1
<b>Weights (in kg)</b>		
Gross vehicle weight	1,975	2,029
Weight in running order (with driver)	1,455	1,485
Gross front axle weight	1,045	1,040
Gross rear axle weight	960	1,010
Permitted roof load	75	75
<b>Maximum trailer weights (in kg)</b>		
Trailer without brakes	720	740
Trailer with brakes, gradients up to 8%	1,500	1,500
Trailer with brakes, gradients up to 12%	1,400	1,400

### Diesel engine 1.6 TDI CR 77 kW (105 PS) with/without DPF

#### Engine specifications

Power output in kW (PS) at rpm	Maximum torque (Nm at rpm)	No. of cylinders/displacement (cm <sup>3</sup> )	Fuel
77 (105)/4,400	250/1,500-2,500	4/1,598	Diesel according to standard DIN EN 590, min. 51 CN <sup>a)</sup>

a) Cetane Number (cetane index) = Measure of the diesel combustion power.

Performance	ALTEA Automatic gearbox	ALTEA XL Automatic gearbox
Top speed (km/h)	183	183
Acceleration 0-80 km/h (seconds)	8	8.1
Acceleration 0-100 km/h (seconds)	12.4	12.6
<b>Weights (in kg)</b>		
Gross vehicle weight	1,995	2,049
Weight in running order (with driver)	1,475	1,505
Gross front axle weight	1,065	1,060
Gross rear axle weight	960	1,010
Permitted roof load	75	75
<b>Maximum trailer weights (in kg)</b>		
Trailer without brakes	730	750
Trailer with brakes, gradients up to 8%	1,500	1,500
Trailer with brakes, gradients up to 12%	1,400	1,400

### Diesel engine 1.6 TDI CR 77 kW (105 PS) DPF Start-Stop

#### Engine specifications

Power output in kW (PS) at rpm	Maximum torque (Nm at rpm)	No. of cylinders/displacement (cm <sup>3</sup> )	Fuel
77 (105)/4,400	250/1,500-2,500	4/1,598	Diesel according to standard DIN EN 590, min. 51 CN <sup>a)</sup>

a) Cetane Number (cetane index) = Measure of the combustion power of the diesel

Performance	ALTEA	ALTEA XL
Top speed (km/h)	183	183
Acceleration 0-80 km/h (seconds)	8	8.2
Acceleration 0-100 km/h (seconds)	12.2	12.4
<b>Weights (in kg)</b>		
Gross vehicle weight	1,970	2,024
Weight in running order (with driver)	1,450	1,480
Gross front axle weight	1,045	1,040
Gross rear axle weight	960	1,010
Permitted roof load	75	75
<b>Maximum trailer weights (in kg)</b>		
Trailer without brakes	720	740
Trailer with brakes, gradients up to 8%	1,500	1,500
Trailer with brakes, gradients up to 12%	1,400	1,400

### Diesel engine 2.0 TDI CR 103 kW (140 PS)

#### Engine specifications

Power output in kW (PS) at rpm	Maximum torque (Nm at rpm)	No. of cylinders/displacement (cm <sup>3</sup> )	Fuel
103 (140)/4,200	320/1,750-2,500	4/1,968	Diesel according to standard DIN EN 590, min. 51 CN <sup>a)</sup>

a) Cetane Number (cetane index) = Measure of the diesel combustion power.

Performance	ALTEA	ALTEA XL	ALTEA XL Four-wheel drive	ALTEA FREETRACK Four-wheel drive
Top speed (km/h)	201	201	198	193
Acceleration 0-80 km/h (seconds)	6.6	6.7	6.9	6.9
Acceleration 0-100 km/h (seconds)	9.7	9.8	10.1	10.2
<b>Weights (in kg)</b>				
Gross vehicle weight	1,985	2,034	2,132	2,159
Weight in running order (with driver)	1,465	1,490	1,588	1,615
Gross front axle weight	1,065	1,070	1,090	1,110
Gross rear axle weight	955	1,020	1,080	1,070
Permitted roof load	75	75	75	75
<b>Maximum trailer weights (in kg)</b>				
Trailer without brakes	730	740	750	750
Trailer with brakes, gradients up to 8%	1,500	1,500	1,650	1,650
Trailer with brakes, gradients up to 12%	1,500	1,500	1,650	1,650

### Dimensions and capacities

#### Dimensions

	ALTEA	ALTEA XL	ALTEA FREETRACK
Length / Width (mm)	4,282/1,768	4,467/1,768	4,493/1,778
Height at kerb weight (mm)	1,546	1,575	1,615
Front and rear projections (mm)	916/788	913/976	940/977
Wheelbase (mm)	2,578	2,578	2,578
Turning radius (m)	10.7	10.7	10.7
Front/rear <sup>a)</sup> track width (mm)	1,525/1,509 1,539/1,523	1,527/1,506 1,541/1,520	1,534/1,519 1,542/1,527

<sup>a)</sup> This data will change depending on the type of wheel rim.

#### Capacities

Fuel tank (l)	Vehicles with front-wheel drive	Vehicles with four-wheel drive
		55 - Reserve 7
LPG Fuel tank (l)	39	
Windscreen washer fluid container/with headlight washer (l)	3/5.5	

#### Tyre pressure

##### Summer-grade tyres:

The correct tyre pressure can be seen on the sticker on the inside of the tank flap.

##### Winter tyres:

The pressure of these tyres is 0.2 bar higher than that of summer tyres (2.9 psi/20 kPa).





## Index

## A

ABS .....	136
control lamp .....	41
Accessories .....	147
Acoustic warning .....	120
Adaptive headlights .....	80
Adjusting the seat belt height .....	16
AFS (cornering lights) .....	80
Airbag covers .....	20
Airbags	
description .....	18
Airbag system .....	17, 20
activation .....	18
control lamp .....	19
functioning .....	18
head-protection airbags .....	22
side airbags .....	21
Air conditioner	
2C-Climatronic .....	112
General notes .....	116
Air conditioner automatic mode	
2C-Climatronic .....	113
Air conditioning .....	109
Air recirculation mode	
2C-Climatronic .....	115
Manual air conditioner .....	111
Alarm system	
Switching off .....	69
Alcantara .....	154
All-wheel drive .....	117
Alternator	
Warning lamp .....	42
Anti-lock brake system .....	136
control lamp .....	41

Anti-theft alarm system .....	68
Interior monitoring .....	70
Switching off .....	69
To-away protection .....	70
Anti-theft wheel bolts .....	184
Antifreeze .....	169
Aquaplaning .....	177
Ashtray .....	98
Aspects to note before setting off .....	5
ASR .....	137
Control lamp .....	46
Audible warning .....	12
Automatic anti-dazzle interior rear vision mirror	
Activating the anti-dazzle function .....	86
Deactivating the anti-dazzle function .....	86
Automatic car wash tunnel .....	149
Automatic gearbox	
Kick-down feature .....	130
Automatic gearbox/DSG automatic gearbox .....	127
Automatic lighting .....	76
Automatic windscreen wiping .....	84
Automatic wipe with rain sensor .....	84
Auxiliary audio input: AUX-IN .....	99

## B

Ball coupling .....	145
Battery .....	68
Changing .....	174
Charging .....	174
Winter conditions .....	173
Before setting off .....	5
Belt tightening .....	16
Biodiesel .....	160
Biodiesel fuel .....	160
Bonnet .....	165

Boot hatch .....	71
control lamp .....	45
Emergency opening .....	194
Boot lid .....	71
Emergency opening .....	194
Brake fluid .....	172
Changing .....	172
control lamp .....	49
Brake pads .....	123
Brake pedal	
Control lamp .....	46
Brakes .....	123
Worn brake pads .....	42
Brake servo .....	123, 138
Brake system .....	172
Brakes .....	123
Brake servo .....	123
warning lamp .....	44
Bulb defect	
Control lamp .....	44
Buzzer .....	77, 120

## C

Car care	
Exterior .....	149
Car care products .....	148
Catalytic converter .....	131
CCS .....	142
CD changer .....	93
Central lock button	
Locking .....	65
Unlocking .....	65
Central locking .....	63
Automatic locking system for involuntary un- locking .....	65
Automatic speed-dependent locking and un- locking system .....	64

- Emergency unlocking system ..... 65  
 Selective unlocking system ..... 64  
 Unlocking system ..... 64  
 Centre armrest ..... 93  
 Cetane number ..... 160  
 Changing gear  
   see Manual gearbox ..... 126  
 Changing gear in Tiptronic mode ..... 129  
 Changing the bulbs  
   Main headlight bulbs ..... 200  
 Changing the lights  
   general remarks ..... 198  
 Changing the main headlight bulbs  
   Main beam lights ..... 201  
   Side lights ..... 201  
   Turn signal bulbs ..... 200  
 Changing the main headlight lamps  
   dipped lights ..... 200  
 Changing the tail light bulbs  
   Position light, fog light and tail light on the  
   rear lid ..... 204  
 Changing the tail lights  
   Luggage compartment lights ..... 205  
   Rear fog light ..... 203  
   Reverse light ..... 203  
   Side lights ..... 202  
   Turn signal light ..... 202  
   Turn signal, side and brake lights on the body ..... 203  
 Changing windscreen wiper blades ..... 194  
 Chassis number ..... 208  
 Checking ..... 174  
 Checking battery electrolyte level ..... 174  
 Checking engine oil level ..... 167  
 Child safety ..... 24  
 Child seat  
   Categorisation in groups ..... 26  
 Child seats ..... 26  
   ISOFIX system ..... 27  
   safety instructions ..... 25  
   Top Tether system ..... 27  
 Cigarette lighter ..... 98  
 Cleaning alloy wheel rims ..... 152  
 Cleaning chrome ..... 152  
 Cleaning engine compartment ..... 153  
 Cleaning exterior mirrors ..... 151  
 Cleaning plastic parts ..... 156  
 Cleaning steel wheel rims ..... 152  
 Cleaning the instrument panel ..... 156  
 Cleaning windows ..... 151  
 Climatic ..... 109  
 Climatronic  
   General notes ..... 116  
 Clock ..... 35  
 Clothes hook ..... 95  
 Coming/Leaving Home function ..... 79  
 Compartment for on-board documentation ..... 93  
 control lamp ..... 19  
 Control lamps ..... 35  
 Controls  
   electric windows ..... 72  
   Exterior mirrors ..... 87  
   Sliding/tilting sunroof ..... 74  
 Convenience closing  
   sliding/tilting sunroof ..... 74  
   Windows ..... 73  
 Convenience opening  
   Windows ..... 73  
 Coolant ..... 170  
   control lamp ..... 49  
 Coolant fluid ..... 169  
 Coolant level ..... 170  
   control lamp ..... 40  
 Coolant loss ..... 170  
 Coolant temperature  
   control lamp ..... 40  
 Gauge ..... 34  
 Safety instructions ..... 40  
 Cornering lights  
   Dynamic ..... 80  
 Correct adjustment of front seat head restraints .. 9  
 Correct adjustment of rear seat head restraints  
   In-use and non-use positions ..... 10  
 Correct sitting position  
   front passenger ..... 8  
   Incorrect sitting position ..... 9  
   passenger ..... 8  
 Cruise control  
   Complete system deactivation ..... 144  
   Control lamp ..... 45  
 Cruise control system ..... 142  
 Cruise speed ..... 142  
   Control lamp ..... 45  
**D**  
 Dangers in not using the seat belt ..... 13  
 Dash panel ..... 31  
 Daytime driving lights ..... 78  
 Daytime running lights  
   Nordic countries ..... 78  
 Deactivating front passenger airbags  
   safety instructions ..... 24  
 Deactivating the airbag  
   Front passenger front airbag ..... 23  
 Diesel ..... 160  
 Diesel engine  
   Winter operation ..... 160  
 Diesel engine particulate filter ..... 132  
 Differential lock ..... 135  
 Differential lock fault (EDL)  
   control lamp ..... 46

- Digital clock ..... 35
- Dipped beam headlights ..... 75
- Display (without warning or information texts) .. 47
- Disposal
- Seat belt tensioners ..... 16
- Door lock ..... 152
- Door lock cylinder ..... 152
- Door lock handle ..... 152
- Door release lever ..... 31
- Doors
- Childproof locks ..... 66
  - control lamp ..... 45
- Drawer ..... 94
- Driver
- see* Correct sitting position ..... 6, 8
- Driveshaft differential
- XDS ..... 137
- Drive wheel traction control system (ASR) ..... 137
- Driving
- Economically/with Respect for the Environment ..... 132
  - journeys abroad ..... 120
  - steering lock ..... 120
  - With a trailer ..... 145
- Driving abroad
- Headlights ..... 120
- Driving Economically ..... 132
- Driving programmes ..... 127
- Driving safety ..... 5
- Driving with automatic gearbox/DSG automatic gearbox ..... 128
- Driving with Respect for the Environment ..... 132
- Duplicate keys ..... 67
- Dust filter ..... 116
- Dynamic headlight range control ..... 79
- E**
- EDL ..... 135
- control lamp ..... 41
- Electric power steering
- Control lamp ..... 45
- Electric windows ..... 72
- Electronic differential lock ..... 135
- control lamp ..... 41
- Electronic immobiliser ..... 46, 121
- Electronic Stability Control ..... 45
- description ..... 134
- Emergency braking warning ..... 81, 136
- Emergency manual locking ..... 193
- Emergency opening
- Doors ..... 69
- Emission control system
- control lamp ..... 45
- Engine
- Running in ..... 130
- Engine compartment ..... 165
- Working in the engine compartment ..... 163
- Engine coolant
- G 12 plus-plus ..... 169
  - G 13 ..... 169
  - Specifications ..... 169
- Engine coolant fluid ..... 169
- Engine fault
- Control lamp ..... 41
- Engine management
- control lamp ..... 41
- Engine oil ..... 166
- Changing ..... 169
  - Checking engine oil level ..... 167
  - Oil properties ..... 167
  - Specifications ..... 166
  - Topping up ..... 168
- Engine oil dipstick ..... 167
- Engine oil pressure
- control lamp ..... 44, 49
- Environment ..... 132
- Environmental friendliness ..... 131
- Environmental tip
- Avoiding pollution ..... 159
- Equipment ..... 147
- ESC ..... 45, 134
- see also* Electronic Stability Control ..... 134
- Example of menu use
- Open the Configuration menu with the steering wheel controls ..... 50
  - Program a speed limit warning ..... 50
  - To activate and deactivate the speed limit warning ..... 50
- Example of the use of the menus
- Open the Configuration menu with the MFI lever ..... 50
- Examples of menu use
- Open the main menu ..... 50
  - Open the winter tyres menu ..... 50
  - To close the winter tyres menu ..... 50
- Exhaust gas emission control system ..... 131
- F**
- Fastening rings ..... 103
- Filling the tank ..... 158
- Fire extinguisher ..... 100
- First-aid kit ..... 100
- Flexible service interval display ..... 48
- Floor mats ..... 11
- Fog lights ..... 76
- Fog lights with cornering function ..... 81
- Folding table ..... 94
- Folding the seat backrest ..... 92
- Front airbags ..... 20
- safety instructions ..... 20

- Front drinks holders ..... 95
- Front interior light  
  Switch off light ..... 82  
  Switch on light ..... 82
- Front passenger airbag deactivation ..... 23
- Front reading lights ..... 82
- Front seat adjustment  
  Lumbar support adjustment ..... 89
- Fuel  
  Diesel ..... 160  
  Petrol ..... 159
- Fuel consumption ..... 132, 208
- Fuel level  
  Indicator ..... 33
- Fuel reserve ..... 40  
  Warning message ..... 49
- Fuel tank  
  *see* Fuel reserve ..... 40
- Fuel Tank  
  Opening the fuel tank flap ..... 158
- Fuel: saving ..... 132
- Fuses ..... 196  
  Fuse box ..... 197  
  Identifying blown fuses ..... 198  
  Identifying by colours ..... 197  
  Preparation before replacing ..... 198  
  Replacement ..... 198
- G**
- Gear shift pattern ..... 126
- General overview of the engine compartment .. 166
- Glove compartment ..... 93
- Glow plug system ..... 122  
  Control lamp ..... 41
- H**
- Handbrake ..... 124  
  Control lamp ..... 44  
  warning lamp ..... 124
- Hazard warning lights ..... 81
- HBA ..... 136
- Head-on collisions and the laws of physics ..... 13
- Head-protection airbags ..... 22  
  safety instructions ..... 22
- Headlight flashers ..... 77
- Headlight range control ..... 79
- Headlights  
  Driving abroad ..... 120  
  fog lights ..... 76  
  Headlight washer ..... 86
- Head restraints  
  Adjusting ..... 90  
  Adjustment of the head restraint angle ..... 90  
  Correct adjustment ..... 90  
  Removing ..... 90
- Heated front seats ..... 91
- Heated rear window  
  2C-Climatronic ..... 113  
  heating element wires ..... 151
- Heating ..... 107
- High pressure cleaners ..... 150
- Hill driving assistant ..... 125
- Horn ..... 31
- How to jump start description ..... 190
- Hydraulic Brake Assist ..... 136
- I**
- Identification number ..... 208
- Identification plate ..... 208
- Ignition ..... 120
- Ignition lock ..... 120
- Information messages in the display ..... 49
- Information on the multi-function display  
  On-screen display ..... 52
- Instrument and switch lighting ..... 79
- Instrument lighting ..... 31
- Instrument panel menu  
  Lights and visibility menu ..... 56
- Instrument panel menus  
  Configuration menu ..... 54  
  Example of menu use ..... 50  
  Main menu ..... 50  
  Vehicle status menu ..... 54
- Instruments ..... 32
- Interior lights ..... 82
- Interior monitoring ..... 70  
  Activation ..... 69  
  Deactivation ..... 69
- Interior rear vision mirror ..... 86
- Intermittent windscreen wipe ..... 84
- ISOFIX system ..... 27
- J**
- Jack position points  
  Sill panel trim ..... 185
- Journeys abroad ..... 120
- Jump-starting ..... 189
- Jump leads ..... 189
- K**
- Keys ..... 66
- L**
- Lifting the seat backrest ..... 92
- Lifting the vehicle ..... 185
- Lights ..... 75  
  general remarks ..... 198
- Load compartment in the luggage compartment  
  *see* Loading the luggage compartment ..... 101

- Loading the luggage compartment ..... 101  
 Locking gear in Tiptronic mode ..... 129  
 LPG ..... 33, 118, 160  
 LPG system  
   Driving ..... 118  
   Gauge ..... 33  
   Refuelling ..... 160  
 LPG System filler neck  
   Filler neck adapter ..... 162  
 Luggage compartment ..... 101  
   *see also* Loading the luggage compartment ..... 101  
 Luggage compartment net ..... 104
- M**
- Main beam ..... 75, 77  
 Main beam headlights  
   control lamp ..... 41  
 Main headlight bulbs ..... 200  
 Maintenance and cleaning ..... 147  
 Manual gearbox ..... 126  
 Manual mode  
   2C-Climatronic ..... 114  
 MEDIA-IN connector ..... 100  
 Mirrors  
   Exterior mirrors ..... 87  
   Interior rear vision mirror ..... 86  
   Vanity mirrors ..... 83  
 Mobile phones and two-way radios ..... 148  
 Multi-purpose mobile storage compartment  
   Closing ..... 96  
   Fitting ..... 97  
   Functions ..... 96  
   Opening ..... 96  
   Removal ..... 97
- N**
- Number of seats ..... 11
- O**
- Octane number ..... 159  
 Odometer ..... 48  
 Oil ..... 166  
 Oil change ..... 169  
 Oil properties ..... 167  
 One-touch opening and closing  
   Electric windows ..... 72  
 Opening and closing ..... 71  
 Outside temperature indicator ..... 54  
 Overview ..... 31  
   control lamps ..... 38  
   Control lamps ..... 35  
   Dash panel ..... 31  
   Instruments ..... 32  
   warning lamps ..... 38  
   Warning lamps ..... 35
- P**
- Parking ..... 125  
 Parking aid acoustic system ..... 140  
 Parking lights ..... 77  
 Parking system ..... 140  
 Parking System Plus ..... 141  
 Passenger  
   *see* Correct sitting position ..... 6, 8  
 Pedals ..... 11  
 Petrol ..... 159  
   journeys abroad ..... 120  
 Petrol additives ..... 159  
 Plastic parts ..... 151  
 Pollen filter ..... 116  
 Pollution filter ..... 116  
 Power ..... 99  
 Power sockets ..... 99  
 Power steering ..... 117  
 Products for vehicle maintenance ..... 149
- Puncture repair ..... 186
- R**
- Rack ..... 104  
 Radio frequency remote control ..... 67  
   Changing the battery ..... 68  
 Radio navigation controls on the steering wheel  
   Audio + telephone version ..... 61  
 Rain sensor ..... 84  
 Raising the vehicle ..... 185  
 Rear cup holder  
   Armrests ..... 95  
 Rear fog light  
   control lamp ..... 40, 76  
   Control lamp ..... 76  
 Rear interior lights ..... 83  
 Rear reading lights ..... 83  
 Rear seats ..... 92  
 Rear shelf ..... 102  
   Storage compartment ..... 101  
 Rear window automatic wiper/washer ..... 85  
 Rear window wiper ..... 85  
 Recommended gear ..... 47  
 Recommended gear display ..... 47  
 Refuelling ..... 158  
 Registration light ..... 205  
 Remote control key  
   Buttons ..... 67  
   Synchronising ..... 68  
 Removing and fitting the wheel ..... 186  
 Replacement keys ..... 67  
 Replacement of parts ..... 147  
 Rev counter ..... 32  
 Reverse gear  
   Manual gearbox ..... 126

- Roll-back function
  - Sliding/tilting sunroof ..... 75
  - Windows ..... 73
- Roof aerial ..... 147
- Roof carrier
  - attachment points ..... 105
- Roof carrier system ..... 104
- Roof rack ..... 104
- Roof storage compartment ..... 94
- Rubber seals ..... 151
- Run-flat tyres ..... 178
- Running in
  - Engine ..... 130
- S**
- Safe - security system ..... 64
- Safe driving ..... 5
- Safety ..... 5
  - child safety ..... 24
  - child seats ..... 24
- Safety equipment ..... 5
- Safety instructions
  - Coolant temperature ..... 40
  - deactivating front passenger airbags ..... 24
  - front airbags ..... 20
  - head-protection airbags ..... 22
  - side airbags ..... 21
  - using child seats ..... 25
- Safety notes
  - Seat belt tensioners ..... 16
  - Using seat belts ..... 13
- Seals ..... 151
- Seat adjustment ..... 88, 89, 92
- Seat belt control lamp ..... 11
- Seat belt position
  - for pregnant women ..... 15
- Seat belts ..... 15
- Seat belt protection ..... 12
- Seat belt release ..... 15
- Seat belts ..... 11
  - Adjustment ..... 14
  - control lamp ..... 11
  - Safety notes ..... 13
  - unfastened ..... 13
- Seat belts cleaning ..... 157
- Seat belt tensioner
  - control lamp ..... 19
- Seat belt tensioners ..... 16
- Seat heating ..... 91
- Seat upholstery
  - Alcantara ..... 154
  - cleaning Alcantara ..... 154
  - Cleaning and maintenance of natural leather ..... 156
  - cleaning the trim fabric ..... 154
  - synthetic leather ..... 156
- Selecting a gear ..... 126
- Selective opening ..... 64
- Selector lever locking ..... 127
- Selector lever positions ..... 127
- servotronic ..... 117
- Side airbags ..... 21
  - safety instructions ..... 21
- Side lights ..... 75
- Sitting position
  - driver ..... 6
- Sitting position, occupants ..... 6
- Sliding/tilting sunroof ..... 74
- Snow chains ..... 181, 210
- Soot accumulation in the diesel engine particulate filter
  - control lamp ..... 41
- Spare parts ..... 147
- Spare wheel ..... 182
- Speed selector lever lock
  - Control lamp ..... 46
- Start-Stop
  - Activating and deactivating ..... 139
  - functioning ..... 138
- Starting petrol engines ..... 121, 122
- Starting the engine ..... 121, 122
  - after the fuel tank has been run dry ..... 122
- Steam jets ..... 150
- Steering ..... 7
- Steering wheel audio controls
  - Audio version ..... 57
  - Audio + telephone version ..... 57
- Steering wheel height adjustment ..... 7
- Stopping distance ..... 123
- Storage compartment
  - Centre armrest ..... 93
  - Front passenger side ..... 93
  - Front seats ..... 94
  - Lock ..... 101
  - Other storage compartments ..... 95
- Storage in the boot floor ..... 104
- Sun blind ..... 83
- Sun visor
  - Sliding/tilting sunroof ..... 74
- Sun visors ..... 83
- Switch
  - Hazard warning lights ..... 81
  - Light switch ..... 75
- Switches
  - electric windows ..... 72
  - Switching off the engine ..... 122
- Switch lighting ..... 31
- T**
- Tank
  - Fuel level ..... 33
  - Reserve indicator ..... 33
  - Tank capacity ..... 33

- Tank flap ..... 158
- Technical modifications ..... 147
- Tightening torque of wheel bolts ..... 210
- Tilting sunroof ..... 74
- Tire Mobility Set
- Check after 10 minutes ..... 189
  - Do not use ..... 187
  - Inflating a tyre ..... 188
  - Sealing a tyre ..... 188
- Tools ..... 181
- Top Tether system ..... 27
- Tow-away protection ..... 70
- Tow-starting ..... 191
- Towing ..... 191
- Towing a trailer ..... 209
- Towing bracket ..... 145, 192
- Towing bracket, fitting ..... 146
- Towing hook ..... 191
- Towline anchorage ..... 191
- Towline anchorages ..... 192
- Tow starting
- General notes ..... 191
- Traction control system (ASR)
- control lamp ..... 46
- Trailer
- Trailer towing ..... 144
- Trailer turn signals
- control lamp ..... 77
- Trailer weights ..... 209
- Transporting children ..... 24
- Transporting objects
- Roof carrier system ..... 104
- Tread depth ..... 177
- Turn signals ..... 77
- control lamp ..... 41, 77
- Tyre mobility set
- Components ..... 187
- Tyre mobility system ..... 186
- Tyre Mobility System
- see tyre mobility system ..... 186
- Tyre pressure ..... 175
- Loss ..... 176
- Tyre pressure control lamp ..... 43
- Tyre pressure monitoring ..... 176
- Tyre pressures ..... 210
- Tyre repair set
- see tyre mobility system ..... 186
- Tyres and wheels
- Dimensions ..... 179
  - Tyres tread depth ..... 177
  - Tyres useful life ..... 177
  - Tyres with directional tread pattern ..... 175
- U**
- Underbody protection ..... 152
- Unlocking and locking ..... 71
- Personalisation ..... 65
- Upholstery
- Treating your upholstery ..... 154
- V**
- Vehicle battery ..... 173
- Vehicle care
- Treating your upholstery ..... 154
- Vehicle data ..... 208
- Vehicle identification data ..... 208
- Vehicle identification number ..... 208
- Vehicle maintenance
- electrically adjustable seats ..... 154
  - heated seats ..... 154
  - natural leather ..... 156
  - non-electrically adjustable seats ..... 155
  - seats with airbag components ..... 154
  - seats without airbag components ..... 155
  - synthetic leather ..... 156
  - trim fabrics ..... 154
  - unheated seats ..... 155
- Vehicle modifications ..... 147
- Vehicle paintwork
- Maintenance ..... 150
  - polishing ..... 150
  - Products for vehicle maintenance ..... 148
- Vehicle tools
- Storage ..... 181
- Vehicle washing ..... 149
- Ventilation slits ..... 101
- W**
- Warning lamps ..... 35
- Warning messages
- Red ..... 38, 49
  - Yellow ..... 39, 49
- Warning messages in the display ..... 49
- Warning symbols ..... 38
- Warning triangle ..... 100
- Washer fluid ..... 171
- Washing by hand ..... 149
- Washing the vehicle ..... 149
- Washing with high pressure cleaners ..... 150
- Water
- Warning message ..... 50
  - Water in the windscreen washer tank ..... 171
- Wear indicators ..... 177
- Wearing suitable shoes ..... 11
- Wheel bolts ..... 184, 210
- Tightening torque ..... 180
- Wheel change ..... 182
- Wheels ..... 175, 210
- Wheel trims ..... 183
- Why assume the correct sitting position? ..... 17
- Why should head restraints be correctly adjusted? 9

Why wear seat belts? .....	11, 17
Windows .....	72
Windscreen washer fluid	
Control lamp .....	42
Windscreen wiper blades	
cleaning .....	151
Windscreen wipers .....	84
Changing blades .....	194
Changing the rear wiper blade .....	195, 196
Winter operation	
Diesel engine .....	160
Winter tyres .....	180
Wooden trim cleaning .....	157
Working in the engine compartment .....	163







SEAT S.A. is permanently concerned about continuous development of its types and models. For this reason we ask you to understand, that at any given time, changes regarding shape, equipment and technique may take place on the car delivered. For this reason no right at all may derive based on the data, drawings and descriptions in this current handbook.

All texts, illustrations and standards in this handbook are based on the status of information at the time of printing. Except for error or omission, the information included in the current handbook is valid as of the date of closing print.

Re-printing, copying or translating, whether total or partial is not allowed unless SEAT allows it in written form.

SEAT reserves all rights in accordance with the "Copyright" Act.

All rights on changes are reserved.

 This paper has been manufactured using bleached non-chlorine cellulose.

© SEAT S.A. - Reprint: 15.11.14

Inglés 5P0012720BC (11.14) (GT9)



5P0012720BC

