

# Petrol - Diesel instrument panels, manual or automatic gearbox

Provided with permanent back-lighting, the instrument panel groups together the vehicle's dials and indicator and warning lamps.

## Dials



**1. Rev counter.**

Indicates the speed of rotation of the engine (x 1 000 rpm).

**2. Vehicle speed.**

Indicates the current speed of the moving vehicle (mph or km/h).

**3. Engine coolant temperature.**

Indicates the temperature of the engine coolant liquid.

**4. Display screen.**

**5. Fuel level.**

Indicates the quantity of fuel remaining in the tank.

**6. Display management button**

Alternates display between range and trip mileage recorder.

Servicing information.

Resets the selected function to zero

(trip distance recorder or service indicator).

**7. Lighting rheostat button.**

Adjusts the level of the instrument and controls illumination and the interior mood lighting.



For more information, refer to the paragraph relating to the button or function and its associated display.

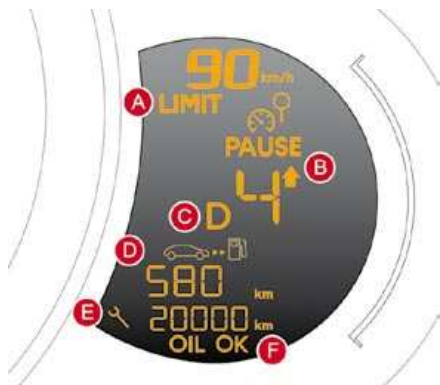

## Screen

### A. Speed limiter

(mph or km/h) or

**Cruise control.**

### B. Gear shift indicator.

### C. Automatic gearbox information.

### D. Range

(miles or km) or

**Trip mileage recorder.**

### E. Service indicator

(miles or km), then

**Total mileage recorder.**

These two functions are displayed successively when switching on the ignition.

### F. Engine oil level indicator.

Appears a few seconds after switching on the ignition, then disappears.

## Indicator and warning lamps



Visual indicators informing the driver that a system is in operation (operation or deactivation indicator lamps) or of the occurrence of a fault (warning lamp).

### When the ignition is switched on

Certain warning lamps come on for a few seconds when the vehicle's ignition is switched on. When the engine is started, these same warning lamps should switch off. If they remain on, before moving off, refer to the information on the warning lamp concerned.

 The passenger airbag system operation lamp stays on for about a minute after switching on the ignition, even after the engine has started.

### Associated warnings









The switching on of certain warning lamps may be accompanied by an audible signal and a message on the multifunction screen.



 The warning lamps may come on continuously (fixed) or flash. Certain warning lamps may come on in two different modes. Only by relating the type of lighting to the operating status of the vehicle can it be ascertained whether the situation is normal or whether a fault has occurred.





## Operation indicator lamps

If one of the following indicator lamps comes on, this confirms that the corresponding system has come into operation.

Warning lamp		is on	Cause	Action/Observations
	<b>Left-hand direction indicator</b>	flashing with buzzer.	The lighting stalk is pushed down.	
	<b>Right-hand direction indicator</b>	flashing with buzzer.	The lighting stalk is pushed up.	
	<b>Hazard warning lamps</b>	flashing with buzzer.	The hazard warning lamps switch, located on the dashboard, has been pressed.	The left-hand and right-hand direction indicators and their associated indicator lamps flash simultaneously.
	<b>Sidelamps</b>	fixed.	The lighting stalk is in the "Sidelamps" position.	
	<b>Dipped beam headlamps</b>	fixed.	The lighting stalk is in the "Dipped beam headlamps" position.	
	<b>Main beam headlamps</b>	fixed.	The lighting stalk is pulled towards you.	Pull the stalk to return to dipped beam headlamps.
	<b>Front foglamps</b>	fixed.	The front foglamps are switched on.	Turn the ring on the stalk rearwards twice to switch off the front foglamps.
	<b>Rear foglamps</b>	fixed.	The rear foglamps are switched on.	Turn the ring on the stalk rearwards to switch off the rear foglamps.



Warning lamp	is on	Cause	Action/Observations
 <b>Diesel engine pre-heating</b>	fixed.	The ignition switch is at the 2nd position (ignition on).	<p>Wait until the warning lamp goes off before starting. The period of illumination of the warning lamp is determined by the climatic conditions (up to about thirty seconds in extreme climatic conditions). If the engine does not start, switch the ignition off and then on, wait until the warning lamp goes off again, then start the engine.</p>
 <b>Parking brake</b>	fixed.	The parking brake is applied or not properly released.	<p>Release the parking brake to switch off the warning lamp, keeping your foot on the brake pedal. Observe the safety. For further information on the parking brake, refer to the "Driving" section.</p>
 <b>Stop &amp; Start</b>	fixed.	The Stop & Start system has put the engine in STOP mode at a vehicle stop (traffic lights, traffic jam, or other...).	The warning lamp goes off and the engine restarts automatically in START mode, as soon as you want to move off.
	flashes for a few seconds, then goes off.	STOP mode is temporarily unavailable. or START mode is invoked automatically.	Refer to "Driving - § Stop & Start" for special cases with STOP mode and START mode.



Warning lamp	is on	Cause	Action/Observations
 <b>Passenger's airbag system</b>	fixed.	The control switch, located in the glove box, is in the <b>"ON"</b> position. The passenger's front airbag is activated. In this case, do not install a rear-facing child seat.	Turn the control switch to the <b>"OFF"</b> position to deactivate the front passenger's airbag. In this case you can install a rear-facing child seat. The passenger's airbag system is automatically put into service on starting the vehicle ( <b>"ON"</b> position).
 <b>Foot on the brake pedal</b>	fixed.	With an automatic gearbox, you have forgotten to press the brake pedal to come out of the <b>P</b> position.	With the engine running, before releasing the parking brake you must press the brake pedal to unlock the the automatic gear selector lever and come out of the <b>P</b> position.
 <b>Automatic wiping</b>	fixed.	The wiper control is pushed downwards.	Automatic front wiping is activated.

## Deactivation indicator lamps

If one of the following indicator lamps comes on, this confirms that the corresponding system has been switched off intentionally. This may be accompanied by an audible signal and a message on the multifunction screen.

Warning lamp	is on	Cause	Action/Observations
 <b>Passenger's airbag system</b>	fixed.	The control, located in the glove box, is set to the <b>OFF</b> position. The passenger's front airbag is deactivated. In this case you can install a "rear facing" child seat.	Set the control to the <b>ON</b> position to activate the passenger's front airbag. In this case, do not fit a child seat in the rear-facing position. The passenger's airbag system is put into service automatically when the vehicle is started ( <b>ON</b> position).
 <b>ESP/ASR</b>	fixed.	The button, located at the bottom left of the dashboard, is pressed. Its indicator lamp is on. The ESP/ASR is deactivated. ESP: electronic stability programme. ASR: anti-skid regulation.	Press the button again to manually reactivate the ESP/ASR. Its indicator lamp switches off. From approximately 30 mph (50 km/h), the system is reactivated automatically (except for the 1.6 litre THP 150 engine). The ESP/ASR system is activated automatically when the vehicle is started.



## Warning lamps





When the engine is running or the vehicle is being driven, the switching on of one of the following warning lamps indicates a fault which requires action on the part of the driver.





Any fault resulting in the switching on of a warning lamp must be investigated further by reading the associated message on the multifunction screen.  
If you encounter any problems, do not hesitate to contact a CITROËN dealer.



Warning lamp		is on	Cause	Action/Observations
<b>STOP</b>	<b>STOP</b>	fixed, alone or associated with another warning lamp, accompanied by an audible signal and a message on the screen.	Illumination of the warning lamp is associated with a serious braking system or engine coolant temperature fault.	Stop as soon as it is safe to do so as the engine may cut out when driving. Park, switch off the ignition and call a CITROËN dealer.
<b>SERVICE</b>	<b>Service</b>	temporarily.	A minor fault has occurred for which there is no specific warning lamp.	Identify the fault by reading the message shown on the screen, such as, for example: <ul style="list-style-type: none"> <li>- the engine oil level,</li> <li>- the screenwash level,</li> <li>- the remote control battery,</li> <li>- saturation of the particle emission filter (Diesel).</li> </ul> For any other faults, contact a CITROËN dealer.
		fixed.	A major fault has occurred for which there is no specific warning lamp.	Identify the fault by reading the message shown on the screen and contact a CITROËN dealer.





Warning lamp		is on	Cause	Action/Observations
  +  	<b>Braking</b>	fixed, associated with the STOP warning lamp.	The braking system fluid level is too low.	You must stop as soon as it is safe to do so. Top up with brake fluid recommended by CITROËN. If the problem persists, have the system checked by a CITROËN dealer.
		fixed, associated with the STOP and ABS warning lamp.	The electronic brake force distribution (EBFD) system has a fault.	You must stop as soon as it is safe to do so. Have it checked by a CITROËN dealer.
	<b>Anti-lock Braking System (ABS)</b>	fixed.	The anti-lock braking system has a fault.	The vehicle retains conventional braking. Drive carefully at reduced speed and contact a CITROËN dealer without delay.
	<b>Dynamic stability control (ESP/ASR)</b>	flashing.	The ESP/ASR regulation is active.	The system optimises traction and improves the directional stability of the vehicle.
		fixed.	Unless it has been deactivated with the indicator lamp on the button on, the ESP/ASR system is faulty.	Have it checked by a CITROËN dealer.



Warning lamp		is on	Cause	Action/Observations
	<b>Engine autodiagnosis system</b>	fixed.	The emission control system has a fault.	This lamp should switch off when the engine is started. If it does not switch off, contact a CITROËN dealer urgently.
		flashing.	The engine management system has a fault.	Risk of destruction of the catalytic convertor. Have it checked by a CITROËN dealer.
	<b>Low fuel level</b>	fixed.	When it first comes on there remains <b>approximately 5 litres of fuel</b> in the tank.	<p>You must refuel as soon as possible to avoid running out of fuel.</p> <p>This warning lamp will come on every time the ignition is switched on, until a sufficient addition of fuel is made.</p> <p>Fuel tank capacity: approximately 50 litres (petrol) or 48 litres (Diesel).</p> <p>Never continue to drive until you run out of fuel as this could damage the emission control and injection systems.</p>
	<b>Maximum coolant temperature</b>	fixed red.	The temperature of the cooling system is too high.	<p>Stop as soon as it is safe to do so.</p> <p>Wait until the engine has cooled down before topping up the level, if necessary.</p> <p>If the problem persists, contact a CITROËN dealer.</p>

Warning lamp	is on	Cause	Action/Observations
 <b>Engine oil pressure</b>	fixed.	There is a fault with the engine lubrication system.	Stop as soon it is safe to do so. Park, switch off the ignition and contact a CITROËN dealer.
 <b>Battery charge</b>	fixed.	The battery charging circuit has a fault (dirty or loose terminals, slack or cut alternator belt, ...).	The warning lamp should go off when the engine is started. If it does not switch off, contact a CITROËN dealer.
 <b>Door(s) open</b>	fixed if the speed is below 6 mph (10 km/h). fixed and accompanied by an audible signal if the speed is above 6 mph (10 km/h).	A door or the boot is still open.	Close the door or boot.



Warning lamp		is on	Cause	Action/Observations
	<b>Airbags</b>	temporarily.	This lamp comes on for a few seconds when you turn on the ignition, then switches off.	This lamp should switch off when the engine is started. If it does not switch off, contact a CITROËN dealer.
		fixed.	One of the airbag or seat belt pretensioner systems has a fault.	Have it checked by a CITROËN dealer.
	<b>Seat belt not fastened/ unfastened</b>	fixed then flashing accompanied by an increasing audible signal.	The driver and/or the front passenger has not fastened or has unfastened their seat belt.	Pull the strap then insert the tongue in the buckle.
	<b>Power steering</b>	fixed.	The power steering has a fault.	Drive carefully at reduced speed. Have it checked by a CITROËN dealer.

## Coolant temperature indicator

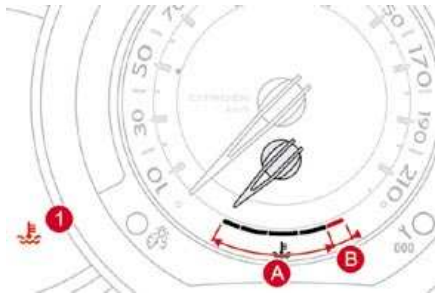

With the engine running, when the needle is:

- in zone **A**, the temperature is correct,
- in zone **B**, the temperature is too high; the central **STOP** warning lamp and the maximum temperature warning lamp **1** light up in red, accompanied by an audible signal and a message on the multifunction screen.

**You must stop as soon as it is safe to do so.**

Wait a few minutes before switching off the engine.

Consult a CITROËN dealer.

After driving for a few minutes, the temperature and pressure in the cooling system increase.

To top up the level:

- ☞ wait for the engine to cool down,
- ☞ unscrew the cap by two turns to allow the pressure to drop,
- ☞ when the pressure has dropped, remove the cap,
- ☞ top up the level to the "MAX" mark.



## Service indicator



System which informs the driver when the next service is due, in accordance with the manufacturer's servicing schedule.

The point at which the service is due is calculated from the last indicator zero reset.

It is determined by two parameters:

- the distance travelled,
- the time elapsed since the last service.

### More than 1 800 miles (3 000 km) remain before the next service is due

When the ignition is switched on, no service information appears on the display.

### Between 600 miles (1 000 km) and 1 800 miles (3 000 km) remain before the next service is due

For a few seconds after the ignition is switched on, the spanner symbolising the service operations comes on. The distance recorder display line indicates the distance remaining before the next service is due.

**Example:** 1 700 miles/2 800 km remain before the next service is due.

For a few seconds after the ignition is switched on, the display indicates:



A few seconds after the ignition is switched on, **the spanner goes off**; the distance recorder resumes its normal operation. The display then indicates the total and trip distances.



### Less than 600 miles (1 000 km) remain before the next service is due

**Example:** 400 miles/900 km remain before the next service is due.

For a few seconds after the ignition is switched on, the display indicates:



A few seconds after the ignition is switched on, the distance recorder resumes its normal operation. **The spanner remains on** to indicate that a service must be carried out soon.



## Service overdue

For a few seconds after the ignition is switched on, **the spanner flashes** to indicate that the service must be carried out as soon as possible.

**Example:** the service is overdue by 300 miles (km).  
For a few seconds after the ignition is switched on, the display indicates:



A few seconds after the ignition is switched on, the distance recorder resumes its normal operation. **The spanner remains on.**



**i** The distance remaining may be weighted by the time factor, depending on the driver's driving habits. Therefore, the spanner may also come on if you have exceeded the two year service interval.

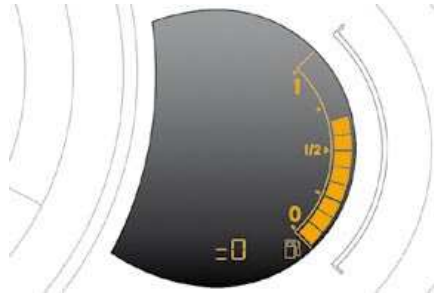

## Service indicator zero reset

After each service, the service indicator must be reset to zero.

The procedure for resetting to zero is as follows:

- ☞ switch off the ignition,
- ☞ press and hold the trip distance recorder zero reset button,
- ☞ switch on the ignition; the distance recorder display begins a countdown,
- ☞ when the display indicates "**=0**", release the button; the spanner disappears.

**i** Following this operation, if you wish to disconnect the battery, lock the vehicle and wait at least five minutes for the zero reset to be taken into account.

## Retrieving the service information

You can access the service information at any time.

- ☞ Press the trip distance recorder zero reset button.

The service information is displayed for a few seconds, then disappears.



## Engine oil level indicator



System which informs the driver whether the engine oil level is correct or not. This information is indicated for a few seconds when the ignition is switched on, after the service information.

**i** The level read will only be correct if the vehicle is on level ground and the engine has been off for more than 15 minutes.



**Oil level correct**



**Lack of oil**

This is indicated by the flashing of "OIL", linked with the service warning lamp, accompanied by an audible signal and a message on the multifunction screen.

If the lack of oil is confirmed by a check using the dipstick, it is essential that the level is topped up to prevent damage to the engine.



**Oil level indicator fault**

This is indicated by the flashing of "OIL--". Consult a CITROËN dealer.

**Dipstick**

Refer to the "Checks" section to locate the dipstick and the oil filler cap on your engine.



There are 2 marks on the dipstick:

- **A** = max; never exceed this level (risk of damage to the engine),
- **B** = min; top up the level via the oil filler cap, using the grade of oil suited to your engine.



## Total distance recorder



System which measures the total distance travelled by the vehicle during its life. The total and trip distances are displayed for thirty seconds when the ignition is switched off, when the driver's door is opened and when the vehicle is locked or unlocked.

## Trip distance recorder



System which measures a distance travelled during a day or other period since it was reset to zero by the driver.

- ☞ With the ignition on, press the button until zeros appear.

## Lighting rheostat



System for manual adjustment of the brightness of the instruments and controls in relation to the exterior brightness.

### Activation

When the lighting is on:

- ☞ press the button to change the brightness of the instruments and controls,
- ☞ when the level of brightness required is reached, release the button.

### Deactivation

When the lighting is off, or in day mode on vehicles fitted with daytime running lamps, pressing the button does not have any effect.



## Black panel



System allowing certain displays to be switched off for night driving.

The instrument panel remains illuminated with only the vehicle speed and cruise control or speed limiter information, if in use.

If there is an alert or a change in a function or to a setting, the black panel mode is interrupted.

### Activation

- ☞ With the lighting on, press the left hand button of the instrument panel several times to progressively reduce the dashboard lighting level.
- ☞ Press the button again to reduce the lighting to the minimum level and switch off the interior mood lighting.
- ☞ Press the button again to activate the black panel.

# Trip computer

System that gives you current information on your journey (range, fuel consumption...).

## Monochrome screen A

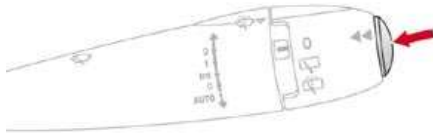

## Information displays

- ☞ Press the button, located at the end of the **wiper stalk**, to display the various items of trip computer information in succession.

The trip computer provides the following information:

- range,



- current fuel consumption,



- Stop & Start time counter,



- distance travelled,



- average fuel consumption,



- average speed.



- ☞ The next press then returns you to the normal display.

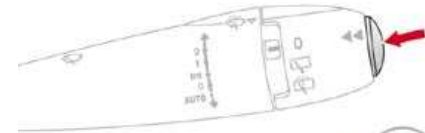

## Zero reset

- ☞ Press the control for more than two seconds to reset to zero the distance travelled, the average fuel consumption and the average speed.

## A few definitions...



### Range

(miles or km)

This indicates the distance which can still be travelled with the fuel remaining in the tank in relation to the average fuel consumption over the last few miles (kilometres) travelled.



This value may vary following a change in the style of driving or the relief, resulting in a significant change in the current fuel consumption.

When the range falls below 20 miles (30 km), dashes are displayed. After filling with at least 5 litres of fuel, the range is recalculated and is displayed when it exceeds 60 miles (100 km).



If dashes are displayed continuously while driving in place of the digits, contact a CITROËN dealer.



### Current fuel consumption

(mpg or l/100 km or km/l)

This is the average fuel consumption during the last few seconds.



This function is only displayed from 20 mph (30 km/h).



### Average fuel consumption

(mpg or l/100 km or km/l)

This is the average fuel consumption since the last trip computer zero reset.



### Average speed

(mph or km/h)

This is the average speed calculated since the last trip computer zero reset (ignition on).



### Distance travelled

(miles or km)

This indicates the distance travelled since the last trip computer zero reset.



### Distance remaining to destination

(miles or km)

This is the distance remaining to be travelled to the final destination. It can be entered by the user.

If the distance is not entered, dashes are displayed in place of the digits.



### Stop & Start time counter

(minutes/seconds or hours/minutes)

If your vehicle is fitted with Stop & Start, a time counter calculates the time spent in STOP mode during a journey.

It resets to zero every time the ignition is switched on with the key.



## Monochrome screen C



## 16/9 colour screen (MyWay)

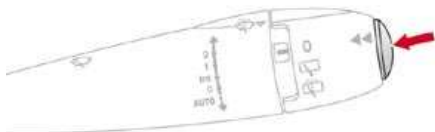
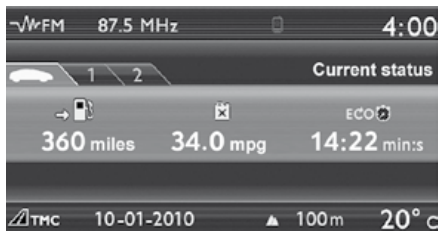

### Information displays

☞ Press the button, located at the end of the **wiper stalk**, to display the various trip computer tabs in succession.



- the current information tab with:
  - the range,
  - the current fuel consumption,
  - the distance remaining to be travelled or the Stop & Start time counter.



- the trip "1" tab with:
  - the distance travelled,
  - the average fuel consumption,
  - the average speed,
  - for the first trip.



- the trip "2" tab with:
  - the distance travelled,
  - the average fuel consumption,
  - the average speed,
  - for the second trip.

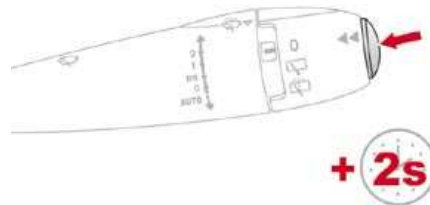

### Trip zero reset

☞ When the trip required is displayed, press the button on the end of the wiper stalk for more than two seconds.

Trips "1" and "2" are independent but their use is identical.

For example, trip "1" can be used for daily figures, and trip "2" for monthly figures.

☞ Pressing the button again returns you to the normal display.

## A few definitions...



### Range

(miles or km)

This indicates the distance which can still be travelled with the fuel remaining in the tank in relation to the average fuel consumption over the last few miles (kilometres) travelled.



This value may vary following a change in the style of driving or the relief, resulting in a significant change in the current fuel consumption.

When the range falls below 20 miles (30 km), dashes are displayed. After filling with at least 5 litres of fuel, the range is recalculated and is displayed when it exceeds 60 miles (100 km).



If dashes are displayed continuously while driving in place of the digits, contact a CITROËN dealer.



### Current fuel consumption

(mpg or l/100 km or km/l)

This is the average fuel consumption during the last few seconds.



This function is only displayed from 20 mph (30 km/h).



### Average fuel consumption

(mpg or l/100 km or km/l)

This is the average fuel consumption since the last trip computer zero reset.



### Average speed

(mph or km/h)

This is the average speed calculated since the last trip computer zero reset (ignition on).



### Distance travelled

(miles or km)

This indicates the distance travelled since the last trip computer zero reset.



### Distance remaining to destination

(miles or km)

This is the distance remaining to be travelled to the final destination. It can be entered by the user.

If the distance is not entered, dashes are displayed in place of the digits.



### Stop & Start time counter

(minutes/seconds or hours/minutes)

If your vehicle is fitted with Stop & Start, a time counter calculates the time spent in STOP mode during a journey.

It resets to zero every time the ignition is switched on with the key.

# Monochrome screen A

## Displays on the screen



This displays the following information:

- time,
- date,
- ambient temperature (this flashes if there is a risk of ice),
- status of the doors and boot,
- audio sources (radio, CD...),
- trip computer (refer to the "Instruments and Controls" section).

Warning messages (e.g.: "Emission control system faulty") or information messages (e.g.: "Boot open") may appear temporarily. These can be cleared by pressing the "**ESC**" button.

## Controls

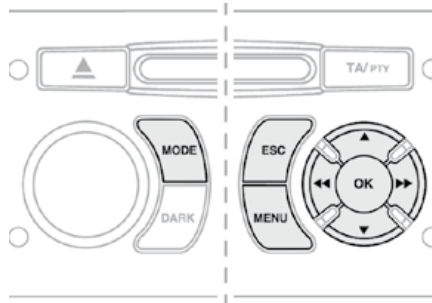

From the control panel of your Audio system, you can:

- ☞ press the "**MENU**" button to gain access to the **main menu**,
  - ☞ press the "▲" or "▼" buttons to scroll through the items on the screen,
  - ☞ press the "**MODE**" button to change the permanent application (date, audio source...),
  - ☞ press the "◀" or "▶" buttons to change a setting value,
  - ☞ press the "**OK**" button to confirm,
- or
- ☞ press the "**ESC**" button to abandon the operation in progress.

## Main menu



- ☞ Press the "**MENU**" button to gain access to the **main menu**, then press the "▲" or "▼" buttons to scroll through the various menus:
  - radio-CD,
  - vehicle configuration,
  - options,
  - display settings,
  - languages,
  - units.
- ☞ Press the "**OK**" button to select the menu required.



## Radio-CD

With the Audio system switched on, once the "Radio-CD" menu has been selected you can activate or deactivate the functions linked with use of the radio (RDS, REG), or the CD (introscan, shuffle, CD repeat).

For more information on the "Radio-CD" application, refer to the Audio system part of the "Audio and Telematics" section.

## Vehicle configuration

Once the "Vehicle Configuration" menu has been selected, you can activate or deactivate the following equipment:

- wiper linked with reverse gear (refer to the "Visibility" section),
- guide-me-home lighting (refer to the "Visibility" section),
- parking sensors (refer to the "Driving" section).

## Options

Once the "Options" menu has been selected, you can start diagnostics of the status of the equipment (active, not active, faulty).



## Display settings

Once the "Display settings" menu has been selected, you can gain access to the following settings:

- year,
- month,
- day,
- hour,
- minutes,
- 12 or 24 hour mode.



For safety reasons, configuration by the driver of the multifunction screen must only be done when stationary.



- ☞ Once you have selected a setting, press the "◀" or "▶" buttons to change its value.



- ☞ Press the "▲" or "▼" buttons to switch respectively to the previous or next setting.
- ☞ Press the "OK" button to save the change and return to the normal display or press the "ESC" button to cancel.

## Languages

Once the "Languages" menu has been selected, you can change the language used by the display (Français, Italiano, Nederlands, Portugues, Portugues-Brasil, Deutsch, English, Espanol).

## Units

Once the "Units" menu has been selected, you can change the units of the following parameters:

- temperature (°C or °F),
- fuel consumption (l/100 km, mpg or km/l).



Once the fuel consumption units have been set to mpg, the information in the instrument panel screen on speed and distance will also be in mph and miles.

# Monochrome screen C

## Displays on the screen



This displays the following information:

- time,
- date,
- ambient temperature (this flashes if there is a risk of ice),
- status of doors and boot,
- audio sources (radio, CD, USB port, jack socket etc.),
- trip computer (refer to the "Instruments and controls" section).

Warning messages (E.g. "Emissions control system faulty") or information messages (E.g.: Automatic headlamps active") may appear temporarily. These can be cleared by pressing the "ESC" button.

## Controls

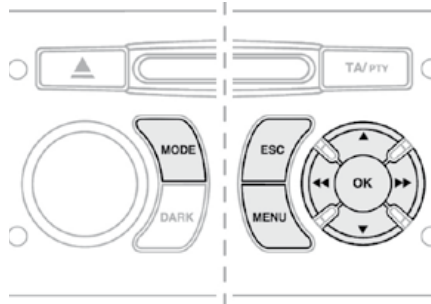

From your Audio system control panel, you can:

- ☞ press the "MENU" button to gain access to the **main menu**,
  - ☞ press the "▲" or "▼" buttons to scroll through the items on the screen,
  - ☞ press the "MODE" button to change the permanent application (trip computer, audio source...),
  - ☞ press the "◀" or "▶" buttons to change a setting value,
  - ☞ press the "OK" button to confirm,
- or
- ☞ press the "ESC" button to abandon the operation in progress.

## Main menu



- ☞ Press the "MENU" button to gain access to the **main menu**:
  - audio functions,
  - the trip computer,
  - personalisation-configuration,
  - telephone (hands-free kit).
- ☞ Press the "▲" or "▼" buttons to select the menu required, then confirm by pressing the "OK" button.

## "Audio functions" menu

With the Audio system switched on, once this menu has been selected you can activate or deactivate the functions linked with use of the radio (RDS, REG, RadioText), the CD (introscan, shuffle, CD repeat) or the MP3 player (USB port/jack socket).

For more information on the "Audio functions" application, refer to the Audio system part of the "Audio and Telematics" section.

## "Trip computer" menu

Once this menu has been selected, you can consult information concerning the status of the vehicle (warnings log, status of functions, etc.)

### Alert log

This summarises the active warning messages, displaying them in succession on the multifunction screen.

### Status of functions

This summarises the status (active or inactive) of the vehicle's functions.

### Enter distance to destination

This allows you to enter an approximate distance until your final destination.

- ☞ Press the **"MENU"** button to gain access to the **general menu**.
- ☞ Press the arrows, then the **"OK"** button to select the **"Trip computer"** menu.



- ☞ In the **"Trip computer"** menu, select one of the following applications:

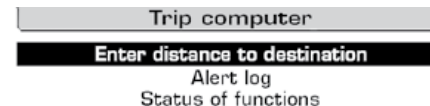

## "Personalisation-Configuration" menu

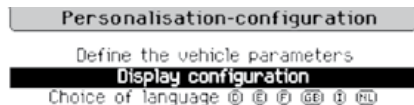

Once this menu has been selected, you can gain access to the following functions:

- define the vehicle parameters,
- display configuration,
- choice of language.

### Define the vehicle parameters

Once this menu has been selected, you can activate or deactivate the following equipment:

- wiper linked to reverse gear (refer to the "Visibility" section),
- guide-me-home lighting
- parking sensors (refer to the "Driving" section).

Example: setting of the duration of the guide-me-home lighting

- ☞ Press the "▲" or "▼" buttons, then the "OK" button to select the menu required.

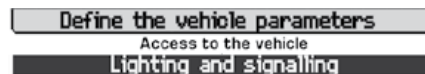

- ☞ Press the "▲" or "▼" buttons, then the "OK" button to select the "Guide-me-home headlamps" line.

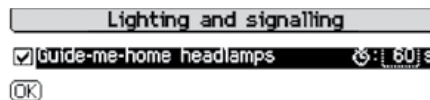

- ☞ Press the "◀" or "▶" buttons to set the value required (15, 30 or 60 seconds), then press the "OK" button to confirm.

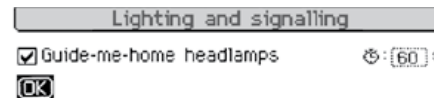

- ☞ Press the "▲" or "▼" buttons, then the "OK" button to select the "OK" box and confirm or press the "ESC" button to cancel.

## Display configuration

Once this menu has been selected, you can gain access to the following settings:

- brightness-video setting,
- date and time setting,
- selection of units.



Once the fuel consumption units have been changed to mpg, the information in the screen relating to speed and distance also changes to mph and miles respectively.

## Choice of language

Once this menu has been selected, you can change the language used by the display (Deutsch, English, Espanol, Français, Italiano, Nederlands, Portugues, Portugues-Brasil, Türkçe\*).



For safety reasons, configuration by the driver of the multifunction screen must only be done when stationary.



## "Telephone" Menu

With Audio system on, once this menu is selected you can configure your Bluetooth hands-free system (pairing), view the various telephone directories (list of calls, services...) and manage your calls (call, hang up, second call, secret mode...).

For more information on the "Telephone" function, refer to the Audio system part of the "Audio and telematics" section.

\* According to country of destination.

# 16/9 colour screen (MyWay)

## Displays on the screen



## Controls

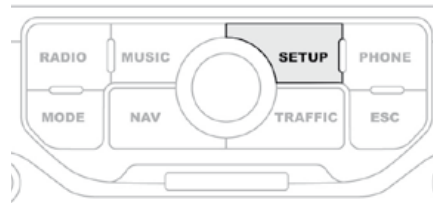

It displays the following information automatically and directly:

- time,
- date,
- altitude,
- ambient temperature (the value displayed flashes if there is a risk of ice),
- check of the doors,
- warning and vehicle function status messages, displayed temporarily,
- audio functions,
- trip computer information (see the "Monitoring" section),
- satellite navigation system information.

MyWay To select one of the applications, at the control panel:

- ☞ press the dedicated **"RADIO"**, **"MUSIC"**, **"NAV"**, **"TRAFFIC"**, **"SETUP"** or **"PHONE"** button for access to the corresponding menu,
- ☞ turn the dial to change the selection,
- ☞ press the dial to confirm the selection, or
- ☞ press the **"ESC"** button to abandon the current operation and return to the previous display.

For more information on these applications, refer to the "Audio and Telematics" section or to the specific user guide given to you with the other owner's documents.

## "SETUP" menu

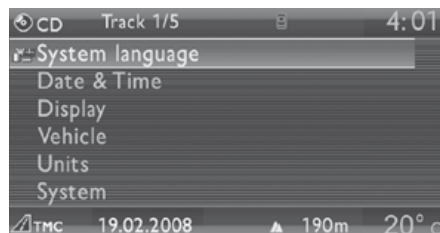

Press the **"SETUP"** button to gain access to the **"SETUP"** menu. This allows you to select from the following functions:

- "System language",
- "Date and time",
- "Display",
- "Vehicle",
- "Units",
- "System".

### System language

This menu allows you to select the language used by the display: Deutsch, English, Espanol, Français, Italiano, Nederlands, Polski, Portugues, Türkçe\*.

### Date and time

This menu allows you to set the date and time, the format of the date and the format of the time (refer to the "Audio and Telematics" section or to the specific user guide given to you with the other owner's documents).

### Display

This menu allows you to set the brightness of the screen, the screen colour scheme and the colour of the map (day/night or auto mode).

### Vehicle

This menu allows you to activate or deactivate certain driving and comfort equipment:

- wiper linked with reverse gear (refer to the "Visibility" section),
- guide-me-home lighting and duration (refer to the "Visibility" section),
- parking sensors (refer to the "Driving" section).

### Units

This menu allows you to select the units: temperature (°C or °F) and fuel consumption (km/l, l/100 or mpg).

### System

This menu allows you to restore the factory configuration, display the software version and activate scrolling text.

 For safety reasons, configuration of the multifunction screen by the driver must only be done when stationary.

\* According to country.

# Ventilation

## Air intake

The air circulating in the passenger compartment is filtered and originates either from the outside via the grille located at the base of the windscreen or from the inside in air recirculation mode.

## Air treatment

The incoming air follows various routes depending on the controls selected by the driver:

- direct arrival in the passenger compartment (air intake),
- passage through a heating circuit (heating),
- passage through a cooling circuit (air conditioning).

The temperature control enables you to obtain the level of comfort required by mixing the air of the various circuits.

The air distribution control enables you to diffuse the air in the passenger compartment combining several air vents.

The air flow control enables you to increase or reduce the speed of the ventilation blower.

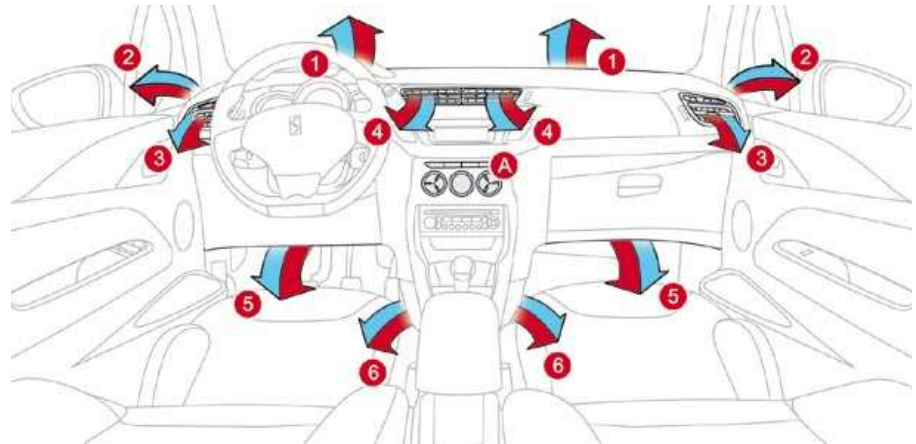

## Control panel

The controls of this system are grouped together on control panel **A** on the centre console. Depending on the model, the functions offered are:

- the level of comfort required,
- air flow,
- air distribution,
- demisting-defrosting,
- manual or digital air conditioning controls.

## Air distribution

1. Windscreen demisting-defrosting vents.
2. Front side window demisting-defrosting vents.
3. Side adjustable air vents.
4. Central adjustable air vents.
5. Air outlets to the front footwells.
6. Air outlets to the rear footwells.





## Recommendations for ventilation and air conditioning

-  In order for these systems to be fully effective, follow the operation and maintenance guidelines below:
- ☞ To obtain an even air distribution, take care not to obstruct the exterior air intake grilles located at the base of the windscreen, the nozzles, the vents and the air outlets, as well as the air extractor located in the boot.
  - ☞ Do not cover the sunshine sensor, located on the dashboard; this is used for regulation of the digital air conditioning system.
  - ☞ Operate the air conditioning system for at least 5 to 10 minutes, once or twice a month to keep it in perfect working order.
  - ☞ Ensure that the passenger compartment filter is in good condition and have the filter elements replaced regularly (refer to the "Checks" section).  
We recommend the use of a combined passenger compartment filter. Thanks to its special active additive, it contributes to the purification of the air breathed by the occupants and the cleanliness of the passenger compartment (reduction of allergic symptoms, bad odours and greasy deposits).
  - ☞ To ensure correct operation of the air conditioning system, you are also advised to have it checked regularly as recommended in the Maintenance and Warranty Guide.
  - ☞ If the system does not produce cold air, deactivate it and contact a CITROËN dealer.
- When towing the maximum load on a steep gradient in high temperatures, switching off the air conditioning increases the available engine power and so improves the towing ability.

 If after an extended stop in sunshine, the interior temperature is very high, first ventilate the passenger compartment for a few moments. Put the air flow control at a setting high enough to quickly change the air in the passenger compartment. The air conditioning system does not contain chlorine and does not present any danger to the ozone layer.

 The condensation created by the air conditioning results in a discharge of water under the vehicle which is perfectly normal.

# Heating/Ventilation

## Manual control panel

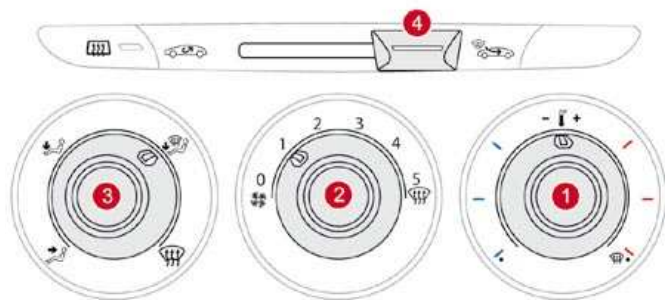

## Electric control panel

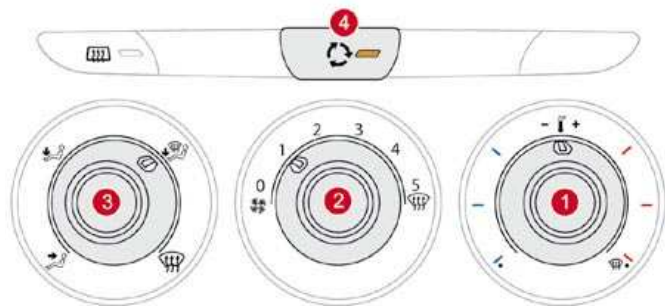

The heating/ventilation or air conditioning systems operates with the engine running, as well as in STOP mode with Stop & Start.

## 1. Temperature adjustment



☞ Turn the dial from blue (cold) to red (hot) to adjust the temperature to your requirements.

## 2. Air flow adjustment



☞ Turn the dial from position 1 to position 5 to obtain a comfortable air flow.



☞ If you place the air flow control in position 0 (deactivation of the system), the temperature is no longer maintained at a comfortable level. However, a slight flow of air, due to the movement of the vehicle, can still be felt.

## 3. Air distribution adjustment



Windscreen and side windows.



Windscreen, side windows and footwells.



Footwells.



Central and side vents.



The air distribution can be adapted by placing the dial in an intermediate position.

## 4. Air intake/Air recirculation

The intake of exterior air avoids the formation of mist on the windscreen and side windows. The recirculation of interior air insulates the passenger compartment from exterior odours and smoke.

Return to exterior air intake as soon as possible to prevent deterioration of the air quality and the formation of mist.

### Manual control panel



☞ Move the manual control to the left to be in the "recycling interior air" position.



☞ Move the manual control to the right to return to the "fresh air intake" position.



### Electric control panel



- ☞ Press the button to recirculate the interior air. The indicator lamp comes on to confirm this.

- ☞ Press the button again to allow fresh air into the passenger compartment. The indicator lamp goes off to confirm this.

## 5. Air conditioning On/Off



The air conditioning is designed to operate effectively in all seasons, with the windows closed.

It enables you to:

- lower the temperature, in summer,
- increase the effectiveness of the demisting in winter, above 3 °C.

### Switching on

- ☞ Press the **"A/C"** button, the button's indicator lamp comes on.

 The air conditioning does not operate when the air flow adjustment control **2** is in position **"0"**.

### Switching off

- ☞ Press the **"A/C"** button again, the button's indicator lamp goes off.
- Switching off may affect comfort levels (humidity, condensation).

# Front demist - defrost



These markings on the control panel indicate the control positions for rapid demisting or defrosting of the windscreen and side windows.

## With the heating/ventilation system

- ☞ Put the temperature and air flow controls to the dedicated marked position.
- ☞ Put the air intake control to the "Exterior air intake" position  
(manual control to the right or electric control with indicator lamp off).
- ☞ Put the air distribution control to the "Windscreen" position.

## With the manual air conditioning system

- ☞ Put the temperature and air flow controls to the dedicated marked position.
- ☞ Put the air intake control to the "Exterior air intake" position  
(manual control to the right or electric control with indicator lamp off).
- ☞ Put the air distribution control to the "Windscreen" position.
- ☞ Switch on the air conditioning by pressing the "**A/C**" button; the associated green warning lamp comes on.

**i** With Stop & Start, when the demisting, air conditioning and air flow functions are activated, STOP mode is not available.

# Manual air conditioning

## Manual control panel

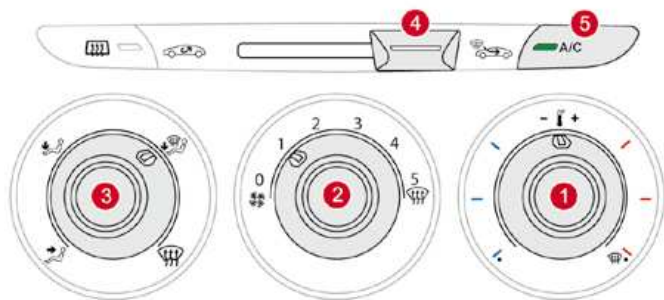

## Electric control panel

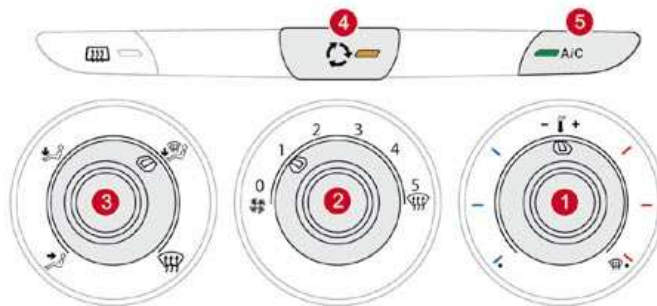

The heating/ventilation or air conditioning systems operates with the engine running, as well as in STOP mode with Stop & Start.

## 1. Temperature adjustment



☞ Turn the dial from blue (cold) to red (hot) to adjust the temperature to your requirements.

## 2. Air flow adjustment



☞ Turn the dial from position 1 to position 5 to obtain a comfortable air flow.



☞ If you place the air flow control in position 0 (deactivation of the system), the temperature is no longer maintained at a comfortable level. However, a slight flow of air, due to the movement of the vehicle, can still be felt.

## 3. Air distribution adjustment



Windscreen and side windows.



Windscreen, side windows and footwells.



Footwells.



Central and side vents.



The air distribution can be adapted by placing the dial in an intermediate position.

## 4. Air intake/Air recirculation

The intake of exterior air avoids the formation of mist on the windscreen and side windows. The recirculation of interior air insulates the passenger compartment from exterior odours and smoke.

Return to exterior air intake as soon as possible to prevent deterioration of the air quality and the formation of mist.

### Manual control panel



☞ Move the manual control to the left to be in the "recycling interior air" position.



☞ Move the manual control to the right to return to the "fresh air intake" position.



### Electric control panel



- ☞ Press the button to recirculate the interior air. The indicator lamp comes on to confirm this.

- ☞ Press the button again to allow fresh air into the passenger compartment. The indicator lamp goes off to confirm this.

## 5. Air conditioning On/Off



The air conditioning is designed to operate effectively in all seasons, with the windows closed.

It enables you to:

- lower the temperature, in summer,
- increase the effectiveness of the demisting in winter, above 3 °C.

### Switching on

- ☞ Press the "A/C" button, the button's indicator lamp comes on.

 The air conditioning does not operate when the air flow adjustment control **2** is in position "0".

### Switching off

- ☞ Press the "A/C" button again, the button's indicator lamp goes off.
- Switching off may affect comfort levels (humidity, condensation).



# Front demist - defrost



These markings on the control panel indicate the control positions for rapid demisting or defrosting of the windscreen and side windows.

## With the heating/ventilation system

- ☞ Put the temperature and air flow controls to the dedicated marked position.
- ☞ Put the air intake control to the "Exterior air intake" position  
(manual control to the right or electric control with indicator lamp off).
- ☞ Put the air distribution control to the "Windscreen" position.

## With the manual air conditioning system

- ☞ Put the temperature and air flow controls to the dedicated marked position.
- ☞ Put the air intake control to the "Exterior air intake" position  
(manual control to the right or electric control with indicator lamp off).
- ☞ Put the air distribution control to the "Windscreen" position.
- ☞ Switch on the air conditioning by pressing the "**A/C**" button; the associated green warning lamp comes on.

**i** With Stop & Start, when the demisting, air conditioning and air flow functions are activated, STOP mode is not available.

# Front demist - defrost



These markings on the control panel indicate the control positions for rapid demisting or defrosting of the windscreen and side windows.

## With the heating/ventilation system

- ☞ Put the temperature and air flow controls to the dedicated marked position.
- ☞ Put the air intake control to the "Exterior air intake" position  
(manual control to the right or electric control with indicator lamp off).
- ☞ Put the air distribution control to the "Windscreen" position.

## With the manual air conditioning system

- ☞ Put the temperature and air flow controls to the dedicated marked position.
- ☞ Put the air intake control to the "Exterior air intake" position  
(manual control to the right or electric control with indicator lamp off).
- ☞ Put the air distribution control to the "Windscreen" position.
- ☞ Switch on the air conditioning by pressing the "**A/C**" button; the associated green warning lamp comes on.

**i** With Stop & Start, when the demisting, air conditioning and air flow functions are activated, STOP mode is not available.

# Digital air conditioning

The air conditioning operates when the engine is running, as well as in STOP mode with Stop & Start.

## Automatic operation

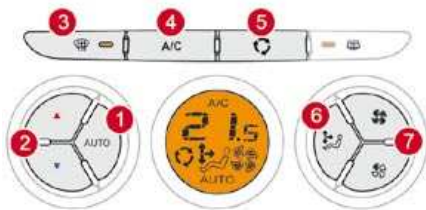

### 1. Automatic "comfort" programme

**AUTO** Press the "AUTO" button. The "AUTO" symbol is displayed. We recommend that you use this mode. It provides optimised automatic control of all of the following functions: passenger compartment temperature, air flow, air distribution and air intake, in accordance with the comfort value that you have chosen. This system is designed to operate effectively in all seasons, with the windows closed.

**i** For your comfort, when the engine is switched off, the settings are retained until the engine is switched on again. To prevent too great a distribution of cold air when the engine is cold, the air flow will only reach its optimum level gradually.

### 2. Temperature adjustment

The value indicated on the display corresponds to a level of comfort and not to a temperature in degrees Celsius or Fahrenheit.

**▲** Press the "▲" and "▼" buttons to change this value. A setting around the value **21** enables optimum comfort to be obtained. However, depending on your requirements, a setting between 18 and 24 is usual.

**i** On entering the vehicle, if the interior is very cold or hot, there is no need to change the value displayed in order to reach the required level of comfort. The system corrects the temperature difference automatically and as quickly as possible.

### 3. Automatic "visibility" programme



The automatic comfort programme may not be sufficient for rapid demisting or defrosting of the windscreen and side windows (humidity, several passengers, ice, etc.). In this case, select the automatic visibility programme. The button **3** indicator lamp comes on. The system automatically controls the air conditioning and the flow of air and provides optimum air distribution to the windscreen and side windows. It deactivates air recirculation **5**. To exit this programme, press button **3** again or "AUTO", the indicator lamp on the button goes off and "AUTO" is displayed.

**i** With Stop & Start, when demisting has been activated, the STOP mode is not available.

## Manual override

It is possible to adjust one or more functions manually while leaving the other functions in automatic mode.

The **"AUTO"** symbol switches off.

To return to automatic mode, press the **"AUTO"** button.

 Switching to manual mode may not be suitable (temperature, humidity, odour, condensation) and does not provide optimum comfort.

 For maximum cooling or heating of the cabin, it is possible to go beyond the minimum 14 or maximum 28 values.

- ☞ Press the blue button **2** until **"LO"** is displayed or the red button **2** until **"HI"** is displayed.

## 4. Air conditioning on/off



Press this button to switch off the air conditioning.

Stopping the air conditioning may cause some problems (humidity, misting).

Automatic operation of the air conditioning is resumed when the button is pressed again. The symbol **"A/C"** is displayed.

## 5. Air intake/Air recirculation



Press this button for recirculation of the interior air. The air recirculation symbol **5** is displayed.

Air recirculation enables the passenger compartment to be isolated from exterior odours and smoke.

Press this button again or press the **"AUTO"** button to resume automatic management of the intake of air. The air recirculation symbol **5** goes off.



Avoid prolonged recirculation of interior air (risk of condensation or deterioration of the air quality).



## 6. Air distribution adjustment



Pressing this button several times in succession enables the air flow to be directed in turn towards:

- the windscreen and the side windows (demisting or defrosting),
- the windscreen, side windows and air vents,
- the windscreen, the side windows, the air vents and the footwells,
- the windscreen, the side windows and the footwells,
- the footwells,
- the air vents and the footwells,
- the air vents.

## 7. Air flow adjustment



Press the **"full fan"** button to increase the air flow.

The air flow symbol, the fan, fills progressively according to the value requested.



Press the **"empty fan"** button to decrease the air flow.

## Switching the system off



Press the air flow **"empty fan"** button **7** until the fan symbol disappears.

This action switches off all of the functions of the air conditioning system.

Thermal comfort is no longer controlled.

A slight flow of air resulting from the movement of the vehicle, remains perceptible however.

Pressing the air flow **"full fan"** button **7** or on **"AUTO"** reactivates the system with the values set before it was switched off.



Avoid driving for long periods with the air conditioning switched off (risk of misting and reduction of the air quality in the cabin).

# Rear screen demist - defrost



The control button is located on the heating or air conditioning system control panel.

## Switching on

The rear screen demisting/defrosting can only operate when the engine is running.

- ☞ Press this button to demist/defrost the rear screen and (depending on version) the door mirrors. The indicator lamp associated with the button comes on.

## Switching off

The demisting/defrosting switches off automatically to prevent an excessive consumption of current.

- ☞ It is possible to stop the demisting/defrosting operation before it is switched off automatically by pressing the button again. The indicator lamp associated with the button switches off.

 If the engine is switched off before the demisting/defrosting is switched off automatically, demisting/defrosting will resume next time the engine is switched on.

 ☞ Switch off the demisting/defrosting of the rear screen and door mirrors as soon as appropriate as lower current consumption results in reduced fuel consumption.

## Scented air freshener

System permitting the diffusion of a fragrance in the passenger compartment in accordance with your requirements, by means of the adjustment dial and the various fragrance cartridges available.

### Adjustment dial

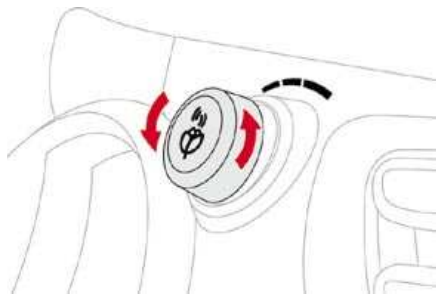

This dial is located on the dashboard. It allows you to adjust the intensity of diffusion of the fragrance.

- ☞ Turn the dial to the right to permit diffusion of the fragrance.
- ☞ Turn the dial to the left to stop diffusion of the fragrance.

**i** Leave the central vents open. The intensity of diffusion of the fragrance may depend on the ventilation or air conditioning settings.

### Fragrance cartridge

This cartridge can be removed easily. The first time it is used, replace the plug with a real cartridge.

You can change it at any time and store it in the sealed case which keeps it closed once it has been opened.

You can obtain different fragrance cartridges from CITROËN dealers.

**i** Do not discard the original cartridge as this serves as a plug when no fragrance cartridge is in use. In order to preserve the service life of the cartridge, turn the dial fully to the left when you no longer wish to diffuse the fragrance in the passenger compartment.

**!** As a safety precaution, do not carry out any action on the cartridge while driving. Do not dismantle the cartridges. Do not attempt to refill the fragrance diffuser or the cartridges. Avoid all contact with the skin and eyes. Keep out of reach of children and animals.

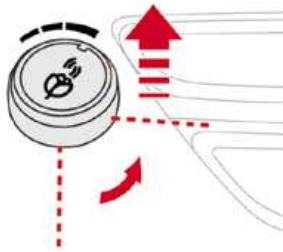

### Removing the cartridge

- ☞ Press the dial and turn it a quarter of a turn anti-clockwise.
- ☞ Remove the cartridge.
- ☞ Refit its sealing case.

### Fitting the cartridge

- ☞ Remove the cartridge from the sealing case.
- ☞ Install the cartridge (flower at top left).
- ☞ Press the dial and turn it a quarter of a turn clockwise.





## Front seats

Seat consisting of a seat cushion, a seat back and a head restraint which can all be adjusted to adapt your position for ease of driving and comfort.

### Manual adjustments

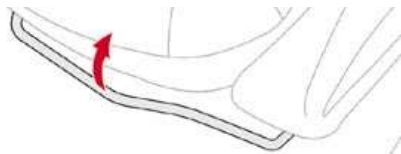
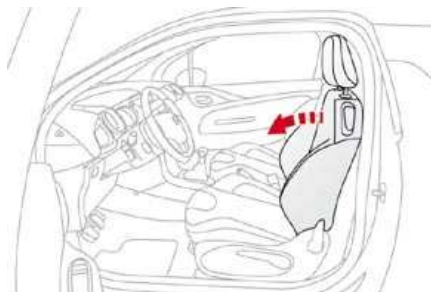
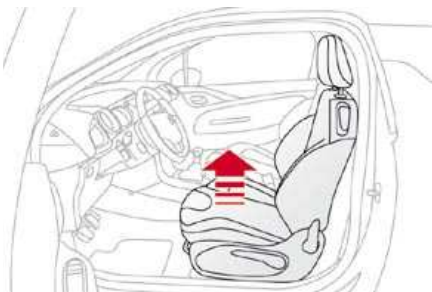

#### Forwards-backwards adjustment

- ☞ Raise the control and slide the seat forwards or backwards.

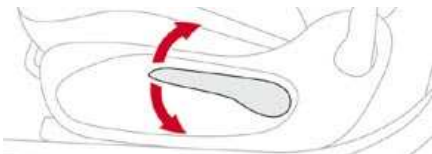

#### Driver's or passenger's seat height adjustment

- ☞ Pull the control upwards to raise or push it downwards to lower, as many times as necessary, to obtain the position required.



#### Seat back angle adjustment

- ☞ Push the control rearwards.

## Additional adjustments



### Head restraint height adjustment

- ☞ To raise the head restraint, pull it upwards.
- ☞ To remove the head restraint, press the lug **A** and pull the head restraint upwards.
- ☞ To put the head restraint back in place, engage the head restraint stems in the openings keeping them in line with the seat back.
- ☞ To lower the head restraint, press the lug **A** and the head restraint at the same time.

 The head restraint is fitted with a frame with notches which prevents it from lowering; this is a safety device in case of impact.

**The adjustment is correct when the upper edge of the head restraint is level with the top of the head.**

Never drive with the head restraints removed; they must be in place and adjusted correctly.



### Access to the rear seats

- ☞ Pull the control upwards to fold the seat back and move the seat forward. When put back in place, the seat returns to its initial position.

 No person or object should prevent the seat slide from returning to its initial position; the return to this position is necessary for longitudinal locking. Check that the seat belt has reeled in correctly so as to not impede access to the rear seats for passengers.

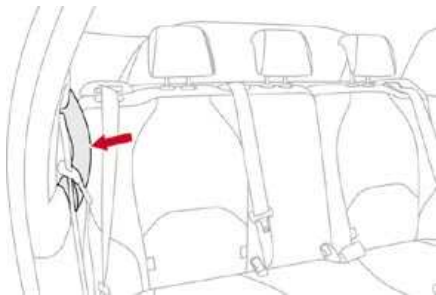

### Grab handle

This easy to use handle, located at the top of the side trim:

- provides a means of support for the outer rear passengers when moving,
- provides a hand hold to ease access to the rear seats,
- facilitates exit from the rear seats.

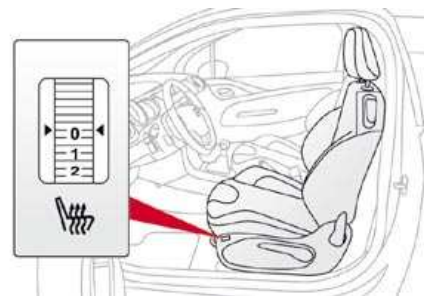

### Heated seats control

With the engine running, the front seats can be heated separately.

- ☞ Use the adjustment dial, placed on the side of each front seat, to switch on and select the level of heating required:
  - 0:** Off.
  - 1:** Low.
  - 2:** Medium.
  - 3:** High.

# Rear seats

Bench seat with fixed one-piece cushion and split backrest (left hand 2/3, right hand 1/3) which can be folded individually to adapt the load space in the boot.

## Folding the backrest

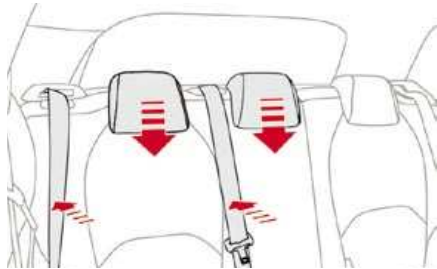

- ☞ Move the corresponding front seat forward if necessary.
- ☞ Check that the seat belt is positioned correctly on the side of the seat back.
- ☞ Place the head restraints in the low position.

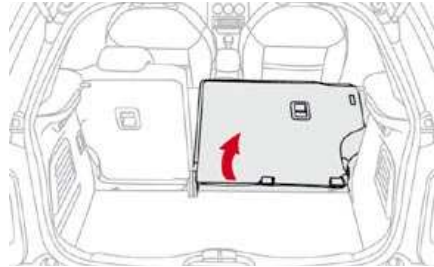
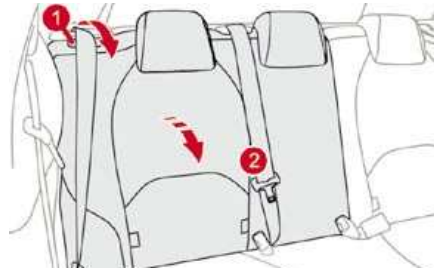

- ☞ Pull control **1** forwards to release the seat back **2**.
- ☞ Fold the seat back **2** on to the cushion.

## Repositioning the seat backrest

When repositioning the rear seat backrest:

- ☞ Straighten the seat back **2** and secure it.
- ☞ Check that the red indicator, located next to the control **1**, is no longer visible.

 When repositioning the seat backrest, take care not to trap the seat belts.



## Steering wheel adjustment

### Rear head restraints

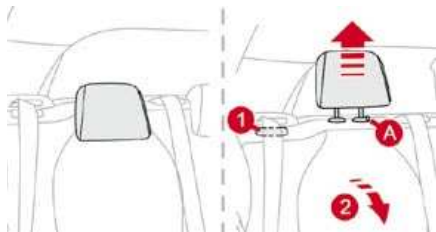

These have one position for use (up) and a stowed position (down).

They can also be removed.

To remove a head restraint:

- ☞ release the backrest using control **1**,
- ☞ tilt the backrest **2** slightly forwards,
- ☞ pull the head restraint upwards to the stop,
- ☞ then, press the lug **A**.



Never drive with the head restraints removed; they must be in place and correctly adjusted.

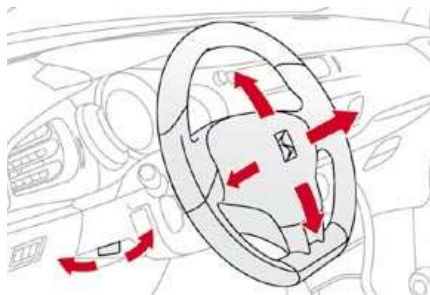

- ☞ **When stationary**, pull the control lever to release the steering wheel.
- ☞ Adjust the height and reach to suit your driving position.
- ☞ Push the control lever to lock the steering wheel.



As a safety precaution, these operations should only be carried out while the vehicle is stationary.



## Steering wheel adjustment

### Rear head restraints

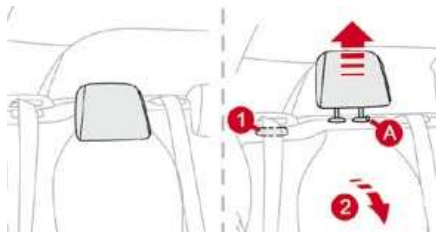

These have one position for use (up) and a stowed position (down).

They can also be removed.

To remove a head restraint:

- ☞ release the backrest using control **1**,
- ☞ tilt the backrest **2** slightly forwards,
- ☞ pull the head restraint upwards to the stop,
- ☞ then, press the lug **A**.



Never drive with the head restraints removed; they must be in place and correctly adjusted.

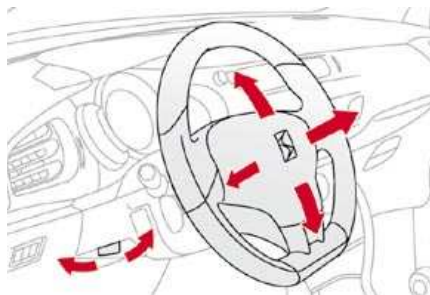

- ☞ **When stationary**, pull the control lever to release the steering wheel.
- ☞ Adjust the height and reach to suit your driving position.
- ☞ Push the control lever to lock the steering wheel.



As a safety precaution, these operations should only be carried out while the vehicle is stationary.

# Mirrors

## Door mirrors

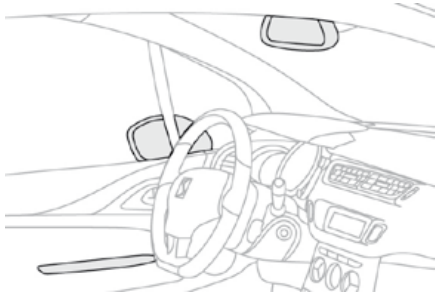

Each fitted with an adjustable mirror glass permitting the lateral rearward vision necessary for overtaking or parking. They can also be folded for parking in confined spaces.

## Demisting - Defrosting

If your vehicle is fitted with heated mirrors, the demisting-defrosting operates with the engine running, by switching on the heated rear screen (refer to the "Rear screen demist-defrost" page).

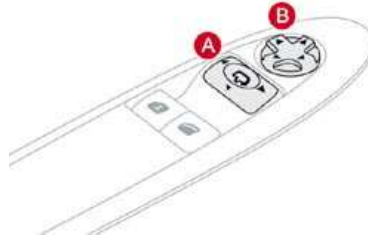

## Adjustment

- ☞ Move control **A** to the right or to the left to select the corresponding mirror.
- ☞ Move control **B** in all four directions to adjust.
- ☞ Return control **A** to the central position.

 The objects observed are, in reality, closer than they appear. Take this into account in order to correctly judge the distance of vehicles approaching from behind.

## Folding

- ☞ From outside: lock the vehicle using the remote control or the key.
- ☞ From inside: with the ignition on, pull control **A** rearwards.

 If the mirrors are folded using control **A**, they will not unfold when the vehicle is unlocked. Pull again on control **A**.

## Unfolding

- ☞ From outside: unlock the vehicle using the remote control or the key.
- ☞ From inside: with the ignition on, pull control **A** rearwards.

 The folding and unfolding of the door mirrors using the remote control can be deactivated by a CITROËN dealer. Never fold or unfold the electric folding mirrors manually.



## Rear view mirror

Adjustable mirror providing a central rearward view.  
Equipped with an anti-dazzle system, useful in poor light.

### Manual day/night model

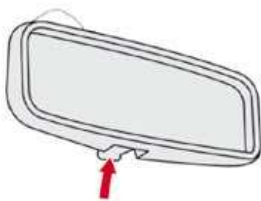

### Adjustment

- ☞ Adjust the mirror so that the glass is directed correctly in the "day" position.

### Day/night position

- ☞ Pull the lever to change to the "night" anti-dazzle position.
- ☞ Push the lever to change to the normal "day" position.

 As a safety precaution, the mirrors must be adjusted to reduce the "blind spot".

### Automatic day/night model



By means of a sensor, which measures the light from the rear of the vehicle, this system automatically and progressively changes between the day and night uses.

It has an anti-dazzle system which darkens the mirror glass: this reduces any driver discomfort caused by the light beams of following vehicles, the sun...

 In order to ensure optimum visibility during your manoeuvres, the mirror lightens automatically when reverse gear is engaged.



# Remote control key

System which permits central unlocking or locking of the vehicle using the lock or from a distance. It is also used to locate and start the vehicle, as well as providing protection against theft.

## Unlocking the vehicle

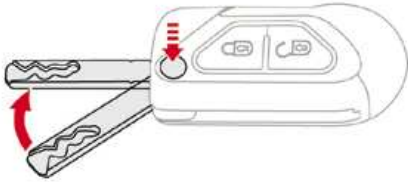

### Unlocking using the remote control



- ☞ Press the open padlock to unlock the vehicle.

### Unfolding the key

- ☞ First press this button to unfold the key.

### Unlocking using the key

- ☞ Turn the key to the left in the driver's door lock to unlock the vehicle.

Unlocking is confirmed by rapid flashing of the direction indicators for approximately two seconds.

According to version, the door mirrors unfold at the same time.



## Locking the vehicle

### Locking using the remote control



- ☞ Press the closed padlock to lock the vehicle.

### Locking using the key

- ☞ Turn the key to the right in the driver's door lock to lock the vehicle completely. Locking is confirmed by fixed lighting of the direction indicators for approximately two seconds. According to version, the door mirrors fold at the same time.

**i** If one of the doors or the boot is still open, the central locking does not take place. When the vehicle is locked, if it is unlocked inadvertently, it will relock automatically after thirty seconds unless a door or the boot is open.

**i** The folding and unfolding of the door mirrors using the remote control can be deactivated by a CITROËN dealer.

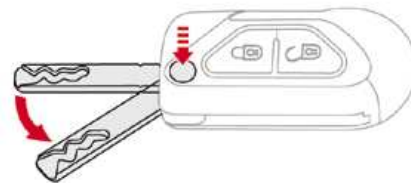

### Folding the key

- ☞ First press this button to fold the key.

## Locating your vehicle



☞ Press the closed padlock to locate your locked vehicle in a car park.

This is indicated by lighting of the courtesy lamps and flashing of the direction indicators for a few seconds.

## Anti-theft protection

### Electronic engine immobiliser

The key contains an electronic chip which has a special code. When the ignition is switched on, this code must be recognised in order for starting to be possible.

This electronic engine immobiliser locks the engine management system a few minutes after the ignition is switched off and prevents starting of the engine by anyone who does not have the key.

### SERVICE

In the event of a malfunction, you are informed by lighting of this warning

lamp, an audible signal and a message on the multifunction screen.

In this case, your vehicle does not start; contact a CITROËN dealer as soon as possible.

## Ignition switch

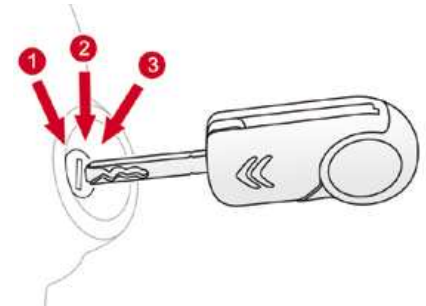

- Position 1: **Stop**
- Position 2: **Ignition**
- Position 3: **Starting**

## Lost keys

Visit a CITROËN dealer with the vehicle's V5 registration document and your personal identification documents.

The CITROËN dealer will be able to retrieve the key code and the transponder code required to order a replacement key.

## Remote control

The high frequency remote control is a sensitive system; do not operate it while it is in your pocket as there is a possibility that it may unlock the vehicle, without you being aware of it. Do not repeatedly press the buttons of your remote control out of range and out of sight of your vehicle. You run the risk of stopping it from working and the remote control would have to be reinitialised.

The remote control does not operate when the key is in the ignition, even when the ignition is switched off, except for reinitialisation.

## Locking the vehicle

Driving with the doors locked may make access to the passenger compartment by the emergency services more difficult in an emergency.

As a safety precaution (with children on board), remove the key from the ignition when you leave the vehicle, even for a short time.

## Anti-theft protection

Do not make any modifications to the electronic engine immobiliser system; this could cause malfunctions.

## When purchasing a second-hand vehicle

Have the key codes memorised by a CITROËN dealer, to ensure that the keys in your possession are the only ones which can start the vehicle.



Do not throw the remote control batteries away, they contain metals which are harmful to the environment. Take them to an approved collection point.

## Locating your vehicle



☞ Press the closed padlock to locate your locked vehicle in a car park.

This is indicated by lighting of the courtesy lamps and flashing of the direction indicators for a few seconds.

## Anti-theft protection

### Electronic engine immobiliser

The key contains an electronic chip which has a special code. When the ignition is switched on, this code must be recognised in order for starting to be possible.

This electronic engine immobiliser locks the engine management system a few minutes after the ignition is switched off and prevents starting of the engine by anyone who does not have the key.

### SERVICE

In the event of a malfunction, you are informed by lighting of this warning

lamp, an audible signal and a message on the multifunction screen.

In this case, your vehicle does not start; contact a CITROËN dealer as soon as possible.

## Ignition switch

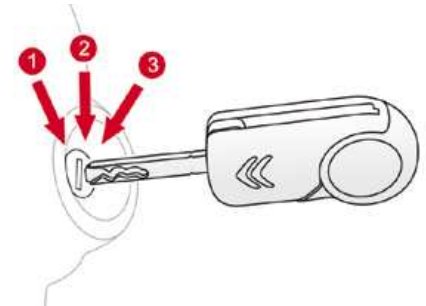

- Position 1: **Stop**
- Position 2: **Ignition**
- Position 3: **Starting**

## Lost keys

Visit a CITROËN dealer with the vehicle's V5 registration document and your personal identification documents.

The CITROËN dealer will be able to retrieve the key code and the transponder code required to order a replacement key.

## Remote control

The high frequency remote control is a sensitive system; do not operate it while it is in your pocket as there is a possibility that it may unlock the vehicle, without you being aware of it. Do not repeatedly press the buttons of your remote control out of range and out of sight of your vehicle. You run the risk of stopping it from working and the remote control would have to be reinitialised.

The remote control does not operate when the key is in the ignition, even when the ignition is switched off, except for reinitialisation.

## Locking the vehicle

Driving with the doors locked may make access to the passenger compartment by the emergency services more difficult in an emergency.

As a safety precaution (with children on board), remove the key from the ignition when you leave the vehicle, even for a short time.

## Anti-theft protection

Do not make any modifications to the electronic engine immobiliser system; this could cause malfunctions.

## When purchasing a second-hand vehicle

Have the key codes memorised by a CITROËN dealer, to ensure that the keys in your possession are the only ones which can start the vehicle.



Do not throw the remote control batteries away, they contain metals which are harmful to the environment. Take them to an approved collection point.



## Starting the vehicle

- ☞ Insert the key in the ignition switch.  
The system recognises the starting code.
- ☞ Turn the key fully towards the dashboard to position **3 (Starting)**.
- ☞ When the engine starts, release the key.

## Switching the vehicle off

- ☞ Immobilise the vehicle.
- ☞ Turn the key fully towards you to position **1 (Stop)**.
- ☞ Remove the key from the ignition switch.

 Do not attach any heavy objects to the key as this could weigh down on it when in the ignition switch and cause a fault.

### **Key reminder**

If the key is left in the ignition switch, an audible signal sounds when the driver's door is opened.

## Remote control problem

Following disconnection of the vehicle battery, replacement of the remote control battery or in the event of a remote control malfunction, you can no longer unlock, lock or locate your vehicle.

- ☞ First of all, use the key in the lock to unlock or lock your vehicle.
  - ☞ Then, reinitialise the remote control.
- If the problem persists, contact a CITROËN dealer as soon as possible.

## Reinitialisation

- ☞ Switch off the ignition.
- ☞ Turn the key to position **2 (Ignition)**.
- ☞ Press the closed padlock immediately for a few seconds.
- ☞ Switch off the ignition and remove the key from the ignition switch.

The remote control is fully operational again.

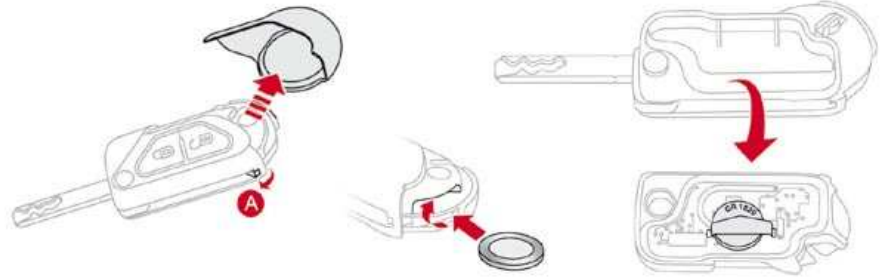

## Changing the battery

Battery ref.: CR1620/3 volts.

This replacement battery is available from CITROËN dealers.

### SERVICE

If the battery is flat, you are informed by lighting of this warning lamp in the instrument panel, an audible signal and a message on the multifunction screen.

- ☞ Unfold the key.
- ☞ Release the chrome finisher by pressing on lug **A**.

- ☞ Maintain pressure on lug **A** and remove the chrome finisher by sliding it off at 45°.
- ☞ Unclip the casing by inserting a coin at the notch and rotating.
- ☞ Slide the flat battery out of its location.
- ☞ Slide the new battery into its location observing the original direction.
- ☞ Clip the casing in place, then the chrome finisher.
- ☞ Reinitialise the remote control.



## Lost keys

Visit a CITROËN dealer with the vehicle's V5 registration document and your personal identification documents.

The CITROËN dealer will be able to retrieve the key code and the transponder code required to order a replacement key.

## Remote control

The high frequency remote control is a sensitive system; do not operate it while it is in your pocket as there is a possibility that it may unlock the vehicle, without you being aware of it. Do not repeatedly press the buttons of your remote control out of range and out of sight of your vehicle. You run the risk of stopping it from working and the remote control would have to be reinitialised.

The remote control does not operate when the key is in the ignition, even when the ignition is switched off, except for reinitialisation.

## Locking the vehicle

Driving with the doors locked may make access to the passenger compartment by the emergency services more difficult in an emergency.

As a safety precaution (with children on board), remove the key from the ignition when you leave the vehicle, even for a short time.

## Anti-theft protection

Do not make any modifications to the electronic engine immobiliser system; this could cause malfunctions.

## When purchasing a second-hand vehicle

Have the key codes memorised by a CITROËN dealer, to ensure that the keys in your possession are the only ones which can start the vehicle.



Do not throw the remote control batteries away, they contain metals which are harmful to the environment. Take them to an approved collection point.

# Window controls

System which opens or closes a window manually or automatically. It is fitted with anti-pinch protection on the driver's side.

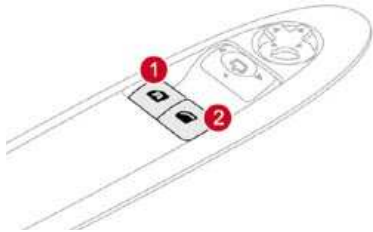

1. Driver's electric window switch.
2. Passenger's electric window switch.

 The electric window switches remain operational for approximately 45 seconds after the ignition is switched off or until a door is opened. If, during this period of 45 seconds, you open a door while operating a window, the window stops. Any new operation of the window switch will only be taken into account after the door has closed.

## Passenger's electric window





-  Press or pull the switch. The window stops as soon as the switch is released.

## Driver's electric window



There are two methods of operation:

- **manual mode**
  -  Press or pull the switch without passing the point of resistance. The window stops as soon as the switch is released.
- **automatic mode**
  -  Press or pull the switch fully. The window opens or closes completely when the switch is released.
  -  Pressing or pulling the switch again stops the movement of the window.



## Safety anti-pinch

On the driver's side, the one-touch front electric window has a safety anti-pinch function. When the window rises and meets an obstacle, it stops and partially lowers again.

 In the event of unwanted opening of the window on closing (for example in the presence of frost):

- ☞ press the switch until it opens completely,
- ☞ then pull it immediately until it closes,
- ☞ continue to hold the switch for approximately one second after the window has closed.

**The safety anti-pinch function is not active during these operations.**

## Reinitialisation

In the event of a malfunction you have to reinitialise the operation of the electric windows:

- ☞ release the switch and pull it again until the window closes completely,
- ☞ hold the switch for approximately one second after closing,
- ☞ press the switch to lower the window automatically.

**The safety anti-pinch function is not active during these operations.**

-  Always remove the key from the ignition when leaving the vehicle, even for a short time.  
In the event of contact during operation of the windows, reverse the movement of the window. To do this, press the corresponding switch.  
When the driver operates the passenger electric window switch, they should ensure that no one is preventing correct closing of the window.  
The driver should ensure that the passenger uses the electric window correctly.  
Be aware of children when operating the windows.

# Doors

## Opening

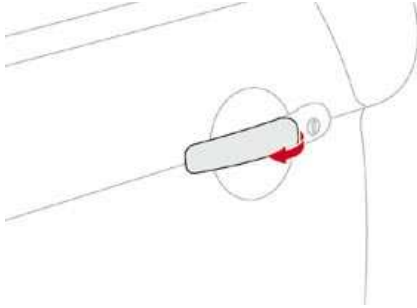

### From outside

- ☞ After unlocking the vehicle using the remote control or the key, pull the door handle.

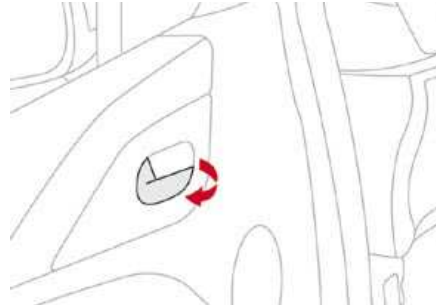

### From inside

- ☞ Pull the door lever to open the door; this unlocks this vehicle completely.

## Closing

When a door is not closed correctly:



- **when the engine is running**, this warning lamp comes on, accompanied by a message on the multifunction screen for a few seconds,
- **when the vehicle is moving** (speed higher than 6 mph (10 km/h)), this warning lamp comes on, accompanied by an audible signal and a message on the multifunction screen for a few seconds.



## Manual centralised control

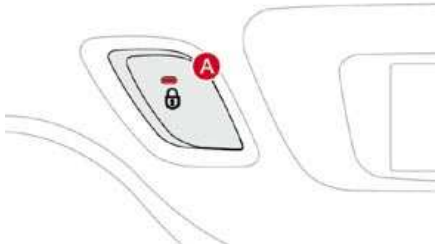

System which provides full manual locking or unlocking of the doors from the inside.

### Locking

☞ Press button **A** to lock the vehicle.  
The red indicator lamp on the button comes on.

**i** If one of the doors is open, central locking from the inside does not take place.

### Unlocking

☞ Press button **A** again to unlock the vehicle.  
The red indicator lamp on the button switches off.

**i** If the vehicle is locked from the outside, the red indicator lamp flashes and button **A** is inactive.  
☞ In this case, use the remote control or the key to unlock the vehicle.

## Automatic centralised control

System which provides full automatic locking or unlocking of the doors and the boot while driving.

You can activate or deactivate this function.

### Locking

When the speed exceeds 6 mph (10 km/h), the doors and the boot lock automatically.

**i** If one of the doors is open, the automatic central locking does not take place.  
If the boot is open, the automatic central locking of the doors is active.

### Unlocking

☞ Above 6 mph (10 km/h), press button **A** to unlock the doors and the boot temporarily.

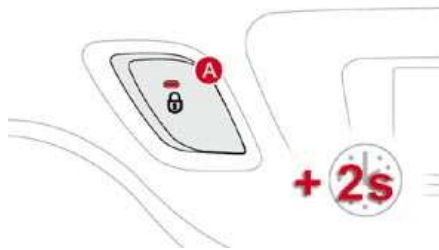

## Activation

- ☞ Press button **A** for more than two seconds. A confirmation message appears on the multifunction screen, accompanied by an audible signal.

## Deactivation

- ☞ Press button **A** again for more than two seconds. A confirmation message appears on the multifunction screen, accompanied by an audible signal.

## Emergency control

To lock or unlock the doors mechanically in the event of a central locking system failure or flat battery.

- 📍 In the event of a fault with the central locking system, you must disconnect the battery to lock the boot and so ensure the complete locking of the vehicle.

## Locking the driver's door

- ☞ Insert the key in the lock, then turn it to the right.

## Unlocking the driver's door

- ☞ Insert the key in the lock, then turn it to the left.

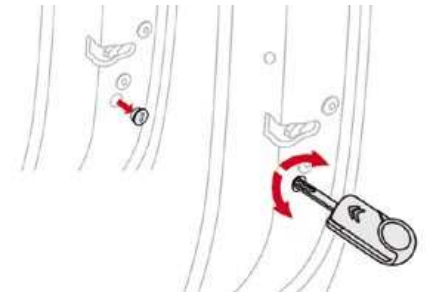

## Locking the passenger's door

- ☞ Remove the black cap, on the edge of the door, using the key.
- ☞ Insert the key in the cavity, then turn it fully.
- ☞ Remove the key and refit the cap.

## Unlocking the passenger's door

- ☞ Pull the interior door opening control.

## Boot Opening

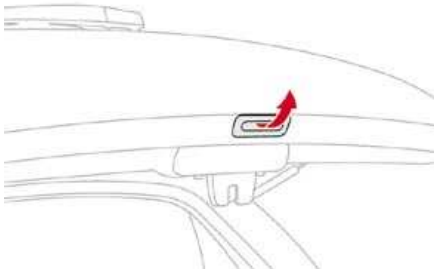

- ☞ After unlocking the vehicle using the remote control or the key, pull the handle and raise the tailgate.

## Closing

- ☞ Lower the tailgate using the interior grab handle.

If the tailgate is not closed correctly:



- **when the engine is running**, this warning lamp comes on, accompanied by a message on the multifunction screen for a few seconds,
- **when the vehicle is moving** (speed above 6 mph (10 km/h)), this warning lamp comes on, accompanied by an audible signal and a message on the multifunction screen for a few seconds.

## Tailgate release

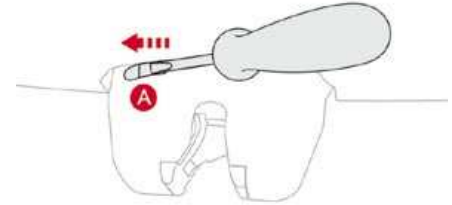

System for mechanical unlocking of the boot in the event of a battery or central locking malfunction.

## Unlocking

- ☞ Fold back the rear benchseat to gain access to the lock from inside the boot.
- ☞ Insert a small screwdriver into hole **A** of the lock to unlock the tailgate.

# Fuel tank

Fuel tank capacity: approximately 50 litres (petrol) or 48 litres (Diesel).

## Low fuel level



When the fuel tank minimum level is reached this warning lamp comes on on the instrument panel. When it first

comes on there remains **approximately 5 litres** of fuel in the tank.

You must refuel as soon as possible to avoid running out of fuel.

If you run out of fuel (Diesel), refer also to the "Checks" section.

## Filling

A label affixed to the inside of the flap reminds you of the type of fuel to be used depending on your engine.

Additions of fuel must be of at least 5 litres, in order to be taken into account by the fuel gauge.



With Stop & Start, never refuel with the system in STOP mode; you must switch off the ignition with the key.

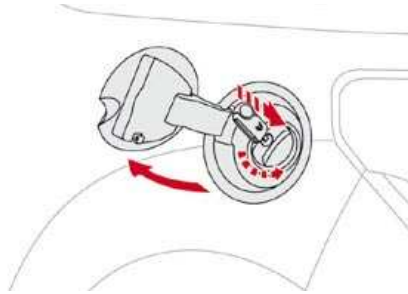

To fill the tank safely:

- ☞ **the engine must be switched off,**
- ☞ open the fuel filler flap,
- ☞ insert the key in the cap, then turn it to the left,



The key cannot be removed from the lock until the cap is refitted. Opening the filler cap may create a noise caused by an inrush of air. This vacuum is entirely normal, resulting from the sealing of the fuel system.

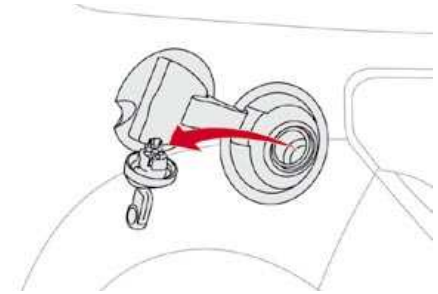

- ☞ remove the cap and hook it onto the clip located on the inside of the flap,
- ☞ fill the tank, **but do not continue after the 3rd cut-off of the pump**; this could cause malfunctions.

When you have filled the tank:

- ☞ put the cap back in place,
- ☞ turn the key to the right, then remove it from the cap,
- ☞ close the flap.





## Quality of the fuel used for petrol engines

The petrol engines are perfectly compatible with E10 type petrol biofuels (containing 10 % ethanol), conforming to European standards EN 228 and EN 15376. E85 type fuels (containing up to 85 % ethanol) are reserved exclusively for vehicles marketed for the use of this type of fuel (BioFlex vehicles). The quality of the ethanol must comply with European standard EN 15293. For Brazil only, special vehicles are marketed to run on fuels containing up to 100 % ethanol (E100 type).

## Quality of the fuel used for Diesel engines

The Diesel engines are perfectly compatible with biofuels which conform to current and future European standards (Diesel fuel which complies with standard EN 590 mixed with a biofuel which complies with standard EN 14214) available at the pumps (containing up to 7 % Fatty Acid Methyl Ester). The B30 biofuel can be used in certain Diesel engines; however, this use is subject to strict application of the special servicing conditions. Consult a CITROËN dealer. The use of any other type of (bio)fuel (vegetable or animal oils, pure or diluted, domestic fuel...) is strictly prohibited (risk of damage to the engine and fuel system).

# Lighting controls

System for selection and control of the various front and rear lamps providing the vehicle's lighting.

## Main lighting

The various front and rear lamps of the vehicle are designed to adapt the driver's visibility progressively according to climatic conditions:

- sidelamps, to be seen,
- dipped beam headlamps to see without dazzling other drivers,
- main beam headlamps to see clearly when the road is clear.

## Programming

Various automatic lighting control modes are also available according to the following options:

- guide-me-home lighting,
- automatic illumination of headlamps.



In some weather conditions (e.g. low temperature or humidity), the presence of misting on the internal surface of the glass of the headlamps and rear lamps is normal; it disappears after the lamps have been on for a few minutes.

## Additional lighting

Other lamps are installed to fulfil the requirements of particular conditions of visibility:

- a rear foglamp to be seen from afar,
- front foglamps for improved vision.
- LED lamps to be seen during the daytime.



## Manual controls

The lighting commands are issued directly by the driver by means of the ring **A** and the stalk **B**.

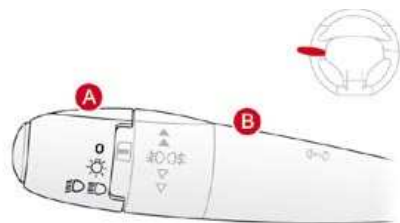



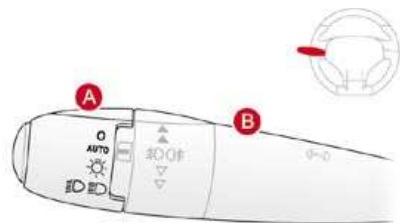

Model without AUTO lighting



Model with AUTO lighting

- A.** Main lighting mode selection ring: turn it to position the symbol required facing the mark.

-  Lamps off.
-  Automatic illumination of headlamps.
-  Sidelamps only.
-  Dipped headlamps or main beam headlamps.

- B.** Stalk for switching the headlamp beam: pull the stalk to switch between dipped and main beam headlamps.

In the lamps off and sidelamps modes, the driver can switch on the main beam headlamps temporarily ("headlamp flash") by maintaining a pull on the stalk.

## Displays

Lighting of the corresponding indicator lamp on the instrument panel confirms the switching on of the lighting selected.

The instrument panel has permanent back-lighting. Illumination of the instrument panel is therefore not linked to the exterior lighting.

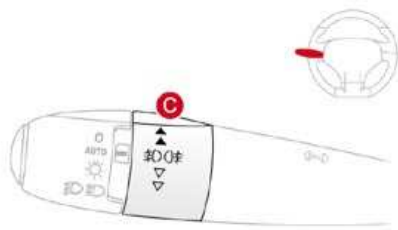

## Model with front foglamps and a rear foglamp

### C. Foglamp selection ring.

The foglamps operate with the dipped and main beam headlamps.



### Front and rear foglamps

Rotate and release the ring **C**:

- ☞ forwards a first time to switch on the front foglamps.
- ☞ forwards a second time to switch on the rear foglamp,
- ☞ rearwards a first time to switch off the rear foglamp
- ☞ rearwards a second time to switch of the front fog lamps.

When the lighting is switched off automatically (with AUTO model) or when the dipped headlamps are switched off manually, the foglamps and sidelamps will remain on.

- ☞ Turn the ring rearwards to switch off the foglamps, the sidelamps will then switch off.

**!** In good or rainy weather, by both day and night, the front foglamps and the rear foglamp are prohibited. In these situations, the power of their beams may dazzle other drivers.

Do not forget to switch off the front foglamps and the rear foglamp when they are no longer necessary.

### **i** Lighting on audible warning

When the ignition is switched off, all of the lamps switch off automatically, unless guide-me-home lighting is activated.

If the lighting is switched on manually after switching off the ignition, there is an audible signal when a front door is opened to warn the driver that they have forgotten to switch off the vehicle's lighting, with the ignition off.



## Manual guide-me-home lighting

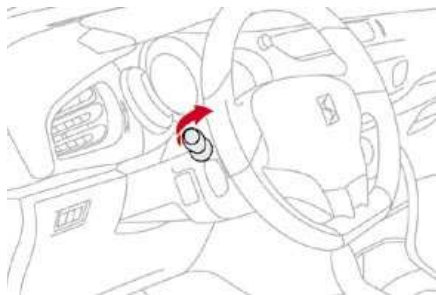

Temporarily keeping the dipped beam headlamps on after the vehicle's ignition has been switched off makes the driver's exit easier when the light is poor.

### Switching on

- ☞ With the ignition off, "flash" the headlamps using the lighting stalk.
- ☞ A further "headlamp flash" switches the function off.

### Switching off

The manual guide-me-home lighting switches off automatically after a set time.

## Automatic illumination of headlamps

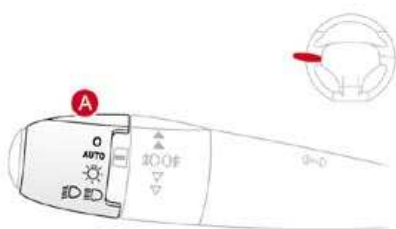

The sidelamps and dipped beam headlamps are switched on automatically, without any action on the part of the driver, when a low level of external light is detected or in certain cases of activation of the windscreen wipers. As soon as the brightness returns to a sufficient level or after the windscreen wipers are switched off, the lamps are switched off automatically.

### Activation

- ☞ Turn ring **A** to the "**AUTO**" position. The automatic illumination of headlamps is accompanied by a message on the multifunction screen.

### Deactivation

- ☞ Turn ring **A** to a position other than "**AUTO**". Deactivation is accompanied by a message on the multifunction screen.

### Coupling with the automatic "Guide-me-home" lighting

Association with the automatic illumination of headlamps provides "guide-me-home" lighting with the following additional options:

- selection of the lighting duration to 15, 30 or 60 seconds in the vehicle parameters on the multifunction screen configuration menu (except in the case of the monochrome screen A, for which the duration is set: 60 seconds),
- automatic activation of "guide-me-home" lighting when automatic illumination of headlamps is in operation.

### Operating fault

#### **SERVICE**

In the event of a fault with the sunshine sensor, the lighting comes on, this warning lamp is displayed on the instrument panel and/or a message appears on the multifunction screen, accompanied by an audible signal. Consult a CITROËN dealer.



In fog or snow, the sunshine sensor may detect sufficient light. Therefore, the lighting will not come on automatically.

Do not cover the sunshine sensor, coupled with the rain sensor and located in the centre of the windscreen behind the rear view mirror; the associated functions would no longer be controlled.

## LED lamps

Daytime external lighting using specific front lamps providing a signature of the vehicle. Comprising two sets of six light emitting diodes (LEDs), they are located in the vertical scoops below each headlamp.

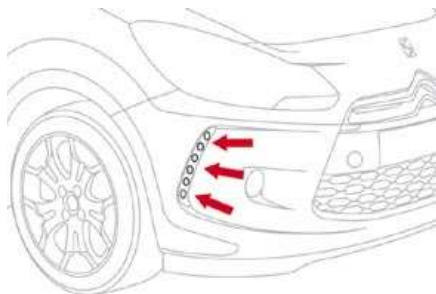

On starting the vehicle, in daylight the LED lamps come on automatically, if the lighting stalk is in position "0" or "AUTO".

If the sidelamps and headlamps are switched on manually or automatically, the LED lamps switch off.

## Programming

For countries where exterior lighting by day is not a legal requirement, you can activate or deactivate the function via the multifunction screen configuration menu.

- i In countries where it is a legal requirement:
  - this function is activated by default and cannot be deactivated,
  - in daylight, the sidelamps and number plate lamps also come on,
  - If the sidelamps or headlamps are switched on manually or automatically, the LED lamps switch off.

For versions not fitted with LED lamps, it is the dipped beam headlamps that come on automatically on starting the vehicle.

## Headlamp adjustment

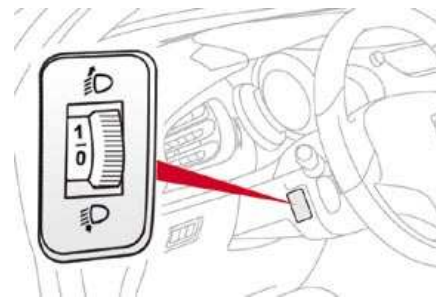

To avoid causing a nuisance to other road users, the height of the headlamps should be adjusted in relation to the load in the vehicle.

- 0.** Driver only or driver + front passenger.
  - Intermediate setting
- 1.** 5 people.
  - 5 people + load in the boot.
- 2.** Driver only + maximum authorised load in the boot.

This position is sufficient to avoid causing dazzle. Higher settings may limit the spread of light from the headlamps.

- i The initial setting is position "0".

# Wiper controls

System for selection and control of the various front and rear wiping modes for the elimination of rain and cleaning.

The vehicle's front and rear wipers are designed to improve the driver's visibility progressively according to the climatic conditions.

## Programming

Various automatic wiper control modes are also available according to the following options:

- automatic rain sensitive windscreen wipers,
- rear wiping on engaging reverse gear.

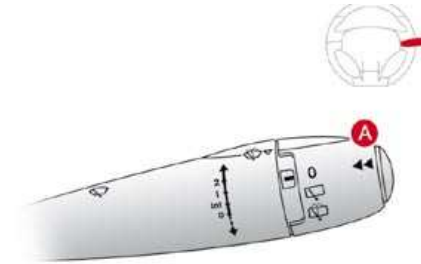

Model with intermittent wiping

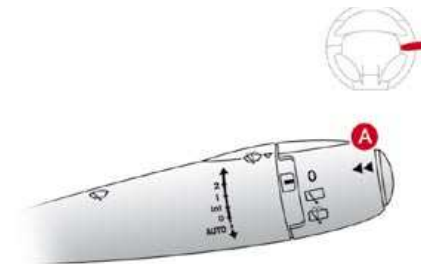

Model with AUTO wiping

## Manual controls

The wiper commands are issued directly by the driver by means of the stalk **A** and the ring **B**.

## Windscreen wipers

A. Wiping speed selection stalk:

**2**

fast (heavy rain),

**1**

normal (moderate rain),

**Int**

intermittent (proportional to the speed of the vehicle),

**0**

park,



single wipe (press downwards),

or

**AUTO ↓**

automatic, then single wipe (see following page).



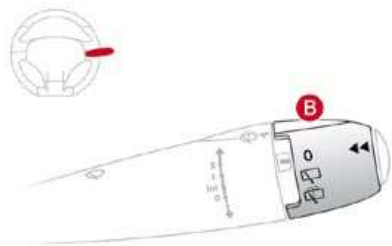

**B.** Rear wiper selection ring:

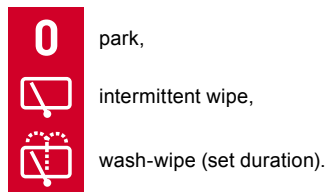

## Rear wiper

**!** If a significant accumulation of snow or ice is present, or when using a tailgate bicycle carrier, deactivate the automatic rear wiper via the multifunction screen configuration menu.

## Reverse gear

When reverse gear is engaged, the rear wiper will come into operation if the windscreen wipers are operating.

## Programming

The function is activated or deactivated via the multifunction screen configuration menu.  
This function is activated by default.

## Windscreen wash

Pull the wiper stalk towards you. The windscreen wash, then the windscreen wipers, operate for a specified time.

## Automatic rain sensitive windscreen wipers

The windscreen wipers operate automatically, without any action on the part of the driver, if rain is detected (sensor behind the rear view mirror), adapting their speed to the intensity of the rainfall.

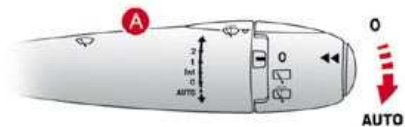

### Activation

This is controlled manually by the driver by pushing stalk **A** to the **"AUTO"** position.



It is accompanied by the lighting of this indicator lamp in the instrument panel and a message on the multifunction screen.

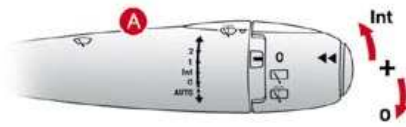

### Switching off

This is controlled manually by the driver by moving stalk **A** upwards, returning it to position **"0"**.



It is accompanied by the indicator lamp in the instrument panel switching off and a message on the multifunction screen.

**i** The automatic wiping must be reactivated if the ignition has been off for more than one minute, by pushing stalk **A** downwards.



## Operating fault

If an automatic wiping malfunction occurs, the wipers will operate in intermittent mode. Have it checked by a CITROËN dealer.

- ⚠ Do not cover the rain sensor, linked with the sunshine sensor and located in the centre of the windscreen behind the rear view mirror. Switch off the automatic wiping when using an automatic car wash. In winter, it is advisable to wait until the windscreen is completely clear of ice before activating the automatic wiping.

## Vertical windscreen wiper position

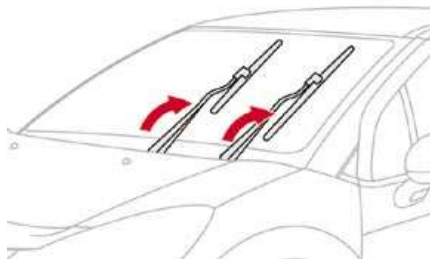

This position allows the wiper blades to be lifted for winter parking, cleaning or replacement without damaging the bonnet.

In the minute following switching off of the ignition, any action on the wiper stalk positions the wipers vertically. To park the wipers after this has been done, switch on the ignition and operate the wiper stalk.

- ℹ To retain the effectiveness of the "flat-blade" wiper blades, it is advisable to:
  - handle them with care,
  - clean them regularly using soapy water,
  - not use them to hold a sheet of cardboard against the windscreen,
  - replace them at the first signs of wear.

## Automatic rain sensitive windscreen wipers

The windscreen wipers operate automatically, without any action on the part of the driver, if rain is detected (sensor behind the rear view mirror), adapting their speed to the intensity of the rainfall.

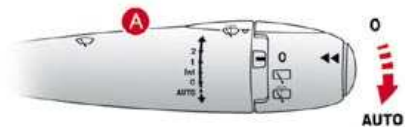

### Activation

This is controlled manually by the driver by pushing stalk **A** to the **"AUTO"** position.



It is accompanied by the lighting of this indicator lamp in the instrument panel and a message on the multifunction screen.

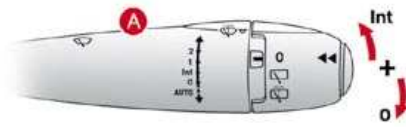

### Switching off

This is controlled manually by the driver by moving stalk **A** upwards, returning it to position **"0"**.



It is accompanied by the indicator lamp in the instrument panel switching off and a message on the multifunction screen.

**i** The automatic wiping must be reactivated if the ignition has been off for more than one minute, by pushing stalk **A** downwards.



## Operating fault

If an automatic wiping malfunction occurs, the wipers will operate in intermittent mode. Have it checked by a CITROËN dealer.

- Do not cover the rain sensor, linked with the sunshine sensor and located in the centre of the windscreen behind the rear view mirror.
- Switch off the automatic wiping when using an automatic car wash.
- In winter, it is advisable to wait until the windscreen is completely clear of ice before activating the automatic wiping.

## Vertical windscreen wiper position

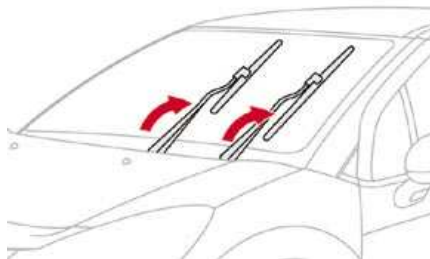

This position allows the wiper blades to be lifted for winter parking, cleaning or replacement without damaging the bonnet.

In the minute following switching off of the ignition, any action on the wiper stalk positions the wipers vertically. To park the wipers after this has been done, switch on the ignition and operate the wiper stalk.

- To retain the effectiveness of the "flat-blade" wiper blades, it is advisable to:
  - handle them with care,
  - clean them regularly using soapy water,
  - not use them to hold a sheet of cardboard against the windscreen,
  - replace them at the first signs of wear.

# Courtesy lamp

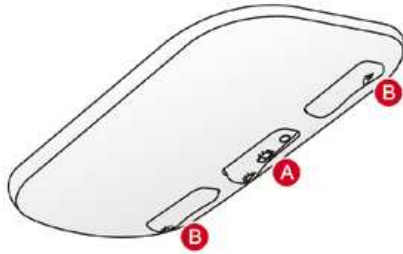

- A. Courtesy lamp
- B. Map reading lamps

## Courtesy lamp



In this position, the courtesy lamp comes on gradually:

- when the vehicle is unlocked,
- when the key is removed from the ignition,
- when a door is opened,
- when the remote control locking button is activated, in order to locate your vehicle.

It switches off gradually:

- when the vehicle is locked,
- when the ignition is switched on,
- 30 seconds after the last door is closed.



Permanently off.



Permanent lighting.



With the "permanent lighting" mode, the duration of lighting varies, depending on the circumstances:

- with the ignition off, approximately ten minutes,
- in energy economy mode, approximately thirty seconds,
- with the engine running, unlimited.

## Map reading lamps

- ☞ With the ignition on, press the corresponding switch.

## Interior mood lighting

The dimmed passenger compartment lighting improves visibility in the vehicle when the light is poor.

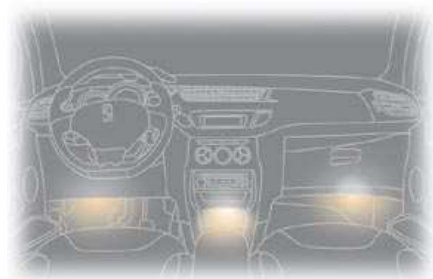

### Switching on

At night, the illumination of footwells and the central dashboard storage compartment comes on automatically when the sidelamps are switched on.

### Switching off

The interior mood lighting switches off automatically when the sidelamps are switched off.

It can be switched off manually using the instrument panel lighting rheostat button.

- ☞ With the lighting on, press several times on the left hand button of the instrument panel to progressively reduce the dashboard lighting level.
- ☞ Press again to reduce the lighting level to the minimum and switch off the interior mood lighting.

## Boot lamp



This comes on automatically when the boot is opened and switches off automatically when the boot is closed.

- i** Different lighting times are provided:
- when the ignition is off, approximately ten minutes,
  - in energy economy mode, approximately thirty seconds,
  - when the engine is running, no limit.

# Interior fittings

- 1. Sun visor**  
(see details on the following page)
- 2. Illuminated glove box**  
(see details on the following page)
- 3. Door tray**
- 4. Upper storage compartment**
- 5. Lower storage compartment with non-slip mat**
- 6. USB port/auxiliary socket**  
(see details on the following pages)
- 7. 12 V accessories socket**  
(see details on following pages)
- 8. Centre armrest with storage**  
(see details on the following page)  
or  
**Cup/bottle holder**

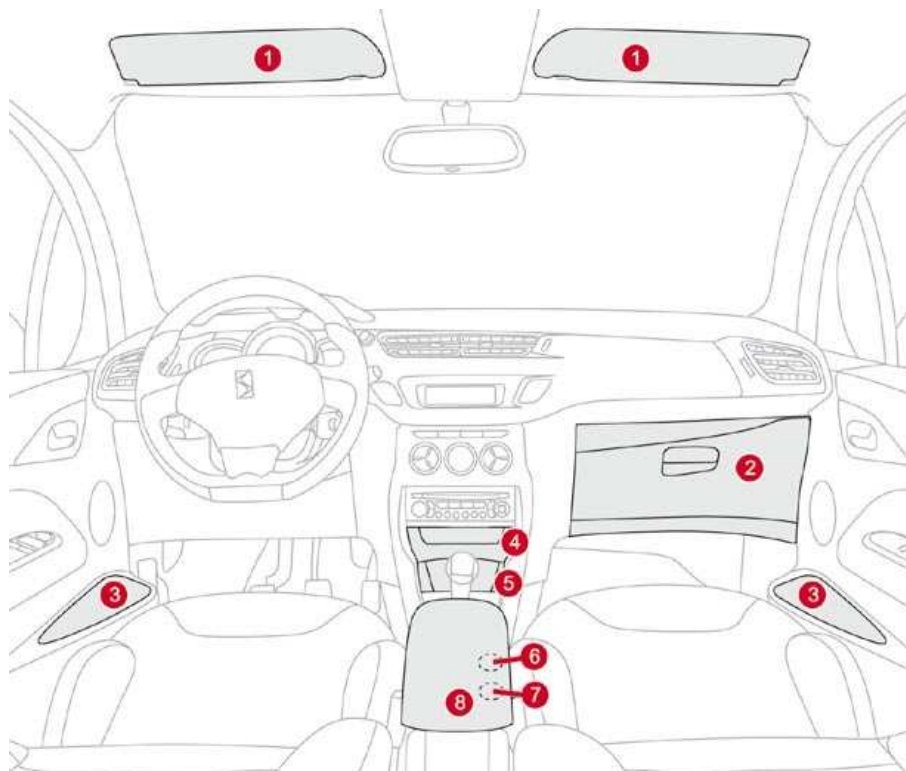



## Sun visor

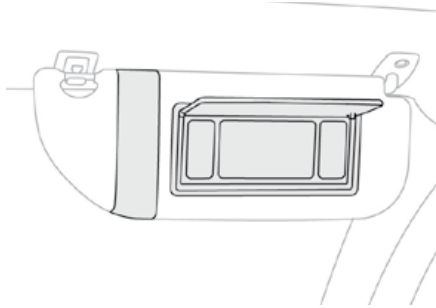

Component which protects against sunlight from the front or the side, also equipped with an illuminated courtesy mirror.

- ☞ With the ignition on, raise the concealing flap; the mirror is lit automatically.

This sun visor is also equipped with a ticket holder.

## Illuminated glove box

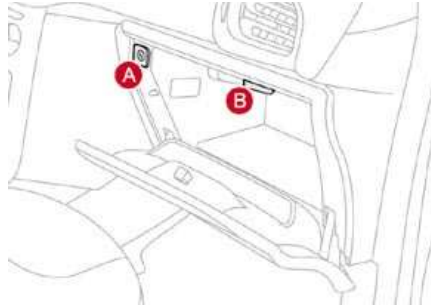

This can be used to hold a water bottle. Its lid has a location for storing the vehicle's handbook pack.

- ☞ To open the glove box, raise the handle.

It is lit when the lid is opened.

It houses the front passenger's airbag

deactivation switch **A**.

It provides access to the ventilation nozzle **B**, distributing the same air as the vents in the passenger compartment.

## Centre armrest

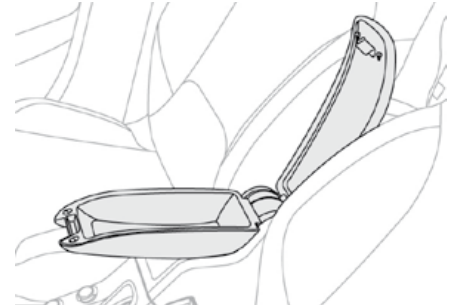

Comfort and storage system for the driver and front passenger.

### Storage

- ☞ For access to the closed storage box, lift the lever to open the lid.
- ☞ For access to the open storage box below the armrest, lift the complete armrest towards the rear.

These can be used for portable devices (mobile phone, MP3 player...) which can be connected to the USB port/auxiliary socket or charged from the 12 V socket in the centre console.

## Auxiliary socket

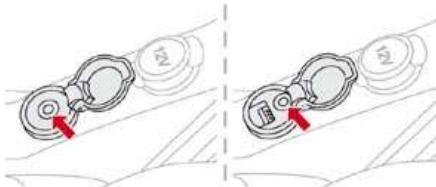

The auxiliary socket is located in the **"AUX"** box on the centre console.

It permits the connection of a portable device, such as a digital audio player of the iPod® type, to listen to your music files using the vehicle's speakers.

 The management of the files is done using your portable device.

For more information on the use of this equipment, refer to the MyWay or Audio system part of the "Audio and Telematics" section.

## USB Player

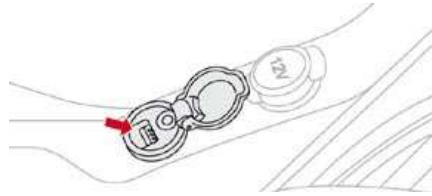

The USB port is located in the **"AUX"** box on the centre console.

It permits the connection of a portable device, such as a digital audio player of the iPod® generation 5 and later type or USB memory stick type.

It reads the audio file formats (mp3, ogg, wma, wav...) which are transmitted to your audio equipment and played via the vehicle's speakers.

You can manage these files using the steering mounted controls or the audio equipment control panel and display them on the multifunction screen.

 When it is in use, the portable device charges automatically.

For more information on the use of this equipment, refer to the Audio system part of the "Audio and Telematics" section.

## 12 V accessory socket

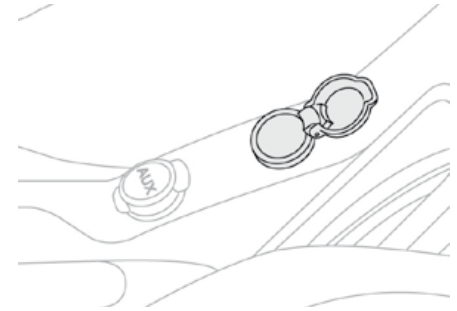

 To connect a 12 V accessory (max power: 120 W), lift the cover and connect a suitable adaptor.

# Mats

Removable carpet protection.

## Fitting

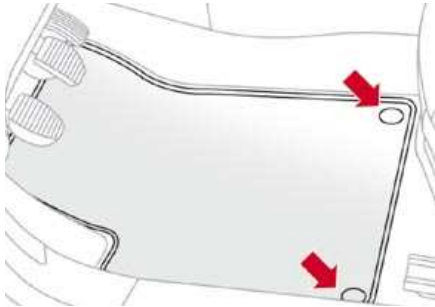

When fitting the mat for the first time, on the driver's side use only the fixings provided in the wallet attached.

The other mats are simply placed on the carpet.

## Removal

To remove the mat on the driver's side:

- ☞ move the seat as far back as possible,
- ☞ unclip the fixings,
- ☞ remove the mat.

## Refitting

To refit the mat on the driver's side:

- ☞ position the mat correctly,
- ☞ refit the fixings by pressing,
- ☞ check that the mat is secured correctly.



To avoid any risk of jamming of the pedals:

- only use mats which are suited to the fixings already present in the vehicle; it is imperative that these are used,
- never fit one mat on top of another.

## Sun visor

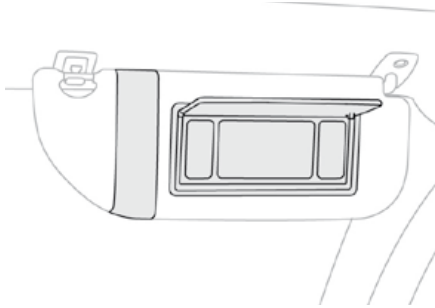

Component which protects against sunlight from the front or the side, also equipped with an illuminated courtesy mirror.

- ☞ With the ignition on, raise the concealing flap; the mirror is lit automatically.

This sun visor is also equipped with a ticket holder.

## Illuminated glove box

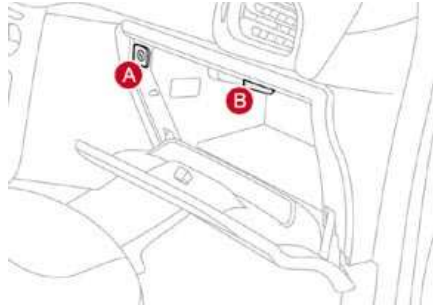

This can be used to hold a water bottle. Its lid has a location for storing the vehicle's handbook pack.

- ☞ To open the glove box, raise the handle.

It is lit when the lid is opened.

It houses the front passenger's airbag

deactivation switch **A**.

It provides access to the ventilation nozzle **B**, distributing the same air as the vents in the passenger compartment.

## Centre armrest

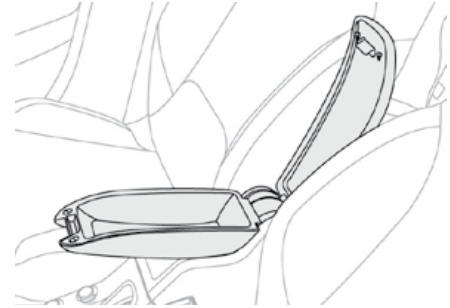

Comfort and storage system for the driver and front passenger.

### Storage

- ☞ For access to the closed storage box, lift the lever to open the lid.
- ☞ For access to the open storage box below the armrest, lift the complete armrest towards the rear.

These can be used for portable devices (mobile phone, MP3 player...) which can be connected to the USB port/auxiliary socket or charged from the 12 V socket in the centre console.

## Auxiliary socket

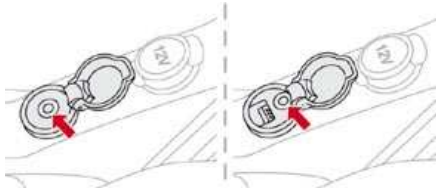

The auxiliary socket is located in the **"AUX"** box on the centre console.

It permits the connection of a portable device, such as a digital audio player of the iPod® type, to listen to your music files using the vehicle's speakers.

 The management of the files is done using your portable device.

For more information on the use of this equipment, refer to the MyWay or Audio system part of the "Audio and Telematics" section.

## USB Player

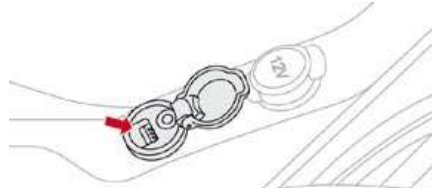

The USB port is located in the **"AUX"** box on the centre console.

It permits the connection of a portable device, such as a digital audio player of the iPod® generation 5 and later type or USB memory stick type.

It reads the audio file formats (mp3, ogg, wma, wav...) which are transmitted to your audio equipment and played via the vehicle's speakers.

You can manage these files using the steering mounted controls or the audio equipment control panel and display them on the multifunction screen.

 When it is in use, the portable device charges automatically.

For more information on the use of this equipment, refer to the Audio system part of the "Audio and Telematics" section.

## 12 V accessory socket

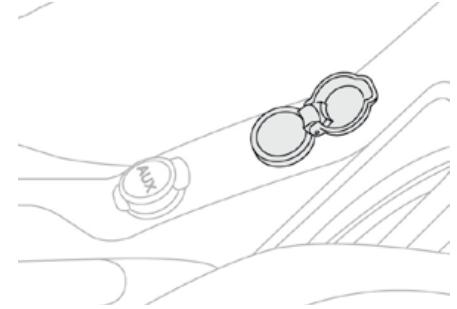

 To connect a 12 V accessory (max power: 120 W), lift the cover and connect a suitable adaptor.

# Mats

Removable carpet protection.

## Fitting

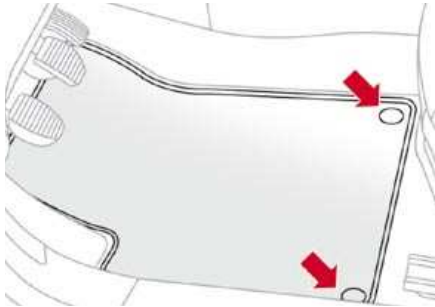

When fitting the mat for the first time, on the driver's side use only the fixings provided in the wallet attached.

The other mats are simply placed on the carpet.

## Removal

To remove the mat on the driver's side:

- ☞ move the seat as far back as possible,
- ☞ unclip the fixings,
- ☞ remove the mat.

## Refitting

To refit the mat on the driver's side:

- ☞ position the mat correctly,
- ☞ refit the fixings by pressing,
- ☞ check that the mat is secured correctly.



To avoid any risk of jamming of the pedals:

- only use mats which are suited to the fixings already present in the vehicle; it is imperative that these are used,
- never fit one mat on top of another.

## Boot fittings

- 1. Rear parcel shelf**  
(see the following page for details)
- 2. Retaining strap**
- 3. Location for Hi-Fi amplifier**  
(see the following page for details)
- 4. Stowing rings**
- 5. Storage box (version equipped with a temporary puncture repair kit)**  
(see the following page for details)  
or  
**Tool box (version equipped with a spare wheel)**  
(refer to section "Practical Information - § Changing a wheel")

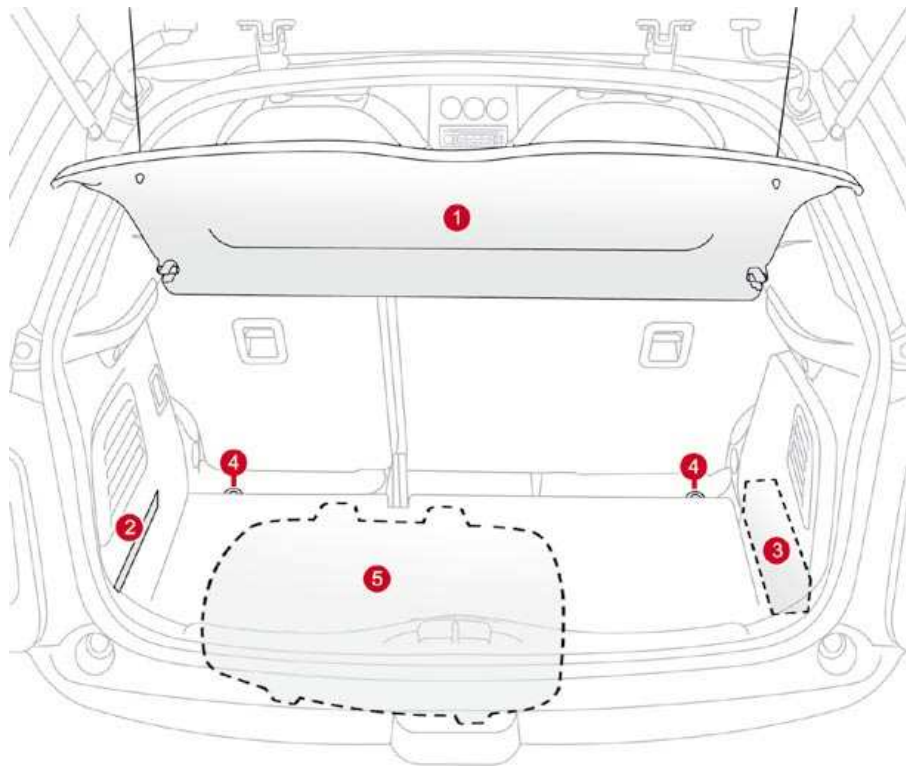



## Rear parcel shelf

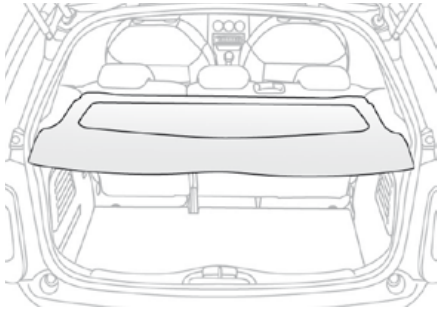

To remove the shelf:

- ☞ unhook the two cords,
- ☞ raise the shelf slightly, then unclip it on each side.

## Storage box

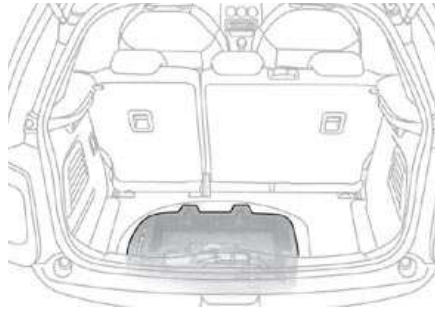

- ☞ Raise the boot carpet by pulling the strap upwards to gain access to the storage box. This has areas for storing a temporary puncture repair kit, a box of spare bulbs, a first aid kit, two warning triangles, ...

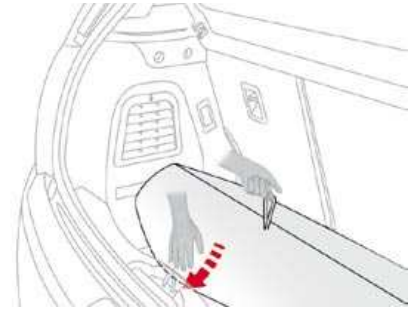

- ☞ refit the boot floor carpet by folding it slightly in the middle.



# General points relating to child seats

Although one of CITROËN's main criteria when designing your vehicle, the safety of your children also depends on you.

For maximum safety, please observe the following recommendations:

- in accordance with European regulations, **all children under the age of 12 or less than one and a half metres tall must travel in approved child seats suited to their weight**, on seats fitted with a seat belt or ISOFIX mountings\*,
- **statistically, the safest seats in your vehicle for carrying children are the rear seats,**
- **a child weighing less than 9 kg must travel in the "rearwards-facing" position both in the front and in the rear.**



**CITROËN recommends** that children should travel in the **rear seats** of your vehicle:

- **"rearwards-facing"** up to the age of 2,
- **"forwards-facing"** over the age of 2.

\* The rules for carrying children are specific to each country. Refer to the current legislation in your country.

## Child seat in the front



### "Rearwards-facing"

When a "rearwards-facing" child seat is installed on the **front passenger seat**, it is essential that the passenger airbag is deactivated. Otherwise, **the child would risk being seriously injured or killed if the airbag were to inflate.**



### "Forwards-facing"

When a "forwards-facing" child seat is installed on the **front passenger seat**, adjust the vehicle's seat to the intermediate longitudinal position with the seat back upright and leave the passenger airbag activated.

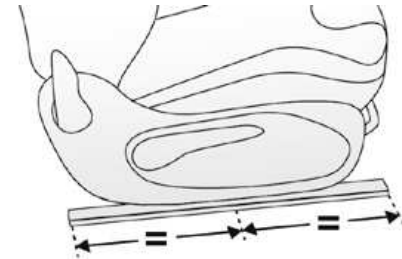



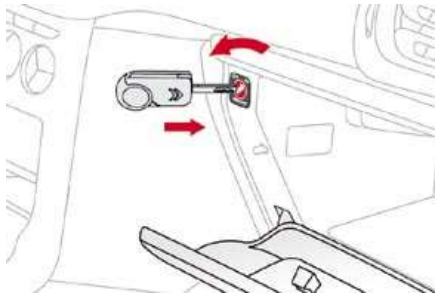

### Intermediate longitudinal position

# Child seats recommended by CITROËN

CITROËN offers a complete range of recommended child seats which are secured using a **three point seat belt**:



**Passenger airbag OFF**



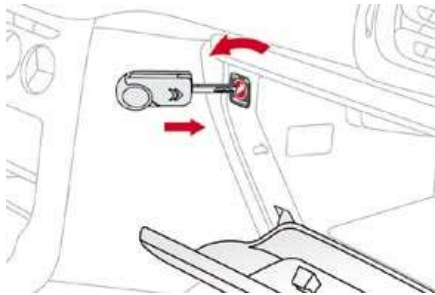

Group 0+: from birth to 13 kg	Groups 1, 2 and 3: from 9 to 36 kg
 <p><b>L1</b> "RÖMER Baby-Safe Plus" Installed in the rearwards-facing position.</p>	 <p><b>L2</b> "KIDDY Life" The use of the restraining cushion is compulsory for carrying young children (from 9 to 18 kg).</p>
Groups 2 and 3: from 15 to 36 kg	
 <p><b>L3</b> "RECARO Start"</p>	 <p><b>L4</b> "KLIPPAN Optima" From the age of 6 years (approximately 22 kg), the booster is used on its own.</p>
 <p><b>L5</b> "RÖMER KIDFIX" Can be fitted to the vehicle's ISOFIX mountings. The child is restrained by the seat belt.</p>	

# Child seats recommended by CITROËN

CITROËN offers a complete range of recommended child seats which are secured using a **three point seat belt**:





**Passenger airbag OFF**

Group 0+: from birth to 13 kg	Groups 1, 2 and 3: from 9 to 36 kg
 <p><b>L1</b> "RÖMER Baby-Safe Plus" Installed in the rearwards-facing position.</p>	 <p><b>L2</b> "KIDDY Life" The use of the restraining cushion is compulsory for carrying young children (from 9 to 18 kg).</p>
Groups 2 and 3: from 15 to 36 kg	
 <p><b>L3</b> "RECARO Start"</p>	 <p><b>L4</b> "KLIPPAN Optima" From the age of 6 years (approximately 22 kg), the booster is used on its own.</p>
 <p><b>L5</b> "RÖMER KIDFIX" Can be fitted to the vehicle's ISOFIX mountings. The child is restrained by the seat belt.</p>	

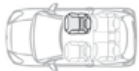

## Installing child seats attached with the seat belt

In accordance with European regulations, this table indicates the options for installing child seats secured using a seat belt and universally approved (a) in accordance with the weight of the child and the seat in the vehicle.

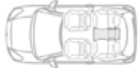
Weight of the child and indicative age					
Seat		Under 13 kg (groups 0 (b) and 0+) Up to approx. 1 year	From 9 to 18 kg (group 1) 1 to 3 years approx.	From 15 to 25 kg (group 2) 3 to 6 years approx.	From 22 to 36 kg (group 3) 6 to 10 years approx.
Front passenger seat (c)					
- fixed		<b>U</b>	<b>U</b>	<b>U</b>	<b>U</b>
- adjustable for height		<b>U(R)</b>	<b>U(R)</b>	<b>U(R)</b>	<b>U(R)</b>
Outer rear seats		<b>U</b>	<b>U</b>	<b>U</b>	<b>U</b>
Centre rear seat		<b>U</b>	<b>U</b>	<b>U</b>	<b>U</b>

**(a)** Universal child seat: child seat that can be installed in all vehicles using a seat belt.

**(b)** Group 0: from birth to 10 kg. Shells seats and baby carriers cannot be installed in the front passenger seat.

**(c)** Consult the legislation in force in your country before installing your child on this seat.

**U:** Seat suitable for the installation of a child seat secured using a seat belt and universally approved, "rearwards-facing" and/or "forwards-facing".

**U(R):** as for **U**, with the vehicle seat adjusted to its highest position and in the fully back position.

# Advice on child seats



The incorrect installation of a child seat in a vehicle compromises the child's protection in the event of an accident.

Remember to fasten the seat belts or the child seat harness **keeping the slack** in relation to the child's body **to a minimum**, even for short journeys.

To install a child seat using the vehicle's seat belt, ensure that the belt is well tightened on the child seat and that it holds the child seat firmly against the vehicle's seat.

For optimum installation of the "forward facing" child seat, ensure that the back of the child seat is in contact with the back of the vehicle's seat and that the head restraint does not cause any discomfort.

If the head restraint has to be removed, ensure that it is stored or attached securely to prevent it from being thrown around the vehicle in the event of sharp braking.

Children under the age of 10 must not travel in the "forward facing" position on the front passenger seat, unless the rear seats are already occupied by other children, cannot be used or are absent.

Deactivate the passenger airbag\* when a "rear facing" child seat is installed on the front seat.

Otherwise, the child would risk being seriously injured or killed if the airbag were to inflate.

## Installing a booster seat

The chest part of the seat belt must be positioned on the child's shoulder without touching the neck.

Ensure that the lap part of the seat belt passes correctly over the child's thighs. CITROËN recommends the use of a booster seat which has a back, fitted with a seat belt guide at shoulder level.

As a safety precaution, do not leave:

- one or more children alone and unsupervised in a vehicle,
- a child or an animal in a vehicle which is exposed to the sun, with the windows closed,
- the keys within reach of children inside the vehicle.

To protect young children from the rays of the sun, fit side blinds on the rear windows.

\* According to country.

## "ISOFIX" mountings

Your vehicle has been approved in accordance with the **new ISOFIX regulation**. The seats, represented below, are fitted with regulation ISOFIX mountings:

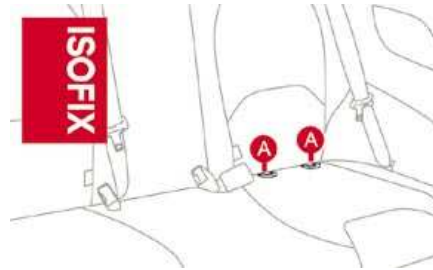
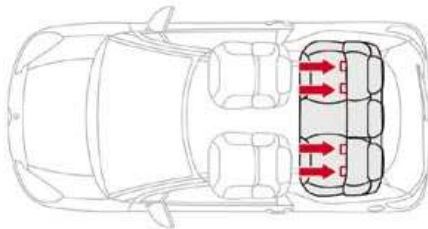

There are three rings for each seat:

- two rings **A**, located between the vehicle seat back and cushion, indicated by a label,



- a ring **B**, behind the seat, referred to as the **TOP TETHER** for fixing the upper strap.

This ISOFIX mounting system provides fast, reliable and safe fitting of the child seat in your vehicle.

The **ISOFIX child seats** are fitted with two latches which are secured on the two rings **A**.

When fitting an ISOFIX child seat to the right hand rear seat, before fixing the seat in place, first move the centre rear seat belt towards the middle of the vehicle so as to not interfere with the operation of the seat belt.

Some seats also have an **upper strap** which is attached to ring **B**.

To attach this strap, raise the vehicle seat's head restraint then pass the hook between its rods. Then fix the hook on ring **B** and tighten the upper strap.

 The incorrect installation of a child seat in a vehicle compromises the child's protection in the event of an accident.

For information regarding the ISOFIX child seats which can be installed in your vehicle, refer to the table showing the locations for installing ISOFIX child seats.

# ISOFIX child seat recommended by CITROËN and approved for your vehicle

<b>RÖMER Duo Plus ISOFIX (size category B1)</b>	
<b>Group 1: from 9 to 18 kg</b>	
	<p>Installed in the forwards-facing position. Fitted with an upper strap to be secured on the upper ring <b>B</b>, referred to as the TOP TETHER. Three seat body angles: sitting, reclining, lying.</p>

**i** This child seat can also be used on seats which are not fitted with ISOFIX mountings. In this case, it must be attached to the vehicle seat using the three point seat belt.  
**Follow the instructions for fitting the child seat given in the seat manufacturer's installation guide.**





## Installing ISOFIX child seats

In accordance with European regulations, this table indicates the options for the installation of ISOFIX child seats on the vehicle seats fitted with ISOFIX mountings.

In the case of the universal and semi-universal ISOFIX child seats, the child seat's ISOFIX size category, determined by a letter between **A** and **G**, is indicated on the child seat next to the ISOFIX logo.

	Weight of the child/indicative age									
	Less than 10 kg (group 0) Up to 6 months approx		Less than 10 kg (group 0) Less than 13 kg (group 0+) Up to 1 year approx			From 9 to 18 kg (group 1) From 1 to 3 years approx				
Type of ISOFIX child seat	Infant car seat*		"rear facing"			"rear facing"		"forward facing"		
ISOFIX size category	F	G	C	D	E	C	D	A	B	B1
Universal and semi-universal ISOFIX child seats which can be installed on the outer rear seats	X		X	IL-SU		X	IL-SU	IUF IL-SU		

**IUF:** seat suitable for the installation of an Isofix Universal seat, "Forward facing" and secured using the "Top Tether" upper strap.

**IL-SU:** seat suitable for the installation an Isofix Semi-Universal seat which is:

- "rear facing" fitted with a "Top Tether" upper strap or a stay,
- "forward facing" fitted with a stay,

For the securing of the "Top Tether" upper strap, refer to the "ISOFIX Mountings" section.

**X:** seat which is not suitable for the installation of an ISOFIX seat of the size category indicated.

\* Infant car seats and "car cots" cannot be installed on the front passenger seat.

## Direction indicators

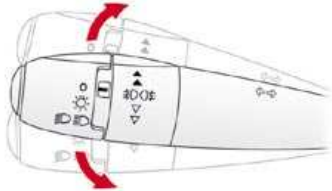

Selection of the left or right direction indicators to signal a change of direction of the vehicle.

- ☞ Left: lower the lighting stalk beyond the point of resistance.
- ☞ Right: raise the lighting stalk beyond the point of resistance.

## "Motorway" function

- ☞ Press briefly upwards or downwards, without going beyond the point of resistance; the direction indicators will flash 3 times.

## Hazard warning lamps

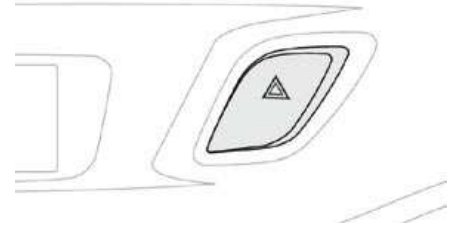

A visual warning by means of the direction indicators to alert other road users to a vehicle breakdown, towing or accident.

- ☞ Press this button, the direction indicators flash.

They can operate with the ignition off.

## Direction indicators

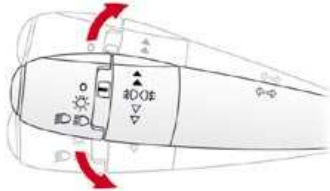

Selection of the left or right direction indicators to signal a change of direction of the vehicle.

- ☞ Left: lower the lighting stalk beyond the point of resistance.
- ☞ Right: raise the lighting stalk beyond the point of resistance.

## "Motorway" function

- ☞ Press briefly upwards or downwards, without going beyond the point of resistance; the direction indicators will flash 3 times.

## Hazard warning lamps

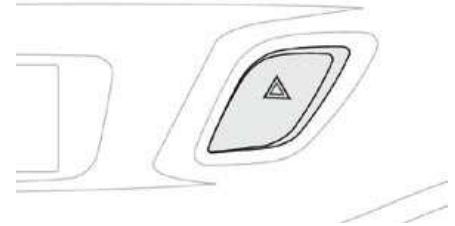

A visual warning by means of the direction indicators to alert other road users to a vehicle breakdown, towing or accident.

- ☞ Press this button, the direction indicators flash.

They can operate with the ignition off.



## Automatic operation of hazard warning lamps

When braking in an emergency, depending on the deceleration, the hazard warning lamps come on automatically.

They switch off automatically the first time you accelerate.

- ☞ You can also switch them off by pressing the button.

## Horn

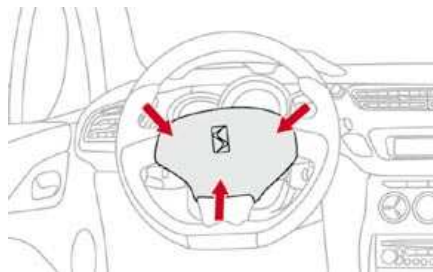

Audible warning to alert other road users to an imminent danger.

- ☞ Press one of the spokes of the steering wheel.



- Use the horn moderately and only in the following cases:
- immediate danger,
  - overtaking a cyclist or pedestrian
  - when approaching an area where there is no visibility.

## Emergency or assistance call



This system allows you to make an emergency or assistance call to the emergency services or to the dedicated CITROËN service.

For more information on the use of this function, refer to the "Audio and telematics" section.



## Automatic operation of hazard warning lamps

When braking in an emergency, depending on the deceleration, the hazard warning lamps come on automatically.

They switch off automatically the first time you accelerate.

- ☞ You can also switch them off by pressing the button.

## Horn

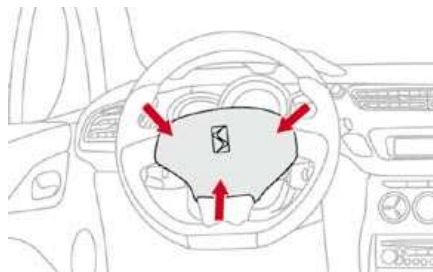

Audible warning to alert other road users to an imminent danger.

- ☞ Press one of the spokes of the steering wheel.



- Use the horn moderately and only in the following cases:
- immediate danger,
  - overtaking a cyclist or pedestrian
  - when approaching an area where there is no visibility.

## Emergency or assistance call



This system allows you to make an emergency or assistance call to the emergency services or to the dedicated CITROËN service.

For more information on the use of this function, refer to the "Audio and telematics" section.

# Braking assistance systems

Group of supplementary systems which help you to obtain optimum braking in complete safety in emergency situations:

- anti-lock braking system (ABS),
- electronic brake force distribution (EBFD),
- emergency braking assistance (EBA).

## Anti-lock braking system and electronic brake force distribution

Linked systems which improve the stability and manoeuvrability of your vehicle when braking, in particular on poor or slippery surfaces.

### Activation

The anti-lock braking system comes into operation automatically when there is a risk of wheel lock.

Normal operation of the ABS may make itself felt by slight vibration of the brake pedal.



When braking in an emergency, press very firmly without releasing the pressure.

## Operating fault



If this warning lamp comes on, accompanied by an audible signal and a message on the multifunction screen, it indicates a malfunction of the anti-lock braking system which could result in loss of control of the vehicle when braking.



If this warning lamp comes on, together with the **STOP** and **ABS** warning lamps, accompanied by an audible signal and a message on the multifunction screen, it indicates a malfunction of the electronic brake force distribution which could result in loss of control of the vehicle when braking.

**You must stop as soon as it is safe to do so.**

In either case, contact a CITROËN dealer.



When replacing wheels (tyres and rims), ensure that they conform to the manufacturer's recommendations.



# Trajectory control systems

## Emergency braking assistance

System which, in an emergency, enables you to obtain the optimum braking pressure more quickly, thus reducing the stopping distance.

### Activation

It is triggered by the speed at which the brake pedal is pressed.

The effect of this is a reduction in the resistance of the pedal and an increase in braking efficiency.



When braking in an emergency, press firmly without releasing the pressure.

## Anti-skid regulation (ASR) and electronic stability programme (ESP)

The anti-skid regulation (also known as Traction Control) optimises traction to prevent skidding of the wheels, by acting on the brakes of the driving wheels and on the engine. The electronic stability programme acts on the brake of one or more wheels and on the engine to keep the vehicle on the trajectory required by the driver, within the limits of the laws of physics.

### Activation

These systems are activated automatically each time the vehicle is started. They come into operation in the event of a grip or trajectory problem.



This is indicated by flashing of this warning lamp on the instrument panel.



# Trajectory control systems

## Emergency braking assistance

System which, in an emergency, enables you to obtain the optimum braking pressure more quickly, thus reducing the stopping distance.

### Activation

It is triggered by the speed at which the brake pedal is pressed.

The effect of this is a reduction in the resistance of the pedal and an increase in braking efficiency.



When braking in an emergency, press firmly without releasing the pressure.

## Anti-skid regulation (ASR) and electronic stability programme (ESP)

The anti-skid regulation (also known as Traction Control) optimises traction to prevent skidding of the wheels, by acting on the brakes of the driving wheels and on the engine. The electronic stability programme acts on the brake of one or more wheels and on the engine to keep the vehicle on the trajectory required by the driver, within the limits of the laws of physics.

### Activation

These systems are activated automatically each time the vehicle is started.

They come into operation in the event of a grip or trajectory problem.



This is indicated by flashing of this warning lamp on the instrument panel.



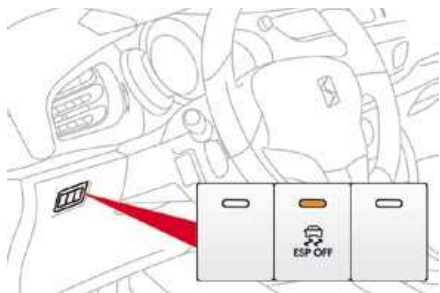

## Deactivation

In exceptional conditions (starting a vehicle which is bogged down, stuck in snow, on soft ground...), it may be advisable to deactivate the ASR and ESP systems, so that the wheels can move freely and regain grip.

- ☞ Press the **"ESP OFF"** button, located on the left below the steering wheel.



If this warning lamp comes on in the instrument panel and the indicator lamp on the button comes on, this indicates that the ASR and ESP systems are deactivated.

## Reactivation

These systems are reactivated automatically each time the ignition is switched back on or from 30 mph (50 km/h) (except 1.6 litre THP 150 petrol engine).

- ☞ Press the **"ESP OFF"** button again to reactivate them manually.

## Operating fault



If this warning lamp comes on, accompanied by an audible signal and a message on the multifunction screen, this indicates a malfunction of these systems.

Have the systems checked by a CITROËN dealer.



The ESP/ASR systems offer exceptional safety in normal driving, but this should not encourage the driver to take extra risks or drive at high speed. The correct functioning of these systems depends on observation of the manufacturer's recommendations regarding the wheels (tyres and rims), the braking components, the electronic components and the CITROËN assembly and operation procedures. After an impact, have these systems checked by a CITROËN dealer.



## Seat belts

### Front seat belts

The front seat belts are fitted with a pretensioning and force limiting system. This system improves safety in the front seats in the event of a front impact. Depending on the severity of the impact, the pretensioning system instantly tightens the seat belts against the body of the occupants.

The pretensioning seat belts are active when the ignition is on.

The force limiter reduces the pressure of the seat belt on the chest of the occupant, so improving their protection.

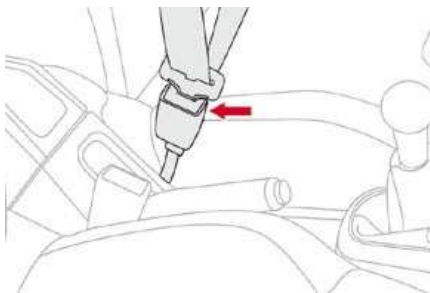

#### Fastening

- ☞ Pull the strap, then insert the tongue in the buckle.
- ☞ Check that the seat belt is fastened correctly by pulling the strap.

#### Unfastening

- ☞ Press the red button on the buckle.
- ☞ Guide the seat belt as it is reeled in.

#### Seat belt not fastened/ unfastened warning lamp



When the ignition is switched on, this warning lamp comes on in the instrument panel, if the driver and/or the front passenger has not fastened their seat belt. From approximately 12 mph (20 km/h) this warning lamp flashes for two minutes accompanied by an audible signal of increasing volume. Once these two minutes have elapsed, this warning lamp remains on until the driver and/or the front passenger fastens their seat belt.

## Rear seat belts



The rear seats are each fitted with a three-point inertia reel seat belt with force limiter.

### Fastening

- ☞ Pull the strap, then insert the tongue in the buckle.
- ☞ Check that the seat belt is fastened correctly by pulling the strap.

### Unfastening

- ☞ Press the red button on the buckle.
- ☞ Guide the seat belt as it is reeled in.

**i** The driver must ensure that passengers use the seat belts correctly and that they are all restrained securely before setting off. Wherever you are seated in the vehicle, always fasten your seat belt, even for short journeys.

Do not invert the seat belt buckles as they will not fulfil their role fully.

The seat belts are fitted with an inertia reel permitting automatic adjustment of the length of the strap to your size. The seat belt is stored automatically when not in use.

Before and after use, ensure that the seat belt is reeled in correctly.

The lower part of the strap must be positioned as low as possible on the pelvis. The upper part must be positioned in the hollow of the shoulder.

The inertia reels are fitted with an automatic locking device which comes into operation in the event of a collision, emergency braking or if the vehicle rolls over. You can release the device by pulling firmly on the strap and releasing it so that it re-winds slightly.

In order to be effective, a seat belt must:

- be tightened as close to the body as possible,
- be pulled in front of you with a smooth movement, checking that it does not twist,
- be used to restrain only one person,
- not bear any trace of cuts or fraying,
- not be converted or modified to avoid affecting its performance.

In accordance with current safety regulations, all repairs and checks must be carried out by a CITROËN dealer who guarantees that the work is carried out correctly.

Have your seat belts checked regularly by a CITROËN dealer and particularly if the straps show signs of damage.

Clean the seat belt straps with soapy water or a textile cleaning product, sold by CITROËN dealers.

After folding or moving a seat or rear bench seat, ensure that the seat belt is positioned and reeled in correctly.

## Recommendations for children

Use a suitable child seat if the passenger is less than 12 years old or shorter than one and a half metres.

Never use the same seat belt to secure more than one person.

Never allow a child to travel on your lap.

## In the event of an impact

**Depending on the nature and seriousness of the impacts**, the pre-tensioning device may be triggered before and independently of the airbags. Triggering of the pre-tensioners is accompanied by a slight discharge of harmless smoke and a noise, due to the activation of the pyrotechnic cartridge incorporated in the system. In all cases, the airbag warning lamp comes on.

Following an impact, have the seat belts system checked, and if necessary replaced, by a CITROËN dealer.

# Airbags

System designed to maximise the safety of the occupants (with the exception of the rear centre passenger) in the event of violent collisions. It supplements the action of the force-limiting seat belts (with the exception of the rear centre passenger).

If a collision occurs, the electronic detectors record and analyse the front and side impacts sustained in the impact detection zones:

- in the case of a serious impact, the airbags are triggered instantly and protect the occupants of the vehicle (with the exception of the rear centre passenger); immediately after the impact, the airbags deflate rapidly so that they do not hinder visibility or the exit of the occupants,
- in the case of a minor or rear impact or in certain roll-over conditions, the airbags will not be triggered; the seat belt alone is sufficient to provide optimum protection in these situations.

## **The airbags do not operate when the ignition is switched off.**

This equipment will only deploy once. If a second impact occurs (during the same or a subsequent accident), the airbag will not be triggered again.

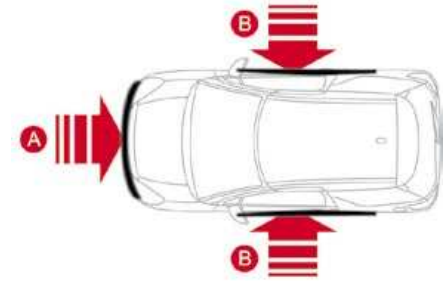

## Impact detection zones

- A. Front impact zone.
- B. Side impact zone.

 Triggering of the airbag(s) is accompanied by a slight emission of harmless smoke and a noise, due to the activation of the pyrotechnic cartridge incorporated in the system. This smoke is not harmful, but sensitive individuals may experience slight irritation. The noise of the detonation may result in a slight loss of hearing for a short time.



## Front airbags

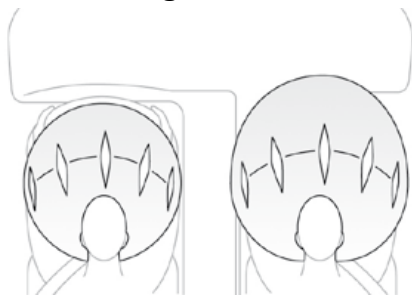

System which protects the driver and front passenger in the event of a serious front impact in order to limit the risk of injury to the head and chest.

The driver's airbag is incorporated in the centre of the steering wheel; the front passenger's airbag is incorporated in the dashboard above the glove box.

### Activation

The airbags are triggered simultaneously, unless the passenger's front airbag is deactivated, in the event of a serious front impact applied to all or part of the front impact zone **A**, in the longitudinal centreline of the vehicle on a horizontal plane and directed from the front to the rear of the vehicle.

The front airbag inflates between the head-thorax of the front occupant of the vehicle and the dashboard to cushion their forward movement.

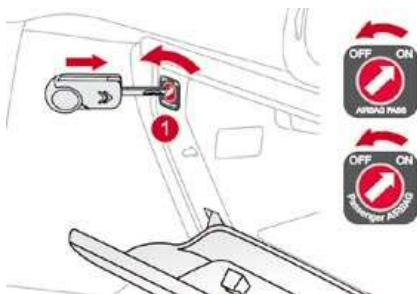

## Deactivation

Only the passenger's front airbag can be deactivated:

- ☞ **with the ignition off**, insert the key in the passenger airbag deactivation switch **1**,
- ☞ turn it to the **"OFF"** position,
- ☞ then, remove the key keeping the switch in the new position.



This warning lamp comes on in the instrument panel when the ignition is on and until the airbag is re-activated.



To assure the safety of your child, the passenger's front airbag must be deactivated when you install a "rear facing" child seat on the front passenger seat. Otherwise, the child would risk being seriously injured or killed if the airbag were triggered.

## Reactivation

When you remove the child seat, turn switch **1** to the **"ON"** position to re-activate the airbag and so assure the safety of your front passenger in the event of an impact.



With the ignition on, this warning lamp comes on in the instrument panel for approximately one minute, if the passenger's front airbag is activated.

## Operating fault



If this warning lamp comes on on the instrument panel, accompanied by an audible warning and a message on the multifunction screen, contact a CITROËN dealer to have the system checked. The airbags may no longer be triggered in the event of a serious impact.



If this warning lamp flashes, contact a CITROËN dealer. The passenger's front airbag may no longer be triggered in the event of a serious impact.



If at least one of the two airbag warning lamps come on continuously, do not install a child seat on the front passenger seat. Have the system checked by a CITROËN dealer.



## Lateral airbags

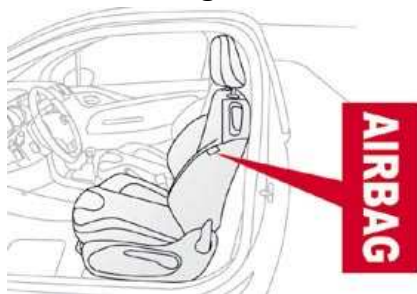

System which protects the driver and front passenger in the event of a serious side impact in order to limit the risk of injury to the chest, between the hip and the shoulder. Each lateral airbag is fitted in the seat backrest frame, door side.

### Activation

The lateral airbags are triggered unilaterally in the event of a serious side impact applied to all or part of the side impact zone **B**, perpendicular to the longitudinal centreline of the vehicle on a horizontal plane and directed from the outside towards the inside of the vehicle.

The lateral airbag inflates between the hip and shoulder of the front occupant of the vehicle and the corresponding door trim panel.

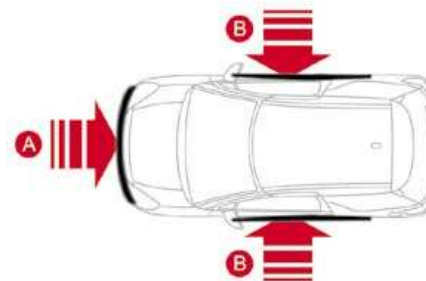

### Impact detection zones

- A. Front impact zone.
- B. Side impact zone.



## Curtain airbags

System which protects the driver and passengers (with the exception of the rear centre passenger) in the event of a serious side impact in order to limit the risk of injury to the side of the head.

Each curtain airbag is built into the pillars and the upper passenger compartment area.

## Activation

The curtain airbag is triggered at the same time as the corresponding lateral airbag in the event of a serious side impact applied to all or part of the side impact zone **B**, perpendicular to the longitudinal centreline of the vehicle on a horizontal plane and directed from the outside towards the inside of the vehicle.

The curtain airbag inflates between the front or rear occupant of the vehicle and the windows.

## Operating fault



If this warning lamp comes on on the instrument panel, accompanied by an audible signal and a message on the multifunction screen, contact a CITROËN dealer to have the system checked. The airbags may no longer be triggered in the event of a serious impact.



In the event of a minor impact or bump on the side of the vehicle or if the vehicle rolls over, the airbag may not be triggered.  
In the event of a rear or front collision, the airbag is not triggered.

## For the airbags to be fully effective, observe the following safety rules:

Sit in a normal upright position.

Wear a correctly adjusted seat belt.

Do not leave anything between the occupants and the airbags (a child, pet, object...). This could hamper the operation of the airbags or injure the occupants.

After an accident or if the vehicle has been stolen or broken into, have the airbag systems checked.

All work on the airbag system is strictly forbidden unless it is carried out by qualified personnel of the CITROËN dealer network. Even if all of the precautions mentioned are observed, a risk of injury or of minor burns to the head, chest or arms when an airbag is triggered cannot be ruled out.

The bag inflates almost instantly (within a few milliseconds) then deflates within the same time discharging the hot gas via openings provided for this purpose.

### Front airbags

Do not drive holding the steering wheel by its spokes or resting your hands on the centre part of the wheel.

Passengers must not place their feet on the dashboard.

If possible, do not smoke as deployment of the airbags can cause burns or the risk of injury from a cigarette or pipe.

Never remove or pierce the steering wheel or hit it violently.

### Lateral airbags

Use only approved covers on the seats.

These will not hinder inflation of the lateral airbags. Consult a CITROËN dealer.

Do not fix or attach anything to the seat backs (clothing...). This could cause injury to the chest or arms if the lateral airbag is triggered.

Do not sit with the upper part of the body any nearer to the door than necessary.

### Curtain airbags

Do not fix or attach anything to the roof.

This could cause injury to the head if the curtain airbag is triggered.

Do not remove the grab handles installed on the roof, they play a part in securing the curtain airbags.

# Parking brake

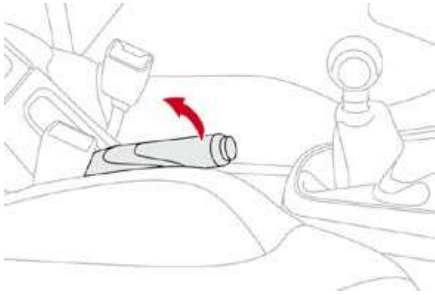



## Applying

- ☞ Pull the parking brake lever fully up to immobilise your vehicle.

## Releasing

- ☞ Pull the parking brake lever gently, press the release button then lower the lever fully.

 When the vehicle is being driven, if this warning lamp and the **STOP** warning lamp come on, accompanied by an audible signal and a message on the multifunction screen, this indicates that the parking brake is still on or has not been properly released.

 When parking on a slope, direct your wheels against the pavement, apply the parking brake and engage a gear.



# 6-speed manual gearbox

## Engaging reverse gear

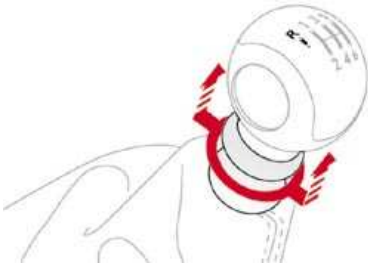

☞ Raise the ring under the knob and push the gear lever to the left then forwards.

⚠ Only engage reverse gear when the vehicle is stationary with the engine at idle.

ℹ As a safety precaution and to facilitate starting of the engine:

- always select neutral,
- press the clutch pedal.

# Gear shift indicator\*

System which reduces fuel consumption by advising the driver to change up on vehicles fitted with a manual gearbox.

## Operation

The system intervenes only when driving economically.

Depending on the driving situation and your vehicle's equipment, the system may advise you to skip one or more gears. You can follow this instruction without engaging the intermediate gears.

The gear engagement recommendations must not be considered compulsory. In fact, the configuration of the road, the amount of traffic and safety remain determining factors when choosing the best gear. Therefore, the driver remains responsible for deciding whether or not to follow the advice given by the system. This function cannot be deactivated.

Example:



- You are in third gear.

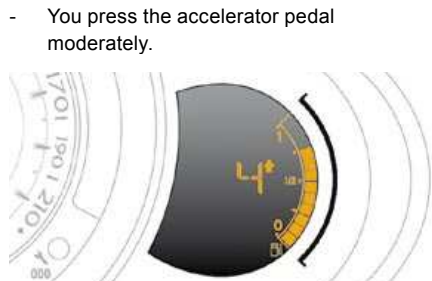

- The system may suggest that you engage a higher gear, if appropriate.

The information appears in the instrument panel screen in the form of an arrow accompanied by the suggested gear.

- i** In the case of driving which makes particular demands on the performance of the engine (firm pressure on the accelerator pedal, for example, when overtaking...), the system will not recommend a gear change. The system never suggests:
- engaging first gear,
  - engaging reverse gear,
  - engaging a lower gear.

\* According to engine.

# Automatic gearbox

Four-speed automatic gearbox which offers a choice between the comfort of fully automatic operation, enhanced by sport and snow programmes, or manual gear changing.

Therefore, four driving modes are offered:

- **automatic** operation for electronic management of the gears by the gearbox,
- **sport** programme for a more dynamic style of driving,
- **snow** programme to improve driving when traction is poor,
- **manual** operation for sequential changing of the gears by the driver.

## Gear selection gate

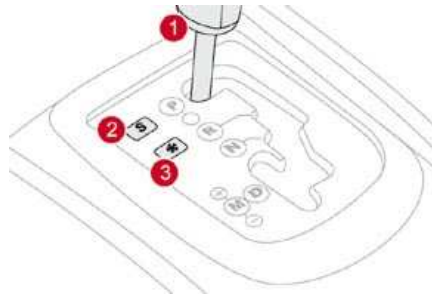

1. Gear lever.
2. Button "**S**" (**sport**).
3. Button "❄" (**snow**).

## Gear lever

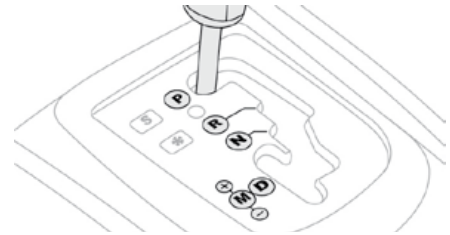

- P.** Park.
- Immobilisation of the vehicle, parking brake on or off.
  - Starting the engine.
- R.** Reverse.
- Reversing manoeuvres, vehicle stationary, engine at idle.
- N.** Neutral.
- Immobilisation of the vehicle, parking brake on.
  - Starting the engine.
- D.** Automatic operation.
- M.** +/- Manual operation with sequential changing of the four gears.
- ☞ Push forwards to change up through the gears.
- or
- ☞ Pull backwards to change down through the gears.

## Displays on the instrument panel



When you move the lever in the gate to select a position, the corresponding indicator is displayed on the instrument panel.

**P.** Park

**R.** Reverse

**N.** Neutral

**D.** Drive (Automatic driving)

**S.** Sport programme

**\*.** Snow programme

**1, 2, 3, 4.** Gear engaged during manual operation

**-.** Invalid value during manual operation

## Foot on brake



- Press the brake pedal when this indicator lamp is displayed on the instrument panel (e.g.: starting the engine).

## Moving off

- Apply the parking brake.
- Select position **P** or **N**.
- Start the engine.

If this procedure is not followed, an audible signal is heard, accompanied by a message on the multifunction screen.

- With the engine running, press the brake pedal.
- Release the parking brake.
- Select position **R**, **D** or **M**,
- Gradually release the brake pedal.

The vehicle moves off immediately.



If position **N** is engaged inadvertently while driving, allow the engine to return to idle then engage position **D** to accelerate.



When the engine is running at idle, with the brakes released, if position **R**, **D** or **M** is selected, the vehicle moves even without the accelerator being pressed.

When the engine is running, never leave children in the vehicle without supervision.

When carrying out maintenance with the engine running, apply the parking brake and select position **P**.



## Automatic operation

☞ Select position **D** for **automatic** changing of the four gears.

The gearbox then operates in auto-adaptive mode, without any intervention on the part of the driver. It continuously selects the most suitable gear according to the style of driving, the profile of the road and the load in the vehicle.

For maximum acceleration without touching the lever, press the accelerator pedal down fully (kick down). The gearbox changes down automatically or maintains the gear selected until the maximum engine speed is reached. On braking, the gearbox changes down automatically to provide efficient engine braking.

If you release the accelerator sharply, the gearbox will not change to a higher gear for safety reasons.



Never select position **N** while the vehicle is moving.  
Never select positions **P** or **R** unless the vehicle is completely stationary.

## Sport and snow programmes

These two special programmes supplement the automatic operation in very specific conditions of use.

### Sport programme "S"

☞ Press button "**S**", after starting the engine. The gearbox automatically favours a dynamic style of driving.



**S** appears on the instrument panel.

### Snow programme "❄"

☞ Press button "❄", after starting the engine. The gearbox adapts to driving on slippery roads. This programme improves starting and drive when traction is poor.



❄ appears on the instrument panel.

## Return to automatic operation

☞ At any time, press the button selected again to quit the programme engaged and return to auto-adaptive mode.



## Manual operation

- ☞ Select position **M** for **sequential** changing of the four gears.
- ☞ Push the lever towards the + sign to change up a gear.
- ☞ Pull the lever towards the - sign to change down a gear.

It is only possible to change from one gear to another if the vehicle speed and engine speed permit; otherwise, the gearbox will operate temporarily in automatic mode.



**D** disappears and the gears engaged appear in succession on the instrument panel.

In the event of the engine labouring or over-revving, the gear selected flashes for a few seconds, then the actual gear engaged is displayed.

It is possible to change from position **D** (automatic) to position **M** (manual) at any time. When the vehicle is stationary or moving very slowly, the gearbox selects gear **M1** automatically.

The sport and snow programmes do not operate in manual mode.

## Invalid value during manual operation



This symbol is displayed if a gear is not engaged correctly (selector between two positions).

## Stopping the vehicle

Before switching off the engine, you can engage position **P** or **N** to place the gearbox in neutral. In both cases, apply the parking brake to immobilise the vehicle.



If the lever is not in position **P**, when the driver's door is opened or approximately 45 seconds after the ignition is switched off, a message appears in the multifunction screen.

- ☞ Return the lever to position **P**; the message disappears.

## Operating fault

### SERVICE

When the ignition is on, the lighting of this warning lamp, accompanied by an audible signal and a message on the multifunction screen, indicates a gearbox malfunction. In this case, the gearbox switches to back-up mode and is locked in 3rd gear. You may feel a substantial knock when changing from **P** to **R** and from **N** to **R**. This will not cause any damage to the gearbox.

Do not exceed 60 mph (100 km/h), local speed restrictions permitting. Contact a CITROËN dealer as soon as possible.



There is a risk of damage to the gearbox:

- if you press the accelerator and brake pedals at the same time,
- if you force the movement of the gear lever from the **P** position to another position when the battery is flat.



To reduce fuel consumption when at a prolonged standstill with the engine running (traffic jam...), put the gear lever in the **N** position and apply the parking brake.

## Stop & Start

The Stop & Start system puts the engine temporarily on standby - STOP mode - during stops in the traffic (red lights, traffic jams, or other...).

The engine restarts automatically - START mode - as soon as you want to move off. The restart takes place instantly, quickly and silently.

Perfect for urban use, the Stop & Start system reduces fuel consumption and exhaust emissions as well as offering the comfort of silence when stationary.

## Operation

### Going into engine STOP mode

 The "ECO" warning lamp comes on in the instrument panel and the engine goes into standby:

- **with a manual gearbox**, at speeds below 12 mph (20 km/h), put the gear lever into neutral, then release the clutch pedal,

 A time counter calculates the sum of the periods in STOP mode during a journey. It rests itself to zero every time the ignition is switched on with the key.

 For your comfort when parking, STOP mode is not available for a few seconds after coming out of reverse gear. STOP mode does not affect the functionality of the vehicle, such as braking, power steering, for example.

 Never refuel with the engine in STOP mode; you must switch off the ignition with the key.

### Special cases: STOP mode unavailable

STOP mode is not invoked when:

- the driver's door is open,
- the driver's seat belt is not fastened,
- the vehicle has not exceeded 6 mph (10 km/h) since the last engine start using the key,
- the engine is needed to maintain a comfortable temperature in the passenger compartment,
- demisting is active,
- some special conditions (battery charge, engine temperature, braking assistance, ambient temperature...) where the engine is needed to assure control of a system.

 The "ECO" warning lamp flashes for a few seconds, then goes off.

**This operation is perfectly normal.**

## Going into engine START mode

**ECO** The "ECO" warning lamp goes off and the engine starts:

- **with a manual gearbox**, depress the clutch pedal,

## Special cases: START invoked automatically

The "ECO" warning lamp flashes for a few seconds, then goes off; START is invoked automatically when:

- the driver's door is open,
- the driver's seat belt is not fastened,
- the speed of the vehicle exceeds 15 mph (25 km/h) with a manual gearbox,
- some special conditions (battery charge, engine temperature, braking assistance, ambient temperature...) where the engine is needed to assure control of a system.

**ECO** The "ECO" warning lamp flashes, then goes off.

**This operation is perfectly normal.**

**i** With a manual gearbox in STOP mode, if a gear is engaged without fully depressing the clutch pedal, a message is displayed asking you to depress the clutch pedal to restart the engine.

## Deactivation

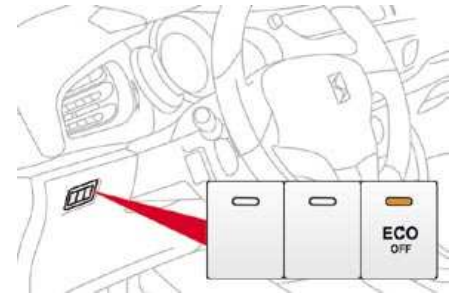

At any time, press the "ECO OFF" switch to deactivate the system.

This is confirmed by the switch warning lamp coming on accompanied by a message on the screen.

**i** If the system has been deactivated in STOP mode, the engine restarts immediately.

## Reactivation

Press the **"ECO OFF"** switch again.  
The system is active again; this is confirmed by the switch warning lamp going off, accompanied by a message on the screen.

**i** The system is reactivated automatically at every new start using the key.

## Operating fault

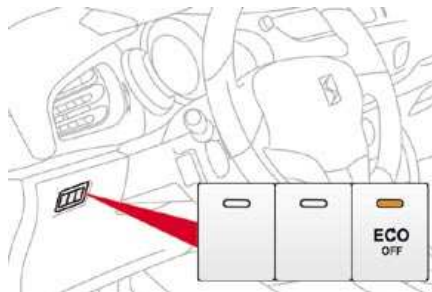

In the event of a malfunction with the system, the **"ECO OFF"** switch warning lamp flashes, then comes on continuously.  
Have it checked by a CITROËN dealer.  
In the event of a fault in STOP mode, the vehicle may stall. It is then necessary to switch off the ignition and start the engine again using the key.

## Maintenance

**!** Before working under the bonnet, deactivate the Stop & Start system to avoid any risk of injury resulting from automatic operation of START mode.

This system requires a battery with a special specification and technology (reference numbers available from CITROËN dealers). Fitting a battery not listed by CITROËN introduces the risk of malfunction of the system.

<b>ATTENTION !</b>	<b>CAUTION !</b>
Votre véhicule nécessite une batterie spécifique	Your vehicle requires a specific battery
<small>EN CAS DE REMPLACEMENT, SE REFERER OBLIGATOIREMENT AU MANUEL DU VEHICULE</small>	<small>IN THE EVENT OF REPLACEMENT, REFER OBLIGATORILY TO THE HANDBOOK OF THE VEHICLE</small>

**!** The Stop & Start system makes use of advanced technology. Specialist knowledge is needed for any work on the system, which can only be assured by CITROËN dealers.

# Speed limiter

System which prevents the vehicle from exceeding the speed programmed by the driver. When the programmed speed limit is reached, pressing the accelerator pedal in the normal manner no longer has any effect.

The speed limiter is **switched on** manually: it requires a programmed speed of at least 20 mph (30 km/h).

The speed limiter is **switched off** by manual operation of the control.

The programmed speed can be exceeded temporarily by pressing the accelerator firmly. To return to the programmed speed, simply slow down to a speed below the programmed speed.

The programmed speed remains in the memory when the ignition is switched off.



The speed limiter cannot, in any circumstances, replace the need to respect speed limits, nor can it replace the need for vigilance and responsibility on the part of the driver.

## Steering mounted controls

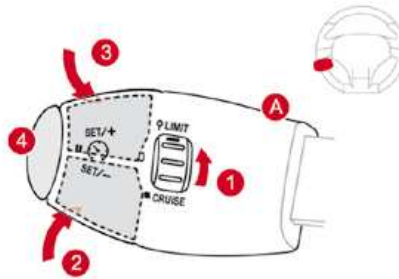

The controls of this system are grouped together on stalk **A**.

1. Speed limiter mode selection thumb wheel.
2. Value decrease button.
3. Value increase button.
4. Speed limiter on/off button.

## Displays on the instrument panel

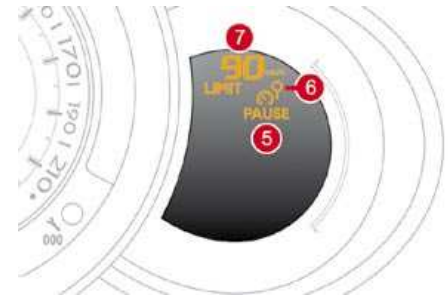

The programmed information is grouped together on the instrument panel screen.

5. Speed limiter on/off indication.
6. Speed limiter mode selection indication.
7. Programmed speed value.

## Programming

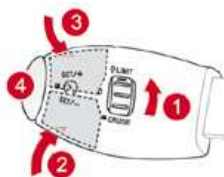

- ☞ Turn thumb wheel **1** to the "LIMIT" position: the speed limiter mode is selected but is not switched on (PAUSE). You do not have to switch the speed limiter on in order to set the speed.
- ☞ Set the speed value by pressing button **2** or **3** (e.g.: 55 mph (90 km/h)).

You can then change the programmed speed using buttons **2** and **3**:

- by + or - 1 mph (km/h) = short press,
- by + or - 5 mph (km/h) = long press,
- in steps of + or - 5 mph (km/h) = maintained press.
- ☞ Switch the speed limiter on by pressing button **4**.
- ☞ Switch the speed limiter off by pressing button **4**: the display confirms that it has been switched off (PAUSE).
- ☞ Switch the speed limiter back on by pressing button **4** again.

## Exceeding the programmed speed

Pressing the accelerator pedal to exceed the programmed speed will not have any effect unless you press the pedal **firmly** past the **point of resistance**. The speed limiter is deactivated temporarily and the programmed speed, which is still displayed, flashes.

Returning to the programmed speed, by means of intentional or unintentional deceleration of the vehicle, automatically cancels the flashing of the programmed speed.



## Leaving limiter mode

- ☞ Turn thumb wheel **1** to the "0" position: the speed limiter mode is deselected. The display returns to the distance recorder.

## Operating fault

In the event of a speed limiter malfunction, the speed is cleared resulting in flashing of the dashes.

Have the system checked by a CITROËN dealer.



- ⚠ On a steep descent or in the event of sharp acceleration, the speed limiter will not be able to prevent the vehicle from exceeding the programmed speed. To avoid any risk of jamming of the pedals:
  - ensure that the mat is positioned correctly,
  - do not fit one mat on top of another.

# Cruise control

System which automatically maintains the speed of the vehicle at the value programmed by the driver, without any action on the accelerator pedal.

The cruise control is **switched on** manually: it requires a minimum vehicle speed of 25 mph (40 km/h), as well as the engagement of:

- fourth gear on a manual gearbox,
- second gear on an automatic gearbox, in sequential mode,
- position **D** on an automatic gearbox.

The cruise control is **switched off** manually or by pressing the brake or clutch pedal or on triggering of the ESP system for safety reasons.

It is possible to exceed the programmed speed temporarily by pressing the accelerator pedal.

To return to the programmed speed, simply release the accelerator pedal.

Switching off the ignition cancels any programmed speed value.

## Steering mounted controls

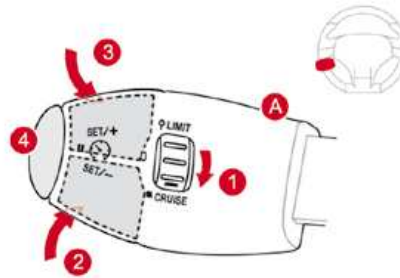

The controls of this system are grouped together on stalk **A**.

1. Cruise control mode selection thumb wheel.
2. Value decrease button.
3. Value increase button.
4. Cruise control off/resume button.



The cruise control cannot, in any circumstances, replace the need to respect speed limits, nor can it replace the need for vigilance and responsibility on the part of the driver.

## Displays on the instrument panel

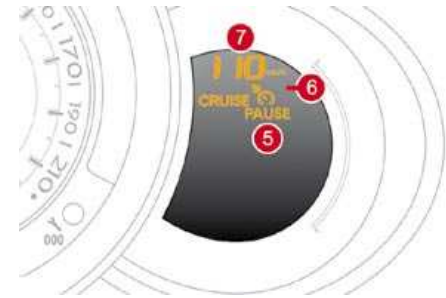

The programmed information is grouped together on the instrument panel display.

5. Cruise control off/resume indication.
6. Cruise control mode selection indication.
7. Programmed speed value.

## Programming

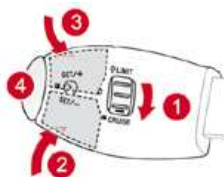

- ☞ Turn thumb wheel **1** to the **"CRUISE"** position: the cruise control mode is selected but is not switched on (PAUSE).
- ☞ Set the programmed speed by accelerating to the required speed, then press button **2** or **3** (e.g.: 70 mph (110 km/h)).

You can then change the programmed speed using buttons **2** and **3**:

- by + or - 1 mph (km/h) = short press,
- by + or - 5 mph (km/h) = long press,
- in steps of + or - 5 mph (km/h) = maintained press.

☞ Switch off the cruise control by pressing button **4**: the display confirms that it has been switched off (PAUSE).

☞ Switch the cruise control back on by pressing button **4** again.

## Exceeding the programmed speed

Intentional or unintentional exceeding of the programmed speed results in flashing of this speed on the display.

Return to the programmed speed, by means of intentional or unintentional deceleration of the vehicle, automatically cancels the flashing of the speed.

## Leaving cruise control mode

☞ Turn thumb wheel **1** to the **"0"** position: the cruise control mode is deselected. The display returns to the distance recorder.



## Operating fault

In the event of a cruise control malfunction, the speed is cleared resulting in flashing of the dashes. Have it checked by a CITROËN dealer.



⚠ When the cruise control is switched on, be careful if you maintain the pressure on one of the programmed speed changing buttons: this may result in a very rapid change in the speed of your vehicle.

Do not use the cruise control on slippery roads or in heavy traffic.

On a steep descent, the cruise control will not be able to prevent the vehicle from exceeding the programmed speed.

To avoid any risk of jamming of the pedals:

- ensure that the mat is positioned correctly,
- never fit one mat on top of another.



# Rear parking sensors

## Activation

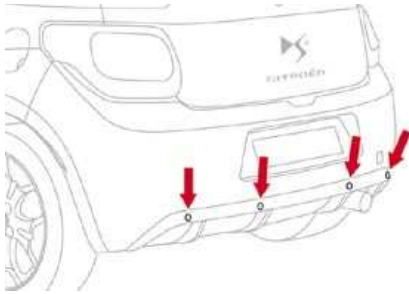

System consisting of four proximity sensors, located in the rear bumper.

This detects any obstacle (person, vehicle, tree, gate, etc.) behind the vehicle, except obstacles located just below the bumper.

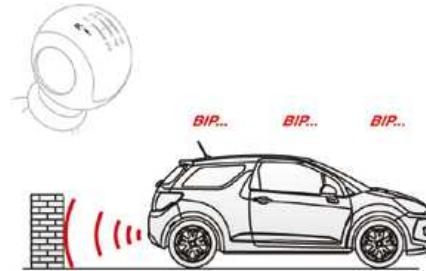

The system is activated as soon as reverse gear is engaged, accompanied by an audible signal. The proximity information is given by:

- an audible signal, which becomes more rapid as the vehicle approaches the obstacle.
- a graphic on the multifunction screen, with blocks which become increasingly closer to the vehicle.



**!** An object, such as a stake, a roadworks cone or any other similar object may be detected at the beginning of the manoeuvre, but may no longer be detected when the vehicle comes close to it.

**!** The parking sensor system cannot, in any circumstances, take the place of the vigilance and responsibility of the driver.

When the distance between the rear of the vehicle and the obstacle is less than thirty centimetres, the audible signal becomes continuous and the "Danger" symbol appears on the multifunction screen. On completion of the manoeuvre, when you exit reverse gear, the system becomes inactive.



## Programming

You can activate or deactivate the system by means of the multifunction screen configuration menu. The system state is memorised when switching off the ignition.

For more information on access to the parking sensors menu, refer to "Configuration/Vehicle parameters" in the "Multifunction screens" section corresponding to your screen.

 The system will be deactivated automatically when towing a trailer or when a bicycle carrier is fitted (vehicle fitted with a towbar or bicycle carrier recommended by CITROËN).

## Operating faults

If there is an operating fault, when reverse gear is engaged this warning lamp comes on on the instrument panel, accompanied by an audible signal (short beep) and a message on the multifunction screen.

 In bad or wintry weather, ensure that the sensors are not covered with mud, frost or snow.

# Bonnet

Protects the components of the engine and provides access for checking levels.

## Opening

- ⚠ Before doing anything under the bonnet, switch off the Stop & Start system to avoid any risk of injury resulting from an automatic change to START mode.

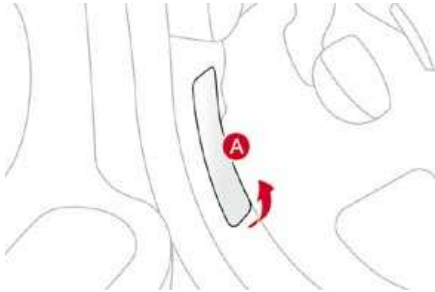

- ☞ Open the front left door.
- ☞ Pull the interior release lever **A**, located at the bottom of the door aperture.

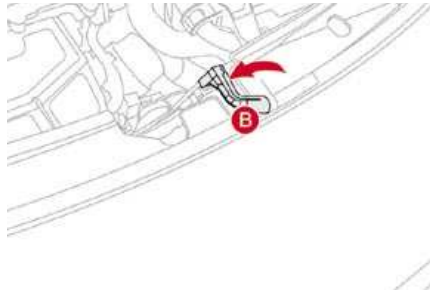

- ☞ Push the exterior safety catch **B** to the left and raise the bonnet.

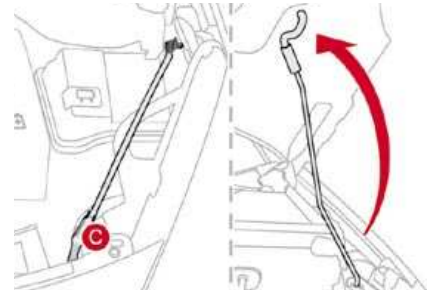

- ☞ Unclip the bonnet stay **C** from its housing, holding it by its foam protection.
- ☞ Fix the stay in the notch to hold the bonnet open.

- i** The location of the interior release lever prevents opening of the bonnet while the front left door is closed.

- ⚠ When the engine is hot, handle the exterior safety catch and the stay with care.

# Running out of fuel (Diesel)

## Closing

- ☞ Take the stay out of the support notch.
- ☞ Clip the stay in its housing.
- ☞ Lower the bonnet and release it at the end of its travel.
- ☞ Pull on the bonnet to check that it is fully latched.

If your vehicle is fitted with an HDI engine, the fuel system must be primed if you run out of fuel.

This system consists of a priming pump and a transparent pipe under the bonnet.

- ☞ Fill the fuel tank with at least five litres of Diesel.
- ☞ Open the bonnet.
- ☞ Depending on version, unclip the cover to gain access to the priming pump.
- ☞ Squeeze and release the priming pump until resistance is felt (could be from the first application) and fuel appears in the transparent pipe with the green connector.
- ☞ Operate the starter until the engine starts.
- ☞ Depending on version, put the cover back in position and clip it in place.
- ☞ Close the bonnet.



If the engine does not start at the first attempt, do not try again. Operate the priming pump again, then the starter.

# Running out of fuel (Diesel)

## Closing

- ☞ Take the stay out of the support notch.
- ☞ Clip the stay in its housing.
- ☞ Lower the bonnet and release it at the end of its travel.
- ☞ Pull on the bonnet to check that it is fully latched.

If your vehicle is fitted with an HDI engine, the fuel system must be primed if you run out of fuel.

This system consists of a priming pump and a transparent pipe under the bonnet.

- ☞ Fill the fuel tank with at least five litres of Diesel.
- ☞ Open the bonnet.
- ☞ Depending on version, unclip the cover to gain access to the priming pump.
- ☞ Squeeze and release the priming pump until resistance is felt (could be from the first application) and fuel appears in the transparent pipe with the green connector.
- ☞ Operate the starter until the engine starts.
- ☞ Depending on version, put the cover back in position and clip it in place.
- ☞ Close the bonnet.



If the engine does not start at the first attempt, do not try again. Operate the priming pump again, then the starter.

## Petrol engines

1. Screenwash fluid reservoir.
2. Coolant header tank.
3. Air filter.
4. Brake fluid reservoir.
5. Battery.
6. Fusebox.
7. Engine oil dipstick.
8. Engine oil filler cap.

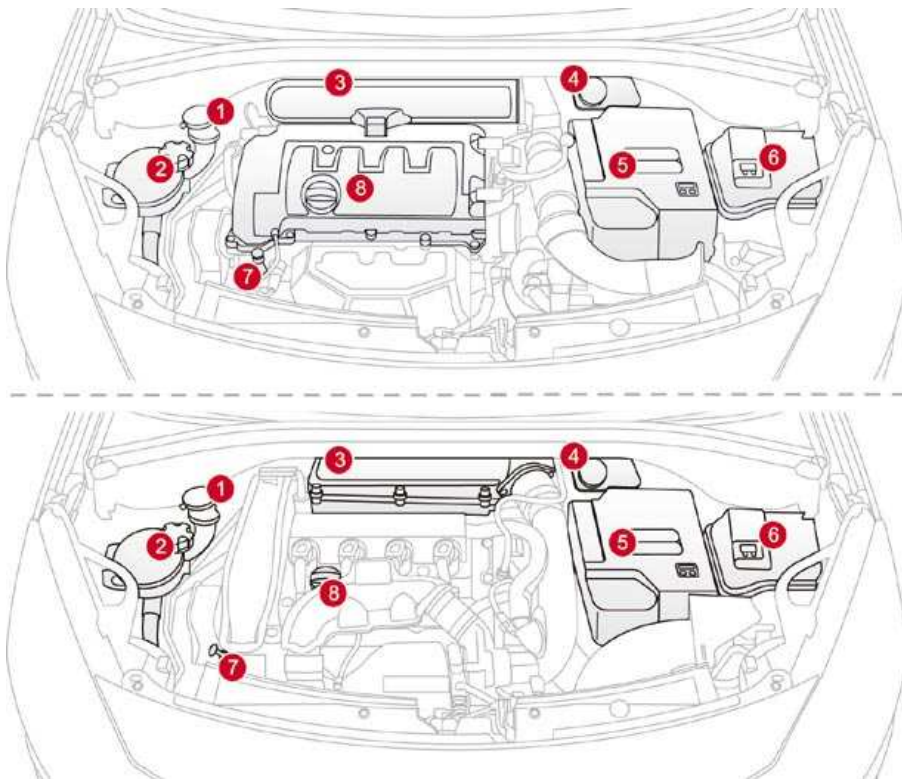

# Diesel engines

1. Screenwash fluid reservoir.
2. Coolant header tank.
3. Air filter.
4. Brake fluid reservoir.
5. Battery.
6. Fusebox.
7. Engine oil dipstick.
8. Engine oil filler cap.
9. Priming pump (on fuel filter).

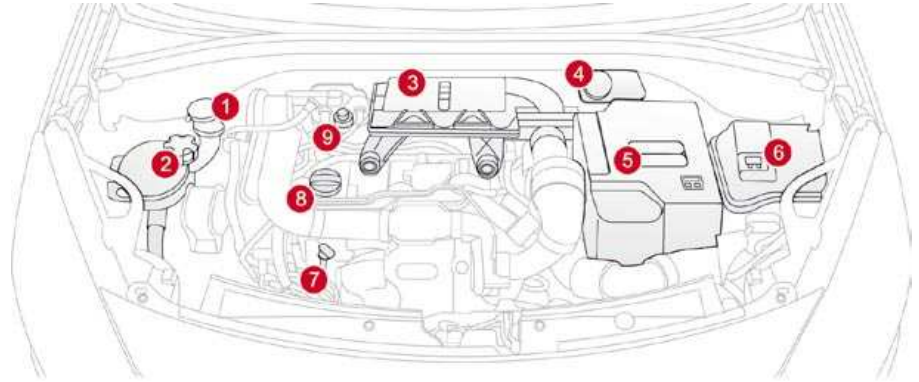



## Checking levels

Check all of these levels regularly and top them up if necessary, unless otherwise indicated. If a level drops significantly, have the corresponding system checked by a CITROËN dealer.

### Oil level



The reading will only be correct if the vehicle is on level ground and the engine has been off for more than 15 minutes.

The check is carried out either when the ignition is switched on using the oil level indicator on the instrument panel, or using the dipstick.

### Engine oil change

Refer to the Maintenance and Warranty Guide for details of the interval for this operation. In order to maintain the reliability of the engine and emission control system, the use of additives in the engine oil is prohibited.

### Oil grade

The oil must be suitable for your engine and conform to the manufacturer's recommendations.

### Brake fluid level



The brake fluid level should be close to the "MAX" mark. If it is not, check the brake pad wear.

### Changing the fluid

Refer to the Maintenance and Warranty Guide for details of the interval for this operation.

### Fluid specification

The brake fluid must conform to the manufacturer's recommendations and meet the DOT4 standard.



## Coolant level



The coolant level should be close to the "MAX" mark but should never exceed it.

When the engine is warm, the temperature of the coolant is regulated by the fan. This can operate with the ignition off.

**On vehicles which are fitted with a particle emission filter, the fan may operate after the vehicle has been switched off, even if the engine is cold.**

In addition, as the cooling system is pressurised, wait at least one hour after switching off the engine before carrying out any work.

To avoid any risk of scalding, unscrew the cap by two turns to allow the pressure to drop.

When the pressure has dropped, remove the cap and top up the level.

## Changing the coolant

The coolant does not have to be changed.

## Fluid specification

The coolant must conform to the manufacturer's recommendations.

## Screenwash fluid level



Top up the level when necessary.

## Fluid specification

For optimum cleaning and to avoid freezing, this fluid must not be topped up or replaced with water.



Take care when carrying out checks under the bonnet as some parts of the engine can be very hot (risk of burns).



## Diesel additive level (Diesel engine with particle emission filter)

A low additive level is indicated by lighting of the service warning lamp, accompanied by an audible warning and a message on the multifunction screen.

## Topping up

This additive must be topped up by a CITROËN dealer without delay.

## Used products

 Avoid prolonged contact of used oil or fluids with the skin.  
Most of these fluids are harmful to health or indeed very corrosive.

 Do not discard used oil or fluids into sewers or onto the ground.  
Take used oil to a CITROËN dealer (France) or an authorised waste disposal site.

# Checks

Unless otherwise indicated, check these components in accordance with the Maintenance and Warranty Guide and according to your engine. Otherwise, have them checked by a CITROËN dealer.

## Battery



The battery does not require any maintenance.

However, check that the terminals are clean and correctly tightened,

particularly in summer and winter.

When carrying out work on the battery, refer to the "Practical information" section for details of the precautions to be taken before disconnecting the battery and following its reconnection.



The presence of this label, in particular with the Stop & Start system, indicates the use of a specific 12 V lead-acid battery with special technology and specification, for which the involvement of a CITROËN dealer is required when replacing or disconnecting the battery. Failure to observe this recommendation may cause premature wear of the battery.

## Air filter and passenger compartment filter



Refer to the Maintenance and Warranty Guide for details of the replacement intervals for these components.

Depending on the environment (e.g. dusty atmosphere) and the use of the vehicle (e.g. city driving), **replace them twice as often if necessary** (refer to the "Engines" section). A clogged passenger compartment filter may have an adverse effect on the performance of the air conditioning system and generate undesirable odours.

## Oil filter



Replace the oil filter each time the engine oil is changed.

Refer to the Maintenance and Warranty Guide for details of the replacement interval for this component.

## Particle emission filter (Diesel)

It is imperative that the maintenance of the particle emission filter is carried out by a CITROËN dealer.

**i** Following prolonged operation of the vehicle at very low speed or at idle, you may, in exceptional circumstances, notice the emission of water vapour at the exhaust on acceleration. This does not affect the behaviour of the vehicle or the environment.

## Manual gearbox



The gearbox does not require any maintenance (no oil change). Refer to the Maintenance and Warranty Guide for the details of the level checking interval for this component.

## Automatic gearbox



The gearbox does not require any maintenance (no oil change). Refer to the Maintenance and Warranty Guide for details of the level checking interval for this component.

## Brake pads



Brake wear depends on the style of driving, particularly in the case of vehicles used in town, over short distances. It may be necessary to have the condition of the brakes checked, even between vehicle services. Unless there is a leak in the circuit, a drop in the brake fluid level indicates that the brake pads are worn.

## Brake disc wear



For information relating to checking the brake disc wear, contact a CITROËN dealer.

## Parking brake



If a loss of effectiveness of this system is noticed, the parking brake must be checked, even between two services. This system must be checked by a CITROËN dealer.



Only use products recommended by CITROËN or products of equivalent quality and specifications. In order to optimise the operation of units as important as the braking system, CITROËN selects and offers very specific products. To avoid damaging the electrical units, the use of a high pressure washer in the engine compartment is strictly **prohibited**.

# Temporary puncture repair kit

Complete system consisting of a compressor and a sealant cartridge which permits **temporary repair** of the tyre so that you can drive to the nearest garage. It is designed to repair most punctures which could affect the tyre, located on the tyre tread or shoulder.

## Access to the kit

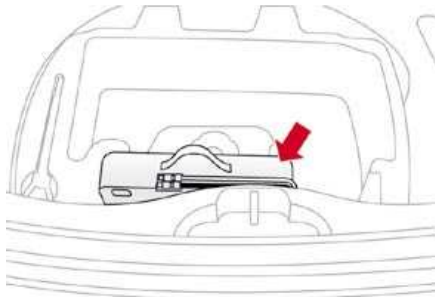

This kit is installed in the storage box, under the boot floor.

## Description of the kit

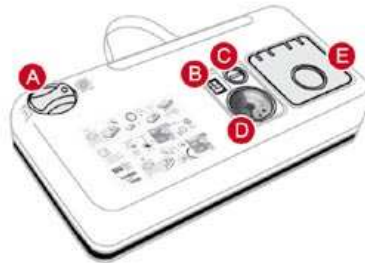

- A. "Sealant" or "Air" position selector.
- B. On "I"/off "O" switch.
- C. Deflation button.
- D. Pressure gauge (in bar or p.s.i.).
- E. Compartment housing:
  - a cable with adaptor for 12 V socket,
  - various inflation adaptors for accessories, such as balls, bicycle tyres...



- F. Sealant cartridge.
- G. White pipe with cap for repair.
- H. Black pipe for inflation.
- I. Speed limit sticker.

**i** The speed limit sticker I must be affixed to the vehicle's steering wheel to remind you that a wheel is in temporary use. Do not exceed a speed of 50 mph (80 km/h) when driving with a tyre repaired using this type of kit.

## Repair procedure

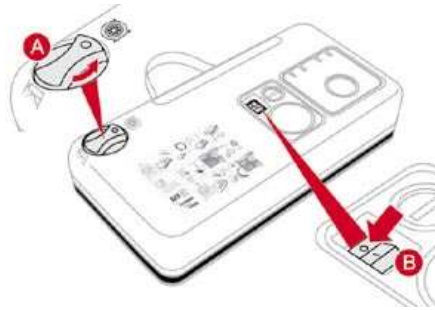

### 1. Sealing

- ☞ Switch off the ignition.
- ☞ Turn the selector **A** to the "SEALANT" position.
- ☞ Check that the switch **B** is in position "O".



**i** Avoid removing any foreign bodies which have penetrated into the tyre.

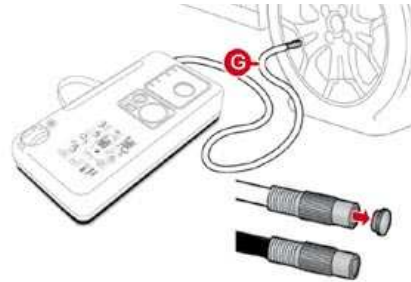

- ☞ Uncoil the white pipe **G** fully.
- ☞ Unscrew the cap from the white pipe.
- ☞ Connect the white pipe to the valve of the tyre to be repaired.

**!** Take care, this product is harmful (e.g. ethylene-glycol, colophony...) if swallowed and causes irritation to the eyes.  
Keep it out of reach of children.

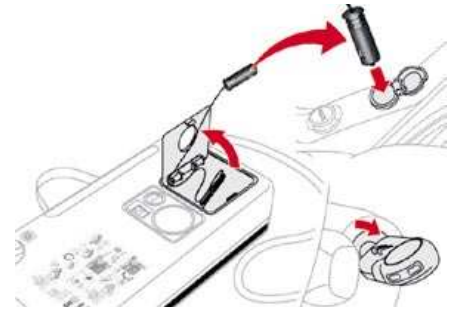

- ☞ Connect the compressor's electric plug to the vehicle's 12 V socket.
- ☞ Start the vehicle and leave the engine running.

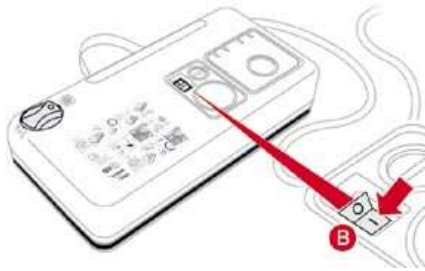

- ☞ Switch on the compressor by moving the switch **B** to position "I" until the tyre pressure reaches 2.0 bars. The sealant is injected into the tyre under pressure; do not disconnect the pipe from the valve during this operation (risk of splashing).

**i** If after around 5 to 7 minutes the pressure is not attained, this indicates that the tyre is not repairable; contact a CITROËN dealer for assistance.

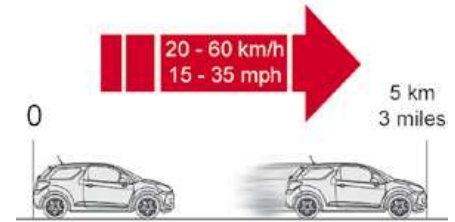

- ☞ Remove the kit and screw the cap back on the white pipe. Take care to avoid staining your vehicle with traces of fluid. Keep the kit to hand.
- ☞ Drive immediately for approximately three miles (five kilometres), at reduced speed (between 15 and 35 mph [20 and 60 km/h]), to plug the puncture.
- ☞ Stop to check the repair and the tyre pressure using the kit.

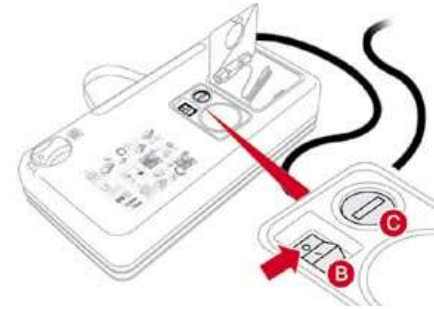
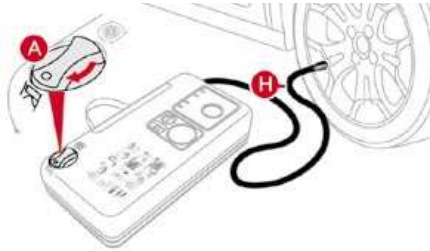

## 2. Inflation

- ☞ Turn the selector **A** to the "AIR" position.
- ☞ Uncoil the black pipe **H** fully.
- ☞ Connect the black pipe to the valve of the wheel.



- ☞ Connect the compressor's electric plug to the vehicle's 12 V socket.
- ☞ Start the vehicle again and leave the engine running.



☞ Visit a CITROËN dealer as soon as possible.  
You must inform the technician that you have used this kit. After inspection, the technician will inform you whether the tyre can be repaired or must be replaced.

- ☞ Adjust the pressure using the compressor (to inflate: switch **B** in position "I"; to deflate: switch **B** in position "O" and press button **C**), in accordance with the vehicle's tyre pressure label (located on the left hand door aperture).

A loss of pressure indicates that the puncture has not been fully plugged; contact a CITROËN dealer for assistance.

- ☞ Remove and stow the kit.
- ☞ Drive at reduced speed (50 mph [80 km/h] max) limiting the distance travelled to approximately 120 miles (200 km).



## Removing the cartridge



- ☞ Stow the black pipe.
- ☞ Detach the angled base from the white pipe.
- ☞ Support the compressor vertically.
- ☞ Unscrew the cartridge from the bottom.



Beware of discharges of fluid.

The expiry date of the fluid is indicated on the cartridge.

The sealant cartridge is designed for single use; even if only partly used, it must be replaced.

After use, do not discard the cartridge into the environment, take it to an authorised waste disposal site or a CITROËN dealer. Do not forget to obtain a new sealant cartridge, available from CITROËN dealers.

## Checking tyre pressures/ inflating accessories

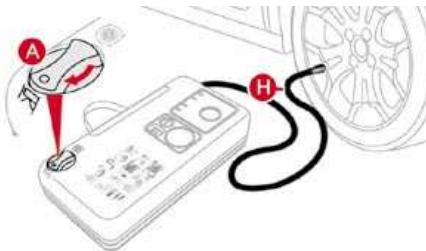

You can also use the compressor, without injecting any product, to:

- check or adjust the pressure of your tyres,
- inflate other accessories.

- ☞ Turn the selector **A** to the "Air" position.
- ☞ Uncoil the black pipe **H** fully.
- ☞ Connect the black pipe to the valve of the wheel or accessory.  
If necessary, fit one of the adaptors supplied with the kit first.

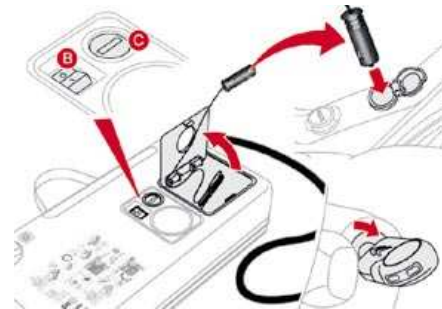

- ☞ Connect the compressor's electrical connector to the vehicle's 12 V socket.
- ☞ Start the vehicle and let the engine run.
- ☞ Adjust the pressure using the compressor (to inflate: switch **B** in position "**I**"; to deflate: switch **B** in position "**O**" and press button **C**), according to the vehicle's tyre pressure label or the accessory's pressure label.
- ☞ Remove the kit then stow it.

# Changing a wheel

Procedure for changing a faulty wheel for the spare wheel using the tools provided with the vehicle.

## Access to the tools

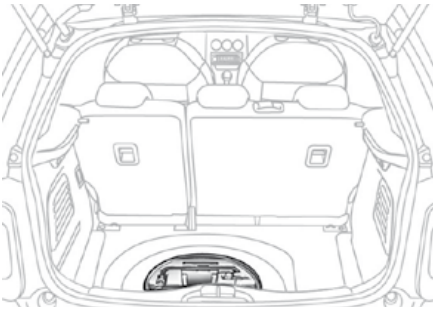

The tools are installed in the boot under the floor.

To gain access to them:

- ☞ open the boot,
- ☞ lift the boot carpet by pulling the strap upwards,
- ☞ remove the polystyrene storage box,
- ☞ unclip and remove the box containing the tools.

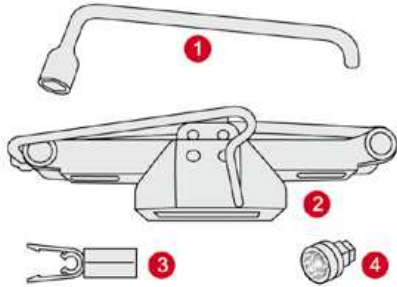

## List of tools

All of these tools are specific to your vehicle.  
Do not use them for other purposes.

1. Wheelbrace.  
For removing the wheel trim and removing the wheel fixing bolts.
2. Jack with integral handle.  
For raising the vehicle.
3. "Bolt cover" tool.  
For removing the bolt protectors (covers) on alloy wheels.
4. Socket for the security wheel bolts (located in the glove box).  
For adapting the wheelbrace to the special security wheel bolts (if your vehicle is fitted with them).

### **i** Wheel with trim

**When removing the wheel**, first detach the trim using the wheelbrace 1 pulling at the valve passage hole.

**When refitting the wheel**, refit the trim starting by placing its cut-out at the valve and press around its edge with the palm of your hand.

## Access to the spare wheel

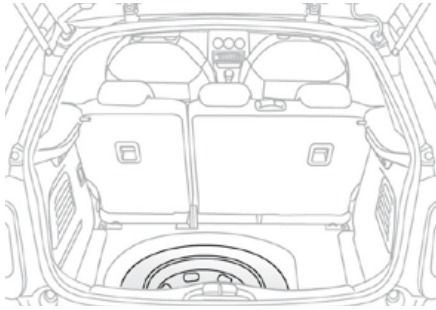

The spare wheel is installed in the boot under the floor.

According to country, you will have either a "space saver" spare wheel or a temporary puncture repair kit.



For access to it, refer to the paragraph "Access to the tools" on the previous page.

### Fitting the "space-saver" type spare wheel

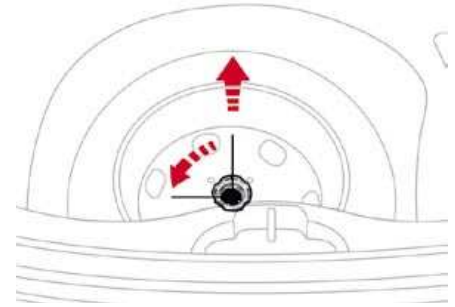
If your vehicle is fitted with alloy wheels, it is normal to notice, when tightening the bolts on fitting, that the washers do not come into contact with the "space-saver" type spare wheel. The wheel is secured by the conical contact of each bolt.



### Taking out the wheel

-  Unscrew the yellow central bolt.
-  Raise the spare wheel towards you from the rear.
-  Take the wheel out of the boot.

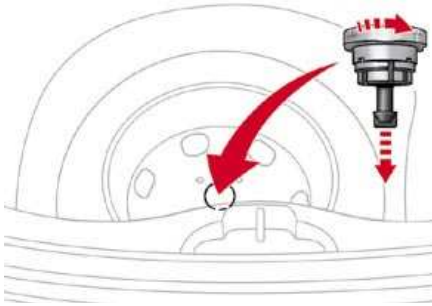

### Putting the wheel back in place

- ☞ Put the wheel back in its housing.
- ☞ Unscrew the yellow central bolt by a few turns then place it in the centre of the wheel.
- ☞ Tighten fully until the central bolt clicks to retain the wheel correctly.

- ☞ Put the box back in place in the centre of the wheel and clip it.
- ☞ Put the polystyrene storage box back in place.
- ☞ Refit the boot floor carpet by lightly folding it in the middle (refer to the section "Fittings - § Storage box").

 On vehicles equipped with a "space-saver" type spare wheel, the punctured wheel can be stowed in place of the "space-saver" wheel; however the boot floor will not then be flat.

## Removing the wheel

### Parking the vehicle

Immobilise the vehicle where it does not block traffic: the ground must be level, stable and not slippery.

Apply the parking brake, switch off the ignition and engage first gear\* to lock the wheels.



If necessary, place a chock under the wheel diagonally opposite the wheel to be changed.

It is imperative that you ensure that the occupants get out of the vehicle and wait where they are safe.

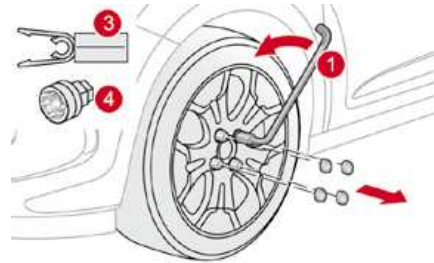
Never go underneath a vehicle raised using a jack; use an axle stand.



### List of operations

-  Remove the chromed bolt cover from each of the bolts using the tool **3** (alloy wheels only).
-  Fit the socket **4** on the wheelbrace **1** to slacken the security bolt (if your vehicle is fitted with them).
-  Slacken the other bolts using the wheelbrace **1** only.

\* position **P** for an automatic gearbox.

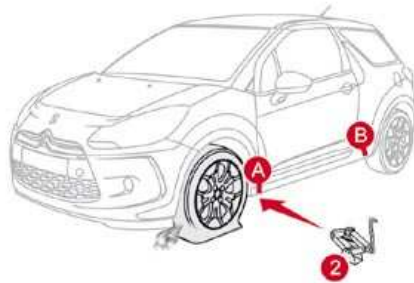

- ☞ Place the jack **2** in contact with one of the two front **A** or rear **B** locations provided on the underbody, whichever is closest to the wheel to be changed.  
On vehicles fitted with sill finishers, the jacking location is indicated by a marking on the finisher. The jack must be placed centrally in line with this marking, at the jacking point located behind the finisher and not on the plastic finisher itself.

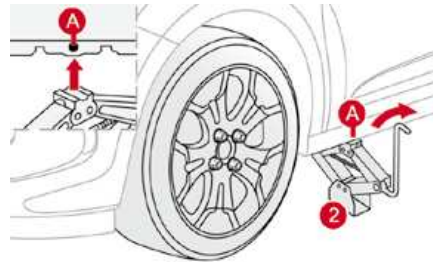

- ☞ Extend the jack **2** until its base plate is in contact with the ground. Ensure that the centreline of the jack base plate is directly below the location **A** or **B** used.
- ☞ Raise the vehicle until there is sufficient space between the wheel and the ground so that the spare (not punctured) wheel can then be fitted without difficulty.



- ☞ Remove the bolts and store them in a clean place.
- ☞ Remove the wheel.

## Fitting the wheel

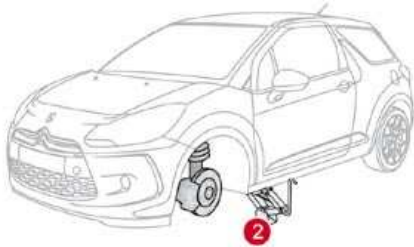

### After changing a wheel

To store the punctured wheel in the boot correctly, first remove the central cover.

When using the "space-saver" type temporary use spare wheel, do not exceed 50 mph (80 km/h).



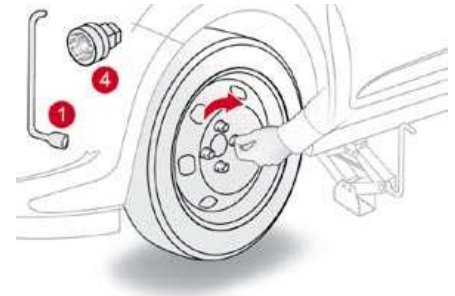

Have the tightening of the bolts and the pressure of the spare wheel checked by a CITROËN dealer without delay.

Have the punctured wheel repaired and replace it on the vehicle as soon as possible.

Do not drive with more than one temporary use spare wheel fitted to the vehicle at one time.



### List of operations

-  Put the wheel in place on the hub.
-  Screw in the bolts by hand.
-  Pre-tighten the security bolt (if your vehicle is fitted with them) using the wheelbrace **1** fitted with the socket **4**.
-  Pre-tighten the other bolts using the wheelbrace **1** only.

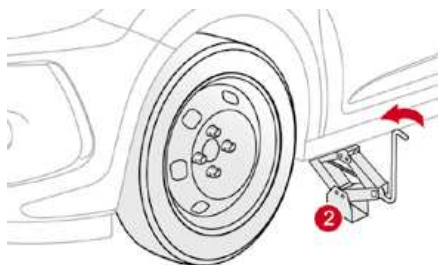

- ☞ Lower the vehicle fully.
- ☞ Fold the jack **2** and detach it.

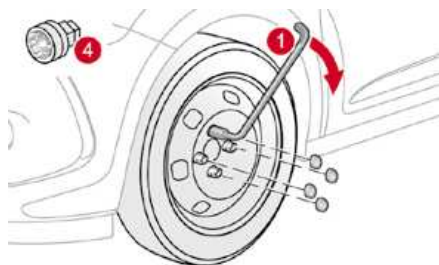

- ☞ Tighten the security bolt (if your vehicle is fitted with them) using the wheelbrace **1** fitted with the socket **4**.
- ☞ Tighten the other bolts using the wheelbrace **1** only.
- ☞ Refit the chromed bolt covers on each of the bolts (with alloy wheels only).
- ☞ Store the tools in the box.



# Changing a bulb

- ⚠ The headlamps are fitted with polycarbonate glass with a protective coating:
  - ☞ **do not clean them using a dry or abrasive cloth, nor with a detergent or solvent product,**
  - ☞ use a sponge and soapy water,
  - ☞ when using a high pressure washer on persistent marks, do not direct at the lamps or their outlines for too long, so as not to damage their protective coating and seals.

- ⚠ ☞ Do not touch the bulb directly with your fingers, use lint-free cloths. Changing a bulb should only be done after the headlamp has been switched off for a few minutes (risk of serious burns). It is imperative to use only anti-ultraviolet (UV) type bulbs in order not to damage the headlamp. Always replace a failed bulb with a new bulb with the same type and specification.

## Front lamps

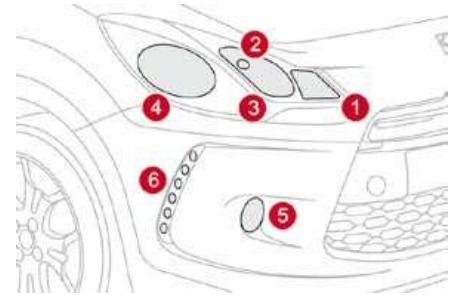

1. Direction indicators (PY21W amber).
2. Sidelamps (W5W).
3. Main beam headlamps (H1-55W).
4. Dipped beam headlamps (H7-55W).
5. Front foglamps (PSX24W).
6. LED lamps (LEDs).

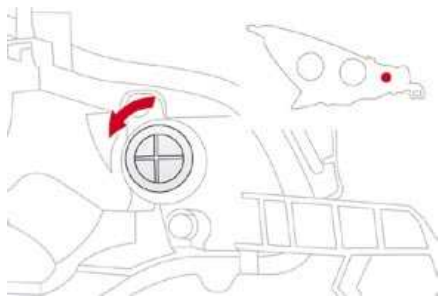

## Changing direction indicator bulbs

**i** Rapid flashing of the direction indicator warning lamp (right or left) indicates the failure of a bulb on that side.

- ☞ Turn the bulb holder a quarter of a turn and extract it.
  - ☞ Pull out the bulb and change it.
- To refit, carry out these operations in reverse order.

**i** Amber coloured bulbs, such as the direction indicators, must be replaced with bulbs of identical specifications and colour.

**!** When refitting, close the protective cover carefully to preserve the sealing of the headlamp.

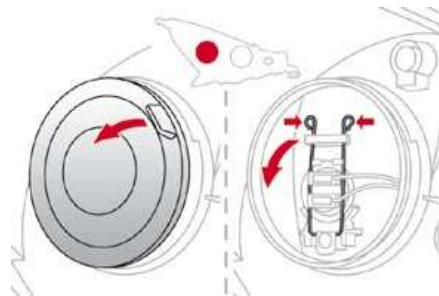

## Changing dipped beam headlamp bulbs

- ☞ Remove the protective cover by pulling on the tab.
- ☞ Disconnect the bulb connector.
- ☞ Spread the springs to release the bulb.
- ☞ Extract the bulb and change it.

To refit, carry out these operations in reverse order.

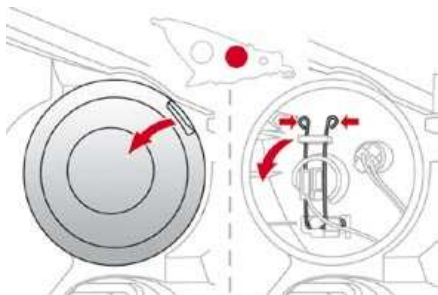

### Changing main beam headlamp bulbs

- ☞ Remove the protective cover by pulling on the tab.
- ☞ Disconnect the bulb connector.
- ☞ Spread the springs to release the bulb.
- ☞ Remove the bulb and change it.

To refit, carry out these operations in reverse order.

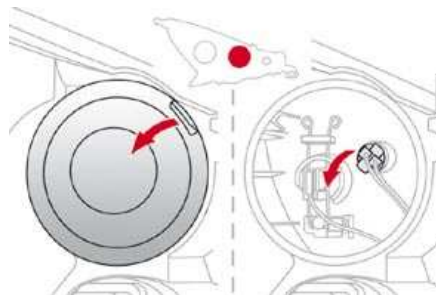

### Changing sidelamp bulbs

- ☞ Remove the protective cover by pulling on the tab.
- ☞ Pull the bulb holder pressing on the tabs on both sides.
- ☞ Pull the bulb and change it.

To refit, carry out these operations in reverse order.

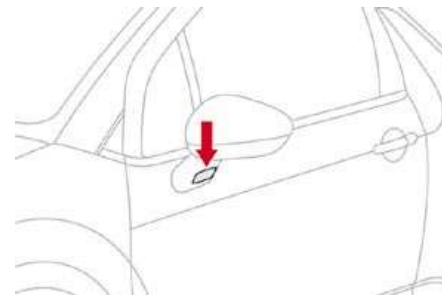

### Changing integrated direction indicator side repeaters

- ☞ Insert a screwdriver towards the centre of the repeater between the repeater and the base of the door mirror.
- ☞ Tilt the screwdriver to extract the repeater and remove it.
- ☞ Disconnect the repeater connector.
- ☞ Replace the module.

To refit, carry out these operations in reverse order.



Contact a CITROËN dealer to obtain a replacement side repeater module.

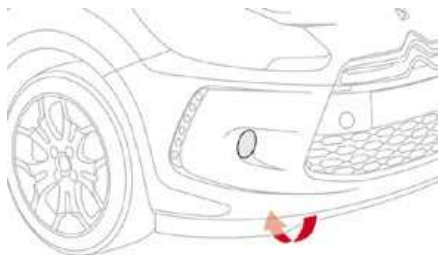

### Changing front foglamp bulbs

- ☞ Access to the front foglamp is through the aperture below the bumper.
- ☞ Disconnect the black bulb holder connector, by pressing on the tab at the top.
- ☞ Remove the bulb-holder by pressing on the 2 clips (at the top and the bottom).
- ☞ Replace the module.

To refit, carry out these operations in reverse order.



To obtain a replacement module, contact your CITROËN dealer.  
If you experience any difficulty in replacing bulbs, contact your CITROËN dealer.

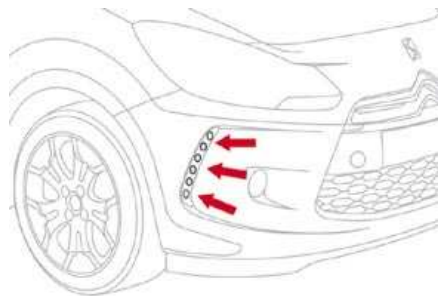

### Changing the LED lamps

For the replacement of this type of LED lamp, contact a CITROËN dealer.

## Rear lamps

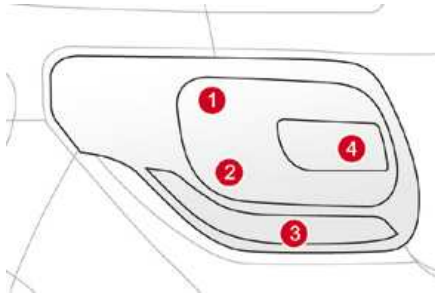

1. Brake lamps/sidelamps (P21/5W).
2. Sidelamps (P5W).
3. Direction indicators (PY21W amber)
4. Foglamp, offside (PR21W red)  
Reversing lamp, nearside (P21W).

**i** Amber or red bulbs, such as those for the direction indicators and rear foglamp, must be replaced by bulbs of the same rating and colour.

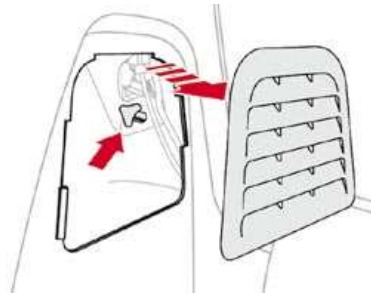

### Changing bulbs

- 🔧 Open the boot.
- 🔧 Remove the access flap from the corresponding side trim panel.
- 🔧 Unscrew the butterfly nut securing the lamp unit.
- 🔧 Unclip the lamp unit connector.
- 🔧 Extract the lamp unit carefully pulling in its middle towards the outside.

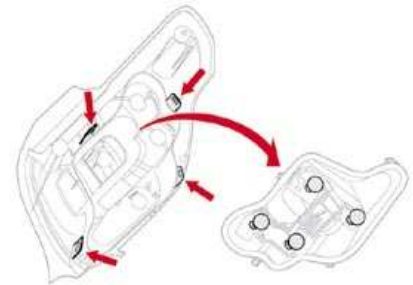

- 🔧 Spread the four tabs and remove the bulb holder.
- 🔧 Turn the bulb a quarter of a turn and change it.

To refit, carry out these operations in reverse order.

Take care to engage the lamp unit in its guides, while keeping it in line with the vehicle.

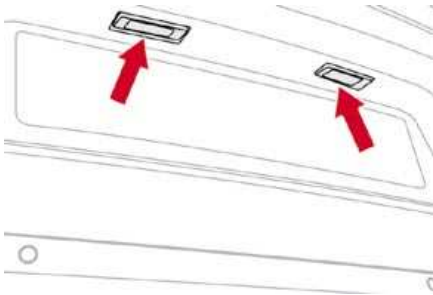

### Changing the number plate lamp bulbs (W5W)

- ☞ Insert a thin screwdriver into one of the outer holes of the lens.
- ☞ Push it outwards to unclip.
- ☞ Remove the lens.
- ☞ Pull the bulb out and change it.

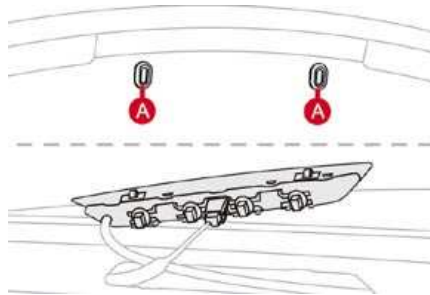

### Third brake lamp (4 W5W bulbs)

- ☞ Open the boot.
- ☞ Remove the plugs **A** on the inner panel.
- ☞ Push on the centre of the lamp using two screwdrivers to lever it outwards.
- ☞ Disconnect the connector and if necessary the screenwash pipe from the lamp.
- ☞ Turn the bulb holder for the faulty bulb a quarter of a turn.
- ☞ Pull out the bulb and change it.

To refit, carry out these operations in reverse order.

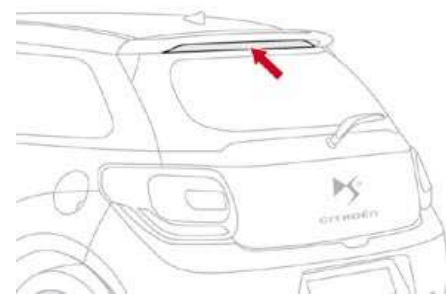

### Third brake lamp (LEDs)

For the replacement of this type of LED lamp, contact a CITROËN dealer.

## Interior lighting

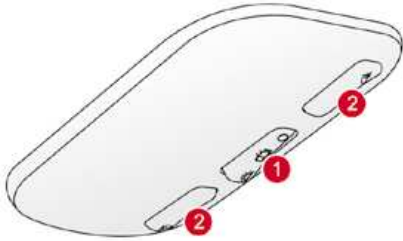

### Interior lamp (1/W5W)

Detach the cover of the interior lamp 1 with a thin screwdriver, close to the button, to access the faulty bulb.

### Map reading lamps (2/W5W)

Detach the cover of the interior lamp 1. To access the faulty bulb, detach the partition for the reading lamp 2 concerned.

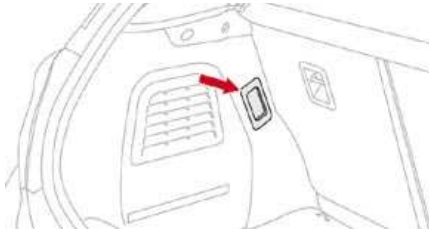

### Boot lamp (W5W)

Detach the unit by pushing it rearwards.



### Glove box lamp (W5W)

Detach the unit for access to the bulb.

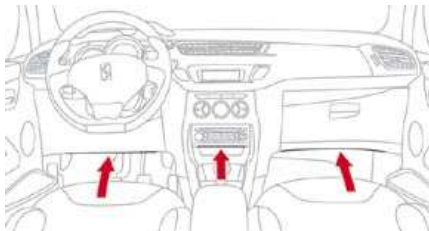

### Footwell and central storage lamps (W5W)

Detach the unit for access to the bulb.

# Changing a fuse

## Access to the tools

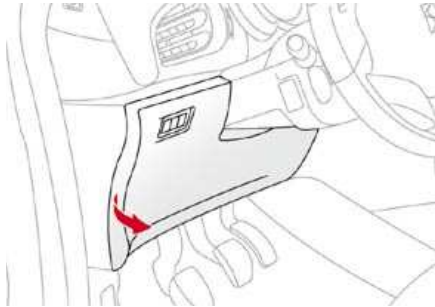

The extraction pliers and the spare fuse storage locations are fitted to the back of the dashboard fuse box cover.

For access to them:

- ☞ unclip the cover by pulling on the side,
- ☞ remove the cover completely,
- ☞ remove the pliers.

## Changing a fuse

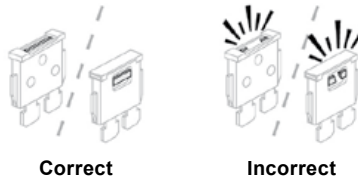

Before changing a fuse, the cause of the failure must be identified and rectified.

- ☞ Identify the faulty fuse by checking the condition of its filament.
- ☞ Use the special pliers to extract the fuse from its housing.
- ☞ Always replace the faulty fuse with a fuse of the same rating.
- ☞ Check the correspondence between the number etched on the box, the rating etched on the fuse and the tables below.

### **i** Installing electrical accessories

Your vehicle's electrical system is designed to operate with standard or optional equipment.

Before installing other electrical equipment or accessories on your vehicle, contact a CITROËN dealer.

- !** CITROËN will not accept responsibility for the cost incurred in repairing your vehicle or for rectifying malfunctions resulting from the installation of accessories not supplied and not recommended by CITROËN and not installed in accordance with its instructions, in particular when the combined consumption of all of the additional equipment connected exceeds 10 milliamperes.



## Dashboard fusebox

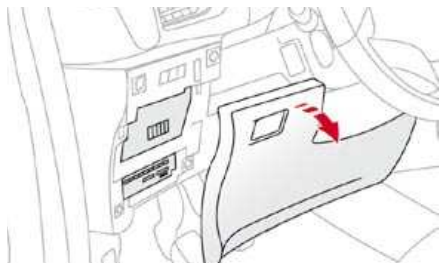

The fusebox is located in the lower dashboard (left-hand side).

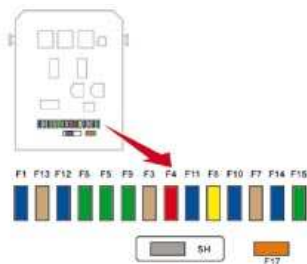

## Access to the fuses

☞ Refer to the paragraph "Access to the tools".

## Fuse tables

Fuse N°	Rating	Functions
FH36	5 A	Trailer relay unit.
FH37	-	Not used.
FH38	20 A	Hi-Fi amplifier.
FH39	20 A	Heated seats.
FH40	30 A	Trailer relay unit.

Fuse N°	Rating	Functions
F1	15 A	Rear wiper.
F2	-	Not used.
F3	5 A	Airbags and pretensioners control unit.
F4	10 A	Air conditioning, clutch switch, electrochromatic mirror, particle filter pump (Diesel), diagnostic socket, airflow sensor (Diesel).
F5	30 A	Electric windows panel, passenger's electric window control, front electric window motor.
F6	30 A	Driver's electric window motor.
F7	5 A	Courtesy lamp, glove box lighting.

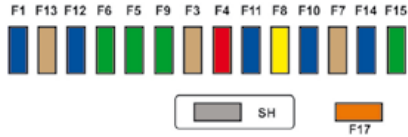

Fuse N°	Rating	Functions
<b>F8</b>	<b>20 A</b>	Multifunction screen, audio system, navigation radio, alarm control unit, alarm siren.
<b>F9</b>	<b>30 A</b>	12 V socket, portable navigation support supply.
<b>F10</b>	<b>15 A</b>	Steering mounted controls.
<b>F11</b>	<b>15 A</b>	Ignition, diagnostic socket, automatic gearbox control unit.
<b>F12</b>	<b>15 A</b>	Rain/sunshine sensor, trailer relay unit.
<b>F13</b>	<b>5 A</b>	Main stop switch, engine relay unit.
<b>F14</b>	<b>15 A</b>	Parking sensors control unit, airbag control unit, instrument panel, digital air conditioning, USB Box, Hi-Fi amplifier.
<b>F15</b>	<b>30 A</b>	Locking.
<b>F16</b>	-	Not used.
<b>F17</b>	<b>40 A</b>	Rear screen and door mirrors demisting/defrosting.
<b>SH</b>	-	PARC shunt.

## Engine compartment fusebox

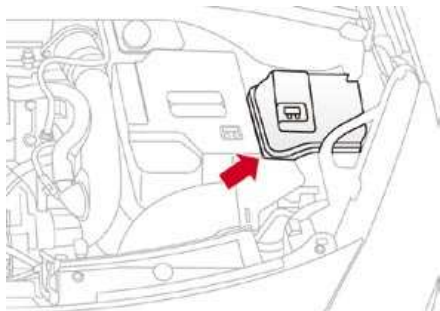

The fusebox is located in the engine compartment near the battery (left-hand side).

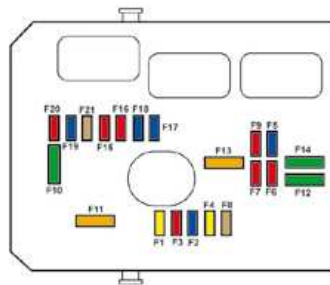

### Access to the fuses

- ☞ Unclip the cover.
- ☞ Change the fuse (see corresponding paragraph).
- ☞ When you have finished, close the cover carefully to ensure the sealing of the fuse box.



## Fuse table

Fuse N°	Rating	Functions
F1	20 A	Engine control unit supply, cooling fan unit control relay, multifunction engine control main relay, injection pump (Diesel).
F2	15 A	Horn.
F3	10 A	Front/rear screenwash.
F4	20 A	LED lamps.
F5	15 A	Diesel heater (Diesel), particle filter additive pump (Diesel), air flow sensor (Diesel), blow-by heater and electrovalves (VTi).
F6	10 A	ABS/ESP control unit, secondary stop switch.
F7	10 A	Electric power steering, automatic gearbox.
F8	25 A	Starter control.
F9	10 A	Switching and protection unit (Diesel).
F10	30 A	Fuel heater (Diesel), blow-by heater (Diesel), fuel pump (VTi), injectors and ignition coils (petrol).
F11	40 A	Heater blower.

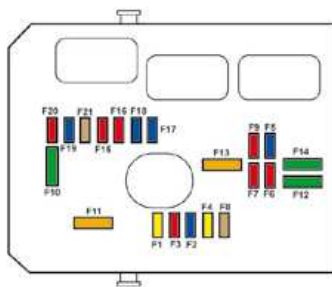

Fuse N°	Rating	Functions
F12	30 A	Windscreen wipers slow/fast speed.
F13	40 A	Built-in systems interface supply (ignition positive).
F14	30 A	Valvetronic supply (VTi).
F15	10 A	Right-hand main beam headlamps.
F16	10 A	Left-hand main beam headlamps.
F17	15 A	Left-hand dipped beam headlamps.
F18	15 A	Right-hand dipped beam headlamps.
F19	15 A	Oxygen sensors and electrovalves (VTi), electrovalves (Diesel), EGR electrovalve (Diesel).
F20	10 A	Pumps, electronic thermostat (VTi), timing electrovalve (THP), water in fuel sensor (Diesel).
F21	5 A	Fan assembly control supply, ABS/ESP, turbo pump (THP).



## Table of maxi-fuses

Fuse N°	Rating	Functions
<b>MF1*</b>	<b>60 A</b>	Fan assembly.
<b>MF2*</b>	<b>30 A</b>	ABS/ESP pump.
<b>MF3*</b>	<b>30 A</b>	ABS/ESP electrovalves.
<b>MF4*</b>	<b>60 A</b>	Built-in Systems Interface (BSI) supply.
<b>MF5*</b>	<b>60 A</b>	Built-in Systems Interface (BSI) supply.
<b>MF6*</b>	<b>20 A</b>	Additional cooling fan unit (THP).
<b>MF7*</b>	-	Dashboard fusebox.
<b>MF8*</b>	-	Not used.

\* The maxi-fuses provide additional protection for the electrical systems. All work on the maxi-fuses must be carried out by a CITROËN dealer.

# Battery

Procedure for charging your battery when it is flat or for starting the engine using another battery.

<b>ATTENTION !</b> Votre véhicule nécessite une batterie spécifique		<b>CAUTION !</b> Your vehicle requires a specific battery
EN CAS DE REMPLACEMENT, SE REFERER OBLIGATOIREMENT AU MANUEL DU VEHICULE		IN THE EVENT OF REPLACEMENT, REFER OBLIGATORILY TO THE HANDBOOK OF THE VEHICLE

 The presence of this label, in particular with the Stop & Start system, indicates the use of a 12 V lead-acid battery with special technology and specification, for which the involvement of a CITROËN dealer is required when replacing or disconnecting the battery. Failure to observe this recommendation may cause premature wear of the battery.

 After refitting the battery, the Stop & Start system will only be active after a continuous period of immobilisation of the vehicle, a period which depends on the climatic conditions and the state of charge of the battery (up to about 8 hours).

## Access to the battery

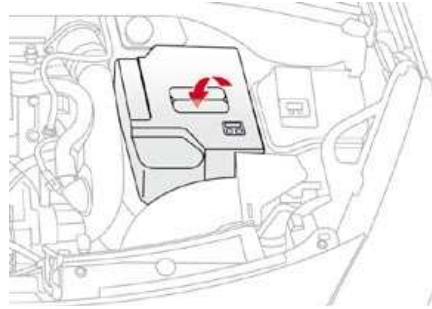

The battery is located under the bonnet.

To gain access to it:

- ☞ open the bonnet using the interior release lever, then the exterior safety catch,
- ☞ secure the bonnet stay,
- ☞ remove the plastic cover by pulling on its grip for access to the two terminals,
- ☞ unclip the fusebox to remove the battery, if necessary.

## Starting using another battery

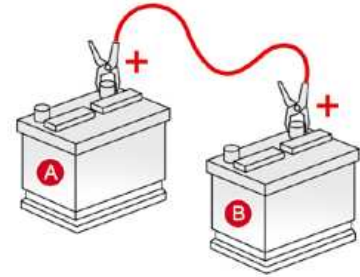

- ☞ Connect the red cable to the positive terminal (+) of the flat battery **A**, then to the positive terminal (+) of the slave battery **B**.



## Charging the battery using a battery charger

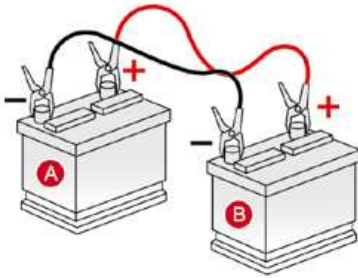

- ☞ Connect one end of the green or black cable to the negative terminal (-) of the slave battery **B**.
- ☞ Connect the other end of the green or black cable to the negative terminal (-) of the flat battery **A**.
- ☞ Start the slave vehicle.
- ☞ Operate the starter of the broken down vehicle and let the engine run.
- ☞ Wait until the engine returns to idle and disconnect the cables.

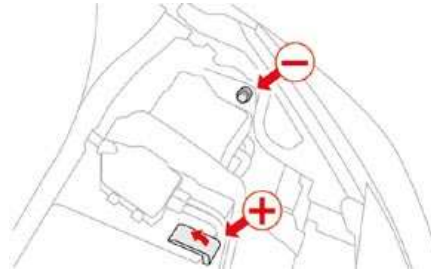

**i** The Stop & Start battery does not have to be disconnected for charging.

- ☞ Disconnect the battery from the vehicle.
- ☞ Follow the instructions for use provided by the manufacturer of the charger.
- ☞ Reconnect starting with the negative terminal (-).
- ☞ Check that the terminals and connectors are clean. If they are covered with sulphate (whitish or greenish deposit), remove them and clean them.

**!** Batteries contain harmful substances such as sulphuric acid and lead. They must be disposed of in accordance with regulations and must not, in any circumstances, be discarded with household waste. Take used remote control batteries and vehicle batteries to a special collection point.

**i** It is advisable to disconnect the battery if the vehicle is to be left unused for more than one month.





Do not disconnect the terminals while the engine is running.  
Do not charge the batteries without disconnecting the terminals first.

### **Before disconnecting the battery**

Wait 2 minutes after switching off the ignition before disconnecting the battery. Close the windows and the doors before disconnecting the battery.

### **Following reconnection of the battery**

Following reconnection of the battery, switch on the ignition and wait 1 minute before starting to permit initialisation of the electronic systems. However, if minor problems persist following this operation, contact a CITROËN dealer.

Referring to the corresponding section, you should yourself reinitialise:

- the remote control key,
- the GPS satellite navigation system.

## Load reduction mode

System which manages the use of certain functions according to the level of charge remaining in the battery.

When the vehicle is being driven, the load reduction function temporarily deactivates certain functions, such as the air conditioning, the heated rear screen...

The deactivated functions are reactivated automatically as soon as conditions permit.



Do not disconnect the terminals while the engine is running.  
Do not charge the batteries without disconnecting the terminals first.

### **Before disconnecting the battery**

Wait 2 minutes after switching off the ignition before disconnecting the battery. Close the windows and the doors before disconnecting the battery.

### **Following reconnection of the battery**

Following reconnection of the battery, switch on the ignition and wait 1 minute before starting to permit initialisation of the electronic systems. However, if minor problems persist following this operation, contact a CITROËN dealer. Referring to the corresponding section, you should yourself reinitialise:

- the remote control key,
- the GPS satellite navigation system.

## Load reduction mode

System which manages the use of certain functions according to the level of charge remaining in the battery.

When the vehicle is being driven, the load reduction function temporarily deactivates certain functions, such as the air conditioning, the heated rear screen...

The deactivated functions are reactivated automatically as soon as conditions permit.



# Energy economy mode

System which manages the period of use of certain functions to conserve a sufficient level of charge in the battery. After the engine has stopped, you can still use functions such as the audio equipment, windscreen wipers, dipped beam headlamps, courtesy lamps, etc. for a maximum combined period of thirty minutes.

 This period may be greatly reduced if the battery is not fully charged.

## Switching to economy mode

Once this period has elapsed, a message appears on the multifunction screen indicating that the vehicle has switched to economy mode and the active functions are put on standby.

 If the telephone is being used at the same time on the MyWay audio navigation system, it will be interrupted after 10 minutes.

## Exiting economy mode

These functions are reactivated automatically the next time the vehicle is driven.  
 In order to resume the use of these functions immediately, start the engine and let it run for a few minutes. The time available to you will then be double the period for which the engine is left running. However, this period will always be between five and thirty minutes.

 A flat battery prevents the engine from starting (refer to the corresponding paragraph).

# Changing a front or rear wiper blade

Procedure for replacing a worn wiper blade with a new one without the use of tools.

## Before removing a front wiper blade

- ☞ Within one minute after switching off the ignition, operate the wiper stalk to position the wiper blades in the vertical position.

This position must be used in order to avoid damaging the wiper blade and the bonnet.

## Removal

- ☞ Raise the corresponding wiper arm.
- ☞ Unclip the wiper blade and remove it.

## Fitting

- ☞ At the front, check the size of the wiper blade as the shorter blade is fitted to the passenger side of the vehicle.
- ☞ Put the corresponding new wiper blade in place and clip it.
- ☞ Fold down the wiper arm carefully.

## After fitting a front wiper blade

- ☞ Switch on the ignition.
- ☞ Operate the wiper stalk again to park the wiper blades.

# Towing the vehicle

Procedure for having your vehicle towed or for towing another vehicle using a removable towing eye.

## Access to the tools

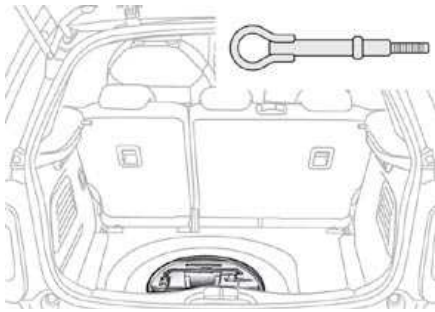

The towing eye is installed in the boot under the floor.

To gain access to it:

- ☞ open the boot,
- ☞ raise the floor,
- ☞ remove the polystyrene storage box,
- ☞ remove the towing eye from the holder.

## Towing your vehicle

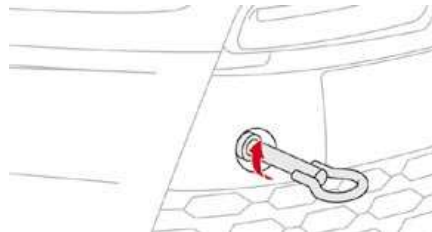

- ☞ On the front bumper, unclip the cover by pressing at the bottom.
- ☞ Screw the towing eye in fully.
- ☞ Install the towing bar.
- ☞ Switch on the hazard warning lamps on the towed vehicle.
- ☞ Place the gear lever in neutral (position **N** for an automatic gearbox).



Failure to observe this special condition could result in damage to certain braking components and the absence of braking assistance the next time the engine is started.

## Towing another vehicle

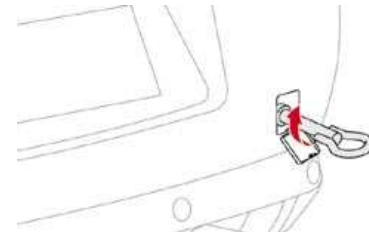

- ☞ On the rear bumper, unclip the cover by pressing at the bottom.
- ☞ Screw the towing eye in fully.
- ☞ Install the towing bar.
- ☞ Switch on the hazard warning lamps on the towed vehicle.



When towing with all four wheels on the ground, always use a towing bar. When towing with only two wheels on the ground, always use professional lifting equipment. When towing with the engine off, there is no longer any assistance for braking or steering.

## Towing a trailer, a caravan, etc.



Towbar suitable for the attachment of a trailer or caravan with additional lighting and signalling.

Your vehicle is primarily designed for transporting people and luggage, but it may also be used for towing a trailer.

**i** We recommend the use of genuine CITROËN towbars and their harnesses that have been tested and approved from the design stage of your vehicle, and that the fitting of the towbar is entrusted to a CITROËN dealer. If the trailer is not fitted by a CITROËN dealer, it is imperative that it is fitted using the electrical pre-equipment installed at the rear of the vehicle, in accordance with the manufacturer's instructions.

Driving with a trailer subjects the towing vehicle to more significant stress and its driver must be particularly careful.



## Driving advice

### Distribution of loads

- ☞ Distribute the load in the trailer so that the heaviest items are as close as possible to the axle and the nose weight approaches the maximum permitted without exceeding it.

Air density decreases with altitude, thus reducing engine performance. Above 1 000 metres, the maximum towing load must be reduced by 10 % and so on for every 1 000 metres of altitude.

Refer to the "Technical Data" section for details of the weights and towing loads which apply to your vehicle.

### Side wind

- ☞ Take into account the increased sensitivity to side wind.

### Cooling

Towing a trailer on a slope increases the temperature of the coolant. As the fan is electrically controlled, its cooling capacity is not dependent on the engine speed.

- ☞ To lower the engine speed, reduce your speed.

The maximum towing load on a long slope depends on the gradient and the ambient temperature.

In all cases, pay attention to the coolant temperature.



- ☞ If the warning lamp and the **STOP** warning lamp come on, stop the vehicle and switch off the engine as soon as possible.

### Braking

Towing a trailer increases the braking distance.

### Tyres

- ☞ Check the tyre pressures of the towing vehicle and of the trailer, observing the recommended pressures.

### Lighting

- ☞ Check the electrical lighting and signalling on the trailer.



The rear parking sensors will be deactivated automatically if a genuine CITROËN towbar is used.

# Accessories



A wide range of accessories and genuine parts is offered by the CITROËN dealer network. These accessories and parts have been tested and approved for reliability and safety.

They are all adapted to your vehicle and benefit from CITROËN's recommendation and warranty.

## "Comfort":

sun blinds, air deflectors, isotherm module, ashtray, fragrance cartridges, coat hanger fixed to head restraint, front centre armrest, movable mirror, reading lamp, front and rear parking sensors...

## "Transport solutions":

boot liner, boot spacers, boot carpet, boot net, transverse roof bars, bicycle carrier, ski carrier, roof boxes, towbars, towbar wiring harnesses... The towbar and wiring harness must be fitted by a CITROËN dealer.

## "Styling":

full grain leather steering wheel, coloured and leather gear lever knobs, aluminium footrest, spoiler, alloy wheels, coloured wheel trims, coloured wheel caps, exterior expressive stickers, exterior chrome kit...

## "Security and safety":

anti-intrusion alarm, wheel security devices, vehicle tracking system, breathalyser, first aid kit, warning triangle, high visibility safety jacket, child seats, snow chains, non-skid covers, fire extinguisher...

## "Protection":

mats\*, mudflaps, seat covers, vehicle covers, bumper protectors...

- \* To avoid any risk of jamming of the pedals:
- ensure that the mat is positioned and secured correctly,
  - never fit one mat on top of another.





## "Multimedia":

hands-free system, audio systems, semi-integral satellite navigation system, portable navigation systems, mapping update CD, speed camera warning, DVD player, reversing camera, USB Box, speakers, Hi-Fi module, 230 V socket, WiFi on Board...

### **Installation of radio communication transmitters**

Before installing on your vehicle any after-market radio communication transmitter with external aerial, we recommend that you contact a CITROËN dealer.

The CITROËN dealer network will give you the specification for transmitters which can be fitted (frequency, maximum power, aerial position, specific installation requirements), in line with the Vehicle Electromagnetic Compatibility Directive (2004/104/EC).

## "Boutique":

windscreen wash fluid, interior and exterior cleaning and maintenance products, bodywork touch-up aerosol and pen...

 Depending on the country in which the vehicle is sold, it may be compulsory to have a high visibility safety jacket, warning triangle and spare bulbs available in the vehicle.

 The fitting of electrical equipment or accessories which are not recommended by CITROËN may result in a failure of your vehicle's electronic system and excessive electrical consumption. Please note this specific warning. You are advised to contact a CITROËN representative to be shown the range of recommended equipment and accessories.

<b>MODELS:</b>	<b>ENGINES AND GEARBOXES</b>			
<b>Model codes: SA...</b>	<b>8FR0</b>	<b>5FS0</b>	<b>5FS9</b>	<b>5FR8 5FX8*</b>
<b>PETROL ENGINES</b>	<b>VTi 95</b>	<b>VTi 120</b>		<b>THP 150</b>
Cubic capacity (cc)	1 397	1 598		1 598
Bore x stroke (mm)	77 x 75	77 x 85.8		77 x 85.8
Max power: EU standard (kW)	70	88		115 110*
Max power engine speed (rpm)	6 000	6 000		6 000
Max torque: EU standard (Nm)	136	160		240
Max torque engine speed (rpm)	4 000	4 250		1 400 to 4 000
Fuel	Unleaded	Unleaded		Unleaded
Catalytic converter	yes	yes		yes
<b>GEARBOX</b>	Manual (5-speed)	Manual (5-speed)	Auto (4-speed)	Manual (6-speed)
<b>OIL CAPACITIES (in litres)</b>				
Engine (with filter replacement)	4.25	4.25	4.25	4.25

\* Belgium and Russia only.

<b>MODELS:</b>	<b>ENGINES AND GEARBOXES</b>			
<b>Model codes: SA...</b>	<b>8HR0</b>	<b>9HP4</b>	<b>9HP0 9HP0/S</b>	<b>9HR8</b>
<b>DIESEL ENGINES</b>	<b>HDi 70 PEF</b>	<b>HDi 90 PEF 99g</b>	<b>HDi 90 PEF</b>	<b>HDi 110 PEF</b>
Cubic capacity (cc)	1 398	1 560		1 560
Bore x stroke (mm)	73.7 x 82	75 x 88.3		75 x 88.3
Max power: EU standard (kW)	50	68		82
Max power engine speed (rpm)	4 000	4 000		3 600
Max torque: EU standard (Nm)	160	230		270
Max torque engine speed (rpm)	2 000	1 750		1 750
Fuel	Diesel	Diesel		Diesel
Catalytic converter	yes	yes		yes
Particle emissions filter (PEF)	yes	yes		yes
<b>GEARBOX</b>	Manual (5-speed)	Manual (5-speed)		Manual (6-speed)
<b>OIL CAPACITIES (in litres)</b>				
Engine (with filter replacement)	3.75	3.75		3.75

.../S: model fitted with Stop & Start.

<b>WEIGHTS AND TOWED LOADS (in kg)</b>				
<b>Petrol engines</b>	<b>VTi 95</b>	<b>VTi 120</b>		<b>THP 150</b>
<b>Gearboxes</b>	<b>Manual</b>	<b>Manual</b>	<b>Auto</b>	<b>Manual</b>
<b>Model codes: SA...</b>	<b>8FR0</b>	<b>5FS0</b>	<b>5FS9</b>	<b>5FR8 5FX8</b>
- Unladen weight	1 075	1 075	1 089	1 165
- Kerb weight	1 150	1 150	1 164	1 240
- Gross vehicle weight (GVW)	1 552	1 554	1 587	1 597
- Gross train weight (GTW) on a 12 % gradient	2 452	2 454	2 487	2 497
- Braked trailer (within the GTW limit) on a 12 % gradient	900	900	900	900
- Braked trailer* (with load transfer within the GTW limit)	1 150	1 150	1 150	1 150
- Unbraked trailer	570	570	570	570
- Recommended nose weight	46	46	46	46

\* The weight of the braked trailer can be increased, within the GTW limit, if the GVW of the towing vehicle is reduced by an equal amount. Warning: towing using a lightly loaded towing vehicle may have an adverse effect on its road holding.

The GTW and towed load values indicated are valid up to a maximum altitude of 1 000 metres; the towed load mentioned must be reduced by 10 % for each additional 1 000 metres of altitude.

The speed of a towing vehicle must not exceed 60 mph (100 km/h) (comply with the legislation in force in your country).

High ambient temperatures may result in a reduction in the performance of the vehicle to protect the engine; if the ambient temperature is above 37 °C, limit the towed load.



<b>WEIGHTS AND TOWED LOADS (in kg)</b>					
<b>Diesel engines</b>	<b>HDi 70 PEF</b>	<b>HDi 90 PEF 99g</b>	<b>HDi 90 PEF</b>		<b>HDi 110 PEF</b>
<b>Gearbox</b>	<b>Manual</b>	<b>Manual</b>	<b>Manual</b>	<b>Manual</b>	<b>Manual</b>
<b>Model codes: SA...</b>	<b>8HR0</b>	<b>9HP4</b>	<b>9HP0</b>	<b>9HP0/S</b>	<b>9HR8</b>
- Unladen weight	1 070	1 080	1 080	1 085	1 090
- Kerb weight	1 145	1 155	1 155	1 160	1 165
- Gross vehicle weight (GVW)	1 553	1 565	1 584	1 602	1 612
- Gross train weight (GTW) on a 12 % gradient	2 253	2 065	2 484	2 502	2 512
- Braked trailer (within GTW limit) on 12 % gradient	700	500	900	900	900
- Braked trailer* (with load transfer with the GTW limit)	950	500	1 150	1 150	1 150
- Unbraked trailer	570	500	570	570	570
- Recommended nose weight	46	46	46	46	46

\* The weight of the braked trailer can be increased, within the GTW limit, if the GVW of the towing vehicle is reduced by an equal amount. Warning: towing using a lightly loaded towing vehicle may have an adverse effect on its road holding.

The GTW and towed load values indicated are valid up to a maximum altitude of 1 000 metres; the towed load mentioned must be reduced by 10 % for each additional 1 000 metres of altitude.

The speed of a towing vehicle must not exceed 60 mph (100 km/h) (comply with the legislation in force in your country).

High ambient temperatures may result in a reduction in the performance of the vehicle to protect the engine; if the ambient temperature is above 37 °C, limit the towed load.

## Dimensions (in mm)

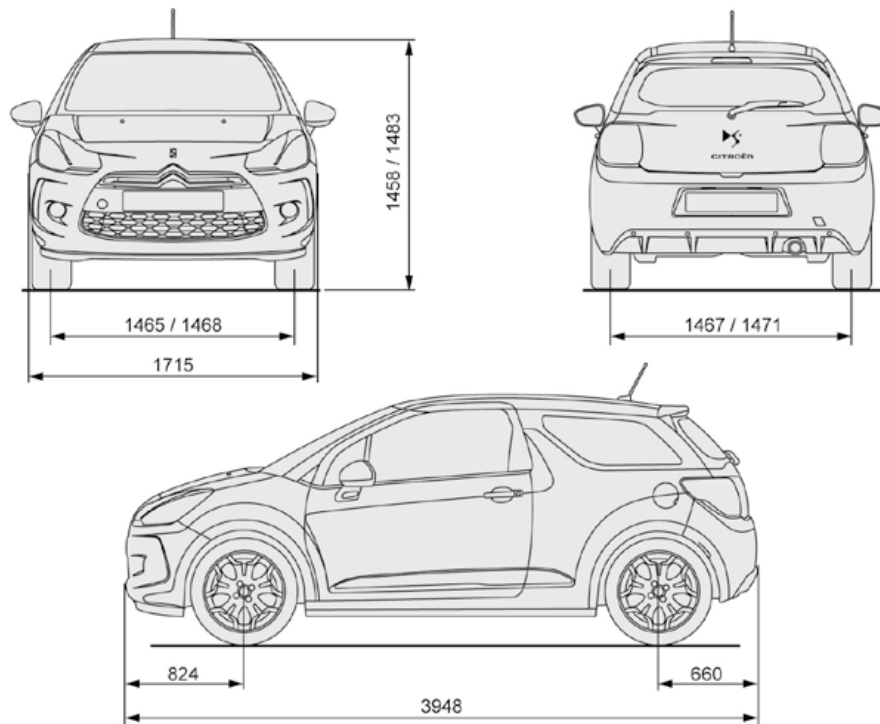

## Identification markings

Various visible markings for the identification of your vehicle.

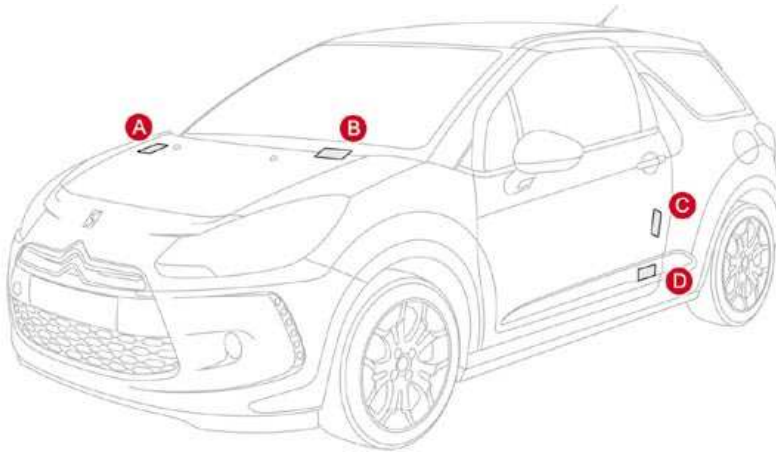

### A. Vehicle identification number (VIN) under the bonnet.

This number is engraved on the bodywork near the damper mounting.

### B. Vehicle identification number on the dashboard.

This number is indicated on a self-adhesive label which is visible through the windscreen.

### C. Manufacturer's label.

The VIN is indicated on a self-destroying label affixed to the left hand centre pillar.

### D. Tyre/paint label.

This label is affixed to the left hand centre pillar.

It bears the following information:

- the tyre pressures, for unladen and laden conditions,
- the wheel rim and tyre sizes,
- the brands of tyre recommended by the manufacturer,
- the spare tyre inflation pressure,
- the paint colour code.



Wheels which are fitted with 205/45 R17 tyres cannot be fitted with snow chains. For more information, contact a CITROËN dealer.



The tyre pressures must be checked when the tyres are cold, at least once a month.



If the tyre pressures are too low, this increases fuel consumption.

# EMERGENCY OR ASSISTANCE CALL

## EMERGENCY CALL



In an emergency, press this button for more than 2 seconds. Flashing of the green indicator lamp and a voice message confirm that the call has been made to the CITROËN Emergency team\*.

Pressing this button again immediately cancels the request. The green indicator lamp goes off.

The green indicator lamp remains on (without flashing) when communication is established. It goes off at the end of communication.

This call is dealt with by the CITROËN Emergency team which receives locating information from the vehicle and can send a detailed alert to the appropriate emergency services. In countries in which the team is not operational, or when the locating service has been expressly refused, the call is dealt with directly by the emergency services (112) without the vehicle location.



If an impact is detected by the airbag ECU, and independently of any triggering of the airbags, an emergency call is made automatically.

\* This service is subject to conditions and availability. Consult a CITROËN dealer.

## ASSISTANCE CALL



Press this button for more than 2 seconds to request assistance if the vehicle breaks down. A voice message confirms that the call has been made\*.

Pressing this button again immediately cancels the request. The cancellation is confirmed by a voice message.

## OPERATION OF THE SYSTEM



When the ignition is switched on, the green indicator lamp comes on for 3 seconds indicating that the system is operating correctly.



If the orange indicator lamp flashes: there is a system malfunction.  
If the orange indicator lamp is on continuously: the backup battery must be replaced.  
In both cases, consult a CITROËN dealer.



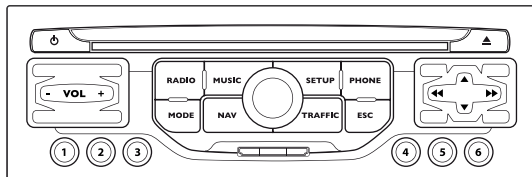

# MYWAY

MULTIMEDIA AUDIO SYSTEM/BLUETOOTH TELEPHONE  
SATELLITE NAVIGATION SYSTEM FOR EUROPE BY SD CARD



The MyWay is protected in such a way that it will only operate in your vehicle. If it is to be installed in another vehicle, contact a CITROËN dealer for configuration of the system.



For safety reasons, the driver must carry out operations which require prolonged attention while the vehicle is stationary.

When the engine is switched off and to prevent discharging of the battery, the MyWay switches off following the activation of the Energy Economy mode.



Certain functions described in this handbook will become available during the year.

## CONTENTS

<b>01</b>	<b>First steps</b>	<b>p. 226</b>
<b>02</b>	<b>Steering mounted controls</b>	<b>p. 227</b>
<b>03</b>	<b>General operation</b>	<b>p. 228</b>
<b>04</b>	<b>Navigation - Guidance</b>	<b>p. 230</b>
<b>05</b>	<b>Traffic information</b>	<b>p. 237</b>
<b>06</b>	<b>Radio</b>	<b>p. 239</b>
<b>07</b>	<b>Music media players</b>	<b>p. 240</b>
<b>08</b>	<b>Bluetooth telephone</b>	<b>p. 243</b>
<b>09</b>	<b>Configuration</b>	<b>p. 245</b>
<b>10</b>	<b>Trip computer</b>	<b>p. 246</b>
<b>11</b>	<b>Screen menu map</b>	<b>p. 247</b>
	<b>Frequently asked questions</b>	<b>p. 250</b>

# 01 FIRST STEPS

## MyWay CONTROL PANEL

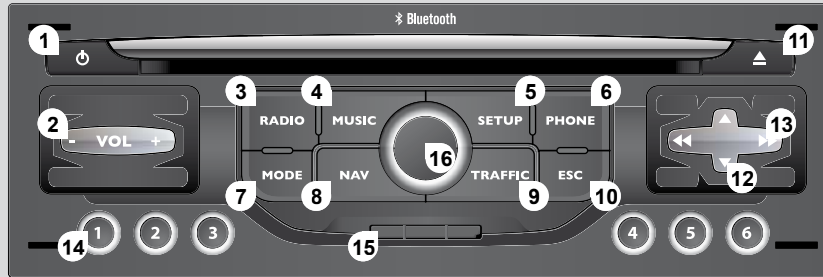

1. Engine not running
  - Short press: on/off.
  - Long press: CD pause, mute for the radio.Engine running
  - Short press: CD pause, mute for the radio.
  - Long press: reinitialisation of the system.
2. Volume adjustment (each source is independent, including also navigation messages and alerts).
3. Access to the "Radio" Menu. Display the list of stations.
4. Access to the "Music" Menu. Display the tracks.
- 3 - 4. Long press: access to the audio settings: front/rear fader and left/right balance, bass/treble, equaliser, loudness, automatic volume adjustment, initialise the settings.
5. Access to the "SETUP" menu.  
Long press: access to the GPS coverage and the demonstration mode.
6. Access to the "Phone" Menu. Display the call list.
7. Access to the "MODE" menu.  
Selection of the successive display of:  
Radio, Map, NAV (if navigation is in progress), Telephone (if a conversation is in progress), Trip computer.  
Long press: display of a black screen (DARK).
8. Access to the "Navigation" Menu. Display the last destinations.
9. Access to the "Traffic" Menu. Display the current traffic alerts.
10. ESC: abandon the operation in progress.
11. CD eject.
12. Selection of the previous/next radio station from the list.  
Selection of the previous/next MP3 directory.  
Selection of the previous/next page of a list.
13. Selection of the previous/next radio station.  
Selection of the previous/next CD or MP3 track.  
Selection of the previous/next line of a list.
14. Buttons 1 to 6:  
Selection of the stored radio station.  
Long press: store the current radio station.
15. SD card reader (navigation SD card only).
16. Dial for selection of the screen display and according to the context of the menu.  
Short press: contextual menu or confirmation.  
Long press press: contextual menu specific to the list displayed.

## 02 STEERING MOUNTED CONTROLS

RADIO: selection of the next stored station.  
Selection of the next entry in the address book.

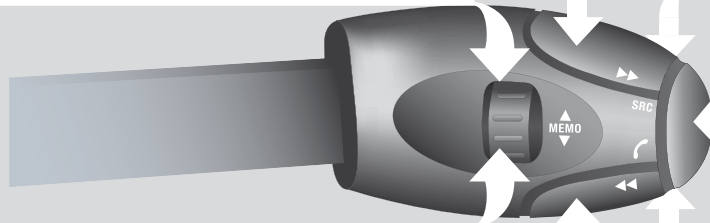

RADIO: selection of the previous stored station.  
Selection of the previous entry in the address book.

RADIO: change to the next radio station on the list.  
Long press: automatic search for a higher frequency.  
CD: selection of the next track.  
CD: continuous press: fast forward play.

Volume increase.

- Change the sound source.
- Make a call from the address book.
- Pick up/Hang up the telephone.
- Press for more than 2 seconds: access to the address book.

Mute: function activated by pressing the volume increase and decrease buttons simultaneously.

Restore the sound by pressing one of the two volume buttons.

Volume decrease.

RADIO: change to the previous radio station on the List.  
Long press: automatic search for a lower frequency.  
CD: selection of the previous track.  
CD: continuous press: fast reverse.

# 03 GENERAL OPERATION

Press the MODE button several times in succession for access to the following menus:

## RADIO/MUSIC MEDIA PLAYERS

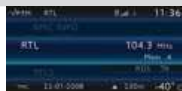

## TELEPHONE

(If a conversation is in progress)



## TRIP COMPUTER

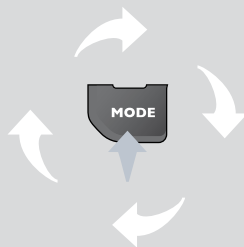

## FULL SCREEN MAP



## NAVIGATION

(If guidance is in progress)



### SETUP:

system language\*, date and time\*, display, vehicle settings\*, unit and system settings, "Demo mode".

\* Available according to model.



### TRAFFIC:

TMC information and messages.



For cleaning the screen, the use of a soft, non-abrasive cloth (spectacles cloth) is recommended, with no additional product.



For a detailed global view of the menus available, refer to the "Screen menu map" section.

# 03 GENERAL OPERATION

## DISPLAY ACCORDING TO THE CONTEXT



A press on the OK dial gives access to short-cut menus according to the display on the screen.

### NAVIGATION (IF GUIDANCE IS IN PROGRESS):

- 1 **Abort guidance**
- 1 **Repeat advice**
- 1 **Block road**
- 1 **Route info**
- 2 **Show destination**
- 2 **Trip info**
- 3 **Route type**
- 3 **Avoid**
- 3 **Satellites**
- 1 **Zoom/Scroll**
- 1 **Voice advice**
- 1 **Route options**

### TELEPHONE:

- 1 **End call**
- 1 **Hold call**
- 1 **Dial**
- 1 **DTMF-Tones**
- 1 **Private mode**
- 1 **Micro off**

### MUSIC MEDIA PLAYERS:

- 1 **Traffic info (TA)**
- 1 **Play options**
- 2 **Normal order**
- 2 **Random track**
- 2 **Repeat folder**
- 2 **Scan**
- 1 **Select music**

### RADIO:

- 1 **In FM mode**
- 2 **Traffic info (TA)**
- 2 **RDS**
- 2 **Radiotext**
- 2 **Regional prog.**
- 2 **AM**
- 1 **In AM mode**
- 2 **TA**
- 2 **Refresh AM list**
- 2 **FM**

### FULL SCREEN MAP:

- 1 **Abort guidance/Resume guidance**
- 1 **Set destination**
- 1 **POIs nearby**
- 1 **Position info**
- 1 **Map settings**
- 1 **Zoom/Scroll**

# 04 NAVIGATION - GUIDANCE

## SELECTING A DESTINATION

Insert the SD card in the front panel I reader and leave it there to use the Navigation functions.

The navigation SD card data must not be modified.

Map data updates are available from CITROËN dealers.

1

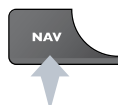

Press the NAV button.

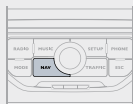

4



Select the "Address input" function and press the dial to confirm.

**Address input**

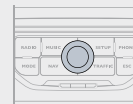

The list of the last 20 destinations appears under the Navigation Menu function.

2



Press the NAV button again or select the Navigation Menu function and press the dial to confirm.

**Navigation Menu**



5



Once the country has been selected, turn the dial and select the town function. Press the dial to confirm.

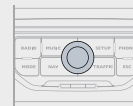

6



Select the letters of the town one by one confirming each time by pressing the dial.

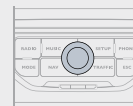

3



Select the "Destination input" function and press the dial to confirm.

**Destination input**

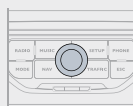

A pre-set list (by entering the first few letters) of the towns in the country selected can be accessed via the LIST button on the virtual keypad.

## 04 NAVIGATION - GUIDANCE

To clear a destination; from steps 1 to 3, select "Choose from last destinations".

A long press on one of the destinations displays a list of actions from which you can select:

Delete entry

Delete list

7



Turn the dial and select OK.  
Press the dial to confirm.



To speed up the process, the post code can be entered directly after selecting the "Postal code" function.  
Use the virtual keypad to enter the letters and digits.

8



Repeat steps 5 to 7 for the "Street" and "House number" functions.



Select the "Save to address book" function to record the address entered in a directory file. Press the dial to confirm the selection.  
MyWay allows up to 500 contact files to be recorded.

9



During guidance, pressing the end of the lighting stalk repeats the last guidance instruction.



10



Then select "Start route guidance" and the press the dial to confirm.

**Start route guidance**



Select the route type:

"Fast route", "Short route" or "Optimized route" and press the dial to confirm.

It is also possible to select a destination via "Choose from address book" or "Choose from last destinations".

**Choose from address book**

**Choose from last destinations**



You can zoom in/zoom out on the map using the dial.

It is possible to scroll the map or select its orientation via the shortcut menu of the FULL SCREEN MAP. Press the dial then select "Map settings".

# 04 NAVIGATION - GUIDANCE

## ROUTE OPTIONS

The route selected by the MyWay system depends directly on the route options.  
Changing these options may change the route completely.

1

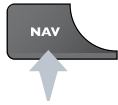

Press the NAV button.



2



Press the NAV button again or select the Navigation Menu function and press the dial to confirm.

**Navigation Menu**



3



Select the "Route options" function and press the dial to confirm.

**Route options**

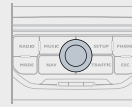

4



Select the "Route type" function and press the dial to confirm. This function allows you to change the route type.

**Route type**



5



Select the "Route dynamics" function.

This function gives access to the "Traffic independent" or "Semi-dynamic" options.

**Route dynamics**



6



Select the "Avoidance criteria" function. This function provides access to the AVOID options (motorways, toll roads, ferries).

**Avoidance criteria**



7



Turn the dial and select the "Recalculate" function to take into account the route options selected. Press the dial to confirm.

**Recalculate**





# 04 NAVIGATION - GUIDANCE

## ADDING A STOPOVER

Stopovers can be added to the route once the destination has been selected.

1

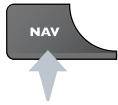

Press the NAV button.

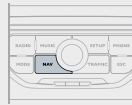

5



Enter a new address, for example.

**Address input**



2



Press the NAV button again or select the Navigation Menu function and press the dial to confirm.

**Navigation Menu**



6



Once the new address has been entered, select OK and press the dial to confirm.

**OK**

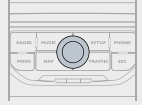

3



Select the "Stopovers" function and press the dial to confirm.

**Stopovers**



7



Select "Recalculate" and press the dial to confirm.

**Recalculate**



4



Select the "Add stopover" function (5 stopovers maximum) and press the dial to confirm.

**Add stopover**



The stopover must be completed or deleted in order for the guidance to continue to the next destination. Otherwise, the MyWay will always return you to the previous stopover.

# 04 NAVIGATION - GUIDANCE

## SEARCHING FOR POINTS OF INTEREST (POI)

The points of interest (POI) indicate all of the service locations in the vicinity (hotels, various businesses, airports...).

1 Press the NAV button.

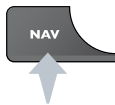

2 Press the NAV button again or select the Navigation Menu function and press the dial to confirm.



**Navigation Menu**



3 Select the "POI search" function and press the dial to confirm.



**POI search**



4 Select the "POI nearby" function to search for POIs around the vehicle.



**POI nearby**



5 Select the "POI near destination" function to search for POIs near the point of arrival of the route.



**POI near destination**



6 Select the "POI in city" function to search for POIs in the city required. Select the country then enter the name of the city using the virtual keypad.



**POI in city**



A list of cities present in the country selected can be accessed via the LIST button on the virtual keypad.

7 Select the "POI in country" function to search for POIs in the country required.



**POI in country**



8 Select the "POI near route" function to search for POIs near the route.





























**POI near route**



# 04 NAVIGATION - GUIDANCE

## LIST OF PRINCIPAL POINTS OF INTEREST (POI)

	Service station		Airport
	LPG station		Railway station
	Garage		Bus station
	CITROËN		Port
	Motor racing circuit		Industrial estate
	Covered car park		Supermarket
	Car park		Bank
	Rest area		Vending machine
	Hotel		Tennis court
	Restaurant		Swimming pool
	Refreshment area		Golf course
	Picnic area		Winter sports resort
	Cafeteria		Theatre



This icon appears when several POIs are grouped together in the same area. Zooming in on this icon shows details of the POIs.

	Cinema
	Camp site
	Theme parks
	Hospital
	Pharmacy
	Police station
	School
	Post office
	Museum
	Tourist information
	Automatic speed camera*
	Red light camera*
	Risk area*

\* According to availability in the country.

# 04 NAVIGATION - GUIDANCE

## NAVIGATION SETTINGS

1  Press the NAV button.



2  Press the NAV button again or select the Navigation Menu function and press the dial to confirm.

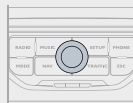

**Navigation Menu**

3  Select the "Settings" function and press the dial to confirm.



**Settings**

4  Select the "Navi volume" function and turn the dial to set the volume of each voice synthesiser (traffic information, alert messages...).



**Navi volume**

**i** To activate or deactivate vocal guidance, with guidance active and the map displayed on the screen, press the dial and then select or deselect "Voice advice".

**Voice advice**

 The adjustment of the volume for the Risk Areas POIs is used only during the transmission of an alert.

5  Select the "POI categories on Map" function to select the POIs to be displayed on the map by default.

**POI categories on Map**



6  Select "Set parameters for risk areas" for access to the "Display on map", "Visual alert" and "Sound alert" functions.

**Set parameters for risk areas**



## **i** UPDATING THE RISK AREAS POIs

Contact a CITROËN dealer for the procedure to follow to obtain the RISK AREA POIs.

This requires an SDHC (High Capacity) compatible reader.

# 05 TRAFFIC INFORMATION

## CONFIGURE THE FILTERING AND DISPLAY OF TMC MESSAGES

1



Press the TRAFFIC button.

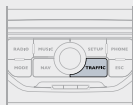

The list of TMC messages appears under the Traffic Menu sorted in order of proximity.

2



Press the TRAFFIC button again or select the Traffic Menu function and press the dial to confirm.

**Traffic Menu**



3



Select the filter of your choice:

**Messages on route**

**Only warnings on route**

**All warning messages**

**All messages**

The messages appear on the map and on the list.

To exit, press ESC.



4



Select the "Geo. Filter" function and press the dial to confirm.

**Geo. Filter**



5



Then select the radius of the filter in miles (km) required in accordance with the route, press the dial to confirm.

When all of the messages on the route are selected, the addition of a geographical filter is recommended (within a radius of 3 miles (5 km) for example) to reduce the number of messages displayed on the map. The geographical filter follows the movement of the vehicle.



The filters are independent and their results are cumulative.

We recommend a filter on the route and a filter around the vehicle of:

- 2 miles (3 km) or 3 miles (5 km) for a region with heavy traffic,
- 6 miles (10 km) for a region with normal traffic,
- 30 miles (50 km) for long journeys (motorway).

# 05 TRAFFIC INFORMATION

## PRINCIPAL TMC SYMBOLS



1 Black and blue triangle: general information, for example:



2 Red and yellow triangle: traffic information, par example:



## RECEIVING TA MESSAGES

-  - the station transmits TA messages.
-  - the station does not transmit TA messages.
-  - TA messages are not activated.

The TA (Traffic Announcement) function gives priority to TA alert messages. To operate, this function needs good reception of a radio station transmitting this type of message. When a traffic report is transmitted, the current audio source (Radio, CD, ...) is interrupted automatically to play the TA message. Normal playback of the audio source resumes at the end of the transmission of the message.

-  With the current audio source displayed on the screen, press the dial.



- The shortcut menu for the source appears and gives access to:



-  Select Traffic Announcements (TA) and press the dial to confirm and go to the associated settings.



# 06 RADIO

The external environment (hill, building, tunnel, underground car park...) may interfere with the reception, including in RDS following mode. This phenomenon is a normal result of the way in which radio waves are transmitted and does not in any way indicate a failure of the audio equipment.

## SELECTING A STATION

1



Press the RADIO button to display the list of stations received locally sorted in alphabetical order. Select the station required by turning the dial and press to confirm.



While listening to the radio, press one of the buttons to select the previous or next station on the list.

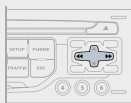

A long press of one of the buttons starts the automatic search for a station with a lower or higher frequency.

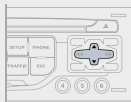

Press one of the buttons on the numeric keypad for more than 2 seconds to store the current station. Press the button on the numeric keypad to recall the stored radio station.

## RDS - REGIONAL MODE

1



When the current radio station is displayed on the screen, press the dial.



2

The radio source short-cuts menu appears and provides access to the following short-cuts:

TA

RDS

Radiotext

Regional prog.

AM

3



Select the function required and press the dial to confirm to gain access to the corresponding settings.



RDS, if displayed, allows you to continue listening to the same station by automatic retuning to alternative frequencies. However, in certain conditions, coverage of an RDS station may not be assured throughout the entire country as radio stations do not cover 100 % of the territory. This explains the loss of reception of the station during a journey.

# 07 MUSIC MEDIA PLAYERS

## CD, MP3/WMA CD INFORMATION AND ADVICE



The MP3 format, an abbreviation of MPEG 1, 2 & 2.5 Audio Layer 3 and the WMA format, an abbreviation of Windows Media Audio and the property of Microsoft, are audio compression standards which permit the recording of several tens of music files on a single disc.



The MyWay will only play audio files with the extension ".mp3" with a speed of between 8 Kbps and 320 Kbps and the extension ".wma" with a speed of between 5 Kbps and 384 Kbps. It also supports the VBR (Variable Bit Rate) mode. No other type of file (.mp4, .m3u...) can be played.



In order to be able to play a recorded CDR or CDRW, when recording it is preferable to select the ISO 9660 level 1, 2 or Joliet standard.

If the disc is recorded in another format it may not be played correctly.

It is recommended that the same recording standard is always used for an individual disc, with as low a speed as possible (4x maximum) for optimum sound quality.

In the particular case of a multi-session CD, the Joliet standard is recommended.



It is advisable to restrict file names to 20 characters, without using special characters (e.g.: " " ? ; ù) to avoid any play or display problems.



# 07 MUSIC MEDIA PLAYERS

## SELECTING/PLAYING MUSIC CD, MP3/WMA CD

1



Press the MUSIC button.

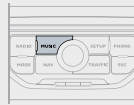

4



Select the music source required:  
CD, MP3/WMA CD. Press the dial to  
confirm. Play begins.



!

The list of tracks or MP3/WMA files appears under Music Menu.

5

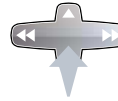

Press the up or down button to select  
the next/previous folder.

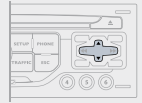

2



Press the MUSIC button again or  
select the Music Menu function and  
press the dial to confirm.

**Music Menu**



6



Press one of the buttons to select a  
music track.  
Press and hold one of the buttons for  
fast forward or rewind play.

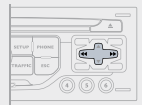

3



Select the "Select music" function  
and press the dial to confirm.

**Select music**



The playing and displaying of an MP3/WMA compilation may depend on the recording programme and/or the settings used. We recommend the ISO 9660 file standard.

# 07 MUSIC MEDIA PLAYERS

## USING THE EXTERNAL INPUT (AUX)

JACK/USB AUDIO CABLE NOT SUPPLIED

1

Connect the portable device (MP3/WMA player...) to the auxiliary JACK socket or to the USB port, using a suitable audio cable.

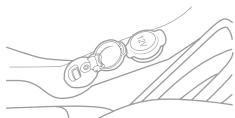

2

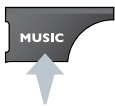

Press the MUSIC button then press it again or select the Music Menu function and press the dial to confirm.

**Music Menu**



3



Select the "External device" function and press the dial to activate it.

**External device**



4



Select the AUX music source and press the dial to confirm. Play begins automatically.



!

The display and management of the controls is via the portable device.



# 08 BLUETOOTH TELEPHONE

## CONNECTING A TELEPHONE

\* The services available depend on the network, the SIM card and the compatibility of the Bluetooth telephone used. Check the telephone manual and with your network provider for details of the services available to you. A list of mobile telephones with the best level of compatibility is available from the dealer network.



For reasons of safety and because they require prolonged attention on the part of the driver, the operations for pairing the Bluetooth mobile telephone to the hands-free system of the MyWay must be carried out with the vehicle stationary. The ignition must be on.

1

Activate the telephone's Bluetooth function. The last telephone connected is reconnected automatically.



2



Press the PHONE button.

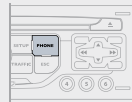

The list of telephones connected previously (4 maximum) appears on the multifunction screen. Select the telephone required for a new connection.

3



For a first connection, select "Search phone" and press the dial to confirm. Then select the name of the telephone.

**Search phone**



4



Enter the authentication code on the telephone. The code to be entered is displayed on the screen.



Once the telephone has been connected, MyWay can synchronise the address book and the call list. This synchronisation may take a few minutes\*.

1



To change the telephone connected, press the PHONE button, then select Phone Menu and press the dial to confirm.

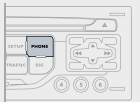

2



Select "Connect phone". Select the telephone and press to confirm.

**Connect phone**



# 08 BLUETOOTH TELEPHONE

## RECEIVING A CALL

- 1 An incoming call is announced by a ring and a superimposed display on the multifunction screen.

- 2 Select the "Yes" tab to accept or "No" to refuse and confirm by pressing the dial.



**Yes** **No**

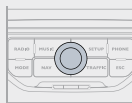

- 3 To hang up, press the PHONE button or press the dial and select "End call" then confirm by pressing the dial.



**End call**

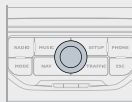

Press the end of the steering mounted control to accept the call or end the call in progress.

## MAKING A CALL

- 1  Press the PHONE button.

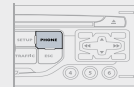

-  The list of the last 20 calls made and received in the vehicle appears under Phone Menu. You can select a number and press the dial to make the call.

- 2 Select the Phone Menu function and press the dial to confirm.



**Phone Menu**

Select "Dial number", then dial the telephone number using the virtual keypad.

**Dial number**

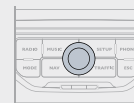

-  It is also possible to select a number from the address book. You can select "Dial from address book". The MyWay can record up to 4 000 entries.

Press the end of the steering mounted control for more than two seconds to gain access to the address book.



To delete a number, press the PHONE button then press and hold on a call number to display a list of actions including:

Delete entry

Delete list

# 09 CONFIGURATION

## SETTING THE DATE AND TIME

The SETUP function gives access to the following options: System language, Date & Time, Display (Brightness, Colour, Map colour), Vehicle, Units, System.

! These settings must be entered again if the battery has been disconnected.

1 Press the SET UP button.

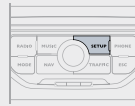
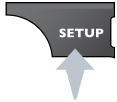

2 Select the "Date & Time" function and press the dial to confirm.



**Date & Time**



3 Select the "Set date & time" function and press the dial to confirm.



**Set date & time**



4 Adjust the settings one by one using the direction arrows and confirm by means of the dial.



5



Select the "Date format" function and press the dial to confirm.



6



Confirm the format required using the dial.  
Select the "Time format" function and press the dial to confirm.



Confirm the format required using the dial.  
Pressing the SET UP button for more than 2 seconds gives access to:

**Description of the unit**

**GPS coverage**

**Demo mode**

# 10 TRIP COMPUTER/VEHICLE PARAMETERS

## TRIP COMPUTER

1

Press the MAIN button or press the MODE button several times in succession until the trip computer is displayed.



- The "vehicle" tab:  
The range, the current fuel consumption and the distance remaining or the Stop & Start time counter.
- The "1" (trip 1) tab with :  
The average speed, the average fuel consumption and the distance travelled calculated over trip "1".
- The "2" (trip 2) tab with the same functions for a second trip.



Each press of the button at the end of the wiper stalk displays the different trip computer information in succession, according to the screen.

## A FEW DEFINITIONS

**i** **Range:** displays the distance which can be travelled with the remaining fuel detected in the tank, based on the average fuel consumption over the last few miles (kilometres).

This displayed value may vary significantly following a change in the vehicle speed or the relief of the route.

When the range falls below 20 miles (30 km), dashes are displayed. After filling with at least 5 litres of fuel, the range is recalculated and is displayed when it exceeds 60 miles (100 km).

If, whilst driving, dashes are displayed continuously in place of the digits, contact a CITROËN dealer.

**Current fuel consumption:** only calculated and displayed above 20 mph (30 km/h).

**Average fuel consumption:** this is the average fuel consumption since the last trip computer zero reset.

**Distance travelled:** calculated since the last trip computer zero reset.

**Distance remaining to the destination:** calculated with reference to the final destination, entered by the user. If guidance is activated, the navigation system calculates it as a current value.

**Average speed:** this is the average speed calculated since the last trip computer zero reset (ignition on).

**Stop & Start time counter**

(minutes/seconds or hours/minutes)

If your vehicle is fitted with Stop & Start, a time counter calculates the time spent in STOP mode during a journey.

It resets to zero every time the ignition is switched on with the key.

# 11 SCREEN MENU MAP



## 1 MAIN FUNCTION

- 2 CHOICE A
  - 3 choice A1
  - 3 choice A2
- 2 CHOICE B...



## 1 "Traffic" Menu

- 2 Messages on route
- 2 Only warnings on route
- 2 All warning messages
- 2 All messages
- 2 Geo. Filter
  - 3 Within 2 miles (3 km)
  - 3 Within 3 miles (5 km)
  - 3 Within 6 miles (10 km)
  - 3 Within 30 miles (50 km)
  - 3 Within 60 miles (100 km)



## 1 "Music" Menu

- 2 Select music
- 2 Sound settings
  - 3 Balance/Fader
  - 3 Bass/Treble
  - 3 Equalizer
    - 4 Linear
    - 4 Classic
    - 4 Jazz
    - 4 Rock/Pop
    - 4 Techno
    - 4 Vocal
  - 3 Loudness
  - 3 Speed dependent volume
  - 3 Reset sound settings



## 1 "Radio" Menu

- 2 Waveband
  - 3 FM
  - 3 AM
- 2 Manual tune
- 2 Sound settings
  - 3 Balance/Fader
  - 3 Bass/Treble
  - 3 Equalizer
    - 4 Linear
    - 4 Classic
    - 4 Jazz
    - 4 Rock/Pop
    - 4 Techno
    - 4 Vocal
  - 3 Loudness
  - 3 Speed dependent volume
  - 3 Reset sound settings



## 1 "Navigation" Menu

2 Abort guidance/Resume guidance

2 Destination input

3 Enter new address

4 Country

4 City

4 Street

4 House number

4 Start route guidance

4 Postal code

4 Save to address book

4 Intersection

4 City district

4 Geo position

4 MAP

3 Navigate HOME

3 Choose from address book

3 Choose from last destinations

3 TMC station information

2 Stopovers

3 Add stopover

4 Address input

4 Navigate HOME

4 Choose from address book

4 Choose from last destinations

3 Rearrange route

3 Replace stopover

3 Delete stopover

3 Recalculate

4 Fast route

4 Short route

4 Optimized route

2 POI search

3 POI nearby

3 POI near destination

3 POI in city

3 POI in country

3 POI near route

2 Route options

3 Route type

4 Fast route

4 Short route

4 Optimized route

3 Route dynamics

4 Traffic independent

4 Semi-dynamic

3 Avoidance criteria

4 Avoid motorways

4 Avoid toll roads

4 Avoid ferries

3 Recalculate

2 Settings

3 Navi volume

3 POI categories on MAP

3 Set parameters for risk areas

4 Display on MAP

4 Visual alert

4 Sound alert





## 1 "Phone" Menu

- 2 Dial number
- 2 Dial from address book
- 2 Call lists
- 2 Connect phone
- 3 Search phone
- 3 Phones connected
  - 4 Disconnect phone
  - 4 Rename phone
  - 4 Delete pairing
  - 4 Delete all pairings
  - 4 Show details
- 2 Settings
  - 3 Select ring tone
  - 3 Phone/Ring tone volume
  - 3 Enter mailbox number



## 1 "SETUP" menu

- 2 System language\*
  - 3 Deutsch
  - 3 English
  - 3 Español
  - 3 Français
  - 3 Italiano
  - 3 Nederlands
  - 3 Polski
  - 3 Portuguese
- 2 Date & Time\*
  - 3 Set date & time
  - 3 Date format
  - 3 Time format
- 2 Display
  - 3 Brightness
  - 3 Colour
    - 4 Pop titanium
    - 4 Toffee
    - 4 Blue steel
    - 4 Technogrey

- 4 Dark blue
- 3 MAP colour
  - 4 Day mode for MAP
  - 4 Night mode for MAP
  - 4 Auto. Day/Night for MAP

## 2 Vehicle\*

- 3 Vehicle information
  - 4 Alert log
  - 4 Status of functions

## 2 Units

- 3 Temperature
  - 4 Celsius
  - 4 Fahrenheit
- 3 Metric/Imperial
  - 4 Kilometres (Consumption: l/100)
  - 4 Kilometres (Consumption: km/l)
  - 4 Miles (Consumption: MPG)

## 2 System

- 3 Factory reset
- 3 Software version
- 3 Automatic scrolling

\* Available according to model.

# FREQUENTLY ASKED QUESTIONS

QUESTION	ANSWER	SOLUTION
<p>There is a difference in sound quality between the different audio sources (radio, CD...).</p>	<p>For optimum sound quality, the audio settings (Volume, Bass, Treble, Ambience, Loudness) can be adapted to the different sound sources, which may result in audible differences when changing source (radio, CD...).</p>	<p>Check that the audio settings (Volume, Bass, Treble, Ambience, Loudness) are adapted to the sources listened to. It is advisable to set the AUDIO functions (Bass, Treble, Front-Rear Balance, Left-Right Balance) to the middle position, select the Linear musical ambience and set the loudness correction to the "Active" position in CD mode or to the "Inactive" position in radio mode.</p>
<p>The CD is ejected automatically or is not played by the player.</p>	<p>The CD is inserted upside down, is unplayable, does not contain any audio data or contains an audio format which the player cannot play. The CD is protected by an anti-pirating protection system which is not recognised by the audio equipment.</p>	<ul style="list-style-type: none"> <li>- Check that the CD is inserted in the player the right way up.</li> <li>- Check the condition of the CD: the CD cannot be played if it is too damaged.</li> <li>- Check the content in the case of a recorded CD: consult the advice in the Audio section.</li> <li>- The audio equipment's CD player does not play DVDs.</li> <li>- Because of their quality level, certain writeable CDs will not be played by the audio system.</li> </ul>
<p>The CD player sound is poor.</p>	<p>The CD used is scratched or of poor quality.</p>	<p>Insert good quality CDs and store them in suitable conditions.</p>
	<p>The audio equipment settings (bass, treble, ambiences) are unsuitable.</p>	<p>Set the treble or bass level to 0, without selecting an ambience.</p>

QUESTION	ANSWER	SOLUTION
The stored stations do not function (no sound, 87.5 Mhz is displayed...)	An incorrect waveband is selected.	Press the BAND AST button to return to the waveband (AM, FM1, FM2, FMAST) on which the stations are stored.
The quality of reception of the radio station listened to gradually deteriorates or the stored stations do not function (no sound, 87.5 Mhz is displayed...).	The vehicle is too far from the transmitter used by the station listened to or there is no transmitter in the geographical area through which the vehicle is travelling.	Activate the RDS function to enable the system to check whether there is a more powerful transmitter in the geographical area.
	The environment (hills, buildings, tunnels, basement car parks...) block reception, including in RDS mode.	This phenomenon is normal and does not indicate a failure of the audio equipment.
	The aerial is absent or has been damaged (for example when going through a car wash or into an underground car park).	Have the aerial checked by a CITROËN dealer.
Sound cut-outs of 1 to 2 seconds in radio mode.	During this brief sound cut-out, the RDS searches for any frequency permitting better reception of the station.	Deactivate the RDS function if the phenomenon is too frequent and always on the same route.
With the engine off, the audio equipment switches off after a few minutes of use.	When the engine is switched off, the audio equipment operating time depends on the battery charge. The switch-off is normal: the audio equipment switches to economy mode and switches off to prevent discharging of the vehicle's battery.	Start the vehicle's engine to increase the battery charge.

QUESTION	ANSWER	SOLUTION
<p>The TA box is selected. However, certain traffic jams along the route are not indicated in real time.</p>	<p>On starting, it is several minutes before the system begins to receive the traffic information.</p>	<p>Wait until the traffic information is being received correctly (displaying of the traffic information symbols on the map).</p>
	<p>In certain countries, only major routes (motorways...) are listed for the traffic information.</p>	<p>This phenomenon is normal. The system is dependent on the traffic information available.</p>
<p>The time taken to calculate a route sometimes seems longer than usual.</p>	<p>The performance of the system may slow down temporarily if a CD is being copied onto the Jukebox at the same time as a route is being calculated.</p>	<p>Wait until the CD has been copied or stop the copying before starting the guidance function.</p>
<p>I receive a speed camera alert for a camera which is not on my route.</p>	<p>The system announces all speed cameras located in a conical zone forward of the vehicle. It may detect speed cameras on nearby or parallel roads.</p>	<p>Zoom the map to view the exact position of the speed camera.</p>
<p>The audible speed camera alert is not working.</p>	<p>Audible alerts are not active.</p>	<p>Activate audible alerts in Navigation Menu, Settings, Set parameters for risk areas.</p>
	<p>The alert volume level is set to minimum.</p>	<p>Increase the speed camera alert volume.</p>
<p>The altitude is not displayed.</p>	<p>On starting, the initialisation of the GPS may take up to 3 minutes to receive more than 3 satellites correctly.</p>	<p>Wait until the system has started up completely. Check that there is a GPS coverage of at least 3 satellites (long press on the SETUP button, then select GPS coverage).</p>
	<p>Depending on the geographical environment (tunnel...) or the weather, the conditions of reception of the GPS signal may vary.</p>	<p>This phenomenon is normal. The system is dependent on the conditions of reception of the GPS signal.</p>
<p>The route is not calculated successfully.</p>	<p>The exclusion criteria may conflict with the current location (exclusion of toll roads on a motorway with tolls).</p>	<p>Check the exclusion criteria.</p>

QUESTION	ANSWER	SOLUTION
There is a long waiting time after inserting a CD.	When a new medium is inserted, the system reads a certain amount of data (directory, title, artist, etc.). This may take a few seconds.	This phenomenon is normal.
I cannot connect my Bluetooth telephone.	The telephone's Bluetooth function may be deactivated or the equipment may not be visible.	<ul style="list-style-type: none"><li>- Check that your telephone's Bluetooth function is activated.</li><li>- Check that your telephone is visible.</li></ul>
A telephone connected by Bluetooth is inaudible.	The volume level depends on both the system and the telephone.	Increase the MyWay volume setting, possibly to maximum, and increase the telephone volume level if necessary.

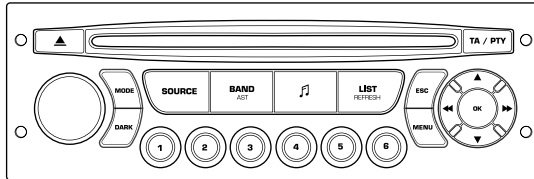

# AUDIO SYSTEM

## AUDIO SYSTEM/BLUETOOTH



Your Audio system is coded in such a way that it will only operate in your vehicle. If it is to be installed in another vehicle, contact your CITROËN dealer for configuration of the system.



For safety reasons, the driver must carry out operations which require prolonged attention while the vehicle is stationary.

When the engine is switched off and to prevent discharging of the battery, the audio equipment may switch off after a few minutes.

## CONTENTS

<b>01</b>	<b>First steps</b>	<b>p. 256</b>
<b>02</b>	<b>Steering mounted controls</b>	<b>p. 257</b>
<b>03</b>	<b>Main menu</b>	<b>p. 258</b>
<b>04</b>	<b>Audio</b>	<b>p. 259</b>
<b>05</b>	<b>USB Player</b>	<b>p. 262</b>
<b>06</b>	<b>Bluetooth functions</b>	<b>p. 265</b>
<b>07</b>	<b>Configuration</b>	<b>p. 267</b>
<b>08</b>	<b>Trip computer</b>	<b>p. 268</b>
<b>09</b>	<b>Screen menu map</b>	<b>p. 269</b>
	<b>Frequently asked questions</b>	<b>p. 271</b>

# 01 FIRST STEPS



1. On/Off and volume adjustment.
2. CD eject.
3. Selection of the display on the screen from the following modes:  
Audio (AUDIO), Trip Computer (TRIP) and Telephone (TEL) functions.
4. Selection of source:  
radio, audio CD/MP3 CD, USB, Jack connection, Streaming.
5. Selection of FM1, FM2, FMast and AM wavebands.
6. Setting audio options: front/rear fader, left/right balance, loudness, sound ambience.
7. Display the list of local stations, of the tracks on the CD or of the MP3 folders.
8. Abandon current operation.
9. TA (Traffic Announcement) function on/off.  
Long press: access to the PTY (Types of radio programme) mode.
10. Confirmation.
11. Automatic search for a lower/higher frequency.  
Selection of previous/next CD, MP3 or USB track.
12. Selection of a lower/higher radio frequency.  
Selection of the previous/next MP3 folder.  
Selection of the previous/next USB device folder/genre/artist/playlist.
13. Display the general menu.
14. Buttons 1 to 6:  
Selection of a stored radio station.  
Long press: store a station.
15. The DARK button changes the display on the screen to improve driving comfort at night.  
1st press: lighting the upper band only.  
2nd press: display of a black screen.  
3rd press: return to the standard display.

## 02 STEERING MOUNTED CONTROLS

RADIO: selection of the previous stored station.  
 USB: selection of the previous genre/artist/ directory from the classification list.  
 Selection of the previous item on a menu.

RADIO: automatic search for a higher frequency.  
 CD/MP3/USB: selection of the next track.  
 CD/USB: continuous press: fast forwards play.  
 Selection of the previous item.

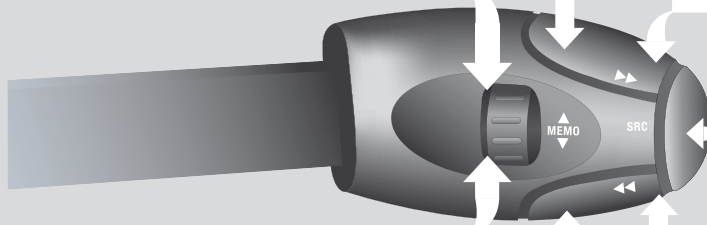

Volume increase.

- Change of sound source.
- Confirmation of a selection.
- Pick up/Hang up the telephone.
- Press for more than 2 seconds: access to the telephone menu.

RADIO: automatic search for a lower frequency.  
 CD/MP3/USB: selection of the previous track.  
 CD/USB: continuous press: fast reverse.  
 Selection of the next item.

RADIO: selection of the next stored station.  
 USB: selection of the next genre/artist/folder from the classification list.  
 Selection of the next item on a menu.

Volume decrease.

Mute: press the volume increase and decrease buttons simultaneously.  
 The sound is restored by pressing one of the two volume buttons.



# 03 MAIN MENU

**AUDIO FUNCTIONS:** radio, CD, USB, options.

**TELEPHONE:** Bluetooth hands-free, pairing, management of a call.

> MONOCHROME SCREEN C



**TRIP COMPUTER:** entering of distances, alerts, status of functions.

**PERSONALISATION-CONFIGURATION:** vehicle parameters, display, languages.

> MONOCHROME SCREEN A



For a detailed global view of the menus available, refer to the "Screen menu map" section.

# 04 AUDIO





The external environment (hills, buildings, tunnels, basement car parks, ...) may block reception, including in RDS mode. This is a normal effect of the way in which radio waves are transmitted and does not indicate any failure of the audio equipment.

## RADIO SELECTING A STATION

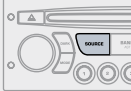
**1**  Press the SOURCE button several times in succession and select the radio.



**2**  Press the BAND AST button to select a waveband: FM1, FM2, FMast, AM.



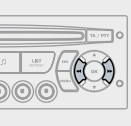

**3**  Briefly press one of the buttons to carry out an automatic search of the radio stations.

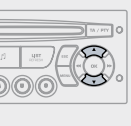

**4**  Press one of the buttons to carry out a manual search of the radio stations.



  Press the LIST REFRESH button to display the list of stations received locally (30 stations maximum). To update this list, press for more than two seconds.

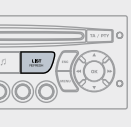

## RDS

**1**  Press the MENU button.

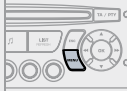

**2**  Select AUDIO FUNCTIONS then press OK.



**3**  Select the FM WAVEBAND PREFERENCES function then press OK.

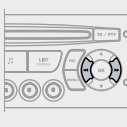

**4**  Select ACTIVATE RDS then press OK. RDS appears on the screen.

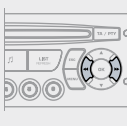

**!** The RDS, if displayed, enables you to continue listening to the same station by automatic retuning to alternative frequencies. However, in certain conditions, coverage of an RDS station may not be assured throughout the country as radio stations do not cover 100 % of the territory. This explains the loss of reception of the station during a journey.

# 04 AUDIO

## CD PLAYING A CD



Insert circular compact discs only.

Some anti-pirating systems, on original discs or CDs copied using a personal recorder, may cause faults which are no reflection on the quality of the original player.

Without pressing the EJECT button, insert a CD in the player, play begins automatically.

1



To play a disc which has already been inserted, press the SOURCE button several times in succession and select CD.



2



Press one of the buttons to select a track on the CD.

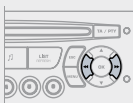

!

Press the LIST REFRESH button to display the list of tracks on the CD.

3



Press and hold one of the buttons for fast forward or backward.

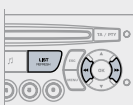

## MP3 CD PLAYING AN MP3 COMPILATION



Insert an MP3 compilation in the player.

The audio equipment searches for all of the music tracks, which may take anything between a few seconds and several tens of seconds, before play begins.

!

On a single disc, the CD player can read up to 255 MP3 files spread over 8 folder levels. However, it is advisable to keep to a limit of two levels to reduce the access time before the CD is played.

While the CD is being played, the folder structure is not followed. All of the files are displayed on a single level.

1



To play a disc which has already been inserted, press the SOURCE button several times in succession and select CD.

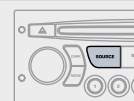

2



Press one of the buttons to select a track on the CD.

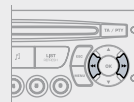

!

Press the LIST REFRESH button to display the list of directories of the MP3 compilation.

3



Press and hold one of the buttons for fast forward or backward play.

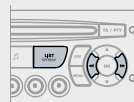

# 04 AUDIO

## MP3 CD INFORMATION AND ADVICE



The MP3 format, an abbreviation of MPEG 1.2 & 2.5 Audio Layer 3, is an audio compression standard which permits the recording of several tens of music files on a single disc.



In order to be able to play a recorded CDR or CDRW, when recording it is preferable to select standards ISO 9660 level 1.2 or Joliet.

If the disc is recorded in another format, it may not be played correctly.

It is recommended that the same recording standard is always used for an individual disc, with as low a speed as possible (4x maximum) for optimum sound quality.

In the particular case of a multi-session CD, the Joliet standard is recommended.



The audio equipment will only play files with the extension ".mp3" with a sampling rate of 22.05 KHz or 44.1 KHz. No other type of file (.wma, .mp4, .m3u...) can be played.



It is advisable to restrict file names to 20 characters without using special characters (e.g. " ? ; ù) to avoid any playing or displaying problems.



Empty CDs are not recognised and may damage the system.

# 05 USB BOX

## USING THE USB BOX

1

This unit consists of a USB port and an auxiliary Jack socket\*. The audio files are transmitted from portable equipment such as a digital player or a USB memory stick to your Audio system to be listened to via the vehicle's speakers.



2

USB memory stick (1.1, 1.2 and 2.0) or iPod® of generation 5 or later:

- USB memory sticks should be formatted FAT or FAT 32 (NTFS not supported),
- the iPod® lead is essential,
- navigation through the file database is by means of the steering wheel controls,
- the iPod® software should be regularly updated for the best connection.



3

Other iPod® players of earlier generations and players using the MTP protocol\*:

- play via Jack-Jack lead only (not supplied),
- navigation through the file database is from the portable equipment.



The list of compatible equipment and the compression rates supported are available from CITROËN dealers.

## CONNECTING A USB MEMORY STICK

1

Connect the memory stick to the port, directly or using a lead. If the audio equipment is switched on, the USB source is detected as soon as it is connected. Play begins automatically after a delay which depends on the capacity of the USB stick.



The file formats recognised are .mp3 (mpeg1 layer 3 only), .wma (standard 9 only, 128 kbits/sec compression), .wav and .ogg.

The playlists types accepted are m3u, .pls, .wpl.

!

The system puts together playlists (temporary memory) created over a period which depends on the capacity of the USB equipment.

The other sources are available during this time.

The playlists are updated each time the ignition is switched off or each time a USB memory stick is connected.

When connecting for the first time, the classification suggested is by folder. When you reconnect, the classification selected previously is retained.

\* According to vehicle.

# 05 USB BOX

## USING THE USB PORT

2

Press and hold LIST to display the different classifications. Select by Folder/Artist/Genre/Playlist, press OK to select the classification required, then press OK again to confirm.

**OK**



- by Folder: all folders containing audio files recognised on the peripheral device, classified in alphabetical order without following the flow chart.
- by Artist: all of the artist names defined in the ID3 Tags, classified in alphabetical order.
- by Genre: all of the genres defined in the ID3 Tags.
- by Playlist: in accordance with the playlists recorded on the USB device.

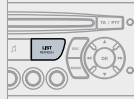

3

Press LIST briefly to display the previously selected classification. Navigate through the list using the left/right and up/down buttons. Confirm the selection by pressing OK.

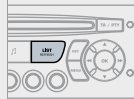

4



Press one of these buttons to gain access to the previous/next track on the classification list currently being played. Press and hold one of the buttons for fast forward or backward play.

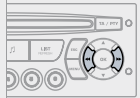

5



Press one of these buttons to gain access to the previous/next Genre, Folder, Artist or Playlist on the classification list currently being played.

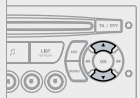

### CONNECTING AN iPod® VIA THE USB PORT

1

The lists available are Artist, Genre and Playlist (as defined on the iPod®). Selection and Navigation are described in steps 1 to 5 above.

!

Do not connect a hard disk or USB devices other than audio equipment to the USB port. This could damage your installation.

# 05 USB BOX

## USING THE AUXILIARY INPUT (AUX) JACK SOCKET OR USB PORT (according to vehicle)



The auxiliary input, JACK or USB, allows the connection of portable equipment (MP3 player...).



Do not connect a single piece of equipment via the JACK socket and the USB port at the same time.

1

Connect the portable equipment (MP3 player...) to the JACK socket or to the USB port, using a suitable cable (not supplied).



2



Press the SOURCE button several times in succession and select AUX.

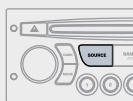

## ADJUSTING THE VOLUME OF THE AUXILIARY SOURCE

1

First adjust the volume of your portable equipment.



2



Then adjust the volume of your audio equipment.



The controls are displayed and managed via the portable equipment.





# 06 BLUETOOTH FUNCTIONS

## BLUETOOTH TELEPHONE

### SCREEN C

(AVAILABILITY DEPENDS ON MODEL AND VERSION)

The services offered depend on the network, the SIM card and the compatibility of the Bluetooth equipment used. Consult your telephone's manual and your operator to find out which services are available to you. A list of mobile telephones which offer the best range of services is available from the network. Consult a CITROËN dealer.

### PAIRING A TELEPHONE



For safety reasons and because they require prolonged attention on the part of the driver, the operations for pairing of the Bluetooth mobile telephone with the Bluetooth hands-free system of your audio equipment must be carried out with the vehicle stationary and the ignition on.

1

Activate the telephone's Bluetooth function.



2



Press the MENU button.

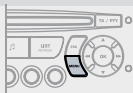

3

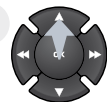

In the menu, select:

- Bluetooth telephone function - Audio
- Bluetooth configuration
- Perform a Bluetooth search

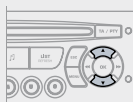

4

A window is displayed with "Searching...".

5

The first 4 telephones recognised are displayed in this window.



The TELEPHONE menu permits access to the following functions in particular: Directory\*, Call list, Pairing management.

\* If your telephone is fully compatible.

6

Select the telephone to be connected from the list. Only one telephone can be connected at a time.

7

A virtual keypad is displayed on the screen: enter a code with at least 4 digits. Confirm by pressing OK.



8

A message is displayed on the screen of the telephone chosen: to accept the pairing, enter the same code on the telephone, then confirm by pressing OK.



9

If pairing fails, the number of attempts is not limited.

10

"Pairing of Name\_telephone successful" appears on the screen. The automatic connection authorised is only active after the telephone has been configured. The directory and the call list can be accessed after the synchronisation period.



The pairing can also be initiated from the telephone.



# 06 BLUETOOTH FUNCTIONS

## BLUETOOTH AUDIO STREAMING

### RECEIVING A CALL

- 1 An incoming call is announced by a ring and a superimposed display on the multifunction screen.

- 2  Select the YES tab on the display using the buttons and confirm by pressing OK.

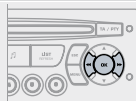

- 2  Press the steering mounted control OK to accept the call.



### MAKING A CALL

- 1 From the Bluetooth telephone function Audio menu, select Manage the telephone call then Call, Call list or Directory.

- 2 Press the end of the steering mounted control for more than two seconds to gain access to your directory.

Or

To dial a number, use your telephone's keypad, with the vehicle stationary.



- 1  Wireless transmission of the telephone's music files via the audio equipment. The telephone must be able to manage the appropriate bluetooth profiles (Profiles A2DP/AVRCP).

- 1 Initiate the pairing between the telephone and the vehicle. This pairing can be initiated from the vehicle's telephone function menu or via the telephone's keypad. See steps 1 to 10 on the previous pages. During the pairing phase, the vehicle must be stationary with the key in the ignition.



- 2 Select the telephone to be connected from the telephone function menu. The audio system connects to a newly paired telephone automatically.

- 3  Activate the streaming source by pressing the SOURCE button\*. The tracks to be played can be controlled as usual via the buttons on the Radio control panel and the steering mounted controls\*\*. The contextual information can be displayed on the screen.

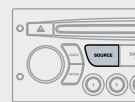

\* In certain cases, playing of the Audio files must be initiated from the keypad.

\*\* If the telephone supports the function.



# 07 CONFIGURATION

## SETTING THE DATE AND TIME SCREEN C

1



Press the MENU button.

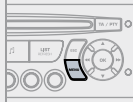

5



Press to confirm the selection.



2



Using the arrows, select  
PERSONALISATION  
CONFIGURATION.

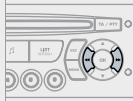

6



Using the arrows, select  
ADJUST  
DATE AND TIME.

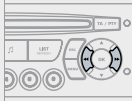

3



Press to confirm the selection.

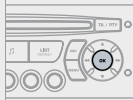

7



Press to confirm the selection.



4



Using the arrows, select  
DISPLAY  
CONFIGURATION.

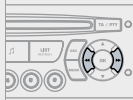

8



Adjust the settings one by one  
confirming by pressing the OK  
button. Next select the OK tab on  
the screen then confirm.

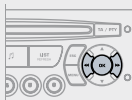

## 08 TRIP COMPUTER



Each press of the button, located at the end of the wiper stalk, displays the different trip computer information in succession, depending on the screen.



- the "vehicle" tab with:
  - the range, the current fuel consumption and the distance remaining to the destination or the Stop & Start time counter,
- the "1" tab (trip 1) with:
  - the average speed, the average consumption and the distance travelled calculated over trip "1",
- the "2" tab (trip 2) with the same information for a second trip.



### Zero reset

When the required trip is displayed, press the control for more than two seconds.

## A FEW DEFINITIONS

**Range:** displays the distance which can be travelled with the remaining fuel detected in the tank, based on the average fuel consumption over the last few miles (kilometres).

This displayed value may vary significantly following a change in the vehicle speed or the relief of the route.

When the range falls below 20 miles (30 km), dashes are displayed. After filling with at least 5 litres of fuel, the range is recalculated and is displayed when it exceeds 60 miles (100 km).

If, whilst driving, dashes are displayed continuously in place of the digits, contact a CITROËN dealer.

**Current fuel consumption:** only calculated and displayed above 20 mph (30 km/h).

**Average fuel consumption:** this is the average fuel consumption since the last trip computer zero reset.

**Distance travelled:** calculated since the last trip computer zero reset.

**Distance remaining to the destination:** calculated with reference to the final destination, entered by the user. If guidance is activated, the navigation system calculates it as a current value.

**Average speed:** this is the average speed calculated since the last trip computer zero reset (ignition on).

### Stop & Start time counter

(minutes/seconds or hours/minutes)

If your vehicle is fitted with Stop & Start, a time counter calculates the time spent in STOP mode during a journey.

It resets to zero every time the ignition is switched on with the key.

# 09 SCREEN MENU MAP

## MONOCHROME A



### 1 RADIO-CD

2 RDS SEARCH

2 REG MODE

2 CD REPEAT

2 RANDOM PLAY

### 1 VEHICLE CONFIG\*

2 REV WIPE ACT

2 GUIDE LAMPS

### 1 OPTIONS

2 DIAGNOSTICS

3 consult

3 abandon

### 1 UNITS

2 TEMPERATURE: °CELSIUS/°FAHRENHEIT

2 FUEL CONSUMPTION:  
KM/L - L/100 - MPG



### 1 MAIN FUNCTION

2 CHOICE A

3 Choice A1

3 Choice A2

2 CHOICE B...

### 1 DISPLAY ADJUST

2 YEAR

2 MONTH

2 DATE

2 HOUR

2 MINUTES

2 12 H/24 H MODE

### 1 LANGUAGE

2 FRANCAIS

2 ITALIANO

2 NEDERLANDS

2 PORTUGUES

2 PORTUGUES-BRASIL

2 DEUTSCH

2 ENGLISH

2 ESPANOL

## MONOCHROME C



Press the OK dial for access to short-cut menus according to the display on the screen:

### RADIO

1 activate/deactivate RDS

1 activate/deactivate REG mode

1 activate/deactivate radiotext

### CD/MP3 CD

1 activate/deactivate Intro

1 activate/deactivate track repeat (the entire current CD for CD, the entire current folder for MP3 CD)

1 activate/deactivate random play (the entire current CD for CD, the entire current folder for MP3 CD)

### USB

1 activate/deactivate track repeat (of the current folder/artist/genre/playlist)

1 activate/deactivate random play (of the current folder/artist/genre/playlist)

\* The parameters vary according to vehicle.

# 09 SCREEN MENU MAP

## MONOCHROME A



### 1 RADIO-CD

2 RDS SEARCH

2 REG MODE

2 CD REPEAT

2 RANDOM PLAY

### 1 VEHICLE CONFIG\*

2 REV WIPE ACT

2 GUIDE LAMPS

### 1 OPTIONS

2 DIAGNOSTICS

3 consult

3 abandon

### 1 UNITS

2 TEMPERATURE: °CELSIUS/°FAHRENHEIT

2 FUEL CONSUMPTION:  
KM/L - L/100 - MPG



### 1 MAIN FUNCTION

2 CHOICE A

3 Choice A1

3 Choice A2

2 CHOICE B...

### 1 DISPLAY ADJUST

2 YEAR

2 MONTH

2 DATE

2 HOUR

2 MINUTES

2 12 H/24 H MODE

### 1 LANGUAGE

2 FRANCAIS

2 ITALIANO

2 NEDERLANDS

2 PORTUGUES

2 PORTUGUES-BRASIL

2 DEUTSCH

2 ENGLISH

2 ESPANOL

## MONOCHROME C



Press the OK dial for access to short-cut menus according to the display on the screen:

### RADIO

1 activate/deactivate RDS

1 activate/deactivate REG mode

1 activate/deactivate radiotext

### CD/MP3 CD

1 activate/deactivate Intro

1 activate/deactivate track repeat (the entire current CD for CD, the entire current folder for MP3 CD)

1 activate/deactivate random play (the entire current CD for CD, the entire current folder for MP3 CD)

### USB

1 activate/deactivate track repeat (of the current folder/artist/genre/playlist)

1 activate/deactivate random play (of the current folder/artist/genre/playlist)

\* The parameters vary according to vehicle.

# 09 SCREEN MENU MAP

# MONOCHROME C



Pressing the MENU button displays:



## 1 AUDIO FUNCTIONS

### 2 FM BAND PREFERENCES

#### 3 alternative frequencies (RDS)

4 activate/deactivate

#### 3 regional mode (REG)

4 activate/deactivate

#### 3 radio-text information (RDTEXT)

4 activate/deactivate

### 2 PLAY MODES

#### 3 album repeat (RPT)

4 activate/deactivate

#### 3 track random play (RDM)

4 activate/deactivate



## 1 TRIP COMPUTER

### 2 ENTER DISTANCE TO DESTINATION

3 Distance: x miles

### 2 ALERT LOG

#### 3 Diagnostics

### 2 STATUS OF THE FUNCTIONS\*

#### 3 Functions activated or deactivated



## 1 PERSONALISATION-CONFIGURATION

### 2 DEFINE THE VEHICLE PARAMETERS\*

#### 2 DISPLAY CONFIGURATION

##### 3 video brightness adjustment

4 normal video

4 inverse video

4 brightness (- +) adjustment

##### 3 date and time adjustment

##### 3 day/month/year adjustment

4 hour/minute adjustment

4 choice of 12 h/24 h mode

##### 3 choice of units

4 l/100 km - mpg - km/l

4 °Celsius/°Fahrenheit

##### 2 CHOICE OF LANGUAGE



## 1 BLUETOOTH TELEPHONE

### 2 BLUETOOTH CONFIGURATION

#### 3 Connect/Disconnect a device

#### 3 Telephone function

#### 3 Audio Streaming function

4 Consult the paired device

4 Delete a paired device

4 Perform a Bluetooth search

### 2 CALL

#### 3 Calls list

4 Directory

### 2 MANAGE THE TELEPHONE CALL

3 Terminate the current call

3 Activate private mode

\* The parameters vary according to vehicle.

# FREQUENTLY ASKED QUESTIONS

QUESTION	ANSWER	SOLUTION
<p>There is a difference in sound quality between the different audio sources (radio, CD...).</p>	<p>For optimum sound quality, the audio settings (Volume, Bass, Treble, Ambience, Loudness) can be adapted to the different sound sources, which may result in audible differences when changing source (radio, CD...).</p>	<p>Check that the audio settings (Volume, Bass, Treble, Ambience, Loudness) are adapted to the sources listened to. It is advisable to set the AUDIO functions (Bass, Treble, Front-Rear Balance, Left-Right Balance) to the middle position, select the musical ambience "None" and set the loudness correction to the "Active" position in CD mode or to the "Inactive" position in radio mode.</p>
<p>The CD is ejected automatically or is not played by the player.</p>	<p>The CD is inserted upside down, is unplayable, does not contain any audio data or contains an audio format which the player cannot play. The CD is protected by an anti-pirating protection system which is not recognised by the audio equipment.</p>	<ul style="list-style-type: none"> <li>- Check that the CD is inserted in the player the right way up.</li> <li>- Check the condition of the CD: the CD cannot be played if it is too damaged.</li> <li>- Check the content in the case of a recorded CD: consult the advice in the "Audio" section.</li> <li>- The audio equipment's CD player does not play DVDs.</li> <li>- Due to their quality level, certain writeable CDs will not be played by the audio system.</li> </ul>
<p>The message "USB peripheral error" is displayed on the screen. The Bluetooth connection is cut.</p>	<p>The battery of the peripheral may not be sufficiently charged.</p> <p>The USB memory stick is not recognised. The memory stick may be corrupt.</p>	<p>Recharge the battery of the peripheral device.</p> <p>Reformat the memory stick.</p>
<p>The CD player sound is poor.</p>	<p>The CD used is scratched or of poor quality.</p> <p>The audio equipment settings (bass, treble, ambiences) are unsuitable.</p>	<p>Insert good quality CDs and store them in suitable conditions.</p> <p>Set the treble or bass level to 0, without selecting an ambience.</p>

QUESTION	ANSWER	SOLUTION
The stored stations do not function (no sound, 87.5 Mhz is displayed...).	An incorrect waveband is selected.	Press the BAND AST button to return to the waveband (AM, FM1, FM2, FMAST) on which the stations are stored.
The traffic announcement (TA) is displayed. I do not receive any traffic information.	The radio station is not part of the regional traffic information network.	Tune to a radio station which broadcasts traffic information.
The quality of reception of the radio station listened to gradually deteriorates or the stored stations do not function (no sound, 87.5 Mhz is displayed...).	The vehicle is too far from the transmitter used by the station listened to or there is no transmitter in the geographical area through which the vehicle is travelling.	Activate the RDS function to enable the system to check whether there is a more powerful transmitter in the geographical area.
	The environment (hills, buildings, tunnels, basement car parks...) block reception, including in RDS mode.	This phenomenon is normal and does not indicate a failure of the audio equipment.
	The aerial is absent or has been damaged (for example when going through a car wash or into an underground car park).	Have the aerial checked by a CITROËN dealer.
Sound cut-outs of 1 to 2 seconds in radio mode.	During this brief sound cut-out, the RDS searches for any frequency permitting better reception of the station.	Deactivate the RDS function if the phenomenon is too frequent and always on the same route.
With the engine off, the audio equipment switches off after a few minutes of use.	When the engine is switched off, the audio equipment operating time depends on the battery charge. The switch-off is normal: the audio equipment switches to economy mode and switches off to prevent discharging of the vehicle's battery.	Start the vehicle's engine to increase the battery charge.
The message "the audio system is overheated" appears on the display.	In order to protect the installation if the surrounding temperature is too high, the audio equipment switches to an automatic thermal protection mode leading to a reduction of the volume or stopping of the playing of the CD.	Switch the audio system off for a few minutes to allow the system to cool.



## Dimensions (in mm)

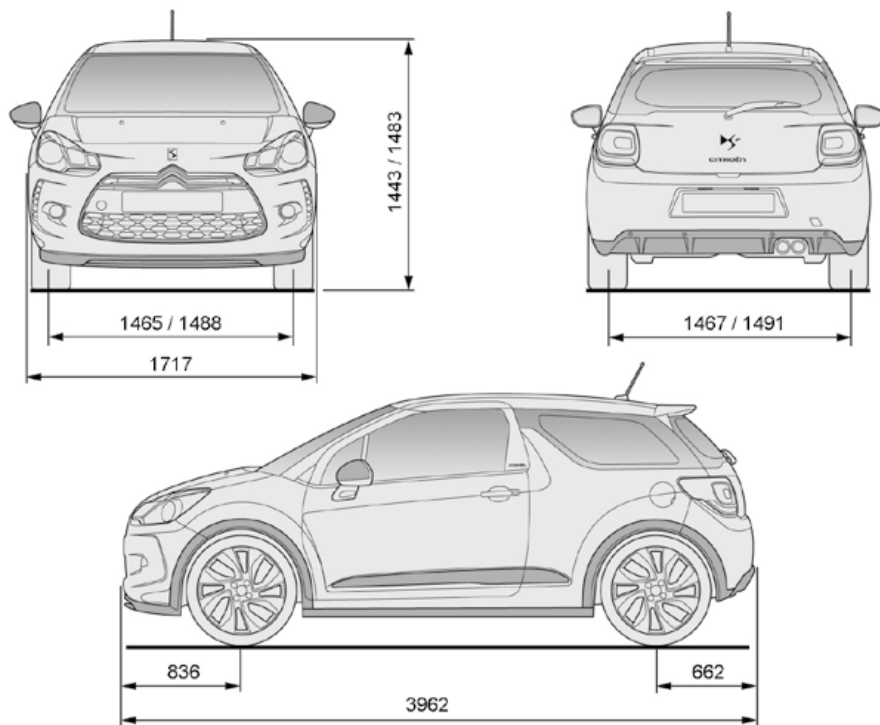

### **Bumpers and lower body**

Your vehicle has reduced ground clearance.

Take care when traversing kerbs, speed humps, access ramps, fords, unmade roads...



CITROËN DS3 RACING



## Welcome

This document describes the special features relating to the presentation and use of your CITROËN DS3 RACING. Refer to the owner's handbook for all other descriptions and specifications, and also to the Maintenance and Warranty Guide for servicing information for your vehicle.



ENGINE AND GEARBOX		
MODELS: Model codes: SA...	5FF8	5FD8
<b>PETROL ENGINE</b>		
Cubic capacity (cm <sup>3</sup> )	1 598	
Bore x stroke (mm)	77 x 85.8	
Max power: EU standard (kW)	149	152
Max power engine speed (rpm)	6 000	
Max torque: EU standard (Nm)	275	
Max torque engine speed (rpm)	2 000	
Fuel	Unleaded*	
Catalytic converter	Yes	
<b>GEARBOX</b>	Manual (6-speed)	
<b>OIL CAPACITY (in litres)</b>		
Engine (with filter replacement)	4.25	



\* CITROËN recommends the use of 98 RON unleaded petrol to ensure optimum engine performance.

# Front seats

Seat consisting of a seat cushion and a seat back which can be adjusted to adapt your position for maximum ease of driving and comfort.

## Manual adjustments



### Forwards-backwards adjustment

- ☞ Lift the control and slide the seat forwards or backwards.

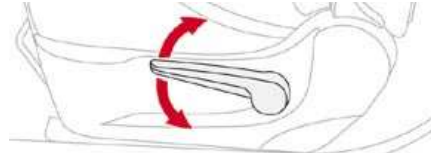
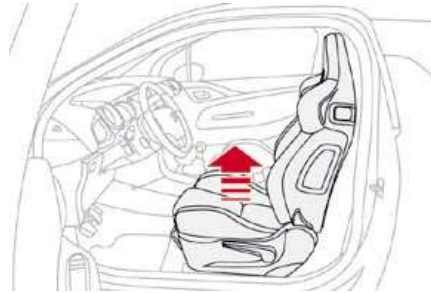

### Driver's or passenger's seat height adjustment

- ☞ Pull the handle upwards to raise or push it downwards to lower, as many times as necessary to obtain the required position.

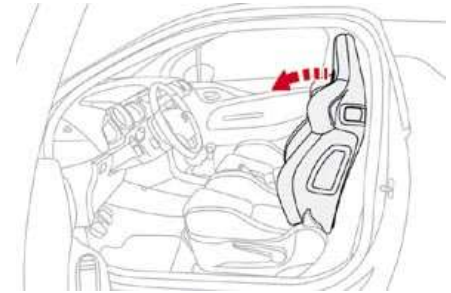

### Seat backrest angle adjustment

- ☞ Push the handle towards the rear and move the seat backrest forwards or backwards.



## Additional adjustments

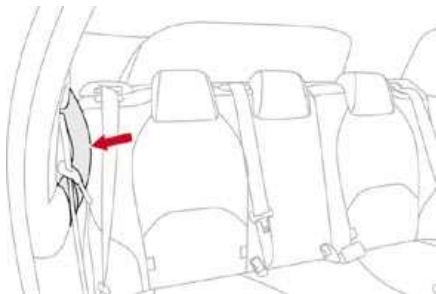
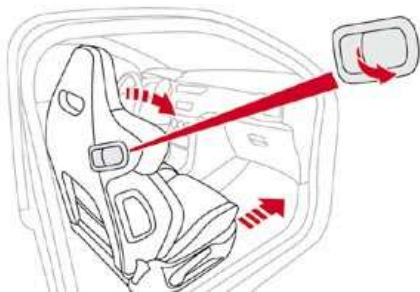

### Access to rear seats

- ☞ Pull the handle forwards to fold the seat backrest and move the seat forwards. On repositioning, the seat returns to its initial position.

**!** No person or object must prevent the seat slide from returning to its initial position; return to this position is necessary for the seat to lock in place. Ensure that the seat belt reels in correctly to avoid hindering access for the passengers to the rear seats.

### Grab handle

This ergonomic grab handle, located at the top of the side trim, serves:

- as a handle to steady rear passengers when driving,
- as a grip to improve access to the rear seats,
- to facilitate exit from the rear seats.

## Petrol engine

1. Screenwash fluid reservoir.
2. Coolant header tank.
3. Air filter.
4. Brake fluid reservoir.
5. Battery.
6. Fusebox.
7. Engine oil dipstick.
8. Engine oil filler cap.

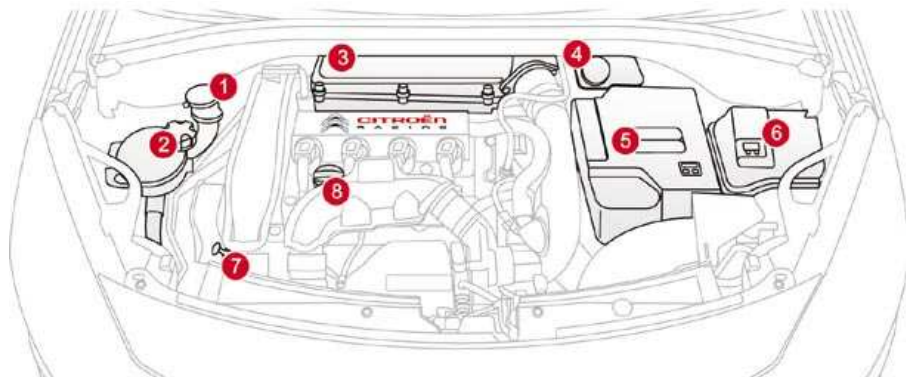



# Petrol instrument panel, manual gearbox

Provided with permanent back-lighting, the instrument panel groups together the vehicle's dials and indicator and warning lamps.

## Dials



**1. Rev counter.**

Indicates the speed of rotation of the engine (x 1 000 rpm).

**2. Vehicle speed.**

Indicates the current speed of the moving vehicle (mph or km/h).

**3. Engine coolant temperature.**

Indicates the temperature of the engine coolant liquid.

**4. Display screen.**

**5. Fuel level.**

Indicates the quantity of fuel remaining in the tank.

**6. Display management button**

Alternates display between range and trip mileage recorder.

Servicing information.

Resets the selected function to zero (trip distance recorder or service indicator).

**7. Lighting dimmer button.**

Adjusts the level of the instrument and controls illumination and the interior mood lighting.

**i** For more information, refer to the paragraph relating to the button or function and its associated display.



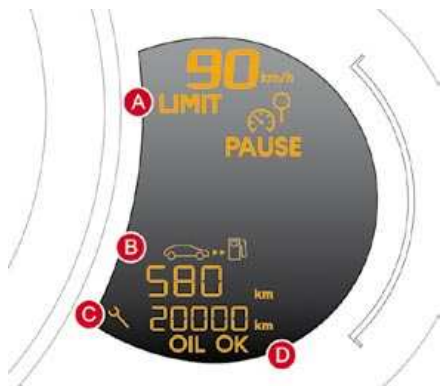

## Screen

- A. Speed limiter**  
(mph or km/h) or  
**Cruise control.**
- B. Range**  
(miles or km) or  
**Trip mileage recorder.**
- C. Service indicator**  
(miles or km), then  
**Total mileage recorder**  
These two functions are displayed successively when switching on the ignition
- D. Engine oil level indicator**  
Appears a few seconds after switching on the ignition, then disappears.



## Towing a trailer...



 Your vehicle cannot be fitted with a towbar. The space occupied by the sport diffuser prevents this.

## Tyres

### Driving in winter conditions

The 215/40 R18 89W tyres fitted as standard are not suitable for severe winter conditions. CITROËN recommends that you use suitable winter tyres during periods of very cold weather.

 If you want to fit snow chains or anti-slip covers to your vehicle, contact a CITROËN dealer for advice on the models recommended for your vehicle.

# Trajectory control systems

## Anti-skid regulation (ASR) and electronic stability programme (ESP)

The anti-skid regulation (also known as Traction Control) optimises traction to prevent skidding of the wheels, by acting on the brakes of the driving wheels and on the engine. The electronic stability programme acts on the brake of one or more wheels and on the engine to keep the vehicle on the trajectory required by the driver, within the limits of the laws of physics.

### Activation

These systems are activated automatically each time the vehicle is started. They come into operation in the event of a grip or trajectory problem.



This is indicated by flashing of this warning lamp on the instrument panel.

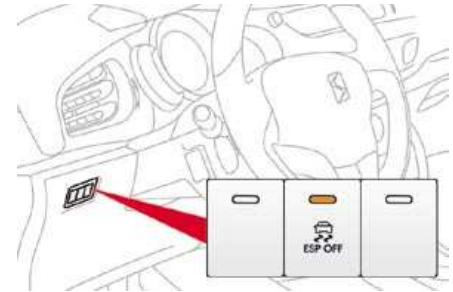

### Deactivation

In exceptional conditions (starting a vehicle which is bogged down, stuck in snow, on soft ground...), it may be advisable to deactivate the ASR and ESP systems, so that the wheels can move freely and regain grip.

- Press the **"ESP OFF"** button, located to the side of the steering wheel.



If this warning lamp comes on in the instrument panel and the indicator lamp in the button comes on, this indicates that the ASR and ESP systems are deactivated.



## Reactivation

These systems are reactivated automatically each time the ignition is switched back on.

- ☞ Press the **"ESP OFF"** button again to reactivate them manually.

## Operating fault



If this warning lamp comes on, accompanied by an audible signal and a message in the multifunction screen, this indicates a fault with these systems.

Have the systems checked by a CITROËN dealer.



The ESP/ASR systems offer exceptional safety in normal driving, but this should not encourage the driver to take extra risks or drive at high speed. The correct functioning of these systems is assured providing that the manufacturer's recommendations are observed regarding:

- wheels (tyres and rims),
- braking components,
- electronic components,
- assembly and repair procedures.

After an impact, have these systems checked by a CITROËN dealer.



WEIGHTS (in kg)		
Petrol engine		
Gearbox	Manual	Manual
Model codes: SA...	5FF8	5FD8
- Unladen weight	1 165	
- Kerb weight	1 240	
- Gross vehicle weight (GVW)	1 597	
- Gross train weight (GTW) on a 12 % gradient	1 597	
- Braked trailer (within the GTW limit) on a 12 % slop	0	
- Braked trailer (with transfer of load within the GTW limit)	0	
- Unbraked trailer	0	
- Recommended nose weight**	0	

\*\* See "Practical information - § Towing a trailer".