

Sachs 200 type AZL-R

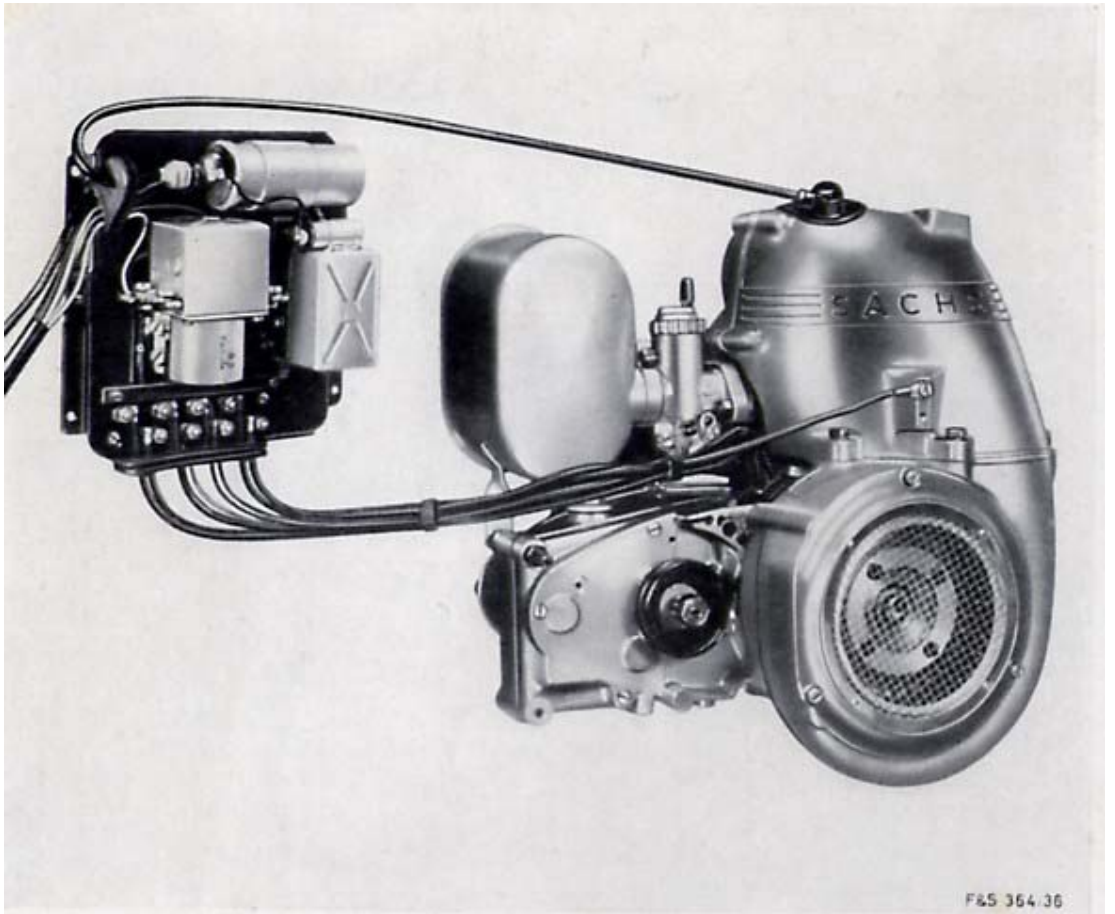

Engine Repair Manual

Robert Soditus

Engine Technical Data – Sachs 200 type AZL-R – For Messerschmitt KR200

Type	Air-cooled single cylinder two stroke engine
Transfer port type	Schnürle loop scavenging
Cylinder bore dia.	65mm
Piston stroke	58mm
Cylinder volume	191cc
Compression ratio	6,3 : 1
Power output	9,7 hp at 5250 rpm
Gearbox	Four speed integrated gearbox
Clutch	Four plate oil bath clutch
Neutral selector	Hand operated lever and cable
Starter system	Dynastarter 12v, 90 – 135 w charging output with electrical reversing gear.
Ignition timing	Forward direction 4,5 – 5,5 mm before TDC. Reverse direction 3- 4mm before TDC
Spark Plug type	Bosch M 225 P11S for normal use.
Carburettor	Bing-Choke carburettor 1/24/87 or 1/24/88
Carburettor settings	Main Jet 120, Needle Jet 1608, Needle position 3, Idle Jet 35, Choke jet 90, Idle adjusting screw 1½ turns open.
Inlet air silencer	Special silencer with wet filter element
Gearbox ratio	Primary drive Crankshaft to layshaft 2,12 : 1 1 st Gear 3,62 : 1 2 nd Gear 1,85 : 1 3 rd Gear 1,24 : 1 4 th Gear 0,86 : 1
Drive chain – mainshaft to rear wheel.	12,7 x 8,2 x 8.51 Roller diameter.

Preface

This procedure is for people who have never overhauled an engine as well as for experienced mechanics. It contains instructions for engine removal, disassembly, inspection, and repair along with helpful hints for easy reassembly. When following these procedures, you should always remember the immortal words of Mike Dan who said,

“You must NEVER let anything mechanical think you are in a hurry.”

All of the operations in this procedure can be accomplished by one person although it is much easier at times if there is someone to help. The procedures presented here may seem tedious and time consuming, but if they are followed, they will result in an engine that is in the best possible condition. It cannot be in perfect condition because new replacement parts are not available in many cases. Wherever possible, worn or damaged parts should be replaced if spares are available from Partsmart.

It is recommended that you read through the entire procedure before starting. This will give you some idea of the overall task and help you to decide what parts you are going to replace and then you can order any parts that will be needed. Try to get everything ready before you start. Some parts cannot be ordered ahead of time because you will not know if you need them until you have the engine completely disassembled. In this case, reassembly of the engine must be delayed until the necessary parts are obtained.

When removing parts always remember the order in which they were removed so that they can be reassembled in the reverse order. When nuts or screws are taken off to remove a part, it is wise to put them back where they came from so they don't get lost and you don't have to remember where they go.

Parts that are removed from the engine should be stored in separate boxes along with the hardware that goes with them. When replacing parts, never throw away the old part. It doesn't matter what shape it is in. It may be repairable and could come in handy some day.

Remember, Messerschmitt engines are 30 to 40 years old. This makes it very difficult to determine the approximate mileage on an engine or how well it has been maintained. You can expect to find many things that need to be changed or fixed.

The engine you are working on has probably been reassembled by someone previously. It may have had changes made to it or it may not have been reassembled properly. It is often wise to question everything you see and then decide for yourself what is the correct thing to do.

This manual is not written as a formal step by step procedure but it is more of a discussion of how to repair an engine. It is desirable to explain why certain adjustments are made and the troubles that can occur if the adjustments are not made properly. When people know the reason for doing something, they are more likely to do it properly. Even though the manual seems quite long, following the steps as listed will enable you to do the job easily and correctly.

The procedures given here are mostly my own. The MOC is not responsible for the accuracy or content of this manual.

I would like to express my appreciation to Dave Garner, Mike Dan, Peter Houghton, Don Anesi and especially Janne Peterson who have offered many useful suggestions.

One of the first rules of troubleshooting and repair is "Don't make things worse." If you feel that you can't do the job properly, take it to a small engine repair shop and let them do it for you.

The most important thing is to work slowly and carefully. It is no fun assembling an engine and installing it in the car only to realize that you forgot something and have to do it all over again. If you don't believe this, ask some of the members who have overhauled engines.

The numbers in parentheses (4-147) are the Plate numbers and the numbers of the parts that are shown in the pamphlet "**List of spares - Sachs 200**" which can be purchased from Partsmart.

In some of the procedures there may be two methods given to perform a task. One is using some of the tools available from Partsmart and the other is without the special tools. The best method is to use the special tools, especially the flywheel holding tool part no. 0419. A complete set of tools for engine work would cost £44.85 (\$73.00 American)

Sometimes a paragraph will be written in Italics. In this manual, italics are used to give additional information and explanations of why adjustments are important. They are usually not a necessary part of the procedures.

The final performance of the engine will be determined by how well the adjustments are made. The KR-200 shop manual gives many dimensions for adjustments that would be made on a new engine. If you are working on an engine that has worn parts or worn gears, the adjustments may be even more critical than specified and should be made to the best of your ability.

Table of contents

<u>Topic</u>	<u>Page</u>
1. Rear bonnet removal.	2
2. Disconnecting the engine.	3
3. Disconnecting the neutral selector cable.	4
4. Removing the engine.	6
5. Engine disassembly.	7
6. Dynastart rotor removal.	8
7. Driving sprocket removal.	12
8. Removing clutch plates.	13
9. Removing the clutch body.	15
10. Shaft endplay.	17
11. Splitting the crankcase.	19
12. Gear alignment and shifting.	20
13. Selector fork adjustment.	23
14. 2nd and 3rd gear alignment.	23
15. Guide plug.	25
16. Making shims.	26
17. Connecting rod and piston.	30
18. Gear inspection.	31
19. Inspection and cleaning.	35
20. Replacing 2nd and 3rd gear.	36
21. Dynastart maintenance and repair.	40
22. Engine reassembly.	50
23. Final transmission assembly.	54
24. Tapered shafts.	54
25. Driving sprocket assembly procedure.	55

Table of contents (cont.)

<u>Topic</u>	<u>Page</u>
26. Crankshaft sprocket.	56
27. Clutch body.	57
28. Thrust pins.	57
29. Serrated clutch hub.	57
30. Clutch plates.	58
31. Magneto system and armature.	59
32. Cylinder.	59
33. Cylinder head.	61
34. Engine timing.	61
35. Fan housing.	63
36. Engine reassembly.	63
37. Installing the engine.	64
38. Teleflex adjustment.	66
39. Rear Bonnet.	67

List of illustrations

<u>Figure No.</u>	<u>Page</u>
1. Flywheel locking tool.	8
2. Armature puller.	9
3. Alternate pulling method.	10
4. Widened woodruff slot.	11
5. Engine cradle.	13
6. Clutch spring compressor.	14
7. Clutch basket wear points.	16
8. Measuring shaft endplay.	18
9. Downshifting into 2nd gear.	20
10. Upshifting into second gear.	21
11. Ratchet action.	22
12. Sliding gear alignment 24	24
13. Guide plug.	25
14. Transmission shim locations.	27
15. Fourth gear alignment.	29
16. Wear due to misalignment.	31
17. Completely ruined gear.	31
18. Small sliding gear.	32
19. Small sliding gear lugs.	32
20. Worn gear teeth.	33
21. Worn 1st gear.	33
22. Mainshaft sliding gear 34	34
23. Scored driving sprocket.	34
24. Sanding the driving sprocket.	35
25. Modified sliding gear.	37

List of illustrations (cont.)

<u>Figure No.</u>	<u>Page</u>
26. Scored layshaft.	38
27. Pressing gear onto layshaft.	39
28. Defective wiring.	41
29. Defective stator coil insulation.	42
30. Stator field coils.	42
31. Armature segments.	43
32. Brush-holder mounting screws and insulation.	46
33. Damaged copper strip.	48
34. Fix for loose wiring.	48
35. Securing stator wiring.	49
36. Stator mounted on the engine.	49.
37. Layshaft and sliding gears.	50
38. Selector bridge orientation.	51
39. Crankcase guide studs.	52
40. Sanding the output sprocket.	55
41. clutch adjustment.	58
42. Measuring piston ring gap.	60
43. Transmission oil level.	66

SACHS 200

ENGINE OVERHAUL PROCEDURES

Manuals needed

List of spares - Sachs 200

KR-200 Manual

Karotips (*useful, but not necessary*)

There are also some tools needed that might not be found in the average workshop.

Special tools

1. Small 3 jaw gear puller.
2. Large puller for flywheel.
3. Vernier calipers.
4. Feeler gauges.
5. Dial indicator (*optional*)
6. Engine cradle.
7. Guide plug.
8. Crankcase studs.
9. 30mm (1 3/16") socket for (4-133).
10. 24mm (15/16") deep socket for (1-29).
11. Ohmmeter.

The following can be purchased from Partsmart.

11. Clutch spring compressor.
Partsmart no. 0414 ----- KR200 manual item 5
12. Clutch holding tools.
Partsmart no. 0405 ----- KR200 manual items 15 & 16
13. Armature extractor.
Partsmart no. 0437 ----- KR200 manual item 22
14. Guide pin tool.
Partsmart no. 0420 ----- KR200 manual item 20
15. Flywheel holding tool.
Partsmart no. 0419 ----- KR200 manual item 8

The following is a list of parts that should be replaced. The numbers are for the illustrations in the list of spares.

<u>Plate & part no.</u>	<u>Description</u>
1-2	Cylinder head gasket.
1-14	Cylinder base gasket
1-10	Carburettor gasket.
1-12	Exhaust gasket.
1-16	Piston rings.
1-22	Crankshaft oil seal <i>(2 required)</i>
2-41	Crankcase gasket
3-77	Crankcase cover gasket.
4-106	Clutch plates <i>(4 Required)</i>
4-110	Set of clutch springs <i>(9 required)</i>
5-173	Pawl spring
8-298	Dynastart brushes <i>(4 required)</i>

Part numbers (2-41) and (3-77) are gaskets that prevent oil leaks and air leaks in the transmission. If you use gasket (2-41), it may tend to get thinner after the engine has warmed up and cooled down many times. The 7 screws that hold the crankcase halves together (*under the armature*) could come loose and damage the armature.

You can cut a little off of the old pawl spring (5-173) which will provide enough tension or you can replace the spring.



1. REAR BONNET REMOVAL

It is not necessary to remove the rear bonnet but it is much easier to work on the engine if the rear bonnet is removed from the car. To do this, you should perform the following steps.

- 1.1. Disconnect the battery.
- 1.2. Disconnect the petrol hose at the carburettor and drain the petrol from the tank.

- 1.3. Disconnect the fuel shutoff lever.
- 1.4. Disconnect the wiring to the rear lights at the terminal strip at the left side of the firewall. Label all wires so they can be properly reconnected.

If some of the wires go directly to the lights, in-line connectors can be installed to make the job easier next time.

- 1.5. Remove the bonnet hinge pins and remove the bonnet.

2. DISCONNECTING THE ENGINE

- 2.1. Remove the air cleaner.
- 2.2. Disconnect the heater pipe and heater control cable.
- 2.3. Disconnect the clutch cable by pushing the *clutch lever (4-116)* forward with a large screwdriver and disconnect the end of the cable.
- 2.4. Remove the clutch cable *adjusting screw (2-45)* from where it is threaded into the side of the engine below the cylinder.
- 2.5. Remove the *cover plate for contact breaker (3-93) (front plate)* and disconnect the wires from the contact breakers. Mark the wires that go to the forward and reverse contacts.

It is not necessary to do this if the neutral selector cable is not going to be disconnected from the engine at this time. (see paragraph 3.7.3)

- 2.6. Disconnect the choke cable from the carburettor. (*screw plug 12-71*).
- 2.7. Remove *rim nut (12-68)* from the top of the carburettor and remove the *throttle slide (12-63)* being careful to place it where *the jet needle (12-64)* can not get bent.

If you haven't got a lock tab for the ring nut, buy one or make one.

- 2.8. Disconnect the Dynastart wiring and battery ground (*earth*) cable. If the ends of the wires are not marked with the proper tags, be sure to label all wires so that they can be properly reconnected.
- 2.9. Disconnect the sparkplug wire.
- 2.10. Disconnect the Teleflex cable from the *gear change lever (5-179)*. The lever can be removed from the transmission at this time if you wish.

3. DISCONNECTING THE NEUTRAL SELECTOR CABLE

- 3.1. Remove the plug from the bottom of the engine and allow some of the oil to drain.
- 3.2. Replace the plug.
- 3.3. Loosen the six (metric 6) screws that hold the *crankcase side cover (3-76)*.

These screws are of three different lengths and must be replaced in the proper locations.

- 3.4. Remove the *gear change lever (5-179)* if it was not removed under paragraph 2.10.
- 3.5. Gently pry the *crankcase sidecover (3-76)* away from the *crankcase half (2-40)* a few millimeters and allow more of the oil to drain and then retighten the bolts enough to prevent more oil from leaking.
- 3.6. Loosen the locknut on *adjusting screw (5-177a)* on the neutral select cable and turn the screw in as far in as possible. This will give provide more "slack" in the cable and make it easier to disconnect.
- 3.7. Separate the sidecover from the crankcase until there is enough space to get at the end of the *neutral selector assembly (5-170)*. Slide the spring on the selector assembly toward the rear of the engine while disengaging the *cable and soldertag (5-177)*.

There are three ways to do this,

- 3.7.1. Disconnect the neutral shift cable in the cockpit and pull the cable back far enough to be able to disconnect it at the engine. Using this method, it will be necessary to readjust the neutral shift cable after the engine is reinstalled.

If the cable is disconnected at the neutral shift lever, solder, braze or melt the end of the cable with a torch so the steel wires do not become frayed.

BE SURE THAT YOU DON'T PULL THE INNER CABLE BACK TOO FAR SO THAT THE FRONT END OF THE CABLE GETS LOST IN THE OUTER SHEATH.

A pair of "vice-grip" locking pliers can be used to grip the forward end of the cable to prevent it from getting lost in the sheath. Slide the spring on the neutral selector assembly toward the rear and disconnect the cable.

- 3.7.2. Force the neutral *actuator arm (5-170)* forward and wedge a large screwdriver behind it to keep it in the forward position. This will allow enough slack for the cable to be disconnected. The front end of the cable does not have to be disconnected at the shift lever in the cockpit which would change the cable adjustment.
- 3.7.3 After trying the first two methods, you will probably find as I have, that it is much easier to disconnect the cable at the shifting lever and pull the entire cable back to the engine. Here it can be coiled up and attached to the engine. The neutral selector cable can be disconnected much easier when the engine is on the workbench. Using this method, you can eliminate steps 3.1, 3.2, 3.3, 3.5, 3.6, and 3.7 and perform them later when the engine is on the workbench.

This is a case where there are three methods of doing something and you should use whichever one you prefer. It is extremely difficult to get at the end of the cable while the engine is in the car. The air deflector hood, primary chain and the clutch basket are all in the way. If you try all three methods, I know you will prefer the third way. It is also easier to drain the oil when the engine is on a workbench and is not as messy as doing it with the engine in the car.

4. REMOVING THE ENGINE

- 4.1. Remove the screw from the top engine mount.
- 4.2. Remove the nut from the front engine mount but let the front mounting bracket remain on the stud.
- 4.3. Before removing the center engine mount, place a block of wood or something under the engine so that if it should fall to the ground, it would not crack the crankcase.
- 4.4. Leave the center engine mount attached to the engine. Remove the two screws that attach the engine mount to the frame. The engine should now be hanging by the center engine mount. Be careful that it does not slip off the frame.
- 4.5. Grasp the engine by the exhaust pipe and the tailpipe and move it to the left so that the center engine mount slips off the fork on the frame. The toothed sleeve (*dogbone*) and the rubber cover will fall off.

Save the pressure spring and plug that are in the toothed sleeve.

You can now slide the front bracket off the front motor mount and set the engine gently on the ground.

BE VERY CAREFUL DURING THIS OPERATION THAT YOU DO NOT BEND THE TELEFLEX CABLE.

5. ENGINE DISASSEMBLY

- 5.1. Remove the silencer and exhaust pipe, saving the *exhaust gasket (1-12)*. Do not hit the *exhaust nut (1-13)* with a hammer and screwdriver. It is made of brass and is easily cracked or damaged. Use a piece of aluminium or brass stock about 5mm x 2cm in cross section and alternately hit opposite sides of the exhaust nut.

The engine can now be placed on a workbench for further disassembly.

- 5.2. Remove the carburettor.
- 5.3. Remove the *air deflector hood (10-372)*.

There should be a *nut (1-7)* and washer on the stud under the hood. This is to prevent bending or cracking the hood when the outside nut is tightened during reassembly. During reassembly, the hood is first bolted on and then by reaching up inside, the inner nut and washer can be wound outward, finger tight against the hood and then the outer nut can be tightened.

A permanent method would be to "jam" two nuts together inside the hood at the proper distance from the cylinder.

- 5.4. Remove the *top cover for fan housing (10-370)*.
- 5.5. Remove the *fan cover with screen (10-362)* and the *fan (10-361)*.
- 5.6. Remove the *cylinder head (1-3)*.
- 5.7. Remove the *fan housing assembly (10-360)*.

If the flywheel locking tool (part no. 0419 listed in special tools) is available and is going to be used, leave this assembly on the engine.

- 5.8. Remove the spark plug.
- 5.9. Remove the four nuts (metric 8)(2-44) and the lockwashers at the bottom of the cylinder. Remove the cylinder and the cylinder base gasket.
- 5.10. Remove the front engine mounting bracket and the center engine mounting bracket.

6. DYNASTART ROTOR REMOVAL

- 6.1. Use the special tool no. 0419 from Partsmart, lock the flywheel and remove *nut (1-33) (right hand thread)* and *springwasher (1-32)* from the crankshaft.

If you do not have the special tool, make one. All you need is a steel bar with two holes drilled for 6mm bolts. Bolt the bar to the flywheel as shown in Figure 1. Make sure that the bolts are no longer than the thickness of the bar plus 11mm. This is 11 full threads. If the bolts go into the armature more than 11mm, they will damage the windings of the rotor.

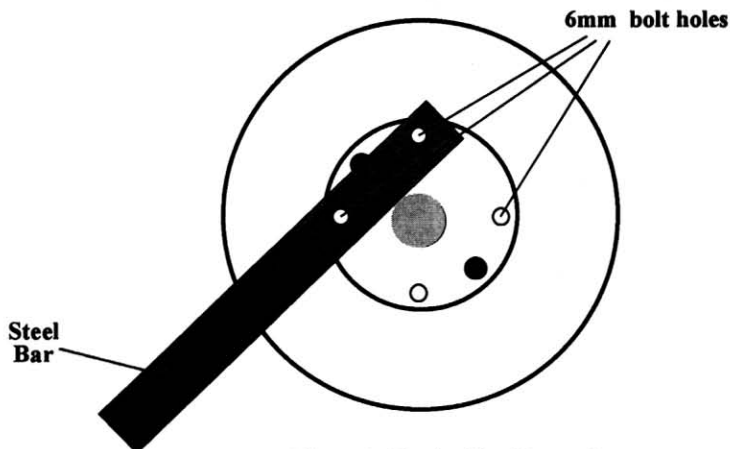

Figure 1. Flywheel locking tool

- 6.2. Keeping the flywheel locked with tool 0419, thread the flywheel extractor tool 0437 into the flywheel. Screw in the center bolt of the extractor to pull the flywheel off.

6.2.1. If you do not have a flywheel extractor, one can be made from a bar of steel or angle iron. The steel should be at least 1/2" thick (13mm) so that it will not bend. Drill holes in the steel for M6 bolts that will attach the puller to the rotor. These bolts should be long enough so that they thread far enough into the armature and will not strip the threads in the armature when pulling. Remember that the bolts do not go more than 11mm into the armature

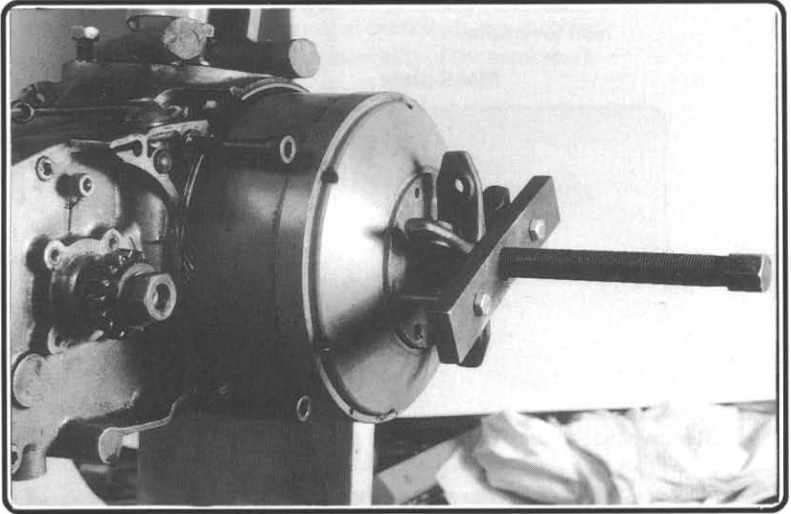

Figure 2. Armature puller

Drill a clearance hole for the center puller bolt. Figure 2. shows the steel bar, the two M6 bolts and the center bolt which is threaded into the crowsfoot of the puller. Remember, the two M6 bolts should not be threaded into the armature more than 11 threads. Turning in the center bolt will pull the armature off.

It should take a lot of force to get the armature off. If it doesn't want to come off when using the commercial puller, "hit" the end of the center bolt with a hammer and then put more pressure on the center bolt. Keep repeating this until the armature comes off.

Remember when using a puller, hammering on the center bolt may drive the shaft against the rollers on the other end of the shaft. This could damage the "race". Try not to hit the puller harder than necessary. Pulling on the shaft while hammering will help protect the race.

If the armature comes off easily, check the taper on the crankshaft and the taper in the armature for dirt, burrs or scoring. The armature should fit very tightly to the crankshaft so that it is hard to remove.

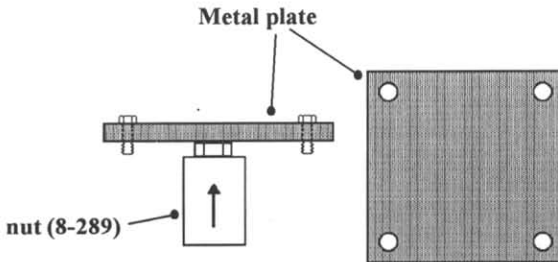

Figure 3. Alternate pulling method.

6.3. Remove the *woodruff key* (1-25) and store it with the armature.

If you forget to remove the woodruff key, it will damage the crankshaft rubber seals when the crankcase halves are separated.

Woodruff keys are not made to "lock" the armature to the shaft. The armature is prevented from slipping on the crankshaft by having a smooth, well-machined taper, good metal to metal contact and a tight nut. If the nut comes loose, the armature will break away from the tapered crankshaft and the soft iron woodruff key will shear off. Now the crankshaft will become badly scored and you will have a real problem. The same is true of the tapered mainshaft and any other tapered shaft.

- 6.4. Check the tapered shaft and armature taper for scoring, burrs and smoothness. Check the fit of the woodruff key in the slot on the crankshaft. Sometimes backfiring of the engine can widen this slot. See Figure 4. In the case of a damaged crankshaft, any machine shop can "mill" another slot on the other side of the crankshaft.

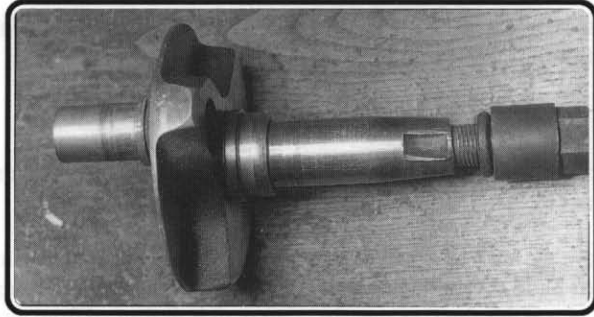

Figure 4 Widened woodruff slot

- 6.5. During reassembly, clean all the oil from the tapered shafts and mating parts. A thin film of oil will prevent a good metal to metal contact and the parts will slip.
- 6.6. Loosen the two wires at the contact breakers if you have not already done so.
- 6.7. Remove the dynastart stator windings (four metric screws) and store it where the carbon brushes can not get broken.
- 6.8. With the crankshaft out of the engine, clamp the crankshaft in a vice between wooden or copper blocks. Put very fine valve grinding paste on the shaft and "lap" the flywheel onto the tapered shaft. Clean everything very thoroughly afterwards.

7. DRIVING SPROCKET REMOVAL

DO NOT REMOVE THE CHAIN FROM THE CLUTCH SIDE AND
DO NOT REMOVE THE CLUTCH PLATES AT THIS TIME

7.1. Shift the transmission into 1st gear.

This is best done by moving the shifting lever forward while turning the gears by hand.

7.2. Remove the *nut (4-147)* and *spring retainer (4-135)* from the mainshaft **(left hand thread)**. Clutch plate pressure will not allow the output shaft to turn at this time because the crankshaft is prevented from moving by the flywheel locking tool. If the nut does not loosen readily, (left hand thread), slight tapping on the wrench (spanner) will jar it loose.

An alternate method can be used if you have spare clutch plates that you have no use for. Take one metal and one cork plate and weld or bolt them together. This will lock the clutch basket (4-105) to the clutch hub (4-134) without relying on clutch plate pressure.

Another method is to grip the output sprocket with good quality locking pliers (mole grip) or clamp the sprocket in a vice to prevent it from turning. (use soft metal in the vice jaws).

7.3. Remove the "cup" that the rubber sleeve was attached to if possible. This is very difficult with the sprocket still on the shaft. Try not to bend the cup too much when removing it. When the cup is removed, you can cut away part of the inside between two of the mounting holes so that it will slip over the sprocket teeth during installation and removal. If you can, try to remove the sprocket before you remove the cup.

7.4. Remove the *driving sprocket (4-146)*. Here you will need the small 3 jaw puller (3 inch).

The sprocket should be very hard to get off. Keep putting pressure on the puller bolt and hitting it with a hammer to jar it loose until it comes off. Go very easy with the hammer so the bearings at the back of the mainshaft are not damaged. Repeated rapid tapping with the hammer will cause enough vibration to loosen the sprocket. If the puller is left on with pressure for a period of time, (a few hours), it will usually pop off by itself. As a last resort, the sprocket can be heated with a torch while the puller is applying pressure but this should not be necessary.

8. REMOVING CLUTCH PLATES

There are 2 ways to do this.

Using the first method, it is not necessary to remove the *clutch adjusting screw (4-113)* which would disturb the clutch adjustment.

A wooden cradle should be made so that the engine can be positioned on its side for ease of working. See Figure 5. Two blocks of wood will do almost as well.

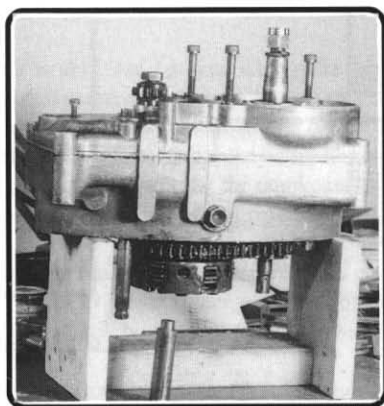

Figure 5. Engine cradle.

8.1. First method

- 8.1.1. Place the engine on its left side, on the cradle, under a drill press.
- 8.1.2. Place a large socket or cylinder over the *spring plate for clutch (4-109)* and, using the drill press as an arbor press, depress the *clutch springs (4-110)*.
- 8.1.3. Remove the clutch plate retaining clips *locking plate for clutch (4-112)* and release the pressure on the clutch springs.
- 8.1.4. Save all parts. (*9 springs, 3 spring cups (4-111) and 2 locking plates (4-112)*).
- 8.1.5. Remove the clutch plates.
- 8.1.6. Remove the three clutch push rods, thrust *pins (4-121)* and *roller (4-122)*.

8.2. Second method

Another way to remove the clutch plates is to use a clamping device that can be purchased from Partsmart (part no. 0414).

You can make your own clamping device from a piece of steel about 6cm square and at least 5mm thick. This is shown in Figure 6. Drill a clearance hole for a 6mm bolt.

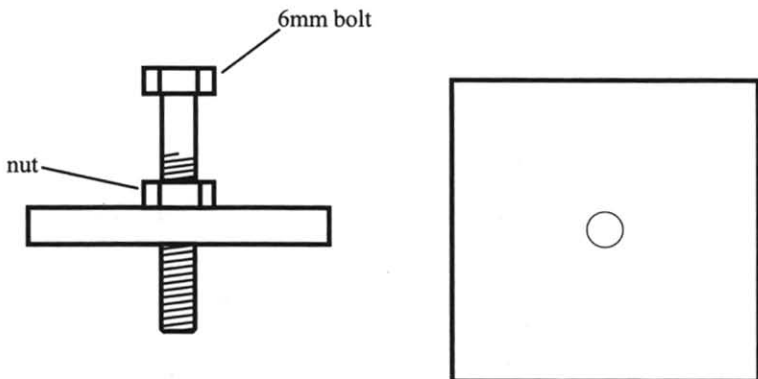

Figure 6. Clutch spring compressor.

- 8.2.1. Remove the *clutch adjusting screw (4-113)*.
- 8.2.2. Put a nut on the bolt, pass the bolt through the plate and thread it into the *clutch pressure plate (4-108)*.
- 8.2.3. Hold the bolt so it can't turn and screw down the nut. This will compress the springs.
- 8.2.4. Complete the steps starting at 8.1.3.
- 8.2.5. Remove the clamping device.

Do not allow the clamping device to keep the clutch springs depressed for a long period of time while working on the engine. This will take the tension out of the springs.

- 8.2.6. Measure the length of the springs.
If they are less than 20mm long, they should be replaced.

9. REMOVING THE CLUTCH BODY

- 9.1. Loosen the *nut (4-136)* on the *layshaft (4-124)*. **(right hand thread)**.

Use the special clutch holding tools from Partsmart part no. 0405 to keep the *clutch body (4-134)* from turning.

Another way to do this is to shift into 1st gear. Clamp the driving sprocket in a vice. Be sure to use soft metal in the vice jaws (brass or aluminium) to prevent damage to the sprocket teeth. These teeth mesh with the toothed sleeve and are not as critical as gear teeth but they should not be unnecessarily damaged. Now loosen the nut while holding the crankcase to prevent it from twisting. (Instead of a vice, you can use mole grip pliers if you have them.)

Useful clutch holding tools can be made from old clutch plates. Weld or bolt a handle to a cork (inner plate 4-106) to make a tool that will "lock" the clutch body (4-134) when removing nut (4-136).

If you have a spare metal outer plate (4-107), you can make a tool to lock the clutch basket (4-105).

- 9.2. Before removing the clutch body, check the *ball bearing sleeve assembly (4-131)*. Wash out any dirt with petrol and check that the bearing spins smoothly with very little friction. Check for wobble of the clutch body. If the top of the clutch basket can be moved more than 3mm from side to side, the bearing should be replaced. Make sure the *nut (4-133)* is tight when doing this so you know the wobble is due to a bad bearing and not due to a loose nut.
- 9.3. Examine the clutch basket, (*clutch body (4-105)*) for wear at the points where the metal lugs on the clutch plates lock into the basket. If deep notches are worn into the basket, they should be welded and filed smooth. Figure 7 shows a clutch basket that has been repaired.

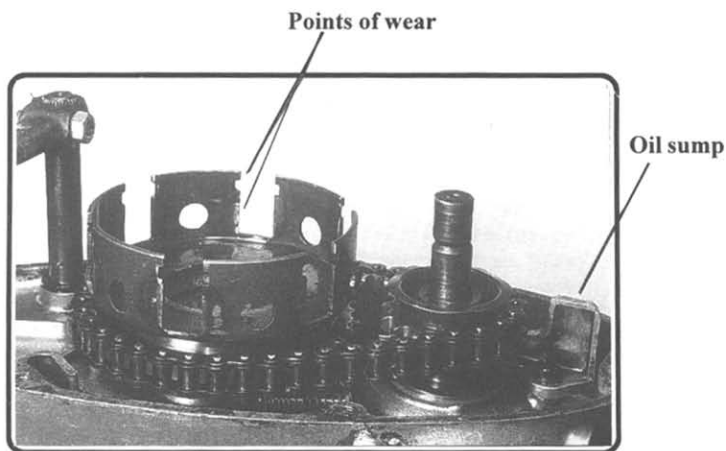

Figure 7. Clutch basket wear points.

- 9.4. Check the chain tension. The chain should not be tight but should be able to be deflected no more than 5mm in either direction from a stretched position.
- 9.5. Remove the serrated clutch hub (*clutch body 4-134*) by gently prying up with two screwdrivers.

DO NOT damage the bottom of the clutch basket with the screwdrivers. If the clutch hub will not come off easily, it can be removed later when the transmission case is separated.

After the transmission halves are separated, the nut (4-136) can be partially threaded onto the layshaft (4-124) and carefully tapped with a hammer. Tap only enough to loosen the clutch hub. Driving it too far will drive the clutch basket ball bearing (4-131) into the gear case. This is no problem because it can easily be reinserted.

If new washers, bearings, or oil seals are to be installed, or gear alignment has to be corrected, new washers (shims) will have to be made and these readings will not be valid. They will however, give some indication of approximately how much the thickness of the spacers will have to be changed.

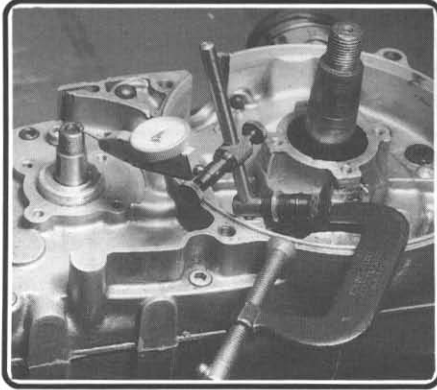

Dial Indicator

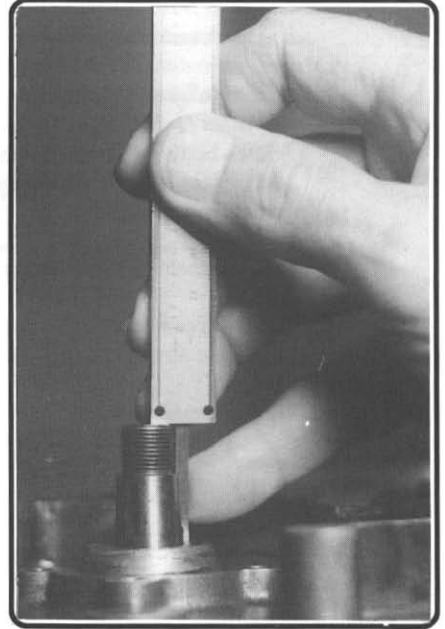

Vernier caliper

Figure 8. Measuring shaft endplay.

	<u>Recommended endplay</u>	<u>Actual measurement</u>
Mainshaft (rear)	.10-.20mm (.004"-.008")	_____
Layshaft (center)	.05-.10mm (.002"-.004")	_____
Crankshaft (front)	.10-.20mm (.004"-.008")	_____

This "shaft endplay" is determined by the spacers placed at the ends of the shafts.

It is extremely important to keep track of where the spacers were located in the transmission so that they can be installed in the proper locations during reassembly.

If they get "mixed up", you will have to reassemble the transmission many times while trying different combinations of spacers (*with the proper gasket installed*) to get the desired endplay.

11. SPLITTING THE CRANKCASE

- 11.1. Remove the seven M6 screws from around the crankshaft and the M6 from the rest of the transmission case.
- 11.2. Carefully separate the crankcase halves and allow the remaining oil to drain.

Make sure the woodruff key is removed from the crankshaft before splitting the transmission case.

- 11.3. Set the crankcase (*on its cradle*) on a clean surface so that no parts (*usually roller bearings*) can get lost.
- 11.4. Hold the mainshaft and gently lift the top half of the transmission case while sliding the mainshaft out of the *sliding gear (4-138)* and sliding the *magneto side of the crankcase (2-42)* off of the crankshaft.
- 11.5. Remove the mainshaft from the transmission case being careful not to lose the fifteen *rollers (2-64)* and check for any *shims (2-60)*.
- 11.6. Check to see what spacers are at the bottom ends of the mainshaft and the layshaft. Mark these spacers and store them until reassembly.
- 11.7. Collect the roller bearings from the layshaft (*13 total*) and store them.
- 11.8. Measure the thickness of the crankcase gasket (2-41). It will have to be replaced with a gasket of the same thickness if the same end spacers are going to be used. This is necessary to maintain the proper endplay of the shafts.

It is possible to reassemble the engine without using gaskets and use only jointing compound. This will work if the mating parts are absolutely flat. The crankcase halves and especially the cylinder head and cylinder must not be warped. You can put some grinding paste on a thick piece of flat glass and "lap" the surfaces until they are smooth and even. Not having a cylinder head gasket will increase the compression ratio giving slightly more power but possibly more trouble if not done properly. I prefer using gaskets and gaskets of the size supplied by Partsmart. I know I can always get them.

12. GEAR ALIGNMENT AND SHIFTING.

Before dismantling the engine any further, a few things should be checked such as shifting and gear alignment.

CHECK THE SHIFTING

- Place the *gear change lever (5-179)* on the gear change shaft and try to shift through all four gears. It is easier to shift if the gears are rotated by hand while doing this so they can align themselves with the lugs on the layshaft.

12.1 Selector fork movement.

While shifting, see if the pawl on the *neutral selector assembly (5-170)* engages fully in the detents on the *selector fork assembly (5-166)*. See figure 9. Figure 9 shows the selector fork assembly moving far enough for the pawl to drop into second gear when downshifting. When downshifting from 3rd to 2nd gear, hold the gear change lever hard against the stop and look at the selector fork assembly and the pawl. They should look something like figure 9. You can see that the pawl is well into the second gear notch of the selector fork assembly. When the gear change lever is released, the spring on the pawl will cause the selector fork assembly to move the rest of the way into second gear.

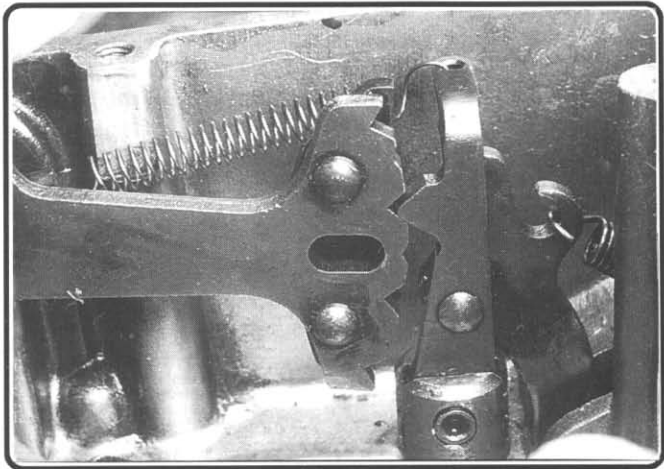

Figure 9. Downshifting into 2nd gear.

Figure 10 shows the selector fork assembly when shifting upward from 1st to 2nd gear. The pawl is just about the same distance into the notch.

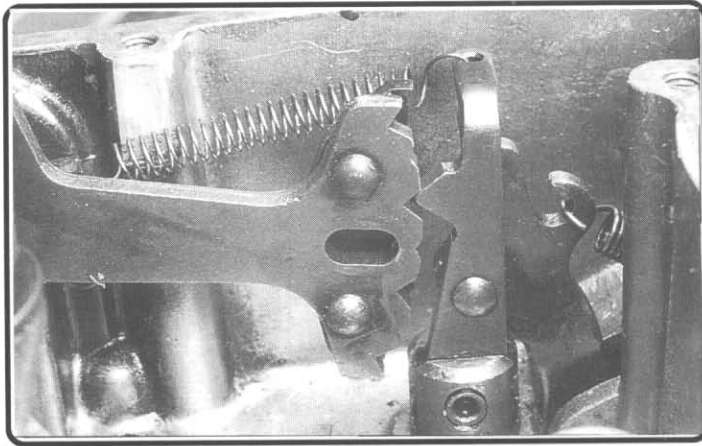

Figure 10. Upshifting into second gear

Here you are looking for positive action when changing from one gear to the next while shifting both upwards and downwards.

Check the position of the pawl when shifting upward into the 3rd gear notch and again shifting downward into the notch from 4th gear. They should both appear to be the same.

If the *selector fork assembly (5-166)* doesn't appear to move far enough for the pawl to be well into the notch, you can get a little more travel by filing notches in the *carrier plate assembly (5-160)* where the pin on the end of the *gear change shaft (5-150)* hits the stop. See Figure 11.

12 .2. Ratchet pawl action

The next thing to check is the action of the *pawl (5-152)* on the *ratchet lever assembly (5-159)*. While operating the gear change lever, make the pawl move over one tooth on the ratchet. Holding the gear change lever hard against the stop, there should be a slight clearance between the pawl and the next tooth on the ratchet. See figure 11.

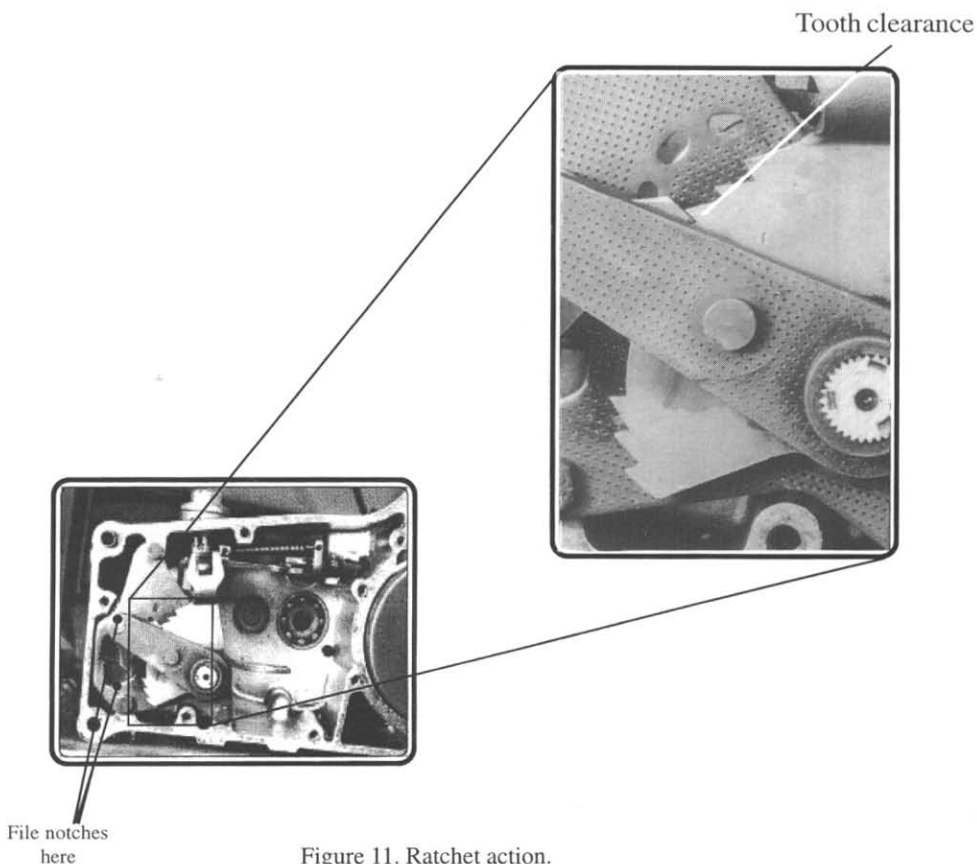

Figure 11. Ratchet action.

It is easier to see this clearance if the right hand screw (5-157) is removed allowing the *stop lever* (5-155) and the *stop bracket* (5-154) to be taken off. The other two screws will keep the carrier plate in position.

Figure 11 has the *stop lever* (5-155) and the *stop bracket* (5-154) removed so it can more easily be observed. Shift in the opposite direction, moving the pawl over one tooth and the clearance in the other direction should be the same. The service manual says there should be .1mm to .3mm clearance. If it is the same in both directions, the *carrier plate* (5-160) is properly positioned. You may not get any clearance when you try this but it doesn't matter as long as it is the same in both directions.

If the clearances are different, the 3 screws holding the *carrier plate* (5-160) should be loosened and the plate moved (*rotated or shifted*) to get equal clearances.

What you are looking for here is a positive ratcheting action when shifting upwards and shifting downwards. If you wish to, you can drill the three holes in the carrier plate a little larger but don't overdo it.

- 12.3. After you get the proper clearances, it is wise to take a prick punch (*center punch*) and mark the carrier plate and the transmission housing at each of the three screws. Now, every time the carrier plate is removed, it can be exactly

13. SELECTOR FORK ADJUSTMENT

- 13.1. If the carrier plate required some adjustment, go back and check the selector fork movement in paragraph 12.1 and the ratchet pawl action para. 12.2.
- 13.2. If there is any problem with the pawl on the *neutral selector (5-170)* dropping into the detents on the *selector fork assembly (5-166)* when shifting in both directions, the neutral selector assembly should be repositioned. This is accomplished by adding or removing *eccentric shims (5-171)*. This will move the pawl back or forth to align with the detents on the selector fork assembly. If eccentric shims are changed, recheck the selector fork operation in paragraph 12.1.
- 13.3. Check the tension on the *tension spring for pawl (5-173)* to make sure it is strong enough to keep the pawl from jumping out of the detent. A weak spring can cause jumping out of gear problems. It would be wise to replace the spring just to be on the safe side or at least shorten it to provide more tension.

14. 2ND AND 3RD GEAR ALIGNMENT

- 14.1. Check the alignment of the inner lugs on *sliding gears (4-126 & 4-127)* with the lugs on the *layshaft (4-124)*.

The distance between the lugs on the layshaft is 30.00mm (1.181") and the outside faces of the gears are 28.9mm (1.138") apart. This leaves .55mm (.022") clearance on each side of the sliding gear when it is exactly centered between the lugs.

With the transmission shifted into neutral (*between 2nd and 3rd gear*), it should just be possible to slide a .55mm feeler gauge between the face of the sliding gear and the lug. See figure 12. This figure shows the shafts and the gears out of the transmission and shows where to place the feeler gauge.

With the gears in the transmission, taking out the oil drain plug will enable you to see the position of the gears.

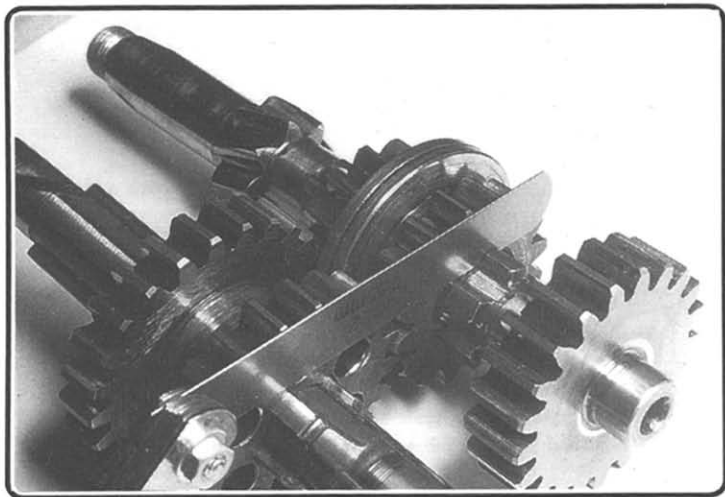

Figure 12. Sliding gear alignment

Now when the gears are shifted to 2nd and 3rd gear, the sliding gear will move the same amount in each direction and the inner lugs on the sliding gears will be aligned with the lugs on the layshaft. This will provide maximum bearing surface with the lugs on the layshaft and will also reduce the chance of slipping out of gear.

The measurements with the feeler gauge should be made with the gears in the transmission and the layshaft pushed in against the layshaft thrust bearing (4-130).

If the clearance is more than or less than .55mm, the layshaft will have to be shifted by changing the thickness of the thrust washer for layshaft (4-130).

- 14.2 To check 2nd and 3rd gear alignment, the layshaft must be installed WITH the thrust washer (4-130). Also install the mainshaft (4-137), large loose gear (4-139), any spacers under the large loose gear, bush 4-140), sliding gear (4-138) and the selector bridge (5-167).

The loose gears on the layshaft are held together loosely by the selector bridge and tend to "flop around". This makes it hard to get an accurate measurement. Turn the mainshaft with the transmission in the normal position (shafts horizontal). This will allow the sliding gears on the layshaft to seek their centered position. Now the .55mm feeler gauge should be able to be inserted without moving the sliding gear. Make sure that the layshaft is moved all the way in against the thrust washer when doing this.

15. GUIDE PLUG

The dimension "B" is slightly less than the mainshaft diameter. The "A" dimension should be long enough to pass through the roller bearings, through any spacers and half way into the large loose gear.

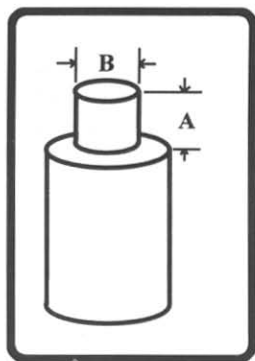
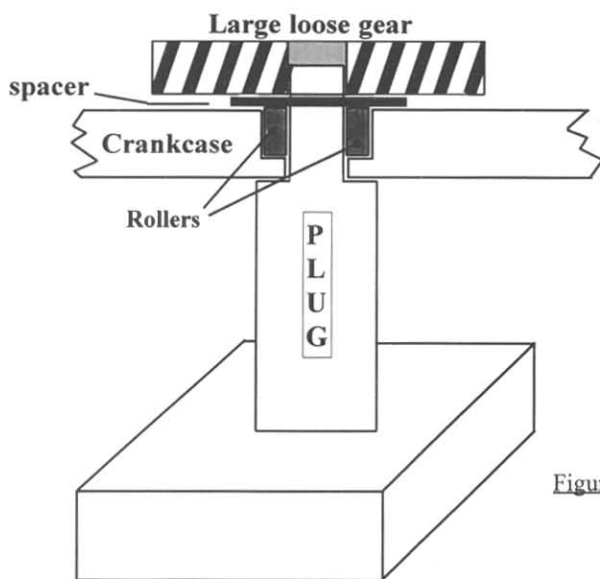

Figure 13. Guide plug

16. MAKING SHIMS

Shims may also be called washers or spacers. They are used to obtain the proper "end-play" of the shafts in the engine. These shims are for the crankshaft (1-20) and the crankshaft sprocket (1-24). The shims (1-20) are used to obtain the proper crankshaft endplay. Shims (1-24) are used to align the small sprocket on the crankshaft (1-26) with the sprocket on the clutch body (4-105).

Other shims are the layshaft thrust washer (4-130) and at the top of the layshaft (4-128), the mainshaft (4-141), (4-142a) and (4-144). There should also be a spacer under the large loose gear (4-139) to prevent the gear from rubbing on the crankcase.

Some of the shims can be purchased from Partsmart no. 1604 but in many cases, they are not the required thickness and must be hand made. A surface grinder would make the job easier but unfortunately very few of us have access to such a machine.

These spacers should be made from mild steel flat washers. Drill and file the inside diameter to fit the shaft. File down to the proper outside diameter and then file to the approximate thickness. (slightly thicker). The final thickness is obtained by placing sandpaper or emery paper on a flat surface and rub the spacer until the proper thickness is obtained. Sandpaper can be "glued" to two pieces of flat glass and the spacer rubbed between them. Double sticky tape can be used to stick the sandpaper to the glass. Use a Micrometer to check for "high spots" and keep sanding until it is the same thickness all around. These spacers fit loosely between the gears and the shaft-end roller bearings and do not have to be perfect. There should be no wear on these spacers during use.

The shims necessary for positioning the shafts are shown in figure 14.

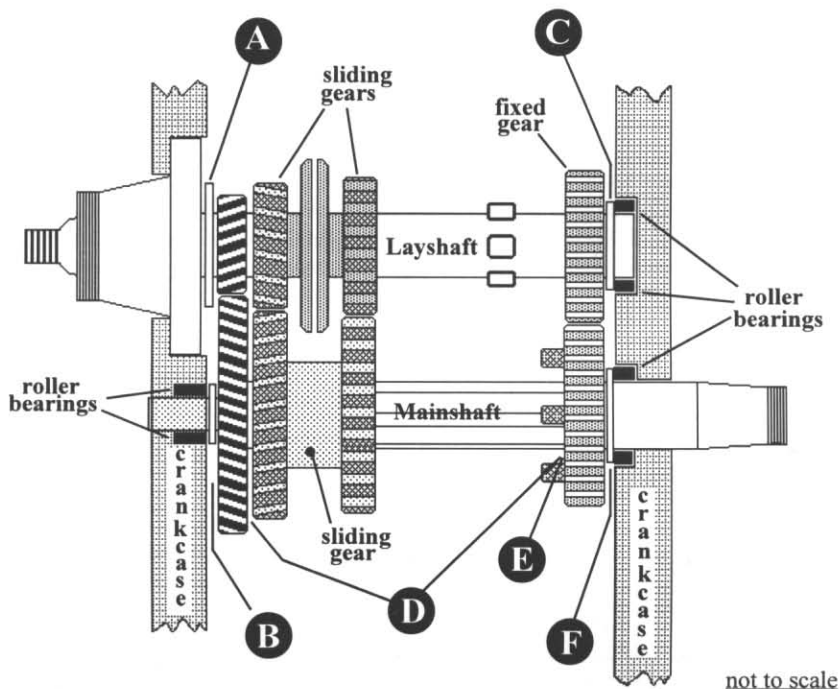

Figure 14. Transmission shim locations.

A Layshaft Thrust Washer (4-130).

This washer should ride on the inner race of ball bearing sleeve assembly (4-131) and its outside diameter should be the same size as the inner race of the bearing. The thickness should be ground (filed) to a size that will position the layshaft to obtain the clearance of .55mm described under "2nd & 3rd gear alignment paragraph 14.1.

B Large Fixed Gear Spacer

Make a spacer for under the large loose gear that is thick enough so that the teeth on the large loose gear do not rub on the layshaft thrust washer. If it is made too thick, it may move the mainshaft out too much which later could cause the 4th gear on the mainshaft to bind when the crankcase halves are firmly bolted together. Make it only thick enough so that the large loose gear just "clears" the layshaft thrust washer.

This spacer (*shim*), along with shims (4-128) and (4-144) will ride on the rollers. The outside diameter of these shims should be a little less than (shaft diameter + 8mm). If it is slightly less, it will not completely cover the rollers and transmission oil can more easily get into the rollers and wash out any dirt that may accumulate.

Check the alignment of the large loose gear (*1st gear*) with the helical gear that is part of the layshaft. Figures 16 and 17 show the type of uneven wear that can occur on gears that are not properly aligned.

C Fixed gear shim

The *shim* (4-128) sets on top of the *fixed gear* (4-125). This shim should have an inside diameter to fit the layshaft and an outside diameter that is 8mm greater. When the crankcase is being reassembled, the rollers will be placed on top of this shim and if it is too narrow, the rollers will fall off.

This shim should have a thickness to provide a shaft endplay of .05mm to .10mm. This is with the layshaft thrust washer and the proper thickness gasket installed. Gaskets supplied by Partsmart are .2mm (.008") thick.

Shims that are placed on the rollers can have holes drilled in them to allow oil to pass through like the original shims. These would be the shims marked B, C and F in figure 14. The ID should be drilled large enough to fit over the shoulder on the layshaft. If the layshaft is pressed too far onto the layshaft, the shoulder can cause interference.

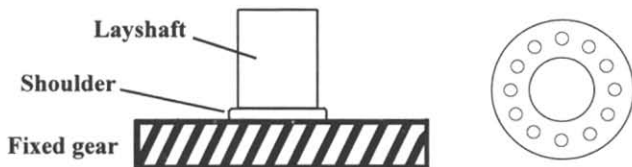

D Mainshaft thrust washers.

There are two thrust washers on the mainshaft. One fits into the recess on the large loose gear, *thrust washer* (4-141) and the other fits in the recess on the small loose gear, *thrust washer* (4-142a). The purpose of these washers is to keep the gears from rubbing directly on the ends of the splines of the mainshaft.

E Additional mainshaft washer.

An additional washer could be used with (4-142a) to provide better 4th gear alignment.

With all the gears, *selector bridge* (5-167), and washers installed, shift into 4th gear. The *sliding gear* (4-138) will lock into the ***small loose gear*** (4-142) and raise it to the level of *fixed gear* (4-125). These two gears should be in alignment. Figure 29 shows a case where the small loose gear is lower than the fixed gear.

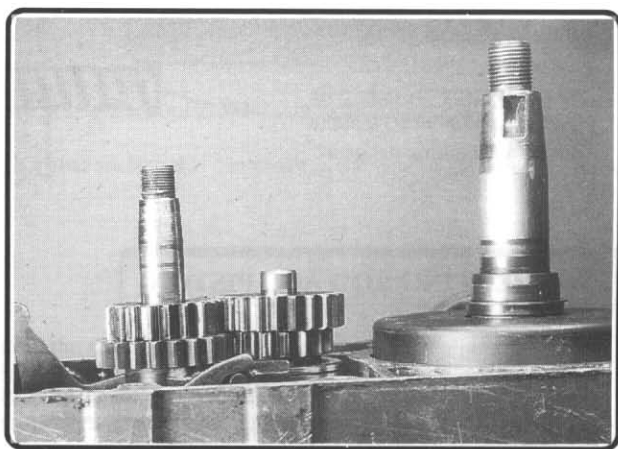

Figure 15. Fourth gear alignment.

CAUTION:

If this additional washer is made too thick, it could cause binding when the crankcase halves are tightly bolted together (*with the proper crankcase gasket installed*) and the mainshaft will not turn freely. It could also cause the *sliding gear* (4-138) to rub on the *fixed gear* (4-125) so check to see if there is enough clearance.

If there is some rubbing, use a thinner “additional washer” or no washer at all and lower the *fixed gear* (4-125) by pressing it farther onto the layshaft.

F Mainshaft output *shim* (4-144).

This is the last shim required and it should have an outside diameter of (mainshaft diameter + 8mm). This would just cover the 4mm rollers around the mainshaft. If it is a slightly smaller diameter, transmission oil can more easily get to the rollers providing better lubrication and flushing out any grit or foreign matter.

The thickness of this shim will determine mainshaft endplay which should be .1mm to .2mm.

If the shaft has a "shoulder", make sure the hole in the spacer is large enough to fit over the shoulder so that the spacer is touching the gear.

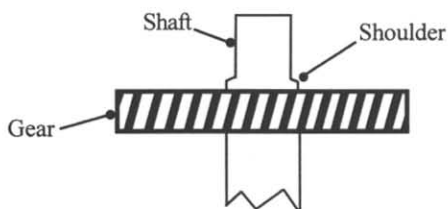

17. CONNECTING ROD AND PISTON

Now that the engine is dismantled, it would be wise to have someone check the cylinder, connecting rod, piston and crankshaft. Changing a connecting rod is beyond the scope of this manual and should be performed by a good Motorcycle or small engine repair shop.

The things to have the shop look for are,

1. Scored piston or cylinder walls.
2. Cylinder "out of round".
3. Excessive play in small end bush (1-30)
4. Big end bush.
5. Worn crankshaft bearings and seals.

Steel connecting rods from a Kawasaki 250 moto-cross engine can be machined to fit if you can't get a Sachs part. When changing the connecting rod, the crankshaft must be split and reassembled so that the both ends of the crankshaft are in-line with each other. This is done with two dial indicators to check the runout of the shafts and is beyond the capabilities of the average workshop.

18. GEAR INSPECTION

Figure 16 shows wear on the teeth of the *large loose gear (4-139)*. The wear is not across the full face of the tooth because the gears were offset due to improper shims.

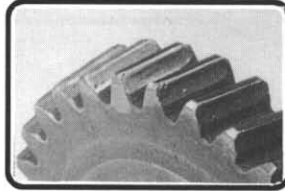

Figure 16. Wear due to misalignment

Running with a gear such as this can result in the type of catastrophic failure shown in figures 17.

Figure 17 shows the results of gears that are not properly aligned. In this case, both gears were damaged beyond repair.



Figure 17. Completely ruined gear.

Figure 18 shows a worn *small sliding gear (4-127)* compared to a new gear. Notice the wear and rounded corners on the locking lugs in the center of the gear. The new gear has lugs with nice squared edges. The main cause of this is grinding the gears while shifting. This is caused by shifting at too high an engine speed or improper clutch adjustment. (*clutch not fully disengaging*). Worn lugs will also cause jumping out of 2nd and 3rd gear.

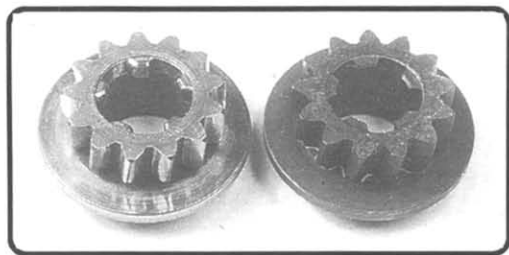

Figure 18. Small sliding gear.

Figure 19 shows a small sliding gear with the inside lugs worn to the point where the gear is unusable. It would be impossible to keep this gear from jumping out of gear under load.

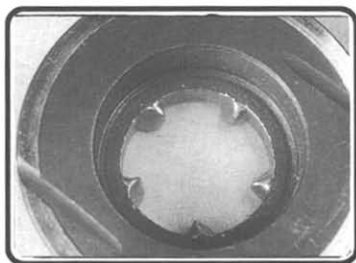

Figure 19. Small sliding gear lugs.

The gear shown in figure 20 has worn lugs on the inside and the teeth are worn. This gear should be replaced if possible. Since the teeth on this gear are worn, the teeth of the sliding gear on the mainshaft probably are just as bad and that gear should also be replaced.

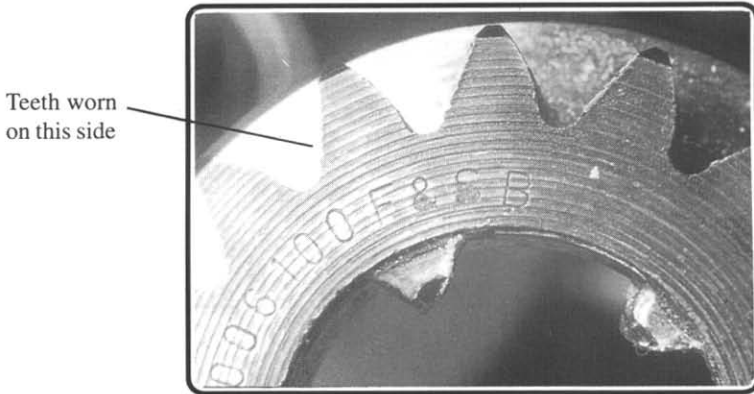

Figure 20. Worn gear teeth.

Gear teeth have a shape (curve) which allows the tooth of one gear to “roll” on the tooth of the mating gear. There is no sliding action. Once the teeth are worn as in Figure 20, there will be a sliding action and the teeth will wear much more rapidly.

The layshaft in figure 21 shows wear on the teeth of the first gear. You will have to live with this unless you can find a better "used" layshaft to replace it.

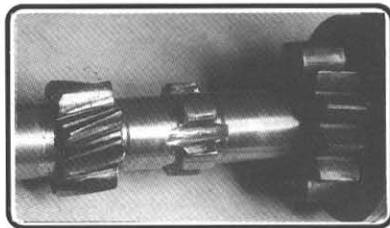

Figure 21. Worn 1st gear.

Figure 22 shows a mainshaft sliding gear with holes that are worn on one side. The wear is getting bad enough to cause the sliding gear to slip off of the lugs on the large loose gear. This wear is caused by jumping out of first gear, downshifting at too high an engine speed or shifting before the clutch is fully disengaged. Improper clutch adjustment will also cause this.

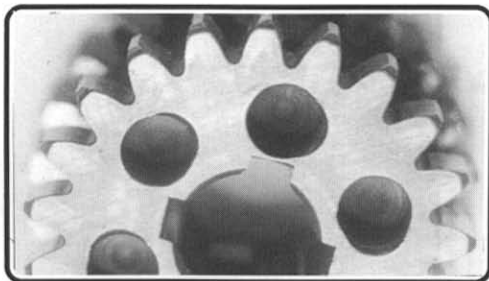

Figure 22. Mainshaft sliding gear.

The inside of the driving sprocket in figure 23 has become "scored", because it slipped on the mainshaft and It should be sanded smooth to eliminate any burrs or high spots.

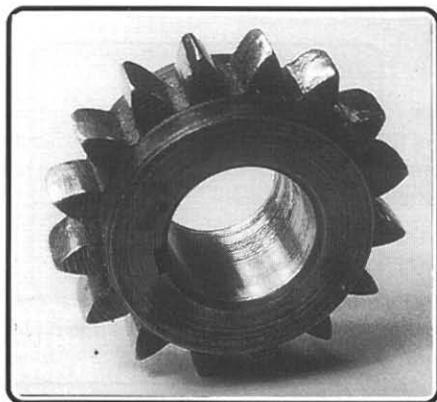

Figure 23. Scored driving sprocket.

If a tapered shaft is scored, it should be repaired before reassembly. Figure 24 shows how to do this. Do not try to file the tapered shaft or the sprocket because you could change the taper. Place a small piece of emery paper on the tapered shaft and slide the sprocket onto the paper as shown in figure 24. Turning the sprocket back and forth should remove any burrs without appreciably changing the taper. After removing all the high spots, fine valve grinding compound can be placed on the parts and they can be lapped together. The inside of the sprocket or the tapered shaft cannot be "reground" in a machine shop because the sprocket would slide too far onto the shaft and be touching the crankcase.

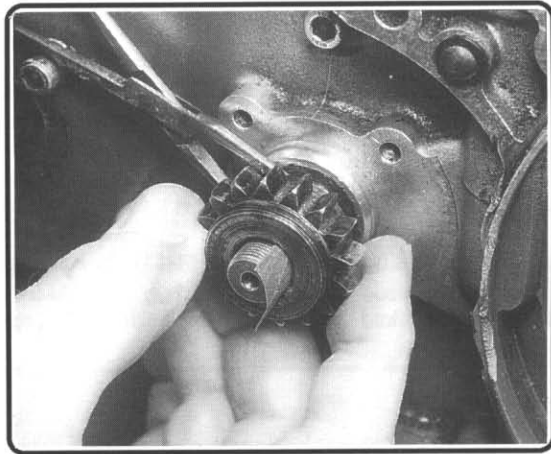

Figure 24. Sanding the driving sprocket.

19. INSPECTION AND CLEANING

When the engine is completely disassembled, all parts should be inspected and cleaned. Any worn or damaged parts should be replaced if new parts are available.

- 19.1. The top and bottom of the cylinder should be cleaned of all dirt and pieces of old gasket. Check for flatness of the mating surfaces using a straightedge.
- 19.2. Clean the carburetor mounting surface.
- 19.3. Clean the carbon from the exhaust port using a scraper and wire brush. Clean the exhaust nut threads.

- 19.4. Clean the carbon from the cylinder head and spark plug threads.
- 19.5. The piston rings are going to be replaced so remove the old rings and clean out the grooves in the piston. A broken piston ring can be used to scrape out the grooves in the piston.
- 19.6. Run an 8mm tap in the headbolt holes to clean out the dirt. Make sure that you do not remove any metal, just the dirt.
- 19.7. Clean the crankshaft bearings (1-21) by washing out with petrol. If bearings are going to be replaced, use NJ205 or NJ205EC3 bearings.
- 19.8. Replace the oil seals for crankshaft (1-22). New rubber can be installed in the old seals if you wish to do so and the old seals are not rusted.
- 19.9. Clean the crankcase halves of all dirt and metal filings.
- 19.10 Clean the edges of the crankcase and check for warpage using a straightedge.
- 19.11 Clean the ball bearing sleeve assembly (4-131) by washing out with petrol.
- 19.12 Insert the layshaft into the bronze bearing bush (4-131a) and check for excessive play.

20. REPLACING 2ND AND 3RD GEAR

If the sliding gears on the mainshaft and layshaft need to be replaced, the fixed gear (4-125) must be removed. This gear is "pressed" onto the layshaft and is very difficult to remove. An arbor press should be used to push the layshaft out of the gear. Before removing the gear, measure the distance from the face of the gear to the end of the layshaft. If the gear can be pressed back onto the layshaft at this same distance, the same spacers (shims) that were used to adjust shaft endplay can be reused.

New sliding gears (4-126) (4-127) and (4-138) can be purchased from Partsmart. Do not replace only one of the gears because there will be new gear teeth meshing with worn gear teeth which will cause excessive wear in a short period of time.

I replaced the 2nd and 3rd sliding gear with new gears. The new gears would not slide over the lugs on the layshaft and were binding quite badly. There are 5 lugs on the layshaft that lock into the sliding gear. The sliding gear should move smoothly over the lugs when the gear is rotated through all five positions.

It may be necessary to grind or round the sharp edges of the new gears with a stone until they slide easily over the layshaft lugs. The lugs on the layshaft probably show some wear but need not be touched. Both sliding gears should move easily on the layshaft as a unit. If this is not done properly, it will be difficult or even impossible to shift gears when the engine is put back in the car. The gears can also be damaged if they do not slide into position easily.

- 20.1. After measuring the position of the *fixed gear* (4-125) on the layshaft, remove it using an arbor press. A large gear puller can be used but it may take a lot of hammering to slowly work it off of the shaft.
- 20.2. Fit the new gears to the layshaft making sure that they smoothly engage the lugs on the layshaft.
- 20.3. Grind the lugs on the new gears until they fit loosely on the layshaft. Figure 25 shows a new gear with the inside face of the lugs that have been ground away. Try to grind the same amount off of each of the five lugs.

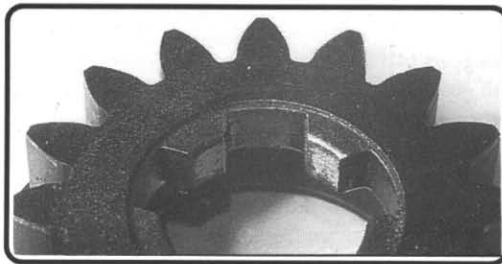

Figure 25. Modified sliding gear.

The gear in figure 25 was initially put on the layshaft without grinding and appeared to work smoothly. When the engine was assembled and put in the car, the transmission didn't seem smooth enough. After dismantling the engine again, it was noticed that the layshaft was scored by the sliding gear.

I replaced the 2nd and 3rd sliding gear with new gears. The new gears would not slide over the lugs on the layshaft and were binding quite badly. There are 5 lugs on the layshaft that lock into the sliding gear. The sliding gear should move smoothly over the lugs when the gear is rotated through all five positions.

It may be necessary to grind or round the sharp edges of the new gears with a stone until they slide easily over the layshaft lugs. The lugs on the layshaft probably show some wear but need not be touched. Both sliding gears should move easily on the layshaft as a unit. If this is not done properly, it will be difficult or even impossible to shift gears when the engine is put back in the car. The gears can also be damaged if they do not slide into position easily.

- 20.1. After measuring the position of the *fixed gear* (4-125) on the layshaft, remove it using an arbor press. A large gear puller can be used but it may take a lot of hammering to slowly work it off of the shaft.
- 20.2. Fit the new gears to the layshaft making sure that they smoothly engage the lugs on the layshaft.
- 20.3. Grind the lugs on the new gears until they fit loosely on the layshaft. Figure 25 shows a new gear with the inside face of the lugs that have been ground away. Try to grind the same amount off of each of the five lugs.

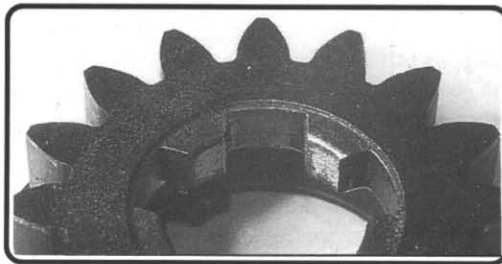

Figure 25. Modified sliding gear.

The gear in figure 25 was initially put on the layshaft without grinding and appeared to work smoothly. When the engine was assembled and put in the car, the transmission didn't seem smooth enough. After dismantling the engine again, it was noticed that the layshaft was scored by the sliding gear.

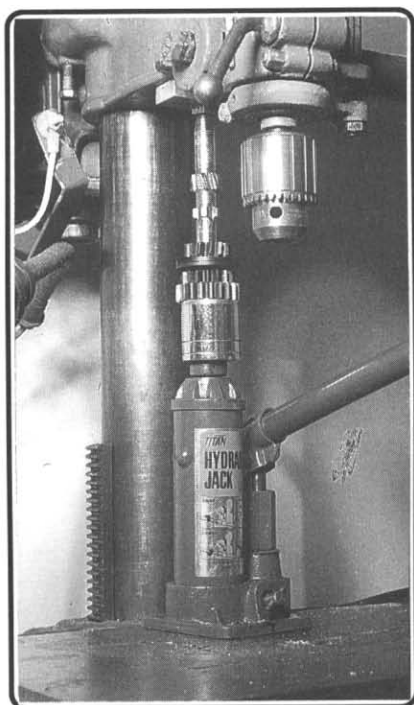

Figure 27. Pressing gear onto layshaft.

21. DYNASTART MAINTENANCE AND REPAIR

The brushes in the Dynastart will wear during normal operation and leave a "dust" of powdered graphite in the Dynastart. This graphite (carbon) will conduct electricity and possibly cause a short circuit in the Dynastart. The place where this will most likely occur is in the "brush-holders" and the brush springs. It could also occur at the armature segments and cause the same problem. Any short circuit could burn out the windings and destroy the Dynastart, Adjacent armature segments are shorted out by the brushes during normal operation so this is not a problem. If there is an excessive amount of carbon dust in the armature, the armature segments could become shorted to the frame which would cause the windings to burn up.

21.1. Test the insulation resistance of the Dynastart.

21.1.1. Disconnect the Dynastart wires from the black box.

21.1.2. Mark each wire as it is disconnected so you will know how to reconnect them. (*B1, B2, HE, A and DF*).

21.1.3. Check the resistance from each of the wires to ground (*earth*).

If the resistance of any of the wires to ground is less than 10 Kilohms, the unit should be cleaned. Since the unit is out of the engine, you should clean it as well as you can. (*See paragraph 21.5 for cleaning instructions*). There is no definite point where the resistance can be considered to be too low, but 10 Kilohms is as good a place to start as any.

21.2. Check the amount of wear on the brushes.

New brushes have about 4.7mm (.187") of material above the connecting wire. When this wears down to about 2mm (.080"), brushes should be replaced. Too short a brush will also decrease the pressure of the brushes against the armature segments. Brushes worn down to where the wire touches the armature segments can cause serious damage.

Regardless of how much wear there is on the brushes, it is wise to replace them with new brushes.

21.3. Stator inspection.

Perform a complete inspection of the stator windings. Check the solder connections to make sure they are good. Figure 28 shows the solder connections on the wide copper straps between the pole windings on the stator. The small wires have insulation broken and one of the wires is touching the frame. The only thing preventing a short circuit is the varnish on the wire. This will soon wear through with vibration and cause a short circuit. Reposition the wires away from the frame and try to add some insulation.



Figure 28. Defective wiring.

The wires on the coil of the pole piece are exposed in figure 29. These wires should be protected by painting the red insulating paint (glyptol) used by motor repair shops. It would be just as good to cover them with varnish to provide insulation and keep dirt out.

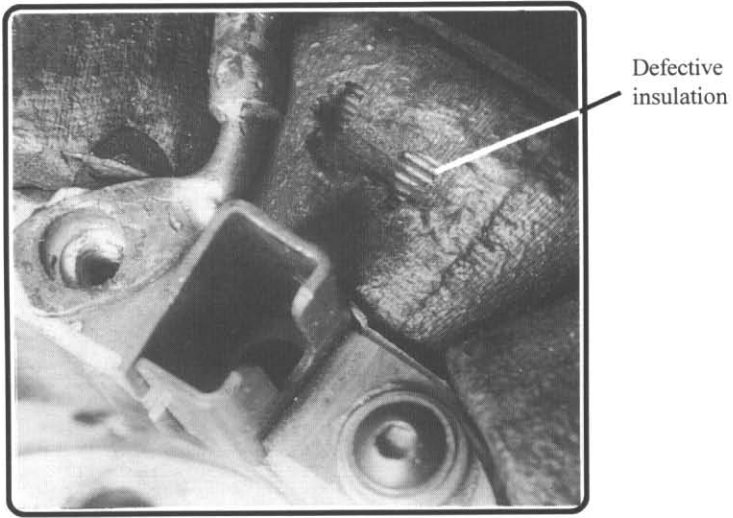

Figure 29. Defective stator coil insulation.

21.4. Check to see if any of the stator field coils are loose. If they are, tighten the screws shown in figure 30.

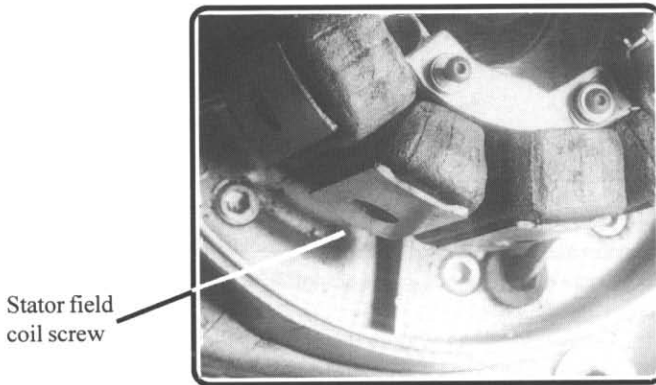

Figure 30. Stator field coils.

21.5 . Armature cleaning

Before doing any cleaning, use the ohmmeter and check the insulation resistance between one of the armature segments shown in figure 31 and the metal flywheel (*earth*).

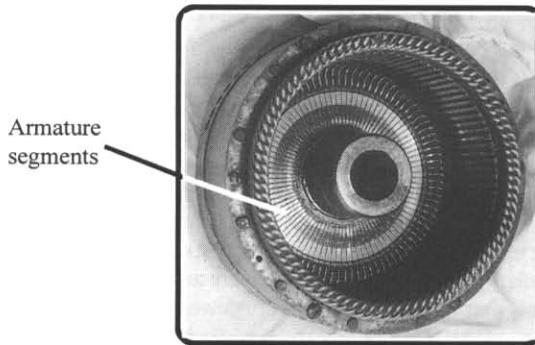

Figure 31. Armature segments.

Also check the resistance from each brush-holder to the stator frame (*earth*). Record these readings so that after cleaning, you will know the amount of improvement.

Clean the armature in Mineral Spirits obtainable in any paint store. DO NOT use petrol (*gasoline*) as it will soften the varnish insulation on the wires. An old toothbrush and a household spray bottle can be used to wash out the carbon dust in places that are hard to get to with a brush.

Check the resistance after cleaning. It can be made to be as high as 100 Megohms. This is a case where if a little resistance is good, a lot is better. The higher you can get this resistance, the longer you can run the engine before cleaning again and the less chance there is for starter failure.

Check for wear of the armature segments. Figure 31 is a view of the inside of the armature and the copper segments can be seen surrounding the hub.

The smoothness of the armature segments can be seen by examining the top of the carbon brushes. If the armature segments are worn or grooved, they will cause excessive wear on the carbon brushes and more dust than necessary will collect in the armature.

If the segments are badly grooved, the segments should be "turned down" on a lathe in a machine shop. Do not attempt to do this yourself.

If the armature segments are turned on a lathe, some copper may be shorting adjacent segments and the insulation between the segments may be too high. High insulation between the segments will not allow the brushes to make good contact. If the insulation is too high, it must be "undercut" so that the insulation is lower than the copper. Use a sharp tool and scrape the insulation until it is below the copper. A tool can be made from an old hacksaw blade. Keep cleaning as you are working so that copper particles are not forced into the insulation. Check to make sure there are no sharp edges on the armature segments that would cause rapid brush wear. The armature segments can be lightly sanded to remove any sharp edges and then thoroughly cleaned.

After cleaning, recheck the resistance to see how much of an improvement you have made.

21.6. Stator cleaning.

Check the resistance from each brush-holder to earth and record the value. This should also be a high resistance (*greater than 10 Kiloohms*). If the resistance is lower, disconnect the link between each pair of brush-holders and determine which holder is causing the low resistance. Wash the stator in Mineral Spirits and recheck the resistance until it is as high as you can get it. (*greater than 1 Megohm*). Completely rebuilding the stator can get this resistance to be infinite.

21.7. Rebuilding the stator.

Carbon will build up between the brush-holder and the frame of the stator. Remove the brush-holder and clean out all the dirt and graphite. The spring on the bottom of the brush rests on a round fibre disk. The spring is in a fibre cylinder which provides insulation on the sides. This bottom disk will sometimes wear through from continuous vibration. Make new parts to insulate the spring from the brush-holder and the frame.

The bottom disk can be glued to the fibre cylinder to prevent carbon dust from shorting the bottom of the spring. Use a non-conducting high temperature glue. Epoxy will soften if exposed to too much heat.

The hard part is mounting the brush-holder to the frame. The holder must be insulated from the frame and the mounting screws. The mounting holes in the brush-holder are oversized to accept a "shoulder washer". These washers will have to be made from "Bakelite" or some other insulating material that will withstand the heat of the engine.

The dimension "A" shown on the fibre washer should not be made greater than the thickness of the brush-holder material plus the thickness of the electrical connector going to the brush. If it is too high, the washer will crack when the screw is tightened. If it is too short, it may not insulate the electrical connection from the screw.

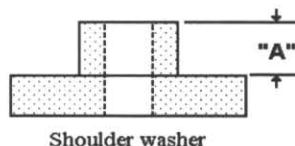

The mounting screw should not be insulated using "shrink tubing" or the insulation from electrical wire. These materials are too soft and vibration may cause them to wear and cause a short circuit.

A possible source of shoulder washers would be from old electrical relays. This type of washer was used to insulate relay contacts.

If you make your own shoulder washers, be sure that they are not too high (*thick*) so that when the mounting screws are tightened, the washer will not crack.

Another reason for not making the shoulder washers too high is that the mounting screw could be touching the washer and appear to be tight. The electrical connecting lug would be loose and you would have a poor connection.

If the shoulder washer is too short, the brush-holder or the electrical solder lug could touch the mounting screw and cause a short circuit.

Figure 32 is a view of a brush-holder with the brush removed. The left mounting screw would also have the "pigtail" of the brush connecting to the strap that goes off to the left. The shoulder washer should insulate the brush-holder, the connecting strap and the brush pigtail connection. Notice that the Allen head mounting screw has a flat metal washer and a Nylon insulating washer under it. The right side mounting screw is removed and you can see the parts that must be insulated.

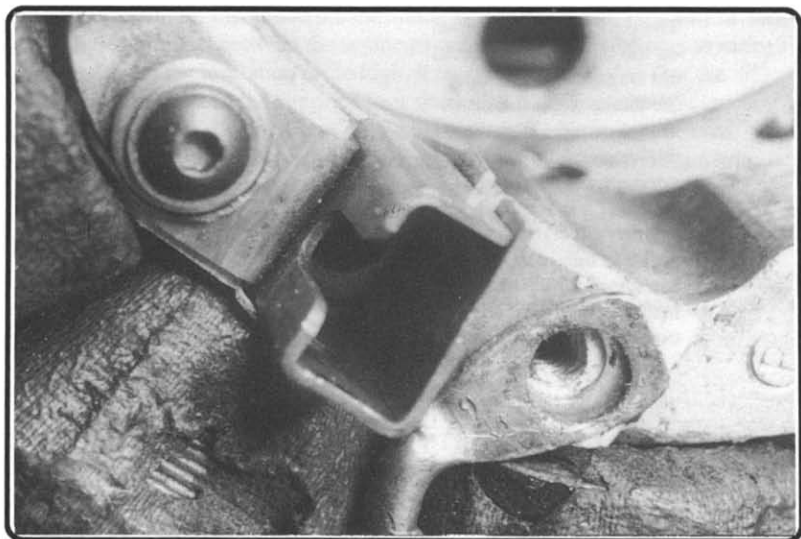
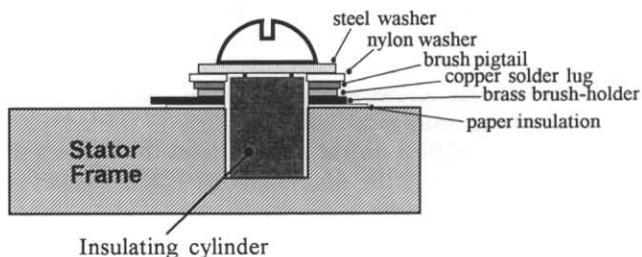

Figure 32. Brush-holder mounting screws and insulation.

The same results can be obtained by using an insulating cylinder.



The metal parts, brush pigtail, solder lug and brush-holder are all squeezed between the nylon washer and the paper insulation. The insulating cylinder keeps the metal parts from touching the screw. Notice that the insulating cylinder is short enough so the steel washer does not crush it. The steel washer is needed for strength.

The brush-holder is insulated from the frame by paper. This is a special paper that can be obtained from any electrical motor repair shop. Do not use any other kind of paper because it can become oil soaked and impregnated with carbon. Use the old insulation as a template and cut new insulation from the paper in this shape.



Form it to this shape to insulate the brush-holder from the frame.

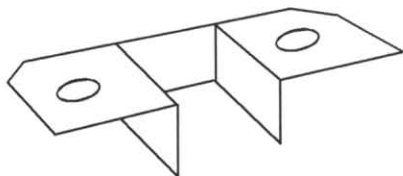

I have replaced the original brush-holder mounting screws with "button-head" Allen cap screws. This makes it possible to apply more torque for a tighter electrical connection and the screw heads are not as easily damaged.

Check the solder connections to the large copper straps that are between the pole pieces. Figure 33 shows the solder connection to the strap and also cracked insulation on the large wire. This copper strap was loose in-between the pole windings as well as one of the other straps. When the engine was assembled, the armature turned freely and smoothly. It was only after the engine was mounted in the car and the bundle of wires moved that this problem occurred. As the car was moved while in gear, a grating noise was heard coming from the engine. The noise was caused by the armature rubbing on the copper straps. In Figure 33, you can see the copper worn off of the edge of the strap below the solder connection. Luckily, this was found before power was applied to the starter.

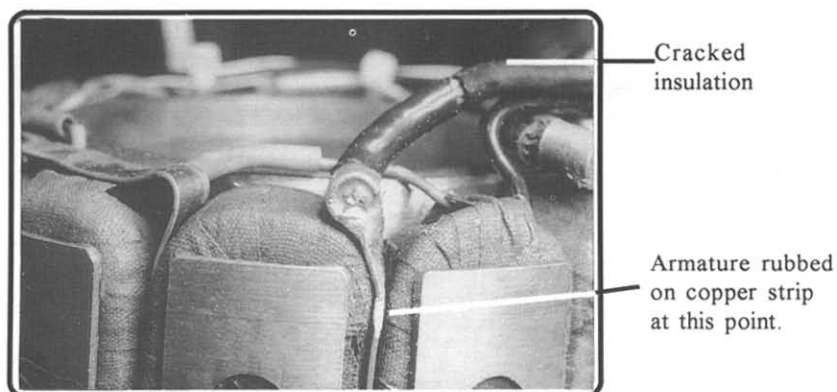

Figure 33. Damaged copper strip.

After cleaning the copper shavings out of the armature, a "fix" was made to hold the copper straps back in between the pole pieces where they belong. The fix is shown in figure 34 and merely consists of brass clips that pull the heavy wires back toward the center of the stator. The stator frame was drilled and tapped for the smallest screw available. (*American 0-80*).

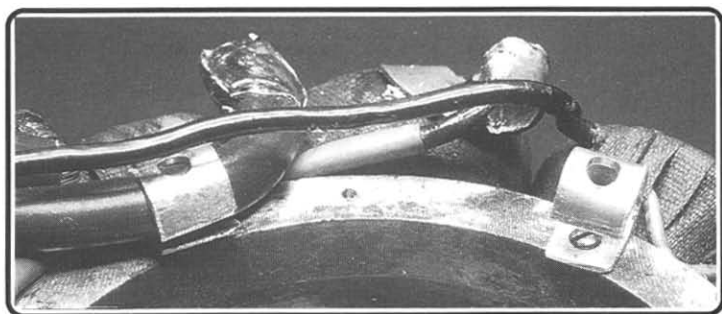

Figure 34. Fix for loose wiring.

I can't over-emphasize the importance of checking and double-checking everything. Look especially for insufficient insulation, loose wires or coils on the pole pieces and poor electrical connections. If you see anything that can be improved, do it. Then after you know that everything is perfect, check it again.

Securing the stator windings.

Figure 35 shows a rear view of the complete stator on the workbench. Notice the white plastic "cable ties" on the large bundle of wires and the two small wires at the bottom. The bottom wires go to the forward and reverse contact breakers (*points*). The contact breaker wires are anchored to the copper straps between the pole pieces.

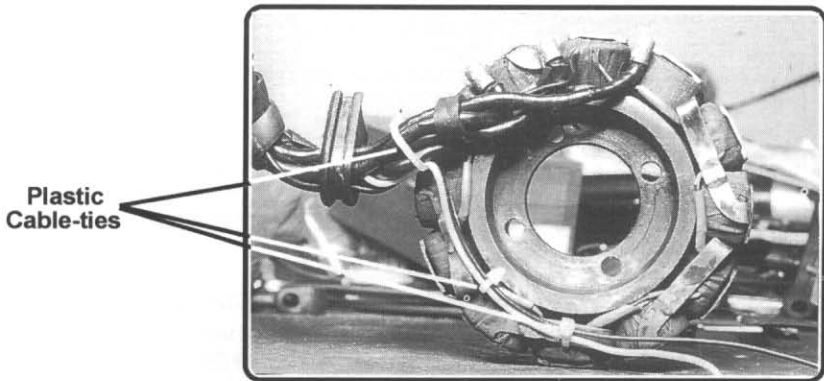

Figure 35. Securing the stator wires.

In Figure 36, the stator is mounted on the engine. Notice the Allen-head mounting bolts and the brush-holder mounting screws. One of the brushes has been removed. You can also see Allen screws bolting the crankcase halves together.

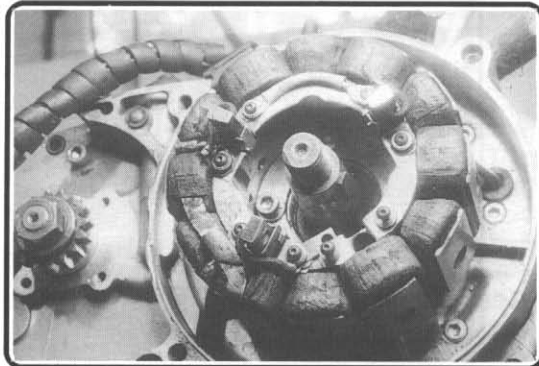

Figure 36. Stator mounted on the engine.

The cable going to the black box is held together with rubber "spiral-wrap". These are heavy wires and are not run "straight" but are twisted so that the cable can more easily be bent around corners.

22. ENGINE REASSEMBLY

(See Addendum for piston modifications)

Clean all parts before reassembly. Clean the gears, roller bearings, clutch ball bearing, all dirt from the crankcase and all dirt (*gasket material*) from the edges of the crankcase. Check the crankcase for warpage using a straightedge. If it is warped, sand it on a flat surface.

- 22.1. Remove the *carrier plate assembly* (5-160).
- 22.2. Place the "guide plug" into the mainshaft hole in the crankcase.
- 22.3. Place the 15 mainshaft *rollers*(2-64), *spacer* (refer to Figure 14, item "B"), the *large loose gear* (4-139) and *bushing* (4-140) on the guide plug.
- 22.4. Shift into 4th gear.
- 22.5. Connect the *sliding gear* (4-138) and the *selector bridge* (5-167) to the sliding gears on the layshaft and install these parts as a unit. Figure 37 shows these parts in the crankcase waiting for the mainshaft to be inserted.

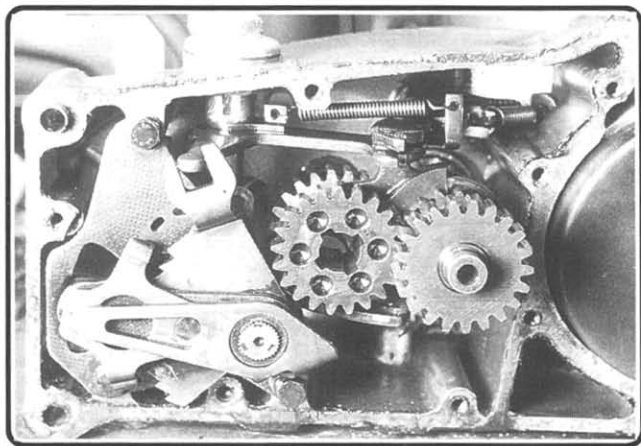

Figure 37. Layshaft and sliding gears.

In figure 38, the gears are removed and only the *selector bridge* (5-167) is in place to show the proper orientation. Notice that the chamfered edge of the selector bridge is at the bottom rear.

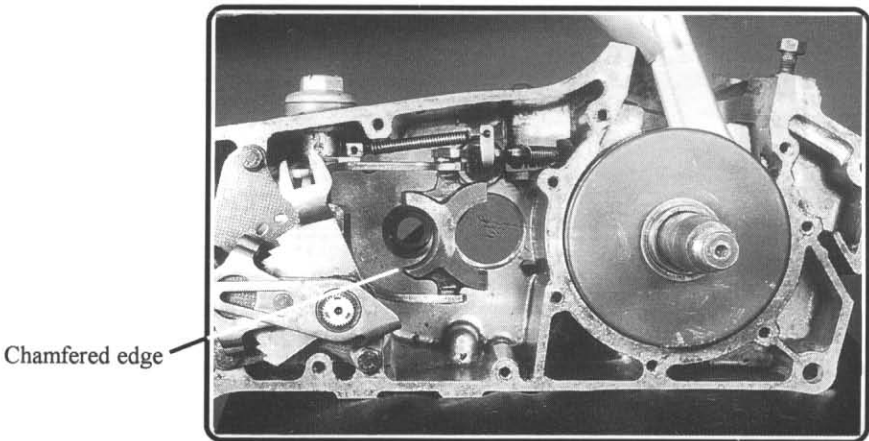

Figure 38. Selector bridge orientation.

- 22.6. Install the *carrier plate assembly* (5-160) and position it to match the "witness marks" made in para. 12.3.
- 22.7. Secure the carrier plate with 3 bolts. The top bolt and the lower right bolt have split lockwashers. The lower left bolt does not have one. Be sure the stop bracket (5-154) and the *stop lever* (5-155) are properly installed.
- 22.8. Put the *small loose gear* (4-142) on the mainshaft with *bushing* (4-143), *thrust washer* (4-142a) and *additional washer* (Figure 14 item "E") if needed.
- 22.9. On the magneto half of the crankcase, insert 13 *rollers* (2-59), *mainshaft output shim* (4-144) (Figure 14, item "F") on the output end of the mainshaft. This assembly will be installed as a unit.
- 22.10. Saw the heads off some long metric bolts to use as studs to guide the magneto half of the crankcase onto the layshaft. These eleven studs will also help to hold the gasket in place during assembly. One of the bolts should have a slot sawed into the end of it so it can easily be removed with a screwdriver. See Figure 39. Place a gasket on the studs.

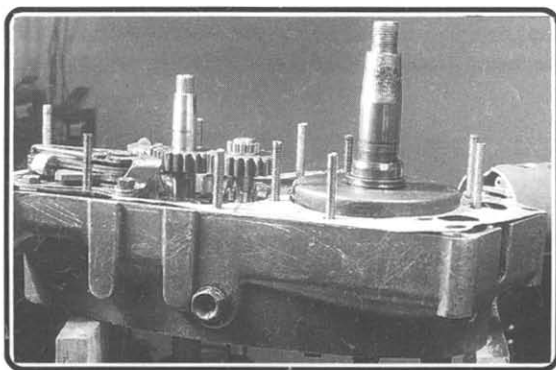

Figure 39. Crankcase guide studs.

The crankcase halves can be assembled without these guide studs. I have done it many times and swore each time one of the rollers fell off and I had to do it over again. It is amazing how smoothly things go together if the guide studs are used.

The gaskets tend to shrink and do not fit evenly around the crankcase. This is especially true at the rear end where the crankcase walls are thin. The studs will also prevent damaging the holes in the gasket when inserting the screws and possibly prevent tearing the gasket during assembly.

Some members recommend soaking the gaskets in warm water but I have never tried it. I prefer to coat the gaskets with sealant during final assembly and I don't now how that would work with a watersoaked gasket. Soaking in oil would be better.

In figure 39, the gasket is placed on the guide studs.

- 22.11. Place the 13 rollers on top of the *layshaft shim (4-128)*. Figure 39 shows the rollers in position on the layshaft. Putting transmission oil (*non hypoid*) or grease on the rollers will cause them to stick to the shim and the layshaft and there is less chance of them becoming dislodged during assembly. If you use grease, the rollers will stick better but may also stick to the crankcase if they fall off and you may not hear them rolling around when you shake the crankcase to see if there are any loose parts after assembly.
- 22.12. Make sure that the two dowels are in position at the front and rear of the crankcase halves.

- 22-13. Grasp the output end of the mainshaft and the magneto half of the crankcase and start the end of the mainshaft into the loose gear. Keeping the magneto side of the crankcase level, slide it down onto the crankshaft using the studs as a guide until the bottom of the mainshaft touches the guide plug. Remove the guide plug and lower the crankcase a little more keeping it level.

The rollers on the layshaft may not be perfectly aligned with the crankcase but turning the gears back and forth slightly will allow the crankcase to drop into position.

- 22-14. Remove the guide studs and replace them with metric screws.

Metric "Allen socket-head" cap screws can be used and more torque can be applied to the screws without damaging the heads. Do not over-torque the screws because they are threaded into aluminium and it is possible to pull the threads out of the aluminium. If this happens, the holes will have to be redrilled and steel "heli-coils" inserted. The screws should be as long as possible to engage the maximum number of threads.

- 22-15. Tighten the screws until the transmission halves are firmly joined.

Turn the gears while tightening the screws and check for any binding or friction. If the gears do not turn freely in first and fourth gear, the shaft end spacer will have to be replaced. It is also possible that the sliding gears are rubbing on the 1st or 4th gears.

- 22-16. Check the shaft endplay to determine if the end spacers are the correct thickness.

- 22-17. Shift into neutral and rotate the shafts individually to check for binding or gears rubbing. (*mainshaft, layshaft and crankshaft*).

- 22-18. Shift through all gears, upward and downward, while slowly turning the output shaft to check the smoothness of shifting.

If everything is satisfactory, the engine is ready for final assembly.

If shifting is a problem, recheck the following paragraphs.

- Para. 12.1 Selector fork movement.(pg 20)
- Para. 12.2 Ratchet pawl action. (pg 21)
- Para. 13 Selector fork adjustment. (pg 23)
- Para. 14 2nd and 3rd gear alignment. (pg 23)

23. FINAL TRANSMISSION ASSEMBLY

Disassemble the transmission and reassemble following the instructions starting at para. 22.1. The only difference is in para. 22.10. Before the gasket is placed on the studs, coat the edge of the crankcase with gasket sealant. This will prevent oil leaks from the gearbox and air leaks at the crankshaft end. Put more sealant on top of the gasket before the crankcase halves are joined.

After the crankcase halves are tightly bolted together, pick it up and shake it hoping you hear nothing. This means that none of the rollers have fallen off the layshaft and there are no loose parts in the transmission.

24. TAPERED SHAFTS

Some parts are fitted to tapered shafts and have woodruff keys. These parts are,

- Driving sprocket (4-146).
- Serrated clutch hub (4-134).
- Dynastart armature (8-276).

As mentioned in para. 6.3, these parts are prevented from slipping by having a smooth taper on the part and the shaft and having a tight nut fastening them together.

The following instructions for driving sprocket assembly should be followed for all tapered shafts that have woodruff keys.

If a tapered shaft is "scored", or the mating part is scored, they should be sanded smooth with emery paper. Do not file or take off too much metal which would affect the taper. See figure 40. Here a small piece of emery paper is placed on the shaft and the sprocket placed over it. By rotating the sprocket back and forth slightly, any burrs can be removed without changing the taper.

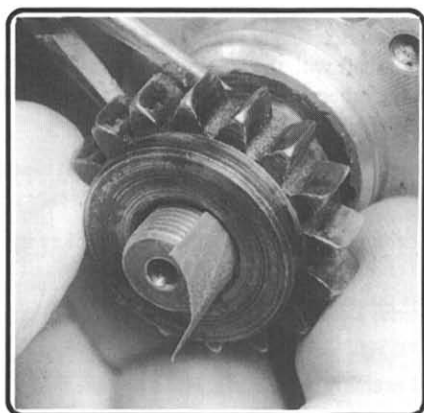

Figure 40. Sanding the output sprocket.

After sanding the high spots on the sprocket and the shaft, you can use fine valve grinding compound to provide a better fit.

25. DRIVING SPROCKET ASSEMBLY PROCEDURE

This procedure can and should be used for any part that is mounted on a tapered shaft.

- 25.1. Place the driving sprocket on the mainshaft without the woodruff key and with the woodruff slots aligned as close as possible.
- 25.2. Gently tap the sprocket onto the shaft until you feel it hitting solid. Do not hammer on it because the roller bearing on the other end of the mainshaft could be damaged. Put the *nut (4-147)* on the shaft and tighten it as much as possible. **(left hand thread).**
- 25.3. Remove the nut.
- 25.4. Measure the distance from the sprocket face to the end of the mainshaft. You can use the back end of a vernier caliper to make this measurement.

When the sprocket is finally installed, it should be the same distance from the end of the shaft with the woodruff key installed. This is the only way to be sure that the tapers are mating properly and the woodruff key is not interfering.

25.5. Remove the driving sprocket.

25.6. Replace the driving sprocket with the woodruff key installed. After tightening the nut, check the distance to the end of the shaft to see if the sprocket has pulled all the way onto the shaft.

If it has not pulled on far enough, the woodruff key is interfering. Remove the key and examine it for burrs. File away the burrs and try again.

Woodruff keys will sometimes "bottom out" in the slot and prevent the sprocket from moving all the way onto the shaft. It is a good idea to file a little off the bottom of the key to make sure that it is not bottoming in the slot.



File off the bottom

This same procedure should be followed when assembling the parts listed in para. 24. If it is not done properly, the parts can slip and cause much damage.

25.7. When finally assembling the part, make sure that all oil is removed from the shaft and mating part so that there is good metal to metal contact.

26. CRANKSHAFT SPROCKET (1-26)

26.1. The *crankshaft sprocket (1-26)(4-26)* is not tapered. Install the sprocket with the woodruff key and the correct number of *shims (1-24)* for proper alignment with the *clutch body sprocket (4-105)*. Don't forget the lockwasher and tighten the *nut (1-29)*. **(left hand thread)**.

If you are using the flywheel holding tool Partsmart no. 0419, this nut can be tightened after the armature is mounted. But don't forget to do it.

26.2. Tighten the nut to a torque of 12 Kg-M (9 lb-ft). Exact torque is not important as long as the nut is tight.

27. CLUTCH BODY (4-105)

- 27.1. Place the *continuous chain (4-115)* on the clutch body and engage it with the teeth on the crankshaft sprocket.
- 27.2. Put the clutch body on the layshaft. If the chain is not long enough to do this, the crankshaft sprocket will have to be removed and assembled with the chain and clutch body as a unit. If the chain has a removable link, the split end of the retaining clip should be toward the rear of the link when the chain is moving in the forward direction.

The original Sachs chain was continuous and did not have a removable link.

- 27.3. Using the same procedure as in para. 25, fit the clutch body to the clutch ball bearing (4-131) first without the woodruff key to see how far it will go on the shaft and then with the woodruff key. Wooden dowels under the piston will prevent the clutch body from turning when tightening the nut (left hand thread) if the chain is installed.
- 27.4. Install the clutch body with the *lockwasher (4-132)*. The tab on the lockwasher fits into a hole on the clutch body. After tightening the nut bend the lockwasher up against one of the flats on the nut.

28. THRUST PINS

- 28.1. Insert thrust *pins (4-121)* and *roller (4-122)*.

29. SERRATED CLUTCH HUB

- 29.1. Fit the *serrated clutch hub (4-134)* to the layshaft using the procedure outlined in para. 25. Use the clutch holding tool Partsmart no 0405 when tightening the nut.

If the tool is not available, shift the transmission into first gear, clamp the *output sprocket (4-146)* in a vice with soft jaws and then tighten the nut.

30. CLUTCH PLATES

- 30.1. Check the clutch plates for wear. When the cork on the plates becomes worn to the point where the grooves start to disappear, they should be replaced.
- 30.2. Insert 4 cork plates and 3 steel plates into the clutch basket. Alternate the plates starting with cork, steel, cork, etc. The steel plates must be inserted with the metal tabs facing up toward the clutch adjusting screw.
- 30.3. Check the length of the clutch springs. New springs are at least 20mm long. Short springs are an indication that they are losing strength and should be replaced. Weak springs will cause the clutch to slip and wear excessively under a heavy load. It is wise to replace the clutch springs every time the engine is overhauled.
- 30.4. Install the *pressure plate (4-108)*, *9 Springs (4-110)* and *3 spring cups (4-111)*. Compress the springs and insert the two *locking plates (4-112)*.
- 30.5. Check to see that none of the springs are out of position and that the locking plates are firmly in position.
- 30.6. The *oil sump (2-46)* was not removed but check to make sure the mounting screws are tight. You can remove the oil sump if you wish because it only works when the engine is in reverse.
- 30.7. Adjust the clutch by loosening the *locknut (4-114)* and *adjust screw (4-113)* to provide 10mm (.400" to .600") movement of the *clutch lever (4-116)*. See figure 41.

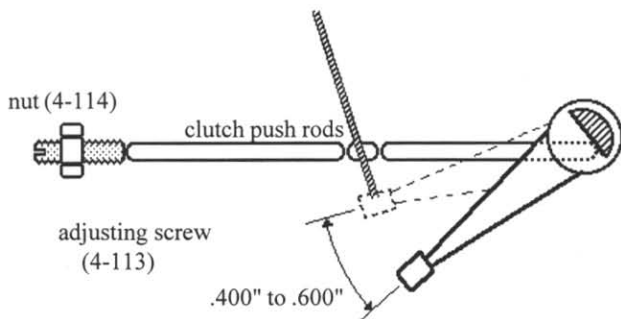

Figure 41. Clutch adjustment

31. MAGNETO SYSTEM AND ARMATURE

- 31.1. If the procedures in section 21 (*Dynastart maintenance and repair*) have been performed satisfactorily, the unit is ready to be assembled.
- 31.2. Clean the crankshaft taper and armature with fine emery paper.
- 31.3. Mount the *stator windings* (8-276) using four metric 6 screws.
- 31.4. Route the two wires for the forward and reverse contact *breaker points* (8-277) under the stator windings and through the hole in the crankcase to the contact breaker side of the crankcase. If the wires are damaged, or short, or if the insulation is damaged, this is the time to replace them. Make sure there is a rubber *grommet* (2-65) in the hole so the insulation is not rubbing against the sharp edge of the metal crankcase. Continuous vibration will cause the insulation to wear and cause a short circuit to earth.
- 31.5. Make sure the brushes slide freely in the brush-holders and the brush wires can move freely.
- 31.6. Repeat the steps outlined in section 25.
- 31.7. Clean all oil from the crankshaft and armature taper.
- 31.8. Place the armature on the crankshaft.

Be careful when putting the armature on the crankshaft.
The brushes are made of soft carbon and are easily broken.
- 31.9. For final assembly, make sure that the *lockwasher* (1-32) is installed. "Loctite" can be used on the threads of nut (1-33) if desired.

32. CYLINDER (1-1)

- 32.1. Clean the top edge of the crankcase around the *studs* (2-43) by carefully scraping away any dirt, pieces of gasket, etc.

- 32.2. Trim any excess *crankcase gasket (2-41)* even with the top of the crankcase.
- 32.3. Clean the surfaces where gaskets are used. Bottom of cylinder, top of cylinder, head, and carburettor mounting surface.
- 32.4. Carefully scrape the carbon scale from the top of the piston. Try not to scrape down to the aluminium as this can cause hot spots on the piston. Try to leave a thin black coating on the piston.
- 32.5. Scrape the excess carbon out of the exhaust port.
- 32.6. If new piston rings are installed, check to see if the cylinder has been rebored so you can get the correct size rings. Check bore diameter and piston diameter. If the cylinder is "out of round" it can be rebored and a larger piston and larger rings can be installed. Any small engine shop can check this.
- 32.7. Place each new ring in the cylinder and check the gap at the ends. See figure 42. Make sure the ends of the ring are not touching. There should be about .3mm to .5mm gap between the ends when the ring is in the cylinder. If necessary, grind some off the end of the ring.

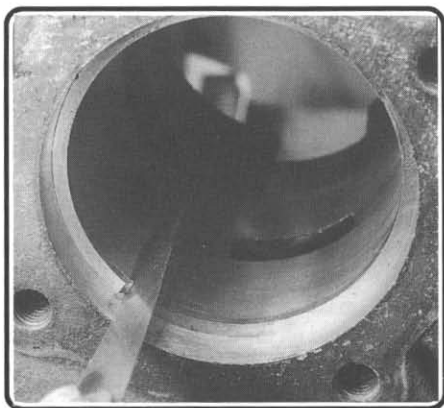

Figure 42. Measuring piston ring gap.

- 32.8. If piston rings are replaced, clean the grooves in the piston. A broken piston ring can be used to scrape out the dirt. Piston rings are very hard and break very easily if spread too much. Carefully slide the ring over the piston until it snaps into the groove. Make sure the rings are right side up so the ends of the rings fit the pin located in the groove.

- 32.9 Put a new *gasket (1-14)* on the crankcase studs.
- 32.10 With the piston rings on the piston, the cylinder can be put on. Place wooden sticks under the piston to keep it from moving and place the cylinder on the top piston ring. Carefully push the top ring into the groove and work around until the entire ring is in the groove. **DO NOT BREAK THE SECOND RING.** The cylinder is heavy and as the first ring snaps into place, the cylinder will drop onto the second ring and may break it.
- 32.11. With all three rings up in the cylinder, bolt the cylinder to the crankcase.

There is a product I recommend made by PERMATEX called "anti-seize". This is a paste made of aluminium particles suspended in oil prevents parts from rusting and seizing. It is especially good on parts that rust, such as wheel nuts, or parts that are subjected to heat like exhaust nuts (1-13) or cylinder bolts.

33. CYLINDER HEAD

- 33.1. Clean the excess carbon from the cylinder head. This can be cleaned down to bare metal and it could be polished to slow down future carbon buildup.
- 33.2 Clean the mating surfaces of the cylinder and the cylinder head and install a new gasket.
- 33.3. Attach the cylinder head with *bolts (1-5)*.

34. ENGINE TIMING

This is probably the best time to set the engine timing. It is much easier than doing it with the engine in the car and everything is easier to see and get at on the workbench.

- 34.1. Temporarily put the *crankcase sidecover (3-76)* on the engine and secure it with the mounting bolts. Pull the contact breaker points back so that the crankshaft does not bend them when doing this.

34.2. Rotate the crankshaft until the points are fully open.

34.3. Adjust the point gap to about .5mm.

Some style of points have an eccentric screw to change point gap. If your points do not have this screw, bend the stationary contact to get this amount of gap.

34.4. Remove the spark plug and insert the back end of the vernier until it touches the piston.

34.5. Turn the armature by hand until the piston reaches TDC. (*top dead center*)

34.6. Using the vernier caliper, measure the distance from the top of the piston to the top of the spark plug hole.

34.7. Increase this measurement on the vernier by 5mm.

The forward contact breaker (*points*) should open between 4.5mm and 5.5mm before top dead center.

34.8. At the contact breakers, attach an ohmmeter from the forward contact breaker wire to earth.

34.9. Turn the armature in the forward direction (*counterclockwise*). With the contacts closed (*zero resistance*), rotate the armature until the contacts open (*high resistance*) at the same time the top of the piston touches the vernier caliper. This is 5mm before TDC.

Be careful when doing this because the top of the piston is "domed" and the vernier must be held the same way so that it touches approx. the same place on the piston. If it is held at a different angle, the readings will be in error.

34.10. To change the timing, loosen the two screws on the contact breaker plate and rotate the plate. Some contact breakers have a screw to hold the contact and an "eccentric" cam (*small screw adjustment*) to move the contact slightly. This is used for the rough adjustment. As the mounting screw for the contact is tightened, the contact will move slightly. The fine adjustment is made by rotating the plate.

34.11. The same method is used for the reverse timing. The only differences are,

The contacts should open 3mm to 4mm before TDC.

Adjust the vernier to 3.5mm lower than TDC and lock it.

Rotate the engine in the reverse direction (*armature turning clockwise*).

DO NOT rotate the breaker plate as this will alter the forward timing.

Bend the fixed contact to get the breaker to open at the right time.

34.12. Lubricate the felt pad with high melting point grease used for contact breakers.

Adjust the pad so it touches the cam on the crankshaft at the high point.

If new contact breakers are installed, the fibre cam-follower will wear quickly until its shape forms to fit the cam. This means that timing should be adjusted again after driving 200-300 Kilometers.

35. FAN HOUSING

35.1. Attach the fan housing assembly (10-360) with three metric screws plus lockwashers. There are openings in this housing for hoses to the manifold heater. If the heater is not used, make a plate to block the opening. If it is left open, the engine cooling air will not circulate properly.

35.2. Attach the *fan* (10-361) with four screws and lockwashers.

35.3. Attach the *fan cover* (10-362).

36. ENGINE REASSEMBLY

36.1. Attach *top cover* (10-370) and *air deflector hood* (10-372).

When *nut* (1-9) is tightened, make sure it is not putting a strain on the air deflector. It should be holding the air deflector against the jammed *nuts* (1-7)
See para. 5.3.

- 36.2. Attach the center engine mounting bracket and the front engine mounting bracket to the engine.
- 36.3. There is a "cup" under the *driving sprocket (4-146)* to which the rubber sleeve is attached. The center hole in the cup may be too small to allow it to pass over the teeth of the driving sprocket. If necessary, cut a notch in the cup between two of the mounting holes just enough to allow the cup to pass over the teeth. If you managed to get the sprocket off without removing the cup, there is no problem. Attach the cup to the crankcase with 4 flat-head screws.
- 36.4. Connect the exhaust pipe and *exhaust gasket (1-12)* to the cylinder and tighten the exhaust nut. Do not hammer on the brass nut as it is easily cracked. See paragraph 5.1.
- 36.5. Attach the silencer to the engine.

37. INSTALLING THE ENGINE

- 37.1. Remove the mudguard (*wing*) from the rear wheel.

This is not necessary but after the engine is installed, the rubber sleeve must be connected from the engine to the rear swinging arm. It is much easier to attach the ends of the rubber sleeve if the mudguard is removed.

- 37.2. Set the parking brake part way so the car can still be moved..
- 37.3. Clean the toothed sleeve (*dogbone*) and pack it with grease. Insert the pressure spring and plug in the toothed sleeve and place it where it is readily accessible. The end of the toothed sleeve that has the spring and plug inserted must be toward the swinging arm.
- 37.4. Grasp the engine by the exhaust pipe and the silencer and place the front engine mounting bracket on the stud of the front engine mount.

Raise the back of the engine and place the toothed sleeve (*with rubber dust cover*) between the engine and the rear swinging arm.

Slide the center engine mount onto the fork in the frame and let the engine hang on the center mount. HOLD IT THERE SO IT DOESN'T SLIP OFF THE FRAME. It may be necessary to put the car into gear and move it slightly for the toothed sleeve to mesh with the sprocket.

- 37.5. Fasten the center mount to the frame with two bolts.
- 37.6. Tighten the front engine mounting nut (*with lockwasher*) and the top engine mount screw.
- 37.7. Connect the clutch cable. Adjust *screw (2-45)* so there is no slack in the cable and it is just starting to pull on the *clutch lever (4-116)*. Attach the clutch return spring to the clutch lever.
- 37.8. Connect the neutral select cable. (see section 3.)
- 37.9. Temporarily attach the *gear change lever (5-179)* and shift into any gear. Rocking the car back and forth will make shifting easier. Squeeze the neutral lever on the gear shift lever in the cockpit and listen for the transmission to “click” into neutral before the lever reaches the end of its travel. Adjust (*5-177a*) *adjusting screw* to do this. If there is not enough adjustment using the screw, the end of the cable in the cockpit should be repositioned.
- 37.10. Clean the edges of the *crankcase sidecover (3-75)*. Put gasket sealant on the edge of the side cover. Insert the six mounting bolts (*different lengths*) in the cover and place a new gasket over the bolts. Put gasket sealant on this side of the gasket and slide the cover onto the engine. Feed the contact breaker wires through the hole in the gasket and the cover while doing this. Pull on the wires as the cover is being positioned so that they do not get pinched between the cover and the transmission. Tighten the cover bolts.
- 37.11. Remove the *air vent plug (2-50)* and add transmission oil. USE NON-HYPOID OIL. DO NOT REMOVE OR LOOSEN THE NUT FOR PIVOT PIN (5-169).

Adding oil is a slow process. A plastic mustard or catsup dispenser that is used in restaurants makes the job easier. The amount of oil needed is approx. 750 ml. I find that filling my dispenser 3 times is just about enough. When the oil is poured into the crankcase, it will slowly seep over into the *crankcase side cover (3-75)* where the clutch plates are located. Very slowly. Allow enough time for the oil to distribute itself evenly in the crankcase and see if it comes up to the bottom of the *clutch cover plate opening (3-92)*.

Don't be in a hurry to add more oil because too much will overflow out of the opening and cause a mess. Go and do something else while the oil is settling. The final oil level should come to the point where it is about to flow out of the opening as shown in figure 43.

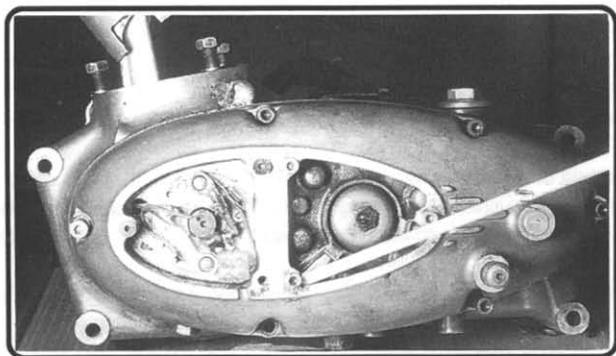

Figure 43. Transmission oil level.

If the neutral selector cable is connected and the *crankcase side cover (3-76)* is attached, the oil can be poured into the clutch opening as shown in figure 43. Place the engine in a level position and you still have to wait until the oil seeks its own level in the crankcase to see if it is filled to this point.

38. TELEFLEX ADJUSTMENT

- 38.1. Move the gear shift lever in the cockpit all the way forward.
- 38.2. At the rear end of the Teleflex cable (*at the engine*), scribe or file a mark on the inner cable where it emerges from the outer cable.
- 38.3. Move the gear shift lever in the cockpit to the rear.
- 38.4. Make another mark as in para. 38.2. The distance between these marks is the maximum travel of the cable.

- 38.5. Make another mark on the cable halfway between the other two. With the Teleflex cable in this center position, the *gear change lever* (5-179) should be in its centered position as determined by the *return spring* (5-163) in the transmission.
- 38.6. Connect the top of the gear change lever to the Teleflex cable.
- 38.7. Slide the bottom of the gear change lever onto the *gear change shaft* (5-150). Insert *clamping screw* (5-181) and fasten with *nut* (5-182).
- 38.9. If the inner cable of the Teleflex had to be moved to engage the gear change lever with the splines on the gear change shaft (5-150), the outer sheath of the Teleflex can be unclamped from the body and moved slightly. This is also the fine adjustment of the Teleflex.

39. REAR BONNET

- 39.1 Reverse the procedure in section 1.

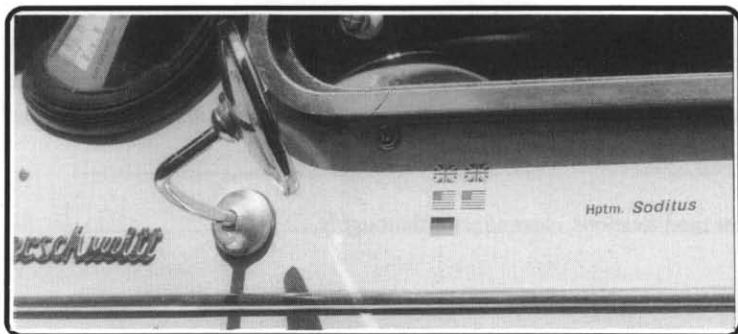

Robert Soditus
13 N. Morningside Drive
Binghamton, NY 13905 USA