

# MATRA



OWNERS & ENTHUSIASTS

## Brake Special

January 2017

### Brake Manual



Murena, Bagheera &  
Espace Brake Overhaul

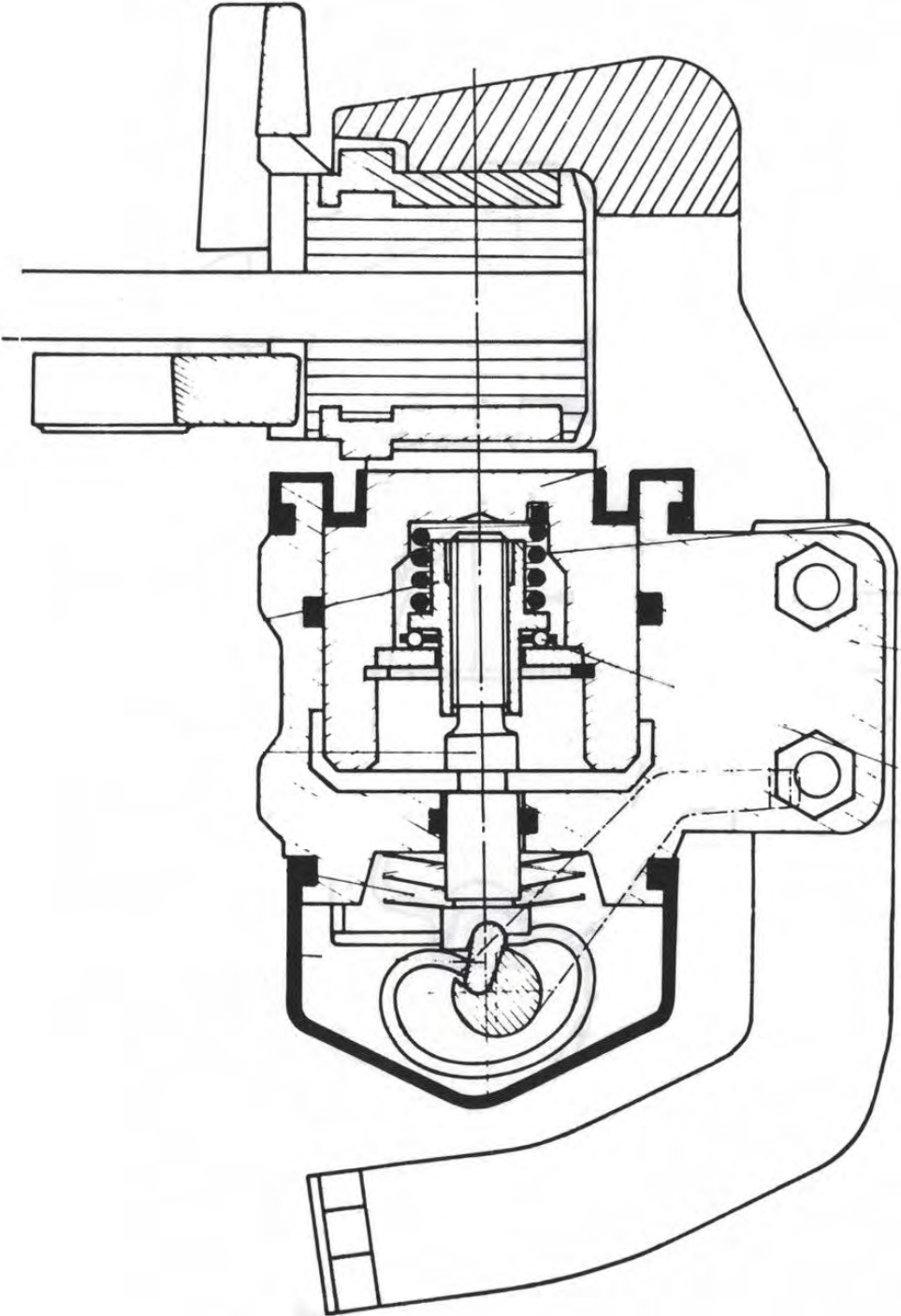

# Possible demonstrations during an event.

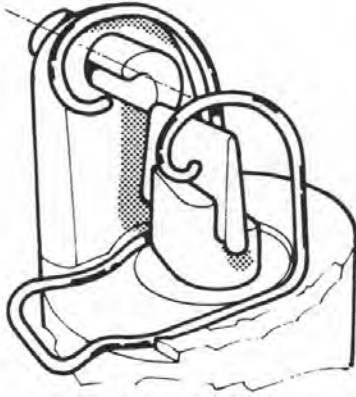

Proposed  
Timetable

Friday  
2.30 pm

Saturday  
11.00 pm

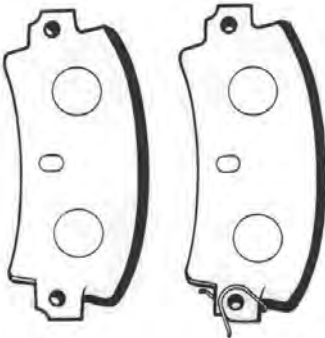

Sunday  
2.00 pm



Check at display  
as times may vary.

# Murena

## *mechanics*

Roy Gillard

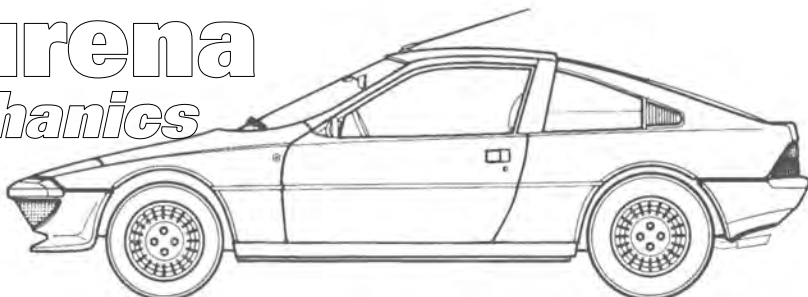

## Rear brakes (6<sup>th</sup> revision)

MURENA REAR BRAKES ALWAYS cause owners trouble as they are discs and the design incorporates the hand brake mechanism, and this complete set up is quite different to what owners expect with normal (i.e. drum) rear brakes. On top of this, the alloy housing sits in a steel frame and the corrosion caused by the reaction between the two different metals causes the rear brakes to bind or seize and you have to know how to strip and overhaul them correctly to get lasting results.

Since the Bagheera uses exactly the same rear calipers, the methods described here apply equally to the Bagheera. Furthermore the Quadra version of the Espace Series 1 uses a very similar caliper but with a smaller piston size; whilst many later Espace calipers are comparable, so you should find this manual useful for them too.

There have been numerous articles in the Matra Enthusiasts Club magazine as well as five earlier versions of this booklet, and if you had carried out any overhaul as previously recommended, you should no longer have any problems. However, there are new owners that may not be aware of the details; and critically, nearly every overhaul I have ever seen or heard about,

misses the one important procedure necessary to give long lasting freedom from sticking rear brakes.

Since the 4<sup>th</sup> revision of this manual, seal kits became available for the Murena & Bagheera brake master cylinders, so the 5<sup>th</sup> revision was produced to describe not only a full overhaul of the rear calipers, but also to include a repair of the master cylinder, and the front calipers were included too. This revision is only a slight update.

I know that if followed correctly, these procedures can bring lasting results, since many calipers I have overhauled myself have lasted a further 10 years without more sticking problems! If you don't think you can do any of this yourself, then at least insist your mechanic reads and understands the importance of the section marked **Very Important** and does not skip it, thinking it won't be necessary. It always is!

Whilst the Murena and Bagheera use exactly the same base rear caliper, they are mounted on opposite sides and upside down compared to one another. This is why the Murena has a large bleed nipple at the bottom where it is almost useless, and a small one fitted into the banjo bolt at the top. It was originally correctly positioned at the top on the Bagheera. Other differences are the hand brake levers, and

early Bagheera calipers had imperial threads whilst all later ones were metric, so beware if using some second hand ones.

As these Bendix rear calipers are no longer available, we need to preserve the stocks around, and since many of these cars do not do a great mileage, they are rarely worn out. Since seal kits are available, they can be overhauled rather than replaced. But I have seen many castings ruined or scrapped by being forced apart because the person trying to overhaul them did not know how they were assembled.

### **Initial checks**

Before you condemn the calipers as the source of sticking rear brakes, please check two things:

1) That the flexible hoses are not too old (definitely not older than 10 years!) as these will swell up inside and block the fluid path, stopping the fluid returning, and causing the brakes to remain on.

2) That the hand brake is not stiff or seized. Disconnect the hand brake cable ends from the caliper levers and check that the inner cable on both sides, slide freely in the outer sections. If these are binding, even the slightest little bit, the drag will be sufficient to stop the caliper levers from returning properly as there is very little return spring force at the caliper.

Any hand brake cable stiffness probably means you will need to replace it. If you are really lucky you may be able to free it off and re-grease it. However make sure that it really **is** free afterwards, and free from water ingress, otherwise it will definitely cause some brake drag, with all the associated problems of overheating and accelerated pad wear etc.

Whilst the hand brake cables are disconnected, you can operate the levers on the calipers by hand to apply the brakes manually and check if they release easily on their own. Do this both sides. Simply grip the lever with some pliers (if necessary) and pivot it forward, and if you are rotating the disc you should feel it being gripped. Then release the lever slowly to see if it returns fully under its own spring pressure (do not pull it back at all yourself) and the disc should now freely rotate again. This assumes of course that you can rotate the discs by hand! If the pistons are sticking, the discs may be gripped so tight without any pedal pressure that you cannot move them at all. In this case the caliper is definitely at fault.

A further point to note at this stage is how much the levers can be moved. If the piston mechanisms have self adjusted correctly, you will only be able to move them a small amount before the pads grip the discs. Any large movement here means the self adjustment is incorrect. These levers only have about 30 degrees of arc before the groove edge hits the side of the wedge and any further force will pop the wedge out. You then lose the hand brake entirely immediately.

Assuming the caliper is in fact the problem, and the piston is sticking out, as it will be if the pads are mostly worn down, the first job is to check the gaiter and piston. The gaiter will probably be split or broken up and if the piston is badly corroded or chipped, you will need some new pistons. Piston and seal kits, as well as plain seal kits, are available again, so it should be possible to overhaul them, but please make sure, once apart, that the caliper bore really is not scored and is undamaged.

**\*Very Important\***

You **must** separate the aluminium housing from the steel frame as in this sketch.

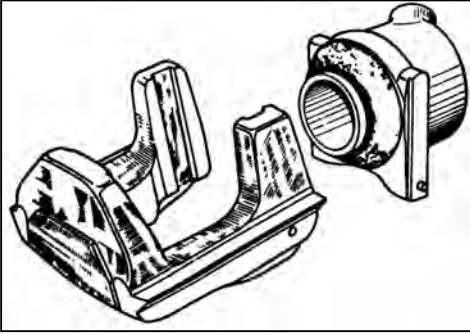

This is likely to be difficult (possibly the most difficult part of the job) especially if they have never been apart before; but if you leave this step out then the rest of the overhaul is largely a waste of time! Since it can be difficult, it is the main reason why it is not done. The problem is that the alloy housing gets squeezed by the steel frame and the corrosion, and the bore becomes oval 'pinching' in on the piston, which will therefore not be able to move freely and retract when you remove your foot from the brake pedal, especially as the only real return action is created by the seal, and the five Belleville (dished) washers around the hand brake pin.

The housing is locked into the steel frame by a spring loaded pin (*indicated below*)

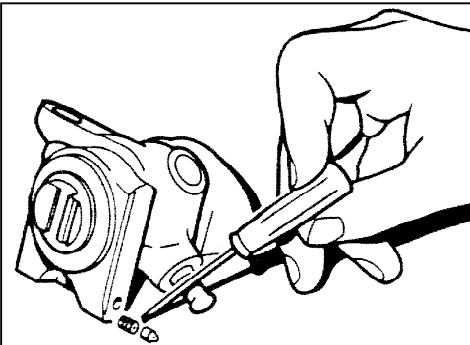

and this **must** be depressed to be able to separate them. As most of those I have seen have become corroded, if you put a small pin punch down the hole in the steel frame, and tap it with a hammer, the pin will usually stay down, allowing you to separate the housing and frame without having to keep the pin depressed. If however you can feel it is free and the spring is pushing back up when you ease the pressure on the pin punch, then you will have to keep it pressed in as you 'slide the housing' in the frame until it is clear of the hole. I say 'slide the housing' but owing to the frame pressure and the corrosion, it will most likely be seized solid!

The manual says you should use special tool number 0016881500 (*this drawing*) to

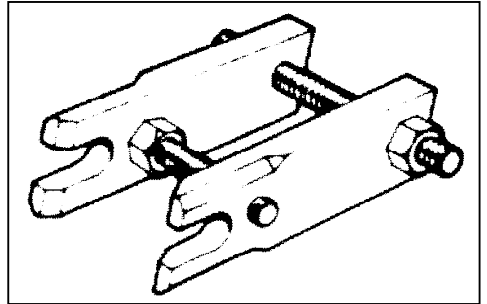

help spread the frame, possibly break the 'corrosion seal' and remove some pressure. Since you won't have one of these, you can make one if you wish as it is simply two shaped plates, a couple of high strength studs, or bolts would do, and four nuts. At this point you may wish to remove the bleed nipples to save them from accidental damage. The sequence of three diagrams to the right, show the tool being used, to spread the frame, the pin being depressed and the housing being removed from the frame. You will see that the housing is slid into the frame in a sort of 'tongue and groove' joint, and you need to push it out

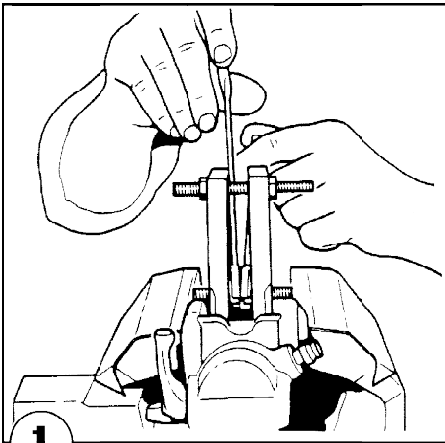

along the groove. A good bench vice and some spacers are needed here. You could use the vice as a press to push the housing out. Alternatively you could use a puller with the 'legs' around the end of the steel frame and the screw pushing onto the housing via a protective spacer. Either way be careful not to damage or distort the alloy housing which is relatively soft.

Another method which you might find easier and prefer, is to make a wedge (*see sketch below for dimensions*) to help ease

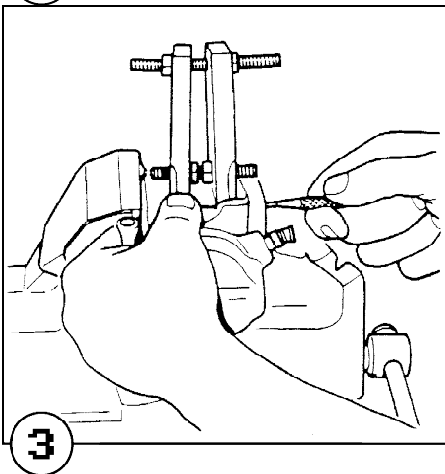
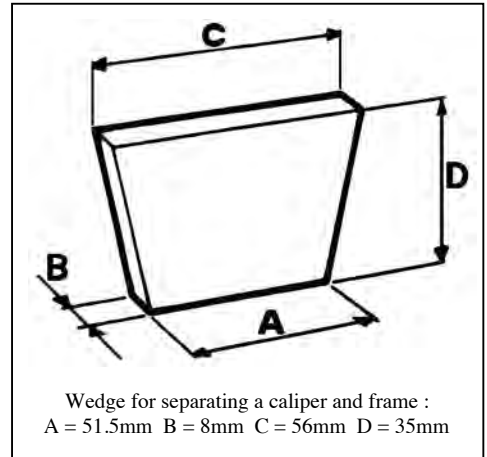
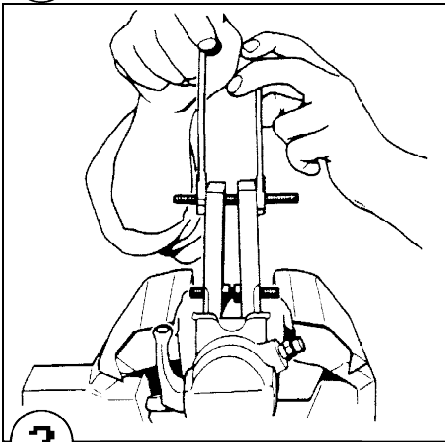

the frame apart. This was recommended in a Renault repair manual, since they use a similar caliper on some of their cars, and they have the same sticking problems, even to this day! Once the housing and frame are separated you can remove the piston and seal and thoroughly clean all the parts. Although the piston was 'seized' and you might expect trouble removing it, once the pressure from the frame is removed, the caliper housing will slowly regain its round shape and the piston should be fairly easy to remove. If it is still very tight, you can connect a pump or air line to the housing using the brake hose thread, and use pressure to eject the piston.

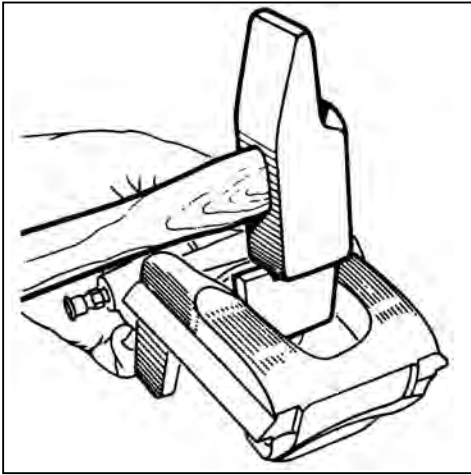

compress the washers, and remove the hand brake lever and shaft. Without the tool you can tap the lever out with a punch. Remove the wedge and spring. You can now pull out the centre screw/pin with the five Belleville and one plain washer from the back of the piston housing. (see drawing at top of next page) Note there is a small 'O' ring seal on the centre screw/pin and a new one is now provided in the caliper seal kits sold by Simon Automobiltechnik in Germany, so remove this and the washers from the pin. Now you can clean and inspect everything prior to re-assembly.

Unless there is a problem with the hand brake mechanism I would leave this alone as it really requires another special tool (Facom T228 - see section view below) to re-assemble it, and this is one you cannot easily make. I do have one myself, but it's not been available for years. It is possible to reassemble it without the tool but it is extremely fiddly; it needs some strong pressure to compress the Belleville washers; and it is easy to damage something or injure yourself. However, if you need to strip this part, then it's important that the Belleville washers are put back correctly otherwise you will lose what little return spring pressure they give.

If you are stripping the hand brake mechanism, then you need to remove the rubber boot and clean out all the grease first so you can see everything properly. Remove the small circlip at the end of the hand brake lever shaft. Next fit the tool,

The main area that will need special attention is the 'tongue and groove' faces where the housing fits in the frame. (see photo bottom of page 7 - the white in the groove is all corrosion) The grooves and corresponding edges of the caliper housing will need to be thoroughly cleaned to get rid of the corrosion, but be very careful **not** to remove the metal itself otherwise the

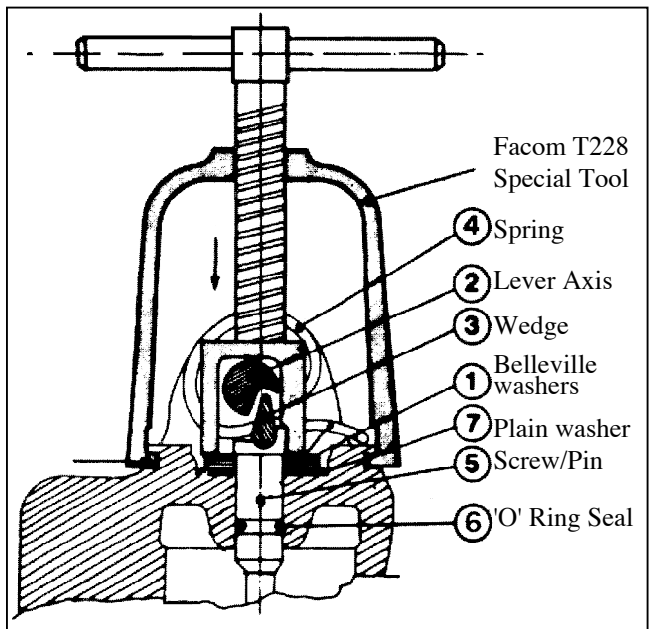



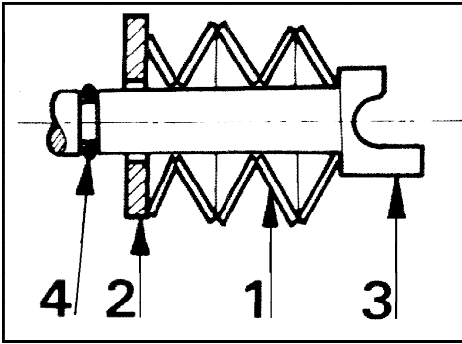

1=Belleville Washers 2=Plain Washer  
3=Handbrake Pin 4='O' Ring Seal

housing will become loose in the frame and will rattle. Once correct, you will just about be able to push the housing back into the frame if greased, with your hands only. It should be really tight, but you should not need any tools to assemble them (this is without the spring loaded pin for the moment). Once you can do this, you will need to decide how you will lock the housing and frame together again.

If you were able to remove the spring loaded pins without ruining them, or you obtained some new ones, then all you need to do is clean, thoroughly grease them, and (re-) use them. If however, these were too seized-in to remove easily, and after carefully drilling out the old pins, you

failed to get some more, you will need to devise another method to lock the housing to the frame, since new pins and springs do not come in the seal kits either. You can sometimes get these pins and springs from Renault but it is getting more difficult.

The problem with any alternative, is that nothing must stick up out of the frame, because one of the wedge plates that hold the caliper in the hub frame has to slide over this hole. That seems to leave only one solution: a grub screw that has a plain leading section. This will locate in the housing hole, without pressing on it. A plain grub screw that presses against the alloy housing will push the frame away in reaction, which will open a small gap for the elements to get in again and restart the corrosion process! Also if you push the two pieces apart, the chances are increased that you will get a rattling from the brakes whilst they're not actually applied. If you want to use a grub screw you will need to tap the frame hole first, and then make up or modify some grub screws (preferably in stainless steel to reduce corrosion) for this specific job. Use a thread locking solution to hold the grub screw in place with the plain end locating in the hole because you must not tighten it against the housing.



Frame showing corrosion in groove

With everything clean, you should inspect all other parts for wear or damage, and if they are all satisfactory, then you can start the caliper re-assembly. You should use a good coating of high melting point grease (such as Castrol LM - wheel bearing grease) on all mating faces, over the springs & pins or grub screws, and the joints between the housing and frames to prevent the elements getting back in to start the corrosion again. Fit the spring and pin, and fit the housing to the frame.

## Re-assembly

Next job is the hand brake mechanism if you stripped it. You replace the centre screw/pin after lightly greasing the 'O' ring seal and making sure the plain hardened washer is fitted for the Belleville washers to seat upon (*see the picture top of page 7*). The next bit is the tricky part unless you have the special tool. You have to put back the hand brake lever, spring and wedge, but to do so you have to compress the Belleville washers at the same time. The tool has an end that fits over the hand brake lever shaft to compress the washers which then leaves your hands free to feed the lever shaft in at the same time fitting the spring and wedge. (*see section diagram page 6*)

Without the tool you will need to compress the washers using a drift which takes up one hand, leaving you only one other hand for the rest of the job! Another pair of hands could be very useful here!! Since the lever shaft runs in steel bushes pressed in to the alloy you must be careful not to push these out as you push the lever in. It can be done, as I've done it several times now, but it is tricky (and almost as bad to describe!) and as I said before, I would leave it alone unless there was a problem. There should be five Belleville washers, the first sits on the hardened washer and the others fit back to back on top of the first.

You should note that owing to the design, the hand brake lever can only turn through about 30 degrees before the side of the groove in the shaft hits the side of the wedge. If you have to pull the handbrake up more to make the car hold, the chances are you will push the wedge out and lose the hand brake on both wheels altogether. This will only happen if the brake is not self adjusting correctly and/or the disc has worn

too thin. Once the lever is back in, you fit the retaining circlip, grease the mechanism, preferably with proper brake grease, and refit the rubber boot.

## Circlips

Please note, there is a correct way to fit a circlip! The holes for the pliers are tapered and the tips of the circlip pliers should also have a reverse taper i.e. the end is slightly wider than the neck. (*see sketch below*,

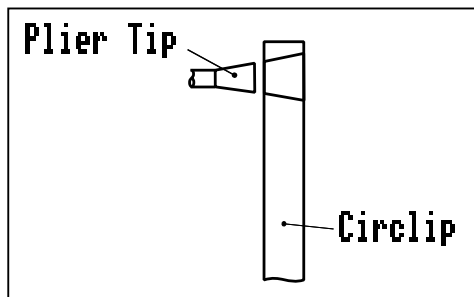

*which is exaggerated to show the effect*). The reason is so that when you squeeze the pliers to open the circlip (or close it for an internal circlip) it is pulled on to the pliers by the taper. If you fit the circlip the wrong way around it will want to slide off the plier tips, making it more difficult to hold on the pliers or remove it from the shaft. Since these holes are small it is often difficult to see which way the tapered hole goes, but if you look carefully, from the larger end of the hole you should be able to make out the narrower end too, whilst looking from the narrow end you will only see that edge of the hole. This mating circlip plier tips and circlip hole effect, seems to be a point many are no longer taught, and I commonly find young mechanics have never heard of it. Since I often find circlips the wrong way around when trying to strip things like gearboxes, it seems that the people at the manufacturers have forgotten or never heard of this either!

However, back to the brake overhaul:

### Self adjusting mechanism

Check the self adjusting mechanism inside the piston. If the piston has never been out before, it should still be correct, but I have now seen several which have obviously been stripped and replaced incorrectly so please give these a quick check before putting the piston back in.



The bar across should be held tight by the clip and it should be parallel with the groove on the face where it contacts the brake pad. (*correct piston on right above*) The piston has a small curved cut out which you can see above, which should be the high point for the air to bleed out when bleeding the brakes, and this is on the same side of the piston face groove which has the smaller groove or scribed line.

Now you should see why this scribed line must be at the top when the caliper is fitted. In this position the small curved cut out will be at the top too, so the air can escape. If the bar across blocks this (*as with piston on left above*) which I have seen on more than one occasion, you will have great difficulty whenever bleeding brakes on the car. The wrong clip has been used in the piston on the left, and the bar was free to turn under it and had moved to the wrong position. The clip in the piston on the right is such a tight fit that it holds the bar securely and it cannot turn once fitted.

Next you should try the piston in the bore without the seal. If you push the piston in until it contacts the pin, then 'screw' it in, it should spin freely and wind itself down, proving the bore is now circular again and the piston is a free fit. Remove the piston again and fit a new piston seal carefully in the groove which must be absolutely clean. Any dirt here will cause the seal to sit 'higher' and grip tighter on the piston. Lubricate the seal with some clean brake fluid, followed by a thin smear of brake grease on the surface of the piston. Screw the piston down until the outer flat surface is level with the top of the bore, and then rotate it further until the groove is horizontal with the smaller line above it, as pointed out above so the air can be bled out easily. This position is obviously relative to when the assembly is back on the car.

Finally, fit the new piston rubber boot, using some more brake grease around the inside. This will help to prevent dirt getting in to the area between the piston and bore which would eventually lead to damage.

### Frame springs

If you have bought a new wedge and spring kit, or for cleaning, have removed the old springs (that tensions the caliper when fitted) from the hub frame; then note that they only fit one way correctly. If you fit them the wrong way, the caliper will not be held tight in the frame and everything will rattle badly once back on the road.

The caliper is now ready to be fitted back to the car. You should really fit new flexible hoses too, since these need to be replaced every few years, yet many will be much older and well overdue for replacement. This rubber is micro porous and it also hardens and cracks on the outside with age.

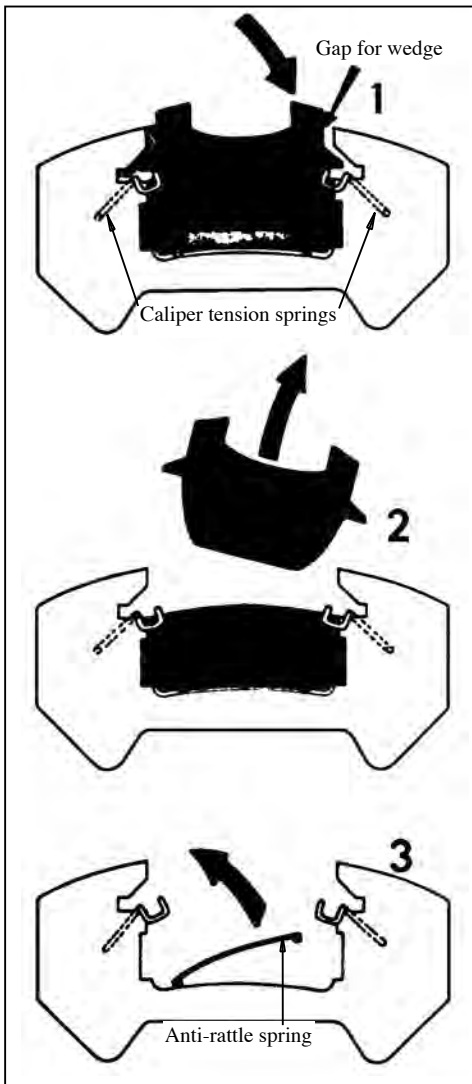

Just as important, it will soften and swell inside and partially block the hole, restricting brake fluid passage to and from the caliper. Since pedal pressure aided by the servo will force the fluid past this restriction the calipers will still apply, but when you release the pedal, the fluid will not be able to return past the restricted flexible hoses and the brakes will remain fully or partially locked on.

Also bits can break off the inside of these old rubber hoses and pass in to the system, clogging it. If you have the metal braided *Aeroquip* type hose this doesn't mean you no longer need to replace them either! In fact since you can't see the state of anything under the braiding, these should be replaced say every eight years maximum too.

### Pad anti-rattle springs

In the drawing on the left, the frame in the bottom sketch shows a different type of anti-rattle spring being lifted out. This is usually a wavy copper type strip which you may occasionally get in a set of new pads. The pad is pushed against it as you insert it into the frame. This will not fit a Bagheera or Murena frame, so discard them (or give them to someone with a Lotus or Renault which do use them). We normally use a small shaped wire anti-rattle spring which is fitted to one of the pad lugs. (see the index page sketches A and B) so that they push the pad in the direction of wheel rotation. These require a small cut out in the corner of the pad lug. Sometimes you may get new pads that don't have this cut out. If this happens, simply file a corner off the lug to make room for the wire spring. Do not try to fit it without this cut out otherwise the pad will jam in the frame and not be free to slide as it should.

### Pad location pip

Another thing that causes confusion is that some pads have a pip on the back and others don't. Do not worry whether it is there or not. It is not really necessary as long as you make sure the groove in the piston face is horizontal. The brakes will work just as well whether it has them or not. When the pads are fitted this pip is offset from the centre of the piston so it's intention is to make sure the piston groove

is horizontal. If it wasn't horizontal the pads would not fit as the groove would not be in the right place to accept the pip. Being offset it would also stop the piston from rotating as some have suggested, but since it never could rotate, that is not its real intention. You can forget about any rotation whilst in use since the amount of friction in the system means the piston will never rotate on its own!

### **Bleeding the brakes**

To bleed brakes, I use a Gunson's pressure bleed kit which is cheap, easy and brilliant, and works the same way as the professional equipment. You only need about 1 bar pressure (12-15 psi will do) - too much will cause leaks, so let down your spare tyre for the supply pressure, but do remember to re-pressurize it again afterwards! On a Murena I bled out the majority of the air via the large bleed nipple that is normally at the bottom of the housing. I do this with the caliper off and held upside down so that this nipple is at the 'top', and I can also agitate the caliper to release the air better. Once the fluid is coming through more or less bubble-free, I fit the caliper back on the car, and do the final bleed from the small nipple in the banjo bolt.

If you are working on a Bagheera, then you don't need to do this as the flexible hose attaches at the bottom and the bleed nipple is correctly at the top as fitted, making bleeding that much simpler. Wipe away any visible fluid afterwards, which will make it easier to spot any leaks.

**Note:** Never over-tighten bleed nipples as they will be so difficult to undo later, they will probably shear when you try to undo them. They use a conical seat which needs little pressure to seal.

Next, pump the brake pedal to bring the pads onto the disc and cause the self adjusting mechanism to set itself. Note the pedal may feel slightly softer than previously, if the calipers had been sticking badly or seized, but this must not be confused with air in the system. If you have the engine off, so there is no servo effect (pump a few times to get rid of any remaining vacuum) then when you pump the pedal rapidly, there should be no difference in pedal movement. If the pedal movement becomes much less then there is probably some air still left in the system which is compressing, and giving a more solid feel and less movement. If you still have rubber flexible hoses, you can clamp individual ones to check where the air is, but the one disadvantage of braided hoses is the fact that you cannot clamp them. It should be fairly obvious though if you still have air in the system, and if that is the case, you need to bleed them a little more.

### **Refitting the wedges**

When you refit the caliper into the frame,

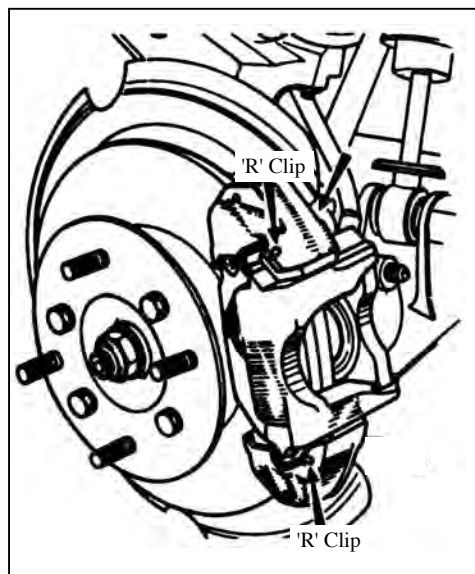

push the sliding plates or wedges in from the rear (use copper grease to lubricate them) and put the 'R' clips in the holes which will be on the outside. If you fit the bottom wedge first it should go in easily as there will be no real spring pressure at this time. You can then use a lever at the top to make it much easier to push the caliper in against the springs, and insert the top wedge. Having the 'R' clips on the outside makes it easy to see them through the holes in the wheels and know that 'all is well'. Also when you come to remove the wedges, say to replace the pads, after removing the 'R' clips it will be easy to tap out the wedges with a drift. If the wedges were fitted from the outside, you would have to try to drift them out from behind which is more difficult.

Once everything is complete you should no longer have any brake drag, and you will need to make sure you fitted brake pad springs, whether or not you had them before, as the pads will now be free enough to move forwards and backwards and rattle. These should be fitted to the lower lug on the rear brakes, pushing in the direction of forward rotation, otherwise you will hear the pads 'knocking' as you apply the brakes.

### **Setting the hand brake**

Finally, refit the hand brake cable to the levers and adjust the setting. Around 3 to 5 clicks of the ratchet should be about right, and you can surprise your M.o.T. man by being able to lock both wheels on the hand brake and still have them release afterwards! Please note that if everything has been done correctly, the brakes will be free enough that the car will now roll without the hand brake, even on slight slopes, - so you will need to use it more. Many I know will have become used to

relying on the brake drag holding the car stationary at temporary halts, like junctions and stoplights, so beware!!

If you find the hand brake is fine for the first hard application but then keeps pulling up further with each subsequent application, the self adjustment mechanism is probably slipping - basically the clutch spring is not holding tight. Since this is not available separately, you will need a new caliper if you can get one, or another piston to take one from.

If you have a Hodec RHD converted Bagheera, the hand brake conversion is so poor it will need some further modifications to make it work correctly. How they ever got the original design accepted I will never know; but contact me if you have one of these and need to make it good.

### **Useful notes:**

Leave the piston in the caliper housing until it is separated from frame as this will help to stop distortion and damage.

**Never** use emery cloth to clean pistons or bores. Use some cloth soaked in brake fluid and 'elbow grease!' The dirt should never be that hard to remove and if you use abrasives, you will cause damage.

Although the rear pads will fit in the front calipers of a Murena you should **never** do this. The primary reason is that pad lugs which locate it relative to the frame are differently positioned (*see the comparison drawing at the top of the next page*) and the pad will be further out from the centre of the disc. Therefore some of it will be off the edge, resulting in less braking frictional area, inferior braking, uneven disc and pad wear, noise, and overheated pads.

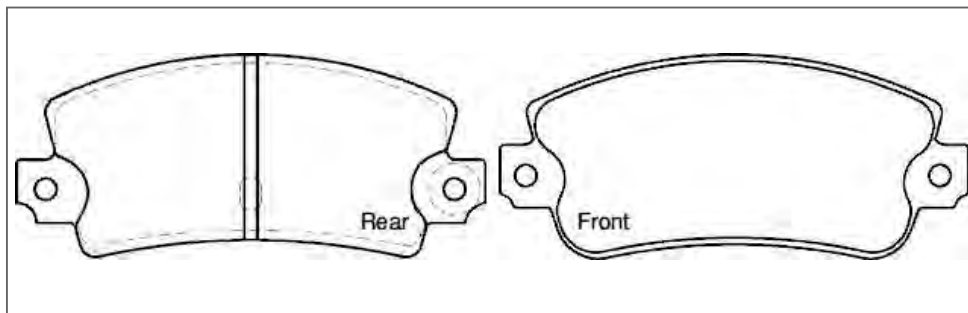

Conversely you cannot fit front pads in the rear since these would have to be closer to the centre of the disc and would foul the hub. *(you can see from the pad lugs that you would have to move the rear pad outwards to align the lugs if fitting incorrectly in the front which would move the pad off the edge of the front disc)*

Another reason not to fit rear pads to the front is that the original specifications had different friction material front and rear. The fronts which do more work and get hotter are rated for this. The rears which run cooler and have a higher friction level and therefore work better for the hand brake, would over heat if used in the front.

### **Brake dust**

If you are thinking about fitting brake dust shields to keep your 'difficult-to-clean' wheels clean, then from trials I carried out I would say that whilst they are just about O.K. on the rear, I wouldn't really advise them as they restrict the cooling flow, and you should certainly never fit them to the front. (my pads lost efficiency during the trials). However, now your calipers are free after the overhaul, you should find the dust problem is much less than it was anyway.

### **Kevlar pads**

Finally, there are now some Kevlar pads available from EBC which give up to 20%

better grip, don't create vast amounts of black dust like the non-asbestos ones, cause much less wear to the discs and should be much better for you, the environment, and the car. In the beginning these EBC pads could be difficult to find, but these days they are now quite common, so you should have no problems. Many websites don't list Matra but if you simply search for the appropriate pad part numbers you should find them. On websites asking for the make and model, most won't list Matra but if you can search by part numbers you should find if they stock them. If you have put in the correct numbers\*, you may see Matra listed along with the other models that these pads fit (which can be useful to know) and you can then add them to your shopping basket.

**N.B.** Very often all makes of brake pads sometimes have the aural warning button fitted in the pads the wrong way round. The large head should be on the material side. When the pad material is almost worn out, the head will touch the disc and make a noise to warn you that they are almost worn out. However, as the button is soft it will not damage the disc.

*\*See the inside of the rear cover for Murena and Bagheera EBC pad part numbers; as well as other part numbers including some alternative Renault ones.*

# Front Brakes

The Murena front calipers by comparison are really easy! If they are sticking at all there are usually only three reasons and one is the most common. This is the piston sticking owing to corrosion, due to the rubber gaiter having split or broken up allowing moisture in. You will have to remove the piston from the caliper to cure this one, so if the rears are stripped, this is the time to do it, whilst the fluid is drained.

After removing the piston and seal, clean off the piston and the bore corrosion, and then try the piston back in the bore. It should now slide in and out easily. Since this area is outside the seal it is not as critical as the bore behind the seal so you can scrape it to clean it, but take care and try not to score it. Clean out the seal groove too. Then you can fit a new seal lubricate it with some brake fluid, smear some brake grease on the piston and refit it.

## Caliper bleed nipples

When you come to bleed the front calipers be careful with the bleed nipples. They are small and easy to shear off. Always use a single hexagon ring spanner or socket and if necessary warm the housing to help it release. If you do shear the nipple, then I now have a kit and can possibly save the caliper, so contact me about it.

The second most common fault particularly with little used cars, are the pads sticking in the frame. Check this one first of course. No point stripping the caliper if the fault is only stuck pads! The lugs can get some corrosion on them and cause jamming in the frame. Simply remove the pads, clean the lugs and frame and then use a little

copper grease, but not too much, when refitting them. Many people use too much grease on pads and since the brakes always generate dust, this will adhere to the grease and the resultant paste makes things sticky.

Finally the third item is the same as the rears - if the rubber hoses have not been changed in a long while they can block internally, so make sure you change them.

# Total brake lock

Just a couple of times I have heard of all the brakes jamming on, and this was due to the pivot at the front having seized. Since the brake master cylinder and servo are mounted across the car, at 90 degrees to the pedal, there is a pivot assembly under the bonnet to translate the pedal motion to the master cylinder. If this hasn't been lubricated during its life, it has been known to seize and jam all the brakes on!

# Brake master cylinder

Until recently brake master cylinder seals were not available, so once the seals were leaking, all you could do was replace it. With these master cylinders difficult to obtain, they are now very expensive.

Simon Auto in Germany now have brake master cylinder seal kits for the Matra cars for a reasonable price. The Murena Bendix unit is very similar to the Bagheera ATE cylinder but uses four seals whilst the Bagheera has five. They now make a kit for both the Bagheera and Murena. The RHD Espace uses Bendix cylinders for which kits are available. Kits for LHD Espace (ATE units) are not available.



**Bagheera brake master cylinder  
with five piston seals**



The Bagheera master cylinder (*above*) was actually easier to disassemble since it used a bolt between the two sections which was simple to remove. The Murena has split roll pins fitted to keep the two pistons in place, and these are a little more difficult to remove, but if you have a pick set they should present no problem. Each roll pin has a hole in both ends, so you can get the point of a pick in them, and pull them out.

If you do buy the Simon master cylinder seal kit please note this does not include the

two seals for the reservoir, so you will need to buy these separately. Also note, the four seals are not all the same, so make sure you mark where the different ones are fitted and replace them as per the original. A good idea now we have easy digital cameras, is to take photos before and during stripping anything and then you will have a record to refer to, if you are not sure.

You can see the bolt head in the Bagheera photo above which you must remove before you can get the inner piston and spring out.

**Murena brake  
master cylinder  
with four piston  
seals**



The photo on the previous page shows a Murena master cylinder stripped and you can see the two roll pins which locate through the slot in the pistons, and the holes in the end of the roll pins are clearly visible in the one on the left. These pins are fitted in the intake area where the reservoir fits, which is why you can't normally see them. Once the reservoir and seals are removed, you will see the pins sticking up.

With all these seal kits there should be some special lubricating fluid in a sachet. Always use this or proper brake grease, to assist assembly and help prevent the delicate seals being torn. Take care particularly with master cylinder seals as you re-insert the pistons.

### **Metal brake pipes**

At this age many cars are needing new brake pipes owing to the originals having corroded. You can replace individual pipes if you wish (just the ones affected) or the complete set. There are only six pipes on the car anyway, as listed below, and a full set made to the right length and with the right ends and a set of new clips will cost approx. £75 (at the time of writing). You have a choice of Copper or Copper-Nickel. I prefer the latter as the plain copper ones are too soft in my opinion, and if you live in Germany only the Copper-Nickel are TUV rated.

You can get the complete kits ready made from Automec Equipment & Parts Ltd. Tel.: 01280 822818 Fax.: 01280 823140 or Email: info@automec.co.uk

For the Murena† the pipes are:

- Pipe No.1 300mm M/Cyl to Union
- Pipe No.2 540mm Union to RH Front
- Pipe No.3 750mm Union to LH Front

- Pipe No.4 2550mm Main Front to Rear
- Pipe No.5 900mm Comp. to RH Rear
- Pipe No.6 2010mm Comp. to LH Rear

Automec can also provide Silicone brake fluid which is superior to normal fluid as it doesn't absorb moisture, so it doesn't deteriorate or cause corrosion. It is also safer since it isn't combustible and won't damage paintwork. (Normal polyglycol brake fluid is more of a potential fire hazard than petrol!) I would certainly recommend it. You should only need a litre to refill and bleed the complete system including the clutch, as long as you are not extravagant! Since it is more expensive than Dot 5 if you need a little extra you could buy a 250ml or 500ml additional bottle.

If you need a set of Aeroquip flexible hoses the company that we have used before, and therefore knows the required Matra specification is :

Earl's Performance Products U.K. Ltd.  
Direct Sales Tel.: 01803 869850 or Email:  
sales@earls.co.uk

With a fully overhauled braking system, *Aeroquip* hoses, new pipes, silicone fluid, and Greenstuff Kevlar pads, your Murena (or Bagheera) will easily be equivalent to today's modern car standards and probably outlast most of them too!

Following are some part numbers for various brake parts you might need. 🌀

*Roy Gillard*

*(†I don't have the measurements for a Bagheera, although I suspect they will be similar, but if anyone can provide them I will include them here).*

## Murena

	Front	Rear
EBC Kevlar Pads (Ferodo)	DP2317 FDB235A	DP2189 FDB106A
Pads (Mintex)	1112	1065

Anti-rattle spring kit (F or R) 13572900

Discs 1.6 17740314 17737614  
2.2 as 1.6 32700500

Wear limit min. 9mm

Caliper RH 13573900 32741000  
LH 13574000 32741100

Caliper Seal Kit 721041B 721013B  
(Bendix)

Caliper spring kit 4427.44 32741200  
(rear kit as above - Renault) 7701201846

Caliper locking pin & spring 13511900  
(Possibly from Renault) 7701201685  
(there are 10 pins/springs in these kits)

Hand brake cable - 3 different ones were originally listed, but 1 is enough and I get them made locally, with greasers.

Master cylinder 30974800  
or Bendix 131465B  
Fluid reservoir 30881800  
Reservoir cap 30881900 (with float)  
Reservoir seals 4654.08

Brake pedal pad 54351200

All part numbers are Talbot unless stated

N.B.: In the Bagheera numbers following the rear calipers were listed originally as 30966200 & 30966300 which had different threads for the fittings, but I have substituted the later Murena numbers simply reversed side to side.

## Bagheera

	Front	Rear
EBC Kevlar Pads (Ferodo)	DP2104 FDB2	DP2189 FDB106
(+wear indicator) Pins & spring kit	FDB190 16869700	FDB106A
Anti-rattle spring kit		13572900

Discs 43023314 17737614

Caliper RH 30364800 32741100  
LH 30942000 32741000

Caliper Seal Kit 721013B  
(Bendix)

Caliper spring kit 32741200  
Caliper locking pin & spring 13511900

Hand brake Cable 30514500  
(Germany) 30514700

Master cylinder 30974800  
Fluid reservoir 30881800  
Reservoir cap 30881900  
Reservoir seals 4654.08

Brake pedal pad 54351200

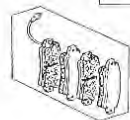
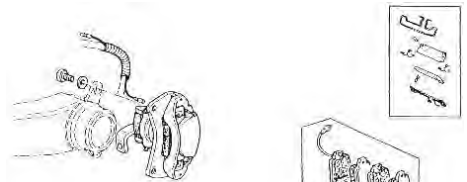

# Redwood RS

## Matra Specialist



## Redwood

*Repairs, Servicing*

Flat 6 Woodlands Court  
Woodlands Road, Harrow.  
Middlesex HA1 2RU  
United Kingdom

+44 (0)20 8861 1035

[redwood@matraclub.org.uk](mailto:redwood@matraclub.org.uk)