



2013 C-MAX HYBRID + C-MAX ENERGY Owner's Manual



Table of Contents	1
Introduction	9
Child Safety	18
Child seats20
Child seat positioning20
Booster seats22
Installing child safety seats25
Child safety locks32
Safety Belts	33
Fastening the safety belts35
Safety belt height adjustment38
Safety belt warning light and indicator chime39
Safety belt-minder39
Child restraint and safety belt maintenance42
Personal Safety System	43
Supplementary Restraints System	44
Driver and passenger airbags46
Front passenger sensing system48
Knee airbag51
Side airbags51
Safety canopy curtain airbags53
Crash sensors and airbag indicator55
Airbag disposal56
Keys and Remote Control	57
General information on radio frequencies57
Remote control58
Keys58
Replacing a lost key or remote control65

MyKey	66
Settings, MyKey66
Creating67
Clearing68
System status68
Remote start, MyKey69
Troubleshooting, MyKey70
Locks	72
Locking and unlocking72
Security	83
SecuriLock® passive anti-theft system83
Steering Wheel	86
Adjusting the steering wheel86
Steering wheel controls87
Wipers and Washers	89
Windshield wipers89
Autowipers90
Windshield washers91
Rear-window wiper and washer91
Lighting	92
Lighting control92
Autolamps93
Instrument lighting dimmer93
Headlamp exit delay94
Daytime running lamps94
Front fog lamps95
Direction indicators95
Interior lamps95
Ambient lighting97

Table of Contents 3

Windows and Mirrors	98
Power windows98
Exterior mirrors101
Interior mirrors103
Sun visors103
Sunshade104
Instrument Cluster	106
Gauges.106
Warning lamps and indicators109
Audible warnings and indicators113
Information Displays	114
Message center.114
Information messages127
Audio System	136
AM/FM/CD with SYNC138
Auxiliary input jack145
USB port146
Satellite radio information.147
Climate Control	151
Dual automatic temperature control.151
Rear window defroster155
Seats	157
Sitting in the correct position157
Head restraints.158
Manual seats161
Power seats163
Rear seats164
Heated seats165

Universal Garage Door Opener (If Equipped)	166
HomeLink® wireless control system	167
Auxiliary Power Points	171
Storage Compartments	173
Center console	173
Overhead console	173
Starting and Stopping the Engine	174
Ignition switch	175
Keyless starting	175
Engine block heater	180
Unique Driving Characteristics	182
Hybrid electric vehicles	182
Fuel and Refueling	190
Fuel quality	191
Refueling	193
Running out of fuel	198
Fuel consumption	200
High Voltage Battery	205
High-voltage battery	205
Charging the high-voltage battery	205
Transmission	213
Automatic transmission	213
Hill start assist	217
Brakes	218
Brakes	218
Hints on driving with anti-lock brakes	219
Traction Control	221
Traction Control™	221

Table of Contents

5

Stability Control	222
AdvanceTrac®223
Parking Aids	224
Sensing system224
Active park assist227
Rear-view camera system231
Cruise Control	236
Driving Aids	238
Steering238
Load Carrying	240
Luggage cover240
Vehicle loading241
Towing	248
Trailer towing248
Wrecker towing248
Recreational towing249
Driving Hints	250
Economical driving250
Floor mats252
Roadside Emergencies	254
Getting roadside assistance256
Hazard warning flashers257
Fuel cut-off switch258
High-voltage shut-off258
Jump starting259
Customer Assistance	263
Reporting safety defects (U.S. only)270
Reporting safety defects (Canada only)270

Fuses	271
Changing a fuse271
Fuse specification chart272
Maintenance	281
General information281
Opening and closing the hood282
Under hood overview283
Engine oil dipstick284
Engine oil check284
Motor/Electronics Coolant286
Engine coolant286
Engine coolant check286
Automatic transmission fluid check291
Brake fluid check292
Power steering fluid check292
Fuel filter292
Washer fluid check293
Changing the vehicle battery293
Checking the wiper blades294
Changing the wiper blades294
Air filter(s)296
Adjusting the headlamps300
Removing a headlamp302
Changing a bulb302
Bulb replacement308
Bulb specification chart309

Table of Contents

7

Vehicle Care	310
Cleaning products310
Cleaning the exterior310
Waxing311
Repairing minor paint damage312
Cleaning the engine312
Cleaning the windows and wiper blades313
Cleaning the interior313
Cleaning the instrument panel and instrument cluster lens314
Cleaning leather seats315
Cleaning the alloy wheels316
Wheels and Tires	321
Tire care321
Tire Pressure Monitoring System (TPMS)336
Temporary mobility kit340
Technical specifications349
Wheel lug nut torque349
Capacities and Specifications	350
Engine specifications350
Part numbers354
Vehicle identification number355
Vehicle certification label356
Transmission code designation356
Accessories	357
Accessories357
Ford Extended Service Plan	359
Scheduled Maintenance	362
Normal scheduled maintenance and log368

SYNC®	381
Pairing your phone for the first time387
911 Assist™401
Vehicle Health Report404
MyFord Touch® (If Equipped)	429
Infotainment display436
Voice recognition438
Listening to music444
Phone features465
Information Menu485
Settings497
Climate features508
Navigation system.511
Appendices	524
Index	544

The information contained in this publication was correct at the time of going to print. In the interest of continuous development, we reserve the right to change specifications, design or equipment at any time without notice or obligation. No part of this publication may be reproduced, transmitted, stored in a retrieval system or translated into any language in any form by any means without our written permission. Errors and omissions excepted.

© Ford Motor Company 2013

ABOUT THIS MANUAL

Thank you for choosing Ford. We recommend that you take some time to get to know your vehicle by reading this manual. The more that you know about it, the greater the safety and pleasure you will get from driving it.



WARNING: Always drive with due care and attention when using and operating the controls and features on your vehicle.

Note: This manual describes a range of product features and options, sometimes before they are generally available. Therefore, you may find options in this manual that are not found on your vehicle.

Note: Some of the illustrations in this manual may be used for different models, so they may appear different than your vehicle. However, the essential information in the illustrations is always correct.

Note: Always use and operate your vehicle in line with all applicable laws and regulations.

Note: Pass on this manual when selling your vehicle. It is an integral part of the vehicle.

This manual may qualify the location of a component as left-hand side or right-hand side. The side is determined when facing forward in the seat.

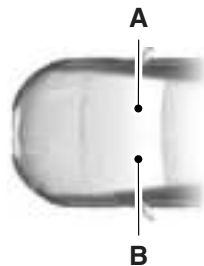

A. Right-hand side

B. Left-hand side



















Protecting the Environment





















You must play your part in protecting the environment. Correct vehicle usage and the authorized disposal of waste, cleaning and lubrication materials are significant steps toward this aim.

SYMBOL GLOSSARY

 **WARNING:** You risk death or serious injury to yourself and others if you do not follow the instruction highlighted by the warning symbol.

These are some of the symbols you may see on your vehicle.

Symbol	Description	Symbol	Description	Symbol	Description
	Safety alert		See Owner's Manual		Anti-lock braking system
	Avoid smoking, flames, or sparks		Battery		Battery acid
	Brake fluid – non petroleum base		Brake system		Cabin air filter
	Check fuel cap		Child Safety Door Lock and Unlock		Child seat lower anchor
	Child seat tether anchor		Cruise control		Do not open when hot
	Engine air filter		Engine coolant		Engine coolant temperature
	Engine oil		Explosive gas		Fan warning
	Fasten safety belt		Front airbag		Front fog lamps

Symbol	Description	Symbol	Description	Symbol	Description
	Fuel pump reset		Fuse compartment		Hazard warning flasher
	Heated rear window		Interior luggage compartment release		Jack
	Lighting control		Low tire pressure warning		Maintain correct fluid level
	Panic alarm		Parking aid system		Parking brake system
	Power steering fluid		Power windows front and rear		Power window lockout
	Service engine soon		Side airbag		Stability control
	Windshield defrost and demist		Windshield washer and wiper		

DATA RECORDING**Service Data Recording**

Service data recorders in your vehicle are capable of collecting and storing diagnostic information about your vehicle. This potentially includes information about the performance or status of various systems and modules in the vehicle, such as engine, throttle, steering or brake systems. In order to properly diagnose and service your vehicle, Ford Motor Company, Ford of Canada, and service and repair facilities may access or share among them vehicle diagnostic information received through a direct connection to your vehicle when diagnosing or servicing your vehicle. Additionally, when your vehicle is in for service or repair, Ford Motor Company, Ford of Canada, and service and repair facilities may access or share among them data for vehicle improvement purposes. For U.S. only (if equipped), if you choose to use the SYNC® Vehicle Health Report, you consent that certain diagnostic information may also be accessed electronically by Ford Motor Company and Ford authorized service facilities, and that the diagnostic information may be used for any purpose. See the *SYNC®* chapter for more information.

Event Data Recording

This vehicle is equipped with an event data recorder (EDR). The main purpose of an EDR is to record, in certain crash or near crash-like situations, such as an airbag deployment or hitting a road obstacle; this data will assist in understanding how a vehicle's systems performed. The EDR is designed to record data related to vehicle dynamics and safety systems for a short period of time, typically 30 seconds or less. The EDR in this vehicle is designed to record such data as:

- **How various systems in your vehicle were operating;**
- **Whether or not the driver and passenger safety belts were buckled/fastened;**
- **How far (if at all) the driver was depressing the accelerator and/or the brake pedal;**
- **How fast the vehicle was travelling;**
- **Where the driver was positioning the steering wheel.**

This data can help provide a better understanding of the circumstances in which crashes and injuries occur.

Note: EDR data is recorded by your vehicle only if a non-trivial crash situation occurs; no data is recorded by the EDR under normal driving conditions and no personal data or information (e.g., name, gender, age, and crash location) is recorded (see limitations regarding 911 Assist and Traffic, Directions and Information privacy below). However, parties, such as law enforcement, could combine the EDR data with the type of personally identifying data routinely acquired during a crash investigation.

To read data recorded by an EDR, special equipment is required, and access to the vehicle or the EDR is needed. In addition to the vehicle manufacturer, other parties, such as law enforcement, that have such special equipment, can read the information if they have access to the vehicle or the EDR. Ford Motor Company and Ford of Canada do not access event data recorder information without obtaining consent, unless pursuant to court order or where required by law enforcement, other government authorities or other third parties acting with lawful authority. Other parties may seek to access the information independently of Ford Motor Company and Ford of Canada.

Note: Including to the extent that any law pertaining to Event Data Recorders applies to SYNC® or its features, please note the following: Once 911 Assist (if equipped) is enabled (set ON), 911 Assist may, through any paired and connected cell phone, disclose to emergency services that the vehicle has been in a crash involving the deployment of an airbag or, in certain vehicles, the activation of the fuel pump shut-off. Certain versions or updates to 911 Assist may also be capable of being used to electronically or verbally provide to 911 operators the vehicle location (such as latitude and longitude), and/or other details about the vehicle or crash or personal information about the occupants to assist 911 operators to provide the most appropriate emergency services. If you do not want to disclose this information, do not activate the 911 Assist feature. See your SYNC® chapter for more information.

Additionally, when you connect to Traffic, Directions and Information (if equipped, U.S. only), the service uses GPS technology and advanced vehicle sensors to collect the vehicle's current location, travel direction, and speed ("vehicle travel information"), only to help provide you with the directions, traffic reports, or business searches that you request. If you do not want Ford or its vendors to receive this information, do not activate the service. Ford Motor Company and the vendors it uses to provide you with this information do not store your vehicle travel information. For more information, see Traffic, Directions and Information, Terms and Conditions. See your SYNC® chapter for more information.

CALIFORNIA PROPOSITION 65



WARNING: Some constituents of engine exhaust, certain vehicle components, certain fluids contained in vehicles and certain products of component wear contain or emit chemicals known to the State of California to cause cancer and birth defects or other reproductive harm.

PERCHLORATE MATERIAL

Note: Certain components in your vehicle, such as airbag modules, safety belt pretensioners, and remote control batteries, may contain perchlorate material. Special handling may apply for service or vehicle end of life disposal. See www.dtsc.ca.gov/hazardouswaste/perchlorate for more information.

FORD CREDIT (U.S. ONLY)

Ford Credit offers a full range of financing and lease plans to help you acquire your vehicle. If you have financed or leased your vehicle through Ford Credit, thank you for your business.

For your convenience, we offer a number of ways to contact us, as well as help manage your account.

Phone: 1-800-727-7000

For more information regarding Ford Credit, as well as access to Account Manager, please go to www.fordcredit.com.

REPLACEMENT PARTS RECOMMENDATION

Your vehicle has been built to the highest standards using quality parts. We recommend that you demand the use of genuine Ford and Motorcraft parts whenever your vehicle requires scheduled maintenance or repair. You can clearly identify genuine Ford and Motorcraft parts by looking for the Ford, FoMoCo or Motorcraft branding on the parts or their packaging.

Scheduled Maintenance and Mechanical Repairs

One of the best ways for you to make sure that your vehicle provides years of service is to have it maintained in line with our recommendations using parts that conform to the specifications detailed in this owner's manual. Genuine Ford and Motorcraft parts meet or exceed these specifications.

Collision Repairs

We hope that you never experience a collision, but accidents do happen. Genuine Ford replacement collision parts meet our stringent requirements for fit, finish, structural integrity, corrosion protection and dent resistance. During vehicle development, we validate that these parts deliver the intended level of protection as a whole system. A great way to know for sure you are getting this level of protection is to use genuine Ford replacement collision parts.

Warranty on Replacement Parts

Genuine Ford and Motorcraft replacement parts are the only replacement parts that benefit from a Ford Warranty. Damage caused to your vehicle as a result of the failure of non-Ford parts may not be covered by the Ford Warranty. For additional information, see the terms and conditions of the Ford Warranty.

SPECIAL NOTICES**New Vehicle Limited Warranty**

For a detailed description of what is covered and what is not covered by your vehicle's New Vehicle Limited Warranty, see the warranty information that is provided to you along with your owner's manual.

Special Instructions

For your added safety, your vehicle is fitted with sophisticated electronic controls.



WARNING: Please read the *Supplementary Restraints System* chapter. Failure to follow the specific warnings and instructions could result in personal injury.



WARNING: Front seat mounted rear-facing child or infant seats should **NEVER** be placed in front of an active passenger airbag.

MOBILE COMMUNICATIONS EQUIPMENT

Using mobile communications equipment is becoming increasingly important in the conduct of business and personal affairs. However, you must not compromise your own or others' safety when using such equipment. Mobile communications can enhance personal safety and security when appropriately used, particularly in emergency situations. Safety must be paramount when using mobile communications equipment to avoid negating these benefits.

Mobile communication equipment includes, but is not limited to, cellular phones, pagers, portable email devices, text messaging devices and portable two-way radios.



WARNING: Driving while distracted can result in loss of vehicle control, accident and injury. Ford strongly recommends that you use extreme caution when using any device or feature that may take your focus off the road. Your primary responsibility is the safe operation of your vehicle. We recommend against the use of any handheld device while driving, encourage the use of voice operated systems when possible and that you become aware of applicable state and local laws that may affect use of electronic devices while driving.

**EXPORT UNIQUE (NON-UNITED STATES/CANADA) VEHICLE
SPECIFIC INFORMATION**

For your particular global region, your vehicle may be equipped with features and options that are different from the features and options that are described in this owner's manual. A market unique supplement may be supplied that complements this book. By referring to the market unique supplement, if provided, you can properly identify those features, recommendations and specifications that are unique to your vehicle. This owner's manual is written primarily for the U.S. and Canadian Markets. Features or equipment listed as standard may be different on units built for Export. **See this owner's manual for all other required information and warnings.**

GENERAL INFORMATION

See the following sections for directions on how to properly use safety restraints for children.



WARNING: Always make sure your child is secured properly in a device that is appropriate for their height, age and weight. Child safety restraints must be bought separately from your vehicle. Failure to follow these instructions and guidelines may result in an increased risk of serious injury or death to your child.



WARNING: All children are shaped differently. The recommendations for safety restraints are based on probable child height, age and weight thresholds from NHTSA and other safety organizations, or are the minimum requirements of law. Ford recommends checking with a NHTSA Certified Child Passenger Safety Technician and consulting your pediatrician to make sure your child seat is appropriate for your child, and is compatible with and properly installed in your vehicle. To locate a child seat fitting station and CPST, contact the NHTSA toll free at 1-888-327-4236 or locate NHTSA on the internet. In Canada, check with your local St. John Ambulance office for referral to a CPST or for further information, contact your provincial ministry of transportation, or locate your local St. John Ambulance office by searching for St. John Ambulance on the internet, or Transport Canada at 1-800-333-0371 (<http://www.tc.gc.ca>). Failure to properly restrain children in safety seats made especially for their height, age, and weight may result in an increased risk of serious injury or death to your child.

Recommendations for Safety Restraints for Children		
	Child size, height, weight, or age	Recommended restraint type
Infants or toddlers	Children weighing 40 lb (18 kg) or less (generally age four or younger).	Use a child safety seat (sometimes called an infant carrier, convertible seat, or toddler seat).

Recommendations for Safety Restraints for Children		
	Child size, height, weight, or age	Recommended restraint type
Small children	Children who have outgrown or no longer properly fit in a child safety seat (generally children who are less than 4 ft. 9 in. (1.45 m) tall, are greater than age four (4) and less than age twelve (12), and between 40 lb (18 kg) and 80 lb (36 kg) and upward to 100 lb (45 kg) if recommended by your child restraint manufacturer).	Use a belt-positioning booster seat.
Larger children	Children who have outgrown or no longer properly fit in a belt-positioning booster seat (generally children who are at least 4 ft. 9 in. (1.45 m) tall or greater than 80 lb (36 kg) or 100 lb (45 kg) if recommended by child restraint manufacturer).	Use a vehicle safety belt having the lap belt snug and low across the hips, shoulder belt centered across the shoulder and chest, and seat back upright.

- You are required by law to properly use safety seats for infants and toddlers in the United States and Canada.
- Many states and provinces require that small children use approved booster seats until they reach age eight, a height of 4 feet 9 inches (1.45 meters) tall, or 80 pounds (36 kilograms). Check your local and state or provincial laws for specific requirements about the safety of children in your vehicle.
- When possible, always properly restrain children twelve (12) years of age and under in a rear seating position of your vehicle. Accident statistics suggest that children are safer when properly restrained in the rear seating positions than in a front seating position. See *Front Passenger Sensing System* in the *Supplementary Restraints System* chapter for more information.

CHILD SEATS

Use a child safety seat (sometimes called an infant carrier, convertible seat, or toddler seat) for infants, toddlers or children weighing 40 pounds (18 kilograms) or less (generally age four or younger).

CHILD SEAT POSITIONING

! **WARNING:** Airbags can kill or injure a child in a child seat. NEVER place a rear-facing child seat in front of an active airbag. If you must use a forward-facing child seat in the front seat, move the vehicle seat upon which the child seat is installed all the way back. When possible, all children age 12 and under should be properly restrained in a rear seating position. If all children cannot be seated and restrained properly in a rear seating position, properly restrain the largest child in the front seat.

! **WARNING:** Always carefully follow the instructions and warnings provided by the manufacturer of any child restraint to determine if the restraint device is appropriate for your child's size, height, weight, or age. Follow the child restraint manufacturer's instructions and warnings provided for installation and use in conjunction with the instructions and warnings provided by your vehicle manufacturer. A safety seat that is improperly installed or utilized, is inappropriate for your child's height, age, or weight or does not properly fit the child may increase the risk of serious injury or death.

! **WARNING:** Never let a passenger hold a child on his or her lap while your vehicle is moving. The passenger cannot protect the child from injury in a crash, which may result in serious injury or death.

! **WARNING:** Never use pillows, books, or towels to boost a child. They can slide around and increase the likelihood of injury or death in a crash.

 **WARNING:** Always restrain an unoccupied child seat or booster seat. These objects may become projectiles in a crash or sudden stop, which may increase the risk of serious injury.

 **WARNING:** Never place, or allow a child to place, the shoulder belt under a child's arm or behind the back because it reduces the protection for the upper part of the body and may increase the risk of injury or death in a crash.

 **WARNING:** Do not leave children or pets unattended in your vehicle.

Restraint Type	Child Weight	Use any attachment method as indicated below by X.				
		LATCH (lower anchors and top tether anchor)	LATCH (lower anchors only)	Safety belt and top tether anchor	Safety belt and LATCH (lower anchors and top tether anchor)	Safety belt only
Rear-facing child seat	Up to 48 lb (21 kg)		X			X
Forward-facing child seat	Up to 48 lb (21 kg)	X		X	X	
Forward-facing child seat	Over 48 lb (21 kg)			X	X	

Note: The child seat must rest tightly against the vehicle seat upon which it is installed. It may be necessary to lift or remove the head restraint. See the *Seats* chapter for information on head restraints.

BOOSTER SEATS

WARNING: Never place, or allow a child to place, the shoulder belt under a child's arm or behind the back because it reduces the protection for the upper part of the body and may increase the risk of injury or death in a crash.

Use a belt-positioning booster seat for children who have outgrown or no longer properly fit in a child safety seat (generally children who are less than 4 feet 9 inches (1.45 meters) tall, are greater than age four (4) and less than age twelve (12), and between 40 pounds (18 kilograms) and 80 pounds (36 kilograms) and upward to 100 pounds (45 kilograms) if recommended by your child restraint manufacturer). Many state and provincial laws require that children use approved booster seats until they reach age eight (8), a height of 4 feet 9 inches (1.45 meters) tall, or 80 pounds (36 kilograms).

Booster seats should be used until you can answer YES to ALL of these questions when the child is seated without a booster seat.

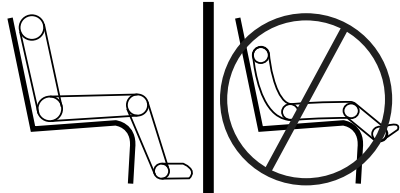

- Can the child sit all the way back against their vehicle seat with knees bent comfortably at the edge of the seat cushion?
- Can the child sit without slouching?
- Does the lap belt rest low across the hips?
- Is the shoulder belt centered on the shoulder and chest?
- Can the child stay seated like this for the whole trip?

Always use booster seats in conjunction with your vehicle lap and shoulder belt.

Types of Booster Seats

- Backless booster seats

If your backless booster seat has a removable shield, remove the shield. If a vehicle seating position has a low seat back or no head restraint, a backless booster seat may place your child's head (as measured at the tops of the ears) above the top of the seat. In this case, move the backless booster to another seating position with a higher seat back or head restraint and lap and shoulder belts, or consider using a high back booster seat.



- High back booster seats

If, with a backless booster seat, you cannot find a seating position that adequately supports your child's head, a high back booster seat would be a better choice.

Children and booster seats vary in size and shape. Choose a booster that keeps the lap belt low and snug across the hips, never up across the stomach, and lets you adjust the shoulder belt to cross the chest and rest snugly near the center of the shoulder. The following drawings compare the ideal fit (center) to a shoulder belt uncomfortably close to the neck and a shoulder belt that could slip off the shoulder. The drawings also show how the lap belt should be low and snug across the child's hips.

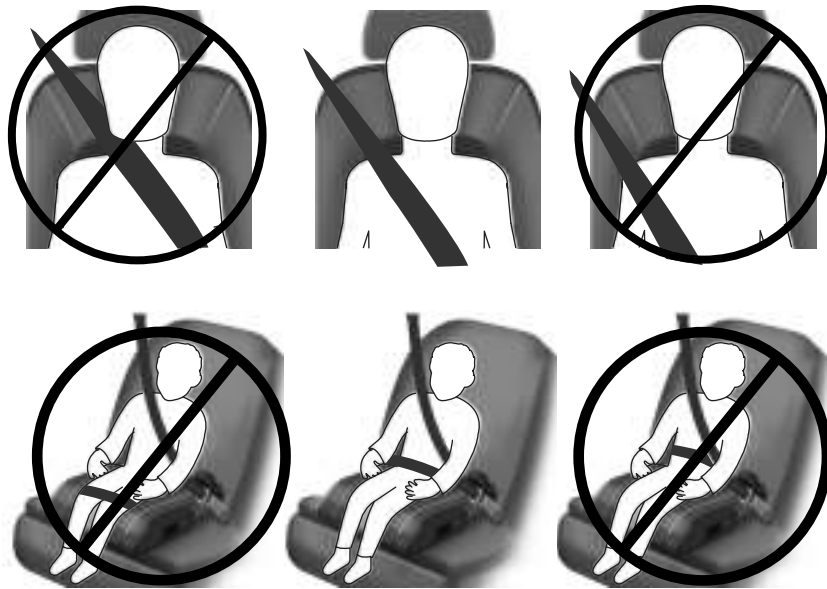

If the booster seat slides on the vehicle seat upon which it is being used, placing a rubberized mesh sold as shelf or carpet liner under the booster seat may improve this condition. Do not introduce any item thicker than this under the booster seat. Check with the booster seat manufacturer's instructions.

INSTALLING CHILD SEATS**Using Lap and Shoulder Belts**

WARNING: Airbags can kill or injure a child in a child seat.

NEVER place a rear-facing child seat in front of an active airbag.

If you must use a forward-facing child seat in the front seat, move the seat all the way back.



WARNING: Airbags can kill or injure a child in a child seat.

Children 12 and under should be properly restrained in the rear seat whenever possible.



WARNING: Depending on where you secure a child restraint, and depending on the child restraint design, you may block access to certain safety belt buckle assemblies or LATCH lower anchors, rendering those features potentially unusable. To avoid risk of injury, occupants should only use seating positions where they are able to be properly restrained.

When installing a child safety seat with combination lap and shoulder belts:

- Use the correct safety belt buckle for that seating position.
- Insert the belt tongue into the proper buckle until you hear a snap and feel it latch. Make sure the tongue is securely fastened in the buckle.
- Keep the buckle release button pointing up and away from the safety seat, with the tongue between the child seat and the release button, to prevent accidental unbuckling.
- Place the vehicle seat upon which the child seat will be installed in the upright position.
- Put the safety belt in the automatic locking mode. See Step 5. This vehicle does not require the use of a locking clip.

Perform the following steps when installing the child seat with combination lap and shoulder belts:

Note: Although the child seat illustrated is a forward-facing child seat, the steps are the same for installing a rear-facing child seat.



1. Position the child safety seat in a seat with a combination lap and shoulder belt.

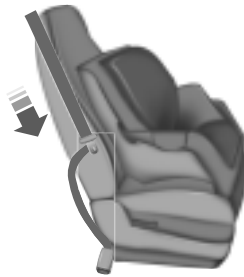

2. Pull down on the shoulder belt and then grasp the shoulder belt and lap belt together.

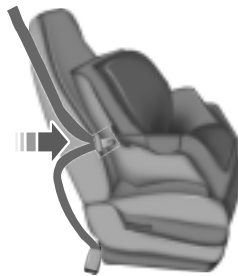

3. While holding the shoulder and lap belt portions together, route the tongue through the child seat according to the child seat manufacturer's instructions. Be sure the belt webbing is not twisted.



4. Insert the belt tongue into the proper buckle (the buckle closest to the direction the tongue is coming from) for that seating position until you hear a snap and feel the latch engage. Make sure the tongue is latched securely by pulling on it.



5. To put the retractor in the automatic locking mode, grasp the shoulder portion of the belt and pull downward until all of the belt is pulled out.

Note: The automatic locking mode is available on the front passenger and rear seats. This vehicle does not require the use of a locking clip.

6. Allow the belt to retract to remove slack. The belt will click as it retracts to indicate it is in the automatic locking mode.

7. Try to pull the belt out of the retractor to make sure the retractor is in the automatic locking mode. You should not be able to pull more belt out. If the retractor is not locked, unbuckle the belt and repeat Steps 5 and 6.

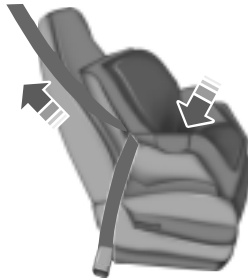

8. Remove remaining slack from the belt. Force the seat down with extra weight, for example, by pressing down or kneeling on the child restraint while pulling up on the shoulder belt in order to force slack from the belt.

This is necessary to remove the remaining slack that will exist once the extra weight of the child is added to the child restraint. It also helps to achieve the proper snugness of the child seat to your vehicle. Sometimes, a slight lean toward the buckle will additionally help to remove remaining slack from the belt.

9. Attach the tether strap (if the child seat is equipped). See *Using Tether Straps* later in this chapter.

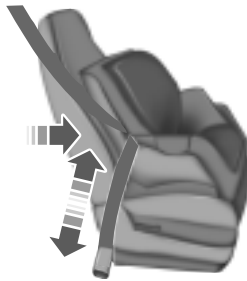

10. Before placing the child in the seat, forcibly move the seat forward and back to make sure the seat is securely held in place.

To check this, grab the seat at the belt path and attempt to move it side to side and forward and back. There should be no more than 1 inch (2.5 centimeters) of movement for proper installation.

Ford recommends checking with a NHTSA Certified Child Passenger Safety Technician (CPST) to make certain the child restraint is properly installed. In Canada, check with your local St. John Ambulance office for referral to a CPST.

Using Lower Anchors and Tethers for Children (LATCH)



WARNING: Never attach two child safety seats to the same anchor. In a crash, one anchor may not be strong enough to hold two child safety seat attachments and may break, causing serious injury or death.



WARNING: Depending on where you secure a child restraint, and depending on the child restraint design, you may block access to certain safety belt buckle assemblies or LATCH lower anchors, rendering those features potentially unusable. To avoid risk of injury, occupants should only use seating positions where they are able to be properly restrained.

The LATCH system is composed of three vehicle anchor points: two lower anchors located where your vehicle seat back and seat cushion meet (called the seat bight) and one top tether anchor located behind that seating position.

LATCH compatible child safety seats have two rigid or webbing mounted attachments that connect to the two lower anchors at the LATCH equipped seating positions in your vehicle. This type of attachment method eliminates the need to use safety belts to attach the child seat, however the safety belt can still be used to attach the child seat. For forward-facing child seats, the top tether strap must also be attached to the proper top tether anchor, if a top tether strap has been provided with your child seat.

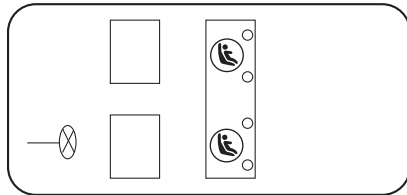

Your vehicle has LATCH lower anchors for child seat installation at the seating positions marked with the child seat symbol.



The LATCH anchors are located at the rear section of the rear seat between the cushion and seat back below the symbols as shown. Follow the child seat manufacturer's instructions to properly install a child seat with LATCH attachments.

Follow the instructions on attaching child safety seats with tether straps. See *Using Tether Straps* in this chapter.

Attach LATCH lower attachments of the child seat only to the anchors shown.

Use of Inboard Lower Anchors from the Outboard Seating Positions (Center Seating Use)

Note: The standardized spacing for LATCH lower anchors is 11 inches (28 centimeters) center to center. Do not use LATCH lower anchors for the center seating position unless the child seat manufacturer's instructions permit and specify using anchors spaced at least as far apart as those in this vehicle.

The lower anchors at the center of the second row rear seat are spaced 18 inches (46 centimeters) apart. A child seat with rigid LATCH attachments cannot be installed at the center seating position. LATCH compatible child seats (with attachments on belt webbing) can only be used at this seating position provided that the child seat manufacturer's instructions permit use with the anchor spacing stated. Do not attach a child seat to any lower anchor if an adjacent child seat is attached to that anchor.

Each time you use the safety seat, check that the seat is properly attached to the lower anchors and tether anchor, if applicable. Tug the child seat from side to side and forward and back where it is secured to your vehicle. The seat should move less than one inch when you do this for a proper installation.

If the safety seat is not anchored properly, the risk of a child being injured in a crash greatly increases.

Combining Safety Belt and LATCH Lower Anchors for Attaching Child Safety Seats

When used in combination, either the safety belt or the LATCH lower anchors may be attached first, provided a proper installation is achieved. Attach the tether strap afterward, if included with the child seat.

Using Tether Straps

Many forward-facing child safety seats include a tether strap which extends from the back of the child safety seat and hooks to an anchoring point called the top tether anchor. Tether straps are available as an accessory for many older safety seats.

Contact the manufacturer of your child seat for information about ordering a tether strap, or to obtain a longer tether strap if the tether strap on your safety seat does not reach the appropriate top tether anchor in your vehicle.

Once the child safety seat has been installed using either the safety belt, the lower anchors of the LATCH system, or both, you can attach the top tether strap.

The tether strap anchors in your vehicle are in the following positions (shown from top view):

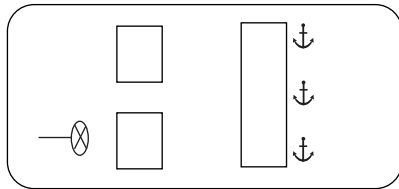

Perform the following steps to install a child safety seat with tether anchors:

Note: If you install a child seat with rigid LATCH attachments, do not tighten the tether strap enough to lift the child seat off your vehicle seat cushion when the child is seated in it. Keep the tether strap just snug without lifting the front of the child seat. Keeping the child seat just touching your vehicle seat gives the best protection in a severe crash.

1. Route the child safety seat tether strap over the back of the seat.

For outboard seating positions, route the tether strap under the head restraint and between the head restraint posts. For the center seating positions, route the tether strap over the top of the head restraint. If needed, the head restraints can also be removed.

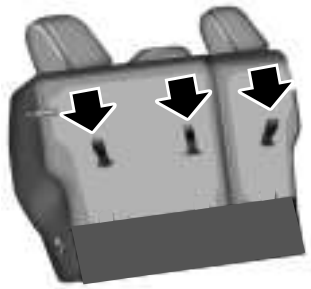

2. Locate the correct anchor on the back panel of the rear seat for the selected seating position. The anchors are labeled with the tether strap symbol.

3. Clip the tether strap to the anchor as shown.



4. Tighten the child safety seat tether strap according to the manufacturer's instructions.

If your child restraint system is equipped with a tether strap, and the child restraint manufacturer recommends its use, Ford also recommends its use.

CHILD SAFETY LOCKS

When these locks are set, the rear doors cannot be opened from the inside.



The childproof locks are located on the rear edge of each rear door and must be set separately for each door.

- Driver side: turn counterclockwise to lock and clockwise to unlock.
- Passenger side: turn clockwise to lock and counterclockwise to unlock.

PRINCIPLES OF OPERATION



WARNING: Never let a passenger hold a child on his or her lap while the vehicle is moving. The passenger cannot protect the child from injury in a crash.



WARNING: It is extremely dangerous to ride in a cargo area, inside or outside of a vehicle. In a crash, people riding in these areas are more likely to be seriously injured or killed. Do not allow people to ride in any area of your vehicle that is not equipped with seats and safety belts. Be sure everyone in your vehicle is in a seat and using a safety belt properly.



WARNING: Always drive and ride with your seat back upright and the lap belt snug and low across the hips.



WARNING: To reduce the risk of injury, make sure children sit where they can be properly restrained.



WARNING: All occupants of the vehicle, including the driver, should always properly wear their safety belts, even when an airbag supplemental restraint system is provided. Failure to properly wear your safety belt could seriously increase the risk of injury or death.



WARNING: In a rollover crash, an unbelted person is significantly more likely to die than a person wearing a safety belt.



WARNING: Each seating position in your vehicle has a specific safety belt assembly which is made up of one buckle and one tongue that are designed to be used as a pair. 1) Use the shoulder belt on the outside shoulder only. Never wear the shoulder belt under the arm. 2) Never swing the safety belt around your neck over the inside shoulder. 3) Never use a single belt for more than one person.



WARNING: When possible, all children 12 years old and under should be properly restrained in a rear seating position. Failure to follow this could seriously increase the risk of injury or death.





WARNING: Safety belts and seats can become hot in a vehicle that has been closed up in sunny weather; they could burn a small child. Check seat covers and buckles before you place a child anywhere near them.



WARNING: Front and rear seat occupants, including pregnant women, should wear safety belts for optimum protection in an accident.

All seating positions in this vehicle have lap and shoulder safety belts. All occupants of the vehicle should always properly wear their safety belts, even when an airbag supplemental restraint system is provided.

The safety belt system consists of:

- lap and shoulder safety belts
- shoulder safety belt with automatic locking mode (except driver safety belt)
- height adjuster at the front outboard seating positions
- safety belt pretensioner at the front outboard seating positions
- belt tension sensor at the front outboard passenger seating position.
-  • safety belt warning light and chime. See *Safety belt warning light and indicator chime* later in this chapter.
-  • crash sensors and monitoring system with readiness indicator. See *Crash sensors and airbag indicator* in the *Supplemental Restraint System* chapter.

The safety belt pretensioners are designed to activate in frontal, near-frontal and side crashes, and in rollovers. The safety belt pretensioners at the front seating positions are designed to tighten the safety belts firmly against the occupant's body when activated. This helps increase the effectiveness of the safety belts. In frontal crashes, the safety belt pretensioners can be activated alone or, if the crash is of sufficient severity, together with the front airbags.

FASTENING THE SAFETY BELTS

The front outboard and rear safety restraints in your vehicle are combination lap and shoulder belts.



1. Insert the belt tongue into the proper buckle (the buckle closest to the direction the tongue is coming from) until you hear a snap and feel it latch. Make sure the tongue is securely fastened in the buckle.

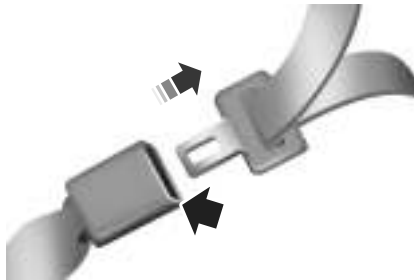

2. To unfasten, press the release button and remove the tongue from the buckle.



When in use, place the rear safety belts in the belt guides on the outboard seat backs.

Restraint of Pregnant Women

 **WARNING:** Always ride and drive with your seat back upright and the safety belt properly fastened. The lap portion of the safety belt should fit snug and be positioned low across the hips. The shoulder portion of the safety belt should be positioned across the chest. Pregnant women should also follow this practice. See the following figure.

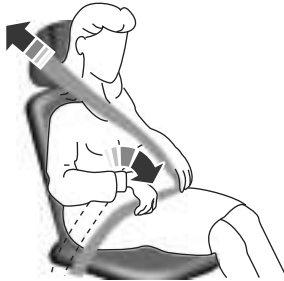

Pregnant women should always wear their safety belts. The lap belt portion of a combination lap and shoulder belt should be positioned low across the hips below the belly and worn as tight as comfort will allow. The shoulder belt should be positioned to cross the middle of the shoulder and the center of the chest.

Safety Belt Locking Modes

 **WARNING:** After any vehicle crash, the safety belt system at all passenger seating positions must be checked by an authorized dealer to verify that the automatic locking retractor feature for child seats is still functioning properly. In addition, all safety belts should be checked for proper function.

 **WARNING:** BELT AND RETRACTOR ASSEMBLY MUST BE REPLACED if the safety belt assembly automatic locking retractor feature or any other safety belt function is not operating properly when checked by an authorized dealer. Failure to replace the belt and retractor assembly could increase the risk of injury in crashes.

All safety restraints in the vehicle are combination lap and shoulder belts. The driver safety belt has the first type of locking mode, and the front outboard passenger and rear seat safety belts have both types of locking modes described as follows:

Vehicle Sensitive Mode

This is the normal retractor mode, which allows free shoulder belt length adjustment to your movements and locking in response to vehicle movement. For example, if the driver brakes suddenly or turns a corner sharply, or the vehicle receives an impact of about 5 mph (8 km/h) or more, the combination safety belts will lock to help reduce forward movement of the driver and passengers.

In addition, the retractor is designed to lock if the webbing is pulled out too quickly. If this occurs, let the belt retract slightly and pull webbing out again in a slow and controlled manner.

Automatic Locking Mode

In this mode, the shoulder belt is automatically pre-locked. The belt will still retract to remove any slack in the shoulder belt. The automatic locking mode is not available on the driver safety belt.

When to Use the Automatic Locking Mode

This mode should be used any time a child safety seat, except a booster, is installed in passenger front or rear seating positions. Children 12 years old and under should be properly restrained in a rear seating position whenever possible. See the *Child Safety* chapter.

How to Use the Automatic Locking Mode

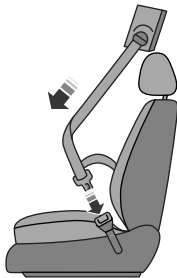

1. Buckle the combination lap and shoulder belt.
2. Grasp the shoulder portion and pull downward until the entire belt is pulled out.
3. Allow the belt to retract. As the belt retracts, you will hear a clicking sound. This indicates the safety belt is now in the automatic locking mode.

How to Disengage the Automatic Locking Mode

Unbuckle the combination lap and shoulder belt and allow it to retract completely to disengage the automatic locking mode and activate the vehicle sensitive (emergency) locking mode.

Safety Belt Extension Assembly

WARNING: Do not use extensions to change the fit of the shoulder belt across the torso.

If the safety belt is too short when fully extended, you can obtain a safety belt extension assembly from an authorized dealer.

Use only extensions manufactured by the same supplier as the safety belt. Manufacturer identification is located at the end of the webbing on the label. Also, use the safety belt extension only if the safety belt is too short for you when fully extended.

SAFETY BELT HEIGHT ADJUSTMENT

WARNING: Position the safety belt height adjusters so that the belt rests across the middle of your shoulder. Failure to adjust the safety belt properly could reduce the effectiveness of the safety belt and increase the risk of injury in a crash.

Adjust the height of the shoulder belt so the belt rests across the middle of your shoulder.



To adjust the shoulder belt height:

1. Squeeze the buttons and slide the height adjuster up or down.
2. Release the buttons and pull down on the height adjuster to make sure it is locked in place.

SAFETY BELT WARNING LIGHT AND INDICATOR CHIME



This lamp illuminates and an audible warning will sound if the driver's safety belt has not been fastened when the vehicle's ignition is turned on.

Conditions of Operation

If...	Then...
The driver's safety belt is not buckled before the ignition switch is turned to the on position...	The safety belt warning light illuminates 1-2 minutes and the warning chime sounds 4-8 seconds.
The driver's safety belt is buckled while the indicator light is illuminated and the warning chime is sounding...	The safety belt warning light and warning chime turn off.
The driver's safety belt is buckled before the ignition switch is turned to the on position...	The safety belt warning light and indicator chime remain off.

SAFETY BELT-MINDER®

This feature supplements the safety belt warning function by providing additional reminders by intermittently sounding a chime and illuminating the safety belt warning light when the driver's or front passenger's seat is occupied and the safety belt is unbuckled.

The system uses information from the front passenger sensing system to determine if a front seat passenger is present and therefore potentially in need of a warning. To avoid activating the Belt-Minder feature for objects placed in the front passenger seat, warnings will only be given to large front seat occupants as determined by the front passenger sensing system.

If the Belt-Minder warnings have expired (warnings for about five minutes) for one occupant (driver or front passenger), the other occupant can still activate the Belt-Minder feature.

If...	Then...
The driver's and front passenger's safety belts are buckled before the ignition switch is turned to the on position or less than 1-2 minutes have elapsed since the ignition switch has been turned to on...	The Belt-Minder feature will not activate.
The driver's or front passenger's safety belt is not buckled when the vehicle has reached at least 6 mph (9.7 km/h) and 1-2 minutes have elapsed since the ignition switch has been turned to on...	The Belt-Minder feature is activated - the safety belt warning light illuminates and the warning chime sounds for six seconds every 30 seconds, repeating for about five minutes or until the safety belts are buckled.
The driver's or front passenger's safety belt becomes unbuckled for about one minute while the vehicle is traveling at least 6 mph (9.7 km/h) and more than 1-2 minutes have elapsed since the ignition switch has been turned to on...	The Belt-Minder feature is activated - the safety belt warning light illuminates and the warning chime sounds for six seconds every 30 seconds, repeating for about five minutes or until the safety belts are buckled.

Deactivating and Activating the Belt-Minder® Feature (If Equipped)

WARNING: While the design allows you to deactivate your Belt-Minder, this system is designed to improve your chances of being safely belted and surviving an accident. We recommend you leave the Belt-Minder system activated for yourself and others who may use the vehicle. To reduce the risk of injury, do not deactivate or activate the Belt-Minder feature while driving the vehicle.

Note: The driver and front passenger Belt-Minder are deactivated and activated independently. When deactivating or activating one seating position, do not buckle the other position as this will terminate the process.

Read Steps 1 - 4 thoroughly before proceeding with the programming procedure.

Before following the procedure, make sure that:

- the parking brake is set
 - the transmission selector lever is in position **P**.
 - the ignition is off
 - the driver and front passenger safety belts are unbuckled
1. Turn the ignition on. Do not start the engine.
 2. Wait until the safety belt warning light turns off (about one minute).
 - Once the next step is started, the procedure must be completed within 60 seconds.
 3. For the seating position being disabled, buckle then unbuckle the safety belt three times at a moderate speed, ending in the unbuckled state.
 - After Step 3, the safety belt warning light will turn on.
 4. While the safety belt warning light is on, buckle and then unbuckle the safety belt.
 - After Step 4, the safety belt warning light will flash three times for confirmation.
 - This will disable the Belt-Minder feature for that seating position if it is currently enabled.
 - This will enable the Belt-Minder feature for that seating position if it is currently disabled.

CHILD RESTRAINT AND SAFETY BELT MAINTENANCE

Inspect the vehicle safety belts and child safety seat systems periodically to make sure they work properly and are not damaged. Inspect the vehicle and child seat safety belts to make sure there are no nicks, tears or cuts. Replace if necessary. All vehicle safety belt assemblies, including retractors, buckles, front safety belt buckle assemblies, buckle support assemblies (slide bar-if equipped), shoulder belt height adjusters (if equipped), shoulder belt guide on seat back (if equipped), child safety seat LATCH and tether anchors, and attaching hardware, should be inspected after a crash. Read the child restraint manufacturer's instructions for additional inspection and maintenance information specific to the child restraint.

Ford Motor Company recommends that all safety belt assemblies in use in vehicles involved in a crash be replaced. However, if the crash was minor and an authorized dealer finds that the belts do not show damage and continue to operate properly, they do not need to be replaced. Safety belt assemblies not in use during a crash should also be inspected and replaced if either damage or improper operation is noted.

For proper care of soiled safety belts, see *Cleaning the Interior* in the *Vehicle Care* chapter.

PERSONAL SAFETY SYSTEM™

The Personal Safety System provides an improved overall level of frontal crash protection to front seat occupants and is designed to help further reduce the risk of airbag-related injuries. The system is able to analyze different occupant conditions and crash severity before activating the appropriate safety devices to help better protect a range of occupants in a variety of frontal crash situations.

Your vehicle's Personal Safety System consists of:

- Driver and passenger dual-stage airbag supplemental restraints.
- Front outboard safety belts with pretensioners, energy management retractors (first row only), and safety belt usage sensors.
- Driver's seat position sensor.
- Front passenger sensing system.
- Passenger airbag off and on indicator lamp.
- Front crash severity sensors.
- Restraints control module with impact and safing sensors.
- Restraint system warning light and backup tone.
- The electrical wiring for the airbags, crash sensor(s), safety belt pretensioners, front safety belt usage sensors, driver seat position sensor, front passenger sensing system, and indicator lights.

How Does the Personal Safety System Work?

The Personal Safety System can adapt the deployment strategy of your vehicle's safety devices according to crash severity and occupant conditions. A collection of crash and occupant sensors provides information to the restraints control module. During a crash, the restraints control module may activate the safety belt pretensioners and/or either one or both stages of the dual-stage airbag supplemental restraints based on crash severity and occupant conditions.

PRINCIPLES OF OPERATION

WARNING: Airbags do not inflate slowly or gently, and the risk of injury from a deploying airbag is the greatest close to the trim covering the airbag module.



WARNING: All occupants of your vehicle, including the driver, should always properly wear their safety belts, even when an airbag supplemental restraint system is provided.



WARNING: Always transport children 12 years old and under in the back seat and always properly use appropriate child restraints.



WARNING: Never place your arm over the airbag module as a deploying airbag can result in serious arm fractures or other injuries.



WARNING: Airbags can kill or injure a child in a child seat. NEVER place a rear-facing child seat in front of an active airbag. If you must use a forward-facing child seat in the front seat, move the seat all the way back.



WARNING: Do not attempt to service, repair, or modify the airbag supplemental restraint systems or its fuses. Contact your authorized dealer as soon as possible.



WARNING: Several airbag system components get hot after inflation. Do not touch them after inflation.



WARNING: If the airbag has deployed, the airbag will not function again and must be replaced immediately. If the airbag is not replaced, the unrepaired area will increase the risk of injury in a crash.

The airbags are a supplemental restraint system and are designed to work with the safety belts to help protect the driver and right front passenger from certain upper body injuries. Airbags do not inflate slowly; there is a risk of injury from a deploying airbag.

Note: You will hear a loud bang and see a cloud of harmless powdery residue if an airbag deploys. This is normal.

The airbags inflate and deflate rapidly upon activation. After airbag deployment, it is normal to notice a smoke-like, powdery residue or smell the burnt propellant. This may consist of cornstarch, talcum powder (to lubricate the bag) or sodium compounds (for example, baking soda) that result from the combustion process that inflates the airbag. Small amounts of sodium hydroxide may be present which may irritate the skin and eyes, but none of the residue is toxic. While the system is designed to help reduce serious injuries, contact with a deploying airbag may also cause abrasions or swelling. Temporary hearing loss is also a possibility as a result of the noise associated with a deploying airbag. Because airbags must inflate rapidly and with considerable force, there is the risk of death or serious injuries, such as fractures, facial and eye injuries or internal injuries, particularly to occupants who are not properly restrained or are otherwise out of position at the time of airbag deployment. Thus, it is extremely important that occupants be properly restrained as far away from the airbag module as possible while maintaining vehicle control.

Routine maintenance of the airbags is not required.

SOS POST-CRASH ALERT SYSTEM™

The system flashes the turn signal lamps and sounds the horn (intermittently) in the event of a serious impact that deploys an airbag equipped on your vehicle, such as front, side, side curtain or Safety Canopy®.

The horn and lamps will turn off when:

- the hazard control button is pressed
- the panic button (if equipped) is pressed on the remote entry transmitter, or
- your vehicle runs out of power.

DRIVER AND PASSENGER AIRBAGS

WARNING: Never place your arm or any objects over an airbag module. Placing your arm over a deploying airbag can result in serious arm fractures or other injuries. Objects placed on or over the airbag inflation area may cause those objects to be propelled by the airbag into your face and torso causing serious injury.



WARNING: Airbags can kill or injure a child in a child seat. Never place a rear-facing child seat in front of an active airbag. If you must use a forward-facing child seat in the front seat, move the seat all the way back.

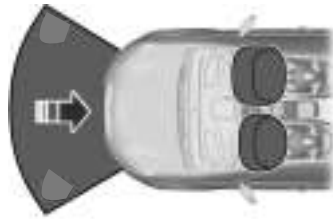

The driver and front passenger airbags will deploy during significant frontal and near-frontal crashes.

The driver and passenger front airbag system consists of:

- driver and passenger airbag modules
-  crash sensors and monitoring system with readiness indicator. See *Crash Sensors and Airbag Indicator* later in this chapter.
- front passenger sensing system

Proper Driver and Front Passenger Seating Adjustment

 **WARNING:** The National Highway Traffic Safety Administration recommends a minimum distance of at least 10 inches (25 centimeters) between an occupant's chest and the driver airbag module.

To properly position yourself away from the airbag:

- Move your seat to the rear as far as you can while still reaching the pedals comfortably.
- Recline the seat slightly (one or two degrees) from the upright position.

After all occupants have adjusted their seats and put on safety belts, it is very important that they continue to sit properly. Properly seated occupants sit upright, lean against the seat back, and center themselves on the seat cushion, with their feet comfortably extended on the floor. Sitting improperly can increase the chance of injury in a crash event. For example, if an occupant slouches, lies down, turns sideways, sits forward, leans forward or sideways, or puts one or both feet up, the chance of injury during a crash is greatly increased.

Children and Airbags

 **WARNING:** Airbags can kill or injure a child in a child seat. Never place a rear-facing child seat in front of an active airbag. If you must use a forward-facing child seat in the front seat, move the seat all the way back.



Children must always be properly restrained. Accident statistics suggest that children are safer when properly restrained in the rear seating positions than in the front seating position. Failure to follow these instructions may increase the risk of injury in a crash.

48 **Supplementary Restraints System**

FRONT PASSENGER SENSING SYSTEM



WARNING: Even with Advanced Restraints Systems, children 12 and under should be properly restrained in a rear seating position.



WARNING: Sitting improperly out of position or with the seat back reclined too far can take off weight from the seat cushion and affect the decision of the front passenger sensing system, resulting in serious injury or death in a crash.
Always sit upright against your seatback, with your feet on the floor.



WARNING: To reduce the risk of possible serious injury:
Do not stow objects in seat back map pocket or hang objects off seat back if a child is in the front passenger seat.
Do not place objects underneath the front passenger seat or between the seat and the center console.
Check the passenger airbag off or pass airbag off indicator lamp for proper airbag status.
Failure to follow these instructions may interfere with the passenger seat sensing system.



WARNING: Any alteration or modification to the front passenger seat may affect the performance of the front passenger sensing system.

This system works with sensors that are part of the front passenger's seat and safety belt to detect the presence of a properly-seated occupant and determine if the front passenger's frontal airbag should be enabled (may inflate) or not.



The front passenger sensing system uses a pass airbag off indicator which will illuminate and stay lit to remind you that the front passenger frontal airbag is disabled.

The indicator lamp is located under the climate controls. The indicator lamp will illuminate for a short period of time when the ignition is turned to the on position to confirm it is functional.

Note: When the passenger airbag off light is illuminated, the passenger (seat mounted) side airbag may be disabled to avoid the risk of airbag deployment injuries.

If the child restraint has been installed and the indicator lamp is not lit, then turn the vehicle off, remove the child restraint from the vehicle and reinstall the restraint following the child restraint manufacturer’s instructions.

If a person of adult size is sitting in the front passenger’s seat, but the pass airbag off indicator lamp is lit, it is possible that the person is not sitting properly in the seat. If this happens:

- Turn the vehicle off and ask the person to place the seat back in the full upright position.
- Have the person sit upright in the seat, centered on the seat cushion, with the person’s legs comfortably extended.
- Restart the vehicle and have the person remain in this position for about two minutes. This will allow the system to detect that person and enable the passenger’s frontal airbag.
- If the indicator lamp remains lit even after this, the person should be advised to ride in the rear seat.

The pass airbag off lamp will operate according to the table below.

Occupant	Pass Airbag Off Indicator Lamp	Passenger Airbag
Empty seat	Unlit	Disabled
Small child	Lit	Disabled
Adult	Unlit	Enabled

The front passenger sensing system may detect small or medium objects placed on the seat cushion. For most objects that are in the front passenger seat, the passenger airbag will be disabled. Even though the passenger airbag is disabled, the pass airbag off lamp may or may not be illuminated.

If you think that the status of the passenger airbag off indicator lamp is incorrect, check for the following:

- Objects lodged underneath the seat
- Objects between the seat cushion and the center console
- Objects hanging off the seat back
- Objects stowed in the seat back map pocket

50 **Supplementary Restraints System**

- Objects placed on the occupant's lap
- Cargo interference with the seat
- Other passengers pushing or pulling on the seat
- Rear passenger feet and knees resting or pushing on the seat

The conditions listed above may cause the weight of a properly seated occupant to be incorrectly interpreted by the passenger sensing system. The person in the front passenger seat may appear heavier or lighter due to the conditions described in the list above.



To know if the front passenger sensing system is operating properly, see *Crash Sensors and Airbag Indicator* later in this chapter.

If the airbag readiness lamp is lit, do the following:

The driver or adult passengers should check for any objects that may be lodged underneath the front passenger seat or cargo interfering with the seat.

If objects are lodged or cargo is interfering with the seat; please take the following steps to remove the obstruction:

- Pull the vehicle over.
- Turn the vehicle off.
- Driver or adult passengers should check for any objects lodged underneath the front passenger seat or cargo interfering with the seat.
- Remove the obstruction(s) (if found).
- Restart the vehicle.
- Wait at least two minutes and verify that the airbag readiness lamp is no longer illuminated.
- If the airbag readiness lamp remains illuminated, this may or may not be a problem due to the front passenger sensing system.

Do not attempt to repair or service the system. Take your vehicle immediately to an authorized dealer.

If it is necessary to modify an advanced front airbag system to accommodate a person with disabilities, contact the Ford Customer Relationship Center at the phone number shown in the *Customer Assistance* section of this owner's manual.

KNEE AIRBAG

A driver's knee airbag is located under or within the instrument panel. During a crash, the restraints control module may activate the driver's knee airbag based on crash severity and occupant conditions. Under certain crash and occupant conditions, the driver's knee airbag may deploy but the driver's front airbag may not activate. As with front and side airbags, it is important to be properly seated and restrained to reduce the risk of death or serious injury.

Note: The driver's knee airbag has a lower deployment threshold than the front airbags. During certain crashes, it is possible that the driver's knee airbag and safety belt pretensioner will deploy, but not the driver's front airbag.



To know if the knee airbag is operating properly, see *Crash Sensors and Airbag Indicator* in this chapter.

SIDE AIRBAGS

WARNING: Do not place objects or mount equipment on or near the airbag cover, on the side of the seat backs (of the front seats), or in front seat areas that may come into contact with a deploying airbag. Failure to follow these instructions may increase the risk of personal injury in the event of a crash.



WARNING: Do not use accessory seat covers. The use of accessory seat covers may prevent the deployment of the side airbags and increase the risk of injury in an accident.



WARNING: Do not lean your head on the door. The side airbag could injure you as it deploys from the side of the seat back.



WARNING: Do not attempt to service, repair, or modify the airbag, its fuses or the seat cover on a seat containing an airbag, as you could be seriously injured or killed. Contact your authorized dealer as soon as possible.



WARNING: If the side airbag has deployed, the airbag will not function again. The side airbag system (including the seat) must be inspected and serviced by an authorized dealer. If the airbag is not replaced, the unrepaired area will increase the risk of injury in a crash.

The side airbags are located on the outboard side of the seat backs of the front seats. In certain lateral crashes, the airbag on the side affected by the crash will be inflated. The airbag was designed to inflate between the door panel and occupant to further enhance the protection provided occupants in side impact crashes.



The system consists of the following:

- a tag on the seat back indicating that side airbags are found on your vehicle
- side airbags located inside the seat back of the driver and front passenger seats.



- crash sensors and monitoring system with readiness indicator. See *Crash Sensors and Airbag Indicator* later in this chapter.
- front passenger sensing system.

Note: The passenger sensing system will deactivate the passenger seat-mounted side airbag if it detects an empty passenger seat.

The design and development of the side airbag system included recommended testing procedures that were developed by a group of automotive safety experts known as the Side Airbag Technical Working Group. These recommended testing procedures help reduce the risk of injuries related to the deployment of side airbags.

SAFETY CANOPY® CURTAIN AIRBAGS

WARNING: Do not place objects or mount equipment on or near the headliner at the siderail that may come into contact with a deploying curtain airbag. Failure to follow these instructions may increase the risk of personal injury in the event of a crash.



WARNING: Do not lean your head on the door. The curtain airbag could injure you as it deploys from the headliner.



WARNING: Do not attempt to service, repair, or modify the curtain airbags, its fuses, the A, B, or C pillar trim, or the headliner on a vehicle containing curtain airbags, as you could be seriously injured or killed. Contact your authorized dealer as soon as possible.



WARNING: All occupants of your vehicle including the driver should always wear their safety belts even when an airbag supplemental restraint system and curtain airbag is provided. Failure to properly wear your safety belt could seriously increase the risk of injury or death.



WARNING: To reduce risk of injury, do not obstruct or place objects in the deployment path of the curtain airbag.



WARNING: If the curtain airbags have deployed, the curtain airbags will not function again. The curtain airbags (including the A, B and C pillar trim and headliner) must be inspected and serviced by an authorized dealer. If the curtain airbag is not replaced, the unrepaired area will increase the risk of injury in a crash.

54 Supplementary Restraints System

The Safety Canopy will deploy during significant side crashes or when a certain likelihood of a rollover event is detected by the rollover sensor. The Safety Canopy is mounted to the roof side-rail sheet metal, behind the headliner, above each row of seats. In certain lateral crashes or rollover events, the Safety Canopy will be activated, regardless of which seats are occupied. The Safety Canopy is designed to inflate between the side window area and occupants to further enhance protection provided in side impact crashes and rollover events.

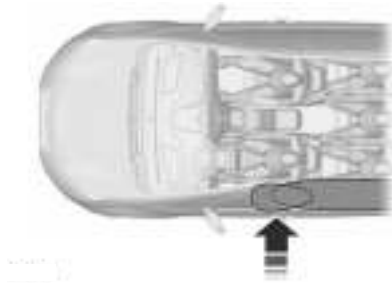

The system consists of:

- safety canopy curtain airbags located above the trim panels over the front and rear side windows identified by wording on the B-pillar trim.

- a flexible headliner which opens above the side doors to allow air curtain deployment.



- crash sensors and monitoring system with readiness indicator. See *Crash Sensors and Airbag Indicator* in this chapter.

Children 12 years old and under should always be properly restrained in the rear seats. The Safety Canopy will not interfere with children restrained using a properly installed child or booster seat because it is designed to inflate downward from the headliner above the doors along the side window opening.

The design and development of the Safety Canopy included recommended testing procedures that were developed by a group of automotive safety experts known as the Side Airbag Technical Working Group. These recommended testing procedures help reduce the risk of injuries related to the deployment of side airbags (including the Safety Canopy).

CRASH SENSORS AND AIRBAG INDICATOR

WARNING: Modifying or adding equipment to the front end of your vehicle (including frame, bumper, front end body structure and tow hooks) may affect the performance of the airbag system, increasing the risk of injury. Do not modify the front end of your vehicle.

Your vehicle has a collection of crash and occupant sensors which provide information to the restraints control module which deploys (activates) the front safety belt pretensioners, driver airbag, passenger airbag, seat mounted side airbags, and the Safety Canopy. Based on the type of accident (frontal impact, side impact or rollover) the restraints control module will deploy the appropriate safety devices.

The restraints control module also monitors the readiness of the above safety devices plus the crash and occupant sensors. The readiness of the safety system is indicated by a warning indicator light in the instrument cluster or by a backup tone if the warning light is not working. See the *Instrument Cluster* chapter. Routine maintenance of the airbag is not required.

A difficulty with the system is indicated by one or more of the following:



- The readiness light will either flash or stay lit.
- The readiness light will not illuminate immediately after the ignition is turned on.
- A series of five beeps will be heard. The tone pattern will repeat periodically until the problem or light are repaired.

If any of these things happen, even intermittently, have the supplemental restraint system serviced at an authorized dealer immediately. Unless serviced, the system may not function properly in the event of a crash.

56 **Supplementary Restraints System**

The safety belt pretensioners and the airbag supplemental restraint system are designed to activate when the vehicle sustains longitudinal or lateral deceleration sufficient to cause the restraints control module to deploy a safety device or when a certain likelihood of a rollover event is detected by the rollover sensor.

The fact that the safety belt pretensioners or airbags did not activate for both front seat occupants in a crash does not mean that something is wrong with the system. Rather, it means the restraints control module determined the accident conditions (such as crash severity, belt usage) were not appropriate to activate these safety devices.

- Front airbags are designed to activate only in frontal and near-frontal crashes (not rollovers, side impacts or rear impacts) unless the crash causes sufficient longitudinal deceleration.
- The safety belt pretensioners are designed to activate in frontal, near-frontal and side crashes, and in rollovers.
- Side airbags are designed to inflate in certain side impact crashes. Side airbags may activate in other types of crashes if the vehicle experiences sufficient sideways motion or deformation.
- The Safety Canopy is designed to inflate in certain side impact crashes or rollover events. The Safety Canopy may activate in other types of crashes if the vehicle experiences sufficient sideways motion or deformation, or a certain likelihood of rollover.

AIRBAG DISPOSAL

Contact your authorized dealer as soon as possible. Airbags **MUST BE** disposed of by qualified personnel.

PRINCIPLE OF OPERATION

The remote control allows you to:

- remotely lock or unlock the vehicle doors
- unlock the doors without actively using a key or remote control (intelligent access only)
- remotely open the power liftgate (if equipped)
- remotely start or stop the engine (if equipped)
- arm and disarm the anti-theft system
- activate the panic alarm.

GENERAL INFORMATION ON RADIO FREQUENCIES

This device complies with part 15 of the FCC Rules and with Industry Canada license-exempt RSS standard(s). Operation is subject to the following two conditions: (1) This device may not cause harmful interference, and (2) This device must accept any interference received, including interference that may cause undesired operation.

Note: Changes or modifications not expressly approved by the party responsible for compliance could void the user's authority to operate the equipment. The term **IC** before the radio certification number only signifies that Industry Canada technical specifications were met.

The typical operating range for your transmitter is approximately 33 feet (10 meters). Vehicles with the remote start feature will have a greater range. A decrease in operating range could be caused by:

- weather conditions
- nearby radio towers
- structures around your vehicle
- other vehicles parked next to your vehicle.

The radio frequency used by your remote control can also be used by other short-distance radio transmissions, for example amateur radios, medical equipment, wireless headphones, remote controls and alarm systems. If the frequencies are jammed, you will not be able to use your remote control. You can lock and unlock the doors with the key.

Note: Make sure your vehicle is locked before leaving it unattended.

Note: If you are in range, the remote control will operate if you press any button unintentionally.

Intelligent Access (If Equipped)

The system uses a radio frequency signal to communicate with your vehicle and authorize your vehicle to unlock when one of the following conditions is met:

- You touch the inside of the front exterior door handle.
- You press the luggage compartment button.
- You press a button on the transmitter.

If excessive radio frequency interference is present in the area or if the transmitter battery is low, it may be necessary to mechanically unlock your door. You can use the mechanical key blade in your intelligent access key to open the driver door in this situation. Refer to *Remote Control* in this chapter for more information on the location and use of the mechanical key blade.

REMOTE CONTROL**Integrated Keyhead Transmitters (IKTs) (If Equipped)**

Your vehicle may be equipped with two integrated keyhead transmitters. Use the key blade to start your vehicle and unlock or lock the driver door from outside the vehicle. The transmitter portion functions as the remote control.



Note: Your vehicle's keys came with a security label that provides important key cut information. Keep the label in a safe place for future reference.

Intelligent Access Key (If Equipped)

Type 1



Type 2

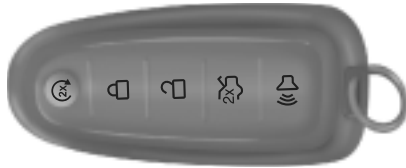

Your vehicle may be equipped with two intelligent access keys which operate the power locks and the remote start system. The key must be in the vehicle to activate the push button start system.

Mechanical Key Blade

The key also contains a removable mechanical key blade that can be used to unlock the driver door.

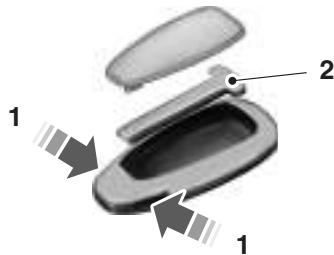

Type 1

To release the mechanical key blade:

1. Press and hold the push buttons on the edges of the transmitter to release the cover. Carefully remove the cover.
2. Remove the key blade.

**Type 2**

To release the key blade, slide the release on the back of the transmitter, then pull the blade out.



Note: Your vehicle's back-up keys were issued with a security tag that provides important vehicle key cut information. Keep the tag in a safe place for future reference.

Replacing the Battery

Note: Refer to local regulations when disposing of transmitter batteries.

Note: Do not wipe off any grease on the battery terminals or on the back surface of the circuit board.

Note: Replacing the battery will not delete the transmitter from the vehicle. The transmitter should operate normally.

The remote control uses one coin-type three-volt lithium battery CR2032 or equivalent.

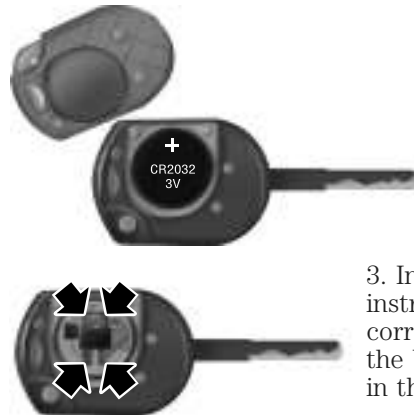
Integrated Keyhead Transmitter

1. Twist a thin coin in the slot of the transmitter near the key ring to remove the battery cover.
2. Remove the old battery.

3. Insert the new battery. Refer to the instructions inside the transmitter for the correct orientation of the battery. Press the battery down to make sure it is fully in the housing.

4. Snap the battery cover back onto the transmitter.

Intelligent Access Key (Type 1)

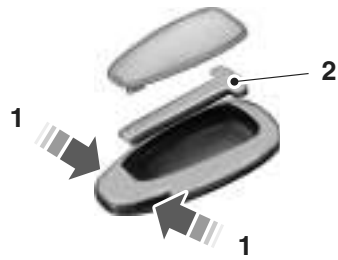

1. Press and hold the push buttons to release the cover. Carefully remove the cover.

2. Remove the key blade.

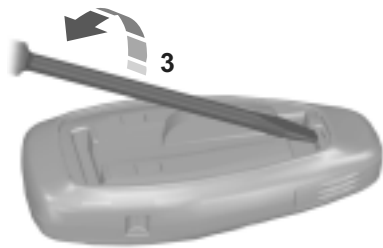

3. Twist the screwdriver in the position shown to start separating the two halves of the remote control.

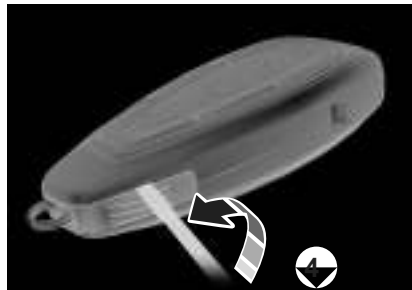

4. Twist the screwdriver in the position shown to separate the two halves of the remote control.



Note: Do not touch the battery contacts or the printed circuit board with the screwdriver.

5. Carefully remove the battery with the screwdriver.

6. Install a new battery with the + facing downward.
7. Assemble the two halves of the transmitter back together.
8. Install the key blade.

Intelligent Access Key (Type 2)

1. Remove the backup key from the transmitter.



2. Twist a thin coin under the tab hidden behind the backup key head to remove the battery cover. Do not use the backup key to remove the cover or you could damage the intelligent access key.



3. Remove the old battery.

4. Insert a new battery with the + facing downward. Press the battery down to make sure it is fully in the housing.
5. Snap the battery cover back onto the transmitter and install the backup key.

Car Finder

Press the lock button on the key twice within three seconds. The horn will sound and the turn signals will flash. We recommend you use this method to locate your vehicle, rather than using the panic alarm.

Sounding a Panic Alarm (If Equipped)



Press the button to activate the alarm. Press the button again or switch the ignition on to deactivate.

Note: The panic alarm will only operate when the ignition is off.

Remote Start (C-MAX Energi Only)

WARNING: To avoid exhaust fumes, do not use remote start if your vehicle is parked indoors or areas that are not well ventilated.

Note: Do not use remote start if your vehicle is low on fuel.



The remote start button is on the transmitter.

This feature allows you to start the vehicle from outside the vehicle. The transmitter has an extended operating range.

Vehicles with automatic climate control can be configured to operate when the vehicle is remote started. Refer to the *Climate Control* chapter for more information.

Many states and provinces have restrictions for the use of remote start. Check your local and state or provincial laws for specific requirements regarding remote start systems.

The remote start system will not work if:

- the ignition is on
- the alarm system is triggered
- the feature has been disabled
- the hood is not closed
- the transmission is not in **P**
- the vehicle battery voltage is too low
- the powertrain malfunction/reduced power indicator was on the last time the vehicle was driven.

Remote Starting the Vehicle

Note: Each button press must be done within three seconds of each other. The vehicle will not remote start if this sequence is not followed and the horn will not chirp.

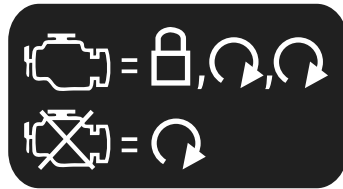

The label on your transmitter details the starting procedure.

To remote start your vehicle:

1. Press the lock button to lock all the doors.
2. Press the remote start button twice. The exterior lamps will flash twice.

The horn will chirp if the system fails to start (unless quiet start is on). Quiet start will run the blower fan at a slower speed to reduce noise. It can be switched on or off. Refer to the *Information Displays* chapter.

Note: If the vehicle has been remote started and is equipped with an integrated keyhead transmitter, you must turn the ignition on before driving the vehicle. If equipped with an intelligent access transmitter, you must press the **START/STOP** button on the instrument panel once while applying the brake pedal before driving the vehicle.

The power windows will be inhibited during the remote start and the radio will not turn on automatically.

The parking lamps will remain on and the vehicle will run for 5, 10, or 15 minutes, depending on the setting. Refer to the *Information Displays* chapter to select the duration of the remote start system.

Extending the Vehicle Run Time

Repeat Steps 1 and 2 with the vehicle still running to extend the run time for another remote start duration. If you programmed the duration to last 10 minutes, the second 10 minutes will be added. For example, if the vehicle had been running from the first remote start for five minutes, the vehicle will continue to run now for a total of 20 minutes.

Wait at least five seconds before remote starting after a vehicle shutdown.

Turning the Vehicle Off After Remote Starting

Press the button once. The parking lamps will turn off.

You may have to be closer to the vehicle than when starting due to ground reflection and the added noise of the running vehicle.

You can disable or enable the remote start system through the information display. Refer to the *Information Display* chapter.

REPLACING A LOST KEY OR REMOTE CONTROL

You can purchase replacement or additional keys or remote controls from an authorized dealer. A dealer can program the transmitters to your vehicle or you may be able to program them yourself. See the *Security* chapter for information on programming your transmitters.

PRINCIPLES OF OPERATION

MyKey allows you to program keys with restricted driving modes to promote good driving habits. You can use all but one of the keys programmed to your vehicle with these restricted modes.

Any keys that have not been programmed are referred to as administrator keys or admin keys. These can be used to:

- create a restricted key
- program optional MyKey settings
- clear all MyKey features.

When you have programmed a MyKey, you can access the following information using the information display:

- How many admin keys and MyKeys are programmed to your vehicle.
- The total distance your vehicle has traveled using a MyKey.

Note: Switch the ignition on to use the system.

Note: All MyKeys are programmed to the same settings. You cannot program them individually.

Note: For vehicles equipped with intelligent access keys (push-button start): When both a MyKey and an admin intelligent access key (fob) are present, your vehicle will recognize the admin fob to start the engine.

Note: If you start your vehicle while using a MyKey, your key's programmed restrictions will remain active until you turn the engine off. This remains true, even if a passenger with an admin key enters your vehicle after you started the engine with a MyKey.

Standard Settings

These settings activate automatically with a programmed MyKey:

- Belt-Minder. You cannot disable this feature. The audio system will mute when this feature is activated.
- Early low fuel. The low-fuel warning activates earlier, giving MyKey drivers more time to refuel.
- Driver assist features remain on and active: the collision warning system, navigation, parking aids and BLIS (Blind Spot Information System) with cross traffic alert.
- Satellite radio adult content restrictions.

Optional Settings

You can configure MyKey settings when you first create a MyKey. You can also change the settings afterward with an admin key.

The following settings can be configured using an admin key:

- Set various vehicle speed limits. Warnings will be shown in the display followed by an audible tone when your vehicle reaches the set speed. You cannot override the set speed by fully depressing the accelerator pedal.
- Set various vehicle speed reminders. Warnings will be shown in the display followed by an audible tone when the set vehicle speed is exceeded.
- Audio system maximum volume of 45%. A message will be shown in the display when you attempt to exceed the limited volume. Automatic volume control will be disabled.
- Always on setting. When this is selected, you will not be able to disable Advance Trac, 911 Assist or the do not disturb feature (if your vehicle is equipped).

CREATING A MYKEY

Use the information display to create a MyKey:

1. Insert the key you want to program into the ignition. If your vehicle is equipped with a push-button start and you have a backup slot, put the intelligent access key in the backup slot. If your vehicle does not have a backup slot, hold your intelligent access key fob next to the steering column. See the *Starting and Stopping the Engine* chapter for the proper key fob placement.
2. Turn the ignition on.
3. From the main menu within the information display, press **OK** or the **>** button to navigate through the various screens. Select **Settings** and then **MyKey**.
4. Press **OK** or the **>** button to select **Create**.
5. When prompted, hold the **OK** button until you see a message informing you to label this key as a MyKey. The key will be restricted at your vehicle's next start.

After the key is successfully programmed, make sure you label it so you can distinguish it from the admin keys.

You can also program optional settings for the key(s). Refer to *Programming/Changing Optional Settings*.

Programming/Changing Optional Settings

Note: All programmed keys can be cleared within the same key cycle in which a key was programmed, otherwise an admin key is required to clear the keys. To clear all keys, see *Clearing all MyKeys*.

You can access the optional settings through the information display control.

1. Turn the ignition on using an admin key.
2. Access the main menu and select Settings, then MyKey.
3. Use the arrow buttons to get to an optional feature.
4. Press **OK** or **>** to scroll through settings.
5. Press **OK** or **>** to make a selection.

CLEARING ALL MYKEYS

You can clear the programming while you create a MyKey or use an admin key to clear the restrictions. When you clear the restrictions, you return the key to its original admin key status.

To clear your MyKey, use the information display to do the following:

1. Access the main menu and select **Settings**, then **MyKey**.
2. Scroll to **Clear All** and press the **OK** button.
3. Hold the **OK** button until **ALL MYKEYS CLEARED** displays .

CHECKING MYKEY SYSTEM STATUS

The information display shows the programmed keys' status:

- **MYKEY DISTANCE:** Tracks distance when drivers use a restricted key. The only way to delete the accumulated distance is by using an admin key to reset this to zero. If the MyKey distance does not accumulate as expected, then:
 1. The intended user is not using the programmed key.
 2. An admin key user recently reset the distance.
- **NUMBER OF MYKEY(S):** Indicates the number of restricted keys programmed to the vehicle. Use this feature to detect how many restricted keys you have for your vehicle, or when a MyKey has recently been deleted.
- **NUMBER OF ADMIN KEY(S):** Indicates how many admin keys are programmed to the vehicle. Use this feature to determine how many unrestricted keys you have for your vehicle, or if an additional MyKey has been programmed.

USING MYKEY WITH REMOTE START SYSTEMS

MyKey is not compatible with non-Ford-approved (unlicensed) aftermarket remote start systems. If you choose to install a remote start system, please see your Ford authorized dealer for a Ford-approved remote start system.

The following information may help customers who choose to install an unlicensed remote start system. The instructions provided below do not make the MyKey system or its features compatible with any unlicensed remote start system, but they may help you retain some MyKey functions.

Vehicles Equipped with Traditional Keys

MyKey programming and restrictions are not compatible with unlicensed remote start systems, but there are ways you can retain some of the MyKey functions. To learn if this is possible, use the remote start to start your vehicle. While the vehicle's engine is running: .

1. Insert your key into the ignition cylinder.
2. Restart the engine using the key in the ignition.
3. If MyKey recognizes your unlicensed remote start system as an additional admin key with its associated privileges, then you can program it as a MyKey just as you would program a traditional key.

To program an unlicensed remote start system as a MyKey, do the following:

- Enter the vehicle and close all doors.
- Use the remote start to start your vehicle.
- See the *Creating a MyKey* section and follow Steps 1–5.

Vehicles Equipped with Intelligent Access Key (Push-button Start)

It is not possible to program your unlicensed remote start system as a MyKey if your vehicle is equipped with intelligent access keys (push-button start), but you can still retain the MyKey programming with your intelligent access key fob by following this process:

1. Enter the vehicle and close all doors.
2. Start your vehicle with the remote start. Do not open a door or shift the vehicle out of P (Park) as either action will cause the engine to stall. While the engine is running, your remote start retains its admin key status.
3. Restart the engine by pressing the Start/Stop button. See *Keyless Starting* for more information. The vehicle will identify your intelligent access fob as an admin key or a MyKey, depending on the settings of the actual key used to start the vehicle.

Note: When you view your MyKey system status, either the number of MYKEY(S) PROGRAMMED or ADMIN KEYS PROGRAMMED may include your unlicensed remote start system in the total count. See the *Checking MyKey System Status* section.

For all vehicles with an unlicensed, non-Ford-approved aftermarket remote start installed, it is possible to program all keys as MyKeys. In this case, you will need to use your remote start system to remove all restrictions and return the key or intelligent access key to its admin key status by doing the following:

- Enter the vehicle and close all doors.
- Start your vehicle with your remote start.
- See the *Clearing All MyKeys* section and follow Steps 1–3.

MYKEY TROUBLESHOOTING

Condition	Potential Causes
I cannot program a key.	<ul style="list-style-type: none"> • The key or fob used to start the vehicle does not have admin privileges. • The key or fob used to start the vehicle is the only admin key (there always has to be at least one admin key). • Vehicles with push button start: The intelligent access key is not in the backup slot or positioned correctly next to the steering column. See the <i>Starting and Stopping the Vehicle</i> chapter for more information. • SecuriLock passive anti-theft system is disabled or in unlimited mode.
I cannot program the optional settings.	<ul style="list-style-type: none"> • The key or fob used to start the vehicle does not have admin privileges. • No keys are programmed to the vehicle. See the <i>Creating a MyKey</i> chapter.

Condition	Potential Causes
I cannot clear the restricted keys.	<ul style="list-style-type: none"> • The key or fob used to start the vehicle does not have admin privileges. • No restricted keys are programmed to the vehicle. See the <i>Creating a MyKey</i> chapter.
I lost the only admin key.	<ul style="list-style-type: none"> • Purchase a new key from your authorized dealer.
I lost a key.	<ul style="list-style-type: none"> • Program spare keys as outlined under <i>SecuriLock</i> in the <i>Security</i> chapter.
No restricted key functions with intelligent access key (push-button start).	<ul style="list-style-type: none"> • The engine recognizes an admin key fob when you start your engine. • Your vehicle's system does not recognize any programmed MyKeys. See the <i>Creating a MyKey</i> chapter.
MyKey miles do not accumulate.	<ul style="list-style-type: none"> • The intended user is not using the restricted key. • An admin key-equipped driver reset the MyKey system.

LOCKING AND UNLOCKING

You can use the power door lock control or the remote control to lock and unlock the vehicle.

Power Door Locks

The power door lock control is located on the driver and front passenger door panels.

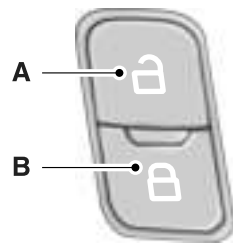

A. Unlock

B. Lock

Door Lock Indicator

An LED on the instrument panel will light when the doors are locked. It is not a functional control.

Central Locking and Unlocking

You can use the key in the driver door to lock or unlock all the doors from outside when they are closed.

- Turn the key counterclockwise to lock all doors. The turn signal lamps flash twice.
- Turn the key clockwise once to unlock the driver door or twice to unlock all doors. The turn signal lamps flash once.

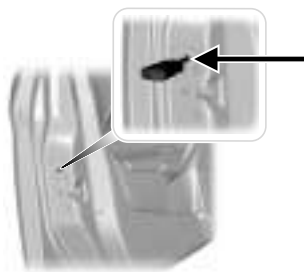

If the central locking function fails to operate, lock the doors individually using the key in the position shown.

Left-Hand Side

Turn clockwise to lock.

Right-Hand Side

Turn counterclockwise to lock.

Remote Control

You can use the remote control anytime the vehicle is not running.

Unlocking the Doors (Two-Stage Unlock)**Type 1****Type 2**

Press the button to unlock the driver door.

Press the button again within three seconds to unlock all doors. The turn signals will flash.

Press and hold both the lock and unlock buttons on the remote control for four seconds to disable or enable two-stage unlocking. Disabling two-stage unlocking allows all vehicle doors to unlock with one press of the button. The turn signals will flash twice to indicate the unlocking mode was changed. The unlocking mode will be applied to the remote control and intelligent access.

Intelligent access at the driver door will unlock all doors when you disable two-stage unlocking.

Locking the Doors**Type 1****Type 2**

Press the button to lock all the doors. The turn signals will illuminate.

Press the button again within three seconds to confirm that all the doors are closed. The doors will lock again, the horn will chirp and the turn signals will illuminate if all the doors and the liftgate are closed.

Note: If any door or the liftgate is not closed, or if the hood is not closed on vehicles equipped with an anti-theft alarm or remote start, the horn will chirp twice and the lamps will not flash.

Liftgate

WARNING: Make sure all persons are clear of the liftgate area before using liftgate control.



WARNING: Make sure the liftgate is closed to prevent exhaust fumes from being drawn into the vehicle. This will also prevent passengers and cargo from falling out. If you must drive with the liftgate open, keep the vents open so outside air comes into the vehicle. Failure to follow this warning could result in serious personal injury.

Note: Be careful when opening or closing the liftgate in a garage or other enclosed area to avoid damaging the liftgate.



Press twice within three seconds to:

- unlatch a manual liftgate
- open, close or reverse the movement of a power liftgate.

Activating Intelligent Access (If Equipped)

The intelligent access key must be within 3 feet (1 meter) of your vehicle.

At the Front Doors

Pull a front exterior door handle. The door will unlock and can be opened.



Press and hold the door handle lock sensor to lock your vehicle. To avoid unlocking the door inadvertently, be sure to only touch the lock sensor and not other areas of the door handle.

At the Liftgate

Press the exterior liftgate release button on the top of the liftgate pull-cup handle.

Smart Unlocks for Integrated Keyhead Transmitter

This feature helps to prevent you from locking yourself out of your vehicle if your key is still in the ignition.

When you open one of the front doors and lock your vehicle with the power door lock control, all the doors will lock then unlock if your key is still in the ignition.

You can still lock your vehicle by pressing the lock button on the transmitter even if the doors are not closed.

If both front doors are closed, you can lock your vehicle by any method, regardless of whether the key is in the ignition or not.

Smart Unlocks for Intelligent Access Keys (If Equipped)

This feature helps to prevent you from unintentionally locking your intelligent access key inside your vehicle's passenger compartment or rear cargo area.

When you lock your vehicle using the power door lock control (with the door open, transmission **P** and ignition off), after you close the door your vehicle will search for an intelligent access key in the passenger compartment. If your vehicle finds a key, all of the doors will immediately unlock and the horn will sound, indicating that the intelligent access key is inside.

You can override the smart unlock feature and intentionally lock the intelligent access key inside your vehicle. To do this, either:

- close all the doors and then press the lock button on another intelligent access key, or
- touch the locking area on the handle with another intelligent access key in your hand.

When you open one of the front doors and lock your vehicle using the power door lock control, all doors will lock then unlock if:

- the ignition is on, or
- the ignition is off and the vehicle is not in **P**.

Autolock and Unlock (If Equipped)

The autolock feature will lock all the doors when:

- all doors are closed
- the ignition is on
- you shift into any gear putting the vehicle in motion, and
- the vehicle attains a speed greater than 4 mph (7 km/h).

The autounlock feature will unlock all the doors when:

- autolock has locked the doors
- you stop the vehicle and switch the ignition off or to accessory mode, and
- the driver's door is opened within 10 minutes.

Note: The doors will not autounlock if you have electronically locked them before opening the driver's door.

Enabling or Disabling Autolock and Autounlock

Note: Your authorized dealer can perform this procedure, or you can do the procedure yourself.

To enable or disable these features, do the following:

Note: You will have 30 seconds to complete the procedure.

1. Switch the ignition on.
2. Press the power door unlock button three times.
3. Switch the ignition off.
4. Press the power door unlock button three times.
5. Switch the ignition on. The horn will chirp indicating the programming mode has been entered.

Autolock: Press the power door unlock control, then the lock control. The horn will chirp once if autolock was disabled or twice (one short and one long chirp) if autolock was enabled.

Autounlock: Press the power door lock control, then the unlock control. The horn will chirp once if autounlock was disabled or twice (one short and one long chirp) if autounlock was enabled.

6. Switch the ignition off. The horn will chirp once to confirm the procedure is complete.

Note: The autounlock feature can be enabled or disabled independently of the autolock feature.

Illuminated Entry

The interior lamps and select exterior lamps illuminate when you unlock the doors with the remote entry system.

The illuminated entry system turns off the lights if:

- the ignition is on,
- you press the remote transmitter lock button, or
- after 25 seconds of illumination.

The lights will not turn off if:

- you turn them on with the lamp control, or
- any door is open.

Illuminated Exit

The interior lamps and select exterior lamps illuminate when all doors are closed and you switch the ignition off and remove the key from the ignition (integrated keyhead transmitter only).

The lamps turn off if all the doors remain closed and:

- 25 seconds elapse
- you insert the key in the ignition (integrated keyhead transmitter only)
- you press the **START/STOP** button (intelligent access key only).

Battery Saver

If you leave the courtesy lamps, dome lamps or headlamps on and switch the ignition off, the battery saver shuts them off after some time.

Accessory Mode Battery Saver for Intelligent Access Keys (If Equipped)

If you leave the ignition on after leaving your vehicle, it will shut off 15 minutes after you close all of the doors.

LIFTGATE

 **WARNING:** It is extremely dangerous to ride in a cargo area, inside or outside of a vehicle. In a crash, people riding in these areas are more likely to be seriously injured or killed. Do not allow people to ride in any area of your vehicle that is not equipped with seats and safety belts. Be sure everyone in your vehicle is in a seat and using a safety belt properly.

Manual Liftgate

 **WARNING:** Make sure that the liftgate is closed to prevent exhaust fumes from being drawn into the vehicle. This will also prevent passengers and cargo from falling out. If you must drive with the liftgate door open, keep the vehicle well ventilated so outside air comes into the vehicle. Failure to follow this warning could result in serious personal injury.

Note: Be careful when opening or closing the liftgate in a garage or other enclosed area to avoid damaging the liftgate.

Note: Do not hang anything (bike rack, etc.) from the spoiler, glass or liftgate. This could damage the liftgate and its components.

Note: Do not leave the liftgate open while driving. This could damage the liftgate and its components.

The liftgate area is only intended for cargo, not passengers.

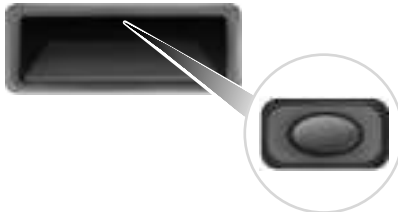

To open the liftgate: Press the button located in the top of the liftgate pull cup handle to unlatch the liftgate, then pull on the outside handle.

Power Liftgate (If Equipped)

WARNING: Make sure all persons are clear of the power liftgate area before using the power liftgate control.



WARNING: Keep keys out of reach of children. Do not allow children to play near an open or moving power liftgate.

Note: Cycling the ignition while the liftgate is power closing and is near the latch may cause the liftgate to stop operation. Make sure that the liftgate is closed before operating or moving the vehicle, especially in an enclosure, like a garage or a parking structure. The liftgate or its components could be damaged.

Opening and Closing the Power Liftgate

Note: The doors must be unlocked to operate the power liftgate.

Note: The liftgate movement direction can be stopped with a second press of the instrument panel, or the control button on the liftgate, a second double press of the transmitter button, or by using a kicking motion with your foot for hands-free liftgates.

If the engine is running, the liftgate will only operate with the vehicle in **P**.

A chime sequence will sound as the liftgate begins to power close. Another chime sequence indicates a problem with the close request, caused by:

- the ignition is on and the transmission is not in **P**, or
- the battery voltage is below the minimum operating voltage, or
- the vehicle speed is at or above 3 mph (5 km/h).

If the liftgate reverses and starts to close after an open request, four short warning chimes indicate excessive load on the gate or a possible strut failure. See your authorized dealer if you still have a fast chime after the load is removed.



To open or close from the instrument panel: Press the instrument panel button.

Note: The doors must be unlocked.



To open or close with the remote control: Press the remote control button twice within three seconds.

**To open or close using the hands-free liftgate feature
(with intelligent access only):**



1. Make sure you have an intelligent access transmitter within 3 feet (1 meter) of the liftgate.
2. Raise and lower your leg, moving your foot toward and away from the rear bumper (similar to a kicking motion). The liftgate will power open/close.

Note: Allow the power system to open the liftgate. Manually pushing or pulling the liftgate may activate the system's obstacle detection feature and stops the power operation.

Note: Splashing water may cause the hands-free liftgate to open. Keep the intelligent access transmitter away from the rear bumper detection area while washing your vehicle.

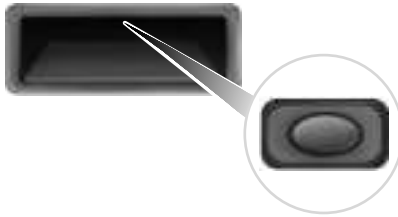

To open with the outside liftgate control button:

1. Unlock the liftgate with the remote control or power door unlock control. If the intelligent access transmitter (if equipped) is within 3 feet (1 meter) of the liftgate, the liftgate will unlock when you press the liftgate release button.
2. Press the control button located in the top of the liftgate pull-cup handle.

Note: Allow the power system to open the liftgate after pressing the control. Manually pushing or pulling the liftgate may activate the system's obstacle detection feature and stops the power operation.



To close with the control on the liftgate: Press and release the button.



WARNING: Keep clear of the liftgate when activating the rear switch.

Setting Liftgate Open Height

1. Open the liftgate.
2. Manually move the liftgate to the desired height.



3. Press and hold the control button on the liftgate until a chime is heard, indicating the new height has been programmed. **Note:** The height cannot be programmed if the liftgate position is too low.

The new open liftgate height will now be recalled when the power liftgate is opened. To change the programmed height, repeat the above procedure. Once the power liftgate is opened it can be manually moved to a different height.

When operating the power liftgate after a lower height than full-open has been programmed, the liftgate can be fully opened by manually pushing it upward to the maximum open position.

Obstacle Detection

When closing: The system will stop when it detects an obstacle and two short chimes will sound. Once the obstacle is removed the liftgate can be closed under power.

Note: Entering the vehicle while the liftgate is closing can cause the vehicle to bounce and activate obstacle detection. To prevent this, allow the power liftgate to fully close before entering the vehicle. Before driving off, check the instrument cluster for a liftgate or door ajar message or warning indicator. Driving off without first checking for the liftgate or door ajar message or warning indicator could result in the liftgate being left open, unintentionally, while you are driving.

When opening: The system will stop and two short chimes will sound when it detects an obstacle. Remove the obstacle to operate the liftgate.

SECURILOCK® PASSIVE ANTI-THEFT SYSTEM

Note: The system is not compatible with non-Ford aftermarket remote start systems. Use of these systems may result in vehicle starting problems and a loss of security protection.

Note: Metallic objects, electronic devices or a second coded key on the same key chain may cause vehicle starting issues if they are too close to the key when starting the engine. Prevent these objects from touching the coded key while starting the engine. Switch the ignition off, move all objects on the key chain away from the coded key and restart the engine if a problem occurs.

Note: Do not leave a duplicate coded key in the vehicle. Always take your keys and lock all doors when leaving the vehicle.

The system is an engine immobilization system. It helps prevent the engine from starting unless a coded key programmed to your vehicle is used. Using the wrong key may prevent the engine from starting. A message may appear in the information display.

If you are unable to start the engine with a correctly coded key, a malfunction has happened and a message may appear in the information display.

Automatic Arming

Your vehicle arms immediately after you switch the ignition off.

Automatic Disarming

Your vehicle disarms when you switch the ignition on with a coded key.

Replacement Keys

Note: Your vehicle comes with two integrated keyhead transmitters or two intelligent access keys.

The integrated keyhead transmitter functions as a programmed ignition key that operates all the locks and starts the vehicle, as well as a remote control.

The intelligent access key functions as a programmed key that operates the driver door lock and activates the intelligent access with push button start systems, as well as a remote control.

If your programmed transmitters or standard SecuriLock coded keys (integrated keyhead transmitters only) are lost or stolen and you do not have an extra coded key, you will need to have your vehicle towed to an authorized dealer. The key codes need to be erased from your vehicle and new coded keys will need to be programmed.

Store an extra programmed key away from the vehicle in a safe place to help prevent any inconveniences. See an authorized dealer to purchase additional spare or replacement keys.

Programming a Spare Integrated Keyhead Transmitter

Note: A maximum of eight coded keys can be programmed to your vehicle; all eight can be integrated keyhead transmitters.

You can program your own integrated keyhead transmitter or standard SecuriLock® coded keys to your vehicle. This procedure will program both the engine immobilizer keycode and the remote entry portion of the remote control to your vehicle.

Only use integrated keyhead transmitters or standard SecuriLock® keys.

You must have two previously programmed coded keys and the new unprogrammed key readily accessible. See your authorized dealer to have the spare key programmed if two previously programmed coded keys are not available.

Read and understand the entire procedure before you begin.

1. Insert the first previously programmed coded key into the ignition.
2. Turn the ignition from off to on. Keep the ignition on for at least three seconds, but no more than 10 seconds.
3. Turn the ignition off and remove the first coded key from the ignition.
4. After three seconds but within 10 seconds of turning the ignition off, insert the second previously coded key into the ignition.
5. Turn the ignition from off to on. Keep the ignition on for at least three seconds, but no more than 10 seconds.
6. Turn the ignition off and remove the second previously programmed coded key from the ignition.
7. After three seconds but within 10 seconds of turning the ignition off and removing the previously programmed coded key, insert the new unprogrammed key into the ignition.
8. Turn the ignition from off to on. Keep the ignition on for at least six seconds.
9. Remove the newly programmed coded key from the ignition.

If the key has been successfully programmed it will start the engine and operate the remote entry system (if the new key is an integrated keyhead transmitter).

If it was not programmed successfully, wait 10 seconds and repeat Steps 1 through 8. If you are still unsuccessful, bring your vehicle to your authorized dealer.

Wait 20 seconds and then repeat this procedure from Step 1 to program an additional key.

Programming a Spare Intelligent Access Key

See your authorized dealer to have additional keys programmed to your vehicle.

ANTI-THEFT ALARM (IF EQUIPPED)

The system will warn you of an unauthorized entry to your vehicle.

The park and turn lamps flash and the horn sounds if unauthorized entry is attempted while the alarm is armed. It triggers immediately if the luggage compartment or the hood opens, and after a 12-second delay if any door opens.

Take all remote controls to an authorized dealer if there is any potential alarm problem with your vehicle.

Arming the Alarm

The alarm is ready to arm when there is not a key in the ignition. Press the door lock button and close the door to arm the alarm.

Disarming the alarm

Disarm the alarm by any of the following actions:

- Unlock the doors or luggage compartment with the remote control.
- Turn the ignition on or start the vehicle.
- Use a key in the driver door to unlock your vehicle, then turn the ignition on within 12 seconds.

ADJUSTING THE STEERING WHEEL

WARNING: Do not adjust the steering wheel when your vehicle is moving.

Note: Make sure that you are sitting in the correct position. See *Sitting in the Correct Position* in the *Seats* chapter.

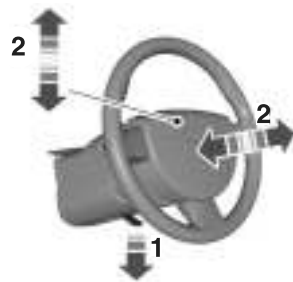

1. Unlock the steering column.
2. Adjust the steering wheel to the desired position.



3. Lock the steering column.

AUDIO CONTROL (IF EQUIPPED)

Select the required source on the audio unit.

The following functions can be operated with the control:

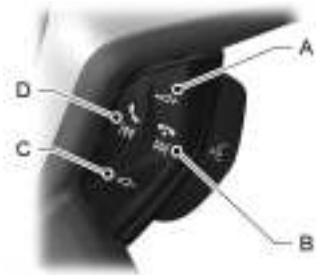

- A. Volume up
- B. Seek up or next
- C. Volume down
- D. Seek down or previous

Seek, Next or Previous

Press the seek button to:

- tune the radio to the next or previous stored preset
- play the next or previous track.

Press and hold the seek button to:

- tune the radio to the next station up or down the frequency band
- seek through a track.

VOICE CONTROL (IF EQUIPPED)

Pull the control to select or deselect voice control. See the *SYNC* or *MyFord Touch* chapter.

CRUISE CONTROL

See the *Cruise Control* chapter.

INFORMATION DISPLAY CONTROL

Use the arrows on the left side of the steering wheel to navigate the information display. See the *Information Displays* chapter for more information.

Multimedia Controls (If Equipped)

Use the arrows on the right side of steering wheel to navigate through the available menus. Press **OK** to make a selection.

WINDSHIELD WIPERS

Note: Fully defrost the windshield before switching on the windshield wipers.

Note: Make sure the windshield wipers are switched off before entering car wash.

Note: Clean the windshield and wiper blades if they begin to leave streaks or smears. If that does not resolve the issue, install new wiper blades.

Note: Do not operate the wipers on a dry windshield. This may scratch the glass, damage the wiper blades or cause the wiper motor to burn out. Always use the windshield washer before wiping a dry windshield.

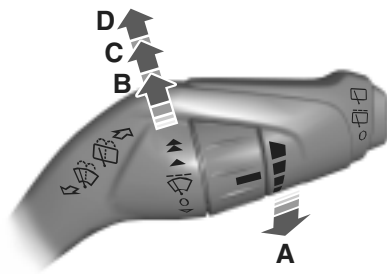

- A. Single wipe
- B. Intermittent wipe
- C. Normal wipe
- D. High-speed wipe

Intermittent Wipe

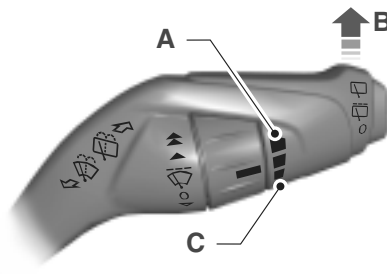

- A. Shortest wipe interval
 - B. Intermittent wipe
 - C. Longest wipe interval
- Use the rotary control to adjust the intermittent wipe interval.

Speed-dependent Wipers (If Equipped)

When your vehicle speed increases, the interval between wipes will decrease when intermittent wipe is selected.

AUTOWIPERS (IF EQUIPPED)

Note: Fully defrost the windshield before switching on the windshield wipers.

Note: Make sure the windshield wipers are switched off before entering a car wash.

Note: Replace the wiper blades as soon as they begin to leave bands of water or smears on the windshield.

Note: If autolamps have been switched on in conjunction with autowipers, low beam headlamps will illuminate automatically when the rain sensor activates the windshield wipers continuously.

Note: Wet road conditions can cause unexpected wiping or smearing.

To reduce smearing we recommend the following:

- Lower the sensitivity of the autowipers.
- Switch to normal or high speed wipe.
- Switch the autowipers off.

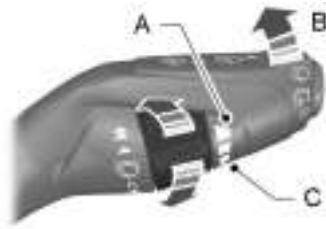

A. Highest sensitivity

B. On

C. Lowest sensitivity

The wipers will function when moisture is detected on the windshield. The rain sensor will continue to monitor the amount of moisture on the windshield and adjust the speed of the wipers automatically.

Use the rotary control to adjust the sensitivity of the rain sensor. With low sensitivity, the wipers will operate when the sensor detects a large amount of moisture on the windshield. With high sensitivity, the wipers will operate when the sensor detects a small amount of moisture on the windshield.

Keep the outside of the windshield clean. Sensor performance will be affected if the area around the interior mirror is dirty. The rain sensor is very sensitive and the wipers may operate if dirt, mist or flies hit the windshield.

WINDSHIELD WASHERS

Note: Do not operate the washers when the washer reservoir is empty. This may cause the washer pump to overheat.



The washer will spray for as long as the lever is pulled toward you. After you release the lever, the wipers will operate for a short time.

A wipe will occur a few seconds after washing to clear any remaining washer fluid.

REAR WINDOW WIPER AND WASHERS (IF EQUIPPED)

Rear Window Wiper



A. Intermittent wipe

B. Low-speed wipe

Press the button at the end of the lever to change between off, intermittent and low speed.

When you select reverse gear, the rear wiper will switch on to

intermittent if the front wipers are activated.

Rear Window Washers

Note: Do not operate the washers when the washer reservoir is empty. This may cause the washer pump to overheat.

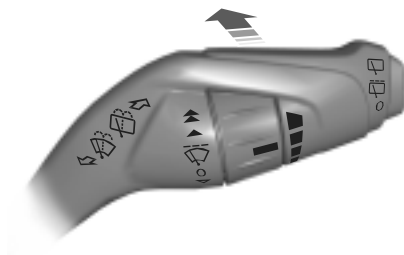

The washer will spray for as long as you push the lever away from you. When you release the lever, the wiper will operate for a short time.

LIGHTING CONTROL

- A. Off
- B. Parking lamps, instrument panel lamps, license plate lamps and tail lamps
- C. Headlamps

High Beams

Push the lever forward to switch the high beams on.
Push the lever forward again or pull the lever toward you to switch the high beams off.

Headlamp Flasher

Pull the lever toward you slightly and release it to flash the headlamps.

AUTOLAMPS (IF EQUIPPED)

Note: It may be necessary to switch your headlamps on manually in severe weather conditions.



The headlamps will switch on and off automatically in low light situations or during inclement weather.

The headlamps will remain on for a period of time after you switch the ignition off. You can adjust the time delay using the information display controls.

Note: If you switch autolamps on in conjunction with autowipers, low beam headlamps will illuminate automatically when the rain sensor activates the windshield wipers continuously.

INSTRUMENT LIGHTING DIMMER

Note: The illumination settings default to the maximum setting after the battery is disconnected then reconnected, or discharged then recharged.

Vehicles With Front Fog Lamps

Press repeatedly or press and hold until the desired level is reached.

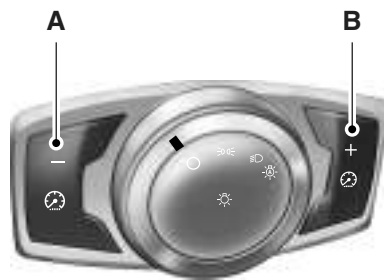
Vehicles Without Front Fog Lamps

A. Press repeatedly or press and hold to dim.

B. Press repeatedly or press and hold to brighten.

HEADLAMP EXIT DELAY

After you switch the ignition off, you can switch the headlamps on by pulling the direction indicator lever toward you. You will hear a short tone. The headlamps will switch off automatically after three minutes with any door open or 30 seconds after the last door has been closed.

You can cancel this feature by pulling the direction indicator toward you again or switching the ignition on.

DAYTIME RUNNING LAMPS (IF EQUIPPED)

WARNING: Always remember to switch your headlamps on in low light situations or during inclement weather. The system does not activate the tail lamps and may not provide adequate lighting during these conditions. Failure to activate your headlamps under these conditions may result in a collision.

The system switches the headlamps on in daylight conditions.

To switch the system on, switch the ignition on, and switch the lighting control to the off, autolamp, or parking lamp positions.

FRONT FOG LAMPS

Press the control to switch the fog lamps on or off.

You can switch the fog lamps on when the lighting control is in any position except off and the high beams are not on.

DIRECTION INDICATORS

Push the lever up or down to use the direction indicators.

Note: Tap the lever up or down to make the direction indicators flash three times to indicate a lane change.

INTERIOR LAMPS

The lamps will switch on when one of the following conditions have been met:

- You open any door.
- You press a remote control button.
- You press switch D on the front interior lamp.

Note: Press switch C on the front interior lamp to switch the courtesy and door illumination function off when you open any door. The indicator lamp will illuminate yellow when the door function is off. When the door function is off and you open a door, the courtesy and door lamps will stay off.

Press switch C again to switch them back on. The indicator lamp will illuminate blue when the door function is on. When the door function is on and you open a door, the courtesy and door lamps will switch on.

Front Interior lamp (if equipped)

Note: Some interior lamps are equipped with a single switch for the left and right map lamps.

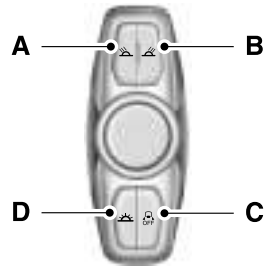

- A. Left map lamp switch, if equipped
- B. Right map lamp switch, if equipped
- C. Door function switch
- D. All lamps on and off switch

Front/Rear Interior lamp (if equipped)

Press switch A to switch individual map lamps on and off (if equipped).

AMBIENT LIGHTING (IF EQUIPPED)

The ambient lighting system illuminates the interior with a choice of several colors. The ambient lighting control is located in the overhead console.

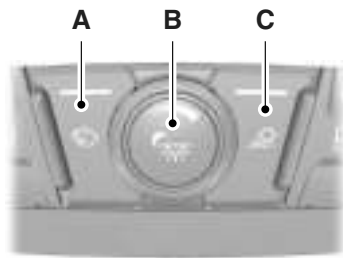

- A. Color palette
- B. Control knob
- C. Search mode

- Rotate B to switch on and adjust to the desired brightness.
- Press A to cycle through the color choices.
- Press C to switch on all interior lamps and all ambient lighting. Press C again to switch off the interior lamps and return the ambient lighting to the previously selected color.

The ambient lighting will switch on when the following conditions have been met:

- you switch the ignition on
- you switch the headlamps on
- the outside ambient light level is low.

The ambient lighting will remain on until you switch the ignition off and one of the following conditions have been met:

- you lock your vehicle
- the accessory delay timer expires.

POWER WINDOWS

WARNING: Do not leave children unattended in your vehicle and do not let them play with the power windows. They may seriously injure themselves.



WARNING: When closing the power windows, you should verify they are free of obstructions and make sure that children and pets are not in the proximity of the window openings.

Note: You may hear a rumbling noise when one or both of the rear windows are open. Lower a front window slightly to reduce this noise.



Press the switch to open the window.

Lift the switch to close the window.

One-Touch Down

Press the switch fully and release it. Press again or lift it to stop the window.

One-Touch Up

Lift the switch fully and release it. Press or lift it again to stop the window.

Global Opening

Note: The ignition must be off and the accessory delay feature must not be activated to operate this feature.

Press and hold the unlock button on the remote control to begin opening the windows. Release the button once motion starts. The windows will continue opening.

Press the lock or unlock button on the remote control to stop motion.

Window Lock

Press the control to lock or unlock the rear window controls. It illuminates when you lock the rear window controls.

Bounce-Back (If Equipped)

The window will stop automatically while closing. It will reverse some distance if there is an obstacle in the way.

Overriding the Bounce-Back Feature

WARNING: When you override the bounce-back feature the window will not reverse if it detects an obstacle. Take care when closing the windows to avoid personal injury.

Proceed as follows to override this protection function when there is a resistance, for example in the winter:

1. Close the window twice until it reaches the resistance and let it reverse.
2. Close the window a third time to the resistance. The bounce-back function is disabled and you can close the window manually. The window will override the resistance and you can close it fully.

Contact your authorized dealer as soon as possible if the window does not close after the third attempt.

Resetting the Bounce-Back Feature

WARNING: The bounce-back function remains deactivated until you have reset the memory.

You must reset the bounce-back memory separately for each window after the battery has been disconnected.

1. Lift and hold the switch until the window is fully closed.
2. Release the switch.
3. Lift the switch again for one more second.
4. Press and hold the switch until the window is fully open.
5. Release the switch
6. Lift and hold the switch until the window is fully closed.
7. Open the window and then try to close it automatically.
8. Reset and repeat the procedure if the window does not close automatically.

Accessory Delay (If Equipped)

You can use the window switches for several minutes after the you switch the ignition off, or until you open either front door.

EXTERIOR MIRRORS

Power Exterior Mirrors



WARNING: Do not adjust the mirror while your vehicle is in motion.



- A. Left-hand mirror
- B. Off
- C. Right-hand mirror

Press the arrows to adjust the mirror.



Fold-Away Exterior Mirrors

Push the mirror toward the door window glass. Make sure that you fully engage the mirror in its support when returning it to its original position.

Signal Indicator Mirrors

The outer portion of the appropriate mirror housing blinks when you activate the turn signal.

Integrated Blind Spot Mirrors



WARNING: Objects in the blind spot mirror are closer than they appear.

Blind spot mirrors have an integrated convex mirror built into the upper outboard corner of the exterior mirrors. They are designed to assist you by increasing visibility along the side of your vehicle.

Check the main mirror first before a lane change, then check the blind spot mirror. If no vehicles are present in the blind spot mirror and the traffic in the adjacent lane is at a safe distance, signal that you are going to change lanes. Glance over your shoulder to verify traffic is clear, and carefully change lanes.

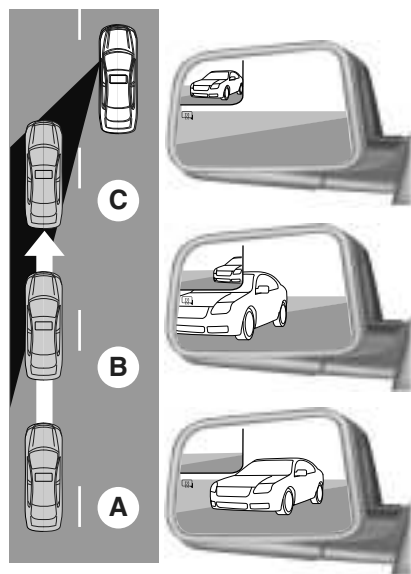

The image of the approaching vehicle is small and near the inboard edge of the main mirror when it is at a distance. The image becomes larger and begins to move outboard across the main mirror as the vehicle approaches (A). The image will transition from the main mirror and begin to appear in the blind spot mirror as the vehicle approaches (B). The vehicle will transition to your peripheral field of view as it leaves the blind spot mirror (C).

INTERIOR MIRROR

WARNING: Do not adjust the mirror when your vehicle is moving.

Note: Do not clean the housing or glass of any mirror with harsh abrasives, fuel or other petroleum or ammonia based cleaning products.

You can adjust the interior mirror to your preference. Some mirrors also have a second pivot point. This lets you move the mirror head up or down and from side to side.

Pull the tab below the mirror toward you to reduce glare at night.

Auto-Dimming Mirror (If Equipped)

Note: Do not block the sensors on the front and back of the mirror. Mirror performance may be affected. A rear center passenger or raised rear center head restraint may also block light from reaching the sensor.

The mirror will dim automatically to reduce glare when bright lights are detected from behind your vehicle. It will automatically return to normal reflection when you select reverse gear to make sure you have a clear view when backing up.

SUN VISORS**Illuminated Visor Vanity Mirror**

Lift the cover to switch on the lamp.

SUN SHADE (IF EQUIPPED)

WARNING: Do not let children play with the sun shade or leave them unattended in the vehicle. They may seriously hurt themselves.



WARNING: When closing the sun shade, you should verify that it is free of obstructions and make sure that children and pets are not in the proximity of the sunshade.

The sun shade controls are located on the overhead console.

The sun shade has a one-touch open and close feature. To stop motion during one-touch operation, press the control a second time.

Opening and Closing the Sun Shade

Fully press and release the front of the control to open the sun shade.

Fully press and release the rear of the control to close the sun shade.

Bounce-Back

The sun shade stops automatically while closing. It will reverse some distance if there is an obstacle in the way.

Sun Shade Relearning

WARNING: The bounce-back function is not active during this procedure. Make sure that there are no obstacles in the way of the moving sun shade.

Note: You must start the relearning process within 30 seconds of switching the ignition on.

In case the sun shade no longer opens or closes properly, follow this relearning procedure:

1. Press the front of the control to the first action point twice and release it within two seconds.
2. Press the rear of the control to the first action point twice and release it within two seconds.
3. Press and hold the front of the control to the first action point, until the sun shade fully opens.
4. Press and hold the rear of the control to the first action point, until the sun shade fully closes.

Note: If you do not complete Step 2 within 15 seconds of Step 1 or if you press the switch to the second action point, the relearning function stops. Switch the ignition off, wait for another 30 seconds and then switch the ignition back on again. Start the procedure again from the beginning.

Confirm that relearning was successful by opening and closing the sun shade with the one-touch feature.

GAUGES

Cluster shown in standard measure – metric clusters similar.

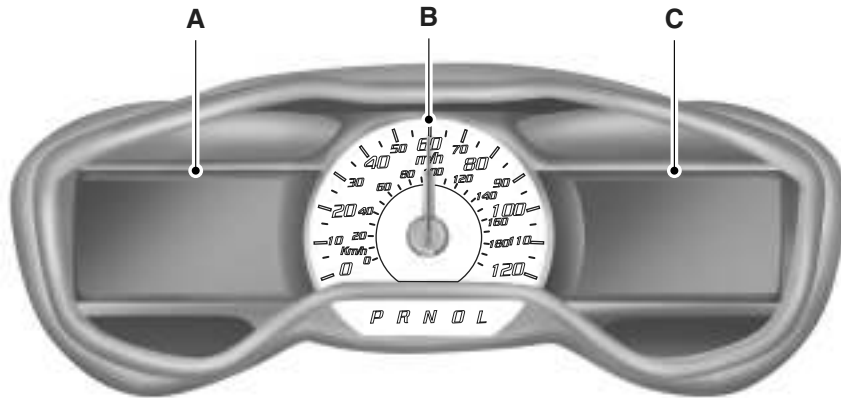

A. Left Information Display

B. Speedometer

C. Right Information Display: See the *MyTouch* chapter for more information.

Left Information Display**Odometer**

Located in the bottom of the information display Registers the accumulated distance your vehicle has travelled.

Outside air temperature

Shows the outside air temperature.

Trip Computer

See *Trip Computer* in *Information Displays*.

Vehicle Settings and Personalization

See *Information Displays*.

Common Displays

Note: Battery gauge information can be individually selected on or off through Battery Display in the Options sub-menu. From any main display a right arrow press on the steering wheel controls will take you to the Options sub-menu.

Note: For Energi vehicles there are two versions of the battery gauge. When the vehicle is in Hybrid Mode the information is shown with a simple battery graphic. When in Plug-in Power Mode an enhanced battery graphic is provided and available electric range is added to the display. .

Battery Gauge: The high voltage battery gauge appears on the right side of the information display screen. This provides Charge Fill (State of Charge), Charge Assist and Regen Display.

- Charge Fill - The fill level, or State of Charge indicates the amount of energy stored in the high voltage battery as a percent of total energy capacity. The level will increase or decrease as the battery charges and discharges during normal operation, but the hybrid system will attempt to control the level to approximately the middle of the gauge under most driving conditions.
- Charge Fill (Energi Plug-in Power Mode) - The fill level indicates the amount of energy stored in the high voltage battery which is available for Plug-in Power Mode. A full fill represents the total amount of energy you can get from an external charge (plugging your vehicle in). When the fill reaches empty your vehicle will automatically enter Hybrid Mode
- Electric Range (Energi Plug-in Power Mode) - The electric range estimate is based on the amount of battery energy currently available in the high voltage battery and your typical energy usage while driving. This includes your drive habits as well as your use of accessories such as Climate Control. The battery energy refers to the energy gained from charging the battery while plugged in.
- Charge Assist - The up and down arrows provide information about the energy going into and out of the high voltage battery. The up arrow above the battery indicates battery charging such as from regenerative braking. The down arrow below the battery indicates battery discharging to provide power for propulsion or vehicle accessories

Note: The Charge Fill is always shown for Plug-in Power Mode, even if Charge Fill is not selected under Battery Display in the Options sub-menu.

- Regen Display - A circular arrow symbol appears in the center of the Battery Gauge when energy is being recaptured through the regenerative braking system.

Fuel Gauge: The fuel gauge will indicate approximately how much fuel is left in the fuel tank. The fuel gauge may vary slightly when your vehicle is moving or on a gradient. The arrow adjacent to the fuel pump symbol indicates on which side of the vehicle the fuel filler door is located.

Brake Coach Display: The Brake Coach appears after the vehicle has come to a stop. It coaches you to brake in a manner which maximizes the amount of energy returned through the regenerative braking system. The percent displayed is an indication of the regenerative braking efficiency with 100% representing the maximum amount of energy recovery.

Trip Summary and Lifetime Summary: These will be displayed upon shutting off the vehicle. Trip Summary will appear first, then Lifetime Summary will be displayed. You can toggle between these displays using the up and down arrow keys on the left hand steering wheel controls.

Trip Summary data is from the last power cycle, while Lifetime Summary data is cumulative from the last Lifetime Summary reset done through the Settings menu in the message center.

Trip Summary:

- Distance - The total distance travelled, distance travelled on battery power only (EV distance) and regen distance are displayed. Regen distance is the estimated range gained from energy recaptured through regenerative braking.
- Energy Use - The average fuel economy and total fuel used are displayed. In addition for Energi, the total electrical energy used while in Plug-in Power Mode is displayed in kilowatt hours (kWh). Trip Summary average fuel economy will be shown in blue if better than your lifetime average fuel economy.
- Brake Score - The average percentage of braking energy recaptured and returned to the high voltage battery through regenerative braking. The brake score will be shown in blue if greater than (better than) the lifetime brake score.

Lifetime Summary:

- Distance - The distance travelled on battery power only (EV distance) and regen distance are displayed. Regen distance is the estimated range gained from energy recaptured through regenerative braking.
- Energy Use - Average fuel economy.
- Brake Score - The average percentage of braking energy recaptured and returned to the high voltage battery through regenerative braking.

WARNING LAMPS AND INDICATORS

The following warning lamps and indicators will alert you to a vehicle condition that may become serious. Some lamps will illuminate when you start your vehicle to make sure they work. If any lamps remain on after starting your vehicle, refer to the respective system warning lamp for further information.

Note: Some warning indicators appear in the information display and function the same as a warning lamp but do not display when you start your vehicle.

Anti-Lock Braking System

If it illuminates when you are driving, this indicates a malfunction. You will continue to have the normal braking system (without ABS) unless the brake warning lamp is also illuminated. Have the system checked by your authorized dealer.

Battery

If it illuminates while driving, it indicates a malfunction. Switch off all unnecessary electrical equipment and have the system checked by your authorized dealer.

Brake System

It will illuminate when the parking brake is engaged and the ignition is on.

If it illuminates when you are driving, check that the parking brake is not engaged. If the parking brake is not engaged, this indicates low brake fluid level or a brake system malfunction. Have the system checked immediately by your authorized dealer.



WARNING: Driving a vehicle with the brake system warning light on is dangerous. A significant decrease in braking performance may occur. It will take you longer to stop the vehicle. Have the vehicle checked by your authorized dealer as soon as possible. Driving extended distances with the parking brake engaged can cause brake failure and the risk of personal injury.

Cruise Control (if equipped)

It will illuminate when you switch this feature on.

Direction Indicator

Illuminates when the left or right turn signal or the hazard warning flasher is turned on. If the indicators stay on or flash faster, check for a burned out bulb.

Door Ajar

Displays when the ignition is on and any door is not completely closed.

Engine/Motor Coolant Overheat Warning

It will illuminate when the engine or motor cooling system is overheating. Stop the vehicle in a safe place and contact your authorized dealer.

Engine Oil

If it illuminates with the engine running or when you are driving, this indicates a malfunction. Stop your vehicle as soon as it is safe to do so and switch the engine off. Check the engine oil level.

Note: Do not resume your journey if it illuminates despite the level being correct. Have the system checked by your authorized dealer.

EV Now

It will illuminate when you select this feature on

EV Later

It will illuminate when you select this feature on

Fasten Safety belt

It will illuminate and a chime will sound to remind you to fasten your safety belt.

Front Airbag

If it fails to illuminate on startup, continues to flash or remains on, it indicates a malfunction. Have the system checked by your authorized dealer. A chime will sound when there is a malfunction in the indicator light.

Front Fog Lamps (if equipped)

It will illuminate when you switch the front fog lamps on.

High Beam

It will illuminate when the headlamp high beam is switched on.

It will flash when you use the headlamp flasher.

Liftgate Ajar

It will illuminate when the liftgate is not completely closed.

Low Battery

It will illuminate when the battery level is low. May also be accompanied by a message suggesting the driver reduce usage of the climate system.

Low Fuel Level

It will illuminate when the fuel level is low or near empty. Refuel as soon as possible.

Low Tire Pressure Warning

It will illuminate when your tire pressure is low. If the lamp remains on with the engine running or when driving, check your tire pressure as soon as possible.

The lamp also illuminates momentarily when you switch the ignition on to confirm the lamp is functional. If it does not illuminate when you switch the ignition on, or begins to flash at any time, have the system checked by your authorized dealer.

Overdrive Cancel and Grade Assist (if equipped)

It will illuminate when the overdrive function of the transmission has been turned off and the grade assist function has been turned on.

Parking Lamps

It will illuminate when you switch the parking lamps or headlights on.

Powertrain Malfunction/Reduced Power

It will illuminate when a powertrain or high-voltage charge system fault has been detected. If the indicator stays on or continues to come on, contact your authorized dealer as soon as possible.

Ready to Drive

It will illuminate once the vehicle has been switched on and is ready to drive. A corresponding message may display stating ready to drive or a message regarding budget if a charge point has not been entered.

Service Engine Soon

The *service engine soon* indicator light illuminates when the ignition is first turned to the on position to check the bulb and to indicate whether the vehicle is ready for Inspection/Maintenance (I/M) testing. Normally, the “service engine soon” light will stay on until the engine is cranked, then turn itself off if no malfunctions are present. However, if after 15 seconds the “service engine soon” light blinks eight times, it means that the vehicle is not ready for I/M testing. See the *Readiness for inspection/maintenance (I/M) testing* in the *Fuel and Refueling* chapter.

Solid illumination after the engine is started indicates the on-board diagnostics system (OBD-II) has detected a malfunction. Refer to *On-board diagnostics (OBD-II)* in the *Fuel and Refueling* chapter. If the light is blinking, engine misfire is occurring which could damage your catalytic converter. Drive in a moderate fashion (avoid heavy acceleration and deceleration) and have your vehicle serviced immediately by your authorized dealer.



WARNING: Under engine misfire conditions, excessive exhaust temperatures could damage the catalytic converter, the fuel system, interior floor coverings or other vehicle components, possibly causing a fire.

Stability Control System

Displays when the AdvanceTrac®/Traction control is active. If the light remains on, have the system serviced immediately.

Stability Control System Off

Illuminates when AdvanceTrac®/Traction control has been disabled by the driver.

Stop Safely

Indicates electrical component fault/failure that will cause the vehicle to shutdown or enter into a limited operating mode. A message may also display.

Vehicle Plugged in (if equipped)

It will illuminate when the vehicle is plugged in. A corresponding message may display after attempting to start the vehicle.

AUDIBLE WARNINGS AND INDICATORS**Key In Ignition Warning Chime**

Sounds when the key is left in the ignition in the off or accessory position and the driver's door is opened.

Keyless Warning Alert (If Equipped)

Sounds when the keyless vehicle is in RUN and the driver's door is opened.

Headlamps On Warning Chime

Sounds when the headlamps or parking lamps are on, the ignition is off (the key is not in the ignition) and the driver's door is opened.

Parking Brake On Warning Chime

Sounds when you have left the parking brake on and drive your vehicle. If the warning chime remains on after you have released the parking brake, have the system checked by your authorized dealer immediately.

GENERAL INFORMATION

WARNING: Driving while distracted can result in loss of vehicle control, accident and injury. Ford strongly recommends that drivers use extreme caution when using any device or feature that may take their focus off the road. Your primary responsibility is the safe operation of the vehicle. We recommend against the use of any handheld device while driving and that you comply with all applicable laws.

Various systems on your vehicle can be controlled using the information display controls on the steering wheel. Corresponding information is displayed in the information display.

Information Display Controls

Use the left steering wheel arrow control buttons to control the cluster information display.

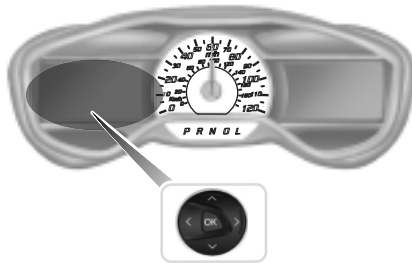





- Press the up and down arrow buttons to scroll through and highlight the options within a menu.
- Press the right arrow button to enter a sub-menu.
- Press the left arrow button to exit a menu.
- Press the OK button to choose and confirm a setting/messages.

The arrows in the upper left corner of the display indicate additional content available when lit.

Main menu

From the main menu bar on the left side of the information display, you can choose from the following categories:

-  Display Mode
-  Trip 1 & 2
-  Fuel Economy
-  Information
-  Settings

Scroll up/down to highlight one of the categories, then press the right arrow key or OK to enter into that category. Press the left arrow key as needed to exit back to the main menu.

Display Mode

-  Use the arrow buttons to choose between the following display options.

Note: The cluster will remember menu level 2 state when the individual key state is changed from RUN to the OFF position.

Display Mode			
Menu level 2	Menu level 3	Menu level 4	Menu level 5
Vehicle Range: Battery Gauge + Fuel Gauge	Instantaneous Fuel	—	—
	Battery Display	Regen Active	Apply to all screens (overlay)
		Charge Assist	
		Charge Level	
		Help	—
	Help	—	—

Display Mode			
Inform: Avg Fuel Economy + Battery Gauge + Fuel Gauge	Instantaneous Fuel	—	—
	Battery Display	Regen Active	Apply to all screens (overlay)
		Charge Assist	
		Charge Level	
	Help		
Help	—	—	
Enlighten: Power + Avg Fuel Economy + Battery Gauge + Fuel Gauge	Instantaneous Fuel	—	—
	Battery Display	Regen Active	Apply to all screens (overlay)
		Charge Assist	
		Charge Level	
	Help		
Help	—	—	
Engage: Split Power + Avg Fuel Economy + Battery Gauge + Fuel Gauge	Instantaneous Fuel	—	—
	Battery Display	Regen Active	Apply to all screens (overlay)
		Charge Assist	
		Charge Level	
	Help		
Help	—	—	
Empower: Power (with engine on/off threshold) + Avg Fuel Economy + Battery Gauge + Fuel Gauge	Instantaneous Fuel	—	—
	Battery Display	Regen Active	Apply to all screens (overlay)
		Charge Assist	
		Charge Level	
	Help		
Help	—	—	

Display Mode			
Menu level 2	Menu level 3	Menu level 4	Menu level 5
MyView	Change MyView	Vehicle Range	Average Speed
		Avg Fuel	Vehicle Range
		Power	Avg Fuel
		Split Power	Inst. Fuel
		Power + Threshold	Coolant Temp
		Tach rpm x 1000	Accessory Power
		Accessory Power	Trip 1
		Trip 1	Trip 2
		Trip 2	Fuel History
		Fuel History	Coach
		Coach	Blank
	Blank	—	
	Battery Display	Regen Active	Apply to all screens (overlay)
		Charge Assist	
		Charge Level	
		Help	
Help	—	—	

Display Mode			
Energi only EV: Auto (consumption gauge, accessory power gauge) EV: Now (consumption gauge with budget cup, accessory power gauge, override) EV: Later (consumption gauge, accessory power gauge, EV miles reserved)	Battery Display	Regen Active	Apply to all screens (overlay)
		Charge Assist	
		Charge Level	
		Help	
	Help	—	—

- Vehicle Range** — Indicates the estimated distance the vehicle will travel with the energy currently available. For Hybrid, the vehicle range estimate is based on the fuel remaining in the gasoline tank. For Energi, the total estimated distance equals the distance available in Hybrid Mode fueled by gasoline, plus the EV distance available in Plug-in Power Mode. Changes in driving pattern may cause the values to vary.

Instantaneous Fuel — This gauge is available on all Display mode screens and shows the instantaneous fuel economy. It can be selected on or off through the Options sub-menu. From any main display a right arrow press on the steering wheel controls will take you to the Options sub-menu.

Instantaneous fuel economy is displayed in miles per gallon, kilometers per liter, or liters per 100 kilometers. Your vehicle must be moving to calculate average fuel economy. If your instantaneous fuel economy is greater than the maximum value the graph can display, a + sign will be shown next to maximum scale number. When the vehicle is operating on battery power only, EV is displayed and the gauge fill is shown in blue.

For Energi vehicles, in the Display section of the Settings menu you can choose your fuel economy units as Fuel only or fuel + electric. When fuel + electric is chosen your electrical energy use during Plug-in Power Mode is included in your instantaneous fuel economy. This is based on its equivalent energy in terms of gallons or liters of gasoline. The units will be displayed as MPGe, which reads miles per gallon equivalent, and similarly, km/Le and Le/100km.

- **Inform** — Inform shows the fuel level, battery display and average fuel economy, with options available for the Battery Display and an Instantaneous Fuel Economy gauge. When the vehicle is operating on battery power only, EV is displayed. Hold OK to reset average fuel economy.
- **Enlighten** — Enlighten displays power demand in addition to the typical information and options from Inform. The Instantaneous Fuel Economy gauge will be displayed by default. When the vehicle is operating on battery power only, EV is displayed and the gauge fill is shown in blue. When both the engine and the electric motor are providing power the gauge fill is white. Hold OK to reset average fuel economy.
- **Engage** — Engage replaces the power demand gauge from Enlighten with separate gauges for engine power and electric motor power. The engine power gauge fill is white and the high voltage battery power gauge fill is blue. When the vehicle is operating on battery power only, EV is displayed. Hold OK to reset average fuel economy.
- **Empower** — Empower adds an engine on/off threshold to the power demand gauge from Enlighten. The threshold is shown as a blue double outline. The gauge is designed to show you how close you are to the gasoline engine on/off threshold and how much power you are requesting by how much you press on the accelerator pedal.

When power demand is below the threshold the vehicle is operating on battery power only, EV is displayed and the gauge fill is shown in blue.

When power demand exceeds the threshold both the engine and the high voltage battery provide power and the gauge fill is white.

When power demand surpasses the amber indicator, this level of demand and associated fuel economy are shown in amber.

Hold OK to reset average fuel economy.

MyView — You can choose what to display in this view. Selecting Change MyView in the Options menu allows you to scroll through two columns of content choices. The content you select is saved to the current driver's key as MyView.

- Avg Fuel — Indicates the average fuel consumption since the function was last reset.
- Power — When the transmission is in a drive gear only, this gauge shows you vehicle power.

- Split Power— This gauge indicates the power being supplied by the vehicle's two power sources: the high voltage battery and the gasoline engine. When the hybrid system is operating in electric vehicle mode (without the gasoline engine), EV is displayed.
- Power + Threshold — When the transmission is in a drive gear only, this gauge shows you vehicle power demand and gasoline engine on/off threshold. It is designed to show you how close you are to the gasoline engine on/off threshold and how much power you are requesting by how much you press on the accelerator pedal.
- Tach rpm x 1000— When the gasoline engine is running, the tachometer gauge displays the engine speed in revolutions per minute (RPM). When the vehicle is operating on battery power only, EV is displayed and the tachometer is greyed out.
- Accessory Power— Indicates electrical power demands from your vehicle's accessory systems. Accessories use power but do not contribute to propelling the vehicle. The gauge separately displays power demand in kilowatts (kW) for climate and other accessories. Climate includes the power being used by high voltage climate control components such as the electric A/C compressor and the electric heater (Energi vehicles only). Other includes all power being used by the low voltage accessories (cabin fans, headlights, heated seats, etc.)
- Battery Display — The high voltage battery display options include Regen Active, Charge Assist and Charge Level.
- Regen Active — A circular arrow symbol appears over the center of the battery when energy is being recaptured through the regenerative braking system.
- Charge Assist — An arrow above the battery indicates the battery is being charged; an arrow below the battery indicates that battery power is being used for propulsion or to power the vehicle accessories.

- Charge Level — This indicates the State of Charge of the battery. Additionally, for Energi vehicles the option only applies for the Hybrid Mode battery display (simple battery graphic). The Plug-in Power Mode battery will always show the charge level with associated remaining EV range.
- Inst. Fuel — Shows instantaneous fuel usage.
- Coolant Temp – Indicates engine coolant temperature. At normal operating temperature, the level indicator will be white and will be in the normal range (between H and C). If the engine coolant temperature exceeds the normal range, the level indicator will change to red to indicate that the engine is overheating. Stop the vehicle as soon as safely possible, turn off the vehicle and let the engine cool.

The thermometer indicator next to the gauge will illuminate in blue or white to indicate the following:

- Blue thermometer : This indicates that the hybrid system is not warm enough to allow EV operation. The gasoline engine will run continuously when the indicator is blue. During silent key start mode, the thermometer indicator will be blue, but the gasoline engine will not run. This is the result of the vehicle computer allowing the engine to be cooler during the silent key start period. This is normal operation and does not indicate a problem with your vehicle. After the first engine start the indicator will turn white when the gasoline engine is warm enough to turn off.
- White thermometer : This indicates that the hybrid system is warm enough to allow EV operation. If the vehicle operates on battery power long enough, it is possible that the gasoline engine may need to run to keep the system warm. In this case, the thermometer indicator will revert back to blue.

Note: Trip data, average fuel economy and average speed cannot be reset in MyView. You can reset this data from other screens where it is shown.

Trip 1 & 2

Use the arrow buttons to choose between the following.

Note: Pressing OK stops/starts the timer. Holding OK resets the odometer and timer.

Trip 1 & 2			
Menu level 2	Menu level 3	Menu level 4	Menu level 5
Trip 1 & Trip 2	Standard	Elapsed trip time	—
		Trip distance	—
		EV distance	—
	Enhanced	Average fuel economy	—
		Estimated amount of fuel consumed	—
		Estimated amount of electricity consumed (Energi only)	—
—	Battery Display	Regen Active	Apply to all screens (overlay)
		Charge Assist	
		Charge Level	
		Help	
	Help	—	—

- Elapsed trip time — timer stops when the vehicle is turned off and restarts when the vehicle is restarted.
- Trip distance — shows the accumulated trip distance.
- EV distance — shows the distance travelled while in electric only mode.
- Estimated amount of fuel consumed — shows the amount of fuel used for a given trip.
- Estimated amount of electricity consumed — shows the amount of plug-in electricity used for a given trip.

Fuel Economy



Use the arrow buttons to choose the desired energy display.

Fuel Economy			
Menu level 2	Menu level 3	Menu level 4	Menu level 5
Fuel History: Instantaneous Fuel Economy + Fuel Economy History + Avg Fuel Economy	Interval Time	1, 2, 6 min. Intervals	—
Coach	Battery Display	Regen Active	Apply to all screens (overlay)
		Charge Assist	
		Charge Level	
		Help	
	Help	—	—

- Fuel History: This view from left to right starts with the instantaneous fuel economy gauge and adds historical fuel economy data. The data is represented as an average for time intervals of either 1, 2 or 6 minutes, with the left most interval being the most recent. Total time for the 5 intervals is shown at the bottom of the view. Interval time can be selected in the options sub menu. For Energi vehicles a blue outline indicates Plug-in Power was used at least half of that interval. Intervals shown in grey color are from the previous drive.
- Coach: This view provides a comparison of your recent Acceleration, Braking and Cruising behavior to what is recommended for most efficient use of energy under present conditions. The horizontal bars fill from left to right with best behavior (and Blue color) shown as at least half full. When the bars are less than half full, the color is Amber, suggesting that a change in behavior is needed to achieve better energy efficiency.

Note that fuel economy is not always a measure of appropriate driving behavior. For example, when driving uphill and maintaining an appropriate speed, your instant fuel economy may not be good (losing leaves) but the Coach may show a blue bar for Acceleration or Cruising.

Information

In this mode, you can view different vehicle system information and perform a system check.

Warnings	
XX Warnings	Displays the number of warnings that need immediate attention in red. You can only view the warnings from the System Check menu. View them immediately by pressing OK and then OK again to enter system check. Use the up/down arrows to scroll through the warnings.
Tutorial	
Find Your Way	
Battery Display	
Brake Coach	
Display Mode	
Trip 1 & 2	
Fuel Economy	
EV Mode (Energi only)	
EV+ Mode	
ECO Cruise	
Efficiency Leaves	
MyKey Info	
MyKeys (Number of MyKeys programmed)	
Admin Keys (Number of Admin Keys)	
MyKey Miles (km) (Distance traveled using a programmed MyKey)	
System Check	
All active warnings will display first if applicable. The system check menu may appear different based upon equipment options and current vehicle status. Use the up/down arrow buttons to scroll through the list.	

Settings



In this mode, you can configure different driver setting choices.

Note: Some items are optional and may not appear.

Note: *Some MyKey items will only appear if a MyKey is set.

Settings			
Menu level 2	Menu level 3	Menu level 4	Menu level 5
Driver Assist	Traction Ctrl	On / Off	—
	ECO Cruise	On (default on key cycle) / Off	—
	Hill Start Assist	On (default on key cycle) / Off	—
	EV + Mode	On / Off	—
	Rear Park Aid	On (default on key cycle) / Off	—
Vehicle	Lighting	Auto Light Rain	On / Off
		Home Light	Manual or select time interval
	Remote Start	Climate Control	Heater – A/C Auto / Last Settings
			Front Defrost Auto / Off
			Rear Defrost Auto / Off
		Duration	5 / 10 / 15 minutes
		Quiet Start	On / Off
	System	Enable / Disable	
	Tire Mobility Kit	Select number of years	—

Information Displays

Settings			
*MyKey	Create MyKey	Hold OK to create MyKey	—
	Traction Control	Always On / User Selectable	—
	Max Speed	Set to 80 MPH (130 km/h) / Off	—
	Speed Minder	45 mph (72 km/h), 55 mph (89 km/h), 65 mph (105 km/h), Off	—
	Volume Limiter	On / Off	—
	Clear MyKeys	Hold OK to Clear All MyKeys	—
Display	Language	Select the desired language	—
	Units	Distance	Select the desired units of measure
		Fuel Economy (Energi only)	Fuel only / Fuel + Electric
		Temperature	Fahrenheit (°F) / Celsius (°C)
	Brake Coach Display	On / Off	—
Lifetime Summary	Lifetime Fuel Economy, Regen Miles, Brake Score, Hold OK to Reset	—	

Brake Coach Display: This appears after the vehicle has come to a stop. It coaches you to brake in a manner which maximizes the amount of energy returned through the regenerative braking system. The percent displayed is an indication of the regenerative braking efficiency with 100% representing the maximum amount of regenerative braking energy recovery.

INFORMATION MESSAGES

Note: Depending on the vehicle options equipped with your vehicle, not all of the messages will display or be available. Certain messages may be abbreviated or shortened depending upon which cluster type you have.



Press the OK button to acknowledge and remove some messages from the information display. Other messages will be removed automatically after a short time. Certain messages need to be confirmed before you can access the menus.

Some messages will be supplemented by a system specific symbol with a message indicator.

AdvanceTrac Message	Action / Description
Service AdvanceTrac	Displayed when the system has detected a condition that requires service. Contact your authorized dealer as soon as possible.
Alarm Message	Action / Description
To Stop Alarm, Start Vehicle	Displayed when unauthorized entry into the vehicle has occurred. Turn the ignition on to stop the alarm.

Information Displays

Brake System Message	Action / Description
Brake Fluid Level LOW	Indicates the brake fluid level is low and the brake system should be inspected immediately.
Check Brake System	Displayed when the brake system needs servicing. If the warning stays on or continues to come on, contact your authorized dealer as soon as possible.
Park Brake Engaged	Displayed when the parking brake is set, the vehicle is in ready to drive and the vehicle is driven more than 3 mph (5 km/h). If the warning stays on after the parking brake is released, contact your authorized dealer as soon as possible.
Charging and Electrical System Message	Action / Description
Check Battery Charge	Displays when battery charge level is low.
Is Vehicle Plugged-in?	Displays when confirmation is needed that the vehicle is unplugged before a start is allowed. You must make sure the vehicle is unplugged and respond to the message prompt before starting your vehicle. (Energi only)
Stop Safely Now	Displays when the stop safety hazard warning lamp is illuminated. This indicates an electrical component fault/failure that will cause the vehicle to shut down or enter into limited operating mode.

Charging and Electrical System Message	Action / Description
Ready to Drive	Displays when the vehicle is ready to drive.
Engine On	Displays when the engine is on.
Unplug Prior to Starting Vehicle	Displays when the vehicle detects it is still plugged and the power is activated. (Energi only)
Doors Message	Action / Description
X Door Ajar	Displays when not completely closed.
Liftgate Ajar	Displays when not completely closed.
Fuel Message	Action / Description
Check Fuel Fill Inlet	Displayed when the fuel fill inlet may not be properly closed.
Fuel Level LOW	Displays when the fuel level is low.
Please Wait to Refuel	Displays when you need to wait before refueling your vehicle.
Ready to Refuel	Displays when the vehicle is ready to be refueled.
Close Fuel Door	Displays when the fuel door listed is not closed.
Refuel Error See Manual	Displays when there is a vehicle error and it cannot be refueled. Refer to <i>Refueling</i> in the <i>Fuel and Refueling</i> chapter for more information.
Fuel Freshness	Displays when EV functionality is disabled and the engine is running to maintain fuel freshness. Refer to the <i>Fuel and Refueling</i> chapter for more information.

Information Displays

Hill Start Assist Message	Action / Description
Hill Start Assist Active	Displays when hill start assist is active.
Hill Start Assist OFF	Displays when hill start assist is off.
Hill start assist not available	Displays when hill start assist is not available. Contact your authorized dealer.
Keyless Vehicle / Immobilizer Message	Action / Description
Starting System Fault	This message is displayed when there is a problem with your vehicle's starting system. See your authorized dealer for service.
Steering Malfunction Service Now	Contact your authorized dealer.
Steering Malfunction Stop Safely	Stop the vehicle in a safe place. Contact your authorized dealer.
Key Inside Vehicle	Displays to remind you that the key is in the luggage compartment. Refer to <i>Push button start system</i> in the <i>Driving</i> chapter for more information.
Key Not Inside Car	Displays if the key is not detected by the system. Refer to <i>Push button start system</i> in the <i>Driving</i> chapter for more information.
No Key Detected	Displays if the key is not detected by the system. Refer to <i>Push button start system</i> in the <i>Driving</i> chapter for more information.
Accessory Power is Active	Displayed when the vehicle is in the accessory ignition state.

Keyless Vehicle / Immobilizer Message	Action / Description
Press Brake to Start	Displayed as a reminder to apply the brake as needed when starting.
Press Brake + Start Button	Displayed as a reminder to apply the brake and push the start button to start the vehicle.
Place Key in Backup Slot	Displayed as needed by the system for proper function.
Restart Now or Key is Needed	Displayed when the start/stop button is pressed to shut off the engine and a Intelligent Access Key is not detected inside the vehicle.
Key Programmed x Keys Total	Displayed during spare key programming, when an intelligent access key is programmed to the system.
Max Number of Keys Learned	Displayed during spare key programming when the maximum number of keys have been programmed.
Could Not Program Integrated Key	This message is displayed when there is a problem programming a spare key. See your authorized dealer for service.

Information Displays

Maintenance Message	Action / Description
LOW Engine Oil Pressure	Stop the vehicle as soon as safely possible, turn off the engine. Check the oil level. If the warning stays on or continues to come on with your engine running, contact your authorized dealer as soon as possible.
Engine Coolant Overtemperature	Displays when the engine is overheating. Stop the vehicle as soon as safely possible, turn off the vehicle and let it cool. If the warning stays on or continues to come on, contact your authorized dealer as soon as possible.
Oil Change Required	Displays when the engine oil life is depleted and requires a change.
Change Engine Oil Soon	Displays when the engine oil life requires a change soon.
Washer Fluid Level LOW	Displays when the washer fluid is low and needs to be refilled. Refer to <i>Windshield washer fluid</i> in the <i>Maintenance and Specifications</i> chapter.
Motor Coolant Overtemperature	Displays when the motor electronics are overheating. Stop the vehicle as soon as safely possible, turn off the vehicle and let it cool. If the warning stays on or continues to come on, contact your authorized dealer as soon as possible.

Maintenance Message	Action / Description
See Manual	Indicates a powertrain or high-voltage charge system fault has been detected. If the indicator stays on or continues to come on, contact your authorized dealer as soon as possible.
Service Tire Mobility Kit	Displayed when the kit needs service. See your authorized dealer.
Oil Maintenance	Displays when EV functionality is disabled and the engine is running to maintain oil quality. Refer to the <i>Maintenance</i> chapter for more information.
MyKey® Message	Action / Description
MyKey not Created	Displayed during key programming when MyKey® cannot be programmed.
MyKey active Drive Safely	Displays when MyKey® is active.
Speed Limited to xx MPH/km/h	Displays when starting the vehicle and MyKey® is in use and the MyKey speed limit is on.
Near Vehicle Top Speed	Displays when a MyKey® is in use and the MyKey speed limit is on and the vehicle speed is approaching 80 mph (130 km/h).
Vehicle at Top Speed of MyKey Setting	Displays when a MyKey® is in use and the MyKey speed limit is on and the vehicle reaches 80 mph (130 km/h).
Check Speed Drive Safely	Displayed when a MyKey® is in use and the optional setting is on and the vehicle exceeds a preselected speed.

Information Displays

MyKey® Message	Action / Description
Buckle Up to Unmute Audio	Displays when a MyKey® is in use and Belt-Minder® is activated.
MyKey Park Aid Cannot be Deactivated	Displays when a MyKey® is in use and park aid is activated.
Traction Control On - MyKey Setting	Displays when a MyKey® is in use and the traction control is always set to on.
Park Aid Message	Action / Description
Check Park Aid	Displayed when the transmission is in R (Reverse) and the park aid is disabled.
Rear Park Aid On Off	Displays the park aid status.
Check Rear Park Aid	Displayed when the transmission is in R (Reverse) and the park aid is disabled.
Check Front Park Aid	Displayed when the transmission is in R (Reverse) and the park aid is disabled.
Park Aid Malfunction	Displays when there is a malfunction with the park aid system.
Power Steering Message	Action / Description
Service Power Steering	The power steering system has detected a condition that requires service. See your authorized dealer.
Service Power Steering Now	The power steering system has detected a condition within the power steering system that requires service immediately. See your authorized dealer.

Information Displays

135

Power Steering Message	Action / Description
Power Steering Assist Fault	The power steering system has disabled power steering assist due to a system error. See your authorized dealer.
Remote Start Message	Action / Description
Remote Start Active	Displayed when the remote start system is active.
Transmission Message	Action / Description
Shift to Park	Displayed as a reminder to shift to park.
Tire Pressure Monitoring System (TPMS) Message	Action / Description
LOW Tire Pressure	Displays when one or more tires on your vehicle have low tire pressure. Refer to <i>Inflating Your Tires</i> in the <i>Tires, Wheels and Loading</i> chapter.
Tire Pressure Monitor Fault	Displays when the tire pressure monitoring system is malfunctioning. If the warning stays on or continues to come on, contact your authorized dealer.
Tire Pressure Sensor Fault	Displays when a tire pressure sensor is malfunctioning, or your spare tire is in use. For more information on how the system operates under these conditions, refer to <i>Understanding Your Tire Pressure Monitoring System (TPMS)</i> in the <i>Tires, Wheels and Loading</i> chapter. If the warning stays on or continues to come on, contact your authorized dealer.

GENERAL INFORMATION**Radio Frequencies and Reception Factors**

AM and FM frequencies are established by the Federal Communications Commission (FCC) and the Canadian Radio and Telecommunications Commission (CRTC). Those frequencies are:

AM: 530, 540–1700, 1710 kHz

FM: 87.9–107.7, 107.9 MHz

Radio reception factors	
Distance and strength	The further you travel from an FM station, the weaker the signal and the weaker the reception.
Terrain	Hills, mountains, tall buildings, bridges, tunnels, freeway overpasses, parking garages, dense tree foliage and thunderstorms can interfere with the reception.
Station overload	When you pass a ground-based broadcast repeating tower, a stronger signal may overtake a weaker one and result in the audio system muting.

CD and CD Player Information

Note: CD units play commercially pressed 4.75-inch (12 centimeter) audio compact discs only. Due to technical incompatibility, certain recordable and re-recordable compact discs may not function correctly when used in Ford CD players.

Note: Do not insert CDs with homemade paper (adhesive) labels into the CD player as the label may peel and cause the CD to become jammed. You should use a permanent felt tip marker rather than adhesive labels on your homemade CDs. Ballpoint pens may damage CDs. Please contact your authorized dealer for further information.

Note: Do not use any irregularly shaped discs or discs with a scratch protection film attached.

Always handle discs by their edges only. Clean the disc with an approved CD cleaner only. Wipe it from the center of the disc toward the edge.

Do not clean in a circular motion.

Do not expose discs to direct sunlight or heat sources for extended periods.

MP3 Track and Folder Structure

Audio systems capable of recognizing and playing MP3 individual tracks and folder structures work as follows:

- There are two different modes for MP3 disc playback: MP3 track mode (system default) and MP3 folder mode.
- MP3 track mode ignores any folder structure on the MP3 disc. The player numbers each MP3 track on the disc (noted by the .mp3 file extension) from T001 to a maximum of T255. **Note:** The maximum number of playable MP3 files may be less depending on the structure of the CD and exact model of radio present.
- MP3 folder mode represents a folder structure consisting of one level of folders. The CD player numbers all MP3 tracks on the disc (noted by the .mp3 file extension) and all folders containing MP3 files, from F001 (folder) T001 (track) to F253 T255.
- Creating discs with only one level of folders helps with navigation through the disc files.

If you are burning your own MP3 discs, it is important to understand how the system reads the structures you create. While various files may be present, (files with extensions other than mp3), only files with the .mp3 extension are played; other files are ignored by the system. This enables you to use the same MP3 disc for a variety of tasks on your work computer, home computer and your in-vehicle system.

In track mode, the system displays and plays the structure as if it were only one level deep (all .mp3 files play, regardless of being in a specific folder). In folder mode, the system only plays the .mp3 files in the current folder.

AM/FM/CD WITH SYNC®

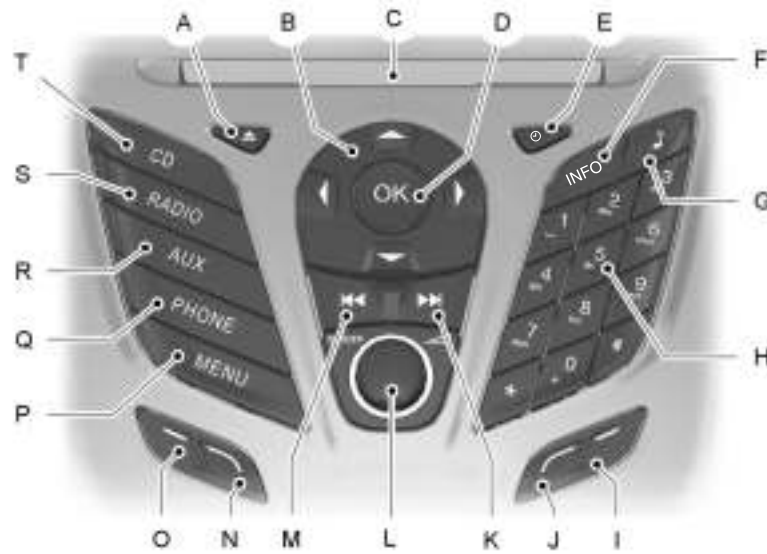

⚠ WARNING: Driving while distracted can result in loss of vehicle control, crash and injury. We strongly recommend that you use extreme caution when using any device that may take your focus off the road. Your primary responsibility is the safe operation of your vehicle. We recommend against the use of any hand-held device while driving and encourage the use of voice-operated systems when possible. Make sure you are aware of all applicable local laws that may affect the use of electronic devices while driving.

Note: You can operate your audio system for up to one hour after you switch off the ignition. Press the ON/OFF control to operate the system with the ignition turned off. The system automatically turns off after one hour.

A. **Eject:** Press this button to eject a CD.

B. **Cursor arrows:** Press these buttons to scroll through on-screen audio system choices.

- C. **CD slot:** Insert a CD.
- D. **OK:** Press this button to confirm menu selections.
- E. **Clock:** Set the time:
1. Press the H or M buttons on the outside of the display repeatedly until the desired time appears.
 2. Press **OK** to confirm the time.
 - You can also set the clock by pressing the **MENU** button and scrolling to **Clock Settings**.
- F. **INFO:** Press this button to access any available radio or CD information.
- G. **SOUND:**
- Press this button to access settings for Treble, Middle, Bass, Fade and Balance.
 - Use the up and down arrow buttons to select the various settings. When you make your selection, press the left and right arrow buttons to change the settings. Press **OK** to set or press **MENU** to exit.
 - Sound settings can be set for each audio source independently.
- H. **Number block:**
- In radio mode, store your favorite radio stations. To store a radio station, tune to the station, then press and hold a preset button until sound returns.
 - In CD mode, select a track.
 - In phone mode, enter a phone number.
- I. **Function Button 4:** Select different functions of the audio system depending on which mode you are in (such as Radio mode or CD mode).
- J. **Function Button 3:** Select different functions of the audio system depending on which mode you are in (such as Radio mode or CD mode).
- K. **SEEK:**
- Press and release this button to go to the next preset radio station or disc track.
 - Press and hold this button to fast forward to the next strong radio station, memory preset or through the current disc track.
- L. **ON/OFF:**
- Press this button to switch the system off and on.
 - Turn to adjust the volume.
- M. **SEEK:**
- Press and release this button to go to the previous preset radio station or disc track.
 - Press and hold this button to reverse to the previous strong radio station, memory preset or through the current disc track.

N. **Function Button 2:** Select different functions of the audio system depending on which mode you are in (such as Radio mode or CD mode).

O. **Function Button 1:** Select different functions of the audio system depending on which mode you are in (such as Radio mode or CD mode).

P. **MENU:** Press this button to access different audio system features. See *Menu structure* later in this section.

Q. **PHONE:** Press this button to access the phone features of the SYNC® system. See the SYNC® chapter for more information.

R. **AUX:** Press this button to access your auxiliary input jack or switch between devices you plug into the input jack or USB port.

S. **RADIO:** Press this button to listen to the radio or change radio frequencies. Press the function buttons below the radio screen to select different radio functions.

T. **CD:** Press this button to listen to a CD. Press the function buttons below the radio screen to select on-screen options of Repeat or Shuffle.

MENU STRUCTURE

Note: Depending on your system, some options may appear slightly different.

Press **MENU**.

Press the up and down arrow buttons to scroll through the options.

Press the right arrow to enter a menu. Press the left arrow to exit a menu.

Press **OK** to confirm a selection.

Radio Settings	
Manual tune	Use the left and right arrows to go up or down the frequency band
Scan	Select for a brief sampling of all available channels.
AST	Select to store the six strongest local stations on the AM-AST and FM-AST frequency bands.
PTY/Set Category	Select to have the system search by certain music categories (such as Rock, Pop or Country).
RBDS/RDS Text	Select to view additional broadcast data, if available. This feature defaults to off. RBDS must be on for you to set a category.

SIRIUS	
Scan	Select for a brief sampling of all available channels.
Show ESN	Select to view your satellite radio electronic serial number (ESN). You need this number when communicating with SIRIUS® to activate, modify or track your account.
Channel Guide	Select to view available satellite radio channels. Press OK to open a list of the following options for this channel: Tune Channel, Skip Channel or Lock Channel. Once you skip or lock a channel, you can only access it by pressing Direct and entering the channel number. Locking or unlocking a channel requires your PIN.
Set Category	Select to view channel categories (such as Pop, Rock or News). If you select a category, seek and scan functions only stop on channels in that category.
Alerts	Select to turn off or turn on alerts for songs, artists or teams. The system alerts you when the selection is playing on another channel. Save up to 20 alerts.
Unlock All Stations	Use your PIN to unlock previously locked stations.
Skip No Stations	Remove the skip feature from all the channels you previously skipped.
Parental Lock (PIN)	Select to create a PIN, which allows you to lock or unlock channels. Your initial PIN is 1234.

Audio System

Audio Settings	
Spd. Comp. Vol.	Automatically adjusts the volume to compensate for speed and wind noise. You can set the system between 0 and +7.
Sound	Select to adjust settings for Treble, Middle, Bass, Fade and Balance.
Occupancy Mode	Select to optimize sound quality for the chosen seating position.
RBDS/RDS Text	Select to view additional broadcast data, if available. This feature defaults to off. RBDS must be on for you to set a category.
DSP	Choose between STEREO SURROUND mode and STEREO mode.
CD Settings	
Scan All	Select to scan all disc selections.
Scan Folder	Select to scan all music in the current MP3 folder.
CD Compression	Select to bring soft and loud passages together for a more consistent listening level.
Clock Settings	
Set Time	Select to set the time.
Set Date	Select to set the calendar date.
24h Mode	Select to view clock time in a 12-hour mode or 24-hour mode.
Display Settings	
Dimming	Select to change display brightness.
Language	Select to display the language in English, French or Spanish.
Temp. Setting	Select to display the outside temperature in Fahrenheit or Celsius.

AM/FM/CD PREMIUM AUDIO SYSTEM

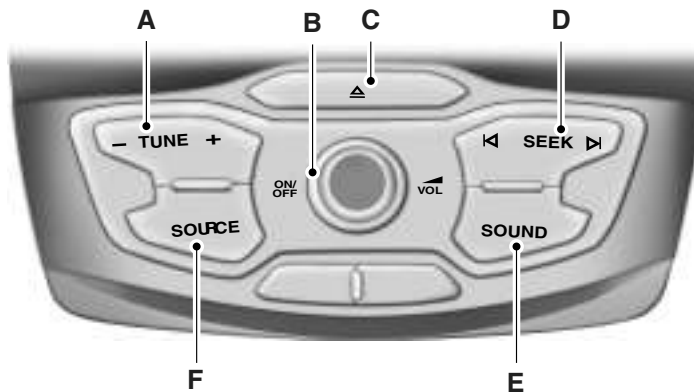

! **WARNING:** Driving while distracted can result in loss of vehicle control, crash and injury. We strongly recommend that you use extreme caution when using any device that may take your focus off the road. Your primary responsibility is the safe operation of your vehicle. We recommend against the use of any hand-held device while driving and encourage the use of voice-operated systems when possible. Make sure you are aware of all applicable local laws that may affect the use of electronic devices while driving.

Note: The CD slot is directly above the touchscreen.

Note: The MyFord Touch® system controls most of the audio features. See the *MyFord Touch®* chapter for more information.

A. **- Tune +:** Press this button to manually search through the radio frequency band.

B. **ON/OFF and VOL:**

- Press this button to switch the audio system off and on.
- Turn to adjust the volume.

C. **Eject:** Press this button to eject a CD.

D. **SEEK:** Press this button to go to the next station up or down the radio frequency band or the next or previous track on a CD.

E. **SOUND:** Press this button to adjust the sound settings for Bass, Treble, Balance and Fade.

F. **SOURCE:** Press this button to access different audio modes, such as AM, FM and A/V Input.

AM/FM/CD SONY® AUDIO SYSTEM

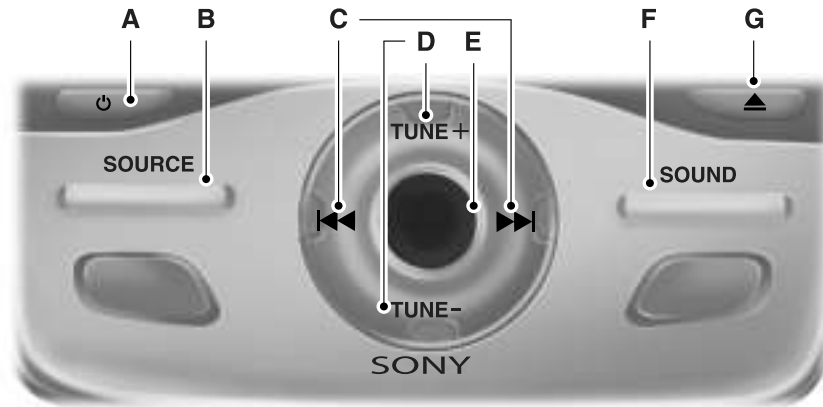

⚠ WARNING: Driving while distracted can result in loss of vehicle control, crash and injury. We strongly recommend that you use extreme caution when using any device that may take your focus off the road. Your primary responsibility is the safe operation of your vehicle. We recommend against the use of any hand-held device while driving and encourage the use of voice-operated systems when possible. Make sure you are aware of all applicable local laws that may affect the use of electronic devices while driving.

Note: The CD slot is directly above the touchscreen.

Note: The MyFord Touch® system controls most of the audio features. See the *MyFord Touch®* chapter for more information.

A. **Power:** Press this button to switch the system off and on.

B. **SOURCE:** Press this button to access different audio modes, such as AM, FM and A/V Input.

C. **Seek, Reverse and Fast Forward:**

- In radio mode, select a frequency band and press these buttons. The system stops at the first station it finds in that direction.
- In SIRIUS mode, press these buttons to select the previous or next channel. If a specific category is selected (such as Jazz, Rock or News), use these buttons to find the previous or next channel in the selected category.
- In CD mode, press these buttons to select the previous or next track.

D. - TUNE +:

- In radio mode, press these buttons to manually search through the radio frequency band.
- In SIRIUS mode, press these buttons to find the next or previous available satellite radio station.

E. Volume: Turn this control to adjust the volume.

F. SOUND: Press this button to access settings for Treble, Middle, Bass, Balance and Fade.

G. Eject: Press this button to eject a CD.

AUXILIARY INPUT JACK

WARNING: Driving while distracted can result in loss of vehicle control, crash and injury. We strongly recommend that you use extreme caution when using any device that may take your focus off the road. Your primary responsibility is the safe operation of your vehicle. We recommend against the use of any hand-held device while driving and encourage the use of voice-operated systems when possible. Make sure you are aware of all applicable local laws that may affect the use of electronic devices while driving.



WARNING: For safety reasons, do not connect or adjust the settings on your portable music player while your vehicle is moving.



WARNING: Store the portable music player in a secure location, such as the center console or the glove box, when your vehicle is moving. Hard objects may become projectiles in a crash or sudden stop, which may increase the risk of serious injury. The audio extension cable must be long enough to allow the portable music player to be safely stored while your vehicle is moving.



The auxiliary input jack allows you to connect and play music from your portable music player through your vehicle speakers. You can use any portable music player designed for use with headphones. Your audio extension cable must have male 1/8-inch (3.5 millimeter) connectors at each end.

1. Switch off the engine, radio and portable music player. Set the parking brake and put the transmission in position **P**.
2. Plug the extension cable from the portable music player into the auxiliary input jack.
3. Switch the radio on. Select either a tuned FM station or a CD.
4. Adjust the volume as desired.
5. Switch your portable music player on and adjust its volume to half its maximum level.
6. Press **AUX** until **LINE** or **LINE IN** appears in the display. You should hear music from your device even if it is low.
7. Adjust the volume on your portable music player until it reaches the volume level of the FM station or CD. Do this by switching back and forth between the AUX and FM or CD controls.

USB PORT (IF EQUIPPED)

 **WARNING:** Driving while distracted can result in loss of vehicle control, crash and injury. We strongly recommend that you use extreme caution when using any device that may take your focus off the road. Your primary responsibility is the safe operation of your vehicle. We recommend against the use of any hand-held device while driving and encourage the use of voice-operated systems when possible. Make sure you are aware of all applicable local laws that may affect the use of electronic devices while driving.



The USB port allows you to plug in media playing devices, memory sticks and charge devices (if supported). See the *SYNC* chapter for more information.

MEDIA HUB (IF EQUIPPED)

The media hub is located in the center console and has the following features:

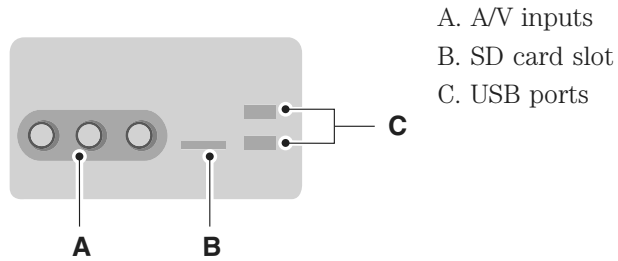

For more information, see the *MyFord Touch* chapter.

SATELLITE RADIO INFORMATION (IF EQUIPPED)**Satellite Radio Channels**

SIRIUS® broadcasts a variety of music, news, sports, weather, traffic and entertainment satellite radio channels. For more information and a complete list of SIRIUS satellite radio channels, visit www.siriusxm.com in the United States, www.sirius.ca in Canada, or call SIRIUS at 1-888-539-7474.

Note: This receiver includes the eCos real-time operating system. eCos is published under the eCos License.

Satellite Radio Reception Factors

Potential satellite radio reception issues	
Antenna obstructions	For optimal reception performance, keep the antenna clear of snow and ice build-up and keep luggage and other material as far away from the antenna as possible.
Terrain	Hills, mountains, tall buildings, bridges, tunnels, freeway overpasses, parking garages, dense tree foliage and thunderstorms can interfere with your reception.
Station overload	When you pass a ground-based broadcast repeating tower, a stronger signal may overtake a weaker one and the audio system may mute.
Satellite radio signal interference	Your display may show ACQUIRING . . . to indicate the interference and the audio system may mute.

SIRIUS Satellite Radio Service

Note: SIRIUS reserves the unrestricted right to change, rearrange, add or delete programming including canceling, moving or adding particular channels, and its prices, at any time, with or without notice to you. Ford Motor Company shall not be responsible for any such programming changes.



SIRIUS satellite radio is a subscription-based satellite radio service that broadcasts a variety of music, sports, news, weather, traffic and entertainment programming.

Your factory-installed SIRIUS satellite radio system includes hardware and a limited subscription term which begins on the date of sale or lease of your vehicle. See an authorized dealer for availability.

For more information on extended subscription terms (a service fee is required), the online media player and a complete list of SIRIUS satellite radio channels, and other features, please visit www.siriusxm.com in the United States, www.sirius.ca in Canada, or call SIRIUS at 1-888-539-7474.

Satellite Radio Electronic Serial Number (ESN)

You need your ESN to activate, modify or track your satellite radio account. When in satellite radio mode, you can view this number by pressing **SIRIUS** and memory preset 1 at the same time. To access your ESN, press the bottom left corner of the touchscreen, then **SIRIUS > Options**.

Troubleshooting

Radio display	Condition	Possible action
Acquiring	Radio requires more than two seconds to produce audio for the selected channel.	No action required. This message should disappear shortly.
Sat Fault/SIRIUS system failure	There is an internal module or system failure present.	If this message does not clear shortly, or with an ignition key cycle, your receiver may have a fault. See an authorized dealer for service.
Invalid Channel	The channel is no longer available.	Tune to another channel or choose another preset.
Unsubscribed Channel	Your subscription does not include this channel.	Contact SIRIUS at 1-888-539-7474 to subscribe to the channel, or tune to another channel.

Radio display	Condition	Possible action
No Signal	The signal is lost from the SIRIUS satellite or SIRIUS tower to your vehicle antenna.	The signal is blocked. When you move into an open area, the signal should return.
Updating	Update of channel programming in progress.	No action required. The process may take up to three minutes.
Call SIRIUS 1-888-539-7474	Your satellite service is no longer available.	Call SIRIUS at 1-888-539-7474 to resolve subscription issues.
None Found. Check Channel Guide.	All the channels in the selected category are either skipped or locked.	Use the channel guide to turn off the Lock or Skip function on that station.
Subscription Updated	SIRIUS has updated the channels available for your vehicle.	No action required.

AUTOMATIC CLIMATE CONTROL

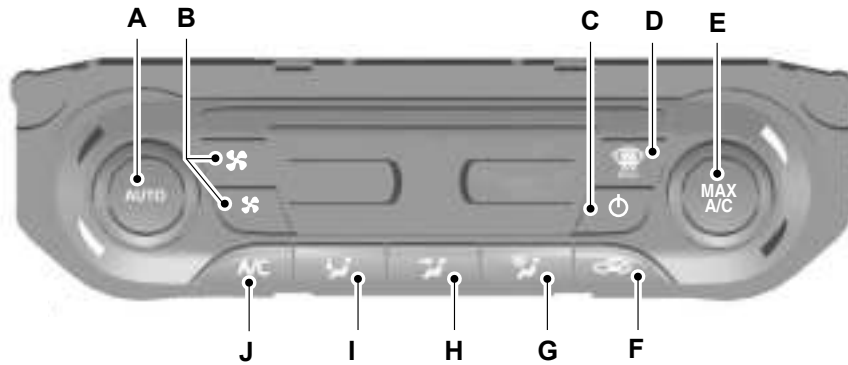

A. **AUTO:** Press to select automatic operation. The system automatically controls the temperature, amount and distribution of the airflow to reach and maintain your previously selected temperature.

B. **Fan speed:** Controls the volume of air circulated in your vehicle. Press to select the desired fan speed. The setting appears in the display.

C. **On and off button:** Press to switch the system off and on.

D. **MAX Defrost:** Press to distribute outside air through the windshield air vents. The system automatically turns on the air conditioning, sets the fan to the highest speed and the temperature to HI. When the air distribution is set in this position, you are unable to select recirculated air or manually adjust the temperature control. Press the **AUTO** button to return to auto mode.

E. **MAX A/C:** Press to distribute maximum air conditioning through the instrument panel air vents. This mode is more economical and efficient than normal air conditioning.

F. **Recirculated air:** Press to switch between outside air and recirculated air. The air currently in the passenger compartment recirculates. This can reduce the time needed to cool the interior and reduce unwanted odors from entering your vehicle.

G. **Defrost:** Press to distribute air through the windshield air vents. You can also use this setting to defog and clear the windshield of a thin covering of ice.

H. **Instrument panel:** Press to distribute air through the instrument panel air vents.

I. **Footwell:** Press to distribute air through the footwell air vents.

J. **Air conditioning:** Press to switch the air conditioning off and on. Air conditioning cools your vehicle using outside air. To improve air conditioning when starting your vehicle, drive with the windows slightly open for two to three minutes.

Temperature Control

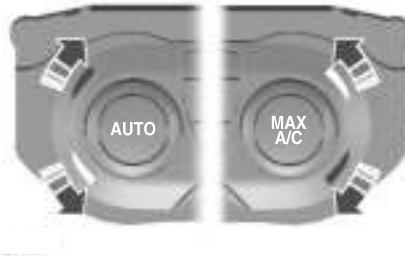

You can set the temperature between 60°F (15.5°C) and 85°F (29.5°C) in 1°F (0.5°C) increments. In position LO, 59°F (15°C), the system switches to permanent cooling. In position HI, 86°F (30°C), the system switches to permanent heating.

Note: If you select either position LO or HI, the system does not regulate a stable temperature.

Single Zone (Driver Temperature Control)

In this mode, the driver's control sets the temperature for both sides. If you adjust the setting using the rotary control on the driver's side, the system sets the passenger's side to the same temperature.

Dual Zone Temperature Control

Select a temperature for the passenger's side using the rotary control on the passenger's side. Mono mode automatically switches off. The temperature on the driver's side remains unchanged. You can now adjust the driver's side and passenger's side temperatures independently of each another. Both temperature settings appear in the display.

Switching Back to Single Zone

Press and hold the **AUTO** button. The passenger's side temperature changes to the driver's side temperature setting.

HINTS ON CONTROLLING THE INTERIOR CLIMATE**General Hints**

Note: Prolonged use of recirculated air may cause the windows to fog up.

Note: You may feel a small amount of air from the footwell air vents regardless of the air distribution setting.

Note: To reduce humidity build-up inside your vehicle, do not drive with the system switched off or with recirculated air always switched on.

Note: Do not place objects under the front seats as this may interfere with the airflow to the rear seats.

Note: Remove any snow, ice or leaves from the air intake area at the base of the windshield.

Automatic Climate Control

Note: Adjusting the settings when your vehicle interior is extremely hot or cold is not necessary. The system automatically adjusts to heat or cool the cabin to your selected temperature as quickly as possible. For the system to function efficiently, the instrument panel and side air vents should be fully open.

Note: At low ambient temperatures with **AUTO** selected, the system directs airflow to the windshield and side window vents and fan may run at a slow speed until the engine warms up.

Heating the Interior Quickly

1	Press the high fan speed button control.
2	Adjust the temperature control to the highest setting.
3	Press the footwell button to distribute air to the footwell air vents.

Recommended Settings for Heating

1	Press the slow fan speed button.
2	Adjust the temperature control to the midway point of the hot settings.
3	Press the footwell and windshield air distribution buttons.
4	Close the instrument panel air vents. Open the side air vents and direct them toward the side windows.

Cooling the Interior Quickly

1	Press AUTO .
2	Adjust the temperature control to the desired setting.

Recommended Settings for Cooling

1	Press the slow fan speed button.
2	Adjust the temperature control to the midway point of the cold settings.
3	Press the instrument panel vent button to distribute air to the instrument panel air vents.

Vehicle Stationary for Extended Periods During Extreme High Ambient Temperatures

1	Apply the parking brake.
2	Move the transmission selector lever to position P .
3	Press MAX A/C .

Side Window Defogging in Cold Weather

1	Press the windshield defrosting and defogging button.
2	Adjust the temperature control to the desired setting.

Maximum Cooling Performance in Instrument Panel or Instrument Panel and Footwell Positions

1	Adjust the temperature control to the lowest setting.
2	Press the A/C and recirculated air buttons.
3	Adjust the fan speed to the highest setting initially and then adjust it to suit the desired comfort level.

HEATED WINDOWS AND MIRRORS (IF EQUIPPED)**Heated Rear Window**

Note: The vehicle must be running to use this feature.

Press the control to clear the rear window of thin ice and fog. Press the control again within 15 minutes to switch it off. It turns off automatically after approximately 15 minutes, or when you switch the ignition off.

Do not use razor blades or other sharp objects to clean the inside of the rear window or to remove decals from the inside of the rear window. This may cause damage to the heated grid lines. Your warranty does not cover this damage.

Heated Exterior Mirror (If Equipped)

Note: Do not remove ice from the mirrors with a scraper or attempt to readjust the mirror glass that has frozen in place. These actions could cause damage to the glass and mirrors.

Note: Do not clean the housing or glass of any mirror with harsh abrasives, fuel or other petroleum-based cleaning products.

Both mirrors heat to remove ice, mist and fog when you turn the rear window defroster on.

CABIN AIR FILTER

Note: Make sure you have a cabin air filter installed at all times. This prevents foreign objects from entering the system. Running the system without a filter in place could result in degradation or damage to the system.

Your cabin air filter is located under the instrument panel in the passenger footwell area. The particulate filtration system reduces the concentration of airborne particles such as dust, spores and pollen in the air supplied to the interior of your vehicle. The particulate filtration system gives you and your passengers the following benefits:

- It improves your driving comfort by reducing particle concentration.
- It improves the interior compartment cleanliness.
- It protects the climate control components from particle deposits.

Replace the filter at regular intervals. See the *Scheduled Maintenance* chapter.

For more information about your filter, see an authorized dealer.

REMOTE START CLIMATE OPERATION (C-MAX ENERGI ONLY)

The climate control system adjusts the cabin temperature during remote start.

You cannot adjust the system during remote start operation. Turn the ignition on to return the system to its previous settings. You can now make adjustments. You will need to turn certain vehicle-dependent features back on, such as:

- heated seats
- heated mirrors
- heated rear window.

You can adjust the settings using the information display controls. See the *Information Displays* chapter.

Automatic Climate Systems***Automatic Settings***

You can set the climate control to operate in AUTO mode through the information display setting: Remote Start > Climate Control > Heater – A/C > Auto. The climate control system automatically sets the interior temperature to 72°F (22°C).

In hot weather, the system is set to 72°F (22°C).

In moderate weather, the system either heats or cools (based on previous settings). The rear defroster, heated mirrors and heated seats do not automatically turn on.

In cold weather, the system is set to 72°F (22°C). The rear defroster and heated mirrors automatically turn on.

Last Settings

You can set the climate control to operate using the last climate control settings through the information display setting: Remote Start > Climate Control > Heater – A/C > Last Settings. The climate control system automatically uses the settings last selected before you turned off the engine.

Heated and Cooled Devices

The climate control system controls other heated and cooled devices inside the vehicle. You can switch these devices on (if available, and selected to **AUTO** in the information displays) during remote start. Heated devices usually switch on during cold weather, and cooled devices during hot weather.

SITTING IN THE CORRECT POSITION

! **WARNING:** Sitting improperly out of position or with the seat back reclined too far can take off weight from the seat cushion and affect the decision of the passenger sensing system, resulting in serious injury or death in a crash. Always sit upright against your seat back, with your feet on the floor.

! **WARNING:** Do not recline the seat back as this can cause the occupant to slide under the seat's safety belt, resulting in severe personal injury in the event of a crash.

! **WARNING:** Do not place objects higher than the seat backs to reduce the risk of injury in a crash or during heavy braking or when stopping suddenly.

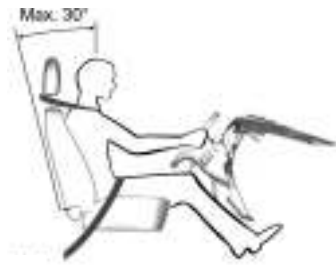

When you use them properly, the seat, head restraint, safety belt and airbags will provide optimum protection in the event of a crash.

We recommend that you follow these guidelines:

- Do not recline the seat back more than 30 degrees from vertical.

- Sit in an upright position with the base of your spine as far back as possible.
- Adjust the head restraint so that the top of it is level with the top of your head and as far forward as possible, remaining comfortable.
- Keep sufficient distance between yourself and the steering wheel. We recommend a minimum of 10 inches (250 millimeters) between your breastbone and the airbag cover.
- Hold the steering wheel with your arms slightly bent.
- Bend your legs slightly so that you can press the pedals fully.
- Position the shoulder strap of the safety belt over the center of your shoulder and position the lap strap tightly across your hips.

Make sure that your driving position is comfortable and that you can maintain full control of your vehicle.

HEAD RESTRAINTS

 **WARNING:** To minimize the risk of neck injury in the event of a crash, the driver and passenger occupants should not sit in or operate the vehicle, until the head restraint is placed in its proper position. The driver should never adjust the head restraint while the vehicle is in motion.

 **WARNING:** The adjustable head restraint is a safety device. Whenever possible, it should be installed and properly adjusted when the seat is occupied.

 **WARNING:** Install the head restraint properly to minimize the risk of neck injury in the event of a crash.

Note: Adjust the seat back to an upright driving position before adjusting any head restraint. Adjust the head restraint so that the top of it is level with the top of your head and as far forward as possible, remaining comfortable. For occupants of extremely tall stature, adjust the head restraint to its highest position.

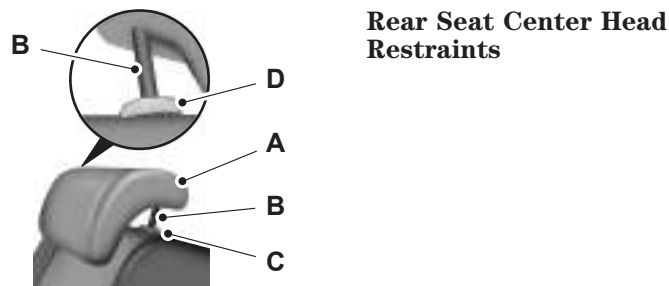
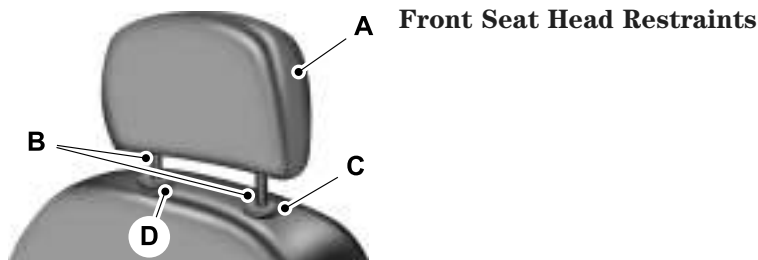

The head restraints consist of:

- A. An energy absorbing head restraint
- B. Two steel stems
- C. Guide sleeve adjust and release button
- D. Guide sleeve unlock and remove button

Adjusting the Head Restraint

Raise: Pull up the head restraint.

Lower:

1. Press and hold button C.
2. Push the head restraint down.

Remove:

1. Pull up the head restraint until it reaches the highest adjustment position.
2. Press and hold buttons C and D.
3. Pull the head restraint up.

Install: Align the steel stems into the guide sleeves and push the head restraint down until it locks.

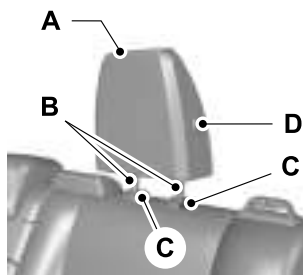

Rear Seat Outboard Head Restraints

The head restraints consist of:

- A. An energy absorbing head restraint
- B. Two steel stems
- C. Guide sleeve unlock and remove button
- D. Fold button

Remove:

1. Press and hold buttons C.
2. Pull the head restraint up.

Install: Align the steel stems into the guide sleeves and push the head restraint down until it locks.

Fold:

1. Press and hold button D.
2. Pull it back up to reset.

Tilting Head Restraints (If Equipped)

The front head restraints may have a tilting feature for extra comfort. To tilt the head restraint, do the following:



1. Adjust the seat back to an upright driving or riding position.
2. Tilt the head restraint forward by gently pulling the top of the head restraint.

Once it is in its forward-most position, tilt it forward once more to release it to the upright position.

Note: Do not attempt to force the head restraint backward after it is tilted. Instead, continue tilting it forward until the head restraint releases to the upright position.

MANUAL SEATS



WARNING: Do not adjust the driver's seat or seat back while the vehicle is moving.

Moving the Seats Backward and Forward



WARNING: Rock the seat backward and forward after releasing the lever to make sure that it is fully engaged.

Adjusting the Height of the Driver's Seat

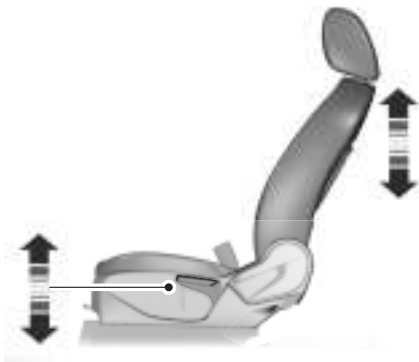

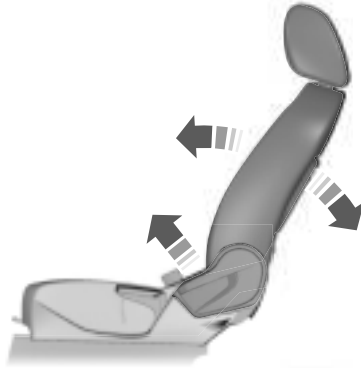

Recline Adjustment

WARNING: Before returning the seat back to its original position, make sure that cargo or any objects are not trapped behind the seat back. After returning the seat back to its original position, pull on the seat back to make sure that it has fully latched. An unlatched seat may become dangerous in the event of a sudden stop or crash .

**Lumbar Adjustment
(If Equipped)**

POWER SEATS (IF EQUIPPED)

 **WARNING:** Never adjust the driver's seat or seat back when the vehicle is moving.

 **WARNING:** Before returning the seat back to its original position, make sure that cargo or any objects are not trapped behind the seat back.

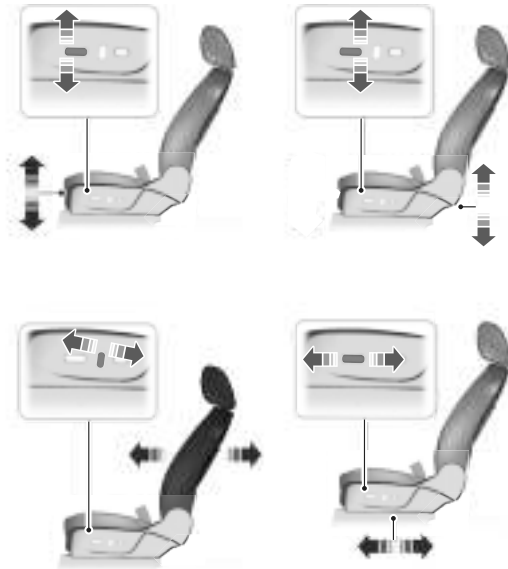

Power Lumbar (If Equipped)

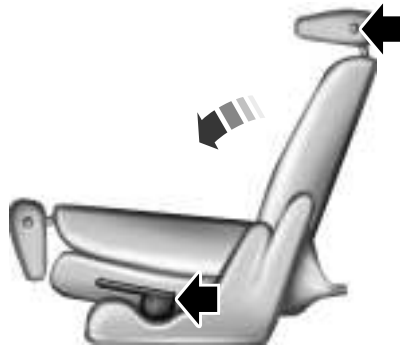

REAR SEATS**Folding the Seat Back (If Equipped)**

1. Press the button on the outboard side of each rear outboard headrest to fold them. Make sure the rear center headrest is in the full down position.

2. To fold the seat, pull the lever up on the outboard side of the seat.

3. To return the seat to the upright position, rotate the seat back upward until the seat back latches.

REAR SEAT ARMREST (IF EQUIPPED)

Fold the armrest down to use the armrest and cup holder.

HEATED SEATS (IF EQUIPPED)

 **WARNING:** Persons who are unable to feel pain to the skin because of advanced age, chronic illness, diabetes, spinal cord injury, medication, alcohol use, exhaustion, or other physical conditions, must exercise care when using the seat heater. The seat heater may cause burns even at low temperatures, especially if used for long periods of time. Do not place anything on the seat that insulates against heat, such as a blanket or cushion, because this may cause the seat heater to overheat. Do not puncture the seat with pins, needles, or other pointed objects because this may damage the heating element which may cause the seat heater to overheat. An overheated seat may cause serious personal injury.

Note: Do not do the following:

- Place heavy objects on the seat.
- Operate the seat heater if water or any other liquid is spilled on the seat. Allow the seat to dry thoroughly.
- Operate the heated seats unless the engine is running. Doing so could drain your vehicle's battery.

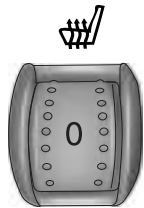

Adjust the control to the desired heat setting.

166 Universal Garage Door Opener (If Equipped)

HOMELINK® WIRELESS CONTROL SYSTEM (IF EQUIPPED)



WARNING: Make sure that the garage door and security device are free from obstruction when you are programming. Do not program the system with the vehicle in the garage.



WARNING: Do not use the system with any garage door opener that does not have the safety stop and reverse feature as required by U.S. Federal Safety Standards (this includes any garage door opener manufactured before April 1, 1982).

Note: Make sure you keep the original remote control transmitter for use in other vehicles as well as for future system programming.

Note: We recommend that upon the sale or lease termination of your vehicle, you erase the programmed function buttons for security reasons. See *Erasing the function button codes* later in this section.

Note: You can program a maximum of three devices. To change or replace any of the three devices after it has been initially programmed, you must first erase the current settings. See *Erasing the function button codes* later in this section.



The universal garage door opener replaces the common hand-held garage door opener with a three-button transmitter that is integrated into the driver's sun visor.

The system includes two primary features, a garage door opener and a platform for remote activation of devices with the home. As well as being programmed for garage doors, the system transmitter can be programmed to operate entry gate operators, security systems, entry door locks, and home or office lighting.

Additional system information can be found online at www.homelink.com or by calling the toll-free help line on 1-800-355-3515.

Universal Garage Door Opener (If Equipped) 167

Programming

Note: Put a new battery in the hand-held transmitter. This will ensure quicker training and accurate transmission of the radio-frequency signal.

1. With your vehicle parked outside of the garage and your key in the ignition, turn the key so that the ignition is in the on position.

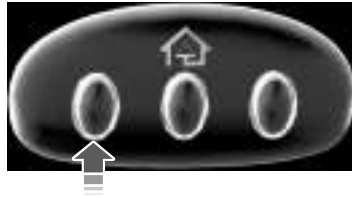

2. Hold your hand-held, garage door transmitter 1–3 inches (2–8 centimeters) away from the HomeLink button you want to program.

3. Using both hands, simultaneously press and hold the desired HomeLink button and the hand-held transmitter button. DO NOT release either one until the HomeLink indicator light flashes slowly and then rapidly. When the indicator light flashes rapidly, both buttons may be released. The rapid flashing indicates successful training.

4. Press and hold the HomeLink button you programmed for five seconds, then release. You may need to do this twice to activate the door. If your garage door does not operate, watch the HomeLink indicator light.

If the indicator light stays on, the programming is complete. Press and release the programmed HomeLink button, and then begin programming your garage door opener. See below for Steps 5 – 7.

If the indicator light flashes rapidly for two seconds and then turns to a constant light, the HomeLink button is not programmed yet. Do the following:

Press and hold the HomeLink button while you press and release the hand-held transmitter button every two seconds. The HomeLink indicator light will flash slowly and then rapidly once the HomeLink function button recognizes and accepts the hand-held transmitter's radio frequency signal.

168 Universal Garage Door Opener (If Equipped)

After programming the HomeLink button, follow Steps 5 – 7 as listed below to program your garage door opener.



Note: You may need a ladder to reach the unit and you may need to remove the cover or lamp lens on your garage door opener.

5. Press the learn button on the garage door opener motor, and then you have 30 seconds to complete the next step.

6. Return to your car.



7. Press and hold the function button you want to program for two seconds, then release. Repeat this step. Depending on your brand of garage door opener, you may need to repeat this sequence a third time.

To program additional buttons, repeat Steps 1 – 4 .

For questions or comments, please contact HomeLink® at www.homelink.com or 1-800-355-3515.

Erasing the Function Button Codes

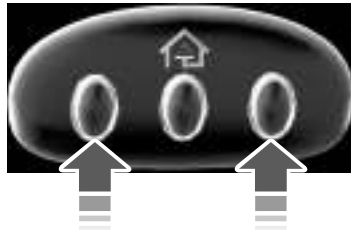

Note: You cannot erase individual buttons.

1. Press and hold the outer two function buttons simultaneously for approximately 20 seconds until the indicator lights above the buttons flash rapidly.

2. When the indicator lights flash, release the buttons. The codes for all buttons are erased.

Reprogramming a single button

To program a device to a previously trained button, follow these steps:

1. Press and hold the desired button. **Do NOT** release the button.

2. The indicator light will begin to flash after 20 seconds. Without releasing the button, follow Step 1 in the *Programming* section.

For questions or comments, contact HomeLink® at www.homelink.com or 1-800-355-3515.

Universal Garage Door Opener (If Equipped) 169

Programming HomeLink to a Genie Intellicode 2 garage door opener

Note: The Genie Intellicode 2 transmitter must already be programmed to operate with the garage door opener.

Programing the transmitters

To program HomeLink to the transmitter you must first put the transmitter into programming mode. To do this:

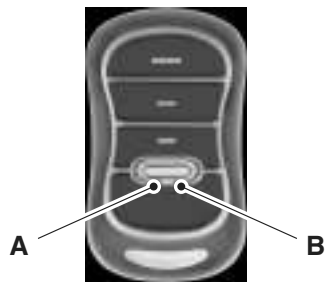

A. Red LED

B. Green LED

1. Press and hold one of the buttons on the hand-held transmitter for 10 seconds. The LED light will change from green to green and red.
2. Press the same button twice to confirm the change to Programming mode. If done properly the LED light will appear red.
3. Hold the transmitter within 1–3 inches (2–8 centimeters) of the button on the sun visor you want to program.
4. Press and hold both the programmed Genie button on the hand-held transmitter and the button on the sun visor you want to program. The indicator light on the sun visor will flash rapidly when the programming is successful.

Note: the Genie transmitter will transmit for up to 30 seconds. If HomeLink does not program within 30 seconds the Genie transmitter will need to be pressed again. If the Genie transmitter LED displays green and red, release the button until the LED turns off before pressing the button again.

Once HomeLink has been programmed successfully, the Genie transmitter must be changed out of program mode. To do this:

1. Press and hold the previously programmed Genie button on the hand-held transmitter for 10 seconds. The indicator light will change from red to red and green.
2. Press the same button twice to confirm the change. If done correctly the LED will turn green.

170 Universal Garage Door Opener (If Equipped)

Programming HomeLink to the Genie Intellicode garage door opener motor

Note: You may need a ladder to access the garage door opener motor.

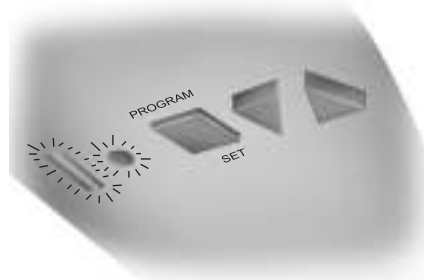

To program HomeLink to the garage door opener motor:

1. Press and hold the PROGRAM button on the garage door opener motor until both blue LED's turn on.
2. Release the PROGRAM button. Only the smaller round LED should be on.
3. Press and release the program button. The larger purple LED will flash.
Note: The next two steps must be completed in 30 seconds.
4. Press and release the Genie Intellicode 2 hand-held transmitter's previously programmed button. Both indicator lights on the garage door opener motor unit should now flash purple.
5. Press and hold the previously programmed button on the sun visor for two seconds. Repeat this step up to 3 times until the garage door moves. Programming is now complete.

Clearing a HomeLink device

To erase programming from the three HomeLink buttons, press and hold the two outer HomeLink buttons until the indicator light begins to flash. The LED will begin flashing in 10 to 20 seconds, at which time both buttons should be released. Programming has now been erased, and the LED should blink slowly to indicate the device is in train mode when any one of the three HomeLink buttons is pressed.

FCC and RSS-210 Industry Canada Compliance

This device complies with Part 15 of the FCC Rules and with RSS-210 of Industry Canada. Operation is subject to the following two conditions: (1) this device may not cause harmful interference, and (2) this device must accept any interference received, including interference that may cause undesired operation.

Changes or modifications to your device not expressly approved by the party responsible for compliance can void the user's authority to operate the equipment.

AUXILIARY POWER POINTS



WARNING: Do not plug optional electrical accessories into the cigarette lighter socket (if equipped). Improper use of the lighter can cause damage not covered by your warranty, and can result in fire or serious injury.

Note: If used when the engine is not running, the battery will discharge. There may be insufficient power to restart your engine.

Note: Do not insert objects other than an accessory plug into the power point. This will damage the outlet and blow the fuse.

Note: Do not hang any type of accessory or accessory bracket from the plug.

Note: Do not use the power point over the vehicle capacity of 12 volts DC 180 watts or a fuse may blow.

Note: Do not use the power point for operating a cigarette lighter element.

Note: Improper use of the power point can cause damage not covered by your warranty.

Note: Always keep the power point caps closed when not in use.

Run the engine for full capacity use of the power point. To prevent the battery from being discharged:

- Do not use the power point longer than necessary when the engine is not running.
- Do not leave devices plugged in overnight or when the vehicle is parked for extended periods.

Locations

Power points may be found:

- on the front of the center console
- inside the center console
- in the luggage compartment.

110 Volt AC Power Point (If Equipped)

WARNING: Do not keep electrical devices plugged in the power point whenever the device is not in use. Do not use any extension cord with the 110 volt AC power point, since it will defeat the safety protection design. Doing so may cause the power point to overload due to powering multiple devices that can reach beyond the 150 watt load limit and could result in fire or serious injury.

Note: The power point will turn off when the ignition is switched off or the battery voltage drops below 11 volts.



The power point is used for powering electrical devices that require up to 150 watts. It is located on the rear of the center console.

When the indicator light, located on the power point, is:

- on — power point is working, ignition is on and a device is plugged in.
- off — power point is off, ignition is off or no device is plugged in.
- blinking — power point is in fault mode

The power point temporarily turns off power if the 150 watt limit is exceeded. It can also switch to a fault mode when it is overloaded, overheated, or shorted. Unplug your device and turn the ignition off then on for overloading and shorting conditions. Let the system cool off, then turn the ignition off then on for an overheating condition.

The power point is not designed for electric devices such as:

- Cathode ray tube type televisions
- Motor loads, such as vacuum cleaners, electric saws and other electric power tools, compressor-driven refrigerators, etc.
- Measuring devices, which process precise data, such as medical equipment, measuring equipment, etc.
- Other appliances requiring an extremely stable power supply: microcomputer-controlled electric blankets, touch sensor lamps, etc.

CENTER CONSOLE

Stow items in the cupholder carefully as items may become loose during hard braking, acceleration or collisions, including hot drinks which may spill.

Available console features include:

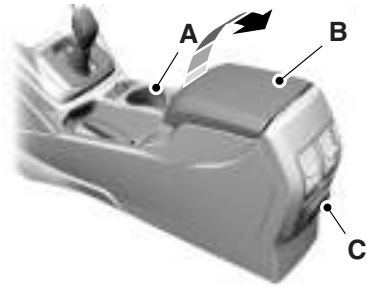

- A. Cupholder
- B. Storage compartment with auxiliary power point, auxiliary input jack, USB port and media hub
- C. Auxiliary power point

OVERHEAD CONSOLE

The appearance of the overhead console will vary according to your option package.





Press near the rear edge of the door to open it.

GENERAL INFORMATION

 **WARNING:** Extended idling at high engine speeds can produce very high temperatures in the engine and exhaust system, creating the risk of fire or other damage.

 **WARNING:** Do not park, idle, or drive your vehicle on dry grass or other dry ground cover. The emission system heats up the engine compartment and exhaust system, which can start a fire.

 **WARNING:** Do not start your vehicle in a closed garage or in other enclosed areas. Exhaust fumes can be toxic. Always open the garage door before you start the engine.

 **WARNING:** If you smell exhaust fumes inside your vehicle, have your vehicle checked by an authorized dealer immediately. Do not drive if you smell exhaust fumes.

If you disconnect the battery, your vehicle may exhibit some unusual driving characteristics for approximately 5 miles (8 kilometers) after you connect it. This is because the engine management system must realign itself with the engine. You may disregard any unusual driving characteristics during this period.

The powertrain control system meets all Canadian interference-causing equipment standard requirements regulating the impulse electrical field or radio noise.

Do not press the accelerator pedal while starting the engine. If you have difficulty starting the engine, see *Failure to start* later in this section.

IGNITION SWITCH (IF EQUIPPED)



0 (Off): The ignition is off.

Note: When you switch the ignition off and leave your vehicle, do not leave your key in the ignition. This could cause your vehicle battery to lose charge.

I (Accessory): Allows the electrical accessories, such as the radio, to operate while the engine is not running.

Note: Do not leave the ignition key in this position for too long. This could cause your vehicle battery to lose charge.

II (On): All electrical circuits are operational and the warning lamps and indicators illuminate.

III (Start): Cranks the engine.

KEYLESS STARTING (IF EQUIPPED)

Note: The keyless starting system may not function if the key is close to metal objects or electronic devices such as cellular phones.

Note: A valid key must be located inside your vehicle to switch the ignition on and start the engine.

Note: When locking your vehicle, any remote controls left inside the vehicle may become disabled. A message may appear in the information display indicating that there is no key detected if you try to start the engine. Press the unlock button on the remote control to enable it, and then start the engine.

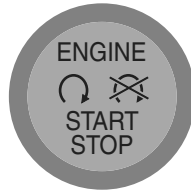
Ignition Modes

Off: Turns the ignition off.

- Without applying the brake pedal, press and release the button once when the ignition is in the on mode, or when the engine is running but the vehicle is not in motion.

On: All electrical circuits are operational. Warning lamps and indicators are illuminated.

- Without applying the brake pedal, press and release the button once from off mode.

Start: Starts the engine.

- Press the brake pedal, and then press the button until the engine starts.

STARTING A GASOLINE ENGINE

When you start the engine, the idle speed increases, this helps to warm up the engine. If the engine idle speed does not slow down automatically, have your vehicle checked by an authorized dealer.

Before starting the engine check the following:

- Make sure all occupants have fastened their safety belts.
- Make sure the headlamps and electrical accessories are off.
- Make sure the parking brake is on.
- Make sure the gearshift is in position **P**.
- Turn the ignition key to position **II**. If your vehicle is equipped with a keyless ignition, see the following instructions.

Vehicles with an Ignition Key

Note: Do not touch the accelerator pedal.

1. Fully press the brake pedal.
2. Turn the key to position **III**. Release the key when the engine starts.

Note: The engine may continue cranking for up to 15 seconds or until it starts.

Note: If you cannot start the engine on the first try, wait for a short period and try again.

Vehicles with Keyless Start

Note: Do not touch the accelerator pedal.

1. Fully press the brake pedal.
2. Press the button.

The system does not function if:

- The key frequencies are jammed.
- The key battery has no charge.

If you are unable to start your vehicle, do the following:

3-button remote



1. Hold the key at the backup location on the steering column.
2. With the key in this position, press the brake pedal, then the button to switch the ignition on and start your vehicle.

5-button remote



1. Hold the key next to the symbol on the steering column.
2. With the key in this position, press the brake pedal, then the button to switch the ignition on and start your vehicle.

Fast Restart (Vehicles with Keyless Start)

The fast restart feature allows you to restart the engine within 20 seconds of switching it off, even if a valid key is not present.

Within 20 seconds of switching the engine off, press the brake pedal and press the button. After 20 seconds have expired, you can no longer start the engine without the key present inside your vehicle.

Once the engine has started, it remains running until you press the button, even if the system does not detect a valid key. If you open and close a door while the engine is running, the system searches for a valid key. You cannot start the engine if the system does not detect a valid key within 20 seconds.

Failure to Start

If you cannot start the engine after three attempts, wait 10 seconds and follow this procedure:

1. Fully press the brake pedal.
2. Fully press the accelerator pedal and hold it there.
3. Start the engine.

Stopping the Engine When Your Vehicle is Stationary

1. Move the transmission selector lever to position **P**.
2. If your vehicle has an ignition key, turn the key to position **0**. If your vehicle has a keyless start system, press the button once.
3. Apply the parking brake.

Note: This switches off the ignition, all electrical circuits, warning lamps and indicators.

Stopping the Engine When Your Vehicle is Moving



WARNING: Switching off the engine when the vehicle is still moving will result in a loss of brake and steering assistance.

The steering will not lock, but higher effort will be required. When the ignition is switched off, some electrical circuits, warning lamps and indicators may also be off.

1. **If your vehicle has an ignition key**, move the transmission selector lever to position **N** and use the brakes to bring your vehicle to a safe stop. When your vehicle has stopped, move the transmission selector lever to position **P** and turn the key to position **0**.
2. **If your vehicle has a keyless start system**, move the transmission selector lever to position **N** and use the brakes to bring your vehicle to a safe stop. When your vehicle has stopped, move the transmission selector lever to position **P** and switch the ignition off by pressing and holding the button for one second, or pressing it three times within two seconds.
3. Apply the parking brake.

Guarding Against Exhaust Fumes



WARNING: If you smell exhaust fumes inside your vehicle, have this checked immediately. Do not drive your vehicle if you smell exhaust fumes. Carbon monoxide is present in exhaust fumes. Take precautions to avoid its dangerous effects.

Important Ventilating Information

If you stop your vehicle and leave the engine idling for long periods of time, we recommend that you do one of the following:

- Open the windows at least 1 inch (2.5 centimeters).
- Set your climate control to outside air.

180 Starting and Stopping the Engine

ENGINE BLOCK HEATER (IF EQUIPPED)



WARNING: Failure to follow engine block heater instructions could result in property damage or physical injury.



WARNING: Do not use your heater with ungrounded electrical systems or two-pronged (cheater) adapters. There is a risk of electrical shock.

Note: The heater is most effective when outdoor temperatures are below 0°F (-18°C).

The heater acts as a starting aid by warming the engine coolant. This allows the climate control system to respond quickly. The equipment includes a heater element (installed in the engine block) and a wire harness. You can connect the system to a grounded 120 volt A/C electrical source.

We recommend that you do the following for safe and correct operation:

- Use a 16-gauge outdoor extension cord that is product certified by Underwriter's Laboratory or Canadian Standards Association. This extension cord must be able to be used outdoors, in cold temperatures, and be clearly marked *Suitable for Use with Outdoor Appliances*. Never use an indoor extension cord outdoors; it could result in an electric shock or become a fire hazard.
- Use as short an extension cord as possible.
- Do not use multiple extension cords.
- Make sure that when in operation, the extension cord plug and the heater cord plug connections are free and clear of water. This could cause an electric shock or fire.
- Make sure your vehicle is parked in a clean area, clear of combustibles.
- Make sure the heater, heater cord and extension cord are firmly connected.

- Check for heat anywhere in the electrical hookup once the system has been operating for approximately 30 minutes.
- Make sure the system is unplugged and properly stowed before driving your vehicle. Make sure the protective cover seals the prongs of the block heater cord plug when not in use.
- Keep plug terminals clean and free of dirt and corrosion.
- Make sure the heater system is checked for proper operation before winter.

Using the Engine Block Heater

Make sure the receptacle terminals are clean and dry prior to use. Clean them with a dry cloth, if necessary.

The heater uses 0.4 to 1.0 kilowatt-hours of energy per hour of use. The system does not have a thermostat. It achieves maximum temperature after approximately three hours of operation. Using the heater longer than three hours does not improve system performance and unnecessarily uses electricity.

PLUG-IN POWER MODE AND HYBRID MODE (C-MAX ENERGI ONLY)

C-MAX Energi vehicles must be plugged in regularly for optimal use of the high voltage battery's extended range capability. When you charge your vehicle you add electrical energy which is then used to propel the vehicle in Plug-in Power Mode. Your estimated electric range in this mode is shown in an enhanced battery gauge on the instrument panel display. Electric only operation is maximized in plug-in power mode. System conditions may require engine operation, however, plug-in power will be used whenever possible.

When your plug-in power has been depleted, the powertrain system will automatically switch to hybrid mode. Your battery gauge will show an electric range of zero before transitioning to a simple battery graphic upon entering hybrid mode. Hybrid mode uses both the gasoline engine and electric motor to power your vehicle and maximize fuel economy as with C-MAX Hybrid.

EV MODES (C-MAX ENERGI ONLY)

EV Your vehicle contains selectable EV modes through the EV button on the center console.

These modes are available when the vehicle can run under high voltage battery power. With the vehicle in driving mode you can change EV modes with each press of the EV button. The current mode will be displayed in the left hand instrument cluster screen.

Auto EV

AUTO This mode provides an automatic use of high-voltage battery power during the drive, staying in electric mode when possible and running the engine when needed. This mode will be the only one available if the plug in power has been depleted.

EV Now

This mode provides an electric only driving experience using plug-in power. The left-hand information display will change to an Energy Use screen that supplies EV specific tools and functions.

The vehicle may accelerate more slowly and the top speed may be lower than in Auto EV. At any time, the engine may be enabled by using one of the following methods:

1. Press the OK button on the left 5-way steering wheel control while viewing the EV screen. The vehicle will automatically exit override after the timer has expired and the engine shuts down.
2. Press the accelerator pedal fully. A pop up message stating **Press OK to Enable Engine** will appear. Press OK on the left steering wheel button to activate as needed. The message will disappear if the accelerator pedal is released.
3. Press the EV button. This will change the mode to EV Later and permit engine operation

The vehicle may automatically enter Engine Enabled mode if system conditions require it. A message **Engine Enabled for System Performance** will display if this occurs. This is normal function, and your vehicle will return to EV Now when possible.

The vehicle may enter Enable Engine mode if the climate control is in a defrost mode and the outside temperature is cold. A message **Engine Enabled Due to Defrost** will display if this occurs. If defrost is not needed, select a different climate control mode to permit EV Now.

There is a blue EV icon that is displayed in the left-hand information display when EV Now is enabled. If the vehicle is in the Engine Enabled mode, the EV icon will be yellow.

EV Now will automatically exit when the Plug in power has been depleted.

EV Later

This mode saves the high voltage battery plug in power for future use (for example, your initial drive is at high speeds on open roads, but later your drive will be at low speeds in an urban area). Your vehicle will run the engine as needed and keep most of the high voltage battery plug in power for later use in Auto EV or EV Now mode.

There is a white EV Later icon that appears on the left-hand information display when EV Later is enabled.

HYBRID VEHICLE OPERATION (C-MAX HYBRID AND C-MAX ENERGI)

This hybrid vehicle combines electric and gasoline propulsion to provide breakthrough performance and improved efficiency. Familiarizing yourself with these unique characteristics will provide an optimal driving experience from your new vehicle.

Note: You may notice higher engine speeds upon start-up. This temporary condition is normal and necessary to heat up the cabin and minimize emissions.



Starting: When you start your vehicle, a green ready indicator light will appear in the lower right portion of the instrument cluster and a ready to drive message will appear in the middle of the left cluster screen, letting you know that the vehicle is ready for driving.

The engine may not start because this hybrid vehicle is equipped with silent key start. This fuel saving feature allows your vehicle to be ready-to-drive without requiring the gas engine to be running. This indicator will remain on while the vehicle is on, whether the engine is running or not to indicate the vehicle is capable of movement (using its electric motor, engine, or both). Typically, the engine will not start unless the vehicle is cold, a climate control change is requested, or the accelerator is pressed.

Driving: The gas engine automatically starts and stops to provide power when it's needed and to save fuel when it's not. While coasting at low speeds, coming to a stop, or standing, the gas engine normally shuts down and the vehicle operates in electric-only mode. Conditions that may cause the engine to start up or remain running include:

- considerable vehicle acceleration
- vehicle speed above 60 mph (96 km/h) For C-MAX Energi vehicles, you can drive up to 85 mph (137 km/h) in EV mode.
- ascending a hill
- charge level of high voltage battery is low
- very high or low outside temperature (to provide system cooling or heating) For C-MAX Energi vehicles, climate control demands by passengers do not directly cause the engine to run. This only occurs when the high voltage battery charge is low.
- engine not warm enough to provide passenger requested cabin temperature

Stopping: The gas engine may shut off to conserve fuel as you come to a stop. Restarting the vehicle is not required. Simply step on the accelerator when you are ready to drive.

Transmission Operation: Due to the technologically advanced, electronically-controlled continuously variable transaxle, you will not feel shift changes like those of a non-hybrid vehicle.

Note: Since engine speed is controlled by the transmission, it may seem elevated at times. This is normal hybrid operation and helps deliver fuel efficiency and performance.

Neutral: It is not recommended to idle the vehicle in position **N** for extended periods of time because this will discharge your high voltage battery and decrease fuel economy. The engine will not start, and cannot provide power to the hybrid system in position **N**.

Low Gear: Low gear (position **L**) is designed to mimic the enhanced engine braking available in non-hybrid vehicles. Low gear will produce high engine speeds to provide necessary engine braking. This is normal and will not damage your vehicle. In low gear, the gas engine will remain on more often than in position **D**.

Reverse: In position **R**, vehicle speed is limited to 22 mph (35 km/h).

Unique Hybrid Operating Characteristics

Your hybrid behaves differently compared to a non-hybrid. Here is a description of the major differences:

Battery: Your hybrid is equipped with a high voltage battery. A cool battery ensures battery life and provides the best possible performance. Your hybrid high voltage battery may periodically re-condition itself to ensure maximum efficiency. You may notice slight changes in drivability during this process, but it's an important part of your hybrid's high voltage battery optimization features.

The high voltage battery is cooled by cabin air drawn from vent holes in the trim panels behind the rear seats. Avoid placing objects at the vent holes which block air flow to the high voltage battery.

The high voltage battery is located behind the rear seat or underneath the load floor. The rear seats can be lowered to increase cargo space.

If the vehicle is left inoperative for over 31 days, it may be necessary to jump start the vehicle. Refer to *Jump starting the vehicle* in the *Roadside Emergencies* chapter and also see *Low and high voltage battery – storage* in the *Vehicle Care* chapter.

Engine: The engine speed in your hybrid is not directly tied to your vehicle speed. Your vehicle's engine and transmission are designed to deliver the power you need at the most efficient engine speed. During heavy accelerations, your hybrid may reach high engine speeds (up to 6000 rpm).

In prolonged mountainous driving, you may see the engine tachometer changing without your input. This is intentional and maintains the battery charge level. You may also notice during extended downhill driving that your engine continues to run instead of shutting off.

During this engine braking, the engine stays on, but it's not using any fuel. You may also hear a slight whine or whistle when operating your vehicle. This is the normal operation of the electric generator in the hybrid system.

During certain events (such as vehicle servicing) your low voltage (underhood) battery may become disconnected or disabled. Once the battery is reconnected and after driving the vehicle, the engine may continue to operate for three to five seconds after the key is turned to off. This is a normal condition.

Braking: Your hybrid is equipped with standard hydraulic braking and regenerative braking. Regenerative braking is performed by your vehicle computer housed with the transmission and it commands a portion of the brake energy stored in your high voltage battery.

Driving to Optimize Fuel Economy

Note: Having your engine running is not always an indication of inefficiency. In some cases, it is actually more efficient than driving in electric mode.

Your fuel economy should improve throughout your hybrid's break-in period. As with any vehicle, fuel economy can be significantly impacted by your driving habits, accessory usage, temperature and terrain. For best results, keep in mind these tips:

- Keep the tires properly inflated and only use the recommended size.
- Aggressive driving increases the amount of energy required to move your vehicle. In general, better fuel economy is achieved with mild to moderate acceleration and deceleration. Moderate braking is particularly important since it allows you to maximize the energy captured by the regenerative braking system.

Additional Tips:

- Do not carry extra loads
- Be mindful of adding external accessories that may increase aerodynamic drag
- Observe posted speed limits
- Perform all scheduled maintenance
- There is no need to wait for your engine to warm up. The vehicle is ready to drive immediately after starting

EV+ Mode

Your vehicle will recognize your frequent destinations and allow for more EV driving as you approach them. For example, when nearing your home it should be easier to stay in electric mode. The EV indicator will display EV+ when this mode is active. You should see this approximately 1/8 mile (200 meters) from a frequent destination.

Note: Frequent destinations are learned by your vehicle after two to four weeks of use. These destinations can be cleared with a Lifetime Summary reset through the Settings menu.

Note: The EV+ feature can be turned on or off through the Driver Assist section of the Settings menu.

Frequently Asked Questions

Question	Answer
What are the series of clicks from the cargo area when I first turn the key in the ignition?	The high voltage battery is electrically isolated from the rest of the vehicle when the key is off. When the key is turned to on, high voltage contactors inside the battery are closed to make the electricity available to the motor/generator and enable the vehicle to drive. The clicks are the sound of these contactors as they close and open during start up and shut down.
Why does the engine sometimes start at key-on?	The vehicle's computer will determine if an engine start is required at key-on. Silent key start will start the engine if it is necessary for cabin heating, windshield defrost, or if the outside temperature is low. (For C-MAX Energi vehicles, engine on is not required to operate these functions.)

Question	Answer
Why does it take a long time before the engine shuts down?	There are several reasons the engine stays on for an extended amount of time when it is first started. One common reason is to ensure that the emissions components are warm enough to minimize tailpipe emissions. As the climate gets cooler, this engine-on time is extended.
Why does my engine never shut down above 60 mph (96 km/h)?	The engine is required to turn on above this speed to protect the transmission hardware. (For C-MAX Energi vehicles, you can travel up to 85 mph [137 km/h] in EV mode.)
Why does my engine stay on when it's extremely cold outside?	In order to ensure that the climate control system can begin heating the cabin or defrosting the windshield as soon as a driver requests it, the engine coolant temperature has to be kept sufficiently hot. Keeping the engine on is required to maintain the correct minimum temperature. (For C-MAX Energi vehicles, this is not required to maintain cabin conditions.)
Why does my engine rev up so high sometimes when I accelerate?	Your vehicle's engine and transmission are designed to deliver the power you need at the most efficient engine speed. This may be higher than expected during heavy accelerations, and may fluctuate during steady state driving. These are characteristics of the Atkinson engine cycle and the eCVT transmission technology that help maximize your hybrid's fuel economy.

Question	Answer
What is the fan noise I hear from the rear of my hybrid?	The fan noise comes from a fan located inside the high voltage battery. This fan turns on when the battery requires cooling air. The fan speed, and associated noise level, will change according to the amount of cooling required to maintain good performance. Maintaining the battery temperature at optimal conditions also prolongs the useful life of the battery and helps to achieve better fuel economy.
What is the engine oil change service interval?	The engine oil should be changed every 10000 miles (16000 km) under normal operating conditions. See the <i>Scheduled maintenance information</i> .
Can I put E15 or E85 in my vehicle, and how will it affect my fuel economy?	Your hybrid vehicle can use E15 (15% ethanol, 85% gasoline) fuel, but you may notice slightly reduced fuel economy because ethanol contains less energy per gallon than gasoline. Your hybrid vehicle is not designed to use E85 (85% ethanol).
How long will my high voltage battery last? Does it need maintenance?	The high voltage battery system is designed to last the life of the vehicle and requires no maintenance.
Can you charge the battery with a plug into an A/C outlet?	There are no provisions for charging the high voltage battery from a power supply external to the vehicle. (For C-MAX Energi vehicles, the vehicle can be plugged into a 110 volt outlet with charge cord provided.)
Can I tow the hybrid behind my motor home with all four wheels down?	Yes. Your hybrid vehicle can be flat-towed without modification. See the <i>Recreational towing</i> section in the <i>Towing</i> chapter for more information.

SAFETY PRECAUTIONS

WARNING: Do not overfill the fuel tank. The pressure in an overfilled tank may cause leakage and lead to fuel spray and fire.



WARNING: The fuel system may be under pressure. If you hear a hissing sound near the fuel filler inlet, do not refuel until the sound stops. Otherwise, fuel may spray out, which could cause serious personal injury.



WARNING: Automotive fuels can cause serious injury or death if misused or mishandled.



WARNING: The flow of fuel through a fuel pump nozzle can produce static electricity, which can cause a fire if fuel is pumped into an ungrounded fuel container.



WARNING: Fuel ethanol and gasoline may contain benzene, which is a cancer-causing agent.



WARNING: When refueling always shut the engine off and never allow sparks or open flames near the filler neck. Never smoke while refueling. Fuel vapor is extremely hazardous under certain conditions. Care should be taken to avoid inhaling excess fumes.

Observe the following guidelines when handling automotive fuel:

- Extinguish all smoking materials and any open flames before refueling your vehicle.
- Always turn off the vehicle before refueling.
- Automotive fuels can be harmful or fatal if swallowed. Fuel, such as gasoline, is highly toxic and if swallowed can cause death or permanent injury. If fuel is swallowed, call a physician immediately, even if no symptoms are immediately apparent. The toxic effects of fuel may not be visible for hours.
- Avoid inhaling fuel vapors. Inhaling too much fuel vapor of any kind can lead to eye and respiratory tract irritation. In severe cases, excessive or prolonged breathing of fuel vapor can cause serious illness and permanent injury.

- Avoid getting fuel liquid in your eyes. If fuel is splashed in the eyes, remove contact lenses (if worn), flush with water for 15 minutes and seek medical attention. Failure to seek proper medical attention could lead to permanent injury.
- Fuels can also be harmful if absorbed through the skin. If fuel is splashed on the skin or clothing, promptly remove contaminated clothing and wash skin thoroughly with soap and water. Repeated or prolonged skin contact with fuel liquid or vapor causes skin irritation.
- Be particularly careful if you are taking Antabuse or other forms of disulfiram for the treatment of alcoholism. Breathing gasoline vapors, or skin contact could cause an adverse reaction. In sensitive individuals, serious personal injury or sickness may result. If fuel is splashed on the skin, promptly wash skin thoroughly with soap and water. Consult a physician immediately if you experience an adverse reaction.

FUEL QUALITY

Note: Use of any fuel other than those recommended may cause powertrain damage and a loss of vehicle performance; repairs may not be covered under warranty.

Your vehicle was not designed to use fuel or fuel additives with metallic compounds, including manganese-based additives.

Choosing the Right Fuel

Use only UNLEADED fuel or UNLEADED fuel blended with a maximum of 15% ethanol. Do not use fuel ethanol (E85), diesel fuel, fuel-methanol, leaded fuel or any other fuel because it could damage or impair the emission control system.

Your vehicle was not designed to use fuel or fuel additives with metallic compounds, including manganese-based additives. The use of leaded fuel is prohibited by law.

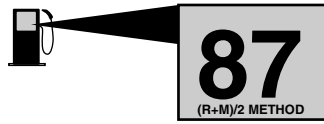
Octane Recommendations

Regular unleaded gasoline with a pump (R+M)/2 octane rating of 87 is recommended. Some stations offer fuels posted as Regular with an octane rating below 87, particularly

in high altitude areas. Fuels with octane levels below 87 are not recommended.

Regular unleaded gasoline with a pump (R+M)/2 octane rating of 87 is recommended. Some stations offer fuels posted as “Regular” with an octane rating below 87, particularly in high altitude areas. Fuels with octane levels below 87 are not recommended.

Do not be concerned if your engine sometimes knocks lightly. However, if it knocks heavily under most driving conditions while you are using fuel with the recommended octane rating, see your authorized dealer to prevent any engine damage.

Fuel Freshness Mode (Energi Vehicles Only)

This feature helps keep the fuel system functional and the fuel fresh.

If you operate your vehicle mainly in plug-in power mode using electricity from plugging in without refueling, the gasoline in your tank eventually becomes old. Old fuel can damage the engine and fuel system.

To prevent the fuel from becoming old, your vehicle will automatically enter fuel freshness mode. In fuel freshness mode, your vehicle will operate in hybrid mode causing the gasoline engine to run in order to consume the fuel in the fuel tank.

Note: If new fuel is not added during an 18 month period, fuel freshness mode will consume fuel until about 1 gallon (3.8 liters) is left in the tank.

During fuel freshness mode:

- The information display screen will indicate that fuel freshness mode is active.
- The vehicle will only run in hybrid mode. EV Now mode will not be available.
- Most of the plug-in power will be stored until fuel freshness mode is completed.

Note: EV Now mode can resume if less than 1 gallon (3.8 liters) of fuel is left in the tank.

Note: In most cases, when the fuel level is below 1/4 tank, refueling the vehicle will end fuel freshness mode and EV Now will now become available. Refueling after consuming a full tank in fuel freshness mode will end the mode.

Note: It is recommended to use a fuel stabilizer if you consume less than a full tank of fuel during an 18 month period.

REFUELING



WARNING: Fuel vapor burns violently and a fuel fire can cause severe injuries. To help avoid injuries to you and others:

- Read and follow all the instructions on the pump island.
- Turn off your engine when you are refueling.
- Do not smoke if you are near fuel or refueling your vehicle.
- Keep sparks, flames and smoking materials away from fuel.
- Stay outside your vehicle and do not leave the fuel pump unattended when refueling your vehicle - this is against the law in some places.
- Keep children away from the fuel pump; never let children pump fuel.
- Do not use personal electronic devices while refueling.

Use the following guidelines to avoid electrostatic charge build-up when filling an ungrounded fuel container:

- Place approved fuel container on the ground.
- DO NOT fill a fuel container while it is in the vehicle (including the cargo area).
- Keep the fuel pump nozzle in contact with the fuel container while filling.
- DO NOT use a device that would hold the fuel pump handle in the fill position.

Using the Easy Fuel™ Capless Fuel System (Except C-MAX Energi)



WARNING: The fuel system may be under pressure. Insert the fuel nozzle slowly. If you hear a hissing sound near the fuel filler door, do not refuel until the sound stops. Otherwise, fuel may spray out, which could cause serious personal injury.

When fueling your vehicle:

1. Put the vehicle in **P** (Park) and turn the ignition off.
2. Open the fuel filler door.

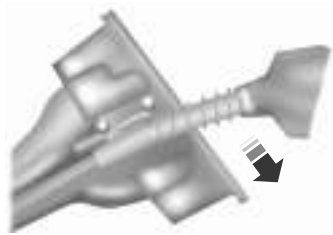

3. Slowly insert the fuel filler nozzle fully into the fuel system, and leave the nozzle fully inserted to open both doors until you are done pumping. Hold handle higher during insertion for easier access.

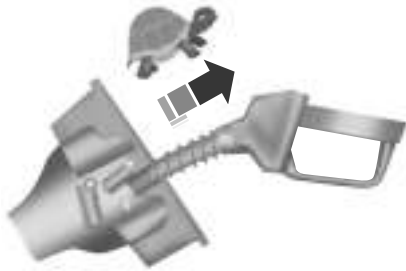

4. After you are done pumping fuel, slowly remove the fuel filler nozzle—allow about five to ten seconds after pumping fuel before removing the fuel filler nozzle. This allows residual fuel to drain back into the fuel tank and not spill onto the vehicle.

Note: A fuel spillage concern may occur if overfilling the fuel tank. Do not overfill the tank to the point that the fuel is able to bypass the fuel filler nozzle. The overfilled fuel may run down the drain located below and in front of the fuel filler door.

If the fuel fill inlet was not properly closed, a Check Fuel Fill Inlet message may appear on the information display screen. At the next opportunity, do the following:

1. Safely pull off the road.
2. Put the vehicle in **P** (Park) and turn the ignition off.
3. Open the fuel filler door and remove any visible debris from the fuel fill opening.
4. Insert either the fuel fill nozzle or the fuel fill funnel provided with the vehicle several times to dislodge any debris and/or allow the inlet to close properly.

If this action corrects the problem, the message may not reset immediately. It may take several driving cycles for the message to turn off. A driving cycle consists of an engine start-up (after four or more hours with the engine off) followed by city/highway driving. Continuing to drive with the message on may cause the service engine soon lamp to turn on as well.

Using the Easy Fuel™ Capless Fuel System (C-MAX Energi Only)



WARNING: The fuel system may be under pressure. Insert the fuel nozzle slowly. If you hear a hissing sound near the fuel filler door, do not refuel until the sound stops. Otherwise, fuel may spray out, which could cause serious personal injury.

Note: Your vehicle features a locking fuel door and an Easy Fuel™ system which has a auto-sealing feature that locks the fuel tank refueling valve. Before you can refuel your vehicle you must first press the button located on your instrument panel. Pressing this button will unlock the fuel tank refueling valve allowing the fuel filler door to open so that the fuel filler nozzle can be inserted into the fuel tank. This could take up to 15 seconds before the fuel filler door pops open allowing the insertion of the fuel filler nozzle. In the event that the fuel valve does not unlock automatically you can pull the manual override lever located in the trunk. This will open the refueling door and allow access to fill your vehicle.

When fueling your vehicle:

1. Put the vehicle in **P** (Park) and turn the ignition off.



2. Press the fuel button located on the instrument panel.

3. Wait up to 15 seconds before opening the fuel filler door. During this time a Please Wait to Refuel message will appear in the information display screen.

Note: When the door is open a Ready to Refuel message will appear in the information display screen indicating that the vehicle is ready to be filled. The vehicle will remain ready to refuel for approximately 20 minutes. If more than 20 minutes is exceeded, the refueling button will need to be pressed again. (You may experience the fuel pump shutting off if the refuel button is not pressed again).

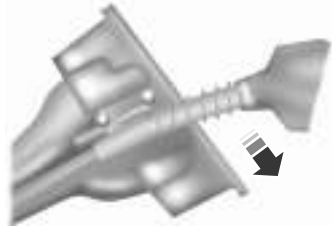

4. Slowly insert the fuel filler nozzle fully into the fuel system, and leave the nozzle fully inserted to open both doors until you are done pumping. Hold handle higher during insertion for easier access.

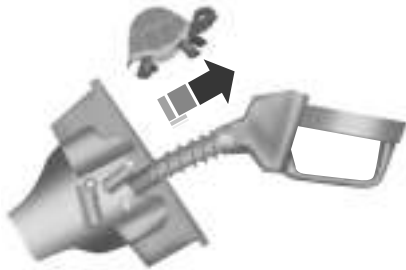

5. After you are done pumping fuel, slowly remove the fuel filler nozzle—allow about five to ten seconds after pumping fuel before removing the fuel filler nozzle. This allows residual fuel to drain back into the fuel tank and not spill onto the vehicle.

Manual override procedure

 **WARNING:** The fuel system may be under pressure. Insert the fuel nozzle slowly. If you hear a hissing sound near the fuel filler door, do not refuel until the sound stops. Otherwise, fuel may spray out, which could cause serious personal injury.

The manual override lever is located inside of the trunk on the right rear side panel.



Remove the panel to access the lever.

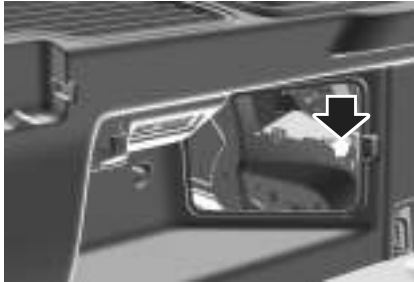

When using the fuel door manual override to access the fuel fill inlet:

1. You must key on prior to using a manual override.
2. Open the fuel door with the manual override mechanism located in trunk.
3. Key off and complete refueling within 15 minutes. If more than 15 minutes is required, close fuel door, and repeat procedure.

This will enable you to refuel without any issue.

Note: A fuel spillage concern may occur if overfilling the fuel tank. Do not overfill the tank to the point that the fuel is able to bypass the fuel filler nozzle. The overfilled fuel may run down the drain located below and in front of the fuel filler door.

If the fuel fill inlet was not properly closed, a Check Fuel Fill Inlet message may appear on the information display screen. At the next opportunity, do the following:

1. Safely pull off the road.
2. Put the vehicle in **P** (Park) and turn the ignition off.
3. Open the fuel filler door and remove any visible debris from the fuel fill opening.
4. Insert either the fuel fill nozzle or the fuel fill funnel provided with the vehicle several times to dislodge any debris and/or allow the inlet to close properly.

If this action corrects the problem, the message may not reset immediately. It may take several driving cycles for the message to turn off. A driving cycle consists of an engine start-up (after four or more hours with the engine off) followed by city/highway driving. Continuing to drive with the message on may cause the service engine soon lamp to turn on as well.

RUNNING OUT OF FUEL

Avoid running out of fuel because this situation may have an adverse effect on vehicle components.

If you have run out of fuel:

- You may need to cycle the ignition from off to on after refueling to allow the fuel system to pump the fuel from the tank to the engine.
- Normally, adding 1 gallon (3.8 liters) of fuel is enough to restart the engine. If the vehicle is out of fuel and on a steep grade, more than 1 gallon (3.8 liters) may be required.
- The service engine soon indicator may come on. For more information on the service engine soon indicator, refer to *Warning lamps and indicators* in the *Instrument Cluster* chapter.

Refilling with a Portable Fuel Container

! **WARNING:** Do not insert the nozzle of portable fuel containers or aftermarket funnels into the capless fuel system. This could damage the fuel system and its seal, and may cause fuel to run onto the ground instead of filling the tank, which could result in serious personal injury.

! **WARNING:** Do not try to pry open or push open the capless fuel system with foreign objects. This could damage the fuel system and its seal and cause injury to you or others.

Note: Do not use aftermarket funnels; they will not work with the capless fuel system and can damage it. The included funnel has been specially designed to work safely with your vehicle.

When filling the vehicle's fuel tank from a portable fuel container, use the funnel included with the vehicle.

Locate the plastic funnel that comes with your vehicle.

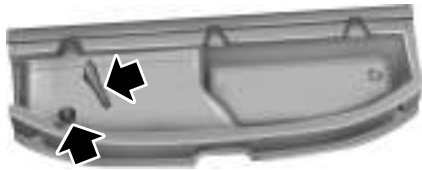

- In C-MAX vehicles, the funnel is located in the rear of the vehicle inside the load compartment.



- In C-MAX Energi vehicles the funnel is located in the rear of the vehicle, inside storage compartment.



After locating the white plastic funnel:

1. Slowly insert the funnel into the capless fuel system.
2. Fill the vehicle with fuel from the portable fuel container.
3. When done, clean the funnel or properly dispose of it. Extra funnels can be purchased from your

authorized dealer if you choose to dispose of the funnel.

Note: For C-MAX Energi vehicles press the fuel button located on the instrument panel before performing step 2.



FUEL CONSUMPTION

Filling the Tank

The advertised capacity is the indicated capacity and the empty reserve combined. Indicated capacity is the difference in the amount of fuel in a full tank and a tank when the fuel gauge indicates empty. Empty reserve is the amount of fuel in the tank after the fuel gauge indicates empty.

Note: The amount of usable fuel in the empty reserve varies and should not be relied upon to increase driving range. When refueling your vehicle after the fuel gauge indicates empty, you might not be able to refuel the full amount of the advertised capacity of the fuel tank due to the empty reserve still present in the tank.

For consistent results when filling the fuel tank:

- Turn the ignition off before fueling; an inaccurate reading results if the engine is left running.
- Use the same fill rate (low–medium–high) each time the tank is filled.
- Allow no more than two automatic click–offs when filling.

Results are most accurate when the filling method is consistent.

Calculating Fuel Economy

Do not measure fuel economy during the first 1000 miles (1600 kilometers) of driving (this is your engine's break-in period); a more accurate measurement is obtained after 2000 miles–3000 miles (3200 kilometers–4800 kilometers). Also, fuel expense, frequency of fill-ups or fuel gauge readings are not accurate ways to measure fuel economy.

1. Fill the fuel tank completely and record the initial odometer reading.
2. Each time you fill the tank, record the amount of fuel added.
3. After at least three to five tank fill-ups, fill the fuel tank and record the current odometer reading.
4. Subtract your initial odometer reading from the current odometer reading.
5. Calculate fuel economy as follows:

Standard: Divide miles traveled by gallons used.

Metric: Multiply liters used by 100, then divide by kilometers traveled.

Keep a record for at least one month and record the type of driving (city or highway). This provides an accurate estimate of the vehicle's fuel economy under current driving conditions. Additionally, keeping records during summer and winter show how temperature impacts fuel economy. In general, lower temperatures mean lower fuel economy.

EMISSION CONTROL SYSTEM

WARNING: Do not park, idle, or drive your vehicle in dry grass or other dry ground cover. The emission system heats up the engine compartment and exhaust system, which can start a fire.



WARNING: Exhaust leaks may result in entry of harmful and potentially lethal fumes into the passenger compartment. If you smell exhaust fumes inside your vehicle, have your dealer inspect your vehicle immediately. Do not drive if you smell exhaust fumes.

Your vehicle is equipped with various emission control components and a catalytic converter which will enable your vehicle to comply with applicable exhaust emission standards. To make sure that the catalytic converter and other emission control components continue to work properly:

- Use only the specified fuel listed.
- Avoid running out of fuel.
- Do not turn off the ignition while your vehicle is moving, especially at high speeds.
- Have the items listed in *Scheduled Maintenance Information* performed according to the specified schedule.

The scheduled maintenance items listed in *Scheduled Maintenance Information* are essential to the life and performance of your vehicle and to its emissions system.

If other than Ford, Motorcraft® or Ford-authorized parts are used for maintenance replacements or for service of components affecting emission control, such non-Ford parts should be equivalent to genuine Ford Motor Company parts in performance and durability.

Illumination of the service engine soon indicator, charging system warning light or the temperature warning light, fluid leaks, strange odors, smoke or loss of engine power could indicate that the emission control system is not working properly.

An improperly operating or damaged exhaust system may allow exhaust to enter the vehicle. Have a damaged or improperly operating exhaust system inspected and repaired immediately.

Do not make any unauthorized changes to your vehicle or engine.

By law, vehicle owners and anyone who manufactures, repairs, services, sells, leases, trades vehicles, or supervises a fleet of vehicles are not permitted to intentionally remove an emission control device or prevent it from working. Information about your vehicle's emission system is on the Vehicle Emission Control Information Decal located on or near the engine. This decal also lists engine displacement.

Please consult your warranty information for complete emission warranty information.

On-board Diagnostics (OBD-II)

Your vehicle is equipped with a computer that monitors the engine's emission control system. This system is commonly known as the on-board diagnostics system (OBD-II). The OBD-II system protects the environment by ensuring that your vehicle continues to meet government emission standards. The OBD-II system also assists your authorized dealer in properly servicing your vehicle.



When the service engine soon indicator illuminates, the OBD-II system has detected a malfunction. Temporary malfunctions may cause the service engine soon indicator to illuminate.

Examples are:

1. The vehicle has run out of fuel—the engine may misfire or run poorly.
2. Poor fuel quality or water in the fuel—the engine may misfire or run poorly.
3. The fuel fill inlet may not have been properly closed. See *Easy Fuel® No Cap Fuel System* in this chapter.
4. Driving through deep water—the electrical system may be wet.

These temporary malfunctions can be corrected by filling the fuel tank with good quality fuel, properly closing the fuel fill inlet or letting the electrical system dry out. After three driving cycles without these or any other temporary malfunctions present, the service engine soon indicator should stay off the next time the engine is started. A driving cycle consists of a cold engine start-up followed by mixed city or highway driving. No additional vehicle service is required.

If the service engine soon indicator remains on, have your vehicle serviced at the first available opportunity. Although some malfunctions detected by the OBD-II may not have symptoms that are apparent, continued driving with the service engine soon indicator on can result in increased emissions, lower fuel economy, reduced engine and transmission smoothness, and can lead to more costly repairs.

Readiness for Inspection/Maintenance (I/M) Testing

Some state, provincial and local governments may have Inspection/Maintenance (I/M) programs to inspect the emission control equipment on your vehicle. Failure to pass this inspection could prevent you from getting a vehicle registration.



If the service engine soon indicator is on or the bulb does not work, the vehicle may need to be serviced. See *On-board Diagnostics (OBD-II)* in this chapter.

Your vehicle may not pass the I/M test if the service engine soon indicator is on or not working properly (bulb is burned out), or if the OBD-II system has determined that some of the emission control systems have not been properly checked. In this case, the vehicle is considered not ready for I/M testing.

If the vehicle's engine or transmission has just been serviced, or the battery has recently run down or been replaced, the OBD-II system may indicate that the vehicle is not ready for I/M testing. To determine if the vehicle is ready for I/M testing, turn the ignition key to the on position for 15 seconds without cranking the engine. If the service engine soon indicator blinks eight times, it means that the vehicle is not ready for I/M testing; if the service engine soon indicator stays on solid, it means that the vehicle is ready for I/M testing.

The OBD-II system is designed to check the emission control system during normal driving. A complete check may take several days. If the vehicle is not ready for I/M testing, the following driving cycle consisting of mixed city and highway driving may be performed:

15 minutes of steady driving on an expressway or highway followed by 20 minutes of stop-and-go driving with at least four 30-second idle periods.

Allow the vehicle to sit for at least eight hours without starting the engine. Then, start the engine and complete the above driving cycle. The engine must warm up to its normal operating temperature. Once the engine is started, do not turn off the engine until the above driving cycle is complete. If the vehicle is still not ready for I/M testing, the above driving cycle will have to be repeated.

HIGH-VOLTAGE BATTERY



WARNING: This battery pack should only be serviced by an authorized electric vehicle technician. Improper handling can result in personal injury or death.

Your vehicle consists of various high-voltage components and wiring. All of the high-voltage power flows through specific wiring assemblies which are labeled as such or are covered with a solid orange convolute, or orange striped tape, or both. Do not come in contact with these components.

The high-voltage battery system is a high-voltage, lithium-ion battery system. The pack is located in the rear cargo area. The high-voltage battery system uses an air cooled system to regulate the high-voltage battery temperature and help maximize high-voltage battery life.

The high-voltage battery is equipped with air vents in the package tray that help to regulate its temperature. It is important to keep these openings free of obstructions. Do not block the flow of cabin air to this area.

No regular maintenance is required.

Note: C-MAX Energi vehicles will require regular charging.

CHARGING THE HIGH-VOLTAGE BATTERY (C-MAX ENERGI ONLY)



WARNING: Do not use the 120 volt convenience cord with an extension cord or adapter.



WARNING: In Canada, do not use the 120 volt convenience cord in commercial garages.



WARNING: This equipment has arcing or sparking parts that should not be exposed to flammable vapors. This equipment should be located at least 18 inches (80 mm) above the floor.

Charging Equipment

Your vehicle comes equipped with a standard 120-volt convenience cord located in the floor compartment behind the driver's seat.



Note: The 120-volt convenience cord allows you to charge the high-voltage battery using a standard 120-volt household outlet. Using the standard 120-volt convenience cord takes up to 7 hours to completely charge from an empty battery.



Ford recommends upgrading to the optional 240-volt charging station for faster more efficient charging. Use of a 240-volt charging station will take approximately 2½ hours to fully charge a empty battery.

Note: Your electrical source must meet certain requirements for the high-voltage batteries to charge. The AC outlet must be a three-prong 110-120 volt AC outlet that is properly grounded, 15–20 amps (or greater), and in good condition. The line also must be dedicated, which means that no other appliances should be connected to the same circuit. If a dedicated circuit is not used, the circuit breaker could trip or open. If a dedicated circuit is not available, contact a licensed professional electrician for proper installation.

Make sure that the 120 volt convenience cord is completely unwound before charging. Always plug the cord into the AC outlet before connecting the charging coupler into the vehicle's charge port receptacle. The 120 volt convenience cord inline control box has three indicator lights that represent the charging status; power, charge and fault.

Power (green light) — this indicator lights up when the cord is plugged into the AC wall outlet.

Charge (green light) — Indicates status of charging:

- No light means the cord is not connected to the vehicle.
- Blinking light means that the charging is in process.
- Solid light means that the vehicle is connected but not charging.

Fault (red triangle light) — Lights up in case of a detected failure. No charging is possible:

- Blinking red triangle light – means that the 120 volt convenience cord is trying to reset the failure and could restart the charging cycle.
- Solid red triangle light – means that the fault is permanent. The cord needs to be unplugged and re-plugged to reset the fault. If the fault persists, contact your authorized dealer.

Charge Port and Light Ring



The charge port is located between the front left side door and front left wheel well. There is an indentation located on the charge port door. Press with your thumb to press to open and close the door.

Note: Do not force the charge port door open or closed. Forcing the door open or closed will damage the charge port.

The light ring located around the charge port indicates the charge status of your vehicle's high-voltage battery. The charge port light ring is divided into four quadrants which display state of charge in 25 percent increments.

There is a cord acknowledgment feature that will be activated when a charge cycle is initiated. The four light quadrants will each individually flash clockwise starting with the top right light and ending with the top left, two full times confirming a charging coupler has been detected.

You can use your keyfob to view the vehicles charge status at any time by pressing the unlock button. The light ring will light up the corresponding quadrant(s) so that the current state of charge can be determined. If the charge is below 25 percent the light ring will not illuminate. Don't forget to press the lock button on your keyfob to re-lock the vehicle.

The light ring will also display the current state of charge when opening the doors.



Charging

Note: The vehicle must be in **P** (Park) to charge the high-voltage battery.

To charge your high-voltage battery:

1. Put the vehicle in **P** (Park) and power down the vehicle.
2. With your thumb, press the indentation located on the charge port door and the door will rotate open.
3. Plug the charging coupler into the vehicles charge port receptacle and make sure the button “clicks” confirming that it is completely engaged.
4. Verify that the cord acknowledgement feature activates. This indicates the beginning of a normal charge cycle.
5. If using a 240 volt charging station, follow the instructions on the charge station to begin the charging process.

When charging, the light ring will display how far along the charge is:

- When the top right quadrant is pulsing the charge is between 0–25 percent.
- When the top right quadrant is solidly lit and the bottom right quadrant is pulsing the charge is between 25–50 percent.
- When both right side quadrants are solidly lit and the bottom left quadrant is pulsing the charge is between 50–75 percent.
- When three quadrants are solidly lit and the top left quadrant is pulsing the charge is between 75–100 percent.
- When the entire ring is solidly lit, the charge is complete.

Note: The illuminated ring will shut off one minute after reaching a full charge.

Waiting to Charge

Note: See *Charge Settings* in the *MyFord Touch* Chapter for more information.

When Value Charge has been selected charging may not begin upon plugging in. The vehicle may delay charging to take advantage of off-peak electricity rates. The vehicle will optimize the charge schedule to be complete by the next GO Time.

When waiting to charge (not actively charging), the light ring will indicate the present state of charge of the high voltage battery as follows:

- When the top right quadrant is shut off the charge is between 0–25 percent.
- When the top right quadrant is solidly lit and the bottom right quadrant is shut off the charge is between 25–50 percent.
- When both right side quadrants are solidly lit and the bottom left quadrant is shut off the charge is between 50–75 percent.
- When three quadrants are solidly lit and the top left quadrant is shut off the charge is between 75–100 percent.
- When the entire ring is solidly lit, the charge is 100 percent.

Note: When the vehicle is Waiting to Charge the light ring will shut off one minute after displaying the present state of charge. When the vehicle automatically begins charging the light ring will turn on and display how far along the charge is per the section above.

Note: If a vehicle charging system fault is detected at any point in a charge cycle the entire light ring will flash continuously for one minute and then shut off. If this happens unplug, and then re-plug the charging coupler into the charge port receptacle. If the problem persists contact your authorized dealer.

The light ring illumination conditions can be modified. See the *Charge Port Light Ring Settings* in the *MyFord Touch* chapter.

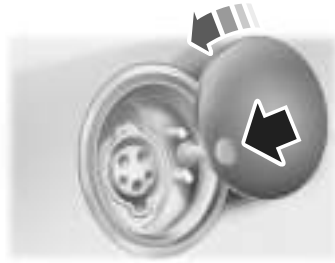
**Disconnecting the Charging Coupler**

Note: Do not pull the wall plug from the wall while the vehicle is charging. Doing so may damage the outlet and the cord.

To disconnect the charging coupler:

1. Press the button on the charging coupler with your thumb.
2. While holding the button, remove the charging coupler from the vehicle's charge port receptacle.

3. Close the charge port door by pressing the indentation on the charge port door. Continue pressing the indentation while the door rotates counter clockwise and closes.

Convenience Charging and MyFord® Mobile

The setting up of the charging convenience features is primarily done with the MyFord Mobile smart phone application. Visit myfordmobile.com for more complete information and to set up your MyFord Mobile account.

Your electric vehicle also has some convenience features to improve your charging experience:

- **Value Charge:** The vehicle schedules charging at the lowest available utility rates. Contact your utility company to see what rates are available.
- **Charge Now:** Fully charge your vehicle at the quickest rate. The vehicle starts charging immediately after you connect the charging plug into the vehicle.
- **My GO Time:** Setting My GO times through the MyFord Mobile application allows you to set charging schedules and cabin preconditioning settings so your vehicle is ready to drive when you are. By setting a My GO time the vehicles charge can be completed before your next set drive time. A calendar view allows you to program two My GO Times per day for each of the seven days of the week. Remember, your vehicle must be plugged in for My GO time to work.
- **Cabin Preconditioning:** Get the most miles out of every charge by preconditioning your vehicle while it's still plugged in and charging. Use your smart phone to set the cabin temperature and departure time before you leave so you use energy from your home wall outlet instead of your battery to heat or cool your vehicle.

HIGH-VOLTAGE SERVICE DISCONNECT

The high-voltage service disconnect shuts off power from the high-voltage battery.

Disabling the High-Voltage Battery

Note: There is a disconnect circuit in your vehicle. Disconnecting the circuit will automatically disable the high-voltage battery.

To disable the high-voltage battery and stop all high-voltage electric activity in the vehicle you can access high-voltage disconnect circuit. To do this, you must unplug the circuit from the circuit port that is connected to the high-voltage battery.

In full hybrid vehicles the high-voltage disconnect circuit is located behind the rear fold-down seats, near the left side of the vehicle.

In plug-in hybrid vehicles the disconnect circuit is located behind the rear fold down seats near on the right side of the vehicle. To access this circuit:

1. Fold down the rear seats.



2. Remove the cover panel. A cut out area will be visible which allows your hand access to the circuit.

3. Slide the handle on the service disconnect outboard.

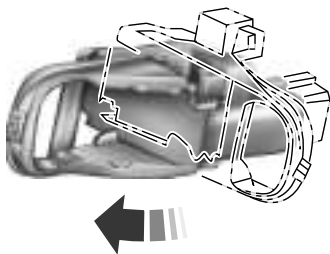

- On C-MAX vehicles, slide the service disconnect handle to the left.

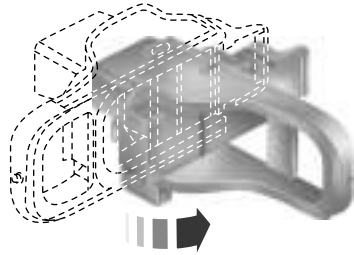

- On C-MAX Energi vehicles, slide the service disconnect handle to the right.

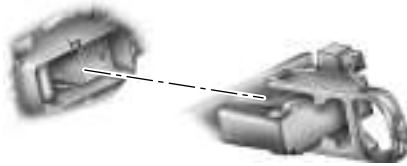

4. Pull the handle toward you and remove the circuit from the vehicle to disable the high-voltage battery.

Reverse this procedure to reinstall the service disconnect.

Reactivating the high-voltage battery

Note: If you have manually disconnected your high-voltage shutoff circuit you will need to reconnect the circuit before it can be reactivated. The vehicle will detect if the electrical system is safe and reactivate automatically.

AUTOMATIC TRANSMISSION

 **WARNING:** Always set the parking brake fully and make sure the gearshift is latched in **P** (Park). Turn the ignition to the off position and remove the key whenever you leave your vehicle

 **WARNING:** When parking, do not use the gearshift in place of the parking brake. Always set the parking brake fully and make sure that the gearshift is securely latched in **P** (Park). Turn off the ignition whenever you leave your vehicle. Never leave your vehicle unattended while it is running. If you do not take these precautions, your vehicle may move unexpectedly and injure someone.

**P (Park)**

This position locks the transmission and prevents the front wheels from turning.

To put your vehicle in gear:

1. Start the engine
2. Release the parking brake
3. Press the brake pedal
4. Move the gearshift lever into the desired gear

To put your vehicle in **P** (Park):

1. Come to a complete stop
2. Move the gearshift lever and securely latch it in **P** (Park)

R (Reverse)

With the gearshift lever in **R** (Reverse), the vehicle will move backward. Always come to a complete stop before shifting into and out of **R** (Reverse).

N (Neutral)

With the gearshift lever in **N** (Neutral), the vehicle is free to roll; hold the brake pedal down while in this position. Because of the unique nature of the hybrid vehicle, the engine will not start in the **N** (Neutral) position.

The vehicle does not charge the high voltage battery in the **N** (Neutral) position. Do not idle the vehicle in **N** (Neutral) for extended periods as this will discharge your high voltage battery.

D (Drive)

The normal driving position for the best fuel economy.

D (Drive) with Grade Assist

Press the transmission control switch on the side of the gearshift lever to activate grade assist and cancel overdrive.



Grade assist:



- The grade assist lamp in the instrument cluster is illuminated.
- Provides additional grade braking with a combination of engine motoring and high-voltage battery charging to help maintain vehicle speed when descending a grade.
- As the vehicle determines the amount of engine motoring and high-voltage battery charging, you may notice the engine speed increasing and decreasing to help maintain your vehicle speed when descending a grade.

Press the transmission control switch again to return to normal **D** (Drive).

- The grade assist lamp in the instrument cluster will not be illuminated.

L (Low)

- Provides maximum engine braking.
- The transmission may be shifted into **L** (Low) at any vehicle speed.

Brake-Shift Interlock

WARNING: Do not drive your vehicle until you verify that the brake lamps are working.



WARNING: When doing this procedure, you will be taking the vehicle out of park which means the vehicle can roll freely. To avoid unwanted vehicle movement, always fully set the parking brake prior to doing this procedure. Use wheel chocks if appropriate.



WARNING: If the parking brake is fully released, but the brake warning lamp remains illuminated, the brakes may not be working properly. See your authorized dealer.

This vehicle is equipped with a brake-shift interlock feature that prevents the gearshift lever from being moved from P (Park) when the ignition is in the on position unless the brake pedal is pressed.

If you cannot move the gearshift lever out of P (Park) with ignition in the on position and the brake pedal pressed, it is possible that a fuse has blown or the vehicle's brake lamps are not operating properly. Refer to *Fuses and relays* in the *Roadside Emergencies* chapter.

If the fuse is not blown and the brake lamps are working properly, the following procedure will allow you to move the gearshift lever from P (Park):



1. Apply the parking brake, turn the ignition key to the off position and remove the key.
2. Using a screwdriver (or similar tool), carefully pry off and remove the passenger side access cover. Remove the fastener, then remove the console side panel to expose the inside of the shifter assembly.



3. Locate the brake shift interlock lever on the passenger side of the shifter assembly.

4. Apply the brake pedal. Using a screwdriver (or similar tool), press and hold the white brake shift interlock lever forward while pulling the gearshift lever out of the P (Park) position and into the N (Neutral) position.

5. Reinstall the console side panel and attach the fastener.

6. Reinstall the access cover.

7. Apply the brake pedal, start the vehicle and release the parking brake.

See your authorized dealer as soon as possible if this procedure is used.

If Your Vehicle Gets Stuck in Mud or Snow

Note: Do not rock the vehicle if the engine is not at normal operating temperature or damage to the transmission may occur.

Note: Do not rock the vehicle for more than a minute or damage to the transmission and tires may occur, or the engine may overheat.

If your vehicle gets stuck in mud or snow, it may be rocked out by shifting between forward and reverse gears, stopping between shifts in a steady pattern. Press lightly on the accelerator in each gear.

HILL START ASSIST

WARNING: The hill start assist feature does not replace the parking brake. When you leave the vehicle, always apply the parking brake and shift the transmission into P (Park).



WARNING: You must remain in the vehicle once you have activated the hill start assist feature.



WARNING: During all times, you are responsible for controlling the vehicle, supervising the hill start assist system and intervening, if required.



WARNING: If the engine is revved excessively, or if a malfunction is detected when the hill start assist feature is active, the hill start assist feature will be deactivated.

Hill start assist keeps your vehicle stationary long enough to move your foot from the brake pedal to the accelerator pedal when your vehicle is on a slope.

The brakes are released automatically once the engine has developed sufficient drive to prevent the vehicle from rolling down the slope. This is an advantage when pulling away on a slope, (for example from a car park ramp, traffic lights or when reversing uphill into a parking space).

Using Hill Start Assist

1. Press the brake pedal to bring the vehicle to a complete standstill. Keep the brake pedal pressed.
2. If the sensors detect that the vehicle is on a slope, the hill start assist feature will be activated automatically.
3. When you remove your foot from the brake pedal, the vehicle will remain on the slope without rolling away for approximately two or three seconds. This hold time will automatically be extended if you are in the process of driving off.
4. Drive off in the normal manner. The brakes will be released automatically.

GENERAL INFORMATION

Note: Occasional brake noise is normal. If a metal-to-metal, continuous grinding or continuous squeal sound is present, the brake linings may be worn out and should be inspected by an authorized dealer. If your vehicle has continuous vibration or shudder in the steering wheel while braking, you should take it to an authorized dealer for inspection.

Note: Brake dust may accumulate on the wheels, even under normal driving conditions. Some dust is inevitable as the brakes wear and does not contribute to brake noise. See the *Vehicle Care* chapter for wheel cleaning instructions.



See the *Instrument Cluster* chapter for information on the brake system warning light.

Wet brakes result in reduced braking efficiency. Gently press the brake pedal a few times when driving from a car wash or standing water to dry the brakes.

Brake Over Accelerator

If the accelerator pedal becomes stuck or entrapped, apply steady and firm pressure to the brake pedal to slow your vehicle and reduce engine power. If you experience this condition, apply the brakes and bring your vehicle to a safe stop. Turn the engine off, shift to position **P** and apply the parking brake, then inspect the accelerator pedal for any interferences. If none are found and the condition persists, have your vehicle towed to the nearest authorized dealer.

Anti-Lock Brake System

This system helps you maintain steering control during emergency stops by keeping the brakes from locking.



The anti-lock brake system lamp momentarily illuminates when the ignition is turned on. If the light does not illuminate during start-up, remains on or flashes, the anti-lock brake system may be disabled and may need to be serviced.



If the anti-lock brake system is disabled, normal braking is still effective. If the brake warning lamp illuminates with the parking brake released, have your brake system serviced immediately.

Regenerative Braking System

This feature is used to simulate the engine braking of an internal combustion engine and assist the standard brake system while recovering some of the energy of motion and storing it in the battery to improve fuel economy. The standard brake system is designed to fully stop the car if regenerative braking is not available. During regenerative braking, the motor is spun as a generator to create electrical current. This recharges the battery and slows the vehicle. In effect, once the accelerator pedal is released, the motor changes from an energy user to an energy producer.

When the accelerator pedal is released or the brake pedal is applied, the brake controller automatically detects the amount of deceleration requested and optimizes how much of the deceleration will be produced by regenerative braking. The remaining portion is generated by standard friction braking. When the battery is almost fully charged, the amount of regenerative braking is limited to avoid overcharging, and the requested deceleration is produced by standard friction braking alone.

Regenerative braking does not take the place of the standard friction brakes; it only assists them. Regenerative braking has also been designed to interact with the anti-lock brake system. Regenerative braking is disabled when the anti-lock brake system is activated or the battery is fully charged.

HINTS ON DRIVING WITH ANTI-LOCK BRAKES

When the system is operating, the brake pedal will pulse and may travel further. Maintain pressure on the brake pedal. You may also hear a noise from the system. This is normal.

The anti-lock braking system will not eliminate the dangers inherent when:

- you drive too closely to the vehicle in front of you.
- your vehicle is hydroplaning.
- you take corners too fast.
- the road surface is poor.

PARKING BRAKE

WARNING: Always set the parking brake fully and leave your vehicle with the transmission selector lever in position **P**.

Note: Do not press the release button while pulling the lever up.

To set the parking brake:

1. Press the foot brake pedal firmly.
2. Pull the parking brake lever up to its fullest extent.

Note: If you park your vehicle on a hill and facing uphill, move the transmission selector lever to position **P** and turn the steering wheel away from the curb.

Note: If you park your vehicle on a hill and facing downhill, move the transmission selector lever to position **P** and turn the steering wheel towards the curb.

To release the parking brake:

1. Press the brake pedal firmly.
2. Pull the lever up slightly.
3. Press the release button and push the lever down.

PRINCIPLES OF OPERATION

The traction control system helps avoid drive wheel spin and loss of traction.

If your vehicle begins to slide, the system applies the brakes to individual wheels and, when needed, reduces engine power at the same time. If the wheels spin when accelerating on slippery or loose surfaces, the system reduces engine power in order to increase traction.

USING TRACTION CONTROL

In certain situations (for example, stuck in snow or mud), turning the traction control off may be beneficial as this allows the wheels to spin with full engine power. Turn the traction control system off through the information display. See the *Information Displays* chapter.

System Indicator Lights and Messages

WARNING: If a failure has been detected within the Traction Control System, the stability control light will illuminate steadily. Verify that the Traction Control System was not manually disabled through the information display. If the stability control light still illuminates steadily, have the system serviced by an authorized dealer immediately. Operating your vehicle with Traction Control disabled could lead to an increased risk of loss of vehicle control, vehicle rollover, personal injury and death.



The stability control light temporarily illuminates on engine start-up and flashes when a driving condition activates the stability system.



The stability control off light temporarily illuminates on engine start-up and stays on when the traction control system is turned off.

When the traction control system is turned off or on, a message appears in the information display showing system status.

PRINCIPLES OF OPERATION

WARNING: Vehicle modifications involving braking system, aftermarket roof racks, suspension, steering system, tire construction or wheel and tire size may change the handling characteristics of the vehicle and may adversely affect the performance of the AdvanceTrac® system. In addition, installing any stereo loudspeakers may interfere with and adversely affect the AdvanceTrac® system. Install any aftermarket stereo loudspeaker as far as possible from the front center console, the tunnel, and the front seats in order to minimize the risk of interfering with the AdvanceTrac® sensors. Reducing the effectiveness of the AdvanceTrac® system could lead to an increased risk of loss of vehicle control, vehicle rollover, personal injury and death.



WARNING: Remember that even advanced technology cannot defy the laws of physics. It's always possible to lose control of a vehicle due to inappropriate driver input for the conditions. Aggressive driving on any road condition can cause you to lose control of your vehicle increasing the risk of personal injury or property damage. Activation of the AdvanceTrac® system is an indication that at least some of the tires have exceeded their ability to grip the road; this could reduce the operator's ability to control the vehicle potentially resulting in a loss of vehicle control, vehicle rollover, personal injury and death. If your AdvanceTrac® system activates, SLOW DOWN.

The AdvanceTrac® with Roll Stability Control™ system helps you keep control of your vehicle when on a slippery surface. The electronic stability control portion of the system helps avoid skids and lateral slides and roll stability control helps avoid a vehicle rollover. The traction control system helps avoid drive wheel spin and loss of traction. See the *Traction Control* chapter for details on traction control system operation.

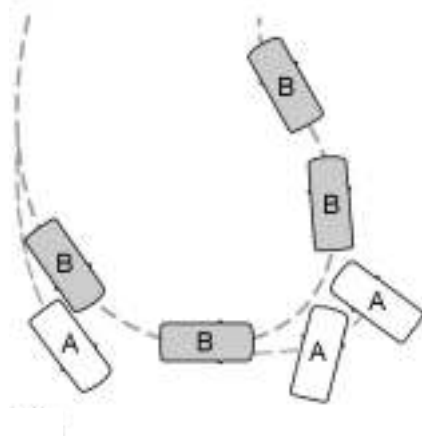

A Vehicle without AdvanceTrac® with RSC® skidding off its intended route.

B Vehicle with AdvanceTrac® with RSC® maintaining control on a slippery surface.

USING ADVANCETRAC® WITH RSC®

The system automatically activates when you start your engine. The AdvanceTrac® with RSC® system cannot be completely turned off, but the electronic stability control and roll stability control portions of the system are disabled when the transmission is in position **R**. You can turn the traction control portion of the system off independently. See the *Traction Control* chapter.

SENSING SYSTEM (IF EQUIPPED)

WARNING: To help avoid personal injury, please read and understand the limitations of the system as contained in this section. Sensing is only an aid for some (generally large and fixed) objects when moving in reverse on a flat surface at parking speeds. Traffic control systems, inclement weather, air brakes, and external motors and fans may also affect the function of the sensing system; this may include reduced performance or a false activation.



WARNING: To help avoid personal injury, always use caution when in R (Reverse) and when using the sensing system.



WARNING: This system is not designed to prevent contact with small or moving objects. The system is designed to provide a warning to assist the driver in detecting large stationary objects to avoid damaging the vehicle. The system may not detect smaller objects, particularly those close to the ground.



WARNING: Certain add-on devices such as large trailer hitches, bike or surfboard racks and any device that may block the normal detection zone of the system, may create false beeps.

Note: Keep the sensors (located on the bumper/fascia) free from snow, ice and large accumulations of dirt. If the sensors are covered, the system's accuracy can be affected. Do not clean the sensors with sharp objects.

Note: If your vehicle sustains damage to the bumper/fascia, leaving it misaligned or bent, the sensing zone may be altered causing inaccurate measurement of obstacles or false alarms.

Note: If your vehicle is equipped with MyKey®, it is possible to prevent turning the sensing system off. Refer to the *MyKey®* chapter.

The sensing system warns the driver of obstacles within a certain range of the bumper area. The system turns on automatically whenever the ignition is switched on.

When receiving a detection warning, the radio volume is reduced to a predetermined level. After the warning goes away, the radio volume returns to the previous level.

Using the Front and Rear Sensing System***Rear Sensing System***

The rear sensors are only active when the transmission is in **R**. As the vehicle moves closer to the obstacle, the rate of the audible warning increases. When the obstacle is fewer than 12 inches (30 centimeters) away, the warning sounds continuously. If a stationary or receding object is detected farther than 12 inches (30 centimeters) from the side of the vehicle, the tone sounds for only three seconds. Once the system detects an object approaching, the warning sounds again.

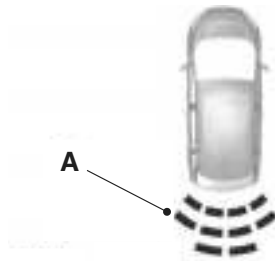

A. Coverage area of up to 6 feet (2 meters) from the rear bumper (with a decreased coverage area at the outer corners of the bumper).

The system detects certain objects while the transmission is in **R**:

- and moving toward a stationary object at a speed of 3 mph (5 km/h) or less.
- but not moving, and a moving object is approaching the rear of the vehicle at a speed of 3 mph (5 km/h) or less.
- and moving at a speed of less than 3 mph (5 km/h) and a moving object is approaching the rear of the vehicle at a speed of less than 3 mph (5 km/h).

Front Sensing System

The front sensors are active when the gearshift is in any position other than P (Park) or N (Neutral) and the vehicle speed is below 7 mph (12 km/h).

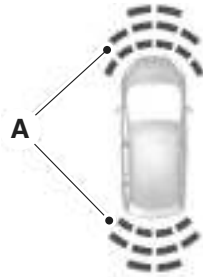

A. Coverage area of up to 27 inches (70 centimeters) from the front of the vehicle and about 6–14 inches (15–35 centimeters) to the side of the front end of the vehicle. Refer to the reverse sensing section for details on coverage area.

The system sounds an audible warning when obstacles are near either bumper in the following manner:

- Objects detected by the front sensors are indicated by a high-pitched tone from the front radio speakers.
- Objects detected by the rear sensors are indicated by a lower pitched tone from the rear radio speakers.
- The sensing system reports the obstacle which is closest to the front or rear of the vehicle. For example, if an obstacle is 24 inches (60 centimeters) from the front of the vehicle and, at the same time, an obstacle is only 16 inches (40 centimeters) from the rear of the vehicle, the lower pitched tone sounds.
- An alternating warning sounds from the front and rear if there are objects at both bumpers that are closer than 10 inches (25 centimeters).

For specific information on the reverse sensing portion of the system, refer to that section.

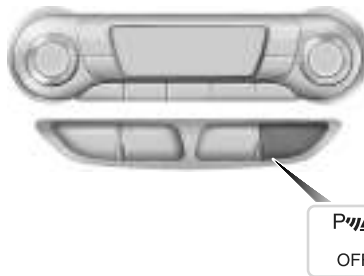

Press the button to switch the system off. It will remain off for the entire ignition cycle.

ACTIVE PARK ASSIST (IF EQUIPPED)

WARNING: This system is designed to be a supplementary park aid. It may not work in all conditions and is not intended to replace the driver's attention and judgment. The driver is responsible for avoiding hazards and maintaining a safe distance and speed, even when the system is in use.

Note: The driver is always responsible for controlling the vehicle, supervising the system and intervening if required.

The system detects an available parallel parking space and automatically steers the vehicle into the space (hands-free) while you control the accelerator, gearshift and brakes. The system visually and/or audibly instructs the driver to park the vehicle.

The system may not function correctly if something passes between the front bumper and the parking space (i.e. a pedestrian or cyclist) or if the edge of the neighboring parked vehicle is high from the ground (i.e. a bus, tow truck or flatbed truck).

Note: The sensors may not detect objects in heavy rain or other conditions that cause disruptive reflections.

Note: The sensors may not detect objects with surfaces that absorb ultrasonic waves.

The system should not be used if:

- a foreign object (i.e. bike rack or trailer) is attached to the front or rear of the vehicle or at another location close to the sensors.
- an overhanging object (i.e. surfboard) is attached to the roof.
- the front bumper or side sensors are damaged (i.e. in a collision) or obstructed by a foreign object (i.e. front bumper cover).
- a mini-spare tire is in use.

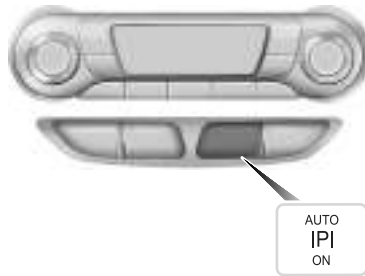
Using Active Park Assist

Press the button; the touch screen displays a message and a corresponding graphic to indicate it's searching for a parking space. Use the turn signal to indicate which side of the vehicle you want the system to search on.

Note: If the turn signal is not on, the system automatically searches on the vehicle's passenger side.



When a suitable space is found, the touch screen displays a message and a chime sounds. Slow down and stop at approximately position (A), then follow the instructions on the touch screen.

Note: You must observe that the selected space remains clear of obstructions at all times in the maneuver.

Note: Vehicles with overhanging loads (e.g. a bus or a truck), street furniture and other items may not be detected by active park assist. You must ensure the selected space is suitable for parking.

Note: The vehicle should be driven as parallel to other vehicles as possible while passing a parking space.

Note: The system always offers the last detected parking space (i.e. if the vehicle detects multiple spaces while you are driving, it offers the last one).

Note: If driven above approximately 20 mph (35 km/h), the touch screen shows a message to alert the driver to reduce vehicle speed.

Automatic Steering into Parking Space

Note: If vehicle speed exceeds 7 mph (12 km/h), the system turns off and you need to take full control of the vehicle.

Note: If a maneuver is interrupted before completion, the system turns off. The steering wheel position will not indicate the actual position of the steering and you have to full take control of the vehicle. In some instances a message may appear that would allow you to resume the maneuver.

With hands off the wheel (and nothing obstructing its movement) and the transmission in R (Reverse), the vehicle steers itself as instructions to safely move the vehicle back and forward in the space are displayed in the touch screen. While reversing, the touch screen displays a message instructing the driver to check their surroundings (for safety reasons) and to back-up slowly, accompanied by a corresponding graphic.



When you think the vehicle has enough space in front and behind it, or you hear a solid tone from the parking aid, bring the vehicle to a complete stop.



When automatic steering is finished, the touch screen displays a message indicating that the active park assist process is done. The driver is responsible for checking the parking job and making any necessary corrections before putting the transmission in P (Park).

Deactivating the Park Assist Feature

The system can be deactivated manually by:

- pressing the active park assist button
- grabbing the steering wheel
- driving above approximately 20 mph (35 km/h) for 30 seconds during an active park search
- driving above 7 mph (12 km/h) during automatic steering
- turning off the traction control system.

Certain vehicle conditions can also deactivate the system:

- Traction control has activated on a slippery or loose surface.
- Anti-lock brake system activation or failure.
- Any door (except the driver's) opens.
- Something touches the steering wheel.

If a problem occurs with the system, a warning message is displayed, followed by a chime. Occasional active park assist messages may occur in normal operation. For recurring or frequent active park assist faults, contact an authorized dealer to have your vehicle serviced.

Troubleshooting the System

The system does not look for a space
The traction control system may be off
Any door (except the driver's) may not be completely closed
The system does not offer a particular space
Something may be contacting the front bumper or side sensors
There is not enough room on both sides of the vehicle in order to park
There is not enough space for the parking maneuver on the opposite side of the parking space
The vehicle is farther than 5 ft (1.5 m) from the parking space
The vehicle is closer than 16 in. (40 cm) from neighboring parked vehicles
The transmission is in R (Reverse); the vehicle must be moving forward to detect a parking space

The system does not position the vehicle where I want in the space
The vehicle is rolling in the opposite direction of the transmission (i.e. rolling forward when R [Reverse] is selected)
The transmission is in R (Reverse); the vehicle must be moving forward to detect a parking space
An irregular curb along the parking space prevents the system from aligning the vehicle properly
Vehicles or objects bordering the space may not be positioned correctly
The vehicle was pulled too far past the parking space. The system performs best when you drive the same distance past the parking space
The tires may not be installed or maintained correctly (i.e. not inflated correctly, improper size, or of different sizes)
A repair or alteration has changed detection capabilities
A parked vehicle has a high attachment (i.e. salt sprayer, snowplow, moving truck bed, etc.)
The parking space length or position of parked objects changed after your vehicle passed
The temperature around your vehicle changes quickly (i.e. driving from a heated garage into the cold, or after leaving a car wash)

REAR VIEW CAMERA SYSTEM (IF EQUIPPED)

 **WARNING:** The rear view camera system is a reverse aid supplement device that still requires the driver to use it in conjunction with the interior and exterior mirrors for maximum coverage.

 **WARNING:** Objects that are close to either corner of the bumper or under the bumper, might not be seen on the screen due to the limited coverage of the camera system.

 **WARNING:** Back up as slow as possible since higher speeds might limit your reaction time to stop the vehicle.

 **WARNING:** Use caution when using the rear video camera and the liftgate is ajar. If the liftgate is ajar, the camera will be out of position and the video image may be incorrect. All guidelines (if enabled) have been removed when the liftgate is ajar.

 **WARNING:** Use caution when turning camera features on or off while in R (Reverse). Make sure the vehicle is not moving.

The rear view camera system provides a video image of the area behind the vehicle.

During operation, lines appear in the display which represent your vehicle's path and proximity to objects behind the vehicle.



The camera is located on the liftgate.

Using the Rear View Camera System

The rear view camera system displays what is behind your vehicle when you place the transmission in R (Reverse). The system uses three types of guides to help you see what is behind your vehicle:

1. Active guidelines: Show the intended path of the vehicle when reversing.
2. Fixed guidelines: Show the actual path the vehicle is moving in while reversing in a straight line, which can be helpful when backing into a parking space or aligning the vehicle with another object behind the vehicle.
3. Centerline: Helps align the center of the vehicle with an object (i.e. a trailer).

Note: If the transmission is in R (Reverse) and the trunk/liftgate is ajar, no rear view camera features are displayed.

Note: If the image comes on while the transmission is not in R (Reverse), have the system inspected by your authorized dealer.

Note: When towing, the camera only sees what is being towed behind the vehicle. This might not provide adequate coverage as it usually provides in normal operation and some objects might not be seen. In some vehicles, the guidelines may disappear once the trailer tow connector is engaged.

Note: The camera may not operate correctly under the following conditions:

- Nighttime or dark areas if one or both reverse lamps are not operating. Do not use the rear view camera display when lighting is low until both reverse lamps are functional.
- The camera's view is obstructed by mud, water or debris. Clean the lens with a soft, lint-free cloth and non-abrasive cleaner.
- The rear of the vehicle is hit or damaged, causing the camera to become misaligned. Check with your authorized dealer to have the rear view camera system checked for proper coverage and operation.

Adjusting the Rear View Camera Settings (If Equipped)

To access any of the rear view camera system settings, make the following selections in the touch screen when the transmission is not in R (Reverse):

1. Menu
2. Vehicle
3. Rear View Camera

After changing a system setting, the touch screen shows a preview of the feature(s) selected.

Guidelines and the Centerline

Note: Fixed guidelines and active guidelines (if equipped) are only available when the transmission is in R (Reverse).

Note: The centerline is only available if Fixed or Active (if equipped) guidelines are on.

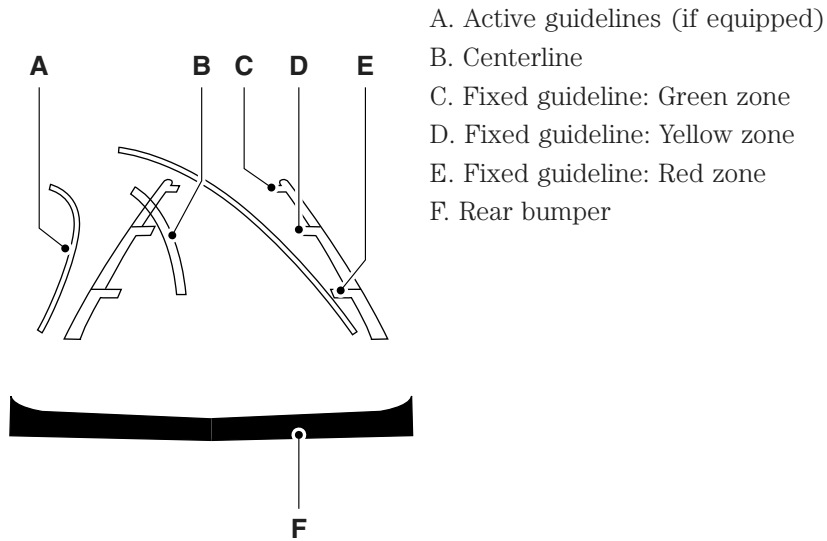

If your vehicle is equipped with active guidelines they are only shown with fixed guidelines. To use active guidelines, turn the steering wheel to point the guidelines toward an intended path. If the steering wheel position is changed while reversing, the vehicle might deviate from the original intended path.

The fixed and active guidelines fade in and out depending on the steering wheel position. When the steering wheel position is straight, the active guidelines are not shown.

Always use caution while reversing. Objects in the red zone are closest to your vehicle and objects in the green zone are further away. Objects are getting closer to your vehicle as they move from the green zone to the yellow or red zones. Use the side view mirrors and rear view mirror to get better coverage on both sides and rear of the vehicle.

Selectable settings for this feature are ACTIVE + FIXED, FIXED and OFF.

Visual Park Aid Alert

Note: Visual park alert is only available when the transmission is in R (Reverse).

Note: The reverse sensing system is not effective at speeds above 3 mph (5 km/h) and may not detect certain angular or moving objects.

The visual park aid alert allows the driver to view the area that is being detected by the reverse sensing system. The system uses red, yellow and green highlights which appear on top of the video image when an object is detected by the reverse sensing system. The alert highlights the closest object detected. The reverse sensing alert can be disabled and if visual park aid alert is enabled, highlighted areas are still displayed.

Selectable settings for this feature are ON and OFF.

Manual Zoom

WARNING: When manual zoom is on, the full area behind the vehicle is not shown. Be aware of your surroundings when using the manual zoom feature.

Note: Manual zoom is only available when the transmission is in R (Reverse).

Note: When manual zoom is enabled, only the centerline is shown.

Allows the driver to get a closer view of an object behind the vehicle. The zoomed image keeps the bumper in the image to provide a reference. The zoom is only active while the transmission is in R (Reverse). When the transmission is shifted out of R (Reverse), the feature automatically turns off and must be reset when it is used again.

Selectable settings for this feature are OFF, Level 1, Level 2 or Level 3. Press the up and down arrows to change the view. The selection level appears between the buttons (i.e. Level 1). The default setting for the manual zoom is OFF.

Rear Camera Delay

When shifting the transmission out of R (Reverse) and into any gear other than P (Park), the camera image remains in the display until the vehicle speed reaches 6 mph (10 km/h). This occurs when the rear camera delay feature is on, or until a radio button is selected.

Selectable settings for this feature are ON and OFF. The default setting for the rear camera delay is OFF.

PRINCIPLES OF OPERATION

Cruise control lets you maintain a set speed without keeping your foot on the accelerator pedal.

USING CRUISE CONTROL

WARNING: Do not use cruise control in heavy traffic or on roads that are winding, slippery or unpaved.

Note: Vehicle speed may vary momentarily when driving up or down a steep hill. Apply the brakes if your vehicle speed increases above the set speed while driving downhill.

Note: Cruise control will disengage if your vehicle speed decreases more than 10 mph (16 km/h) below your set speed while driving uphill.



The cruise controls are located on the steering wheel.

Switching Cruise Control On

Press and release **ON**.



The indicator will appear in the instrument cluster.

Setting a Speed

1. Accelerate to the desired speed.
2. Press and release **SET+**.
3. Take your foot off the accelerator pedal.

Changing the Set Speed

- Press and hold **SET+** or **SET-**. Release the control when you reach the desired speed.
- Press and release **SET+** or **SET-**. The set speed will change in approximately 1 mph (2 km/h) increments.
- Press the accelerator or brake pedal until you reach the desired speed. Press and release **SET+**.

Canceling the Set Speed

Pull **CAN** toward you and release, tap the brake pedal or press the clutch pedal. You will not erase the set speed.

Note: When you use the clutch pedal to cancel a set speed, the engine speed may briefly increase.

Resuming the Set Speed

Pull **RES** toward you and release.

Switching Cruise Control Off

Note: You will erase the set speed if you switch the system off.

Press and release **OFF** or switch the ignition off.

STEERING**Electric Power Steering**

WARNING: The electric power steering system has diagnostic checks that continuously monitor the system to ensure proper operation. When a system error is detected a steering message will appear in the information display.



WARNING: The electric power steering system has diagnostic checks that continuously monitor the system to ensure proper operation of the electronic system. When an electronic error is detected, a message will be displayed in the information display. If this happens, stop the vehicle in a safe place, and turn off the engine. After at least 10 seconds, reset the system by restarting the engine, and watch the information display for a steering message. If a steering message returns, or returns while driving, take the vehicle to your dealer to have it checked.



WARNING: Obtain immediate service if a system error is detected. You may not notice any difference in the feel of your steering, but a serious condition may exist. Failure to do so may result in loss of steering control.

Your vehicle is equipped with an electric power-assisted steering system. There is no fluid reservoir to check or fill.

If your vehicle loses electrical power while you are driving (or if the ignition is turned off), you can steer the vehicle manually, but it takes more effort. Extreme continuous steering may increase the effort it takes for you to steer. This occurs to prevent internal overheating and permanent damage to your steering system. If this should occur, you will neither lose the ability to steer the vehicle manually nor will it cause permanent damage. Typical steering and driving maneuvers will allow the system to cool and steering assist will return to normal.

When a steering system error is detected, steering messages may appear in the information display.

Steering Tips

If the steering wanders or pulls, check for:

- an improperly inflated tire
- uneven tire wear
- loose or worn suspension components
- loose or worn steering components
- improper vehicle alignment

A high crown in the road or high crosswinds may also make the steering seem to wander/pull.

REAR UNDER FLOOR STORAGE

The under floor storage compartments are located in front of the rear seats. Make sure the lids are secure before driving.

LUGGAGE COVERS (IF EQUIPPED)

WARNING: Make sure that the posts are properly latched in mounting features. The cover may cause injury in a sudden stop or accident if it is not securely installed.



WARNING: Do not place any objects on the cargo area shade. They may obstruct your vision or strike occupants of vehicle in the case of a sudden stop or collision.

Use the shade to cover items in the cargo area of your vehicle.



Insert the ends of the cargo shade into the mounting features located behind the rear seat on the rear trim panels to install the shade.

To operate the shade:

1. Pull the rear edge of the cargo shade rearward, below and past the retention slots.
2. Lift the shade up and secure both ends of the support rod into the

retention slots located on the rear quarter trim panels.



Remove the cargo shade by pressing the release lever on each side forward, then lifting the shade out of the mounting feature. You will see a red mark when the lever is unlatched.

LOAD LIMIT

Vehicle loading

This section will guide you in the proper loading of your vehicle to keep your loaded vehicle weight within its design rating capability. Properly loading your vehicle will provide maximum return of vehicle design performance. Before loading your vehicle, familiarize yourself with the following terms for determining your vehicle's weight ratings from the vehicle's Tire Label or Safety Compliance Certification Label:

Base Curb Weight – is the weight of the vehicle including a full tank of fuel and all standard equipment. It does not include passengers, cargo, or optional equipment.

Vehicle Curb Weight – is the weight of your new vehicle when you picked it up from your authorized dealer plus any aftermarket equipment.



Payload – is the combined weight of cargo and passengers that the vehicle is carrying. The maximum payload for your vehicle can be found on the Tire Label on the B-Pillar or the edge of the driver’s door (vehicles exported outside the US and Canada may not have a Tire Label). Look for **“THE COMBINED WEIGHT OF OCCUPANTS AND CARGO SHOULD NEVER EXCEED XXX kg OR XXX lb.”** for maximum payload. The payload listed on the Tire Label is the maximum payload for the vehicle as built by the assembly plant. If any aftermarket or authorized-dealer installed equipment has been installed on the vehicle, the weight of the equipment must be subtracted from the payload listed on the Tire Label in order to determine the new payload.



WARNING: The appropriate loading capacity of your vehicle can be limited either by volume capacity (how much space is available) or by payload capacity (how much weight the vehicle should carry). Once you have reached the maximum payload of your vehicle, do not add more cargo, even if there is space available. Overloading or improperly loading your vehicle can contribute to loss of vehicle control and vehicle rollover.

Example only:

TIRE AND LOADING INFORMATION

SEATING CAPACITY	TOTAL 5	FRONT 2	REAR 3
------------------	---------	---------	--------

The combined weight of occupants and cargo should never exceed : **XXX kg or XXX lbs.**

TIRE	SIZE	COLD TIRE PRESSURE	SEE OWNERS MANUAL FOR ADDITIONAL INFORMATION
FRONT	LT225/75R 16.5E	200 KPA, 29 PSI	
REAR	LT225/75R 16.5E	200 KPA, 29 PSI	
SPARE	T145/80D16 P225/60R17	420 KPA, 60 PSI 200 KPA, 29 PSI	

TIRE AND LOADING INFORMATION
RENSEIGNEMENTS SUR LES PNEUS ET LE CHARGEMENT

SEATING CAPACITY	TOTAL 5	FRONT 2	REAR 3
NOMBRE DE PLACES		AVANT	ARRIÈRE

The combined weight of occupants and cargo should never exceed **492 kg or 1085 lbs.**
Le poids total des occupants et du chargement ne doit jamais dépasser **492 kg ou 1085 lb.**

TIRE PNEU	SIZE DIMENSIONS	COLD TIRE PRESSURE PRESSION DES PNEUS A FROID	SEE OWNER'S MANUAL FOR ADDITIONAL INFORMATION VOIR LE MANUEL DE L'USAGER POUR PLUS DE RENSEIGNEMENTS
FRONT AVANT	P235/70R16	240 KPA, 35 PSI	
REAR ARRIERE	P235/70R16	240 KPA, 35 PSI	
SPARE DE SECOURS	T145/90R17	415 KPA, 60 PSI	

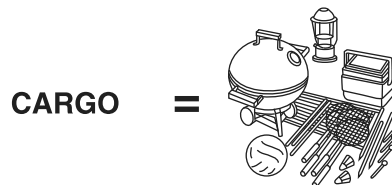

Cargo Weight – includes all weight added to the Base Curb Weight, including cargo and optional equipment.

GAW (Gross Axle Weight) – is the total weight placed on each axle (front and rear) – including vehicle curb weight and all payload.

GAWR (Gross Axle Weight Rating) – is the maximum allowable weight that can be carried by a single axle (front or rear). **These numbers are shown on the Safety Compliance Certification Label. The label shall be affixed to either the door hinge pillar, door-latch post, or the door edge that meets the door-latch post, next to the driver’s seating position. The total load on each axle must never exceed its GAWR.**

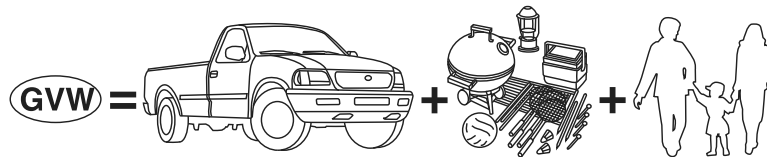

GVW (Gross Vehicle Weight) – is the Vehicle Curb Weight + cargo + passengers.

GVWR (Gross Vehicle Weight Rating) – is the maximum allowable weight of the fully loaded vehicle (including all options, equipment, passengers and cargo). **The GVWR is shown on the Safety Compliance Certification Label. The label shall be affixed to either the door hinge pillar, door-latch post, or the door edge that meets the door-latch post, next to the driver’s seating position. The GVW must never exceed the GVWR.**

- Example only:

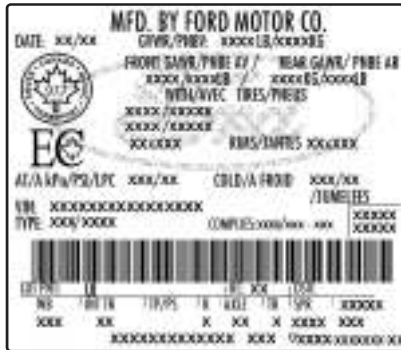
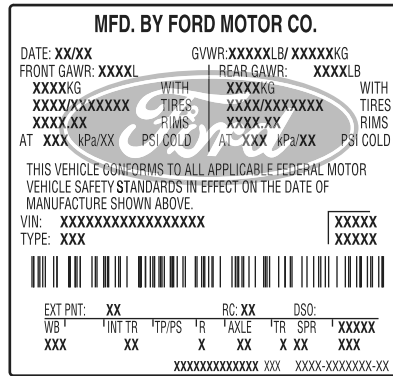

WARNING: Exceeding the Safety Compliance Certification Label vehicle weight rating limits could result in substandard vehicle handling or performance, engine, transmission and/or structural damage, serious damage to the vehicle, loss of control and personal injury.

WARNING: Do not exceed the GVWR or the GAWR specified on the Safety Compliance Certification Label.



WARNING: Do not use replacement tires with lower load carrying capacities than the original tires because they may lower the vehicle's GVWR and GAWR limitations. Replacement tires with a higher limit than the original tires do not increase the GVWR and GAWR limitations.



WARNING: Exceeding any vehicle weight rating limitation could result in serious damage to the vehicle and/or personal injury.

Steps for determining the correct load limit:

1. Locate the statement "The combined weight of occupants and cargo should never exceed XXX kg or XXX lbs." on your vehicle's placard.
2. Determine the combined weight of the driver and passengers that will be riding in your vehicle.
3. Subtract the combined weight of the driver and passengers from XXX kg or XXX lbs.
4. The resulting figure equals the available amount of cargo and luggage load capacity. For example, if the "XXX" amount equals 1,400 lbs. and there will be five 150 lb. passengers in your vehicle, the amount of available cargo and luggage load capacity is 650 lbs. ($1400 - 750$ (5×150) = 650 lb.). In metric units ($635 - 340$ (5×68) = 295 kg.)
5. Determine the combined weight of luggage and cargo being loaded on the vehicle. That weight may not safely exceed the available cargo and luggage load capacity calculated in Step 4.

The following gives you a few examples on how to calculate the available amount of cargo and luggage load capacity:

- Suppose your vehicle has a 1400 lb. (635 kg) cargo and luggage capacity. You decide to go golfing. Is there enough load capacity to carry you, 4 of your friends and all the golf bags? You and four friends average 220 lb. (99 kg) each and the golf bags weigh approximately 30 lb. (13.5 kg) each. The calculation would be: $1400 - (5 \times 220) - (5 \times 30) = 1400 - 1100 - 150 = 150$ lb. Yes, you have enough load capacity in your vehicle to transport four friends and your golf bags. In metric units, the calculation would be: $635 \text{ kg} - (5 \times 99 \text{ kg}) - (5 \times 13.5 \text{ kg}) = 635 - 495 - 67.5 = 72.5$ kg.

- Suppose your vehicle has a 1400 lb. (635 kg) cargo and luggage capacity. You and one of your friends decide to pick up cement from the local home improvement store to finish that patio you have been planning for the past 2 years. Measuring the inside of the vehicle with the rear seat folded down, you have room for 12-100 lb. (45 kg) bags of cement. Do you have enough load capacity to transport the cement to your home? If you and your friend each weigh 220 lb. (99 kg), the calculation would be: $1400 - (2 \times 220) - (12 \times 100) = 1400 - 440 - 1200 = -240$ lb. No, you do not have enough cargo capacity to carry that much weight. In metric units, the calculation would be: $635 \text{ kg} - (2 \times 99 \text{ kg}) - (12 \times 45 \text{ kg}) = 635 - 198 - 540 = -103$ kg. You will need to reduce the load weight by at least 240 lb. (104 kg). If you remove 3-100 lb. (45 kg) cement bags, then the load calculation would be:
 $1400 - (2 \times 220) - (9 \times 100) = 1400 - 440 - 900 = 60$ lb. Now you have the load capacity to transport the cement and your friend home. In metric units, the calculation would be: $635 \text{ kg} - (2 \times 99 \text{ kg}) - (9 \times 45 \text{ kg}) = 635 - 198 - 405 = 32$ kg.

The above calculations also assume that the loads are positioned in your vehicle in a manner that does not overload the Front or the Rear Gross Axle Weight Rating specified for your vehicle on the Safety Compliance Certification Label. The label shall be affixed to either the door hinge pillar, door-latch post, or the door edge that meets the door-latch post, next to the driver's seating position.

TOWING A TRAILER

WARNING: Never tow a trailer with this vehicle. Your vehicle is not equipped to tow. No towing packages are available through an authorized dealer.

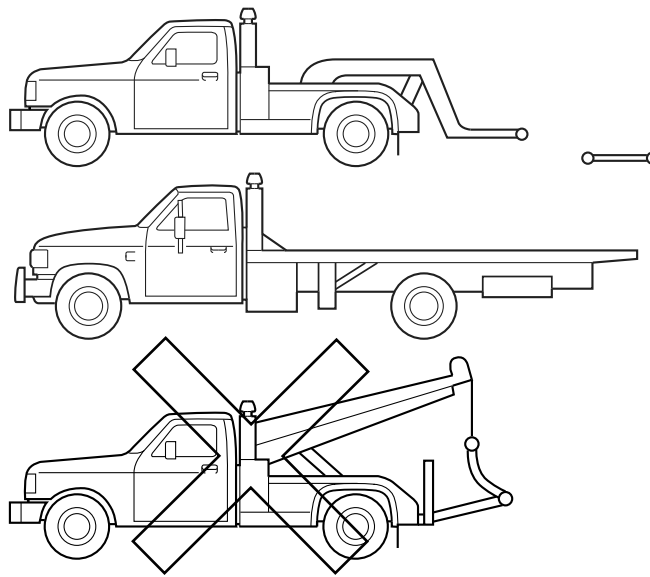
TRANSPORTING THE VEHICLE

If you need to have your vehicle towed, contact a professional towing service or, if you are a member of a roadside assistance program, your roadside assistance service provider.

We recommend the use of a wheel lift and dollies or flatbed equipment to tow your vehicle. Do not tow with a slingbelt. Ford Motor Company has not approved a slingbelt towing procedure. Vehicle damage may occur if towed incorrectly, or by any other means.

Ford Motor Company produces a towing manual for all authorized tow truck operators. Have your tow truck operator refer to this manual for proper hook-up and towing procedures for your vehicle.

It is acceptable to have your vehicle towed from the front if using proper wheel lift equipment to raise the front wheels off the ground. When towing in this manner, the rear wheels can remain on the ground.

The front wheels must be on a tow dolly when towing your vehicle from the rear using wheel lift equipment. This prevents damage to the transmission.

TOWING THE VEHICLE ON FOUR WHEELS

Emergency Towing

If your vehicle becomes inoperable (without access to wheel dollies, car-hauling trailer, or flatbed transport vehicle), it can be flat-towed (all wheels on the ground, regardless of the powertrain and transmission configuration) under the following conditions:

- Your vehicle is facing forward for towing in a forward direction.
- Place the transmission in position **N**. See *Automatic transmission* in the *Transmission* chapter if you cannot move the transmission into **N**.
- Maximum speed is 35 mph (56 km/h).
- Maximum distance is 50 miles (80 kilometers).

Recreational Towing

Note: Put your climate control system in recirculated air mode to prevent exhaust fumes from entering your vehicle. See the *Climate Control* chapter.

Follow these guidelines if you have a need for recreational towing, such as towing your vehicle behind a motorhome. We designed these guidelines to prevent damage to your transmission.

You can tow your vehicle with all four wheels on the ground or with the front wheels off the ground by using a tow dolly. If you are using a tow dolly, follow the instructions specified by the equipment provider. If you are towing with all four wheels on the ground, see the following instructions.

If you tow your vehicle with all four wheels on the ground:

- Tow only in the forward direction.
- Release the parking brake.
- Place the transmission in position **N**.
- Place the ignition in the accessory mode. See the *Starting and Stopping the Engine* chapter.
- Do not exceed 70 mph (113 km/h).
- Place the transmission in position **P**, start the engine and allow it to run for one minute at the beginning of each day (you may need to press the accelerator pedal in order to start the engine). After allowing the engine to run, place the transmission back into position **N** and the ignition in the accessory position.

BREAKING-IN

You need to break in new tires for approximately 300 miles (480 kilometers). During this time, your vehicle may exhibit some unusual driving characteristics. The engine also needs to break in. Avoid hard accelerations and driving too fast for the first 1000 miles. If possible, avoid carrying heavy loads up steep grades during the break-in period.

ECONOMICAL DRIVING

Fuel economy is affected by several things such as how you drive, the conditions you drive under and how you maintain your vehicle.

There are some things to keep in mind that may improve your fuel economy:

- Accelerate and slow down in a smooth, moderate fashion.
- Drive at steady speeds.
- Anticipate stops; slowing down may eliminate the need to stop.
- Combine errands and minimize stop-and-go driving. (When running errands, go to the furthest destination first and then work your way back home.)
- Close the windows for high-speed driving.
- Drive at reasonable speeds. (Traveling at 65 miles per hour/105 kilometers per hour uses about 15 percent less fuel than traveling at 75 miles per hour/121 kilometers per hour).
- Keep the tires properly inflated and use only the recommended size.
- Use the recommended engine oil.
- Perform all regularly scheduled maintenance.

There are also some things you may want to avoid doing because they reduce your fuel economy:

- Avoid sudden or hard accelerations.
- Avoid revving the engine before turning off the car.
- Avoid long idle periods.
- Do not warm up your vehicle on cold mornings.
- Reduce the use of air conditioning and heat.
- Avoid using speed control in hilly terrain.

- Do not rest your foot on the brake pedal while driving.
- Avoid carrying unnecessary weight (approximately 1 mile per gallon [0.4 kilometers per liter] is lost for every 400 pounds [180 kilograms] of weight carried).
- Avoid adding particular accessories to your vehicle (e.g. bug deflectors, rollbars/light bars, running boards, ski racks).
- Avoid driving with the wheels out of alignment.

DRIVING THROUGH WATER

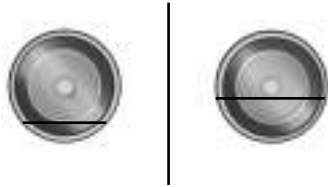

If driving through deep or standing water is unavoidable, proceed very slowly. Never drive through water that is higher than the bottom of the wheel rims (for cars) or the bottom of the hubs (for trucks).

When driving through water, traction or brake capability may be limited. Also, water may enter your engine's air intake and severely damage your engine or your vehicle may stall.

Note: Driving through deep water where the transmission vent tube is submerged may allow water into the transmission and cause internal transmission damage.

Note: Once through the water, always dry the brakes by moving your vehicle slowly while applying light pressure on the brake pedal. Wet brakes do not stop the vehicle as quickly as dry brakes.

FLOOR MATS

! **WARNING:** Always use floor mats that are designed to fit the footwell of your vehicle. Only use floor mats that leave the pedal area unobstructed. Only use floor mats that are firmly secured to retention posts so that they cannot slip out of position and interfere with the pedals or impair safe operation of your vehicle in other ways.

- Pedals that cannot move freely can cause loss of vehicle control and increase the risk of serious personal injury.
- Always make sure that the floor mats are properly attached to the retention posts in the carpet that are supplied with your vehicle. Floor mats must be properly secured to both retention posts to ensure mats do not shift out of position.
- Never place floor mats or any other covering in the vehicle footwell that cannot be properly secured to prevent them from moving and interfering with the pedals or the ability to control the vehicle.
- Never place floor mats or any other covering on top of already installed floor mats. Floor mats should always rest on top of the vehicle carpeting surface and not another floor mat or other covering. Additional floor mats or any other covering will reduce the pedal clearance and potentially interfere with pedal operation.

**WARNING** *(Continued)*

- Check attachment of floor mats on a regular basis. Always properly reinstall and secure floor mats that have been removed for cleaning or replacement.
- Always make sure that objects cannot fall into the driver footwell while the vehicle is moving. Objects that are loose can become trapped under the pedals causing a loss of vehicle control.
- Failure to properly follow floor mat installation or attachment instructions can potentially cause interference with pedal operation causing loss of control of vehicle.
- To install floor mats, position the floor mat so that the eyelet is over the retention post and press down to lock in.
- To remove the floor mat, reverse the installation procedure.

In the event of damage or fire involving an electric vehicle (EV) or hybrid-electric vehicle (HEV):

- Always assume the high-voltage battery and associated components are energized and fully charged.
- Exposed electrical components, wires, and high-voltage batteries present potential high-voltage shock hazards.
- Venting/off-gassing high-voltage battery vapors are potentially toxic and flammable.
- Physical damage to the vehicle or high-voltage battery may result in immediate or delayed release of toxic and/or flammable gases and fire.

Vehicle information and general safety practices:

- Know the make and model of your vehicle.
- Review the Owner's Manual and become familiar with your vehicle's safety information and recommended safety practices.
- Do not attempt to repair damaged electric and hybrid-electric vehicles yourself. Contact an authorized Ford Dealer or vehicle manufacturer representative for service.

Crashes

A crash or impact significant enough to require an emergency response for conventional vehicles would also require the same response for an electric or hybrid-electric vehicle.

If possible

- Move your car to a safe, nearby location and remain on the scene.
- Roll down windows before shutting vehicle off.
- Place vehicle in Park, set parking brake, turn off the vehicle, activate hazard lights, and move key(s) at least 16 feet (5 meters) away from the vehicle.

Always

- Call 911 if assistance is needed and advise that an electric or hybrid-electric vehicle is involved.
- Do not touch exposed electrical components or the engine compartment, as a shock hazard may exist.
- Avoid contact with leaking fluids and gases, and remain out of the way of oncoming traffic until emergency responders arrive.
- When emergency responders arrive, tell them that the vehicle involved is an electric vehicle or hybrid-electric vehicle.

Fires

As with any vehicle, call 911 immediately if you see sparks, smoke, or flames coming from the vehicle.

- Exit the vehicle immediately.
- Advise 911 that an electric or hybrid-electric vehicle is involved.
- As with any vehicle fire, do not inhale smoke, vapors, or gas from the vehicle, as they may be hazardous.
- Remain a safe distance upwind and uphill from the vehicle fire.
- Stay out of the roadway and stay out of the way of any oncoming traffic while awaiting the arrival of emergency responders.

Post-Incident

- Do not store a severely damaged vehicle with a lithium-ion battery inside a structure or within 50 feet (15 meters) of any structure or vehicle.
- Ensure that passenger and cargo compartments remain ventilated (i.e., open door, trunk or liftgate).
- For vehicles in the United States, notify Ford Motor Company 1-800-392-3673 (then follow the prompts on the voice response menu), an authorized Ford dealer or service center as soon as possible as there may be other steps to secure and/or discharge the HV battery.
- For vehicles in Canada, notify Ford Motor Company 1-800-565-3673 (then follow the prompts on the voice response menu), an authorized Ford dealer or service center as soon as possible as there may be other steps to secure and/or discharge the HV battery.
- Call 911 if you observe leaking fluids, sparks, smoke, or flames, or hear gurgling or bubbling from the HV battery.

ROADSIDE ASSISTANCE**Vehicles Sold in the U.S.: Getting Roadside Assistance**

To fully assist you should you have a vehicle concern, Ford Motor Company offers a complimentary roadside assistance program.

This program is separate from the New Vehicle Limited Warranty.

The service is available:

- 24 hours a day, seven days a week
- for the coverage period listed on the Roadside Assistance Card included in your owner's manual portfolio.

Roadside assistance will cover:

- a flat tire change with a good spare (except vehicles that have been supplied with a tire inflation kit).
- battery jump start.
- lock-out assistance (key replacement cost is the customer's responsibility).
- fuel delivery – Independent Service Contractors, if not prohibited by state, local or municipal law, shall deliver up to 2.0 gallons (7.5 liters) of gasoline or 5.0 gallons (18.9 liters) of diesel fuel to a disabled vehicle. Fuel delivery service is limited to two no-charge occurrences within a 12-month period.
- winch out – available within 100 feet (30.5 meters) of a paved or county maintained road, no recoveries.
- towing – Ford and Lincoln eligible vehicles towed to an authorized dealer within 35 miles (56 kilometers) of the disablement location or to the nearest authorized dealer. If a member requests to be towed to an authorized dealer more than 35 miles (56 kilometers) from the disablement location, the member shall be responsible for any mileage costs in excess of 35 miles (56 kilometers).

Trailers shall be covered up to \$200 if the disabled eligible vehicle requires service at the nearest authorized dealer. If the trailer is disabled, but the towing vehicle is operational, the trailer does not qualify for any roadside services.

Vehicles Sold in the U.S.: Using Roadside Assistance

Complete the roadside assistance identification card and place it in your wallet for quick reference. This card is found in the owner's manual portfolio in the glove compartment.

U.S. Ford vehicle customers who require Roadside Assistance, call 1-800-241-3673.

If you need to arrange roadside assistance for yourself, Ford Motor Company will reimburse a reasonable amount for towing to the nearest dealership within 35 miles (56 kilometers). To obtain reimbursement information, U.S. Ford vehicle customers call 1-800-241-3673. Customers will be asked to submit their original receipts.

Vehicles Sold in Canada: Getting Roadside Assistance

Canadian customers who require roadside assistance, call 1-800-665-2006.

Vehicles Sold in Canada: Using Roadside Assistance

Complete the roadside assistance identification card and place it in your wallet for quick reference. In Canada, the card is found in the warranty information in the glove box.

Canadian roadside coverage and benefits may differ from the U.S. coverage. Please see your warranty information or visit our website at www.ford.ca for information on Canadian services and benefits.

Canadian customers who need to obtain roadside information, call 1-800-665-2006 or visit our website at www.ford.ca.

HAZARD WARNING FLASHERS

The hazard flasher control is located on the instrument panel by the radio. Use it when your vehicle is disabled and is creating a safety hazard for other motorists.

- Press the flasher control and all front and rear direction signals will flash.
- Press the flasher control again to turn them off.

Note: With extended use, the flashers may run down your 12-volt battery.

FUEL CUT-OFF SWITCH

WARNING: Failure to inspect and if necessary repair fuel leaks after a collision may increase the risk of fire and serious injury. Ford Motor Company recommends that the fuel system be inspected by an authorized dealer after any collision.

In the event of a moderate to severe collision, this vehicle is equipped with a fuel pump shut-off feature that stops the flow of fuel to the engine. Not every impact will cause a shutoff.

1. Turn the ignition off.
2. Turn the ignition to crank.
3. Turn the ignition to crank.
4. Turn the ignition on again to re-enable the fuel pump.

For vehicles equipped with a push button start system:

1. Press the START/STOP button to power the vehicle off.
2. Press the START/STOP button to power the vehicle on.
3. Repeat steps 1 and 2 to re-enable fuel pump.

HIGH VOLTAGE SHUT OFF

In the event of a crash:

- Take the same actions as you would take in a crash involving a gasoline-powered vehicle — exit the vehicle safely or await the assistance of an emergency responder if they are unable to get out on their own, move a safe distance away from the vehicle, and notify the authorities of the crash.
- If possible, inform emergency responders that the vehicle is electric powered.
- Vehicle owners should not store a severely damaged vehicle in a garage or near other vehicles.

The high voltage shut off operation shuts off power from the high voltage battery after a collision, or if your vehicle receives a substantial physical jolt.

To reactivate the vehicle after either event perform the following steps:

1. Press the START/STOP button to power the vehicle on.
2. Press the START/STOP button to power the vehicle off.
3. Press the START/STOP button to power the vehicle on again.

Note: After completing this process the vehicle will detect if the electrical system is safe and reactivate. Once your vehicle determines the electrical system safe you can start your vehicle as you would normally by pressing the brake in combination with the START/STOP button.

JUMP STARTING THE VEHICLE



WARNING: Batteries contain sulfuric acid which can burn skin, eyes and clothing, if contacted.

Note: Use only a 12 volt supply to start your vehicle.

Note: The high-voltage battery cannot be jumped with a standard 12 volt battery.

Note: Do not disconnect the battery of the disabled vehicle as this could damage the vehicle's electrical system. The 12 volt battery controls the switches and contacts that engage the high-voltage battery.

Preparing your vehicle

1. Park the booster vehicle close to the hood of the disabled vehicle making sure the two vehicles do not touch. Set the parking brake on both vehicles. Stay clear of any moving parts on both vehicles that can cause harm.
2. Check all battery terminals and remove any excessive corrosion before you attach the battery cables. Ensure that vent caps are tight and level.
3. Turn the heater fan on in both vehicles to protect from any electrical surges. Turn all other accessories off.

Connecting the Jumper Cables

 **WARNING:** Do not connect the end of the second cable to the negative (-) terminal of the battery to be jumped. A spark may cause an explosion of the gases that surround the battery or a surge of the battery.

Your vehicle has a 12 volt battery that has two prongs accessible from under the hood. Your vehicle can be jumped the same way conventional vehicles can be using these prongs. The illustration below shows the two connector prongs used for jump-starting your vehicle.

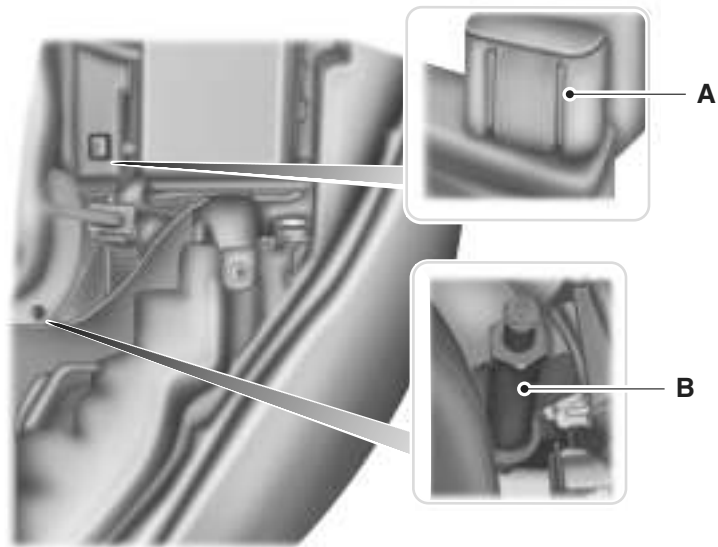

A. Positive prong (+)

B. Negative prong (-)

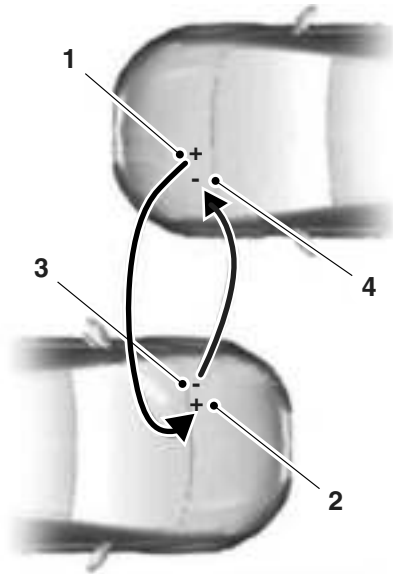

Note: In the illustration, the vehicle on the bottom is used to designate the assisting (boosting) battery.

Note: Remove the red cap from the positive prong (A) on your vehicle before connecting the cables.

1. Connect the positive (+) jumper cable to the positive (+) prong (A) of the discharged battery.
2. Connect the other end of the positive (+) cable to the positive (+) terminal of the assisting battery.
3. Connect the negative (-) cable to the negative (-) terminal of the assisting battery.
4. Make the final connection of the negative (-) cable to the negative (-) prong (B) of your vehicle.

Jump Starting

1. Start the engine of the booster vehicle and run the engine at a moderately increased speed.
2. Start the engine of the disabled vehicle.
3. Once the disabled vehicle has been started, run both engines for an additional three minutes before disconnecting the jumper cables.

Removing the Jumper Cables

Note: In the illustration, the vehicle on the bottom is used to designate the assisting (boosting) battery.

Remove the jumper cables in the reverse order that they were connected.

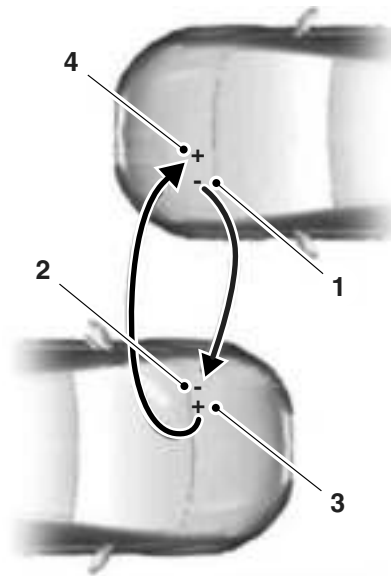

1. Remove the jumper cable from the negative (-) prong on your vehicle's battery.
2. Remove the jumper cable on the negative (-) terminal of the booster vehicle's battery.
3. Remove the jumper cable from the positive (+) terminal of the booster vehicle's battery.
4. Remove the jumper cable from the positive (+) prong of your vehicle's battery.

After the cables have been removed from both vehicles replace the red cap to the positive (+) prong . After the disabled vehicle has been started and the jumper cables removed, allow it to idle for several minutes so the engine computer can relearn its idle conditions.

GETTING THE SERVICES YOU NEED

Warranty repairs to your vehicle must be performed by an authorized dealer. While any authorized dealer handling your vehicle line will provide warranty service, we recommend you return to your selling authorized dealer who wants to ensure your continued satisfaction.

Please note that certain warranty repairs require special training, equipment or both, so not all authorized dealers are authorized to perform all warranty repairs. This means that, depending on the warranty repair needed, you may have to take your vehicle to another authorized dealer.

A reasonable time must be allowed to perform a repair after taking your vehicle to the authorized dealer. Repairs will be made using Ford or Motorcraft parts, or remanufactured or other parts that are authorized by Ford.

Away from Home

If you are away from home when your vehicle needs service, contact the Ford Customer Relationship Center or use the online resources listed below to find the nearest authorized dealer.

In the United States:

Mailing Address

Ford Motor Company
Customer Relationship Center
P.O. Box 6248
Dearborn, MI 48121

Telephone

1-800-392-3673 (FORD)
(TDD for the hearing impaired: 1-800-232-5952)

Online

Additional information and resources are available online at www.fordowner.com.

These are some of the items that can be found online:

- U.S. Dealer Locator by Dealer Name, City/State, or Zip Code
- Owner Manuals
- Maintenance Schedules
- Recalls
- Ford Extended Service Plans

- Ford Genuine Accessories
- Service specials and promotions.

In Canada:

Mailing address

Customer Relationship Centre
Ford Motor Company of Canada, Limited
P.O. Box 2000
Oakville, Ontario L6K 0C8

Telephone

1-800-565-3673 (FORD)

Online

www.ford.ca

Additional Assistance

If you have questions or concerns, or are unsatisfied with the service you are receiving, follow these steps:

1. Contact your Sales Representative or Service Advisor at your selling or servicing authorized dealer.
2. If your inquiry or concern remains unresolved, contact the Sales Manager, Service Manager or Customer Relations Manager.
3. If you require assistance or clarification on Ford Motor Company policies, please contact the Ford Customer Relationship Center.

In order to help serve you better, please have the following information available when contacting a Customer Relationship Center:

- Vehicle Identification Number (VIN)
- Your telephone number (home and business)
- The name of the authorized dealer and city where located
- The vehicle's current odometer reading.

In some states, you must directly notify Ford in writing before pursuing remedies under your state's warranty laws. Ford is also allowed a final repair attempt in some states.

In the United States, a warranty dispute must be submitted to the BBB AUTO LINE before taking action under the Magnuson-Moss Warranty Act, or to the extent allowed by state law, before pursuing replacement or repurchase remedies provided by certain state laws. This dispute handling procedure is not required prior to enforcing state created rights or other rights which are independent of the Magnuson-Moss Warranty Act or state replacement or repurchase laws.

IN CALIFORNIA (U.S. ONLY)

California Civil Code Section 1793.2(d) requires that, if a manufacturer or its representative is unable to repair a motor vehicle to conform to the vehicle's applicable express warranty after a reasonable number of attempts, the manufacturer shall be required to either replace the vehicle with one substantially identical or repurchase the vehicle and reimburse the buyer in an amount equal to the actual price paid or payable by the consumer (less a reasonable allowance for consumer use). The consumer has the right to choose whether to receive a refund or replacement vehicle.

California Civil Code Section 1793.22(b) presumes that the manufacturer has had a reasonable number of attempts to conform the vehicle to its applicable express warranties if, within the first 18 months of ownership of a new vehicle or the first 18000 mi (29 000 km), whichever occurs first:

1. Two or more repair attempts are made on the same nonconformity likely to cause death or serious bodily injury OR
2. Four or more repair attempts are made on the same nonconformity (a defect or condition that substantially impairs the use, value or safety of the vehicle) OR
3. The vehicle is out of service for repair of nonconformities for a total of more than 30 calendar days (not necessarily all at one time).

In the case of 1 or 2 above, the consumer must also notify the manufacturer of the need for the repair of the nonconformity at the following address:

Ford Motor Company
16800 Executive Plaza Drive
Mail Drop 3NE-B
Dearborn, MI 48126

You are required to submit your warranty dispute to BBB AUTO LINE before asserting in court any rights or remedies conferred by California Civil Code Section 1793.22(b). You are also required to use BBB AUTO LINE before exercising rights or seeking remedies created by the Federal Magnuson-Moss Warranty Act, 15 U.S.C. sec. 2301 et seq. If you choose to seek redress by pursuing rights and remedies not created by California Civil Code Section 1793.22(b) or the Magnuson-Moss Warranty Act, resorting to BBB AUTO LINE is not required by those statutes.

THE BETTER BUSINESS BUREAU (BBB) AUTO LINE PROGRAM (U.S. ONLY)

Your satisfaction is important to Ford Motor Company and to your dealer. If a warranty concern has not been resolved using the three-step procedure outlined earlier in this chapter in the *Getting the Services You Need* section, you may be eligible to participate in the BBB AUTO LINE program.

The BBB AUTO LINE program consists of two parts – mediation and arbitration. During mediation, a representative of the BBB will contact both you and Ford Motor Company to explore options for settlement of the claim. If an agreement is not reached during mediation or you do not want to participate in mediation, and if your claim is eligible, you may participate in the arbitration process. An arbitration hearing will be scheduled so that you can present your case in an informal setting before an impartial person. The arbitrator will consider the testimony provided and make a decision after the hearing.

Disputes submitted to the BBB AUTO LINE program are usually decided within 40 days after you file your claim with the BBB. You are not bound by the decision, and may reject the decision and proceed to court where all findings of the BBB Auto Line dispute, and decision, are admissible in the court action. Should you choose to accept the BBB AUTO LINE decision, Ford is then bound by the decision, and must comply with the decision within 30 days of receipt of your acceptance letter.

BBB AUTO LINE Application: Using the information provided below, please call or write to request a program application. You will be asked for your name and address, general information about your new vehicle, information about your warranty concerns, and any steps you have already taken to try to resolve them. A Customer Claim Form will be mailed that will need to be completed, signed and returned to the BBB along with proof of ownership. Upon receipt, the BBB will review the claim for eligibility under the Program Summary Guidelines.

You can get more information by calling BBB AUTO LINE at 1-800-955-5100, or writing to:

**BBB AUTO LINE
3033 Wilson Boulevard, Suite 600
Arlington, Virginia 22201**

BBB AUTO LINE applications can also be requested by calling the Ford Motor Company Customer Relationship Center at 1-800-392-3673.

Note: Ford Motor Company reserves the right to change eligibility limitations, modify procedures, or to discontinue this process at any time without notice and without obligation.

**UTILIZING THE MEDIATION or ARBITRATION PROGRAM
(CANADA ONLY)**

This pertains to vehicles delivered to authorized Canadian dealers. In those cases, where you continue to feel that the efforts by Ford of Canada and the authorized dealer to resolve a factory-related vehicle service concern have been unsatisfactory, Ford of Canada participates in an impartial third party mediation or arbitration program administered by the Canadian Motor Vehicle Arbitration Plan (CAMVAP).

The CAMVAP program is a straightforward and relatively speedy alternative to resolve a disagreement when all other efforts to produce a settlement have failed. This procedure is without cost to you and is designed to eliminate the need for lengthy and expensive legal proceedings.

In the CAMVAP program, impartial third-party arbitrators conduct hearings at mutually convenient times and places in an informal environment. These impartial arbitrators review the positions of the parties, make decisions and, when appropriate, render awards to resolve disputes. CAMVAP decisions are fast, fair, and final as the arbitrator's award is binding on both you and Ford of Canada.

CAMVAP services are available in all Canadian territories and provinces. For more information, without charge or obligation, call your CAMVAP Provincial Administrator directly at 1-800-207-0685 or visit www.camvap.ca.

GETTING ASSISTANCE OUTSIDE THE U.S. AND CANADA

Before exporting your vehicle to a foreign country, contact the appropriate foreign embassy or consulate. These officials can inform you of local vehicle registration regulations and where to find unleaded fuel.

If you cannot find unleaded fuel or can only get fuel with an anti-knock index lower than is recommended for your vehicle, contact our Customer Relationship Center.

The use of leaded fuel in your vehicle without proper conversion may damage the effectiveness of your emission control system and may cause engine knocking or serious engine damage. Ford Motor Company or Ford of Canada is not responsible for any damage caused by use of improper fuel. Using leaded fuel may also result in difficulty importing your vehicle back into the United States.

If your vehicle must be serviced while you are traveling or living in Asia-Pacific Region, Sub-Saharan Africa, U.S. Virgin Islands, Central America, the Caribbean, and Israel, contact the nearest authorized dealer. If the authorized dealer cannot help you, contact:

**FORD MOTOR COMPANY
FORD EXPORT OPERATIONS & GLOBAL INITIATIVES**

Customer Relationship Center
1555 Fairlane Drive Fairlane Business Park #3
Allen Park, Michigan 48101
U.S.A.
Telephone: (313) 594-4857
FAX: (313) 390-0804 Email: expcac@ford.com

**For customers in Guam, the Commonwealth of the Northern Mariana Islands (CNMI), America Samoa, and the U.S. Virgin Islands, please feel free to call our Toll-Free Number:
(800) 841-FORD (3673)**

If your vehicle must be serviced while you are traveling or living in Puerto Rico, contact the nearest authorized dealer. If the authorized dealer cannot help you, contact:

**FORD MOTOR COMPANY
FORD EXPORT OPERATIONS & GLOBAL INITIATIVES**

Customer Relationship Center
1555 Fairlane Drive Fairlane Business Park #3
Allen Park, Michigan 48101
U.S.A.
Telephone: (313) 594-4857
FAX: (313) 390-0804 Email: www.ford.com.pr

If your vehicle must be serviced while you are traveling or living in the Middle East, contact the nearest authorized dealer. If the authorized dealer cannot help you, contact:

**Ford Middle East
Customer Relationship Center**

P.O. Box 21470 Dubai, United Arab Emirates
Telephone: +971 4 3326084
Toll-Free Number of the Kingdom of Saudi Arabia: 800 8971409
Local Telephone Number of Kuwait: 24810575
FAX: +971 4 3327299
Email: menacac@ford.com
www.me.ford.com

If you buy your vehicle in North America and then relocate to any of the above locations, register your vehicle identification number (VIN) and new address with Ford Motor Company Export Operations & Global Growth Initiatives by emailing expcac@ford.com.

If you are in another foreign country, contact the nearest authorized dealer. In the event your inquiry is unresolved, communicate your concern with the dealership's Sales Manager, Service Manager or Customer Relations Manager. If you require additional assistance or clarification, please contact the respective Customer Relationship Center as previously listed.

Customers in the U.S. should call 1-800-392-3673.

ORDERING ADDITIONAL OWNER'S LITERATURE

To order the publications in this portfolio, contact Helm, Incorporated at:

HELM, INCORPORATED
47911 Halyard Drive
Plymouth, Michigan 48170
Attention: Customer Service

Or to order a free publication catalog, call toll free: 1-800-782-4356

Monday-Friday 8:00 a.m. - 6:00 p.m. EST

Helm, Incorporated can also be reached by their website:
www.helminc.com.

(Items in this catalog may be purchased by credit card, check or money order.)

Obtaining a French Owner's Manual

A French owner's manual can be obtained from your authorized dealer or by contacting Helm, Incorporated using the contact information listed previously in this section.

REPORTING SAFETY DEFECTS (U.S. ONLY)

If you believe that your vehicle has a defect which could cause a crash or could cause injury or death, you should immediately inform the National Highway Traffic Safety

Administration (NHTSA) in addition to notifying Ford Motor Company.

If NHTSA receives similar complaints, it may open an investigation, and if it finds that a safety defect exists in a group of vehicles, it may order a recall and remedy campaign. However, NHTSA cannot become involved in individual problems between you, your dealer, or Ford Motor Company.

To contact NHTSA, you may call the Vehicle Safety Hotline toll-free at 1-888-327-4236 (TTY: 1-800-424-9153); go to <http://www.safercar.gov>; or write to:

Administrator
1200 New Jersey Avenue, Southeast
Washington, D.C. 20590

You can also obtain other information about motor vehicle safety from <http://www.safercar.gov>.

REPORTING SAFETY DEFECTS (CANADA ONLY)

If you believe that your vehicle has a defect which could cause a crash or could cause injury or death, you should immediately inform Transport Canada, using their toll-free number: 1-800-333-0510, or online at: <https://wwwapps.tc.gc.ca/Saf-Sec-Sur/7/PCDB-BDPP/Index.aspx>.

CHANGING A FUSE

Fuses

! **WARNING:** Always replace a fuse with one that has the specified amperage rating. Using a fuse with a higher amperage rating can cause severe wire damage and could start a fire.

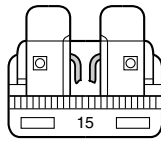

If electrical components in the vehicle are not working, a fuse may have blown. Blown fuses are identified by a broken wire within the fuse. Check the appropriate fuses before replacing any electrical components.

Standard Fuse Amperage Rating and Color

COLOR					
Fuse rating	Mini fuses	Standard fuses	Maxi fuses	Cartridge maxi fuses	Fuse link cartridge
2A	Grey	Grey	—	—	—
3A	Violet	Violet	—	—	—
4A	Pink	Pink	—	—	—
5A	Tan	Tan	—	—	—
7.5A	Brown	Brown	—	—	—
10A	Red	Red	—	—	—
15A	Blue	Blue	—	—	—
20A	Yellow	Yellow	Yellow	Blue	Blue
25A	Natural	Natural	—	Natural	Natural
30A	Green	Green	Green	Pink	Pink
40A	—	—	Orange	Green	Green
50A	—	—	Red	Red	Red
60A	—	—	Blue	Yellow	Yellow
70A	—	—	Tan	—	Brown
80A	—	—	Natural	Black	Black

FUSE SPECIFICATION CHART**Pre-Fuse Box**

Your vehicle has a pre-fuse box attached to the power distribution box. There is a second pre-fuse box attached to the 12-volt battery terminal in the rear of your vehicle. They contain high-current fuses. If you need to replace one of these fuses, see an authorized dealer.

Power Distribution Box

WARNING: Always disconnect the battery before servicing high current fuses.



WARNING: To reduce risk of electrical shock, always replace the cover to the power distribution box before reconnecting the battery or refilling fluid reservoirs.

The power distribution box is located in the engine compartment. It has high-current fuses that protect your vehicle's main electrical systems from overloads.

If the battery has been disconnected and reconnected, see *Changing the Vehicle Battery* in the *Maintenance* chapter.

Lift the release lever at the rear of the cover to remove it.

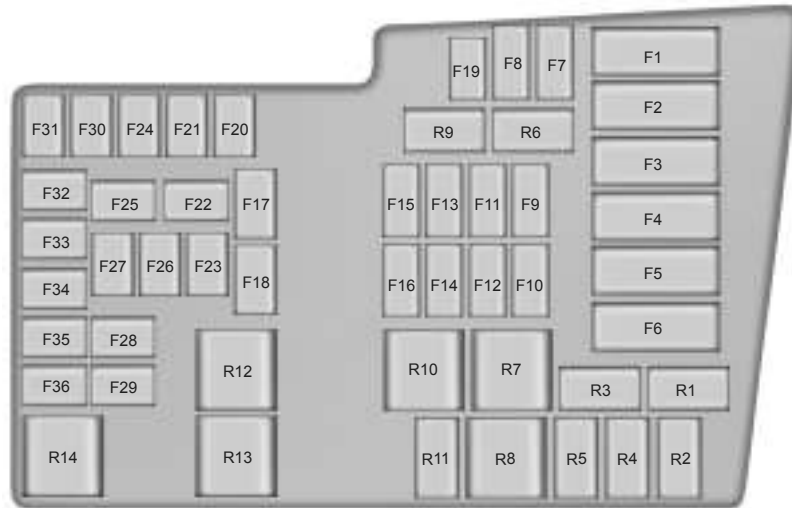

The high-current fuses are coded as follows:

Fuse or relay number	Fuse amp rating	Protected components
F1	50A Midi	Cooling fan module
F2	50A Midi	Electric water pump
F3	50A Midi	Body control module supply 1
F4	50A Midi	Body control module supply 2
F5	—	Not used
F6	—	Not used
F7	40A**	Anti-lock brake system pump
F8	30A**	Anti-lock brake system valve
F9	40A**	Vacuum pump
F10	40A**	Heater blower motor
F11	30A**	Engine management
F12	—	Not used
F13	25A**	Powertrain control module relay

Fuse or relay number	Fuse amp rating	Protected components
F14	20A**	Rear wiper
F15	—	Not used
F16	20A**	Body control module 15 feed
F17	20A**	Transmission oil pump (C-MAX Energi)
F18	20A**	Front wiper motor
F19	5A*	Anti-lock brake system / Electronic stability program module
F20	15A*	Horn
F21	5A*	Stop light switch
F22	5A*	Vacuum pump monitoring
F23	5A*	Engine control module 15 / Powertrain control module 15 / Transmission oil pump 15
F24	5A*	Relay coils
F25	10A*	Motor electronic cooling pump
F26	5A*	Electronic power assist steering module 15
F27	5A*	Mass air flow sensor
F28	15A*	Powertrain control module
F29	10A*	Electronic A/C compressor / Positive temperature coefficient heater
F30	10A*	Engine control module, Powertrain control module
F31	5A*	Charge port light ring (C-MAX Energi)
F32	20A*	Vehicle power 2
F33	15A*	Vehicle power 4
F34	10A*	Injectors
F35	10A*	Vehicle power 3
F36	20A*	Vehicle power 1

Fuse or relay number	Fuse amp rating	Protected components
R1	—	Not used
R2	Micro relay	Horn
R3	Micro relay	Hybrid powertrain control
R4	Micro relay	Front wiper
R5	—	Not used
R6	Micro relay	Front and rear wiper high/low
R7	Power relay	Vacuum pump
R8	Power relay	Ignition feed
R9	—	Not used
R10	Mini relay	Vacuum pump sensor
R11	—	Not used
R12	Power relay	Cooling fan
R13	Mini relay	Heater blower
R14	Mini relay	Engine control relay
*Mini Fuses **Cartridge Fuses		

Passenger Compartment Fuse Panel

The fuse panel is located on the right side below the glove box.

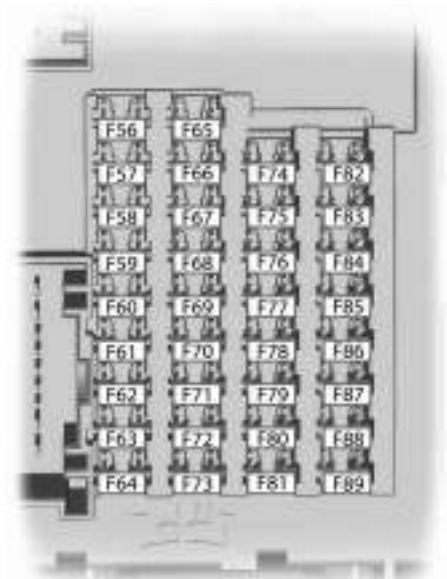

Fuse or relay number	Fuse amp rating	Protected components
56	20A	Fuel pump supply
57	—	Not used
58	—	Not used
59	5A	Passive anti-theft system
60	10A	Interior light, Driver door switch pack, Glove box illumination
61	20A	Cigar lighter, Second row power point
62	5A	Autowipers module, Auto-dimming rear view mirror
63	—	Not used
64	—	Not used
65	10A	Liftgate release

Fuse or relay number	Fuse amp rating	Protected components
66	20A	Driver door unlock supply, Double lock
67	7.5A	Cell phone passport (C-MAX Energi)
68	—	Not used
69	5A	Instrument cluster
70	20A	Central lock and unlock supply
71	10A	Heating control head (manual A/C), Climate control module
72	7.5A	Steering wheel module
73	5A	Data link connector
74	15A	Headlamp supply
75	15A	Fog lamp supply
76	10A	Reverse lamp supply
77	20A	Windshield and rear washer supply
78	5A	Ignition switch, Start button
79	15A	Radio, Hazard light switch
80	20A	Not used (spare)
81	5A	Power sun shade
82	20A	Windshield and rear washer relay
83	20A	Central lock and unlock supply
84	20A	Drive door unlock supply, Double lock
85	7.5A	Electronic 15 feed
86	10A	Restraints control module, Passenger air bag deactivation indicator
87	—	Not used
88	—	Not used
89	—	Not used

Luggage Compartment Fuse Panel

The fuse panel is located in the luggage compartment behind the left side wheel well. Remove the fuse panel cover to gain access to the fuses.

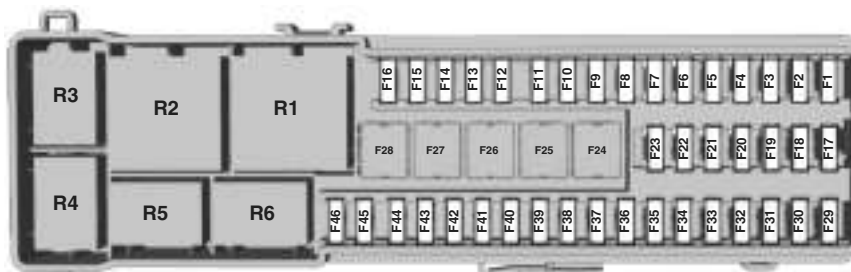

The fuses are coded as follows:

Fuse/Relay Number	Fuse Amp Rating	Protected Components
F1	5A	Hands-free liftgate entry module
F2	10A	Keyless vehicle module
F3	5A	Keyless vehicle door handles
F4	25A	Door control unit front left
F5	25A	Door control unit front right
F6	25A	Door control unit rear left
F7	25A	Door control unit rear right
F8	—	Not used
F9	25A	Driver seat motor
F10	25A	Heated rear window
F11	—	Not used
F12	15A	Battery electronics control module
F13	—	Not used

Fuse/Relay Number	Fuse Amp Rating	Protected Components
F14	10A	Charger (C-MAX Energi)
F15	—	Not used
F16	—	Not used
F17	10A	Battery electronics control module
F18	15A	Battery electronics control module — fan
F19	15A	Charger fan (C-MAX Energi)
F20	—	Not used
F21	10A	Smart datalink connector
F22	10A	Active noise cancellation
F23	—	Not used
F24	30A	DC/AC power converter
F25	25A	Power liftgate
F26	40A	AC/DC charger (C-MAX Energi)
F27	20A	Luggage compartment outlet
F28	—	Not used
F29	—	Not used
F30	5A	Parking aid module
F31	5A	Rear view camera
F32	5A	DC/AC power converter
F33	—	Not used
F34	20A	Driver seat heater
F35	20A	Passenger seat heater
F36	—	Not used
F37	20A	Power sun shade
F38	—	Not used
F39	—	Not used
F40	—	Not used
F41	—	Not used
F42	—	Not used

Fuse/Relay Number	Fuse Amp Rating	Protected Components
F43	—	Not used
F44	—	Not used
F45	5A	Humidity sensor
F46	10A	Fuel system
R1	Power relay	Rear 15 relay
R2	Mini relay	Heated rear window
R3	Micro relay	Fuel door (C-MAX Energi)
R4	—	Not used
R5	—	Not used
R6	Micro relay	Rear wiper

GENERAL INFORMATION

Have your vehicle serviced regularly to help maintain its roadworthiness and resale value. There is a large network of Ford authorized dealers who are there to help you with their professional servicing expertise. We believe that their specially trained technicians are best qualified to service your vehicle properly and expertly. They are supported by a wide range of highly specialized tools developed specifically for servicing your vehicle.

To help you service your vehicle, we provide *Scheduled Maintenance Information* which makes tracking routine service easy.

If your vehicle requires professional service, your authorized dealer can provide the necessary parts and service. Check your warranty information to find out which parts and services are covered.

Use only recommended fuels, lubricants, fluids and service parts conforming to specifications. Motorcraft® parts are designed and built to provide the best performance in your vehicle.

Precautions

- Do not work on a hot engine.
- Make sure that nothing gets caught in moving parts.
- Do not work on a vehicle with the engine running in an enclosed space, unless you are sure you have enough ventilation.
- Keep all open flames and other burning material (such as cigarettes) away from the battery and all fuel related parts.

Working with the Engine Off

1. Set the parking brake and shift to **P** (Park).
2. Turn off the engine and remove the key (if equipped).
3. Block the wheels.

Working with the Engine On

WARNING: To reduce the risk of vehicle damage or personal burn injuries, do not start your engine with the air cleaner removed and do not remove it while the engine is running.

1. Set the parking brake and shift to position **P**.
2. Block the wheels.

OPENING AND CLOSING THE HOOD

1. Inside the vehicle, pull the hood release handle located under the instrument panel.

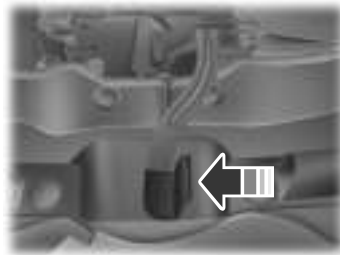

2. Go to the front of the vehicle.
3. Raise the hood slightly and release the secondary latch located under the front center of the hood.



4. Raise the hood and support it with the prop rod.
5. Lower and secure the prop rod in the clip.
6. Lower the hood and allow it to drop the last 8 to 11 inches (20 to 30 centimeters).

Note: Make sure that the hood is closed properly.

UNDER HOOD OVERVIEW**2.0L ATK iVCT Engine**

! **WARNING:** The inverter system controller contains various high-voltage components that can cause serious injury or death. The inverter system controller is not serviceable and should never be touched, probed, or tampered with.

Note: Do not attempt to service any of the high-voltage components or wiring. For easier identification, the high-voltage wiring insulation is color coated orange.

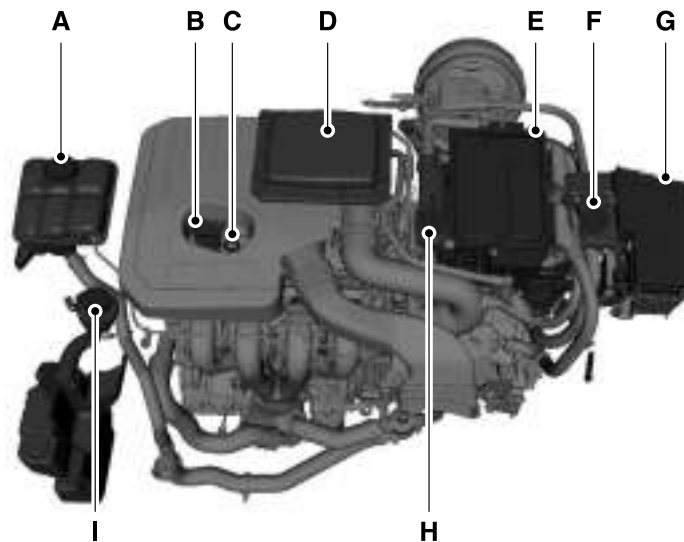

- | | |
|---------------------------------|--|
| A. Engine coolant reservoir cap | F. Brake fluid reservoir cap |
| B. Engine oil filler cap | G. Power distribution box |
| C. Engine oil dipstick | H. Inverter system controller
coolant reservoir cap |
| D. Air cleaner cover | I. Windshield washer fluid reservoir
cap |
| E. Inverter system controller | |

ENGINE OIL DIPSTICK

- A. MIN
- B. MAX

**ENGINE OIL CHECK**

Note: Check the level before starting the engine.

Note: Make sure that the level is between the MIN and MAX marks.

1. Make sure that your vehicle is on level ground.
2. Turn the engine off and wait 10 minutes for the oil to drain into the oil pan.
3. Remove the dipstick and wipe it with a clean, lint-free cloth. Replace the dipstick and remove it again to check the oil level.

If the level is at the MIN mark, add oil immediately.

Adding Engine Oil

Note: Do not remove the filler cap when the engine is running.

Note: Do not add engine oil further than the MAX mark. Oil levels above the MAX mark may cause engine damage.



Only use oils certified for gasoline engines by the American Petroleum Institute (API). An oil with this trademark symbol conforms to the current engine and emission system protection standards and fuel economy requirements of the International Lubricants Specification Advisory Council (ILSAC), comprised of U.S. and Japanese automobile manufacturers.

1. Remove the filler cap.
2. Add engine oil that meets Ford specifications. See *Capacities and Specifications* for more information.
3. Replace the filler cap. Turn it until you feel a strong resistance.

Resetting the Oil Life Monitoring System

Note: Reset the oil life monitoring only after an oil change.

1. Turn the ignition key to the on position. Do not start the engine. For vehicles with push-button start, press and hold the start button for two seconds without pressing the brake pedal. Do not attempt to start the engine.
2. Press both the accelerator and brake pedals at the same time.
3. Keep both pedals fully pressed.
4. After three seconds, the **Service: Oil reset in prog.** message will be displayed.
5. After 25 seconds, the **Service: Oil reset complete** message will be displayed.
6. Release both the accelerator and brake pedals.
7. The **Service: Oil reset complete** message will no longer be displayed.
8. Rotate the key to the off position.
For vehicles with push-button start, press the start button to turn the vehicle off completely.

Oil Maintenance Mode (If Equipped)

The oil maintenance mode is equipped on Energi models only. The oil maintenance mode keeps the engine oil quality in good condition when you drive the vehicle with limited engine use. If the vehicle is in oil maintenance mode when you start the vehicle, a message will appear in the instrument cluster. While the vehicle is in oil maintenance mode, the vehicle will run the engine as necessary.

If you select the EV Now mode while the vehicle is in the oil maintenance mode, EV Now mode will be suspended for as long as you are in oil maintenance mode.

The oil maintenance mode will resume the next time you start the vehicle. Changing the engine oil and resetting the oil life monitoring system will suspend the oil maintenance mode.

COOLANT**Engine Coolant and Inverter System Controller Coolant**

Your vehicle is equipped with two separate cooling systems. One is for cooling the engine and one is for cooling the inverter system controller that is specific to the hybrid operating system. The two systems operate similarly, with the inverter system controller cooling system generally operating at a lower temperature and pressure.

Checking the Engine Coolant

When the engine is cold, check the concentration and level of the engine coolant at the intervals listed in the *Scheduled Maintenance Information*.

Note: Make sure that the level is between the MIN and MAX marks on the engine coolant reservoir.

Note: Coolant expands when it is hot. The level may extend beyond the MAX mark.

Note: If the level is at the MIN mark, below the MIN mark, or empty, add prediluted coolant immediately. Refer to *Adding Engine Coolant* in this chapter.

The coolant concentration should be maintained at 50%.

Note: For best results, coolant concentration should be tested with a refractometer such as Rotunda tool ROB75240 available from your dealer. Ford does not recommend the use of hydrometers or coolant test strips for measuring coolant concentrations.

Note: Automotive fluids are not interchangeable; do not use engine coolant/antifreeze or windshield washer fluid outside of its specified function and vehicle location.

Checking the Inverter System Controller Coolant

When the engine is cold, check the concentration and level of the inverter system controller coolant at the intervals listed in the *Scheduled Maintenance Information*.

Note: Make sure that the level is between the MIN and MAX marks on the inverter system controller coolant reservoir.

Note: Coolant expands when it is hot. The level may extend beyond the MAX mark.

Note: If the level is at the MIN mark, below the MIN mark, or empty, add prediluted coolant immediately. Refer to *Adding Inverter System Controller Coolant* in this chapter.

The coolant concentration should be maintained at 50%.

Note: For best results, coolant concentration should be tested with a refractometer such as Rotunda tool ROB75240 available from your dealer. Ford does not recommend the use of hydrometers or coolant test strips for measuring coolant concentrations.

Note: It is very important to use prediluted coolant meeting the Ford specification in order to avoid plugging the small coolant passageways. Use of concentrated coolant and water may cause coolant passageway plugging and void the warranty. See the technical specifications chart in the *Capacities and Specifications* chapter.

Note: Automotive fluids are not interchangeable; do not use coolant/antifreeze or windshield washer fluid outside of its specified function and vehicle location.

Adding Coolant



WARNING: Do not add engine coolant when the engine is hot.

Steam and scalding liquids released from a hot cooling system can burn you badly. Also, you can be burned if you spill coolant on hot engine parts.



WARNING: Do not put engine coolant in the windshield washer

fluid container. If sprayed on the windshield, engine coolant could make it difficult to see through the windshield.



WARNING: To reduce the risk of personal injury, make sure the engine is cool before unscrewing the coolant pressure relief cap.

The cooling system is under pressure; steam and hot liquid can come out forcefully when the cap is loosened slightly.



WARNING: Do not add coolant further than the MAX mark.

Note: Do not use stop leak pellets or cooling system sealants/additives as they can cause damage to the cooling and/or heating systems. This damage would not be covered under your vehicle's warranty.

Note: During normal vehicle operation, the coolant may change color from orange to pink or light red. As long as the coolant is clear and uncontaminated, this color change does not indicate the coolant has degraded nor does it require the coolant to be drained, the system to be flushed, or the coolant to be replaced.

- DO NOT MIX different colors or types of coolant in your vehicle. Make sure the correct coolant is used. Mixing of coolants may harm your cooling system. The use of an improper coolant may harm engine, inverter system controller, and cooling system components and may void the warranty.
- In case of emergency, a large amount of water without engine coolant may be added to the engine cooling system only in order to reach a vehicle service location. In this instance, the engine cooling system must be drained, chemically cleaned with Motorcraft® Premium Cooling System Flush, and refilled with prediluted engine coolant as soon as possible. Water alone (without engine coolant) can cause engine damage from corrosion, overheating, or freezing. DO NOT use this method for the inverter system controller cooling system. The inverter system controller cooling system operates close to ambient temperature, and is susceptible to freezing in any subfreezing environment in the absence of coolant.
- Do not use alcohol, methanol, brine or any engine coolants mixed with alcohol or methanol antifreeze (coolant). Alcohol and other liquids can cause engine damage from overheating or freezing.
- Do not add extra inhibitors or additives to the coolant. These can be harmful and compromise the corrosion protection of the coolant.

Adding Engine Coolant

1. Remove the Easy Fuel funnel from the storage compartment. Refer to *Running Out of Fuel* for the location of the Easy Fuel funnel.
2. Unscrew the engine coolant reservoir cap slowly. Any pressure will escape as you unscrew the cap.
3. Position the Easy Fuel funnel in the engine coolant reservoir opening. Push the Easy Fuel funnel neck fully into the engine coolant reservoir, past the vent tube, in order to avoid pouring the coolant into the vent tube and spilling the coolant on the ground.
4. Add prediluted engine coolant to the engine coolant reservoir. Make sure that the level is between the MIN and MAX marks on the engine coolant reservoir. Use prediluted engine coolant meeting the Ford specification. See the technical specifications chart in the *Capacities and Specifications* chapter.

5. Close the engine coolant reservoir cap.
6. Clean the Easy Fuel funnel.
7. Store the Easy Fuel funnel in the storage compartment.

Whenever you add engine coolant, check the coolant level in the engine coolant reservoir the next few times you drive the vehicle. If necessary, add enough prediluted engine coolant to bring the engine coolant level to the proper level.

Adding Inverter System Controller Coolant

1. Open the inverter system controller coolant reservoir cap.
2. Use a funnel to add prediluted coolant to the inverter system controller coolant reservoir. Make sure that the level is between the MIN and MAX marks on the inverter system controller coolant reservoir. Use prediluted coolant meeting the Ford specification. See the technical specifications chart in the *Capacities and Specifications* chapter.
3. Close the inverter system controller coolant reservoir cap.

Whenever you add coolant, check the coolant level in the inverter system controller coolant reservoir the next few times you drive the vehicle. If necessary, add enough prediluted coolant to bring the inverter system controller coolant level to the proper level.

Recycled Engine Coolant

Ford Motor Company does not recommend the use of recycled engine coolant since a Ford-approved recycling process is not yet available.



Used engine coolant should be disposed of in an appropriate manner. Follow your community's regulations and standards for recycling and disposing of automotive fluids.

Severe Climates

If you drive in extremely cold climates:

- It may be necessary to have a Ford authorized dealer increase the coolant concentration above 50%.
- A coolant concentration of 60% will provide improved freeze point protection. Engine coolant concentrations above 60% will decrease the overheat protection characteristics of the engine coolant and may cause engine damage.

If you drive in extremely hot climates:

- It may be necessary to have a Ford authorized dealer decrease the coolant concentration to 40%.
- A coolant concentration of 40% will provide improved overheat protection. Engine coolant concentrations below 40% will decrease the corrosion/freeze protection characteristics of the engine coolant and may cause engine damage.

Vehicles driven year-round in non-extreme climates should use prediluted engine coolant for optimum cooling system and engine protection.

What You Should Know About Fail-Safe Cooling

If the engine coolant supply is depleted, this feature allows the vehicle to be driven temporarily before incremental component damage is incurred. The fail-safe distance depends on ambient temperatures, vehicle load and terrain.

How Fail-Safe Cooling Works

If the engine begins to overheat, the engine coolant temperature gauge will move to the red (hot) area and:



The coolant temperature warning light will illuminate.



The service engine soon indicator will illuminate.

If the engine reaches a preset over-temperature condition, the engine will automatically switch to alternating cylinder operation. Each disabled cylinder acts as an air pump and cools the engine.

When this occurs the vehicle will still operate. However:

- The engine power will be limited.
- The air conditioning system will be disabled.

Continued operation will increase the engine temperature and the engine will completely shut down, causing steering and braking effort to increase.

Once the engine temperature cools, the engine can be restarted. Take your vehicle to an authorized dealer as soon as possible to minimize engine damage.

When Fail-Safe Mode is Activated

WARNING: Fail-safe mode is for use during emergencies only.

Operate the vehicle in fail-safe mode only as long as necessary to bring the vehicle to rest in a safe location and seek immediate repairs. When in fail-safe mode, the vehicle will have limited power, will not be able to maintain high-speed operation, and may completely shut down without warning, potentially losing engine power, power steering assist, and power brake assist, which may increase the possibility of a crash resulting in serious injury.



WARNING: Never remove the coolant reservoir cap while the engine is running or hot.

You have limited engine power when in the fail-safe mode, so drive the vehicle with caution. The vehicle will not be able to maintain high-speed operation and the engine will run rough. Remember that the engine is capable of completely shutting down automatically to prevent engine damage, therefore:

1. Pull off the road as soon as safely possible and turn off the engine.
2. Arrange for the vehicle to be taken to an authorized dealer.
3. If this is not possible, wait a short period for the engine to cool.
4. Check the coolant level and replenish if low.
5. Restart the engine and take your vehicle to an authorized dealer.

Note: Driving the vehicle without repairing the engine problem increases the chance of engine damage. Take your vehicle to an authorized dealer as soon as possible.

AUTOMATIC TRANSMISSION FLUID CHECK

Note: Transmission fluid should be checked by an authorized dealer. If required, fluid should be added by an authorized dealer.

The automatic transmission does not have a transmission fluid dipstick.

Refer to your *scheduled maintenance information* for scheduled intervals for fluid checks and changes. Your transmission does not consume fluid. However, the fluid level should be checked if the transmission is not working properly, (i.e., if the transmission slips or shifts slowly) or if you notice some sign of fluid leakage.

Do not use supplemental transmission fluid additives, treatments or cleaning agents. The use of these materials may affect transmission operation and result in damage to internal transmission components.

BRAKE FLUID CHECK

Fluid levels between the MIN and MAX lines are within the normal operating range; there is no need to add fluid. If the fluid levels are outside of the normal operating range, the performance of the system could be compromised; seek service from your authorized dealer immediately.

POWER STEERING FLUID CHECK

Your vehicle is equipped with an electric power steering system. There is no fluid reservoir to check or fill.

FUEL FILTER

Your vehicle is equipped with a lifetime fuel filter that is integrated with the fuel tank. Regular maintenance or replacement is not needed.

WASHER FLUID CHECK

WARNING: If you operate your vehicle in temperatures below 40°F (5°C), use washer fluid with antifreeze protection. Failure to use washer fluid with antifreeze protection in cold weather could result in impaired windshield vision and increase the risk of injury or accident.

Add fluid to fill the reservoir if the level is low. Only use a washer fluid that meets Ford specifications. See the technical specifications chart in the *Capacities and Specifications* chapter.

Note: The front and rear washer systems are supplied from the same reservoir.

State or local regulations on volatile organic compounds may restrict the use of methanol, a common windshield washer antifreeze additive. Washer fluids containing non-methanol antifreeze agents should be used only if they provide cold weather protection without damaging the vehicle's paint finish, wiper blades or washer system.

CHANGING THE LOW VOLTAGE BATTERY

Your vehicle is equipped with a Motorcraft® maintenance-free low voltage battery which normally does not require additional water during its life of service.

Note: See an authorized dealer for low voltage battery access, testing, or replacement.

When a low voltage battery replacement is necessary, see an authorized dealer to replace the low voltage battery with a Ford recommended replacement low voltage battery that matches the electrical requirements of the vehicle.

To ensure proper operation of the battery management system (BMS), do not allow a technician to connect any electrical device ground connection directly to the low voltage battery negative post. A connection at the low voltage battery negative post can cause inaccurate measurements of the battery condition and potential incorrect system operation.

Note: If a person adds electrical or electronic accessories or components to the vehicle, the accessories or components may adversely affect the low voltage battery performance and durability and may also affect the performance of other electrical systems in the vehicle.

Note: Always dispose of automotive batteries in a responsible manner. Follow your local authorized standards for disposal. Call your local authorized recycling center to find out more about recycling automotive batteries.

Because your vehicle's engine is electronically-controlled by a computer, some engine control settings are maintained by power from the low voltage battery. Some engine computer settings, like the idle trim and fuel trim strategy, optimize the driveability and performance of the engine. Some other computer settings, like the clock and radio station presets, are also maintained in memory by power from the low voltage battery. When a technician disconnects and connects the low voltage battery, these settings are erased. Complete the following procedure in order to restore the settings:

1. With the vehicle at a complete stop, set the parking brake.
2. Shift the transmission to P (Park).
3. Turn off all accessories.
4. Step on the brake pedal and start the vehicle.
5. Step on the accelerator to start the engine.

6. Run the engine until the engine reaches normal operating temperature. While the engine is warming up, complete the following:
 - Reset the clock. See *Clock* in the *Audio System* chapter.
 - Reset the radio station presets. See *Number block* in the *Audio System* chapter.
 - Reset the power windows bounce-back feature. See *Resetting the Bounce-Back Feature* in the *Power Windows* section.
7. Allow the engine to idle for at least one minute.
8. If the engine turns off, step on the accelerator to start the engine.
9. While the engine is running, step on the brake pedal and shift the transmission to N (Neutral).
10. Allow the engine to run for at least one minute by pressing on the accelerator pedal.
11. Drive the vehicle at least 10 miles (16 kilometers) to completely relearn the idle and fuel trim strategy.

Note: If you do not allow the engine to relearn the idle and fuel trim strategy, the idle quality of your vehicle may be adversely affected until the engine computer eventually relearns the idle trim and fuel trim strategy.

CHECKING THE WIPER BLADES

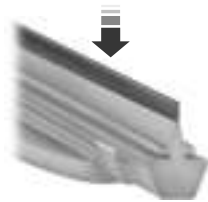

Run the tip of your fingers over the edge of the blade to check for roughness.

Clean the wiper blades with washer fluid or water applied with a soft sponge or cloth.

CHANGING THE WIPER BLADES

Note: Use the service position in winter to provide easier access to the front wiper blades for freeing them from snow and ice. The front wipers will not return to their normal position as soon as you switch on the ignition. The front wipers will stay in the service position when you switch the ignition on or start the engine. Switch on the front wipers to any mode, then switch off the front wipers to bring the front wipers back to the park position.

Note: The windshield wiper blades are different in length. If you install wiper blades of the wrong length, the wipers may not work correctly. If equipped with autowipers, the rain sensor may not work correctly.

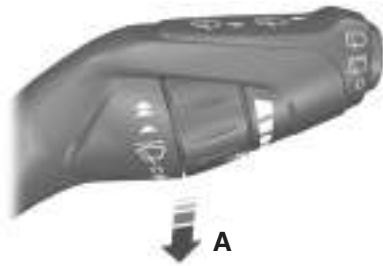
Setting the Front Wipers in the Service Position

1. Make sure that the outside of the windshield is free from snow and ice.
2. Switch on the ignition.
3. Switch off the ignition, and move the wiper lever to position A within three seconds. Hold the lever in position A.



4. Release the lever when the wipers have moved to the service position.

Changing the Front Wiper Blades

Set the front wipers in the service position and lift the wiper arms.

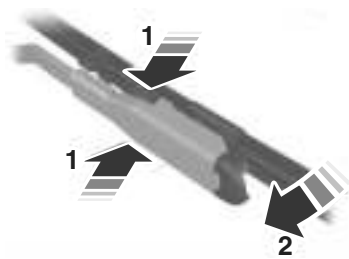

1. Press the locking buttons together.
2. Rotate and remove the wiper blade.

Note: Make sure that the wiper blade locks into place.

3. Install in the reverse order.

Replace wiper blades at least once per year for optimum performance.

Poor wiper quality can be improved by cleaning the wiper blades and the windshield.

Changing the Rear Window Wiper Blade

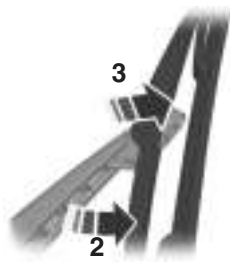

1. Lift the wiper arm.
2. Slightly rotate the wiper blade from the wiper arm.
3. Disengage the wiper blade from the wiper arm.
4. Remove the wiper blade.

Note: Make sure that the wiper blade locks into place.

5. Install in the reverse order.

Replace wiper blades at least once per year for optimum performance.

Poor wiper quality can be improved by cleaning the wiper blades and the windshield.

AIR FILTER CHECK



WARNING: To reduce the risk of vehicle damage and/or personal burn injuries do not start your engine with the air cleaner removed and do not remove it while the engine is running.

Note: Failure to re-install the air cleaner assembly properly by fully seating on the mounting studs in (5) places and securing with the (2) bolts may result in air cleaner assembly dislodgement from engine and damage to the air cleaner assembly and other engine components. Therefore we recommend that the air filter be serviced at a Ford dealer.

When changing the air filter element, use only the air filter element listed. Refer to *Motorcraft® part numbers* in the *Capacities and Specifications* chapter.

Refer to *Scheduled Maintenance* for the appropriate intervals for changing the air filter element.

Note: Failure to use the correct air filter element may result in severe engine damage. The customer warranty may be void for any damage to the engine if the correct air filter element is not used.

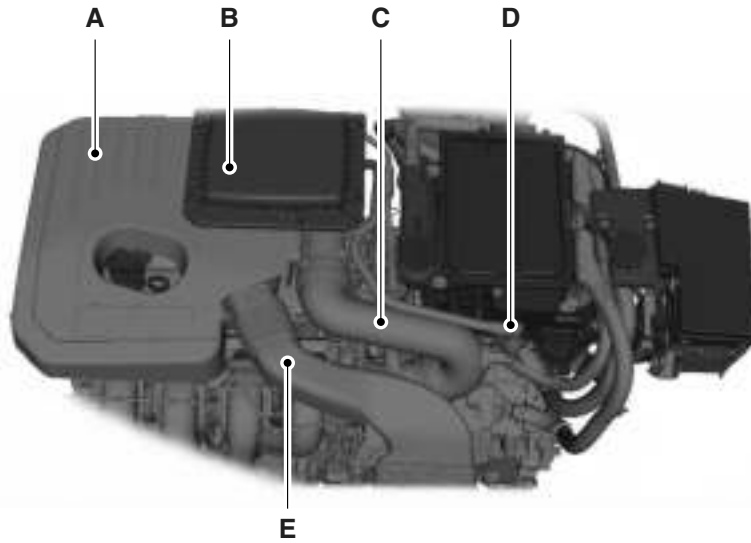
Identifying Air Filter Element Components

- A. Air cleaner assembly
- B. Air cleaner cover
- C. Air cleaner outlet tube
- D. Positive crankcase ventilation (PCV) tube
- E. Air cleaner intake tube

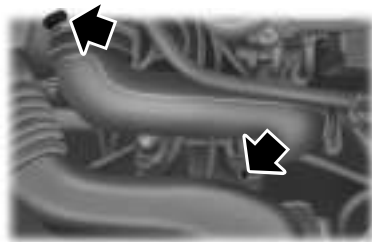
Removing the Engine Air Filter Element

1. Loosen the hose clamps for air cleaner outlet tube (C). Disconnect the tube from the air cleaner assembly (A).

2. Release the tabs and disconnect the PCV tube (D) from the air cleaner outlet tube (C) and remove the tube.

3. Disconnect the air cleaner intake tube (E) from the air cleaner assembly (A).



4. Remove the bolts from each side of the air cleaner assembly (A) as shown with arrows.

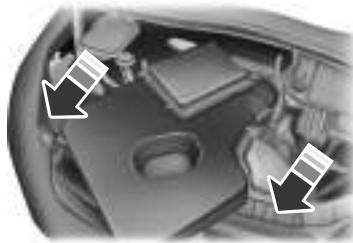

5. Lift the air cleaner assembly (A) from the mounting studs, then rotate and pull it towards the front of the vehicle.

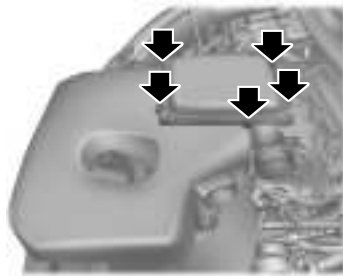

6. Loosen the 5 bolts from the air cleaner cover (B).

7. Remove the air cleaner cover (B) from the air cleaner assembly (A).

Installing the Engine Air Filter Element

Note: Clean the inside of the air filter assembly before installing a new air filter.

1. Install the new engine air filter into the engine air cleaner assembly.

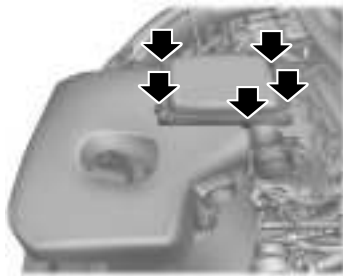

2. Install the air cleaner cover (B) and tighten the 5 bolts.

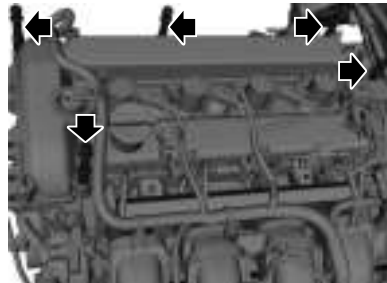

3. Position the air cleaner assembly (A) onto the engine and make sure the assembly is aligned with the studs.



4. Install and tighten the bolts to each side of the air cleaner assembly (A) as shown with arrows.

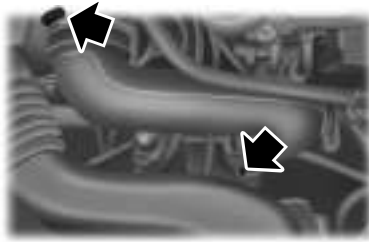

5. Install the air cleaner outlet tube (C) and tighten the hose clamps.

6. Connect the PCV tube (D) to the air cleaner outlet tube (C).

7. Connect the air cleaner intake tube (E) to the air cleaner assembly (A).

ADJUSTING THE HEADLAMPS

The headlamps on your vehicle are properly aimed at the assembly plant. If your vehicle has been in an accident, the alignment of your headlamps should be checked by your authorized dealer.

Vertical Aim Adjustment

1. Park the vehicle directly in front of a wall or screen on a level surface, approximately 25 feet (7.6 meters) away.

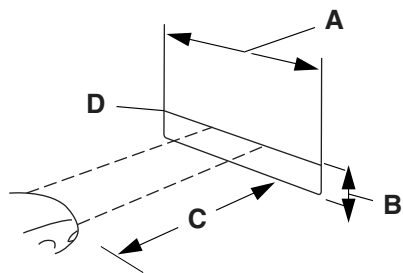

- (A) 8 feet (2.4 meters)
- (B) Center height of lamp to ground
- (C) 25 feet (7.6 meters)
- (D) Horizontal reference line

2. Measure the height of the headlamp bulb center from the ground and mark an 8 foot (2.4 meter) horizontal reference line on the vertical wall or screen at this height.

3. Turn on the low beam headlamps to illuminate the wall or screen and open the hood.

To see a clearer light pattern for adjusting, you may want to block the light from one headlamp while adjusting the other.



On the wall or screen you will observe a flat zone of high intensity light located at the top of the right hand portion of the beam pattern. If the top edge of the high intensity light zone is not at the horizontal reference line, the headlamp will need to be adjusted.



4. Locate the vertical adjuster on each headlamp. Using a Phillips #2 screwdriver, turn the adjuster either clockwise or counterclockwise in order to aim the headlamp. The horizontal edge of the brighter light should touch the horizontal reference line.

5. Close the hood and turn off the lamps.

HORIZONTAL AIM IS NOT REQUIRED FOR THIS VEHICLE AND IS NOT ADJUSTABLE.

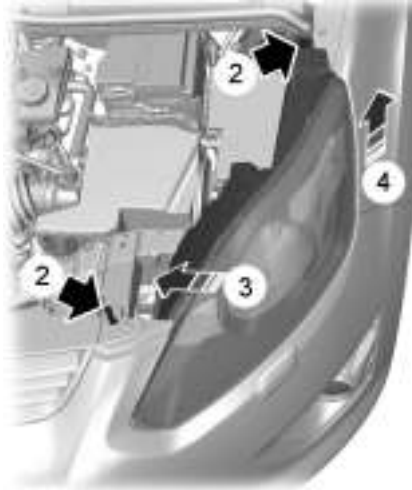
REMOVING A HEADLAMP

1. Make sure the lighting control is in the off position and open the hood.
2. Remove the two screws from the headlamp assembly.
3. Carefully pull the headlamp assembly as far as possible towards the center of the vehicle to disengage it from the lower fixing point.
4. Carefully lift the outer side of the headlamp and remove it.
5. Disconnect the electrical connector.

CHANGING A BULB**Lamp Assembly Condensation**

Exterior lamps are vented to accommodate normal changes in pressure. Condensation can be a natural by-product of this design. When moist air enters the lamp assembly through the vents, there is a possibility that condensation can occur when the temperature is cold. When normal condensation occurs, a thin film of mist can form on the interior of the lens. The thin mist eventually clears and exits through the vents during normal operation. Clearing time may take as long as 48 hours under dry weather conditions.

These are examples of acceptable condensation:

- Presence of thin mist (no streaks, drip marks or droplets).
- Fine mist covers less than 50% of the lens.

These are examples of unacceptable moisture (usually caused by a lamp water leak):

- Water puddle inside the lamp.
- Large water droplets, drip marks or streaks present on the interior of the lens.

Take your vehicle to a dealer for service if any of the above conditions of unacceptable moisture are present.

Replacing Headlamp Bulbs

! **WARNING:** Handle a halogen headlamp bulb carefully and keep out of children's reach. Grasp the bulb by only its plastic base and do not touch the glass. The oil from your hand could cause the bulb to break the next time the headlamps are operated.

Note: If the bulb is accidentally touched, it should be cleaned with rubbing alcohol before being used.

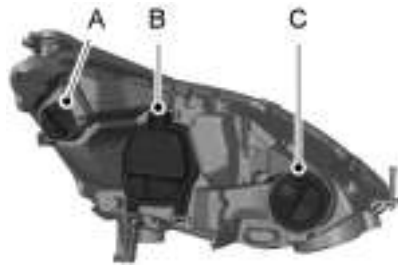

Locating the Headlamp Bulbs:

- A. Turn lamp
- B. Low beam headlamp
- C. High beam headlamp



Replacing the High Beam Headlamp Bulb:

1. Remove the headlamp assembly.
2. Remove the service cap.
3. Disconnect the electrical connector
4. Release the clip and remove the bulb from the headlamp assembly.



Replacing the Low Beam Headlamp Bulb:

1. Remove the headlamp assembly.
2. Remove the cover.
3. Turn the bulb holder counterclockwise and remove it.
4. Remove the bulb from the headlamp assembly.

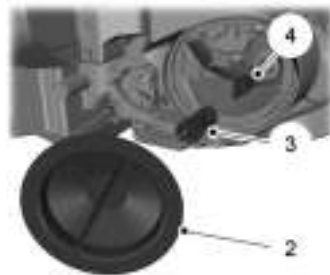

Replacing the Side Lamp Bulb:

1. Remove the headlamp assembly.
2. Remove the service cap.
3. Remove the bulb holder.
4. Remove the bulb from the headlamp assembly.

Install the new bulbs in reverse order.

Replacing the Fog Lamp Bulbs (If Equipped)



Note: You cannot separate the fog lamp bulb from the bulb holder.

1. Remove the fog lamp cover
2. Remove the 2 screws.
3. Remove the lamp.

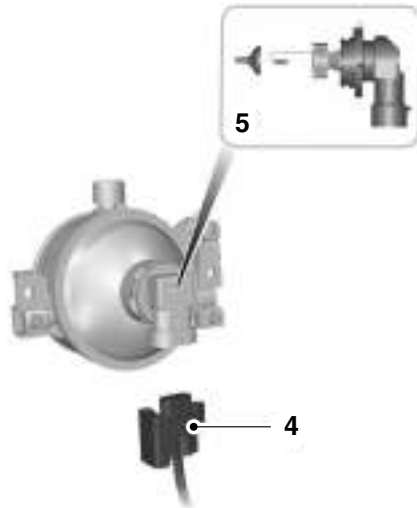

4. Disconnect the electrical connector.
5. Turn the bulb holder counterclockwise and remove it. Install the new bulb in reverse order.

Replacing the Tail Lamp, Brake Lamp, and Turn Lamp Bulbs:



1. Make sure the lighting control is in the off position.
2. Open the liftgate.
3. Remove the trim panel cover.



4. Disconnect the electrical connector.
5. Remove the wing nut.
6. Gently pull the lamp assembly away from the vehicle



7. Remove the bulb holder.
 8. Gently press the bulb into the bulb holder, turn the bulb counterclockwise, and remove the bulb.
- A. Tail lamp and brake lamp
B. Turn lamp

Install the new bulb in reverse order.

Replacing the Reverse Lamp and Tail Lamp Bulbs:



1. Make sure the lighting control is in the off position.
2. Open the liftgate.
3. Remove the trim panel cover.



4. Remove the wing nut.
5. Gently pull the lamp assembly away from the vehicle

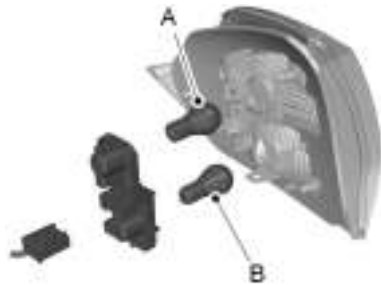

6. Disconnect the electrical connector.
7. Remove the bulb holder.
8. Gently press the bulb into the bulb holder, turn the bulb counterclockwise, and remove the bulb.

A. Reverse lamp
B. Tail lamp

Install the new bulb in reverse order.

Replacing the License Plate Lamp Bulb

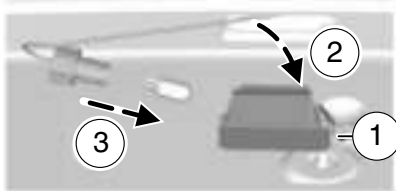

1. Carefully release the spring clip.
2. Remove the lamp.
3. Remove the bulb.

Install the new bulb in reverse order.

Replacing the Center High Mounted Brake Lamp Bulbs:

1. Open the liftgate.
2. Detach the clips above the inboard side of the rear window.



3. Insert a suitable tool into the holes.
4. Carefully pull the lamp towards the front of the vehicle in order to release the spring clips.



5. Gently pull the lamp assembly away from the vehicle.



6. Remove the bulb holder.
7. Remove the bulb.

Install the new bulb in reverse order.

BULB SPECIFICATION CHART

Replacement bulbs are specified in the chart below. Headlamp bulbs must be marked with an authorized "D.O.T." for North America to ensure lamp performance, light brightness and pattern and safe visibility. The correct bulbs will not damage the lamp assembly or void the lamp assembly warranty and will provide quality bulb burn time.

Function	Trade number
Headlamps high beam	H1
Headlamps low beam	H11
Park/turn lamp (front)	3457AK
Side marker (front)	W5W
Fog lamps (if equipped)	H11LL
Tail/brake lamp in the rear fender	W21/5W
Turn lamp in the rear fender	WY21W
Tail lamp in the liftgate	P21/5W
Backup lamp	W16W
License plate lamp	W5W
Cargo area lamp	W6W
High-mount brake lamp	W5W
* Interior lamps	LED
* To replace these lamps - see your authorized dealer.	
To replace all instrument panel lights - see your authorized dealer	

GENERAL INFORMATION

Your Ford or Lincoln authorized dealer has many quality products available to clean your vehicle and protect its finishes.

CLEANING PRODUCTS

For best results, use the following products or products of equivalent quality:

- Motorcraft® Bug and Tar Remover (ZC-42)
- Motorcraft® Custom Bright Metal Cleaner (ZC-15)
- Motorcraft® Detail Wash (ZC-3-A)
- Motorcraft® Dusting Cloth (ZC-24)
- Motorcraft® Engine Shampoo and Degreaser (U.S. only) (ZC-20)
- Motorcraft® Engine Shampoo (Canada only) (CXC-66-A)
- Motorcraft® Multi-Purpose Cleaner (Canada only) (CXC-101)
- Motorcraft® Premium Glass Cleaner (Canada only) (CXC-100)
- Motorcraft® Premium Quality Windshield Washer Fluid (Canada only) [CXC-37-(A, B, D or F)]
- Motorcraft® Premium Windshield Washer Concentrate (U.S. only) (ZC-32-A)
- Motorcraft® Professional Strength Carpet & Upholstery Cleaner (ZC-54)
- Motorcraft® Spot and Stain Remover (U.S. only) (ZC-14)
- Motorcraft® Ultra-Clear Spray Glass Cleaner (ZC-23)
- Motorcraft® Vinyl Cleaner (Canada only) (CXC-93)
- Motorcraft® Wheel and Tire Cleaner (ZC-37-A)

CLEANING THE EXTERIOR

Wash your vehicle regularly with cool or lukewarm water and a neutral pH shampoo, such as Motorcraft® Detail Wash.

- Never use strong household detergents or soap, such as dish washing or laundry liquid. These products can discolor and spot painted surfaces.
- Never wash a vehicle that is hot to the touch or during exposure to strong, direct sunlight.
- Dry the vehicle with a chamois or soft terry cloth towel in order to eliminate water spotting.
- Immediately remove items such as gasoline, diesel fuel, bird droppings and insect deposits because they can cause damage to the vehicle's paintwork and trim over time. Use Motorcraft® Bug and Tar Remover.

- **Note:** Suntan lotions and insect repellents can damage any painted surface; if these substances come in contact with your vehicle, wash it off as soon as possible.
- Remove any exterior accessories before entering a car wash.

Exterior Chrome

Note: Never use abrasive materials such as steel wool or plastic pads as they can scratch the chrome surface.

Note: Do not use chrome cleaner, metal cleaner or polish on wheels and wheel covers.

- Wash the vehicle first, using cool or lukewarm water and a neutral pH shampoo, such as Motorcraft® Detail Wash.
- Use Motorcraft® Custom Bright Metal Cleaner. Apply the product as you would a wax to clean bumpers and other chrome parts; allow the cleaner to dry for a few minutes, then wipe off the haze with a clean, dry rag.
- Do not apply cleaning product to hot surfaces and do not leave cleaning product on chrome surfaces for a period of time exceeding that which is recommended.
- **Note:** Using other non-recommended cleaners can result in severe and permanent cosmetic damage.

Underbody

Flush the complete underside of your vehicle frequently. Keep body and door drain holes free from packed dirt.

Cleaning Plastic Exterior Parts

Use only approved products to clean plastic parts.

- For routine cleaning, use Motorcraft® Detail Wash.
- If tar or grease spots are present, use Motorcraft® Bug and Tar Remover.

WAXING

- Wash the vehicle first.
- Use a quality wax that does not contain abrasives.
- Do not allow paint sealant to come in contact with any non-body (low-gloss black) colored trim, such as grained door handles, roof racks, bumpers, side moldings, mirror housings or the windshield cowl area. The paint sealant will grey or stain the parts over time.

REPAIRING MINOR PAINT DAMAGE

Your authorized dealer has touch-up paint to match your vehicle's color. Take your color code (printed on a sticker in the driver's door jamb) to your authorized dealer to make sure you get the correct color.

- Remove particles, such as bird droppings, tree sap, insect deposits, tar spots, road salt and industrial fallout, before repairing paint chips.
- Always read the instructions before using the products.

CLEANING THE ENGINE

WARNING: Exposure to high voltage may result in severe personal injury or death. High voltage components must be serviced by a trained service technician.

Engines are more efficient when they are clean because grease and dirt buildup keep the engine warmer than normal.

When washing, always power-down the vehicle and wait five minutes before touching any electrical components. Observe the following:

- Use a dry cloth to remove excess dirt that collects on the electrical components or in the charge port.
- Cover the inverter system controller, power distribution box, and air filter assembly to prevent water damage when cleaning the engine.
- Never use a power washer to clean the engine or in the charge port. The high-pressure fluid could penetrate the sealed parts and cause damage and risk of personal injury.
- Never spray water on any of the orange colored components because these components use high voltage. Never wash or rinse any ignition coil, spark plug wire or spark plug well, or the area in and around these locations. Water ingress can damage electrical components and connections.
- Do not spray a hot engine with cold water to avoid cracking the engine block or other engine components.
- Never wash or rinse the engine while it is hot or running; water in the running engine may cause internal damage.
- Spray Motorcraft® Engine Shampoo and Degreaser on all parts that require cleaning and rinse clean. In Canada, use Motorcraft® Engine Shampoo.

CLEANING THE WINDOWS AND WIPER BLADES

The windows and wiper blades should be cleaned regularly. If the wipers do not wipe properly, substances on the vehicle's glass or the wiper blades may cause squeaking or chatter noise from the blades, and streaking and smearing of the windshield. To clean these items, follow these tips:

- The windows may be cleaned with a non-abrasive cleaner such as Motorcraft® Ultra-Clear Spray Glass Cleaner.
- The wiper blades can be cleaned with isopropyl (rubbing) alcohol or Motorcraft® Premium Windshield Washer Concentrate in the U.S., or Premium Quality Windshield Washer Fluid in Canada. Be sure to replace wiper blades when they appear worn or do not function properly.
- Do not use abrasives, as they may cause scratches.
- Do not use fuel, kerosene, or paint thinner to clean any parts.

If you cannot remove those streaks after cleaning with the glass cleaner or if the wipers chatter and move in a jerky motion, clean the outer surface of the windshield and the wiper blades using a sponge or soft cloth with a neutral detergent or mild-abrasive cleaning solution. After cleaning, rinse the windshield and wiper blades with clean water. The windshield is clean if beads do not form when you rinse the windshield with water.

Note: Do not use sharp objects, such as a razor blade, to clean the inside of the rear window or to remove decals, as it may cause damage to the rear window defroster's heated grid lines.

CLEANING THE INTERIOR

WARNING: Do not use cleaning solvents, bleach or dye on the vehicle's safety belts, as these actions may weaken the belt webbing.



WARNING: On vehicles equipped with seat-mounted airbags, do not use chemical solvents or strong detergents. Such products could contaminate the side airbag system and affect performance of the side airbag in a crash.

For fabric, carpets, cloth seats, safety belts and seats equipped with side airbags:

- Remove dust and loose dirt with a vacuum cleaner.
- Remove light stains and soil with Motorcraft® Professional Strength Carpet & Upholstery Cleaner.
- If grease or tar is present on the material, spot-clean the area first with Motorcraft® Spot and Stain Remover. In Canada, use Motorcraft® Multi-Purpose Cleaner.
- If a ring forms on the fabric after spot cleaning, clean the entire area immediately (but do not oversaturate) or the ring will set.
- Do not use household cleaning products or glass cleaners, which can stain and discolor the fabric and affect the flame retardant abilities of the seat materials.

CLEANING THE INSTRUMENT PANEL AND INSTRUMENT CLUSTER LENS



WARNING: Do not use chemical solvents or strong detergents when cleaning the steering wheel or instrument panel to avoid contamination of the airbag system.

Clean the instrument panel and cluster lens with a clean, damp, white, cotton cloth, then use a clean and dry, white, cotton cloth to dry these areas.

- Avoid cleaners or polishes that increase the gloss of the upper portion of the instrument panel. The dull finish in this area helps protect the driver from undesirable windshield reflection.
- Be certain to wash or wipe your hands clean if you have been in contact with certain products, such as insect repellent and suntan lotion, in order to avoid possible damage to the interior painted surfaces.
- Do not use household or glass cleaners as these may damage the finish of the instrument panel, interior trim and cluster lens.
- Do not allow air fresheners and hand sanitizers to spill on interior surfaces. If a spill occurs, wipe off immediately. Damage may not be covered by your warranty.

If a staining liquid like coffee or juice has been spilled on the instrument panel or on interior trim surfaces, clean as follows:

1. Wipe up spilled liquid using a clean, white, cotton cloth.
2. Wipe the surface with a damp, clean, white, cotton cloth. For more thorough cleaning, use a mild soap and water solution. If the spot cannot be completely cleaned by this method, the area may be cleaned using a commercially available cleaning product designed for automotive interiors.
3. If necessary, apply more soap and water solution or cleaning product to a clean, white, cotton cloth and press the cloth onto the soiled area; allow this to set at room temperature for 30 minutes.
4. Remove the soaked cloth, and if it is not soiled badly, use this cloth to clean the area by using a rubbing motion for 60 seconds.
5. Following this, wipe area dry with a clean, white, cotton cloth.

CLEANING LEATHER SEATS (IF EQUIPPED)

- Remove dust and loose dirt with a vacuum cleaner.
- Clean spills and stains as quickly as possible.
- For routine cleaning, wipe the surface with a soft, damp cloth. For more thorough cleaning, wipe the surface with a mild soap and water solution. In Canada, use Motorcraft® Vinyl Cleaner. Dry the area with a soft cloth.
- If the leather cannot be completely cleaned using a mild soap and water solution, the leather may be cleaned using a commercially available leather cleaning product designed for automotive interiors.
- To check for compatibility, first test any cleaner or stain remover on an inconspicuous part of the leather.
- Do not use household cleaning products, alcohol solutions, solvents or cleaners intended for rubber, vinyl and plastics or petroleum-based leather conditioners. These products may cause premature wearing or damage to the leather.

CLEANING THE ALLOY WHEELS

Note: Do not use chrome cleaner, metal cleaner or polish on wheels and wheel covers.

Aluminum wheels and wheel covers are coated with a clearcoat paint finish. In order to maintain their shine:

- Clean weekly with Motorcraft® Wheel and Tire Cleaner. Heavy dirt and brake dust accumulation may require agitation with a sponge. Rinse thoroughly with a strong stream of water.
- Never apply any cleaning chemical to hot or warm wheel rims or covers.
- Some automatic car washes may cause damage to the finish on your wheel rims or covers. Industrial-strength (heavy-duty) cleaners, or cleaning chemicals, in combination with brush agitation to remove brake dust and dirt, could wear away the clearcoat finish over time.
- Do not use hydrofluoric acid-based or high caustic-based wheel cleaners, steel wool, fuels or strong household detergent.
- To remove tar and grease, use Motorcraft® Bug and Tar Remover.

VEHICLE STORAGE

If you plan on storing your vehicle for an extended period of time (30 days or more), refer to the following maintenance recommendations to ensure your vehicle stays in good operating condition.

All motor vehicles and their components were engineered and tested for reliable, regular driving. Long term storage under various conditions may lead to component degradation or failure unless specific precautions are taken to preserve the components.

General

- Store all vehicles in a dry, ventilated place.
- Protect from sunlight, if possible.
- If vehicles are stored outside, they require regular maintenance to protect against rust and damage.

Body

- Wash vehicle thoroughly to remove dirt, grease, oil, tar or mud from exterior surfaces, rear-wheel housing and underside of front fenders. See the *Cleaning* chapter for more information.
- Periodically wash vehicles stored in exposed locations.
- Touch-up raw or primed metal to prevent rust.
- Cover chrome and stainless steel parts with a thick coat of auto wax to prevent discoloration. Re-wax as necessary when the vehicle is washed. See the *Cleaning* chapter for more information.
- Lubricate all hood, door and trunk lid hinges, and latches with a light grade oil. See the *Cleaning* chapter for more information.
- Cover interior trim to prevent fading.
- Keep all rubber parts free from oil and solvents.

Engine

- The engine oil and filter should be changed prior to storage, as used engine oil contain contaminants that may cause engine damage.
- Start the engine every 15 days. Run at fast idle until it reaches normal operating temperature.
- With your foot on the brake, shift through all the gears while the engine is running.

Fuel system

- Fill the fuel tank with high-quality fuel until the first automatic shutoff of the fuel pump nozzle.

Note: During extended periods of vehicle storage (30 days or more), fuel may deteriorate due to oxidation. Add a quality gas stabilizer product to the vehicle fuel system whenever actual or expected storage periods exceed 30 days. Follow the instructions on the additive label. The vehicle should then be operated at idle speed to circulate the additive throughout the fuel system.

Cooling system

- Protect against freezing temperatures.
- When removing vehicle from storage, check coolant fluid level. Confirm there are no cooling system leaks, and fluid is at the recommended level.

Low voltage battery (except C-MAX Energi)

Complete the following steps:

1. Open the liftgate.
2. Remove the carpet from the cargo area.
3. Remove the bolts and the cargo area floor storage interior trim panel.
4. Check and recharge the low voltage battery as necessary. Keep connections clean.
5. If you are storing your vehicle for more than 30 days without recharging the battery, disconnect the negative battery cable from the low voltage battery.
6. If you disconnected the negative battery cable, apply painter's tape to the liftgate latch in order to prevent the liftgate from closing fully.

Note: If you disconnected the negative battery cable, it will be necessary to reset memory features. See *Changing the Low Voltage Battery*.

Low voltage battery (C-MAX Energi)

Complete the following steps:

1. Open the liftgate.
2. Pull and remove the access panel from the rear of the cargo area in order to access the low voltage battery.
3. Check and recharge the low voltage battery as necessary. Keep connections clean.
4. If you are storing your vehicle for more than 30 days without recharging the battery, disconnect the negative battery cable from the low voltage battery.
5. If you disconnected the negative battery cable, apply painter's tape to the liftgate latch in order to prevent the liftgate from closing fully.

Note: If you disconnected the negative battery cable, it will be necessary to reset memory features. See *Changing the Low Voltage Battery*.

Brakes

- Make sure brakes and parking brake are fully released.

Tires

- Maintain recommended air pressure.

Miscellaneous

- Make sure all linkages, cables, levers and pins under vehicle are covered with grease to prevent rust.
- Move vehicles at least 25 feet (8 m) every 15 days to lubricate working parts and prevent corrosion.

Removing Vehicle from Storage

When your vehicle is ready to come out of storage, do the following:

- Wash your vehicle to remove any dirt or grease film build-up on window surfaces.
- Check windshield wipers for any deterioration.
- Check under the hood for any foreign material that may have collected during storage (mice or squirrel nests).
- Check the exhaust for any foreign material that may have collected during storage.
- Check tire pressures and set tire inflation per the Tire Label.
- Check brake pedal operation. Drive the vehicle 15 ft (4.5 m) back and forth to remove rust build-up.
- Check fluid levels (including coolant, oil and gas) to make sure there are no leaks and fluids are at recommended levels.

Note: If you disconnected the negative battery cable and closed the liftgate fully, you will need to connect a 12 volt power supply to the jump start prongs under the hood so that you can open the liftgate. See *Jump-Starting the Vehicle* in the *Roadside Emergencies* chapter.

Low voltage battery (except C-MAX Energi)

Complete the following steps:

1. Check and recharge the low voltage battery as necessary. Keep connections clean.
2. If you disconnected the negative battery cable, connect the negative battery cable to the low voltage battery.
3. Install the cargo area floor storage interior trim panel and secure with the bolts.

4. Install the carpet to the cargo area.
5. Remove the painter's tape from the liftgate latch.
6. Close the liftgate.

Note: If you disconnected the negative battery cable, it will be necessary to reset memory features. See *Changing the Low Voltage Battery*.

Low voltage battery (C-MAX Energi)

Complete the following steps:

1. Check and recharge the low voltage battery as necessary. Keep connections clean.
2. If you disconnected the negative battery cable, connect the negative battery cable to the low voltage battery.
3. Install the low voltage battery access panel to the rear of the cargo area.
4. Remove the painter's tape from the liftgate latch.
5. Close the liftgate.

Note: If you disconnected the negative battery cable, it will be necessary to reset memory features. See *Changing the Low Voltage Battery*.

Contact your authorized dealer if you have any concerns or issues.

TIRE CARE**Information About Uniform Tire Quality Grading**

Tire Quality Grades apply to new pneumatic passenger car tires. The Tire Quality Grades can be found where applicable on the tire sidewall between tread shoulder and maximum section width. For example:

- **Treadwear 200 Traction AA Temperature A**

These Tire Quality Grades are determined by standards that the United States Department of Transportation has set.

Tire Quality Grades apply to new pneumatic passenger car tires. They do not apply to deep tread, winter-type snow tires, space-saver or temporary use spare tires, light truck or LT type tires, tires with nominal rim diameters of 10 to 12 inches or limited production tires as defined in Title 49 Code of Federal Regulations Part 575.104(c)(2).

U.S. Department of Transportation-Tire quality grades: The U.S. Department of Transportation requires Ford Motor Company to give you the following information about tire grades exactly as the government has written it.

Treadwear

The treadwear grade is a comparative rating based on the wear rate of the tire when tested under controlled conditions on a specified government test course. For example, a tire graded 150 would wear 1½ times as well on the government course as a tire graded 100. The relative performance of tires depends upon the actual conditions of their use, however, and may depart significantly from the norm due to variations in driving habits, service practices, and differences in road characteristics and climate.

Traction AA A B C

Note: The traction grade assigned to this tire is based on straight-ahead braking traction tests, and does not include acceleration, cornering, hydroplaning or peak traction characteristics.

The traction grades, from highest to lowest are AA, A, B, and C. The grades represent the tire's ability to stop on wet pavement as measured under controlled conditions on specified government test surfaces of asphalt and concrete. A tire marked C may have poor traction performance.

Temperature A B C

WARNING: The temperature grade for this tire is established for a tire that is properly inflated and not overloaded. Excessive speed, underinflation, or excessive loading, either separately or in combination, can cause heat buildup and possible tire failure.

The temperature grades are A (the highest), B and C, representing the tire's resistance to the generation of heat and its ability to dissipate heat when tested under controlled conditions on a specified indoor laboratory test wheel. Sustained high temperature can cause the material of the tire to degenerate and reduce tire life, and excessive temperature can lead to sudden tire failure. The grade C corresponds to a level of performance which all passenger car tires must meet under the Federal Motor Vehicle Safety Standard No. 139. Grades B and A represent higher levels of performance on the laboratory test wheel than the minimum required by law.

Glossary of Tire Terminology

- **Tire label:** A label showing the OE (Original Equipment) tire sizes, recommended inflation pressure and the maximum weight the vehicle can carry.
- **Tire Identification Number (TIN):** A number on the sidewall of each tire providing information about the tire brand and manufacturing plant, tire size and date of manufacture. Also referred to as DOT code.
- **Inflation pressure:** A measure of the amount of air in a tire.

- **Standard load:** A class of P-metric or Metric tires designed to carry a maximum load at 35 psi [37 psi (2.5 bar) for Metric tires]. Increasing the inflation pressure beyond this pressure will not increase the tire's load-carrying capability.
- **Extra load:** A class of P-metric or Metric tires designed to carry a heavier maximum load at 41 psi [43 psi (2.9 bar) for Metric tires]. Increasing the inflation pressure beyond this pressure will not increase the tire's load-carrying capability.
- **kPa:** Kilopascal, a metric unit of air pressure.
- **PSI:** Pounds per square inch, a standard unit of air pressure.
- **Cold tire pressure:** The tire pressure when the vehicle has been stationary and out of direct sunlight for an hour or more and prior to the vehicle being driven for 1 mile (1.6 kilometers).
- **Recommended inflation pressure:** The cold inflation pressure found on the Safety Compliance Certification Label (affixed to either the door hinge pillar, door-latch post, or the door edge that meets the door-latch post, next to the driver's seating position) or Tire Label located on the B-Pillar or the edge of the driver's door.
- **B-pillar:** The structural member at the side of the vehicle behind the front door.
- **Bead area of the tire:** Area of the tire next to the rim.
- **Sidewall of the tire:** Area between the bead area and the tread.
- **Tread area of the tire:** Area of the perimeter of the tire that contacts the road when mounted on the vehicle.
- **Rim:** The metal support (wheel) for a tire or a tire and tube assembly upon which the tire beads are seated.

INFORMATION CONTAINED ON THE TIRE SIDEWALL

Both U.S. and Canada Federal regulations require tire manufacturers to place standardized information on the sidewall of all tires. This information identifies and describes the fundamental characteristics of the tire and also provides a U.S. DOT Tire Identification Number for safety standard certification and in case of a recall.

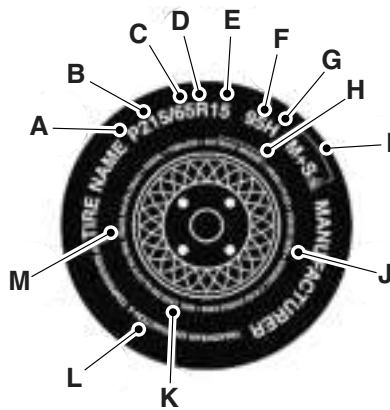
Information on P Type Tires

P215/65R15 95H is an example of a tire size, load index and speed rating. The definitions of these items are listed below. (Note that the tire size, load index and speed rating for your vehicle may be different from this example.)

A. **P:** Indicates a tire, designated by the Tire and Rim Association, that may be used for service on cars, sport utility vehicles, minivans and light trucks.

Note: If your tire size does not begin with a letter, this may mean it is designated by either the European Tire and Rim Technical Organization or the Japan Tire Manufacturing Association.

B. **215:** Indicates the nominal width of the tire in millimeters from sidewall edge to sidewall edge. In general, the larger the number, the wider the tire.

C. **65:** Indicates the aspect ratio which gives the tire's ratio of height to width.

D. **R:** Indicates a radial type tire.

E. **15:** Indicates the wheel or rim diameter in inches. If you change your wheel size, you will have to purchase new tires to match the new wheel diameter.

F. **95:** Indicates the tire's load index. It is an index that relates to how much weight a tire can carry. You may find this information in your owner's manual. If not, contact a local tire dealer.

Note: You may not find this information on all tires because it is not required by federal law.

G. **H:** Indicates the tire's speed rating. The speed rating denotes the speed at which a tire is designed to be driven for extended periods of time under a standard condition of load and inflation pressure. The tires on your vehicle may operate at different conditions for load and inflation pressure. These speed ratings may need to be adjusted for the difference in conditions. The ratings range from 81 mph (130 km/h) to 186 mph (299 km/h). These ratings are listed in the following chart.

Note: You may not find this information on all tires because it is not required by federal law.

Letter rating	Speed rating - mph (km/h)
M	81 (130)
N	87 (140)
Q	99 (159)
R	106 (171)
S	112 (180)
T	118 (190)
U	124 (200)
H	130 (210)
V	149 (240)
W	168 (270)
Y	186 (299)

Note: For tires with a maximum speed capability over 149 mph (240 km/h), tire manufacturers sometimes use the letters ZR. For those with a maximum speed capability over 186 mph (299 km/h), tire manufacturers always use the letters ZR.

H. U.S. DOT Tire Identification Number (TIN): This begins with the letters DOT and indicates that the tire meets all federal standards. The next two numbers or letters are the plant code designating where it was manufactured, the next two are the tire size code and the last four numbers represent the week and year the tire was built. For example, the numbers 317 mean the 31st week of 1997. After 2000 the numbers go to four digits. For example, 2501 means the 25th week of 2001. The numbers in between are identification codes used for traceability. This information is used to contact customers if a tire defect requires a recall.

I. M+S or M/S: Mud and Snow, or

AT: All Terrain, or

AS: All Season.

J. Tire Ply Composition and Material Used: Indicates the number of plies or the number of layers of rubber-coated fabric in the tire tread and sidewall. Tire manufacturers also must indicate the ply materials in the tire and the sidewall, which include steel, nylon, polyester, and others.

K. Maximum Load: Indicates the maximum load in kilograms and pounds that can be carried by the tire. See the Safety Compliance Certification Label (affixed to either the door hinge pillar, door-latch post, or the door edge that meets the door-latch post, next to the driver's seating position), for the correct tire pressure for your vehicle.

L. Treadwear, Traction and Temperature Grades

- **Treadwear:** The treadwear grade is a comparative rating based on the wear rate of the tire when tested under controlled conditions on a specified government test course. For example, a tire graded 150 would wear one and one-half (1½) times as well on the government course as a tire graded 100.
- **Traction:** The traction grades, from highest to lowest, are AA, A, B, and C. The grades represent the tire's ability to stop on wet pavement as measured under controlled conditions on specified government test surfaces of asphalt and concrete. A tire marked C may have poor traction performance.
- **Temperature:** The temperature grades are A (the highest), B and C, representing the tire's resistance to the generation of heat and its ability to dissipate heat when tested under controlled conditions on a specified indoor laboratory test wheel.

M. Maximum Inflation Pressure: Indicates the tire manufacturer's maximum permissible pressure or the pressure at which the maximum load can be carried by the tire. This pressure is normally higher than the manufacturer's recommended cold inflation pressure, which can be found on the Safety Compliance Certification Label (affixed to either the door hinge pillar, door-latch post, or the door edge that meets the door-latch post, next to the driver's seating position), or Tire Label which is located on the B-Pillar or the edge of the driver's door. The cold inflation pressure should never be set lower than the recommended pressure on the vehicle label.

The tire suppliers may have additional markings, notes or warnings, such as standard load or radial tubeless.

Additional Information Contained on the Tire Sidewall for LT Type Tires

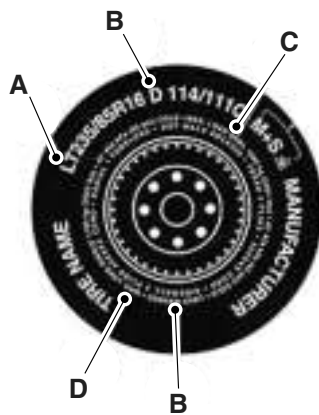

LT type tires have some additional information beyond those of P type tires. These differences are described below.

Note: Tire Quality Grades do not apply to this type of tire.

A. **LT:** Indicates a tire, designated by the Tire and Rim Association, that is intended for service on light trucks.

B. **Load Range/Load Inflation Limits:** Indicates the tire's load-carrying capabilities and its inflation limits.

C. **Maximum Load Dual lb (kg) at psi (kPa) cold:** Indicates the maximum load and tire pressure when the tire is used as a dual, defined as four tires on the rear axle (a total of six or more tires on the vehicle).

D. **Maximum Load Single lb (kg) at psi (kPa) cold:** Indicates the maximum load and tire pressure when the tire is used as a single, defined as two tires (total) on the rear axle.

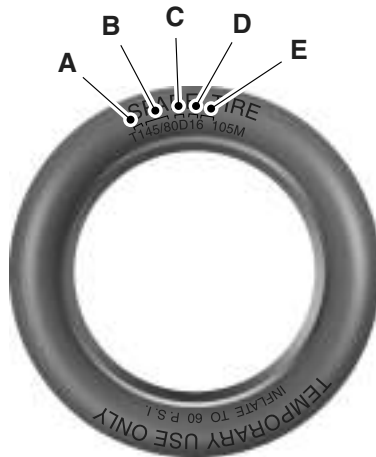
Information on T Type Tires

T type tires have some additional information beyond those of P type tires. These differences are described below.

T145/80D16 is an example of a tire size.

Note: The temporary tire size for your vehicle may be different from this example. Tire Quality Grades do not apply to this type of tire.

A. **T:** Indicates a type of tire, designated by the Tire and Rim Association, that is intended for temporary service on cars, sport-utility vehicles, minivans and light trucks.

B. **145:** Indicates the nominal width of the tire in millimeters from sidewall edge to sidewall edge. In general, the larger the number, the wider the tire.

C. **80:** Indicates the aspect ratio, which gives the tire's ratio of height to width. Numbers of 70 or lower indicate a short sidewall.

D. **D:** Indicates a diagonal type tire. **R:** Indicates a radial type tire.

E. **16:** Indicates the wheel or rim diameter in inches. If you change your wheel size, you will have to purchase new tires to match the new wheel diameter.

Location of the Tire Label

You will find a Tire Label containing tire inflation pressure by tire size and other important information located on the B-Pillar or the edge of the driver's door. See the payload description and graphic in the *Load Carrying* chapter.

INFLATING YOUR TIRES

Safe operation of your vehicle requires that your tires are properly inflated. Remember that a tire can lose up to half of its air pressure without appearing flat.

Every day before you drive, check your tires. If one looks lower than the others, use a tire gauge to check pressure of all tires and adjust if required.

At least once a month and before long trips, inspect each tire and check the tire pressure with a tire gauge (including spare, if equipped). Inflate all tires to the inflation pressure recommended by Ford Motor Company.



WARNING: Under-inflation is the most common cause of tire failures and may result in severe tire cracking, tread separation or “blowout”, with unexpected loss of vehicle control and increased risk of injury. Under-inflation increases sidewall flexing and rolling resistance, resulting in heat buildup and internal damage to the tire. It also may result in unnecessary tire stress, irregular wear, loss of vehicle control and accidents. A tire can lose up to half of its air pressure and not appear to be flat!

You are strongly urged to buy a reliable tire pressure gauge, as automatic service station gauges may be inaccurate. Ford recommends the use of a digital or dial-type tire pressure gauge rather than a stick-type tire pressure gauge.

Use the recommended cold inflation pressure for optimum tire performance and wear. Under-inflation or over-inflation may cause uneven treadwear patterns.

Always inflate your tires to the Ford recommended inflation pressure even if it is less than the maximum inflation pressure information found on the tire. The Ford recommended tire inflation pressure is found on the Safety Compliance Certification Label (affixed to either the door hinge pillar, door-latch post, or the door edge that meets the door-latch post, next to the driver's seating position), or Tire Label which is located on the B-Pillar or the edge of the driver's door. Failure to follow the tire pressure recommendations can cause uneven treadwear patterns and adversely affect the way your vehicle handles.

Maximum Inflation Pressure is the tire manufacturer's maximum permissible pressure or the pressure at which the maximum load can be carried by the tire. This pressure is normally higher than the manufacturer's recommended cold inflation pressure which can be found on the Safety Compliance Certification Label (affixed to either the door hinge pillar, door-latch post, or the door edge that meets the door-latch post, next to the driver's seating position), or Tire Label which is located on the B-Pillar or the edge of the driver's door. The cold inflation pressure should never be set lower than the recommended pressure on the Safety Compliance Certification Label or Tire Label.

When weather temperature changes occur, tire inflation pressures also change. A 10°F (6°C) temperature drop can cause a corresponding drop of 1 psi (7 kPa) in inflation pressure. Check your tire pressures frequently and adjust them to the proper pressure which can be found on the Safety Compliance Certification Label or Tire Label.

To check the pressure in your tire(s):

1. Make sure the tires are cool, meaning they are not hot from driving even a mile.

If you are checking tire pressure when the tire is hot (for example, driven more than 1 mile [1.6 kilometers]), never bleed or reduce air pressure. The tires are hot from driving and it is normal for pressures to increase above recommended cold pressures. A hot tire at or below recommended cold inflation pressure could be significantly under-inflated.

Note: If you have to drive a distance to get air for your tire(s), check and record the tire pressure first and add the appropriate air pressure when you get to the pump. It is normal for tires to heat up and the air pressure inside to go up as you drive.

2. Remove the cap from the valve on one tire, then firmly press the tire gauge onto the valve and measure the pressure.
3. Add enough air to reach the recommended air pressure.

Note: If you overfill the tire, release air by pressing on the metal stem in the center of the valve. Then recheck the pressure with your tire gauge.

4. Replace the valve cap.
5. Visually inspect the tires to make sure there are no nails or other objects embedded that could poke a hole in the tire and cause an air leak.
6. Check the sidewalls to make sure there are no gouges, cuts or bulges.

Inspecting Your Tires and Wheel Valve Stems

Periodically inspect the tire treads for uneven or excessive wear and remove objects such as stones, nails or glass that may be wedged in the tread grooves. Check the tire and valve stems for holes, cracks, or cuts that may permit air leakage and repair or replace the tire and replace the valve stem. Inspect the tire sidewalls for cracking, cuts, bruises and other signs of damage or excessive wear. If internal damage to the tire is suspected, have the tire demounted and inspected in case it needs to be repaired or replaced. For your safety, tires that are damaged or show signs of excessive wear should not be used because they are more likely to blow out or fail.

Improper or inadequate vehicle maintenance can cause tires to wear abnormally. Inspect all your tires frequently, and replace them if one or more of the following conditions exist:

Tire Wear

When the tread is worn down to 1/16th of an inch (2 millimeters), tires must be replaced to help prevent your vehicle from skidding and hydroplaning. Built-in treadwear indicators, or wear bars, which look like narrow strips of smooth rubber across the tread will appear on the tire when the tread is worn down to 1/16th of an inch (2 millimeters).

When the tire tread wears down to the same height as these wear bars, the tire is worn out and must be replaced.

Damage

Periodically inspect the tire treads and sidewalls for damage (such as bulges in the tread or sidewalls, cracks in the tread groove and separation in the tread or sidewall). If damage is observed or suspected, have the tire inspected by a tire professional. Tires can be damaged during off-road use, so inspection after off-road use is also recommended.

**WARNING: Age**

Tires degrade over time depending on many factors such as weather, storage conditions, and conditions of use (load, speed, inflation pressure, etc.) the tires experience throughout their lives. In general, tires should be replaced after six years regardless of tread wear. However, heat caused by hot climates or frequent high loading conditions can accelerate the aging process and may require tires to be replaced more frequently.

U.S. DOT Tire Identification Number

Both U.S. and Canada Federal regulations require tire manufacturers to place standardized information on the sidewall of all tires. This information identifies and describes the fundamental characteristics of the tire and also provides a U.S. DOT Tire Identification Number for safety standard certification and in case of a recall.

This begins with the letters DOT and indicates that the tire meets all federal standards. The next two numbers or letters are the plant code designating where it was manufactured, the next two are the tire size code and the last four numbers represent the week and year the tire was built. For example, the numbers 317 mean the 31st week of 1997. After 2000 the numbers go to four digits. For example, 2501 means the 25th week of 2001. The numbers in between are identification codes used for traceability. This information is used to contact customers if a tire defect requires a recall.

Tire Replacement Requirements

WARNING: Only use replacement tires and wheels that are the same size, load index, speed rating and type (such as P-metric versus LT-metric or all-season versus all-terrain) as those originally provided by Ford. The recommended tire and wheel size may be found on either the Safety Compliance Certification Label (affixed to either the door hinge pillar, door-latch post, or the door edge that meets the door-latch post, next to the driver's seating position), or the Tire Label which is located on the B-Pillar or edge of the driver's door. If this information is not found on these labels, then you should contact your authorized dealer as soon as possible. Use of any tire or wheel not recommended by Ford can affect the safety and performance of your vehicle, which could result in an increased risk of loss of vehicle control, vehicle rollover, personal injury and death. Additionally the use of non-recommended tires and wheels could cause steering, suspension, axle, transfer case or power transfer unit failure. If you have questions regarding tire replacement, contact your authorized dealer as soon as possible.



WARNING: To reduce the risk of serious injury, when mounting replacement tires and wheels, you should not exceed the maximum pressure indicated on the sidewall of the tire to set the beads without additional precautions listed below. If the beads do not seat at the maximum pressure indicated, re-lubricate and try again.

When inflating the tire for mounting pressures up to 20 psi (1.38 bar) greater than the maximum pressure on the tire sidewall, the following precautions must be taken to protect the person mounting the tire:

1. Make sure that you have the correct tire and wheel size.
2. Lubricate the tire bead and wheel bead seat area again.
3. Stand at a minimum of 12 feet (3.66 meters) away from the tire wheel assembly.
4. Use both eye and ear protection.

For a mounting pressure more than 20 psi (1.38 bar) greater than the maximum pressure, a Ford dealer or other tire service professional should do the mounting.

Always inflate steel carcass tires with a remote air fill with the person inflating standing at a minimum of 12 feet (3.66 meters) away from the tire wheel assembly.

Your vehicle is equipped with tires designed to provide a safe ride and handling capability.

Important: Remember to replace the wheel valve stems when the road tires are replaced on your vehicle.

The two front tires or two rear tires should generally be replaced as a pair.

The tire pressure sensors mounted in the wheels (originally installed on your vehicle) are not designed to be used in aftermarket wheels.

The use of wheels or tires not recommended by Ford Motor Company may affect the operation of your tire pressure monitoring system.

If the tire pressure monitoring system indicator is flashing, the system is malfunctioning. Your replacement tire might be incompatible with your tire pressure monitoring system, or some component of the system may be damaged.

Safety Practices



WARNING: If your vehicle is stuck in snow, mud, sand, etc., do not rapidly spin the tires; spinning the tires can tear the tire and cause an explosion. A tire can explode in as little as three to five seconds.



WARNING: Do not spin the wheels at over 35 mph (56 km/h). The tires may fail and injure a passenger or bystander.

Driving habits have a great deal to do with your tire mileage and safety.

- Observe posted speed limits
- Avoid fast starts, stops and turns
- Avoid potholes and objects on the road
- Do not run over curbs or hit the tire against a curb when parking

Highway Hazards

No matter how carefully you drive there's always the possibility that you may eventually have a flat tire on the highway. Drive slowly to the closest safe area out of traffic. This may further damage the flat tire, but your safety is more important.

If you feel a sudden vibration or ride disturbance while driving, or you suspect your tire or vehicle has been damaged, immediately reduce your speed. Drive with caution until you can safely pull off the road. Stop and inspect the tires for damage. If you cannot detect the cause, have the vehicle towed to the nearest repair facility or tire dealer to have the vehicle inspected. Before attempting to use the sealing kit, please read about the Temporary Mobility Kit in this chapter of the Owner's Manual.

Tire and Wheel Alignment

A bad jolt from hitting a curb or pothole can cause the front end of your vehicle to become misaligned or cause damage to your tires. If your vehicle seems to pull to one side when you are driving, the wheels may be out of alignment. Have an authorized dealer check the wheel alignment periodically.

Wheel misalignment in the front or the rear can cause uneven and rapid treadwear of your tires and should be corrected by an authorized dealer. Front-wheel drive vehicles and those with an independent rear suspension may require alignment of all four wheels.

The tires should also be balanced periodically. An unbalanced tire and wheel assembly may result in irregular tire wear.

Tire Rotation

Note: If your tires show uneven wear ask an authorized dealer to check for and correct any wheel misalignment, tire imbalance or mechanical problem involved before tire rotation.

Note: After having your tires rotated, inflation pressure must be checked and adjusted to the vehicle requirements.

Rotating your tires at the recommended interval (as indicated in the scheduled maintenance information) will help your tires wear more evenly, providing better tire performance and longer tire life.

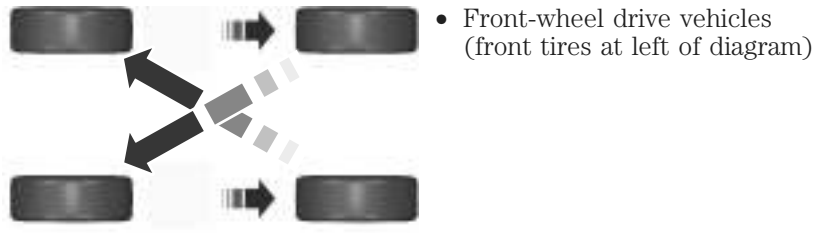

Sometimes irregular tire wear can be corrected by rotating the tires.

USING SNOW CHAINS

WARNING: Snow tires must be the same size, load index, speed rating as those originally provided by Ford. Use of any tire or wheel not recommended by Ford can affect the safety and performance of your vehicle, which could result in an increased risk of loss of vehicle control, vehicle rollover, personal injury and death. Additionally, the use of non-recommended tires and wheels could cause steering, suspension, axle, transfer case or power transfer unit failure.

The tires on your vehicle have all-weather treads to provide traction in rain and snow. Snow chains have not been approved for use on your vehicle.

Consult your authorized dealer for information on other Ford Motor Company approved methods of traction control.

TIRE PRESSURE MONITORING SYSTEM

WARNING: The tire pressure monitoring system is NOT a substitute for manually checking tire pressure. The tire pressure should be checked periodically (at least monthly) using a tire gauge. See *Inflating Your Tires* in this chapter. Failure to properly maintain your tire pressure could increase the risk of tire failure, loss of control, vehicle rollover and personal injury.



Each tire, including the spare (if provided), should be checked monthly when cold and inflated to the inflation pressure recommended by the vehicle manufacturer on the vehicle placard or tire inflation pressure label. (If your vehicle has tires of a different size than the size indicated on the vehicle placard or tire inflation pressure label, you should determine the proper tire inflation pressure for those tires.)

As an added safety feature, your vehicle has been equipped with a tire pressure monitoring system (TPMS) that illuminates a low tire pressure telltale when one or more of your tires is significantly under-inflated. Accordingly, when the low tire pressure telltale illuminates, you should stop and check your tires as soon as possible, and inflate them to the proper pressure. Driving on a significantly under-inflated tire causes the tire to overheat and can lead to tire failure. Under-inflation also reduces fuel efficiency and tire tread life, and may affect the vehicle's handling and stopping ability.

Please note that the TPMS is not a substitute for proper tire maintenance, and it is the driver's responsibility to maintain correct tire pressure, even if under-inflation has not reached the level to trigger illumination of the TPMS low tire pressure telltale.

Your vehicle has also been equipped with a TPMS malfunction indicator to indicate when the system is not operating properly. The TPMS malfunction indicator is combined with the low tire pressure telltale. When the system detects a malfunction, the telltale will flash for approximately one minute and then remain continuously illuminated. This sequence will continue upon subsequent vehicle start-ups as long as the malfunction exists.

When the malfunction indicator is illuminated, the system may not be able to detect or signal low tire pressure as intended. TPMS malfunctions may occur for a variety of reasons, including the installation of replacement or alternate tires or wheels on the vehicle that prevent the TPMS from functioning properly. Always check the TPMS malfunction telltale after replacing one or more tires or wheels on your vehicle to ensure that the replacement or alternate tires and wheels allow the TPMS to continue to function properly.

The tire pressure monitoring system complies with part 15 of the FCC rules and with RSS-210 of Industry Canada. Operation is subject to the following two conditions: (1) This device may not cause harmful interference, and (2) This device must accept any interference received, including interference that may cause undesired operation.

Changing Tires with a Tire Pressure Monitoring System



Note: Each road tire is equipped with a tire pressure sensor located inside the tire and wheel assembly cavity. The pressure sensor is attached to the valve stem. The pressure sensor is covered by the tire and is not visible unless the tire is removed. Take care when changing the tire to avoid damaging the sensor.

You should always have your tires serviced by an authorized dealer.

Check the tire pressure periodically (at least monthly) using an accurate tire gauge. See *Inflating Your Tires* in this chapter.

Understanding Your Tire Pressure Monitoring System

The tire pressure monitoring system measures pressure in your four road tires and sends the tire pressure readings to your vehicle. The low tire pressure warning light will turn on if the tire pressure is significantly low. Once the light is illuminated, your tires are under-inflated and need to be inflated to the manufacturer's recommended tire pressure. Even if the light turns on and a short time later turns off, your tire pressure still needs to be checked.

When You Believe Your System Is Not Operating Properly

The main function of the tire pressure monitoring system is to warn you when your tires need air. It can also warn you in the event the system is no longer capable of functioning as intended. Please refer to the following chart for information concerning your tire pressure monitoring system:

Low tire pressure warning light	Possible cause	Customer action required
Solid warning light	Tire(s) under-inflated	1. Make sure tires are at the proper pressure. See <i>Inflating your tires</i> in this chapter. 2. After inflating your tires to the manufacturer's recommended pressure as shown on the Tire Label (located on the edge of driver's door or the B-Pillar), the vehicle must be driven for at least two minutes over 20 mph (32 km/h) before the light turns off.
	TPMS malfunction	If the tires are properly inflated but the light remains on, contact your authorized dealer as soon as possible.
Flashing warning light	TPMS malfunction	If the tires are properly inflated, but the light remains on, contact your authorized dealer as soon as possible.

When Inflating Your Tires

When putting air into your tires (such as at a gas station or in your garage), the tire pressure monitoring system may not respond immediately to the air added to your tires.

It may take up to two minutes of driving over 20 mph (32 km/h) for the light to turn off after you have filled your tires to the recommended inflation pressure.

How Temperature Affects Your Tire Pressure

The tire pressure monitoring system monitors tire pressure in each pneumatic tire. While driving in a normal manner, a typical passenger tire inflation pressure may increase approximately 2 to 4 psi (14 to 28 kPa) from a cold start situation. If the vehicle is stationary overnight with the outside temperature significantly lower than the daytime temperature, the tire pressure may decrease approximately 3 psi (21 kPa) for a drop of 30°F (17°C) in ambient temperature. This lower pressure value may be detected by the system as being significantly lower than the recommended inflation pressure and activate the system warning light for low tire pressure. If the low tire pressure warning light is on, visually check each tire to verify that no tire is flat. If one or more tires are flat, repair as necessary. Check air pressure in the road tires. If any tire is under-inflated, carefully drive the vehicle to the nearest location where air can be added to the tires. Inflate all the tires to the recommended inflation pressure.

TEMPORARY MOBILITY KIT

Note: The temporary mobility kit sealant compound in the canister is to be used for one tire only. See your Ford authorized dealer for additional replacement sealant canisters.

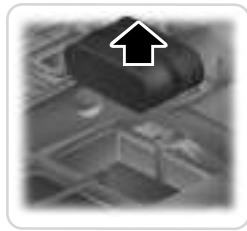

The kit is located under the front row passenger seat.

Loosen the Velcro® straps to access the kit.



The temporary mobility kit consists of an air compressor to reinflate the tire and a sealing compound in a canister that will seal most punctures caused by nails or similar objects. This kit will provide a temporary seal allowing you to drive your vehicle up to 120 miles (200 kilometers) at a maximum speed of 50 mph (80 km/h).

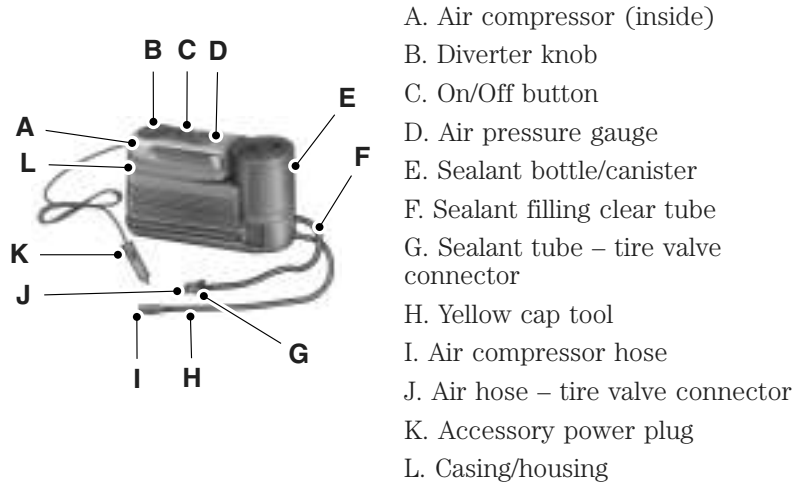

General Information



WARNING: Failure to follow these guidelines could result in an increased risk of loss of vehicle control, injury or death.

Note: Do not use the temporary mobility kit if a tire has become severely damaged by driving the vehicle with a tire that has insufficient air pressure. Only punctured areas located within the tire tread can be sealed with the temporary mobility kit.

Do not attempt to repair punctures larger than ¼ inch (6 millimeters) or damage to the tire's sidewall. The tire may not completely seal.

Loss of air pressure may adversely affect tire performance. For this reason:

- **Note:** Do not drive the vehicle above 50 mph (80 km/h).
- **Note:** Do not drive further than 120 miles (200 kilometers). Drive only to your closest authorized dealer or tire repair shop to have your tire inspected.
- Drive carefully and avoid abrupt steering maneuvers.
- Periodically monitor tire inflation pressure in the affected tire; if the tire is losing pressure, have the vehicle towed.
- Read the information in the *Tips for Use of the Temporary Mobility Kit* section to make sure of safe operation of the temporary mobility kit and your vehicle.

Tips for Use of the Temporary Mobility Kit

Read the following list of tips to make sure safe operation of the temporary mobility kit:

- Before operating the temporary mobility kit, make sure your vehicle is safely off the road and away from moving traffic. Turn on the hazard lights.
- Always set the parking brake to make sure the vehicle does not move unexpectedly.
- Do not remove any foreign objects, such as nails or screws, from the tire.
- When using the temporary mobility kit, leave the engine running (only if the vehicle is outdoors or in a well-ventilated area) so the compressor does not drain the vehicle's battery.
- Do not allow the compressor to operate continuously for more than 15 minutes; this will help prevent the compressor from overheating.
- Never leave the temporary mobility kit unattended when it is operating.
- Sealant compound contains latex. Make sure that you use the non-latex gloves provided to avoid an allergic reaction.
- Keep the temporary mobility kit away from children.
- Only use the temporary mobility kit when the ambient temperature is between -22°F (-30°C) and 158°F (70°C).
- Only use the sealing compound before the use by date. The use by date is on the lower right hand corner of the label located on the sealant canister (bottle). **Note:** Check the use by date regularly and replace the canister after four years.
- Do not store the temporary mobility kit unsecured inside the passenger compartment of the vehicle as it may cause injury during a sudden stop or collision. Always store the kit in its original location.
- After sealant use, the tire pressure monitoring system sensor and valve stem on the wheel must be replaced by an authorized Ford dealer.
- When inflating a tire or other objects, use the black air hose only. Do not use the transparent hose which is designed for sealant application only.
- Operating the temporary mobility kit could cause an electrical disturbance in radio, CD, and DVD player operation (if equipped).

What to Do When a Tire Is Punctured

A tire puncture within the tire's tread area can be repaired in two stages with the temporary mobility kit:

- In the first stage, the tire will be reinflated with a sealing compound and air. After the tire has been reinflated, you will need to drive the vehicle a short distance (about 4 miles [6 kilometers]) to distribute the sealant in the tire.
- In the second stage, check the tire pressure and adjust, if necessary, to the vehicle's tire inflation pressure.

First Stage: Reinflating the Tire with Sealing Compound and Air

WARNING: Do not stand directly over the temporary mobility kit while inflating the tire. If you notice any unusual bulges or deformations in the tire's sidewall during inflation, stop and call roadside assistance.



WARNING: If the tire does not inflate to the recommended tire pressure within 15 minutes, stop and call roadside assistance.

Preparation

Park the vehicle in a safe, level and secure area, away from moving traffic. Turn the hazard lights on. Apply the parking brake and turn the engine off. Inspect the flat tire for visible damage.

Sealant compound contains latex. To avoid any allergic reactions, use the non-latex gloves located in the accessory box on the underside of the temporary mobility kit housing.

Do not remove any foreign object that has pierced the tire. If a puncture is located in the tire sidewall, stop and call roadside assistance.

1. Remove the valve cap from the tire valve.
2. Unwrap the clear tube from the compressor housing.
3. Remove the tube cap and fasten the metal connector of the tube to the tire valve, turning clockwise. Make sure the connection is tightly fastened.



4. Plug the power cable into the 12-volt power point in the vehicle.

5. Remove the warning sticker found on the canister and place it on the top of the instrument panel or the center of the dash.

6. **Note:** Start the engine only if the vehicle is outdoors or in a well-ventilated area.

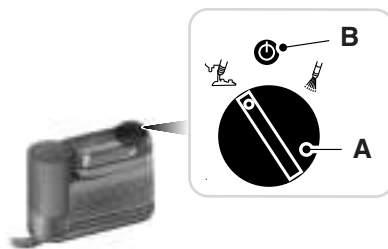

7. Push and turn dial (A) counterclockwise to the sealant position. Turn on the kit by pressing the on button (B).



8. Inflate the tire to the pressure listed on the Tire Label located on the driver's door or the door jamb area.

Note: When the sealing compound is first added into the tire, the air pressure gauge reading on the compressor unit may indicate a higher value; this is normal and should be no reason for concern. The pressure will drop after about 30 seconds of operation. The tire pressure has to be checked with the compressor in the OFF position to get the correct tire pressure reading.

9. When the recommended tire pressure is reached, turn off the kit by pressing the on and off button, then disconnect the kit from the tire valve and the power point. Re-install the valve cap on the tire valve, place the tube cap on the metal connector, and return the kit to the stowage area.

10. **Note:** Immediately and cautiously, drive the vehicle 4 miles (6 kilometers) to distribute the sealant evenly inside the tire. Do not exceed 50 mph (80 km/h).

Note: If you experience any unusual vibration, ride disturbance or noise while driving, reduce your speed until you can safely pull off to the side of the road to call for roadside assistance. **Note:** Do not proceed to the second stage of this operation.

11. After 4 miles (6 kilometers), stop and check the tire pressure. See *Second Stage: Checking Tire Pressure*.

Second Stage: Checking Tire Pressure



WARNING: If you are proceeding from the *First Stage: Reinflating the Tire with Sealing Compound and Air* section and have injected sealant in the tire and the pressure is below 20 psi (1.4 bar), stop and call roadside assistance. If tire pressure is above 20 psi (1.4 bar), continue to the next step.



WARNING: The power plug may get hot after use and should be handled carefully while unplugging.

Check the air pressure of your tires as follows:

1. Remove the valve cap from the tire valve.
2. Unhook the black hose from the side of the compressor and fasten firmly on the valve stem by turning clockwise.
3. Press down and turn the dial clockwise to the air position. Turn on the kit by pressing the on/off button.

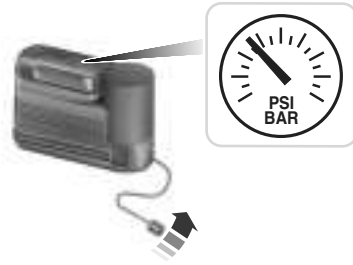

4. Adjust the tire to the recommended inflation pressure from the Tire Label located on the driver's door or door jamb area.

Note: The tire pressure has to be checked with the compressor in the OFF position to get the correct tire pressure reading.

5. Turn the compressor off by pressing the on/off button.

6. Unplug the hoses, re-install the valve cap on the tire and return the kit to the stowage area.

What To Do After the Tire Has Been Sealed

After using the temporary mobility kit to seal your tire, you will need to replace the sealant canister and clear tube (hose). Sealing compound and spare parts can be obtained and replaced at an authorized Ford Motor Company dealership or tire dealer. Empty sealant bottles may be disposed of at home. However, liquid residue from the sealing compound should be disposed by your local Ford Motor Company dealership or tire dealer, or in accordance with local waste disposal regulations.

Note: After the sealing compound has been used, the maximum vehicle speed is 50 mph (80 km/h) and the maximum driving distance is 120 miles (200 kilometers). The sealed tire should be inspected immediately.

Note: After sealant use, the tire pressure monitoring system sensor and valve stem on the wheel must be replaced by an authorized Ford dealer.

You can check the tire pressure anytime within the 120 miles (200 kilometers) by performing the procedure from *Second Stage: Checking Tire Pressure* listed previously.

Removal of the sealant canister from the temporary mobility kit:

1. Unwrap the clear tube from the compressor housing.



2. Locate the yellow cap at the end of the clear tube.



3. Using the yellow cap tool, press the tab located on the temporary mobility kit compressor housing while pulling up on the sealant canister.



Installation of the sealant canister to the temporary mobility kit:

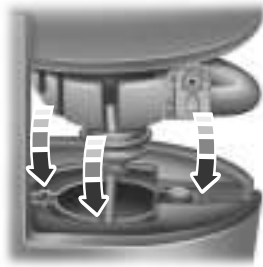

1. Align the sealant canister with the temporary mobility kit housing.



2. Once aligned, seat the sealant canister by lightly pushing down until you hear an audible click.

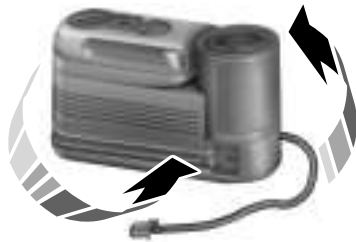

3. Wrap the clear tube around the compressor housing.

Note: If you experience any difficulties with the removal or installation of the sealant canister, consult your Ford Motor Company authorized dealer for assistance.

Use By / Utiliser avant:

Be sure to check the sealant compound's use-by date regularly. The use-by date is on the lower right hand corner of the label located on the sealant canister.

The sealant canister should be replaced after four years.

TECHNICAL SPECIFICATIONS

Wheel Lug Nut Torque Specifications

! **WARNING:** When a wheel is installed, always remove any corrosion, dirt or foreign materials present on the mounting surfaces of the wheel or the surface of the wheel hub, brake drum or brake disc that contacts the wheel. Make sure that any fasteners that attach the rotor to the hub are secured so they do not interfere with the mounting surfaces of the wheel. Installing wheels without correct metal-to-metal contact at the wheel mounting surfaces can cause the wheel nuts to loosen and the wheel to come off while the vehicle is in motion, resulting in loss of control.

Retighten the lug nuts to the specified torque within 100 miles (160 kilometers) after any wheel disturbance (such as tire rotation, changing a flat tire, wheel removal).

Bolt size	Wheel lug nut torque*	
	ft-lb	N•m
M12 x 1.5	100	135

* Torque specifications are for nut and bolt threads free of dirt and rust. Use only Ford recommended replacement fasteners.



Note: Inspect the wheel pilot bore and mounting surface prior to installation. Remove any visible corrosion or loose particles.

350 Capacities and Specifications

ENGINE SPECIFICATIONS

Engine	2.0L ATK iVCT Engine
Cubic inches	122
Required fuel	Minimum 87 octane
Firing order	1-3-4-2
Ignition system	Coil on plug (COP)
Compression ratio	12.3:1
Spark plug gap	0.051 in. \pm 0.002 in. (1.3 mm \pm 0.05 mm)

TECHNICAL SPECIFICATIONS

Item	Capacity	Ford Part Name or Equivalent	Ford Part Number / Ford Specification
Brake fluid ¹	Between MIN and MAX on reservoir	Motorcraft® DOT 4 LV High Performance Brake Fluid	PM-1-C / WSS-M6C65-A2 and ISO 4925 Class 6
Door latch, hood latch, auxiliary hood latch, liftgate latch, seat tracks.	—	Multi-Purpose Grease (Lithium grease)	XG-4 or XL-5 or equivalent / ESB-M1C93-B
Lock cylinder	—	Motorcraft® Penetrating and Lock Lubricant	XL-1 / None
Automatic transmission fluid ^{2,3}	5.7 quarts (5.4L)	Motorcraft® MERCON® LV ATF	XT-10-QLV MERCON® LV

Item	Capacity	Ford Part Name or Equivalent	Ford Part Number / Ford Specification
Engine oil ^{4,5}	4.5 quarts (4.3L)	<ul style="list-style-type: none"> •Motorcraft® SAE 5W-20 Premium Synthetic Blend Motor Oil (US) •Motorcraft® SAE 5W-20 Full Synthetic Motor Oil (US) •Motorcraft® SAE 5W-20 Super Premium Motor Oil (Canada) •Motorcraft® SAE 5W-20 Synthetic Motor Oil (Canada) 	<ul style="list-style-type: none"> •XO-5W20-QSP (US) •XO-5W20-QFS (US) •CXO-5W20-LSP12 (Canada) •CXO-5W20-LFS12 (Canada) / WSS-M2C945-A
C-MAX engine coolant ⁶	7.4 quarts (7L)	Motorcraft® Orange Antifreeze/Coolant Prediluted	<ul style="list-style-type: none"> •VC-3DIL-B (US) •CVC-3DIL-B (Canada) / WSS-M97B44-D2
C-MAX Energi engine coolant ⁶	8.8 quarts (8.3L)		
Inverter system controller coolant ⁶	1.1 quarts (1L)		

Item	Capacity	Ford Part Name or Equivalent	Ford Part Number / Ford Specification
Windshield washer fluid	Fill as required	Motorcraft® Premium Windshield Washer Concentrate (US) Premium Quality Windshield Washer Fluid (Canada)	ZC-32-A (US) CXC-37-(A, B, D, and F) (Canada) / WSB-M8B16-A2/- -
C-MAX Fuel tank	13.5 gallons (51.1L)	—	—
C-MAX Energi Fuel tank	14 gallons (53L)		
¹ Use only Motorcraft® DOT 4 LV High Performance Brake Fluid or equivalent meeting WSS-M6C65-A2 and ISO 4925 Class 6. Use of any fluid other than the recommended fluid may cause brake system damage.			
² Approximate dry fill capacity. Actual amount may vary during fluid changes.			
³ Automatic transmissions that require Motorcraft MERCON® LV transmission fluid should only use Motorcraft MERCON® LV transmission fluid. Refer to <i>scheduled maintenance</i> to determine the correct service interval. Use of any fluid other than the recommended fluid may cause transmission damage.			
⁴ Use of synthetic or synthetic blend motor oil is not mandatory. Engine oil need only meet the requirements of Ford specification WSS-M2C945-A, SAE 5W-20, GF5, and display the API Certification Mark.			
⁵ Your engine has been designed to be used with Ford engine oil, which gives a fuel economy benefit while maintaining the durability of your engine. Using oils other than the one specified can result in longer engine cranking periods, reduced engine performance, reduced fuel economy and increased emission levels.			
⁶ Add the coolant type originally equipped in your vehicle.			

MOTORCRAFT® PART NUMBERS

Component	2.0L ATK iVCT engine
Air filter element ¹	FA-1911
Oil filter ²	FL-910- S
Low-Voltage Battery	BXT-96R-500 / BXT-96R-590
Spark plugs ³	CYFS12YPC5 / SP531
Cabin air filter	FP70
Windshield wiper blade	WW29 (driver side) WW25 (passenger side)

¹Failure to use the correct air filter element may result in severe engine damage. The customer warranty may be void for any damage to the engine if the correct air filter element is not used.

²Only use the specified replacement oil filter. The use of a non-specified oil filter can result in engine damage.

³For spark plug replacement, see your authorized dealer. Refer to the *Scheduled Maintenance Information* for the appropriate intervals for changing the spark plugs. Have your authorized dealer replace the spark plugs with ones that meet Ford material and design specifications for your vehicle, such as Motorcraft® or equivalent replacement parts. The customer warranty may be void for any damage to the engine if such spark plugs are not used.

VEHICLE IDENTIFICATION NUMBER

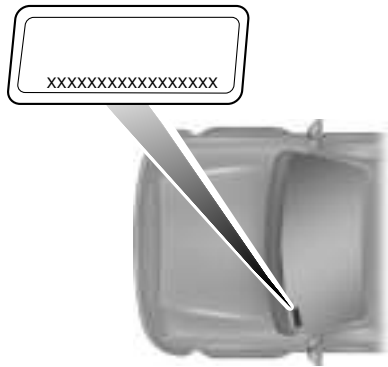

The vehicle identification number is located on the driver's side instrument panel.

Please note that in the graphic, XXXX is representative of your vehicle identification number.

The Vehicle Identification Number (VIN) contains the following information:

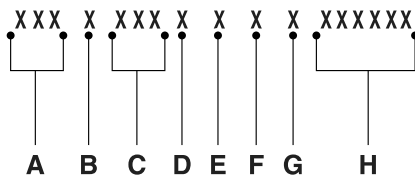

- A. World manufacturer identifier
- B. Brake system / Gross Vehicle Weight Rating (GVWR) / Restraint Devices and their location
- C. Make, vehicle line, series, body type
- D. Engine type
- E. Check digit
- F. Model year

- G. Assembly plant
- H. Production sequence number.

VEHICLE CERTIFICATION LABEL

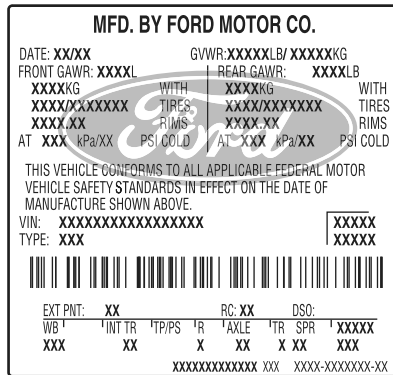

The National Highway Traffic Safety Administration Regulations require that a Safety Compliance Certification Label be affixed to a vehicle and prescribe where the Safety Compliance Certification Label may be located. The Safety Compliance Certification Label shall be affixed to either the door hinge pillar, the door latch post, or the edge of the door near the door latch, next to the driver's seating position.

TRANSMISSION CODE DESIGNATION

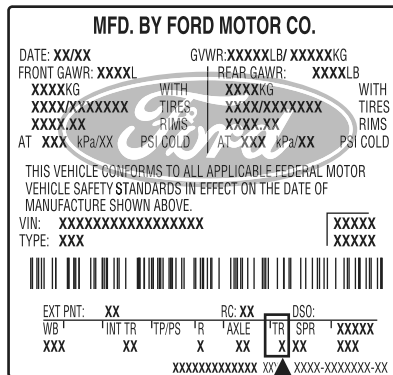

You can find a transmission code on the Safety Compliance Certification Label. The following table tells you which transmission each code represents.

Description	Code
Electronic continuously variable transmission (HF35 eCVT)	J

ACCESSORIES

For a complete listing of the accessories that are available for your vehicle, please contact your dealer or visit our online store at:

Accessories.Ford.com (U.S. only).

Ford Custom Accessories are available for your vehicle through your local Ford or Ford of Canada dealer. Ford Motor Company will repair or replace any properly dealer-installed Ford Custom Accessories found to be defective in factory-supplied materials or workmanship during the warranty period, as well as any component damaged by the defective accessories. The accessories will be warranted for whichever provides you the greatest benefit:

- 12 months or 12000 miles (20000 kilometers) (whichever occurs first), or
- the remainder of your new vehicle limited warranty.

Contact your dealer for details and a copy of the warranty.

Exterior style

- Hood deflectors
- Side window deflectors
- Splash guards
- Custom graphics*

Interior style

- Floor mats

Lifestyle

- Ash cup (smoker's package)
- Soft cargo organizers
- Cargo net*
- Roof racks and carriers*

Peace of mind

- Keyless entry keypad
- Remote start
- Vehicle security systems
- Wheel locks
- Bumper mounted parking assist system*

*Ford Licensed Accessories (FLA) are warranted by the accessory manufacturer's warranty. Ford Licensed Accessories are fully designed and developed by the accessory manufacturer and have not been designed or tested to Ford Motor Company engineering requirements. Contact your Ford dealer for details regarding the manufacturer's limited warranty and/or a copy of the FLA product limited warranty offered by the accessory manufacturer.

For maximum vehicle performance, keep the following information in mind when adding accessories or equipment to your vehicle:

- When adding accessories, equipment, passengers and luggage to your vehicle, do not exceed the total weight capacity of the vehicle or of the front or rear axle (GVWR or GAWR as indicated on the Safety Compliance Certification label). Consult your authorized dealer for specific weight information.
- The Federal Communications Commission (FCC) and Canadian Radio Telecommunications Commission (CRTC) regulate the use of mobile communications systems — such as two-way radios, telephones and theft alarms — that are equipped with radio transmitters. Any such equipment installed in your vehicle should comply with FCC or CRTC regulations and should be installed only by a qualified service technician.
- Mobile communications systems may harm the operation of your vehicle, particularly if they are not properly designed for automotive use.
- To avoid interference with other vehicle functions, such as anti-lock braking systems, amateur radio users who install radios and antennas onto their vehicle should not locate the amateur radio antennas in the area of the driver's side hood.
- Any non-Ford custom electrical or electronic accessories or components that are added to the vehicle by the authorized dealer or the owner may adversely affect battery performance and durability, and may also adversely affect the performance of other electrical systems in the vehicle.

FORD ESP EXTENDED SERVICE PLANS

PROTECT YOURSELF FROM THE RISING COST OF VEHICLE REPAIRS WITH A FORD EXTENDED SERVICE PLAN.

SERVICE PLANS (U.S. only)

More than 32 Million Ford and Lincoln owners have discovered the powerful protection Ford ESP. It is the only extended service plan backed by Ford Motor Company, and provides peace of mind protection beyond the expiration of the New Vehicle Warranty coverage.

Ford ESP can quickly pay for itself

One service bill – the cost of parts and labor – can easily exceed the price of your Ford Extended Service Plan. With Ford ESP, you minimize your risk for unexpected repair bills and rising repair costs.

Coverage for up to 500+ covered components

There are four, Extended Service Plans with different levels of coverage. Ask your dealer for details.

1. PremiumCARE – Our most comprehensive coverage. With over 500 covered components, this plan is so complete that we generally only discuss what's not covered.
2. ExtraCARE – Covers 113 components, and includes many high tech items
3. BaseCARE – Covers 84 components
4. PowertrainCARE – Covers 29 critical components

Ford ESP is honored by all Ford and Lincoln Dealers in the United States and Canada. It is the only Extended Service Plan authorized and backed by Ford Motor Company. That means you get:

- Reliable, quality service anywhere you go
- Repairs performed by factory trained technicians, using Genuine Ford and Lincoln parts

Rental Car Reimbursement

1st day Rental Benefit – You take advantage of replacement transportation if your vehicle is at the dealership for same day covered repairs.

Extended Rental Benefits – If your vehicle is kept overnight for covered repairs, you are eligible for rental car coverage, including Bumper to Bumper warranty repairs, or Field Service Actions.

Roadside Assistance

Exclusive 24/7 roadside assistance, including:

- Towing, flat-tire change and battery jump starts
- Out of fuel and lock-out assistance
- Travel Expense reimbursement for lodging, meals and rental car
- Destination assistance for taxi, shuttle, rental car coverage and emergency transportation

Transferable Coverage

If you sell your vehicle before your Ford Extended Service Plan coverage expires, you can transfer any remaining coverage to the new owner. Whenever you sell your vehicle, prospective buyers may have a higher degree of confidence that vehicle was properly maintained with Ford ESP, thereby improving resale value!

Avoid the Rising cost of vehicle maintenance

Ford ESP also offers a Premium Maintenance Plan that covers all scheduled maintenance, and select items that routinely wear out.

The coverage is prepaid, so you never have to worry about affording vehicle maintenance. It covers regular checkups, routine inspections, preventative care and replacement items that require periodic attention for normal wear:

- Windshield Wiper Blades
- Spark Plugs (except in California)
- The clutch Disc
- Brake pads and linings
- Shock Absorbers
- Belts and Hoses
- Diesel Exhaust Fluid Replenishment

Contact your selling dealership today so they can customize a Genuine Ford Extended Service Plan that fits your driving lifestyle and budget.

Interest Free Financing Options Available

Take advantage of our interest free installment payment plan. Just a 10% down payment will provide you with an affordable, no interest, no fee payment program.

Complete the information below and mail to:

Ford ESP
PO Box 8072
Royal Oak Michigan 48068-0039

To learn more, call our Ford ESP specialists at 800-367-3377. Don't forget to ask about our interest free payment program, allowing you all the security and benefits Ford ESP has to offer while paying over time. You are pre-approved with no credit checks, no hassles!

SERVICE PLANS (CANADA ONLY)

You can get more protection for your vehicle by purchasing a Ford Extended Service Plan. Ford Extended Service Plan is the only service contract backed by Ford Motor Company of Canada, Limited. Depending on the plan you purchase, Ford Extended Service Plan provides benefits such as:

- Rental reimbursement
- Coverage for certain maintenance and wear items
- Protection against repair costs after your New Vehicle Limited Warranty Coverage expires
- Roadside Assistance benefits

There are several Ford Extended Service Plans available in various time, distance and deductible combinations. Each plan is tailored to fit your own driving needs, including reimbursement for towing and rental.

When you purchase Ford Extended Service Plan, you receive added peace-of-mind protection throughout Canada and the United States, provided by a network of participating Ford Motor Company dealers. The Lincoln Maintenance Protection Plan is honored at authorized Lincoln dealers.

Note: Repairs performed outside of Canada and the United States are not eligible for Ford Extended Service Plan coverage.

This information is subject to change.

For more information, visit your local Ford of Canada dealer or www.ford.ca to find the Ford Extended Service Plan that is right for you.

GENERAL MAINTENANCE INFORMATION**Why Maintain Your Vehicle?**

Carefully following the maintenance schedule helps protect against major repair expenses resulting from neglect or inadequate maintenance and may also help to increase the value of your vehicle when you sell or trade it. Keep all receipts for completed maintenance with the vehicle.

Regular maintenance intervals for your vehicle have been established based upon rigorous testing. It is important that you have your vehicle serviced at the proper times. These intervals serve two purposes; one is to maintain the reliability of your vehicle and the second is to keep your cost of owning the vehicle down.

It is your responsibility to see that all scheduled maintenance is performed and that the materials used meet the specifications identified in the *Capacities and Specifications* chapter. Failure to perform scheduled maintenance invalidates warranty coverage on parts affected by the lack of maintenance.

Why Maintain Your Vehicle at Your Dealership?***Factory-Trained Technicians***

Service technicians participate in extensive factory-sponsored certification training to help them become experts on the operation of your vehicle. Ask your dealership about the training and certification their technicians have received.

Genuine Ford and Motorcraft® Replacement Parts

Dealerships stock Ford, Motorcraft® and Ford-authorized branded remanufactured replacement parts. These parts meet or exceed Ford Motor Company's specifications. Parts installed at your dealership carry a nationwide, 12 month/12000 mile (20000 kilometer) parts and labor limited warranty. If you do not use Ford authorized parts, they may not meet Ford specifications and, depending on the part, it could affect emissions compliance.

Convenience

Many dealerships have extended evening and Saturday hours to make your service visit more convenient and they offer one stop shopping. They can perform any services that are required on your vehicle, from general maintenance to collision repairs.

Note: Not all dealers have extended hours or bodyshops. Please contact your dealer for details.

Protecting Your Investment

Maintenance is an investment that pays dividends in the form of improved reliability, durability and resale value. To maintain the proper performance of your vehicle and its emission control systems, it is imperative that scheduled maintenance be completed at the designated intervals.

C-MAX full hybrid vehicles are equipped with an information display which indicates the proper oil change service interval; the interval is up to one year or 10000 miles (16000 kilometers). When ENGINE OIL CHANGE DUE or OIL CHANGE REQUIRED appears in the information display, it's time for an oil change; the oil change must be done within two weeks or 500 miles (800 kilometers) of the ENGINE OIL CHANGE DUE or OIL CHANGE REQUIRED message appearing. The oil life monitoring system must be reset after each oil change. See *Engine oil check* in the *Maintenance* chapter.

If your information display is prematurely reset or becomes inoperative, you should perform the oil change interval at six months or 5000 miles (8000 kilometers) from your last oil change. Never exceed one year or 10000 miles (16000 kilometers) between oil change intervals.

C-MAX Energi plug-in hybrid vehicles are equipped with the Intelligent Oil-Life Monitor® (IOLM) system which shows a message in the information display at the proper oil change service interval; this interval may be up to two years or 20000 miles (32000 kilometers). When ENGINE OIL CHANGE DUE or OIL CHANGE REQUIRED appears in the information display, it's time for an oil change; the oil change must be done within two weeks or 500 miles (800 kilometers) of the ENGINE OIL CHANGE DUE or OIL CHANGE REQUIRED message appearing. The Intelligent Oil-Life Monitor® must be reset after each oil change. See *Engine oil check* in the *Maintenance* chapter.

If your information display is prematurely reset or becomes inoperative, you should perform the oil change interval at six months or 5000 miles (8000 kilometers) from your last oil change. Never exceed two years or 20000 miles (32000 kilometers) between oil change intervals.

Your vehicle is very sophisticated and built with multiple complex performance systems. Every manufacturer develops these systems using different specifications and performance features. That is why it is important to rely upon your dealership to properly diagnose and repair your vehicle.

Ford Motor Company has recommended maintenance intervals for various parts and component systems based upon engineering testing. Ford Motor Company relies upon this testing to determine the most appropriate mileage for replacement of oils and fluids to protect your vehicle at the lowest overall cost to you and recommends against maintenance schedules that deviate from the scheduled maintenance information.

Ford strongly recommends using only genuine Ford, Motorcraft® or Ford-authorized remanufactured replacement parts because they are engineered for your vehicle.

Additives and Chemicals

Ford Motor Company recommended additives and chemicals are listed in this book and in the *Workshop Manual*. Additional chemicals or additives not approved by Ford Motor Company are not recommended as part of normal maintenance. Please consult your warranty information.

Oils, Fluids and Flushing

In many cases, fluid discoloration is a normal operating characteristic and, by itself, does not necessarily indicate a concern or that the fluid needs to be changed. However, discolored fluids that also show signs of overheating and/or foreign material contamination should be inspected immediately by a qualified expert such as the factory-trained technicians at your dealership. Your vehicle's oils and fluids should be changed at the specified intervals or in conjunction with a repair. Flushing is a viable way to change fluid for many vehicle sub-systems during scheduled maintenance. It is critical that systems are flushed only with new fluid that is the same as that required to fill and operate the system, or using a Ford-approved flushing chemical.

Owner Checks and Services

Certain basic maintenance checks and inspections should be performed every month or at six month intervals.

Check every month
Engine oil level.
Function of all interior and exterior lights.
Tires (including spare) for wear and proper pressure.
Windshield washer fluid level.
Check every six months
Battery connections. Clean if necessary.
Body and door drain holes for obstructions. Clean if necessary.
Cooling system fluid level and coolant strength.
Door weatherstrips for wear. Lubricate if necessary.
Hinges, latches and outside locks for proper operation. Lubricate if necessary.
Parking brake for proper operation.
Safety belts and seat latches for wear and function.
Safety warning lamps (brake, ABS, airbag, safety belt) for operation.
Washer spray and wiper operation. Clean or replace blades as necessary.

Multi-point Inspection

In order to keep your vehicle running right, it is important to have the systems on your vehicle checked regularly. This can help identify potential issues and prevent major problems. Ford Motor Company recommends the following multi-point inspection be performed at every scheduled maintenance interval to help make sure your vehicle keeps running great.

Multi-point Inspection	
Battery performance	Horn operation
Engine air filter	Radiator, cooler, heater and A/C hoses
Exhaust system	Suspension components for leaks or damage
Exterior lamps and hazard warning system operation	Steering and linkage
Fluid levels [*] ; fill if necessary	Tires (including spare) for wear and proper pressure ^{**}
For oil and fluid leaks	Windshield for cracks, chips or pits
Half-shaft dust boots	Washer spray and wiper operation

^{*}Brake, coolant recovery reservoir, automatic transmission and window washer.

^{**}If your vehicle is equipped with a temporary mobility kit, check the tire sealant expiration Use By date on the canister. Replace as needed.

Be sure to ask your dealership service advisor or technician about the multi-point vehicle inspection. It is a comprehensive way to perform a thorough inspection of your vehicle. It is your checklist that gives you immediate feedback on the overall condition of your vehicle. You will know what has been checked, what is okay, as well as those things that may require future or immediate attention. The multi-point vehicle inspection is one more way to keep your vehicle running great!

NORMAL SCHEDULED MAINTENANCE AND LOG**C-MAX Full Hybrid**

Normal Scheduled Maintenance*	
At every oil change interval as indicated by the information display. Can be up to 10000 miles (16000 km) or 12 months.	Change engine oil and filter.**
	Rotate tires, inspect tire wear and measure tread depth.
	Perform multi-point inspection (recommended).
	Inspect automatic transmission fluid level. Consult dealer for requirements.
	Inspect brake pads, shoes, rotors, drums, brake linings, hoses and parking brake.
	Inspect cabin air filter.
	Inspect engine cooling system and motor/electronics cooling system strength and hoses.
	Inspect exhaust system and heat shields.
	Inspect half-shaft boots.
	Inspect steering linkage, ball joints, suspension and tie-rod ends.
	Inspect wheels and related components for abnormal noise, wear, looseness or drag.

*Do not exceed one year or 10000 miles (16000 kilometers) between service intervals.

**Reset your oil monitor system after each engine oil and filter change. See the *Information Displays* chapter.

Additional Maintenance Items*	
Every 20000 miles (32000 km)	Replace cabin air filter.
Every 30000 miles (48000 km)	Replace engine air filter.
At 100000 miles (160000 km)	Change engine coolant and motor/electronics coolant.**
Every 100000 miles (160000 km)	Replace spark plugs.
Every 150000 miles (240000 km)	Change automatic transmission fluid.
	Replace auxiliary transmission fluid pump filter (if the vehicle is equipped with the Auto Stop/Start feature).

*Additional maintenance items can be performed within 3000 miles (4800 kilometers) of the last oil change. Do not exceed the designated distance for the interval.

**Initial replacement at six years or 100000 miles (160000 kilometers), then every three years or 50000 miles (80000 kilometers).

C-MAX Energi

Normal Scheduled Maintenance*	
At every oil change interval as indicated by the information display.	Change engine oil and filter.**
	Inspect automatic transmission fluid level. Consult dealer for requirements.
	Inspect brake pads, shoes, rotors, drums, brake linings, hoses and parking brake.
	Inspect cabin air filter.
	Inspect engine cooling system and motor/electronics cooling system strength and hoses.
	Inspect exhaust system and heat shields.
	Inspect half-shaft boots.
	Inspect steering linkage, ball joints, suspension and tie-rod ends.
	Inspect wheels and related components for abnormal noise, wear, looseness or drag.

*Do not exceed two years or 20000 miles (32000 kilometers) between service intervals.

**Reset your Intelligent Oil-Life Monitor after each engine oil and filter change. See *Engine oil check* in the *Maintenance* chapter.

Additional Maintenance Items¹	
Every 10000 miles (32000 km)	Rotate tires, inspect tire wear and measure tread depth.
	Inspect engine oil filter for corrosion ²
	Perform multi-point inspection (recommended).
Every 20000 miles (32000 km)	Replace cabin air filter.
Every 30000 miles (48000 km)	Replace engine air filter.
At 100000 miles (160000 km)	Change engine coolant and motor/electronics coolant. ³
Every 100000 miles (160000 km)	Replace spark plugs.
Every 150000 miles (240000 km)	Change automatic transmission fluid.
	Replace auxiliary pump inlet screen.
	Replace auxiliary transmission fluid pump filter (if the vehicle is equipped with the Auto Stop/Start feature).

¹Additional maintenance items can be performed within 3000 miles (4800 kilometers) of the last oil change. Do not exceed the designated distance for the interval.

²Inspect the engine oil filter for signs of damage such as rust, paint blistering, scratches or dents every one year or 10000 miles (16000 kilometers). If any of these conditions are present, change the filter then top-off the engine oil, if required. Do not reset your Intelligent Oil-Life Monitor.

³Initial replacement at six years or 100000 miles (160000 kilometers), then every three years or 50000 miles (80000 kilometers).

Maintenance Schedule Log

<p style="text-align: center;">DEALER VALIDATION:</p> <p>RO#: P&A CODE: HOURS: DATE: MILEAGE:</p>	<p style="text-align: center;">DEALER VALIDATION:</p> <p>RO#: P&A CODE: HOURS: DATE: MILEAGE:</p>
<p style="text-align: center;">DEALER VALIDATION:</p> <p>RO#: P&A CODE: HOURS: DATE: MILEAGE:</p>	<p style="text-align: center;">DEALER VALIDATION:</p> <p>RO#: P&A CODE: HOURS: DATE: MILEAGE:</p>
<p style="text-align: center;">DEALER VALIDATION:</p> <p>RO#: P&A CODE: HOURS: DATE: MILEAGE:</p>	<p style="text-align: center;">DEALER VALIDATION:</p> <p>RO#: P&A CODE: HOURS: DATE: MILEAGE:</p>
<p style="text-align: center;">DEALER VALIDATION:</p> <p>RO#: P&A CODE: HOURS: DATE: MILEAGE:</p>	<p style="text-align: center;">DEALER VALIDATION:</p> <p>RO#: P&A CODE: HOURS: DATE: MILEAGE:</p>
<p style="text-align: center;">DEALER VALIDATION:</p> <p>RO#: P&A CODE: HOURS: DATE: MILEAGE:</p>	<p style="text-align: center;">DEALER VALIDATION:</p> <p>RO#: P&A CODE: HOURS: DATE: MILEAGE:</p>

Scheduled Maintenance

373

<p style="text-align: center;">DEALER VALIDATION:</p> <p style="text-align: center;">P&A CODE:</p> <p>RO#: HOURS:</p> <p>DATE: MILEAGE:</p>	<p style="text-align: center;">DEALER VALIDATION:</p> <p style="text-align: center;">P&A CODE:</p> <p>RO#: HOURS:</p> <p>DATE: MILEAGE:</p>
<p style="text-align: center;">DEALER VALIDATION:</p> <p style="text-align: center;">P&A CODE:</p> <p>RO#: HOURS:</p> <p>DATE: MILEAGE:</p>	<p style="text-align: center;">DEALER VALIDATION:</p> <p style="text-align: center;">P&A CODE:</p> <p>RO#: HOURS:</p> <p>DATE: MILEAGE:</p>
<p style="text-align: center;">DEALER VALIDATION:</p> <p style="text-align: center;">P&A CODE:</p> <p>RO#: HOURS:</p> <p>DATE: MILEAGE:</p>	<p style="text-align: center;">DEALER VALIDATION:</p> <p style="text-align: center;">P&A CODE:</p> <p>RO#: HOURS:</p> <p>DATE: MILEAGE:</p>
<p style="text-align: center;">DEALER VALIDATION:</p> <p style="text-align: center;">P&A CODE:</p> <p>RO#: HOURS:</p> <p>DATE: MILEAGE:</p>	<p style="text-align: center;">DEALER VALIDATION:</p> <p style="text-align: center;">P&A CODE:</p> <p>RO#: HOURS:</p> <p>DATE: MILEAGE:</p>
<p style="text-align: center;">DEALER VALIDATION:</p> <p style="text-align: center;">P&A CODE:</p> <p>RO#: HOURS:</p> <p>DATE: MILEAGE:</p>	<p style="text-align: center;">DEALER VALIDATION:</p> <p style="text-align: center;">P&A CODE:</p> <p>RO#: HOURS:</p> <p>DATE: MILEAGE:</p>

Scheduled Maintenance

<p>DEALER VALIDATION:</p> <p>RO#: P&A CODE: HOURS: DATE: MILEAGE:</p>	<p>DEALER VALIDATION:</p> <p>RO#: P&A CODE: HOURS: DATE: MILEAGE:</p>
<p>DEALER VALIDATION:</p> <p>RO#: P&A CODE: HOURS: DATE: MILEAGE:</p>	<p>DEALER VALIDATION:</p> <p>RO#: P&A CODE: HOURS: DATE: MILEAGE:</p>
<p>DEALER VALIDATION:</p> <p>RO#: P&A CODE: HOURS: DATE: MILEAGE:</p>	<p>DEALER VALIDATION:</p> <p>RO#: P&A CODE: HOURS: DATE: MILEAGE:</p>
<p>DEALER VALIDATION:</p> <p>RO#: P&A CODE: HOURS: DATE: MILEAGE:</p>	<p>DEALER VALIDATION:</p> <p>RO#: P&A CODE: HOURS: DATE: MILEAGE:</p>
<p>DEALER VALIDATION:</p> <p>RO#: P&A CODE: HOURS: DATE: MILEAGE:</p>	<p>DEALER VALIDATION:</p> <p>RO#: P&A CODE: HOURS: DATE: MILEAGE:</p>

SPECIAL OPERATING CONDITIONS

If you operate your vehicle **primarily** in any of the following conditions, you need to perform additional maintenance as indicated. If you **occasionally** operate your vehicle under any of these conditions, it is not necessary to perform the additional maintenance. For specific recommendations, see your dealership service advisor or technician.

Perform the services shown in the following tables when specified or within 3000 miles (4800 kilometers) of the OIL CHANGE REQUIRED message appearing in the information display.

Example #1: The OIL CHANGE REQUIRED message comes on at 28751 miles (46270 kilometers); perform the 30000 mile (48000 kilometer) automatic transmission fluid replacement.

Example #2: The OIL CHANGE REQUIRED message has **not** come on, but the odometer reads 30000 miles (48000 kilometers); perform the engine air filter replacement. (i.e., Intelligent Oil-Life Monitor® was reset at 25000 miles [40000 kilometers].)

Extensive Idling or Low-speed Driving for Long Distances as in Heavy Commercial Use (i.e., Delivery, Taxi, Patrol Car or Livery)	
As required	Change engine oil and filter as indicated by the information display and perform services listed in the Normal Scheduled Maintenance chart.
Inspect frequently, service as required	Replace cabin air filter.
	Replace engine air filter.
Every 60000 miles (96000 km)	Replace spark plugs.

Operating in Dusty or Sandy Conditions such as Unpaved or Dusty Roads	
Inspect frequently, service as required	Replace cabin air filter.
	Replace engine air filter.
Every 5000 miles (8000 km)	Inspect the wheels and related components for abnormal noise, wear, looseness or drag.
	Rotate tires, inspect tires for wear and measure tread depth.
Every 5000 miles (8000 km) or six months	Change engine oil and filter.*
	Perform multi-point inspection.

***C-MAX Energi only:** Reset your Intelligent Oil-Life Monitor® after each engine oil and filter change. See *Engine oil check* in the *Maintenance* chapter.

Special Operating Condition Log

<p>DEALER VALIDATION:</p> <p>RO#: P&A CODE: HOURS: DATE: MILEAGE:</p>	<p>DEALER VALIDATION:</p> <p>RO#: P&A CODE: HOURS: DATE: MILEAGE:</p>
<p>DEALER VALIDATION:</p> <p>RO#: P&A CODE: HOURS: DATE: MILEAGE:</p>	<p>DEALER VALIDATION:</p> <p>RO#: P&A CODE: HOURS: DATE: MILEAGE:</p>
<p>DEALER VALIDATION:</p> <p>RO#: P&A CODE: HOURS: DATE: MILEAGE:</p>	<p>DEALER VALIDATION:</p> <p>RO#: P&A CODE: HOURS: DATE: MILEAGE:</p>
<p>DEALER VALIDATION:</p> <p>RO#: P&A CODE: HOURS: DATE: MILEAGE:</p>	<p>DEALER VALIDATION:</p> <p>RO#: P&A CODE: HOURS: DATE: MILEAGE:</p>
<p>DEALER VALIDATION:</p> <p>RO#: P&A CODE: HOURS: DATE: MILEAGE:</p>	<p>DEALER VALIDATION:</p> <p>RO#: P&A CODE: HOURS: DATE: MILEAGE:</p>

Scheduled Maintenance

<p style="text-align: center;">DEALER VALIDATION:</p> <p style="text-align: center;">P&A CODE:</p> <p>RO#: HOURS:</p> <p>DATE: MILEAGE:</p>	<p style="text-align: center;">DEALER VALIDATION:</p> <p style="text-align: center;">P&A CODE:</p> <p>RO#: HOURS:</p> <p>DATE: MILEAGE:</p>
<p style="text-align: center;">DEALER VALIDATION:</p> <p style="text-align: center;">P&A CODE:</p> <p>RO#: HOURS:</p> <p>DATE: MILEAGE:</p>	<p style="text-align: center;">DEALER VALIDATION:</p> <p style="text-align: center;">P&A CODE:</p> <p>RO#: HOURS:</p> <p>DATE: MILEAGE:</p>
<p style="text-align: center;">DEALER VALIDATION:</p> <p style="text-align: center;">P&A CODE:</p> <p>RO#: HOURS:</p> <p>DATE: MILEAGE:</p>	<p style="text-align: center;">DEALER VALIDATION:</p> <p style="text-align: center;">P&A CODE:</p> <p>RO#: HOURS:</p> <p>DATE: MILEAGE:</p>
<p style="text-align: center;">DEALER VALIDATION:</p> <p style="text-align: center;">P&A CODE:</p> <p>RO#: HOURS:</p> <p>DATE: MILEAGE:</p>	<p style="text-align: center;">DEALER VALIDATION:</p> <p style="text-align: center;">P&A CODE:</p> <p>RO#: HOURS:</p> <p>DATE: MILEAGE:</p>
<p style="text-align: center;">DEALER VALIDATION:</p> <p style="text-align: center;">P&A CODE:</p> <p>RO#: HOURS:</p> <p>DATE: MILEAGE:</p>	<p style="text-align: center;">DEALER VALIDATION:</p> <p style="text-align: center;">P&A CODE:</p> <p>RO#: HOURS:</p> <p>DATE: MILEAGE:</p>

EXCEPTIONS

California fuel filter replacement: If the vehicle is registered in California, the California Air Resources Board has determined that the failure to perform this maintenance item will not nullify the emission warranty or limit recall liability prior to the completion of the vehicle's useful life. Ford Motor Company, however, urges you to have all recommended maintenance services performed at the specified intervals and to record all vehicle service.

Hot climate oil change intervals: Vehicles operating in the Middle East, North Africa, Sub-Saharan Africa or locations with similar climates using an American Petroleum Institute (API) Certified for Gasoline Engines (Certification mark) oil of SM or SN quality, the normal oil change interval is 5000 miles (8000 kilometers). If the available API "SM" or "SN" oils are not available, then the oil change service interval is 3000 miles (4800 kilometers).

Engine air filter & cabin air filter replacement: Engine air filter and cabin air filter life is dependent on exposure to dusty and dirty conditions. Vehicles operated in these conditions require frequent inspection and replacement of the engine air filter and cabin air filter.

ENGINE COOLANT AND MOTOR ELECTRONICS COOLANT CHANGE RECORD

Initial change	Six years or 100000 miles (160000 km) (whichever comes first)
After initial change	Every three years or 50000 miles (80000 km)

Engine Coolant and Motor/Electronics Coolant Change Log

<p style="text-align: center;">DEALER VALIDATION:</p> <p style="text-align: center;">P&A CODE:</p> <p>RO#: HOURS:</p> <p>DATE: MILEAGE:</p>	<p style="text-align: center;">DEALER VALIDATION:</p> <p style="text-align: center;">P&A CODE:</p> <p>RO#: HOURS:</p> <p>DATE: MILEAGE:</p>
<p style="text-align: center;">DEALER VALIDATION:</p> <p style="text-align: center;">P&A CODE:</p> <p>RO#: HOURS:</p> <p>DATE: MILEAGE:</p>	<p style="text-align: center;">DEALER VALIDATION:</p> <p style="text-align: center;">P&A CODE:</p> <p>RO#: HOURS:</p> <p>DATE: MILEAGE:</p>
<p style="text-align: center;">DEALER VALIDATION:</p> <p style="text-align: center;">P&A CODE:</p> <p>RO#: HOURS:</p> <p>DATE: MILEAGE:</p>	<p style="text-align: center;">DEALER VALIDATION:</p> <p style="text-align: center;">P&A CODE:</p> <p>RO#: HOURS:</p> <p>DATE: MILEAGE:</p>

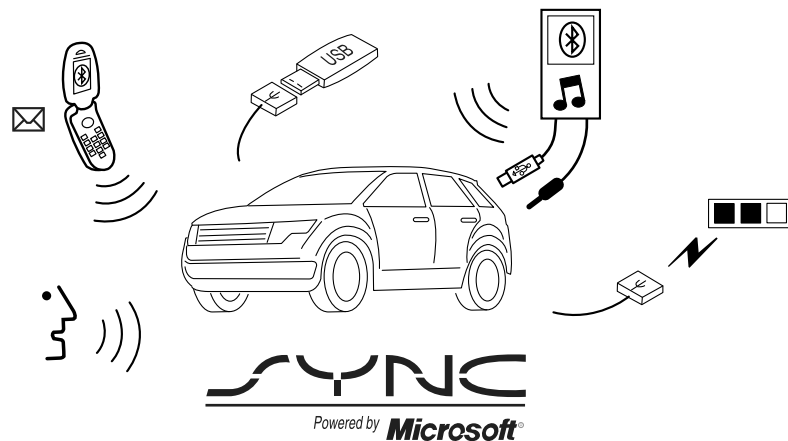

SYNC is an in-vehicle communications system that works with your Bluetooth-enabled cellular phone and portable media player. This allows you to:

- Make and receive calls.
- Access and play music from your portable music player.
- Use 911 Assist®, Vehicle Health Report and SYNC Services (Traffic, Directions & Information) (if equipped).
- Use applications, such as Pandora and Stitcher, via SYNC AppLink™ (if applicable).
- Access phonebook contacts and music via voice commands.
- Stream music from your connected phone.
- Text message.
- Use the advanced voice recognition system.
- USB device charging (if your device supports this).

GENERAL INFORMATION

Make sure you review your device's manual before using it with SYNC.

Support

The SYNC support team is available to help you with any questions you cannot answer on your own.

Monday-Saturday, 8:30am-8:00pm EST

In the United States, call: 1-888-270-1055

In Canada, call: 1-800-565-3673

Times are subject to change due to holidays.

SYNC Owner Account

Why do I need a SYNC owner account?

- Required to activate Vehicle Health Report and to view the reports online.
- Required to activate the subscription-based SYNC Services and to personalize your Saved Points and Favorites.
- Essential for keeping up with the latest software downloads available for SYNC.
- Access to customer support for any questions you may have.

Driving Restrictions

For your safety, certain features are speed-dependent and restricted when your vehicle is traveling over 3 mph (5 km/h).

Safety Information

WARNING: Driving while distracted can result in loss of vehicle control, accident and injury. Ford strongly recommends that drivers use extreme caution when using any device that may take their focus off the road. Your primary responsibility is the safe operation of the vehicle. We recommend against the use of any handheld device while driving, encourage the use of voice-operated systems when possible and that you become aware of applicable state and local laws that may affect use of electronic devices while driving.

When using SYNC:

- Do not operate playing devices if the power cords or cables are broken, split or damaged. Place cords and cables out of the way, so they do not interfere with the operation of pedals, seats, compartments or safe driving abilities.

- Do not leave playing devices in your vehicle during extreme conditions as it could cause them damage. See your device's manual for further information.
- Do not attempt to service or repair the system. See your authorized dealer.

For your safety, some SYNC functions are speed-dependent. Their use is limited to when your vehicle is traveling at speeds under 3 mph (5 km/h).

Make sure that you review your device's manual before using it with SYNC.

Privacy Information

When a cellular phone is connected to SYNC, the system creates a profile within your vehicle that is linked to that cellular phone. This profile is created in order to offer you more cellular features and to operate more efficiently. Among other things, this profile may contain data about your cellular phone book, text messages (read and unread), and call history, including history of calls when your cell phone was not connected to the system. In addition, if you connect a media device, the system creates and retains an index of supported media content. The system also records a short development log of approximately 10 minutes of all recent system activity. The log profile and other system data may be used to improve the system and help diagnose any problems that may occur.

The cellular profile, media device index, and development log remain in the vehicle unless you delete them and are generally accessible only in the vehicle when the cellular phone or media player is connected. If you no longer plan to use the system or the vehicle, we recommend you perform a Master Reset to erase all stored information.

System data cannot be accessed without special equipment and access to the vehicle's SYNC module. Ford Motor Company and Ford of Canada do not access the system data for any purpose other than as described absent consent, a court order, or where required by law enforcement, other government authorities, or other third parties acting with lawful authority. Other parties may seek to access the information independently of Ford Motor Company and Ford of Canada. For further privacy information, see the sections on 911 Assist®, Vehicle Health Report, and Traffic, Directions and Information.

USING VOICE RECOGNITION

This system helps you control many features using voice commands. This allows you to keep your hands on the wheel and focus on what is in front of you.

Initiating a Voice Session



Push the voice icon; a tone sounds and Listening appears in the display. Say any of the following:

Say:	If you want to:
“Phone”	Make calls.
“USB”	Access the device connected to your USB port.
“Bluetooth Audio”	Stream audio from your phone.
“Line in”	Access the device connected to the auxiliary input jack.
“Cancel”	Cancel the requested action.
“SYNC”	Return to the main menu.
“Voice settings”	Adjust the level of voice interaction and feedback.
“Vehicle Health Report”	Run a vehicle health report.*
“Services”	Access the SYNC Services portal.*
“Mobile apps”	Access mobile applications.*
“Help”	Hear a list of voice commands available in the current mode.

*If equipped, U.S. only.

System Interaction and Feedback

The system provides feedback through audible tones, prompts, questions and spoken confirmations depending on the situation and the chosen level of interaction (voice settings). You can customize the voice recognition system to provide more or less instruction and feedback.

The default setting is to a higher level of interaction in order to help you learn to use the system. You can change these settings at any time.

Adjusting the Interaction Level



Push the voice icon; when prompted, say “Voice settings”, then any of the following:

When you say:	The system:
“Interaction mode standard”	Provides more detailed interaction and guidance.
“Interaction mode advanced”	Provides less audible interaction and more tone prompts.

The system defaults to the standard interaction mode.

Confirmation prompts are short questions the system asks when it is not sure of your request or when there are multiple possible responses to your request. (For example, the system may ask “Phone, is that correct?”) If turned off, the system simply makes a best guess as to what you requested and you may still occasionally be asked to confirm settings.

“Confirmation prompts on”
“Confirmation prompts off”

The system creates candidate lists when it has the same confidence level of several options based on your voice command. When turned on, you may be prompted with as many as four possibilities for clarification.

For example, “Say 1 after the tone to call John Doe at home. Say 2 after the tone to call Johnny Doe on mobile. Say 3 after the tone to call Jane Doe at home.” Or, “Say 1 after the tone to play John Doe, Say 2 after the tone to play Johnny Doe.”

“Phone candidate lists on”
“Phone candidate lists off”
“Media candidate lists on”
“Media candidate lists off”

Helpful Hints

- Make sure the interior of the vehicle is as quiet as possible. Wind noise from open windows and road vibrations may prevent the system from correctly recognizing spoken commands.
- After pressing the voice icon, wait until after the tone sounds and Listening appears before saying a command. Any command spoken prior to this does not register with the system.
- Speak naturally, without long pauses between words.
- At any time you can interrupt the system while it is speaking by pressing the voice icon.

USING SYNC WITH YOUR PHONE

Hands-free calling is one of the main features of SYNC. While the system supports a variety of features, many are dependent on your cellular phone's functionality. At a minimum, most cellular phones with Bluetooth wireless technology support the following functions:

- Answering an incoming call.
- Ending a call.
- Using privacy mode.
- Dialing a number.
- Redialing.
- Call waiting notification.
- Caller ID.

Other features, such as text messaging using Bluetooth and automatic phonebook download, are phone-dependent features. To check your phone's compatibility, see your phone's user manual and visit www.SYNCMYRide.com, www.SYNCMYRide.ca or www.syncmaroute.ca.

Pairing a Phone for the First Time

Note: SYNC can support downloading up to approximately 2000 entries per Bluetooth-enabled cellular phone.

Note: Make sure the vehicle ignition and radio are turned on and the transmission is in position **P**.

Note: To scroll through the menus, press the up and down arrows on your audio system.

Wirelessly pairing your phone with SYNC allows you to make and receive hands-free calls.

1. Press the phone button; when the display indicates no phone is paired, press **OK**.
2. When **Find SYNC** appears in the display, press **OK**.
3. Put your phone into Bluetooth discovery mode. See your phone's user guide if necessary.
4. When prompted on your phone's display, enter the six-digit PIN provided by SYNC in the radio display.
5. The display indicates when the pairing is successful.

Depending on your phone's capability and your market, the system may prompt you with questions such as setting the current phone as the primary phone (the phone SYNC automatically tries to connect with first upon vehicle start-up), downloading your phone book, etc.

Pairing Subsequent Phones

Note: To scroll through the menus, press the up and down arrows on your audio system.

Note: Make sure the vehicle ignition and radio are turned on and that the transmission is in position **P**.

1. Press the phone button and scroll until System Settings is selected.
2. Press OK and scroll until Bluetooth Devices is selected and press OK.
3. Scroll until Add Bluetooth Device is selected and press OK.
4. When Find SYNC appears in the display, press OK.
5. Put your phone into Bluetooth discovery mode. See your phone's user guide if necessary.
6. When prompted on your phone's display, enter the six-digit PIN provided by SYNC in the radio display. The display indicates when the pairing is successful.
7. The system then prompts with questions such as if you would like to set the current phone as the primary phone (the phone SYNC automatically tries to connect with first upon vehicle start-up), download your phone book, etc.

Phone Voice Commands

Press the voice icon and say “Phone”. Say any of the following:

“PHONE”
“Call <name>” ^{1,2}
“Call <name> on mobile OR cell” ^{1,2}
“Call <name> on other” ^{1,2}
“Phone book <name> at home” ²
“Phone book <name> on mobile OR cell” ²
“Call history outgoing” ²
“Phone book <name> on Other” ²
“Call history missed” ²
“Menu” ^{2,3}
“Join”
“Call <name> at home” ^{1,2}
“Call <name> at work” OR “Call <name> in office” ^{1,2}
“Dial” ^{1,4}
“Phone book <name>” ²
“Phone book <name> at work” OR “Phone book <name> at office” ²
“Call history incoming” ²
“Connections” ²
“Go to privacy”
“Hold”

¹These commands do not require you to say “Phone” first.

²These commands are not available until phone information is completely downloaded using Bluetooth.

³See “MENU” table below.

⁴See “DIAL” table below.

“MENU”
“(Phone) connections”*
“(Phone) settings (message) notification off”*
“(Phone) settings (message) notification on”*
“(Phone) settings (set) phone ringer”*
“(Phone) settings (set) ringer 1”*
“(Phone) settings (set) ringer 2”*
“(Phone) settings (set) ringer 3”*
“(Phone) settings (set) ringer off”*
“Battery”
“Phone name”
“Signal”
“Text message inbox”

*Words in () are optional and do not have to be spoken for the system to understand the command.

Phone book commands: When you ask SYNC® to access a phone book name, number, etc., the requested information appears in the display to view. Press the phone button and say “Call” to call the contact.

“DIAL”
“411” (four-one-one), “911” (nine-one-one)
“700 (seven hundred)” (seven hundred)
“800 (eight hundred)” (eight hundred)
“900 (nine hundred)” (nine hundred)
“#” (pound)
“<number> 0-9”
“Asterisk” (*)
“Clear” (deletes all entered digits)
“Delete” (deletes one digit)
“Plus”
“Star”

Note: To exit dial mode, press and hold the phone button or press MENU to go to the PHONE menu.

Making Calls

Press the voice icon and when prompted say:

1. Say "Call <name>" or "Dial", then the desired number.
2. When the system confirms the number, say "Dial" again to initiate the call.

To erase the last spoken digit, say "Delete" or press the left arrow button. To erase all spoken digits, say "Clear" or press and hold the left arrow button.

To end the call, press and hold the phone button.

Receiving Calls

When receiving a call, you can:



Answer the call by pressing this button on your steering wheel controls.



Reject the call by pressing this button on your steering wheel controls.

Ignore the call by doing nothing.

Phone Options during an Active Call

During an active call, you have additional menu features which become available such as putting a call on hold, joining calls, etc. Use the arrow buttons to scroll through the menu options.

To access:

1. Press MENU during an active call.
2. When Active Call Menu is selected, press OK.
3. Scroll to cycle through the following options:

When you select:	You can:
Mute Call?	Mute the call.
Privacy	Switch a call from an active hands-free environment to your cellular phone for a more private conversation. Press OK when Privacy on/off appears. (The display indicates In Privacy and the system transfers your call.)

When you select:	You can:
Call Hold	Put an active call on hold. Press OK when Place Call on Hold? appears. To answer another call at this time, press the phone button.
Join Calls	Join two separate calls. 1. Press the phone button. 2. Access the desired contact through SYNC or use voice commands to place the second call. Once actively in the second call, press MENU. 3. Scroll until Join Calls appears and press OK. Press OK again when Join Calls? appears. Note: SYNC supports a maximum of three callers on a multiparty/conference call.
Enter Tones	Enter “tones” such as numbers for passwords. Scroll until the desired number appears in the display, then press OK; a tone sounds as confirmation. Repeat as necessary.
Phonebook	Access your phonebook contacts. 1. Press OK to select, then scroll through your phonebook contacts. 2. Press OK again when the desired selection appears in the display. 3. Press the phone button.
Call History	Access your call history log. 1. Press OK to select, then scroll through your call history options (incoming, outgoing or missed). 2. Press OK when the desired selection appears in the display. 3. Press the phone button to call the selection.
Return	Exit the current menu.

Accessing Features through the Phone Menu

SYNC's phone menu allows you to redial a number, access your call history and phone book and send text messages as well as access phone and system settings. You can also access advanced features, such as 911 Assist®, Vehicle Health Report and SYNC Services.

1. Press the phone button to enter the Phone Menu.
2. Scroll to cycle through:

When you select:	You can:
Phone Redial	Redial the last number called (if available). Press OK to select, then press OK again to confirm.
Call History ¹	Allows you to access any previously dialed, received or missed calls while your phone has been connected to the system. <ol style="list-style-type: none"> 1. Press OK to select. 2. Scroll to select from Call History Incoming, Call History Outgoing or Call History Missed. Press OK make your selection. 3. Press OK or the phone button to call the desired selection. <p>Note: The system attempts to automatically re-download your phone book and call history each time your phone connects to SYNC (if the auto download feature is on and your Bluetooth-enabled cellular phone supports this feature).</p>
Phonebook ^{1,2}	Allows you to access your downloaded phonebook. <ol style="list-style-type: none"> 1. Press OK to confirm and enter. If your phonebook has fewer than 255 listings, they appear alphabetically in flat file mode. If there are more, they are organized into alphabetical categories. 2. Scroll until the desired contact appears, then press OK. 3. Press OK or the phone button.

When you select:	You can:
Text Message ¹	Enables you to send, download and delete text messages.
Phone Settings ¹	Allows you to view your phone's status, set ring tones, select your message notification, change phone book entries and automatically download your cellular phone among other features.
SYNC Services ³	Access the SYNC services portal where you can request various types of information, traffic reports and directions.
911 Assist ⁴	Place an emergency call to a 911 operator for you after an accident (if the feature is used properly).
Vehicle Health Report ³	Create and receive a diagnostic report card on your vehicle.
Mobile Apps ³	Interact with SYNC®-capable mobile applications on your smartphone.
System Settings	Access Bluetooth Devices menu listings (add, connect, set as primary, on/off, delete) as well as Advanced menu listings (prompts, languages, defaults, master reset, install application and system information).
Exit Phone Menu	Exit the phone menu by pressing OK.

¹This is a phone-dependent feature.

²This is a phone-dependent and speed-dependent feature.

³If equipped, U.S. only.

⁴If equipped, U.S. and Canada only.

Text Messaging

Note: This is a phone-dependent feature.

SYNC allows you to receive, send, download and delete text messages. The system can also read incoming text messages to you so that you do not have to take your eyes off the road.

Receiving a Text Message

Note: This is a phone-dependent feature. Your phone must support downloading text messages using Bluetooth to receive incoming text messages.

Note: Forwarding a text message is a speed-dependent feature and can only be done when the vehicle is traveling at 3 mph (5 km/h) or less.

Note: Only one recipient is allowed per text message.

When a new message arrives, an audible tone sounds and the display indicates you have a new message. You have these options:

1. Press the voice button, wait for the prompt and say "Read Message" to have SYNC read the message to you.
2. Press OK to receive and open the text message or do nothing and the message goes into your text message inbox. Press OK again and SYNC reads your message aloud as you are not able to view the message. You can then also choose whether you'd like to reply or forward the message.
3. Press OK and scroll to choose between:
 - Reply to Text Message: Press OK to access and then scroll through the list of pre-defined messages to send.
 - Forward Text Message: Press OK to forward the message to anyone in your Phonebook or Call History. You can also choose Enter Number.

Sending, Downloading and Deleting Your Text Messages

Text messaging is a phone-dependent feature. If your phone is compatible, SYNC allows you to receive, send, download and delete text messages.

1. Press the phone button.
2. Scroll until Text Message appears and press OK.
3. Scroll to select from the following options:

Send Text Message? enables you to send a new text message based on a pre-defined set of 15 messages.

Download Unread Msgs allows you to download your unread messages (only) to SYNC. To download the messages, press OK to select. The display indicates your messages are being downloaded. When complete, SYNC takes you to your inbox.

Delete All Messages? allows you to delete current text messages from SYNC (not your phone). To delete the messages, press OK to select. The display indicates when all your text messages have been deleted and SYNC returns you to the text message menu.

Note: SYNC does not automatically download all of your unread text messages at every ignition cycle (as it does with call history and phonebook if automatic download is set to on).

Return exits the current menu when you press OK.

If you select **Send Text Message?**:

1. Press OK to select. If the system detects your phone does not support this feature, Unsupported appears in the display and SYNC returns to the main menu.
2. Scroll to cycle through the message options in the following chart.
3. Press OK when the desired selection is in the display. The system now needs to know who to send the message to.
4. Scroll to cycle through Phonebook or Call History entries. You can also select Enter Number to audibly enter a desired number.
5. Press OK to enter the desired menu and scroll to select the specific contact.
6. Press OK when the contact appears and press OK again to confirm when the system asks if you would like to send the message. Each text message is sent with the following signature: "This message was sent from my <Ford or Lincoln>".

Pre-defined text message options
Can't talk right now
Call me
Call you later
Be there in 10 minutes
Be there in 20 minutes
Yes
No
Why?
Thanks
Where R you?
I need more directions
I love you
Too funny
Can't wait to see you
I'm stuck in traffic

Accessing Your Phone Settings

These are phone-dependent features. Your phone settings allow you to access and adjust features such as your ring tone, text message notification, modify your phone book and also set up automatic download.

1. Press the phone button.
2. Scroll until Phone Settings appears, then press OK.
3. Scroll to select from the following options:

When you select:	You can:
Phone Status	See the provider, name, signal power, battery power and roaming status of your connected phone. Press OK to select and scroll to view the information. When done, press OK again to return to the phone status menu.
Set Ringer	Select which ring tone sounds during an incoming call (one of the system's or your phone's). 1. Press OK to select and scroll to hear Ringer 1, Ringer 2, Ringer 3 and Phone Ringer. 2. Press OK to select. Note: If your phone supports in-band ringing, your phone's ringer sounds when Phone Ringer is chosen.
Message Notification	Have the option of hearing an audible tone to notify you when a text message arrives. 1. Press OK to select and scroll between Message Notification On or Message Notification Off. 2. Press OK to select.

When you select:	You can:
Modify Phonebook	<p>Modify the contents of your phone book (i.e., add, delete, download). Press OK to select and scroll between:</p> <p>Add Contacts: Press OK to add more contacts from your phone book. Push the desired contact(s) on your phone. See your phone's user guide on how to push contacts.</p> <p>Delete Phonebook: Press OK to delete the current phone book and call history. When Delete Phonebook appears, press OK to confirm. SYNC takes you back to the Phone Settings menu.</p> <p>Download Phonebook: Press OK to select and press OK again when Confirm Download? appears.</p>
Auto Download	<p>Automatically download your phone book each time your phone connects to SYNC. Press OK to select. When Auto Download On? appears, press OK to have your phonebook automatically downloaded each time.</p> <p>Select Off to NOT download your phonebook every time your phone connects to SYNC. Your phonebook, call history and text messages can only be accessed when your specific phone is connected to SYNC.</p> <p>Note: Downloading times are phone- and quantity-dependent.</p> <p>Note: When auto download is on, any changes, additions or deletions saved since your last download are deleted.</p>
Return	Exit the current menu.

System Settings

System Settings provide access to your Bluetooth Devices and Advanced menu features. Use the arrow buttons to scroll through the menu options.

The Bluetooth Devices menu allows you to add, connect, delete and set a phone as primary as well as turn your Bluetooth feature on and off.

The Advanced menu allows you to access and set prompts, languages, defaults, perform a master reset, install an application and view system information.

Bluetooth Devices Menu Options

This menu allows you to add, connect, delete, set a phone as primary, and turn Bluetooth on or off.

1. Press the phone button to enter the Phone Menu.
2. Scroll until System Settings appears and press OK.
3. Scroll until Bluetooth Devices appears and select OK.
4. Scroll to select from the following options:

If you select:	You can:
Add Bluetooth Device*	See <i>Using SYNC with your phone</i> earlier in this chapter for pairing instructions.
Connect Bluetooth Device	Connect a previously paired Bluetooth-enabled phone. <ol style="list-style-type: none"> 1. Press OK to select and view a list of previously paired phones. 2. Scroll until the desired device is chosen, then press OK to connect the phone. Note: Only one device can be connected at a time. When another phone is connected, the previous one is disconnected.
Set Primary Phone	Set a previously paired phone as your primary phone. Press OK to select and scroll to select the desired phone. Press OK to confirm. Note: SYNC attempts to connect with the primary phone at every ignition cycle. When a phone is selected as primary, it appears first in the list and is marked with an *.

If you select:	You can:
Set Bluetooth On/Off	Turn the Bluetooth feature on and off. Press OK and scroll to toggle between On and Off. When the desired selection is chosen, press OK. Note: Turning Bluetooth off disconnects all Bluetooth devices and deactivates all Bluetooth features.
Delete Device	Delete a paired phone. Press OK and scroll to select the device. Press OK to confirm.
Delete All Devices	Delete all previously paired phones (and all information originally saved with those phones). Press OK to select.
Return	Exit the current menu.

*This is a speed-dependent feature.

Advanced Menu Options

This menu allows you to access settings such as prompts, languages, defaults, perform a master reset, install an application and view system information.

1. Press the phone button to enter the Phone Menu.
2. Scroll until System Settings appears and press OK.
3. Scroll until Advanced appears and select OK.
4. Scroll to select from the following options:

If you select:	You can:
Prompts	Get help from SYNC by using questions, helpful hints or asking you for a specific action. To turn these prompts on or off: 1. Press OK to select and scroll to select between on or off. 2. Press OK when the desired selection appears in the display. SYNC takes you back to the Advanced menu.

If you select:	You can:
Languages	Choose between English, Espanol and Francais. Once selected, all of SYNC's radio displays and prompts are in the selected language. 1. Press OK to select and then scroll through the languages. 2. Press OK when the desired selection appears in the display. If you change the language setting, the display indicates that the system is updating. When complete, SYNC takes you back to the Advanced menu.
Factory Defaults	Return to the factory default settings. This selection does not erase your indexed information (phonebook, call history, text messages and paired devices). 1. Press OK to select and then press OK again when Restore Defaults? appears in the display. 2. Press OK to confirm.
Master Reset	Completely erase all information stored on SYNC (phonebook, call history, text messages and paired devices) and return to the factory default settings. Press OK to select. The display indicates when complete and SYNC takes you back to the Advanced menu.
Install Application	Install applications you have downloaded. Press OK and scroll to select. Press OK to confirm.
System Info	Access the Auto Version number as well as the FPN number. Press OK to select.
MAP Profile	This is a Bluetooth component which can further help your phone with the exchange of text messages.
Return	Exit the current menu.

SYNC APPLICATIONS AND SERVICES (IF EQUIPPED)

Note: In order for the following features to work, your cellular phone must be compatible with SYNC. To check your phone's compatibility, visit www.SYNCMyRide.com, www.SYNCMyRide.ca or www.syncmaroute.ca.

- SYNC Services (if equipped, U.S. only): Provides access to traffic, directions and information such as travel, horoscopes, stock prices and more.
- 911 Assist®: Can alert 911 in the event of an emergency.
- Vehicle Health Report (if equipped, U.S. only): Provides a diagnostic and maintenance report card of your vehicle.

911 Assist®

WARNING: Unless the 911 Assist setting is set on prior to a crash, the system will not dial for help which could delay response time, potentially increasing the risk of serious injury or death after a crash.



WARNING: Do not wait for 911 Assist to make an emergency call if you can do it yourself. Dial emergency services immediately to avoid delayed response time which could increase the risk of serious injury or death after a crash. If you do not hear 911 Assist within five seconds of the crash, the system or phone may be damaged or non-functional.



WARNING: Always place your phone in a secure location in the vehicle so it does not become a projectile or get damaged in a crash. Failure to do so may cause serious injury to someone or damage the phone which could prevent 911 Assist from working properly.

Note: SYNC 911 Assist feature must be set on prior to the incident.

Note: Before setting this feature on, ensure that you read the 911 Assist privacy notice later in this section for important information.

Note: If 911 Assist is turned on or off by any user, that setting applies for all paired phones. If 911 Assist is turned off, a voice message plays and/or a display message/icon comes on when the vehicle is started after a previously paired phone connects.

Note: Every phone operates differently. While SYNC 911 Assist works with most cellular phones, some may have trouble using this feature.

If a crash deploys an airbag (excludes knee airbags and rear inflatable safety belts [if equipped]) or activates the fuel pump shut-off, your SYNC equipped vehicle may be able to contact emergency services by dialing 911 through a paired and connected Bluetooth-enabled phone. For more information about 911 Assist, visit www.SYNCMYride.com, www.SYNCMYride.ca or www.syncmaroute.ca.

- For information on airbag deployment, see the *Supplementary Restraints System* chapter.
- For information on the fuel pump shut-off, see the *Roadside Emergencies* chapter.

Setting 911 Assist On

Perform the following:

1. Press the phone button to enter the Phone Menu.
2. Scroll until 911 Assist is selected.
3. Press OK to confirm and enter the 911 Assist menu.
4. Scroll to select between On and Off selections.
5. Press OK when the desired option appears in the radio display. Set On or Set Off appears in the display as confirmation.

Off selections include: Off with reminder and Off without reminder. Off with reminder provides a display and voice reminder at phone connection at vehicle start. Off without reminder provides a display reminder only without a voice reminder at phone connection.

To make sure that 911 Assist works properly:

- SYNC must be powered and working properly at the time of the incident and throughout feature activation and use.
- SYNC 911 Assist feature must be set on prior to the incident.
- A Bluetooth-enabled and compatible phone has to be paired and connected to SYNC.
- A connected Bluetooth-enabled phone must have the ability to make and maintain an outgoing call at the time of the incident.
- A connected Bluetooth-enabled phone must have adequate network coverage, battery power and signal strength.
- The vehicle must have battery power and be located in the U.S., Canada or in a territory in which 911 is the emergency number.

In the Event of a Crash

Not all crashes deploy an airbag or activate the fuel pump shut-off (which would activate 911 Assist); however, if 911 Assist is triggered, SYNC tries to contact emergency services. If a connected phone is damaged or loses connection to SYNC, SYNC searches for, and tries to connect to, any available previously paired phone and tries to make the call to 911.

Before making the call:

- SYNC provides a short window of time (about 10 seconds) to cancel the call. Failure to cancel the call results in SYNC attempting to dial 911.
- SYNC says the following, or a similar message: “SYNC will attempt to call 911, to cancel the call, press Cancel on your screen or press and hold the phone button on your steering wheel.”

If the call is not cancelled and a successful call is made, a pre-recorded message is played for the 911 operator, then the occupant(s) in the vehicle is able to talk with the operator. Be prepared to provide your name, phone number and location immediately, because not all 911 systems are capable of receiving this information electronically.

911 Assist May Not Work If

- Your cellular phone or 911 Assist hardware was damaged in a crash.
- The vehicle’s battery or SYNC system has no power.
- The phone(s) paired and connected to the system was thrown from the vehicle.

911 Assist Privacy Notice

Once 911 Assist is set on, it may disclose to emergency services that the vehicle has been in a crash involving the deployment of an airbag or activation of the fuel pump shut-off. Certain versions or updates to 911 Assist may also be capable of electronically or verbally disclosing to 911 operators the vehicle location, and/or other details about the vehicle or crash to assist 911 operators to provide the most appropriate emergency services. If you do not want to disclose this information, do not turn the feature on.

Vehicle Health Report



WARNING: Always follow scheduled maintenance instructions, regularly inspect your vehicle, and seek repair for any damage or problem you suspect. Vehicle Health Report supplements, but cannot replace normal maintenance and vehicle inspection. Vehicle Health Report only monitors certain systems that are electronically monitored by the vehicle and will not monitor or report the status of any other system, (i.e., brake lining wear). Failure to perform scheduled maintenance and regularly inspect your vehicle may result in vehicle damage and serious injury.

Note: Your Vehicle Health Report feature requires activation prior to use. Visit www.SYNCMYRide.com to register. There is no fee or subscription associated with Vehicle Health Report, but you must register to use this feature.

Note: This feature may not function properly if you have enabled caller ID blocking on your mobile phone. Before running a report, review the *Vehicle Health Report privacy notice*.

Note: In order to allow a break-in period for your vehicle, you may not be able to create a Vehicle Health Report until your vehicle odometer has reached 200 miles.

Register for Vehicle Health Report and set your report preferences at www.SYNCMYRide.com. After registering, you can request a Vehicle Health Report (inside your vehicle). Return to your account at www.SYNCMYRide.com to view your report. You can also choose for SYNC to automatically remind you to run reports at specific mileage intervals. Cellular phone airtime usage may apply when reporting.

The system allows you to check your vehicle's overall health in the form of a diagnostic report card. The vehicle health report contains valuable information such as:

- Vehicle Diagnostic Information
- Scheduled maintenance
- Open Recalls and Field Service Actions
- Unserviced items from vehicle inspections by your authorized dealer.

You can run a report (after the vehicle has been running a minimum of 60 seconds) by pressing the voice button and saying "Vehicle health report", or pressing the phone button.

To run a report using the phone button:

1. Press the phone button to enter Phone Menu.
2. Scroll until Vehicle Health is selected and press OK.
3. Scroll to select from the following options:

Vehicle Health Report Options	
User Preferences: Press OK to select and enter the menu. Scroll to select from:	<p>Automatic Reports: Press OK and select on or off. Select On to have SYNC automatically prompt you to run a health report at certain mileage intervals. Note: You must first turn this feature on before you can select the mileage intervals at which you would like to be prompted.</p> <p>Mileage Intervals: Press OK. Scroll to select between 5000, 7500 or 10000 mile intervals and press OK to make your selection.</p> <p>Return: Press OK to exit the menu.</p>
Run Report?	Press OK for SYNC to run a health report of your vehicle's diagnostic systems and send the results to Ford where it is combined with scheduled maintenance information, open recalls and other field service actions and unserviced vehicle inspection items from your authorized dealer.

Vehicle Health Report Privacy Notice

When you run a Vehicle Health Report, Ford Motor Company may collect your cellular phone number (to process your report request) and diagnostic information about your vehicle. Certain versions or updates to Vehicle Health Report may also collect additional vehicle information. Ford may use the vehicle information it collects for any purpose. If you do not want to disclose your cellular phone number or vehicle information, do not run the feature or set up your Vehicle Health Report profile at www.SYNCMYride.com. See www.SYNCMYride.com - Vehicle Health Report Terms and Conditions, and Privacy Statement - for more information.

SYNC Services: Traffic, Directions & Information (TDI)

Note: SYNC Services requires activation prior to use. Visit www.SYNCMYride.com to register and check your eligibility for complimentary services. Standard phone and message rates may apply. Subscription may be required. You must also have the active SYNC Services Bluetooth-enabled cellular phone paired and connected to the system in order to connect to, and use, SYNC Services. See *Using SYNC with your phone* for pairing instructions.

Note: This feature does not function properly if you have enabled caller ID blocking on your mobile phone. Make sure your mobile phone is not blocking caller ID before using SYNC Services.

Note: The driver is ultimately responsible for the safe operation of the vehicle, and therefore, must evaluate whether it is safe to follow the suggested directions. Any navigation features are provided only as an aid. Make your driving decisions based on your observations of local conditions and existing traffic regulations. Do not follow the route suggestions if doing so would result in an unsafe or illegal maneuver, if you would be placed in an unsafe situation, or if you would be directed into an area that you consider unsafe. Maps used by this system may be inaccurate because of errors, changes in roads, traffic conditions or driving conditions.

Note: When you connect, the service uses GPS technology and advanced vehicle sensors to collect the vehicle's current location, travel direction and speed to help provide you with the directions, traffic reports, or business searches you request. Further, to provide the services you request and for continuous improvement, the service may collect and record call details and voice communications. For more information, see SYNC Services Terms and Conditions at www.SYNCMYride.com. If you do not want Ford or its service providers to collect the vehicle travel information or other information identified in the Terms and Conditions, do not activate or use the service.

SYNC Services uses advanced vehicle sensors, integrated GPS technology and comprehensive map and traffic data, to give you personalized traffic reports, precise turn-by-turn directions, business search, news, sports, weather and more. For a complete list of services, or to learn more, please visit www.SYNCMYride.com.

Connecting to SYNC Services Using Voice Commands

1. Press the voice button.
2. When prompted, say “Services”. This initiates an outgoing call to SYNC Services using your paired and connected Bluetooth-enabled cellular phone.
3. Once you are connected to the service, follow the voice prompts to request the desired service, such as “Traffic” or “Directions”. You can also say “What are my choices?” to receive a complete list of available services from which to choose.
4. Say “Services” to return to the services main menu or for help, say “Help”.

Connecting to SYNC Services Using the Phone Menu

1. Press the phone button to enter the Phone Menu.
2. Scroll until *Services* appears in the display.
3. Press OK to confirm and enter the Services menu. The display indicates the system is connecting.
4. Press OK. SYNC initiates the call to the Services portal.
5. Once connected, follow the voice prompts to request your desired Service, such as Traffic or Directions. You can also say “What are my choices?” to receive a complete list of available services from which to choose.
6. To return to the Services menu, say “Services” or for help, say “Help”.

Receiving Turn-by-Turn Directions

1. When connected to SYNC Services, say “Directions” or “Business search”. To find the closest business or type of business to your current location, just say “Business search” and then “Search near me”. If you need further assistance in finding a location you can say “Operator” at any time within a Directions or Business search to speak with a live operator. You may also be prompted to speak with an operator when the automatic system has difficulty matching your voice request. The live operator can assist you by searching for businesses by name or by category, residential addresses by street address or by name or specific street intersections. Operator Assist is a feature of your SYNC Services subscription. For more information on Operator Assist visit www.SYNCMYride.com/support.

2. Follow the voice prompts to select your destination. Once your destination is selected, your current vehicle location is uploaded and a route based on current traffic conditions is calculated and sent back to your vehicle. After the route download is complete, the phone call is automatically ended. You then receive audible and visual driving instructions as you travel toward your destination.
3. While on an active route, you can select or say “Route summary” or “Route status” to view the Route Summary turn list or the Route Status ETA. You can also turn voice guidance on or off, cancel the route or update the route.

If you miss a turn, SYNC automatically asks if you want the route updated. Just say, “Yes” when prompted and a new route will be delivered to your vehicle.

Disconnecting from SYNC Services

1. Press and hold the phone button on the steering wheel.
2. Say “Good-bye” from the SYNC Services main menu.

SYNC Services Quick Tips	
Personalizing	You can personalize your Services feature to provide quicker access to your most used or favorite information. You can save address points such as work or home. You can also save favorite information like sports teams or a news category. To learn more, log onto www.SYNCMYride.com .
Push to interrupt	Press the voice button at any time (while you are connected to SYNC TDI Services) to interrupt a voice prompt or an audio clip (such as a sports report), wait for the listening tone, and say your voice command.

SYNC Services Quick Tips	
Portable	<p>Your subscription is associated with your Bluetooth-enabled cellular phone number, not your VIN (Vehicle Identification Number). You can pair and connect your phone to any vehicle equipped with Traffic, Directions and Information and continue enjoying your personalized services.</p> <p>You can even access your account outside the vehicle. Just use the number on your phone's call history. Traffic and Directions features do not function properly but information services and the 411 connect and text message features are available.</p>

SYNC AppLink™

Note: This feature is only available in the United States.

Note: Your smartphone must be paired and connected to SYNC to access AppLink.

Note: iPhone® users need to connect the phone to the USB port in order to start the application. It is recommended to lock your iPhone® after starting an application.

Note: The AppLink feature is not available if your vehicle is equipped with the MyFord Touch® or MyLincoln Touch™ system.

Depending on your display type, you can access AppLink from the media menu, the phone menu, or by using voice commands. Once an app is running through AppLink, you can control main features of the app through voice commands and steering wheel controls.

To Access Using the Phone Menu

1. Press the phone button to access the SYNC phone menu on-screen.
2. Scroll to Mobile Apps and press OK to access a list of available applications.
3. Scroll through the list of available applications and press OK to select a particular app.
4. Once an app is running through SYNC, you can access an app's menu by pressing the MENU button to first access the SYNC menu.
5. Select "SYNC-Media" by pressing OK.
6. Scroll until "<App name> Menu" is displayed (i.e., Pandora Menu), then press OK. From here, you can access an application's features, such as Thumbs up, Thumbs down, etc. For more information, please visit www.SYNCMYride.com.

To Access Using the Media Menu

1. Press AUX button on the center console.
2. Press MENU to access the SYNC menu.
3. Select "SYNC-Media" by pressing OK.
4. Then scroll to Mobile Apps and press OK to access a list of available applications.
5. Scroll through the list of available applications and press OK to select a particular app.
6. Once an app is running through SYNC, you can access an app's menu by pressing the MENU button to first access the SYNC menu.
7. Select "SYNC-Media" by pressing OK.
8. Scroll until "<App name> Menu" is displayed (i.e., Pandora Menu), then press OK. From here, you can access an application's features, such as Thumbs up, Thumbs down, etc. For more information, please visit www.SYNCMYride.com.

To Access Using Voice Commands

1. Press the voice icon.
2. When prompted, say "Mobile Apps".
3. Say the name of the application after the tone.
4. The app should start. While an app is running through SYNC, you can press the voice button and speak commands specific to the app, such as "Play Station Quickmix". Say "Help" to discover available voice commands.

USING SYNC WITH YOUR MEDIA PLAYER

You can access and play music from your digital music player over the vehicle's speaker system using the system's media menu or voice commands. You can also sort and play your music by specific categories, such as artists, albums, etc.

SYNC is capable of hosting nearly any digital media player including: iPod®, Zune™, Plays from device players, and most USB drives. SYNC also supports audio formats such as MP3, WMA, WAV and ACC.

Connecting Your Digital Media Player via the USB Port

Note: If your digital media player has a power switch, ensure that the device is turned on.

To connect using voice commands:

1. Plug the device into the vehicle's USB port.
2. Press the voice icon and when prompted, say "USB".
3. You can now play music by saying any of the appropriate voice commands. See the media voice commands.

To connect using the system menu:

1. Plug the device into the vehicle's USB port.
2. Press AUX and then MENU to enter the Media Menu.
3. Scroll until Select Source appears and press OK.
4. Scroll to select USB and press OK.
5. Depending on how many digital media files are on your connected device, Indexing may appear in the radio display. When indexing is complete, the screen returns to the Play Menu.
6. Press OK and scroll through selections of:
 - Play All
 - Artists
 - Albums
 - Genres
 - Playlists
 - Tracks
 - Explore USB
 - Similar Music
 - Return

When the desired selection appears in the display, press OK to build your desired music selection.

What's Playing?

At any time when a track is playing, you can press the voice icon and ask the system, "What's playing?". The system reads the metadata tags (if populated) of the playing track to you.

Media Voice Commands

Press the voice icon and, when prompted, say "USB" then any of the following:

"USB"
"Autoplay off"
"Autoplay on"
"(Phone) (Media) (Bluetooth) Connections"
"Pause"
"Play"
"Play album <name>" ^{1,3}
"Play all"
"Play artist <name>" ^{1,3}
"Play genre <name>" ^{1,3}
"Play next folder" ²
"Play next track"
"Play playlist <name>" ^{1,3}
"Play previous folder" ²
"Play previous track"
"Play song <name>" ^{1,3}
"Play track <name>" ^{1,3}
"Refine album <name>" ^{1,3}
"Refine artist <name>" ^{1,3}
"Refine song <name>" ^{1,3}
"Refine track <name>" ^{1,3}
"Repeat off"
"Repeat on"
"Search album <name>" ^{1,3}
"Search artist <name>" ^{1,3}
"Search genre <name>" ^{1,3}

“USB”
“Search song <name>” ^{1,3}
“Search track <name>” ^{1,3}
“Shuffle off”
“Shuffle on”
“Similar music”
“What’s playing?”

¹<name>” is a dynamic listing, meaning that it could be the name of any desired group, artist, etc.

²Voice commands which are only available in folder mode.

³Voice commands which are not available until indexing is complete.

Voice Command Guide	
“Autoplay”	Turn on to listen to music which has already been randomly indexed during the indexing process. Turn off and the system does not begin to play any of your music until all media has all been indexed. Indexing times can vary from device to device and also with regard to the number of songs being indexed.
“Search/Play Genre”	The system searches all the data from your indexed music and, if available, begins to play the chosen type of music. You can only play genres of music which are present in the GENRE metadata tags that you have on your digital media player.

Voice Command Guide	
“Similar Music”	The system compiles a playlist and then plays similar music to what is currently playing from the USB port using indexed metadata information.
“Search/Play Artist/Track/Album”	The system searches for a specific artist/track/album from the music indexed through the USB port.
“Refine”	This allows you to make your previous command more specific. For example, if you asked to search and play all music by a certain artist, you could then say “refine album” and choose a specific album from the list to view. If you then select Play, the system only plays music from that specific album.

Press the voice icon and when prompted say “Bluetooth Audio” and then any of the following:

“BLUETOOTH AUDIO”
“(Phone) (Media) (Bluetooth) Connections”
“Pause”
“Play”
“Play next track ”
“Play previous track ”

Media Menu Features

The media menu allows you to select your media source, how to play your music (by artist, genre, shuffle, repeat, etc.), and also to add, connect or delete devices.

1. Press AUX and then MENU to enter the Media Menu.
2. Scroll to cycle through:

When you select:	You can:
Play Menu	Play your music by artist, album, genre, playlists, tracks, similar music or to simply, play all. You can also choose to Explore USB to view the supported digital music files on your playing device. See Play Menu later in this section for more information.
Select Source	<p>SYNC USB: Press OK to access music plugged into your USB port. You can also plug in devices to charge them (if supported by your device). Once connected, the system indexes any readable media files. (The time required to complete this depends on the size of the media content being indexed.) If Autoplay is on, you can access media files randomly as they are indexed. If turned off, indexed media is not available until the indexing process is complete. SYNC is capable of indexing thousands of average size media and notifies you if the maximum indexing file size is reached.</p> <p>Bluetooth Audio: This is a phone-dependent feature which allows you to stream music playing on your Bluetooth-enabled phone. If supported by your device, you can press SEEK to play the previous or next track.</p> <p>SYNC Line In: Press OK to select and play music from your portable music player over the vehicle's speakers.</p> <p>Note: If you have already connected a device to the USB port, you cannot access the line in feature. Some digital media players require both USB and line in ports to stream data and music separately.</p>

When you select:	You can:
Media Settings	<p>Choose to shuffle or repeat your music and select your Autoplay settings. Once these selections are turned on, they remain on until turned off. Press SEEK to play the previous or next track.</p> <p>Note: Some digital media players require both USB and line in ports to stream data and music separately. Press OK to select and then scroll to choose from:</p> <p>Shuffle: Press OK to shuffle available media files in the current playlist. Note: To shuffle all media tracks, you must select Play All in the Play Menu and then select Shuffle.</p> <p>Repeat: Press OK to repeat any song.</p> <p>Autoplay: Press OK to listen to music which has already been randomly indexed during the indexing process.</p>
Mobile Apps	Interact with SYNC®-capable mobile applications on your smart phone. See <i>SYNC® AppLink™</i> earlier in this chapter for more information.
System Settings	<p>Access Bluetooth Device menu listings (add, connect, set as primary, on/off, delete) as well as Advanced menu listings (prompts, languages, defaults, master reset, install application and system information).</p> <p>Note: See System Settings for more information.</p>
Exit Media Menu	Press OK to exit the media menu.

Accessing Your Play Menu

This menu allows you to select and play your media by artist, album, genre, playlist, track, similar music or even to explore what is on your USB device.

1. Make sure that your device is plugged into the USB port and is turned on.
2. Press AUX and then MENU to enter the Media Menu.
3. Scroll to select the Play Menu and press OK.

If there are no media files to access, the display indicates there is no media. If there are media files, you have the following options to scroll through and select from:

When you select:	You can:
Play All	Play all indexed media (tracks) from your playing device in flat file mode, one at a time in numerical order. Press OK to select. The first track title appears in the display.
Artists	Sort all indexed media by artist. Once selected, the system lists and then play all artists and tracks alphabetically. If there are less than 255 indexed artist, they are listed alphabetically in flat file mode. If there are more, they are categorized in alphabetical categories. 1. Press OK to select. You can select to play All Artists or any indexed artist. 2. Scroll until the desired artist is chosen and press OK.

When you select:	You can:
Albums	<p>Sort all indexed media by albums. If there are less than 255 indexed albums, they are listed alphabetically in flat file mode. If there are more, they are organized into alphabetical categories.</p> <ol style="list-style-type: none"> 1. Press OK to enter the album menu and select from playing all albums or from any individual indexed album. 2. Scroll until the desired album is chosen and press OK.
Genres	<p>Sort indexed music by genre (category) type. SYNC lists the genres alphabetically in flat file mode. If there are more than 255, SYNC automatically organizes them into alphabetical categories.</p> <p>Press OK to select and then scroll to select the desired genre and press OK.</p>
Playlists	<p>Access your playlists (from formats such as ASX, .M3U, .WPL, .MTP.). The system lists your playlists alphabetically in flat file mode. If there are more than 255, they are organized into alphabetical categories.</p> <p>Press OK to select. Then scroll to select the desired playlist and press OK.</p>
Tracks	<p>Search for and play a specific track which has been indexed. SYNC lists your tracks alphabetically in flat file mode. If there are more than 255, SYNC automatically organizes them into alphabetical categories.</p> <p>Press OK to select. Then scroll to select the desired track and press OK.</p>

When you select:	You can:
Explore USB	Explore all supported digital media on your media device connected to the USB port. You can only view media content which is compatible with SYNC; other files saved are not visible. Press OK to select. Then scroll to explore indexed media on your flash drive.
Similar Music	Play music similar to what is currently playing from the USB port. The system uses the metadata information of each song to compile a playlist for you. Press OK to select. The system creates a new list of similar songs and begins playing. The metadata tags must be populated for this feature to include each track. Note: With certain playing devices, if your metadata tags are not populated, the tracks won't be available in voice recognition, play menu or similar music. However, if you place these tracks onto your playing device in "Mass Storage Device Mode", they are available in voice recognition, play menu browsing and similar music. Unknowns are placed into any unpopulated metadata tag.
Return	Exit the current menu.

System Settings

System settings provide access to your Bluetooth Devices and Advanced menu features.

The Bluetooth Devices menu allows you to add, connect and delete a device as turn the Bluetooth feature on and off.

Your Advanced menu allows you to access and set prompts, languages, defaults and perform a master reset.

Bluetooth Devices Menu Options

This menu allows you to add, connect and delete devices as well as turn Bluetooth on and off.

1. Press AUX and then MENU to enter the Media Menu.
2. Scroll until System Settings appears and select OK.
3. Scroll until Bluetooth Devices appears.
4. Press OK and then scroll to select from:

When you select:	You can:
Add Bluetooth Device*	Allows you to pair additional devices to the system. 1. Press OK to select and press OK again when Find SYNC appears in the display. 2. Follow the directions in your phone's user guide to put your phone into discovery mode. A six-digit PIN appears in the display. 3. When prompted on your phone's six-digit display, enter the PIN.
Connect Bluetooth Device	Connect a previously paired Bluetooth-enabled phone. 1. Press OK to select and view a list of devices. 2. Scroll until the desired device is chosen and press OK to connect the device.
Set Bluetooth On/Off	Turn the Bluetooth feature on and off. Press OK and scroll to toggle between On and Off. When the desired selection is chosen, press OK. Turning Bluetooth off disconnects all Bluetooth devices and deactivates Bluetooth features.
Delete Device	Delete a paired media device. Press OK and scroll to select the device. Press OK to confirm.
Delete All Devices	Delete all previously paired devices. Press OK to select.
Return	Exit the current menu.

*This is a speed-dependent feature

Advanced Menu Options

This menu allows you to access settings such as prompts, language, performing a master reset as well as returning to factory defaults.

1. Press AUX and then MENU to access the Media Menu.
2. Scroll until System Settings appears and select OK.
3. Scroll until Advanced appears.
4. Press OK and then scroll to select from the following:

When you select:	You can:
Prompts	<p>Have SYNC guide you via questions, helpful hints or ask you for a specific action.</p> <ol style="list-style-type: none"> 1. Press OK to select and scroll to select between on or off. 2. Press OK when the desired selection appears in the display. SYNC takes you back to the Advanced menu.
Languages	<p>Choose from English, Francais and Espanol. The displays and prompts are in the selected language.</p> <ol style="list-style-type: none"> 1. Press OK to select and then scroll through the languages. 2. Press OK when the desired selection appears in the display. 3. If you change the language setting, the display indicates that the system is updating. When complete, SYNC takes you back to the Advanced menu.
Factory Defaults	<p>Return to the factory default settings. This selection does not erase your indexed information (phonebook, call history, text messages and paired devices).</p> <ol style="list-style-type: none"> 1. Press OK to select and then press OK again when Restore Defaults? appears in the display. 2. Press OK to confirm.

When you select:	You can:
Master Reset	Completely erase all information stored on SYNC (all phonebook, call history, text messages and all paired devices) and return to the factory default settings.
Application	Download new software applications (if available) and then load the desired applications through your USB port. See the web site for more information.
Return	Exit the current menu.

TROUBLESHOOTING

Your SYNC system is easy to use. However, should questions arise, see the tables below.

Use the website at any time to check your phone's compatibility, register your account and set preferences as well as access a customer representative via an online chat (during certain hours). Visit www.SYNCMYride.com, www.SYNCMYride.ca or www.syncmaroute.ca for more information.

Phone Issues		
Issue	Possible Cause(s)	Possible Solution(s)
Excessive background noise during a phone call.	The audio control settings on your phone may be affecting SYNC performance.	Review your phone's user guide regarding audio adjustments.
During a call, I can hear the other person but they cannot hear me.	Possible phone malfunction.	Try turning off the device, resetting the device, removing the device's battery, then trying again.

Phone Issues		
Issue	Possible Cause(s)	Possible Solution(s)
SYNC is not able to download my phonebook.	<ul style="list-style-type: none"> • This is a phone-dependent feature, OR • Possible phone malfunction. 	<ul style="list-style-type: none"> • Go to the website to review your phone's compatibility. • Try turning off the device, resetting the device or removing the device's battery, then trying again. • Try pushing your phonebook contacts to SYNC by using the Add Contacts feature. • Use the SYNCmyphone feature available on the website.
The system says Phonebook Downloaded but my phonebook in SYNC is empty or is missing contacts.	Limitations on your phone's capability.	<ul style="list-style-type: none"> • Try pushing your phonebook contacts to SYNC by using the Add Contacts feature. • If the missing contacts are stored on your SIM card, try moving them to the device memory. • Remove any pictures or special ring tones associated with the missing contact.

Phone Issues		
Issue	Possible Cause(s)	Possible Solution(s)
I am having trouble connecting my phone to SYNC.	<ul style="list-style-type: none"> • This is a phone-dependent feature, OR • Possible phone malfunction. 	<ul style="list-style-type: none"> • Go to the website to review your phone's compatibility. • Try turning off the device, resetting the device or removing the device's battery, then trying again. • Try deleting your device from SYNC, deleting SYNC from your device and trying again. • Check the security and auto accept/prompt always settings relative to the SYNC Bluetooth connection on your phone. • Update your device's software firmware. • Turn off the Auto phonebook download setting.
Text messaging is not working on SYNC.	<ul style="list-style-type: none"> • This is a phone-dependent feature, OR • Possible phone malfunction. 	<ul style="list-style-type: none"> • Go to the website to review your phone's compatibility. • Try turning off the device, resetting the device or removing the device's battery, then trying again.

USB/Media Issues		
Issue	Possible Cause(s)	Possible Solution(s)
I am having trouble connecting my device.	Possible device malfunction.	<ul style="list-style-type: none"> • Try turning off the device, resetting the device or removing the device's battery, then trying again. • Make sure you are using the manufacturer's cable. • Make sure the USB cable is properly inserted into the device and the vehicle's USB port. • Make sure that the device does not have an auto-install program or active security settings.
SYNC does not recognize my device when I turn on the car.	This is a device limitation.	Make sure you are not leaving the device in your vehicle during very hot or cold temperatures.
Bluetooth audio does not stream.	<ul style="list-style-type: none"> • This is a phone-dependent feature, OR • The device is not connected. 	Make sure the device is connected to SYNC and that you have pressed play on your device.
SYNC does not recognize music that is on my device.	<ul style="list-style-type: none"> • Your music files may not contain the proper artist, song title, album or genre information, OR • The file may be corrupted, OR • The song may have copyright protection which does not allow it to play. 	<ul style="list-style-type: none"> • Make sure that all song details are populated. • Some devices require you to change the USB settings from mass storage to MTP class.

Vehicle Health Report/Services (Traffic, Directions and Information) Issues		
Issue	Possible Cause(s)	Possible Solution(s)
I received a text that the Vehicle Health Report is not activated.	<ul style="list-style-type: none"> • Your account may not be activated on the website, OR • You may have the wrong VIN (vehicle identification number) listed. 	<ul style="list-style-type: none"> • This is a free feature, but you must first register online to use it. • Make sure that your VIN is correctly listed in your account.
I am unable to retrieve the report on the website, or I receive a system error.	The preferred dealer information did not load correctly.	When you register your account, you must list a preferred dealer. If one is already listed, try selecting another dealer and logging out. Log back in and change it back to your preferred dealer and retrieve the report.
I am unable to submit a report.	<ul style="list-style-type: none"> • This could be due to your phone's compatibility, OR • Bad signal strength, OR • Your phone may not be activated on the website. 	<ul style="list-style-type: none"> • Update your mobile number in your account on the website. • Make sure you have full signal strength and that your <i>Bluetooth</i> volume level has been turned up. • Try deleting your phone and performing a clean pairing.
I heard a commercial when I tried to use Traffic, Directions and Information.	<ul style="list-style-type: none"> • The phone in use is not activated, OR • Your phone has ID blocker active. 	<ul style="list-style-type: none"> • This is a free feature, but you must first register online to use it. • Turn off ID blocker on your phone as the system recognizes you by your phone number. • Make sure the currently connected phone is the same one that is registered on your SyncMyRide account.

Voice Command Issues		
Issue	Possible Cause(s)	Possible Solution(s)
SYNC does not understand what I am saying.	<ul style="list-style-type: none"> You may be using the wrong voice commands, OR You may be speaking too soon or at the wrong time. 	<ul style="list-style-type: none"> Review the Phone voice commands and the Media voice commands at the beginning of their respective sections. Be aware that SYNC's microphone is either in your rear view mirror or in the headliner just above the windshield.
SYNC does not understand the name of a song or artist.	<ul style="list-style-type: none"> You may be using the wrong voice commands, OR You may not be saying the name exactly as it is saved, OR The system may not be reading the name the same way you are saying it. 	<ul style="list-style-type: none"> Review the media voice commands at the beginning of the media section. Say the song or artist exactly as listed. If you say, "Play Artist Prince", the system does not play music by Prince and the Revolution or Prince and the New Power Generation. Make sure you are saying the complete title, such as "California remix featuring Jennifer Nettles". If the songs are saved in all CAPS, you have to spell them. LOLA requires you to say, "Play L-O-L-A". Do not use special characters in the title as the system does not recognize them.

Voice Command Issues		
Issue	Possible Cause(s)	Possible Solution(s)
SYNC does not understand or is calling the wrong contact when I want to make a call.	<ul style="list-style-type: none"> • You may be using the wrong voice commands, OR • You may not be saying the name exactly as it is saved, OR • Contacts in your phonebook may be very short and similar, or they may contain special characters, OR • Your phonebook contacts may be saved in CAPS. 	<ul style="list-style-type: none"> • Review the phone voice commands at the beginning of the phone section. • Make sure you are saying the contacts exactly as listed. For example, if a contact is saved as Joe Wilson, say “Call Joe Wilson”. • The system works better if you list full names, such as “Joe Wilson” rather than “Joe”. • Do not use special characters such as 123 or ICE, as the system does not recognize them. • If contacts are saved in CAPS, you have to spell them. JAKE requires you to say, “Call J-A-K-E”.

INTRODUCTION

 **WARNING:** Driving while distracted can result in loss of vehicle control, crash and injury. We strongly recommend that you use extreme caution when using any device that may take your focus off the road. Your primary responsibility is the safe operation of your vehicle. We recommend against the use of any hand-held device while driving and encourage the use of voice-operated systems when possible. Make sure you are aware of all applicable local laws that may affect the use of electronic devices while driving.

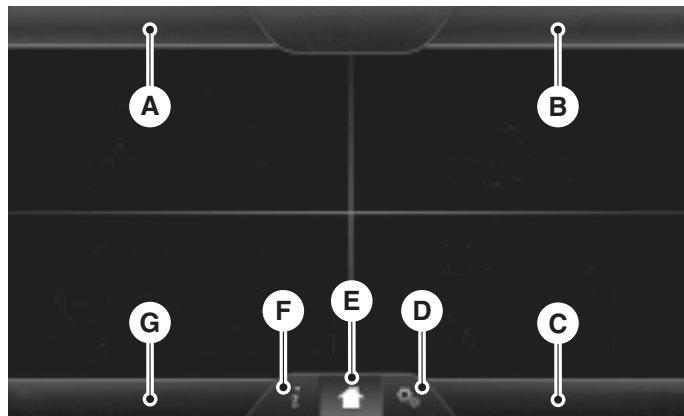

- A. Phone
- B. Navigation (or Information if your vehicle is not equipped with Navigation)
- C. Climate
- D. Settings
- E. Home
- F. Information
- G. Entertainment

This system uses a four-corner strategy to provide quick access several vehicle features and settings. The touchscreen provides easy interaction with your cellular phone, multimedia, climate control and navigation system. The corners display any active modes within those menus, such as phone status or the climate temperature.

Note: Some features are not available while your vehicle is moving.

Note: Your system is equipped with a feature that allows you to access and control audio features for 30 minutes after you switch the ignition off (and no doors open).

PHONE

Press to select any of the following:

- Making and Receiving Calls
- Quick Dial
- Phonebook
- Call History
- Text Messaging
- Settings

NAVIGATION

Press to select any of the following:

- My Home
- Favorites
- Previous Destinations
- Point of Interest
- Emergency
- Street Address
- Intersection
- City Center
- Map
- Edit Route Cancel Route

CLIMATE

Press to select any of the following:

- Driver Settings
- Recirculated Air
- Auto
- Dual
- Passenger Settings
- A/C
- Defrost

**SETTINGS**

Press to select any of the following:

- Clock
- Display
- Sound
- Vehicle
- Settings
- Help

**HOME**

Press to access your home screen. Depending on your vehicle's option package and software, your screens may vary in appearance from the descriptions in this section. Your features may also be limited depending on your market. Check with your authorized dealer for availability.

**INFORMATION**

Press to select any of the following:

- SYNC® Services
- SIRIUS® Travel Link™
- Alerts
- Calendar
- SYNC Apps

If the icon is yellow, see *Alerts* in the *Information* section of this chapter.

ENTERTAINMENT

Press to select any of the following:

- AM
- FM
- SIRIUS
- CD
- USB
- BT Stereo
- SD Card
- A/V In

Using the Touch-sensitive Controls on Your System

To turn a feature on and off, just touch the graphic with your finger. To get the best performance from the touch-sensitive controls:

- Do not press hard on the controls. They are sensitive to light touch.
- Use your bare finger to touch the center of a touch-control graphic. Touching off-center of the graphic may affect operation of a nearby control.
- Make sure your hands are clean and dry.
- Keep metal and other conductive material away from the surface of the touchscreen as this may cause electronic interference (for example, inadvertently turning on a feature other than the one you meant to turn on).

Depending on your vehicle and option package, you may also have these controls on your bezel:

- Power: Switch the media or climate features off and on.
- **VOL:** Control the volume of playing media.
- Fan: Control the speed of the climate system fan.
- Seek and Tune buttons: Use as you normally would in media modes.
- Eject: Eject a CD from the entertainment system.
- **SOURCE:** Touch the word repeatedly to see all available media modes. The screen does not change, but you see the media change in the lower left status bar.
- **SOUND:** Touch the word to access the Sound menu where you can adjust settings such as: Bass, Treble, Midrange, Balance and Fade, THX Deep Note Demo, DSP (Digital Signal Processing), Occupancy Mode and Speed Compensated Volume. (Your vehicle may not have all of these sound options.)
- Hazard flasher: Switch the hazard flashers off and on.

Cleaning the Touchscreen Display

Use a clean, soft cloth such as one used for cleaning glasses. If dirt or fingerprints are still visible, apply a small amount of alcohol to the cloth. Do not pour or spray alcohol onto the display. Do not use detergent or any type of solvent to clean the display.

Support

The SYNC support team is available to help you with any questions you cannot answer on your own.

Monday-Saturday, 8:30am-8:00pm EST

In the United States, call: 1-888-270-1055

In Canada, call: 1-800-565-3673

Times are subject to change due to holidays.

Safety Information

WARNING: Driving while distracted can result in loss of vehicle control, accident and injury. Ford strongly recommends that drivers use extreme caution when using any device that may take their focus off the road. Your primary responsibility is the safe operation of the vehicle. We recommend against the use of any handheld device while driving, encourage the use of voice-operated systems when possible and that you become aware of applicable state and local laws that may affect use of electronic devices while driving.

When using SYNC:

- Do not operate playing devices if the power cords or cables are broken, split or damaged. Place cords and cables out of the way, so they do not interfere with the operation of pedals, seats, compartments or safe driving abilities.
- Do not leave playing devices in your vehicle during extreme conditions as it could cause them damage. See your device's manual for further information.
- Do not attempt to service or repair the system. See your authorized dealer.

For your safety, some SYNC functions are speed-dependent. Their use is limited to when your vehicle is traveling at speeds under 3 mph (5 km/h).

Make sure that you review your device's manual before using it with SYNC.

Speed-restricted Features

Some features of this system may be too difficult to use while your vehicle is moving so they are restricted from use unless your vehicle is stationary.

- Screens that are too crowded with information, such as Point of Interest reviews and ratings, SIRIUS® Travel Link™ sports scores, movie times and ski conditions.
- Any action that requires you to use a keyboard is restricted, such as entering a navigation destination or editing information.
- All lists are limited so the user can view fewer entries (such as phone contacts or recent phone call entries).

See the following chart for more specific examples:

Restricted Features	
Cellular Phone	Pairing a Bluetooth phone
	Adding phonebook contacts or uploading phonebook contacts (from a USB)
	List entries are limited for phone contacts and recent phone call entries
System Functionality	Editing the keypad code
	Enabling Valet Mode
	Editing settings while the rear view camera or Active Park Assist are active
Wi-Fi and Wireless	Editing wireless settings
	Editing the list of wireless networks
Videos, Photos and Graphics	Playing video
	Editing the screen's wallpaper or adding new wallpaper
Text Messages	Composing text messages
	Viewing received text messages
	Editing preset text messages
Navigation	Using the keyboard to enter a destination
	Demo navigation route
	Adding or Editing Address Book entries or Avoid Areas

Privacy Information

When a cellular phone is connected to SYNC, the system creates a profile within your vehicle that is linked to that cellular phone. This profile is created in order to offer you more cellular features and to operate more efficiently. Among other things, this profile may contain data about your cellular phone book, text messages (read and unread), and call history, including history of calls when your cell phone was not connected to the system. In addition, if you connect a media device, the system creates and retains an index of supported media content. The system also records a short development log of approximately 10 minutes of all recent system activity. The log profile and other system data may be used to improve the system and help diagnose any problems that may occur.

The cellular profile, media device index, and development log remain in the vehicle unless you delete them and are generally accessible only in the vehicle when the cellular phone or media player is connected. If you no longer plan to use the system or the vehicle, we recommend you perform a Master Reset to erase all stored information.

System data cannot be accessed without special equipment and access to the vehicle's SYNC module. Ford Motor Company and Ford of Canada do not access the system data for any purpose other than as described absent consent, a court order, or where required by law enforcement, other government authorities, or other third parties acting with lawful authority. Other parties may seek to access the information independently of Ford Motor Company and Ford of Canada. For further privacy information, see the sections on 911 Assist®, Vehicle Health Report, and Traffic, Directions and Information.

ACCESSING AND ADJUSTING MODES THROUGH YOUR RIGHT VEHICLE INFORMATION DISPLAY

The display is located on the right side of your instrument cluster. You can use your steering wheel controls to view and make minor adjustments to active modes without taking your hands off the wheel. For example:

- In Entertainment mode, you can view what is now playing, change the audio source, select memory presets and make some adjustments.
- In Phone mode, you can accept or reject an incoming call.
- If your vehicle is equipped with Navigation, you can view the current route or activate a route.
- In Efficiency Leaves mode, you can learn how your vehicle informs you of your driving efficiency. Press **OK** to exit the menu.



Use the **OK** and arrow buttons on the right side of your steering wheel to scroll through the available modes:



Entertainment



Phone



Navigation

You can make selections from the menu by using the **OK** button. The selection menu expands and different options appear.

- Press the up and down arrows to scroll through the modes.
- Press the right arrow to enter the mode.
- Press the left or right arrows to make adjustments within the chosen mode.
- Press **OK** to confirm your selection.

Note: If your vehicle is not equipped with Navigation, Compass appears in the display instead of Navigation. If you press the right arrow to go into the Compass menu, you can see the compass graphic. The compass displays the direction in which the vehicle is traveling, not true direction for example, if the vehicle is traveling west, the middle of the compass graphic displays west; north displays to the left of west though its true direction is to the right of west).

USING VOICE RECOGNITION

This system helps you control many features using voice commands. This allows you to keep your hands on the wheel and focus on what is in front of you. The system provides feedback through audible tones, prompts, questions and spoken confirmations depending on the situation and the chosen level of interaction (voice settings).

The system also asks short questions (confirmation prompts) when it is not sure of your request or when there are multiple possible responses to your request.

When using voice commands, words and icons may appear in the lower left status bar indicating the status of the voice session (such as Listening, Success, Failed, Paused or Try Again).

How to Use Voice Commands with Your System

Press the voice icon. After the tone, speak your command clearly.

These commands can be said at any time.
“Cancel”
“Exit”
“Go back”
“List of commands”
“Main menu”
“Next page”
“Previous page”
“What can I say?”
“Help”

What Can I Say?

To access the available voice commands for the current session, do one of the following:

- During a voice session, press the Help icon (?) in the lower left status bar of the screen.
- Say, “What can I say?” for an on-screen listing of the possible voice commands associated with your current voice session.
- Press the voice icon. After the tone, say, “Help” to hear a list of possible voice commands.

Helpful Hints

- Make sure the interior of your vehicle is as quiet as possible. Wind noise from open windows and road vibrations may prevent the system from correctly recognizing spoken commands.
- After pressing the voice icon, wait until after the tone sounds and Listening appears before saying a command. Any command spoken prior to this does not register with the system.
- Speak naturally, without long pauses between words.
- At any time, you can interrupt the system while it is speaking by pressing the voice icon.

Accessing a List of Available Commands

- If you use the touchscreen, press the Settings icon > **Help** > **Voice Command List**.
- If you use the steering wheel control, press the voice icon. After the tone, speak your command clearly.

Voice command list
“Audio list of commands”
“Bluetooth audio list of commands”
“Browse list of commands”
“CD list of commands”
“Climate control list of commands”
“List of commands”
“Navigation list of commands”*
“Phone list of commands”
“Radio list of commands”
“SD card list of commands”
“Sirius satellite list of commands”**
“Travel link list of commands”*
“USB list of commands”
“Voice instructions list of commands”
“Voice settings list of commands”
“Help”

*These commands are only available when your vehicle is equipped with the navigation system, and the navigation system SD card is in the card slot.

**This command is only available when you have an active SIRIUS satellite radio subscription.

Voice Settings

Voice settings allow you to customize the level of system interaction, help and feedback. The system defaults to standard interaction that uses candidate lists and confirmation prompts as these provide the highest level of guidance and feedback.

Interaction Mode: Novice mode provides detailed interaction and guidance while the advanced mode has less audible interaction and more tone prompts.

Confirmation Prompts: The system uses these short questions to confirm your voice request. If turned off, the system simply makes a best guess as to what you requested. The system may still occasionally ask you to confirm settings.

Phone/Media Candidate Lists: Candidate lists are lists of possible results from your voice commands. The system creates these lists when it has the same confidence level of several options based on your voice command.

To access these settings using the touchscreen:

1. Press the **Settings** icon > **Settings** > **Voice Control**.
2. Select from:
 - Interaction Mode
 - Confirmation Prompts
 - Media Candidate Lists
 - Phone Candidate Lists
 - Voice Control Volume.

To access these settings using voice commands:



Press the voice icon. Wait for the prompt “Please say a command”. Another tone sounds to let you know the system is listening.

Voice settings using voice commands
“Interaction Mode Novice”
“Interaction Mode Advanced”
“Confirmation Prompts On”
“Confirmation Prompts Off”
“Phone Candidate Lists On”
“Phone Candidate Lists Off”
“Media Candidate Lists On”
“Media Candidate Lists Off”
“Help”

Using Voice Commands with the Touchscreen Options

Your voice system has a dual mode feature which allows you to switch between using voice commands and making on-screen selections. This is most often available when using navigation.

Buttons outlined in blue indicate selections that are part of the dual mode feature. For example, if while you are in a voice session rather than saying the command “Enter Street Name” to change the field, you can press Street and the voice session does not end. Instead, the voice system changes to the Street field and asks you to say the street name. You cannot use the buttons not outlined in blue as voice commands. If they are touched during a voice session, the voice session ends.

For example, you can choose from the following on the Navigation home screen:

- My Home
- Favorites
- Previous Destinations
- Point of Interest (POI)
- Emergency
- Street Address
- Intersection
- Cancel Route.

Some of the voice commands that are available while viewing this screen are:

“DESTINATION”
“Destination my home”
“Destination street address”
“Destination favorites”
“Destination previous destinations”
“Destination POI”
“Destination intersection”
“Destination emergency”

If you choose Street Address from the navigation screen, you can choose from the following:

- Number
- City
- Street Name
- State/Prov.

Some of the voice commands that are available while viewing this screen are:

“STREET ADDRESS”
“Enter house number”
“Change house number”
“Enter street name”
“Change street name”
“Enter city”
“Change city”
“Enter state”
“Change state”

If you choose Points of Interest from the navigation screen, you can choose from the following:

- Search Area
- Search By Name
- Fuel Station
- ATM
- All Restaurants
- Accommodations
- Parking.

Some of the voice commands that are available while viewing this screen are:

“POINTS OF INTEREST” or “POI”
“Destination <POI category name>”
“Search by name”
“Search by category”
“Change search area”

Note: These are just a sample of the voice commands available within the Points of Interest section; the categories themselves are also technically voice commands.

If you choose Intersection from the navigation screen, you can choose from the following:

- 1st Street
- 2nd Street
- City
- State/Prov.

Some of the voice commands that are available while viewing this screen are:

“INTERSECTION”
“Enter first street name”
“Change first street name”
“Enter second street name”
“Change second street name”
“Enter city”
“Change city”
“Enter state”
“Change state”

The dual mode feature is also available when the voice system displays a list of items to pick from during a voice session, where you would be able to touch the line item or say “Line 2”. If the system does not understand a voice command, or there are multiple options, the system displays a voice command list for you.

ENTERTAINMENT

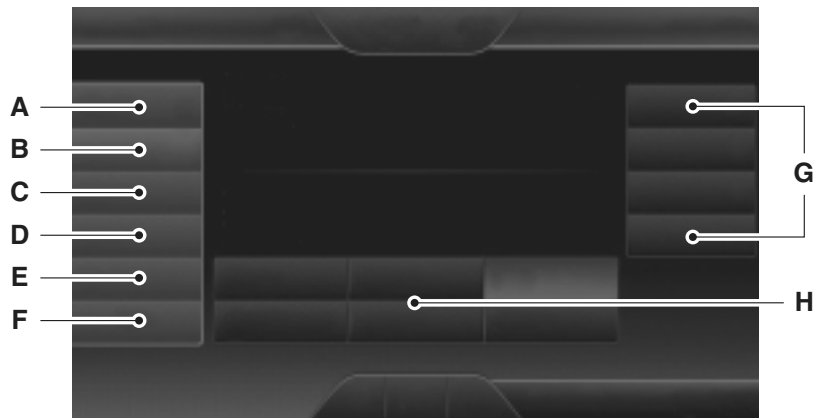

A. AM 1 and AM AST

B. FM 1, FM 2 and FM AST

C. SIRIUS

D. CD

E. USB

F. Touch this button to scroll down for more options, such as:

- SD Card
- BT Stereo
- A/V In

G. These buttons change with the media mode you are in.

H. Radio memory presets and CD controls.

Note: Some features may not be available in your area. Contact an authorized dealer for more information.

You can access these options using the touchscreen or voice commands.

Browsing Device Content

When listening to audio on a device, you can browse through other devices without having to change sources. For example, if you are currently listening to audio on an SD card, you can browse all the artists that are stored on your USB device.



Press the voice icon on the steering wheel. When prompted, you can say:

“BROWSE” within Devices
“Browse”*
“Browse <league> games”
“Browse <Sirius category> channels”
“Browse CD track list”
“Browse Sirius channel guide”
“Browse SD card”
“Browse USB”
“Help”

*If you have said “Browse”, you can then say any commands in the following chart.

**This command is only usable if you have an active subscription to SIRIUS satellite radio.

“BROWSE”
“<League> games”
”<Sirius category> channels”
“CD track list”
“SD card”
“Sirius channel guide”
“USB”
“Help”

*This command is only usable if you have an active subscription to SIRIUS satellite radio.

**For more commands in SD card or USB mode, see the “SD card and USB Port” section of this chapter.

For a complete list of “Browse” voice commands, see *USB and SD card voice commands* and *Bluetooth audio voice commands* in the following sections.

Your voice system allows you to change audio sources with a simple voice command. For example, if you are listening to music on a USB device, then want to switch to a satellite radio channel, simply press the voice button on the steering wheel controls and say the name of the SIRIUS station (such as, “the Highway”). The following voice commands are available at the top level of the voice session no matter which current audio source you are listening to (such as a USB device or SIRIUS satellite radio). **Note:** This is only available when your MyFord Touch® system language is set to North American English.

“AM <530 - 1710>”	“FM <87.7 - 107.9>”
“<530 - 1710>”	“<87.7 - 107.9>”
“Sirius <0-233>”*	“<Channel name>”*
“Play [genre] <name>”**	“Play [playlist] <name>”**
“Play [artist] <name>”**	“Play [song] <name>”**
“Play [album] <name>”**	“Play <name (song or album)> by <artist name>”
“Play <name>”	“Sports games”*

*This command is only usable if you have an active subscription to SIRIUS satellite radio.

**The commands that have [] around the word means that the word is optional. For example, if you say, “Play Metallica”, this is the same as the voice command, “Play [artist] <name>”.

AM and FM



Touch the **AM** or **FM** tab to listen to the radio.

To change between AM and FM presets, just touch the **AM** or **FM** tab.

Memory Presets

Save a station by pressing and holding one of the memory preset areas. There is a brief mute while the radio saves the station. Sound returns when finished.

HD Radio

Touch this button to turn HD Radio on. The light on the button illuminates when the feature is on. HD Radio allows you to receive radio broadcasts digitally, where available, providing free, crystal-clear sound. See *HD Radio information* later in this chapter.

Scan

Touch this button to go to the next strong AM or FM radio station. The light on the button illuminates when the feature is on.

Options

Sound Settings allows you to adjust settings for:

- Bass
- Midrange
- Treble
- Balance and Fade
- DSP (Digital Signal Processing)
- Occupancy Mode
- Speed Compensated Volume.

Note: Your vehicle may not have all these sound settings.

Set PTY for Seek/Scan allows you to select a category of music you would like to search for. You can then choose to either seek or scan for the stations playing that category.

RDS Text Display allows you to view the information broadcast by FM stations.

AST allows you to have the system automatically store the six strongest stations in your current location.

TAG Button is available when HD Radio is on, and allows you to tag a song to download later. When you select **On**, TAG appears on-screen when HD Radio is active. You can touch **TAG** to save the information of the song that is playing. When you plug in your portable music player, the information transfers, if supported by your device. When you are connected to iTunes, the tags appear to remind you of the songs you would like to download. See *HD Radio information* later in this chapter.

Direct Tune

Touch this button to manually enter the desired station number. Touch **Enter** when you are done.

HD Radio™ Information (If Available)

Note: HD Radio broadcasts are not available in all markets.

HD Radio technology is the digital evolution of analog AM/FM radio. Your system has a special receiver that allows it to receive digital broadcasts (where available) in addition to the analog broadcasts, it already receives. Digital broadcasts provide a better sound quality than analog broadcasts with free, crystal-clear audio and no static or distortion. For more information, and a guide to available stations and programming, please visit www.hdradio.com.

When HD Radio is on and you tune to a station broadcasting HD Radio technology, you may notice the following indicators on your screen:



HD) logo blinks when acquiring a digital station and stays solid when digital audio is playing. When this logo is available, you may also see Title and Artist fields on-screen.

Multicast indicator appears in FM mode (only) if the current station is broadcasting multiple digital broadcasts. The highlighted numbers signify available digital channels where new or different content is available. HD1 signifies the main programming status and is available in analog and digital broadcasts. Other multicast stations (HD2 through HD7) are only available digitally.

TAG allows you to save a song to download later when you are on an acquired HD Radio station and the feature is on. To turn the feature on and use it:

1. Press **AM** or **FM** > **Options** > **TAG** button > **On**.
2. When you hear a song you like, touch **TAG**.
3. The system automatically saves the song's information and transfers it to your portable music player (if supported) when you connect it to the system. The system automatically transfers the tag to your player (if already connected) and a pop-up confirms the transfer.
4. When you access iTunes® with your portable music player, the tags appear to you as a reminder. The system allows you to tag up to approximately 100 songs. For a list of devices that support tagging, see www.SYNCMYRide.com, www.SYNCMYRide.ca or www.syncmaroute.ca.

When HD Radio broadcasts are active, you can access the following functions:

- **Scan** allows you to hear a brief sampling of all available stations. This feature still works when HD Radio reception is on, although it does not scan for HD2-HD7 channels. You may see the HD logo appear if the station has a digital broadcast.
- **Memory presets** allow you to save an active channel as a memory preset. Touch and hold a memory preset slot until the sound returns. There is a brief mute while the radio saves the station. Sound returns when finished. When switching to an HD2 or HD3 memory preset, the sound mutes before the digital audio plays, because the system has to reacquire the digital signal.
 - **Note:** As with any saved radio station, you cannot access the saved station if your vehicle is outside the station's reception area.

HD Radio Reception and Station Troubleshooting

Potential Reception Issues	
Reception area	If you are listening to a multicast station and you are on the fringe of the reception area, the station may mute due to weak signal strength.
	If you are listening to HD1, the system switches back to the analog broadcast until the digital broadcast is available again. However, if you are listening to any of the possible HD2 through HD7 multicast channels, the station mutes and stays muted unless it is able to connect to the digital signal again.
Station blending	When the system first receives a station (aside from HD2-HD7 multicast stations), it first plays the station in the analog version. Once the receiver verifies the station is an HD Radio station, it shifts to the digital version. Depending on the station quality, you may hear a slight sound change when the station changes from analog to digital. Blending is the shift from analog to digital sound or digital back to analog sound.

In order to provide the best possible experience, use the contact form to report any station issues found while listening to a station broadcasting with HD Radio technology. Independent entities own and operate each station. These stations are responsible for making sure all audio streams and data fields are accurate.

Potential Station Issues		
Issue	Cause	Action
Echo, stutter, skip or repeat in audio. Increase or decrease in audio volume.	This is poor time alignment by the radio broadcaster.	No action required. This is a broadcast issue.
Sound fading or blending in and out.	The radio is shifting between analog and digital audio.	No action required. The reception issue may clear up as you continue to drive.
There is an audio mute delay when selecting HD2 or HD3, multicast preset or Direct Tune .	The digital multicast is not available until the HD Radio broadcast is decoded. Once decoded, the audio is available.	No action required. This is normal behavior. Wait until the audio is available.
Cannot access HD2 or HD3 multicast channel when recalling a preset or from a direct tune.	The previously stored multicast preset or direct tune is not available in your current reception area.	No action required. The station is not available in your current location.
Text information does not match currently playing audio.	Data service issue by the radio broadcaster.	Fill out the station issue form at website listed below.*
There is no text information shown for currently selected frequency.	Data service issue by the radio broadcaster.	Fill out the station issue form at website listed below.*
HD2-HD7 stations not found when Scan is pressed.	Pressing Scan disables HD2-HD7 channel search.	No action required. This is normal behavior.

*http://www.ibequity.com/automotive/report_radio_station_experiences

HD Radio™ Technology manufactured under license from iBiquity Digital Corp. U.S. and foreign patents. HD Radio™ and the HD and HD Radio logos are proprietary trademarks of iBiquity Digital Corp. Ford Motor Company and iBiquity Digital Corp. are not responsible for the content sent using HD Radio technology. Content may be changed, added or deleted at any time at the station owner's discretion.

Radio Voice Commands



If you are listening to the radio, press the voice button on the steering wheel control. When prompted, say any of the commands in the following chart.

If you are not listening to the radio, press the voice button and, after the tone, say “Radio”, then any of the commands in the following chart.

“RADIO”	
“<87.9–107.9>”	“FM autosest preset <#>”
“<87.9–107.9> HD” ¹	“FM preset <#>”
“<530–1710>”	“FM1”
“AM”	“FM 1 preset <#>”
“AM <530–1710>”	“FM2”
“AM autosest”	“FM 2 preset <#>”
“AM autosest preset <#>”	“HD <#>” ¹
“AM preset <#>”	“Preset <#>”
“Browse” ²	“Radio off”
“FM”	“Radio on”
“FM <87.9–107.9>”	“Set PTY”
“FM <87.9–107.9> HD <#>” ¹	“Tune” ³
“FM autosest”	“Help”

¹If available.

²If you have said, “Browse”, see *Browsing device content* earlier in this section.

³If you have said, “Tune”, see the following “Tune” chart.

“TUNE”	
“<87.9–107.9>”	“FM autosest”
“<87.9-107.9> HD <#>”*	“FM autosest preset <#>”
“<530–1710>”	“FM preset <#>”
“AM”	“FM1”
“AM <530–1710>”	“FM 1 preset <#>”
“AM autosest”	“FM2”
“AM autosest preset <#>”	“FM 2 preset <#>”
“AM preset <#>”	“HD <#>”*
“FM”	“Preset <#>”
“FM <87.9–107.9>”	“Help”
“FM <87.9-107.9> HD <#>”*	

*If available.

SIRIUS® Satellite Radio (If Activated)



Press the lower left corner of the touchscreen, then select the **SIRIUS** tab.

Presets

Save a channel by pressing and holding one of the memory preset areas. There is a brief mute while the radio saves the channel. Sound returns when finished.

ALERT

Save the current song, artist, or team as a favorite. The system alerts you when it plays again on any channel.

Replay

Replay audio on the current channel. You can replay approximately 45 minutes of audio as long as you have remained tuned to the current station. Changing stations erases the previous audio.

While in replay mode:

- Press and release the seek buttons to hear the previous or next song.
- Press and hold the seek buttons to reverse or fast forward in the current track.
- Press play or pause to play or pause the audio.
- Press **Replay** to return to live audio if you have been using the feature to replay audio.

Scan

Touch this button to hear a brief sampling of channels.

Options

Sound Settings allows you to adjust settings for:

- Bass
- Midrange
- Treble
- Balance and Fade
- DSP (Digital Signal Processing)
- Occupancy Mode
- Speed Compensated Volume.

Note: Your vehicle may not have all these sound settings.

Set Category for Seek/Scan allows you to select a category of music you would like to search for. You can then choose to either seek or scan for the stations playing that category.

Parental Lockout allows you to lock and unlock channels, change or reset your PIN or unlock all channels. To use this feature, you need your initial PIN, which is 1234.

Artist/Title/Team Alerts allows you to select Artists, Titles and Teams that you would like the system to alert you to when they are playing on other channels. Press **Edit Alerts** to delete or turn off alerts. You can also set all alerts to on or off. When an alert appears on the screen, you can choose to Tune to the channel, to Cancel the alert or to Disable Alerts. If you are listening to a sporting event, you can save your favorite teams so that the system can alert you when they are playing on a satellite radio channel.

Note: SIRIUS does not support the Alert feature on all channels. Ford Motor Company shall not be responsible for Alert feature variation.

Electronic Serial Number (ESN) is required when communicating with SIRIUS about your account.

Direct Tune

Touch this button to manually enter the desired satellite channel number. Touch **Enter** when you are done.

Browse

Touch this button to view a list of all available stations. Scroll to see more categories. Touch the station you want to listen to.

Touch **Skip** if you want to skip this channel.

Touch **Lock** if you do not want anyone to listen to this channel.

Touch **Title** or **Artist** to see song and artists on other stations.

Satellite Radio Voice Commands

If you are listening to SIRIUS satellite radio, press the voice button on the steering wheel control. When prompted, say any of the commands in the following chart.

If you are not listening to SIRIUS satellite radio, press the voice button and, after the tone, say “Sirius”, then any of the commands in the following chart.

“SIRIUS”	
“Sirius <0–223>”	“SAT 3”
“<Channel name>”	“SAT 3 preset <#>”
“Preset <#>”	“SAT preset <#>”
“SAT”	“Sirius off”
“SAT 1”	“Sirius on”
“SAT 1 preset <#>”	“Sports game”*
“SAT 2”	“Tune”**
“SAT 2 preset <#>”	“Help”

*If you have said, “Sports game”, see the following “Sports game” chart.

**If you have said, “Tune”, see the following “Tune” chart.

“SPORTS GAME”
“Tune to the <college name> game”
“Tune to the <team city> game”
“Tune to the <team city> <team name> game”
“Tune to the <team name> game”
“Help”

“TUNE”
“Sirius <0–223>”
“<Channel name>”
“Preset <#>”
“SAT”
“SAT 1”
“SAT 1 preset <#>”
“SAT 2”
“SAT 2 preset <#>”
“SAT 3”
“SAT 3 preset <#>”
“Help”

SIRIUS Satellite Radio Information

Note: SIRIUS reserves the unrestricted right to change, rearrange, add or delete programming including canceling, moving or adding particular channels, and its prices, at any time, with or without notice to you. Ford Motor Company shall not be responsible for any such programming changes.

Note: This receiver includes the eCos real-time operating system. eCos is published under the eCos License.



SIRIUS satellite radio is a subscription-based satellite radio service that broadcasts a variety of music, sports, news, weather, traffic and entertainment programming. Your factory-installed SIRIUS satellite radio system includes hardware and

a limited subscription term that begins on the date of sale or lease of your vehicle. See your authorized dealer for availability.

For more information on extended subscription terms (a service fee is required), the online media player and a list of SIRIUS satellite radio channels, and other features, please visit www.siriusxm.com in the United States, www.sirius.ca in Canada, or call SIRIUS at 1-888-539-7474.

Satellite radio electronic serial number (ESN): You need your ESN to activate, modify or track your satellite radio account. The ESN is on the System Information Screen (SR ESN: XXXXXXXXXXXX). To access your ESN, press the bottom left corner of the touchscreen, then **SIRIUS** > **Options**.

Potential Satellite Radio Reception Issues	
Antenna obstructions	For optimal reception performance, keep the antenna clear of snow and ice build-up and keep luggage and other materials as far away from the antenna as possible.
Terrain	Hills, mountains, tall buildings, bridges, tunnels, freeway overpasses, parking garages, dense tree foliage and thunderstorms can interfere with your reception.
Station overload	When you pass a ground-based broadcast-repeating tower, a stronger signal may overtake a weaker one and the audio system may mute.
Satellite radio signal interference	Your display may show ACQUIRING . . . to indicate the interference and the audio system may mute.

SIRIUS Troubleshooting Tips		
Radio Display	Condition	Possible Action
Acquiring...	Radio requires more than two seconds to produce audio for the selected channel.	No action required. This message should disappear shortly.
Sat Fault/SIRIUS system failure.	There is an internal module or system failure present.	If this message does not clear shortly, or with an ignition key cycle, your receiver may have a fault. See your authorized dealer for service.
Invalid Channel.	The channel is no longer available.	Tune to another channel or choose another preset.

SIRIUS Troubleshooting Tips		
Radio Display	Condition	Possible Action
Unsubscribed Channel.	Your subscription does not include this channel.	Contact SIRIUS at 1-888-539-7474 to subscribe to the channel, or tune to another channel.
No Signal.	The signal is lost from the SIRIUS satellite or SIRIUS tower to your vehicle antenna.	The signal is blocked. When you move into an open area, the signal should return.
Updating.	Update of channel programming in progress.	No action required. The process may take up to three minutes.
Call SIRIUS 1-888-539-7474.	Your satellite service is no longer available.	Contact SIRIUS at 1-888-539-7474 to resolve subscription issues.
None Found. Check Channel Guide.	All the channels in the selected channels are either skipped or locked.	Use the channel guide to turn off the Lock or Skip function on that station.
Subscription Updated.	SIRIUS has updated the channels available for your vehicle.	No action required.

CD

Press the lower left corner of the touchscreen, and then select the **CD** tab.

You can also advance and reverse the current track or current folder, if applicable.

Repeat

Touch this button to repeat the currently playing track, all tracks on the disc or turn the feature off if already on.

Shuffle

Touch this button to play the tracks or entire albums in random order, or turn the feature off if already on.

Scan

Touch this button to hear a brief sampling of all available tracks.

More Info

Touch this button to see disc information.

Options

Sound Settings allows you to adjust settings for:

- Bass
- Midrange
- Treble
- Balance and Fade
- DSP (Digital Signal Processing)
- Occupancy Mode
- Speed Compensated Volume.

Note: Your vehicle may not have all these sound settings.

Compression allows you to turn the compression feature on and off.

Browse

Touch this button to look through all available CD tracks.

CD Voice Commands

If you are listening to a CD, press the voice button on the steering wheel control. When prompted, say any of the commands in the following chart.

If you are not listening to a CD, press the voice button and, after the tone, say “CD”, then any of the commands in the following chart.

“CD”	
“Pause”	“Repeat off”
“Play”	“Repeat track”
“Play next track”	“Shuffle”
“Play previous track”	“Shuffle CD”*
“Play track <1-512>”	“Shuffle folder”*
“Repeat”	“Shuffle off”
“Repeat folder”*	“Help”

*This applies to WMA or MP3 files only.

SD Card Slot and USB Port**SD Card Slot**

Note: Your SD card slot is spring-loaded. To remove the SD card, press the card in and the system ejects it. Do not attempt to pull the card to remove it as this could cause damage.

Note: The navigation system also uses this card slot. See *Navigation system* later in this chapter for more information.

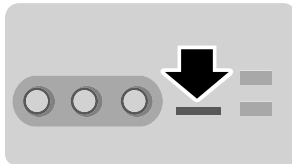

The slot is located either in the center console or behind a small access door in the instrument panel. To access and play music from your card, press the lower left corner of the touchscreen, and then select the **SD Card** tab.

SD logo is a trademark of SD-3C, LLC.

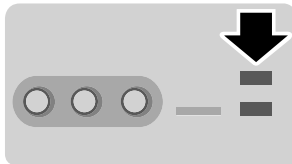
**USB Port**

The ports are located either in the center console or behind a small access door in the instrument panel. To access and play music from your device, press the lower left corner of the touchscreen, and then select the **USB** tab.

This feature allows you to plug in media playing devices, memory sticks, flash drives or thumb drives, and charge devices if they support this feature.

In order to playback video from your iPod® or iPhone®, if compatible, you must have a special combination USB/RCA composite video cable, which you can buy from Apple®. When the cable is connected to your iPod® or iPhone®, plug the other end into both the RCA jacks and the USB port.

Playing Music from Your Device

Insert your device and select the **SD Card** or **USB** tab once the system recognizes it. You can then select from the following options:

Repeat replays the currently playing song or album.

Shuffle plays music on the selected album or folder in random order.

Similar Music allows you to choose music similar to what is currently playing.

More Info displays information such as current track, artist name, album and genre.

Options allows you to view and adjust various media settings.

- **Sound Settings** allows you to adjust settings for:
 - Bass
 - Midrange
 - Treble
 - Balance and Fade
 - DSP (Digital Signal Processing)
 - Occupancy Mode
 - Speed Compensated Volume.

Note: Your vehicle may not have all these sound settings.

- **Media Player Settings** allows you to select more settings, which is under **Media Player**. See *Settings*.
- **Device Information** displays software and firmware information about the currently connected media device.
- **Update Media Index** indexes your device each time you connect it to make sure you have the latest voice commands available for all media on the device.

Browse allows you to view the contents of the device. It also allows you to search by categories, such as genre, artist or album.

If you want to view song information such as Title, Artist, File, Folder, Album, and Genre, touch the on-screen album art.

You can also touch **What's Playing** to hear how the system pronounces the current band and song. This can be helpful when using voice commands to make sure the system correctly plays your request.

SD Card and USB Voice Commands

If you are listening to a USB device or an SD card, press the voice button on the steering wheel control. When prompted, say any of the commands in the following chart.

If you are not listening to a USB device or an SD card, press the voice button and, after the tone, say “USB” or “SD card”, then any of the commands in the following chart.

“USB” or “SD CARD”	
“Browse”*	“Play previous song”
“Next”	“Play similar music”
“Pause”	“Play song <name>”
“Play”	“Play TV show <name>”**
“Play album <name>”	“Play TV show episode <name>”**
“Play all”	“Play video <name>”**
“Play artist <name>”	“Play video podcast <name>”**
“Play audiobook <name>”	“Play video podcast episode <name>”**
“Play author <name>”	“Play video playlist <name>”**
“Play composer <name>”	“Previous”
“Play folder <name>”	“Repeat all”
“Play genre <name>”	“Repeat off”
“Play movie <name>”**	“Repeat one”
“Play music video <name>”**	“Shuffle”
“Play next song”	“Shuffle off”
“Play playlist <name>”	“What’s this?”
“Play podcast <name>”	“Help”
“Play podcast episode <name>”	

*If you have said you would like to browse your USB or SD card, the system prompts you to specify what you would like to browse. When prompted, see the following “Browse” chart.

**These commands are only available in USB mode and are device-dependent.

"BROWSE"	
"Album <name>"	"All video podcasts"*
"All albums"	"All videos"*
"All artists"	"Artist <name>"
"All audiobooks"	"Audiobook <name>"
"All authors"	"Author <name>"
"All composers"	"Composer <name>"
"All folders"	"Folder <name>"
"All genres"	"Genre <name>"
"All movies" *	"Playlist <name>"
"All music videos"*	"Podcast <name>"
"All playlists"	"TV show <name>"*
"All podcasts"	"Video <name>"*
"All songs"	"Video playlist <name>"*
"All TV shows"*	"Video podcast <name>"*
"All video playlists"*	"Help"

*These commands are only available in USB mode and are device-dependent.

Supported Media Players, Formats and Metadata Information

SYNC is capable of hosting nearly any digital media player, including iPod®, Zune™, plays from device players, and most USB drives. Supported audio formats include MP3, WMA, WAV and AAC.

It is also able to organize your indexed media from your playing device by metadata tags. Metadata tags, which are descriptive software identifiers embedded in the media files, provide information about the file.

If your indexed media files contain no information embedded in these metadata tags, SYNC may classify the empty metadata tags as **Unknown**.

In order to playback video from your iPod® or iPhone®, (if compatible), you **MUST** have a special combination USB/RCA composite video cable (which you can buy from Apple®). When the cable is connected to your iPod® or iPhone®, plug the other end into both the RCA jacks and the USB port.

Bluetooth Audio

Your system allows you to stream audio over your vehicle's speakers from your connected, Bluetooth-enabled cellular phone.



To access, press the lower left corner on the touchscreen, then select the **BT Stereo** tab.

Bluetooth Audio Voice Commands



If you are listening to a Bluetooth audio device, press the voice button on the steering wheel control. When prompted, say "Next song", "Pause", "Play" or "Previous song".

If you are not listening to a Bluetooth audio device, press the voice button and, after the tone, say "Bluetooth Audio", then "Next song", "Pause", "Play" or "Previous song".

A/V Inputs



WARNING: Driving while distracted can result in loss of vehicle control, crash and injury. We strongly recommend that you use extreme caution when using any device that may take your focus off the road. Your primary responsibility is the safe operation of your vehicle. We recommend against the use of any hand-held device while driving and encourage the use of voice-operated systems when possible. Make sure you are aware of all applicable local laws that may affect the use of electronic devices while driving.



WARNING: For safety reasons, do not connect or adjust the settings on your portable music player while your vehicle is in motion.



WARNING: Store the portable music player in a secure location, such as the center console or the glove box, when your vehicle is in motion. Hard objects may become projectiles in a crash or sudden stop, which may increase the risk of serious injury. The audio extension cable must be long enough to allow the portable music player to be safely stored while your vehicle is in motion.

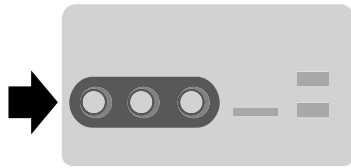

Your A/V inputs allow you to connect an auxiliary audio/video source (such as a gaming systems or a personal camcorder) by connecting RCA cords (not included) to these input jacks. The jacks are yellow, red and white and are located either behind a small access door on the

instrument panel or in your center console.

You can also use the A/V inputs as an auxiliary input jack to play music from your portable music player over your vehicle's speakers. Plug in your 1/8 inch (3.5 millimeter) RCA adapter into the two left A/V input jacks (red and white).

Press the lower left corner of the touchscreen, and then select **A/V In**.

To use the auxiliary input jack feature, make sure that your portable music player is designed for use with headphones and that it is fully charged. You also need an audio extension cable with stereo male 1/8th-inch (3.5 millimeter) connectors at one end and a RCA jack at the other.

1. Switch off the engine, radio and portable music player. Set the parking brake and put the transmission in position **P**.
2. Attach one end of the audio extension cable to the headphone output of your player and the other end into the adapter in one of the two left A/V input jacks (white or red) inside the center console.
3. Press the lower left corner on the touchscreen. Select either a tuned FM station or a CD (if there is a CD already loaded into the system).
4. Adjust the volume as desired.
5. Turn the portable music player on and adjust the volume to ½ the maximum.
6. Press the lower left corner on the touchscreen. Select the A/V In tab. (You should hear audio from your portable music player although it may be low.)
7. Adjust the sound on your portable music player until it reaches the level of the FM station or CD by switching back and forth between the controls.

In order to playback video from your iPod® or iPhone® (if compatible), you must have a special combination USB/RCA composite video cable (which you can buy from Apple®). When the cable is connected to your iPod® or iPhone®, plug the other end into both the RCA jacks and the USB port.

Troubleshooting

- Do not connect the audio input jack to a line level output. The jack only works correctly with devices that have a headphone output with a volume control.
- Do not set the portable music player's volume level higher than is necessary to match the volume of the CD or FM radio as this causes distortion and reduces sound quality.
- If the music sounds distorted at lower listening levels, turn the portable music player volume down. If the problem persists, replace or recharge the batteries in the portable media player.
- Control the portable media player in the same manner when used with headphones, as the auxiliary input jack does not provide control (such as Play or Pause) over the attached portable media player.

PHONE

- A. Phone
- B. Quick Dial
- C. Phonebook
- D. History
- E. Messaging
- F. Settings

Hands-free calling is one of the main features of SYNC®. Once you pair your phone, you can access many options using the touchscreen or voice commands. While the system supports a variety of features, many are dependent on your cellular phone's functionality. At a minimum, most cellular phones with Bluetooth wireless technology support the following functions:

- Answering an incoming call
- Ending a call
- Using privacy mode
- Dialing a number
- Redialing
- Call waiting notification
- Caller ID.

Other features, such as text messaging using Bluetooth and automatic phonebook download, are phone-dependent features. To check your phone's compatibility, see your phone's user manual and visit www.SYNCMyRide.com, www.SYNCMyRide.ca or www.syncmaroute.ca.

Pairing Your Phone for the First Time



WARNING: Driving while distracted can result in loss of vehicle control, crash and injury. We strongly recommend that you use extreme caution when using any device that may take your focus off the road. Your primary responsibility is the safe operation of your vehicle. We recommend against the use of any hand-held device while driving and encourage the use of voice-operated systems when possible. Make sure you are aware of all applicable local laws that may affect the use of electronic devices while driving.

The first thing you must do to use the phone features of SYNC is to pair your Bluetooth-enabled cellular phone with SYNC. This allows you to use your phone in a hands-free manner.

Note: Put the transmission in position **P**. Turn on your vehicle ignition and the radio.

1. Touch **Add Phone** in the upper left corner of the touchscreen. **Find SYNC** appears on the screen and instructs you to begin the pairing process from your device.
2. Make sure that Bluetooth is set to **On** and that your cellular phone is in the proper mode. See your phone's manual if necessary.
 - Select **SYNC**, and a six-digit PIN appears on your device.

3. If you are prompted to enter a PIN on your device, it does not support Secure Simple Pairing. To pair, enter the PIN displayed on the touchscreen. Skip the next step.
4. When prompted on your phone's display, confirm that the PIN provided by SYNC matches the PIN displayed on your cellular phone.
5. The display indicates when the pairing is successful.

SYNC may prompt you with more phone options. For more information on your phone's capability, see your phone's manual and visit the website.

Pairing Subsequent Phones

Note: Put the transmission in position **P**. Turn on your vehicle ignition and the radio.

1. Press the **Phone** corner of the touchscreen > **Settings** > **BT Devices** > **Add Device**.
2. Make sure that Bluetooth is set to **On** and that your cellular phone is in the proper mode. See your phone's user guide if necessary.
3. When prompted on your phone's display, enter the six-digit PIN provided by SYNC on the screen. The display indicates when the pairing is successful. The system asks you if you want to download your phonebook.

SYNC may prompt you with more phone options. For more information on your phone's capability, see your phone's user guide and visit the website.

Making Calls



Press the voice button on your steering wheel controls. When prompted, say, "Call <name>" or say "Dial", then the desired number.



To end the call or exit phone mode, press and hold the phone button.

Receiving Calls

During an incoming call, an audible tone sounds. Call information appears in the display if it is available.



Accept the call by pressing **Accept** on the touchscreen or by pressing this phone button on your steering wheel controls.



Reject the call by pressing **Reject** on the touchscreen or by pressing and holding this phone button on your steering wheel controls.

Ignore the call by doing nothing. SYNC logs it as a missed call.

Phone Menu Options

Press the top left corner on your touchscreen to select from the following options:

Phone

Touch this button to access the on-screen numerical pad to enter a number and place a call. During an active call, you can also choose to:

- Mute the call
- Put it on hold
- Turn on privacy (returns the call to your cellular phone)
- Join two calls
- End the call.

Quick Dial

Set up favorite contacts from you phonebook or history folder.

Phonebook

Touch this button to access and call any contacts in your previously downloaded phone book. The system places the entries in alphabetical categories summarized at the top of the screen.

To turn on contact picture settings, if your device supports this feature, press **Phone > Settings > Manage Phonebook > Download photos from Phonebook > On.**

Certain smart phones may support transferring street addresses when listed with phone book contact information. If your phone supports this feature, you can select and use these addresses as destinations and save them as favorites.

History

After you connect your Bluetooth-enabled phone to SYNC, you can access any previously dialed, received or missed calls. You can also choose to save these to your **Favorites** or to **Quick Dial**.

Note: This is a phone-dependent feature. If your phone does not support downloading call history using Bluetooth, SYNC keeps track of calls made with the SYNC system.

Messaging

Send text messages using your touchscreen. See *Text messaging* later in this section.

Settings

Touch this button to access various phone settings, such turning Bluetooth on and off, managing your phonebook and more. See *Phone settings* later in this section.

Text Messaging

Note: Downloading and sending text messages using Bluetooth are phone-dependent features.

Note: Certain features in text messaging are speed-dependent and not available when your vehicle is traveling at speeds over 3 mph (5 km/h).

Note: SYNC does not download read text messages from your phone.

You can send and receive text messages using Bluetooth, read them aloud and translate text messaging acronyms, such as LOL.

1. Touch the top left corner of the display to access the **Phone** menu.
2. Select **Messaging**.
3. Choose from the following:
 - **Listen** (speaker icon)
 - **Dial**
 - **Send Text**
 - **View**
 - **Delete**.

Composing a Text Message

Note: This is a speed-dependent feature. It is unavailable when your vehicle is traveling at speeds over 3 mph (5 km/h).

Note: Downloading and sending text messages using Bluetooth are phone-dependent features.

1. Touch the top left corner of the display to access the **Phone** menu.
2. Touch **Messaging > Send Text**.
3. Enter a phone number or choose from your phone book.
4. You can select from the following options:
 - **Send** which sends the message as it is.
 - **Edit Text** allows you to customize the pre-defined message or create a message on your own.

You can then preview the message, verify the recipient as well as update the message list, and send it to a connected device (such as a USB drive).

Pre-defined Text Message Options
I'll call you back in a few minutes.
I just left, I'll be there soon.
Can you give me a call?
I'm on my way.
I'm running a few minutes late.
I'm ahead of schedule, so I'll be there early.
I'm outside.
I'll call you when I get there.
OK
Yes
No
Thanks
Stuck in traffic.
Call me later.
LOL

Receiving a Text Message

When a new message arrives, an audible tone sounds and the screen displays a pop-up with the caller name and ID, if supported by your phone. You can press:

- **View** to view the text message.
- **Listen** for SYNC to read the message to you.
- **Dial** to call the contact.
- **Ignore** to exit the screen.

Note: If you select **View** and your vehicle is traveling over 5 mph (8 km/h), the system offers to read the message to you instead of allowing you to view it while driving.

Phone Settings

Press **Phone** > **Settings**.

Bluetooth Devices

Touch this tab to connect, disconnect, add or delete a device, as well as save it as a favorite.

Bluetooth

Touch this tab to turn Bluetooth off or on.

Do Not Disturb

Touch this tab if you want all calls to go directly to your voice mail and not ring in the vehicle. When this feature is on, text message notifications do not ring inside the cabin either.

911 Assist

Turn on or turn off the 911 Assist™ feature. See *911 Assist®* in the *SYNC Services and Applications* section.

Phone Ringer

Select the ring tone you want to hear when you receive a call. Choose from possible system ring tones, your currently paired phone's ring tone, a beep, text-to-speech or a silent notification.

Text Message Notification

Select a text message notification, if supported by your phone. Choose from possible system alert tones, text-to-speech or silent.

Internet Data Connection

If your phone is compatible, use this screen to adjust your internet data connection. Select to make your connection profile with the personal area network or to turn off your connection. You can also choose to adjust your settings or have the system always connect, never connect when roaming or query on connect. Press ? for more information.

Manage Phonebook

Touch this button to access features such as automatic phonebook download, re-download your phonebook, add contacts from your phone as well as delete or upload your phonebook.

Roaming Warning

Touch this button to have the system alert you when your phone is in roaming mode.

Phone Voice Commands

Press the voice button on the steering wheel control. After the tone, say any of the following commands:

“PHONE”	
“Bluetooth off”	“Hold call off”*
“Bluetooth on”	“Hold on”*
“Call”	“Join calls”*
“Call <name>”	“Listen to text message <#>”
“Call <name> at home”	“Listen to text messages”
“Call <name> at work”	“Messages”**
“Call <name> on cell”	“Mute call”*
“Call <name> on other”	“Pair phone”
“Call voicemail”	“Privacy on”*
“Dial”	“Reply to text messages”
“Do not disturb off”	“Turn ringer off”
“Do not disturb on”	“Turn ringer on”
“Forward text messages”	“Unmute call”*
“Go to hands free”*	“Help”

*These commands are only available during an active call.

**If you have said “Messages”, see the following “Messages” chart.

“MESSAGES”
“Call”
“Forward text messages”
“Listen to text message <#>”
“Listen to text messages”
“Reply to text messages”
“Help”

ELECTRIC VEHICLE INFORMATION



Your system has special electric vehicle screens, which display power flow and charge settings. To access these screens, press the EV Info button.



A. Settings

B. Power

Settings

This screen allows you to set up the charging convenience features.

Note: You can also set up the charging convenience features using MyFord Mobile over the internet or smartphone application. For more information on MyFord Mobile, and to set up your MyFord Mobile account, visit www.myfordmobile.com.

To improve the charging experience, your vehicle has the following convenience features:

- **Value Charge:** Your vehicle schedules its charging time when the utility rates are lowest. Contact your utility company to see what rates are available.
- **Charge Now:** Fully charge your vehicle at the quickest rate. Your vehicle starts charging immediately after you connect the charging plug to your vehicle.
- **My GO Time:** Setting the My GO Time allows you to control charging schedules and cabin conditioning settings so your vehicle is ready to drive when you are. By setting a My GO Time, your vehicle can have a complete charge before your next set drive time. A calendar view allows you to program two My GO Times per day for each day of the week.

Note: Remember, you must plug in your vehicle for My GO Time to work.

- **Cabin Conditioning:** Get the most miles out of every charge by conditioning your vehicle while it is charging. Set the cabin temperature and departure time before you leave so you use energy from your home instead of your vehicle's battery.

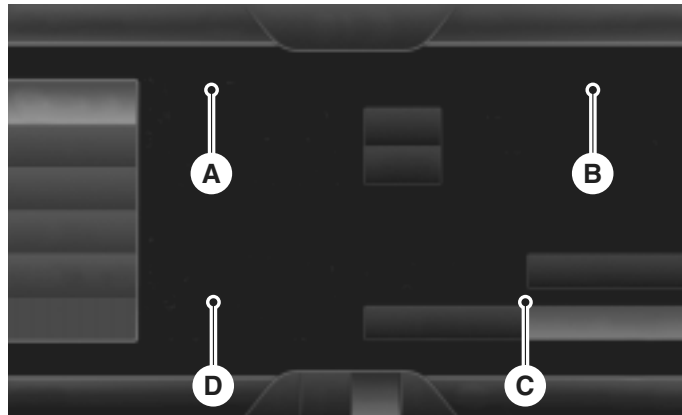

A. **My GO Time summary** displays the next My GO Time and cabin temperature setting.

B. **Estimated charge time limits**

- Displays the estimated minimum and maximum times to fully charge the high-voltage battery.
- Displays the battery's current charge as a percentage.

C. **Charge profile and mode** displays the current charging profile and charging mode.

D. **Charging status and actual times** displays charging status with the actual charging start time, end time, and duration.

My GO Time Summary

Temperature is the chosen cabin conditioning setting for this My GO Time.

GO Time is the time and date of your next set drive time. Your vehicle automatically schedules charging and cabin conditioning to finish by this time. The electric motor and gasoline engine are powering vehicle.

Skip cancels the cabin conditioning for the present My GO Time. Once you touch Skip, the GO Time and Temperature are not selectable, and the LED illuminates on the Skip button. Touch the button again to turn on the cabin conditioning. This feature allows you to ignore the present GO Time without having to delete the My GO Time or turning off the entire schedule (see **GO Time Schedule** later in this section). After the present GO Time passes, the Skip feature resets.

Edit accesses your My GO Time Schedule (see **GO Time Schedule** later in this section)

The system also alerts you to any conflicts by highlighting areas of the screen in yellow. If your battery cannot have a full charge by the scheduled drive time, the system highlights the current My GO Time and Actual Charge End Time and a message **Charge at GO Time: under 100%** appears. This is normal; the vehicle is informing you of the conflicting situation. This notification only displays when the gearshift selector lever is in position **P**.

Note: Charging occurs as soon as you plug the vehicle in. The system limits cabin conditioning to 15 minutes before the My GO Time.

To eliminate the conflict notification immediately or to prevent a conflict in the future, try the following:

- Change the present My GO Time to occur later.
- Plug the vehicle into a 240V charging station instead of 120V convenience cord. Higher power charging yields shorter charge times.
- Plug the vehicle in sooner.

Estimated Charge Time Limits

Battery shows you the battery's current charge displayed as a percentage. A reading of 100% means the battery has a full charge. A reading of 0% means the battery has no charge.

To fully charge

- **240V** is the estimated minimum charging time from the current high-voltage battery level to full charge (100%). This represents the shortest amount of time you should expect the high-voltage battery to recharge under ideal conditions. Ideal conditions include a 240V charging station and a minimum 30A service and high-voltage battery at a moderate temperature.

Note: This charging time is only an estimate. It is normal for your actual charge duration to be longer.

Note: Some charging stations use lower voltage (208V), which result in longer charge times.

- **120V** is the estimated maximum charging time from the current high-voltage battery level to full charge (100%). This represents the longest amount of time you should expect the high-voltage battery to recharge under normal conditions. Normal conditions include a 120V convenience cord and 12A service.

Note: This charging time is only an estimate. It is possible for your actual charge duration to be longer. This occurs when the AC line voltage is low and may indicate your electrical source is not meeting certain requirements (see *Charging the high-voltage battery* in the *High Voltage Battery* chapter).

Value Charge Profile and Mode

Value Charge profile name is the name of the presently detected Value Charge Profile. The system detects a customer defined value charge profile when the vehicle is within approximately 300 feet (100 meters) of the GPS location registered for the profile. If the vehicle is close to more than one charge profile, it chooses the closest. When the vehicle is not at a defined profile, it uses the **Default Value** charge profile. The system normally displays **Default Profile** while you are driving because the vehicle is typically between defined value charge profiles.

Edit allows you to access your Value Charge profiles settings screen (see **Value Charge Profiles** later in this section).

Charge Now if you want your vehicle to immediately charge when plugged in at this profile location. This button illuminates if the current charge mode for the currently detected charge profile.

Value Charge if you want to take advantage of off-peak electricity rates. The vehicle optimizes the charge schedule to be complete by the next GO Time. This button illuminates if the current charge mode for the currently detected charge profile.

Charging Status and Actual Times

This is the status of the charging system, which includes the charging plug, high-voltage battery and charger.

Next Charge means the vehicle is unplugged. Estimated charge information is for the present vehicle location.

Waiting to Charge means the vehicle is plugged in. Typical of Value Charge mode, the vehicle may not start charging right away because it is set to charge at times with lower utility costs.

Charging means the high-voltage battery is charging.

Charged means the high-voltage battery is fully charged and not currently scheduled for further charging.

Charge Fault means a fault is present that is preventing the high-voltage battery from charging. Inspect the charge plug connection, charge cord and charging station.

Start is the scheduled start time of charging.

- **At Plug In:** When the vehicle is in Charge Now mode, and unplugged, the message At Plug In appears, indicating the vehicle immediately starts charging once you plug it in. Once you plug it in, the system shows the actual charge start time.
- **Scheduled Charge Start Time:** When the vehicle is in Value Charge mode, the system displays the scheduled charge start time (for example, 8:00 PM). Once charging starts, the system continues to display the actual charge start time.

End is the estimated end time of charging.

- **Charge Now Duration:** When the vehicle is in Charge Now mode, and unplugged, the system displays the charging duration in hours. Once you plug in the vehicle, the value shows the estimated time to finish charging.
- **Scheduled Charge End Time:** When the vehicle is in Value Charge mode, the system displays the estimated charge end time. It is normal for the actual end time to change while charging. The vehicle keeps charging until the high-voltage battery is fully charged.

GO Time Schedule

The highlighted button displays the current schedule mode. Touch the **Edit** button next to the My GO Time to see the GO Time Schedule.

On turns on the GO Time schedule.

Off turns off the GO Time schedule. This also turns off the cabin conditioning function. Use this mode when you store your vehicle on-plug to prevent using energy for cabin preconditioning.

Note: If you choose to perform Value Charging with the schedule off, the vehicle schedules charging to finish at the lowest cost within 24 hours of plugging the vehicle in.

GO Time events displays the GO Time day-of-week and time. The blue highlighted GO Time is the current GO Time the vehicle is using for charge scheduling and cabin conditioning. You can schedule two GO Time events per day for each day of the week.

- **GO Time** allows you to edit the GO Time and cabin conditioning temperature.
- **--:--** indicates that you can add a GO Time to this slot.

You can enter the GO Time choices in any order. The schedule automatically sorts the GO Time events to appear in the correct order.

GO Time and Cabin Conditioning

This screen allows you to enter or change the GO Time and cabin conditioning temperature.

Time Buttons (+ and -) changes the hours and minutes of your GO Time. The minutes change in increments of five. You can also change the settings for AM and PM by touching those buttons.

Cabin Conditioning Buttons (+ and -) changes the setting for your selected cabin conditioning temperature for this GO Time event. You can select from four settings:

- 65°F (18.5°C)
- 72°F (22.0°C)
- 85°F (29.5°C)
- Off.

Clear erases the GO Time and cabin conditioning temperature.

Save stores the GO Time and temperature settings.

- **Note:** If you select a My GO Time, but choose **Off** for the temperature setting, the vehicle schedules charging to be complete by your GO Time and does not condition the cabin.
- **Note:** Make sure you save your settings before returning to the previous screen. If you do not touch **Save**, your settings are not stored in the system.

Value Charge Profiles

Default displays the charging mode and off-peak times for your Default Value Charge profile. The system displays off-peak times for weekdays; the remaining hours of the day are considered peak time. The system displays similar off-peak times for weekend days.

- **Charge Now** if you want your vehicle to immediately charge when you plug it in at this profile location.
- **Value Charge** if you want to take advantage of off-peak electricity rates. The vehicle optimizes the charge schedule to be complete by the next GO Time.
- **Edit** to access your **Default Value Charge Profile** settings screen (see **Default Value Charge Profile** later in this section).

Customer Defined Value Charge Profiles displays the Value Charge profile names and current Charge Mode for specific locations once you create profile names. You can set up and edit these profiles using the MyFord Mobile internet or smartphone application. You can program up to nine unique charge profiles.

Default Value Charge Profile

Weekday and **Weekend** display the My GO Time schedules when you touch either button.

Start and **Finish** display the times, which you can modify, using the following:

- **+** and **-** allow you to change the hours and minutes of your start and finish times.
- **AM** and **PM** allow you to change the time of your start and finish time. This setting is viewable in 12-hour mode.

240V and **120V** represent the voltage service the default profile is using. The system uses this selection to calculate estimated charge times.

Clear erases the Default Value Charge preferences.

Save All stores your Default Value Charge preferences.

- **Note:** Make sure you save your settings before returning to the previous screen. If you do not touch **Save**, your settings are not stored in the system.

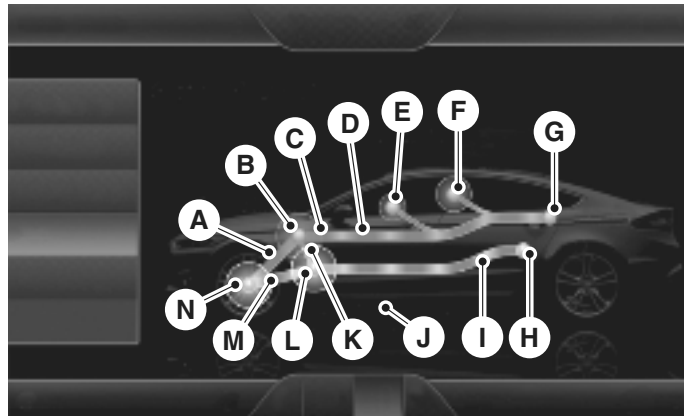
Power

This screen displays how the electric vehicle system transfers power in order to accelerate or recharge the battery. The power flow screens show power going to or through a component. These screens are for your information only, and do not require any input from you.

Depending on your vehicle type, the power flow screen may vary in order to show the appropriate components.

Note: Vehicle configuration and status displayed may not always match actual vehicle state due to display constraints and simplified graphics.

A. **Motor-to-wheel flow** shows the direction of power flow between the wheels and the electric motor.

B. **Electric Motor** represents the hybrid electric motor. The higher the motor power is, the larger the circle around this node. Any time the vehicle is ready to be driven, the motor node illuminates.

C. **Battery-to-motor flow** shows the direction of power flow between the high-voltage battery and the electric motor. Flow toward the motor indicates the battery is providing power to accelerate the vehicle (discharging the battery). Flow toward the battery indicates the electric motor is providing power to the battery (charging the battery).

Note: The battery-to-motor flow includes battery power the vehicle is using for acceleration. It does not include energy the vehicle is using for accessories (such as air conditioning, headlights and radio). This screen displays accessories and climate usage separately.

D. **Plug (Energi only)** appears when you plug your vehicle into the wall. When charging the high voltage battery from the wall, you can see flow from the plug to the battery on the screen.

- **Accessories** indicates electrical power demands from your vehicle's accessory systems. Accessories use power but do not contribute to making the vehicle move. The power flow displays power usage from the climate control system and other accessories separately.

E. **Other** includes all power usage from the low voltage accessories such as the climate control fan, headlights and heated seats. The higher the power usage is from these accessories, the larger the circle around the node. This node illuminates anytime the vehicle is on since there is always some low level power in use.

F. **Climate** includes the power usage from the high-voltage climate control components such as the electric A/C compressor and the electric heater (Energi only). The higher the power usage is from these components, the larger the circle around this node.

Note: The climate control system may determine A/C is necessary even when you turn it off. In this case, you may see some climate power when the A/C is off.

G. **High voltage battery power** represents your high-voltage battery. A circle illuminates around the node when the high-voltage battery is receiving power from regenerative braking, engine charging or external charging (when you plug it in). The higher the power usage is from the high-voltage battery, the larger the circle around this node.

H. **Fuel** represents the fuel tank in the vehicle.

I. **Fuel-to-engine flow** shows flow from the fuel tank to the engine when the engine is on and using fuel (there are some cases where the engine is on, but not using any fuel). When the engine is on, but not using fuel, the engine node is active, but the fuel flow path is off. An example of this is when your foot is off the accelerator pedal and the vehicle is traveling at a high speed.

J. **Engine On due to** provides you with the reason(s) the gasoline engine is on. When the gasoline engine is off, this display does not appear. **Engine On due to** reasons displayed by the system are in a chart following this list.

K. **Motor-to-engine flow** shows the direction of power flow between the engine and the electric motor. The direction indicates if the engine is providing power to the high-voltage electrical system, or if the high-voltage electrical system is providing power to control or start the engine.

L. **Engine power** represents the gasoline engine. It illuminates only when the gasoline engine is on. The higher the engine power is, the larger the circle around this node.

M. **Engine-to-wheels flow** shows the direction of the power flow between the engine and the wheels.

N. **Wheel power** represents the power going to the wheels. The higher the wheel power is, the larger the circle around this node.

Engine On due to	
Engine Cold (Hybrid only)	The engine is on to warm-up. The vehicle return to electric mode when the engine is warm. This reason may reappear during a drive or after shutting the vehicle down for a short period. This is normal operation.
Heater Setting	The engine is on because of the heater setting. Reduce or turn off the heater setting to return to electric mode.
High Speed	The engine is on because the vehicle speed exceeds the level for electric mode operation. Reduce the speed to return to electric mode.
Acceleration	The engine is on because the speed control is on or you are pressing the accelerator pedal. Reduce pressure on the accelerator pedal or turn the speed control off to return to full electric mode.
Neutral Gear	The engine is on because the vehicle is in neutral gear. Shift out of neutral gear to return to electric mode.
Low Gear	The engine is on because the vehicle is in low gear. Shift out of low gear to return to electric mode.
Battery Charging	The engine is on to charge the high-voltage battery. The vehicle returns to electric mode once the battery is charged.

Engine On due to	
Grade Assist	The engine is on to provide increased powertrain braking when you turn on the grade assist feature. Turn off the grade assist feature to return to electric mode.
Oil Maintenance (Energi Only)	The engine is on to maintain engine oil quality. The vehicle returns to electric mode when engine oil maintenance is complete. See <i>Engine oil check</i> in the <i>Maintenance</i> chapter for more information.
Batt Temperature (Energi Only)	The engine is on due to high or low high-voltage battery temperature. This is a normal operating condition. The vehicle returns to electric mode automatically when possible.
Normal Operation	The engine is on to optimize vehicle operation. The vehicle returns to electric mode when possible.

Status

This indicates which mode is active within the vehicle system.

Hybrid Drive

The electric motor and gasoline engine are powering vehicle.

Charging HV Battery

The hybrid system is storing power in the high-voltage battery.

Idle

The vehicle is either at rest, or sharing very little power between the electric system parts.

Idle with Charging

The high-voltage battery is receiving power in order to recharge.

Electric Drive

The vehicle is driving in electric mode (the power is coming from the electric motor). The gasoline engine is off in this mode.

Charge Complete (Energi only)

The high-voltage battery charging from the wall is complete. This mode applies to plug in vehicles only.

INFORMATION

 If your vehicle is equipped with Navigation, touch the i (Information) button to access these features. If your vehicle is not equipped with Navigation, touch the corner of the touchscreen with the green tab.



Under the Information menu, you can access features, such as:

- A. SYNC® Services
- B. SIRIUS® Travel Link™
- C. Alerts
- D. Calendar
- E. SYNC Applications.

SYNC Services (If Equipped, U.S. Only)

Note: SYNC Services requires activation before use. Visit www.SYNCMyRide.com to register and check your eligibility for complimentary services. Standard phone and message rates may apply. Subscription may be required. You must also have the active SYNC Services Bluetooth-enabled cellular phone paired and connected to the system in order to connect to, and use, SYNC Services. (See *Phone* earlier in this chapter for pairing instructions.)

Note: This feature does not function properly if you have enabled caller ID blocking on your mobile phone. Make sure your mobile phone is not blocking caller ID before using SYNC Services.

Note: The driver is ultimately responsible for the safe operation of the vehicle, and therefore, must evaluate whether it is safe to follow the suggested directions. Any navigation features are provided only as an aid. Make your driving decisions based on your observations of local conditions and existing traffic regulations. Do not follow the route suggestions if doing so would result in an unsafe or illegal maneuver, if you would be placed in an unsafe situation, or if you would be directed into an area that you consider unsafe. Maps used by this system may be inaccurate because of errors, changes in roads, traffic conditions or driving conditions.

Note: When you connect, the service uses GPS technology and advanced vehicle sensors to collect your vehicle's current location, travel direction and speed to help provide you with the directions, traffic reports, or business searches you request. Further, to provide the services you request, for continuous improvement, the service may collect and record call details and voice communications. For more information, see SYNC Services Terms and Conditions at www.SYNCMYride.com. If you do not want Ford or its service providers to collect your vehicle travel information or other information identified in the Terms and Conditions, do not subscribe or use the service.

SYNC Services uses advanced vehicle sensors, integrated GPS technology and comprehensive map and traffic data, to give you personalized traffic reports, precise turn-by-turn directions, business search, news, sports, weather and more. For a complete list of services, or to learn more, please visit www.SYNCMYride.com.

Connecting to SYNC Services Using Voice Commands



Press the voice button on the steering wheel controls.

1. When prompted, say "Services". This initiates an outgoing call to SYNC Services using your paired and connected Bluetooth-enabled cellular phone.
2. Once you connect to the service, follow the voice prompts to request the desired service, such as "Traffic" or "Directions". You can also say, "What are my choices?" to receive a list of available services from which to choose.
3. Say, "Services" to return to the Services main menu or for help, say, "Help".

Connecting to SYNC Services Using the Touchscreen

 If your vehicle is equipped with Navigation, touch the i (Information) button to access these features. If your vehicle is not equipped with Navigation, touch the corner of the touchscreen with the green tab.

Press **Services**.

1. Select **Connect to Services** to initiate an outgoing call to SYNC Services using your paired and connected Bluetooth-enabled cellular phone.
2. Once you connect to the service, follow the voice prompts to request the desired service, such as “Traffic” or “Directions”. You can also say, “What are my choices?” to receive a list of available services from which to choose.
3. Say, “Services” to return to the Services main menu or for help, say, “Help”.

Receiving Turn-by-Turn Directions

1. When connected to SYNC Services, say “Directions” or “Business Search”. To find the closest business or type of business to your current location, just say “Business Search” and then “Search Near Me”. If you need further assistance in finding a location, you can say “Operator” at any time within a Directions or Business search to speak with a live operator. The system may prompt you to speak with an operator when it has difficulty matching your voice request. The live operator can assist you by searching for businesses by name or by category, residential addresses by street address or by name or specific street intersections. Operator Assist is a feature of your SYNC Services subscription. For more information on Operator Assist, visit www.SYNCMyRide.com/support.
2. Follow the voice prompts to select your Destination. After the route download is finished, the phone call automatically ends.

If your vehicle is not equipped with Navigation:

- Turn-by-turn directions appear in the information display, in the status bar of your touchscreen system and on the SYNC Services screen. You also receive driving instructions from audible prompts.
- When on an active route, you can select **Route Summary** or **Route Status** using the touchscreen controls or voice commands to view the **Route Summary Turn List** or the **Route Status ETA**. You can also turn voice guidance on or off, cancel the route or update the route.

If you miss a turn, SYNC automatically asks if you want the route updated. Just say, “Yes” when prompted and the system delivers a new route to your vehicle.

If your vehicle is equipped with Navigation, SYNC Services downloads your requested destination to the navigation system. The navigation system then calculates the route and provides driving instructions. See the *Navigation system* section for more information.

Disconnecting from SYNC Services

1. Press and hold the hang-up phone button on the steering wheel.
2. Say “Goodbye” from the SYNC Services main menu.

SYNC Services quick tips	
Personalizing	You can personalize your Services feature to provide quicker access to your most used or favorite information. You can save address points, such as work or home. You can also save favorite information like sports teams, such as Detroit Lions, or a news category. You can learn more about personalization by logging onto www.SYNCMYride.com .
Push to interrupt	Press the voice button at any time (while connected to SYNC TDI Services) to interrupt a voice prompt or an audio clip (such as a sports report) and say your voice command.
Portable	Your subscription is associated with your Bluetooth-enabled cellular phone number, not your VIN (Vehicle Identification Number). You can pair and connect your phone to any vehicle equipped with Traffic, Directions and Information and continue enjoying your personalized services.

SYNC Services Voice Commands

When a route has been downloaded (non-navigation systems), press the voice button on the steering wheel control. When prompted, say any of the following commands:

“SERVICES”
“Cancel route”
“Navigation voice off”
“Navigation voice on”
“Next turn”
“Route status”
“Route summary”
“Services”
“Update route”
“Help”

SIRIUS Travel Link (If Equipped and If Activated)

WARNING: Driving while distracted can result in loss of vehicle control, crash and injury. We strongly recommend that you use extreme caution when using any device that may take your focus off the road. Your primary responsibility is the safe operation of your vehicle. We recommend against the use of any hand-held device while driving and encourage the use of voice-operated systems when possible. Make sure you are aware of all applicable local laws that may affect the use of electronic devices while driving.

Note: In order to use SIRIUS Travel Link, your vehicle must be equipped with navigation and your navigation SD card must be in the SD card slot.

Note: A paid subscription is required to access and use these features. Go to www.siriusxm.com/travellink for more information.

Note: Visit www.siriusxm.com/traffic# and click on Coverage map and details for a complete listing of all traffic areas covered by SIRIUS Travel Link.

Note: Neither SIRIUS nor Ford is responsible for any errors or inaccuracies in the SIRIUS Travel Link services or its use in vehicles.

When you subscribe to SIRIUS Travel Link, it can help you locate the best gas prices, find movie listings, get current traffic alerts, view the current weather map, get accurate ski conditions and see scores to current sports games.



If your vehicle is equipped with Navigation, touch the i (Information) button to access these features. If your vehicle is not equipped with Navigation, touch the corner of the touchscreen with the green tab.

Traffic On Route and Traffic Nearby

Touch these buttons to identify traffic incidents on your route, nearby your vehicle's current location or near any of your favorite places, if programmed.

Fuel Prices

Touch this button to view fuel prices at stations close to your vehicle's location or on an active navigation route.

Movie Listings

Touch this button to view nearby movie theaters and their show times, if available.

Weather

Touch this button to view the nearby weather, current weather, or the five day forecast for the chosen area. Select **Map** to see the weather map, which can show storms, radar information, charts and winds. Select **Area** to select from a listing of weather locations.

Sports Info

Touch this button to view scores and schedules from a variety of sports. You can also save up to 10 favorite teams for easier access. The score automatically refreshes when a game is in progress.

Ski Conditions

Touch this button to view ski conditions for a specific area.

SIRIUS Travel Link Voice Commands

Note: In order to use SIRIUS Travel Link, your vehicle must be equipped with navigation and your navigation SD card must be in the SD card slot.



Press the voice button on the steering wheel controls and, when prompted, say any of the following:

Travel Link voice commands	
"5-day weather forecast"	"Sports scores"*
"Fuel prices"	"Traffic"
"Movie listings"	"Travel Link"**
"Sports headlines"*	"Weather"
"Sports schedule"*	"Weather map"

*If you have said, "Sports headlines", "Sports schedule" or "Sports scores", you may say any of the commands in the "Sports headlines, Sports schedules and Sports scores" commands chart:

**If you have said, "Travel Link", you may say any of the commands in the "Travel Link" chart:

Sports headlines, sports schedules and sports scores voice commands	
"Baseball"	"My teams"
"College basketball"	"NBA"
"College football"	"NFL"
"Golf"	"NHL"
"MLS"	"WNBA"
"Motor sports"	

“TRAVEL LINK”		
“5-day weather forecast”	“Golf schedule”	“NBA scores”
“Baseball headlines”	“MLS headlines”	“NFL headlines”
“Baseball schedule”	“MLS schedule”	“NFL schedule”
“Baseball scores”	“MLS scores”	“NFL scores”
“College basketball headlines”	“Motor sports”	“NHL headlines”
“College basketball schedule”	“Motor sports order”	“NHL schedule”
“College basketball scores”	“Motor sports schedule”	“NHL scores”
“College football headlines”	“Movie listings”	“Traffic”
“College football schedule”	“My team headlines”	“Weather”
“College football scores”	“My teams schedule”	“Weather map”
“Fuel prices”	“My teams scores”	“WNBA headlines”
“Golf headlines”	“NBA headlines”	“WNBA schedule”
“Golf leaderboard”	“NBA schedule”	“WNBA scores”

Alerts



If your vehicle is equipped with Navigation, touch the i (Information) button to access these features. If your vehicle is not equipped with Navigation, touch the corner of the touchscreen with the green tab.

Press **Alerts**, and then choose from any of the following services:

- **View** the message.
- **Delete** the message.
- **Delete All** messages.

This screen displays any system messages (such as an SD card fault).

Note: The system alerts you to any messages by turning the information icon yellow. After you read or delete the messages, the icon returns to white.

Calendar

If your vehicle is equipped with Navigation, touch the i (Information) button to access these features. If your vehicle is not equipped with Navigation, touch the corner of the touchscreen with the green tab.

Press **Calendar**. You can view the current calendar by day, week or month.

911 Assist® (If Equipped)

WARNING: Unless the 911 Assist setting is set on before a crash, the system will not dial for help, which could delay response time, potentially increasing the risk of serious injury or death after a crash.



WARNING: Do not wait for 911 Assist to make an emergency call if you can do it yourself. Dial emergency services immediately to avoid delayed response time, which could increase the risk of serious injury or death after a crash. If you do not hear 911 Assist within five seconds of the crash, the system or phone may be damaged or non-functional.



WARNING: Always place your phone in a secure location in your vehicle so it does not become a projectile or damaged in a crash. Failure to do so may cause serious injury to someone or damage the phone, which could prevent 911 Assist from working properly.

Note: The SYNC 911 Assist feature must be set on prior to the incident.

Note: Before setting this feature on, make sure that you read the 911 Assist privacy notice later in this section for important information.

Note: If any user turns 911 Assist on or off, that setting applies for all paired phones. If 911 Assist is turned off, either a voice message plays or a display message (or icon) comes on (or both) when your vehicle is started after a previously paired phone connects.

Note: Every phone operates differently. While SYNC 911 Assist works with most cellular phones, some may have trouble using this feature.

If a crash deploys an airbag (excludes knee airbags and rear inflatable safety belts [if equipped]) or activates the fuel pump shut-off, your SYNC-equipped vehicle may be able to contact emergency services by dialing 911 through a paired and connected Bluetooth-enabled phone. You can learn more about the 911 Assist feature, visit

www.SYNCMYride.com, www.SYNCMYride.ca or www.syncmaroute.ca.

- For information on airbag deployment, see the *Supplementary Restraints System* chapter.
- For information on the fuel pump shut-off, see the *Roadside Emergencies* chapter.

Setting 911 Assist On



If your vehicle is equipped with Navigation, touch the **i** (Information) button to access these features. If your vehicle is not equipped with Navigation, touch the corner of the touchscreen with the green tab.

Press **Apps** > 911 Assist, then select **On**.

You can also access 911 Assist by:



- Pressing the Settings icon > **Settings** > **Phone** > **911 Assist**, or
- Pressing the Settings icon > **Help** > **911 Assist**.

To Make Sure that 911 Assist Works Properly

- SYNC must be powered and working properly at the time of the incident and throughout feature activation and use.
- The 911 Assist feature must be set on before the incident.
- You must pair and connect a Bluetooth-enabled and compatible phone to SYNC.
- A connected Bluetooth-enabled phone must have the ability to make and maintain an outgoing call at the time of the incident.
- A connected Bluetooth-enabled phone must have adequate network coverage, battery power and signal strength.
- The vehicle must have battery power and be located in the U.S., Canada or in a territory in which 911 is the emergency number.

In the Event of a Crash

Not all crashes deploy an airbag or activate the fuel pump shut-off (which would trigger 911 Assist); however, SYNC tries to contact emergency services if 911 Assist triggers. If a connected phone sustains damage or loses connection to SYNC, SYNC searches for, and tries to connect to, any available previously paired phone and tries to make the call to 911.

Before making the call:

- SYNC provides a short window of time (about 10 seconds) to cancel the call. If you fail to cancel the call, SYNC attempts to dial 911.
- SYNC says the following, or a similar message: “SYNC will attempt to call 911, to cancel the call, press Cancel on your screen or press and hold the phone button on your steering wheel.”

If you do not cancel the call, and SYNC makes a successful call, a pre-recorded message plays for the 911 operator, and then the occupant(s) in your vehicle is able to talk with the operator. Be prepared to provide your name, phone number and location immediately, because not all 911 systems are capable of receiving this information electronically.

911 Assist May Not Work If

- Your cellular phone or 911 Assist hardware sustains damage in a crash.
- The vehicle’s battery or SYNC system has no power.
- The phone(s) thrown from your vehicle are the ones paired and connected to the system.

911 Assist Privacy Notice

When you turn on 911 Assist, it may disclose to emergency services that your vehicle has been in a crash involving the deployment of an airbag or activation of the fuel pump shut-off. Certain versions or updates to 911 Assist may also be capable of electronically or verbally disclosing to 911 operators your vehicle location or other details about your vehicle or crash to assist 911 operators to provide the most appropriate emergency services. If you do not want to disclose this information, do not turn the feature on.

Vehicle Health Report (If Equipped, U.S. Only)

WARNING: Always follow scheduled maintenance instructions, regularly inspect your vehicle, and seek repair for any damage or problem you suspect. Vehicle Health Report supplements, but cannot replace, normal maintenance and vehicle inspection. Vehicle Health Report only monitors certain systems electronically monitored by your vehicle and will not monitor or report the status of any other system, (such as brake lining wear). Failure to perform scheduled maintenance and regularly inspect your vehicle may result in vehicle damage and serious injury.

Note: Your Vehicle Health Report feature requires activation prior to use. Visit www.SYNCMYRide.com to register. There is no fee or subscription associated with Vehicle Health Report, but you must register to use this feature.

Note: This feature may not function properly if you have enabled caller ID blocking on your mobile phone. Before running a report, review the *Vehicle Health Report Privacy Notice*.

Note: In order to allow a break-in period for your vehicle, you may not be able to create a Vehicle Health Report until your vehicle odometer has reached 200 miles.

Note: Cellular phone and SMS charges may apply when making a report.

Register for Vehicle Health Report and set your report preferences at www.SYNCMYRide.com. After registering, you can request a Vehicle Health Report (inside your vehicle). Return to your account at www.SYNCMYRide.com to view your report. You can also choose for SYNC to remind you automatically to run reports at specific mileage intervals. Cellular phone airtime usage may apply when reporting.

The system allows you to check your vehicle's overall health in the form of a diagnostic report card. The Vehicle Health Report contains valuable information, such as:

- Vehicle Diagnostic Information
- Scheduled maintenance
- Open Recalls and Field Service Actions
- Items noted during vehicle inspections by your authorized dealer that still need servicing.

Making a Report

If your vehicle is equipped with Navigation, touch the i (Information) button to access these features. If your vehicle is not equipped with Navigation, touch the corner of the touchscreen with the green tab.

If you want to run a report by using the touchscreen, touch **Apps >**

Vehicle Health Report.

To run a report by voice command, press the voice button on the steering wheel and, when prompted, say “Vehicle health report”.

Vehicle Health Report Privacy Notice

When you create a Vehicle Health Report, Ford Motor Company may collect your cellular phone number (to process your report request) and diagnostic information about your vehicle. Certain versions or updates to Vehicle Health Report may also collect more vehicle information. Ford may use your vehicle information it collects for any purpose. If you do not want to disclose your cellular phone number or vehicle information, do not run the feature or set up your Vehicle Health Report profile at www.SYNCMYRide.com. See www.SYNCMYRide.com (Vehicle Health Report Terms and Conditions, and Privacy Statement) for more information.

SETTINGS



- A. Clock
- B. Display
- C. Sound
- D. Vehicle
- E. Settings
- F. Help



Under this menu, you can set your clock, access and adjust the display, sound and vehicle settings as well as access settings for specific modes or the help feature.

Clock

Note: You cannot manually set the date. Your vehicle's GPS does this for you.

Note: If the battery has been disconnected, your vehicle needs to acquire a GPS signal to update the clock. Once your vehicle acquires the signal, it may take a few minutes for the update to display the correct time.

1. Press the **Settings** icon > **Clock**.
2. Press + and - to adjust the time.

From this screen, you can also make other adjustments, such as 12- or 24-hour mode, activate GPS time synchronization and have the system automatically update for daylight savings time and new time zones.

You can also turn the outside air temperature display on and off. It appears at the top center of the touchscreen, next to the time and date.

The system automatically saves any updates you make to the settings.

Display

You can adjust the touchscreen display through the touchscreen or by pressing the voice button on your steering wheel controls and when prompted, say, "Display settings".



Press the **Settings** icon > **Display**, then select from the following:

Brightness allows you to make the screen display brighter or dimmer.

Mode allows you to set the screen to a certain brightness or have the system automatically change based on the outside light level.

- If you select AUTO or NIGHT, you have the options of turning the display's Auto Dim feature on or off and changing the Auto Dim Manual Offset feature.

Edit Wallpaper

- You can have your touchscreen display the default photo or upload your own.

Uploading Photos for Your Home Screen Wallpaper

Note: You cannot load photos directly from your camera. You must access the photos either from your USB mass storage device or from an SD card.

Note: Photographs with extremely large dimensions (i.e., 2048 x 1536) may not be compatible and appear as a blank (black) image on the display.

Your system allows you to upload and view up to 32 photos.

To access, press the **Settings** icon > **Display** > **Edit Wallpaper**, and then follow the system prompts to upload your photographs.

Only the photograph(s), which meets the following conditions, display:

- Compatible file formats are as follows: .jpg, .gif, .png, .bmp.
- Each file must be 1.5 MB or less.
- Recommended dimensions: 800 x 384.

Sound

Press the **Settings** icon > **Sound**, then select from the following:

Sound Settings	
Bass	DSP*
Midrange	Occupancy Mode*
Treble	Speed Compensated Volume
Set Balance and Fade	

*If equipped.

Vehicle

Press the **Settings** icon > **Vehicle**, then select from the following:

- Active Park Assist
- Vehicle Health Report
- Rear View Camera
- Enable Valet Mode.

Active Park Assist

When activated, your system displays directions for you regarding the active park assist process.

For complete information on this system, see *Active park assist* in the *Driving Aids* chapter.

Vehicle Health Report

Turn Automatic Reminders on and off and set the mileage interval at which you would like to receive the reports. Press the ? for more information on these selections.

When done making your selections, press **Run Vehicle Health Report Now** if you want your report.

Rear View Camera

This menu allows you to access settings for your rear view camera.

Press the **Settings** icon > **Vehicle** > **Rear View Camera**, then select from the following settings:

- Rear Camera Delay
- Visual Park Aid Alert
- Guidelines.

Enable Valet Mode

Note: If the system locks, and you need to reset the PIN, enter 3681 and the system unlocks.

Valet mode allows you to lock the system. No information is accessible until the system is unlocked with the correct PIN.

1. Press the **Settings** icon > **Vehicle** > **Enable Valet Mode**.
2. When prompted, enter a four-digit PIN.

After you press Continue, the system locks until you enter the PIN again.

Settings

Access and adjust system settings, voice features, as well as phone, navigation and wireless settings.

System

Press the **Settings** icon > **Settings** > **System**, then select from the following:

System	
Language	Select to have the touchscreen display in English, Spanish or French.
Distance	Select to display units in kilometers or miles.
Temperature	Select to display units in Celsius or Fahrenheit.
System Prompt Volume	Adjust the volume of voice prompts from the system.
Touch Screen Button Beep	Select to have the system beep to confirm choices made through the touchscreen.
Touch Panel Button Beep	Select to have the system beep to confirm button choices made through the climate or audio system.
Keyboard Layout	Have the touchscreen keyboard display in QWERTY or ABC format.
Install Applications	Install any downloaded applications or view the current software licenses.
Master Reset	Select to restore factory defaults. This erases all personal settings and personal data.

Charge Point Light Ring

Press the **Settings** icon > **Settings** > **Charge Port Light Ring**, then select from the following:

Charge Port Light Ring	
On	Illuminates when plugging in, opening doors, pressing the unlock button on your remote, and while charging.
Off	Does not illuminate.
Limited	Cord Acknowledgement: Illuminates when plugging in.
	Charge Status: Illuminates when opening doors or pressing the unlock button on your remote.

Note: See the *High Voltage Battery* chapter for details on the charge port light ring functions.

Voice Control

Press the **Settings** icon > **Settings** > **Voice Control**, then select from the following:

Voice Control	
Interaction Mode	Standard interaction mode provides more detailed interaction and guidance. Advanced mode has less audible interaction and more tone prompts.
Confirmation Prompts	Have the system ask you short questions if it has not clearly heard or understood your request. Note: Even with confirmation prompts turned off, the system may occasionally ask you to confirm settings.
Media Candidate Lists	Candidate lists are possible results from your voice commands. The system simply makes a best guess at your request with these turned off.

Voice Control	
Phone Candidate Lists	Candidate lists are possible results from your voice commands. The system simply makes a best guess at your request with these turned off.
Voice Control Volume	This allows you to adjust the system's voice volume level.

Media Player

Press the **Settings** icon > **Settings** > **Media Player**, then select from the following:

Media Player	
Autoplay	When this feature is on, the system automatically switches to the media source upon initial connection. This allows you to listen to music during the indexing process. When this feature is off, the system does not automatically switch to the inserted media source.
Bluetooth Devices	Select to connect, disconnect, add or delete a device. You can also set a device as your favorite so that the system automatically attempts to connect to that device at every ignition cycle.
Gracenote® Database Info	This allows you to view the version level of the Gracenote Database.
Gracenote® Mgmt	With this feature on, the Gracenote Database supplies metadata information for your music files. This overrides information from your device. This feature defaults to off.
Cover Art Priority	With this feature on, the Gracenote Database supplied cover art for your music files. This overrides any art from your device. This feature defaults to Media Player.

Navigation

Press the **Settings** icon > **Settings** > **Navigation**, then select from the following:

Navigation	
Map Preferences	Turn breadcrumbs on and off.
	Have the system display your turn list top to bottom or bottom to top.
	Turn the Parking POI notification on and off.
Route Preferences	Have the system display the shortest route, fastest route or ecological route.
	Have the system avoid freeways.
	Have the system avoid tollroads.
	Have the system avoid ferries or car trains.
	Have the system use high-occupancy vehicle lanes.
Navigation Preferences	Have the system use guidance prompts.
	Have the system automatically fill-in State/Province information.
Traffic Preferences	Have the system display areas where roadwork occurs.
	Have the system display incident icons.
	Have the system display areas where difficult driving conditions may occur.
	Have the system display areas where snow and ice on the road may occur.
	Have the system display any smog alerts.
	Have the system display weather warnings.
	Have the system display where there may be reduced visibility.
	Have the system turn on your radio for traffic announcements.
Avoid Areas	Enter specific areas that you would like to avoid on planned navigation routes.

Phone Settings

Press the **Settings** icon > **Settings** > **Phone**, then select from the following:

Phone	
Bluetooth Devices	Connect, disconnect, add or delete a device, as well as save it as a favorite.
Bluetooth	Turn Bluetooth on and off.
Do Not Disturb	Have all calls go directly to your voice mail and not ring inside your vehicle. With this feature turned on, text message notifications are also suppressed and do not ring inside your vehicle.
911 Assist	Turn on or turn off the 911 Assist feature. See <i>911 Assist</i> in the <i>SYNC applications and services</i> section.
Phone Ringer	Select the type of notification for phone calls - ring tone, beep, text to speech, or have it be silent.
Text Message Notification	Select the type of notification for text messages - alert tone, beep, text to speech, or have it be silent.
Internet Data Connection	If compatible with your phone, you can adjust your internet data connection. Select to make your connection profile with the personal area network or to turn off your connection. You can also choose to adjust your settings or have the system always connect, never connect when roaming or query on connect. Press ? for more information.
Manage Phonebook	Access features, such as automatic phonebook download, re-download your phonebook, add contacts from your phone as well as delete or upload your phonebook.
Roaming Warning	Have the system alert you when in Roaming mode.

Wireless & Internet

Your system has a Wi-Fi feature that creates a wireless network within your vehicle, thereby allowing other devices (such as personal computers or phones) in your vehicle to speak to each other, share files or play games. Using this Wi-Fi feature, everyone in your vehicle can also gain access the internet if you have a USB mobile broadband connection inside your vehicle, your phone supports personal area networking and if you park outside a wireless hotspot.



Press the **Settings** icon > **Settings** > **Wireless & Internet**, then select from the following:

Wireless & Internet	
Wi-Fi Settings	Wi-Fi Network (Client) Mode turns the Wi-Fi feature on and off in your vehicle. Make sure you turn it on for connectivity purposes.
	Choose a Wireless Network allows you to use a previously stored wireless network. You can categorize by alphabetical listing, priority and signal strength. You can also choose to search for a network, connect to a network, disconnect from a network, receive more information, prioritize a network or delete a network.
	Gateway (Access Point) Mode makes SYNC an access point for a phone or a computer when turned on. This forms the local area network within your vehicle for things, such as game playing, file transfer and internet browsing. Press ? for more information.
	Gateway (Access Point) Settings allows you to view and change settings for using SYNC as the internet gateway.
	Gateway (Access Point) Device List allows you to view recent connections to your Wi-Fi system.

Wireless & Internet	
USB Mobile Broadband	Instead of using Wi-Fi, your system can also use a USB mobile broadband connection to access the internet. (You must turn on your mobile broadband device on your personal computer before connecting it to the system.) This screen allows you to set up what is your typical area for your USB mobile broadband connection. (USB mobile broadband settings may not display if the device is already on.) You can select the following: Country, Carrier, Phone Number, User Name and Password.
Bluetooth Settings	Shows you the currently paired devices as well as giving you your typical Bluetooth options to connect, disconnect, set as favorite, delete and add device. Bluetooth is a registered trademark of the Bluetooth SIG.
Prioritize Connection Methods	Choose your connection methods and change them as needed. You can select to Change Order and have the system either always attempt to connect using a USB mobile broadband or using Wi-Fi.

The Wi-Fi CERTIFIED Logo is a certification mark of the Wi-Fi Alliance.



Help

Press the **Settings** icon > **Help**, then select from the following:

Help	
Where Am I?	View your vehicle's current location, if your vehicle is equipped with navigation. If your vehicle is not equipped with navigation, nothing displays.
System Information	Touchscreen system serial number.
	Your vehicle identification number (VIN).
	Touchscreen system software version.
	Navigation system version.
	Map database version.
	Sirius satellite radio electronic serial number (ESN).
	Gracenote® Database Information and Library version.
Software Licenses	View the licenses for any software and applications installed on your system.
Driving Restrictions	Certain features are not accessible when your vehicle is moving.
911 Assist	Turn on and turn off the 911 Assist feature. See <i>911 Assist</i> in the <i>SYNC applications and services</i> section. In Case of Emergency (ICE) Speed Dial allows you to save up to two numbers as ICE contacts for quick access if there is an emergency. Select Edit to access your phonebook and then select the desired contacts. The numbers then appear as options on this screen for the ICE 1 and ICE 2 buttons. The ICE contacts you select appear at the end of the 911 Assist call process.
Voice Command List	View categorized lists of voice commands.

To access Help using the voice commands, press the voice button, then, after the tone, say "Help". The system provides allowable voice commands for the current mode.

CLIMATE

Press the lower right corner on the touchscreen to access your climate control features. Depending on your vehicle line and option package, your climate screen may look different from the screen shown here.

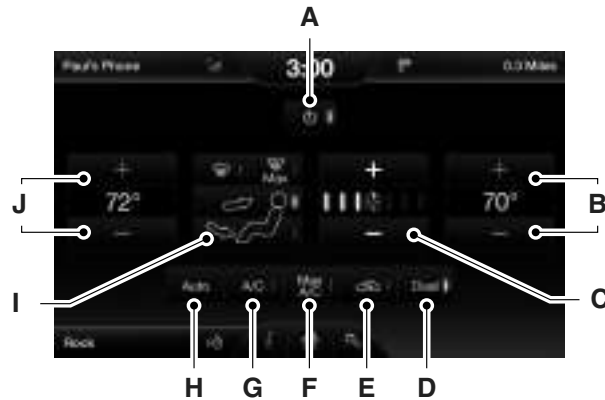

- A. **Power:** Touch to switch the system off and on. Outside air cannot enter your vehicle when you switch off the system.
- B. **Passenger settings:** Touch + or – to adjust the temperature.
- C. **Fan speed:** Touch + or – to adjust fan speed.
- D. **DUAL:** Touch to switch on the passenger temperature control.
- E. **Recirculated air:** Touch to turn the recirculated air on or off which:
- May reduce the amount of time needed to cool down the interior.
 - May help reduce odors from reaching the interior.
 - Engages automatically when MAX A/C or MAX defrost is selected.
 - May be engaged manually in any airflow mode except defrost.
 - May turn off in all airflow modes except MAX A/C and MAX defrost to reduce fog potential.
- F. **MAX A/C:** Touch to cool your vehicle with recirculated air. Touch again for normal A/C operation. MAX A/C:
- Distributes air through instrument panel vents.
 - Is more economical and efficient than normal A/C mode.
 - May help reduce odors from entering your vehicle.

- G. **A/C:** Touch to turn the air conditioning on or off.
- Use with recirculated air to improve cooling performance and efficiency.
 - Engages automatically in MAX A/C, defrost and floor/defrost.
- H. **AUTO:** Touch to engage automatic operation, then set the temperature using the temperature control. The system automatically controls:
- Fan speed
 - Airflow distribution
 - A/C on or off
 - Outside or recirculated air.
- I. **Manual controls:** Select any of the following airflow distribution modes:
- **Floor and Defrost:** Distributes air through the windshield defroster vents, demister vents, floor vents and rear seat floor vents, and provides outside air to reduce window fogging.
 - **Panel:** Distributes air through the instrument panel vents.
 - **Panel and Floor:** Distributes air through the instrument panel vents, demister vents, floor vents and rear seat floor vents.
 - **Floor:** Distributes air through the demister vents, floor vents and rear seat floor vents.
 - **MAX Defrost:** Distributes outside air through the windshield air vents and automatically switches the air conditioning on. The fan is set to the highest speed and the temperature to HI. When the air distribution is set in this position, you are unable to select recirculated air or manually adjust the fan speed and temperature control.
 - **Defrost:** Touch to clear the windshield of fog and thin ice. Touch again to return to the previous airflow selection. When on, defrost provides outside air to reduce window fogging and distributes air through the windshield defroster vents and demister vents.
- J. **Driver settings:** Touch + or – to adjust the temperature.

Climate Control Voice Commands

The following voice commands are available at the main menu level of a voice session. For example, press the voice button and after the prompt, “Say a command”; say any of the following commands:

Climate control voice commands
“Climate automatic”
“Climate off”
“Climate on”
“Climate temperature <15.5–29.5> degrees”
“Climate temperature <60–85> degrees”
“Help”

There are additional climate control commands but in order to access them, you have to say “Climate” first, then when the system is ready to listen, you may say any of the following commands:

Additional climate control voice commands	
“Automatic”	“Panel floor on”
“A/C off”	“Panel off”
“A/C on”	“Panel on”
“Defrost off”	“Rear defrost off”
“Defrost on”	“Rear defrost on”
“Dual off”	“Recirc off”
“Fan decrease”	“Recirc on”
“Fan increase”	“Temperature”*
“Floor off”	“Temperature <15.5–29.5> degrees”
“Floor on”	“Temperature <60–85> degrees”
“Max A/C off”	“Temperature decrease”
“Max A/C on”	“Temperature high on”
“Maximum fan”	“Temperature increase”
“Maximum windshield off”	“Temperature low on”

Additional climate control voice commands	
“Maximum windshield on”	“Windshield floor on”
“Minimum fan”	“Windshield panel floor on”
“Off”	“Windshield panel on”
“On”	“Help”

*If you have said “Temperature”, you can say any of the commands in the following “Temperature” chart.

“TEMPERATURE”
“<15.5–29.5> degrees”
“<60–85> degrees”
“High”
“Low”
“Help”

NAVIGATION SYSTEM (IF EQUIPPED)

Note: The navigation SD card must be in the SD card slot to operate the navigation system. If you need a replacement SD card, see your authorized dealer.

Note: The SD card slot is spring-loaded. To remove the SD card, just push the card in and release it. Do not attempt to pull the card out to remove it; this could cause damage.

Your navigation system is comprised of two main features, destination mode and map mode.

To set a destination, press the green corner of your touchscreen, then **Dest** when it appears. See *Setting a destination* later in this chapter.

To view the navigation map and your vehicle’s current location, touch the green bar in the upper right hand corner of the touchscreen, or, press **Dest > Map**. See *Map mode* later in this chapter.

Setting a Destination

Press the green corner of your touchscreen, then **Dest** when it appears. Choose any of the following:

Destination Selections	
My Home	Street Address
Favorites	Intersection
Previous Destinations	City Center
Point of Interest	Map
Emergency	Edit Route Cancel Route
Previous Starting Point	Freeway Entrance/Exit
Latitude/Longitude	

1. Enter the necessary information into the highlighted text fields (in any order). For address destination entry, **Go!** appears once all the necessary information has been entered. Pressing **Go!** makes the address location appear on the map. If you choose **Previous Destination**, the last 20 destinations you have selected appear.
2. Select **Set as Dest** to make this your destination. You can also choose to set this as a waypoint (have the system route to this point on the way to your current destination) or save it as a favorite. The system considers any **Avoid Areas** selections in its route calculation.
3. Choose from up to three different types of routes, and then select **Start Route**.
 - **Fastest Route:** Uses the fastest moving roads possible.
 - **Shortest Route:** Uses the shortest distance possible.
 - **Eco Route:** Uses the most fuel-efficient route.

You can cancel the route or have the system demo the route for you. Select **Route Prefs** to set route preferences like avoiding freeways, tollroads, ferries and car trains as well as to use or not use high-occupancy vehicle lanes. (High-occupancy vehicle lanes also known as carpool or diamond lanes. People who ride in buses, vanpools or carpools use these lanes.)

Note: If your vehicle is on a recognized road and you do not press the **Start Route** button, the system defaults to the **Fastest Route** option and begins guidance.

During route guidance, you can press the talking bubble icon that appears in the upper right navigation corner (green bar) if you want the system to repeat route guidance information. When the system repeats the last guidance instruction, it updates the distance to the next guidance instruction, since it detects when the vehicle is moving.

Point of Interest (POI) Categories

Your system offers a variety of points of interest categories.

Main Categories	
Food/Drink & Dining	Automotive
Travel & Transportation	Shopping
Financial	Entertainment & Arts
Emergency	Recreation & Sports
Community	Government
Health & Medicine	Domestic Services

Within these main categories, there are subcategories which contain more listings:

Subcategories
Restaurant
Golf
Parking
Home & Garden
Personal Care Services
Automobile Dealership
Government Office
Public Transit
Education

To expand these listings, press the + in front of the point of interest listing.

When programming a point of interest destination, the system allows you to sort the resulting lists alphabetically, by distance or by cityseekr listings (if available).

Range Rings and Charge Points (Energi Only)

Shaded rings appear on the map when you are driving in EV Now mode. The inner ring with no shading indicates a safe range you can travel using plug-in power only. The lightly shaded outer ring reflects a range where your vehicle may or may not be able while driving in EV NOW mode. If your destination is within this band, your vehicle may operate in Auto EV mode, running the engine as needed. The darker shaded area, beyond the rings, represents distances your vehicle most likely does not have enough energy to reach using the available plug-in energy.

The rings represent approximate ranges. Actual route distances, road grades, vehicle speed, accessory usage and other conditions affect how far your vehicle can travel in EV Now mode before recharging.

You can turn off the rings in the Settings menu. Press the Settings icon, Navigation, then Map Preferences.

You can turn the charge point POIs on and off. Touch the map, use the buttons at the bottom of the screen, and then select the POI icon button. The icons only appear at a map scale of 5 miles (8 km) and lower.

cityseekr (If Available)

Note: cityseekr point of interest information is limited to approximately 154 cities (132 in the U.S., 13 in Canada and 9 in Mexico).



cityseekr, when available, is a service that provides more information about certain points of interest such as restaurants, hotels and attractions.

When you have selected a point of interest, the location and information appear, such as address and phone number. If cityseekr lists the point

of interest, more information is available, such as a brief description, hotel check-in and checkout times or restaurant hours.

Press **More Information** for a longer review, a list of services and facilities, the average room or meal price as well as the website link.

This screen displays point of interest icons, such as:



Hotel



Coffeehouse



Food & Drink



Nightlife













Attraction



This icon appears when your selection exists in multiple categories within the system.

When you are viewing more information for hotels, cityseekr also tells you if the hotel has certain services and facilities using icons.

Hotel Services and Facilities	
 Restaurant	 24 Hr Room Service
 Business Center	 Fitness Center
 Handicap Facilities	 Internet Access
 Laundry	 Pool
 Refrigerator	 Wi-Fi

For restaurants, cityseekr can provide information, such as star rating, average cost, review, handicap access, hours of operation, and website address.

For hotels, cityseekr can provide information, such as star rating, price category, review, check-in and check-out times, hotel service icons and website address.

Setting Your Navigation Preferences

Select settings for the system to take into account when planning your route.



Press the **Settings** icon > **Settings** > **Navigation**.

When you select:	You can:
Map Preferences	Turn breadcrumbs on and off.
	Have the system display your turn list top to bottom or bottom to top.
	Set the automatic parking points of interest notification. When parking points of interest notification is on, the icons display on the map when you get close to your destination. (This may not be very useful in dense areas, and may clutter the map when other points of interest display.)
Route Preferences	Choose to have the system display the shortest route, fastest route or most ecological route.
	Avoid freeways, toll roads, ferries and car trains when planning your route.
	Use high-occupancy vehicle lanes (if available).
Navigation Preferences	Choose prompts to be either voice or tone only.
	Have the system automatically fill in the state and province based on the information already entered into the system.
Traffic Preferences	Choose how you want the system to handle traffic problems along your route. Automatic: Have the system reroute you to avoid traffic incidents that develop and impact the current route (no notification is provided). Manual: Have the system always provide a traffic alert notification for traffic incidents along the planned route. You have a choice to accept or ignore the notification before making the route deviation.
	Turn on certain, or all, traffic icons on the map (such as road work, incident, accidents and closed roads).

When you select:	You can:
Avoid Areas	Choose areas which you want the system to avoid when calculating a route for you. Press Add to select a category. Once you select, the system tries to avoid the area(s) if possible for all routes. To delete a selection, choose the listing on the screen. When the screen changes to Avoid Areas Edit , you can press Delete at the bottom right of the screen.

Map Mode

Press the green bar in the upper right area of the touchscreen to view map mode. Map mode shows advanced viewing comprised of both 2D city maps as well as 3D landmarks (when available).

2D city maps show detailed outlines of buildings, visible land use and land elements and detailed railway infrastructure for the most essential cities around the globe. These maps also contain features, such as town blocks, building footprints, and railways.

3D landmarks appear as clear, visible objects that are typically recognizable and have a certain tourist value. The 3D landmarks appear in 3D map mode only. Coverage varies, and improves with updated map releases.



Change the appearance of the map display by repeatedly pressing the arrow button in the upper left corner of the screen. It toggles between three different map modes: Heading up, North up, and 3D.



Heading up (2D map) always shows the direction of forward travel to be upward on the screen. This view is available for map scales up to 2.5 miles (4 kilometers). The system remembers this setting for larger map scales, but shows the map in North up only.

If the scale returns below this level, the system restores Heading up.



North up (2D map) always shows the northern direction to be upward on the screen.



3D map mode provides an elevated perspective of the map. This viewing angle can be adjusted and the map can be rotated 180 degrees by dragging your finger along the shaded bar with arrows at the bottom of the map.



Re-center the map by pressing this icon whenever you scroll the map away from your vehicle's current location.

Auto Zoom

Press the green bar to access map mode, then select the + or - zoom button to bring up the zoom level and Auto buttons on the touchscreen. When you press **Auto**, Auto Zoom turns on and **Auto** displays in the bottom left corner of the screen in the map scale. The map zoom level then synchronizes with vehicle speed. The slower your vehicle is traveling, the farther in the map zooms; the faster your vehicle is traveling, the farther the map zooms out. To turn the feature off, just press the + or - button again.

In 3D mode, rotate the map view by swiping your finger across the shaded bar with the arrows.

Map Icons

Vehicle mark shows the current location of your vehicle. It stays in the center of the map display, except when in scroll mode.



Scroll cursor allows you to scroll the map; the fixed icon is in the center of the screen. The map position closest to the cursor is in a window on the top center part of the screen.



Address book entry default icon(s) indicates the location on the map of an address book entry. This is the default symbol shown after the entry has been stored to the Address Book by any method other than the map. You can select from any of the 22 icons available. You can use each icon more than once.



Home indicates the location on the map currently stored as the home position. You can only save one address from the Address Book as your Home entry. You cannot change this icon.



POI (Point Of Interest) icons indicate locations of any point of interest categories you choose to display on the map. You can choose to display about 56 point of interest subcategories on the map at one time.



Starting point indicates the starting point of a planned route.



Waypoints indicates the location of a waypoint on the map. The number inside the circle is different for each waypoint and represents the position of the waypoint in the route list.



Destination symbol indicates the ending point of a planned route.



Next maneuver point indicates the location of the next turn on the planned route.



No GPS symbol indicates that insufficient GPS satellite signals are available for accurate map positioning. This icon may display under normal operation in an area with poor GPS access.

Quick-touch Buttons

When in map mode, touch anywhere on the map display to access the following options:

When you select:	You can:
Set as Dest	Select a scrolled location on the map as your destination. (You may scroll the map by pressing your index finger on the map display. When you reach the desired location, simply let go and then touch Set as Dest.)
Set as Waypoint	Set the current location as a waypoint.
Save to Favorites	Save the current location to your favorites.
POI Icons On/Off	Select icons to display on the map. You can select up to three icons to display on the map at the same time.
Cancel Route	Cancel the active route.
View/Edit Route	Access these features when a route is active: <ul style="list-style-type: none"> • View route • Edit destination/waypoints • Edit turn list • Detour • Edit route preferences • Edit traffic preferences • Cancel route.

Navteq is the digital map provider for the navigation application. If you find map data errors, you may report them directly to Navteq by going to <http://mapreporter.navteq.com>. Navteq evaluates all reported map errors and responds with the result of their investigation by e-mail.

Navigation Map Updates

Annual navigation map updates are available for purchase through your dealership, by calling 1-800-NAVMAPS (in Mexico, call 01-800-557-5539) or going to www.navigation.com/ford. You need to specify the make and model of your vehicle to determine if there is an update available.

Navigation Voice Commands

When in navigation mode, press the voice button on the steering wheel control. After the tone, say any of the following commands:

Navigation System Voice Commands	
“Cancel next waypoint” ¹	“Navigation” ³
“Cancel route” ¹	“Repeat instruction” ¹
“Destination” ²	“Show 3D”
“Destination <nametag>”	“Show heading up”
“Destination <POI category>”	“Show map”
“Destination favorites”	“Show north up”
“Destination home”	“Show route” ¹
“Destination intersection”	“Show turn list” ¹
“Destination nearest <POI category>”	“Voice guidance off”
“Destination nearest POI”	“Voice guidance on”
“Destination play nametags”	“Voice volume decrease”
“Destination POI”	“Voice volume increase”
“Destination POI category”	“Where am I?”
“Destination previous destination”	“Zoom in”
“Destination street address”	“Zoom out”
“Detour” ¹	“Help”

¹These commands are only available when a navigation route is active.

²If you have said the command, “Destination”, you may say any of the above commands or commands in the following Destination chart.

³If you have said the command, “Navigation”, you may say any of the above commands or commands in the following Navigation chart.

“DESTINATION”
“<nametag>”
“<POI category>”
“Favorites”
“Home”
“Intersection”
“Nearest <POI category>”
“Nearest POI”
“Play nametags”
“POI category”
“Previous destination”
“Street address”
“Help”
“NAVIGATION”
“Destination”*
“Zoom city”
“Zoom country”
“Zoom in minimum”
“Zoom out maximum”
“Zoom province”
“Zoom state”
“Zoom street”
“Zoom to <distance>”
“Help”

*If you have said, “Destination”, you may say any of the commands in the Destination chart.

One-shot Destination Street Address

If your vehicle is equipped with the SD card navigation feature, you have the ability to enter in a street address using a feature called one-shot destination street address. When you say either “Navigation destination street address” or “Destination street address”, the system asks you to say the full address. The system displays an example on-screen. You can then speak the address naturally, such as “One two three four Main Street, Anytown”.

GENERAL INFORMATION**SYNC® End User License Agreement (EULA)**

- You have acquired a device (“DEVICE”) that includes software licensed by Ford Motor Company and its affiliates (“FORD MOTOR COMPANY”) from an affiliate of Microsoft Corporation (“MS”). Those installed software products of MS origin, as well as associated media, printed materials, and “online” or electronic documentation (“MS SOFTWARE”) are protected by international intellectual property laws and treaties. The MS SOFTWARE is licensed, not sold. All rights reserved.
- The MS SOFTWARE may interface with and/or communicate with, or may be later upgraded to interface with and/or communicate with additional software and/or systems provided by FORD MOTOR COMPANY. The additional software and systems of FORD MOTOR COMPANY origin, as well as associated media, printed materials, and “online” or electronic documentation (“FORD SOFTWARE”) are protected by international intellectual property laws and treaties. The FORD SOFTWARE is licensed, not sold. All rights reserved.
- The MS SOFTWARE and/or FORD SOFTWARE may interface with and/or communicate with, or may be later upgraded to interface with and/or communicate with additional software and/or systems provided by third party software and service suppliers. The additional software and services of third party origin, as well as associated media, printed materials, and “online” or electronic documentation (“THIRD PARTY SOFTWARE”) are protected by international intellectual property laws and treaties. The THIRD PARTY SOFTWARE is licensed, not sold. All rights reserved.
- The MS SOFTWARE, FORD SOFTWARE and THIRD PARTY SOFTWARE hereinafter collectively and individually will be referred to as “SOFTWARE.”

IF YOU DO NOT AGREE TO THIS END USER LICENSE AGREEMENT (“EULA”), DO NOT USE THE DEVICE OR COPY THE SOFTWARE. ANY USE OF THE SOFTWARE, INCLUDING BUT NOT LIMITED TO USE ON THE DEVICE, WILL CONSTITUTE YOUR AGREEMENT TO THIS EULA (OR RATIFICATION OF ANY PREVIOUS CONSENT).

GRANT OF SOFTWARE LICENSE: This EULA grants you the following license:

- You may use the SOFTWARE as installed on the DEVICE and as otherwise interfacing with systems and/or services provide by or through FORD MOTOR COMPANY or its third party software and service providers.

DESCRIPTION OF OTHER RIGHTS AND LIMITATIONS:

- **Speech Recognition:** If the SOFTWARE includes speech recognition component(s), you should understand that speech recognition is an inherently statistical process and that recognition errors are inherent in the process. Neither FORD MOTOR COMPANY nor its suppliers shall be liable for any damages arising out of errors in the speech recognition process.
- **Limitations on Reverse Engineering, Decompilation and Disassembly:** You may not reverse engineer, decompile, or disassemble nor permit others to reverse engineer, decompile or disassemble the SOFTWARE, except and only to the extent that such activity is expressly permitted by applicable law notwithstanding this limitation.
- **Limitations on Distributing, Copying, Modifying and Creating Derivative Works:** You may not distribute, copy, make modifications to or create derivative works based on the SOFTWARE, except and only to the extent that such activity is expressly permitted by applicable law notwithstanding this limitation.
- **Single EULA:** The end user documentation for the DEVICE and related systems and services may contain multiple EULAs, such as multiple translations and/or multiple media versions (e.g., in the user documentation and in the software). Even if you receive multiple EULAs, you are licensed to use only one (1) copy of the SOFTWARE.
- **SOFTWARE Transfer:** You may permanently transfer your rights under this EULA only as part of a sale or transfer of the DEVICE, provided you retain no copies, you transfer all of the SOFTWARE (including all component parts, the media and printed materials, any upgrades, and, if applicable, the Certificate(s) of Authenticity), and the recipient agrees to the terms of this EULA. If the SOFTWARE is an upgrade, any transfer must include all prior versions of the SOFTWARE.
- **Termination:** Without prejudice to any other rights, FORD MOTOR COMPANY or MS may terminate this EULA if you fail to comply with the terms and conditions of this EULA.

- **Security Updates/Digital Rights Management:** Content owners use the WMDRM technology included in your DEVICE to protect their intellectual property, included copyrighted content. Portions of the SOFTWARE on your DEVICE use WMDRM software to access WMDRM-protected content. If the WMDRM software fails to protect the content, content owners may ask Microsoft to revoke the SOFTWARE's ability to use WMDRM to play or copy protected content. This action does not affect unprotected content. When your DEVICE downloads licenses for protected content, you agree that Microsoft may include a revocation list with the licenses. Content owners may require you to upgrade the SOFTWARE on your DEVICE to access their content. If you decline an upgrade, you will not be able to access content that requires the upgrade.
- **Consent to Use of Data:** You agree that MS, Microsoft Corporation, FORD MOTOR COMPANY, third party software and systems suppliers, their affiliates and/or their designated agent may collect and use technical information gathered in any manner as part of product support services related to the SOFTWARE or related services. MS, Microsoft Corporation, FORD MOTOR COMPANY, third party software and services suppliers, their affiliates and/or their designated agent may use this information solely to improve their products or to provide customized services or technologies to you. MS, Microsoft Corporation, FORD MOTOR COMPANY, third party software and systems suppliers, their affiliates and/or their designated agent may disclose this information to others, but not in a form that personally identifies you.
- **Internet-Based Services Components:** The SOFTWARE may contain components that enable and facilitate the use of certain Internet-based services. You acknowledge and agree that MS, Microsoft Corporation, FORD MOTOR COMPANY, third party software and service suppliers, their affiliates and/or their designated agent may automatically check the version of the SOFTWARE and/or its components that you are utilizing and may provide upgrades or supplements to the SOFTWARE that may be automatically downloaded to your DEVICE.
- **Additional Software/Services:** The SOFTWARE may permit FORD MOTOR COMPANY, third party software and service suppliers, MS, Microsoft Corporation, their affiliates and/or their designated agent to provide or make available to you SOFTWARE updates, supplements, add-on components, or Internet-based services components of the SOFTWARE after the date you obtain your initial copy of the SOFTWARE ("Supplemental Components").

If FORD MOTOR COMPANY or third party software and services suppliers provide or make available to you Supplemental Components and no other EULA terms are provided along with the Supplemental Components, then the terms of this EULA shall apply.

If MS, Microsoft Corporation, their affiliates and/or their designated agent make available Supplemental Components, and no other EULA terms are provided, then the terms of this EULA shall apply, except that the MS, Microsoft Corporation or affiliate entity providing the Supplemental Component(s) shall be the licensor of the Supplemental Component(s).

FORD MOTOR COMPANY, MS, Microsoft Corporation, their affiliates and/or their designated agent reserve the right to discontinue without liability any Internet-based services provided to you or made available to you through the use of the SOFTWARE.

- **Links to Third Party Sites:** The MS SOFTWARE may provide you with the ability to link to third party sites through the use of the SOFTWARE. The third party sites are not under the control of MS, Microsoft Corporation, their affiliates and/or their designated agent. Neither MS nor Microsoft Corporation nor their affiliates nor their designated agent are responsible for (i) the contents of any third party sites, any links contained in third party sites, or any changes or updates to third party sites, or (ii) webcasting or any other form of transmission received from any third party sites. If the SOFTWARE provides links to third party sites, those links are provided to you only as a convenience, and the inclusion of any link does not imply an endorsement of the third party site by MS, Microsoft Corporation, their affiliates and/or their designated agent.
- **Obligation to Drive Responsibly:** You recognize your obligation to drive responsibly and keep attention on the road. You will read and abide with the DEVICE operating instructions particularly as they pertain to safety and assumes any risk associated with the use of the DEVICE.

UPGRADES AND RECOVERY MEDIA: If the SOFTWARE is provided by FORD MOTOR COMPANY separate from the DEVICE on media such as a ROM chip, CD ROM disk(s) or via web download or other means, and is labeled "For Upgrade Purposes Only" or "For Recovery Purposes Only" you may install one (1) copy of such SOFTWARE onto the DEVICE as a replacement copy for the existing SOFTWARE, and use it in accordance with this EULA, including any additional EULA terms accompanying the upgrade SOFTWARE.

INTELLECTUAL PROPERTY RIGHTS: All title and intellectual property rights in and to the SOFTWARE (including but not limited to any images, photographs, animations, video, audio, music, text and “applets,” incorporated into the SOFTWARE), the accompanying printed materials, and any copies of the SOFTWARE, are owned by MS, Microsoft Corporation, FORD MOTOR COMPANY, or their affiliates or suppliers. The SOFTWARE is licensed, not sold. You may not copy the printed materials accompanying the SOFTWARE. All title and intellectual property rights in and to the content which may be accessed through use of the SOFTWARE is the property of the respective content owner and may be protected by applicable copyright or other intellectual property laws and treaties. This EULA grants you no rights to use such content. All rights not specifically granted under this EULA are reserved by MS, Microsoft Corporation, FORD MOTOR COMPANY, third party software and service providers, their affiliates and suppliers. Use of any on-line services which may be accessed through the SOFTWARE may be governed by the respective terms of use relating to such services. If this SOFTWARE contains documentation that is provided only in electronic form, you may print one copy of such electronic documentation.

EXPORT RESTRICTIONS: You acknowledge that the SOFTWARE is subject to U.S. and European Union export jurisdiction. You agree to comply with all applicable international and national laws that apply to the SOFTWARE, including the U.S. Export Administration Regulations, as well as end-user, end-use and destination restrictions issued by U.S. and other governments. For additional information, see <http://www.microsoft.com/exporting/>.

TRADEMARKS: This EULA does not grant you any rights in connection with any trademarks or service marks of FORD MOTOR COMPANY, MS, Microsoft Corporation, third party software or service providers, their affiliates or suppliers.

PRODUCT SUPPORT: Product support for the SOFTWARE is not provided by MS, its parent corporation Microsoft Corporation, or their affiliates or subsidiaries. For product support, please refer to FORD MOTOR COMPANY instructions provided in the documentation for the DEVICE. Should you have any questions concerning this EULA, or if you desire to contact FORD MOTOR COMPANY for any other reason, please refer to the address provided in the documentation for the DEVICE.

No Liability for Certain Damages: EXCEPT AS PROHIBITED BY LAW, FORD MOTOR COMPANY, ANY THIRD PARTY SOFTWARE OR SERVICES SUPPLIERS, MS, MICROSOFT CORPORATION AND THEIR AFFILIATES SHALL HAVE NO LIABILITY FOR ANY INDIRECT, SPECIAL, CONSEQUENTIAL OR INCIDENTAL DAMAGES ARISING FROM OR IN CONNECTION WITH THE USE OR PERFORMANCE OF THE SOFTWARE. THIS LIMITATION SHALL APPLY EVEN IF ANY REMEDY FAILS OF ITS ESSENTIAL PURPOSE. IN NO EVENT SHALL MS, MICROSOFT CORPORATION AND/OR THEIR AFFILIATES BE LIABLE FOR ANY AMOUNT IN EXCESS OF U.S. TWO HUNDRED FIFTY DOLLARS (U.S.\$250.00).

- THERE ARE NO WARRANTIES OTHER THAN THOSE THAT MAY EXPRESSLY BE PROVIDED FOR YOUR NEW VEHICLE.

Adobe

Contains Adobe® [Flash® Player] or [AIR®] technology by Adobe Systems Incorporated. This [Licensee Product] contains [Adobe® Flash® Player] [Adobe® AIR®] software under license from Adobe Systems Incorporated, Copyright © 1995-2009 Adobe Macromedia Software LLC. All rights reserved. Adobe, Flash and AIR are trademarks of Adobe Systems Incorporated.

End user notice**Microsoft® Windows® Mobile for Automotive Important Safety Information**

This system Ford SYNC™ contains software that is licensed to Manufacturer FORD MOTOR COMPANY by an affiliate of Microsoft Corporation pursuant to a license agreement. Any removal, reproduction, reverse engineering or other unauthorized use of the software from this system in violation of the license agreement is strictly prohibited and may subject you to legal action.

Read and follow instructions

Before using your Windows Automotive-based system, read and follow all instructions and safety information provided in this end user manual (“User’s Guide”). Not following precautions found in this User’s Guide can lead to an accident or other serious consequences.

Keep User's Guide in Vehicle

When kept in the vehicle, the User's Guide will be a ready reference for you and other users unfamiliar with the Windows Automotive-based system. Please make certain that before using the system for the first time, all persons have access to the User's Guide and read its instructions and safety information carefully.



WARNING: Operating certain parts of this system while driving can distract your attention away from the road, and possibly cause an accident or other serious consequences. Do not change system settings or enter data non-verbally (using your hands) while driving. Stop the vehicle in a safe and legal manner before attempting these operations. This is important since while setting up or changing some functions you might be required to distract your attention away from the road and remove your hands from the wheel.

General operation**Voice Command Control**

Functions within the Windows Automotive-based system may be accomplished using only voice commands. Using voice commands while driving allows you to operate the system without removing your hands from the wheel.

Prolonged Views of Screen

Do not access any function requiring a prolonged view of the screen while you are driving. Pull over in a safe and legal manner before attempting to access a function of the system requiring prolonged attention. Even occasional short scans to the screen may be hazardous if your attention has been diverted away from your driving task at a critical time.

Volume Setting

Do not raise the volume excessively. Keep the volume at a level where you can still hear outside traffic and emergency signals while driving. Driving while unable to hear these sounds could cause an accident.

Use of Speech Recognition Functions

Speech recognition software is inherently a statistical process which is subject to errors. It is your responsibility to monitor any speech recognition functions included in the system and address any errors.

Navigation Features

Any navigation features included in the system are intended to provide turn by turn instructions to get you to a desired destination. Please make certain all persons using this system carefully read and follow instructions and safety information fully.

Distraction Hazard

Any navigation features may require manual (non-verbal) setup. Attempting to perform such set-up or insert data while driving can seriously distract your attention and could cause an accident or other serious consequences. Stop the vehicle in a safe and legal manner before attempting these operations.

Let Your Judgment Prevail

Any navigation features are provided only as an aid. Make your driving decisions based on your observations of local conditions and existing traffic regulations. Any such feature is not a substitute for your personal judgment. Any route suggestions made by this system should never replace any local traffic regulations or your personal judgment or knowledge of safe driving practices.

Route Safety

Do not follow the route suggestions if doing so would result in an unsafe or illegal maneuver, if you would be placed in an unsafe situation, or if you would be directed into an area that you consider unsafe. The driver is ultimately responsible for the safe operation of the vehicle and therefore, must evaluate whether it is safe to follow the suggested directions.

Potential Map Inaccuracy

Maps used by this system may be inaccurate because of changes in roads, traffic controls or driving conditions. Always use good judgment and common sense when following the suggested routes.

Emergency Services

Do not rely on any navigation features included in the system to route you to emergency services. Ask local authorities or an emergency services operator for these locations. Not all emergency services such as police, fire stations, hospitals and clinics are likely to be contained in the map database for such navigation features.

TeleNav Software End User License Agreement

Please read these terms and conditions carefully before you use the TeleNav Software. Your use of the TeleNav Software indicates that you accept these terms and conditions. If you do not accept these terms and conditions, do not break the seal of the package, launch, or otherwise use the TeleNav Software.

TeleNav may revise this Agreement and the privacy policy at any time, with or without notice to you. You agree to visit <http://www.telenav.com> from time to time to review the then current version of this Agreement and of the privacy policy.

1. Safe and Lawful Use

You acknowledge that devoting attention to the TeleNav Software may pose a risk of injury or death to you and others in situations that otherwise require your undivided attention, and you therefore agree to comply with the following when using the TeleNav Software: (a) observe all traffic laws and otherwise drive safely; (b) use your own personal judgment while driving. If you feel that a route suggested by the TeleNav Software instructs you to perform an unsafe or illegal maneuver, places you in an unsafe situation, or directs you into an area that you consider to be unsafe, do not follow such instructions; (c) do not input destinations, or otherwise manipulate the TeleNav Software, unless your vehicle is stationary and parked; (d) do not use the TeleNav Software for any illegal, unauthorized, unintended, unsafe, hazardous, or unlawful purposes, or in any manner inconsistent with this Agreement; (e) arrange all GPS and wireless devices and cables necessary for use of the TeleNav Software in a secure manner in your vehicle so that they will not interfere with your driving and will not prevent the operation of any safety device (such as an airbag).

You agree to indemnify and hold TeleNav harmless against all claims resulting from any dangerous or otherwise inappropriate use of the TeleNav Software in any moving vehicle, including as a result of your failure to comply with the directions above.

2. Account Information

You agree: (a) when registering the TeleNav Software, to provide TeleNav with true, accurate, current, and complete information about yourself, and (b) to inform TeleNav promptly of any changes to such information, and to keep it true, accurate, current and complete.

3. Software License

Subject to your compliance with the terms of this Agreement, TeleNav hereby grants to you a personal, non-exclusive, non-transferable license (except as expressly permitted below in connection with your permanent transfer of the TeleNav Software license), without the right to sublicense, to use the TeleNav Software (in object code form only) in order to access and use the TeleNav Software. This license shall terminate upon any termination or expiration of this Agreement. You agree that you will use the TeleNav Software only for your personal business or leisure purposes, and not to provide commercial navigation services to other parties.

3.1 License limitations

You agree not to do any of the following: (a) reverse engineer, decompile, disassemble, translate, modify, alter or otherwise change the TeleNav Software or any part thereof; (b) attempt to derive the source code, audio library or structure of the TeleNav Software without the prior express written consent of TeleNav; (c) remove from the TeleNav Software, or alter, any of TeleNav's or its suppliers' trademarks, trade names, logos, patent or copyright notices, or other notices or markings; (d) distribute, sublicense or otherwise transfer the TeleNav Software to others, except as part of your permanent transfer of the TeleNav Software; or (e) use the TeleNav Software in any manner that (i) infringes the intellectual property or proprietary rights, rights of publicity or privacy or other rights of any party, (ii) violates any law, statute, ordinance or regulation, including but not limited to laws and regulations related to spamming, privacy, consumer and child protection, obscenity or defamation, or (iii) is harmful, threatening, abusive, harassing, tortuous, defamatory, vulgar, obscene, libelous, or otherwise objectionable; and (f) lease, rent out, or otherwise permit unauthorized access by third parties to the TeleNav Software without advanced written permission of TeleNav.

4. Disclaimers

To the fullest extent permissible pursuant to applicable law, in no event will TeleNav, its licensors and suppliers, or agents or employees of any of the foregoing, be liable for any decision made or action taken by you or anyone else in reliance on the information provided by the TeleNav Software. TeleNav also does not warrant the accuracy of the map or other data used for the TeleNav Software. Such data may not always reflect reality due to, among other things, road closures, construction, weather, new roads and other changing conditions. You are responsible for the entire risk arising out of your use of the TeleNav Software. For example but without limitation, you agree not to rely on the TeleNav Software for critical navigation in areas where the well-being or survival of you or others is dependent on the accuracy of navigation, as the maps or functionality of the TeleNav Software are not intended to support such high risk applications, especially in more remote geographical areas. TELENAV EXPRESSLY DISCLAIMS AND EXCLUDES ALL WARRANTIES IN CONNECTION WITH THE TELENAV SOFTWARE, WHETHER STATUTORY, EXPRESS OR IMPLIED, INCLUDING ALL WARRANTIES WHICH MAY ARISE FROM COURSE OF DEALING, CUSTOM OR TRADE AND INCLUDING, BUT NOT LIMITED TO, THE IMPLIED WARRANTIES OF MERCHANTABILITY, FITNESS FOR A PARTICULAR PURPOSE AND NON-INFRINGEMENT OF THIRD PARTY RIGHTS WITH RESPECT TO THE TELENAV SOFTWARE. Certain jurisdictions do not permit the disclaimer of certain warranties, so this limitation may not apply to you.

5. Limitation of Liability

TO THE EXTENT PERMITTED UNDER APPLICABLE LAW, UNDER NO CIRCUMSTANCES SHALL TELENAV OR ITS LICENSORS AND SUPPLIERS BE LIABLE TO YOU OR TO ANY THIRD PARTY FOR ANY INDIRECT, INCIDENTAL, CONSEQUENTIAL, SPECIAL OR EXEMPLARY DAMAGES (INCLUDING IN EACH CASE, BUT NOT LIMITED TO, DAMAGES FOR THE INABILITY TO USE THE EQUIPMENT OR ACCESS DATA, LOSS OF DATA, LOSS OF BUSINESS, LOSS OF PROFITS, BUSINESS INTERRUPTION OR THE LIKE) ARISING OUT OF THE USE OF OR INABILITY TO USE THE TELENAV SOFTWARE, EVEN IF TELENAV HAS BEEN ADVISED OF THE POSSIBILITY OF SUCH DAMAGES.

NOTWITHSTANDING ANY DAMAGES THAT YOU MIGHT INCUR FOR ANY REASON WHATSOEVER (INCLUDING, WITHOUT LIMITATION, ALL DAMAGES REFERENCED HEREIN AND ALL DIRECT OR GENERAL DAMAGES IN CONTRACT, TORT (INCLUDING NEGLIGENCE) OR OTHERWISE), THE ENTIRE LIABILITY OF TELENV AND OF ALL OF TELENV'S SUPPLIERS SHALL BE LIMITED TO THE AMOUNT ACTUALLY PAID BY YOU FOR THE TELENV SOFTWARE. SOME STATES AND/OR JURISDICTIONS DO NOT ALLOW THE EXCLUSION OR LIMITATION OF INCIDENTAL OR CONSEQUENTIAL DAMAGES, SO THE ABOVE LIMITATIONS OR EXCLUSIONS MAY NOT APPLY TO YOU.

6. Arbitration and Governing Law

You agree that any dispute, claim or controversy arising out of or relating to this Agreement or the TeleNav Software shall be settled by independent arbitration involving a neutral arbitrator and administered by the American Arbitration Association in the County of Santa Clara, California. The arbitrator shall apply the Commercial Arbitration Rules of the American Arbitration Association, and the judgment upon the award rendered by the arbitrator may be entered by any court having jurisdiction. Note that there is no judge or jury in an arbitration proceeding and the decision of the arbitrator shall be binding upon both parties. You expressly agree to waive your right to a jury trial. This Agreement and performance hereunder will be governed by and construed in accordance with the laws of the State of California, without giving effect to its conflict of laws provisions. To the extent judicial action is necessary in connection with the binding arbitration, both TeleNav and you agree to submit to the exclusive jurisdiction of the courts of the County of Santa Clara, California. The United Nations Convention on Contracts for the International Sale of Goods shall not apply.

7. Assignment

You may not resell, assign, or transfer this Agreement or any of your rights or obligations, except in totality, in connection with your permanent transfer of the TeleNav Software, and expressly conditioned upon the new user of the TeleNav Software agreeing to be bound by the terms and conditions of this Agreement. Any such sale, assignment or transfer that is not expressly permitted under this paragraph will result in immediate termination of this Agreement, without liability to TeleNav, in which case you and all other parties shall immediately cease all use of the TeleNav Software. Notwithstanding the foregoing, TeleNav may assign this Agreement to any other party at any time without notice, provided the assignee remains bound by this Agreement.

8. Miscellaneous

8.1 This Agreement constitutes the entire agreement between TeleNav and you with respect to the subject matter hereof.

8.2 Except for the limited licenses expressly granted in this Agreement, TeleNav retains all right, title and interest in and to the TeleNav Software, including without limitation all related intellectual property rights. No licenses or other rights which are not expressly granted in this Agreement are intended to, or shall be, granted or conferred by implication, statute, inducement, estoppel or otherwise, and TeleNav and its suppliers and licensors hereby reserve all of their respective rights other than the licenses explicitly granted in this Agreement.

8.3 By using the TeleNav Software, you consent to receive from TeleNav all communications, including notices, agreements, legally required disclosures or other information in connection with the TeleNav Software (collectively, "Notices") electronically. TeleNav may provide such Notices by posting them on TeleNav's Website or by downloading such Notices to your wireless device. If you desire to withdraw your consent to receive Notices electronically, you must discontinue your use of the TeleNav Software.

8.4 TeleNav's or your failure to require performance of any provision shall not affect that party's right to require performance at any time thereafter, nor shall a waiver of any breach or default of this Agreement constitute a waiver of any subsequent breach or default or a waiver of the provision itself.

8.5 If any provision herein is held unenforceable, then such provision will be modified to reflect the intention of the parties, and the remaining provisions of this Agreement will remain in full force and effect.

8.6 The headings in this Agreement are for convenience of reference only, will not be deemed to be a part of this Agreement, and will not be referred to in connection with the construction or interpretation of this Agreement. As used in this Agreement, the words "include" and "including," and variations thereof, will not be deemed to be terms of limitation, but rather will be deemed to be followed by the words "without limitation."

9. Other Vendors Terms and Conditions

The TeleNav Software utilizes map and other data licensed to TeleNav by third party vendors for the benefit of you and other end users. This Agreement includes end-user terms applicable to these companies (included at the end of this Agreement), and thus your use of the TeleNav Software is also subject to such terms. You agree to comply with the following additional terms and conditions, which are applicable to TeleNav's third party vendor licensors:

NavTeq End User License Agreement**END USER TERMS**

The content provided ("Data") is licensed, not sold. By opening this package, or installing, copying, or otherwise using the Data, you agree to be bound by the terms of this agreement. If you do not agree to the terms of this agreement, you are not permitted to install, copy, use, resell or transfer the Data. If you wish to reject the terms of this agreement, and have not installed, copied, or used the Data, you must contact your retailer or NAVTEQ North America, LLC ("NT") within thirty (30) days of purchase for a refund of your purchase price. To contact NT, please visit www.navteq.com.

The Data is provided for your personal, internal use only and may not be resold. It is protected by copyright, and is subject to the following terms (this "End User License Agreement") and conditions which are agreed to by you, on the one hand, and NAVTEQ North America, LLC ("NT") and its licensors (including their licensors and suppliers) on the other hand.

The Data for areas of Canada includes information taken with permission from Canadian authorities, including: © Her Majesty the Queen in Right of Canada, © Queen's Printer for Ontario, © Canada Post Corporation, GeoBase ®.

NT holds a nonexclusive license from the United States Postal Service ® to publish and sell ZIP+4 ® information.

© United States Postal Service ® 2009. Prices are not established, controlled or approved by the United States Postal Service ®. The following trademarks and registrations are owned by the USPS: United States Postal Service, USPS, and ZIP+4.

The Data for Mexico includes certain Data from Instituto Nacional de Estadística y Geografía.

TERMS AND CONDITIONS

License Limitations on Use: You agree that your license to use this Data is limited to and conditioned on use for solely personal, noncommercial purposes, and not for service bureau, timesharing or other similar purposes. Except as otherwise set forth herein, you agree not to otherwise reproduce, copy, modify, decompile, disassemble or reverse engineer any portion of this Data, and may not transfer or distribute it in any form, for any purpose, except to the extent permitted by mandatory laws.

License Limitations on Transfer: Your limited license does not allow transfer or resale of the Data, except on the condition that you may transfer the Data and all accompanying materials on a permanent basis if: (a) you retain no copies of the Data; (b) the recipient agrees to the terms of this End User License Agreement; and (c) you transfer the Data in the exact same form as you purchased it by physically transferring the original media (e.g., the CD-ROM or DVD you purchased), all original packaging, all Manuals and other documentation. Specifically, Multi-disc sets may only be transferred or sold as a complete set as provided to you and not as a subset thereof.

Additional License Limitations: Except where you have been specifically licensed to do so by NT in a separate written agreement, and without limiting the preceding paragraph, your license is conditioned on use of the Data as prescribed in this agreement, and you may not (a) use this Data with any products, systems, or applications installed or otherwise connected to or in communication with vehicles capable of vehicle navigation, positioning, dispatch, real time route guidance, fleet management or similar applications; or (b) with, or in communication with, including without limitation, cellular phones, palmtop and handheld computers, pagers, and personal digital assistants or PDAs.



WARNING: This Data may contain inaccurate or incomplete information due to the passage of time, changing circumstances, sources used and the nature of collecting comprehensive geographic Data, any of which may lead to incorrect results.

No Warranty: This Data is provided to you “as is”, and you agree to use it at your own risk. NT and its licensors (and their licensors and suppliers) make no guarantees, representations or warranties of any kind, express or implied, arising by law or otherwise, including but not limited to, content, quality, accuracy, completeness, effectiveness, reliability, fitness for a particular purpose, usefulness, use or results to be obtained from this Data, or that the Data or server will be uninterrupted or error free.

Disclaimer of Warranty: NT AND ITS LICENSORS (INCLUDING THEIR LICENSORS AND SUPPLIERS) DISCLAIM ANY WARRANTIES, EXPRESS OR IMPLIED, OF QUALITY, PERFORMANCE, MERCHANTABILITY, FITNESS FOR A PARTICULAR PURPOSE OR NON-INFRINGEMENT. Some States, Territories and Countries do not allow certain warranty exclusions, so to that extent the above exclusion may not apply to you.

Disclaimer of Liability: NT AND ITS LICENSORS (INCLUDING THEIR LICENSORS AND SUPPLIERS) SHALL NOT BE LIABLE TO YOU IN RESPECT OF ANY CLAIM, DEMAND OR ACTION, IRRESPECTIVE OF THE NATURE OF THE CAUSE OF THE CLAIM, DEMAND OR ACTION ALLEGING ANY LOSS, INJURY OR DAMAGES, DIRECT OR INDIRECT, WHICH MAY RESULT FROM THE USE OR POSSESSION OF THIS DATA; OR FOR ANY LOSS OF PROFIT, REVENUE, CONTRACTS OR SAVINGS, OR ANY OTHER DIRECT, INDIRECT, INCIDENTAL, SPECIAL OR CONSEQUENTIAL DAMAGES ARISING OUT OF YOUR USE OF OR INABILITY TO USE THIS DATA, ANY DEFECT IN THIS DATA, OR THE BREACH OF THESE TERMS OR CONDITIONS, WHETHER IN AN ACTION IN CONTRACT OR TORT OR BASED ON A WARRANTY, EVEN IF NT OR ITS LICENSORS HAVE BEEN ADVISED OF THE POSSIBILITY OF SUCH DAMAGES. Some States, Territories and Countries do not allow certain liability exclusions or damages limitations, so to that extent the above may not apply to you.

Export Control: You agree not to export from anywhere any part of the Data or any direct product thereof except in compliance with, and with all licenses and approvals required under, applicable export laws, rules and regulations, including but not limited to the laws, rules and regulations administered by the Office of Foreign Assets Control of the U.S. Department of Commerce and the Bureau of Industry and Security of the U.S. Department of Commerce. To the extent that any such export laws, rules or regulations prohibit NT from complying with any of its obligations hereunder to deliver or distribute Data, such failure shall be excused and shall not constitute a breach of this Agreement.

Entire Agreement: These terms and conditions constitute the entire agreement between NT (and its licensors, including their licensors and suppliers) and you pertaining to the subject matter hereof, and supersedes in their entirety any and all written or oral agreements previously existing between us with respect to such subject matter.

Severability: You and NT agree that if any portion of this agreement is found illegal or unenforceable, that portion shall be severed and the remainder of the Agreement shall be given full force and effect.

Governing Law: The above terms and conditions shall be governed by the laws of the State of Illinois, without giving effect to (i) its conflict of laws provisions, or (ii) the United Nations Convention for Contracts for the International Sale of Goods, which is explicitly excluded. You agree to submit to the personal jurisdiction of the State of Illinois for any and all disputes, claims and actions arising from or in connection with the Data provided to you hereunder.

Government End Users: If the Data is being acquired by or on behalf of the United States government or any other entity seeking or applying rights similar to those customarily claimed by the United States government, this Data is a “commercial item” as that term is defined at 48 C.F.R. (“FAR”) 2.101, is licensed in accordance with this End User License Agreement, and each copy of Data delivered or otherwise furnished shall be marked and embedded as appropriate with the following “Notice of Use”, and be treated in accordance with such Notice:

NOTICE OF USE

CONTRACTOR (MANUFACTURER/ SUPPLIER)

NAME:

NAVTEQ

CONTRACTOR (MANUFACTURER/SUPPLIER)

ADDRESS:

425 West Randolph Street, Chicago, IL 60606.

This Data is a commercial item as defined in FAR 2.101 and is subject to the EndUser License Agreement under which this Data was provided.

© 2011 NAVTEQ. All rights reserved.

If the Contracting Officer, federal government agency, or any federal official refuses to use the legend provided herein, the Contracting Officer, federal government agency, or any federal official must notify NAVTEQ prior to seeking additional or alternative rights in the Data.

Wi-Fi hotspot data provided by JiWire ©2013 JiWire.

Gracenote® Copyright

CD and music — related data from Gracenote, Inc., copyright © 2000–2007 Gracenote. Gracenote Software, copyright © 2000–2007 Gracenote. This product and service may practice one or more of the following U.S. Patents #5,987,525; #6,061,680; #6,154,773, #6,161,132, #6,230,192, #6,230,207, #6,240,459, #6,330,593, and other patents issued or pending. Some services supplied under license from Open Globe, Inc. for U.S. Patent: #6,304,523.

Gracenote and CDDB are registered trademarks of Gracenote. The Gracenote logo and logotype, and the "Powered by Gracenote™" logo are trademarks of Gracenote.

Gracenote® End User License Agreement (EULA)

This device contains software from Gracenote, Inc. of 2000 Powell Street Emeryville, California 94608 ("Gracenote").

The software from Gracenote (the "Gracenote Software") enables this device to do disc and music file identification and obtain music-related information, including name, artist, track, and title information ("Gracenote Data") from online servers ("Gracenote Servers"), and to perform other functions. You may use Gracenote Data only by means of the intended End User functions of this device

This device may contain content belonging to Gracenote's providers. If so, all of the restrictions set forth herein with respect to Gracenote Data shall also apply to such content and such content providers shall be entitled to all of the benefits and protections set forth herein that are available to Gracenote.

You agree that you will use the content from Gracenote ("Gracenote Content"), Gracenote Data, the Gracenote Software, and Gracenote Servers for your own personal, non-commercial use only. You agree not to assign, copy, transfer or transmit the Gracenote Content, Gracenote Software or any Gracenote Data (except in a Tag associated with a music file) to any third party. YOU AGREE NOT TO USE OR EXPLOIT GRACENOTE CONTENT, GRACENOTE DATA, THE GRACENOTE SOFTWARE, OR GRACENOTE SERVERS, EXCEPT AS EXPRESSLY PERMITTED HEREIN.

You agree that your non-exclusive licenses to use the Gracenote Content, Gracenote Data, the Gracenote Software, and Gracenote Servers will terminate if you violate these restrictions. If your licenses terminate, you agree to cease any and all use of the Gracenote Content, Gracenote Data, the Gracenote Software, and Gracenote Servers. Gracenote,

respectively, reserve all rights in Gracenote Data, the Gracenote Software, and the Gracenote Servers and Gracenote Content, including all ownership rights. Under no circumstances will either Gracenote become liable for any payment to you for any information that you provide, including any copyrighted material or music file information. You agree that Gracenote may enforce its respective rights, collectively or separately, under this agreement against you, directly in each company's own name.

Gracenote uses a unique identifier to track queries for statistical purposes. The purpose of a randomly assigned numeric identifier is to allow Gracenote to count queries without knowing anything about who you are. For more information, see the web page at www.gracenote.com for the Gracenote Privacy Policy

THE GRACENOTE SOFTWARE, EACH ITEM OF GRACENOTE DATA AND THE GRACENOTE CONTENT ARE LICENSED TO YOU "AS IS." NEITHER GRACENOTE MAKES ANY REPRESENTATIONS OR WARRANTIES, EXPRESS OR IMPLIED, REGARDING THE ACCURACY OF ANY GRACENOTE DATA FROM THE GRACENOTE SERVERS OR GRACENOTE CONTENT. GRACENOTE COLLECTIVELY AND SEPARATELY RESERVE THE RIGHT TO DELETE DATA AND/OR CONTENT FROM THE COMPANIES' RESPECTIVE SERVERS OR, IN THE CASE OF GRACENOTE, CHANGE DATA CATEGORIES FOR ANY CAUSE THAT GRACENOTE DEEMS SUFFICIENT. NO WARRANTY IS MADE THAT EITHER GRACENOTE CONTENT OR THE GRACENOTE SOFTWARE OR GRACENOTE SERVERS ARE ERROR-FREE OR THAT THE FUNCTIONING OF THE GRACENOTE SOFTWARE OR GRACENOTE SERVERS WILL BE UNINTERRUPTED. GRACENOTE IS NOT OBLIGATED TO PROVIDE YOU WITH ANY ENHANCED OR ADDITIONAL DATA TYPES THAT GRACENOTE MAY CHOOSE TO PROVIDE IN THE FUTURE AND IS FREE TO DISCONTINUE ITS ONLINE SERVICES AT ANY TIME. GRACENOTE DISCLAIMS ALL WARRANTIES EXPRESS OR IMPLIED, INCLUDING, BUT NOT LIMITED TO, IMPLIED WARRANTIES OF MERCHANTABILITY, FITNESS FOR A PARTICULAR PURPOSE, TITLE, AND NON-INFRINGEMENT. NEITHER GRACENOTE WARRANTS THE RESULTS THAT WILL BE OBTAINED BY YOUR USE OF THE GRACENOTE SOFTWARE OR ANY GRACENOTE SERVER. IN NO CASE WILL GRACENOTE BE LIABLE FOR ANY CONSEQUENTIAL OR INCIDENTAL DAMAGES OR FOR ANY LOST PROFITS OR LOST REVENUES FOR ANY REASON WHATSOEVER.

© Gracenote 2007

Vehicle without MyFord Touch or MyLincoln Touch

FCC ID: KMHSG1G1 IC: 1422A-SG1G1

FCC ID: WDGSG1G1 IC: 5248B-SG1G1

Vehicle with MyFord Touch or MyLincoln Touch

FCC ID: KMHSYNG2 IC: 1422A-SYNG2

This device complies with Part 15 of the FCC Rules and with RSS-210 of Industry Canada. Operation is subject to the following two conditions: (1) This device may not cause harmful interference, and (2) this device must accept any interference received, including interference that may cause undesired operation.



WARNING: Changes or modifications not expressly approved by the party responsible for compliance could void the user's authority to operate the equipment. The term "IC:" before the radio certification number only signifies that Industry Canada technical specifications were met.

The antenna used for this transmitter must not be co-located or operating in conjunction with any other antenna or transmitter.

-
- 911 Assist™401, 492
- A**
- ABS (see Brakes)218
- Accessing and using your
USB port459
- Accessing call history/phone
book during active call390
- Accessing your calendar492
- Accessing your media menu
features415
- Accessing your phone menu
features392
- Accessory delay100
- Active call menu options390
- Active Park Assist227
- Adding (pairing) a phone467
- Advanced menu options ...399, 421
- Advanced menu options
(prompts, languages, defaults,
master reset, installing
applications)399
- Airbag supplemental restraint
system46
and child safety seats47
description46
disposal56
driver airbag46
passenger airbag46
side airbag46, 51
- Air cleaner filter296–297, 354
- Air filter283, 297, 354
- Ambient mood/lighting97, 499
- AM/FM446
- Antifreeze (see Engine
coolant)286
- Anti-lock brake system
(see Brakes)218
- Anti-theft system83
arming the system83, 85
disarming a triggered system ..85
- AppLink™409
- Armrests164
- Audio system
Single CD138, 143–144
- Audio system
(see Radio)138, 143–144
- Automatic transmission
driving an automatic
overdrive213
fluid, adding291
fluid, checking291
fluid, refill capacities351
- Auxiliary Input Jack455
- Auxiliary input jack (Line in) ..145
- Auxiliary powerpoint171
- A/V inputs147, 463
- B**
- Battery293
jumping a disabled battery259
maintenance-free293
replacement, specifications ...354
servicing293
traction battery pack
assembly205
- Booster seats23
- Brakelamp
high-mount brakelamp308

Brakes	218	wiper blades	313
anti-lock	218	Climate voice commands	510
anti-lock brake system (ABS)		Clock	138, 497
warning light	218	Console	173
brake warning light	218	overhead	173
fluid, checking and adding	292	Coolant	286
fluid, refill capacities	351	checking and adding	286
fluid, specifications	351	recovery reservoir	283
lubricant specifications	351	refill capacities	351
parking	220	specifications	351
shift interlock	215	Customer Assistance	256
C		Ford Extended Service	
Capacities for refilling fluids	351	Plan	359
Cargo area shade	240	Getting roadside assistance	256
CD	138, 143–144	Getting the service	
CD player	136, 457	you need	263
CD voice commands	458	Ordering additional owner's	
Cell phone use	16	literature	269
Changing the air filter	297	Utilizing the	
Child safety restraints	28, 30	Mediation/Arbitration	
Child safety seats		Program	267
attaching with tether straps	30	D	
automatic locking mode		Defrost	151
(retractor)	36	rear window	155
LATCH	28	Dipstick	
Child safety seats - booster		automatic transmission	
seats	23	fluid	291
Cleaning the touchscreen	432	engine oil	283–284
Cleaning your vehicle	310	Display settings	498
engine compartment	312	Doors	
instrument panel	314	central unlocking	72
interior	313	Driving under special	
plastic parts	311	conditions	216
washing	310	through water	251
waxing	311	Dual automatic temperature	
wheels	316	control (DATC)	151

-
- E**
- Eco Mode182
 - Electronic message center114
 - Electronic stability control223
 - Emergencies, roadside
 - jump-starting259
 - running out of fuel198
 - Emergency brake
(see Parking brake)220
 - Emission control system201
 - End user license agreement524
 - Engine283, 350–351
 - cleaning312
 - coolant286
 - fail-safe cooling290
 - lubrication specifications351
 - refill capacities351
 - service points283
 - Engine block heater180
 - Engine fan283
 - Engine oil
 - checking and adding284
 - dipstick283–284
 - filter, specifications354
 - refill capacities351
 - specifications351
 - Event data recording12
 - Exhaust fumes179
- F**
- Fail safe cooling290
 - Fan, Engine Cooling283
 - Fleet MyKey programming66
 - Floor mats252
 - Fluid capacities351
 - Fog lamps95
 - Forward and reverse sensing
system225
 - Fuel
 - cap195
 - capacity351
 - choosing the right fuel191
 - filler funnel198
 - filling your vehicle
 - with fuel193, 195
 - filter, specifications292
 - fuel pump shut-off258
 - octane rating192, 350–351
 - quality191–192
 - running out of fuel198
 - safety information relating to
automotive fuels190
 - Fuses271–272, 278
- G**
- Garage door opener166
 - Gas cap (see Fuel cap)195
 - Gauges106
- H**
- Hazard flashers257
 - HD Radio™448
 - Headlamps
 - aiming300
 - bulb specifications309
 - flash to pass92
 - high beam92
 - replacing bulbs302–303
 - Head restraints158
 - Heated steering wheel508
 - Heating151
 - Help507

High-voltage battery		L	
charging	205	Lamps	
service disconnect	211	bulb replacement	
High-voltage shut off	258	specifications chart	309
Hill start assist	217	fog lamps	95
Homelink wireless control		headlamps, flash to pass	92
system	166	interior lamps	95
Hood	282	replacing bulbs	302–303, 308
How to use voice commands ...	438	LATCH anchors	28
I		Liftgate	74, 78–79
Ignition	175, 350	Lights, warning and indicator ..	109
Illuminated visor mirror	103	Listening to music	444
Information displays	114	Load limits	241
Inspection/maintenance (I/M)		Locks	
testing	204	autolock	76
Instrument panel		childproof	32
cleaning	314	doors	72
cluster	109	Lubricant specifications	351
Intelligent Access Key	59	Lug nuts	349
J		M	
Joining two calls		Making and receiving calls	467
(multiparty/conference call) ...	390	MAP DVD - Loading and	
Jump-starting your vehicle	259	Unloading	467
K		Map icons	520
Keyless entry system		Map mode	518
autolock	76	Map preferences	517
Keys	58, 83	Map updates	521
positions of the ignition	175	Media Bluetooth menu options	
		(adding, connecting, deleting,	
		turning on/off)	420
		Message center	114
		warning messages	127

-
- Mirrors101, 103
 - fold away101
 - side view mirrors (power)101
 - Motorcraft® parts310, 354
 - MyFord Touch™ system429
 - MyKey66
 - N**
 - Navigation features511
 - Navigation voice commands522
 - Notifications491
 - O**
 - Octane rating192
 - P**
 - Pairing other phones387, 467
 - Pairing your phone466
 - Pairing your phone for the first time387, 466
 - Parental MyKey programming ...66
 - Park Assist227
 - Parking brake220
 - Parts (see Motorcraft® parts)354
 - Passenger Occupant Classification Sensor48
 - Phone Bluetooth menu options (adding, connecting, deleting, turning on/off)398
 - Phone redial392
 - Phone settings471, 504
 - Phone voice commands472
 - Playing music (by artist, album, genre, playlist, tracks, similar)417
 - POI categories513
 - Point of Interest (POI)513
 - Power distribution box (see Fuses)272
 - Power door locks72
 - Power liftgate79
 - Power mirrors101
 - Powerpoint171
 - Power steering238
 - Power Windows98
 - Privacy information383, 435
 - Push button start system175
 - Putting a call on/off hold390
 - Q**
 - Quick touch buttons521
 - R**
 - Radio138, 143–144
 - AM/FM446
 - Single CD138, 143–144
 - Radio reception136
 - Radio voice commands451
 - Rear view camera display231, 499
 - Rear window defroster151
 - Receiving a text message394, 471
 - Recommendations for attaching safety restraints for children25

-
- Relays271–272
 - Remote entry system
 - illuminated entry77
 - locking/unlocking doors73
 - opening the trunk74
 - replacing the batteries60
 - Roadside assistance256
 - Roll stability control223
 - Route preferences517
 - S**
 - Safety Belt Maintenance42
 - Safety belts (see Safety restraints)35, 38
 - Safety defects, reporting270
 - Safety information382, 433
 - Safety restraints35–36, 38
 - Belt-Minder®39
 - extension assembly38
 - for adults35–36
 - for children20, 25
 - Occupant Classification
 - Sensor48
 - safety belt maintenance42
 - seat belt maintenance42
 - warning light and chime39
 - Safety restraints - LATCH
 - anchors28
 - Safety seats for children20, 25
 - Safety Compliance
 - Certification Label356
 - Satellite Radio452
 - Scheduled Maintenance Guide
 - Normal Scheduled
 - Maintenance and Log368
 - SD card147, 459, 511
 - Seat belts (see Safety restraints)35
 - Seats164
 - child safety seats20, 25
 - front seats161, 163
 - heated165
 - second row seats164
 - SecuriLock passive anti-theft system83
 - Selecting your media source (USB, Line in, BT audio)415
 - Sending new text messages470
 - Setting a destination511
 - Setting a destination by voice512
 - Settings497
 - Setting the clock138, 497
 - Side air curtain53
 - Side-curtain airbags system53
 - SIRIUS® satellite radio452
 - SIRIUS satellite radio voice
 - commands454
 - SIRIUS Travel Link489
 - SIRIUS Travel Link voice
 - commands490
 - SOS Post Crash Alert45
 - Spark plugs,
 - specifications350–351, 354
 - Specification chart,
 - lubricants351
 - Stability system223
 - Starting your vehicle176
 - jump starting259
 - push button start system175

-
- Steering wheel86
 - controls87
 - tilting86
 - Sunshade104
 - Supplemental Restraint System (SRS) (see airbags)46
 - Supported media file types462
 - Supported player, media formats and metadata information462
 - SYNC® AppLink™409
 - SYNC® customer support382, 432
 - SYNC® Services406, 485
 - System settings500
 - T**
 - Temperature control (see Climate control)151, 508
 - Temporary mobility kit340
 - Text messaging393, 469
 - Text messaging (sending, downloading, deleting)394, 396
 - Tilt steering wheel86
 - Tires321–322
 - alignment335
 - care321
 - checking the pressure331
 - inflating329
 - label328
 - replacing333
 - rotating335
 - safety practices334
 - sidewall information324
 - snow tires and chains336
 - Temporary mobility kit340
 - terminology322
 - tire grades322
 - treadwear321, 331
 - Touchscreen features (climate)508
 - Towing248–249
 - recreational towing249
 - trailer towing248
 - wrecker248
 - Traction control221
 - Traffic, Directions and Information406
 - Traffic preferences517
 - Transmission
 - brake-shift interlock (BSI)215
 - fluid, checking and adding (automatic)291
 - fluid, refill capacities351
 - lubricant specifications351
 - Turn signal95
 - U**
 - USB port146–147, 459
 - Using privacy mode390
 - V**
 - Vehicle health report404, 495
 - Vehicle Identification Number (VIN)355
 - Vehicle loading241
 - Ventilating your vehicle179
 - Voice commands in media mode412
 - Voice commands in phone mode388
 - Voice recognition438

W

- Warning lights (see Lights)109
- Washer fluid292–293
 - reservoir283
- Water, Driving through251
- Windows
 - power98
 - rear wiper/washer91, 296
- Windshield washer fluid and wipers
 - checking and adding fluid292–293
 - replacing wiper blades ...294, 296
 - reservoir283
- Wrecker towing248