

## Driving

This information is in addition to the information contained in your Owner's Guide.

### **ENGINE IDLE SHUTDOWN (IF EQUIPPED)**

Your vehicle may be equipped with an Engine Idle Shutdown system. This system will automatically shut down your engine when it has been idling in P (Park) or N (Neutral) for five minutes (parking brake set) or 15 minutes (parking brake not set). During the engine idle shutdown process:

- The **Service Engine Soon** light will flash, once per second, for the final 30 seconds just prior to shutdown.
- Within the final 30 seconds, the timer can be reset by:
  1. changing the position of the accelerator pedal, or
  2. changing the brake pedal, clutch pedal, or park brake from engaged to disengaged or from disengaged to engaged.
- When the timer reaches zero, the engine will shut down.
- In this event, the key remains in the ON (Run) position, and power continues to be supplied to the accessories.

### **Battery power may be drained if the key is left in the ON (Run) position without the engine running.**

**Note:** The engine idle shutdown timer will not start if:

- The engine is operating in power take-off (PTO) mode.
- The engine coolant temperature is below 60° F (16° C).
- The exhaust emission control system is regenerating the diesel particulate filter (DPF).

## Table of Contents

<b>Introduction</b>	<b>4</b>
Safety and environment protection	5
<b>Vehicle Inspection Guide</b>	<b>11</b>
<b>Instrument Cluster</b>	<b>21</b>
Warning lights and chimes	21
Gauges	27
<b>Entertainment Systems</b>	<b>32</b>
AM/FM stereo	32
AM/FM stereo with in-dash six CD	38
<b>Climate Controls</b>	<b>44</b>
Heater only	44
Manual heating and air conditioning	45
<b>Lights</b>	<b>47</b>
Headlamps	47
Turn signal control	48
Interior lamps	49
Bulb replacement	49
<b>Driver Controls</b>	<b>52</b>
Windshield wiper/washer control	52
Steering wheel adjustment	52
Power windows	53
Mirrors	55
Speed control	57
<b>Locks and Security</b>	<b>61</b>
Keys	61
Locks	61

## Table of Contents

<b>Seating and Safety Restraints</b>	<b>62</b>
Seating	62
Safety restraints	69
Child restraints	78
<b>Driving</b>	<b>85</b>
Starting	85
Brakes	92
Air suspension	113
Transmission operation	115
Vehicle loading	128
<b>Roadside Emergencies</b>	<b>134</b>
Hazard flasher switch	135
Fuses and relays	135
Jump starting	142
Wrecker towing	146
<b>Customer Assistance</b>	<b>150</b>
Getting assistance outside the U.S. and Canada	152
Ordering additional owner's literature	153
Reporting safety defects (U.S. only)	153
<b>Cleaning</b>	<b>155</b>
Cleaning your vehicle	155
Repairing paint chips	156
Underbody preservation	158
<b>Maintenance and Specifications</b>	<b>160</b>
Hood	168
Engine oil	171
Battery	171
Engine coolant	173
Fuel information	175
Lubricant specifications	209
Refill capacities	222

## Table of Contents

<b>Scheduled Maintenance Guide</b>	<b>227</b>
<b>Index</b>	<b>262</b>

All rights reserved. Reproduction by any means, electronic or mechanical including photocopying, recording or by any information storage and retrieval system or translation in whole or part is not permitted without written authorization from Ford Motor Company. Ford may change the contents without notice and without incurring obligation.

Copyright © 2006 Ford Motor Company

## Introduction

### CALIFORNIA Proposition 65 Warning



**WARNING:** Engine exhaust, some of its constituents, and certain vehicle components contain or emit chemicals known to the State of California to cause cancer and birth defects or other reproductive harm. In addition, certain fluids contained in vehicles and certain products of component wear contain or emit chemicals known to the State of California to cause cancer and birth defects or other reproductive harm.

### PERCHLORATE MATERIAL

Certain components of this vehicle such as air bag modules, seat belt pretensioners, and button cell batteries may contain Perchlorate Material – Special handling may apply for service or vehicle end of life disposal. See [www.dtsc.ca.gov/hazardouswaste/perchlorate](http://www.dtsc.ca.gov/hazardouswaste/perchlorate).

### CONGRATULATIONS

Congratulations on acquiring your new Ford. Please take the time to get well acquainted with your vehicle by reading this handbook. The more you know and understand about your vehicle, the greater the safety and pleasure you will derive from driving it.

For more information on Ford Motor Company and its products visit the following website:

- In the United States: [www.ford.com](http://www.ford.com)
- In Canada: [www.ford.ca](http://www.ford.ca)
- In Mexico: [www.ford.com.mx](http://www.ford.com.mx)

Additional owner information is given in separate publications.

## Introduction

This *Owner's Guide* describes every option and model variant available and therefore some of the items covered may not apply to your particular vehicle. Furthermore, due to printing cycles it may describe options before they are generally available.

Remember to pass on the *Owner's Guide* when reselling the vehicle. It is an integral part of the vehicle.

### SAFETY AND ENVIRONMENT PROTECTION



#### Warning symbols in this guide

How can you reduce the risk of personal injury and prevent possible damage to others, your vehicle and its equipment? In this guide, answers to such questions are contained in comments highlighted by the warning triangle symbol. These comments should be read and observed.



#### Warning symbols on your vehicle

When you see this symbol, it is imperative that you consult the relevant section of this guide before touching or attempting adjustment of any kind.



#### Protecting the environment

We must all play our part in protecting the environment. Correct vehicle usage and the authorized disposal of waste cleaning and lubrication materials are significant steps towards this aim. Information in this respect is highlighted in this guide with the tree symbol.



## Introduction

### SPECIAL NOTICES

#### Emission warranty

The New Truck Limited Warranty includes Basic Coverage, Corrosion Coverage, Frame Coverage, Federal Emissions Defect Warranty and California Defects Warranty. For a detailed description of what is covered and what is not covered, refer to the *Warranty Guide* that is provided to you along with your *Owner's Guide*.

#### Special instructions

For your added safety, your vehicle is fitted with sophisticated electronic controls.

#### Service Data Recording

Service data recorders in your vehicle are capable of collecting and storing diagnostic information about your vehicle. This potentially includes information about the performance or status of various systems and modules in the vehicle, such as engine, throttle, steering or brake systems. In order to properly diagnose and service your vehicle, Ford Motor Company, Ford of Canada, and service and repair facilities may access vehicle diagnostic information through a direct connection to your vehicle when diagnosing or servicing your vehicle.

#### Event Data Recording

Other modules in your vehicle - event data recorders - are capable of collecting and storing data during a crash or near crash event. The recorded information may assist in the investigation of such an event. The modules may record information about both the vehicle and the occupants, potentially including information such as:

- how various systems in your vehicle were operating;
- whether or not the driver and passenger seatbelts were buckled;
- how far (if at all) the driver was depressing the accelerator and/or the brake pedal;
- how fast the vehicle was traveling; and
- where the driver was positioning the steering wheel.

## Introduction

To access this information, special equipment must be directly connected to the recording modules. Ford Motor Company and Ford of Canada do not access event data recorder information without obtaining consent, unless pursuant to court order or where required by law enforcement, other government authorities or other third parties acting with lawful authority. Other parties may seek to access the information independently of Ford Motor Company and Ford of Canada.

### Cell phone use

The use of Mobile Communications Equipment has become increasingly important in the conduct of business and personal affairs. However, drivers must not compromise their own or others' safety when using such equipment. Mobile Communications can enhance personal safety and security when appropriately used, particularly in emergency situations. Safety must be paramount when using mobile communications equipment to avoid negating these benefits.

Mobile Communication Equipment includes, but is not limited to cellular phones, pagers, portable email devices, in-vehicle communications systems, telematics devices and portable two-way radios.



Driving while distracted can result in loss of vehicle control, accident and injury. Ford strongly recommends that drivers use extreme caution when using any device that may take their focus off the road. The drivers primary responsibility is the safe operation of their vehicle. Only use cell phones and other devices not essential to the driving task when it is safe to do so.



## Introduction





These are some of the symbols you may see on your vehicle.

### Vehicle Symbol Glossary

Safety Alert		See Owner's Guide	
Fasten Safety Belt		Airbag - Front	
Airbag - Side		Child Seat Lower Anchor	
Child Seat Tether Anchor		Brake System	
Anti-Lock Brake System		Parking Brake System	
Brake Fluid - Non-Petroleum Based		Parking Aid System	
Stability Control System		Speed Control	
Master Lighting Switch		Hazard Warning Flasher	
Fog Lamps-Front		Fuse Compartment	
Fuel Pump Reset		Windshield Wash/Wipe	
Windshield Defrost/Demist		Rear Window Defrost/Demist	

## Introduction

### Vehicle Symbol Glossary

Power Windows Front/Rear		Power Window Lockout	
Child Safety Door Lock/Unlock		Interior Luggage Compartment Release	
Panic Alarm		Engine Oil	
Engine Coolant		Engine Coolant Temperature	
Do Not Open When Hot		Battery	
Avoid Smoking, Flames, or Sparks		Battery Acid	
Explosive Gas		Fan Warning	
Power Steering Fluid		Maintain Correct Fluid Level	
Emission System		Engine Air Filter	
Passenger Compartment Air Filter		Jack	
Check Fuel Cap		Low Tire Pressure Warning	

## Introduction

### FEDERAL HIGHWAY ADMINISTRATION REGULATION

Regulations such as those issued by the Federal Highway Administration or issued pursuant to the Occupational Safety and Health Act (OSHA), and/or state and local laws and regulations may require additional equipment for the way you intend to use the vehicle. It is the responsibility of the registered owner to determine the applicability of such laws and regulations to your intended use for the vehicle, and to arrange for the installation of required equipment. Your dealer has information about the availability of equipment which may be ordered for your vehicle.

### ENTERING, EXITING AND/OR CLIMBING ON THIS VEHICLE

You must be careful and deliberate to minimize the possibility of personal injury from a slip and fall when entering, exiting and/or climbing on this vehicle. Always use the steps and assist handles before climbing. Do not skip any steps or assist handles. Use three point contact at all times with at least two feet and one hand or two hands and one foot firmly placed during all phases of entering, exiting and/or climbing. Always keep your shoe soles and hands clean. Keep the steps and assist handles free of snow, ice, oil, grease, substances or debris. Be sure to use extra care in bad weather. Avoid wearing thick gloves. Always perform trailer hook-up while standing on the ground.



Do not carry items while entering, exiting, and/or climbing. Make sure you keep a firm grip. Always FACE the VEHICLE STEP and HANDLE SYSTEM while climbing up and down. Do not climb behind the cab unless you have three point contact with a step and handle system at all times.

## Vehicle Inspection Guide

To be sure your vehicle is ready to operate, conduct a pre-trip inspection at the beginning of each work period. Follow the steps listed in this section to ensure a proper vehicle inspection procedure. The pages in this section may be produced locally and used on a regular basis.

### VEHICLE INSPECTION INFORMATION

**Note:** Always make sure the parking brake is applied before starting the engine.

<b>Engine compartment (with engine stopped)</b>	
<b>Engine oil level:</b>	Use the engine oil dipstick to verify that the engine oil level is between the ADD and OPERATING RANGE marks.
<b>Engine coolant level:</b>	Look through the plastic reservoir or the clear sight glass on the reservoir, depending upon vehicle equipment, and make sure the fluid is within the minimum and maximum fluid level range as marked on the reservoir. <b>Do not remove pressure cap until the coolant has cooled.</b>
<b>Power steering fluid:</b>	Verify that the fluid level is between the proper operating range Refer to <i>Power steering fluid</i> in the <i>Maintenance and Specifications</i> chapter.
<b>Brake fluid (master cylinder):</b>	Remove the master cylinder caps and inspect the fluid level. The full mark is at the bottom of the opening of the port ring.
<b>Hydraulic clutch fluid:</b>	Check for adequate amount of hydraulic clutch fluid. Fluid level should be at the step of the reservoir; refer to <i>Clutch fluid/linkage adjustments</i> in the <i>Maintenance and Specifications</i> chapter.
<b>Belts (Fan, alternator, water pump and A/C compressor):</b>	Check for glazing, fraying or cracking. There should be no more than five - seven cracks per rib per inch.

## Vehicle Inspection Guide

<b>Engine compartment (with engine stopped)</b>	
<b>Any leaks:</b>	Check for signs of fluid puddles, dripping fluid on the ground under the engine or the underside of the engine.
<b>HVAC air inlet:</b>	Check for debris, leaves, etc. that may have collected on the HVAC air inlet grille or inside the exterior module as this may cause reduced system performance.



Exercise great caution when working on vehicle equipped with an automatic fan clutch. The fan starts in motion only after the engine coolant reaches a predetermined temperature or the refrigerant pressure (if equipped with air conditioning) reaches a predetermined setting. The fan will start at this point with no advance warning. Never reach near, or permit objects to protrude into, the fan blade radius while the engine is running as this could result in vehicle damage, personal injury or death.

<b>Engine starting (parking brake applied)</b>	
<b>Safety/Emergency equipment:</b>	Prior to entering the cab, verify that the vehicle is equipped with spare electrical fuses (if used), three red reflective triangles, a properly charged and rated fire extinguisher and wheel chocks. Walk around the vehicle and check that all steps and grab handles, inside and out as well as behind, are tight and clean. Use extreme caution and a three-point stance at all times. Check door latches for positive closing, latching and locking.

## Vehicle Inspection Guide

<b>Engine starting (parking brake applied)</b>	
<b>Starting the engine:</b>	Verify the parking brake is set. Depress the clutch (if equipped with a manual transmission) and verify the transmission is in neutral. Vehicles equipped with an automatic transmission should be in N (Neutral) or P (Park) if equipped with a Park position. When the WAIT TO START indicator light in the instrument cluster turns off, turn the key to START.
<b>Oil pressure builds:</b>	Make sure engine oil pressure is building to normal operating range.
<b>Air chime sounds (if equipped with air compressor):</b>	The low air pressure warning chime should sound immediately after the engine starts but before the compressor has built up pressure. The low air pressure warning chime should stop when the air pressure reaches 70 psi (483 kPa) (or more). Let the air pressure build to governed cut-out pressure, which should occur between 115–130 psi (793–896 kPa).
<b>Accelerator:</b>	Depress the accelerator and verify that it operates smoothly without any binding or irregular feel. Remove your foot from the pedal and make sure the engine returns to idle speed immediately.
<b>Ammeter/Voltmeter:</b>	Check the gauge to see if the alternator is charging.
<b>Steering linkage free play:</b>	Check for excessive free play in the steering linkages. The steering wheel should have less than two inches (five cm) of free play at rim of steering wheel.
<b>Hydraulic brake check:</b>	When the engine is off, the pump will turn on if the brake pedal is applied, or if the ignition is turned to the ON position.

## Vehicle Inspection Guide

<b>Engine starting (parking brake applied)</b>	
<b>Parking brake:</b>	Check that the parking brake will hold the vehicle by gently trying to pull forward with the parking brake applied.
<b>Air brake check:</b>	<p>Check the air brakes in the following manner (Chock the wheels, if necessary. Push in the parking brake and on tractors, also push in the tractor parking brake knob):</p> <ol style="list-style-type: none"> <li>1. Check the air compressor or governor cut-out pressure (approximately 120 psi [827 kPa]).</li> <li>2. Cut-off the engine and turn the key back to ON, without starting the engine.</li> <li>3. Without the brake pedal applied, note the air pressure drop for one minute. It should be less than 2 psi (14 kPa) for single vehicle and 3 psi (21 kPa) for combination vehicles.</li> <li>4. Depress and hold the brake pedal with 90 psi (621 kPa) or more and make sure there is no more than a 3 psi (21 kPa) per minute leak. For combination vehicles, no more than 4 psi (28 kPa) per minute.</li> <li>5. Pump the brake pedal to deplete the system air pressure. The warning light and chime should activate 57 psi (393 kPa).</li> <li>6. Pump the brake pedal and make sure the parking brake and trailer parking brake knobs pop out at 20 psi (138 kPa) or higher.</li> </ol>
<b>Automatic transmission fluid:</b>	With the engine idling at normal operating temperature and the parking brake applied, check the automatic transmission fluid. If fluid needs to be added, place the transmission in the appropriate gear as specified in the transmission operator's manual and refer to <i>Transmission fluid</i> in the <i>Maintenance and Specifications</i> chapter.

## Vehicle Inspection Guide

<b>Front of vehicle</b>	
<b>Lights:</b>	Make sure all lights illuminate and are clean. Make sure headlights function on both high and low beams. Make sure reflectors are clean and unbroken and of proper color (red on rear, amber elsewhere). Make sure the running lights are also clean and unbroken.
<b>Steering gear:</b>	Look for missing or loose fasteners, power steering fluid leaks and damage to power steering hoses.
<b>Steering linkage:</b>	Make sure connecting links, arms and rods are not worn or cracked; joints, sockets and boot seals are not worn or loose and that there are no loose or missing cotter keys, nuts or bolts.
<b>Tow hooks:</b>	Front and rear tow hooks should be inspected for damage or loose mounting. This is particularly important on vehicles where tow hooks are frequently used.
<b>Front suspension</b>	
<b>Spring:</b>	Inspect for missing, broken or shifted leaves or leaves that are in contact, or nearly contacting a tire, rim, brake drum, frame or body components.
<b>Spring mount:</b>	Inspect spring hangers, bolts, bushings, axle mounting bolts and nuts for cracks, breaks, wear, damage and tightness.
<b>Shock absorber:</b>	Inspect for cracks, leaks and missing or broken bolts or bushings.

**Note:** Never apply grease to spring pads.



Do not operate the vehicle if any suspension conditions listed in the *Front suspension* chart are evident. Loss of steering or suspension could result in property damage, personal injury or death.



## Vehicle Inspection Guide

<b>Front brakes</b>	
<b>Hoses:</b>	Check for cracked, worn or frayed hoses. Make sure all couplings are secured.
<b>Chambers:</b>	Make sure brake chambers are not cracked or dented and that they are securely mounted.
<b>Slack adjuster:</b>	Check for broken, loose or missing parts; the angle between the push rod and adjuster arm should be approximately 90° when the brakes are applied. When pulled by hand, the push rod should not move more than approximately one inch (2.5 cm).
<b>Drum:</b>	Make sure there are no cracks, dents or holes and no loose or missing bolts. Make sure brake linings are not worn or dangerously thin or contaminated by lubricant.
<b>Front wheels</b>	
<b>Rims:</b>	Check for damaged or bent rims. Rims should not have welding repairs and no rust trails that indicate it is loose on the wheel.
<b>Lug nuts:</b>	Make sure all lug nuts are present and not loose (look for rust trails around the lug nuts). There should be no cracks radiating from the lug bolt holes or distortion of the bolt holes.
<b>Hub oil seal:</b>	Check wheel hub oil seal for leaks, and if sight glass if present, check to see that the oil level is adequate.
<b>Oil-lubricated front wheel bearing:</b>	If the hubcap has a transparent window, check for proper lubrication level. If the hubcap does not have a transparent window, remove the rubber fill-plug and check for proper level.

## Vehicle Inspection Guide



If a wheel must be changed, obtain expert tire service help. Mounting and un-mounting of tires should only be performed by a qualified technician using necessary safety procedures and equipment, otherwise the result could be property damage, personal injury or death.

<b>Driver/Fuel area</b>	
<b>Fuel tank:</b>	Make sure the fuel tank and caps are secure. Make sure there is no damage to the tank.
<b>Leaks:</b>	Check for any leaks from the fuel tanks.
<b>Underbody of vehicle</b>	
<b>Driveshaft:</b>	Make sure that the driveshaft is not bent or cracked. Ensure all driveshaft couplings are secure.
<b>Exhaust system:</b>	Make sure the outside visible parts are securely mounted. Make sure there are no cracks, holes or severe dents.
<b>Frame:</b>	Check for cracks or bends in longitudinal frame members. Make sure there are no loose, cracked, bent, broken or missing crossmembers or crossmember fasteners.



Maintain adequate clearance between all parts of the exhaust system and all hoses, wires and lines for engine cooling, brake system, fuel system, power steering system and electrical system. Heat damage to hoses, wires or lines may cause vehicle malfunction that could result in property damage, personal injury or death.

## Vehicle Inspection Guide

<b>Rear of vehicle</b>	
<b>Air/Electric lines:</b>	Make sure that air hoses are not cut, cracked, chafed or worn. Listen for audible air leaks. Make sure air and electrical lines are not tangled, crimped or pinched or being dragged against any truck parts. Electrical line insulation should not be cut, cracked, chafed or worn. None of the air or electrical line should be spliced or taped. Check for corrosion on pins and in electrical sockets to ensure continuity and reduced heat build-up potential.
<b>Deck plate:</b>	Make sure deck plate is clean, securely bolted to the frame and clear of loose objects.
<b>Signal/Brake lights:</b>	Make sure both brake lights illuminate when the brake pedal is applied. Also, make sure each signal flashes. Make sure that four-way flashers work properly.
<b>Lights, reflectors:</b>	Make sure all lights illuminate and are clean. Make sure headlights function on both high and low beams. Make sure reflectors are clean and unbroken and of proper color (red on rear, amber elsewhere). Make sure the running lights are also clean and unbroken. Rear running lights must be checked separately from signal, flasher and brake lights.
<b>Tractor - coupling system</b>	
<b>Mounting bolts:</b>	Check for loose or missing mounting brackets, clamps, bolts or nuts. Both fifth wheel and slide mounting must be solidly attached.
<b>Platform:</b>	Check for cracks or breaks in the platform structure.
<b>Safety latch:</b>	Make sure safety latch is engaged.
<b>Release arm:</b>	Make sure safety latch is in the engaged position and that any safety latch is in place.

## Vehicle Inspection Guide

<b>Tractor - coupling system</b>	
<b>Kingpin/Apron:</b>	Make sure kingpin is not bent or worn. Also make sure that the apron lies flat on the fifth wheel skid plate and that the visible part of the apron is not bent, worn, cracked or broken.
<b>Rear springs</b>	
<b>Springs:</b>	Check for broken or shifted leaves or leaves that are in contact, or nearly contacting a tire, rim, brake drum, frame or body components. Check for missing or broken leaves in the leaf spring.
<b>Spring mounts:</b>	Check for cracked or broken spring hangers, broken, missing or loose bolts, missing or damaged bushings, broken, loose or missing axle mounting parts.
<b>Torsion, shocks:</b>	Make sure torsion arm is not cracked, broken or missing. Check the shock absorber for cracks or leaks; there should be no missing or broken mounting bolts or worn bushings.
<b>Rear brakes</b>	
<b>Hoses:</b>	Checked for cracked, worn or frayed hoses. Make sure all couplings are secured.
<b>Chambers:</b>	Make sure brake chambers are not cracked or dented and that they are securely mounted.
<b>Slack adjuster:</b>	Check for broken, loose or missing parts; the angle between the push rod and adjuster arm should be approximately 90° when the brakes are applied. When pulled by hand, the push rod should not move more than approximately one inch (2.5 cm).

## Vehicle Inspection Guide

<b>Rear brakes</b>	
<b>Drum:</b>	Make sure there are no cracks, dents or holes and no loose or missing bolts. Make sure brake linings are not worn or dangerously thin or contaminated by lubricant.
<b>Rear wheels</b>	
<b>Spacers:</b>	Make sure dual wheels are evenly separated and that tires are not touching one another.
<b>Rims:</b>	Check for damaged or bent rims. Rims should not have welding repairs and no rust trails that indicate it is loose on the wheel.
<b>Lug nuts:</b>	Make sure all lug nuts are present and not loose (look for rust trails around the lug nuts). There should be no cracks radiating from the lug bolt holes or distortion of the bolt holes.

### Trailer

If you are pulling a trailer, an inspection of the trailer similar to that of the tractor should be done. Such an inspection should follow trailer manufacturer recommendation and should include at a minimum: general condition, landing gear, doors, sides, lights, reflectors, suspension, brakes, tires, wheels, cargo placement, stability and tie-downs.

### Transmission

If your vehicle is equipped with an automatic transmission, regularly check the transmission's neutral start switch. The engine should only start in the N (Neutral) or P (Park) positions.



If the unit starts in gear and/or the neutral start switch is not functioning correctly, the vehicle may inadvertently move which could result in property damage, personal injury or death.

Check the transmission fluid level and shift linkage for proper operation.

## Instrument Cluster

### WARNING LIGHTS AND CHIMES

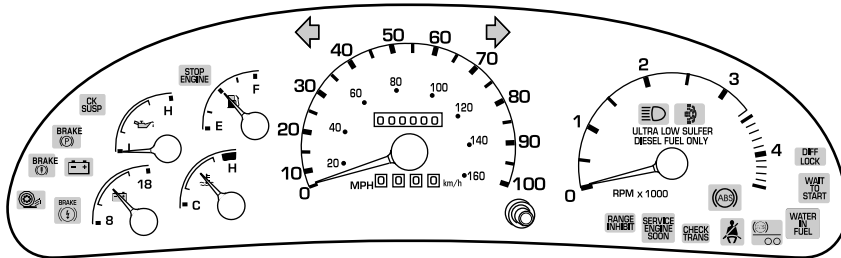

Warning lights and gauges can alert you to a vehicle condition that may become serious enough to cause expensive repairs. A warning light may illuminate when a problem exists with one of your vehicle's functions. Many lights will illuminate when you start your vehicle to make sure the bulb works. If any light remains on after starting the vehicle, have the respective system inspected immediately.

Some of the warning lights shown are optional based on vehicle equipment; your vehicle may not have some of the warning lights shown in this section.

**Service engine soon:** If this light illuminates while driving, it is a possible indication that one of the engine's emission control systems has failed.

SERVICE  
ENGINE  
SOON

**Check suspension (if equipped):** Illuminates when the air suspension dump switch has been activated.

CK  
SUSP

## Instrument Cluster

**Stop engine:** This light is used in conjunction with the electronic engine control. When illuminated, the STOP ENGINE lamp indicates the need to **stop** the engine as soon as it can be safely done.

**STOP  
ENGINE**

**If the STOP ENGINE lamp begins flashing automatic engine shutdown may take place in as little as 20 seconds.**



In the event of engine shutdown, make sure the vehicle is safely off the road and the problem is remedied prior to returning to the road. Failure to remove the vehicle from the road could result in an accident, causing serious injury or death.

Refer to your engine operator's manual for specific information regarding this feature.

If the engine shuts down, it can be restarted and operated for 30 seconds at a time or until the problem is corrected. For more information, refer to *Engine automatic shutdown warning light or chime* in the *Driving* chapter of this owner guide and/or your engine operator's manual.

**Drivers of electronically controlled engines should know the extent of warning engine shutdown system before operating the vehicle.**

**Brake reserve system warning:**

Illuminates to indicate normal Hydromax booster reserve system activation when the engine is OFF and the service brake pedal is applied.

**BRAKE**



This light may also illuminate momentarily if the engine is running and the driver turns the steering wheel fully in one direction while braking.

If the light remains on while the engine is running, this indicates inadequate hydraulic booster pressure or reserve pump system failure. Stop the vehicle safely as soon as possible and seek service immediately.

## Instrument Cluster

**Brake system warning light:** To confirm the brake system warning light is functional, this light will momentarily illuminate when the ignition is turned to the ON position when the engine is not running. If the brake system warning light does not illuminate at this time, seek service immediately from your dealership. Illumination after starting the vehicle indicates a pressure differential in the master cylinder and the brake system should be inspected immediately by your dealership.

If equipped with an air brake system, the warning light stays on until the air pressure builds up to 60 psi (414 kPa). If the air pressure drops below 60 psi (414 kPa) during operation, the remaining brake system is still operational but the stopping distance will be greater.

**BRAKE**  



Driving a vehicle with the brake system warning light on is dangerous. A significant decrease in braking performance may occur. It will take you longer to stop the vehicle. Have the vehicle checked by your dealer immediately. Driving extended distances with the parking brake engaged can cause brake failure and the risk of personal injury.

**Wait to start:** Indicates the air intake heater is in operation and special starting procedures are required. Refer to the *Driving* chapter.

**WAIT  
TO  
START**



If equipped with an air intake heater, DO NOT use ether or any other starting fluids. The use of starting fluids (ether) in an engine equipped with an air intake heater could result in damage and/or personal injury.



## Instrument Cluster

**Water in fuel:** During refueling, it is possible for water-contaminated diesel fuel to be pumped into your tank. Your vehicle fuel system is equipped with a fuel filter/water separator to remove water from the fuel. The WATER IN FUEL light will illuminate when the fuel filter/water separator has a significant quantity of water in it.

**WATER  
IN  
FUEL**

If the light illuminates when the engine is running, stop the vehicle as soon as safely possible, shut off the engine, then drain the fuel filter/water separator. Refer to your engine operator's manual for the drain procedure. Allowing water to stay in the system could result in extensive damage to, or failure of, the fuel injection system.

 Do not drain water separator while engine is running. Fuel may ignite if separator is drained while engine is running or vehicle is moving.

**Traction control (if equipped):** Illuminates and flashes slowly if the Off Road mode is selected and flashes rapidly during a traction control event.



**Differential lock:** Illuminates when the main differential is locked (engaged).

**DIFF  
LOCK**

**Parking brake warning:** Momentarily illuminates when the ignition is turned to the ON position and the engine is off. Also illuminates when the parking brake is engaged. If the brake warning lamp does not illuminate at these times, seek service immediately.



**Vehicles equipped with the Power Park (air-operated parking brake) option:** If after setting the parking brake on your vehicle the park brake warning lamp begins to blink, this may indicate a failure in the parking brake system. Seek service from your dealer immediately.

## Instrument Cluster

### **Trailer ABS brake system:**

Illuminates briefly when the engine is powered-up and only when a PLC trailer or a PLC diagnostic tool is connected. If the light remains on after the vehicle is started, continues to flash or fails to illuminate, have the system serviced immediately.

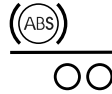

**Anti-lock brake system:** If the ABS light stays illuminated or continues to flash, a malfunction has been detected, have the system serviced immediately. Normal



braking is still functional unless the brake warning light also is illuminated.

### **Check trans (Allison automatic transmission only):**

The lamp will illuminate for several seconds after the ignition is turned to the ON position. Illumination of this light indicates that a problem has been detected and shifting may be restricted. Depending upon the severity of the problem, the read-out digit on the shifter display may be blank. Operation may continue in order to reach service assistance. The ECU may not respond to shift selector requests, since operating limitations are being placed on the transmission, i.e. upshifts and downshifts may be restricted. Direction changes will not occur.

**CHECK  
TRANS**

Refer to the *Transmission Operator's Manual* for more information.

**Safety belt:** Reminds you to fasten your safety belt.



**Range inhibit:** Illuminates when the transmission is not engaged in the selected gear. The warning light will go off when the gearshift lever is adjusted in to the appropriate gear.

**RANGE  
INHIBIT**

Refer to the *Transmission Operator's Manual* for more information.

## Instrument Cluster

**Charging system:** Illuminates when the battery is not charging properly.



**Diesel particulate filter (Cummins engines only):**

Illuminates if the soot in the DPF has reached a level where it requires operator assistance. Refer to *Diesel Particulate Filter* in the *Maintenance and Specifications* chapter and your engine operator's manual, for more details.



**Turn signal:** Illuminates when the left or right turn signal or the hazard lights are turned on. If the indicators stay on or flash faster, check for a burned out bulb.



**High beams:** Illuminates when the high beam headlamps are turned on.



**Safety belt warning chime:** Sounds when the key is in the ignition and the driver's safety belt is not fastened.

**Key-in-ignition warning chime:** Sounds when the key is left in the ignition in the OFF/LOCK or ACC position and the driver's door is opened.

**Headlamps on warning chime:** Sounds when the headlamps or parking lamps are on, the ignition is off (and the key is not in the ignition) and the driver's door is opened.

## Instrument Cluster

### GAUGES

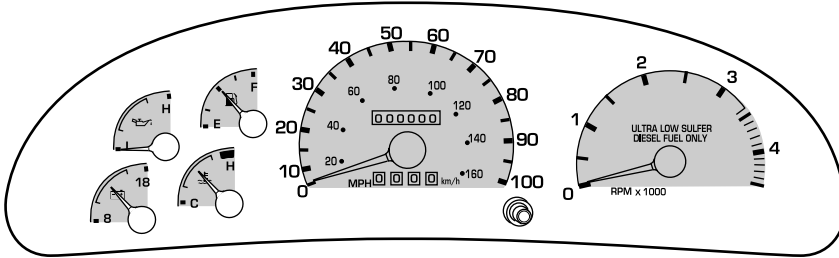

Some of the gauges shown are optional based on vehicle equipment; your vehicle may not have some of the gauges shown in this section.

**Speedometer:** Indicates the current vehicle speed.

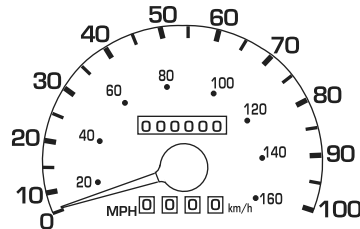

**Tachometer:** Indicates the engine speed in revolutions per minute. Driving with your tachometer pointer continuously at the top of the scale may damage the engine.

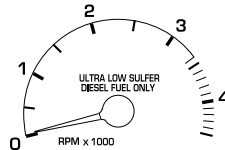

**Odometer:** Registers the total miles (kilometers) of the vehicle.

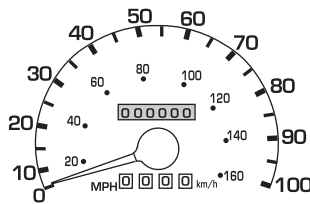

## Instrument Cluster

**Trip odometer:** Registers the miles (kilometers) of individual journeys. To reset, depress the control.

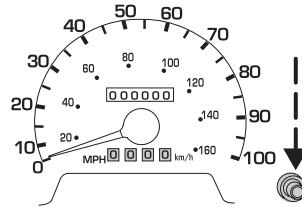

**Fuel gauge:** Indicates approximately how much fuel is left in the fuel tank (when the ignition is in the on position). If your vehicle is equipped with dual fuel tanks, the engine will draw fuel from the passenger-side fuel tank only. With dual fuel tanks, the vehicle will be equipped with a fuel transfer pump system that will draw fuel from the driver-side fuel tank and send fuel to the passenger-side fuel tank. The passenger-side fuel tank must have fuel in it at all times otherwise the vehicle may stall and may be difficult to re-start. The fuel gauge reads the fuel level only from the passenger-side fuel tank.

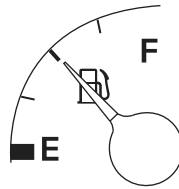

**Engine coolant temperature gauge:** Indicates engine coolant temperature. At normal operating temperature, the needle will be in the normal range (between “H” and “C”). **If it enters the red section, the engine is overheating. Stop the vehicle as soon as safely possible, switch off the engine and let the engine cool.**

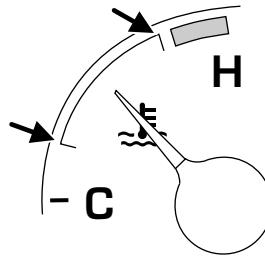

Never remove the coolant reservoir cap while the engine is running or hot.

## Instrument Cluster

### Engine oil pressure gauge:

Indicates engine oil pressure. The needle should stay in the normal operating range (as indicated by the arrows). If the needle falls below the normal range, stop the vehicle, turn off the engine and check the engine oil level. Add oil if needed. If the oil level is correct, have your vehicle checked at your dealership or by a qualified technician.

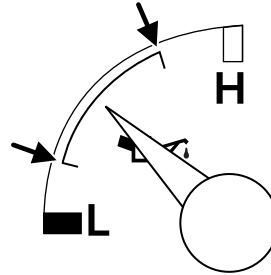

**Battery voltage gauge:** Indicates the battery voltage when the ignition is in the ON position. If the pointer moves and stays outside the normal operating range (as indicated by arrows), have the vehicle's electrical system checked as soon as possible.

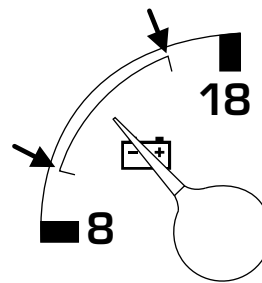

### Transmission fluid temperature gauge (if equipped, automatic transmission only):

Indicates the temperature of the transmission fluid. The normal temperature range is 150°–230°F (65°–110°C). Readings of 230°–250°F (110°–121°C) are satisfactory for intermittent operation and are not cause for alarm. Operation above 250°F (121°C) can cause the fluid to break down and will result in component damage.

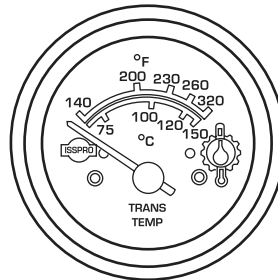

## Instrument Cluster

### **Hourmeter (if equipped):**

Registers the hours the engine has been operating.

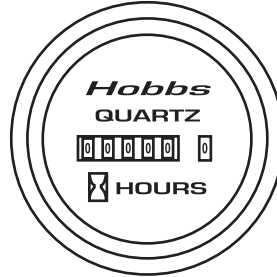

### **Air filter restriction gauge:**

Measures the vacuum inside the air cleaner. The more the air cleaner is restricted (dirty, clogged), the higher the vacuum reading. Change the air filter when the gauge reads 25 inches. After installation of the new filter element, reset the gauge to 0.

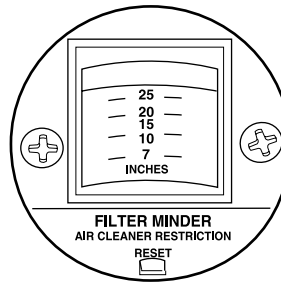

## Instrument Cluster

**Air pressure gauge:** All vehicles equipped with air brakes have a dual-pointer air gauge to indicate the pressure in each brake circuit. The green pointer indicates the air pressure in the primary system and the red pointer indicates the air pressure in the secondary system. When the pressure is too low for normal brake operation (less than 60 psi [414 kPa]) and the ignition is on:

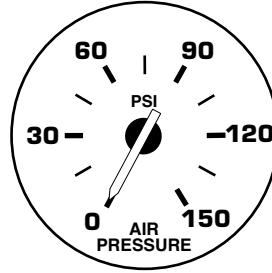

- a warning buzzer will sound and
- a warning light will illuminate in the instrument cluster



Do not drive the vehicle when the low air pressure buzzer is sounding or the warning light is lit. These warnings indicate there is not enough air pressure for the brake or suspension system to operate properly.

Vehicles equipped with hydraulic brakes and an air compressor have a single-pointer air gauge.

**Note:** This system does **not** have a low air pressure warning buzzer or a low air pressure warning light.



## Entertainment Systems

### AUDIO SYSTEMS

#### AM/FM stereo (if equipped)

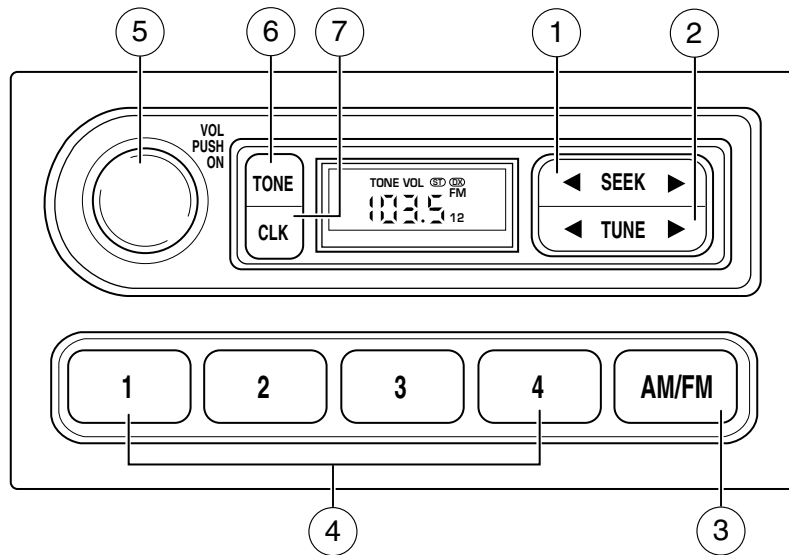

1. **SEEK:** Press ◀/▶ to find the next strong station down/up the frequency band.



2. **TUNE:** Press ◀/▶ to manually change radio frequency down/up.



3. **AM/FM:** Press to choose a frequency band in radio mode.



4. **Memory preset buttons:** To set a station: Select frequency band AM/FM; tune to a station, press and hold a preset button until sound returns.



## Entertainment Systems

5. **Power/Volume:** Press to turn ON/OFF; turn to increase or decrease volume levels.

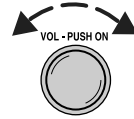

6. **TONE:** Press TONE until the desired level — Bass, Treble, Fade appears on the display. Turn the volume control to raise/lower the levels, or to move the audio sound from the right to left or the front to back (if equipped).

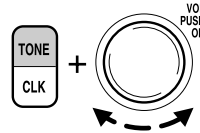

7. **CLK (Clock):** To set the hour, press and hold CLK until CLOCK SET appears in the display. Press SEEK to decrease ◀ or increase ▶ the hours.



To set the minute, press and hold CLK until CLOCK set appears in the display. Press TUNE to decrease ◀ or increase ▶ the minutes.

## Entertainment Systems

### Satellite Compatible AM/FM Stereo In-Dash Single CD/MP3 Radio (if equipped)

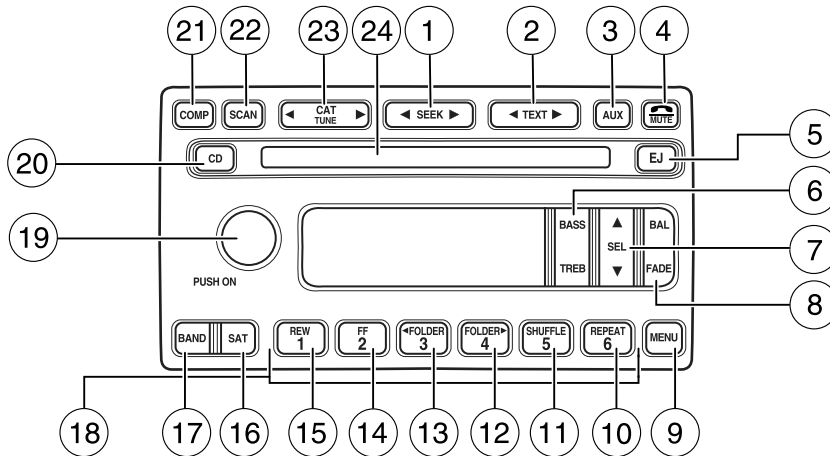

1. **SEEK:** Press and release  
SEEK ◀ / ▶ for previous/next  
strong station or track.



2. **TEXT:** The filename (Fi), song  
title (So), artist text (Ar) or album  
text (AL) may be viewed while  
playing an MP3 selection. When MP3 selection text is shown on the  
message display, its corresponding text indicator (Fi, So, Ar, or AL) is  
shown in the elapsed time display. Press TEXT to scroll through the text  
fields. The display will scroll through all of the text in the current field  
before changing to the next field. (TEXT must be pressed within 3  
seconds of the previous press to proceed to the next/last text display.  
The last text field shown on the display will become the new display  
message default.



TEXT is also available when equipped with Satellite radio. Your radio  
comes equipped with Satellite ready capability. The kit to enable Satellite  
reception is available through your dealer. Detailed Satellite instructions  
are included with the dealer installed kit.

*Dealer installed satellite kit only available in the continental United States.*

## Entertainment Systems

3. **AUX:** This function is not operational.



4. **MUTE:** Press to MUTE playing media; press again to return to playing media.



5. **EJ:** Press to eject a CD.



6. **Bass:** Press BASS; then press SEL ▼ / ▲ to decrease/increase the bass output.

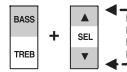

**Treble:** Press TREB; then press SEL ▼ / ▲ to decrease/increase the treble output.



7. **Select:** Use with Bass, Treble, Balance, Fade and other menu selections.



8. **Balance:** Press BAL; then press SEL ▼ / ▲ to shift sound to the left/right speakers.

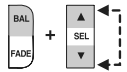

**Fade:** Press FADE; then press SEL ▼ / ▲ to shift sound to the rear/front speakers.



9. **Menu:** Press MENU and SEL to access AUTOSET and Setting the clock.

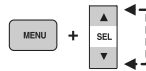

**Autoset:** Press MENU until AUTOSET appears in the display. Press SEL to toggle ON/OFF. Allows you to set the strongest local radio stations without losing your original manually set preset stations for AM/FM1/FM2. When the six strongest stations are filled, the station stored in preset 1 will begin playing. If there are less than six strong stations, the system will store the last one in the remaining presets.

**Setting the clock:** Press MENU until SELECT HOUR or SELECT MINUTE is displayed. Use SEL to manually increase (▲) or decrease (▼) the hours/minutes.

## Entertainment Systems

**Folder/Track mode:** In MP3 mode, press MENU until MODE appears in the display. Use SEL to toggle between FOLDER (only tracks within selected folder are accessible) or TRACK (all tracks on disc are accessible) MODE.

10. **REPEAT:** Repeats the current CD/MP3 track when active (ON). Press to show repeat status. Press again to toggle status.



11. **SHUFFLE:** Plays CD/MP3 tracks in random order when active (ON). Press to show shuffle status. Press again to toggle status.



12. **FOLDER▶:** Press to access the next MP3 directory.



13. **FOLDER◀:** Press to access the previous MP3 directory.



14. **FF**(Fast forward): In CD/MP3 mode, press until desired selection is reached.



15. **REW**(Rewind): In CD/MP3 mode, press until desired selection is reached.



16. **SAT (if equipped):** Your radio comes equipped with Satellite Ready capability. The kit to enable the Satellite reception is available through your dealer. Detailed satellite instructions are included with the dealer installed kit.



*Dealer installed satellite kit only available in the continental United States.*

17. **BAND:** Press to toggle between AM/FM1/FM2 frequency band.



18. **Memory presets:** To set a station: Select frequency band; tune to a station, press and hold a preset button until sound returns.



## Entertainment Systems

19. **Power/volume:** Press to turn ON/OFF; turn to increase or decrease volume levels.

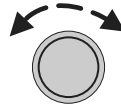

20. **CD:** Press to enter CD mode.



**CD units are designed to play commercially pressed 4.75 in (12 cm) audio compact discs only. Due to technical incompatibility, certain recordable and re-recordable compact discs may not function correctly when used in Ford CD players. Irregular shaped CDs, CDs with a scratch protection film attached, and CDs with homemade paper (adhesive) labels should not be inserted into the CD player. The label may peel and cause the CD to become jammed. It is recommended that homemade CDs be identified with permanent felt tip marker rather than adhesive labels. Ballpoint pens may damage CDs. Please contact your dealer for further information.**

21. **COMP**(Compression): Brings soft and loud CD passages together for a more consistent listening level when in CD mode. Press COMP to turn the feature ON/OFF.



22. **Scan:** Press SCAN to hear a brief sampling of radio stations or CD/MP3 tracks. Press again to stop.



23. **CAT/Tune:** Press ◀ or ▶ to manually tune down/up the radio frequency band.



**CAT (Category):** CAT is only available when equipped with Satellite Radio. Your radio comes equipped with Satellite ready capability. The kit to enable Satellite reception is available through your dealer. Detailed Satellite instructions are included with the dealer installed kit. *Dealer installed satellite kit only available in the continental United States.*

For information regarding SIRIUS Satellite Radio, please call toll-free 888-539-SIRIUS (888-539-7474) or visit the SIRIUS website at [www.siriusradio.com](http://www.siriusradio.com)

24. **CD slot:** Insert a CD with the label side up.

## Entertainment Systems

### Premium Satellite Compatible AM/FM Stereo In-Dash Six CD/MP3 Radio (if equipped)

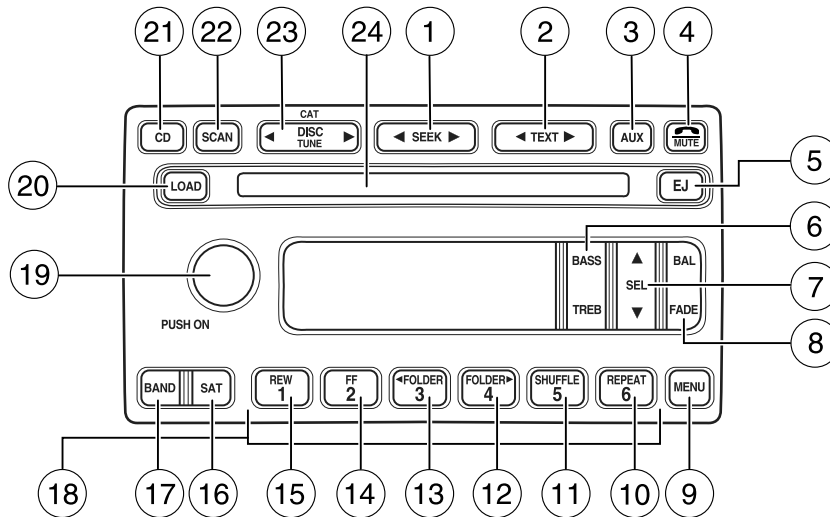

1. **SEEK:** Press and release SEEK ◀ / ▶ for previous/next strong station or track.



2. **TEXT:** The filename (Fi), song title (So), artist text (Ar) or album text (AL) may be viewed while playing an MP3 selection. When MP3 selection text is shown on the message display, its corresponding text indicator (Fi, So, Ar, or AL) is shown in the elapsed time display. Press TEXT to scroll through the text fields. The display will scroll all of the text in the current field before changing to the next field. (TEXT must be pressed within 3 seconds of the previous button press to proceed to the next/last text display.)



TEXT is also available when equipped with Satellite radio. Your radio comes equipped with Satellite ready capability. The kit to enable Satellite reception is available through your dealer. Detailed Satellite instructions are included with the dealer installed kit. *Dealer installed satellite kit only available in the continental United States.*

## Entertainment Systems

3. **AUX:** Press to toggle between the current playing media and DVD (if equipped).



4. **MUTE:** Press to MUTE playing media; press again to return to playing media



5. **EJ:** Press to eject a CD. Press EJ and a memory preset to eject a specific disc. Press and hold to eject all loaded discs.



6. **Bass:** Press BASS; then press SEL ▼ / ▲ to decrease/increase the bass output.



**Treble:** Press TREB; then press SEL ▼ / ▲ to decrease/increase the treble output.



7. **Select:** Use with Bass, Treble, Balance, Fade and other menu functions.



8. **Balance:** Press BAL; then press SEL ▼ / ▲ to shift sound to the left/right speakers.



**Fade:** Press FADE; then press SEL ▼ / ▲ to shift sound to the rear/front speakers.





## Entertainment Systems

9. **Menu:** Press to access the following functions:



**Compression:** Brings soft and loud CD passages together for a more

consistent listening level when in CD mode. Press MENU until compression status is displayed. Press the SEL control to enable the compression feature when COMPRESS OFF is displayed. Press the SEL control again to disable the feature when COMPRESS ON is displayed.

**Autoset:** Press MENU until AUTOSSET appears in the display. Press SEL to toggle ON/OFF. Allows you to set the strongest local radio stations without losing your original manually set preset stations for AM/FM1/FM2. When the six strongest stations are filled, the station stored in preset 1 will begin playing. If there are less than six strong stations, the system will store the last one in the remaining presets.

**Setting the clock:** Press MENU until SELECT HOUR or SELECT MINUTE is displayed. Use SEL to manually increase (▲) or decrease (▼) the hours/minutes. Press MENU again to disengage clock mode.

**Folder/Track Mode:** In MP3 mode, press MENU until MODE appears in the display. Use SEL to toggle between FOLDER (only tracks within selected folder are accessible) or TRACK (all tracks on disc are accessible) MODE.

10. **REPEAT:** Press to repeat the current CD/MP3 track. Press again to disable.



11. **SHUFFLE:** Press play the CD/MP3 tracks on the current disc in random order. Press again to disable.



12. **FOLDER ▶:** Press to access the next MP3 directory.



13. **FOLDER ◀:** Press to access the previous MP3 directory



14. **FF**(Fast forward): In CD/MP3 mode, press until desired selection is reached.



40

## Entertainment Systems

15. **REW**(Rewind): In CD/MP3 mode, press until desired selection is reached.



16. **SAT (if equipped)**: Your radio comes equipped with Satellite Ready capability. The kit to enable the Satellite reception is available through your dealer. Detailed satellite instructions are included with the dealer installed kit. *Dealer installed satellite kit only available in the continental United States.*



17. **BAND**: Press to toggle between AM/FM1/FM2 frequency band.



18. **Memory presets**: To set a station: Select frequency, tune to a station, press and hold a preset button until sound returns.



19. **Power/volume**: Press to turn ON/OFF; turn to increase or decrease volume levels.

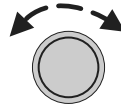

20. **Load**: Press to load a CD. Press LOAD and a memory preset to load to a specific disc slot. Press and hold to load up to six discs.



21. **CD**: Press to enter CD mode.



**CD units are designed to play commercially pressed 4.75 in (12 cm) audio compact discs only. Due to technical incompatibility, certain recordable and re-recordable compact discs may not function correctly when used in Ford CD players. Irregular shaped CDs, CDs with a scratch protection film attached, and CDs with homemade paper (adhesive) labels should not be inserted into the CD player. The label may peel and cause the CD to become jammed. It is recommended that homemade CDs be identified with permanent felt tip marker rather than adhesive labels. Ballpoint pens may damage CDs. Please contact your dealer for further information.**

## Entertainment Systems

22. **Scan:** Press SCAN to hear a brief sampling of radio stations or CD/MP3 tracks. Press again to stop.



23. **Disc/Tune:** Press ◀ or ▶ to manually tune down/up the radio frequency band, or to listen to the previous/next CD.



**CAT (Category):** CAT is only available when equipped with Satellite Radio. Your Audiophile radio comes equipped with Satellite ready capability. The kit to enable Satellite reception is available through your dealer. Detailed Satellite instructions are included with the dealer installed kit. *Dealer installed satellite kit only available in the continental United States.*

For information regarding SIRIUS Satellite Radio, please call toll-free 888-539-SIRIUS (888-539-7474) or visit the SIRIUS website at [www.siriusradio.com](http://www.siriusradio.com)

24. **CD slot:** Insert a CD, label side up.

### GENERAL AUDIO INFORMATION

#### Radio frequencies

AM and FM frequencies are established by the Federal Communications Commission (FCC) and the Canadian Radio and Telecommunications Commission (CRTC). Those frequencies are:

AM - 530, 540–1700, 1710 kHz

FM- 87.7, 87.9–107.7, 107.9 MHz

#### Radio reception factors

There are three factors that can effect radio reception:

- Distance/Strength: The further you travel from an FM station, the weaker the signal and the weaker the reception.
- Terrain: Hills, mountains, tall buildings, power lines, electric fences, traffic lights and thunderstorms can interfere with your reception.
- Station overload: When you pass a broadcast tower, a stronger signal may overtake a weaker one and play while the weak station frequency is displayed.

## Entertainment Systems

### CD/CD player care

Do:

- Handle discs by their edges only. Never touch the playing surface.
- Inspect discs before playing. Clean only with an approved CD cleaner and wipe from the center out.

Don't:

- Expose discs to direct sunlight or heat sources for extended periods of time.
- Insert more than one disc into each slot of the CD changer magazine.
- Clean using a circular motion.

**CD units are designed to play commercially pressed 4.75 inch (12 cm) audio compact discs only. Due to technical incompatibility, certain recordable and re-recordable compact discs may not function correctly when used in Ford CD players. Irregular shaped CDs, CDs with a scratch protection film attached, and CDs with homemade paper (adhesive) labels should not be inserted into the CD player. The label may peel and cause the CD to become jammed. It is recommended that homemade CDs be identified with permanent felt tip marker rather than adhesive labels. Ball point pens may damage CDs. Please contact your dealer for further information.**

### Audio system warranty and service

Refer to the *Warranty Guide* for audio system warranty information. If service is necessary, see your dealer or qualified technician.

## Climate Controls

### HEATER ONLY SYSTEM (IF EQUIPPED)

1. **Fan speed adjustment:** Controls the volume of air circulated in the vehicle.

2. **Temperature selection:** Controls the temperature of the airflow in the vehicle.

3. **Air flow selections:** Controls the direction of the airflow in the vehicle. See the following for a brief description on each control.

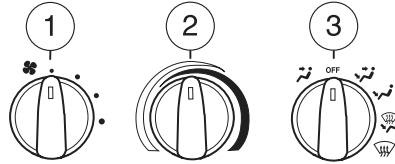

 : Distributes outside air through the instrument panel vents.

**OFF:** Outside air is shut out and the fan will not operate.

 : Distributes outside air through the instrument panel vents and the floor vents.

 : Distributes outside air through the floor vents.

 : Distributes outside air through the windshield defroster vents and floor vents.

 : Distributes outside air through the windshield defroster vents.

### Operating tips

- To reduce fog build up on the windshield during humid weather, place the air flow selector in the  position.
- To reduce humidity build up inside the vehicle during cold or warm weather, do not drive with the air flow selector in the OFF position.
- Under normal weather conditions, do not leave the air flow selector in OFF when the vehicle is parked. This allows the vehicle to “breathe” using the outside air inlet vents.
- Do not put objects under the front seats that will interfere with the air flow to the back seats.
- Remove any snow, ice or leaves from the air intake area at the base of the windshield.

## Climate Controls

To aid in side window defogging/demisting in cold weather:

1. Select 
2. Set the temperature control to full heat
3. Set the fan speed to its highest speed
4. Direct the outer instrument panel vents towards the side windows

To increase airflow to the outer instrument panel vents, close the vents located in the middle of the instrument panel.



Do not place objects on top of the instrument panel as these objects may become projectiles in a collision or sudden stop.

### MANUAL HEATING AND AIR CONDITIONING SYSTEM (IF EQUIPPED)

1. **Fan speed adjustment:** Controls the volume of air circulated in the vehicle.

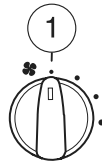

2. **Temperature selection:**

Controls the temperature of the airflow in the vehicle.

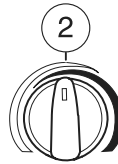

3. **Air flow selections:** Controls the direction of the airflow in the vehicle. See the following for a brief description on each control.

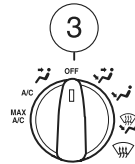

**MAX A/C:** Uses recirculated air to cool the vehicle. Air flows from the instrument panel vents only.

**A/C:** Uses outside air to cool the vehicle. Air flows from the instrument panel vents only.

 : Distributes outside air through the instrument panel vents.

**OFF:** Outside air is shut out and the fan will not operate.

 : Distributes outside air through the instrument panel vents and the floor vents.

 : Distributes outside air through the floor vents.

 : Distributes outside air through the windshield defroster vents and floor vents.

 : Distributes outside air through the windshield defroster vents.

## Climate Controls

### Operating tips

- To reduce fog build up on the windshield during humid weather, place the air flow selector in the  position.
- To reduce humidity build up inside the vehicle: do not drive with the air flow selector in the OFF or MAX A/C position.
- Under normal weather conditions, do not leave the air flow selector in MAX A/C or OFF when the vehicle is parked. This allows the vehicle to “breathe” using the outside air inlet vents.
- Do not put objects under the front seats that will interfere with the airflow to the back seats.
- Remove any snow, ice or leaves from the air intake area at the base of the windshield.

To aid in side window defogging/demisting in cold weather:

1. Select 
2. Select A/C
3. Modulate the temperature control to maintain comfort.
4. Set the fan speed to its highest speed
5. Direct the outer instrument panel vents towards the side windows

To increase airflow to the outer instrument panel vents, close the vents located in the middle of the instrument panel.



Do not place objects on top of the instrument panel as these objects may become projectiles in a collision or sudden stop.

## Lights

### HEADLAMP CONTROL

- Turns the lamps off.
- P☞ Turns on the parking lamps, instrument panel lamps, license plate lamps and tail lamps.
- ☞ Turns the headlamps on.

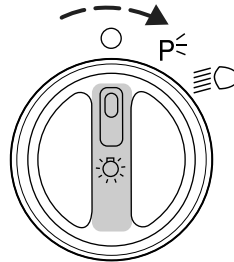

### High beams/Flash-to-pass

Push the lever toward the instrument panel to activate the high beams. Pull the lever towards you to deactivate.

Pull toward you slightly to activate flash-to-pass. Release to deactivate.

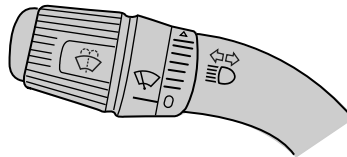

### Daytime Running Lamps (DRL) (if equipped)

Turns the headlamps on with a reduced output.

To activate:

- the ignition must be in the ON position and
- the headlamp control is in the OFF, parking lamp or autolamp position.



Always remember to turn on your headlamps at dusk or during inclement weather. The Daytime Running Lamp (DRL) system does not activate your tail lamps and generally may not provide adequate lighting during these conditions. Failure to activate your headlamps under these conditions may result in a collision.



## Lights

### PANEL DIMMER CONTROL

Use to adjust the brightness of the instrument panel and all applicable switches in the vehicle during headlamp and parklamp operation.

Rotate the control to the full up position, past the detent, to turn on the interior lamps.

Rotate the control to the full down position, past the detent, to prevent the interior lights from illuminating when the doors are opened.

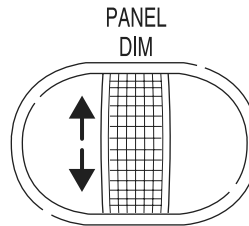

### AIMING THE HEADLAMPS

The headlamps on your vehicle are properly aimed at the assembly plant. If your vehicle has been in an accident the alignment of your headlamps should be checked by a qualified service technician.

### TURN SIGNAL CONTROL

- Push down to activate the left turn signal.
- Push up to activate the right turn signal.

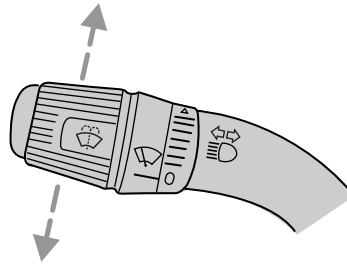

If your vehicle is a tractor, the turn signals may not shut off when a turn is completed; this is normal. Please see your dealer if there are any questions on the options your vehicle has been equipped with.

## Lights

### INTERIOR LAMPS

#### Map lamps (if equipped)

To turn on the map lamps, press the control next to each lamp.

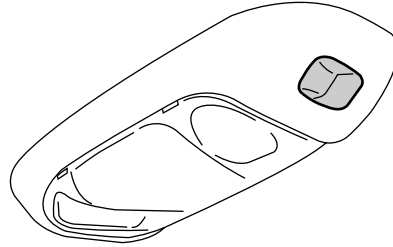

### EXTERIOR BULBS

#### Bulb inspection

It is a good safety practice to check operation of headlamps, parking lamps, turn signals, clearance and marker lamps, instrument panel and control lamps each day.

#### Using the right bulbs

Function	Number of bulbs	Trade number
Headlamps	2	H6054
Front turn signal lamps	2	1157
Front sidemarker/Park lamps	2 (amber)	194
Brake/Tail/Stop/Rear turn signal/License lamps	1 bulb each side	1157
Back-up lamps	2	1156
Front clearance and identification lamps	5	168
Dome lamp	1	105
To replace all instrument panel lights - see your dealer		

## Lights

### Bulb replacement

#### **Replacing headlamp bulbs**

To remove the headlamp bulbs:

1. Make sure the headlamp control is in the  position.
2. Remove the four screws and move the parking lamp assembly away from the headlamp bulb.

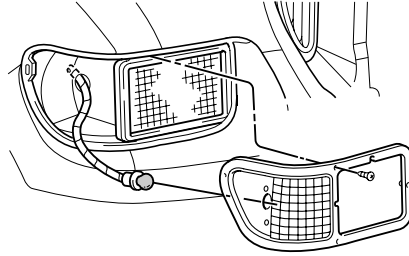

3. Remove the four screws and the retaining bracket from the headlamp bulb.

4. Pull the headlamp bulb out of the housing, disconnect the electrical connector and remove the headlamp bulb.

5. To complete installation, follow the removal procedure in reverse order.

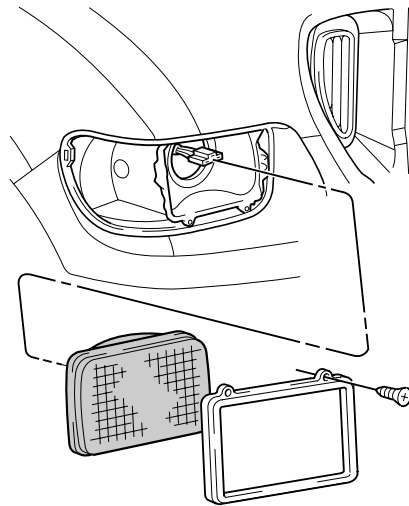

#### **Replacing front parking lamp/turn signal/side marker bulbs**

To remove the parking lamp/turn signal bulbs:

1. Make sure the headlamp control is in the  position and the turn signals are off.

## Lights

2. Remove the four screws from the lamp assembly.

3. Carefully lower the lamp assembly and pull the bulb socket straight out of the lamp assembly.

4. Carefully pull the bulb straight out of the socket and push in the new bulb.

5. To complete installation, follow the removal procedure in reverse order.

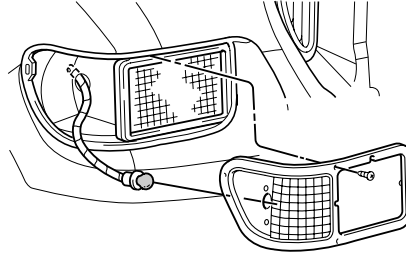

### **Replacing front clearance and identification lamp bulbs**

To change the cab marker bulbs:

1. Make sure the headlamp control is in the  position, then remove the screw and lens from the lamp assembly.

2. Carefully pull the bulb straight out of the socket and push in the new bulb.

3. Install the lens on lamp assembly with screw.

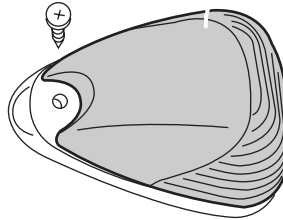

### **Replacing brake/tail/rear turn signal/back-up/license plate lamp bulbs**

The brake/tail/turn signal/back-up/license plate lamp bulbs are located in the same portion of the tail lamp assembly. Follow the same steps to replace any of these bulbs:

1. Make sure the headlamp control is in the  position and the turn signals are off, then remove the four screws and the lamp lens from lamp assembly.

2. Carefully pull the bulb straight out of the socket and push in the new bulb.

3. Install the lens on the lamp assembly with the four screws.

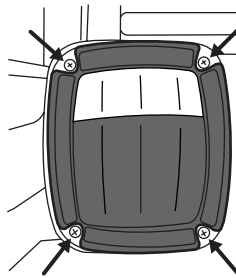

## Driver Controls

### MULTI-FUNCTION LEVER

#### Windshield wiper/washer controls

Rotate the windshield wiper control to the desired interval, low or high speed position.

The bars of varying length are for intermittent wipers. When in this position rotate the control upward for fast intervals and downward for slow intervals.

Push the control on the end of the stalk to activate washer. Push and hold for a longer wash cycle. The washer will automatically shut off after ten seconds of continuous use.

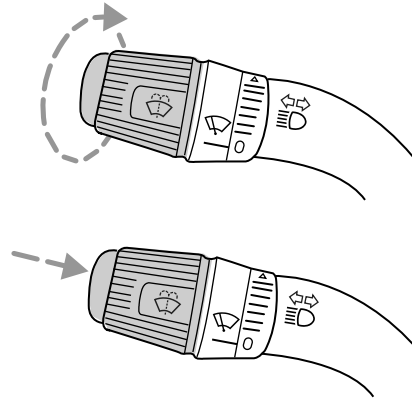

#### TILT STEERING

Pull the tilt steering control toward you to move the steering wheel up or down. Hold the control while adjusting the wheel to the desired position, then release the control to lock the steering wheel in position.

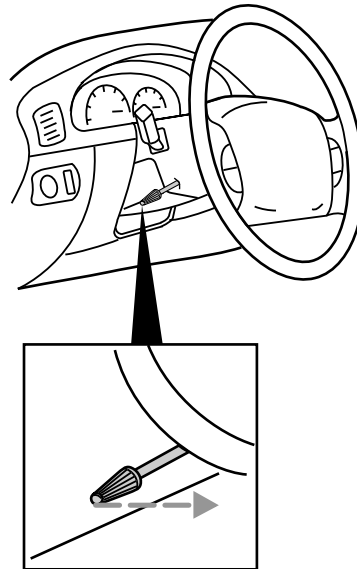

## Driver Controls



Never adjust the steering wheel when the vehicle is moving.

### AUXILIARY POWER POINT

The auxiliary power point is located on the instrument panel.

**Note:** Do not use the power point for operating the cigarette lighter element (if equipped).

**Note:** To prevent the fuse from being blown, do not use the power point(s) over the vehicle capacity of 12 VDC/180W.

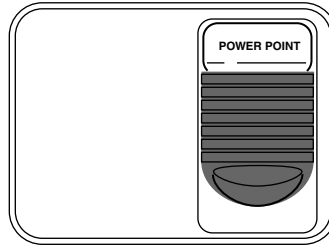

**Note:** To prevent the battery from being discharged, do not use the power point longer than necessary when the engine is not running.

**Power points are designed for accessory plugs only. Do not hang any type of accessory or accessory bracket from the plug.**

**Improper use of the power point can cause damage not covered by your warranty.**

**Do not plug optional electrical accessories into the cigarette lighter; use the power point.**

### POWER WINDOWS (IF EQUIPPED)



Do not leave children unattended in the vehicle and do not let children play with the power windows. They may seriously injure themselves.



When closing the power windows, you should verify they are free of obstructions and ensure that children and/or pets are not in the proximity of the window openings.

Press and hold the rocker switches to open and close windows.

## Driver Controls

- Press the top portion of the rocker switch to close.

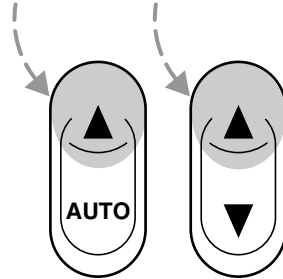

- Press the bottom portion of the rocker switch to open.

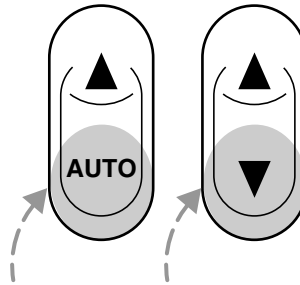

### One touch down

- Press AUTO completely down and release quickly. The driver's window will open fully. Depress again to stop window operation.

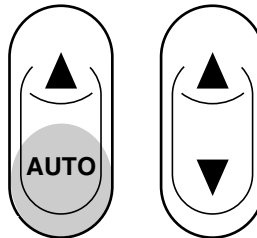

## Driver Controls

### Window lock

The window lock feature allows only the driver to operate the power windows.

To lock out all the window controls except for the driver's press the left side of the control. Press the right side to restore the window controls.

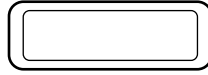

### EXTERIOR MIRRORS

With the doors closed and the seat adjusted for proper comfort, move the mirrors to maximize rear viewing area by adjusting the western mirrors left or right as required.

Adjust the auxiliary convex mirrors. Convex mirrors are a ball-stud design for precise adjustment to maximize viewing area.

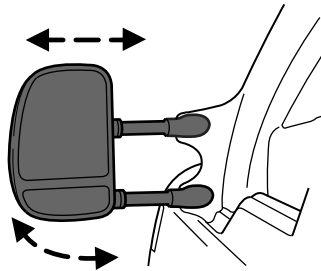
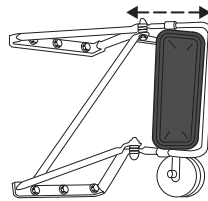



## Driver Controls

### Power side view mirrors (if equipped)

The ignition can be in any position to adjust the power side view mirrors.

To adjust your mirrors:

1. Select L to adjust the left mirror or R to adjust the right mirror.

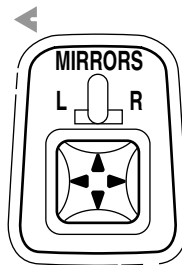

2. Move the control in the direction you wish to tilt the mirror.

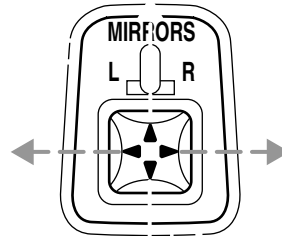

3. Return to the center position to lock mirrors in place.

4. If your vehicle's mirrors are equipped with spotter mirrors (located below the main mirrors), they must be adjusted manually.

### Heated mirrors (if equipped)

Both main mirrors are heated automatically to remove ice, mist and fog and are automatically activated when the vehicle is started.

**Note:** The mirrors may be **hot** to the touch but will not burn. This is a normal condition.

**Do not remove ice from the mirrors with a scraper or attempt to readjust the mirror glass if it is frozen in place. These actions could cause damage to the glass and mirrors.**

The mirror heating elements are designed to operate regardless of the geographic location of the vehicle. There is no switch to turn on, or other operator involvement required other than to start the vehicle.

## Driver Controls

The spotter mirror (if equipped) is not heated.

### Fold-away mirrors

The mirrors can be manually folded forward or backwards for narrow spaces like driving through an automatic car wash or backing out of a garage with the trailer tow mirror.

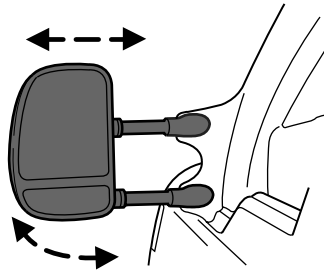

The telescoping feature (if equipped) allows the mirror to extend approximately three inches (76 mm). This feature is especially useful to the driver when towing a trailer.

### SPEED CONTROL (IF EQUIPPED)

#### To turn speed control on

Press CRUISE RPM. If the vehicle is moving, speed control will be enabled; if the vehicle is stationary, engine RPM can be controlled.

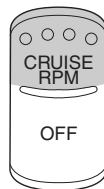

Do not use the speed control in heavy traffic or on roads that are winding, slippery, or unpaved.

**Do not shift the gearshift lever into N (Neutral) with the speed control on.**

## Driver Controls

### To turn speed control off

Press OFF or turn off the ignition.

Once speed control is switched off, the previously programmed engine RPM will be erased.

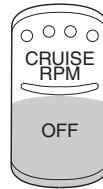

Do not use the speed control in heavy traffic or on roads that are winding, slippery, or unpaved.

### To set a speed

Press SET +. If the vehicle is moving, this will set the vehicle speed. If the vehicle is stationary, this will set the vehicle idle RPM.

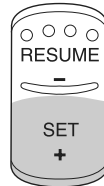

If you drive up or down a steep hill, your vehicle speed may vary momentarily slower or faster than the set speed; this is normal.

Speed control cannot reduce the vehicle speed if it increases above the set speed on a downhill. If your vehicle speed is faster than the set speed while driving on a downhill, you may want to shift to the next lower gear or apply the brakes to reduce your vehicle speed.

If the vehicle speed falls below 30 mph (48 km/h) or engine RPM falls below 1,000 RPM, your speed control will disengage; this is normal. Pressing RESUME - will re-engage it.



Do not use the speed control in heavy traffic or on roads that are winding, slippery, or unpaved.

## Driver Controls

### To set a higher set speed

Press and hold SET +. If the vehicle is moving, this will increase vehicle speed; if the vehicle is stationary, this will increase engine RPM. Release the control when the desired vehicle speed/engine RPM is reached.

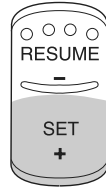

Press and release SET + to operate the tap-up function. Each press will increase the set speed by 1 mph (1.6 km/h) or engine RPM in idle mode.

### To set a lower set speed

Press and hold RESUME -. If the vehicle is moving, this will decrease vehicle speed; if the vehicle is stationary, this will decrease engine RPM. Release the control when the desired vehicle speed/engine RPM is reached.

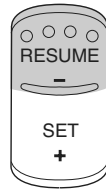

Press and release RESUME - to operate the tap-down function. Each press will decrease the set speed in increments of 1 mph (1.6 km/h) or engine RPM in idle mode.

## Driver Controls

### To disengage speed control

- Depress the brake pedal or

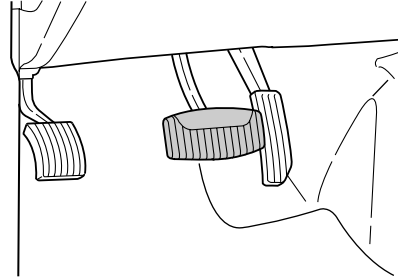

- Depress the clutch pedal (if equipped).

Disengaging the speed control will not erase the previously programmed set speed or engine RPM.

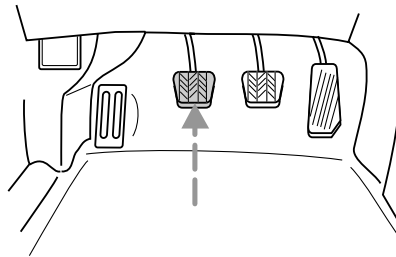

Pressing OFF will erase the previously programmed engine RPM.

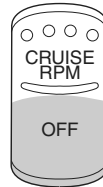

## Locks and Security

### To return to a previously set speed

Press RESUME -. For RESUME - to operate, the vehicle speed must be above 30 mph (48 km/h) or engine speed must be above 1,000 RPM.

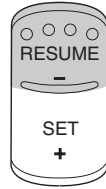

### KEYS

The key operates all locks on your vehicle. In case of loss, replacement keys are available from your dealer.

You should always carry a second key with you in a safe place in case you require it in an emergency.

### POWER DOOR LOCKS (IF EQUIPPED)

Press U to unlock all doors and L to lock all doors.

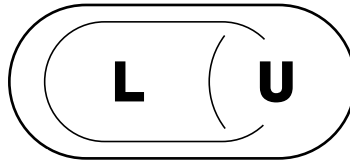

## Seating and Safety Restraints

### SEATING

#### Notes:



Reclining the seatback can cause an occupant to slide under the seat's safety belt, resulting in severe personal injuries in the event of a collision.



Do not pile cargo higher than the seatbacks to reduce the risk of injury in a collision or sudden stop.

#### 40/20/40 split bench seat (if equipped)

- Lift the track release bar to move the seat forward or backward. Ensure the seat is re-latched into place.
- Pull the handle on the side of the seat up to recline the seat.
- Push down the lever located at the bottom of the seatback to quickly fold the seatback forward.

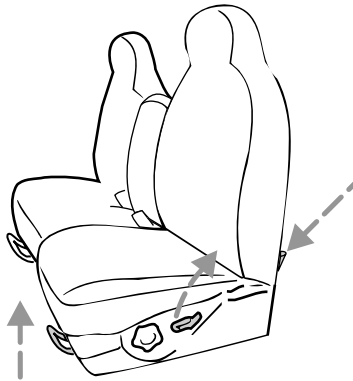

#### Recline seat (if equipped)

Move handle to the left to move seat forward or backward.

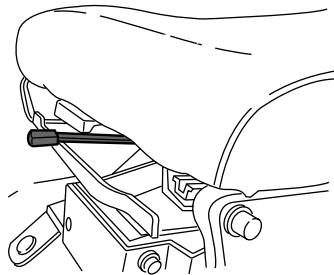

## Seating and Safety Restraints

Rotate control to adjust seatback.

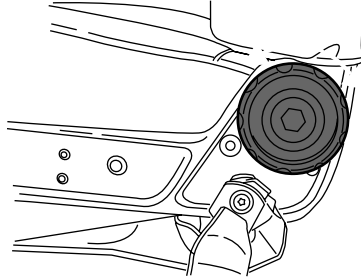

### Using the manual lumbar support

For more lumbar support, turn the lumbar support control toward the front of the vehicle.

For less lumbar support, turn the lumbar support control toward the rear of the vehicle.

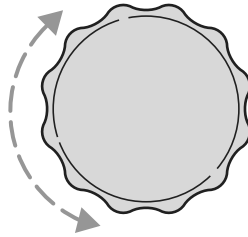

### Easy-Aire seat (if equipped)

Move handle to the left to move seat forward or backward.

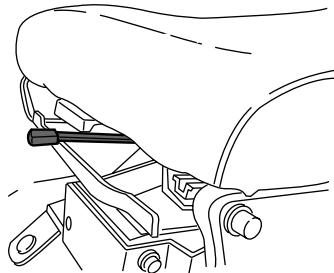



## Seating and Safety Restraints

Pull handle out to move the seat cushion forward or backward.

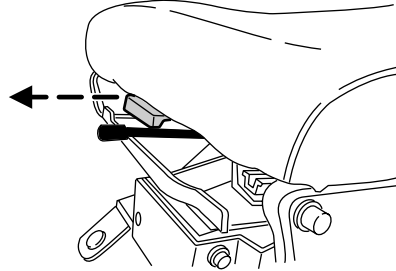

Rotate control to adjust seatback.

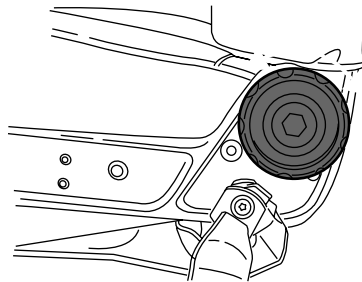

Pump handle to raise seat height.

Push handle full down to lower.



To reduce the risk of excess slack in the belt system, always adjust the seat height before fastening the seat belt.

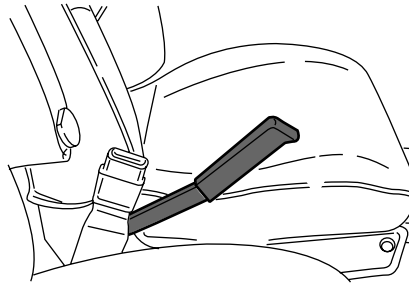

## Seating and Safety Restraints

### Adjusting the front power seat (if equipped)

The control is located on the outboard side of the seat cushion.

Press to raise or lower the front portion of the seat cushion.

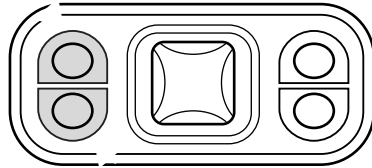

Press to raise or lower the rear portion of the seat cushion.

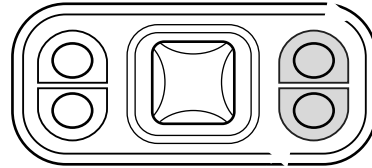

Press the control to move the seat forward, backward, up or down.

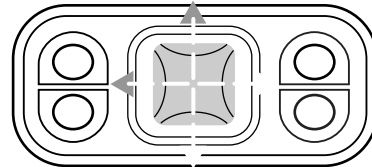

## Seating and Safety Restraints

### Air-Ride seat without self-contained pump (if equipped)

Move handle to the left to move seat forward or backward.

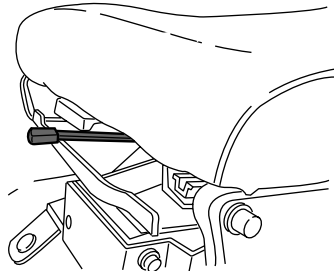

Push up on the switch to raise the seat height.

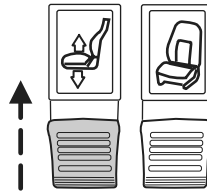

Press down on the switch to lower the seat height.

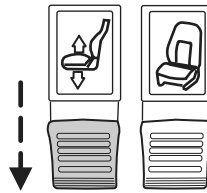

To reduce the risk of excess slack in the belt system, always adjust the seat height before fastening the seat belt.

Press up on the switch to increase the firmness (lumbar support) of the seatback.

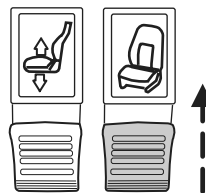

## Seating and Safety Restraints

Press down on the switch to reduce the firmness (lumbar support) of the seatback.

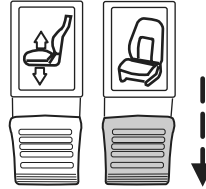

### Air-Ride seat with self-contained pump (if equipped)

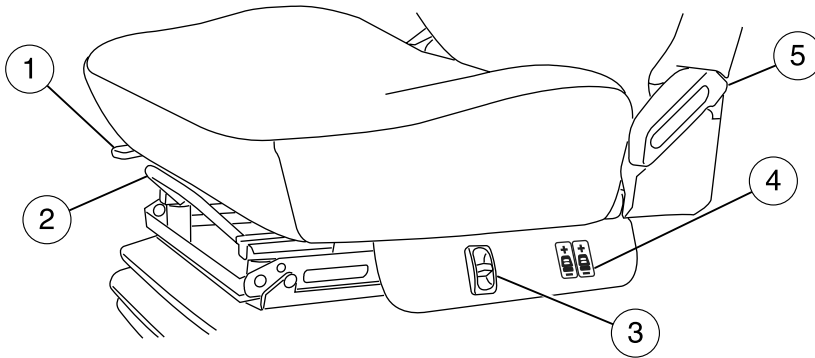

- 1. Chugger option:** Dampens road vibrations and allows the seat to move with the driver when unlocked.  
To unlock, sit in the seat and slide the tab away from the seat (to the right).  
To lock, sit in the seat and slide the tab toward the seat (to the left).
- 2. Seat adjuster:** Lift up to move the seat forward or backward. Release the bar to lock the seat in position.
- 3. Seat height adjuster:** Pull the control up to raise the seat, push it down to lower the seat.



To reduce the risk of excess slack in the belt system, always adjust the seat height before fastening the seat belt.

- 4. Power lumbar:** Press the top of the forward control to inflate the lower lumbar support; press the bottom of the forward control to deflate the lower lumbar support.

## Seating and Safety Restraints

Press the top of the rear control to inflate the upper lumbar support; press the bottom of the rear control to deflate the upper lumbar support.

5. **Recline:** Lift the handle to adjust the angle of the seatback.

### Heated seats (if equipped)

To operate the heated seats:

- Push control to activate.
- Push again to deactivate.



### REAR FLIP-UP SEAT (IF EQUIPPED)

#### Flipping up the seat

The rear seatback has a split 60/40 seat. Each seat cushion can be flipped-up into the seatback position.

1. Pull the control to release the seat cushion.
2. Rotate the seat cushion up until it locks into the vertical storage position.

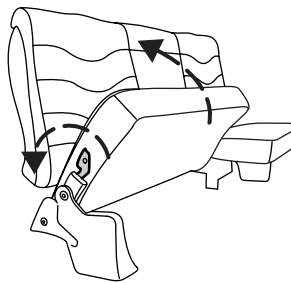

#### Returning the seat to horizontal position



Always latch the vehicle seat to the floor, whether the seat is occupied or empty. If not latched, the seat may cause injury during a sudden stop.



Make sure the safety belts are accessible and not trapped behind the seat when the seat is returned to its horizontal position.

1. Pull the control on the side of the seat to release the seat cushion from its storage position.
2. Push the seat cushion down until it locks into the horizontal position.

## Seating and Safety Restraints

### SAFETY RESTRAINTS

#### Safety restraints precautions



Always drive and ride with your seatback upright and the lap belt snug and low across the hips.



To reduce the risk of injury, make sure children sit where they can be properly restrained.



All occupants of the vehicle, including the driver, should always properly wear their safety belts.



Never let a passenger hold a child on his or her lap while the vehicle is moving. The passenger cannot protect the child from injury in a collision.



It is extremely dangerous to ride in a cargo area, inside or outside of a vehicle. In a collision, people riding in these areas are more likely to be seriously injured or killed. Do not allow people to ride in any area of your vehicle that is not equipped with seats and safety belts. Be sure everyone in your vehicle is in a seat and using a safety belt properly.



In a rollover crash, an unbelted person is significantly more likely to die than a person wearing a safety belt.



Each seating position in your vehicle has a specific safety belt assembly which is made up of one buckle and one tongue that are designed to be used as a pair. 1) Use the shoulder belt on the outside shoulder only. Never wear the shoulder belt under the arm. 2) Never swing the safety belt around your neck over the inside shoulder. 3) Never use a single belt for more than one person.

## Seating and Safety Restraints

### Combination lap and shoulder belts

1. Insert the belt tongue into the proper buckle (the buckle closest to the direction the tongue is coming from) until you hear a snap and feel it latch. Make sure the tongue is securely fastened in the buckle.

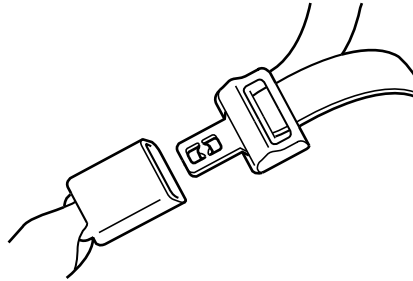

2. To unfasten, push the release button and remove the tongue from the buckle.

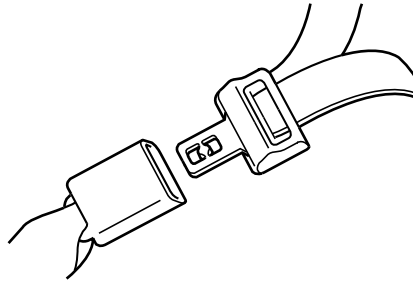

The front and rear outboard safety restraints in the vehicle are combination lap and shoulder belts. The front and rear seat passenger outboard safety belts have vehicle sensitive emergency locking retractors.

### Lap belts

The front center and rear center lap belts do not adjust automatically.



The lap belt should fit snugly and as low as possible around the hips, not across the waist.

Insert the tongue into the correct buckle (the buckle closest to the direction the tongue is coming from). To lengthen the belt, turn the tongue at a right angle to the belt and pull across your lap until it reaches the buckle. To tighten the belt, pull the loose end of the belt through the tongue until it fits snugly across the hips.

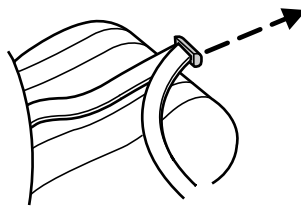

## Seating and Safety Restraints

Shorten and fasten the belt when not in use.

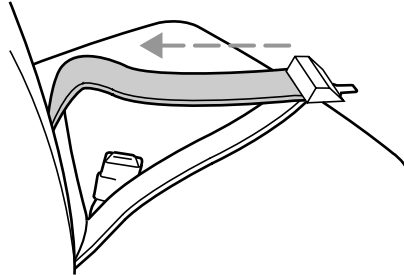

### Vehicle sensitive mode

The vehicle sensitive retractor allows free shoulder belt length adjustment to your movements and locks in response to vehicle movement. For example, if the driver brakes suddenly or turns a corner sharply, or the vehicle receives an impact of approximately 5 mph (8 km/h) or more, the combination safety belts will lock to help reduce forward movement of the driver and passengers.

### Front safety belt height adjustment

SuperCab and Crew Cab vehicles have safety belt height adjustments for the driver and front outboard passenger. Adjust the height of the shoulder belt so the belt rests across the middle of your shoulder.



## Seating and Safety Restraints

- SuperCab

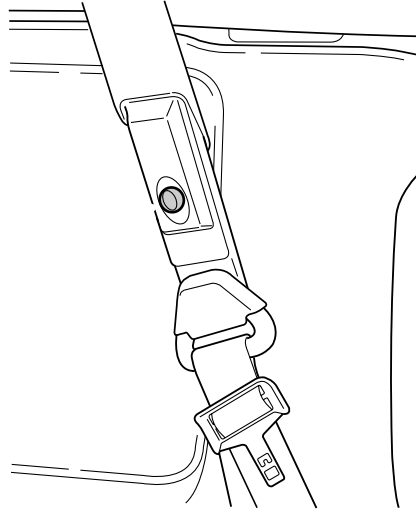

- Crew Cab

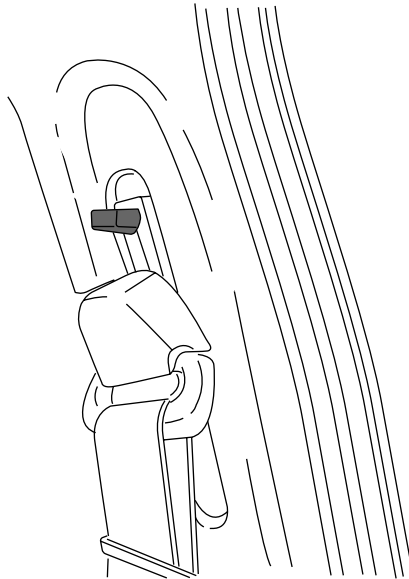

## Seating and Safety Restraints

To lower the shoulder belt height, push the button and slide the height adjuster down. To raise the height of the shoulder belt, slide the height adjuster up. Pull down on the height adjuster to make sure it is locked in place.



Position the safety belt height adjusters so that the belt rests across the middle of your shoulder. Failure to adjust the safety belt properly could reduce the effectiveness of the seat belt and increase the risk of injury in a collision.

### Safety belt extension assembly

If the safety belt is too short when fully extended, there is an eight inch (20 cm) safety belt extension assembly that can be added (part number 611C22). This assembly can be obtained from your dealer at no cost.

Use only extensions manufactured by the same supplier as the safety belt. Manufacturer identification is located at the end of the webbing on the label. Also, use the safety belt extension only if the safety belt is too short for you when fully extended.



Do not use extensions to change the fit of the shoulder belt across the torso.

### Safety belt maintenance

Inspect the safety belt systems periodically to make sure they work properly and are not damaged. Inspect the safety belts to make sure there are no nicks, tears or cuts. Replace if necessary. All safety belt assemblies, including retractors, buckles, front seat belt buckle assemblies, buckle support assemblies (slide bar-if equipped), shoulder belt height adjusters (if equipped), shoulder belt guide on seatback (if equipped), child safety seat tether anchors, and attaching hardware, should be inspected after a collision.



Ford Motor Company recommends that all safety belt assemblies used in vehicles involved in a collision be inspected for proper function and replaced, if necessary. Safety belt assemblies not in use during a collision should also be inspected and replaced if either damage or improper operation is noted.

## Seating and Safety Restraints



Failure to inspect and if necessary replace the safety belt assembly under the above conditions could result in severe personal injuries in the event of a collision.

Refer to *Interior* in the *Cleaning* chapter.

### Safety belt warning light and indicator chime

The safety belt warning light illuminates in the instrument cluster and a chime sounds to remind the occupants to fasten their safety belts.

#### Conditions of operation

If...	Then...
The driver's safety belt is not buckled before the ignition switch is turned to the ON position...	The safety belt warning light illuminates 1-2 minutes and the warning chime sounds 4-8 seconds.
The driver's safety belt is buckled while the indicator light is illuminated and the warning chime is sounding...	The safety belt warning light and warning chime turn off.
The driver's safety belt is buckled before the ignition switch is turned to the ON position...	The safety belt warning light and indicator chime remain off.

#### Belt-Minder®

The Belt-Minder® feature is a supplemental warning to the safety belt warning function. This feature provides additional reminders to the driver that the driver's safety belt is unbuckled by intermittently sounding a chime and illuminating the safety belt warning lamp in the instrument cluster.

## Seating and Safety Restraints

If...	Then...
The driver's safety belt is not buckled before the vehicle has reached at least 3 mph (5 km/h) and 1-2 minutes have elapsed since the ignition switch has been turned to ON...	The Belt-Minder® feature is activated - the safety belt warning light illuminates and the warning chime sounds for 6 seconds every 30 seconds, repeating for approximately 5 minutes or until safety belt is buckled.
The driver's safety belt is buckled while the safety belt indicator light is illuminated and the safety belt warning chime is sounding...	The Belt-Minder® feature will not activate.
The driver's safety belt is buckled before the ignition switch is turned to the ON position...	The Belt-Minder® feature will not activate.

The following are reasons most often given for not wearing safety belts:  
(All statistics based on U.S. data)

Reasons given...	Consider...
"Crashes are rare events"	<b>36700 crashes occur every day.</b> The more we drive, the more we are exposed to "rare" events, even for good drivers. <i>1 in 4 of us will be seriously injured in a crash during our lifetime.</i>
"I'm not going far"	<b>3 of 4</b> fatal crashes occur within <b>25</b> miles of home.
"Belts are uncomfortable"	We design our safety belts to enhance comfort. If you are uncomfortable - try different positions for the safety belt upper anchorage and seatback which should be as upright as possible; this can improve comfort.
"I was in a hurry"	<b>Prime time for an accident.</b> Belt-Minder® reminds us to take a few seconds to buckle up.
"Seat belts don't work"	<b>Safety belts</b> , when used properly, <b>reduce risk of death</b> to front seat occupants by <b>45% in cars</b> , and by <b>60% in light trucks</b> .

## Seating and Safety Restraints

Reasons given...	Consider...
"Traffic is light"	<b>Nearly 1 of 2 deaths occur in single-vehicle crashes</b> , many when no other vehicles are around.
"Belts wrinkle my clothes"	Possibly, but a serious crash can do much more than wrinkle your clothes, particularly if you are unbelted.
"The people I'm with don't wear belts"	Set the example, teen deaths occur 4 times more often in vehicles with TWO or MORE people. Children and younger brothers/sisters imitate behavior they see.
"I have an air bag"	Air bags offer greater protection when used with safety belts. Frontal air bags are not designed to inflate in rear and side crashes or rollovers.
"I'd rather be thrown clear"	Not a good idea. <b>People</b> who are <b>ejected are 40 times more likely to DIE</b> . Safety belts help prevent ejection, WE CAN'T "PICK OUR CRASH".



Do not sit on top of a buckled safety belt or insert a latchplate into the buckle to avoid the Belt-Minder® chime. To do so may adversely affect the performance of the vehicle's air bag system

### **One-time disable**

Any time the safety belt is buckled and then unbuckled during an ignition ON cycle, Belt-Minder® will be disabled for that ignition cycle only.

### **Deactivating/Activating the Belt-Minder® feature**

*Read Steps 1 - 9 thoroughly before proceeding with the deactivation/activation programming procedure.*

The Belt-Minder® feature can be deactivated/activated by performing the following procedure:

Before following the procedure, make sure that:

- The parking brake is set.
- The gearshift is in P (Park) (if equipped) or N (Neutral) (automatic transmissions) or the neutral position (manual transmission).
- The ignition switch is in the OFF position.
- All vehicle doors are closed.

## Seating and Safety Restraints

- The driver's safety belt is unbuckled.
- The headlamp control is in the ○ position.



While the design allows you to deactivate your Belt-Minder®, this system is designed to improve your chances of being safely belted and surviving an accident. We recommend you leave the Belt-Minder® system activated for yourself and others who may use the vehicle. To reduce the risk of injury, do not deactivate/activate the Belt-Minder® feature while driving the vehicle.

### **Belt-Minder® activation and deactivation procedure**

1. Turn the ignition switch to the RUN (or ON) position. (DO NOT START THE ENGINE.)
2. Wait until the safety belt warning light turns off. (Approximately 1–2 minutes.)
  - Steps 3–5 must be completed within 60 seconds or the procedure will have to be repeated.
3. Buckle then unbuckle the safety belt three times, ending with the safety belt unbuckled. This can be done before or during Belt-Minder® warning activation.
4. Turn on the parklamps/headlamps, turn off the parklamps/headlamps.
5. Buckle then unbuckle the safety belt three times, ending with the safety belt unbuckled.
  - After step 5 the safety belt warning light will be turned on for three seconds.
6. Within seven seconds of the safety belt warning light turning off, buckle then unbuckle the safety belt.
  - This will disable Belt-Minder® if it is currently enabled, or enable Belt-Minder® if it is currently disabled.
7. Confirmation of disabling Belt-Minder® is provided by the safety belt warning light flashing four times per second for three seconds.
8. Confirmation of enabling Belt-Minder® is provided by:
  - The safety belt warning light flashing four times per second for three seconds.
  - Followed by three seconds with the safety belt warning light off.
  - Once again, the safety belt warning light will flash four times per second for three seconds.

## Seating and Safety Restraints

9. After receiving confirmation, the deactivation/activation procedure is complete.

### SAFETY RESTRAINTS FOR CHILDREN

#### Important child restraint precautions

You are required by law to use safety restraints for children in the U.S. and Canada. If small children (generally children who are four years old or younger and who weigh 40 lb. [18 kg] or less) ride in your vehicle, you must put them in safety seats made especially for children. Many states require that children use approved booster seats until they are eight years old. Check your local and state or provincial laws for specific requirements regarding the safety of children in your vehicle. When possible, always place children under age 12 in the rear seat of your vehicle. Accident statistics suggest that children are safer when properly restrained in the rear seating positions than in the front seating position.



Never let a passenger hold a child on his or her lap while the vehicle is moving. The passenger cannot protect the child from injury in a collision.

Always follow the instructions and warnings that come with any infant or child restraint you might use.

#### Children and safety belts

If the child is the proper size, restrain the child in a safety seat.

Children who are too large for child safety seats (as specified by your child safety seat manufacturer) should always wear safety belts.

Follow all the important safety restraint precautions that apply to adult passengers in your vehicle.

If the shoulder belt portion of a combination lap and shoulder belt can be positioned so it does not cross or rest in front of the child's face or neck, the child should wear the lap and shoulder belt. Moving the child closer to the center of the vehicle may help provide a good shoulder belt fit.



Do not leave children, unreliable adults, or pets unattended in your vehicle.

## Seating and Safety Restraints



Safety belts and seats can become hot in a vehicle that has been closed up in sunny weather; they could burn a small child. Check seat covers and buckles before you place a child anywhere near them.

### Child booster seats

Children outgrow a typical convertible or toddler seat when they weigh 40 lb. (18 kg) and are around 4 years of age. Although the lap/shoulder belt will provide some protection, these children are still too small for lap/shoulder belts to fit properly, which could increase the risk of serious injury.

To improve the fit of both the lap and shoulder belt on children who have outgrown child safety seats, Ford Motor Company recommends use of a belt-positioning booster.

Booster seats position a child so that safety belts fit better. They lift the child up so that the lap belt rests low across the hips and the knees bend comfortably. Booster seats also make the shoulder belt fit better and more comfortably for growing children.

### When children should use booster seats

Children need to use booster seats from the time they outgrow the toddler seat until they are big enough for the vehicle seat and lap/shoulder belt to fit properly. Generally this is when they weigh about 80 lb. (36 kg) (about 8 to 12 years old).

Booster seats should be used until you can answer YES to ALL of these questions:

- Can the child sit all the way back against the vehicle seat back with knees bent comfortably at the edge of the seat without slouching?

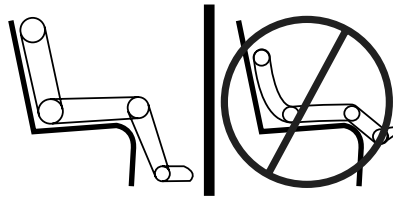

- Does the lap belt rest low across the hips?
- Is the shoulder belt centered on the shoulder and chest?
- Can the child stay seated like this for the whole trip?



## Seating and Safety Restraints

### **Types of booster seats**

There are two types of belt-positioning booster seats:

- Those that are backless.

If your backless booster seat has a removable shield, remove the shield and use the lap/shoulder belt. If a seating position has a low seat back and no head restraint, a backless booster seat may place your child's head (top of ear level) above the top of the seat. In this case, move the backless booster to another seating position with a higher seat back and lap/shoulder belts.



- Those with a high back.

If, with a backless booster seat, you cannot find a seating position that adequately supports your child's head, a high back booster seat would be a better choice.



Both can be used in any vehicle in a seating position equipped with lap/shoulder belts if your child is over 40 lb. (18 kg).

The shoulder belt should cross the chest, resting snugly on the center of the shoulder. The lap belt should rest low and snug across the hips, never up high across the stomach.

If the booster seat slides on the vehicle seat, placing a rubberized mesh sold as shelf or carpet liner under the booster seat may improve this condition.

### **The importance of shoulder belts**

Using a booster without a shoulder belt increases the risk of a child's head hitting a hard surface in a collision. For this reason, you should never use a booster seat with a lap belt only. It is best to use a booster seat with lap/shoulder belts in the back seat- the safest place for children to ride.

## Seating and Safety Restraints



Follow all instructions provided by the manufacturer of the booster seat.



Never put the shoulder belt under a child's arm or behind the back because it eliminates the protection for the upper part of the body and may increase the risk of injury or death in a collision.



Never use pillows, books, or towels to boost a child. They can slide around and increase the likelihood of injury or death in a collision.

### SAFETY SEATS FOR CHILDREN

#### Child and infant or child safety seats

Use a safety seat that is recommended for the size and weight of the child. Carefully follow all of the manufacturer's instructions with the safety seat you put in your vehicle. If you do not install and use the safety seat properly, the child may be injured in a sudden stop or collision.

When installing a child safety seat:

- Use the correct safety belt buckle for that seating position.
- Insert the belt tongue into the proper buckle until you hear a snap and feel it latch. Make sure the tongue is securely fastened in the buckle.
- Keep the buckle release button pointing up and away from the safety seat, with the tongue between the child seat and the release button, to prevent accidental unbuckling.

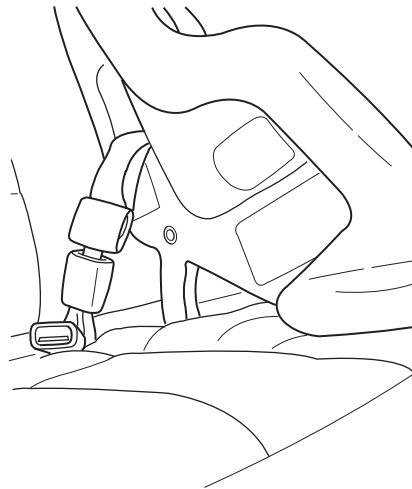

- Place seat back in upright position.

## Seating and Safety Restraints

Ford recommends the use of a child safety seat having a top tether strap. Install the child safety seat in a seating position with a tether anchor. For more information on top tether straps and anchors, refer to *Attaching safety seats with tether straps*.

 Carefully follow all of the manufacturer's instructions included with the safety seat you put in your vehicle. If you do not install and use the safety seat properly, the child may be injured in a sudden stop or collision.

### Installing child safety seats with combination lap and shoulder belts

1. Position the child safety seat in a seat with a combination lap and shoulder belt.

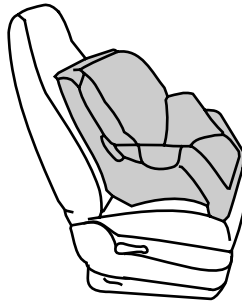

 Children under 12 are safer when properly restrained in the rear seat, to the extent this is possible.

2. While holding the shoulder and lap belt portions together, route the tongue through the child seat according to the child seat manufacturer's instructions. Be sure the belt webbing is not twisted.

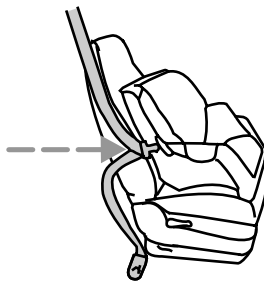

## Seating and Safety Restraints

3. Buckle the seat belt. Push down on the child seat and pull on the shoulder portion of the belt to snug the lap belt. Hold the lap and shoulder belts next to the tongue and unbuckle the belt.

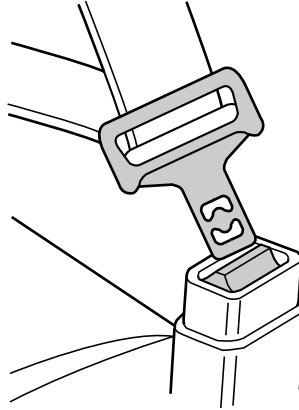

4. Install a locking clip over both lap and shoulder belt portions next to the sliding tongue. Rebuckle the belt. Obtain the locking clip kit (part number FO3Z-5461248-A) at no charge from an authorized Ford or Lincoln Mercury dealer.

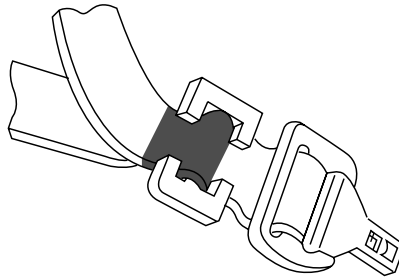

5. Before placing the child in the seat, forcibly tilt the seat forward and back to make sure the seat is securely held in place. To check this, grab the seat at the belt path and attempt to move it side to side and forward and back. There should be no more than one inch of movement for proper installation.

6. If the child seat is not tight enough, unbuckle the seat belt, move the tongue and locking clip to shorten the lap portion and push down hard on the child seat while you rebuckle the belt.

7. Check to make sure the child seat is properly secured before each use.

## Seating and Safety Restraints

### Attaching safety seats with tether straps

Most forward-facing child safety seats include a tether strap which goes over the back of the seat and hooks to an anchoring point. The F-650/750 vehicles are not equipped with an anchoring point. Tether straps are available as an accessory for many older safety seats. Contact the manufacturer of your child safety seat for information about ordering a tether strap.

### Tether anchorage hardware

A tethered seat can be installed in the front seat. Put the tether strap over the seatback and attach it to an anchor bracket.

An anchor bracket can be installed to the inside of the back panel of your vehicle.

The anchor bracket must be installed using the instructions provided with the tether anchorage hardware kit.

Tether anchorage hardware kits (part number 613D74) including instructions, may be obtained at no charge from any Ford or Lincoln Mercury dealer.

If you have a SuperCab or Crew Cab, Ford recommends you attach tether safety seats in the rear seating position (if possible) with the tether strap attached to the tether anchorage bracket as shown in the instructions provided with the tether anchor kit.



Tighten the anchor according to specifications. Otherwise, the safety seat may not be properly secured and the child may be injured in a sudden stop or collision.

### STARTING

#### Positions of the ignition

1. ACCESSORY, allows the electrical accessories such as the radio to operate while the engine is not running.

2. LOCK, locks the steering wheel, automatic transmission gearshift lever and allows key removal.

3. OFF, shuts off the engine and all accessories without locking the steering wheel.

4. ON, all electrical circuits operational. Warning lights illuminated. Key position when driving.

5. START, cranks the engine. Release the key as soon as the engine starts.

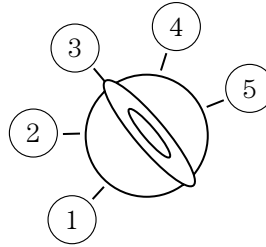

#### Starting the engine



Operation of a diesel engine near flammable vapors in the air may cause the engine speed to increase uncontrollably and over speed. If this situation occurs, mechanical damage, fire, explosion, personal injury or death could result. *Turning off the ignition key will not slow or stop the engine due to uncontrollable fueling of the engine through flammable vapors being drawn into the engine air inlet.* Operation of components such as starter, alternator, electric motors, etc. and static electricity could also ignite flammable vapors. Do not operate the truck in the possible presence of flammable vapors unless both a complete hazard analysis is performed and necessary additional safety processes and/or equipment such as vapor testing, air intake shutoff devices, ventilation, etc. are utilized. The operator is responsible for using those processes and/or equipment to ensure that the diesel engine and all other components on the truck can be operated safely under the specific conditions and hazards that may be encountered.

## Driving

**Note:** When starting the engine, do not press the accelerator as engine damage may result.

1. Ensure headlamps and all accessories are turned off, the parking brake is applied and the transmission is in the neutral position (or P [Park] for Allison 2200 transmissions).
2. Turn the key to ON, but do not start the engine. In cooler weather, the air intake heater may activate the WAIT TO START light in the instrument cluster.

If the WAIT TO START light illuminates, **do not** crank the engine until the light goes off.

**WAIT  
TO  
START**



If equipped with an air intake heater, **DO NOT** use ether or any other starting fluids. The use of starting fluids (ether) in an engine equipped with an air intake heater could cause an explosion and result in property damage and/or personal injury.

3. When the WAIT TO START light turns off, turn the key to START; when the engine starts, release the key.

If the engine does not start after 30 seconds of cranking, allow two minutes for the starter to cool before trying again. Excessive cranking may damage the starter.

After the engine starts:

- On some engines, the WAIT TO START light should illuminate after the engine starts. Allow the engine to idle about three minutes or until the engine coolant temperature gauge begins to rise. Maintain idle speed until the WAIT TO START light cycles off to indicate the air intake heater has shut off (approximately six minutes). Operating the engine at higher speeds will reduce the effectiveness of the air inlet heater.

**WAIT  
TO  
START**

## Driving

- Do not increase engine speed until the oil pressure gauge indicates normal pressure; this should be indicated on the gauge within 15 seconds after starting.
- Idle the engine for three to five minutes before operating with a full load.
- Try to limit engine idle to 10 minutes. Excessive idling reduces fuel economy.
- When starting a cold engine, increase the engine speed (RPM) slowly to make sure adequate lubrication is available to the bearings.

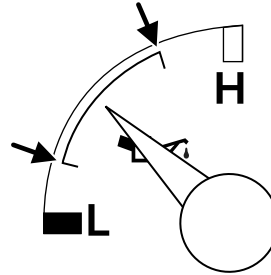

### Cold weather operation

 Do not use volatile starting aids such as ether, propane or gasoline in the engine air intake system. Glow plugs may ignite vapors which can cause engine damage or personal injury.

In order to operate the engine in temperatures of 32°F (0°C) or lower, read the following instructions:

- Make sure that the batteries are of sufficient size and are fully charged. Check other electrical components to make sure they're in optimum condition.
- Use a permanent-type engine coolant solution to protect the engine against damage from freezing.
- If your vehicle is equipped with a water-fuel separator, drain it daily. Fill the fuel tank at the end of daily operation to prevent condensation in the fuel system.
- Make sure you use proper cold weather engine oil and that it is at its proper level.
- At temperatures of -4°F (-20°C) or below, it is recommended that you use a crankcase-mounted coolant heater to improve cold engine starting.
- If operating in arctic temperatures of -20°F (-29°C) or lower, consult your truck dealer for information about special cold weather equipment and precautions.

**Note:** Idling in cold weather will not heat the engine to its normal operating temperature. Long periods of idling in cold weather can cause



## Driving

a buildup of heavy deposits of carbon and rust on valve stems causing them to stick which, in turn, can cause valvetrain damage.

### **Winter fronts**

The use of winter fronts, or other air-restrictive devices mounted in front of the radiator on vehicles with chassis-mounted charge air coolers, are not recommended unless extremely cold weather conditions exist. Air flow restriction can cause high exhaust temperatures, power loss, excessive fan usage and a reduction in fuel economy. If you must use a winter front, the device should have a permanent opening of at least 120 sq in. (774 sq. cm) directly in line with the fan hub.

### **Hot weather operation**

- Keep the engine cooling system filled with a clean, permanent coolant solution to protect against damage from overheating.
- Fill the fuel tank at the end of daily operation to prevent condensation in the fuel system.
- Keep external surfaces of the engine, radiator, charge air cooler, A/C condenser and accessories clean to avoid dirt build-up.

Above normal coolant temperatures could be experienced while driving in a transmission gear ratio which lugs the engine. To correct this problem, engine speed should be increased by downshifting in to the next lower gear to increase engine RPM.

### **Starting a turbocharged engine with the vehicle on a steep grade**

When starting a diesel engine when the loaded vehicle is on a grade, the engine RPM will start to fall slightly when the clutch is engaged; do not disengage the clutch and try to increase engine RPM as this may damage driveline components. The engine will recover as the vehicle begins moving.

### **Engine shutdown**

Allow the engine to idle for three to five minutes before shutting it down. The larger the engine, the greater the need for this idling period. However, do not let the engine idle for more than 10 minutes.

### **Restarting after running out of fuel**

The fuel system may need to be purged of air, refer to *Running out of fuel* in the *Maintenance and Specifications* chapter.

### GENERAL OPERATING INSTRUCTIONS

- Avoid extended and unnecessary idling.
- Start the vehicle in motion by using the highest gear speed in the transmission that will let the engine easily start the load without slipping the clutch.
- Accelerate smoothly and evenly; rapid acceleration increases fuel consumption without increasing engine performance.
- When approaching a hill, depress the accelerator smoothly to start the incline at full power, then shift down as needed to maintain vehicle speed.
- When going down a hill, or long steep grades, prevent over-speeding of the engine. The engine governor has no control over engine speed when it is being pushed by a loaded vehicle.
- Always shift to a lower gear at high altitudes to prevent engine smoking.
- Operate in a gear that will permit an engine speed not in excess of the maximum governed speed or high-idle RPM (no load).
- Normally, choose the same gear to descend the hill that you would use to ascend the hill.



All vehicles have blind spots. To reduce the risk of severe injury or property damage, never move your vehicle to the side or rear or change lanes without being sure your way is clear on both sides and to your rear.

### Backing up



To reduce the risk of the possibility of personal injury while backing the vehicle, always be sure your vehicle's path is clear.

Before backing your vehicle, be sure you can do so safely. If anything behind the cab limits your view, do not rely on mirrors alone to ensure that your intended path is clear. If other people are in the vicinity, have someone standing well behind your vehicle and outside of your intended path (visible through an exterior mirror) guide you as you back up.

Although OSHA or some governmental regulations may require the use of an electrical or mechanical back-up alarm to warn bystanders, such an alarm does not ensure that the intended path is clear. When in doubt,

## Driving

get out of the vehicle and visually check the intended path is clear; back-up slowly as to allow others time to move, if necessary.

If an electrical back-up alarm is installed, it should be connected to the back-up lamp circuit.

### Parking your vehicle

Always use the parking brake. When parking on a grade, block the wheels and turn the front wheels to one side so that if the vehicle rolls, the front tires will act against the curb to stop the vehicle. The front wheels will be more effective at stopping a rolling vehicle than the rear wheels.



When parking your vehicle, do not leave the transmission in gear; if the key is in the ON position and the vehicle rolls, the engine could start. Failure to follow these instructions could result in an unattended vehicle moving, possibly causing personal injury or property damage.

### Driving through water

If driving through deep or standing water is unavoidable, proceed very slowly especially if the depth is not known. Never drive through water that is higher than the bottom of the hubs (for trucks) or the bottom of the wheel rims (for cars). Traction or brake capability may be limited and your vehicle may stall. Water may also enter your engine's air intake and severely damage your engine, drive axles or the transmission (through the breather ports).

Once through the water, always dry the brakes by moving your vehicle slowly while applying light pressure on the brake pedal. Wet brakes do not stop the vehicle as quickly as dry brakes.

### ENGINE AUTOMATIC SHUTDOWN WARNING LIGHT OR CHIME (IF EQUIPPED)

Your vehicle may be equipped with an automatic shutdown feature that stops the engine in the event of high coolant temperature, low engine oil pressure, high diesel particulate filter soot loading or low engine coolant level. A warning light in the instrument cluster and a warning chime will indicate high engine coolant temperature, low engine oil pressure or the need to have the diesel particulate filter cleaned or serviced. If the engine coolant temperature becomes too high, engine oil pressure too low or the diesel particulate filter too restricted, the engine will automatically shut down.

## Driving

If the engine shuts down, it can be restarted and operated for 30 seconds at a time or until the problem is corrected. Do not attempt to use this restarting feature to drive the vehicle very far as serious engine damage could result.



In the event of engine shutdown, make sure the vehicle is safely off the road and the problem is remedied prior to returning to the road. Failure to remove the vehicle from the road could result in an accident, causing serious injury or death.

### GENERAL BRAKE INFORMATION

All standard equipment brakes are designed to be self-adjusting. Automatic adjustment, when required, occurs whenever the brakes are applied and released during forward or reverse operation. Refer to the *Scheduled Maintenance Guide* chapter for scheduled maintenance.

Occasional brake noise is normal and often does not indicate a performance concern with the vehicle's brake system. In normal operation, automotive brake systems may emit occasional or intermittent squeal or groan noises when the brakes are applied. Such noises are usually heard during the first few brake applications in the morning; however, they may be heard at any time while braking and can be aggravated by environmental conditions such as cold, heat, moisture, road dust, salt or mud. If a "metal-to-metal," "continuous grinding" or "continuous squeal" sound is present while braking, the brake linings may be worn-out and should be inspected by a qualified service technician.

Know the required stopping distances for all driving conditions that may be encountered. For longer brake lining life, take full advantage of engine braking power when coming to a stop.



Do not drive with your foot resting on the brake pedal. This will result in abnormally high brake temperatures, excessive lining wear and increased stopping distances.

Before descending a long or steep hill, shift to a lower gear and avoid continuous application of the brakes. Normally, choose the same gear to descend the hill that you would use to ascend the hill.



Continuous application of the brakes will cause the brakes to overheat, resulting in a temporary loss of braking.

## Driving

### If brakes do not grip well

- If you have been driving through deep water, gently apply the brakes several times while the vehicle is moving slowly.
- Let the brakes cool if you have been using them excessively, as in mountain driving or after several fast, high speed stops.
- Check brake adjustment.
- Check brake linings for excessive wear.
- Check system air pressure. (Air brakes only)

### HYDRAULIC BRAKES (IF EQUIPPED)

#### HydroMax brake booster system

The HydroMax systems receive fluid pressure from the power steering pump to provide power assist during braking.

The HydroMax booster receives back-up pressure from the reserve system electric pump whenever the fluid in the power steering system is not flowing. When the engine is off, the pump will turn on if the brake pedal is applied, or if the ignition is turned to the ON position.

The sound of the pump operating or fluid flowing through the booster may be heard; this is a normal characteristic of the system and should be no reason for concern.

The reserve system provides reduced braking power, so the vehicle should be operated under these conditions with caution, and only to seek service repair and remove the vehicle from the roadway.

If braking performance or pedal response becomes very poor, even when the pedal is strongly applied, this may indicate the presence of air in the hydraulic system or fluid leakage. Stop the vehicle safely as soon as possible and seek service immediately.

If the red BRAKE warning lamp in the instrument cluster remains illuminated after engine start up, this indicates a system failure in the master cylinder of the brake system. Stop the vehicle safely as soon as possible and seek service immediately.

**BRAKE**  
(!)

## Driving

If the yellow BRAKE RESERVE (E-motor) warning light remains on while the engine is running, this indicates inadequate hydraulic booster pressure or reserve pump system failure. Stop the vehicle safely as soon as possible and seek service immediately.



### Parking brake

Apply the parking brake whenever the vehicle is parked. To set the parking brake, pull handle up until it snaps into the locked position.

 Do not use the gearshift selector in place of the parking brake. Always set the parking brake fully AND make sure the gearshift selector is in R (Reverse) for vehicles equipped with manual transmission, P (Park) **(if equipped)** or N (Neutral) for vehicles with automatic transmission. Use of wheel chocks is also recommended in hilly or off-road usage.

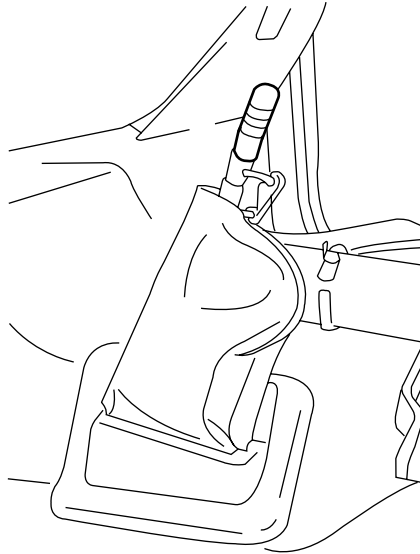

 Unexpected and possible sudden vehicle movement may occur if these precautions are not taken.

When the parking brake is out of adjustment, seek service immediately.

## Driving

The parking BRAKE warning lamp in the instrument cluster illuminates and will remain illuminated (when the ignition is turned on) until the parking brake is released.



Push the palm release lever on the parking brake handle and push down as far as possible to release the brake. Driving with the parking brake on will cause the brakes to wear out quickly and reduce fuel economy.



If the parking brake is fully released but the parking brake warning lamp remains illuminated, the brakes may not be working properly. See your dealer or a qualified service technician.

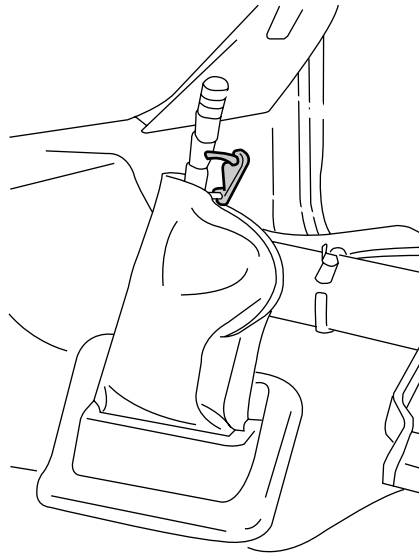

The parking brake is not recommended to stop a moving vehicle. However, if the normal brakes fail, the parking brake can be used to stop your vehicle in an emergency. Since the parking brake only applies retardation to the rear wheels, the vehicle's stopping distance will increase greatly and the handling of your vehicle will be adversely affected.

### **POWER PARK (AIR-OPERATED PARKING BRAKE) OPTION (IF EQUIPPED)**

This feature uses a brake chamber mounted on the chassis to power a spring-applied, air-released driveline parking brake. It is controlled by a yellow, dash-mounted parking brake knob.

### Applying the parking brake

To apply the parking brake, pull the yellow, dash-mounted parking brake knob. A red light on the dash panel should illuminate indicating that the parking brake has been successfully set.

**Note:** If the park brake indicator light blinks and a warning chime sounds when the control knob is pulled, the parking brake is not functioning properly; seek immediate service from your dealer. Refer to the *Parking Brake Warning System* section.

### Releasing the parking brake

**Note:** Read and understand the following steps and perform them whenever you prepare to drive the vehicle.

**Note:** The parking brake will not disengage unless sufficient system air pressure is available.

#### ***For vehicles with automatic transmissions - dash-mounted push button (Allison 3000 Series) and steering column-mounted (Allison 2200 and 2500) gear selection:***

1. With the engine running, depress and hold the service brake pedal.
2. Wait until system air pressure is above 100 psi (690 kPa).
3. Select the appropriate drive gear.
4. Push the yellow, dash-mounted parking brake knob.

#### ***For vehicles with manual transmissions - (TTC 7-speed, Eaton/Fuller 5-speed and 6-speed):***

1. With the engine running, depress and hold the service brake pedal.
2. Wait until system air pressure is above 100 psi (690 kPa).
3. Depress and hold the clutch pedal.
4. Select the appropriate drive gear.
5. Push the yellow, dash-mounted parking brake knob.



Hold the brake pedal down while moving the gearshift lever from position to position. If the brake pedal is not held down, the vehicle may move unexpectedly resulting in property damage, personal injury or death.

### Parking brake light illumination due to low air pressure

If at any time during vehicle operation air pressure is too low, the parking brake may apply and the parking brake light will turn on.



## Driving

If the parking brake is applied due to low air pressure, immediate service is required to the parking brake system.

### Parking brake warning system

If the park brake light blinks and a chime sounds when pulling the yellow control knob out, this indicates the parking brake is not functioning properly; seek service for the parking brake immediately.

The light will blink and the chime will sound until the yellow control knob is pushed in or approximately eight minutes have passed. If the yellow control knob is pulled out again, the light will blink and the chime will sound as a reminder that immediate service is required to the parking brake system.

### Releasing spring manually



Do not attempt to disassemble the parking brake chamber under any circumstances. The high spring load may cause serious injury.

If air pressure is released from the spring brake chamber the power spring applies the brake and, unless air pressure can be re-established, the spring brake must be released as follows in order to move the vehicle.



Block the wheels to help prevent the vehicle from moving.



Unexpected and possibly sudden vehicle movement may occur if these precautions are not taken.

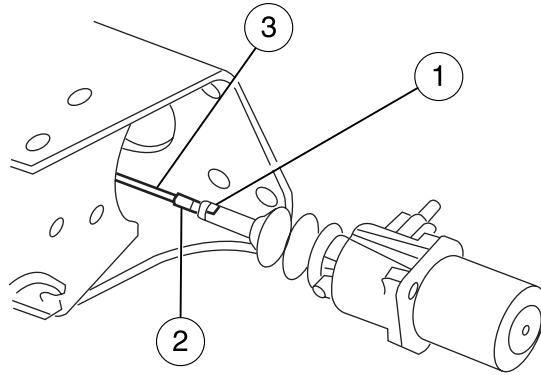

Loosen the jam nut (1) and un-thread the adjustment rod (2) from the chamber to reduce tension on the cable (3). Continue to un-thread the adjustment rod all the way and remove it from the chamber. The nut and shaft are metric.

### **AIR BRAKES (IF EQUIPPED)**

#### **General air brake information**

After starting the engine, give the air compressor time to build up the air pressure to 60 psi (414 kPa) before moving the vehicle.



Do not drive or continue to drive if the low air pressure buzzer is sounding or the brake warning light is lit. These warnings indicate that air pressure is not to normal operating level. Continued use of the vehicle could result in loss of braking ability.



Avoid repeated light application of the brake pedal. This will deplete air pressure faster and could result in loss of braking capability.

## Driving

Periodically check the air pressure gauge while driving. Pressure should range between approximately 100–125 psi (690–862 kPa). The air compressor governor cut-in and cut-out pressure settings are preset at the factory and are not adjustable.

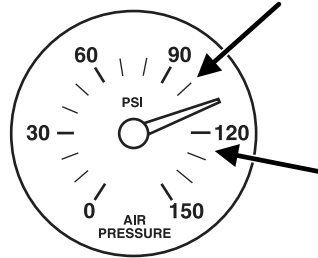

When air pressure is insufficient (below 60 psi [414 kPa]), a warning light illuminates and a buzzer sounds when the ignition is in the ON position.



This condition may be caused by excessive brake applications depleting the system air pressure. If this condition occurs, stop driving the vehicle until the compressor has fully recharged the air system.



Do not move the vehicle when the air pressure is insufficient because the brake system may be inoperative.

Select a gear ratio to help slow your vehicle before descending grades. Supplement with brakes as required to safely slow the vehicle and avoid overspeeding the engine.

### **Air chamber stroke indication**

Air chamber push rods have orange stroke indicator markers that warn when the braking system requires adjustment or repair. The orange stripe is painted on the air chamber push rod at the slack adjuster stroke dimension which requires service when visible during brake application.

Air brake inspection and adjustment or repairs should be performed by a qualified service technician in accordance with the instructions in the service manual.

### **Cam brakes - automatic slack adjusters**

Standard air brakes (cam) are equipped with automatic brake adjusters. Automatic adjustment occurs during brake applications. Inspect brakes for proper adjustment at the intervals listed in the *Scheduled Maintenance Guide* chapter.

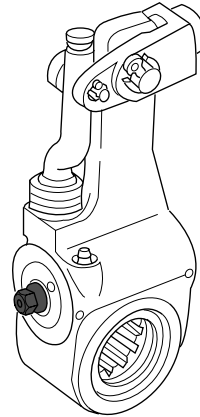

 Do not manually adjust the automatic slack adjusters to correct excessive pushrod stroke as it may result in reduced brake effectiveness and a vehicle crash. Excessive pushrod stroke indicates that a problem exists with the automatic adjuster, with the installation of the adjuster, or with foundation brake components that manual adjustment will not remedy. Seek service from a qualified facility for excessive pushrod stroke.

### **Emergency air brake**

All vehicles are equipped with a dual brake system. In the unlikely event of a failure of one system, the second system will function for emergency stopping. These systems are all controlled by the brake pedal in the same manner as for normal stops.

 Do not continue to operate the vehicle with a failure of one of the brake systems. Take the vehicle to your dealer for service immediately.

### **Air brake reservoir draining**

 Failure to drain air brake reservoirs can result in a reduction or loss of braking ability due to fluid accumulation in the reservoir and/or possible freeze-up during cold weather.

## Driving

Drain all the air brake reservoirs daily, completely to 0 psi/kPa, by opening the draincock at the ends of the tanks (where accessible). Pull-chains are used when the drains are undercab or otherwise inaccessible). Close draincock after complete draining. Air tanks equipped with automatic moisture ejector valves may also be drained manually as required to maintain a dry air system. Contact your dealer if you are unsure of the air reservoir locations or the draining procedure.

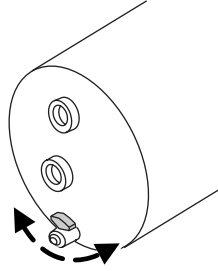

## Parking brake



Do not use the gearshift selector in place of the parking brake; unexpected and possible sudden vehicle movement may occur if these precautions are not taken. Always set the parking brake fully AND make sure the gearshift selector is in R (Reverse) for vehicles equipped with manual transmission, N (Neutral) for vehicles with automatic transmission (except Allison 2200 transmission) or P (Park) (Allison 2200 transmission).

If the service brakes should fail to operate while the vehicle is in motion, you can make an emergency stop with the parking brake. Since the parking brake only applies stopping power to the rear wheels, the vehicle's stopping distance will greatly increase and the handling of the vehicle will be adversely affected. Repairs should be made immediately to an inoperative air brake system circuit.

### **Parking brake control (knob)**

Pull the yellow parking brake knob out to apply the parking brake. Push the knob in to release the parking brake.



This control is used for parking only. Do not leave the vehicle unattended after setting the parking brake without placing the transmission in R (Reverse) for manual transmission, N (Neutral) for automatic transmission (except Allison 2200 transmission) or P (Park) (Allison 2200 transmission). Use of wheel chocks is also recommended in hilly or off-road usage.



The parking BRAKE warning lamp in the instrument cluster illuminates and remains illuminated (when the ignition is turned ON) until the parking brake is released.



### **Releasing spring brake with air pressure**

The air system in all vehicles with spring-actuated rear wheel parking brakes is equipped with a tank valve located on the supply or service air tank for connection to an outside air supply. The valve permits the system to be recharged with air from an outside source, releasing the spring-actuated parking brakes. The vehicle may then be towed in an emergency.

An outside air source can be used only if the protected system is in operating condition. If air pressure cannot be restored in the protected air system, the spring-actuated brakes must be released manually.

## Driving

### **Releasing spring brake manually**



Do not attempt to disassemble the parking brake chamber under any circumstances. The high spring load may cause serious injury if the chamber clamps are removed.

If air pressure is released from the spring brake chamber the power spring applies the brake and, unless air pressure can be re-established, the spring brake must be released as follows in order to move the vehicle.



Block the wheels to help prevent the vehicle from moving.



Unexpected and possibly sudden vehicle movement may occur if these precautions are not taken.

Impact wrenches should not be used as they may damage the piston and prevent proper caging of the spring. Do not apply more than 50 lb. ft. (68 N•m) torque to the release bolt nut.

1. Remove the stud tool and nut from the carrying pocket on the brake chamber assembly.
2. Remove the access plug from the end of the spring chamber.
3. Insert the release stud through the opening in the chamber and into the spring pressure plate.

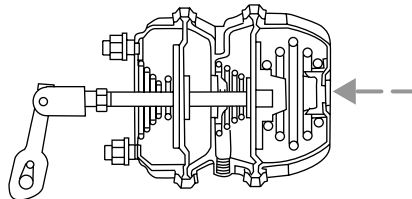

## Driving

4. Turn the release stud one-quarter turn to engage the stud tangs with the slot in the pressure plate. Keep the stud engaged and install the nut on the release stud.

5. Tighten the nut until the spring is fully caged and the brakes are released. Do not loosen or remove the release stud and nut unless the brake chamber is completely assembled and is securely clamped.

6. When the air pressure is restored, unscrew and remove the release stud and install in the carrying pocket. Install the access plug.

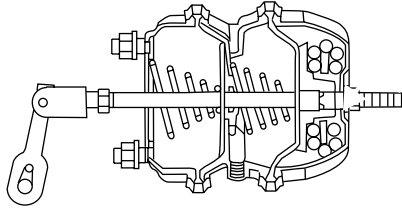

### EXHAUST BRAKE (IF EQUIPPED)

**Note:** The exhaust brake is intended to help control vehicle speed; it is not a vehicle stopping device.

An exhaust brake is an optional auxiliary braking system that assists, but does not replace, the primary service brake system. An on-off switch on the instrument panel, in combination with the accelerator and clutch pedal switches, allows the operator to make maximum use of the exhaust brake in the following conditions:

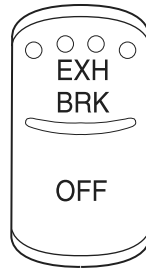

- off-highway driving
- mountain driving
- heavy traffic
- high speed highway driving



## Driving

### Operation

Push the rocker switch up to turn the exhaust brake on. The switch will illuminate in the ON position. Push the switch down to turn the brake off.

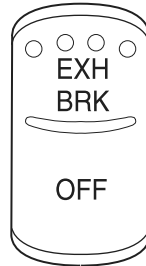

### Starting engine

Before starting the engine, make sure that the exhaust brake switch is in the OFF position. Do not turn the exhaust brake on until the engine has reached normal operating temperatures.

### Driving downhill

While approaching a steep grade, make sure that the exhaust brake switch is in the ON position. The exhaust brake actuates as soon as you remove your foot from the accelerator pedal. While going down the grade, use a low enough gear to descend safely with a minimum application of the service brakes. As a general guideline, use the same gear as you would to ascend the hill.

Before descending a hill or steep grade always select the proper gear. If the transmission is taken out of gear while descending it is possible that you will not be able to select another gear because of maximum RPM being governed.

**Note:** Maximum exhaust brake performance is related to the type of transmission your vehicle is equipped with.

**Note:** Manual transmissions should be downshifted to the lowest gear possible, without exceeding the maximum RPM limit of the engine. This will maximize the exhaust brake's retarding effect.

**Note:** Exhaust brakes will operate effectively with automatic transmission, but performance will vary with engine speed and the gear selected by the transmission.

Make sure the engine speed does not exceed the maximum allowable engine RPM. Exceeding the maximum allowable engine RPM will result in damage to the engine. Apply the service brakes to reduce the engine RPM or make a slower descent by using a lower gear.

**Note:** Engine speed has a major influence of retarding performance. When engine speed is maintained at the maximum allowable level, the exhaust brake will operate at peak performance.



The exhaust brake is not recommended for use on slippery or low traction road surfaces. Under these conditions a loss of vehicle control could occur.

### Exhaust brake operating characteristics

When you remove your feet from both the accelerator and clutch pedals and the exhaust brake switch is in the on position, the exhaust brake is activated. The following conditions should exist if the brake is operating properly:

- A slight change in the sound of the engine when the exhaust brake is activated.
- Engine temperature remains in the normal operating range.
- Road speed usually decreases when the exhaust brake is applied during a descent, except when the vehicle is carrying a heavy load or the grade is extremely steep. In these instances, you may need to apply the service brakes occasionally.
- During a descent, the tachometer usually shows a drop in RPM depending on the grade and the vehicle load.
- Do not expect a retarding effect similar to sudden hard application of the service brakes. The exhaust brake retards the vehicle with a smooth braking effect.
- Depending on the grade and vehicle load, you may or may not feel the retarding force acting against your body when the brake is applied. The brake's retarding force is actually preventing the vehicle from going much faster.
- Engine speed has a major effect on retarding performance, with higher engine speeds permitting greater retarding ability.
- Engine brake performance is closely related to the type of transmission your vehicle is equipped with. Downshifting of manual transmission to the lowest gear possible, without exceeding the maximum engine RPM limit, will maximize retarding performance. Exhaust brakes will operate effectively with automatic transmissions, but performance will vary with engine speed and the gear selected by the transmission.

Make sure the exhaust brake is turned off before shutting off the engine.

## Driving

**Note:** Installing an exhaust or auxiliary brake does not necessarily protect the engine from exceeding maximum governed speed. The primary brakes should be used to never allow the engine to exceed maximum governed speed under any conditions.

### TRAILER BRAKE HAND CONTROL (IF EQUIPPED)

The hand control, located on the right-hand side of the instrument panel, is used to apply the trailer service brakes which are independent of the truck or tractor service brakes.

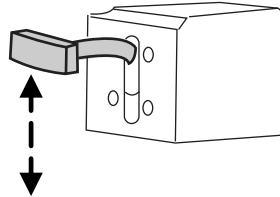

 The hand control should never be used to apply the brakes when the tractor and trailer are parked unattended. Air may leak from the system and the vehicle could possibly move, resulting in possible property damage, personal injury or death.

The hand control operates a valve that provides gradual control of air pressure applied; when the valve is only partially applied, the trailer brakes can be overridden by pressing fully on the brake pedal.

To apply the trailer brakes using the hand control, move the lever downward. The further the lever is pushed downward, the greater the air pressure is applied to the brakes. The lever will remain in place until manually moved.

To release the trailer brakes, move the lever upward completely.

### TRAILER AIR SUPPLY AND PARKING BRAKE MODULAR CONTROLS (IF EQUIPPED)



The trailer air supply valve delivers air to the trailer supply and will automatically pop out, shutting off the trailer supply if pressure is decreased to approximately 35 psi (249 kPa).



The parking brake controls the spring brakes on the tractor. When the knob is pulled out it causes the trailer supply valve to pop out, applying both the tractor and trailer parking brakes. The trailer brakes may be independently released by pushing only the trailer air supply valve in.

#### Initial charge

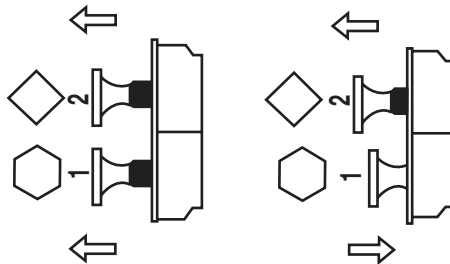

With the air system completely discharged, both knobs (1 and 2) will be out. When the air pressure reaches 70 psi (483 kPa) the trailer air supply (1 – red knob) may be pushed in and should stay in charging the trailer air system and releasing the trailer brakes.

## Driving

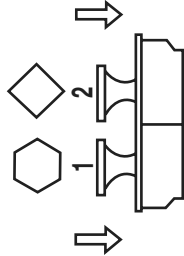

The parking brake (2–yellow knob) can now be pushed in and supply air to the tractor spring brakes, releasing them.

### Normal driving position

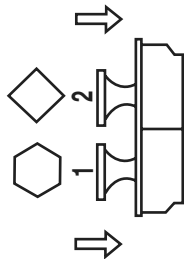

With both knobs pushed in, air is then supplied to both trailer and tractor spring brakes, and all brakes are released.

### System park

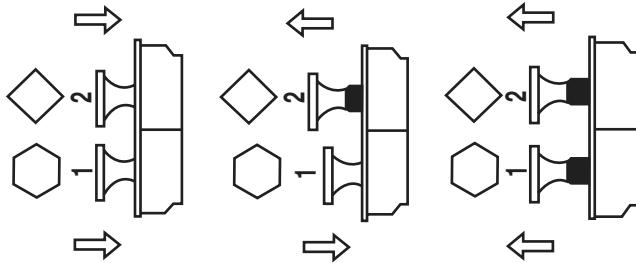

With both knobs pushed in (normal driving position), the parking brakes for both the tractor and trailer can be applied by pulling the parking brake knob (2) out, exhausting air from the tractor spring brakes, simultaneously causing the trailer air supply valve to pop out, applying the trailer brakes.

### Trailer charge

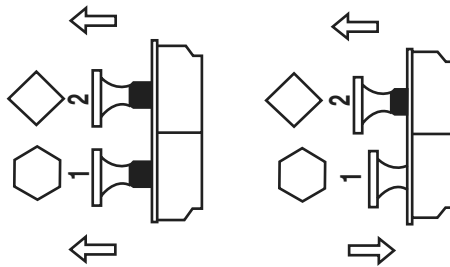

If both knobs are out, and you want to recharge the trailer while leaving the tractor spring brakes applied, the trailer air supply (1) can be pushed in to recharge the trailer air supply line. This mode may also be used to park a combination vehicle with tractor spring brakes.

## Driving

### Automatic application

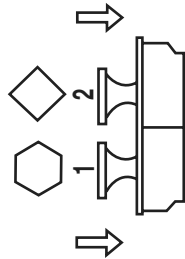

If both knobs are pushed in and the brake system air pressure is reduced to approximately 35 psi (249 kPa), the trailer air supply (1) knob will automatically pop out applying the emergency or parking brakes on the trailer. If the trailer air supply (1) knob is manually held in and the air pressure is reduced to approximately 30 psi (207 kPa), a tripper piston within the valve will move, exhausting the trailer air supply, applying the trailer brakes. Further reduction of air pressure, while holding the trailer air supply knob in, will cause the parking brake knob to pop out at 25 psi (172 kPa).

### Actuation of trailer park (emergency) or tractor bobtail position

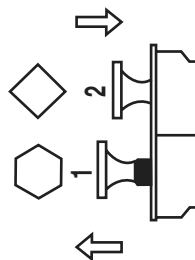

To actuate the trailer brakes only, pull out the trailer air supply knob (1). The trailer brakes are now applied whether emergency or spring brakes are used on the trailer.

This mode is also used when the tractor or truck with trailer is used during bobtail operation.

### ANTI-LOCK BRAKE SYSTEM (ABS)

A noise from the hydraulic pump motor and pulsation in the pedal may be observed during ABS braking events. Pedal pulsation coupled with noise while braking under panic conditions or on loose gravel, bumps, wet or snowy roads is normal and indicates proper functioning of the vehicle's ABS. If the vehicle has continuous vibration or shudder in the steering wheel while braking, the vehicle should be inspected by a qualified service technician.

The ABS operates by detecting the onset of wheel lockup during brake applications and compensating for this tendency. The wheels are prevented from locking even when the brakes are firmly applied. The accompanying illustration depicts the advantage of an ABS equipped vehicle (on bottom) to a non-ABS equipped vehicle (on top) during hard braking with loss of front braking traction.

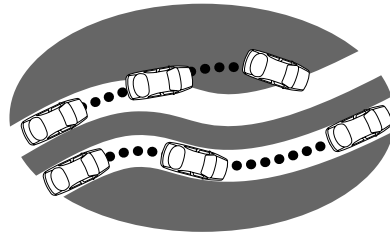

### ABS warning lamp

The  warning lamp in the instrument cluster momentarily illuminates when the ignition is turned on and the engine is off. If the light does not illuminate momentarily at start up, remains on after the vehicle reaches 5–10 mph (8–16 km/h), or continues to flash, the ABS needs to be serviced.

With the ABS light on, the anti-lock brake system is disabled and normal braking is still effective unless the brake warning light also remains illuminated. (If your parking brake warning lamp illuminates, have your vehicle serviced immediately).

### Using ABS

- In an emergency or when maximum efficiency from the ABS is required, apply continuous full force on the brake. The ABS will be activated immediately, thus allowing you to retain full steering control of your vehicle and, providing there is sufficient space, will enable you to avoid obstacles and bring the vehicle to a controlled stop.
- The ABS does not decrease the time necessary to apply the brakes or always reduce stopping distance. Always leave enough room between your vehicle and the vehicle in front of you to stop.



## Driving

- We recommend that you familiarize yourself with this braking technique. However, avoid taking any unnecessary risks.

### TRACTION CONTROL™ (IF EQUIPPED)

Your vehicle may be equipped with a Traction Control™ system. This system helps you maintain the stability and steerability of your vehicle, especially on slippery road surfaces such as snow- or ice-covered roads and gravel roads, by reducing engine power and/or selectively applying the rear brakes. The system will allow your vehicle to make better use of available traction in these conditions.

**Note:** The traction control system will not apply the brakes when the vehicle speed is above 25 mph (40 km/h).

During Traction Control™ operation, the traction control light in the instrument cluster will flash rapidly and the engine will not “rev-up” when you push further on the accelerator. This is normal system behavior and should be no reason for concern. If the traction control light does not flash during a traction control event or stays illuminated, the system is not functioning properly, take your vehicle to your dealer for service.



When the Traction Control™ switch, located on the instrument panel, is activated standard Traction Control™ will change to Off Road traction mode, the traction control light will be illuminated and flash slowly. If a traction event occurs, in either mode the traction control light will flash rapidly. The standard Traction Control™ can be selected by pushing the Traction Control™ switch again or will be automatically selected at next ignition cycle.



If you should become stuck in snow or ice or on a very slippery road surface, try switching to the Off Road Traction Control™ mode. This may allow excess wheel spin to “dig” the vehicle out and enable a successful “rocking” maneuver.

## Driving



Aggressive driving in any road conditions can cause you to lose control of your vehicle increasing the risk of severe personal injury or property damage. The occurrence of a Traction Control<sup>®</sup> event is an indication that at least some of the tires have exceeded their ability to grip the road; this may lead to an increased risk of loss of vehicle control, vehicle rollover, personal injury and death. If you experience a severe road event, SLOW DOWN.

### AIR SUSPENSION (IF EQUIPPED)

**Note:** The vehicle must not be operated without air in the suspension springs. Operating the vehicle without air in the air suspension springs will damage the suspension, degrade ride performance and may cause property damage.

The suspension system automatically adjusts to different loads to maintain a constant frame height. The system allows for ease of vehicle loading and provides improved vehicle ride and increased driver comfort.

#### Air suspension dump switch

The system is controlled by a switch located on the instrument panel. The switch will operate only when the ignition is in the ACC (Accessory) or IGNITION positions and the air tanks have sufficient pressure to fill the air springs. When the ignition is turned off, the suspension will remain in whatever state it was last set.

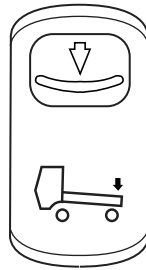



**Note:** The suspension will dump air when the ignition is in the ACC or IGNITION position, but will only fill when the ignition is in the IGNITION position.

When the upper portion of the switch is pressed air supplied to the air spring is exhausted, lowering the frame for loading. Pressing the lower portion of the switch causes air to fill the air springs so the vehicle will remain at normal ride height.

## Driving

### Tractor-trailer connections

 To reduce the risk of personal injury, use extreme caution when making brake and light connections. Inclement weather and accumulated road contamination deposits on handhold and stepping surfaces require extra care to avoid slip and falls. Provide adequate lighting of working areas.

 Do not climb on the back of the tractor unless it has been provided with a deck plate and handholds. Use a three-point stance when climbing up and down from a deck plate. Do not jump from the vehicle. Whenever possible, make all connections while standing on the ground.

### **Connecting and disconnecting a trailer with air suspension**

When connecting to a trailer:

- Press the lower portion of the switch and air will exhaust from the air suspension system.
- After making the connection to the trailer, press the upper portion of the switch, then raise the landing gear.

When disconnecting the trailer:

- Lower the landing gear, then press the lower portion of the switch.
- Disconnect the brake hoses, trailer-side and rear light connectors, then pull the release lever on the fifth wheel.

The upper portion of the switch must be pressed before operating with a trailer or operating in the bobtail mode.

### **Suspension conversions**

It is not recommended, or approved, that suspension conversions be performed. However, it is understood that, on occasion, aftermarket add-on suspensions are installed by others on the truck chassis which allow operator control for weight transfer from other axles (i.e., air lift axles).

 When operating a loaded vehicle, the driver must keep all adjustable axles on the ground at all times, supporting their share of the vehicle's load. Failure to do so can overload other axles, tires, wheels, springs, steering components, brakes and frames, resulting in early component failure, loss of vehicle control, possible property damage and personal injury.

## Driving

### **AUTOMATIC TRANSMISSION OPERATION (IF EQUIPPED)**

Main transmission, auxiliary transmission, transfer case and power take-off (PTO) control shift patterns can be found on a placard or decal on the driver's sun visor, on the instrument panel or on the shift control itself.

The main transmission control is used to select the various gear ratios or speeds of the transmission. Selecting D (Direct Drive), does not change the transmission gear ratio, but is used where the gear ratios in the main transmission are adequate to handle the vehicle operation.

If the transmission fails to shift properly, check the inline 10A fuse located in the battery cables above the battery.



Hold the brake pedal down while you move the gearshift lever between positions. If you don't hold the brake pedal down, your vehicle may move unexpectedly and cause property damage, personal injury or death.

### **Allison 2200 with park pawl feature**

**Note:** For Allison automatic transmission-equipped vehicles, also refer to the separate Allison Transmission Operator's Manual.

A parking pawl effectively grounds the transmission's output shaft preventing rotation of the driveline. If the vehicle is stationary, selecting the P (Park) position places the transmission in neutral and engages the parking pawl (always use the parking brake, also).

**Note:** If the P (Park) position is selected when the vehicle is in motion, the parking pawl mechanism will ratchet and **NOT** hold the truck.



Always set the parking brake fully. Do not use the gearshift in place of the parking brake.



### **To avoid sudden, unexpected vehicle movement and possible personal injury or death:**

1. Bring the vehicle to a complete stop.
2. Shift the transmission into P (Park). Slowly lift your foot from the brake pedal to engage the transmission parking pawl mechanism.
3. Apply the parking brake and make sure it is holding properly. Do not rely solely on the parking mechanism of the transmission.)
4. Turn the engine off when you leave the vehicle. **Never leave the vehicle unattended when the engine is running.**

## Driving

### Allison 2500

This transmission is available with a column-mounted gearshift lever. The gear positions are displayed on the RNDL in the instrument cluster.



**To avoid sudden, unexpected vehicle movement and possible personal injury or death:**

1. Bring the vehicle to a complete stop.
2. Shift the transmission into N (Neutral).
3. Apply the parking brake and make sure it is holding properly.
4. Turn the engine off when you leave the vehicle. **Never leave the vehicle unattended when the engine is running.**

### Allison 3000 series

Two modes are available for the Allison 3000 Series: Performance and Economy. Performance mode will give you the best all-around transmission operation; Economy provides operation at lower engine RPM while maintaining adequate performance. The transmission will automatically default to Performance mode when you start the engine. Pressing MODE on the shifter will activate the Economy mode; this will also illuminate the Mode ON lamp.

If the engine speed is above idle when a gear is selected using the shifter, the vehicle will not move. To move the vehicle, the shifter must be moved to re-select a gear after the engine speed returns to idle.

**Note:** For more information regarding the Allison 3000 Series, refer to the separate Allison 3000 Series Operator's Manual.

### **Torque lock**

If your vehicle is parked on an incline and P (Park) is not properly engaged (The parking brake is not applied before the transmission is shifted into P [Park]), the weight of the vehicle may generate an excessive amount of torque on the park pawl. In this situation, it may be difficult to shift the transmission out of P (Park). Hold the brake pedal down while shifting out of P (Park), then release the parking brake.

### Allison 3000 series push-button shifter

To shift the transmission into R (Reverse) or D (Drive), depress the brake pedal, then press R or D, then release the brake pedal. To select a lower range when in D (Drive), press the down-arrow button. To select a higher range when in D (Drive), press the up-arrow button. To place the transmission in N (Neutral), press N.

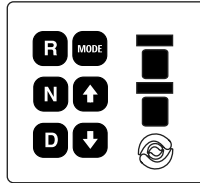

### Automatic transmission fluid operating temperatures

Allison 2200/2500 – The sump/fluid reservoir temperatures should not exceed 250°F (120°C). The converter temperature should not exceed 300°F (144°C).

### CLUTCH (IF EQUIPPED)

Do not ride or slip the clutch as this will cause unnecessary heat and wear. Maintain the specified clutch adjustment to prolong its life and regularly inspect the clutch control linkage for tightness. Refer to the *Scheduled Maintenance Guide* chapter for other maintenance information. When adjustment of the clutch is necessary, it is very important that the work be performed properly or early clutch failure may result and a costly clutch overhaul may become necessary. Clutch work should only be performed by a qualified technician.

### Engaging the clutch

- **Always start in the proper gear.** An empty vehicle can start in a higher gear than a fully loaded vehicle. Starting in too high a gear can cause clutch slippage and excessive heat and wear on the clutch. A gear that will start the vehicle moving at idle speed is the correct gear. If the engine has to be revved to get the vehicle going, the gear selection is too high.
- **Do not shift until the vehicle has reached the proper speed.** Upshifting before the vehicle has reached the proper speed can cause clutch slippage and excessive heat and wear on the clutch.
- **Never hold a vehicle on a grade with the clutch.** This will cause the clutch to slip and can actually burn up the clutch.
- **Never coast with the clutch disengaged.** The high RPM (sometimes over 10,000), can actually burst the facing material of the clutch.

## Driving

- **Never engage the clutch while coasting.** Re-engaging the clutch after coasting may not only cause a great shock to the clutch, but the whole drivetrain. Internal engine damage and/or clutch and flywheel failure can result from this.

If your vehicle's transmission is equipped with a ceramic clutch, you must start the vehicle moving in first gear and engage the clutch before pressing the accelerator at idle. Also, don't try to slip the clutch by raising engine RPM and riding or feathering the clutch pedal since the vehicle will experience erratic engagement. Erratic engagement can cause the engine stalling and potential serious damage to the vehicle's driveline components.

### **Clutch brake (vehicles equipped with a non-synchronized transmission) - Vehicle stationary**

A clutch brake is used to stop the transmission input shaft rotation so that the initial 1 (First) or R (Reverse) gear selection can be accomplished when the vehicle is stationary and the engine is running at idle speed. Clutch brake application occurs in the last inch (25 mm) of clutch pedal travel.

When using the clutch brake, fully depress the clutch pedal and shift the transmission into 1 (First) or R (Reverse). If the transmission won't go into one of these gears, slowly release the clutch pedal while applying light pressure on the transmission shift lever until it shifts into gear.

**Note:** After engagement of 1 (First) gear, **do not** use the clutch brake for upshifting or downshifting. If you do, clutch brake life will shorten and gear selection shift efforts may increase.

### **Double-clutch procedures - vehicles equipped with a non-synchronized transmission**

In order to properly upshift or downshift, perform the following steps:

1. Depress the clutch pedal to disengage the clutch.
2. Shift the transmission into neutral.
3. Release the clutch pedal.

**If upshifting**, wait until the engine speed matches the transmission speed of the gear you are selecting.

**If downshifting**, accelerate the engine until the engine speed matches the input speed of the gear you are selecting. Depress the clutch pedal immediately and shift into the desired gear, then release the clutch pedal.

## Driving

### MANUAL TRANSMISSION OPERATION (IF EQUIPPED)

**Note:** Continued use of a damaged or worn clutch, prolonged clutch slippage or downshifting at excessive speeds can result in a failure of the engine, transmission or clutch components.

**Note:** To avoid premature clutch wear and failure, do not drive with your foot resting on the clutch pedal or use it to hold the vehicle at a standstill on an upgrade as when waiting for a traffic light.

Manual transmission shift patterns are displayed on either the shift lever knob or the sun visor.

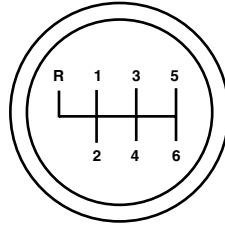

Study this information carefully before you drive the vehicle even though you may be familiar with similar units. Do not attempt to drive the vehicle without knowing the exact shift pattern of the transmission. Consult your authorized dealer if any questions exist as to the shifting instructions posted in your vehicle.



Do not coast the vehicle with the clutch pedal depressed or with the transmission in neutral. This practice could result in loss of vehicle control.

### Driving hints

The following driving hints are provided as a brief, general guide in operating the different manual transmissions used in your vehicle.

- When shifting into 1 (First) or R (Reverse) with vehicle standing still, quickly release and depress the clutch pedal (if necessary to complete gear engagement).
- Always use the lowest (or most appropriate) gear to start the vehicle.
- Always use a gear ratio low enough to allow the engine to operate above the minimum engine operation speed range.
- Do not lug the engine.
- Do not slam or jerk the gearshift lever into gear.
- When more power is required, shift to a lower gear and accelerate the engine near the governed speed.



## Driving

### Shifting with a synchronized transmission

With the clutch pedal depressed, use 2 (Second) gear synchronizer to stop the clutch disc rotation; this allows smooth engagement of 1 (First) or R (Reverse) To complete the gear engagement, it may be necessary to apply light pressure to the gearshift lever during initial engagement of the clutch. It takes a second or two to match gear speeds; steady pressure on the gearshift lever will help the synchronizer perform its job more quickly. If the gearshift lever is forced into position, this action defeats the purpose of the synchronizer by causing gear clash.

### Shifting with a non-synchronized transmission

Refer to *Clutch brake* and *Double clutch procedures* in the *Clutch* section of this chapter.

### Operating the Eaton FS-5205A 5-speed transmission

The 5-speed transmission is equipped with five forward gears and one reverse. The 2nd, 3rd, 4th and 5th gears are synchronized. The shift pattern is embossed on the gear shift knob.

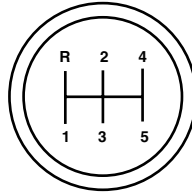

Do not shift the transmission into R (Reverse) while the vehicle is moving as this could damage the transmission.

#### **To go forward**

With the engine idling, depress the clutch pedal and shift into 1 (First). Engage the clutch while pressing the accelerator to start forward. Operate the clutch and upshift as required by driving conditions.

#### **To go backward**

Reverse is obtained by putting the gearshift lever in R (Reverse) and engaging the clutch while pressing lightly on the accelerator.

### Operating the Eaton FS-5406A, FS-5406N, FS-6406A and FSO-6406A 6-speed transmissions

These 6-speed transmissions are equipped with six forward gears and one reverse. All the forward gears are synchronized. The shift pattern is embossed on the gear shift knob.

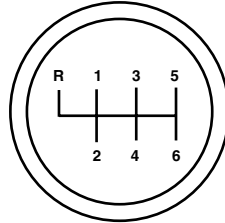

Do not shift the transmission into 1 (First) or R (Reverse) while the vehicle is moving as this could damage the transmission.

#### **To go forward**

With the engine idling, depress the clutch pedal and shift into 1 (First). Engage the clutch while pressing the accelerator to start forward. Operate the clutch and upshift as required by driving conditions.

#### **To go backward**

Reverse is obtained by putting the gearshift lever in R (Reverse) and engaging the clutch while pressing lightly on the accelerator.

### Operating the Spicer ES56-7B and ES066-7B 7-speed transmissions

These 7-speed transmissions are equipped with seven forward gears and one reverse. The 2nd, 3rd, 4th, 5th, 6th and 7th gears are synchronized. The shift pattern is embossed on the gear shift knob.

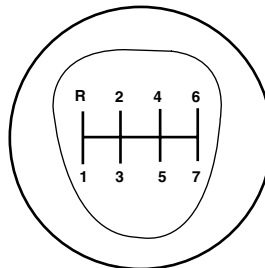

Do not shift the transmission into 1 (First) or R (Reverse) while the vehicle is moving as this could damage the transmission.

## Driving

### ***To go forward***

With the engine idling, depress the clutch pedal and shift into 1 (First). Engage the clutch while pressing the accelerator to start forward. Operate the clutch and upshift as required by driving conditions.

### ***To go backward***

Reverse is obtained by putting the gearshift lever in R (Reverse) and engaging the clutch while pressing lightly on the accelerator.

## **POWER TAKE-OFF (PTO) OPERATION (IF EQUIPPED)**

### **Vehicles equipped with an Allison automatic transmission (except 3000 Series applications and vehicles equipped with a Caterpillar engine)**

The PTO can be operated while the vehicle is standing or moving. To engage the PTO, apply the brakes and shift to any gear other than N (Neutral), then engage the PTO.

If engagement is prevented by the gear teeth not meshing properly, release the brakes and allow the vehicle to creep slightly or shift the selector to N (Neutral) and then back into gear. The PTO should never be engaged by clashing the gear teeth as this may damage the PTO unit and the transmission PTO drive gear teeth. This could result in further damage to the transmission and PTO.

### ***PTO operation with vehicle stationary***

Stop the vehicle, idle the engine and set the parking brake. Make sure the gear selector is in any forward drive range, then engage the PTO. After the PTO is engaged, move the range selector to N (Neutral). Increase the engine speed until the desired power take-off operation speed is obtained. To disengage the PTO after operation with the vehicle standing, release the throttle, allow the drive equipment to come to a stop, and then disengage the PTO.



When the PTO is operated with the vehicle stationary, the transmission must be placed in N (Neutral) with the parking brake set. If the transmission is not in N (Neutral) and is equipped with a remote throttle control, an increase in engine speed can overpower the parking brake and cause the vehicle to move, possibly resulting in personal injury and/or property damage.

### ***PTO operation while vehicle is moving***

After the PTO is engaged for driven vehicle operation, shift to the desired range and drive the vehicle. The speed of the PTO, during this period of operation, will always maintain direct relation to vehicle speed. PTO speed will decrease in relation to vehicle (transmission output) speed as shifts to a higher gear occur. When operating the PTO while the vehicle is moving, the PTO may be disengaged whenever it is no longer required. When there is no load on the PTO gear, it can be pulled out of engagement.

### **Vehicles equipped with an Allison 3000 Series automatic transmission**

The PTO drive gear is engine driven and provides direct engine power. The PTO can be operated when the vehicle is either stationary or moving.

The PTO gear is in constant mesh with the drive gear in the torque converter housing. A friction clutch or constant drive is used to transmit power to the PTO.

### **Vehicles equipped with a Caterpillar engine**

The PTO will only operate if the transmission is in N (Neutral). This feature can be overridden by a special service tool; see your dealer or service representative for more information.

### **Vehicles equipped with a manual transmission**

Transmission-mounted PTO units are available for local installation on your vehicle. See your *Body Builder's Layout Book* for restrictions on use and installation of PTO units.

To engage the PTO unit, stop the vehicle and place the transmission in N (Neutral). Depress the clutch and allow the gears to stop rotating, then engage the PTO unit. The PTO can also be selected with the transmission in gear as long as the clutch is depressed.

When operating the PTO with the vehicle stationary, first set the parking brake (chock the wheels if the vehicle is on a hill or another uneven surface).

## **REAR AXLE INFORMATION**

Axle operating temperature normally will not exceed 100°F (38°C). If the operating temperature exceeds 230°F (110°C), the rate of axle lubrication oxidation will increase and shorten the life of the lubricant

## Driving

and seals, requiring axle lubrication changes to become more frequent to preserve the axle. Extreme Pressure (EP) lubricants should not be run consistently above 230°F (110°C).

### Gross axle weight

Your truck has gross axle weight, gross vehicle weight and gross combination weight ratings. Do not exceed these ratings.



Exceeding these ratings by overloading can cause component failure resulting in property damage, personal injury or death.

### Rear axles with locking or limited-slip differentials (if equipped)

If your vehicle is equipped with a locking or limited-slip differential, note the following:

- Power will be transmitted to the opposite wheel should one of the wheels begin to slip.
- Both wheels must be raised off the ground should it be necessary to operate one wheel with the vehicle stationary.



If both wheels are not raised off the ground, the one wheel that is not raised may pull the vehicle off its support, possibly resulting in personal injury

### Driver-controlled differential lock

To prevent the vehicle from moving when servicing the wheels, tires or brakes, turn the engine off and raise all drive wheels of the locker differential axle. Axles equipped with NoSPIN Detroit Locker differentials deliver power to both wheels even when only one wheel is on the ground.



Failure to raise all drive wheels with this type of differential could cause the vehicle to move unexpectedly, resulting in property damage, personal injury or death.

Care should be taken to avoid sudden accelerations when both drive wheels are on a slippery surface.



Sudden accelerations on slippery surfaces could cause the wheels to spin, the vehicle to turn sideways on a crowned road surface or in a turn, possibly resulting in loss of vehicle control and personal injury.

## Driving

Some Dana/Spicer drive axles have a driver-controlled differential lock. The differential lock can lock or unlock the differential when the vehicle is moving or stopped. When extra traction is required, the differential lock will provide full power to both axles.

When the differential is locked, the vehicle's turning radius will increase (vehicle will "under-steer")

The differential can be locked or unlocked when the vehicle is moving at a constant speed of less than 25 mph (40 km/h) and while the wheels are not slipping. The differential must not be locked when the vehicle is traveling down steep grades and traction is minimal.

**Note:** Never use the differential lock at vehicle speeds above 25 mph (40 km/h).

**Note:** The driver-controlled differential lock function will vary with some transmissions.

- **Vehicles equipped with an Allison 3000 Series transmission:** The differential lock and differential lock light will automatically disengage at speeds above 25 mph (40 km/h). The differential lock will remain off until either the vehicle is restarted or the differential lock switch is turned off then back on.
- **Vehicles equipped with a 5-speed, 6-speed or 7-speed manual:** The differential lock and differential lock light will automatically disengage at speeds above 25 mph (40 km/h). The differential lock will remain off until either the vehicle is restarted or the differential lock switch is turned off then back on.

### Axle conversions

It is not recommended, or approved, for axle conversions to be performed. However, it is understood that, on occasion, aftermarket add-on axles are installed by others on the truck chassis which allow operator control for weight transfer from other axles (i.e., air lift axles).



When operating a loaded vehicle, the driver must keep all adjustable axles on the ground at all times, supporting their share of the vehicle's load. Failure to do so can overload other axles, tires, wheels, springs, steering components, brakes and frames, resulting in early component failure, loss of vehicle control, possible property damage and personal injury.

### TWO-SPEED REAR AXLE (IF EQUIPPED)

A two-speed rear axle allows the driver to select a LO range for greater pulling power and a HI range for greater road speed and fuel economy.

## Driving

These ranges can also be used to provide additional steps between transmission shifts when driving on steep grades and/or fuel economy may be factors.

**Note:** Do not shift between ranges when the speed control is on.



Never shift a two-speed axle when descending a steep grade as this may cause loss of vehicle control and result in personal injury.

### Axle shifting

#### Manual transmissions:

- **To downshift**, select the next lower gear, release and depress the accelerator pedal rapidly, or while holding the accelerator pedal down, release and engage the clutch rapidly. **Note:** The clutch method is recommended when driving at slower speeds.
- **To upshift**, keep the accelerator pedal down, select the next higher gear, release the accelerator and pause until the axle upshifts. **Note:** De-clutch for smoother axle upshifts when driving at slower speeds.

#### Automatic transmissions:

- Use LO range for when you drive a fully loaded vehicle on a severe grade or in congested traffic. To activate LO range, press the upper portion of the switch.
- Use HI range for all normal driving conditions with a lightly loaded or partially loaded vehicle. To activate HI range, press the lower portion of the switch.



**Note:** You cannot split-shift with an automatic transmission. Also, downshifting above 40 mph (64 km/h) may result in transmission or axle damage.

#### **Shifting the axle from LO to HI range - vehicle stopped**

Place the transmission in N (Neutral), then press the lower part of the switch.

#### **Shifting the axle from LO to HI range - vehicle moving**

Accelerate to approximately 35 mph (56 km/h), press the lower part of the switch while the transmission is in N (Neutral), then release and apply the accelerator.

## Driving

### **Shifting the axle from HI to LO range - vehicle stopped**

Place the transmission in N (Neutral), then press the upper part of the switch.

**Note:** Do not shift the axle to LO range with the vehicle in motion.

### **Split-shifting (combined axle and transmission shift - manual transmissions only)**

Split-shift sequence											
Ratio combination	1	2	3	4	5	6	7	8	9	10	11
Transmission gear	1st	1st	2nd	2nd	3rd	3rd	4th	4th	5th	6th	6th
Axle range	LO	HI	LO	HI	LO	HI	LO	HI	LO	LO	HI

**To downshift** the axle to a slower ratio and shift the transmission, shift the transmission and move the control switch to the lower ratio before the clutch is re-engaged.

**To upshift** the axle and shift the transmission, move the control switch to a faster ratio and make the transmission shift in the usual manner.

### **Ratio extender use**

#### **Low End**

A two-speed axle can be used as a ratio-extender when split shifting is not necessary. For low end use, just shift the axle into LO to start out, and shift to HI when the extra torque is no longer needed.

Transmission (5-speed)	1st	1st	2nd	3rd	4th	5th	6th
Two-speed axle	Axle low		Axle high				

#### **High End**

To use the two-speed axle as a high end ratio-extender, stay in the LO range for normal upshifts and only shift the axle to HI on the freeway for greater road speed.

Transmission (5-speed)	1st	2nd	3rd	4th	5th	6th Speed
Two-speed axle	Low for gradeability					Axle high



## Driving

### MAXIMUM VEHICLE LOADING

Every vehicle manufactured by Ford Motor Company is supplied with information on the Safety Compliance Certification Label, located on either the B-pillar or the driver's door edge, listing the maximum loading for the vehicle (GVWR), and its axle systems (GAWR) at the tire to ground interface.

A product of <b>FORD MOTOR COMPANY</b>							
Incomplete Vehicle Manufactured By (Vehicle incomplet fabrique par)							
<b>BLUE DIAMOND TRUCK, S. de R.L. de C.V.</b>							
		FRONT				REAR	
G   P	G   P	G   P	G   P	G   P	G   P	G   P	G   P
V   N (33000 LB )	A   N (12000 LB )	A   N (12000 LB )	A   N (21000 LB )	A   N (21000 LB )	A   N (21000 LB )	A   N (21000 LB )	A   N (21000 LB )
W   B 14969 KG	W   B 5443 KG	W   B 5443 KG	W   B 9525 KG	W   B 9525 KG	W   B 9525 KG	W   B 9525 KG	W   B 9525 KG
R   V	R   E	R   E	R   E	R   E	R   E	R   E	R   E
A SUITABLE TIRE		11RX22.5-14	TIRES	11RX22.5-14	TIRES	11RX22.5-14	TIRES
AND RIM CHOICE:		22.5X8.25	RIMS	22.5X8.25	RIMS	22.5X8.25	RIMS
		AT 724 KPA/105	PSI COLD	AT 724 KPA/105	PSI COLD DUAL	AT 724 KPA/105	PSI COLD DUAL
WB: 194.0 IN		493.0	CM	Model: F750 4X2	ASSEMBLED IN MEXICO	ASSEMBLED IN MEXICO	ASSEMBLED IN MEXICO
<b>VIN 3FRXF75L0V285893</b>				<b>MFD ON AUG-24-2006</b>			
VIN BARCODE HERE							
Ext. Pnt: XX		Int. Trim: XX		Axle: XX		Tran: X	

Under no circumstances should your vehicle be loaded in excess of the GVWR or GAWR. It is the operator's responsibility to ensure that neither the axle capacities, spring capacities, tire capacities nor the vehicle rated GVWR is exceeded.



Do not exceed the GVWR or the GAWR specified on the Safety Compliance Certification Label.



Do not use replacement tires with lower load carrying capacities than the originals because they may lower the vehicle's GVWR and GAWR limitations. Replacement tires with a higher limit than the originals do not increase the GVWR and GAWR limitations.



Exceeding any vehicle weight rating limitation could result in serious damage to the vehicle and/or personal injury.

### Unloaded or lightly loaded vehicles

The braking system has been designed to safely stop your vehicle when fully loaded to its GVWR.

## Driving



When operating empty or lightly loaded, sudden or hard braking may induce wheel lockup with loss of vehicle control and the possibility of accident and serious injury, especially on wet or slippery road surfaces.

### TRAILER TOWING

Towing a trailer places an additional load on your vehicle's engine, transmission, axle, brakes, tires and suspension. Inspect these components carefully prior to and after any towing operation.

Your vehicle's load capacity is designated by weight, not by volume, so you cannot necessarily use all available space when loading a vehicle. 2nd unit bodies are not included in maximum trailer weight ratings. The weight of the additional "body" must be subtracted from the maximum trailer weight.

**Note:** Do not exceed the GVWR or the GAWR specified on the certification label.



Towing trailers beyond the maximum recommended gross trailer weight exceeds the limit of the vehicle and could result in engine damage, transmission damage, structural damage, loss of vehicle control, vehicle rollover and personal injury.

Model	Maximum GVWR - lb. (kg)	Maximum GCWR - lb. (kg)*
F-650 Regular/Super/Crew Cab	26000 (11793)	40000 (18143)
F-750 Regular/Super/Crew Cab	30000 (13608)	45000 (20412)
F-750 Regular/Super/Crew Cab	33000 (14969)	60000 (27216)

\* Figures shown are the maximum available for each model. Actual ratings may be less, depending on your transmission. Check with your sales consultant for the exact rating on your vehicle.

### Preparing to tow

Use the proper equipment for towing a trailer and make sure it is properly attached to your vehicle. See your dealer or a reliable trailer dealer if you require assistance.

### Hitches

Do not use hitches that clamp onto the vehicle's bumper or attach to the axle. You must distribute the load in your trailer so that 10–15% of the total weight of the trailer is on the tongue.

## Driving

### Safety chains

Always connect the trailer's safety chains to the frame or hook retainers of the vehicle hitch. To connect the trailer's safety chains, cross the chains under the trailer tongue and allow slack for turning corners.

If you use a rental trailer, follow the instructions that the rental agency gives to you.

**Do not attach safety chains to the bumper.**

### Trailer brakes

Electric brakes and manual, automatic or surge-type trailer brakes are safe if installed properly and adjusted to the manufacturer's specifications. The trailer brakes must meet local and Federal regulations.



Do not connect a trailer's hydraulic brake system directly to your vehicle's brake system. Your vehicle may not have enough braking power and your chances of having a collision greatly increase.

### Trailer lamps

Trailer lamps are required on most towed vehicles. Your vehicle may be equipped with one of two possible trailer wiring designs. Make sure all running lights, brake lights, turn signals and hazard lights are working. See your dealer or trailer rental agency for proper instructions and equipment for hooking up trailer lamps.

### Driving while you tow

When towing a trailer:

- Keep your speed no faster than 70 mph (112 km/h) during the first 500 miles (800 km) of towing a trailer, and don't make full throttle starts.
- Turn off the speed control. The speed control may shut off automatically when you are towing on long, steep grades.
- Consult your local motor vehicle speed regulations for towing a trailer.
- To eliminate excessive transmission shifting, use a lower gear. This will also assist in transmission cooling.
- Anticipate stops and brake gradually.
- Do not exceed the GCWR rating or transmission damage may occur.

### Servicing after towing

If you tow a trailer for long distances, your vehicle will require more frequent service intervals. Refer to your *Scheduled Maintenance Guide* for more information.

### Trailer towing tips

- Practice turning, stopping and backing up before starting on a trip to get the feel of the vehicle trailer combination. When turning, make wider turns so the trailer wheels will clear curbs and other obstacles.
- Allow more distance for stopping with a trailer attached.
- If you are driving down a long or steep hill, shift to a lower gear. Do not apply the brakes continuously, as they may overheat and become less effective.
- The trailer tongue weight should be 10–15% of the loaded trailer weight.
- If you will be towing a trailer frequently in hot weather, hilly conditions, at GCW, or any combination of these factors, consider refilling your rear axle with synthetic gear lube if not already so equipped. Refer to *Lubricant specifications* in the *Maintenance and Specifications* chapter for the lubricant specification. Remember that regardless of the rear axle lube used, do not tow a trailer for the first 500 miles (800 km) of a new vehicle, and that the first 500 miles (800 km) of towing be done at no faster than 70 mph (112 km/h) with no full throttle starts.
- After you have traveled 50 miles (80 km), thoroughly check your hitch, electrical connections and trailer wheel lug nuts.
- To aid in engine/transmission cooling and A/C efficiency during hot weather while stopped in traffic, place the gearshift lever in P (Park) (if available on your automatic transmission) or N (Neutral) (manual transmissions and automatic transmissions without a P [Park] position).
- Vehicles with trailers should not be parked on a grade. If you must park on a grade, place wheel chocks under the trailer's wheels.

### FIFTH WHEEL OPERATION



Failure to follow the fifth wheel manufacturer's instructions for hooking and unhooking as well as sliding the fifth wheel could result in an accident, personal injury or death.



When the tractor and trailer are parked unattended, the trailer brake hand control should never be used to apply the brake, since air may leak from the system, allowing vehicle movement, resulting in possible property damage, personal injury or death.

## Driving

Before hook-up, make sure:

- The fifth wheel jaws are fully opened.
- The fifth wheel is fully tilted back to prevent body damage when the tractor is backed under a trailer.
- The trailer wheels are blocked and the trailer spring brakes are adjusted and applied. Never chase a trailer.
- The brake hoses and light cords are clear of the fifth wheel.

### Hook-up

1. Back the tractor squarely under the trailer, engaging the fifth wheel jaws on the kingpin. Always back-up slowly, making sure the trailer is neither too high nor too low. Avoid backing under the trailer from an angle.
2. Connect the service and emergency brake hoses and trailer light connector. Refer to *Tractor-trailer connection* in the *Air suspension* section of this chapter, adhering to the warning and using the three-point stance while connecting and disconnecting the trailer.
3. Inspect the jaws of the fifth wheel to be sure they have fully closed on the trailer kingpin and the trailer plate is resting securely on the fifth wheel.
4. Be sure the coupler release lever is in the locked position.
5. Charge the trailer brake system. Set the trailer brakes, either with the hand valve or tractor protection valve. Pull against the trailer for an additional check of proper hook-up. Do not pull hard enough to damage or strain the equipment.
6. Set the tractor parking brakes and fully raise the trailer landing gear. Refer to *Brakes* in this chapter for proper operation of the parking brake and trailer brakes.
7. Check the operation of all trailer lights and correct any lights that may be faulty.

### Un-hook

1. Try to keep the tractor and trailer in a straight line.
2. Apply the parking brakes.
3. Lower the trailer landing gear, making sure it is on solid, level ground. The weight of the trailer is to be on the landing gear.
4. Block the trailer wheels.

132

## Driving

5. Disconnect the brake hoses and light cords. Be sure hoses and cords are clear.
6. Pull coupler release lever to disengage the fifth wheel jaws.
7. Release the tractor parking brakes.
8. Pull out from the trailer slowly, allowing the landing gear to take the load gradually.

## Roadside Emergencies

### GETTING ROADSIDE ASSISTANCE

To fully assist you should you have a vehicle concern, Ford offers a complimentary roadside assistance program. This program is separate from the New Vehicle Limited Warranty and is not applicable to vehicles sold in Canada. The service is available:

- 24-hours, seven days a week
- for the New Vehicle Limited Warranty period (U.S.) of two years (unlimited miles)

Roadside assistance will cover:

- battery jump start.
- lock out assistance (key replacement is customer responsibility).
- towing – Ford/Mercury/Lincoln eligible vehicle towed to the nearest authorized dealer within 35 miles (56.3 km) of the disablement location or to the nearest authorized dealer. If a member requests to be towed to the nearest authorized dealer more than 35 miles (56.3 km) from the disablement location, the member shall be responsible for any mileage costs in excess of 35 miles (56.3 km).

Trailers shall be covered up to \$100 if the disabled Eligible Vehicles requires service at the nearest authorized dealer. If the trailer is disabled, but the towing vehicle is operational, the trailer does not qualify for any Roadside services.

### Using roadside assistance

Complete the roadside assistance identification card and place it in your wallet for quick reference. This card is found in the Owner Guide portfolio in the glove compartment.

To receive roadside assistance in the United States, call 1-800-241-3673.

If you need to arrange roadside assistance for yourself, Ford will reimburse a reasonable amount. To obtain information about reimbursement, call 1-800-241-3673.

## Roadside Emergencies

### HAZARD FLASHER

The hazard flasher control is located on the steering column, just behind the steering wheel. The hazard flashers will operate when the ignition is off.

Push in the flasher control and all front and rear direction signals will flash. Press the flasher control again to turn them off. Use it when your vehicle is disabled and is creating a safety hazard for other motorists.

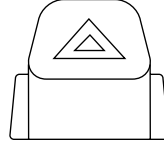

**Note:** With extended use, the flasher may run down your battery.

### FUSING

If electrical components in the vehicle are not working, a fuse may have blown. Blown fuses are identified by a broken wire within the fuse. Check the appropriate fuses before replacing any electrical components.

**Note:** Always replace a fuse with one that has the specified amperage rating. Using a fuse with a higher amperage rating can cause severe wire damage and could start a fire.



## Roadside Emergencies

### Passenger compartment fuse panel

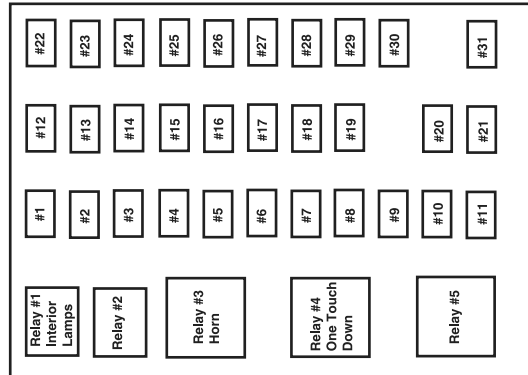

Fuse/Relay Location	Fuse Amp Rating	Fuse Description
1	20A	Horn relay
2	15A	Flasher
3	20A	Cigar lighter
4	10A	Diagnostics, Parking brake warning
5	15A	Blend door actuator, Climate mode, Back-up lamps, DRL signal, Heated seats, Trailer ABS, Exhaust brakes
6	—	Not used
7	—	Not used
8	5A	Radio, GEM 4
9	5A	Power window switch LED and relay
10	15A	Heated mirrors
11	5A	Wiper motor, Washer pump relays
12	10A	Stoplamp switch (Hydraulic brake vehicles only), Allison push-button shifter
13	20A	Cluster, Radio
14	10A	Interior lamp relay

## Roadside Emergencies

Fuse/Relay Location	Fuse Amp Rating	Fuse Description
15	10A	Interior lamp relay, GEM, Vanity mirrors
16	15A	High beams, Indicator
17	—	Not used
18	5A	Headlamp switch interior lighting
19	15A	Engine control
20	5A	Starting system
21	10A	DRL resistor
22	15A	Air horn, Air suspension dump, Two-speed axle, Driver-controlled locking differential
23	10A	Flasher
24	15A	ABS, Air dryer, Vacuum pump, Fuel heater relay
25	10A	Function selector switch
26	10A	RH low beam headlamp
27	—	Not used
28	10A	LH low beam headlamp
29	10A	Cluster warning lamps, Gauges, GEM, Hydraulic ABS
30	15A	Allison electronic transmission
31	—	Not used
Relay 1	—	Interior lamps
Relay 2	—	Not used
Relay 3	—	Horn
Relay 4	—	One-touch down window
Relay 5	—	Not used

### Power distribution box



Always disconnect the battery before servicing high current fuses.

## Roadside Emergencies



To reduce risk of electrical shock, always replace the cover to the Power Distribution Box before reconnecting the battery or refilling fluid reservoirs.

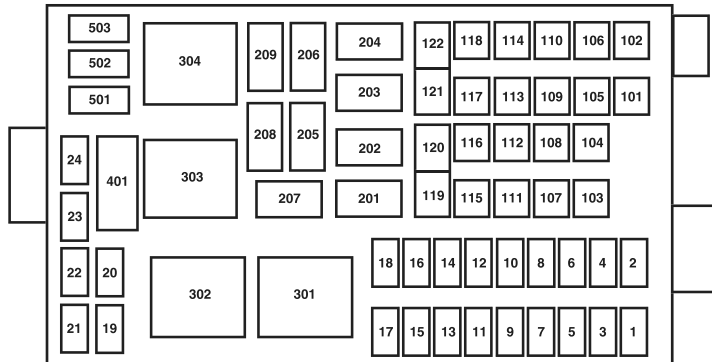

Fuse/Relay Location	Fuse Amp Rating	Fuse Description
1	15A*	Main light switch
2	30A*	Power seat (driver)
3	30A*	Power seat (passenger)
4	15A*	Washer pump relay, Washer pump motor
5	—	Not used
6	15A*	Air intake heater (Caterpillar engine only)
7	15A*	Stoplamp switches (Air brake vehicles only)
8	25A*	Fuel heater relay (Caterpillar engine-equipped vehicles with dual fuel tanks only)
9	20A*	Inhibit relay, Engine ECM, Cluster, Transmission TCM
10	15A*	Heated drain valve
11	30A*	Electric trailer brake

## Roadside Emergencies

Fuse/Relay Location	Fuse Amp Rating	Fuse Description
12	20A*	Daytime Running Lamps (DRL), Blend door actuator, Climate mode, Back-up, Heated seats, Trailer ABS, Exhaust brake
13	—	Not used
14	—	Not used
15	7.5A*	Body builder - trailer adapter stoplamps
16	5A*	Bendix Air ABS (Air brake vehicles only)
		WABCO ABS (Hydraulic brake vehicles only)
17	—	Not used
18	10A*	Fuel transfer pump (dual fuel tanks only)
19	—	Not used
20	—	Not used
21	10A*	Hydromax motor control
22	—	Not used
23	—	Not used
24	—	Not used
101	30A**	Bendix Air ABS relay (Air brake vehicles only)
		WABCO ABS modulator relay (Hydraulic brake vehicles only)
102	20A**	Ignition switch to customer access
103	20A**	Ignition switch (Junction box fuses 8, 9, 10, 11, 19, 29 and 30)
104	20A**	Power point
105	20A**	Power door locks
106	30A**	Main light switch, Multifunction switch, CJB fuses 16, 26 and 28, Headlamps, DRL relays
107	50A**	Junction box fuses 1, 2, 3, 4, 12, 13, 14 and 15
108	40A**	Fuel heater relay (Cummins engine only)
109	40A**	Power window relay
110	30A**	Wiper power relay (Park, Low/High speed)

## Roadside Emergencies

Fuse/Relay Location	Fuse Amp Rating	Fuse Description
111	30A**	Park lamps relay, Park lamps
112	40A**	Blower motor relay, Blower motor
113	30A**	Heated seats
114	25A**	Hydraulic ABS ECU power
115	20A**	Ignition switch, Central Junction Box fuses 8, 9, 10 and 11, Starter motor relay
116	30A**	Left/Right turn relays, Back-up lamp relay
117	20A**	Stoplamps relay
118	60A**	Hydraulic brake vehicles (Trailer tow package only)
119/120	60A**	Hydraulic brake vehicle (Trailer tow package only) Air brake vehicles (Trailer tow package only)
121/122	60A**	Hydraulic brake, ABS system Air brake trailer tow fuse block
201	—	Washer pump relay
202	—	Wiper speed relay
203	—	Wiper on/off relay
204	—	Wiper power relay
205	—	RH stop/turn relay
206	—	LH stop/turn relay
207	—	Hydraulic ABS event relay
208	—	Back-up lamps relay
209	—	Stoplamp relay
301	—	Fuel heater/Fuel transfer pump relay
302	—	Park lamps relay
303	—	Blower motor relay
304	—	Air ABS relay Hydraulic modulator relay
* Mini fuse **Maxi fuse		

## Roadside Emergencies

### Trailer tow relays (if equipped)

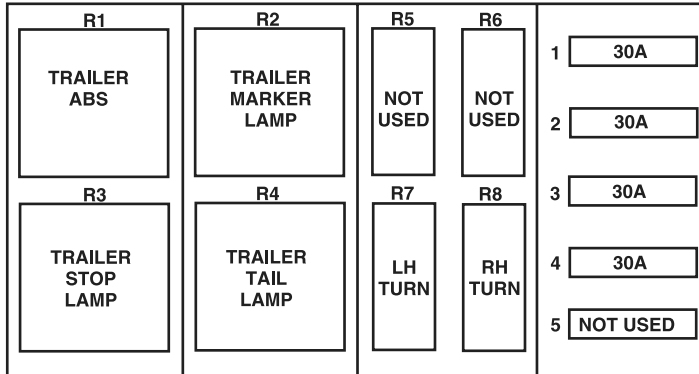

Fuse/Relay Location	Fuse Amp Rating	Description
1	30A*	Trailer tow ABS feed
2	30A*	Trailer tow park/marker lamps
3	30A*	Trailer tow stop lamps
4	30A*	Trailer tow turn/stop lamps (combined)
		Trailer tow turn lamps (separate)
5	—	Not used
R1	—	Trailer tow ABS relay
R2	—	Trailer tow marker lamp relay
R3	—	Trailer tow stop lamp relay
R4	—	Trailer tow tail lamp relay
R5	—	Not used
R6	—	Not used
R7	—	Trailer tow left turn lamp relay
R8	—	Trailer tow right turn lamp relay
*Maxi fuse		

#### Inline fuses

Your vehicle has two inline fuses located in/on the battery cables by the battery. A 10A fuse for the transmission control module and a 40A fuse

## Roadside Emergencies

for the engine control module. Refer to *Automatic transmission operation* in the *Driving* chapter and *Battery* in the *Maintenance and Specifications* chapter for more information.

### JUMP STARTING



The gases around the battery can explode if exposed to flames, sparks, or lit cigarettes. An explosion could result in injury or vehicle damage.



Batteries contain sulfuric acid which can burn skin, eyes and clothing, if contacted.

**Do not attempt to push-start your automatic transmission vehicle. Automatic transmissions do not have push-start capability. Attempting to push-start a vehicle with an automatic transmission may cause transmission damage.**

Before connecting a fast-charger, booster battery or installing a new battery, make sure the ground polarities of the fast-charger, booster battery or alternator (when installing a battery) are matched to the ground polarity of the vehicle battery. Improper usage of the fast-charger, hook-up of booster battery or installation of a new battery can cause damage to the electrical system or to the alternator. Do not attempt to polarize the alternator.

### Preparing your vehicle

1. **Use only a 12-volt supply to start your vehicle.** Do not attach the jumper cables to the glow plug relay as this could severely damage the glow plugs, injector driver module and PCM.
2. Do not disconnect the battery of the disabled vehicle as this could damage the vehicle's electrical system.
3. Park the booster vehicle close to the hood of the disabled vehicle making sure the two vehicles **do not** touch. Set the parking brake on both vehicles and stay clear of the engine cooling fan and other moving parts.
4. Check all battery terminals and remove any excessive corrosion before you attach the battery cables. Ensure that vent caps are tight and level.
5. Turn the heater fan on in both vehicles to protect from any electrical surges. Turn all other accessories off.

## Roadside Emergencies

### Connecting the jumper cables

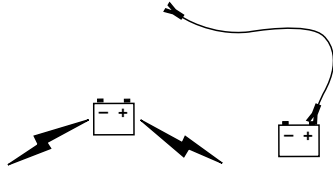

1. Connect the positive (+) jumper cable to the positive (+) terminal of the discharged battery.

**Note:** In the illustrations, *lightning bolts* are used to designate the assisting (boosting) battery.

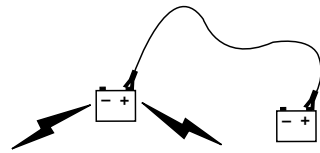

2. Connect the other end of the positive (+) cable to the positive (+) terminal of the assisting battery.

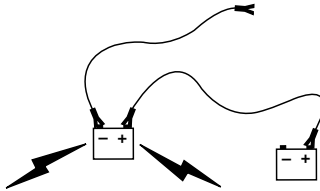

3. Connect the negative (-) cable to the negative (-) terminal of the assisting battery.



## Roadside Emergencies

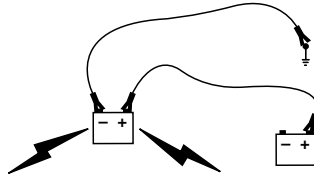

4. Make the final connection of the negative (-) cable to an exposed metal part of the stalled vehicle's engine, away from the battery and the carburetor/fuel injection system. **Do not** use fuel lines, engine rocker covers or the intake manifold as *grounding* points.



Do not connect the end of the second cable to the negative (-) terminal of the battery to be jumped. A spark may cause an explosion of the gases that surround the battery.

5. Ensure that the cables are clear of fan blades, belts, moving parts of both engines, or any fuel delivery system parts.

### **Jump starting**

1. Start the engine of the booster vehicle and run the engine at moderately increased speed.
2. Start the engine of the disabled vehicle.
3. Once the disabled vehicle has been started, run both engines for an additional three minutes before disconnecting the jumper cables.

## Roadside Emergencies

### Removing the jumper cables

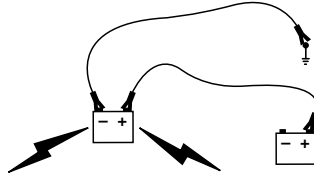

**Remove the jumper cables in the reverse order that they were connected.**

1. Remove the jumper cable from the *ground* metal surface.

**Note:** In the illustrations, *lightning bolts* are used to designate the assisting (boosting) battery.

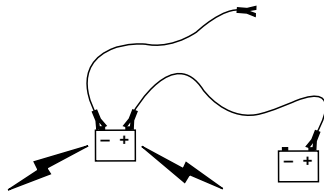

2. Remove the jumper cable on the negative (-) connection of the booster vehicle's battery.

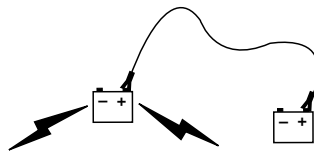

3. Remove the jumper cable from the positive (+) terminal of the booster vehicle's battery.

## Roadside Emergencies

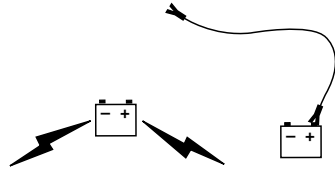

4. Remove the jumper cable from the positive (+) terminal of the disabled vehicle's battery.

After the disabled vehicle has been started and the jumper cables removed, allow it to idle for several minutes so the engine computer can *relearn* its idle conditions.

### WRECKER TOWING INSTRUCTIONS

Before moving the towed vehicle, check for adequate road clearance of vehicle components. It is recommended the towed vehicle be unloaded prior to being towed to reduce any abnormal load to the vehicle components resulting from the towing procedures. Before towing, be sure to fully release the parking brake. The spring-actuated type parking brake can be reset by recharging the air system with at least 64 psi (441 kPa) of air. If the brake system will not retain air pressure, then the spring brakes must be released manually. Refer to *Parking brake* in the *Driving* chapter

**Note:** For towing, make sure the vehicle is securely connected to the tow vehicle and the tow vehicle parking brakes are applied before releasing the disabled vehicle's spring brakes.



To reduce the risk of personal injury or property damage when manually releasing the spring brakes, be sure to block the wheels so the vehicle cannot move once the brakes are released.

### Towing the vehicle with the front wheels suspended

When it is necessary to tow a vehicle with the front wheels suspended, extra precautions must be taken to avoid transmission or differential damage. Proceed as follows:

- Remove the axle shafts from the axle assembly to prevent the wheels from driving the differential and the transmission.
- The wheel hub ends must be covered to prevent loss of axle lubricant and entrance of other contaminants. If the axle shafts are not removed, removal of the driveshaft is required.

## Roadside Emergencies

**Note:** To avoid transmission damage, vehicles should not be towed even a short distance without suspending rear wheels or removing the axle shaft or driveshaft.

**Note:** In the event the chassis is equipped with a tandem axle and the vehicle is to be towed from the front, the forward rear axle may be raised to clear the road surface and secured to the frame by chains or U-bolts, allowing only the rear rear axle to contact the road surface. Axle shafts must be removed from the rear rear axle assembly. The wheel hub ends must be covered to prevent loss of axle lubricant and entrance of contaminants. Use extreme care in securing the chains or U-bolts to avoid possible damage to the brake lines, hoses or other components.

### Towing vehicles equipped with a driver-controlled differential lock

**Note:** If the vehicle must be towed to a service facility with the drive axle wheels on the ground, it is necessary to remove the axle shafts before the vehicle is towed.

1. Shift collar in the locked position
2. Actuator assembly and shift fork
3. Axle shaft
4. Interference between the shift collar and housing
5. Shift collar in the unlocked position
6. Outer splines - axle shaft to collar
7. Shift collar and differential case splines
8. Inner splines - axle shaft to side gear
9. Side gear
10. Differential (plain) case half

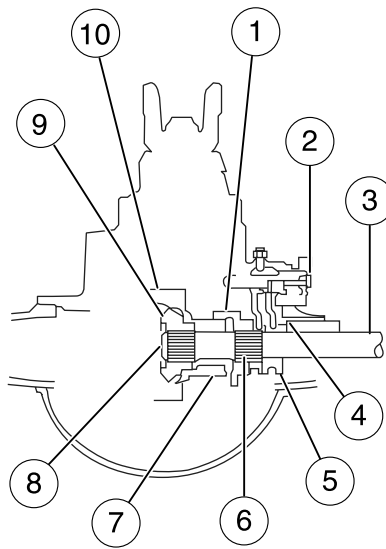

### Removing axle shafts before towing

1. Shift the main differential to the unlocked (disengaged) position. The differential lock light will turn off.

## Roadside Emergencies

2. Remove the capscrews and washers or stud nuts and washers from flanges of both axle shafts.
3. Loosen the tapered dowels in the flanges of both axle shafts by holding a 1½ inch diameter brass drift or hammer against the axle shaft center and hitting it with a five or six pound hammer. **Note:** Do not use a chisel or wedge to loosen the axle shafts and dowels. Use of a chisel or wedge can damage the hub, axle shafts and oil seals.
4. Remove the tapered dowels and both axle shafts from the axle assembly.
5. Assemble a cover over openings of both wheels ends to prevent loss of lubricant and keep dirt away from the wheel bearing cavities.

**Note:** One of the axle shafts has two sets of splines. One set to engage with the differential side gear and one set to engage with the shift collar for the differential lock. It may be necessary to rotate the shaft slightly to align the gear spline teeth with the shift collar teeth in order to remove the axle shaft.

### ***Installing the axle shafts***

1. Remove the covers from the wheel ends
2. Shift the differential lock to the unlocked position (disengaged) position.
3. Install the axle shafts
  - Place the gaskets on the wheel hub studs.
  - Push the right-hand axle shaft and gasket into the wheel end and housing until the shaft stops against the differential shift collar.
  - Push down and in on the axle shaft flange and rotate the shaft until the splines of the shaft and shift collar are engaged.
  - Push the axle shaft further into the housing until the shaft stops against the differential side gear.
  - Push down on the axle shaft flange and rotate the shaft until the splines of the shaft and side gear are engaged.
  - Push the axle shaft completely into the housing until the axle shaft flange and the gasket are flush against the wheel hub.
  - Install the left-hand axle shaft and gasket into the wheel end.
4. If tapered dowels are required, install them at each stud and into the flange of the axle shaft. Use a punch or drift and hammer, if needed.
5. Install the fasteners and tighten to correct torque value. Refer to the Service Manual.

## Roadside Emergencies

### **Towing the vehicle with the rear wheels suspended**

**Note:** To avoid damage to the cab roof or air deflector when towing the vehicle backward (rear wheels suspended) the air deflector must be removed.

Whenever possible, it is preferable to tow a disabled vehicle from the rear by raising the rear of the chassis. When towing a vehicle with the rear of the chassis suspended the front wheels must be locked in the straight-ahead position.

Vehicles equipped with a manual transmission must have at least 1.0 pint (0.5L) of transmission fluid drained from the case. This will prevent the transmission fluid from entering the clutch housing and fluid saturating the clutch discs. Make sure that the transmission fluid is replaced before the vehicle is returned to service.

## Customer Assistance

### GETTING THE SERVICES YOU NEED

#### At home

Ford Motor Company and Ford of Canada have authorized dealerships to service your vehicle. It is preferred that you return to the authorized dealer where your vehicle was purchased when warranty repairs are needed. However, you may also take your vehicle to another Ford Motor Company or Ford of Canada dealership authorized for warranty repairs. Please note that certain warranty repairs require special training and/or equipment, so not all dealers are authorized to perform all warranty repairs. That means that depending on the warranty repair needed, the vehicle may need to be taken to another dealer. If a particular dealership cannot assist you, then contact the Commercial Vehicle Hotline.

If you have questions or concerns, or are unsatisfied with the service you are receiving, follow these steps:

1. Contact your Sales Representative or Service Advisor at your selling/servicing dealership.
2. If your inquiry or concern remains unresolved, contact the Sales Manager or Service Manager at the dealership.
3. If the inquiry or concern cannot be resolved at the dealership level, please contact the Ford Commercial Vehicle Hotline.

#### Away from home

If you own a F-650 or F-750 and need more help than the dealership can provide after following the steps provided above call the Ford Fleet and Commercial Vehicle Hotline.

In the United States:

Ford Motor Company  
Commercial Vehicle Hotline  
1655 Fairlane Circle  
Allen Park, MI 48101  
800-782-8627 (option #3)  
(TDD for the hearing impaired: 1-800-232-5952)  
[www.fleet.ford.com](http://www.fleet.ford.com)

In Canada:

Customer Relationship Centre  
Ford Motor Company of Canada, Limited  
P.O. Box 2000  
Oakville, Ontario L6J 5E4  
1-800-565-3673 (FORD)  
[www.ford.ca](http://www.ford.ca)

150

## Customer Assistance

In order to help you service your Ford vehicle, please have the following information available when contacting the Commercial Vehicle Hotline:

- Your telephone number (home and business)
- The name of the dealer and the city where the dealership is located
- The year and make of your vehicle
- The date of vehicle purchase
- The current odometer reading
- The vehicle identification number (VIN)

### **Additional assistance**

If you still have a complaint involving a warranty dispute, you must directly notify Ford in writing before pursuing remedies under your state's warranty laws. Ford is also allowed a final repair attempt in some states.

### **IN CALIFORNIA (U.S. ONLY)**

California Civil Code Section 1793.2(d) requires that, if a manufacturer or its representative is unable to repair a motor vehicle to conform to the vehicle's applicable express warranty after a reasonable number of attempts, the manufacturer shall be required to either replace the vehicle with one substantially identical or repurchase the vehicle and reimburse the buyer in an amount equal to the actual price paid or payable by the consumer (less a reasonable allowance for consumer use). The consumer has the right to choose whether to receive a refund or replacement vehicle.

California Civil Code Section 1793.22(b) presumes that the manufacturer has had a reasonable number of attempts to conform the vehicle to its applicable express warranties if, within the first 18 months of ownership of a new vehicle or the first 18,000 miles (29,000 km), whichever occurs first:

1. Two or more repair attempts are made on the same nonconformity likely to cause death or serious bodily injury OR
2. Four or more repair attempts are made on the same nonconformity (a defect or condition that substantially impairs the use, value or safety of the vehicle) OR
3. The vehicle is out of service for repair of nonconformities for a total of more than 30 calendar days (not necessarily all at one time)



## Customer Assistance

In the case of 1 or 2 above, the consumer must also notify the manufacturer of the need for the repair of the nonconformity at the following address:

Ford Motor Company  
16800 Executive Plaza Drive  
Mail Drop 3NE-B  
Dearborn, MI 48126

### **GETTING ASSISTANCE OUTSIDE THE U.S AND CANADA**

Before exporting your vehicle to a foreign country, contact the appropriate foreign embassy or consulate. These officials can inform you of local vehicle registration regulations and where to find diesel fuel.

If you cannot find diesel fuel or can only get fuel with an anti-knock index lower than is recommended for your vehicle, contact a regional office or owner relations/customer relationship office.

The use of low quality diesel fuel may affect your emissions control system and may cause engine damage. Ford Motor Company/Ford of Canada is not responsible for any damage caused by use of improper fuel. In the United States, using leaded fuel may also result in difficulty importing your vehicle back into the U.S.

Ford dealerships outside of the US & Canada may be unable to support the F-650/750 due to the specialized training and servicing requirements of these vehicles. If your vehicle must be serviced while you are traveling or living in Central or South America, the Caribbean, or the Middle East, contact the nearest Ford dealership. If the dealership cannot help you, write or call:

FORD MOTOR COMPANY  
FORD EXPORT OPERATIONS  
1555 Fairlane Drive  
Fairlane Business Park #3  
Allen Park, Michigan 48101  
U.S.A.  
Telephone: (313) 594-4857  
FAX: (313) 390-0804

If you are in another foreign country, contact the nearest Ford dealership. If the dealership employees cannot help you, they can direct you to the nearest Ford affiliate office.

If you buy your vehicle in North America and then relocate outside of the U.S. or Canada, register your vehicle identification number (VIN) and new address with Ford Motor Company Export Operations.

152

## Customer Assistance

### ORDERING ADDITIONAL OWNER'S LITERATURE

To order the publications in this portfolio, contact Helm, Incorporated at:

HELM, INCORPORATED  
P.O. Box 07150  
Detroit, Michigan 48207

Or call:

**For a free publication catalog, order toll free: 1-800-782-4356**

Monday-Friday 8:00 a.m. - 6:00 p.m. EST

Helm, Incorporated can also be reached by their website:  
[www.helminc.com](http://www.helminc.com).

*(Items in this catalog may be purchased by credit card, check or money order.)*

### Obtaining a French owner's guide

French Owner's Guides can be obtained from your dealer or by writing to Ford Motor Company of Canada, Limited, Service Publications, P.O. Box 1580, Station B, Mississauga, Ontario L4Y 4G3.

### REPORTING SAFETY DEFECTS (U.S. ONLY)

If you believe that your vehicle has a defect which could cause a crash or could cause injury or death, you should immediately inform the National Highway Traffic Safety



Administration (NHTSA) in addition to notifying Ford Motor Company.

If NHTSA receives similar complaints, it may open an investigation, and if it finds that a safety defect exists in a group of vehicles, it may order a recall and remedy campaign. However, NHTSA cannot become involved in individual problems between you, your dealer, or Ford Motor Company.

To contact NHTSA, you may call the Vehicle Safety Hotline toll-free at 1-888-327-4236 (TTY: 1-800-424-9153); go to <http://www.safercar.gov>; or write to:

NHTSA  
400 Seventh Street, SW.  
Washington, D.C. 20590

You can also obtain other information about motor vehicle safety from <http://www.safercar.gov>.

## **Customer Assistance**

### **REPORTING SAFETY DEFECTS (CANADA ONLY)**

If you believe your vehicle has a defect which could cause a crash or could cause injury or death, you should immediately inform Transport Canada, using their toll-free number: 1-800-333-0510.

### WASHING THE EXTERIOR

Wash your vehicle regularly with cool or lukewarm water and a neutral pH shampoo, such as Motorcraft Detail Wash (ZC-3-A), which is available from your dealer.

- Never use strong household detergents or soap, such as dish washing or laundry liquid. These products can discolor and spot painted surfaces.
- Never wash a vehicle that is “hot to the touch” or during exposure to strong, direct sunlight.
- Always use a clean sponge or car wash mitt with plenty of water for best results.
- Dry the vehicle with a chamois or soft terry cloth towel in order to eliminate water spotting.
- It is especially important to wash the vehicle regularly during the winter months, as dirt and road salt are difficult to remove and cause damage to the vehicle.
- Immediately remove items such as gasoline, diesel fuel, bird droppings and insect deposits because they can cause damage to the vehicle’s paintwork and trim over time.
- Remove any exterior accessories, such as antennas, before entering a car wash.
- **Suntan lotions and insect repellents can damage any painted surface; if these substances come in contact with your vehicle, wash off as soon as possible.**

### WAXING

Applying a polymer paint sealant to your vehicle every six months will assist in reducing minor scratches and paint damage.

- Wash the vehicle first.
- Do not use waxes that contain abrasives.
- Do not allow paint sealant to come in contact with any non-body (low-gloss black) colored trim, such as grained door handles, roof racks, bumpers, side moldings, mirror housings or the windshield cowl area. The paint sealant will “gray” or stain the parts over time.

## Cleaning

### PAINT CHIPS

Your dealer has touch-up paint and sprays to match your vehicle's color. Take your color code (printed on a sticker in the driver's door jam) to your dealer to ensure you get the correct color.

- Remove particles such as bird droppings, tree sap, insect deposits, tar spots, road salt and industrial fallout before repairing paint chips.
- Always read the instructions before using the products.

### ALUMINUM WHEELS AND COVERS

- Clean with Motorcraft Wheel and Tire Cleaner (ZC-37-A), which is available from your dealer.
- Never apply any cleaning chemical to hot or warm wheel rims or covers.
- Some automatic car washes may cause damage to the finish on your wheel rims or covers. Chemical-strength cleaners, or cleaning chemicals, in combination with brush agitation to remove brake dust and dirt, could wear away the clearcoat finish over time.
- Do not use hydrofluoric acid-based or high caustic-based wheel cleaners, steel wool, fuels or strong household detergent.
- To remove tar and grease, use Motorcraft Bug and Tar Remover (ZC-42), available from your dealer.

### ENGINE

Engines are more efficient when they are clean because grease and dirt buildup keep the engine warmer than normal. When washing:

- Take care when using a power washer to clean the engine. The high-pressure fluid could penetrate the sealed parts and cause damage.

**Note:** To prevent damage to the engine control module, never spray-wash it directly. Never spray any connector.

- Do not spray a hot engine with cold water to avoid cracking the engine block or other engine components.
- Spray Motorcraft Engine Shampoo and Degreaser (ZC-20) on all parts that require cleaning and pressure rinse clean.
- Never wash or rinse the engine while it is running; water in the running engine may cause internal damage.

### PLASTIC (NON-PAINTED) EXTERIOR PARTS

Use only approved products to clean plastic parts. These products are available from your dealer.

## Cleaning

- For routine cleaning, use Motorcraft Detail Wash (ZC-3-A).
- If tar or grease spots are present, use Motorcraft Bug and Tar Remover (ZC-42).

### WINDOWS AND WIPER BLADES

The windshield, rear and side windows and the wiper blades should be cleaned regularly. If the wipers do not wipe properly, substances on the vehicle's glass or the wiper blades may be the cause. These may include hot wax treatments used by commercial car washes, tree sap, or other organic contamination. To clean these items, please follow these tips:

- The windshield, rear windows and side windows may be cleaned with a non-abrasive cleaner such as Motorcraft Ultra Clear Spray Glass Cleaner (ZC-23), available from your dealer.
- Do not use abrasives, as they may cause scratches.
- Do not use fuel, kerosene, or paint thinner to clean any parts.
- Wiper blades can be cleaned with isopropyl (rubbing) alcohol or windshield washer solution. Be sure to replace wiper blades when they appear worn or do not function properly.

### INSTRUMENT PANEL AND CLUSTER LENS

Clean the instrument panel with a damp cloth, then dry with a dry cloth.

- Avoid cleaners or polish that increase the gloss of the upper portion of the instrument panel. The dull finish in this area helps protect the driver from undesirable windshield reflection.
- Be certain to wash or wipe your hands clean if you have been in contact with certain products such as insect repellent and suntan lotion in order to avoid possible damage to the painted surfaces.

### INTERIOR TRIM

- Clean the interior trim areas with a damp cloth, then dry by wiping with a dry, soft, clean cloth.
- Do not use household or glass cleaners as these may damage the finish.

### INTERIOR

For fabric, carpets, cloth seats and safety belts:

- Remove dust and loose dirt with a vacuum cleaner.
- Remove light stains and soil with Motorcraft Professional Strength Carpet and Upholstery Cleaner (ZC-54).

## Cleaning

- If grease or tar is present on the material, spot-clean the area first with Motorcraft Spot and Stain Remover (ZC-14).
- Never saturate the seat covers with cleaning solution.
- Do not use household cleaning products or glass cleaners, which can stain and discolor the fabric and affect the flame retardant abilities of the seat materials.



Do not use cleaning solvents, bleach or dye on the vehicle's seat belts, as these actions may weaken the belt webbing.

### LEATHER SEATS (IF EQUIPPED)

Your leather seating surfaces have a clear, protective coating over the leather.

- To clean, use a soft cloth with Motorcraft Deluxe Leather and Vinyl Cleaner (ZC-11-A). Dry the area with a soft cloth.
- To help maintain its resiliency and color, use the Motorcraft Deluxe Leather Care Kit (ZC-11-D), available from your authorized dealer.
- Do not use household cleaning products, alcohol solutions, solvents or cleaners intended for rubber, vinyl and plastics, or oil/petroleum-based leather conditioners. These products may cause premature wearing of the clear, protective coating.

### UNDERBODY

Flush the complete underside of your vehicle frequently. Keep body and door drain holes free from packed dirt.

### FORD CAR CARE PRODUCTS

Your vehicle's dealer has many quality products available to clean your vehicle and protect its finishes. These quality products have been specifically engineered to fulfill your automotive needs; they are custom designed to complement the style and appearance of your vehicle. Each product is made from high quality materials that meet or exceed rigid specifications. For best results, use the following products or products of equivalent quality:

Motorcraft Bug and Tar Remover (ZC-42)

Motorcraft Car Care Kit (ZC-26)

Motorcraft Car Wash (Canada only) (CXC-21)

Motorcraft Custom Bright Metal Cleaner (ZC-15)

158

## Cleaning

Motorcraft Custom Clear Coat Polish (ZC-8-A)  
Motorcraft Custom Vinyl Protectant (U.S. only) (ZC-40-A)  
Motorcraft Dash and Vinyl Cleaner (ZC-38-A)  
Motorcraft Deluxe Leather and Vinyl Cleaner (U.S. only) (ZC-11-A)  
Motorcraft Detail Wash (ZC-3-A)  
Motorcraft Dusting Cloth (ZC-24)  
Motorcraft Engine Shampoo and Degreaser (U.S. only) (ZC-20)  
Motorcraft Engine Shampoo (Canada only) (CXC-66-A)  
Motorcraft One Step Wash and Wax Concentrate (ZC-6-A)  
Motorcraft Paint Sealant (ZC-45)  
Motorcraft Premium Car Wash Concentrate (U.S. only) (ZC-17-B)  
Motorcraft Premium Glass Cleaner (Canada only) (CXC-100)  
Motorcraft Premium Liquid Wax (ZC-53-A)  
Motorcraft Professional Strength Carpet & Upholstery Cleaner (ZC-54)  
Motorcraft Spot and Stain Remover (U.S. only) (ZC-14)  
Motorcraft Tire Clean and Shine (ZC-28)  
Motorcraft Triple Clean (U.S. only) (ZC-13)  
Motorcraft Ultra-Clear Spray Glass Cleaner (ZC-23)  
Motorcraft Vinyl Cleaner (Canada only) (CXC-93)  
Motorcraft Wheel and Tire Cleaner (ZC-37-A)



## Maintenance and Specifications

### GENERAL SERVICING GUIDELINES AND PRECAUTIONS

As with any machine, care should be taken to avoid being injured when performing maintenance, repairs or system checks. Improper or incomplete service could result in the vehicle not working properly which, in turn, may result in personal injury or damage to the vehicle or equipment. It is the operator's responsibility to see that the vehicle receives proper care and maintenance. If you have any questions about performing some service, have the service done by a qualified technician.

#### Servicing guidelines

When servicing your vehicle, always:

- turn off the ignition unless the particular procedure calls for the engine to be running.
- set the parking brake or chock the wheels.
- use support stands, not a jack, whenever you must be under a raised vehicle.
- do not smoke.
- wear safety glasses for eye protection.
- operate the engine in a well-ventilated area
- do not work on the brakes or the clutch unless the proper precautions are taken to avoid inhaling friction material dust.
- do not wear loose-fitting clothing, hanging jewelry, watches or rings.
- avoid contact with hot metal parts. Allow the hot components to cool before working with, or around them.

Quality service parts are available through your dealer. If dealer parts are not used, the owner must make sure that the parts that are being used are equivalent quality to dealer parts.



The use of inferior parts can adversely affect the quality and reliability of your vehicle which, in turn, can result in property damage, personal injury or death.

**Note:** To avoid damage to the vehicle's electrical components, disconnect the positive (+) and negative (-) battery cables prior to electric welding. Attach the welder ground cable as close as possible to the part being welded. If it is necessary to weld close to an electrical component, it is recommended that the electronic component be temporarily removed.

Follow the periodic lubrication procedures and regular inspection intervals as outlined. Have your dealer or service center inspect your

## Maintenance and Specifications

vehicle at least once a year. Remember that regular maintenance and replacement of worn components will usually prevent serious problems from developing later.



Making modifications to various parts, components and systems of the vehicle, such as brake and steering systems can adversely affect the quality, reliability and operation of your vehicle and could result in property damage, personal injury or death. Such modifications must be avoided.

The lubrication intervals present a good opportunity to inspect the vehicle. It is suggested that the various points listed herein be checked at the lubrication or other recommended intervals.



Failure to properly perform maintenance and servicing procedures could result in vehicle damage, personal injury or death.

If the owner/operator of the vehicle is a skilled technician and intends on performing the vehicle maintenance and service, he is strongly urged to purchase a service manual.



Take care when performing any maintenance, system check or service on your vehicle. Some of the materials may also be hazardous if used, serviced or handled improperly and could result in property damage, personal injury or death.

### Air conditioning system checks

Have your air conditioning system checked each spring. The refrigerant charge, cleanliness of the condenser-evaporator cores and belt condition are essential to air conditioning performance.

When the air conditioning system is being used daily, remove the fresh air filter (if equipped) once each season and check for dirt, lint, etc. Replace the filter if necessary. Vehicles operating in unusually dusty conditions may require inspecting and replacing the fresh air filter more often.

### Front axle - general service information

Maintaining the front axle alignment to specifications is very important and should only be performed by a qualified technician. Toe-in adjustment is particularly important with radial tires.

## Maintenance and Specifications

Check to make sure that the axle mounting U-bolt nuts, attaching or mounting bolts and nuts are securely tightened. Regularly check front axle for damage, binding, worn parts and adequate lubrication.

At regular intervals, or during other scheduled maintenance, (tire rotation/service, wheel bearing service, alignment, etc.) the kingpins should be checked for excessive wear. Refer to the service manual for proper procedures.

### ***Toe-in setting - general inspection***

Inspecting steer axle tires in the first 3,000–10,000 service miles (4,800–16,000 service km) will generally show if tires are wearing normally.

Rapid outside shoulder wear on both tires indicates too much toe-in. Rapid inside shoulder wear on both tires indicates too much toe-out. In P&D-type service, left-to-right steer tire tread life differentials up to 40% can be observed depending on routes and other variables.

Follow the tire manufacturer's recommended cold inflation pressure for the tire size, load range (ply rating) and steer axle loading typical for their operation (each steer axle tire will equal  $\frac{1}{2}$  steer axle loading).

Special applications may warrant a setting based on past experience with the type of tire operating loads and conditions. Radial tires are more sensitive to toe-in setting than bias ply tires. While not insensitive to vehicle alignment, fine tuning school bus alignment to line-haul truck standards will not drastically improve tire tread life.

It is essential that correct toe-in and tire pressure be maintained for optimum tire wear.

### **Rear axle - general inspection**

Check to make sure that the axle mounting U-bolts, attaching or mounting bolts and nuts are securely tightened. Refer to *U-bolt nut torque* in this chapter. Regularly check the rear axle for damaged, binding or worn parts.

### ***NoSpin Detroit Locker positive locking differential***

Vehicles equipped with this type differential have the operator's manual supplied with the vehicle. Refer to this manual for maintenance checks.

### **Brake system - general inspection**

Your vehicle is equipped with non-asbestos brake linings. However, exposure to excessive amounts of brake material (whether asbestos or

## Maintenance and Specifications

non-asbestos, fiberglass, mineral wool, aramid or carbon) may be a potentially serious health hazard.

**Note:** Persons handling brake linings should follow all precautions listed below:



1. Always wear a respirator approved by the National Institute of Occupational Studies of Health (NIOSH) or Mine Safety and Appliance (MSA) during all brake service procedures. Wear the respirator from removal of the wheels through assembly.
2. **Never** use compressed air or dry brushing to clean brake parts or assemblies.
3. Clean brake parts and assemblies in open air. During assembly, carefully place all parts on the floor to avoid getting dust in the air. Use an industrial vacuum cleaner with a HEPA filter system to clean dust from the brake drums, backing plates and other brake parts. After using the vacuum, remove any remaining dust with a rag soaked in water and wrung until nearly dry.
4. **Never** use compressed air or dry sweeping to clean the work area. Use an industrial vacuum cleaner with a HEPA filter system and rags soaked in water until wrung until nearly dry. Dispose of used rags with care to avoid getting dust in the air. Use an approved respirator when emptying vacuum cleaners and handling used rags.
5. **Worker clean-up:** Wash your hands before eating, drinking or smoking. Vacuum your work clothes after use and then launder them separately, without shaking them, to prevent fiber dust getting into the air.

### ***Air brakes - inspection and adjustment***

A regular schedule for periodic cleaning, lubrication and adjustment inspection should be established based on the type of vehicle operation. It is difficult to predetermine an exact maintenance interval (time or mileage), since vehicles will be used in a wide variety of applications and conditions. If you are uncertain of the proper schedule and procedures for your vehicle, contact your dealer.

Periodic checking of push rod travel or brake adjustment is essential for effective braking. Push rod travel should be checked every service interval to determine if adjustment is correct. Brake chamber push rods

## Maintenance and Specifications

on original equipment chambers now incorporate a stroke indicator to aid in adjustment checks; an orange paint marker near the base of the push rod. If the push rod is clean and the brakes are out of adjustment, the orange marker can be seen protruding from the chamber when the brakes are applied.



Do not manually adjust the automatic slack adjusters to correct excessive pushrod stroke as it may result in reduced brake effectiveness and a vehicle crash. Excessive pushrod stroke indicates that a problem exists with the automatic adjuster, with the installation of the adjuster, or with foundation brake components that manual adjustment will not remedy. Seek service from a qualified facility for excessive pushrod stroke.

Inspect the brake lining every maintenance interval. When brake lining or blocks are worn to within 1/16 inch (1.6 mm) of rivets, brake lining must be replaced. This inspection or adjustment should only be performed by a qualified technician and must be in accordance with instructions provided by the service manual.

Do not back off or disconnect the front brakes so that they are less effective, letting the rear brakes do all the stopping of the vehicle. Do not overlook the brakes on the trailer, either. Brake condition on the trailer is just as important as the tractor. Proper brake balance on trucks and tractor-trailers is essential for effective braking.

Once a year, the entire brake system must be inspected. Check the following:

- Any rubber as it may deteriorate whenever used. Rubber brake components should be inspected by a qualified technician and replaced as necessary. Replacement intervals vary according to the severity and length of vehicle service.
- Condition of brake drums, brake chambers and slack adjusters.
- System for air leaks.
- Hose or pipes for rust, damage and deterioration.
- Operation of service and parking brakes.

Some parts such as air brake chamber diaphragm, air compressor and air cleaner should be inspected periodically and replaced if considered unserviceable.

## Maintenance and Specifications

### ***Air brakes - air dryer***

Performance of desiccant or after-cooler type air dryers is dependent on climatic conditions in which your vehicle is operating. Maintenance schedules must be established for each specific operation.

The use of an air dryer on a vehicle does not eliminate the need to periodically drain the air reservoirs.

### ***Air brakes - desiccant air dryer***

Inspect for moisture in the air system by opening reservoirs, drain cocks or valves and checking for presence of water. The presence of small amounts of water due to condensation is normal and should not be considered as an indication that the dryer is not functioning properly.

The desiccant cartridge should be replaced or rebuilt when it has been determined that the desiccant is contaminated and does not have adequate water absorption capacity. The desiccant change interval may vary; it is generally recommended that the desiccant be replaced every 12 months (yearly). If experience has shown that extended or shortened life has resulted for a particular installation, then the yearly interval can be increased or decreased accordingly.

### ***Hydraulic brakes - inspection and adjustment***

A regular schedule for periodic cleaning, lubrication, adjustment and inspection should be established based on the type of vehicle operation. It is difficult to predetermine an exact maintenance interval (time or mileage), since vehicles will be used in a wide variety of applications and conditions. If you are uncertain of the proper schedule and procedures for your vehicle, contact your dealer.

Inspect the brake lining every maintenance interval. Establish inspection intervals that provide for lining replacement before damage to the disc occurs. Excessive lining wear may expose the backing plate to the disc causing scoring of the disc faces.

This inspection should be performed by a qualified technician and must be in accordance with instructions provided by the service manual.

**Note:** Hydraulic brake system are power assisted. Braking capabilities will be greatly reduced without engine assist.

### ***Hydraulic brakes - fluid level***

Fluid level should be at the bottom edge of the ring on each reservoir fill port. Do not fill the master cylinder to the top of the reservoir.

## Maintenance and Specifications

**Note:** If brake fluid requires attention to maintain a proper master cylinder level, this is an indication of either severe operation (pad wear) or fluid system leakage. A more frequent and thorough brake inspection will be required.

### **Hydraulic brakes - fluid precautions**

The HydroMax brake system consists of two completely separate hydraulic systems operating with two different and incompatible fluids; power steering fluid and hydraulic brake fluid. Failure to observe precautions preventing the contamination of either system with fluid from the other will result in swelling and deterioration of rubber parts leading to reduced brake performance and eventual brake failure.

To avoid fluid contamination, the following should always be observed:

1. Use only fluids specified (or equivalent) and properly identified.
2. Add fluids only to the following locations:
  - Power steering fluid to the power steering fluid pump reservoir
  - Brake fluid to the brake master cylinder

### **Hydraulic brakes - brake lines, hoses and fittings**

Inspect these components every 4,000 miles (6,400 km).

- Check lines for kinks, dents, corrosion or rupture.
- Check hoses for abrasions, kinks, soft spots or rupture, collapse, cracks, twists or loose frame supports. When replacing a hose, be sure there is adequate clearance to the hose to avoid an abrasion to the new hose.
- Examine all connections for leaks.
- Repair or replace brake line tubes, hoses or fittings as required.

### **Driveline parking brake**

Parking brake adjustment should only be performed by a qualified technician, and in accordance with the instructions in the service manual.



Use wheel chocks and exercise caution when inspecting under the vehicle. A vehicle roll-away could result in property damage, personal injury or death.

### **Catalytic converter**

If your diesel engine is equipped with a catalytic converter, it is important to review the maintenance schedule to ensure proper

## Maintenance and Specifications

functioning of the catalytic converter. Also, take precautions not to damage the catalytic converter when servicing your engine or storing your vehicle.

**Note:** If your vehicle is equipped with a catalytic converter/muffler, **do not** blend waste oil with Diesel fuel. Operate only on ultra low sulfur (less than 15 parts per million sulfur) diesel fuel with a cetane value of 45 or higher.

### Air induction system

Once each year, perform a complete inspection of the air induction system. In areas where road salt is used, the inspection consists of disassembling the joints of each aluminum component and inspecting for salt build-up, presence of chlorine that can cause aluminum particles to flake off and enter the engine combustion chambers.

If evidence of corrosion is found (usually at the pipe connections), use a wire brush to clean the inside of the pipes and inside the rubber hoses.

If the intake pipes are pitted at the joint ends, use Motorcraft Silicone Gasket and Sealant TA-30 to seal the joints. Be certain that no excess material is on the inside of the pipes that can be pulled into the engine. If the service condition of the pipes, hoses or clamps is questionable, replace the defective part(s).

Be sure that prior to reassembly all dust and debris has been cleaned out of the pipes and couplings with a clean, damp rag.



When performing maintenance to any turbocharged engine with engine air inlet piping disconnected, keep loose clothing, jewelry and long hair away from the engine air inlet piping. A turbocharger compressor air inlet protective shield should be installed over the turbocharger air inlet to reduce the risk of personal injury or death.

### Steering - general inspection

- Ask your service technician to examine the steering mechanism. Only minor adjustments may be necessary.
- Check tie rod, drag link end clamp bolts and ball joints. They must be tight.
- Check for installation and spread of cotter pins and tightness of nuts at both ends of the tie rod and drag link.
- Check that pitman arm (steering arm at steering gear) mounting is tight and locked. Check system for leaks or hose chafing. Repair at once.



## Maintenance and Specifications

- Maintain proper steering gear and power steering pump lubricant levels.
- Regularly inspect steering column joint bolts and steering linkage, particularly for body-to-chassis clearance.

**Note:** Have any steering problems corrected at once by a qualified service technician.



Failure to maintain the steering system in proper condition can cause reduced steering ability resulting in property damage, personal injury or death.

### ***Tightening steering column joint bolts***

As a good maintenance practice, it is recommended that steering column joint bolts be checked for tightness every 60,000 miles (96,000 km) or annually, whichever occurs first. **DO NOT OVERTIGHTEN.**

### ***Power steering***

Whenever the power steering's hydraulic system has been drained and refilled for any reason, air must be bled from the system before returning the vehicle to service. Failure to properly bleed the hydraulic system can result in degradation of power system performance.

Consult your dealer who is aware of the proper procedures for filling and bleeding the system.

## **OPENING THE HOOD**

The hood and fenders are held in position by a latch located on each fender.



The parking brake must be fully set before opening the hood or possible personal injury may occur.



To reduce the risk of the possibility of personal injury, never stand beneath the hood when it is being raised or lowered.



If you must leave the engine running while checking under the hood, do not allow any loose clothing, jewelry, hair or other items to get near moving engine components or possible personal injury may occur.

## Maintenance and Specifications

To open the hood:

1. Set the parking brake, shift into N (Neutral) (automatic transmission) or 1 (First) (manual transmission) and turn the engine off.
2. Lift upward on the bottom of each latch.

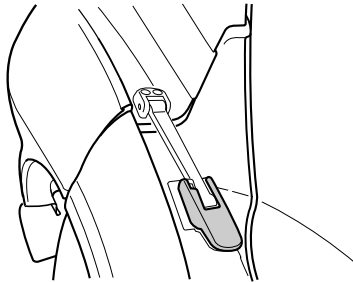

3. Pull the bottom of each latch away from the fender.

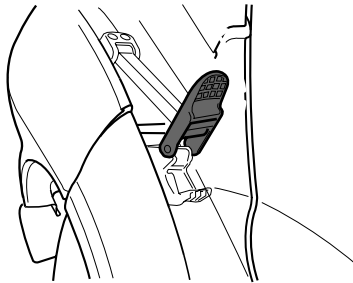

4. Tilt the hood forward until stopped by the retaining cables.

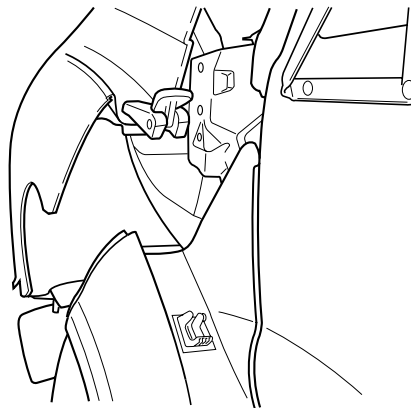

## Maintenance and Specifications

To lower the hood:

1. Push the hood rearward at the top center of the hood above the grille until closed.
2. Engage the latch on each fender.
3. Push down on the bottom of each latch until locked.

### WINDSHIELD WASHER FLUID

The reservoir capacity is 4.0 quarts (3.8L); use windshield washer fluid that meets the Ford specification listed. Refer to *Lubricant specifications* in this chapter.

Inspect the fluid level in the washer reservoir when insufficient fluid is sprayed.

State or local regulations on volatile organic compounds may restrict the use of methanol, a common windshield washer antifreeze additive. Washer fluids containing non-methanol antifreeze agents should be used only if they provide cold weather protection without damaging the vehicle's paint finish, wiper blades or washer system.

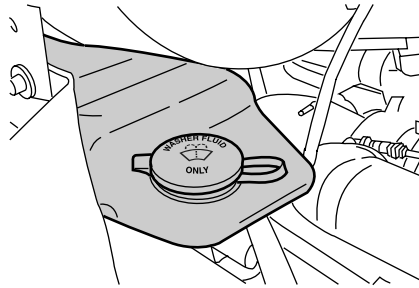

Do not put engine coolant in the washer fluid reservoir. Engine coolant can severely reduce visibility if sprayed on the windshield.

## Maintenance and Specifications

### CHANGING THE WIPER BLADES

To replace the wiper blades:

1. Pull the wiper arm away from the windshield and lock into the service position.
2. Turn the blade at an angle from the wiper arm. Push the lock pin manually to release the blade and pull the wiper blade down toward the windshield to remove it from the arm.
3. Attach the new wiper to the wiper arm and press it into place until a click is heard.

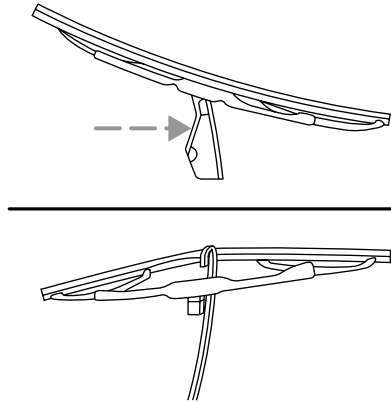

### ENGINE OIL

Refer to your engine operator's manual for information on checking and adding engine oil as well as engine oil specifications, capacities and required maintenance.

### BATTERY

Your vehicle is equipped with two or three maintenance-free batteries which are mounted in a covered tray and located on the left frame rail. The covered battery tray, depending upon application, may also have one or two steps attached.

- Covered battery tray shown.  
Battery tray with steps similar.  
The two rubber straps on top of the cover must be pulled up and moved to the side of the battery in order to remove the lid.

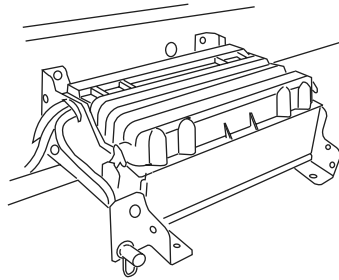

## Maintenance and Specifications

- Battery tray with cover removed.

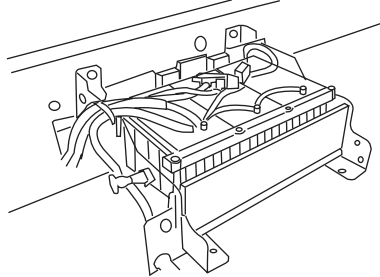

Maintenance-free batteries do not normally require adding additional water.

**Make sure the battery cover/shield is reinstalled after the battery has been cleaned or replaced.**

For longer, trouble-free operation, keep the top of the batteries clean and dry. Also, make certain the battery cables are always tightly fastened to the battery terminals.

If you see any corrosion on the battery or terminals, remove the cables from the terminals and clean with a wire brush. You can neutralize the acid with a solution of baking soda and water.

It is recommended that the negative battery cable terminal be disconnected from the battery if you plan to store your vehicle for an extended period of time. This will minimize the discharge of your battery during storage.

If the engine cranks but does not start, remove the battery box cover and check the 40A inline fuse located on the battery cable above the battery.



Batteries normally produce explosive gases which can cause personal injury. Therefore, do not allow flames, sparks or lighted substances to come near the battery. When working near the battery, always shield your face and protect your eyes. Always provide proper ventilation.



When lifting a plastic-cased battery, excessive pressure on the end walls could cause acid to flow through the vent caps, resulting in personal injury and/or damage to the vehicle or battery. Lift the battery with a battery carrier or with your hands on opposite corners.

## Maintenance and Specifications

 Keep batteries out of reach of children. Batteries contain sulfuric acid. Avoid contact with skin, eyes or clothing. Shield your eyes when working near the battery to protect against possible splashing of acid solution. In case of acid contact with skin or eyes, flush immediately with water for a minimum of 15 minutes and get prompt medical attention. If acid is swallowed, call a physician immediately.

 Battery posts, terminals and related accessories contain lead and lead compounds. **Wash hands after handling.**

Always dispose of automotive batteries in a responsible manner. Follow your local authorized standards for disposal. Call your local authorized recycling center to find out more about recycling automotive batteries.

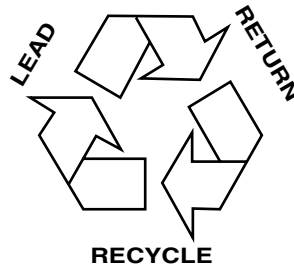

### ENGINE COOLANT

Refer to your engine operator's manual for engine coolant checking and adding instructions as well as engine coolant specifications and capacities.

#### Severe climates

If you drive in extremely cold climates (less than  $-34^{\circ}\text{F}$  [ $-36^{\circ}\text{C}$ ]):

- **It may be necessary to increase the coolant concentration above 50%.**
- **NEVER increase the coolant concentration above 60%.**
- **Engine coolant concentrations above 60% will decrease the overheat protection characteristics of the engine coolant and may cause engine damage.**
- **If available, refer to the chart on the coolant container to ensure the coolant concentration in your vehicle will provide adequate freeze protection at the temperatures in which you drive in the winter months.**

## Maintenance and Specifications

If you drive in extremely hot climates:

- **It is still necessary to maintain the coolant concentration above 40%.**
- **NEVER decrease the coolant concentration below 40%.**
- **Engine coolant concentrations below 40% will decrease the corrosion protection characteristics of the engine coolant and may cause engine damage.**
- **Engine coolant concentrations below 40% will decrease the freeze protection characteristics of the engine coolant and may cause engine damage.**
- **If available, refer to the chart on the coolant container to ensure the coolant concentration in your vehicle will provide adequate protection at the temperatures in which you drive.**

Vehicles driven year-round in non-extreme climates should use a 50/50 mixture of engine coolant and distilled water for optimum cooling system and engine protection.

### Fan clutches

Your vehicle's cooling system is equipped with a viscous fan clutch.

- The fan clutch helps control cooling, increase performance, improve fuel economy and reduce noise.
- The fan clutch is controlled by bimetallic spring sensors. Do not tamper with these sensors as this may change their calibration or keep the fan clutch from operating at all.



Stay clear of the fan/fan area while the engine is running or possible personal injury may occur.

### FUEL FILTER/WATER SEPARATOR



Do not drain water separator while engine is running. Fuel may ignite if separator is drained while engine is running or vehicle is moving.

The fuel filter/water separator removes any contaminated particles and/or water from the fuel before the fuel enters the engine.

Refer to your engine operator's manual for information on draining and replacing the fuel filter.

## Maintenance and Specifications

### FUEL INFORMATION

#### Important safety precautions



Do not overfill the fuel tank. The pressure in an overfilled tank may cause leakage and lead to fuel spray and fire.



The fuel system may be under pressure. If the fuel cap is venting vapor or if you hear a hissing sound, wait until it stops before completely removing the cap.



Automotive fuels can cause serious injury or death if misused or mishandled.

Observe the following guidelines when handling fuel:

- Extinguish all smoking materials and any open flames before fueling your vehicle.
- Always turn off the vehicle before fueling.
- Automotive fuels can be harmful or fatal if swallowed. If fuel is swallowed, call a physician immediately, even if no symptoms are immediately apparent. The toxic effects of fuel may not be visible for hours.
- Avoid inhaling fuel vapors. Inhaling too much fuel vapor of any kind can lead to eye and respiratory tract irritation. In severe cases, excessive or prolonged breathing of fuel vapor can cause serious illness and permanent injury.
- Avoid getting fuel liquid in your eyes. If fuel is splashed in the eyes, remove contact lenses (if worn), flush with water for 15 minutes and seek medical attention. Failure to seek proper medical attention could lead to permanent injury.
- Fuels can also be harmful if absorbed through the skin. If fuel is splashed on the skin and/or clothing, promptly remove contaminated clothing and wash skin thoroughly with soap and water. Repeated or prolonged skin contact with fuel liquid or vapor causes skin irritation.





## Maintenance and Specifications

**If you must replace the fuel filler cap, replace it with a genuine Ford or Motorcraft part. The customer warranty may be void for any damage to the fuel tank or fuel system if a genuine Ford or Motorcraft fuel filler cap is not used.**



If you do not use the proper fuel filler cap, excessive pressure or vacuum in the fuel tank may damage the fuel system or cause the fuel cap to disengage in a collision, which may result in possible personal injury.

### Choosing the right fuel

**Use only Ultra Low Sulfur (15 ppm Sulfur Maximum) number 1-D or 2-D diesel fuel in your diesel engine. The engine and exhaust system were designed to only use this fuel. Look for the ULTRA-LOW SULFUR HIGHWAY DIESEL FUEL (15 ppm Sulfur Maximum) label on fuel pumps when purchasing your fuel.**



Number 1-D or winter blend number 2-D fuel is recommended at temperatures below 20°F (-7°C) (see *Cold weather operation* in the *Driving* chapter. Diesel fuel containing no more than 5% biodiesel may be used. Biodiesel fuel is a product that has been converted from renewable fuel sources, including vegetable oil, animal fat and cooking oil. Raw or refined vegetable oil, animal fat, cooking oil or recycled greases should not be used.

Since it is normal for a small amount of unburned fuel to enter the crankcase and mix with the engine oil, the use of biodiesel requires that the engine oil and filter be changed more often. Refer to the *Exceptions* section of the *Scheduled Maintenance Guide* chapter for more information.

**Do not use home heating oil or any diesel fuel not intended for highway use. Red dye is used to identify fuels intended for agricultural and non-highway use. Damage to the fuel injection system, engine and exhaust catalyst can occur if an improper fuel is used. Do not add gasoline, gasohol or alcohol to diesel fuel. This practice creates a serious fire hazard and engine performance problems.**

## Maintenance and Specifications

 Using low sulfur (16-500 ppm) or high sulfur (greater than 500 ppm) diesel fuel in a diesel engine designed to use only Ultra Low Sulfur Diesel fuel increases the likelihood of engine oil dilution with fuel which may lead to major engine damage.

 Using low sulfur (16-500 ppm) or high sulfur (greater than 500 ppm) diesel fuel in a diesel engine designed to use only Ultra Low Sulfur Diesel fuel will cause certain emission components to malfunction which may also cause the Service Engine Soon (  ) light to illuminate indicating an emissions-related concern.

 Do not mix diesel fuel with gasoline, gasohol or alcohol. This could cause an explosion resulting in personal injury.

 Do not use starting fluid such as ether or gasoline. Such fluids can cause immediate explosive damage to the engine and possible personal injury.

### Fuel quality

It should not be necessary to add any aftermarket additives to your fuel tank if you use a properly formulated diesel fuel that meets ASTM D 975 specification. Aftermarket additives can damage the injector system or engine. Repairs to correct the effects of using an aftermarket product in your fuel may not be covered by your warranty.

**Do not blend used engine oil with diesel fuel under any circumstances.** Blending used oil with the fuel will significantly increase your vehicle's exhaust emissions and reduce engine life due to increased internal wear.

Many of the world's automakers approved the World-wide Fuel Charter that recommends diesel fuel specifications to provide improved performance and emission control system protection for your vehicle. Diesel fuel that meet the World-wide Fuel Charter should be used when available. Ask your fuel supplier about fuel that meet the World-Wide Fuel Charter.

## Maintenance and Specifications

### Running out of fuel

Avoid running out of fuel as this will allow air to enter the fuel system, which will make restarting the vehicle difficult.

If you have run out of fuel:

- **If your vehicle is equipped with dual fuel tanks**, add at least 4–5 gallons (15–19 liters) of fuel to each tank before attempting to restart the engine.
- The fuel system must be primed before attempting to restart the engine. Refer to the engine operator's manual for instructions on priming the engine.
- **Use caution not to overheat and damage the starter** by cranking the engine for an excessive period of time. You may need to crank the engine for a longer time than normal. If the engine fails to start in 30 seconds, turn the ignition to the OFF position and wait for two minutes before cranking the engine again.
- Any remaining trapped air will self-purge from the fuel system once the engine starts running.
- The engine may run rough and produce white smoke while air is in the fuel system. This is normal and should stop after a short period of time.

### FUEL CONSUMPTION IMPROVEMENT MEASURES

There are two important factors you can control to improve fuel economy: the mechanical condition of your vehicle and how you drive it.

A properly maintained vehicle will deliver better performance than a neglected vehicle. Always follow your maintenance schedule to keep your vehicle in top operating condition.

Also, your driving habits have a significant influence on use of fuel. By following these suggestions, you can stretch your fuel use:

- Avoid changes in speed as much as possible.
- Anticipate changing traffic conditions. Sudden stops and fast acceleration waste fuel.
- Avoid extensive idling.
- Do not drive with your foot resting on the brake pedal.

## Maintenance and Specifications

### Essentials of good fuel economy

#### **Measuring techniques**

Your best source of information about actual fuel economy is you, the driver. You must gather information as accurately and consistently as possible. Fuel expense, frequency of fill-ups or fuel gauge readings are NOT accurate as a measure of fuel economy. We do not recommend taking fuel economy measurements during the first 1,000 miles (1,600 km) of driving (engine break-in period). You will get a more accurate measurement after 2,000–3,000 miles (3,000–5,000 km).

The advertised fuel capacity of the fuel tank(s) on your vehicle is equal to the rated refill capacity of the fuel tank(s) as listed in *Fuel tanks* in this chapter. The advertised capacity is the amount of the Indicated Capacity and the Empty Reserve combined. Indicated Capacity is the difference in the amount of fuel in a full tank and a tank when the fuel gauge indicates empty. Empty Reserve is the small amount of usable fuel remaining in the fuel tank after the fuel gauge indicates empty.

**The amount of Empty Reserve varies and should not be relied upon to increase driving range. When refueling your vehicle after the fuel gauge indicates empty, you might not be able to refuel the full amount of the advertised capacity of the fuel tank due to the empty reserve still present in the tank.**

#### **Filling the tank**

For consistent results:

- Use the same fill rate setting (low - medium - high) each time during filling.
- Allow three automatic click-offs when filling.
- Always use fuel of a known quality, preferably a national brand.
- Have the vehicle loading and distribution the same every time.
- When refueling a vehicle equipped with dual fuel tanks, if the two tanks are not filled equally, the fuel gauge reading may fluctuate slightly until the fuel level between the two tanks balance out and become equal.

Your results will be most accurate if your filling method is consistent.

**Note:** For vehicles equipped with dual fuel tanks, engine performance may degrade if fuel is not added to both tanks when refueling.

## Maintenance and Specifications

### **Calculating fuel economy**

1. Fill the fuel tank(s) completely and record the initial odometer reading (in miles or kilometers).
2. Each time you fill the tank(s), record the amount of fuel added (in gallons or liters).
3. After at least three to five tank fill-ups, fill the fuel tank(s) and record the current odometer reading.
4. Subtract your initial odometer reading from the current odometer reading.
5. Follow one of the simple calculations in order to determine fuel economy:
  - Divide total miles traveled by total gallons used.
  - Multiply liters used by 100, then divide by total kilometers traveled.

Keep a record for at least one month and record the type of driving (city or highway). This will provide an accurate estimate of the vehicle's fuel economy under current driving conditions. Additionally, keeping records during summer and winter will show how temperature impacts fuel economy. In general, lower temperatures give lower fuel economy.

### **Driving style - good driving and fuel economy habits**

Give consideration to the lists that follow and you may be able to change a number of variables and improve your fuel economy.

#### **Habits**

- Smooth, moderate operation can yield up to 10% savings in fuel.
- Steady speeds without stopping will usually give the best fuel economy.
- Anticipate stopping; slowing down may eliminate the need to stop.
- Sudden or hard accelerations may reduce fuel economy.
- Slow down gradually.
- Driving at reasonable speeds (traveling at 55 mph [88 km/h] uses 15% less fuel than traveling at 65 mph [105 km/h]).
- Using the air conditioner or defroster may reduce fuel economy.
- Resting your foot on the brake pedal while driving may reduce fuel economy.

## Maintenance and Specifications

### Conditions

- Carrying unnecessary weight may reduce fuel economy.
- Fuel economy may decrease with lower temperatures during the first 8–10 miles (12–16 km) of driving.
- Flat terrain driving improves fuel economy over hilly roads.
- Transmissions give their best fuel economy when operated in the top cruise gear and with steady pressure on the accelerator.
- Close windows for highway driving.

### DIESEL PARTICULATE FILTER (DPF)

Your vehicle is equipped with a diesel particulate filter (DPF), as part of the after-treatment exhaust system, to trap soot and other large particles produced by the engine combustion process. The soot that accumulates in the filter must be periodically reduced to ash to prevent excessive exhaust restriction. The soot reduction process, also known as “filter regeneration,” is generally performed automatically by your engine and after-treatment system.



The normal operating temperature of the exhaust system is very high. Never work around, or attempt to repair, any part of the exhaust system until it has cooled. Use special care when working around the diesel particulate filter. The DPF heats up to a high temperature after only a short period of engine operation, and can remain hot even after the engine is turned off. Failure to follow these instructions may result in personal injury.

### Diesel particulate filter regeneration (Caterpillar engine only)

DPF regeneration requires no operator interaction and may occur at any time. A small increase in engine sound-level during filter regeneration is normal and should be no reason for concern.

A separate fuel injector/nozzle, which requires periodic cleaning, is used in the regeneration process. Refer to Caterpillar's *Operation and Maintenance Manual* for details regarding cleaning requirements.

## Maintenance and Specifications

### Diesel particulate filter regeneration (Cummins engine only)

Under most operating conditions, DPF regeneration will be transparent to the operator. A small increase in engine/turbo sound-level is normal during filter regeneration. If, however, your engine is operated for extended periods of time under one of the following conditions, operator assistance may be required to facilitate the filter regeneration process:

- Vehicle is operated in stop-and-go traffic and/or maintains low speeds as in a city/delivery driving
- Engine is started and shut-off frequently
- Vehicle payload is relatively light
- Vehicle is regularly operated in cold ambient temperatures (i.e. below 0°F [-18°C])

<b>Diesel Particulate Filter Four-Level Loading Chart</b>		
<b>Level/Lamp status</b>	<b>Filter status</b>	<b>Requested action</b>
Level 1 DPF lamp solid	Regeneration required.	Drive on highway at highway speeds <b>OR</b> started “parked regeneration” to prevent loss of engine performance.
Level 2 DPF lamp flashing	Nearly full. Engine performance is limited.	
Level 3 DPF lamp flashing + Service Engine Soon lamp solid	Full. Engine is increasingly limited.	Perform “parked regeneration” to prevent loss of engine performance.
Level 4 Stop Engine lamp solid	Over full. Engine performance is highly limited. Continued operation may result in irreparable damage to the filter.	Pull vehicle safely off roadway, turn on hazard flashers and shut down engine as soon as possible. Seek service immediately.

## Maintenance and Specifications

Instrument cluster lamp(s) will illuminate and/or flash when operator assistance is required. In addition, engine performance will become increasingly limited above Level 1.



At Levels 1 and 2, two courses of action may be taken by the operator to facilitate filter regeneration:

1. The vehicle may be driven on the highway at highway speeds,
2. The operator may perform a parked regeneration by following the steps in *Parked regeneration procedure (Cummins engine only)*.

At Level 3, performing a parked regeneration is the only available course of action (short of professional servicing) available to the operator for regenerating the filter. At Level 4, professional servicing is the only way to regenerate the filter.

### Parked regeneration procedure (Cummins engine only)



When performing the parked regeneration procedure, make certain the vehicle is safely off roadway, and the exhaust system is away from people, or any flammable materials, vapors, or structures. Engine speed may increase during parked regeneration.

**Note:** Parked regeneration is only available when the DPF lamp on the instrument cluster is illuminated (solid or flashing).

1. Bring the vehicle to a complete stop on level ground and safely off the road with the exhaust system away from people, flammable materials, vapors or structures.
2. If your vehicle is equipped with an automatic transmission and a steering column shift lever, place transmission in P (Park). Otherwise, place the transmission in N (Neutral).
3. Remove feet from the accelerator pedal and clutch pedal (if equipped).
4. Set the parking brake.
5. **Within 5 seconds of setting the parking brake**, remove foot from the service brake pedal.



## Maintenance and Specifications

When these steps are performed successfully in the order outlined above, the DPF lamp will begin flashing at a rate of once every 10 seconds. The engine speed may also increase slightly. To allow parked regeneration to continue uninterrupted:

1. The vehicle must remain parked
2. The transmission must remain in P (Park) or N (Neutral) (as previously described in Step 2).
3. The accelerator pedal, service brake pedal, and clutch pedal (if equipped) must not be depressed
4. The parking brake must remain set

On average (depending on filter level and other factors), the process will take 20–30 minutes to complete. The DPF lamp will turn off when the process is complete. Repeat Steps 1–5, if parked regeneration is interrupted.

### **To discontinue parked regeneration (Cummins engine only)**

Depress any of the floor pedals to discontinue parked regeneration.

### **Diesel particulate filter maintenance and service**

The DPF is designed to retain a relatively large amount of residual ash and provide many miles and hours of maintenance-free operation. At some point, generally beyond 150,000 miles (240,000 km) or 5,000 hours of operation (whichever comes first), the DPF will require professional cleaning to remove the accumulated ash

The exact number of miles or hours of operation will vary greatly depending upon vehicle/engine loading and operating conditions, ash content of the engine oil, and quality of the diesel fuel used in your truck. Adhering to your engine manufacturer's recommended oil and fuel specifications will maximize the miles and hours of operation before a DPF professional cleaning is required. Refer to your engine manufacturer's owner's manual for more details regarding recommended maintenance and service of your DPF.

### **Exhaust outlet assembly**



The normal operating temperature of the exhaust system is very high. Never work around or attempt to repair any part of the exhaust system until it has cooled. Failure to follow these instructions may result in personal injury.

## Maintenance and Specifications

The exhaust outlet assembly on your vehicle is a uniquely functioning device that accompanies the DPF assembly. It is designed to help control the temperature of the exhaust during the DPF regeneration process. **Do not modify or remove this device. Modification of the system and/or additions of aftermarket devices can reduce the effectiveness of the system, as well as cause damage to the exhaust system and/or engine. Any modifications may also invalidate the vehicle and/or engine warranties. See the vehicle and engine warranty guides for more information.**

The inlet holes in the side of the assembly are functional. These holes allow outside air to be drawn into the outlet assembly. The holes need to be kept clear of mud and other foreign material to maintain proper functionality of the system. One way to keep the holes clear is to spray the outlet assembly with a hose when washing the vehicle. Failure to keep the functional holes clear of foreign material may result in the holes becoming blocked or plugged. **Blocked/plugged holes or modification/removal of the outlet assembly could result in elevated exhaust temperatures which may result in vehicle/property damage and/or personal injury.**

### NOISE EMISSIONS – EXTERIOR

In order to comply with the federal exterior noise regulations, your vehicle may be equipped with noise emission items. Depending on the vehicle configuration, it may have all or some of the following items:

#### Air Intake System

- **Air Cleaner:** should be inspected and its location should not be altered. Do not alter inlet and outlet piping.

#### Body

- **Wheel Well:** splash shields, cab shields and under-hood insulation should be inspected for deterioration, dislocation, and orientation.

#### Cooling System

- Check the fan for damage to blades; replace, if damaged, with the recommended parts. Inspect for fan to shroud interference, and any damage to shroud such as cracks and holes.
- The fan ratio should not be changed and the fan spacer dimensions and positions should not be altered.
- Inspect the fan clutch for proper operation, make sure that the fan is disengaged when cooling of the engine is not required.

## Maintenance and Specifications

- Check for proper operation of radiator shutters, if equipped. The shutters should be open during normal operating temperatures.

### Engine and Driveline System

- **Transmission Enclosure:** inspect for cracks, holes, and tears. Clean any deposits such as oil, dirt, and stones.
- Engine valve covers and block covers are made to damp out engine mechanical noise and, if needed, should be replaced with recommended parts. Check for mechanical isolations.

### Exhaust System

- Inspect the exhaust system for leaks at various joint connections and tighten the clamps.
- Do a visual inspection for cracks or holes in the muffler and tail pipe.
- Always use the recommended parts when items need to be replaced.
- The tail pipe elbow or offset tail pipe orientation must not be changed from the standard position as originally received.
- To avoid abnormal changes in vehicle sound levels, it is necessary for the owner to perform inspections and necessary maintenance at the intervals shown in the *Scheduled Maintenance Guide* chapter.

### POWER STEERING FLUID

Check the power steering fluid level using the following procedure. If adding fluid is necessary, refer to *Lubricant Specifications* in this chapter for the proper fluid type. Refer to the *Scheduled Maintenance Guide* chapter for the recommended service intervals.

1. Set the parking brake, shift into N (Neutral) (automatic transmission) or 1 (First) (manual transmission) and turn the engine off.
2. Open the hood.
3. Clean the top of the power steering fluid reservoir.
4. Remove the dipstick from the reservoir and wipe the dipstick clean.
5. Reinstall the dipstick. Remove it again and check the fluid level.

## Maintenance and Specifications

- If the fluid temperature is at approximately 68°-120°F (20°-49°C) (**fluid cool or warm to the touch**), check the COLD side of the dipstick. The fluid level should be within the FULL range

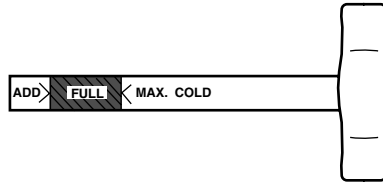

- If the fluid level is below the ADD line, add fluid in small amounts, continuously checking the level until it reaches the proper level.
- If the fluid temperature is at approximately 176°-230°F (80°-110°C) (**fluid too hot to touch**), check the HOT side of the dipstick. The fluid level should be within the FULL range.
- If the fluid level is below the ADD line, add fluid in small amounts, continuously checking the level until it reaches the proper level.

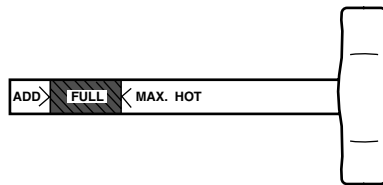

**Note:** The fluid level may also be checked by looking at the see-through plastic reservoir. Make sure that the fluid is within the minimum and maximum fluid range as marked on the reservoir.

A low fluid level may indicate a leak in the power steering system. Inspect the power steering system and repair the leak. If necessary, see your dealer or a qualified service technician.

To avoid damage to the power steering system, **do not** operate the vehicle with a low power steering fluid level.

Whenever the dipstick is installed, make sure it is properly seated and tightened securely.

## Maintenance and Specifications

### BRAKE FLUID

Check and refill the HydroMax brake fluid reservoir using the following procedure. Refer to the *Scheduled Maintenance Guide* chapter for the service interval.

1. Clean the reservoir caps before removal to prevent dirt or water from entering the reservoir.
2. Visually inspect the fluid level; the level should be at the bottom of the fill ports.
3. If necessary, add brake fluid from a clean unopened container until the level reaches the bottom of the fill ports. Do not fill above this line.
4. Use only a DOT 3 brake fluid certified to meet manufacturer specifications. Refer to *Lubricant specifications* in this chapter.

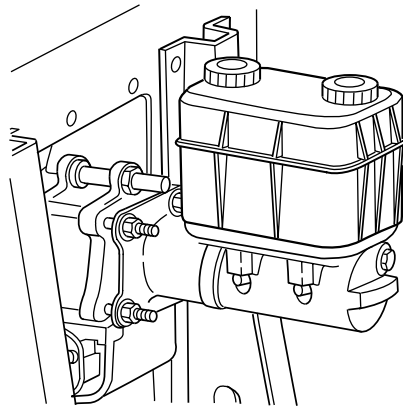

 Brake fluid is toxic. If brake fluid contacts the eyes, flush eyes with running water for 15 minutes. Seek medical attention if irritation persists. If taken internally, drink water and induce vomiting. Seek medical attention immediately.

 If you use a brake fluid that is not DOT 3, you will cause permanent damage to your brakes.

 Do not let the reservoir for the master cylinder run dry. This may cause the brakes to fail.

### CLUTCH FLUID/LINKAGE ADJUSTMENTS

#### Clutch fluid (if equipped)

Check the clutch fluid level. Refer to the *Scheduled Maintenance Guide* chapter for the service interval schedules.

During normal operation, the fluid level in the clutch reservoir should remain constant. If the fluid level drops, maintain the fluid level at the step in the reservoir.

## Maintenance and Specifications

Use only a DOT 3 brake fluid designed to meet manufacturer specifications. Refer to *Lubricant specifications* in this chapter.

 Carefully read cautionary information on product label. For **MEDICAL EMERGENCY INFORMATION**, contact a physician or Poison Control Center immediately; on Ford-Motorcraft products call: 1-800-959-3673 (FORD). Failure to follow these instructions may result in personal injury.

1. Set the parking brake, shift into 1 (First) and turn the engine off.
2. Open the hood.
3. Clean the reservoir cap before removal to prevent dirt and water from entering the reservoir.
4. Remove cap and rubber diaphragm from reservoir.
5. Add fluid until the level reaches the step in the reservoir.
6. Reinstall rubber diaphragm and cap onto reservoir.

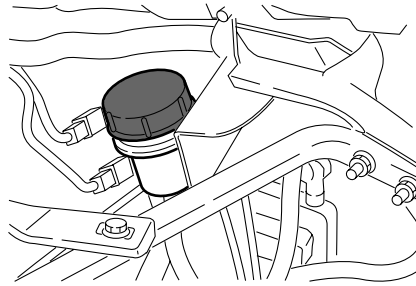

### Clutch linkage (if equipped)

Lubricate the clutch linkage using the following procedure. Refer to the *Scheduled Maintenance Guide* chapter for the service interval schedules.

Use a grease which meets manufacturer specifications. Refer to *Lubricant specifications* in this chapter.

1. Set the parking brake, shift into 1 (First) and turn the engine off.
2. Remove the inspection cover from the clutch housing.

## Maintenance and Specifications

- **Transmission and clutch removed for clarity.**

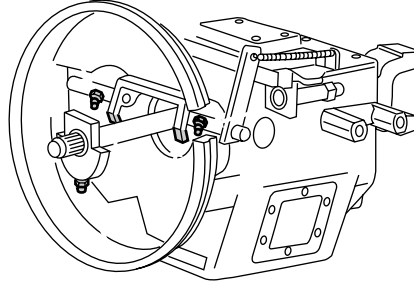

3. With a grease gun, lubricate the clutch release bearing (at one location) and the clutch release shaft (at two locations) using the grease fittings provided.
4. Lubricate clutch release wear pads at the two locations where they contact the clutch release bearing using a brush or similar tool.
5. Install the inspection cover onto the clutch housing.

### TRANSMISSION FLUID



Always dispose of used automotive fluids in a responsible manner. Follow your community's standards for disposing of these types of fluids. Call your recycling center to find out about recycling automotive fluids.

### Automatic transmission fluid

Refer to your Allison Automatic Transmission Operator's Manual for scheduled intervals for transmission fluid checks and changes. Your transmission does not consume fluid. However, the fluid level should be checked if the transmission is not working properly, i.e., if the transmission slips or shifts slowly or if you notice some sign of fluid leakage.

Automatic transmission fluid expands when warmed. To obtain an accurate fluid check, drive the vehicle until it is warmed up (approximately 20 miles [30 km]). If your vehicle has been operated for an extended period at high speeds, in city traffic or during hot weather, the vehicle should be turned off for about 30 minutes to allow fluid to cool before checking.

1. Drive the vehicle 20 miles (30 km) or until it reaches normal operating temperature.
2. Park the vehicle on a level surface and engage the parking brake.

190

## Maintenance and Specifications

3. With the parking brake engaged and your foot on the brake pedal, start the engine and move the gearshift lever through all of the gear ranges. Allow sufficient time for each gear to engage.
4. Place the gearshift lever in N (Neutral) or P (Park) and leave the engine running.
5. Remove the dipstick, wiping it clean with a clean, dry lint free rag.
6. Install the dipstick making sure it is fully seated in the filler tube.
7. Remove the dipstick and inspect the fluid level.

If you must add transmission fluid, make sure the correct type of fluid is being used. The type of fluid used is indicated in your Allison Automatic Transmission Operator's Manual.

Fluid levels above the safe range may result in transmission failure; an overfill condition of transmission fluid may cause shift and/or engagement concerns and/or possible damage.

**Use of a non-approved automatic transmission fluid may cause internal transmission component damage.**

### Manual transmission fluid

Refer to the *Scheduled Maintenance Guide* chapter for transmission fluid level checks and fluid change intervals.

Your manual transmission may be filled with an optional synthetic fluid which allows the use of extended service intervals. A tag on the filler plug will identify the use of the synthetic fluid.

Use only fluid that meets manufacturer specifications (refer to *Lubricant specifications* in this chapter).

**Use of a non-approved transmission fluid may cause internal transmission component damage.**

Check your transmission fluid level using the following procedure:

1. Park the vehicle on level ground.
2. Set the parking brake and shift into 1 (First) and turn the engine off.
3. Clean any dirt from around the filler plug.
4. Remove the filler plug and inspect the fluid level.
5. The fluid level should be up to the bottom of the filler plug opening.
6. If necessary, add enough fluid through the filler plug opening so that the fluid level is at the bottom of the opening.
7. Clean and install the filler plug securely.



## Maintenance and Specifications

Drain and refill your transmission fluid using the following procedure:

1. Drain the transmission while the fluid is warm.
2. Park the vehicle on level ground.
3. Set the parking brake and shift into 1 (First) and turn the engine off.
4. Clean any dirt from around the filler and drain plugs.
5. Remove the filler and drain plugs and drain the fluid into a suitable container. Dispose all used automotive fluids in a responsible manner following your local authorized standards.
6. Clean and install the drain plug securely.
7. Add enough fluid through the filler plug opening so that the fluid level is up to the bottom of the opening.
8. Clean and install the filler plug securely.

### CHASSIS-MOUNTED CHARGE AIR COOLER

#### Inspect charge air cooler daily

With the engine off, visually inspect the charge air cooler core assembly for debris and clogging of external fins. Prior to engine operation, remove any debris blocking the core.

- Turbocharger-to-charge air cooler
- Charge air cooler-to-intake manifold pipe
- Mounting bracket
- Chassis-mounted charge air cooler core

#### Inspect air intake piping

- Check for accumulation of salt deposits (where applicable). If present, disassemble and clean the complete air intake piping system. If the intake piping is pitted, use Motorcraft Silicone Gasket and Sealant TA-30 to seal joints against leakage.
- Check for loose hoses and clamps.
- Check for ruptured or collapsed hoses.
- Check air cleaner housing for cracks.

### ELECTRICAL SYSTEM INSPECTIONS

Periodically inspect electrical connectors on the outside of the cab, on the engine and frame for corrosion and tightness. Exposed terminals

## Maintenance and Specifications

such as the fuel sender, cranking motor, alternator and feed-through studs should be cleaned and re-coated with a lubricant sealing grease such as Motorcraft Silicone Brake Caliper Grease and Dielectric Compound XG-3, or equivalent. This should include the ground cable connector for batteries, engine and cab as well as the jump starting stud.

### Accessory feed connections

Vehicle electrical systems are complex and often include electronic components such as engine and transmission controls, instrument panels, ABS, etc. While most systems operate on battery voltage (12 volts), some systems can be as high as 90 volts or as low as five volts. Refer to the Electrical Circuit Diagram Manuals, available from your vehicle's manufacturer, to ensure that any additional body lights and accessories are connected to circuits that are both appropriate and not overloaded. No modification should be made to any vehicle control system without first contacting your dealer.

### SUSPENSION INSPECTION

**Note:** Do not adjust air suspension height to any setting other than the specified setting. Altering the height setting will change the driveline angle and may result in unwarrantable component damage, such as transmission component damage.

Verify drive axle air suspension height and height control valve performance at engine lube oil change intervals.

Periodically:

- Check condition of spring leaves for evidence of fatigue, bending or breakage.
- Check condition of suspension mounting brackets and bushings.
- Check that torque rod mounting fasteners are tight.
- Check to be sure the suspension alignment is maintained at all times.
- Check U-bolts after the chassis has been operating under load for 1,000 miles (1,600 km) or six months, whichever comes first, the U-Bolt nuts must be re-torqued. The U-Bolt nuts thereafter must be re-torqued every 36,000 miles (58,000 km). The U-Bolt and nut threads and seats should be cleaned and lubricated to ensure a "like new" condition when re-torquing.

**Note:** See the *U-Bolt Nut Torque* chart later in this section.

## Maintenance and Specifications

### Supporting your vehicle for service

When performing service repairs on your vehicle, first prepare the vehicle by doing the following:

1. Park the vehicle on a level concrete floor.
2. Set the parking brake and block the wheels to prevent the vehicle from moving.
3. Select a jack with a rated capacity sufficient to lift and hold up the vehicle.
4. Raise the vehicle with the jack applied to the axle(s). DO NOT use the bumper as a lifting point.
5. Support the vehicle with floor stands under the axle(s). If the axle or the suspension are being serviced, support the vehicle with floor stands under the frame side-members, preferably between the axles.



Do not use a jack when working under a vehicle. It may give way, causing the vehicle to fall and result in property damage, personal injury or death. Always use floor stands to support the vehicle.

### FRAME AND TOW HOOKS

Your vehicles chassis is manufactured with frame rails of either HSLA steel or heat-treated steel. Each must be handled in a specific manner to ensure maximum service life. Before attempting frame repair or modification, consult the service manual or your dealer.

It is important, particularly on vehicles where the tow hooks are used frequently to inspect the front and rear tow hooks for damage or a loose mounting.

### U-BOLT NUT TORQUE

U-bolt diameter (nominal) (all spring suspensions)	U-bolt diameter (nominal)	
	Ft. lb.	N•m
IROS Air w/15,500 lb. axles and less	260–300	353–407
IROS Air w/greater than 15,500 lb. axles	370–400	502–542
Hendrickson 23,000 lb. axle	370–400	502–542

## Maintenance and Specifications

### Air suspension U-bolt checks and re-torquing procedures

1. Inspect the threads of the U-bolt and nut for rust and debris. Clean the threads if contaminated.
2. Using a torque wrench, determine if any nuts can be turned with a force below the specified torque.
3. Using the lowest discovered torqued nut as a starting point, retighten the nuts using the sequence listed under *Air suspension U-bolt and U-bolt nut installation*.

### Air suspension U-bolt and U-bolt nut installation

1. Inspect the threads of the U-bolt and nut for rust and debris. Clean the threads if contaminated.
2. Install the U-bolts and nuts and torque the nuts to 15 ft. lb. (20 N•m), using a diagonal pattern.
3. Re-torque the nuts to 100 ft. lb. (136 N•m), using a diagonal pattern.
4. Re-torque the nuts to 200 ft. lb. (271 N•m), using a diagonal pattern.
5. Re-torque the nuts to 400 ft. lb. (542 N•m), using a diagonal pattern. (For vehicles equipped with 14ACC, 14 ADN and 14ADP axles, do not use Step 6.)
6. Re-torque the nuts to 425 ft. lb (576 N•m), using a diagonal pattern. (For vehicles equipped with 14ACC, 14 ADN and 14ADP axles.)
7. Use the same diagonal pattern with each U-bolt nut re-torque.

### Spring U-bolt checks

Check U-bolt nuts and re-torque every 36,000 miles (58,000 km) after initial 1,000 miles (1,600 km) re-torque. The U-bolt and nut threads and seats should be cleaned and lubricated to ensure peak condition when re-torqued.

### DRIVESHAFT

At the regular lubrication interval, check the universal joints for any evidence of wear or looseness. Should driveshaft vibrations occur, stop the vehicle immediately to avoid possible hazardous consequences or damage to other components.

### REAR AXLE LUBRICANT

Refer to the *Scheduled Maintenance Guide* chapter for rear axle lubricant level checks and lubricant change intervals.

## Maintenance and Specifications

Your rear axle may be filled with an optional synthetic lubricant which allows the use of extended service intervals. A tag on the filler plug will identify the use of the synthetic lubricant.

Use only a lubricant that meets manufacturer specifications (refer to *Lubricant specifications* in this chapter).

**Use of a non-approved rear axle lubricant may cause internal axle component damage.**

### Checking the rear axle lubricant level

1. Park the vehicle on level ground.
2. Set the parking brake and shift into N (Neutral) (automatic transmission) or 1 (First) (manual transmission) and turn the engine off.
3. Clean any dirt from around the rear axle filler plug.
4. Remove the filler plug and inspect the lubricant level.
5. The lubricant level should be up to the bottom of the filler plug opening.
6. If necessary, add enough lubricant through the filler plug opening so that the lubricant level is at the bottom of the opening.
7. Clean and install the filler plug securely.

### Draining and refilling the rear axle lubricant

1. Drain the rear axle while the lubricant is warm.
2. Park the vehicle on level ground.
3. Set the parking brake and shift into N (Neutral) (automatic transmission) or 1 (First) (manual transmission) and turn the engine off.
4. Clean any dirt from around the rear axle filler and drain plugs.
5. Remove the filler and drain plugs and drain the lubricant into a suitable container. Dispose of all used automotive fluids in a responsible manner following your local authorized standards.
6. Clean and install the drain plug securely.
7. Add enough lubricant through the filler plug opening so that the lubricant level is up to the bottom of the opening.
8. Clean and install the filler plug securely.

## WHEELS

### General

Wheel bearings should be inspected, lubricated and adjusted at regular intervals. This is especially important if operating in deep sand, mud, or water. Refer to *Lubricant specifications* in this chapter.

## Maintenance and Specifications

When installing wheel balance weights, they must be mounted on the dome-side of the wheel only. Failure to do so may result in loss of wheel weight and/or damage to brakes or wheels.

**Important:** Remember to replace the wheel air valves when the road tires are replaced at the end of their useful life.

### Oil lubricated front wheel bearings

During normal vehicle duty cycle, the lube and air inside the hub/wheel cavity expands and if not vented, causes pressure build-up that could cause accelerated seal wear.

There are two venting methods:

- a slit or small hole in the rubber check vent or
- the window

You can use either of these methods to prevent pressure build-up.

### Normal maintenance

Over a period of time, if not routinely cleaned, a slight film of oil can collect dirt around the rubber fill plug and face, which could appear to be a leak. Routine cleaning ensures that the lube level can be easily observed through the clear window as intended. In situations where the window is clean on the outside but discolored on the inside, the lube level may be checked by inserting a finger through the rubber check vent hole.

The specified lube level for a clear window type hubcaps is from the minimum line to + 5/16 inch above the minimum line.

If the lube level should suddenly drop dramatically below the minimum level, see the *Workshop Manual* for diagnostic procedure.

### Installation, tightening and alignment

When installing wheels, be certain that the threads on studs and nuts are clean to permit correct torque. The mounting surfaces of rims, wheels, spacer rings and clamps must be free of dirt, rust, lubricants or damage.

Use a wire brush to clean the mounting contact surfaces. Do not use lubricant on threads.

After the rim or wheel has been properly tightened, it should be checked for alignment. Rotate the wheel with a piece of chalk attached to a steady, firm surface, and placed to just barely clear the outside surface of the tire bead seat. This procedure will point out the high spot. A high spot does not necessarily mean that the lug nuts have been unevenly tightened. This condition or misalignment could be caused by a bent wheel.

## Maintenance and Specifications

Use the following installation procedure:

1. Slide inner rear or front tire and wheel in position over studs and push it back as far as possible. Use care so that the threads on studs are not damaged.

### Disc wheel with flange nuts (hub-piloted)

Front wheel mounting of flange nut system

1. Flange nut
2. Wheel(s)
3. Brake drum
4. Wheel stud (22 mm)
5. Wheel hub

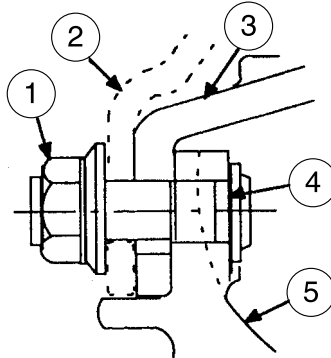

2. Position the outer rear tire and wheel in place over the studs and push it back as far as possible. Use care so that the threads on studs are not damaged.

Rear wheel mounting of flange nut system

1. Flange nut
2. Wheel(s)
3. Brake drum
4. Wheel stud (22 mm)
5. Wheel hub

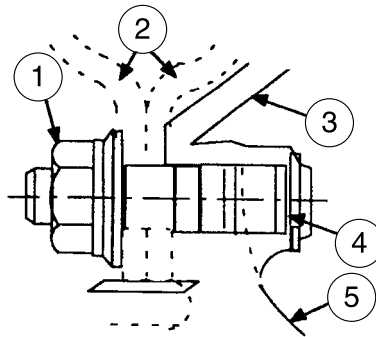

## Maintenance and Specifications

### Aluminum rear disc wheel with flange nuts (hub-piloted)

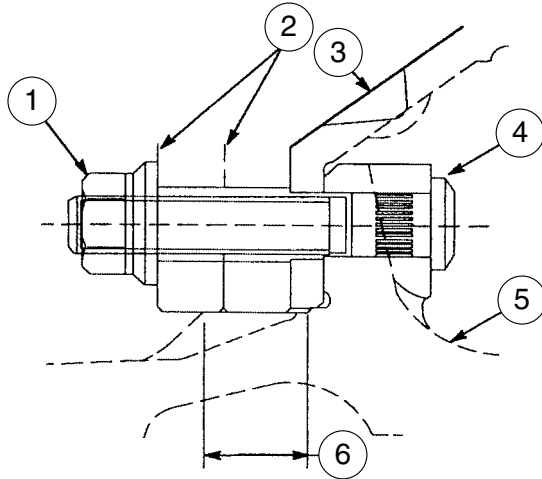

1. Flange nut
2. Wheel(s)
3. Brake drum
4. Wheel stud (22 mm)
5. Wheel hub
6. Wheel locator pad

**Note for aluminum wheels:** Prior to re-installing rear aluminum hub-piloted wheels, clean each wheel locator pad on the hub from all dirt, rust and foreign material. Apply a light coat of chassis grease, never-seize or disc brake corrosion control grease, only to the wheel locator pad.

3. Run the nuts on the studs until they contact the wheel(s). Rotate the wheel assembly a half-turn to permit the parts to seat.

4. Draw up the nuts alternately following the crisscross sequence illustrated under the following wheel tightening sequence illustrations. Do not fully tighten the nuts. This will allow uniform seating of the nuts and ensure even face-to-face contact of the wheel and hub.



## Maintenance and Specifications

### Wheel tightening sequence:

#### 8-lug wheel

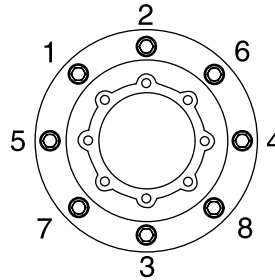

#### 10-lug wheel

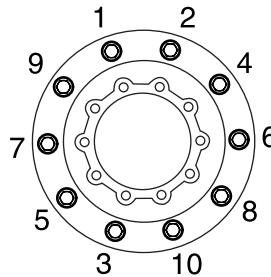

5. Continue tightening the nuts to the torque specifications in the torque chart using the same crisscross sequence shown.

6. After operating the vehicle approximately 50 miles (80 km), check the nuts for tightness. Some natural seating of parts may be encountered and the torque on the nuts will drop. Retighten all nuts to specifications. Once a week, inspect and retighten the wheel stud nuts.

**Note:** When installing the tire and rim assembly on disc-brake equipped axles, make sure the tire valve stem clears the brake caliper. The use of a tire manufacturer's stem forming tool is the only acceptable method of obtaining clearance when necessary.

#### Proper torque

It is important to tighten and maintain wheel and rim mounting nuts to the proper torque. Loose nuts or over-tightened nuts can lead to premature wear and possible failure of the wheel and/or mounting hardware.

#### Changing wheel types

Consult your dealer or wheel/rim distributor before attempting any wheel or fastener changes.

200

## Maintenance and Specifications



Use only the same type and style wheels and mounting hardware to replace original parts. Failure to do so may result in an assembly that looks fine, but does not fit together properly. This could possibly cause wheel or fastener failures which could result in property damage, personal injury or death.

**Note:** Do not attempt to mix stud-piloted wheels or fasteners with hub-piloted wheels or fasteners.

**Note:** Do not change from aluminum wheels to steel wheels or vice-versa without changing the mounting hardware required or, with flange-nut mounting systems, changing the hub and stud assembly.

### WHEEL NUT TORQUE

Size	Nut mounting	Torque	
		Ft. lb.	N•m
22 mm	Flange	450–500	610–678

**Note:** Do not use lubrication on dry threads. Where excessive corrosion exists, a light coat of lubricant on the first three threads of the stud bolt is permitted. Keep lubricant away from:

- Hex nut and rim clamp contact surfaces.
- Cap nut ball face and ball seat on the disc wheel.
- Flange nut washer surface and flat on the disc wheel.

### TIRE INFORMATION

#### Inflation



Always maintain your tires in good condition. Frequently check and maintain correct inflation pressures as specified by tire manufacturers. Inspect periodically for abnormal wear patterns and repair/replace cut or broken tire casing. Always use experienced, trained personnel with proper equipment and correct procedures to mount or remove tires and wheels. Failure to adhere to these warnings could result in wheel or tire malfunction, damage to your vehicle, personal injury, or death.

## Maintenance and Specifications



To avoid personal injury or death, always follow these instructions when mounting radial tires on wheels:

- Only personnel that have had proper training and experience should mount or remove tires from rims or wheels.
- Use only heavy-duty rims or approved rims for radial tires. It may be necessary to contact your wheel and rim distributor to determine if your rims are approved for radial tires.
- If a tube is to be used, make sure special radial tire tubes are used because of the increased flexing of the sidewalls on radial tires.
- Never use anti-freeze, silicones, or petroleum based lubricants when mounting radial tires. Only an approved lubricant should be used as an aid for mounting tires.
- Always inflate tires in a safety cage.
- Do not attempt to mix stud piloted wheels or fasteners with hub piloted wheels or fasteners. To do so may cause premature wheel failure resulting in property damage, personal injury, or death.
- Do not mix foreign (not made in North America) wheel mounting parts with domestic (made in North America) parts. Many foreign wheel components look similar to, but not exactly the same as domestic made components. Mixing components could cause wheel or fastener failures and result in property damage, personal injury, or death.
- Do not change from aluminum wheels to steel wheels or vice-versa without changing the mounting hardware where required or, in some cases with flange nut mounting systems, changing the hub and stud assembly. Mixing components could cause wheel or fastener failures and result in property damage, personal injury, or death.

## Maintenance and Specifications

All tires with Steel Carcass Plies (if equipped):

This type of tire utilizes steel cords in the sidewalls. As such, they cannot be treated like normal light truck tires. Tire service, including adjusting the air pressure, must be performed by personnel trained, supervised and equipped according to Federal Occupational Safety and Health Administration (OSHA) regulations. For example, during any procedure involving tire inflation, the technician or individual must utilize a remote inflation device, and ensure that all persons are clear of the trajectory area.

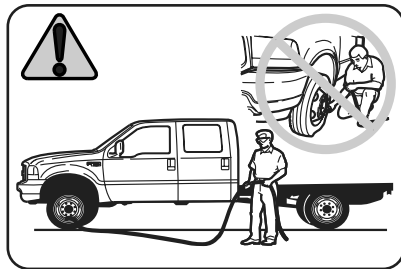

 **WARNING** An inflated tire and rim can be very dangerous if improperly used, serviced or maintained. To avoid serious injury, never attempt to re-inflate a tire which has been run flat or seriously under-inflated without first removing the tire from the wheel assembly for inspection. Do not attempt to add air to tires or replace tires or wheels without first taking precautions to protect persons and property.

## Maintenance and Specifications

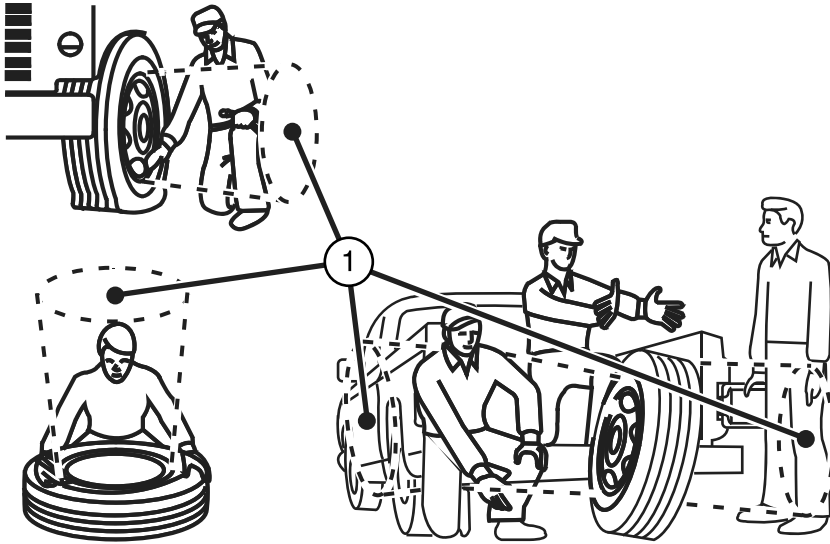

Stay out of the trajectory (1) as indicated in the illustration.

 Do not mount tube type tires on tubeless wheels or tubeless tires on tube type wheels. To do so could result in tire or wheel failure and cause property damage, personal injury or death.

Preserving proper inflation pressure is a very important maintenance practice to insure safe vehicle operation and long life for the tires. Failure to maintain correct inflation pressure may result in sudden tire destruction, improper vehicle handling, and may cause rapid and irregular tire wear. Therefore, inflation pressures should be checked daily and always before long distance trips.

Follow the tire manufacturer's recommended cold inflation pressure for the tire size, type, load range (ply rating) and axle loading typical for your operation. (Each steer axle tire load will equal  $\frac{1}{2}$  steer axle loading; each drive tire load will be  $\frac{1}{4}$  the axle loading if fitted with four tires).

### **Checking inflation**

Always check inflation pressure when tires are cold. Never bleed air from hot tires to relieve normal pressure build-up. Normal increases in pressure due to service conditions will be 10 to 15 psi, which is allowable in truck tires.

204

## Maintenance and Specifications

Tires should be properly inflated to manufacturers recommended pressure for the size and service load in which the vehicle is being used. Refer to the tire manufacturer in which your vehicle is equipped for the latest information concerning service load and inflation pressure.

It is particularly important to keep moisture from the inside of tires, and proper selection of air compressor equipment, proper air line routing, and the use of shop air dryers is strongly recommended to avoid moisture in the high pressure air used for tire inflation.

### ***Under-inflation***

Tires should not be permitted to become under-inflated. Increased flexing due to under-inflation causes heat build-up within the tire components. This leads to reduced strength, breakdown of the rubber compounds, and possible separation of the tire components (i.e., ply and tread separation and reduced retreadability).

Under-inflation is the primary cause of premature tire concerns including sudden loss of air. In addition, low inflation causes an increase in rolling resistance. This results in reduced fuel mileage, a loss in tread mileage, and uneven wear due to increased tread movement. To determine proper inflation refer to the tire manufacturer load/inflation guide which can be found on the tire manufacturer website or at your local truck tire dealer.

### ***Inspection***

Check condition of tires for abnormal wear patterns, and proper inflation pressures. Cut or broken tire casing must be repaired or replaced.

Tires should be inspected for the following conditions. If any are present, the tire should be removed and repaired, retreaded or scrapped as the condition indicates.

- Any blister, bump or raised portion anywhere on the surface of the tire tread or sidewall (other than a bump made by a repair). These indicate the start of internal separation.
- Any cut that reaches to the belt or ply cords, or any cut that is large enough to grow in size and depth.
- Any nail or puncturing object.
- If any stone or object is held by a tread groove and is starting to drill into the tread base, remove the object.

Proper tire inflation, toe-in adjustment, loads, and road speeds are important factors governing tire mileage, steering ease and maneuverability.

## Maintenance and Specifications

### Loads



Loading tires beyond their rated capacity decreases tire life requiring more frequent replacement of tires. Overloading creates an unsafe condition that may result in sudden air loss from a tire failure resulting in an accident that could cause property damage, personal injury or death.

**Note:** Your GAW/GVW rating is correct at the time of your vehicle production, and reflects the exact rating of the tires specified. When replacing tires be sure that the replacement tire load rating (listed in pounds and kilograms on the tire sidewall) is the same or higher than the tire that is removed. Failure to do so will adversely affect maximum load carrying capacity. Tires with the same size specification do not always have the same load specification.

### Matching

**Dual Tires:** Dual tires should be matched using tires of equivalent size. Tires which differ more than  $\frac{1}{4}$  inch (6 mm) in diameter or  $\frac{3}{4}$  inch (19 mm) in circumference should not be mounted on the same dual wheel assembly.

**Mixing:** Never mix bias and radial tires on this vehicle. Never mix different tire sizes or constructions on the same axle. **Note:** Never mix bias and radial tires on this vehicle.

### Rotation:

Rotation is always advisable:

1. If front (steering) axle tires become irregularly worn, move to rear position.
2. In a dual assembly, reverse the position of the tires if one tire wears much faster than its mate.
3. On the drive axle, if heel and toe wear or alternate lug wear occurs, rotating the tires from one end of the axle to the other end of the axle may help even out this wear.

Rotation may not advisable:

1. **Front (Steering) Axle:** Tires must be removed when tread is worn to  $\frac{4}{32}$  inch (3 mm) or less. Retread or rotate worn tires to drive position. Retreaded tires are not recommended to be used on steering axles.
2. **Rear Axles:** Tires must be removed when tread is worn to  $\frac{2}{32}$  inch (2 mm).

206

## Maintenance and Specifications

If rib tire is used on front axle and lug or off-road type on rear axle positions:

1. **Front (Steering) Axle:** Replace tires at front wheels when tread is worn to 4/32 inch (3 mm) or less.
2. **Rear Axles:** Tires must be removed when the tread is worn to 2/32 inch (2 mm) or less. Tires identified with the word "re-groovable" molded on the sidewall can be re-grooved. A minimum of 3/32 inch (2.5 mm) of under-tread must be left at the bottom of the grooves.

### **Wheel and tire balancing**

Out-of-round or out-of-balance wheels or tires can cause vehicle vibration, bounce and shimmy. Replace damaged or out-of-round wheels. Out-of-round tires and wheel assemblies can be corrected by re-clocking the tire relative to the wheel.

The tire and wheel assembly should then be dynamically balanced.

### **Wear**

Radial tires can exhibit three types of normal wear patterns: 1) Even, 2) Erosion, 3) Chamfer.

**Even wear** is a sign that the tire is being properly used and maintained.

**Erosion wear** has also been called rolling wear, channel or river wear. Erosion wear is found more often at free rolling tires. This is an indication that the tire is being used in a slow wearing operation. What happens is that the belt plies are held very rigid and the tread is not allowed to distort as it passes through the contact area. Wear will only occur at the edge of the tread. No corrective action required. If erosion gets to be 1/16 inch (2 mm) or more, the tire may be rotated to a drive axle.

**Chamfer or shoulder wear**, with tires inflated properly, is a normal tendency of most radial tire designs. If both inside and outside shoulders are wearing evenly around the tire, no further action is required. Over-inflation is not effective in correcting this effect.

### **Tires: Irregular Wear**

If irregular wear is present, check the axle alignment, tire pressure, wheel balancing, shock and suspension component condition, and wheel bearing end play.

This condition not only shortens tire life, but will adversely affect the handling of your vehicle, which is dangerous.



## Maintenance and Specifications

Rotating tires from one wheel position to another is a way often used to even out many types of irregular wear or to avoid it altogether. Some of the more effective tire rotation programs are:

- Steer tires that have developed some type of irregular wear pattern can be rotated to drive axles if rib tires are being used on all wheel positions. Applying steer tires to a drive position will often clean them and they can be moved back to the steer axles or run out to re-tread stage on the rear axle.
- Another rotation possibility for fleets with rib tires in all wheel positions is to break in the new steer tires in the drive axle positions, then move them to steer axles. This will wear away tread rubber relatively quickly in the early life of a tire when it is most likely to develop an unusual wear pattern.
- Drive axle tires may be placed on the other end of the same axle so that direction of rotation is reversed. This is often helpful if a heel and toe or alternate lug wear pattern has developed.

### **Irregular wear can be minimized by:**

- Using the right inflation pressure for the load being carried.
- Maintaining proper front wheel alignment - **especially toe-in** - to specifications.
- Maintaining proper tire and wheel balance.
- Maintaining shock absorbers and suspension components.

### ***Use of tire chains***

Refer to chain manufacturer's recommendation for correct tire chain usage, installation and removal.

## Maintenance and Specifications

### LUBRICANT SPECIFICATIONS

Component	Lubrication type	Viscosity / Ambient temperature / Notes	Equivalent Ford part name / number
<b>Non-driving front axle</b>			
Eaton-Spicer axle (generic) - front axle wheel bearing oil	Multipurpose EP gear lube of API GL-5 quality meeting MIL-PRF-2105E specifications including synthetic lubricants. <b>Do not mix conventional and synthetic lubricants.</b>	SAE 75W: -40°F to -15°F (-40°C to -26°C)	Motorcraft SAE 75W-140 Motorcraft
		SAE 75W-80: -40°F to 80°F (-40°C to 27°C)	Synthetic Rear Axle Lubricant / XY-75W140-QL
		SAE 75W-140: -40°F to 100°F (-40°C to 38°C)	
		SAE 75W-140: -40°F and above (-40°C and above)	Motorcraft SAE 75W-140 Motorcraft Synthetic Rear Axle Lubricant / XY-75W140-QL
		SAE 80W-90: -15°F to 100°F (-26°C to -38°C)	Motorcraft SAE 80W-90 Premium Rear Axle Lubricant / XY-80W90-QL
		SAE 80W-140: -15°F and above (-26°C and above)	Motorcraft SAE 75W-140 Motorcraft Synthetic Rear
		SAE 85W-140: 10°F and above (-12°C and above)	Axle Lubricant / XY-75W140-QL

## Maintenance and Specifications

Component	Lubrication type	Viscosity / Ambient temperature / Notes	Equivalent Ford part name / number
Spicer axle - front axle wheel bearing oil	Multipurpose EP gear lube of API GL-5 quality meeting MIL-PRF-2105E specifications including synthetic lubricants. <b>Do not mix conventional and synthetic lubricants.</b>	SAE 75W: -40°F to 32°F (-40°C to 0°C)	Motorcraft SAE 75W-140 Motorcraft Synthetic Rear Axle Lubricant / XY-75W140-QL
		SAE 75W-140: -40°F to 100°F (-40°C to 38°C)	Motorcraft SAE 80W-90 Premium Rear Axle Lubricant / XY-80W90-QL
		SAE 80W: -15°F to 70°F (-26°C to 21°C)	SAE 90 Hypoid Gear Oil / C6AZ-19580-E
		SAE 90W: 10°F to 100°F (-12°C to 38°C)	Motorcraft SAE 75W-140 Motorcraft Synthetic Rear Axle Lubricant / XY-75W140-QL
		SAE 75W-140: -40°F and above (-40°C and above)	
		SAE 80W-140: -15°F and above (-26°C and above)	
		SAE 85W-140: 10°F and above (-12°C and above)	
		SAE 140W: 40°F and above (4°C and above)	

## Maintenance and Specifications

Component	Lubrication type	Viscosity / Ambient temperature / Notes	Equivalent Ford part name / number
Eaton-Spicer axle, Spicer axle - Front axle wheel bearing grease, tie rod ends, drag link, kingpin and bushing	EP2 Lithium complex-based moly grease (or equivalent) GC/LB NLGI #2 multi-purpose lithium complex grease	<b>Note:</b> Eaton-Spicer and Meritor Easy Steer axles: With chassis load on axle, force grease through thrust bearings; then with axle lifted clear of the floor, force grease between kingpin and bushing surfaces.	Motorcraft Premium Long Life Grease / XG-1-C
<b>Steering</b>			
Power steering fluid	MERCON <sup>®</sup> V Automatic Transmission Fluid	—	MERCON <sup>®</sup> V / XT-5-QMC
Steering gear Ross TAS - Output Seal	GC/LB NLGI #2 lithium complex-based moly grease or multi-purpose lithium complex grease	—	Motorcraft Premium Long Life Grease / XG-1-C

## Maintenance and Specifications

Component	Lubrication type	Viscosity / Ambient temperature / Notes	Equivalent Ford part name / number
Steering column U-joints / slip joint	GC/LB NLGI #2 lithium complex-based moly grease or multi-purpose lithium complex grease	—	Motorcraft Premium Long Life Grease / XG-1-C
<b>Driveshaft</b>			
U-joint	GC/LB NLGI #2 lithium complex-based moly grease or multi-purpose lithium complex grease	—	Motorcraft Premium Long Life Grease / XG-1-C
<b>Clutch</b>			
Release bearing / shafts / fork	GC/LB NLGI #2 lithium complex-based moly grease or multi-purpose lithium complex grease	—	Motorcraft Premium Long Life Grease / XG-1-C
Reservoir	DOT 3, ESA-M6C25-A or WSS-M6C62-A	—	Motorcraft High Performance DOT 3 Motor Vehicle Brake Fluid, PM-1 or PM-1-C

## Maintenance and Specifications

Component	Lubrication type	Viscosity / Ambient temperature / Notes	Equivalent Ford part name / number
<b>Cooling system</b>			
Engine coolant	Refer to engine operator's manual		
<b>Windshield washer</b>			
Washer fluid	WSB-M8B16-A2	—	Motorcraft Premium Windshield Washer Concentrate / ZC-32-A
<b>Transmission</b>			
Eaton-Fuller	Petroleum oil: Engine oil API-SL or API-CF (MIL-L-2104E or MIL-L-46152E)	SAE 50: above 10°F (-12°C)	—
		SAE 40: below 10°F (-12°C)	—
	Mineral gear oil: API-GL-1 (rust and oxidation inhibited)	SAE 80W-90: above 10°F (-12°C)	—
		SAE 75W: below 10°F (-12°C)	—
	Synthetic oil: Eaton®, Roadranger® synthetic CD-50 transmission fluid	CD SAE 50: All temperatures	—

## Maintenance and Specifications

Component	Lubrication type	Viscosity / Ambient temperature / Notes	Equivalent Ford part name / number
Spicer (non-synchronized) (lubricants are listed in order of preference)	Petroleum oil: Engine oil API-SL or API-CF (MIL-L-2104E or MIL-L-46152E)	SAE 50: above 0°F (-18°C)	—
		SAE 40: below 0°F (-18°C)	—
	Mineral gear oil: API-GL-1 (rust and oxidation inhibited) (EP gear oils are not acceptable)	SAE 90: above 0°F (-18°C)	—
		SAE 80: below 0°F (-18°C)	—
	Synthetic oil: Synthetic Engine Oil meeting MIL-L-2104E or MIL-L-46152E, API-SL or API-CF	CD SAE 50: All temperatures	—

## Maintenance and Specifications

Component	Lubrication type	Viscosity / Ambient temperature / Notes	Equivalent Ford part name / number
Spicer (synchronized) (lubricants are listed in order of preference)	Petroleum oil: Engine oil API-SL or API-CF (MIL-L-2104E or MIL-L-46152E)	SAE 50: above 10°F (-12°C)	—
		SAE 40: below 10°F (-12°C)	—
	Mineral gear oil: API-GL-1 (rust and oxidation inhibited)	SAE 90: above 10°F (-12°C)	—
		SAE 80W: below 10°F (-12°C)	—
	Synthetic oil: Synthetic Engine Oil meeting MIL-L-2104E or MIL-L-46152E, API-SL or API-CF	SAE 50: All temperatures	—



## Maintenance and Specifications

Component	Lubrication type	Viscosity / Ambient temperature / Notes	Equivalent Ford part name / number
Meritor	Petroleum oil: Heavy Duty Engine Oil MIL-L-2104E or API-SL or API-CF (previous API designations acceptable)	SAE 50: above 10°F (-12°C)	—
		SAE 40: above 10°F (-12°C)	—
		SAE 30: below 10°F (-12°C)	Motorcraft SAE 30 Super Duty Motor Oil / XO-30-QSD
	Mineral gear oil with rust and oxidation inhibitor API-GL-1 <b>Do not use multi-weight and GL-5 EP gear oils; they may cause transmission failure or damage.</b>	SAE 90: above 10°F (-12°C)	—
		SAE 80: below 10°F (-12°C)	—
Synthetic oil: MIL-L-2104E or MIL-L-46152D <b>Do not use multi-weight and GL-5 EP gear oils; they may cause transmission failure or damage.</b>	SAE 50: All temperatures	—	

## Maintenance and Specifications

Component	Lubrication type	Viscosity / Ambient temperature / Notes	Equivalent Ford part name / number
Allison	Refer to transmission operator's manual		
<b>Rear axle</b>			
Eaton-Spicer - two-speed axle	RHEOLUBE 362 (or equivalent) (Eaton part number 113741)	—	—

## Maintenance and Specifications

Component	Lubrication type	Viscosity / Ambient temperature / Notes	Equivalent Ford part name / number
Eaton - single-speed axle	Generic lubricant	SAE 75W: -40°F to -15°F (-40°C to -26°C)	Motorcraft SAE 75W-140
		SAE 75W-80: -40°F to 80°F (-40°C to 27°C)	Motorcraft Synthetic Rear Axle Lubricant / XY-75W140-QL
		SAE 75W-140: -40°F to 100°F (-40°C to 38°C)	
		SAE 80W-90: -15°F to 100°F (-26°C to 38°C)	Motorcraft SAE 80W-90 Premium Rear Axle Lubricant / XY-80W90-QL
		SAE 75W-140: -40°F and above (-40°C and above)	Motorcraft SAE 75W-140 Motorcraft Synthetic Rear Axle Lubricant / XY-75W140-QL
		SAE 80W-140: -15°F and above (-26°C and above)	
		SAE 85W-140: 10°F and above (-12°C and above)	

## Maintenance and Specifications

Component	Lubrication type	Viscosity / Ambient temperature / Notes	Equivalent Ford part name / number
Spicer - single-speed axle	Multipurpose EP gear lube of API GL-5 quality meeting MIL-PRF-2105E specifications including synthetic lubricants	SAE 75W: -40°F to 32°F (-40°C to 0°C)	Motorcraft SAE 75W-140
		SAE 75W-140: -40°F to 100°F (-40°C to 38°C)	Motorcraft Synthetic Rear Axle Lubricant / XY-75W140-QL
		SAE 80W: -15°F to 70°F (-26°C to 21°C)	
		SAE 75W-140: -40°F and above (-40°C and above)	Motorcraft SAE 75W-140
		SAE 80W-140: -15°F and above (-26°C and above)	Motorcraft Synthetic Rear Axle Lubricant / XY-75W140-QL
		SAE 85W-140: 10°F and above (-12°C and above)	
		SAE 140W: 40°F and above (4°C and above)	
		SAE 90W: 10°F to 100°F (-12°C to 38°C)	SAE 90 Hypoid Gear Oil / C6AZ-19580-E

## Maintenance and Specifications

Component	Lubrication type	Viscosity / Ambient temperature / Notes	Equivalent Ford part name / number
Meritor - single-speed axle	Fill at the factory with Synthetic SAE 75W-140, will have a tag attached to fill plug that reads as follows: "Filled with synthetic lube. Do not mix."	—	—
	Multipurpose EP gear lube of API GL-5 quality meeting MIL-PRF-2105E specifications including synthetic lubricants. <b>Do not mix conventional and synthetic lubricants.</b>	SAE 75W-140: Above -40°F (-40°C)	Motorcraft SAE 75W-140
		SAE 85W-140: above 10°F (-12°C)	Motorcraft Synthetic Rear Axle Lubricant / XY-75W140-QL
		SAE 85W-140: above -15°F (-26.1°C)	
		SAE 80W-90: above -15°F (-26.1°C)	Motorcraft SAE 80W-90 Premium Rear Axle Lubricant / XY-80W90-QL
	SAE 75W maximum outside temperature (35°F (1.6°C); Above -40°F (-40°C)	Motorcraft SAE 75W-140 Motorcraft Synthetic Rear Axle Lubricant / XY-75W140-QL	

## Maintenance and Specifications

Component	Lubrication type	Viscosity / Ambient temperature / Notes	Equivalent Ford part name / number
<b>Cab components</b>			
Hydraulic lift pump fluid	Dexron III	—	Motorcraft MERCON® Multi-Purpose (ATF) Transmission Fluid / XT-2-QDX
Cab latch and lock levers	Mobile SHC 32 Low Temperature Lubricant (or equivalent)	—	—
Cab latch pivots; Door check, hinges, latches and strikers; Seat adjuster slides	GC/LB NLGI #2 lithium complex-based moly grease (or equivalent) or multi-purpose lithium complex grease	—	Motorcraft Premium Long Life Grease / XG-1-C
Cab latch pivot pins	Light engine oil	—	Motorcraft SAE 5W-30 Super Premium Motor Oil / XO-5W30-QSP
Door lock cylinders	Lock oil	—	Motorcraft Penetrating and Lock Lubricant / XL-1

## Maintenance and Specifications

Component	Lubrication type	Viscosity / Ambient temperature / Notes	Equivalent Ford part name / number
Door window regulators	NGLI #2 multipurpose lithium complex grease	—	Motorcraft Multi-Purpose Grease Spray / XL-5 or Motorcraft Multi-Purpose Grease / XG-4
Weatherstripping	Silicone lubricant	—	Motorcraft Silicone Spray / XL-6
<b>Engine oil</b>			
Refer to engine operator manual			
<b>Brake fluid</b>			
Master cylinder	DOT 3, ESA-M6C25-A or WSS-M6C62-A	—	Motorcraft High Performance DOT 3 Motor Vehicle Brake Fluid, PM-1 or PM-1-C

### REFILL CAPACITIES

#### Rear axle

Axle code	Weight capacity - lb. (kg)	Description	Fluid capacity - pints (liters) <sup>1,2</sup>
S135-S	13500 (6123)	Single rear axle, single reduction	24.5 (11.6)
4S150-S	15500 (7031)	Single rear axle, single reduction	24.5 (11.6)

## Maintenance and Specifications

<b>Axle code</b>	<b>Weight capacity - lb. (kg)</b>	<b>Description</b>	<b>Fluid capacity - pints (liters)<sup>1,2</sup></b>
17060S	17500 (7938)	Single rear axle, single reduction	28.0 (13.2)
19055T	17500 (7938)	Single rear axle, two-speed	28.0 (13.2)
M190T	19000 (8618)	Single rear axle, two-speed	35.0 (17.0)
19060S	19000 (8618)	Single rear axle, single reduction	28.0 (13.2)
21060S	21000 (9525)	Single rear axle, single reduction	28.0 (13.2)
21060D	21000 (9525)	Single rear axle, single reduction with driver-controlled locking differential	28.0 (13.2)
M210T	21000 (9525)	Single rear axle, two-speed	16.0 (33.0)
23090S	23000 (10432)	Single rear axle, single reduction	39.0 (18.5)
23090D	23000 (10432)	Single rear axle, single reduction with driver-controlled locking differential	39.0 (18.5)
23082T	23000 (10432)	Single rear axle, two-speed	37.0 (17.5)

<sup>1</sup> Quantities listed are approximate. Fill axle until the lubricant level is at the bottom of the filler hole, with the vehicle on level ground.

<sup>2</sup> If hubs are removed, add an additional 1.6 pints (0.75L) of axle lubricant. Add lubricant through the axle vent.



## Maintenance and Specifications

### Engine coolant and oil

Engine type	Engine coolant (approximate capacity) *	Engine oil (approximate capacity)
Caterpillar	57.0 pints (27.0L)	Refer to engine operator's manual.
Cummins	52.0 pints (24.6L)	

\* Add the coolant type originally equipped in your vehicle.

### Power steering system

Steering gear	Power steering fluid volume
TAS40	17.6 pints
TAS66	18.4 pints

### Transmission

Description	Pints (Liters)
Allison 2000 Series	30.0 (14.2)*
Allison 3000 Series	37.6 (17.8)*
FS-5205A 5-speed manual	12.5 (5.9)
FS-5406A/5406N and FS-6406A/FSO-6406A 6-speed manuals	19.5 (9.2)
ES56-7B/ES066-7B 7-speed manual	22.0 (10.4)

\*Total fluid capacity (dry transmission and torque converter).

### Air conditioner refrigerant - r134a

Lb. (Kg)	Oz.
2.75 (1.03)	44

**Note:** This system uses PAG-type refrigerant oil.

### Refrigerant fitting torque

Captured washer nut: 170–190 inch lb. (19–21 N•m)

**Note:** This system uses mineral based refrigerant oil to lubricate o-rings and fittings.

## Maintenance and Specifications

### Fuel tanks

Standard tanks are listed as such; all other tanks available for your vehicle are optional equipment.

Vehicle	Tank type	Gallons (Liters)
F-650 Low Profile (standard), F-650 Dock Height	Single, steel rectangular	35 (132)
F-650 Low Profile, F-650 Dock Height (standard), F-750 Pick-up and Delivery (standard), F-750 Severe Service (standard)	Single, steel rectangular	45 (170)
F-650 Dock Height, F-750 Pick-up and Delivery, F-750 Severe Service	Single, steel rectangular	50 (189)
F-650 Low Profile, F-650 Dock Height, F-750 Pick-up and Delivery, F-750 Severe Service	Single, steel rectangular	65 (246)
F-650 Dock Height, F-750 Pick-up and Delivery, F-750 Severe Service	Single, steel D-style	65 (246)
F-650 Dock Height, F-750 Pick-up and Delivery, F-750 Severe Service	Single, steel D-style	80 (302)
F-650 Low Profile, F-650 Dock Height, F-750 Pick-up and Delivery, F-750 Severe Service	Dual, steel rectangular	25(LH)/45(RH) (95[LH]/170[RH])
F-650 Low Profile, F-650 Dock Height	Dual, steel rectangular	35(RH)/45(LH) (132[RH]/170[LH])
F-650 Low Profile, F-650 Dock Height, F-750 Pick-up and Delivery, F-750 Severe Service	Dual, steel rectangular	45/45 (170/170)
F-650 Dock Height, F-750 Pick-up and Delivery, F-750 Severe Service	Dual, steel D-style	50/50 (189/189)

## Maintenance and Specifications

Vehicle	Tank type	Gallons (Liters)
F-650 Low Profile, F-650 Dock Height, F-750 Pick-up and Delivery, F-750 Severe Service	Dual, steel rectangular	45(RH)/65(LH) (170[RH]/246[LH])
F-650 Low Profile, F-650 Dock Height, F-750 Pick-up and Delivery, F-750 Severe Service	Dual, steel rectangular	65/65 (246/246)
F-650 Dock Height, F-750 Pick-up and Delivery, F-750 Severe Service	Dual, steel D-style	65/65 (246/246)
F-650 Dock Height, F-750 Pick-up and Delivery, F-750 Severe Service	Dual, steel D-style	65 (LH)/80 (RH) (246[LH]/302[RH])
F-650 Dock Height, F-750 Pick-up and Delivery, F-750 Severe Service	Dual, steel D-style	80/80 (302/302)

### VEHICLE IDENTIFICATION NUMBER (VIN)

The VIN is printed on the Vehicle Rating Decal attached to the vehicle. The VIN also serves as the warranty number. If you ever find it necessary to communicate with Ford Motor Company about your vehicle, always include the VIN in your communication.

## Scheduled Maintenance Guide

### GENERAL MAINTENANCE INFORMATION

The general maintenance services listed in this section are required because they are considered essential to the life and performance of your vehicle. Refer to the “Daily Owner Checks” chart for important maintenance items.

Ford Motor Company recommends you perform the owner maintenance services listed in this section. These services are matters of day-to-day care that are important to the proper operation of your vehicle. In addition to the conditions described in owner maintenance, be alert for any unusual noise, vibration or other indication that your vehicle may need service and attend to it promptly.

Your vehicle is very sophisticated and built with multiple complex performance systems. Every manufacturer develops these systems using different specifications and performance features. That’s why it’s important to rely upon your Ford dealership to properly diagnose and repair your vehicle.

Use only recommended fuels, lubricants, fluids and service parts conforming to Ford specifications. Motorcraft parts are designed and built for best performance in your vehicle. Using these parts for replacement is your assurance that Ford-Built quality stays in your vehicle.

Non-Ford approved chemicals or additives are not required for factory recommended maintenance. In fact, Ford Motor Company recommends against the use of such additive products unless specifically recommended by Ford for a particular application.

### SCHEDULED MAINTENANCE

Ford Motor Company has recommended maintenance intervals for various parts and component systems based upon engineering testing. Ford Motor Company relies upon this testing to determine the most appropriate mileage for replacement of oils and fluids to protect your vehicle at the lowest overall cost to you and recommends against maintenance schedules that deviate from the scheduled maintenance information.

The maintenance or replacement of the emission control devices (or systems) in your new Ford Motor Company vehicle (or engine) may be performed at your expense. These services may be performed by any automotive repair establishment or individual using automotive parts equivalent to those with which your vehicle or engine was originally equipped. If any parts other than Ford, Motorcraft, or Ford authorized,

## Scheduled Maintenance Guide

remanufactured parts are used for maintenance replacements (or for the service) of components effecting the emission control, the owner should be ensured that such parts are warranted by their manufacturer to be equivalent to genuine Ford Motor Company Parts in performance and durability. Please consult your warranty information booklet for complete warranty information.

### **Authorized dealer maintenance**

Your authorized dealer specializes in knowing all about Ford Motor Company vehicles rather than knowing a little about all makes.

There are Ford or Ford of Canada dealer service shops ready to serve you wherever you drive in the U.S. or Canada. They stock Ford and Motorcraft parts, and Ford Chemicals and lubricants. You can be confident that these meet the same exacting design and quality standards as those used to build the vehicle originally. Dealer Service Technicians have available training in the latest product developments and service techniques.

### ***Oils, Fluids and Flushing***

In many cases, fluid discoloration is a normal operating characteristic of the chemical compound and in itself does not demonstrate that a fluid needs to be changed. Oils and fluids identified in the *Scheduled Maintenance Guide* chapter should be changed at the specified interval or in conjunction with a repair. Flushing is a viable way to change fluid for many vehicle sub-systems during scheduled maintenance and should only be done using the same fluid required to finish the maintenance procedure, or a Ford approved flushing chemical.

### **OWNER MAINTENANCE**

You can do much of the maintenance your vehicle requires yourself, if you have the time and a reasonable amount of mechanical ability. If you prefer to have this work done professionally, your authorized dealer stands ready to help you.

All mechanical components and attachments are important in that they could affect the performance of vital components and systems. If replacement becomes necessary, they must be replaced with parts having the same part number or with equivalent parts. Torque values of the attaching parts must be used as specified during any reassembly procedure to ensure proper retention.

228

## Scheduled Maintenance Guide

### FACTORY AUTHORIZED SYSTEMS CHECKS

In the event that your vehicle experiences a component related concern, please contact your Ford dealership. The Ford Motor Company Trained Technicians who work at Ford dealerships are specifically trained to understand your vehicle.

A proper repair begins with a thorough system check. A Factory Authorized Systems Check can ONLY be found at a Ford dealership. In some circumstances, the technician may need to request your authorization to perform additional operations to determine the final diagnosis. The technician's goal is to ensure that your vehicle is fixed right the first time, at the best value to you.

The following list represents several of the Factory Authorized Systems Checks available at a participating Ford dealers:

- Air Conditioning
- Check Engine Light
- All Wheel Drive and 4x4
- Automatic Transmission
- Engine Cooling and Cabin Heating
- Steering and Suspension
- Charge/Start/Battery
- Wheel Alignment
- Anti-Lock Brake System

### EMISSIONS CONTROL SYSTEM

To ensure the emissions control systems operate effectively, you should have the services listed in the maintenance schedule performed at the specified time and mileage/km intervals. You should avoid running out of fuel or turning off the ignition while the vehicle is in motion, especially at high speeds.



Because of high engine compartment and exhaust system temperatures resulting from emissions equipment, do not park, idle or operate your vehicle in dry grass or other dry ground cover where the possibility of ground fire exists.

Do not make unauthorized modifications to the engine or vehicle. Modifications causing increased amounts of unburned fuel to reach the exhaust system can significantly increase the temperature of the engine compartment and/or the exhaust system.

## Scheduled Maintenance Guide

Avoid driving your vehicle if it does not operate properly. If the engine diesels (more than five seconds of engine run-on after shut-off), misfires, surges, stalls or backfires, see your dealer. Be alert for fluid leakage, odor, smoke, loss of oil pressure, or charge indicator or over temperature warning.

Do NOT use diesel fuel blended with waste oil in engines equipped with a catalytic converter-muffler. Waste lube oil blending in fuel will plug the catalytic converter-muffler, resulting in a significant loss of engine power.

### **Emissions control system(s) laws**

Federal law prohibits vehicle manufacturers, dealers and other persons engaged in the business of repairing, servicing, selling, leasing or trading motor vehicles, as well as fleet operators from knowingly removing or rendering an emissions control device or system inoperative. Further, modifications of the emissions control system(s) could create liability on the part of individual owners under the laws of some states. In Canada, modification of the emissions control system could create liability under applicable Federal or Provincial laws.

### **NOISE EMISSIONS WARRANTY, PROHIBITED TAMPERING ACTS AND MAINTENANCE**

On January 1, 1978, Federal regulations became effective governing the noise emissions on trucks over 10,000 lb. (4,536 kg) GVWR. The following statements concerning prohibited tampering acts and maintenance and the noise warranty are found in the Warranty Guide, and are applicable to completed trucks.

### **Tampering with noise control system prohibited**

Federal law prohibits the following acts or the causing thereof: (1) The removal or rendering inoperative, by any person other than for purposes of maintenance, repair or replacement, of any device or element of design incorporated into any new vehicle for the purpose of noise control prior to its sale or delivery to the ultimate purchaser or while it is in use, or (2) the use of the vehicle after such device or element of design has been removed or rendered inoperative by any person.

## Scheduled Maintenance Guide

Among those acts presumed to constitute tampering are the following acts listed:

<b>Vehicle System</b>	<b>Acts</b>
Acoustical Shielding	Removal of noise shields, hood blanket, tunnel liner or acoustical absorptive material.
Engine	Removal or rendering inoperative the engine speed governor so as to allow engine speed to exceed manufacturer specifications. Removal of engine mounted noise shield or oil pan enclosure.
Engine Air Induction System	Removal of the air duct, silencer, air cleaner, and/or air cleaner element and baffle in air cleaner; re-indexing of air cleaner.
Exhaust System	Removal or rendering inoperative exhaust system components including the catalytic converter - muffler assembly, inlet pipe, outlet pipe, resonator and flexpipe. Rotation of horizontal exhaust system directional outlet pipe to cause the exhaust to be emitted in a direction other than the orientation the vehicle was originally produced with.
Engine Cooling System	Removal or rendering inoperative the fan clutch. Removal or modification of the fan shroud. Replacing a fixed fan with a fan of increased diameter, different number of blades or different pitch width.



## Scheduled Maintenance Guide

### MAINTENANCE

Instructions for maintenance and service of the noise control system have been included in the required maintenance services and in the general maintenance section. To further help minimize noise emissions degradation throughout the life of the vehicle, Ford Motor Company recommends that this vehicle should be operated in the manner described within this Owner Guide. Caution should be exercised by the owner when installing replacement parts to be sure that a tampering act (as outlined above) is not committed. Note any inspection and service performed in the Maintenance Record.

### EMISSIONS INFORMATION LABEL

Emissions information appears on the Important Engine Information decal located on or near the engine.

### SCHEDULED MAINTENANCE SERVICES

Maintenance service adjustments must conform to specifications contained in this manual, and those shown on the Important Engine Information decal. The following services are to be performed at scheduled intervals because they are considered essential to the life and performance of your vehicle. Ford recommends that you perform maintenance on all designated items to achieve best vehicle operation.

Maintenance intervals are provided for three types of general vehicle environments: On-Highway, City and Severe Service. In all applications, the actual interval is determined by monitoring kilometers (miles) and time and when the engine is due for an oil change. When the engine oil change is required prior to the truck lubrication interval, it is recommended that the lubrication be performed at the same time in order to reduce your vehicle's time out of service.

- **On-Highway:** 60,000 miles (96,000 km) or more annually.
- **City:** 60,000 miles (96,000 km) or less annually.
- **Severe Service:** 20,000 miles (32,000 km) or less annually on/off road in dirty conditions.

Scheduled maintenance beyond 100,000 miles (160,000 km) should be continued as before 100,000 miles (160,000 km).

## Scheduled Maintenance Guide

### AIR BRAKE ADJUSTMENT



Failure to maintain proper air brake adjustment can result in reduction or loss of braking ability.

Air brake inspection and adjustment or repairs should be performed by a qualified service technician in accordance with the instructions in the service manual.

#### Cam brakes - automatic slack adjusters

Inspect standard air brakes equipped with automatic slack adjusters for proper brake adjustment as per *scheduled maintenance information*.

However, more frequent inspection is required if your vehicle's brakes are subjected to heavy use or adverse operating conditions such as:

- Frequent brake applications while fully loaded.
- Operation on hilly or mountainous terrain.
- Frequent operation on dirt, gravel or mud.

Some aftermarket brake linings also require more frequent inspections.



Do not manually adjust the automatic slack adjusters to correct excessive pushrod stroke as it may result in reduced brake effectiveness and a vehicle crash. Excessive pushrod stroke indicates that a problem exists with the automatic adjuster, with the installation of the adjuster, or with foundation brake components that manual adjustment will not remedy. Seek service from a qualified facility for excessive pushrod stroke.

**MAINTENANCE SERVICES AND RECORD RETENTION**

The maintenance record form which follows is for your convenience. In addition to recording the services performed, you should retain copies of your receipts for the services. You also should keep records of any emission control systems maintenance services performed on your vehicle.

**Maintenance Record**

Warranty  
Start Date \_\_\_\_\_ Engine Displacement \_\_\_\_\_

Vehicle  
Identification  
Number \_\_\_\_\_ Owner Name \_\_\_\_\_

**IMPORTANT** — This document should remain with the vehicle at all times.

## Scheduled Maintenance Guide

<b>Daily owner checks</b>	
<b>Engine</b>	Check the air filter restriction gauge.
	Check the engine oil.
	Inspect the coolant level
<b>Brake system</b>	Check the air brake system reservoir automatic drain valve operation.
	Drain the air brake system reservoir - manual valve.
<b>Transmission system</b>	Visually check the automatic transmission for fluid leakage.
<b>Steering system</b>	Check the power steering pump fluid level and check the system for leaks.
	Check the entire vehicle for evidence of fluid leaks.
<b>U.S. Department of Transportation, Federal Highway Administration requirements (ensure that the entire system is functioning properly)</b>	Check the service brakes.
	Check the parking brake.
	Check the steering mechanism.
	Check the lighting devices and reflectors.
	Check the tires.
	Check the horn.
	Check the windshield wipers.
	Check the rear vision mirrors.
	Check the wheels and rims.
Check the emergency equipment.	

## Scheduled Maintenance Guide

<b>Check every oil change</b>	
<b>Engine system</b>	Check the engine cooling system - hoses, clamps and protection*.
	Inspect the drive belts.
<b>Exhaust system</b>	Inspect the entire exhaust system (including the inlet pipe(s), muffler(s), outlet pipe(s), clamps and fasteners) for holes, leakage, breakage, corrosive damage and separation from other components. Adjust, service or replace with the same or the equivalent part. (Also a noise emission control service).
<b>Suspension system</b>	Tighten the front and rear spring U-bolts to the specified torque.
<b>Driveline and rear axle system</b>	Lubricate the U-joints and the slip yoke.
<b>Brake system</b>	Lube the air brake foot control valve, hinge and roller.
	Inspect the drum brake linings through the inspection holes.
	Lubricate the brake camshafts (air brakes only).
	Lubricate the brake slack adjuster (air brakes only).
	Lubricate rear caliper slide rails.
	Inspect the disc brake pads and the piston boots (hydraulic brakes only).
<b>Clutch system</b>	Lubricate the clutch release cross shaft and all linkages.
	Check the clutch fluid.
<b>Fuel system</b>	Drain the accumulated water or sediment from the fuel tank(s).

## Scheduled Maintenance Guide

Check every oil change	
<b>Steering system</b>	Lubricate the steering shaft(s), U-joints and splines when equipped with grease fittings.
	Lubricate the front axle spindle pins.
	Lubricate the steering linkage when equipped with grease fittings.
	Grease the power steering gear output shaft.
* Coolant protection checks should be made just prior to the onset of freezing weather, where applicable. If coolant is dirty or rusty in appearance, the system should be drained, flushed and refilled with the prescribed solution of cooling system fluid and water. Use only permanent type coolant that meets specifications as listed in your engine operator's manual. See the engine manufacturer's operating guide for supplemental corrosion inhibitor specifications.	

In addition to the items to be performed daily or at each oil change, the following need to be completed as specified:

### GENERAL MAINTENANCE SERVICES

The following are vehicle checks that should be made periodically either by the owner or a qualified technician. It is recommended that deficiencies be brought to the attention of your dealer or another qualified service outlet as soon as possible in order that advice regarding the need for service or replacement can be obtained.

Maintenance Operation	Frequency - Observation
Inspect the automatic slack adjuster function	Insufficient power shown in loaded practice stop.
Check the operation of the brakes, the clutch, and the steering <sup>(1),(2)</sup>	Vehicle handling qualities not up to par.
Inspect the vehicle for missing, damaged, or mislocated noise shields	Excessive noise emanates from under the cab or engine compartment.

## Scheduled Maintenance Guide

Maintenance Operation	Frequency - Observation
Check the engine performance and the engine governor	Excessive engine noise.
Inspect the fan, the fan shroud, and the fan clutch	Engine overheats, fan runs at high speed constantly, excessive fan noise, or fan wobble due to worn bearings.
Check for operation of ABS warning lamp	At each engine start up.
Inspect the entire exhaust system (including inlet pipe, muffler, outlet pipe and all exhaust clamps and fasteners) for holes, leakage, breakage, looseness and corrosive damage	Excessive noise or the smell of fumes is experienced.
Inspect the engine air induction system (including the air ducts and the air filter) for loose fitting, damaged or missing components	Excessive noise emanates from the engine compartment.
Inspect the tires and check the air pressure <sup>(3)</sup>	Poor steering, wandering or excessive tire wear.
Balance the wheels and the tires	Vibration or abnormal tire wear indicates imbalance.
Check the front end alignment <sup>(3)</sup>	Poor steering, wandering or excessive tire wear.
Check the transmission and engine mountings <sup>(2)</sup>	Hard shifting or excessive vibration.
Check and adjust transmission controls <sup>(2)</sup>	High effort to shift or noisy transmission.
Check fuel pump pressure	Insufficient full-throttle power or backfiring.
Clean radiator cap seal. Clean and inspect the cap surface on the radiator	When the cap does not hold pressure.

## Scheduled Maintenance Guide

Maintenance Operation	Frequency - Observation
Check the battery terminals for corrosion	Whenever electrical power supply has diminished.
Tighten the wheel mounting nuts to the specified torque. Refer to <i>Wheels</i> in the <i>Maintenance and Specifications</i> chapter	Required initially at 500 and 1000 miles (800 and 1600 km). Perform again at 500 and 1000 mile (800 and 1600 km) intervals after each tire removal/replacement.
Clean body/door drain holes	At least twice annually.
Clean windshield wiper blades	As required.
Replace windshield wiper blades	If wiping the blades with a clean cloth and mild detergent and washing with a cleaner does not restore a clean wipe.
Lubricate body lock cylinders	Noisy or difficult to operate.
Check headlamp alignment	Lamp beams in wrong position when vehicle operating loaded.
Check windshield washer fluid level; add fluid if required	If washes do not spray when operated.
<sup>1</sup> - During maintenance and repair, protect the fuel tube and the hose assemblies, the power steering lines, and the brake lines from the external heat, the acids and the abrasion that could damage the lines.	
<sup>2</sup> - Check for (free) linkage action and ensure that (return) spring force is adequate to maintain pedal free play.	
<sup>3</sup> - Adjust, repair or replace as required with the same or equivalent parts.	



ON-HIGHWAY - 60,000 MILES (96,000 KM) OR MORE ANNUALLY (Miles, kilometers or months - whichever occurs first)										
Miles (x 1000)	15	30	45	60	75	90	105	120	135	150
Kilometers (x 1000)	24	48	72	96	120	144	168	192	216	240
Months	3	6	9	12	15	18	21	24	27	30
<b>Non-driving front axle</b>										
Wheel bearing - oil type - check level	•	•	•	•	•	•	•	•	•	•
Wheel bearing - oil type - change oil						•				
Wheel bearing - grease type - repack		•		•		•		•		•
Tie rod ends - lubricate	•	•	•	•	•	•	•	•	•	•
Drag link - lubricate	•	•	•	•	•	•	•	•	•	•
King pin and bushing - lubricate	•	•	•	•	•	•	•	•	•	•
<b>Brake system - air</b>										
Slack adjusters - lubricate				•				•		
S-cam - lubricate	•	•	•	•	•	•	•	•	•	•
<b>Brake system - hydraulic</b>										
Master cylinder - check level	•	•	•	•	•	•	•	•	•	•
Park brake relay lever / linkage - lubricate				•				•		
<b>Steering</b>										
Power steering fluid - check level	•	•	•	•	•	•	•	•	•	•
Power steering fluid - change fluid						•				
Power steering filter - replacement	Five years or 500,000 miles (800,000 km)									
Steering gear Ross TAS - output shaft - lubricate			•			•			•	
Steering column u-joints / slip joint - lubricate	•	•	•	•	•	•	•	•	•	•

ON-HIGHWAY - 60,000 MILES (96,000 KM) OR MORE ANNUALLY (Continued)										
(Miles, kilometers or months - whichever occurs first)										
Miles (x 1000)	15	30	45	60	75	90	105	120	135	150
Kilometers (x 1000)	24	48	72	96	120	144	168	192	216	240
Months	3	6	9	12	15	18	21	24	27	30
<b>Driveshaft SPL</b>										
U-joint - lubricate	Every 100,000 miles (160,000 km) or six months, whichever comes first									
<b>Driveshaft non-SPL</b>										
U-joint and slip joint - lubricate	Every 10,000–15,000 miles (16,000–24,000 km) or three months, whichever comes first									
<b>Clutch</b>										
Release bearing / shafts / forks - lubricate	•	•	•	•	•	•	•	•	•	•
<b>Cooling system</b>										
Coolant - check level	•	•	•	•	•	•	•	•	•	•
Coolant - check freeze protection	•	•	•	•	•	•	•	•	•	•
Extended life coolant - add extender	See engine manufacturer's recommendation									
Extended life coolant - replace	See engine manufacturer's recommendation									
<b>Engine - Refer to your engine operator's manual</b>										
<b>Transmission</b>										
Automatic and Auto-shift transmissions	Refer to transmission operator's manual									
Manual transmission - check fluid level	•	•	•	•	•	•	•	•	•	•
Eaton-Fuller manual transmission - petroleum oil change				•				•		

ON-HIGHWAY - 60,000 MILES (96,000 KM) OR MORE ANNUALLY (Continued)										
(Miles, kilometers or months - whichever occurs first)										
Miles (x 1000)	15	30	45	60	75	90	105	120	135	150
Kilometers (x 1000)	24	48	72	96	120	144	168	192	216	240
Months	3	6	9	12	15	18	21	24	27	30
Eaton-Fuller manual transmission - synthetic oil change	Factory fill w/synthetic at 500,000 miles (800,000 km); Converted to synthetic at 250,000 miles (400,000 km)									
<b>Rear axle</b>										
Fluid level - check	•	•	•	•	•	•	•	•	•	•
Eaton / Dana / Spicer petroleum oil - change				•				•		
Eaton / Dana / Spicer synthetic oil - change	Factory fill w/synthetic at 500,000 miles (800,000 km); Converted to synthetic at 250,000 miles (400,000 km) or three years									
<b>Cab components</b>										
Door hinges / Latches / Strikers - lubricate, check link				•				•		
Door lock cylinders - lubricate				•				•		
Seat adjuster slides - lubricate				•				•		

ON-HIGHWAY - 60,000 MILES (96,000 KM) OR MORE ANNUALLY (Miles, kilometers or months - whichever occurs first)										
Miles (x 1000)	165	180	195	210	225	240	255	270	285	300
Kilometers (x 1000)	264	288	312	336	360	384	408	432	456	480
Months	33	36	39	42	45	48	51	54	57	60
<b>Non-driving front axle</b>										
Wheel bearing - oil type - check level	•	•	•	•	•	•	•	•	•	•
Wheel bearing - oil type - change oil		•						•		
Wheel bearing - grease type - repack		•		•		•		•		•
Tie rod ends - lubricate	•	•	•	•	•	•	•	•	•	•
Drag link - lubricate	•	•	•	•	•	•	•	•	•	•
King pin and bushing - lubricate	•	•	•	•	•	•	•	•	•	•
<b>Brake system - air</b>										
Slack adjusters - lubricate		•				•				•
S-cam - lubricate	•	•	•	•	•	•	•	•	•	•
<b>Brake system - hydraulic</b>										
Master cylinder - check fluid level	•	•	•	•	•	•	•	•	•	•
Park brake relay level / linkage - lubricate		•				•				
<b>Steering</b>										
Power steering fluid - check level	•	•	•	•	•	•	•	•	•	•
Power steering fluid - change level		•						•		
Power steering filter - replacement	Five years or 500,000 miles (800,000 km)									
Steering gear Ross TAS - output seal - lubricate		•			•			•		
Steering column u-joints / slip joint - lubricate	•	•	•	•	•	•	•	•	•	•

ON-HIGHWAY - 60,000 MILES (96,000 KM) OR MORE ANNUALLY (Continued)										
(Miles, kilometers or months - whichever occurs first)										
Miles (x 1000)	165	180	195	210	225	240	255	270	285	300
Kilometers (x 1000)	264	288	312	336	360	384	408	432	456	480
Months	33	36	39	42	45	48	51	54	57	60
<b>Driveshaft SPL</b>										
U-joint - lubricate	Every 100,000 miles (160,000 km) or six months, whichever comes first									
<b>Driveshaft non-SPL</b>										
U-joint and slip joint - lubricate	Every 10,000–15,000 miles (16,000–24,000 km) or three months, whichever comes first									
<b>Clutch</b>										
Release bearing / shafts / fork - lubricate	•	•	•	•	•	•	•	•	•	•
<b>Cooling system</b>										
Coolant - check level	•	•	•	•	•	•	•	•	•	•
Coolant - check freeze protection	•	•	•	•	•	•	•	•	•	•
Extended life coolant - add extender	See engine manufacturer's recommendation									
Extended life coolant - replace	See engine manufacturer's recommendation									
<b>Engine - Refer to your engine operator's manual</b>										
<b>Transmission</b>										
Automatic and Auto-shift transmissions	Refer to transmission operator's manual									
Manual transmission - check fluid level	•	•	•	•	•	•	•	•	•	•
Eaton-Fuller manual transmission - petroleum oil change		•				•				•

ON-HIGHWAY - 60,000 MILES (96,000 KM) OR MORE ANNUALLY (Continued)										
(Miles, kilometers or months - whichever occurs first)										
Miles (x 1000)	165	180	195	210	225	240	255	270	285	300
Kilometers (x 1000)	264	288	312	336	360	384	408	432	456	480
Months	33	36	39	42	45	48	51	54	57	60
Eaton-Fuller manual transmission - synthetic oil change	Factory fill w/synthetic at 500,000 miles (800,000 km); Converted to synthetic at 250,000 miles (400,000 km)									
<b>Rear axle</b>										
Fluid level - check	•	•	•	•	•	•	•	•	•	•
Eaton / Dana / Spicer petroleum oil - change		•				•				•
Eaton / Dana / Spicer synthetic oil - change	Factory fill w/synthetic at 500,000 miles (800,000 km); Converted to synthetic at 250,000 miles (400,000 km) or three years									
<b>Cab components</b>										
Door hinges / Latches / Strikers - lubricate, check link		•				•				•
Door lock cylinders - lubricate		•				•				•
Seat adjuster slides - lubricate		•				•				•

CITY - 60,000 MILES (96,000 KM) OR LESS ANNUALLY (Miles, kilometers or months - whichever occurs first)										
Miles (x 1000)	10	20	30	40	50	60	70	80	90	100
Kilometers (x 1000)	16	32	48	64	80	96	112	128	144	160
Months	3	6	9	12	15	18	21	24	27	30
<b>Non-driving front axle</b>										
Wheel bearing - oil type - check level	•	•	•	•	•	•	•	•	•	•
Wheel bearing - oil type - change oil				•				•		
Wheel bearing - grease type - repack				•				•		
Tie rod ends - lubricate	•	•	•	•	•	•	•	•	•	•
Drag link - lubricate	•	•	•	•	•	•	•	•	•	•
King pin and bushing - lubricate	•	•	•	•	•	•	•	•	•	•
<b>Brake system - air</b>										
Slack adjusters - lubricate				•				•		
S-cam - lubricate	•	•	•	•	•	•	•	•	•	•
<b>Brake system - hydraulic</b>										
Master cylinder - check fluid level	•	•	•	•	•	•	•	•	•	•
Park brake relay lever / linkage - lubricate			•			•			•	
<b>Steering</b>										
Power steering fluid - check level	•	•	•	•	•	•	•	•	•	•
Power steering fluid - change fluid				•				•		
Power steering filter - replacement	Five years or 50,000 miles (80,000 km)									
Steering gear Ross TAS - output seal - lubricate			•			•			•	
Steering column u-joints / slip joint - lubricate	•	•	•	•	•	•	•	•	•	•

CITY - 60,000 MILES (96,000 KM) OR LESS ANNUALLY (Continued) (Miles, kilometers or months - whichever occurs first)										
Miles (x 1000)	10	20	30	40	50	60	70	80	90	100
Kilometers (x 1000)	16	32	48	64	80	96	112	128	144	160
Months	3	6	9	12	15	18	21	24	27	30
<b>Driveshaft SPL</b>										
U-joint - lubricate	Every 25,000 miles (40,000 km) or six months, whichever comes first									
<b>Driveshaft non-SPL</b>										
U-joint and slip joint - lubricate	Every 5,000-8,000 miles (8,000 km-12,800 km) or three months, whichever comes first									
<b>Clutch</b>										
Release bearing / shafts / fork - lubricate	•	•	•	•	•	•	•	•	•	•
<b>Cooling system</b>										
Coolant - check level	•	•	•	•	•	•	•	•	•	•
Coolant - check freeze protection	•	•	•	•	•	•	•	•	•	•
Extended life coolant - add extender	See engine manufacturer's recommendation									
Extended life coolant - replace	See engine manufacturer's recommendation									
<b>Engine - refer to your engine operator's manual</b>										
<b>Transmission</b>										
Automatic and Auto-shift transmissions	Refer to transmission operator's manual									
Manual transmission - check fluid level	•	•	•	•	•	•	•	•	•	•
Eaton-Fuller manual transmission - petroleum oil change					•					•



CITY - 60,000 MILES (96,000 KM) OR LESS ANNUALLY (Continued)										
(Miles, kilometers or months - whichever occurs first)										
Miles (x 1000)	10	20	30	40	50	60	70	80	90	100
Kilometers (x 1000)	16	32	48	64	80	96	112	128	144	160
Months	3	6	9	12	15	18	21	24	27	30
<b>Rear axle</b>										
Fluid level - check	•	•	•	•	•	•	•	•	•	•
Eaton / Dana / Spicer petroleum oil - change					•					•
<b>Cab components</b>										
Door hinges / latches / strikers - lubricate, check link			•			•			•	
Door lock cylinders - lubricate			•			•			•	
Seat adjuster slides - lubricate			•			•			•	

CITY - 60,000 MILES (96,000 KM) OR LESS ANNUALLY (Miles, kilometers or months - whichever occurs first)										
Miles (x 1000)	110	120	130	140	150	160	170	180	190	200
Kilometers (x 1000)	176	192	208	224	240	256	272	288	304	320
Months	33	36	39	42	45	48	51	54	57	60
<b>Non-driving front axle</b>										
Wheel bearing - oil type - check level	•	•	•	•	•	•	•	•	•	•
Wheel bearing - oil type - change oil		•				•				•
Wheel bearing - grease type - repack		•				•				•
Tie rode ends - lubricate	•	•	•	•	•	•	•	•	•	•
Drag link - lubricate	•	•	•	•	•	•	•	•	•	•
King pin and bushing - lubricate	•	•	•	•	•	•	•	•	•	•
<b>Brake system - air</b>										
Slack adjusters - lubricate		•				•				•
S-cam - lubricate	•	•	•	•	•	•	•	•	•	•
<b>Brake system - hydraulic</b>										
Master cylinder - check fluid level	•	•	•	•	•	•	•	•	•	•
Park brake relay lever / linkage - lubricate		•			•			•		
<b>Steering</b>										
Power steering fluid - check level	•	•	•	•	•	•	•	•	•	•
Power steering fluid - change fluid		•				•				•
Power steering filter - replacement	Five years or 50,000 miles (80,000 km)									
Steering gear Ross TAS - output seal - lubricate		•			•			•		
Steering column u-joints / slip joint - lubricate	•	•	•	•	•	•	•	•	•	•

CITY - 60,000 MILES (96,000 KM) OR LESS ANNUALLY (Continued) (Miles, kilometers or months - whichever occurs first)										
Miles (x 1000)	110	120	130	140	150	160	170	180	190	200
Kilometers (x 1000)	176	192	208	224	240	256	272	288	304	320
Months	33	36	39	42	45	48	51	54	57	60
<b>Driveshaft SPL</b>										
U-joint - lubricate	Every 25,000 miles (40,000 km) or six months, whichever comes first									
<b>Driveshaft non-SPL</b>										
U-joint and slip joint - lubricate	Every 5,000-8,000 miles (8,000 km-12,800 km) or three months, whichever comes first									
<b>Clutch</b>										
Release bearing / shafts / fork - lubricate	•	•	•	•	•	•	•	•	•	•
<b>Cooling system</b>										
Coolant - check level	•	•	•	•	•	•	•	•	•	•
Coolant - check freeze protection	•	•	•	•	•	•	•	•	•	•
Extended life coolant - add extender	See engine manufacturer's recommendation									
Extended life coolant - replace	See engine manufacturer's recommendation									
<b>Engine - refer to your engine operator's manual</b>										
<b>Transmission</b>										
Automatic and Auto-shift transmission	Refer to transmission operator's manual									
Manual transmission - check fluid level	•	•	•	•	•	•	•	•	•	•
Eaton-Fuller manual transmission - petroleum oil change					•					•

CITY - 60,000 MILES (96,000 KM) OR LESS ANNUALLY (Continued)										
(Miles, kilometers or months - whichever occurs first)										
Miles (x 1000)	110	120	130	140	150	160	170	180	190	200
Kilometers (x 1000)	176	192	208	224	240	256	272	288	304	320
Months	33	36	39	42	45	48	51	54	57	60
Eaton-Fuller manual transmission - synthetic oil change		•								
<b>Rear axle</b>										
Fluid level - check	•	•	•	•	•	•	•	•	•	•
Eaton / Dana / Spicer petroleum oil - change					•					•
Eaton / Dana / Spicer synthetic oil - change		•								
<b>Cab components</b>										
Door hinges / latches / strikers - lubricate, check link		•			•			•		
Door lock cylinders - lubricate		•			•			•		
Seat adjuster slides - lubricate		•			•			•		

SEVERE SERVICE - ON/OFF ROAD IN DIRTY CONDITIONS OR 20,000 MILES (32,000 KM) OR LESS ANNUALLY (Miles, kilometers or months - whichever occurs first)										
Miles (x 1000)	5	10	15	20	25	30	35	40	45	50
Kilometers (x 1000)	8	16	24	32	40	48	56	64	72	80
Months	3	6	9	12	15	18	21	24	27	30
<b>Non-driving front axle</b>										
Wheel bearing - oil type - check level	•	•	•	•	•	•	•	•	•	•
Wheel bearing - oil type - change oil				•				•		
Wheel bearing - grease type - repack				•				•		
Tie rod ends - lubricate	•	•	•	•	•	•	•	•	•	•
Drag link - lubricate	•	•	•	•	•	•	•	•	•	•
King pin and bushing - lubricate	•	•	•	•	•	•	•	•	•	•
<b>Brake system - air</b>										
Slack adjusters - lubricate				•				•		
S-cam - lubricate	•	•	•	•	•	•	•	•	•	•
<b>Brake system - hydraulic</b>										
Master cylinder - check fluid level	•			•		•				
Park brake relay lever / linkage - lubricate			•			•			•	
<b>Steering</b>										
Power steering fluid - check fluid level	•	•	•	•	•	•	•	•	•	•
Power steering fluid - change fluid				•				•		
Steering gear Ross TAS - output seal - lubricate			•			•			•	
Steering column u-joints / slip joints - lubricate	•	•	•	•	•	•	•	•	•	•

SEVERE SERVICE - ON/OFF ROAD IN DIRTY CONDITIONS OR 20,000 MILES (32,000 KM) OR LESS ANNUALLY (Continued) (Miles, kilometers or months - whichever occurs first)										
Miles (x 1000)	5	10	15	20	25	30	35	40	45	50
Kilometers (x 1000)	8	16	24	32	40	48	56	64	72	80
Months	3	6	9	12	15	18	21	24	27	30
<b>Driveshaft - SPL</b>										
Slip joint - inspect boot	Every 25,000 miles (40,000 km) or six months, whichever comes first									
U-joint - lubricate										
<b>Driveshaft - non-SPL</b>										
U-joint and slip joint - lubricate	Every 5,000–8,000 miles (8,000–12,800 km) or three months, whichever comes first									
<b>Clutch</b>										
Release bearing / shafts / forks	•	•	•	•	•	•	•	•	•	•
<b>Cooling system</b>										
Coolant - check level	•	•	•	•	•	•	•	•	•	•
Coolant - check freeze protection	•	•	•	•	•	•	•	•	•	•
Extended life coolant - add extender	See engine manufacturer's recommendation									
Extended life coolant - replace	See engine manufacturer's recommendation									
<b>Engine - refer to your engine operator's manual</b>										
<b>Transmission</b>										
Automatic and Auto-shift transmissions	Refer to transmission operator's manual									
Manual transmission - check fluid level	•	•	•	•	•	•	•	•	•	•
Eaton-Fuller manual transmission - petroleum oil change				•				•		

SEVERE SERVICE - ON/OFF ROAD IN DIRTY CONDITIONS OR 20,000 MILES (32,000 KM) OR LESS ANNUALLY (Continued) (Miles, kilometers or months - whichever occurs first)										
Miles (x 1000)	5	10	15	20	25	30	35	40	45	50
Kilometers (x 1000)	8	16	24	32	40	48	56	64	72	80
Months	3	6	9	12	15	18	21	24	27	30
<b>Rear axle</b>										
Fluid level - check	•	•	•	•	•	•	•	•	•	•
Eaton / Dana / Spicer - petroleum oil change				•				•		•
Eaton / Dana / Spicer - synthetic oil change				•				•		
<b>Cab components</b>										
Door hinges / latches / strikers - lubricate, check link				•				•		
Door lock cylinders - lubricate				•				•		
Seat adjuster slides - lubricate				•				•		

SEVERE SERVICE - ON/OFF ROAD IN DIRTY CONDITIONS OR 20,000 MILES (32,000 KM) OR LESS ANNUALLY (Miles, kilometers or months - whichever occurs first)										
Miles (x 1000)	55	60	65	70	75	80	85	90	95	100
Kilometers (x 1000)	88	96	104	112	120	128	136	144	152	160
Months	33	36	39	42	45	48	51	54	57	60
<b>Non-driving front axle</b>										
Wheel bearing - oil type - check level	•	•	•	•	•	•	•	•	•	•
Wheel bearing - oil type - change oil		•				•				•
Wheel bearing - grease type - repack		•				•				•
Tie rod ends - lubricate	•	•	•	•	•	•	•	•	•	•
Drag link - lubricate	•	•	•	•	•	•	•	•	•	•
King pin and bushing - lubricate	•	•	•	•	•	•	•	•	•	•
<b>Brake system - air</b>										
Slack adjusters - lubricate		•				•				•
S-cam - lubricate	•	•	•	•	•	•	•	•	•	•
<b>Brake system - hydraulic</b>										
Master cylinder - check fluid level	•	•	•	•	•	•	•	•	•	•
Park brake relay lever / linkage - lubricate		•			•			•		
<b>Steering</b>										
Power steering fluid - check level	•	•	•	•	•	•	•	•	•	•
Power steering fluid - change fluid		•				•				•
Power steering filter - replacement		•								
Steering gear Ross TAS - output seal - lubricate		•			•			•		
Steering column u-joints / slip joint - lubricate	•	•	•	•	•	•	•	•	•	•



SEVERE SERVICE - ON/OFF ROAD IN DIRTY CONDITIONS OR 20,000 MILES (32,000 KM) OR LESS ANNUALLY (Continued) (Miles, kilometers or months - whichever occurs first)										
Miles (x 1000)	55	60	65	70	75	80	85	90	95	100
Kilometers (x 1000)	88	96	104	112	120	128	136	144	152	160
Months	33	36	39	42	45	48	51	54	57	60
<b>Driveshaft SPL</b>										
Slip joint - inspect boot	Every 25,000 miles (40,000 km) or six months, whichever comes first									
U-joint - lubricate										
<b>Driveshaft non-SPL</b>										
U-joint and slip joint - lubricate	Every 5,000–8,000 miles (8,000–12,800 km) or three months, whichever comes first									
<b>Clutch</b>										
Release bearing / shafts / fork - lubricate	•	•	•	•	•	•	•	•	•	•
<b>Cooling system</b>										
Coolant - check level	•	•	•	•	•	•	•	•	•	•
Coolant - check freeze protection	•	•	•	•	•	•	•	•	•	•
Extended life coolant - add extender	See engine manufacturer's recommendation									
Extended life coolant - replace	See engine manufacturer's recommendation									
<b>Engine - refer to your engine operator's manual</b>										
<b>Transmission</b>										
Automatic and Auto-shift transmissions	Refer to transmission operator's manual									
Manual transmission - check fluid level	•	•	•	•	•	•	•	•	•	•
Eaton-Fuller manual transmission - petroleum oil change		•				•				•

SEVERE SERVICE - ON/OFF ROAD IN DIRTY CONDITIONS OR 20,000 MILES (32,000 KM) OR LESS ANNUALLY (Continued)										
(Miles, kilometers or months - whichever occurs first)										
Miles (x 1000)	55	60	65	70	75	80	85	90	95	100
Kilometers (x 1000)	88	96	104	112	120	128	136	144	152	160
Months	33	36	39	42	45	48	51	54	57	60
Eaton-Fuller manual transmission - synthetic oil change		•				•				
<b>Rear axle</b>										
Fluid level - check	•	•	•	•	•	•	•	•	•	•
Eaton / Dana / Spicer petroleum oil - change		•				•				•
Eaton / Dana / Spicer synthetic oil - change		•				•				
<b>Cab components</b>										
Door hinges / latches / strikers - lubricate, check link		•				•				•
Door lock cylinders - lubricate		•				•				•
Seat adjuster slides - lubricate		•				•				•

## Scheduled Maintenance Guide

<b>Date:</b> <b>Odometer reading:</b> <b>R.O.#</b>	<b>Dealer's Stamp:</b>
--	------------------------

<b>Date:</b> <b>Odometer reading:</b> <b>R.O.#</b>	<b>Dealer's Stamp:</b>
--	------------------------

<b>Date:</b> <b>Odometer reading:</b> <b>R.O.#</b>	<b>Dealer's Stamp:</b>
--	------------------------

<b>Date:</b> <b>Odometer reading:</b> <b>R.O.#</b>	<b>Dealer's Stamp:</b>
--	------------------------

<b>Date:</b> <b>Odometer reading:</b> <b>R.O.#</b>	<b>Dealer's Stamp:</b>
--	------------------------

<b>Date:</b> <b>Odometer reading:</b> <b>R.O.#</b>	<b>Dealer's Stamp:</b>
--	------------------------

## Scheduled Maintenance Guide

<b>Date:</b> <b>Odometer reading:</b> <b>R.O.#</b>	<b>Dealer's Stamp:</b>
--	------------------------

<b>Date:</b> <b>Odometer reading:</b> <b>R.O.#</b>	<b>Dealer's Stamp:</b>
--	------------------------

<b>Date:</b> <b>Odometer reading:</b> <b>R.O.#</b>	<b>Dealer's Stamp:</b>
--	------------------------

<b>Date:</b> <b>Odometer reading:</b> <b>R.O.#</b>	<b>Dealer's Stamp:</b>
--	------------------------

<b>Date:</b> <b>Odometer reading:</b> <b>R.O.#</b>	<b>Dealer's Stamp:</b>
--	------------------------

<b>Date:</b> <b>Odometer reading:</b> <b>R.O.#</b>	<b>Dealer's Stamp:</b>
--	------------------------

## Scheduled Maintenance Guide

<b>Date:</b> <b>Odometer reading:</b> <b>R.O.#</b>	<b>Dealer's Stamp:</b>
--	------------------------

<b>Date:</b> <b>Odometer reading:</b> <b>R.O.#</b>	<b>Dealer's Stamp:</b>
--	------------------------

<b>Date:</b> <b>Odometer reading:</b> <b>R.O.#</b>	<b>Dealer's Stamp:</b>
--	------------------------

<b>Date:</b> <b>Odometer reading:</b> <b>R.O.#</b>	<b>Dealer's Stamp:</b>
--	------------------------

<b>Date:</b> <b>Odometer reading:</b> <b>R.O.#</b>	<b>Dealer's Stamp:</b>
--	------------------------

<b>Date:</b> <b>Odometer reading:</b> <b>R.O.#</b>	<b>Dealer's Stamp:</b>
--	------------------------

## Scheduled Maintenance Guide

<b>Date:</b> <b>Odometer reading:</b> <b>R.O.#</b>	<b>Dealer's Stamp:</b>
--	------------------------

<b>Date:</b> <b>Odometer reading:</b> <b>R.O.#</b>	<b>Dealer's Stamp:</b>
--	------------------------

## Index

### A

- Air conditioning .....45
  - manual heating and air conditioning system .....45
- Air suspension .....113
- Anti-lock brake system (see Brakes) .....111
- Audio system (see Radio) .....32, 34, 38
- Automatic transmission .....115
  - fluid, adding .....190
  - fluid, checking .....190
  - fluid, refill capacities .....224
  - fluid, specification .....209
- Auxiliary power point .....53
- Axle .....123, 162, 195
  - lubricant specifications .....209
  - refill capacities .....222

### B

- Battery .....171
  - charging system warning light .....21
  - jumping a disabled battery ....142
  - voltage gauge .....27
- Belt-Minder® .....74
- Brakes .....92, 97, 162
  - adjustment .....165
  - anti-lock .....111
  - anti-lock brake system (ABS) warning light .....21, 111
  - brake warning light .....21
  - fluid, checking and adding .....165, 188
  - fluid, specifications .....209
  - parking .....93, 100, 166
- Bulbs .....49

### C

- Catalytic converter (see Emission control) .....166
- CD-single premium .....32
- Cell phone use .....7
- Child safety restraints .....78
  - child safety belts .....78
- Child safety seats .....81
  - attaching with tether straps ....84
  - in front seat .....82
  - in rear seat .....82
  - tether anchorage hardware ....84
- Child safety seats - booster seats .....79
- Cleaning your vehicle
  - chrome and aluminum parts .....156
  - engine compartment .....156
  - exterior .....158
  - instrument panel .....157
  - interior .....157
  - interior trim .....157
  - plastic parts .....156
  - washing .....155
  - waxing .....155
  - wheels .....156
- Climate control (see Air conditioning or Heating) .....44-45
- Clutch .....117, 188
  - adjusting .....189
  - fluid .....188
  - operation while driving .....117
  - specifications .....209
- Controls
  - power seat .....65
- Coolant .....173
  - refill capacities .....224
  - specifications .....209

## Index

- temperature gauge .....27
- Cruise control  
(see Speed control) .....57
- Customer Assistance .....134, 150
  - Ford accessories for your vehicle .....158
  - Getting assistance outside the U.S. and Canada .....150, 152
  - Getting roadside assistance ...134
  - Getting the service you need .....150
  - Ordering additional owner's literature .....153
- D**
- Daytime running lamps  
(see Lamps) .....47
- Defects, reporting .....153
- Defrost .....44–45
  - windshield .....44–45
  - with heating and air conditioning system .....45
  - with standard heating system .....44
- Doors
  - lubricant specifications .....209
- Driving under special conditions
  - through water .....90
- E**
- Emergencies, roadside
  - jump-starting .....142
- Emission control system .....185, 229
  - catalytic converter .....166
- Engine
  - cleaning .....156
  - coolant .....173
  - lubrication specifications .....209
- Engine fan .....174
- Engine oil .....171
  - oil pressure gauge .....27
  - refill capacities .....224
  - specifications .....209
- Event data recording .....6
- F**
- Fan, Engine Cooling .....174
- Flashers, hazard .....135
- Fuel .....175
  - calculating fuel economy .....178–179
  - capacity .....225
  - choosing the right fuel .....176
  - filling your vehicle with fuel .....175
  - filter, specifications .....174
  - gauge .....27
  - improving fuel economy .....178–179
  - running out of fuel .....88, 178
  - safety information relating to automotive fuels .....175
- Fuses .....135, 141
- G**
- Gas mileage  
(see Fuel economy) .....178–179
- Gauges .....27
  - battery voltage gauge .....27
  - engine coolant temperature gauge .....27
  - engine oil pressure gauge .....27
  - fuel gauge .....27
  - odometer .....27



## Index

- speedometer .....27  
tachometer .....27  
trip odometer .....27
- H**
- Hazard flashers .....135  
Headlamps .....47  
  aiming .....48  
  daytime running lights .....47  
  high beam .....47  
  warning chime .....21  
Heating .....44–45  
  heater only system .....44  
  manual heating and air  
  conditioning system .....45  
Hood .....168
- I**
- Ignition .....85  
  chime .....21  
Infant seats  
(see Safety seats) .....81  
Instrument panel  
  cleaning .....157  
  lighting up panel and  
  interior .....48
- J**
- Jump-starting your vehicle .....142
- K**
- Keys  
  key in ignition chime .....21  
  positions of the ignition .....85
- L**
- Lamps  
  bulb replacement  
  specifications chart .....49  
  cargo lamps .....48  
  daytime running light .....47  
  headlamps .....47  
  high beams .....47  
  instrument panel, dimming .....48  
  interior lamps .....49  
  replacing bulbs .....49–51  
Lane change indicator  
(see Turn signal) .....48  
Lights, warning and indicator ....21  
  air suspension .....21  
  anti-lock brakes (ABS) ....21, 111  
  brake .....21  
  charging system .....21  
  safety belt .....21  
  service engine soon .....21  
  traction control off .....21  
  turn signal indicator .....21  
Lubricant specifications .....209
- M**
- Manual transmission .....119  
  lubricant specifications .....209  
Mirrors .....55  
  fold away .....57  
  heated .....56  
  side view mirrors (power) .....56
- O**
- Odometer .....27
- P**
- Paint chips, repairing .....156

264

## Index

- Parking brake .....93, 100  
warning light .....21
- Power door locks .....61
- Power mirrors .....56
- Power point .....53
- Power steering .....168  
fluid, checking and adding ....186  
fluid, refill capacity .....224  
fluid, specifications .....209
- Power Take-Off (PTO)  
operation .....122
- Power Windows .....53
- R**
- Radio .....32, 34, 38
- Relays .....136
- Remote entry system  
locking/unlocking doors .....61
- Roadside assistance .....134
- S**
- Safety belts  
(see Safety restraints) .....69–71
- Safety defects, reporting ..153–154
- Safety restraints .....69–71  
Belt-Minder® .....74  
cleaning the safety belts .....73  
extension assembly .....73  
for adults .....70–71  
for children .....78  
lap belt .....70  
warning light and chime ....21, 74
- Safety seats for children .....81
- Scheduled Maintenance  
Guide .....227
- General Maintenance  
Information .....227
- Seat belts  
(see Safety restraints) .....69
- Seats .....62  
child safety seats .....81  
heated .....68
- Special notice .....6
- Specification chart,  
lubricants .....209
- Speed control .....57
- Speedometer .....27
- Starting your vehicle .....85  
jump starting .....142  
preparing to start your  
vehicle .....85
- Steering .....167
- Steering wheel  
controls .....52, 57  
tilting .....52
- Suspension .....113, 193
- T**
- Tachometer .....27
- Temperature control  
(see Climate control) .....44–45
- Towing  
wrecker .....146
- Traction control  
off light .....21
- Transmission .....115, 119  
automatic operation .....115  
fluid, checking and adding  
(automatic) .....190  
fluid, checking and adding  
(manual) .....191

## Index

- fluid, refill capacities .....224
- lubricant specifications .....209
- manual operation .....119
- Turn signal .....48
- V**
- Vehicle loading .....128
- Voltmeter  
(see Battery voltage gauge) .....27
- W**
- Warning chimes .....21
- Warning lights (see Lights) .....21
- Warranty coverage .....6
- Washer fluid .....170
- Washing your vehicle .....155
- Water, Driving through .....90
- Waxing your vehicle .....155
- Wheels .....196
- Windows  
power .....53
- Windshield  
defrosting .....44-45
- Windshield washer fluid and  
wipers .....52  
checking and cleaning .....157  
operation .....52  
replacing wiper blades .....171
- Wrecker towing .....146













