

# HYUNDAI



## ***OWNER'S MANUAL***

### **Santa Fe**

**Operation  
Maintenance  
Specifications**

All information in this Owner's Manual is current at the time of publication. However, Hyundai reserves the right to make changes at any time so that our policy of continual product improvement may be carried out.

This manual applies to all Hyundai models and includes descriptions and explanations of optional as well as standard equipment. As a result, you may find material in this manual that does not apply to your specific vehicle.



### **CAUTION: MODIFICATIONS TO YOUR HYUNDAI**

Your Hyundai should not be modified in any way. Such modifications may adversely affect the performance, safety or durability of your Hyundai and may, in addition, violate conditions of the limited warranties covering the vehicle. Certain modifications may also be in violation of regulations established by the U.S. Department of Transportation and other federal or state agencies.

### **TWO-WAY RADIO OR CELLULAR TELEPHONE INSTALLATION**

Your vehicle is equipped with electronic fuel injection and other electronic components. It is possible for an improperly installed/adjusted two-way radio or cellular telephone to adversely affect electronic systems. For this reason, we recommend that you carefully follow the radio manufacturer's instructions or consult your Hyundai dealer for precautionary measures or special instructions if you choose to install one of these devices.

## SAFETY AND VEHICLE DAMAGE WARNING

This manual includes information titled as WARNING, CAUTION and NOTICE.

These titles indicate the following:

### **WARNING**

**This indicates that a condition may result in harm, serious injury or death to you or other persons if the warning is not heeded. Follow the advice provided with the warning.**

### **! CAUTION**

*This indicates that a condition may result in damage to your vehicle or its equipment if the caution is not heeded. Follow the advice provided with the caution.*

### **\* NOTICE**

This indicates that interesting or helpful information is being provided.

## FOREWORD

Thank you for choosing Hyundai. We are pleased to welcome you to the growing number of discriminating people who drive Hyundais. The advanced engineering and high-quality construction of each Hyundai we build is something of which we're very proud.

Your Owner's Manual will introduce you to the features and operation of your new Hyundai. It is suggested that you read it carefully because the information it contains can contribute greatly to the satisfaction you receive from your new car.

The manufacturer also recommends that all service and maintenance on your car be performed by an authorized Hyundai dealer. Hyundai dealers are prepared to provide high-quality service, maintenance and any other assistance that may be required.

## HYUNDAI MOTOR AMERICA

**Note** : Because future owners will also need the information included in this manual, if you sell this Hyundai, please leave the manual in the vehicle for their use. Thank you.

### **! CAUTION**

***Severe engine and transaxle damage may result from the use of poor quality fuels and lubricants that do not meet Hyundai specifications. You must always use high quality fuels and lubricants that meet the specifications listed on Page 8-4 in the Vehicle Specifications section of the Owner's Manual.***

Copyright 2009 Hyundai Motor America. All rights reserved. No part of this publication may be reproduced, stored in any retrieval system or transmitted in any form or by any means without the prior written permission of Hyundai Motor America.

## Guide to Hyundai Genuine Parts

### 1. What are Hyundai Genuine Parts?

Hyundai Genuine Parts are the same parts used by Hyundai Motor Company to manufacture vehicles. They are designed and tested for the optimum safety, performance, and reliability to our customers.

### 2. Why should you use genuine parts?

Hyundai Genuine Parts are engineered and built to meet rigid manufacturing requirements. Using imitation, counterfeit or used salvage parts is not covered under the Hyundai New Vehicle Limited Warranty or any other Hyundai warranty.

In addition, any damage to or failure of Hyundai Genuine Parts caused by the installation or failure of an imitation, counterfeit or used salvage part is not covered by any Hyundai Warranty.

### 3. How can you tell if you are purchasing Hyundai Genuine Parts?

Look for the Hyundai Genuine Parts Logo on the package (see below).

Hyundai Genuine Parts exported to are packaged with labels written only in English.

Hyundai Genuine Parts are only sold through authorized Hyundai Dealerships.

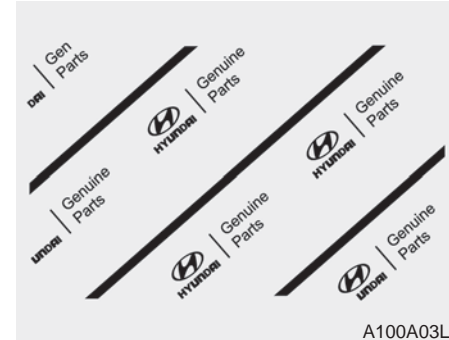

A100A03L



A100A01L



A100A02L

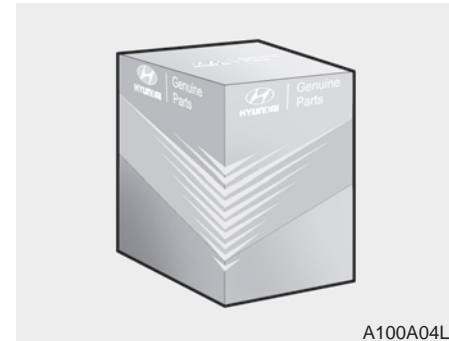

A100A04L



---

## ***TABLE OF CONTENTS***

---

Introduction	<b>1</b>
Your vehicle at a glance	<b>2</b>
Safety system of your vehicle	<b>3</b>
Features of your vehicle	<b>4</b>
Driving your vehicle	<b>5</b>
What to do in an emergency	<b>6</b>
Maintenance	<b>7</b>
Specifications, Consumer information and Reporting safety defects	<b>8</b>
Index	<b>I</b>

# Introduction

1

**How to use this manual / 1-2**

**Fuel requirements / 1-2**

**Vehicle handling instructions / 1-4**

**Vehicle break-in process / 1-5**

**Vehicle data collection and event data recorders / 1-5**

**Indicator symbols on the instrument cluster / 1-6**



### HOW TO USE THIS MANUAL

A010000AUN

We want to help you get the greatest possible driving pleasure from your vehicle. Your Owner's Manual can assist you in many ways. We strongly recommend that you read the entire manual. In order to minimize the chance of death or injury, you must read the WARNING and CAUTION sections in the manual.

Illustrations complement the words in this manual to best explain how to enjoy your vehicle. By reading your manual, you will learn about features, important safety information, and driving tips under various road conditions.

The general layout of the manual is provided in the Table of Contents. A good place to start is the index; it has an alphabetical listing of all information in your manual.

Sections: This manual has eight sections plus an index. Each section begins with a brief list of contents so you can tell at a glance if that section has the information you want.

You'll find various WARNINGS, CAUTIONS, and NOTICES in this manual. These were prepared to enhance your personal safety. You should carefully read and follow ALL procedures and recommendations provided in these WARNINGS, CAUTIONS and NOTICES.

#### **WARNING**

**A WARNING indicates a situation in which harm, serious bodily injury or death could result if the warning is ignored.**

#### **! CAUTION**

**A CAUTION indicates a situation in which damage to your vehicle could result if the caution is ignored.**

#### **\* NOTICE**

**A NOTICE indicates interesting or helpful information is being provided.**

### FUEL REQUIREMENTS

Your new vehicle is designed to use only unleaded fuel having a pump octane number((RTM)/2) of 87 or higher.

Your new vehicle is designed to obtain maximum performance with UNLEADED FUEL, as well as minimize exhaust emissions and spark plug fouling.

#### **! CAUTION**

***Never add any fuel system cleaning agents to the fuel tank other than what has been specified. (Consult an authorized HYUNDAI dealer for details.)***

**⚠ WARNING**

- Do not "top off" after the nozzle automatically shuts off when refueling.
- Tighten the cap until it clicks, otherwise the Check Engine  light will illuminate.
- Always check that the fuel cap is installed securely to prevent fuel spillage in the event of an accident.

A020103AUN

***Gasoline containing alcohol and methanol***

Gasohol, a mixture of gasoline and ethanol (also known as grain alcohol), and gasoline or gasohol containing methanol (also known as wood alcohol) are being marketed along with or instead of leaded or unleaded gasoline.

Do not use gasohol containing more than 10% ethanol, and do not use gasoline or gasohol containing any methanol. Either of these fuels may cause drivability problems and damage to the fuel system.

Discontinue using gasohol of any kind if drivability problems occur.

Vehicle damage or driveability problems may not be covered by the manufacturer's warranty if they result from the use of:

1. Gasohol containing more than 10% ethanol.
2. Gasoline or gasohol containing methanol.
3. Leaded fuel or leaded gasohol.

"E85" fuel is an alternative fuel composed of 85 percent ethanol and 15 percent gasoline, and is manufactured exclusively for use in Flexible Fuel Vehicles. "E85" is not compatible with your vehicle. Use of "E85" may result in poor engine performance and damage to your vehicle's engine and fuel system. HYUNDAI recommends that customers do not use fuel with an ethanol content exceeding 10 percent.

**! CAUTION**

***Your New Vehicle Limited Warranty does not cover damage to the fuel system or any performance problems caused by the use of "E85" fuel.***

**! CAUTION**

***Never use gasohol which contains methanol. Discontinue use of any gasohol product which impairs drivability.***

A020104AUN

### **Use of MTBE**

We recommend that fuels containing MTBE (Methyl Tertiary Butyl Ether) over 15.0% vol. (Oxygen Content 2.7% weight) should not be used in your vehicle.

Fuel containing MTBE over 15.0% vol. (Oxygen Content 2.7% weight) may reduce vehicle performance and produce vapor lock or hard starting.

### **! CAUTION**

***Your New Vehicle Limited Warranty may not cover damage to the fuel system and any performance problems that are caused by the use of fuels containing methanol or fuels containing MTBE (Methyl Tertiary Butyl Ether) over 15.0% vol. (Oxygen Content 2.7% weight.)***

A020105AUN

### **Do not use methanol**

Fuels containing methanol (wood alcohol) should not be used in your vehicle. This type of fuel can reduce vehicle performance and damage components of the fuel system.

A020106AUN

### **Gasolines for cleaner air**

To help contribute to cleaner air, we recommend that you use gasolines treated with detergent additives, which help prevent deposit formation in the engine. These gasolines will help the engine run cleaner and enhance performance of the Emission Control System.

A020107AUN

### **Operation in foreign countries**

If you are going to drive your vehicle in another country, be sure to:

- Observe all regulations regarding registration and insurance.
- Determine that acceptable fuel is available.

## **VEHICLE HANDLING INSTRUCTIONS**

As with other vehicles of this type, failure to operate this vehicle correctly may result in loss of control, an accident or vehicle rollover.

Specific design characteristics (higher ground clearance, track, etc.) give this vehicle a higher center of gravity than other types of vehicles. In other words they are not designed for cornering at the same speeds as conventional 2-wheel drive vehicles. Avoid sharp turns or abrupt maneuvers. Again, failure to operate this vehicle correctly may result in loss of control, an accident or vehicle rollover. **Be sure to read the “Reducing the risk of a rollover” driving guidelines, in section 5 of this manual.**

## VEHICLE BREAK-IN PROCESS

A030000AUN

No special break-in period is needed. By following a few simple precautions for the first 600 miles (1,000 km) you may add to the performance, economy and life of your vehicle.

- Do not race the engine.
- While driving, keep your engine speed (rpm, or revolutions per minute) between 2,000 rpm and 4,000 rpm.
- Do not maintain a single speed for long periods of time, either fast or slow. Varying engine speed is needed to properly break-in the engine.
- Avoid hard stops, except in emergencies, to allow the brakes to seat properly.
- Don't let the engine idle longer than 3 minutes at one time.
- Don't tow a trailer during the first 1,200 miles (2,000 km) of operation.

## VEHICLE DATA COLLECTION AND EVENT DATA RECORDERS

A040000AFD

**This vehicle is equipped with an event data recorder (EDR). The main purpose of an EDR is to record, in certain crash or near crash-like situations, such as an air bag deployment or hitting a road obstacle, data that will assist in understanding how a vehicle's systems performed. The EDR is designed to record data related to vehicle dynamics and safety systems for a short period of time, typically 30 seconds or less. The EDR in this vehicle is designed to record such data as:**

- \* How various systems in your vehicle were operating;
- \* Whether or not the driver and passenger safety belts were buckled/fastened;
- \* How far (if at all) the driver was depressing the accelerator and/or brake pedal; and,
- \* How fast the vehicle was traveling.

These data can help provide a better understanding of the circumstances in which crashes and injuries occur. **NOTE: EDR data are recorded by your vehicle only if a nontrivial crash situation occurs; no data are recorded by the EDR under normal driving conditions and no personal data (e.g., name, gender, age, and crash location) are recorded. However, other parties, such as law enforcement, could combine the EDR data with the type of personally identifying data routinely acquired during a crash investigation.**

To read data recorded by an EDR, special equipment is required, and access to the vehicle or the EDR is needed.

In addition to the vehicle manufacture, other parties, such as law enforcement, that have the special equipment, can read the information if they have access to the vehicle or the EDR.

## INDICATOR SYMBOLS ON THE INSTRUMENT CLUSTER

A050000BFD



Door ajar warning light



Air bag warning light



CRUISE Cruise indicator



Tailgate open warning light



Parking brake & Brake fluid warning light



SET Cruise SET indicator



Seat belt warning light



Engine oil pressure warning light



Low fuel level warning light



High beam indicator



AWD system warning light\*



Shift pattern indicator



Turn signal indicator



AWD LOCK indicator\*



Low tire pressure telltale / TPMS(Tire Pressure Monitoring System) malfunction indicator



ESC indicator



Low windshield washer fluid level warning light\*



ECO ECO indicator\*



ESC OFF indicator



Charging system warning light

\*: if equipped

\*: For more detailed explanations, refer to section 4, "Instrument cluster".



ABS warning light



Malfunction indicator\*

## Your vehicle at a glance

2

**Interior overview / 2-2**

**Instrument panel overview / 2-3**

**Engine compartment / 2-4**

## INTERIOR OVERVIEW

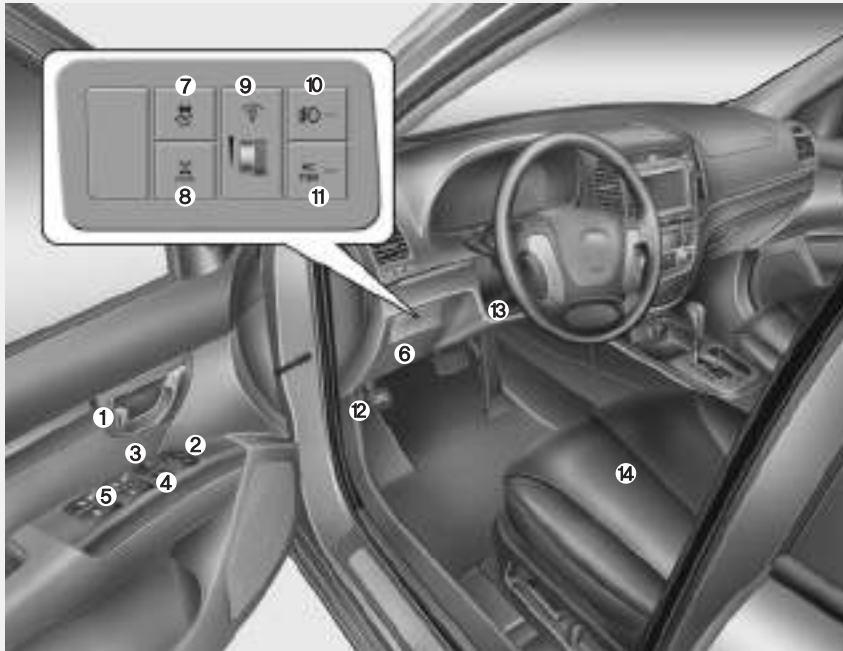

- 1. Door lock/unlock button .....4-8
  - 2. Outside rearview mirror control switch\* .....4-38
  - 3. Central door lock switch\* .....4-8
  - 4. Power window lock button\* .....4-15
  - 5. Power window switches .....4-13
  - 6. Fuse box .....7-47
  - 7. ESC OFF button .....5-28
  - 8. AWD Lock button .....5-17
  - 9. Instrument panel illumination .....4-41
  - 10. Front fog light button\* .....4-60
  - 11. AC inverter button\* .....4-93
  - 12. Hood release lever .....4-17
  - 13. Steering wheel tilt .....4-26
  - 14. Seat .....3-2
- \* : if equipped

## INSTRUMENT PANEL OVERVIEW

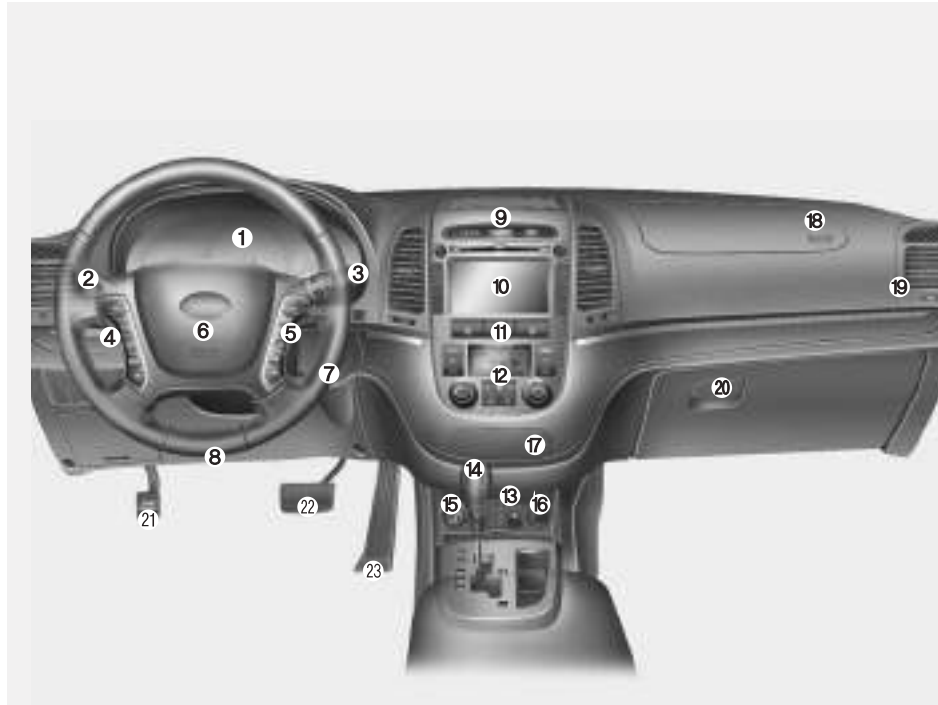

- 1. Instrument cluster .....4-40
  - 2. Light control / Turn signals .....4-57
  - 3. Wiper/Washer.....4-61
  - 4. Steering wheel audio controls\* .....4-99
  - 5. Auto cruise controls\* .....5-33
  - 6. Driver's air bag .....3-45
  - 7. Ignition switch .....5-4
  - 8. Steering wheel .....4-26
  - 9. Digital clock .....4-94
  - 10. Audio system\* .....4-104
  - 11. Hazard warning flasher switch.....4-56
  - 12. Climate control system\* .....4-67/4-76
  - 13. Seat warmer\* .....3-10
  - 14. Shift lever .....5-7/5-10
  - 15. Cigarette lighter.....4-89
  - 16. Power outlet .....4-92
  - 17. Ashtray .....4-89
  - 18. Passenger's air bag .....3-45
  - 19. Vent controls .....4-70
  - 20. Glove box .....4-86
  - 21. Parking brake pedal .....5-24
  - 22. Brake pedal.....5-23
  - 23. Accelerator pedal .....5-6
- \* : if equipped

B020000AFD

OCM010002N



## ENGINE COMPARTMENT

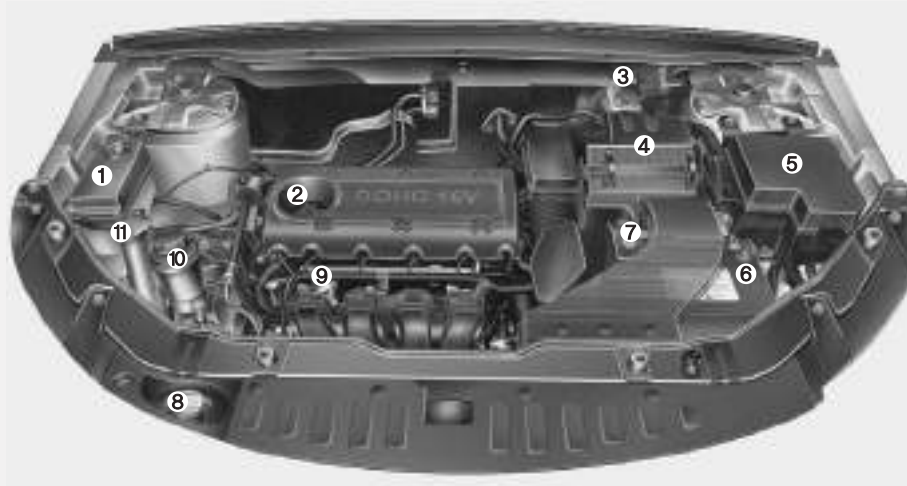

- 1. Engine coolant reservoir.....7-16
- 2. Engine oil filler cap .....7-14
- 3. Brake fluid reservoir.....7-18
- 4. Air cleaner .....7-22
- 5. Fuse box .....7-47
- 6. Negative battery terminal .....7-29
- 7. Positive battery terminal .....7-29
- 8. Radiator cap .....7-17
- 9. Engine oil dipstick.....7-14
- 10. Power steering fluid reservoir .....7-19
- 11. Windshield washer fluid reservoir ..7-20

\* The actual engine room in the vehicle may differ from the illustration.

OXM079001

Seat / 3-2

Seat belts / 3-17

Child restraint system / 3-28

Airbag-supplemental restraint system / 3-36

## Safety system of your vehicle

**3**

## SEAT

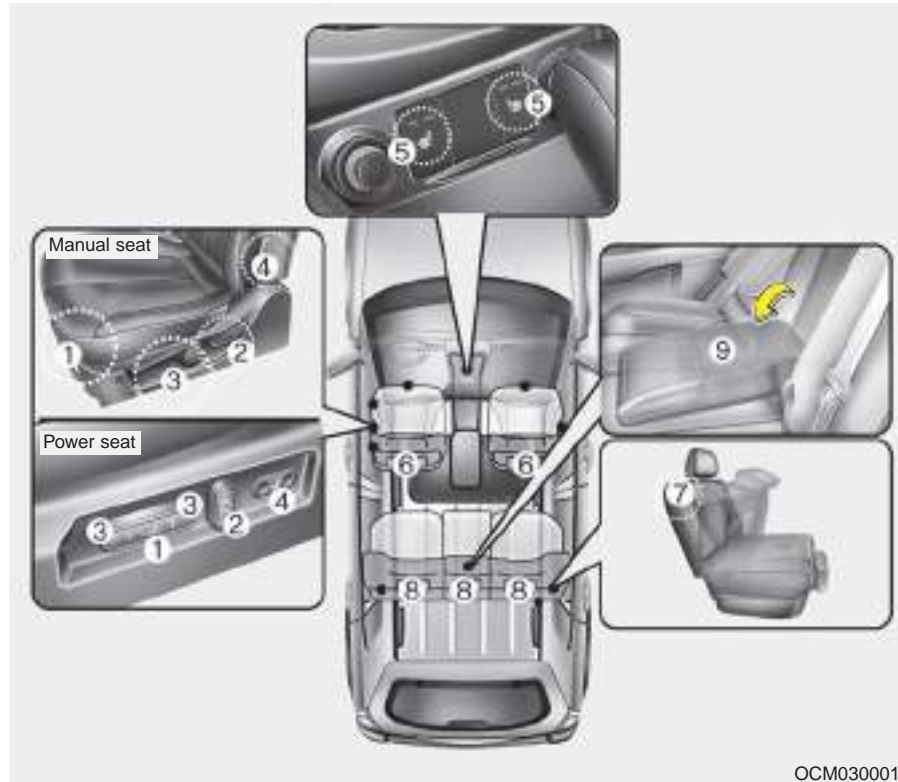

### Front seat

- (1) Forward and backward
- (2) Seatback angle
- (3) Seat cushion height (Driver's seat)
- (4) Lumbar support (Driver's seat)\*
- (5) Seat warmer\*
- (6) Headrest

### Rear seat

- (7) Seatback angle and folding
- (8) Headrest
- (9) Armrest

\* if equipped

C010000AFD

OCM030001N

 **WARNING - Loose objects**  
Loose objects in the driver's foot area could interfere with the operation of the foot pedals, possibly causing an accident. Do not place anything under the front seats.

 **WARNING - Uprighting seat**  
When you return the seatback to its upright position, hold the seatback and return it slowly and be sure there are no other occupants around the seat. If the seatback is returned without being held and controlled, the back of the seat could spring forward resulting in accidental injury to a person struck by the seatback.

 **WARNING - Driver responsibility for front seat passenger**  
Riding in a vehicle with a front seatback reclined could lead to serious or fatal injury in an accident. If a front seat is reclined during an accident, the occupant's hips may slide under the lap portion of the seat belt applying great force to the unprotected abdomen. Serious or fatal internal injuries could result. The driver must advise the front passenger to keep the seatback in an upright position whenever the vehicle is in motion.

 **WARNING - Driver's seat**

- Never attempt to adjust seat while the vehicle is moving. This could result in loss of control, and an accident causing death, serious injury, or property damage.
- Do not allow anything to interfere with the normal position of the seatback. Storing items against a seatback or in any other way interfering with proper locking of a seatback could result in serious or fatal injury in a sudden stop or collision.
- Always drive and ride with your seatback upright and the lap portion of the seat belt snug and low across the hips. This is the best position to protect you in case of an accident.
- In order to avoid unnecessary and perhaps severe air bag injuries, always sit as far back as possible from the steering wheel while maintaining comfortable control of the vehicle. It is recommended that your chest is at least 10 inches (250 mm) away from the steering wheel.

 **WARNING - Rear seat-backs**

- The rear seatback must be securely latched. If not, passengers and objects could be thrown forward resulting in serious injury or death in the event of a sudden stop or collision.
- Luggage and other cargo should be laid flat in the cargo area. If objects are large, heavy, or must be piled, they must be secured. Under no circumstances should cargo be piled higher than the seatbacks. Failure to follow these warnings could result in serious injury or death in the event of a sudden stop, collision or rollover.
- No passenger should ride in the cargo area or sit or lie on folded seatbacks while the vehicle is moving. All passengers must be properly seated in seats and restrained properly while riding.

(Continued)

(Continued)

- When resetting the seatback to the upright position, make sure it is securely latched by pushing it forward and backwards.
- To avoid the possibility of burns, do not remove the carpet in the cargo area. Emission control devices beneath this floor generate high temperatures.

 **WARNING**

After adjusting the seat, always check that it is securely locked into place by attempting to move the seat forward or reverse without using the lock release lever. Sudden or unexpected movement of the driver's seat could cause you to lose control of the vehicle resulting in an accident.



OCM030002

### Front seat adjustment - Manual

C010101AUN

#### **Forward and backward**

To move the seat forward or backward:

1. Pull the seat slide adjustment lever under the front edge of the seat cushion up and hold it.
2. Slide the seat to the position you desire.
3. Release the lever and make sure the seat is locked in place.

Adjust the seat before driving, and make sure the seat is locked securely by trying to move forward and backward without using the lever. If the seat moves, it is not locked properly.



OCM030003

C010102AUN

#### **Seatback angle**

To recline the seatback:

1. Lean forward slightly and lift up on the seatback recline lever located on the outside of the seat at the rear.
2. Carefully lean back on the seat and adjust the seatback of the seat to the position you desire.
3. Release the lever and make sure the seatback is locked in place. (The lever MUST return to its original position for the seatback to lock.)



OCM030004

C010103AUN

#### **Seat cushion height (for driver's seat)**

To change the height of the seat cushion, push the lever that is located on the outside of the seat cushion upwards or downwards.

- To lower the seat cushion, push down the lever several times.
- To raise the seat cushion, pull up the lever several times.

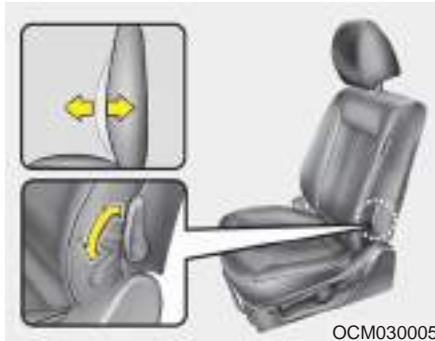

C010105AFD

### **Lumbar support (for driver's seat, if equipped)**

The lumbar support can be adjusted by moving the lever on the outside of the driver's seatback. Pivoting the lever increases or decreases lumbar support.

### **Front seat adjustment - power (if equipped)**

The front seat can be adjusted by using the control switches located on the outside of the seat cushion. Before driving, adjust the seat to the proper position so as to easily control the steering wheel, pedals and switches on the instrument panel.

#### **⚠ WARNING**

**The power seat is operable with the ignition OFF.**

**Therefore, children should never be left unattended in the vehicle.**

#### **! CAUTION**

- *The power seat is driven by an electric motor. Stop operating once the adjustment is completed. Excessive operation may damage the electrical equipment.*
- *When in operation, the power seat consumes a large amount of electrical power. To prevent unnecessary charging system drain, don't adjust the power seat longer than necessary while the engine is not running.*
- *Do not operate two or more power seat control switches at the same time. Doing so may result in power seat motor or electrical component malfunction.*



**Forward and backward**

Push the control switch forward or backward to move the seat to the desired position. Release the switch once the seat reaches the desired position.

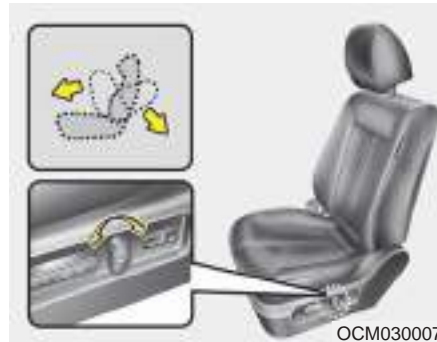

**Seatback angle**

Push the control switch forward or backward to move the seatback to the desired angle. Release the switch once the seat reaches the desired position.



**Seat height (for driver's seat)**

Pull the front portion of the control switch up to raise or down to lower the front part of the seat cushion. Pull the rear portion of the control switch up to raise or down to lower the rear part of the seat cushion. Release the switch once the seat reaches the desired position.





### **Lumbar support (for driver's seat)**

The lumbar support can be adjusted by pressing the button.

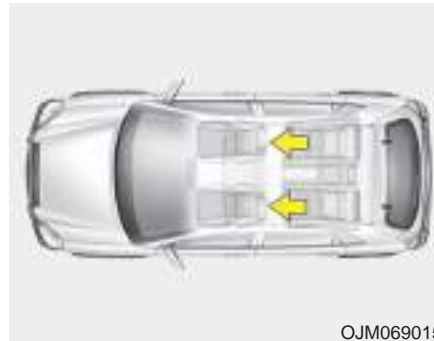

C010104BFD

### **Headrest**

The driver's and front passenger's seats are equipped with a headrest for the occupant's safety and comfort.

The headrest not only provides comfort for the driver and front passenger, but also helps to protect the head and neck in the event of a collision.

### **⚠ WARNING**

- For maximum effectiveness in case of an accident, the headrest should be adjusted so the middle of the headrest is at the same height of the center of gravity of an occupant's head. Generally, the center of gravity of most people's head is similar with the height of the top of their eyes. Also, adjust the headrest as close to your head as possible. For this reason, the use of a cushion that holds the body away from the seatback is not recommended.
- Do not operate the vehicle with the headrests removed as severe injury to the occupants may occur in the event of an accident. Headrests may provide protection against neck injuries when properly adjusted.
- Do not adjust the headrest position of the driver's seat while the vehicle is in motion.



**Active headrest (if equipped)**

The active headrest is designed to move forward and upward during a rear impact. This helps prevent the driver's and front passenger's heads from moving backward and thus helps minimize neck injuries.

For your safety, the active headrest can't be removed. If there is any problem with the active headrest, take your vehicle to an authorized HYUNDAI dealer and have the system checked.



**Forward and backward adjustment (if equipped)**

The headrest may be adjusted forward to 3 different positions by pulling the headrest forward to the desired detent. To adjust the headrest to its furthest backwards position, pull it fully forward to the farthest position and release it. Adjust the headrest so that it properly supports the head and neck.



**Adjusting the height up and down**

To raise the headrest, pull it up to the desired position (1). To lower the headrest, push and hold the release button (2) on the headrest support and lower the headrest to the desired position (3).

## Safety system of your vehicle



### Removal

To remove the headrest, raise it as far as it can go then press the release button (1) while pulling upward (2).

To reinstall the headrest, put the headrest poles (3) into the holes while pressing the release button (1). Then adjust it to the appropriate height.



### WARNING

Make sure the headrest locks in position after adjusting it to properly protect the occupants.



C010107AFD

### Seat warmer (if equipped)

The seat warmer is provided to warm the front seats during cold weather. With the ignition switch in the ON position, push either of the switches to warm the driver's seat or the front passenger's seat.

During mild weather or under conditions where the operation of the seat warmer is not needed, keep the switches in the "OFF" position.

- Each time you push the button, the temperature setting of the seat is changed as follows :

OFF → HIGH (☀️) → LOW (☀️)  
↑

- The seat warmer defaults to the OFF position whenever the ignition switch is turned on.

☀️ : HIGH

☀️ : LOW

**\* NOTICE**

With the seat warmer switch in ON position, the heating system in the seat turns off or on automatically depending on the seat temperature.

**! CAUTION**

- *When cleaning the seats, do not use an organic solvent such as thinner, benzene, alcohol and gasoline. Doing so may damage the surface of the heater or seats.*
- *To prevent overheating the seat warmer, do not place blankets, cushions or seat covers on the seats while the seat warmer is in operation.*
- *Do not place heavy or sharp objects on seats equipped with seat warmers. Damage to the seat warming components could occur.*



**WARNING - Seat warmer burns**

Passengers should use extreme caution when using seat warmers due to the possibility of excess heating or burns. In particular, the driver must exercise extreme care for the following types of passengers:

1. Infants, children, elderly or handicapped persons, or hospital outpatients
2. Persons with sensitive skin or those that burn easily
3. Fatigued individuals
4. Intoxicated individuals
5. Individuals taking medication that can cause drowsiness or sleepiness (sleeping pills, cold tablets, etc.)

Type A



OMG039017

Type B



OHM038010

C010108AUN

***Seatback pocket (if equipped)***

The seatback pocket is provided on the back of the front passenger's and driver's seatbacks.

### **WARNING - Seatback pockets**

Do not put heavy or sharp objects in the seatback pockets. In an accident they could come loose from the pocket and injure vehicle occupants.

### **WARNING**

For proper operation of the occupant classification system:

- Do not place any items cumulatively weighing over 2.2 lbs (1 kg) in the seatback pocket or on the seat.
- Do not hang onto the front passenger seat.



### **Rear seat adjustment**

#### *Seatback angle*

To recline the seatback:

1. Pull up the seatback recline lever.
2. Hold the lever and adjust the seatback of the seat to the position you desire.
3. Release the lever and make sure the seatback is locked in place. (The lever MUST return to its original position for the seatback to lock.)

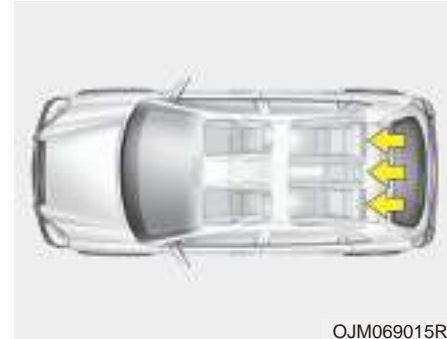

### *Headrest*

The rear seat(s) is equipped with headrests in all the seating positions for the occupant's safety and comfort.

The headrest not only provides comfort for passengers, but also helps protect the head and neck in the event of a collision.

**⚠ WARNING**

- For maximum effectiveness in case of an accident, the headrest should be adjusted so the middle of the headrest is at the same height of the center of gravity of an occupant's head. Generally, the center of gravity of most people's head is similar with the height of the top of their eyes. Also adjust the headrest as close to your head as possible. For this reason, the use of a cushion that holds the body away from the seatback is not recommended.
- Do not operate the vehicle with the headrests removed. Severe injury to an occupant may occur in the event of an accident. Headrests may provide protection against severe neck injuries when properly adjusted.



**Adjusting the height up and down**

To raise the headrest, pull it up to the desired position (1). To lower the headrest, push and hold the release button (2) on the headrest support and lower the headrest to the desired position (3).

**Removal**

The headrest can't be removed. If there is any problem with the headrest, take your vehicle to an authorized HYUNDAI dealer and have the system checked.

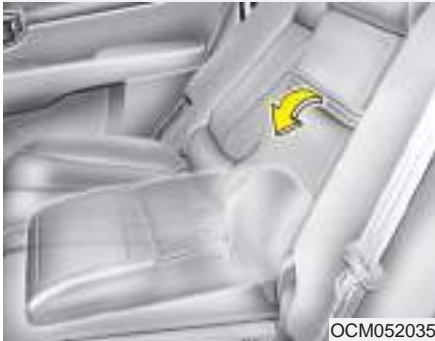

### **Armrest**

To use the armrest, pull it forward from the seatback.

### **Folding the rear seat**

The rear seatbacks can be folded to facilitate carrying long items or to increase the luggage capacity of the vehicle.

#### **⚠ WARNING**

The purpose of the fold-down rear seatbacks is to allow you to carry longer objects that could not be accommodated in the cargo area.

Never allow passengers sit on top of the folded down seatback while the vehicle is moving. This is not a proper seating position and no seat belts are available for use. This could result in serious injury or death in case of an accident or sudden stop. Objects carried on the folded down seatback should not extend higher than the top of the front seatbacks. This could allow cargo to slide forward and cause injury or damage during sudden stops.

1. Insert the rear seat belt buckle in the pocket between the rear seat back and cushion, and make sure the rear seat belt webbing does not get in the way when folding the rear seat.
2. Set the front seatback to the upright position and if necessary, slide the front seat forward.
3. Lower the rear headrests to the lowest position.



OCM030063N



OCM030064N

4. Pull on the seatback folding lever, then fold the seat toward the front of the vehicle. The headrest will fold forward. When you return the seatback to its upright position, always be sure it has locked into position by pushing on the top of the seatback.



OCM030065N

Also, unfold the headrest manually.

**⚠ WARNING**

When you return the rear seatback to its upright position after being folded down:

Be careful not to damage the seat belt webbing or buckle. Do not allow the seat belt webbing or buckle to get caught or pinched in the rear seat. Ensure that the seatback is completely locked into its upright position by pushing on the top of the seatback. Otherwise, in an accident or sudden stop, the seat could fold down and allow cargo to enter the passenger compartment, which could result in serious injury or death.

**⚠ WARNING - Uprighting seat**

When you return the seatback to its upright position, hold the seatback and return it slowly. If the seatback is returned without holding it, the back of the seat could spring forward resulting in injury caused by being struck by the seatback.



**! CAUTION - Damaging rear seat belt buckles**

*When you fold the rear seatback, insert the buckle in the pocket between the rear seatback and cushion. Doing so can prevent the buckle from being damaged by the rear seatback.*

**! CAUTION - Rear seat belts**

*When returning the rear seatbacks to the upright position, remember to return the rear shoulder belts to their proper position.*

** WARNING - Cargo**

Cargo should always be secured to prevent it from being thrown about the vehicle in a collision and causing injury to the vehicle occupants. Do not place objects in the rear seats, since they cannot be properly secured and may hit the front seat occupants in a collision.

** WARNING - Cargo loading**

Make sure the engine is off, the automatic transaxle is in P (Park) and the parking brake is securely applied whenever loading or unloading cargo. Failure to take these steps may allow the vehicle to move if the shift lever is inadvertently moved to another position.

## SEAT BELTS

C020100AUN

### Seat belt restraint system

#### **WARNING**

- For maximum restraint system protection, the seat belts must always be used whenever the car is moving.
- Seat belts are most effective when seatbacks are in the upright position.
- Children age 12 and younger must always be properly restrained in the rear seat. Never allow children to ride in the front passenger seat. If a child over 12 must be seated in the front seat, he/she must be properly belted and the seat should be moved as far back as possible.
- Never wear the shoulder belt under your arm or behind your back. An improperly positioned shoulder belt can cause serious injuries in a crash. The shoulder belt should be positioned midway over your shoulder across your collarbone.

(Continued)

(Continued)

- Avoid wearing twisted seat belts. A twisted belt can't do its job as well. In a collision, it could even cut into you. Be sure the belt webbing is straight and not twisted.
- Be careful not to damage the belt webbing or hardware. If the belt webbing or hardware is damaged, replace it.

#### **WARNING**

Seat belts are designed to bear upon the bony structure of the body, and should be worn low across the front of the pelvis or the pelvis, chest and shoulders, as applicable; wearing the lap section of the belt across the abdominal area must be avoided.

Seat belts should be adjusted as firmly as possible, consistent with comfort, to provide the protection for which they have been designed. A slack belt will greatly reduce the protection afforded to the wearer.

(Continued)

(Continued)

Care should be taken to avoid contamination of the webbing with polishes, oils and chemicals, and particularly battery acid. Cleaning may safely be carried out using mild soap and water. The belt should be replaced if webbing becomes frayed, contaminated or damaged. It is essential to replace the entire assembly after it has been worn in a severe impact even if damage to the assembly is not obvious. Belts should not be worn with straps twisted. Each seat belt assembly must only be used by one occupant; it is dangerous to put a belt around a child being carried on the occupant's lap.

#### **WARNING**

No modifications or additions should be made by the user which will either prevent the seat belt adjusting devices from operating to remove slack, or prevent the seat belt assembly from being adjusted to remove slack.



### **Seat belt warning**

As a reminder to the driver, the seat belt warning light will blink for approximately 6 seconds each time you turn the ignition switch ON regardless of belt fastening.

If the driver's seat belt is not fastened when the ignition switch is turned on, the seat belt warning light and the seat belt warning chime will operate for approximately 6 seconds. But if it is fastened within the 6 seconds, the warning light will blink till the 6 seconds and the warning chime will turn off immediately.

If the driver's seat belt is disconnected after the ignition switch is turned to the ON position, the seat belt warning light will operate for approximately 6 seconds. But if it is fastened within the 6 seconds, the warning light will turn off immediately. If the driver's seat belt is not fastened when the vehicle speed exceeds 6 mph (10 km/h), the seat belt warning light and chime will operate for approximately 11 times with a pattern of 6 seconds on and 24 seconds off until the belt is fastened or the vehicle speed decreases below 3 mph (5 km/h).

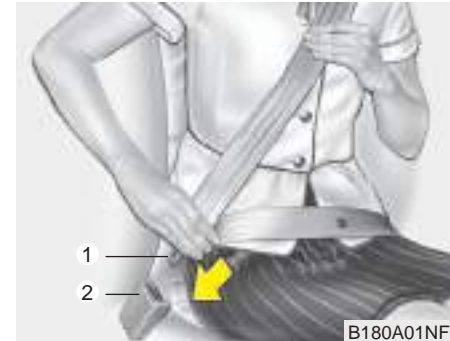

C020102AFD-EU

### **Seat belt - Driver's 3-point system with emergency locking retractor**

#### **To fasten your seat belt:**

To fasten your seat belt, pull it out of the retractor and insert the metal tab (1) into the buckle (2). There will be an audible "click" when the tab locks into the buckle.

The seat belt automatically adjusts to the proper length only after the lap belt portion is adjusted manually so that it fits snugly around your hips. If you lean forward in a slow, easy motion, the belt will extend and let you move around. If there is a sudden stop or impact, however, the belt will lock into position. It will also lock if you try to lean forward too quickly.

**\* NOTICE**

If you are not able to pull out the seat belt from the retractor, firmly pull the belt out and release it. Then you will be able to pull the belt out smoothly.

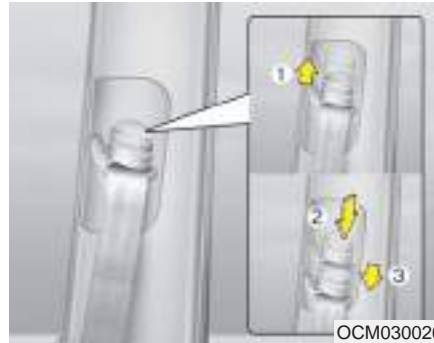

**Height adjustment (Front)**

You can adjust the height of the shoulder belt anchor to one of 4 positions for maximum comfort and safety.

If the height of the adjusting seat belt is too near your neck, you will not be getting the most effective protection. The shoulder portion should be adjusted so that it lies across your chest and midway over your shoulder nearest the door and not your neck.

To adjust the height of the seat belt anchor, lower or raise the height adjuster into an appropriate position.

To raise the height adjuster, pull it up (1). To lower it, push it down (3) while pressing the height adjuster button (2).

Release the button to lock the anchor into position. Try sliding the height adjuster to make sure that it has locked into position.

**⚠ WARNING**

- Verify the shoulder belt anchor is locked into position at the appropriate height. Never position the shoulder belt across your neck or face. Improperly positioned seat belts can cause serious injuries in an accident.
- Failure to replace seat belts after an accident could leave you with damaged seat belts that will not provide protection in the event of another collision leading to personal injury or death. Replace your seat belts after being in an accident as soon as possible.

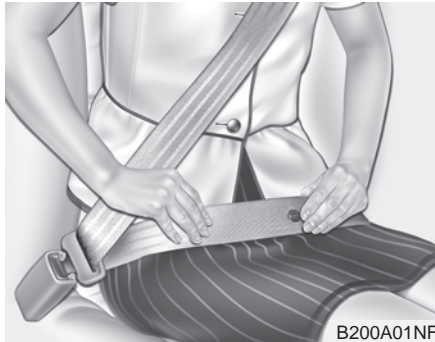

### **WARNING**

You should place the lap belt portion as low as possible and snugly across your hips, not on your waist. If the lap belt is located too high on your waist, it may increase the chance of injury in the event of a collision. Both arms should not be under or over the belt. Rather, one should be over and the other under, as shown in the illustration. Never wear the seat belt under the arm near the door.

C020106AFD

### **Seat belts - Front passenger and rear seat 3-point system with combination locking retractor**

#### **To fasten your seat belt:**

Combination retractor type seat belts are installed in the rear seat positions to help accommodate the installation of child restraint systems. Although a combination retractor is also installed in the front passenger seat position, it is strongly recommended that children always be seated in the rear seat. NEVER place any infant restraint system in the front seat of the vehicle.

This type of seat belt combines the features of both an emergency locking retractor seat belt and an automatic locking retractor seat belt. To fasten your seat belt, pull it out of the retractor and insert the metal tab into the buckle. There will be an audible "click" when the tab locks into the buckle. When not securing a child restraint, the seat belt operates in the same way as the driver's seat belt (Emergency Locking Retractor Type). It automatically adjusts to the proper length only after the lap belt portion of the seat belt is adjusted manually so that it fits snugly around your hips.

When the seat belt is fully extended from the retractor to allow the installation of a child restraint system, the seat belt operation changes to allow the belt to retract, but not to extend (Automatic Locking Retractor Type). Refer to "Using a child restraint system" in this section.

### **\* NOTICE**

Although the combination retractor provides the same level of protection for seated passengers in either emergency or automatic locking modes, it is recommended that seated passengers use the emergency locking feature for improved convenience. The automatic locking function is intended to facilitate child restraint installation. To convert from the automatic locking feature to the emergency locking operation mode, allow the unbuckled seat belt to fully retract.

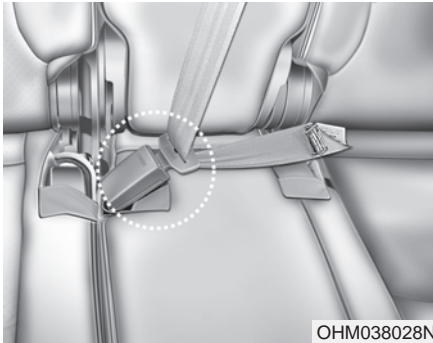

When using the rear center seat belt, the buckle with the “CENTER” mark must be used.

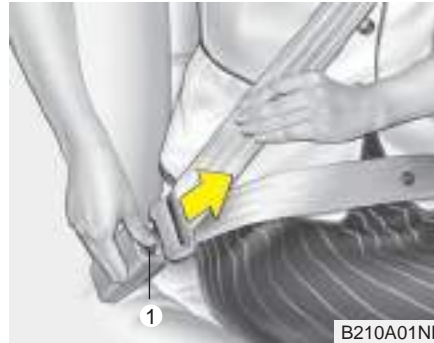

**To release the seat belt:**

The seat belt is released by pressing the release button (1) in the locking buckle. When it is released, the belt should automatically draw back into the retractor.

If this does not happen, check the belt to be sure it is not twisted, then try again.

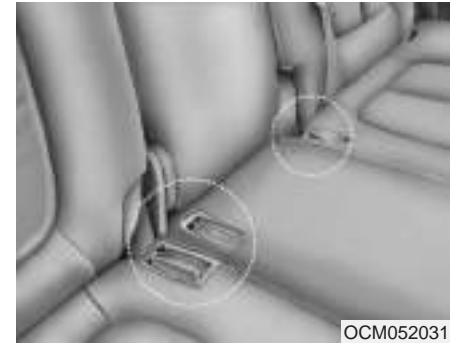

***Stowing the rear seat belt***

The rear seat belt buckles can be stowed in the pocket between the rear seatback and cushion when not in use.



### Pre-tensioner seat belt

Your vehicle is equipped with driver's and front passenger's pre-tensioner seat belts. The purpose of the pre-tensioner is to make sure that the seat belts fit tightly against the occupant's body in certain frontal collisions (or side collisions or rollovers). The pre-tensioner seat belts can be activated, where the frontal collision (or side collisions or rollovers) is severe enough, together with the air bags.

When the vehicle stops suddenly, or if the occupant tries to lean forward too quickly, the seat belt retractor will lock into position. In certain frontal collisions (or side collisions or rollovers), the pre-tensioner will activate and pull the seat belt into tighter contact against the occupant's body.

If the system senses excessive seat belt tension on the driver or passenger's seat belt when the pre-tensioner activates, the load limiter inside the pre-tensioner will release some of the pressure on the affected seat belt.

### \* NOTICE

**The pre-tensioner will activate not only in a frontal collision but also in a side collision or rollover, if the vehicle is equipped with a side or curtain air bag.**

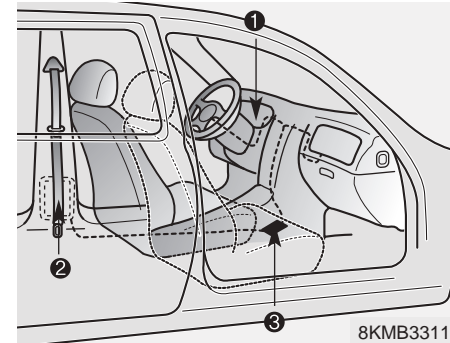

The seat belt pre-tensioner system consists mainly of the following components. Their locations are shown in the illustration:

1. SRS air bag warning light
2. Retractor pre-tensioner assembly
3. SRS control module

**WARNING**

To obtain maximum benefit from a pre-tensioner seat belt:

1. The seatbelt must be working correctly and adjusted to the proper position. Please read and follow all of the important information and precautions about your vehicle's occupant safety features – including seat belts and air bags – that are provided in this manual.
2. Be sure you and your passengers always wear seat belts properly.

**\* NOTICE**

- Both the driver's and front passenger's pre-tensioner seat belts may be activated in certain frontal collisions (or side collisions or rollovers). The pre-tensioners will not be activated if the seat belts are not being worn at the time of the collision.
- When the pre-tensioner seat belts are activated, a loud noise may be heard and fine dust, which may appear to be smoke, may be visible in the passenger compartment. These are normal operating conditions and are not hazardous.
- Although it is harmless, the fine dust may cause skin irritation and should not be breathed for prolonged periods. Wash all exposed skin areas thoroughly after an accident in which the pre-tensioner seat belts were activated.
- Because the sensor that activates the SRS air bag is connected with the pre-tensioner seat belt, the SRS air bag warning light on the instrument panel will illuminate for approximately 6 seconds after the ignition switch has been turned to the "ON" position, and then it should turn off.

**! CAUTION**

*If the pre-tensioner seat belt is not working properly, this warning light will illuminate even if there is no malfunction of the SRS air bag. If the SRS air bag warning light does not illuminate when the ignition key is turned to "ON", or if it remains illuminated after illuminating for approximately 6 seconds, or if it illuminates while the vehicle is being driven, please have an authorized HYUNDAI dealer inspect the pre-tensioner seat belt or SRS air bag system as soon as possible.*



### **WARNING**

- Pre-tensioners are designed to operate only one time. After activation, pre-tensioner seat belts must be replaced. All seat belts, of any type, should always be replaced after they have been worn during a collision.
- The pre-tensioner seat belt assembly mechanisms become hot during activation. Do not touch the pre-tensioner seat belt assemblies for several minutes after they have been activated.
- Do not attempt to inspect or replace the pre-tensioner seat belts yourself. This must be done by an authorized HYUNDAI dealer.
- Do not strike the pre-tensioner seat belt assemblies.

(Continued)

(Continued)

- Improper handling of the pre-tensioner seat belt assemblies, and failure to heed the warnings not to strike, modify, inspect, replace, service or repair the pre-tensioner seat belt assemblies may lead to improper operation or inadvertent activation and serious injury.
- Always wear the seat belts when driving or riding in a motor vehicle.
- If the vehicle or pre-tensioner seat belt must be discarded, contact an authorized HYUNDAI dealer.

## Seat belt precautions

### **WARNING**

All occupants of the vehicle must wear their seat belts at all times. Seat belts and child restraints reduce the risk of serious or fatal injuries for all occupants in the event of a collision or sudden stop. Without a seat belt, occupants could be shifted too close to a deploying air bag, strike the interior structure or be thrown from the vehicle. Properly worn seat belts greatly reduce these hazards.

Even with advanced air bags, unbelted occupants can be severely injured by a deploying air bag.

Always follow the precautions about seat belts, air bags and occupant seat contained in this manual.

**Infant or small child**

All 50 states have child restraint laws. You should be aware of the specific requirements in your state. Child and/or infant seats must be properly placed and installed in the rear seat. For more information about the use of these restraints, refer to “Child restraint system” in this section.



**WARNING**

Every person in your vehicle needs to be properly restrained at all times, including infants and children. Never hold a child in your arms or lap when riding in a vehicle. The violent forces created during a crash will tear the child from your arms and throw the child against the interior. Always use a child restraint appropriate for your child's height and weight.

**\* NOTICE**

Small children are best protected from injury in an accident when properly restrained in the rear seat by a child restraint system that meets the requirements of the Federal Motor Vehicle Safety Standards. Before buying any child restraint system, make sure that it has a label certifying that it meets Federal Motor Vehicle Safety Standards 213. The restraint must be appropriate for your child's height and weight. Check the label on the child restraint for this information. Refer to “Child restraint system” in this section.

C020301AUN

**Larger children**

Children who are too large for child restraint systems should always occupy the rear seat and use the available lap/shoulder belts. The lap portion should be fastened snug on the hips and as low as possible. Check belt fit periodically. A child's squirming could put the belt out of position. Children are afforded the most safety in the event of an accident when they are restrained by a proper restraint system in the rear seat. If a larger child (over age 12) must be seated in the front seat, the child should be securely restrained by the available lap/shoulder belt and the seat should be placed in the rearmost position. Children age 12 and under should be restrained securely in the rear seat. NEVER place a child age 12 and under in the front seat. NEVER place a rear facing child seat in the front seat of a vehicle.

If the shoulder belt portion slightly touches the child's neck or face, try placing the child closer to the center of the vehicle. If the shoulder belt still touches their face or neck they need to be returned to a child restraint system.

 **WARNING - Shoulder belts on small children**

- Never allow a shoulder belt to be in contact with a child's neck or face while the vehicle is in motion.
- If seat belts are not properly worn and adjusted on children, there is a risk of death or serious injury.

C020302AUN

**Pregnant women**

The use of a seat belt is recommended for pregnant women to lessen the chance of injury in an accident. When a seat belt is used, the lap belt portion should be placed as low and snugly as possible on the hips, not across the abdomen. For specific recommendations, consult a physician.

 **WARNING - Pregnant women**

**Pregnant women must never place the lap portion of the safety belt over the area of the abdomen where the fetus is located or above the abdomen where the belt could crush the fetus during an impact.**

C020303AUN

**Injured person**

A seat belt should be used when an injured person is being transported. When this is necessary, you should consult a physician for recommendations.

C020304AUN

**One person per belt**

Two people (including children) should never attempt to use a single seat belt. This could increase the severity of injuries in case of an accident.

**Do not lie down**

To reduce the chance of injuries in the event of an accident and to achieve maximum effectiveness of the restraint system, all passengers should be sitting up and the front and rear seats should be in an upright position when the car is moving. A seat belt cannot provide proper protection if the person is lying down in the rear seat or if the front and rear seats is in a reclined position.



**WARNING**

Riding with a reclined seatback increases your chance of serious or fatal injuries in the event of a collision or sudden stop. The protection of your restraint system (seat belts and air bags) is greatly reduced by reclining your seat. Seat belts must be snug against your hips and chest to work properly. The more the seatback is reclined, the greater the chance that an occupant's hips will slide under the lap belt causing serious internal injuries or the occupant's neck could strike the shoulder belt. Drivers and passengers should always sit well back in their seats, properly belted, and with the seatbacks upright.

C020400AUN

**Care of seat belts**

Seat belt systems should never be disassembled or modified. In addition, care should be taken to assure that seat belts and belt hardware are not damaged by seat hinges, doors or other abuse.



**WARNING**

When you return the rear seatback to its upright position after the rear seatback was folded down, be careful not to damage the seat belt webbing or buckle. Be sure that the webbing or buckle does not get caught or pinched in the rear seat. A seat belt with damaged webbing or buckle will not be as strong and could possibly fail during a collision or sudden stop, resulting in serious injury.

***Periodic inspection***

All seat belts should be inspected periodically for wear or damage of any kind. Any damaged parts should be replaced as soon as possible.

C020402AUN

***Keep belts clean and dry***

Seat belts should be kept clean and dry. If belts become dirty, they can be cleaned by using a mild soap solution and warm water. Bleach, dye, strong detergents or abrasives should not be used because they may damage and weaken the fabric.

C020403AFD

***When to replace seat belts***

Entire in-use seat belt assembly or assemblies should be replaced if the vehicle has been involved in an accident. This should be done even if no damage is visible. Additional questions concerning seat belt operation should be directed to an authorized HYUNDAI dealer.

### CHILD RESTRAINT SYSTEM

C030000AEN-EU

Children riding in the car should sit in the rear seat and must always be properly restrained to minimize the risk of injury in an accident, sudden stop or sudden maneuver. According to accident statistics, children are safer when properly restrained in the rear seats than in the front seat. Larger children not in a child restraint should use one of the seat belts provided.

You should be aware of the specific requirements in your state. Child and/or infant safety seats must be properly placed and installed in the rear seat. You must use a commercially available child restraint system that meets the requirements of the Federal Motor Vehicle Safety Standards (FMVSS).

Child restraint systems are designed to be secured in vehicle seats by lap belts or the lap belt portion of a lap/shoulder belt, or by a LATCH system.

Children could be injured or killed in a crash if their restraints are not properly secured. For small children and babies, a child seat or infant seat must be used. Before buying a particular child restraint system, make sure it fits your car seat and seat belts, and fits your child. Follow all the instructions provided by the manufacturer when installing the child restraint system.

#### WARNING

- A child restraint system must be placed in the rear seat. Never install a child or infant seat on the front passenger's seat. Should an accident occur and cause the passenger-side air bag to deploy, it could severely injure or kill an infant or child seated in an infant or child seat. Thus only use a child restraint in the rear seat of your vehicle.
- A seat belt or child restraint system can become very hot if it is left in a closed vehicle on a sunny day, even if the outside temperature does not feel hot. Be sure to check the seat cover and buckles before placing a child there.
- When the child restraint system is not in use, store it in the luggage area or fasten it with a seat belt so that it will not be thrown forward in the case of a sudden stop or an accident.
- Children may be seriously injured or killed by an inflating air bag. All children, even those too large for child restraints, must ride in the rear seat.

#### WARNING

To reduce the chance of serious or fatal injuries:

- Children of all ages are safer when restrained in the rear seat. A child riding in the front passenger seat can be forcefully struck by an inflating air bag resulting in serious or fatal injuries.
- Always follow the child restraint system manufacturer's instructions for installation and use of the child restraint.
- Always make sure the child seat is secured properly in the car and your child is securely restrained in the child seat.
- Never hold a child in your arms or lap when riding in a vehicle. The violent forces created during a crash will tear the child from your arms and throw the child against the car's interior.
- Never put a seat belt over yourself and a child. During a crash, the belt could press deep into the child causing serious internal injuries.

(Continued)

(Continued)

- Never leave children unattended in a vehicle – not even for a short time. The car can heat up very quickly, resulting in serious injuries to children inside. Even very young children may inadvertently cause the vehicle to move, entangle themselves in the windows, or lock themselves or others inside the vehicle.
- Never allow two children, or any two persons, to use the same seat belt.
- Children often squirm and reposition themselves improperly. Never let a child ride with the shoulder belt under their arm or behind their back. Always properly position and secure children in rear seat.
- Never allow a child to stand-up or kneel on the seat or floorboard of a moving vehicle. During a collision or sudden stop, the child can be violently thrown against the vehicles interior, resulting in serious injury.

(Continued)

(Continued)

- Never use an infant carrier or a child safety seat that "hooks" over a seatback, it may not provide adequate security in an accident.
- Seat belts can become very hot, especially when the car is parked in direct sunlight. Always check seat belt buckles before fastening them over a child.

Rearward-facing child restraint system



CRS09

Forward-facing child restraint system



OUN026150

C030100AFD

### Using a child restraint system

For small children and babies, the use of a child seat or infant seat is required. This child seat or infant seat should be of appropriate size for the child and should be installed in accordance with the manufacturer's instructions. For safety reasons, we recommend that the child restraint system be used in the rear seats.

### **WARNING**

Never place a rear-facing child restraint in the front passenger seat, because of the danger that an inflating passenger-side air bag could impact the rear-facing child restraint and kill the child.

Since all passenger seat belts move freely under normal conditions and only lock under extreme or emergency conditions (emergency lock mode), you must manually change these seat belts to the auto lock mode to secure a child restraint.

### **WARNING - Child seat installation**

- Before installing the child restraint system, read the instructions supplied by the child restraint system manufacturer.
- If the seat belt does not operate as described in this section, have the system checked immediately by your authorized HYUNDAI dealer.
- Failure to observe this manual's instructions regarding child restraint system and the instructions provided with the child restraint system could increase the chance and/or severity of injury in an accident.

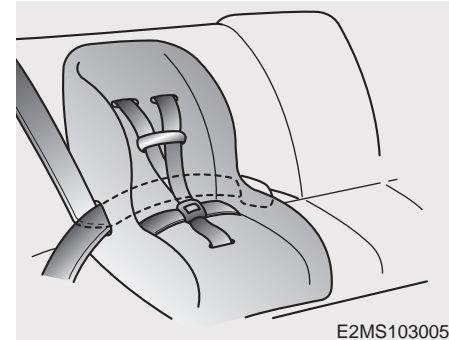

E2MS103005

C030102BUN-EU

### ***Placing a passenger seat belt into the auto lock mode***

The auto lock mode will help prevent the normal movement of the child in the vehicle from causing the seat belt to loosen and compromise the child restraint system. To secure a child restraint system, use the following procedure.

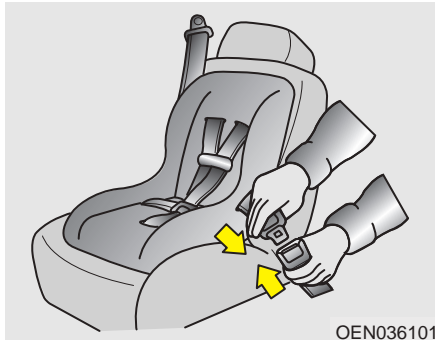

To install a child restraint system on the outboard or center rear seats, do the following:

1. Place the child restraint system in the seat and route the lap/shoulder belt around or through the restraint, following the restraint manufacturer's instructions. Be sure the seat belt webbing is not twisted.
2. Fasten the lap/shoulder belt latch into the buckle. Listen for the distinct "click" sound.

*Position the release button so that it is easy to access in case of an emergency.*

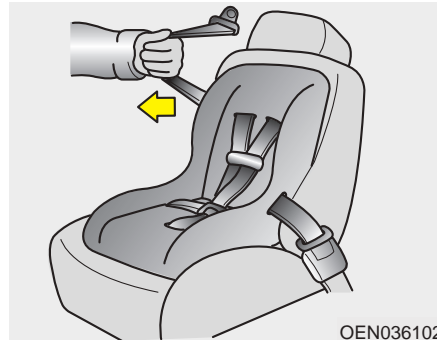

3. Pull the shoulder portion of the seat belt all the way out. When the shoulder portion of the seat belt is fully extended, it will shift the retractor to the "Auto Lock" (child restraint) mode.

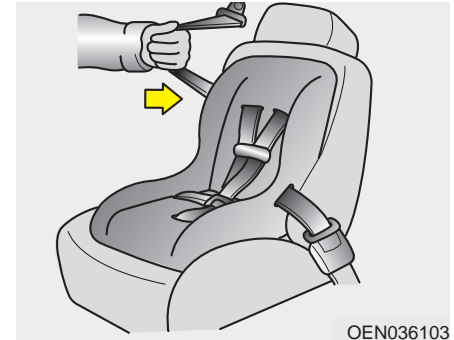

4. Slowly allow the shoulder portion of the seat belt to retract and listen for an audible "clicking" or "ratcheting" sound. This indicates that the retractor is in the "Auto Lock" mode. If no distinct sound is heard, repeat steps 3 and 4.





- Remove as much slack from the belt as possible by pushing down on the child restraint system while feeding the shoulder belt back into the retractor.
- Push and pull on the child restraint system to confirm that the seat belt is holding it firmly in place. If it is not, release the seat belt and repeat steps 2 through 6.
- Double check that the retractor is in the "Auto Lock" mode by attempting to pull more of the seat belt out of the retractor. If you cannot, the retractor is in the "Auto Lock" mode.

To remove the child restraint, press the release button on the buckle and then pull the lap/shoulder belt out of the restraint and allow the seat belt to retract fully.

### **WARNING - Auto lock mode**

The lap/shoulder belt automatically returns to the "emergency lock mode" whenever the belt is allowed to retract fully. Therefore, the preceding seven steps must be followed each time a child restraint is installed.

If the retractor is not in the Automatic Locking mode, the child restraint can move when your vehicle turns or stops suddenly. A child can be seriously injured or killed if the child restraint is not properly anchored to the car, including setting the retractor to the Automatic Locking mode.

When the seat belt is allowed to retract to its fully stowed position, the retractor will automatically switch from the "Auto Lock" mode to the emergency lock mode for normal adult usage.

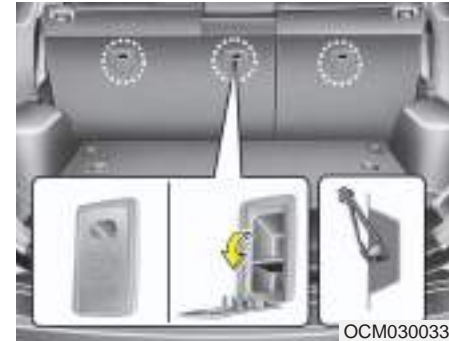

C030103AFD

### ***Securing a child restraint seat with "Tether Anchor" system (if equipped)***

Child restraint hook holders are located on the back of the rear seats.



1. Route the child restraint seat strap over the seatback.  
For vehicles with adjustable headrest, route the tether strap under the headrest and between the headrest posts, otherwise route the tether strap over the top of the seatback.
2. Connect the tether strap hook to the appropriate child restraint hook holder and tighten to secure the seat.

**⚠ WARNING**

A child can be seriously injured or killed in a collision if the child restraint is not properly anchored to the car and the child is not properly restrained in the child restraint. Always follow the child seat manufacturer's instructions for installation and use.

**⚠ WARNING - Tether strap**

Never mount more than one child restraint to a single tether or to a single lower anchorage point. The increased load caused by multiple seats may cause the tethers or anchorage points to break, causing serious injury or death.

**⚠ WARNING - Child restraint check**

Check that the child restraint system is secure by pushing and pulling it in different directions. Incorrectly fitted child restraints may swing, twist, tip or separate causing death or serious injury.

**⚠ WARNING**

**- Child restraint anchorage**

- Child restraint anchorages are designed to withstand only those loads imposed by correctly fitted child restraints. Under no circumstances are they to be used for adult seat belts or harnesses or for attaching other items or equipment to the vehicle.
- The tether strap may not work properly if attached somewhere other than the correct tether anchor.

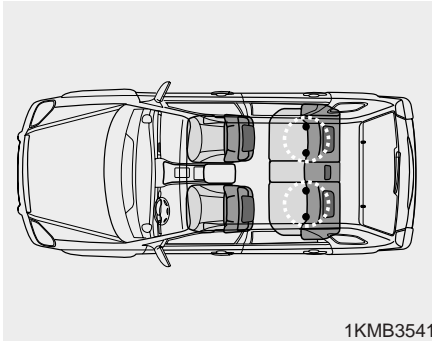

C030104AFD-EU

### ***Securing a child restraint seat with child seat lower anchor system***

Some child seat manufacturers make child restraint seats that are labeled as LATCH or LATCH-compatible child restraint seats. LATCH stands for "Lower Anchors and Tethers for Children". These seats include two rigid or webbing mounted attachments that connect to two LATCH anchors at specific seating positions in your vehicle. This type of child restraint seat eliminates the need to use seat belts to attach the child seat in the rear seats.

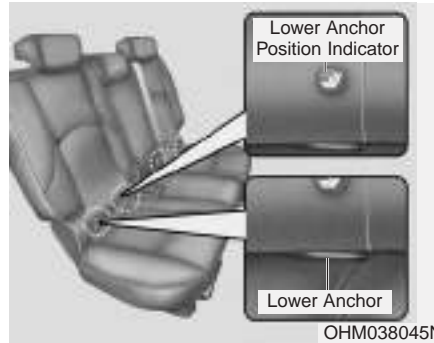

Child restraint symbols are located on the left and right rear seat backs to indicate the position of the lower anchors for child restraints.

### **⚠ WARNING**

When using the vehicle's "LATCH" system to install a child restraint system in the rear seat, all unused vehicle rear seat belt metal latch plates or tabs must be latched securely in their seat belt buckles and the seat belt webbing must be retracted behind the child restraint to prevent the child from reaching and taking hold of unretracted seat belts. Unlatched metal latch plates or tabs may allow the child to reach the unretracted seat belts which may result in strangulation and a serious injury or death to the child in the child restraint.

### **⚠ WARNING**

Install the child restraint seat fully rearward against the seatback with the seatback reclined two positions from the most upright latched position.



B230D03NF

LATCH anchors have been provided in your vehicle. The LATCH anchors are located in the left and right outboard rear seating positions. Their locations are shown in the illustration. There is no LATCH anchor provided for the center rear seating position.

The LATCH anchors are located between the seatback and the seat cushion of the rear seat left and right outboard seating positions.

Follow the child seat manufacturer's instructions to properly install child restraint seats with LATCH or LATCH-compatible attachments.

Once you have installed the LATCH child restraint, assure that the seat is properly attached to the LATCH and tether anchors. Also, test the child restraint seat before you place the child in it. Tilt the seat from side to side. Also try to tug the seat forward. Check to see if the anchors hold the seat in place.

**! CAUTION**

*Do not allow the rear seat belt webbing to get scratched or pinched by the child-seat latch and LATCH anchor during installation.*

**! WARNING**

**If the child restraint is not anchored properly, the risk of a child being seriously injured or killed in a collision greatly increases.**

**! WARNING - LATCH lower anchors**

**LATCH lower anchors are only to be used with the left and right rear outboard seating positions. Never attempt to attach a LATCH equipped seat in the center seating position. You may damage the anchors or the anchors may fail and break in a collision.**

## AIR BAG - ADVANCED SUPPLEMENTAL RESTRAINT SYSTEM

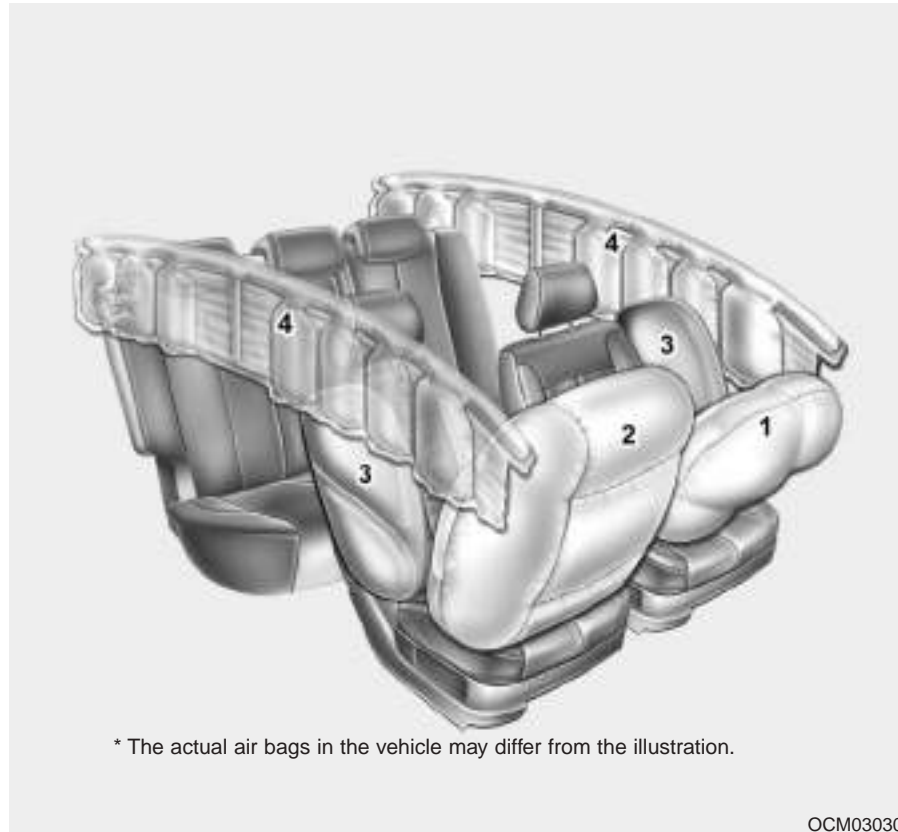

- (1) Driver's front air bag
- (2) Passenger's front air bag
- (3) Side impact air bag
- (4) Curtain air bag



### WARNING

Even in vehicles with air bags, you and your passengers must always wear the safety belts provided in order to minimize the risk and severity of injury in the event of a collision or rollover.

\* The actual air bags in the vehicle may differ from the illustration.

OCM030303

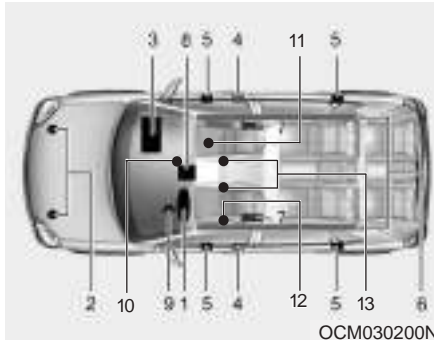

- 10. PASS AIR BAG "OFF" indicator (Front passenger's seat only)\*
- 11. Occupant classification system (Front passenger's seat only)
- 12. Driver's seat track position sensor
- 13. Driver's and front passenger's seat belt buckle sensors

\*: if equipped

### SRS components and functions

The SRS consists of the following components:

- 1. Driver's front air bag module
- 2. Front impact sensors
- 3. Passenger's front air bag module\*
- 4. Retractor pre-tensioner assemblies\*
- 5. Side impact sensors\*
- 6. Curtain air bag modules\*
- 7. Side impact air bag modules\*
- 8. SRS control module (SRSCM)/ Rollover sensor\*
- 9. Air bag warning light

The SRSCM continually monitors all SRS components while the ignition switch is ON to determine if a crash impact is severe enough to require air bag deployment or pre-tensioner seat belt deployment.

The SRS air bag warning light on the instrument panel will illuminate for about 6 seconds after the ignition switch is turned to the ON position, after which the air bag warning light should go out.

### WARNING

If any of the following conditions occurs, this indicates a malfunction of the SRS. Have an authorized HYUNDAI dealer inspect the air bag system as soon as possible.

- The light does not turn on briefly when you turn the ignition ON.
- The light stays on after illuminating for approximately 6 seconds.
- The light comes on while the vehicle is in motion.
- The light blinks when the ignition switch is in ON position.

## Safety system of your vehicle

Driver's front air bag (1)



B240B01L

The front air bag modules are located both in the center of the steering wheel and in the front passenger's panel above the glove box. When the SRSCM detects a sufficiently severe impact to the front of the vehicle, it will automatically deploy the front air bags.

Driver's front air bag (2)

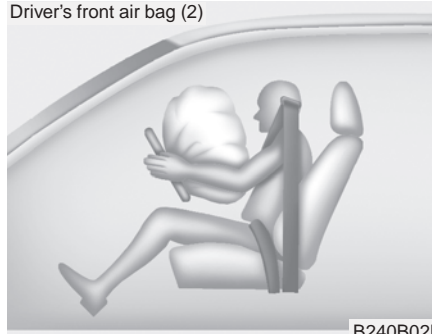

B240B02L

Upon deployment, tear seams molded directly into the pad covers will separate under pressure from the expansion of the air bags. Further opening of the covers then allows full inflation of the air bags.

Driver's front air bag (3)

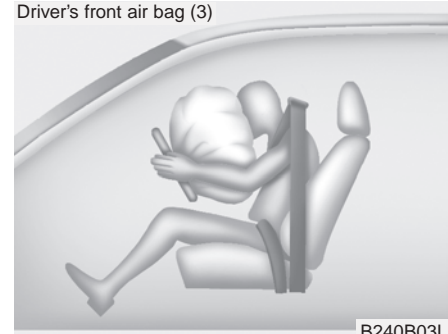

B240B03L

A fully inflated air bag, in combination with a properly worn seat belt, slows the driver's or the passenger's forward motion, reducing the risk of head and chest injury.

After complete inflation, the air bag immediately starts deflating, enabling the driver to maintain forward visibility and the ability to steer or operate other controls.

Passenger's front air bag



B240B05L

**⚠ WARNING**

- Do not install or place any accessories (drink holder, cassette holder, sticker, etc.) on the front passenger's panel above the glove box in a vehicle with a passenger's air bag. Such objects may become dangerous projectiles and cause injury if the passenger's air bag inflates.
- When installing a container of liquid air freshener inside the vehicle, do not place it near the instrument cluster nor on the instrument panel surface. It may become dangerous projectiles and cause injury if the passenger's air bag inflates.

**⚠ WARNING**

- If an air bag deploys, there may be a loud noise followed by a fine dust released in the vehicle. These conditions are normal and are not hazardous - the air bags are packed in this fine powder. The dust generated during air bag deployment may cause skin or eye irritation as well as aggravate asthma for some persons. Always wash all exposed skin areas thoroughly with lukewarm water and a mild soap after an accident in which the air bags were deployed.

(Continued)

(Continued)

- The SRS can function only when the ignition key is in the "ON" position. If the SRS air bag warning light does not illuminate, or continuously remains on after illuminating for about 6 seconds when the ignition key is turned to the ON position, or after the engine is started, comes on while driving, the SRS is not working properly. If this occurs, have your vehicle immediately inspected by an authorized HYUNDAI dealer.
- Before you replace a fuse or disconnect a battery terminal, turn the ignition switch to the LOCK position and remove the ignition key. Never remove or replace the air bag related fuse(s) when the ignition switch is in the ON position. Failure to heed this warning will cause the SRS air bag warning light to illuminate.





C040300AUN-EU

### Occupant classification system

Your vehicle is equipped with an occupant classification system in the front passenger's seat.

The occupant classification system is designed to detect the presence of a properly-seated front passenger and determine if the passenger's front air bag should be enabled (may inflate) or not. The driver's front air bag is not affected or controlled by the occupant classification system.

### *Main components of occupant classification system*

- A detection device located within the front passenger seat track.
- Electronic system to determine whether the passenger air bag systems (both front and side) should be activated or deactivated.
- A warning light located on the instrument panel which illuminates the words PASS AIR BAG "OFF" indicating the front passenger air bag system is deactivated.
- The instrument panel air bag warning light is interconnected with the occupant classification system.

If the front passenger seat is occupied by a person that the system determines to be of adult size, and he/she sits properly (sitting upright with the seatback in an upright position, centered on the seat cushion with their seat belt on, legs comfortably extended and their feet on the floor), the PASS AIR BAG "OFF" indicator will be turned off and the front passenger's air bag will be able to inflate, if necessary, in frontal crashes.

You will find the PASS AIR BAG "OFF" indicator on the center facia panel. This system detects the conditions 1~4 in the following table and activates or deactivates the front passenger air bag based on these conditions.

Always be sure that you and all vehicle occupants are seated and restrained properly (sitting upright with the seat in an upright position, centered on the seat cushion, with the person's legs comfortably extended, feet on the floor, and wearing the safety belt properly) for the most effective protection by the air bag and the safety belt.

- The OCS may not function properly if the passenger takes actions which can defect the detection system. These include:
  - (1) Failing to sit in an upright position.
  - (2) Leaning against the door or center console.
  - (3) Sitting towards the sides or the front of the seat.
  - (4) Putting legs on the dashboard or resting them on other locations which reduce the passenger weight on the front seat.
  - (5) Improperly wearing the safety belt.
  - (6) Reclining the seat back.

**Condition and operation in the front passenger occupant classification system**

Condition detected by the occupant detection system	Indicator/Warning light		Devices
	PASS AIR BAG "OFF" indicator light	SRS warning light	Front passenger air bag
1. Adult *1 or child age 13 and up*2	Off	Off	Activated
2. Infant or child restraint system with 12 months old*3 *4	On	Off	Deactivated
3. Unoccupied	On	Off	Deactivated
4. Malfunction in the system	On	On	Deactivated

- \*1) The system judges a person of adult size as an adult. When a smaller adult sits in the front passenger seat, the system may recognize him/her as a child depending on his/her physique and posture.
- \*2) Do not allow children to ride in the front passenger seat. When a smaller child than the same age sits in the front passenger seat, the system may recognize him/her as an infant depending on his/her physique or posture.

- \*3) Never install a child restraint system on the front passenger seat.
- \*4) The PASS AIR BAG "OFF" indicator may turn on or off when a child above 12 months to 12 years old (with or without child restraint system) sits in the front passenger seat. This is a normal condition.

 **WARNING**  
 Riding in an improper position or placing weight on the front passenger's seat when it is unoccupied by a passenger adversely affects the occupant classification system (OCS).

(Continued)

(Continued)



OVQ036013N

- Never put a heavy load in the front passenger seat or seatback pocket.



1KMN3663

- Never sit with hips shifted towards the front of the seat.



1KMN3665

- Never place feet on the dashboard.



OVQ036014N

- Never place feet on the front passenger seatback.



1KMN3662

- Never excessively recline the front passenger seatback.



1KMN3664

- Never lean on the door or center console.
- Never sit on one side of the front passenger seat.

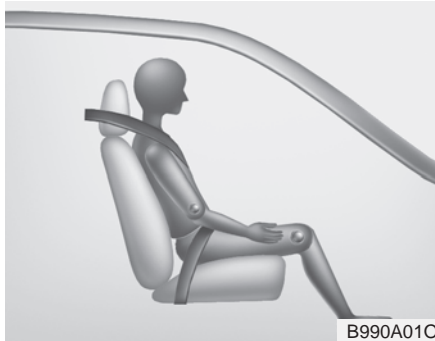

When an adult is seated in the front passenger seat, if the PASS AIR BAG "OFF" indicator is on, turn the ignition switch to the LOCK position and ask the passenger to sit properly (sitting upright with the seat back in an upright position, centered on the seat cushion with their seat belt on, legs comfortably extended and their feet on the floor). Restart the engine and have the person remain in that position. This will allow the system to detect the person and to enable the passenger air bag.

If the PASS AIR BAG "OFF" indicator is still on, ask the passenger to move to the rear seat.

 **WARNING**

Do not allow an adult passenger to ride in the front seat when the PASS AIR BAG "OFF" indicator is illuminated because the air bag will not deploy in the event of a crash. If the PASS AIR BAG "OFF" indicator remains illuminated after the adult passenger repositions themselves properly and the car is restarted, it is recommended that passenger move to the rear seat because the passenger's front air bag will not deploy.

Front seat passengers must stay properly seated to avoid serious injury from a deploying air bag.

**\* NOTICE**

The PASS AIR BAG "OFF" indicator illuminates for about 4 seconds after the ignition switch is turned to the ON position or after the engine is started. If the front passenger seat is occupied, the occupant classification sensor will then classify the front passenger after several more seconds.

 **WARNING**

Do not put a heavy load in the front passenger seatback pocket or on the front passenger seat. Do not hang onto the front passenger seat. Do not hang any items, such as a seatback table, on the front passenger seatback. Do not place feet on the front passenger seatback. Do not place any items under the front passenger seat. Any of these could interfere with proper sensor operation.

 **WARNING**

- Even though your vehicle is equipped with the occupant classification system, never install a child restraint system in the front passenger's seat. A deploying air bag can forcefully strike a child resulting in serious injuries or death. Any child age 12 and under should ride in the rear seat. Children too large for child restraints should use the available lap/shoulder belts. No matter what type of crash, children of all ages are safer when restrained in the rear seat.
- If the PASS AIR BAG "OFF" indicator is illuminated when the front passenger's seat is occupied by an adult and he/she sits properly (sitting upright with the seatback in an upright position, centered on the seat cushion with their seat belt on, legs comfortably extended and their feet on the floor), have that person sit in the rear seat.

(Continued)

(Continued)

- Do not modify or replace the front passenger seat. Don't place anything on or attach anything such as a blanket or seat heater to the front passenger seat. This can adversely affect the occupant classification system.
- Do not sit on sharp objects such as tools when occupying the front passenger seat. This can adversely affect the occupant classification system.
- Do not use accessory seat covers on the front seats.
- Accident statistics show that children are safer if they are restrained in the rear, as opposed to the front seat. It is recommended that child restraints be secured in a rear seat, including an infant riding in a rear-facing infant seat, a child riding in a forward-facing child seat and an older child riding in a booster seat.

(Continued)

(Continued)

- Air bags can only be used once – have an authorized HYUNDAI dealer replace the air bag immediately after deployment.
- A smaller-stature adult who is not seated correctly (for example: seat excessively reclined, leaning on the door or center console, or hips shifted forward in the seat) can cause a condition where the advanced frontal air bag system senses less weight than if the occupant were seated properly (sitting upright with the seatback in an upright position, centered on the seat cushion with their seat belt on, legs comfortably extended and their feet on the floor).

This condition can result in an adult potentially being misclassified and illumination of the PASS AIR BAG "OFF" indicator.

**⚠ WARNING**

If the occupant classification system is not working properly, the SRS air bag warning light on the instrument panel will illuminate because the passenger's front air bag is connected with the occupant classification system. If there is a malfunction of the occupant classification system, the PASS AIR BAG "OFF" indicator will not illuminate and the passenger's front air bag will inflate in frontal impact crashes even if there is no occupant in the front passenger's seat. If the SRS air bag warning light does not illuminate when the ignition switch is turned to the ON position, remains illuminated after approximately 6 seconds when the ignition switch is turned to the ON position, or if it illuminates while the vehicle is being driven, have an authorized HYUNDAI dealer inspect the occupant classification system and the SRS air bag system as soon as possible.

Driver's front air bag



OCM030037

Passenger's front air bag



OCM030038

C040400AFD

**Driver's and passenger's front air bag (if equipped)**

Your vehicle is equipped with an Advanced Supplemental Restraint (Air Bag) System and lap/shoulder belts at both the driver and passenger seating positions.

The indications of the system's presence are the letters "SRS AIR BAG" embossed on the air bag pad cover in the steering wheel and the passenger's side front panel pad above the glove box.

The SRS consists of air bags installed under the pad covers in the center of the steering wheel and the passenger's side front panel above the glove box.

The purpose of the SRS is to provide the vehicle's driver and/or the front passenger with additional protection than that offered by the seat belt system alone in case of a frontal impact of sufficient severity. The SRS uses sensors to gather information about the driver's seat position, the driver's and front passenger's seat belt usage and impact severity.

### **WARNING**

If a seat track position sensor or an occupant classification system is not working properly, the SRS air bag warning light on the instrument panel will illuminate because the SRS air bag warning light is connected with the seat track position sensor and the occupant classification system. If the SRS air bag warning light does not illuminate when the ignition switch is turned to the ON position, remains illuminated after approximately 6 seconds when the ignition switch is turned to the ON position, or if it illuminates while the vehicle is being driven, have an authorized HYUNDAI dealer inspect the advanced SRS air bag system as soon as possible.

The driver's seat track position sensor, which is installed on the seat track, determines if the seat is fore or aft of a reference position. The seat belt buckle sensors determine if the driver and front passenger's seat belts are fastened. These sensors provide the ability to control the SRS deployment based on how close the driver's seat is to the steering wheel, whether or not the seat belts are fastened, and how severe the impact is.

The advanced SRS offers the ability to control the air bag inflation with two levels. A first stage level is provided for moderate-severity impacts. A second stage level is provided for more severe impacts.

According to the impact severity, seating position and seat belt usage, the SRSCM (SRS Control Module) controls the air bag inflation. Failure to properly wear seat belts can increase the risk or severity of injury in an accident.

Additionally, your vehicle is equipped with an occupant classification system in the front passenger's seat. The occupant classification system detects the presence of a passenger in the front passenger's seat and will turn off the front passenger's air bag under certain conditions. For more detail, see "Occupant classification system" in this section.

### **WARNING**

- **Modification to the seat structure can adversely affect the seat track position sensor and cause the air bag to deploy at a different level than should be provided.**
- **Do not place any objects underneath the front seats as they could damage the seat track position sensor or interfere with the occupant classification system.**
- **Do not place any objects that may cause magnetic fields near the front seat. These may cause a malfunction of the seat track position sensor.**

 **WARNING**

If you are considering modification of your vehicle due to a disability, please contact the Hyundai Customer Assistance Center at 1-800-633-5151.

**\* NOTICE**

- Be sure to read information about the SRS on the labels provided on the sun visor.
- Advanced air bags are combined with pre-tensioner seat belts to help provide enhanced occupant protection in frontal crashes. Front air bags are not intended to deploy in collisions in which protection can be provided by the pre-tensioner seat belt.

 **WARNING**

Always use seat belts and child restraints – every trip, every time, everyone! Air bags inflate with considerable force and in the blink of an eye. Seat belts help keep occupants in proper position to obtain maximum benefit from the air bag. Even with advanced air bags, improperly and unbelted occupants can be severely injured when the air bag inflates. Always follow the precautions about seat belts, air bags and occupant safety contained in this manual.

To reduce the chance of serious or fatal injuries and receive the maximum safety benefit from your restraint system:

- Never place a child in any child or booster seat in the front seat.
- ABC – Always Buckle Children in the back seat. It is the safest place for children of any age to ride.
- Front and side air bags can injure occupants improperly positioned in the front seats.

(Continued)

(Continued)

- Move your seat as far back as practical from the front air bags, while still maintaining control of the vehicle.
- You and your passengers should never sit or lean unnecessarily close to the air bags. Improperly positioned driver and passengers can be severely injured by inflating air bags.
- Never lean against the door or center console – always sit in an upright position.
- Do not allow a passenger to ride in the front seat when the PASS AIR BAG "OFF" indicator is illuminated, because the air bag will not deploy in the event of a moderate or severe frontal crash.

(Continued)



**(Continued)**

- No objects should be placed over or near the air bag modules on the steering wheel, instrument panel, and the front passenger's panel above the glove box, because any such object could cause harm if the vehicle is in a crash severe enough to cause the air bags to deploy.
- Never place covers, blankets or seat warmers on the passenger seat as these may interfere with the occupant classification system.
- Do not tamper with or disconnect SRS wiring or other components of the SRS system. Doing so could result in injury, due to accidental deployment of the air bags or by rendering the SRS inoperative.
- If the SRS air bag warning light remains illuminated while the vehicle is being driven, have an authorized HYUNDAI dealer inspect the air bag system as soon as possible.

**(Continued)**

**(Continued)**

- Air bags can only be used once – have an authorized HYUNDAI dealer replace the air bag immediately after deployment.
- The SRS is designed to deploy the front air bags only when an impact is sufficiently severe and when the impact angle is less than 30° from the forward longitudinal axis of the vehicle. Additionally, the air bags will only deploy once. Seat belts must be worn at all times.
- Front air bags are not intended to deploy in side-impact, rear-impact or rollover crashes. In addition, front air bags will not deploy in frontal crashes below the deployment threshold.

**(Continued)**

**(Continued)**

- Even though your vehicle is equipped with the occupant classification system, do not install a child restraint system in the front passenger seat position. A child restraint system must never be placed in the front seat. The infant or child could be severely injured or killed by an air bag deployment in case of an accident.
- Children age 12 and under must always be properly restrained in the rear seat. Never allow children to ride in the front passenger seat. If a child over 12 must be seated in the front seat, he or she must be properly belted and the seat should be moved as far back as possible.
- For maximum safety protection in all types of crashes, all occupants including the driver should always wear their seat belts whether or not an air bag is also provided at their seating position to minimize the risk of severe injury or death in the event of a crash. Do not sit or lean unnecessarily close to the air bag while the vehicle is in motion.

**(Continued)**

(Continued)

- Sitting improperly or out of position can result in serious or fatal injury in a crash. All occupants should sit upright with the seat-back in an upright position, centered on the seat cushion with their seat belt on, legs comfortably extended and their feet on the floor until the vehicle is parked and the ignition key is removed.
- The SRS air bag system must deploy very rapidly to provide protection in a crash. If an occupant is out of position because of not wearing a seat belt, the air bag may forcefully contact the occupant causing serious or fatal injuries.

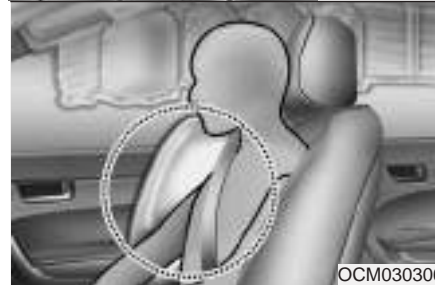
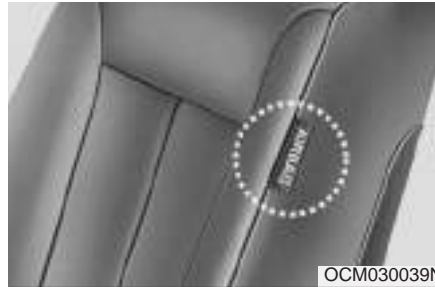

- The side impact air bags are designed to deploy only during certain side-impact collisions, depending on the crash severity, angle, speed and point of impact.
- The side impact air bags do not only deploy on the side of the impact but also on the opposite side.
- Also, both sides of the side impact air bags deploy in certain rollover situations.
- The side impact air bags are not designed to deploy in all side impact.

### Side impact air bag

Your vehicle is equipped with a side impact air bag in each front seat. The purpose of the air bag is to provide the vehicle's driver and/or the front passenger with additional protection than that offered by the seat belt alone.

### **WARNING**

- The side impact air bag is supplemental to the driver's and the passenger's seat belt systems and is not a substitute for them. Therefore your seat belts must be worn at all times while the vehicle is in motion. The air bags deploy only in certain side impact or rollover conditions severe enough to cause significant injury to the vehicle occupants.
- For best protection from the side impact air bag system and to avoid being injured by the deploying side impact air bag, both front seat occupants should sit in an upright position with the seat belt properly fastened. The driver's hands should be placed on the steering wheel at the 9:00 and 3:00 positions. The passenger's arms and hands should be placed on their laps.
- Do not use any accessory seat covers.

(Continued)

### (Continued)

- Use of seat covers could reduce or prevent the effectiveness of the system.
- Do not install any accessories on the side or near the side air bag.
- Do not place any objects over the air bag or between the air bag and yourself.
- Do not place any objects (an umbrella, bag, etc.) between the front door and the front seat. Such objects may become dangerous projectiles and cause injury if the supplemental side air bag inflates.
- To prevent unexpected deployment of the side impact air bag that may result in personal injury, avoid impact to the side impact sensor when the ignition key is on.
- If the seat or seat cover is damaged, have the vehicle checked and repaired by an authorized HYUNDAI dealer because your vehicle is equipped with side impact air bags and an occupant classification system.

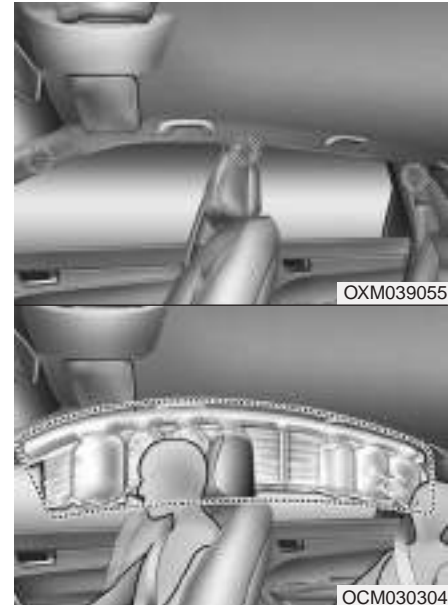

C040700AFD

### **Curtain air bag**

Curtain air bags are located along both sides of the roof rails above the front and rear doors.

They are designed to help protect the heads of the front seat occupants and the rear outboard seat occupants in certain side impact collisions.

- The curtain air bags are designed to deploy during certain side impact collisions, depending on the crash severity, angle, speed and point of impact.
- The curtain air bags do not only deploy on the side of the impact but also on the opposite side.
- Also, both sides of the curtain air bags deploy in certain rollover situations.
- The curtain air bags are not designed to deploy in all side impact.

 **WARNING**

- **In order for side and curtain air bags to provide its best protection, both front seat occupants and both outboard rear occupants should sit in an upright position with the seat belts properly fastened. Importantly, children should sit in a proper child restraint system in the rear seat.**
- **When children are seated in the rear outboard seats, they must be seated in the proper child restraint system.**

**Make sure to put the child restraint system as far away from the door side as possible, and secure the child restraint system in a locked position.**

- **Do not allow the passengers to lean their heads or bodies onto doors, put their arms on the doors, stretch their arms out of the window, or place objects between the doors and passengers when they are seated on seats equipped with side and/or curtain air bags.**

(Continued)

(Continued)

- **Never try to open or repair any components of the side curtain air bag system. This should only be done by an authorized HYUNDAI dealer.**

**Failure to follow the above mentioned instructions can result in injury or death to the vehicle occupants in an accident.**

C040800AFD

### Why didn't my air bag go off in a collision? (Inflation and non-inflation conditions of the air bag)

There are many types of accidents in which the air bag would not be expected to provide additional protection.

These include rear impacts, second or third collisions in multiple impact accidents, as well as low speed impacts. In other words, just because your vehicle is damaged and even if it is totally unusable, don't be surprised that the air bags did not inflate.

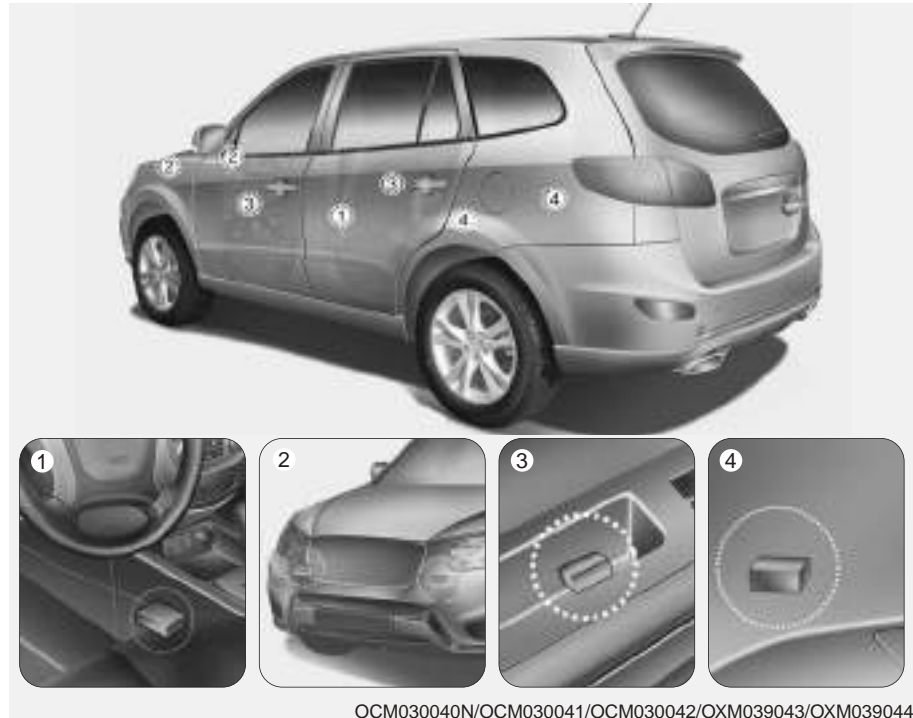

OCM030040N/OCM030041/OCM030042/OXM039043/OXM039044

#### **Air bag collision sensors**

- (1) SRS control module / Rollover sensor
- (2) Front impact sensor
- (3) Side impact sensor
- (4) Side impact sensor

**⚠ WARNING**

- Do not hit or allow any objects to impact the locations where air bag or sensors are installed. This may cause unexpected air bag deployment, which could result in serious personal injury or death.
- If the installation location or angle of the sensors is altered in any way, the air bags may deploy when they should not or they may not deploy when they should, causing severe injury or death. Therefore, do not try to perform maintenance on or around the air bag sensors. Have the vehicle checked and repaired by an authorized HYUNDAI dealer.

(Continued)

(Continued)

- Problems may arise if the sensor installation angles are changed due to the deformation of the front bumper, body or front doors and/or C pillars where side collision sensors are installed. Have the vehicle checked and repaired by an authorized HYUNDAI dealer.
- Your vehicle has been designed to absorb impact and deploy the air bag(s) in certain collisions. Installing bumper guards (or side step or running board) or replacing a bumper (or front door) with non-genuine parts may adversely affect your vehicles collision and air bag deployment performance.

**⚠ WARNING**

If your vehicle is equipped with side and curtain air bag, set the ignition switch to OFF or ACC position when the vehicle is being towed. The side and curtain air bag may deploy when the ignitions is ON, and the rollover sensor detects the situation as a rollover.



C040801AUN

***Air bag inflation conditions***

**Front air bags**

Front air bags are designed to inflate in a frontal collision depending on the intensity, speed or angles of impact of the front collision.

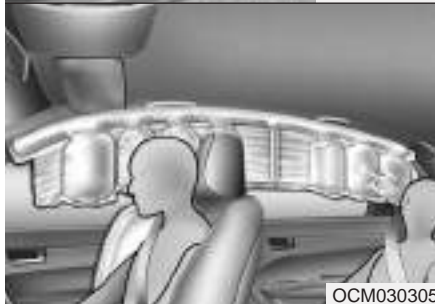

### Side impact and curtain air bags

Side impact and curtain air bags are designed to inflate when an impact is detected by side collision sensors depending on the strength, speed or angles of impact resulting from a side impact collision.

Also, the side impact and curtain air bags are designed to inflate when a rollover is detected by a rollover sensor.

Although the front air bags (driver's and front passenger's air bags) are designed to inflate only in frontal collisions, they also may inflate in other types of collisions if the front impact sensors detect a sufficient impact. Side impact and curtain air bags are designed to inflate only in side impact collisions or rollovers. But they may inflate in other type of collisions or similar rollover situations, if the side impact sensors or rollover sensor detect a sufficient impact or rollover.

If the vehicle chassis is impacted by bumps or objects on unimproved roads, the air bags may deploy. Drive carefully on unimproved roads or on surfaces not designed for vehicle traffic to prevent unintended air bag deployment.



C040802AUN

### *Air bag non-inflation conditions*

- In certain low-speed collisions the air bags may not deploy. The air bags are designed not to deploy in such cases because they may not provide benefits beyond the protection of the seat belts in such collisions.



- Air bags are not designed to inflate in rear collisions, because occupants are moved backward by the force of the impact. In this case, inflated air bags would not be able to provide any additional benefit.



- Front air bags may not inflate in side impact collisions, because occupants move to the direction of the collision, and thus in side impacts, frontal air bag deployment would not provide additional occupant protection.
- However, if equipped with side impact and curtain air bags, the air bags may inflate depending on the intensity, vehicle speed and angles of impact.

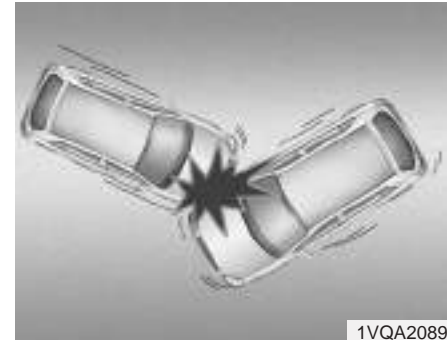

- In an angled collision, the force of impact may direct the occupants in a direction where the air bags would not be able to provide any additional benefit, and thus the sensors may not deploy any air bags.



## Safety system of your vehicle



- Just before impact, drivers often brake heavily. Such heavy braking lowers the front portion of the vehicle causing it to “ride” under a vehicle with a higher ground clearance. Air bags may not inflate in this “under-ride” situation because deceleration forces that are detected by sensors may be significantly replaced by such “under-ride” collisions.

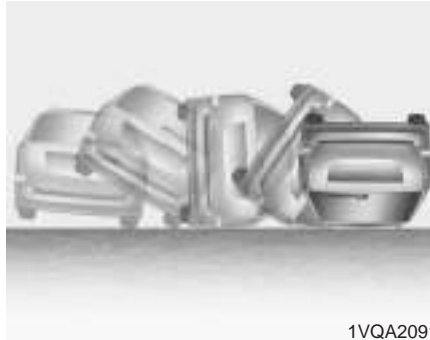

- Front air bags may not inflate in rollover accidents because front air bag deployment would not provide additional occupant protection. However, if equipped with side impact and curtain air bags, the air bags may inflate in a rollover, when it is detected by the rollover sensor. Also, side and curtain air bags may inflate when the vehicle is rolled over by a side impact collision, if the vehicle is equipped with side impact air bags and curtain air bags.



- Air bags may not inflate if the vehicle collides with objects such as utility poles or trees, where the point of impact is concentrated to one area and the full force of the impact is not delivered to the sensors.

### How does the air bag system operate

- Air bags are activated (able to inflate if necessary) only when the ignition switch is turned to the ON or START position.
- Air bags inflate instantly in the event of serious frontal or side collision in order to help protect the occupants from serious physical injury.  
Also, the air bags inflate instantly in the event of a rollover in order to help protect the occupants from serious physical injury.
- There is no single speed at which the air bags will inflate.  
Generally, air bags are designed to inflate by the severity of a collision and its direction. These two factors determine whether the sensors send out an electronic deployment/inflation signal.

- Air bag deployment depends on a number of factors including vehicle speed, angles of impact and the density and stiffness of the vehicles or objects which your vehicle hits in the collision. Though, factors are not limited to those mentioned above.
- The front air bags will completely inflate and deflate in an instant.  
It is virtually impossible for you to see the air bags inflate during an accident. It is much more likely that you will simply see the deflated air bags hanging out of their storage compartments after the collision.
- In order to help provide protection in a severe collision, the air bags must inflate rapidly. The speed of air bag inflation is a consequence of the extremely short time in which a collision occurs and the need to get the air bag between the occupant and the vehicle structures before the occupant impacts those structures. This speed of inflation reduces the risk of serious or life-threatening injuries in a severe collision and is thus a necessary part of air bag design.

However, air bag inflation can also cause injuries which normally can include facial abrasions, bruises and broken bones, and sometimes more severe injuries because the inflation speed also causes the air bags to expand with a great deal of force.

- **There are even circumstances under which contact with the steering wheel air bag can cause fatal injuries, especially if the occupant is positioned excessively close to the steering wheel.**

### **WARNING**

- To avoid severe personal injury or death caused by deploying air bags in a collision, the driver should sit as far back from the steering wheel air bag as possible (at least 10 inches (250 mm) away). The front passenger should always move their seat as far back as possible and sit back in their seat.
- Air bag inflates instantly in an event of collision, passengers may be injured by the air bag expansion force if they are not in proper position.
- Air bag inflation may cause injuries which normally include facial or bodily abrasions, injuries from broken glasses or burns by the air bag inflation gasses.

C040902AUN

### **Noise and smoke**

When the air bags inflate, they make a loud noise and they leave smoke and powder in the air inside of the vehicle. This is normal and is a result of the ignition of the air bag inflator. After the air bag inflates, you may feel substantial discomfort in breathing due to the contact of your chest to both the seat belt and the air bag, as well as from breathing the smoke and powder. **We strongly urge you to open your doors and/or windows as soon as possible after impact in order to reduce discomfort and prevent prolonged exposure to the smoke and powder.**

Though smoke and powder are non-toxic, it may cause irritation to the skin (eyes, nose and throat etc). If this is the case, wash and rinse with the cold water immediately and consult the doctor if the symptom persists.

### **WARNING**

**When the air bags deploy, the air bag related parts in steering wheel and/or instrument panel and/or in both sides of the roof rails above the front and rear doors are very hot. To prevent injury, do not touch the air bag storage areas internal components immediately after an air bag has inflated.**



1JBH3051

C040903AUN

***Do not install a child restraint on the front passenger's seat***

Never place a rear-facing child restraint in the front passenger's seat. If the air bag deploys, it would impact the rear-facing child restraint, causing serious or fatal injury.

In addition, do not place front-facing child restraint in the front passenger's seat either. If the front passenger air bag inflates, it would cause serious or fatal injuries to the child.

**WARNING**

- **Extreme Hazard! Do not use a rearward facing child restraint on a seat protected by an air bag in front of it!**
- **Never put child restraint in the front passenger's seat. If the front passenger air bag inflates, it would cause serious or fatal injuries.**
- **When children are seated in the rear outboard seats of a vehicle equipped with side and/or curtain air bags, be sure to install the child restraint system as far away from the door side as possible, and securely lock the child restraint system in position. Inflation of side and curtain air bags could cause serious injury or death to an infant or child.**



W7-147

C041000AUN

**Air bag warning light**

The purpose of air bag warning light in your instrument panel is to alert you of a potential problem with your air bag - Supplemental Restraint System (SRS).

When the ignition switch is turned ON, the indicator light should illuminate for approximately 6 seconds, then go off.

Have the system checked if:

- The light does not turn on briefly when you turn the ignition ON.
- The light stays on after illuminating for approximately 6 seconds.
- The light comes on while the vehicle is in motion.
- The light blinks when the ignition switch is in ON position.

### SRS Care

The SRS is virtually maintenance-free and so there are no parts you can safely service by yourself. If the SRS air bag warning light does not illuminate, or continuously remains on, have your vehicle immediately inspected by an authorized HYUNDAI dealer.

Any work on the SRS system, such as removing, installing, repairing, or any work on the steering wheel, the front passenger's panel, front seats and roof rails must be performed by an authorized HYUNDAI dealer. Improper handling of the SRS system may result in serious personal injury.



### WARNING

- **Modification to SRS components or wiring, including the addition of any kind of badges to the pad covers or modifications to the body structure, can adversely affect SRS performance and lead to possible injury.**
- **Not only the modification of the parts where the SRS sensors are but also the modification of other parts of the vehicle may affect the SRS performance and lead to possible injury.**
- **For cleaning the air bag pad covers, use only a soft, dry cloth or one which has been moistened with plain water. Solvents or cleaners could adversely affect the air bag covers and proper deployment of the system.**
- **No objects should be placed over or near the air bag modules on the steering wheel, instrument panel, and the front passenger's panel above the glove box, because any such object could cause harm if the vehicle is in a crash severe enough to cause the air bags to inflate.**

(Continued)

(Continued)

- If the air bags inflate, they must be replaced by an authorized HYUNDAI dealer.
- Do not tamper with or disconnect SRS wiring, or other components of the SRS system. Doing so could result in injury, due to accidental inflation of the air bags or by rendering the SRS inoperative.
- If components of the air bag system must be discarded, or if the vehicle must be scrapped, certain safety precautions must be observed. An authorized HYUNDAI dealer knows these precautions and can give you the necessary information. Failure to follow these precautions and procedures could increase the risk of personal injury.
- If your car was flooded and has soaked carpeting or water on flooring, you shouldn't try to start the engine; have the car towed to an authorized HYUNDAI dealer.

C041300AUN

**Additional safety precautions**

- **Never let passengers ride in the cargo area or on top of a folded-down back seat.** All occupants should sit upright, fully back in their seats with their seat belts on and their feet on the floor.
- **Passengers should not move out of or change seats while the vehicle is moving.** A passenger who is not wearing a seat belt during a crash or emergency stop can be thrown against the inside of the vehicle, against other occupants, or out of the vehicle.
- **Each seat belt is designed to restrain one occupant.** If more than one person uses the same seat belt, they could be seriously injured or killed in a collision.
- **Do not use any accessories on seat belts.** Devices claiming to improve occupant comfort or reposition the seat belt can reduce the protection provided by the seat belt and increase the chance of serious injury in a crash.
- **Passengers should not place hard or sharp objects between themselves and the air bags.** Carrying hard or sharp objects on your lap or in your mouth can result in injuries if an air bag inflates.

- **Keep occupants away from the air bag covers.** All occupants should sit upright, fully back in their seats with their seat belts on and their feet on the floor. If occupants are too close to the air bag covers, they could be injured if the air bags inflate.
- **Do not attach or place objects on or near the air bag covers.** Any object attached to or placed on the front or side air bag covers could interfere with the proper operation of the air bags.
- **Do not modify the front seats.** Modification of the front seats could interfere with the operation of the supplemental restraint system sensing components or side air bags.
- **Do not place items under the front seats.** Placing items under the front seats could interfere with the operation of the supplemental restraint system sensing components and wiring harnesses.
- **Never hold an infant or child on your lap.** The infant or child could be seriously injured or killed in the event of a crash. All infants and children should be properly restrained in appropriate child safety seats or seat belts in the rear seat.

### **WARNING**

- Sitting improperly or out of position can cause occupants to be shifted too close to a deploying air bag, strike the interior structure or be thrown from the vehicle resulting in serious injury or death.
- Always sit upright with the seat-back in an upright position, centered on the seat cushion with your seat belt on, legs comfortably extended and your feet on the floor.
- Always have the ignition OFF in an abnormal situation. The side air bags may inflate if the vehicle is tilted such as when being towed because the rollover sensor detects it as a rollover situation.
- Be careful not to cause impact to the doors when the ignition is ON. The air bags may inflate.

C041400AUN

### **Adding equipment to or modifying your air bag-equipped vehicle**

If you modify your vehicle by changing your vehicle's frame, bumper system, front door, front end or side sheet metal or ride height, this may affect the operation of your vehicle's air bag system.



OCM030053L

### **Air bag warning label**

Air bag warning labels, some required by the U.S. National Highway Traffic Safety Administration (NHTSA), are attached to alert the driver and passengers of potential risks of the air bag system.

**Keys / 4-2**  
**Remote keyless entry / 4-3**  
**Theft-alarm system / 4-5**  
**Door locks / 4-7**  
**Tailgate / 4-11**  
**Windows / 4-13**  
**Hood / 4-17**  
**Fuel filler lid / 4-19**  
**Sunroof / 4-22**

## Features of your vehicle

**4**

**Steering wheel / 4-26**  
**Mirrors / 4-28**  
**Instrument cluster / 4-40**  
**Rearview camera / 4-56**  
**Hazard warning flasher / 4-56**  
**Lighting / 4-57**  
**Wipers and washers / 4-61**  
**Interior light / 4-63**  
**Defroster / 4-66**  
**Manual climate control system / 4-67**  
**Automatic climate control system / 4-76**  
**Windshield defrosting and defogging / 4-83**  
**Storage compartment / 4-86**  
**Interior features / 4-89**  
**Exterior features / 4-98**  
**Audio system / 4-99**



### KEYS

D010100AFD

#### Record your key number



The key code number is stamped on the bar code tag attached to the key set. Should you lose your keys, this number will enable an authorized HYUNDAI dealer to duplicate the keys easily. Remove the bar code tag and store it in a safe and handy place, but not in the vehicle.



OUN026060

D010200AFD

#### Key operations

- Used to start the engine.
- Used to lock and unlock the doors.
- Used to lock and unlock the glove box. (if equipped)

#### **WARNING**

Use only HYUNDAI original parts for the ignition key in your vehicle. If an aftermarket key is used, the ignition switch may not return to ON after START. If this happens, the starter will continue to operate causing damage to the starter motor and possible fire due to excessive current in the wiring.

#### **WARNING - Ignition key**

Leaving children unattended in a vehicle with the ignition key is dangerous even if the key is not in the ignition. Children copy adults and they could place the key in the ignition. The ignition key would enable children to operate power windows or other controls, or even make the vehicle move, which could result in serious bodily injury or even death. Never leave the keys in your vehicle with unsupervised children.

## REMOTE KEYLESS ENTRY (IF EQUIPPED)



### Remote keyless entry system operations

#### *Lock (1)*

All doors are locked if the lock button is pressed.

If all doors are closed, the hazard warning lights will blink once to indicate that all doors are locked. However, if any door remains open, the hazard warning lights will not blink. If all doors are closed after the lock button is pressed, the hazard warning lights will blink once.

#### *Unlock (2)*

The driver's door is unlocked if the unlock button is pressed once. The hazard warning lights will blink twice to indicate that the driver's door is unlocked.

All doors are unlocked if the unlock button is pressed once more within 4 seconds. The hazard warning lights will blink twice again to indicate that all doors are unlocked.

After depressing this button, the doors will be locked automatically unless you open any door within 30 seconds.

D020104AUN

#### *Alarm (3, if equipped)*

The horn sounds and the hazard warning lights blink for about 30 seconds if this button is pressed for more than 0.5 second. To stop the horn and lights, press any button on the transmitter.

### Transmitter precautions

#### \* NOTICE

The transmitter will not work if any of following occur:

- The ignition key is in ignition switch.
- You exceed the operating distance limit (about 30 feet [10 m]).
- The battery in the transmitter is weak.
- Other vehicles or objects may be blocking the signal.
- The weather is extremely cold.
- The transmitter is close to a radio transmitter such as a radio station or an airport which can interfere with normal operation of the transmitter.

When the transmitter does not work correctly, open and close the door with the ignition key. If you have a problem with the transmitter, contact an authorized HYUNDAI dealer.

#### ! CAUTION

*Keep the transmitter away from water or any liquid. If the keyless entry system is inoperative due to exposure to water or liquids, it will not be covered by your manufacturer vehicle warranty.*

### This device complies with Part 15 of the FCC rules.

Operation is subject to the following two conditions:

1. This device may not cause harmful interference, and
2. This device must accept any interference received, including interference that may cause undesired operation.



### WARNING

Changes or modifications not expressly approved by the party responsible for compliance could void the user's authority to operate the equipment. If the keyless entry system is inoperative due to changes or modifications not expressly approved by the party responsible for compliance, it will not be covered by your manufacturer's vehicle warranty.



D020300AFD

### Battery replacement

Transmitter uses a 3 volt lithium battery which will normally last for several years. When replacement is necessary, use the following procedure.

1. Insert a slim tool into the slot and gently pry open the transmitter center cover.
2. Replace the battery with new one. When replacing the battery, make sure the battery positive "+" symbol faces down as indicated in the illustration.
3. Install the battery in the reverse order of removal.

For transmitter replacement, see an authorized HYUNDAI dealer for reprogramming.

### ! CAUTION

- *The keyless entry system transmitter is designed to give you years of trouble-free use, however it can malfunction if exposed to moisture or static electricity. If you are unsure how to use your transmitter or replace the battery, contact an authorized HYUNDAI dealer.*
- *Using the wrong battery can cause the transmitter to malfunction. Be sure to use the correct battery.*
- *To avoid damaging the transmitter, don't drop it, get it wet, or expose it to heat or sunlight.*

### ! CAUTION

*An inappropriately disposed battery can be harmful to the environment and human health. Dispose the battery according to your local law(s) or regulation.*

## THEFT-ALARM SYSTEM (IF EQUIPPED)

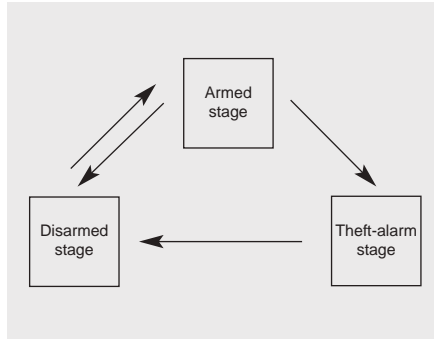

D030000AUN-EE

This system is designed to provide protection from unauthorized entry into the car. This system is operated in three stages: the first is the "Armed" stage, the second is the "Theft-alarm" stage, and the third is the "Disarmed" stage. If triggered, the system provides an audible alarm with blinking of the hazard warning lights.

D030100AUN-EE

### Armed stage

Park the car and stop the engine. Arm the system as described below.

1. Remove the ignition key from the ignition switch and exit the vehicle.
2. Make sure that all doors (and tailgate) and the engine hood are closed and latched.
3. Lock the doors using the transmitter of the keyless entry system.

After completion of the steps above, the hazard warning lights will blink once to indicate that the system is armed. The system can also be armed by locking the doors with the key. However, the hazard warning lights will not blink.

If any door (or tailgate) or engine hood remains open, the hazard warning lights will not blink and the theft-alarm will not arm. If all doors (and tailgate) and engine hood are closed after the lock button is pressed, the hazard warning lights blink once.

- **Do not arm the system until all passengers have left the vehicle. If the system is armed while a passenger(s) remains in the vehicle, the alarm may be activated when the remaining passenger(s) leave the vehicle. If any door (or tailgate) or engine hood is opened within 30 seconds after the system enters the armed stage, the system is disarmed to prevent unnecessary alarm.**

### Theft-alarm stage

The alarm will be activated if any of the following occurs while the system is armed.

- A front or rear door is opened without using ignition key or transmitter.
- The tailgate is opened without using ignition key or transmitter.
- The engine hood is opened.

The horn will sound and the hazard warning lights will blink continuously for approximately 30 seconds, and repeat the horn 3 times unless the system is disarmed. To turn off the system, unlock the doors with the transmitter or ignition key.

### Disarmed stage

The system will be disarmed when:

- The doors are unlocked using the transmitter or ignition key.
- The engine is started.
- The ignition switch is in the "ON" position for 30 seconds or more.

After pressing unlock button, the hazard warning lights will blink twice to indicate that the system is disarmed.

After pressing the unlock button, if any door is not opened within 30 seconds, the system will be rearmed.

### \* NOTICE

- **Avoid trying to start the engine while the alarm is activated. The vehicle starting motor is disabled during the theft-alarm stage.**

**If the system is not disarmed with the transmitter, insert the key into the ignition switch, turn the ignition switch to the ON position and wait for 30 seconds. Then the system will be disarmed.**

- **If you lose your keys, consult your authorized HYUNDAI dealer.**

### ! CAUTION

***Do not change, alter or adjust the theft-alarm system because it could cause the theft-alarm system to malfunction and should only be serviced by an authorized HYUNDAI dealer.***

***Malfunctions caused by improper alterations, adjustments or modifications to the theft-alarm system are not covered by your vehicle manufacturer warranty.***

## DOOR LOCKS



### Operating door locks from outside the vehicle

- Turn the key toward the rear of the vehicle to unlock and toward the front of vehicle to lock.
- If you lock the door with a key, all vehicle doors will lock automatically.
- From the driver's door, turn the key to the right once to unlock the driver's door and once more within 4 seconds to unlock all doors.

- Doors can also be locked and unlocked with the transmitter (if equipped).
- Once the doors are unlocked, they may be opened by pulling the door handle.
- When closing the door, push the door by hand. Make sure that doors are closed securely.

※ If your vehicle is equipped with the remote keyless entry system, there is no key lock on the front passenger's door.

### \* NOTICE

- **In cold and wet climates, door lock and door mechanisms may not work properly due to freezing conditions.**
- **If the door is locked/unlocked multiple times in rapid succession with either the vehicle key or door lock switch, the system may stop operating temporarily in order to protect the circuit and prevent damage to system components.**



- To lock a door without the key, push the inside door lock button (1) or central door lock switch (2) to the "Lock" position and close the door (3).
- If you lock the door with the central door lock switch, all vehicle doors will lock automatically.

### \* NOTICE

**Always remove the ignition key, engage the parking brake, close all windows and lock all doors when leaving your vehicle unattended.**

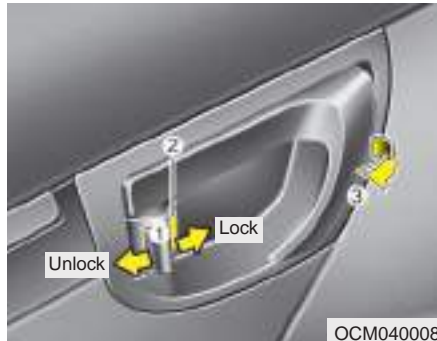

### Operating door locks from inside the vehicle

#### *With the door lock button*

- To unlock a door, push the door lock button (1) to the “Unlock” position. The red mark (2) on the button will be visible.
- To lock a door, push the door lock button (1) to the “Lock” position. If the door is locked properly, the red mark (2) on the door lock button will not be visible.
- To open a door, pull the door handle (3) outward.

- If the inner door handle of the front door is pulled when the door lock button is in the lock position, the button will unlock and the door will open. (if equipped)
- Front doors cannot be locked if the ignition key is in the ignition switch and any front door is opened.

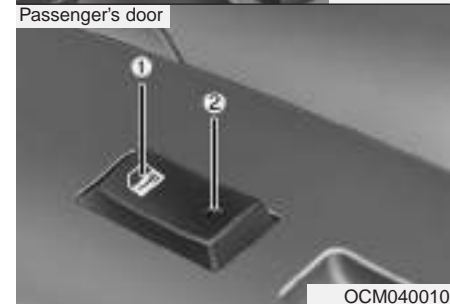

D050202AUN

#### *With central door lock switch*

Operate by depressing the central door lock switch.

- When pushing down on the front portion (1) of the switch, all vehicle doors will lock.

- When pushing down on the rear portion (2) of the switch, all vehicle doors will unlock.
- However, if the key is in the ignition switch and the driver's door is opened, the driver's door will not lock when the front portion (1) of the central door lock switch is pressed.
- Also, if the key is in the ignition switch and the passenger's door is opened, all of the doors will not lock when the front portion (1) of the central door lock switch is pressed.

 **WARNING - Doors**

- The doors should always be fully closed and locked while the vehicle is in motion to prevent accidental opening of the door. Locked doors will also discourage potential intruders when the vehicle stops or slows.
- Be careful when opening doors and watch for vehicles, motorcycles, bicycles or pedestrians approaching the vehicle in the path of the door. Opening a door when something is approaching can cause damage or injury.

 **WARNING - Unlocked vehicles**

**Leaving your vehicle unlocked can invite theft or possible harm to you or others from someone hiding in your vehicle while you are gone. Always remove the ignition key, engage the parking brake, close all windows and lock all doors when leaving your vehicle unattended.**

 **WARNING - Unattended children**

**An enclosed vehicle can become extremely hot, causing death or severe injury to unattended children or animals who cannot escape the vehicle. Furthermore, children might operate features of the vehicle that could injure them, or they could encounter other harm, possibly from someone gaining entry to the vehicle. Never leave children or animals unattended in your vehicle.**

D050300AUN

**Impact sensing door unlock system (if equipped)**

All doors will be automatically unlocked when the impact is delivered to impact sensors while the ignition switch is ON. However, the doors may not be unlocked if mechanical problems occur with the door lock system or battery.



### Auto door lock/unlock feature (if equipped)

- All doors will automatically lock when the transaxle shift lever is shifted out of P(Park).
- All doors will automatically unlocked when the transaxle shift lever is shifted into P(Park).
- All doors will automatically unlock when the ignition key is removed from the ignition switch.



D050500AUN

### Child-protector rear door lock

The child safety lock is provided to help prevent children from accidentally opening the rear doors from inside the vehicle. The rear door safety locks should be used whenever children are in the vehicle.

1. Open the rear door.
2. Push the child safety lock located on the rear edge of the door to the "Lock" position. When the child safety lock is in the "Lock (  )" position, rear door will not open even though the inner door handle is pulled inside the vehicle.

3. Close the rear door.

To open the rear door, pull the outside door handle (1).

Even though the doors may be unlocked, the rear door will not open by pulling the inner door handle (2) until rear door child safety lock is unlocked (  ).



### **WARNING - Rear door locks**

**If children accidentally open the rear doors while the vehicle is in motion, they could fall out and be severely injured or killed. To prevent children from opening the rear doors from the inside, the rear door safety locks should be used whenever children are in the vehicle.**

## TAILGATE



OCM040011A

### Opening the tailgate

- The tailgate is locked or unlocked when all doors are locked or unlocked with the key, transmitter or central door lock switch.
- If unlocked, the tailgate can be opened by pressing the handle and pulling it up.

### \* NOTICE

In cold and wet climates, door lock and door mechanisms may not work properly due to freezing conditions.

### WARNING

The tailgate swings upward. Make sure no objects or people are near the rear of the vehicle when opening the tailgate.

### ! CAUTION

*Make certain that you close the tailgate before driving your vehicle. Possible damage may occur to the tailgate lift cylinders and attaching hardware if the tailgate is not closed prior to driving.*



OCM040015

D070200AUN

### Closing the tailgate

To close the tailgate, lower and push down the tailgate firmly. Make sure that the tailgate is securely latched.

 **WARNING - Exhaust fumes**

If you drive with the tailgate open, you will draw dangerous exhaust fumes into your vehicle which can cause serious injury or death to vehicle occupants.

If you must drive with the tailgate open, keep the air vents and all windows open so that additional outside air comes into the vehicle.

 **WARNING - Rear cargo area**

Occupants should never ride in the rear cargo area where no restraints are available. To avoid injury in the event of an accident or sudden stops, occupants should always be properly restrained.

**WINDOWS**

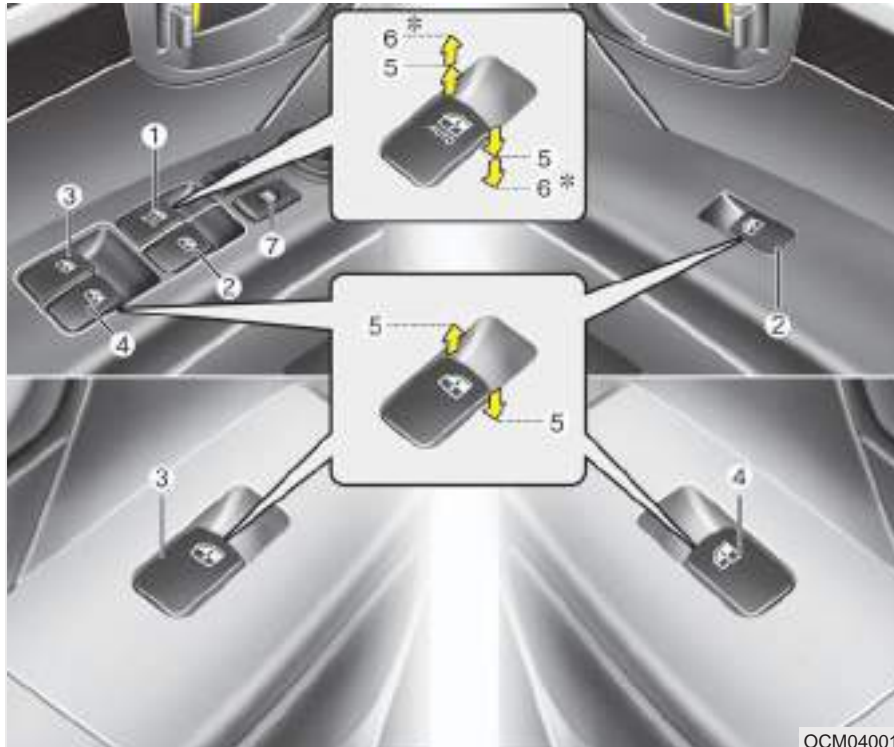

D080000AFD

- (1) Driver's door power window switch
- (2) Front passenger's door power window switch
- (3) Rear door (left) power window switch
- (4) Rear door (right) power window switch
- (5) Window opening and closing
- (6) Automatic power window up\*/down\*
- (7) Power window lock switch

\*: if equipped

**\* NOTICE**

**In cold and wet climates, power windows may not work properly due to freezing conditions.**

OCM040016

### Power windows

The ignition switch must be in the ON position for power windows to operate. Each door has a power window switch that controls the door's window. The driver's door has a master power window switch that controls all the windows in the vehicle.

The power windows can be operated for approximately 30 seconds after the ignition key is removed or turned to the ACC or LOCK position. However, if the front doors are opened, the power windows cannot be operated even within the 30 seconds period.

#### \* NOTICE

**While driving with the rear windows down or with the sunroof (if equipped) in an open (or partially open position), your vehicle may demonstrate a wind buffeting or pulsation noise. This noise is a normal occurrence and can be reduced or eliminated by taking the following actions. If the noise occurs with one or both of the rear windows down, partially lower both front windows approximately one inch. If you experience the noise with the sunroof open, slightly reduce the size of the sunroof opening.**



OHM048016

D080101AUN

#### *Window opening and closing (if equipped)*

The driver's door has a master power window switch that controls all the windows in the vehicle.

To open or close a window, press down or pull up the front portion of the corresponding switch to the first detent position (5).

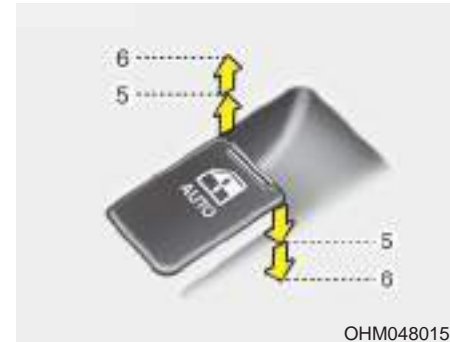

OHM048015

D080103AUN

#### *Auto up/down window (if equipped)*

Pressing or pulling up the power window switch momentarily to the second detent position (6) completely lowers or lifts the window even when the switch is released. To stop the window at the desired position while the window is in operation, pull up or press down and release the switch.

If the power window is not operated correctly, the automatic power window system must be reset as follows:

1. Turn the ignition switch to the ON position.
2. Close driver's window and continue pulling up on driver's power window switch for at least 1 second after the window is completely closed.



OUN026013

**Automatic reversal**

If the upward movement of the window is blocked by an object or part of the body, the window will detect the resistance and will stop upward movement. The window will then lower approximately 30 cm (11.8 in.) to allow the object to be cleared.

If the window detects the resistance while the power window switch is pulled up continuously, the window will stop upward movement then lower approximately 2.5 cm (1 in.). And if the power window switch is pulled up continuously again within 5 seconds after the window is lowered by the automatic window reversal feature, the automatic window reversal will not operate.

**\* NOTICE**

The automatic reverse feature for the driver's window is only active when the "auto up" feature is used by fully pulling up the switch. The automatic reverse feature will not operate if the window is raised using the halfway position on the power window switch.

**⚠ WARNING**

**Always check for obstructions before raising any window to avoid injuries or vehicle damage. If an object less than 4 mm (0.16 in.) in diameter is caught between the window glass and the upper window channel, the automatic reverse window may not detect the resistance and will not stop and reverse direction.**



OCM052013

**Power window lock button**

- The driver can disable the power window switches on a front and rear passenger door by pressing the power window lock button located on the driver's door to the LOCK position (pressed).
- **When the power window lock button is in the LOCK position (pressed), the driver's master control cannot operate the front and rear passenger door power windows.**

### **! CAUTION**

- *To prevent possible damage to the power window system, do not open or close two windows or more at the same time. This will also ensure the longevity of the fuse.*
- *Never try to operate the main switch on the driver's door and the individual door window switch in the opposite directions at the same time. If this is done, the window will stop and cannot be opened or closed.*

### **WARNING - Windows**

- **NEVER** leave the ignition key in the vehicle.
- **NEVER** leave any child unattended in the vehicle. Even very young children may inadvertently cause the vehicle to move, entangle themselves in the windows, or otherwise injure themselves or others.
- Always double check to make sure all arms, hands, head and other obstructions are safely out of the way before closing a window.
- Do not allow children to play with the power windows. Keep the driver's door power window lock switch in the LOCK position (pressed). Serious injury can result from unintentional window operation by the child.
- Do not extend face or arms outside through the window opening while driving.

## HOOD



D090100AUN

### Opening the hood

1. Pull the release lever to unlatch the hood. The hood should pop open slightly.



2. Go to the front of the vehicle, raise the hood slightly, push the secondary latch (1) inside of the hood center and lift the hood (2).
3. Raise the hood. It will completely rise by itself after it has been raised about halfway.

D090200AUN

### Closing the hood

1. Before closing the hood, check the following:
  - All filler caps in engine compartment must be correctly installed.
  - Gloves, rags or any other combustible material must be removed from the engine compartment.
2. Lower the hood halfway and push down to securely lock in place.



### **WARNING - Hood**

- Before closing the hood, ensure that all obstructions are removed from the hood opening. Closing the hood with an obstruction present in the hood opening may result in property damage or severe personal injury.
- Do not leave gloves, rags or any other combustible material in the engine compartment. Doing so may cause a heat-induced fire.

### **WARNING**

- Always double check to be sure that the hood is firmly latched before driving away. If it is not latched, the hood could fly open while the vehicle is being driven, causing a total loss of visibility, which might result in an accident.
- Do not move the vehicle with the hood raised. The view will be blocked and the hood could fall or be damaged.

## FUEL FILLER LID



### Opening the fuel filler lid

The fuel-filler lid must be opened from inside the vehicle by pulling up on the fuel-filler lid opener located on the floor next to the driver's seat.

### \* NOTICE

If the fuel-filler lid will not open because ice has formed around it, tap lightly or push on the lid to break the ice and release the lid. Do not pry on the lid. If necessary, spray around the lid with an approved de-icer fluid (do not use radiator anti-freeze) or move the vehicle to a warm place and allow the ice to melt.

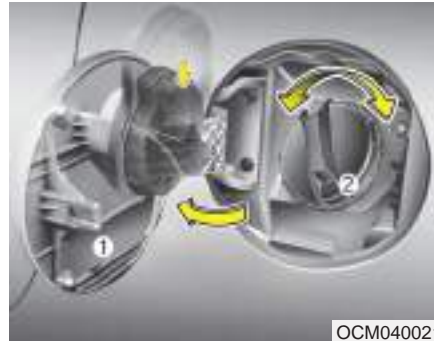

1. Stop the engine.
2. To open the fuel filler lid, pull the fuel filler lid opener up.
3. Pull the fuel filler lid (1) out to fully open.
4. To remove the cap (2), turn the fuel tank cap counterclockwise.
5. Refuel as needed.

D100200AUN

### Closing the fuel filler lid

1. To install the cap, turn it clockwise until it "clicks". This indicates that the cap is securely tightened.
2. Close the fuel filler lid and push it lightly and make sure that it is securely closed.

D100300BFD



### **WARNING - Refueling**

- If pressurized fuel sprays out, it can cover your clothes or skin and thus subject you to the risk of fire and burns. Always remove the fuel cap carefully and slowly. If the cap is venting fuel or if you hear a hissing sound, wait until the condition stops before completely removing the cap.
- Do not "top off" after the nozzle automatically shuts off when refueling.
- Tighten the cap until it clicks, otherwise the Check Engine  light will illuminate.
- Always check that the fuel cap is installed securely to prevent fuel spillage in the event of an accident.



### **WARNING - Refueling dangers**

Automotive fuels are flammable materials. When refueling, please note the following guidelines carefully. Failure to follow these guidelines may result in severe personal injury, severe burns or death by fire or explosion.

- Read and follow all warning at the gas station facility.
- Before refueling note the location of the Emergency Gasoline Shut-Off, if available, at the gas station facility.
- Before touching the fuel nozzle, you should eliminate potentially dangerous static electricity discharge by touching another metal part of the vehicle, a safe distance away from the fuel filler neck, nozzle, or other gas source.

(Continued)

(Continued)

- Do not get back into a vehicle once you have begun refueling since you can generate static electricity by touching, rubbing or sliding against any item or fabric (polyester, satin, nylon, etc.) capable of producing static electricity. Static electricity discharge can ignite fuel vapors resulting in rapid burning. If you must re-enter the vehicle, you should once again eliminate potentially dangerous static electricity discharge by touching a metal part of the vehicle, away from the fuel filler neck, nozzle or other gasoline source.
- When using a portable fuel container be sure to place the container on the ground prior to refueling. Static electricity discharge from the container can ignite fuel vapors causing a fire. Once refueling has begun, contact with the vehicle should be maintained until the filling is complete.

(Continued)

(Continued)

Use only portable plastic fuel containers designed to carry and store gasoline.

- Do not use cellular phones while refueling. Electric current and/or electronic interference from cellular phones can potentially ignite fuel vapors causing a fire.
- When refueling, always shut the engine off. Sparks produced by electrical components related to the engine can ignite fuel vapors causing a fire. Once refueling is complete, check to make sure the filler cap and filler door are securely closed, before starting the engine.
- DO NOT use matches or a lighter and DO NOT SMOKE or leave a lit cigarette in your vehicle while at a gas station especially during refueling. Automotive fuel is highly flammable and can, when ignited, result in fire.

(Continued)

(Continued)

- If a fire breaks out during refueling, leave the vicinity of the vehicle, and immediately contact the manager of the gas station and then contact the local fire department or 911. Follow any safety instructions they provide.

### **! CAUTION**

- *Make sure to refuel your vehicle according to the "Fuel requirements" suggested in section 1.*
- *If the fuel filler cap requires replacement, use only a genuine HYUNDAI cap or the equivalent specified for your vehicle. An incorrect fuel filler cap can result in a serious malfunction of the fuel system or emission control system.*
- *Do not spill fuel on the exterior surfaces of the vehicle. Any type of fuel spilled on painted surfaces may damage the paint.*
- *After refueling, make sure the fuel cap is installed securely to prevent fuel spillage in the event of an accident.*

## SUNROOF (IF EQUIPPED)



OCM040232N

D110000AUN

If your vehicle is equipped with this feature, you can slide or tilt your sunroof with the sunroof control switch located on the overhead console.

The sunroof can only be opened, closed, or tilted when the ignition switch is in the ON position.

### \* NOTICE

- In cold and wet climates, sunroof may not work properly due to freezing conditions.
- After washing the car or after there is rain, be sure to wipe off any water that is on the sunroof before operating it.

### ! CAUTION

*Do not continue to press the sunroof control switch after the sunroof is fully opened, closed, or tilted. Damage to the motor or system components could occur.*

### \* NOTICE

The sunroof cannot slide when it is in the tilt position nor can it be tilted while in an open or slide position.

### WARNING

Never adjust the sunroof or sunshade while driving. This could result in loss of control and an accident that may cause death, serious injury, or property damage.



OCM029024L

D110100AFD

### Sliding the sunroof

To open the sunroof (autoslide feature), move the sunroof control switch towards the rear of the vehicle for more than 0.5 second.

The sunroof will slide to the recommended open position.

To stop the sunroof sliding at any point, pull or push the sunroof control switch momentarily.

**\* NOTICE**

To reduce wind noise while driving, we recommend you to drive at the recommended position.

To close the sunroof (autoslide feature), move the sunroof control switch towards the front of the vehicle for more than 0.5 second.

The sunroof will close all the way. To stop the sunroof sliding at any point, pull or push the sunroof control switch momentarily.



OUN026027

D110101AUN

**Automatic reversal**

If an object or part of the body is detected while the sunroof is closing automatically, it will reverse the direction, and then stop.

The auto reverse function does not work if a tiny obstacle is between the sliding glass and the sunroof sash. You should always check that all passengers and objects are away from the sunroof before closing it.



OCM029025L

D110200AUN

**Tilting the sunroof**

To open the sunroof (autotilt feature), push the sunroof control switch upward for more than 0.5 second.

The sunroof will tilt all the way open. To stop the sunroof tilting at any point, pull the sunroof control switch downward momentarily.

To close the sunroof, pull the sunroof control switch downward and hold it until the sunroof is closed.

### **WARNING - Sunroof**

- Be careful that someone's head, hands and body are not trapped by a closing sunroof.
- Do not extend face, neck, arms or body outside through the sunroof opening while driving.
- Make sure hand and face are safely out of the way before closing a sunroof.

### **! CAUTION**

- *Periodically remove any dirt that may accumulate on the guide rail.*
- *If you try to open the sunroof when the temperature is below freezing or when the sunroof is covered with snow or ice, the glass or the motor could be damaged.*
- *The sunroof is made to slide together with sunshade. Do not leave the sunshade closed while the sunroof is open.*



D110300AUN

### **Sunshade**

The sunshade will be opened with the glass panel automatically when the glass panel is slid. You will have to close it manually if you want it closed.

### Resetting the sunroof

Whenever the vehicle battery is disconnected or discharged, or related fuse is blown, you must reset your sunroof system as follows:

1. Turn the ignition switch to the ON position and close the sunroof completely.
2. Release the control switch.
3. Pull and hold the sunroof control switch downward until the sunroof tilts and slightly moves up and down. Then, release the control switch.
4. Pull and hold the sunroof control switch downward until the sunroof is operated as follows;

TILT DOWN → SLIDE OPEN →  
SLIDE CLOSE

Then, release the control switch.

When this is complete, the sunroof system is reset.

※ For more detailed information, contact an authorized HYUNDAI dealer.

#### **! CAUTION**

***If the sunroof is not reset when the vehicle battery is disconnected or discharged, or related fuse is blown, the sunroof may operate improperly.***



### STEERING WHEEL

#### Power steering

Power steering uses energy from the engine to assist you in steering the vehicle. If the engine is off or if the power steering system becomes inoperative, the vehicle may still be steered, but it will require increased steering effort.

Should you notice any change in the effort required to steer during normal vehicle operation, have the power steering checked by an authorized HYUNDAI dealer.

#### **! CAUTION**

***Never hold the steering wheel to the extreme right or left for more than 5 seconds with the engine running. Holding the steering wheel for more than 5 seconds in either position may cause damage to the power steering pump.***

#### **\* NOTICE**

**If the power steering drive belt breaks or if the power steering pump malfunctions, the steering effort will greatly increase.**

#### **\* NOTICE**

**If the vehicle is parked for extended periods outside in cold weather (below 14°F/-10°C), the power steering may require increased effort when the engine is first started. This is caused by increased fluid viscosity due to the cold weather and does not indicate a malfunction.**

When this happens, increase the engine RPM by depressing the accelerator until the RPM reaches 1,500 rpm then release or let the engine idle for two or three minutes to warm up the fluid.

D130300AFD

#### **Tilt steering**

A tilt steering wheel allows you to adjust the steering wheel before you drive. You can also raise it to give your legs more room when you exit and enter the vehicle (if equipped).

The steering wheel should be positioned so that it is comfortable for you to drive, while permitting you to see the instrument panel warning lights and gauges.



#### **WARNING**

- **Never adjust the angle and height of steering wheel while driving. You may lose your steering control and cause severe personal injury or accidents.**
- **After adjusting, push the steering wheel both up and down to be certain it is locked in position.**



OCM040180



OCM040033

To change the steering wheel angle, pull down the lock release lever (1), adjust the steering wheel to the desired angle (2) and height (if equipped) (3), then pull up the lock-release lever to lock the steering wheel in place. Be sure to adjust the steering wheel to the desired position before driving.



OCM040034

D130500AUN

### Horn

To sound the horn, press the horn symbol on your steering wheel. Check the horn regularly to be sure it operates properly.

### \* NOTICE

To sound the horn, press the area indicated by the horn symbol on your steering wheel (see illustration). The horn will operate only when this area is pressed.

### ! CAUTION

*Do not strike the horn severely to operate it, or hit it with your fist. Do not press on the horn with a sharp-pointed object.*

## MIRRORS

### Inside rearview mirror

Adjust the rearview mirror so that the center view through the rear window is seen. Make this adjustment before you start driving.



**WARNING - Rear visibility**  
Do not place objects in the rear seat or cargo area which would interfere with your vision out the rear window.



D140101AUN

#### *Day/night rearview mirror*

Make this adjustment before you start driving and while the day/night lever is in the day position.

Pull the day/night lever toward you to reduce glare from the headlights of vehicles behind you during night driving.

*Remember that you lose some rearview clarity in the night position.*

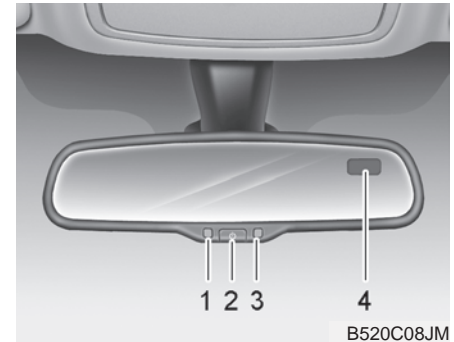

#### *Electric chromic mirror (ECM) with compass (if equipped)*

1. Status Indicator LED
2. Feature Control Button
3. Rear Light Sensor
4. Display Window

The electric chromic mirror automatically controls the glare from headlights behind you when the function is turned on by pressing and holding the Feature Control Button for more than 3 but less than 6 seconds. This feature can be turned off by pressing and holding the button for the same amount of time once more.

**To operate Compass feature**

Press and release the button, then the vehicle's directional heading will be displayed. Pressing and releasing the button again will turn off the display.

Heading display

- E : East
- W : West
- S : South
- N : North

ex) NE : North East

**Calibration procedure**

The compass may not indicate the correct compass direction if the electronic compass has not been calibrated correctly, if the compass zone number is different from your current location, or when you are driving in certain areas (tunnel, parking garage, underground parking lot, near transformer substation, etc.), and the following may occur:

- "C" is displayed.
- The compass headings become inaccurate.
- The compass heading does not change when the vehicle changes direction.
- Some compass headings are not displayed.
- The compass headings are inaccurate in long distance driving.

If the vehicle's compass headings become inaccurate, the compass should be calibrated as follows:

1. Ensure the vehicle is not located near large steel structures or under electric power lines.
2. Turn on the compass by pressing the button.
3. Press and hold the button for more than 6 but less than 9 seconds. The current zone number will appear in the display. Release then press the button until your zone number appears in the display.
4. Check the mirror angle by pressing and holding the button for more than 12seconds. Release then press the button to "L"(for steering wheel on the Left side of the vehicle). (if installed)
5. Press and hold the button between 9 and 12 seconds. Release the button when a "C" appears in the display.
6. Drive the vehicle in 2 complete circles at less than 5mph(8km/h) or until the compass heading appears.

**! CAUTION**

*Be sure the area is free of traffic, pedestrians, and obstructions.*

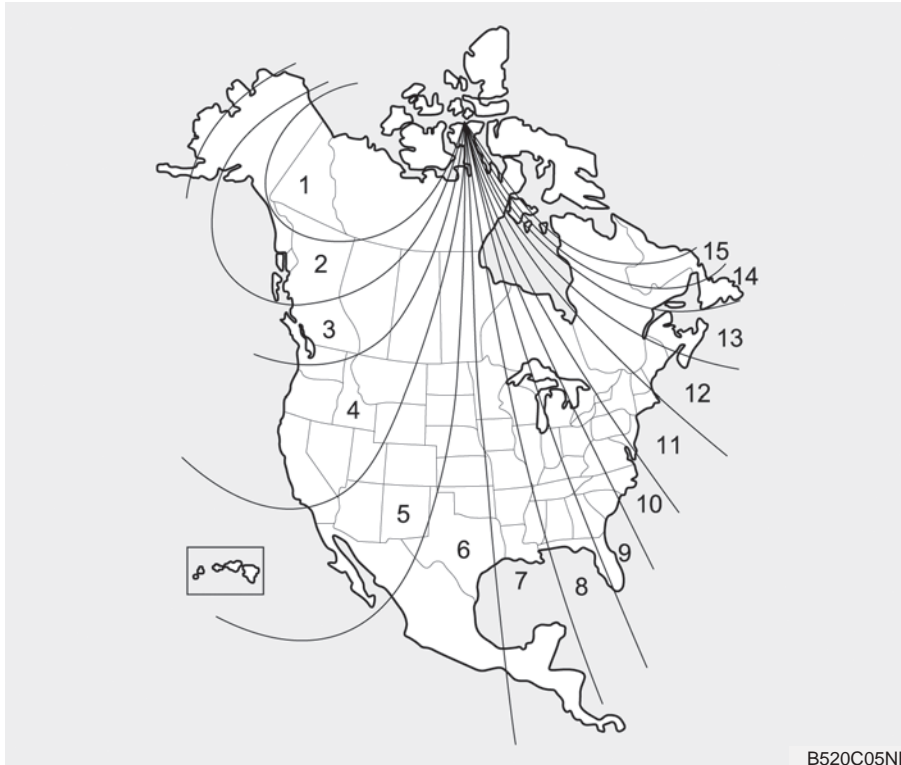

### Setting the compass zone

1. Determine the Zone Number based on your current location in the Zone Map.
2. Press and hold the button for more than 6 but less than 9 seconds. The current zone number will appear in the display.
3. Release then press the button to increment to new your zone number.
4. Drive the vehicle in 2 complete circles at less than 5mph(8km/h) or until the compass heading appears.

**! CAUTION**

- **Do not install a ski rack, antenna, etc. that is attached to the vehicle using a magnet. Anything attached to the roof of the vehicle with a magnet will effect the compass operation.**
- **If the compass deviates from the correct indication after repeating the adjustment, have the compass checked by an authorized dealer.**
- **The compass may not indicate the correct compass point in tunnels or while driving up or down a steep hill. (The compass returns to the correct compass point when the vehicle moves to an area where the geomagnetism is stabilized.)**
- **When cleaning the mirror, use a paper towel or similar material dampened with glass cleaner. Do not spray glass cleaner directly on the mirror as that may cause the liquid cleaner to enter the mirror housing.**

D140105AEN

**Electric chromic mirror (ECM) with compass and HomeLink® system (if equipped)**

Your vehicle may be equipped with a Gentex Automatic-Dimming Mirror with a Z-Nav™ Electronic Compass Display and an Integrated HomeLink® Wireless Control System. During nighttime driving, this feature will automatically detect and reduce rearview mirror glare while the compass indicates the direction the vehicle is pointed. The HomeLink® Universal Transceiver allows you to activate your garage door(s), electric gate, home lighting, etc.

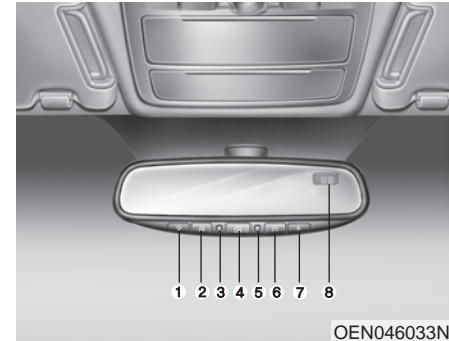

OEN046033N

- (1) Channel 1 button
- (2) Channel 2 button
- (3) Status indicator LED
- (4) Channel 3 button
- (5) Rear light sensor
- (6) Dimming ON/OFF button
- (7) Compass control button
- (8) Compass display

### Automatic-Dimming Night Vision Safety™ (NVS®) Mirror

The NVS® Mirror in your vehicle is the most advanced way to reduce annoying glare in the rearview mirror during any driving situation. For more information regarding NVS® mirrors and other applications, please refer to the Gentex website:



[www.gentex.com](http://www.gentex.com)

#### ! CAUTION

*The NVS® Mirror automatically reduces glare during driving conditions based upon light levels monitored in front of the vehicle and from the rear of the vehicle. These light sensors are visible through openings in the front and rear of the mirror case. Any object that would obstructs either light sensor will degrade the automatic dimming control feature.*

### Automatic-dimming function

Your mirror will automatically dim upon detecting glare from the vehicles traveling behind you. The auto-dimming function can be controlled by the Dimming ON/OFF Button:

1. Pressing the  button turns the auto-dimming function OFF which is indicated by the green Status Indicator LED turning off.
2. Pressing the  button again turns the auto-dimming function ON which is indicated by the green Status Indicator LED turning on.

#### \* NOTICE



The mirror defaults to the ON position each time the vehicle is started.

### Z-Nav™ Compass Display

The NVS™ Mirror in your vehicle is also equipped with a Z-Nav™ Compass that shows the vehicle Compass heading in the Display Window using the 8 basic cardinal headings (N, NE, E, SE, etc.).

#### Compass function

The Compass can be turned ON and OFF and will remember the last state when the ignition is cycled. To turn the display feature ON/OFF:



1. Press and release the  button to turn the display feature OFF.
2. Press and release the  button again to turn the display back ON.

Additional options can be set with press and hold sequences of the  button and are detailed below.

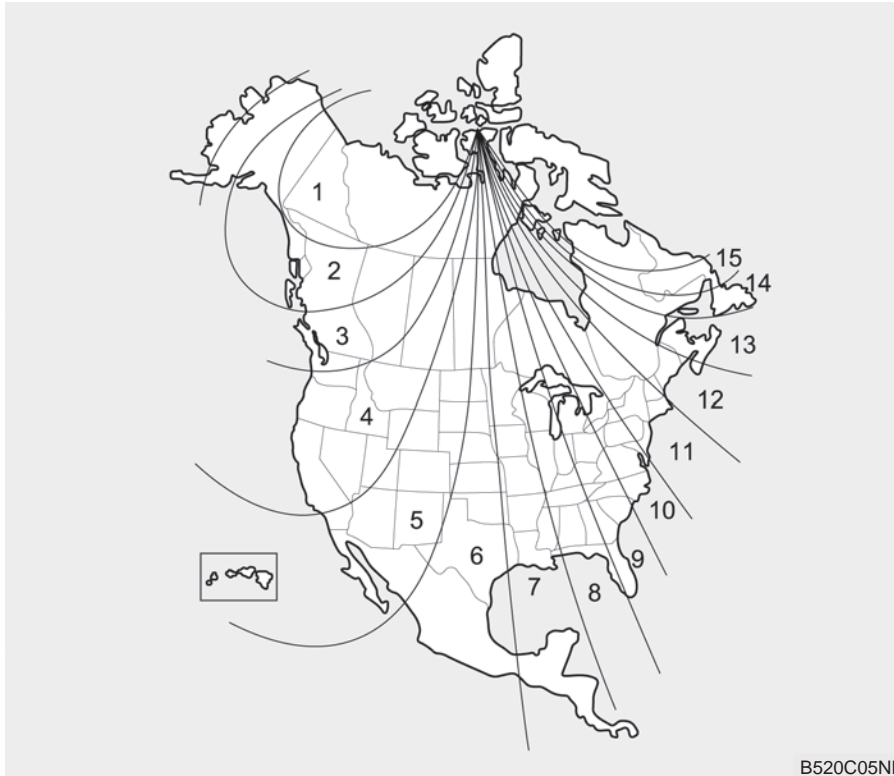
There is a difference between magnetic north and true north. The compass in the mirror can compensate for this difference when it knows the Magnetic Zone in which it is operating. This is set either by the dealer or by the user. The operating Zone Numbers for North America are shown in the figure on the following section.



To adjust the Zone setting:

1. Determine the desired Zone Number based upon your current location on the Zone Map.
2. Press and hold the  button for more than 3 but less than 6 seconds, the current Zone Number will appear on the display.
3. Pressing and holding the  button again will cause the numbers to increment (Note: they will repeat ...13, 14, 15, 1, 2, ...). Releasing the button when the desired Zone Number appears on the display will set the new Zone.
4. Within about 5 seconds the compass will start displaying a compass heading again.

There are some conditions that can cause changes to the vehicle magnets, such as installing a ski rack or a CB antenna. Body repair work on the vehicle can also cause changes to the vehicle's magnetic field. In these situations, the compass will need to be re-calibrated to quickly correct for these changes. To re-calibrate the compass:



1. Press and hold the  button for more than 6 seconds. When the compass memory is cleared a "C" will appear in the display.
2. To calibrate the compass, drive the vehicle in 2 complete circles at less than 5 mph (8 km/h).

### Integrated HomeLink® Wireless Control System

The HomeLink® Wireless Control System provides a convenient way to replace up to three hand-held radio-frequency (RF) transmitters with a single built-in device. This innovative feature will learn the radio frequency codes of most current transmitters to operate devices such as gate operators, garage door openers, entry door locks, security systems, even home lighting. Both standard and rolling code-equipped transmitters can be programmed by following the outlined procedures. Additional HomeLink® information can be found at: [www.homelink.com](http://www.homelink.com) or by calling 1-800-355-3515.

### **! CAUTION**

***Before programming HomeLink® to a garage door opener or gate operator, make sure that people and objects are out of the way of the device to prevent potential harm or damage. Do not use HomeLink® with any garage door opener that lacks the safety stop and reverse features required by U.S. federal safety standards (this includes any garage door opener model manufactured before April 1, 1982). A garage door that cannot detect an object - signaling the door to stop and reverse - does not meet current U.S. federal safety standards. Using a garage door opener without these features increases the risk of serious injury or death.***

Retain the original transmitter of the RF device you are programming for use in other vehicles as well as for future HomeLink® programming. It is also suggested that upon the sale of the vehicle, the programmed HomeLink® buttons be erased for security purposes.

### Programming HomeLink®

#### **\* NOTICE**

- When programming a garage door opener, it is advised to park the vehicle outside of the garage.
- It is recommended that a new battery be placed in the hand-held transmitter of the device being programmed to HomeLink® for quicker training and accurate transmission of the radio-frequency signal.
- Some vehicles may require the ignition switch to be turned to the second (or "accessories") position for programming and/or operation of HomeLink.
- In the event that there are still programming difficulties or questions after following the programming steps listed below, contact HomeLink® at: [www.homelink.com](http://www.homelink.com) or 1-800-355-3515.

### Standard programming

To train most devices, follow these instructions:

1. For first-time programming, press and hold the two outside buttons, HomeLink® Channel 1 and Channel 3 Buttons, until the indicator light begins to flash (after 20 seconds). Release both buttons. Do not hold the buttons for longer than 30 seconds.
2. Position the end of your hand-held transmitter 1-3 inches (2-8 cm) away from the HomeLink® buttons while keeping the indicator light in view.
3. Simultaneously press and hold both the HomeLink® and hand-held transmitter button. DO NOT release the buttons until step 4 has been completed.
4. While continuing to hold the buttons the red Indicator Status LED will flash slowly and then rapidly after HomeLink® successfully trains to the frequency signal from the hand-held transmitter. Release both buttons.

5. Press and hold the just-trained HomeLink® button and observe the red Status Indicator LED. If the indicator light stays on constantly, programming is complete and your device should activate when the HomeLink® button is pressed and released.
6. To program the remaining two HomeLink® buttons, follow steps 2 through 5.

### Rolling code programming

Rolling code devices which are "code-protected" and manufactured after 1996 may be determined by the following:

- Reference the device owner's manual for verification.
- The handheld transmitter appears to program the HomeLink® Universal Transceiver but does not activate the device.
- Press and hold the trained HomeLink button. The device has the rolling code feature if the indicator light flashes rapidly and then turns solid after 2 seconds.

To train rolling code devices, follow these instructions:

1. At the garage door opener receiver (motor-head unit) in the garage, locate the "learn" or "smart" button. This can usually be found where the hanging antenna wire is attached to the motor-head unit. Exact location and color of the button may vary by garage door opener brand.

If there is difficulty locating the training button, reference the device owner's manual or please visit our Web site at [www.homelink.com](http://www.homelink.com).

2. Firmly press and release the "learn" or "smart" button (which activates the "training light").

### \* NOTICE

There are 30 seconds in which to initiate step 3.

3. Return to the vehicle and firmly press, hold for two seconds and then release the desired HomeLink® button. Repeat the "press/hold/release" sequence a second time to complete the programming. (Some devices may require you to repeat this sequence a third time to complete the programming.)
4. Press and hold the just-trained HomeLink® button and observe the red Status Indicator LED. If the indicator light stays on constantly, programming is complete and your device should activate.
5. To program the remaining two HomeLink® buttons, follow either steps 1 through 4 above for other Rolling Code devices or steps 2 through 5 in Standard Programming for standard devices.

### Gate operator & Canadian programming

During programming, your handheld transmitter may automatically stop transmitting. Continue to press the Integrated HomeLink® Wireless Control System button (note steps 2 through 4 in the Standard Programming portion of this document) while you press and re-press ("cycle") your handheld transmitter every two seconds until the frequency signal has been learned. The indicator light will flash slowly and then rapidly after several seconds upon successful training.

### Operating HomeLink®

To operate, simply press and release the programmed HomeLink® button. Activation will now occur for the trained device (i.e. garage door opener, gate operator, security system, entry door lock, home/office lighting, etc.). For convenience, the hand-held transmitter of the device may also be used at any time.

### Reprogramming a single HomeLink® button

To program a new device to a previously trained HomeLink® button, follow these steps:

1. Press and hold the desired HomeLink® button. Do NOT release until step 4 has been completed.
2. When the indicator light begins to flash slowly (after 20 seconds), position the handheld transmitter 1 to 3 inches away from the HomeLink® surface.
3. Press and hold the handheld transmitter button. The HomeLink® indicator light will flash, first slowly and then rapidly.
4. When the indicator light begins to flash rapidly, release both buttons.
5. Press and hold the just-trained HomeLink® button and observe the red Status Indicator LED. If the indicator light stays on constantly, programming is complete and your new device should activate.

**Erasing HomeLink® buttons**

Individual buttons cannot be erased. However, to erase all three programmed buttons:

1. Press and hold the two outer HomeLink® buttons until the indicator light begins to flash-after 20 seconds.
2. Release both buttons. Do not hold for longer than 30 seconds.

The Integrated HomeLink® Wireless Control System is now in the training (learn) mode and can be programmed at any time following the appropriate steps in the Programming sections above.

**FCC ID: NZLZTVHL3  
IC: 4112A-ZTVHL3**

**This device complies with Part 15 of the FCC Rules.**

Operation is subject to the following two conditions:

1. this device may not cause harmful interference, and
2. This device must accept any interference received, including interference that may cause undesired operation.

NVS® is a registered trademark and Z-Nav™ is a trademark of the Gentex Corporation, Zeeland, Michigan. HomeLink® is a registered trademark owned by Johnson Controls, Incorporated, Milwaukee, Wisconsin.

 **WARNING**

**The transceiver has been tested and complies with FCC and Industry Canada rules. Changes or modifications not expressly approved by the party responsible for compliance could void the user's authority to operate the device.**

D140200AUN

### Outside rearview mirror

Be sure to adjust mirror angles before driving.

Your vehicle is equipped with both left-hand and right-hand outside rearview mirrors. The mirrors can be adjusted remotely with the remote switch. The mirror heads can be folded back to prevent damage during an automatic car wash or when passing in a narrow street.

#### **WARNING - Rearview mirrors**

- The right outside rearview mirror is convex. Objects seen in the mirror are closer than they appear.
- Use your interior rearview mirror or direct observation to determine the actual distance of following vehicles when changing lanes.

#### **! CAUTION**

*Do not scrape ice off the mirror face; this may damage the surface of the glass. If ice should restrict movement of the mirror, do not force the mirror for adjustment. To remove ice, use a deicer spray, or a sponge or soft cloth with very warm water.*

#### **! CAUTION**

*If the mirror is jammed with ice, do not adjust the mirror by force. Use an approved spray de-icer (not radiator antifreeze) to release the frozen mechanism or move the vehicle to a warm place and allow the ice to melt.*

#### **WARNING**

**Do not adjust or fold the outside rearview mirrors while the vehicle is moving. This could result in loss of control, and an accident which could cause death, serious injury or property damage.**



OCM040038

#### *Remote control*

The electric remote control mirror switch allows you to adjust the position of the left and right outside rearview mirrors. To adjust the position of either mirror, move the lever (1) to R or L to select the right side mirror or the left side mirror, then press a corresponding point on the mirror adjustment control to position the selected mirror up, down, left or right.

After adjustment, put the lever into neutral position to prevent inadvertent adjustment.

**! CAUTION**

- *The mirrors stop moving when they reach the maximum adjusting angles, but the motor continues to operate while the switch is pressed. Do not press the switch longer than necessary, the motor may be damaged.*
- *Do not attempt to adjust the outside rearview mirror by hand. Doing so may damage the parts.*



B510E01E

D140202AFD

***Folding the outside rearview mirror***

To fold outside rearview mirror, grasp the housing of mirror and then fold it toward the rear of the vehicle.

## INSTRUMENT CLUSTER



1. Tachometer
2. Engine coolant temperature gauge
3. Fuel gauge
4. Speedometer
5. Turn signal indicators
6. Warning and indicator lights (if equipped)
7. Odometer/Trip computer (if equipped)

\* The actual cluster in the vehicle may differ from the illustration.  
For more details refer to the "Gauges" in the next pages.

OCM040050N



OCM052056

### Instrument panel illumination

When the vehicle's parking lights or head-lights are on, rotate the illumination control knob to adjust the instrument panel illumination intensity.



OCM040053N

### Gauges

D150201AUN

#### ***Speedometer***

The speedometer indicates the forward speed of the vehicle.

The speedometer is calibrated in miles per hour and/or kilometers per hour.



OCM040053N

D150202AFD

#### ***Tachometer***

The tachometer indicates the approximate number of engine revolutions per minute (rpm).

Use the tachometer to select the correct shift points and to prevent lugging and/or over-revving the engine.

The tachometer pointer may move slightly when the ignition switch is in ACC or ON position with the engine OFF. This movement is normal and will not affect the accuracy of the tachometer once the engine is running.



### **! CAUTION**

*Do not operate the engine within the tachometer's RED ZONE. This may cause severe engine damage.*



D150203AUN

### ***Engine coolant temperature gauge***

This gauge shows the temperature of the engine coolant when the ignition switch is ON.

Do not continue driving with an overheated engine. If your vehicle overheats, refer to “If the engine overheats” in section 6.

### **! CAUTION**

*If the gauge pointer moves beyond the normal range area toward the “H” position, it indicates overheating that may damage the engine.*

### **⚠ WARNING**

Never remove the radiator cap when the engine is hot. The engine coolant is under pressure and could cause severe burns. Wait until the engine is cool before adding coolant to the reservoir.



OCM040058

D150204AUN

### Fuel gauge

The fuel gauge indicates the approximate amount of fuel remaining in the fuel tank. The fuel tank capacity is given in section 8. The fuel gauge is supplemented by a low fuel warning light, which will illuminate when the fuel tank is nearly empty.

On inclines or curves, the fuel gauge pointer may fluctuate or the low fuel warning light may come on earlier than usual due to the movement of fuel in the tank.



### WARNING - Fuel gauge

Running out of fuel can expose vehicle occupants to danger.

You must stop and obtain additional fuel as soon as possible after the warning light comes on or when the gauge indicator comes close to the E level.

### ! CAUTION

*Avoid driving with a very low fuel level. If you run out of fuel, it could cause the engine to misfire and result in excessive loading of the catalytic converter.*



OCM040071R

D150205AFD

### Odometer/Tripmeter (if equipped)

Push the TRIP button for less than 1 second to select odometer, tripmeter A or B and ECO ON/OFF as follows:

TRIP A → TRIP B → Odometer → ECO ON/OFF\*

\* if equipped

### Odometer

The odometer indicates the total distance the vehicle has been driven.

You will also find the odometer useful to determine when periodic maintenance should be performed.

### \* NOTICE

It is forbidden to alter of the odometer of any vehicle with the intent to change the mileage registered on the odometer. The alteration may void your warranty coverage.

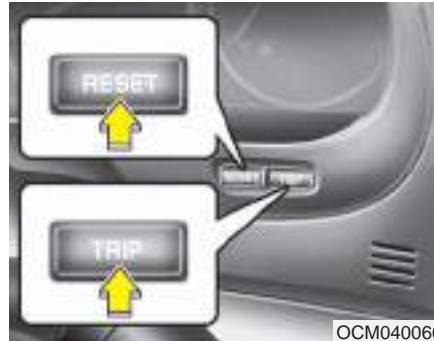

### Tripmeter

The tripmeter indicates the distance of individual trip selected by the driver. Tripmeter can be reset to 0 by pressing the RESET button for 1 second or more.



### ECO ON/OFF mode (if equipped)

You can turn the ECO indicator on/off on the instrument cluster in this mode.

If you push the RESET button more than 1 second in the ECO ON mode, ECO OFF is displayed in the screen and the ECO indicator turns off while driving.

If you want to display the ECO indicator again, press the RESET button more than 1 second in the ECO OFF mode and then ECO ON mode is displayed in the screen.

When you press the TRIP button less than 1 second in the ECO mode, the mode is changed to tripmeter.

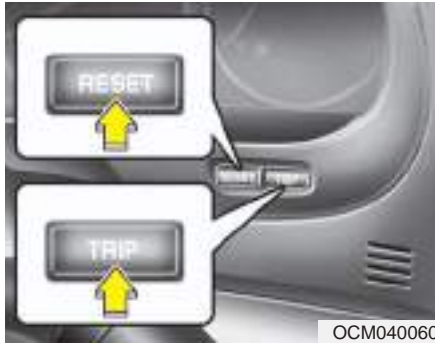

OCM040060

D150206AFD

**Trip computer (if equipped)**

The trip computer is a microcomputer-controlled driver information system that displays information related to driving on the display when the ignition switch is in the ON position. All stored driving information (except odometer, distance to empty and instant fuel consumption) is resets if the battery is disconnected.

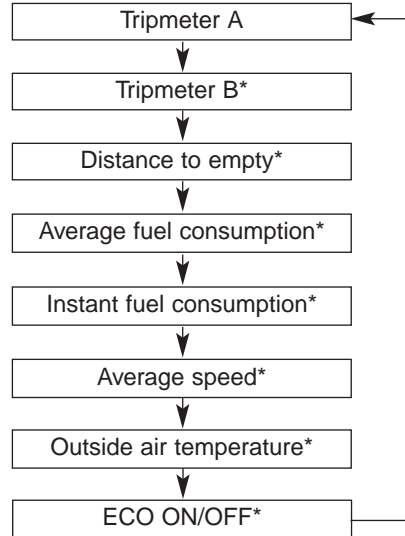

\* if equipped



OCM040061N

**Odometer**

The odometer indicates the total distance the vehicle has been driven. You will also find the odometer useful to determine when periodic maintenance should be performed.



### **Tripmeter**

TRIP A : Tripmeter A

TRIP B : Tripmeter B

This mode indicates the distance of individual trips selected since the last tripmeter reset.

The meter's working range is from 0.0 to 999.9 miles (0.0 to 999.9 km).

Pressing the RESET button for more than 1 second, when the tripmeter (TRIP A or TRIP B) is being displayed, clears the tripmeter to zero (0.0).



### **Distance to empty (if equipped)**

This mode indicates the estimated distance to empty based on the current fuel in the fuel tank and the amount of fuel delivered to the engine. When the remaining distance is below 30 miles (50 km), "---" will be displayed and the distance to empty indicator will blink.

The meter's working range is from 30 to 999 miles (50 to 999 km).



### **Average fuel consumption (if equipped)**

This mode calculates the average fuel consumption from the total fuel used and the distance since the last average consumption reset. The total fuel used is calculated from the fuel consumption input. For an accurate calculation, drive more than 0.03 miles (50 m).

Pressing the RESET button for more than 1 second, when the average fuel consumption is being displayed, clears the average fuel consumption to zero (---).

**\* NOTICE**

- If the vehicle is not on level ground or the battery power has been interrupted, the “Distance to empty” function may not operate correctly. The trip computer may not register additional fuel if less than 1.6 gallons (6 liters) of fuel are added to the vehicle.
- The fuel consumption and distance to empty values may vary significantly based on driving conditions, driving habits, and condition of the vehicle.
- The distance to empty value is an estimate of the available driving distance. This value may differ from the actual driving distance available.



OCM040067N

**Average speed (if equipped)**

This mode calculates the average speed of the vehicle since the last average speed reset.

Even if the vehicle is not in motion, the average speed keeps changing while the engine is running.

Pressing the RESET button for more than 1 second, when the average speed is being displayed, clears the average speed to zero (---).



OCM040069N

**Outside air temperature (if equipped)**

This mode indicates the outside air temperature.

The meter's working range is from -40°F to 75°F (-40°C to 167°C).

To change the outside temperature display unit (°F ↔ °C), press the RESET button for more than 5 seconds in this mode.



OCM040070

### ECO ON/OFF mode (if equipped)

You can turn the ECO indicator on/off on the instrument cluster in this mode.

If you push the RESET button more than 1 second in the ECO ON mode, ECO OFF is displayed in the screen and the ECO indicator turns off.

If you want to display the ECO indicator again, press the RESET button more than 1 second in the ECO OFF mode and then ECO ON mode is displayed in the screen.

When you press the TRIP button less than 1 second in the ECO mode, the mode is changed to odometer.

D150300AFD

### Warnings and indicators

All warning lights are checked by turning the ignition switch ON (do not start the engine). Any light that does not illuminate should be checked by an authorized HYUNDAI dealer.

After starting the engine, check to make sure that all warning lights are off. If any are still on, this indicates a situation that needs attention. When releasing the parking brake, the brake system warning light should go off. The fuel warning light will stay on if the fuel level is low.

D150301AAM-EU

### ECO indicator (if equipped)

## ECO

The ECO indicator is a system that informs you to drive economically. It is displayed if you drive fuel efficiently to help you improve fuel efficiency.

- The ECO indicator (green) will turn on when you are driving fuel efficiently in the ECO ON mode.

If you don't want the indicator displayed, you can turn the ECO ON mode to OFF mode by pressing the TRIP button.

As per ECO ON/OFF Mode operation, refer to the previous page.

- The fuel-efficiency can be changed by the driver's driving habits and road conditions.
- It doesn't work at the conditions which doesn't meet economical driving such as P (Park), N (Neutral) and R (Reverse).



**WARNING**

Don't keep watching the indicator while driving. It will distract you while driving and cause an accident that results in severe personal injury.

D150302AFD

***Air bag warning light  
(if equipped)***



This warning light will illuminate for approximately 6 seconds each time you turn the ignition switch to the ON position.

This light also comes on when the SRS is not working properly. If the AIRBAG warning light does not come on, or continuously remains on after operating for about 6 seconds when you turned the ignition switch to the ON position or started the engine, or if it comes on while driving, have the SRS inspected by an authorized HYUNDAI dealer.

D150303AFD

***Anti-lock brake system  
(ABS) warning light  
(if equipped)***



This light illuminates if the ignition switch is turned to ON and goes off in approximately 3 seconds if the system is operating normally.

If the ABS warning light remains on, comes on while driving, or does not come on when the ignition switch is turned to the ON position, this indicates that there may be a problem with the ABS.

If this occurs, have your vehicle checked by an authorized HYUNDAI dealer as soon as possible. The normal braking system will still be operational, but without the assistance of the anti-lock brake system.



### Electronic brake force distribution (EBD) system warning light



If two warning lights illuminate at the same time while driving, your vehicle may have a malfunction with ABS and EBD system.

In this case, your ABS and regular brake system may not work normally. Have the vehicle checked by an authorized HYUNDAI dealer as soon as possible.



### WARNING

If both ABS and Brake warning lights are on and stay on, your vehicle's brake system will not work normally. So you may experience an unexpected and dangerous situation during sudden braking. In this case, avoid high speed driving and abrupt braking. Have your vehicle checked by an authorized HYUNDAI dealer as soon as possible.

### \* NOTICE

If the ABS warning light or EBD warning light is on and stays on, the speedometer or odometer/tripmeter may not work. In this case, have your vehicle checked by an authorized HYUNDAI dealer as soon as possible.

### Seat belt warning



### Seat belt warning light

As a reminder to the driver the seat belt warning light will blink for approximately 6 seconds each time you turn the ignition switch ON regardless of belt fastening.

For details, refer to the seat belt on chapter 3.

D150305AFD

### Turn signal indicator lights



The blinking green arrows on the instrument panel show the direction indicated by the turn signals. If the arrow comes on but does not blink, blinks more rapidly than normal, or does not illuminate at all, a malfunction in the turn signal system is indicated. Your dealer should be consulted for repairs.

This indicator also blinks when the hazard warning switch is turned on.

D150306AUN

### High beam indicator



This indicator illuminates when the headlights are on and in the high beam position or when the turn signal lever is pulled into the Flash-to-Pass position.

D150307AFD

**Engine oil pressure warning light**



This warning light indicates the engine oil pressure is low.  
If the warning light illuminates while driving:

1. Drive safely to the side of the road and stop.
2. With the engine off, check the engine oil level. If the level is low, add oil as required.

If the warning light remains on after adding oil or if oil is not available, call an authorized HYUNDAI dealer.

**! CAUTION**

*If the engine is not stopped immediately after the engine oil pressure warning light is illuminated, severe damage could result.*

**! CAUTION**

*If the oil pressure warning light stays on while the engine is running, serious engine damage may result. The oil pressure warning light comes on whenever there is insufficient oil pressure. In normal operation, it should come on when the ignition switch is turned on, then go out when the engine is started. If the oil pressure warning light stays on while the engine is running, there is a serious malfunction.*

*If this happens, stop the car as soon as it is safe to do so, turn off the engine and check the oil level. If the oil level is low, fill the engine oil to the proper level and start the engine again. If the light stays on with the engine running, turn the engine off immediately. In any instance where the oil light stays on when the engine is running, the engine should be checked by an authorized HYUNDAI dealer before the car is driven again.*

D150308AFD

**Parking brake & brake fluid warning**



**Parking brake warning**

This light is illuminated when the parking brake is applied with the ignition switch in the START or ON position. The warning light should go off when the parking brake is released.

**Low brake fluid level warning**

If the warning light remains on, it may indicate that the brake fluid level in the reservoir is low.

If the warning light remains on:

1. Drive carefully to the nearest safe location and stop your vehicle.
2. With the engine stopped, check the brake fluid level immediately and add fluid as required. Then check all brake components for fluid leaks.
3. Do not drive the vehicle if leaks are found, the warning light remains on or the brakes do not operate properly. Have it towed to any authorized HYUNDAI dealer for a brake system inspection and necessary repairs.

Your vehicle is equipped with dual-diagonal braking systems. This means you still have braking on two wheels even if one of the dual systems should fail. With only one of the dual systems working, more than normal pedal travel and greater pedal pressure are required to stop the car. Also, the car will not stop in as short a distance with only a portion of the brake system working. If the brakes fail while you are driving, shift to a lower gear for additional engine braking and stop the car as soon as it is safe to do so.

To check bulb operation, check whether the parking brake and brake fluid warning light illuminates when the ignition switch is in the ON position.

### **WARNING**

**Driving the vehicle with a warning light on is dangerous. If the brake warning light remains on, have the brakes checked and repaired immediately by an authorized HYUNDAI dealer.**

### **TPMS (Tire Pressure Monitoring System) indicator (if equipped)**

#### **Low tire pressure telltale**



The low tire pressure telltale comes on for 3 seconds after the ignition switch is turned to the "ON" position.

The low tire pressure and position telltales illuminate when one or more of your tires is significantly underinflated.

The low tire pressure telltale will illuminate after it blinks for approximately one minute when there is a problem with the Tire Pressure Monitoring System.

If this occurs, have the system checked by an authorized HYUNDAI dealer as soon as possible.

For details, refer to the TPMS on chapter 6.

### **WARNING - Safe stopping**

- The TPMS cannot alert you to severe and sudden tire damage caused by external factors.
- If you feel any vehicle instability, immediately take your foot off the accelerator, apply the brakes gradually and with light force, and slowly move to a safe position off the road.

D150312AUN

**Shift pattern indicators  
(if equipped)**



The indicator displays to show the automatic transaxle shift lever selection.

D150313AFD

**Charging system warning**



This warning light indicates a malfunction of either the generator or electrical charging system.

If the warning light comes on while the vehicle is in motion:

1. Drive to the nearest safe location.
2. With the engine off, check the generator drive belt for looseness or breakage.
3. If the belt is adjusted properly, a problem exists somewhere in the electrical charging system. Have an authorized HYUNDAI dealer correct the problem as soon as possible.

**Door ajar warning light**



This warning light illuminates when a door is not closed securely.

**Tailgate open warning light**



This warning light illuminates when the tailgate is not closed securely.

D150318AFD

**Low fuel level warning**



This warning light indicates the fuel tank is nearly empty. When it comes on, you should add fuel as soon as possible. Driving with the fuel level warning light on or with the fuel level below "E" can cause the engine to misfire and damage the catalytic converter.

D150319AUN

**Low washer fluid level  
warning indicator  
(if equipped)**



This warning light indicates the washer fluid reservoir is nearly empty. Refill the washer fluid as soon as possible.

D150320ACM

**Malfunction indicator lamp  
(MIL) (check engine light)**



This indicator light is part of the Engine Control System which monitors various emission control system components. If this light illuminates while driving, it indicates that a potential problem has been detected somewhere in the emission control system.

This light will also illuminate when the ignition switch is turned to the ON position, and will go out in a few seconds after the engine is started. If it illuminates while driving, or does not illuminate when the ignition key is turned to the ON position, take your vehicle to your nearest authorized HYUNDAI dealer and have the system checked.

Generally, your vehicle will continue to be drivable, but have the system checked by an authorized HYUNDAI dealer promptly.

### **! CAUTION**

*Prolonged driving with the Emission Control System Malfunction Indicator Light illuminated may cause damage to the emission control systems which could effect drivability and/or fuel economy.*

### **! CAUTION**

*If the Emission Control System Malfunction Indicator Light illuminates, potential catalytic converter damage is possible which could result in loss of engine power. Have the Engine Control System inspected as soon as possible by an authorized HYUNDAI dealer.*

### **ESC (Electronic Stability Control) indicator (if equipped)**



The ESC indicator will illuminate when the ignition switch is turned ON, but should go off after approximately 3 seconds. When the ESC is on, it monitors the driving conditions. Under normal driving conditions, the ESC indicator will remain off. When a slippery or low traction condition is encountered, the ESC will operate, and the ESC indicator will blink to indicate the ESC is operating.

But, if the ESC system malfunctions the indicator illuminates and stays on. Take your vehicle to an authorized HYUNDAI dealer and have the system checked.

### **ESC OFF indicator (if equipped)**



The ESC OFF indicator will illuminate when the ignition switch is turned ON, but should go off after approximately 3 seconds. To switch to ESC OFF mode, press the ESC OFF button. The ESC OFF indicator will illuminate indicating the ESC is deactivated.

### **Cruise indicator (if equipped)**

#### **CRUISE indicator**



**CRUISE**

The indicator illuminates when the cruise control system is enabled.

The cruise indicator in the instrument cluster is illuminated when the cruise control ON-OFF button on the steering wheel is pushed.

The indicator goes off when the cruise control ON-OFF button is pushed again. For more information about the use of cruise control, refer to "Cruise control system" in section 5.

**Cruise SET indicator**



The indicator illuminates when the cruise control switch (-SET or RES+) is ON. The cruise SET indicator in the instrument cluster is illuminated when the cruise control switch (-SET or RES+) is pushed. The cruise SET indicator does not illuminate when the cruise control switch (CANCEL) is pushed or the system is disengaged.

D150327AUN

**Key reminder warning chime (if equipped)**

If the driver's door is opened while the ignition key is left in the ignition switch (ACC or LOCK position), the key reminder warning chime will sound. This is to prevent you from locking your keys in the vehicle. The chime sounds until the key is removed from the ignition switch or the driver's door is closed.

**AWD system warning light (if equipped)**

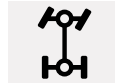

When the ignition switch is turned to the ON position, the AWD indicator will illuminate and then go off in a few seconds. If the AWD system warning light illuminates, this indicates that there is a malfunction in the AWD system. If this occurs, have your vehicle checked by an authorized HYUNDAI dealer as soon as possible.

**AWD LOCK indicator (if equipped)**



The AWD LOCK indicator light is illuminated when the AWD LOCK button is pushed. The purpose of this AWD LOCK mode is to increase the drive power when driving on dry road surfaces, wet pavement, snow-covered roads and/or off-road. The AWD LOCK indicator light is turned off by pushing the button again.

**! CAUTION**  
*Do not use AWD LOCK mode on dry paved roads or highway, it can cause noise, vibration or damage of AWD related parts.*

## REARVIEW CAMERA (IF EQUIPPED)



The rearview camera will activate when the back-up light is ON with the ignition switch ON and the shift lever in the R (Reverse) position.

This system is a supplemental system that shows behind the vehicle through the A/V system while backing-up.

### **WARNING**

- This system is a supplementary function only. It is the responsibility of the driver to always check the inside/outside rearview mirror and the area behind the vehicle before and while backing up because there is a dead zone that can't see through the camera.
- Always keep the camera lens clean. If the lens is covered with foreign matter, the camera may not operate normally.

## HAZARD WARNING FLASHER



D180000AUN

The hazard warning flasher should be used whenever you find it necessary to stop the car in a hazardous location. When you must make such an emergency stop, always pull off the road as far as possible.

The hazard warning lights are turned on by pushing in the hazard switch. This causes all turn signal lights to blink. The hazard warning lights will operate even though the key is not in the ignition switch.

To turn the hazard warning lights off, push the switch a second time.

## LIGHTING

D190100AUN

### Battery saver function

- The purpose of this feature is to prevent the battery from being discharged. The system automatically turns off the small light when the driver removes the ignition key and opens the driver- side door.
- With this feature, the parking lights will be turned off automatically if the driver parks on the side of road at night. If necessary, to keep the lights on when the ignition key is removed, perform the following :
  - 1) Open the driver-side door.
  - 2) Turn the parking lights OFF and ON again using the light switch on the steering column.



OCM040120

D190400AUN

### Lighting control

The light switch has a Headlight and a Parking light position.

To operate the lights, turn the knob at the end of the control lever to one of the following positions:

- (1) OFF position
- (2) Parking light position
- (3) Headlight position
- (4) Auto light position (if equipped)



OCM040121

D190401AUN

### ***Parking light position ( 1st position )***

When the light switch is in the parking light position (1st position), the tail, position, license and instrument panel lights are ON.





OCM040122

D190402AUN

### Headlight position (2)

When the light switch is in the headlight position (2nd position) the head, tail, position, license and instrument panel lights are ON.

### \* NOTICE

The ignition switch must be in the ON position to turn on the headlights.



OCM040123

D190403AUN

### Auto light position (if equipped)

When the light switch is in the AUTO light position, the taillights and headlights will be turned ON or OFF automatically depending on the amount of light outside the vehicle.

### ! CAUTION

- Never place anything over the sensor (1) located on the instrument panel. This will ensure better auto-light system control.
- Don't clean the sensor using a window cleaner, the cleaner may leave a light film which could interfere with sensor operation.
- If your vehicle has window tint or other types of coating on the front windshield, the Auto light system may not work properly.

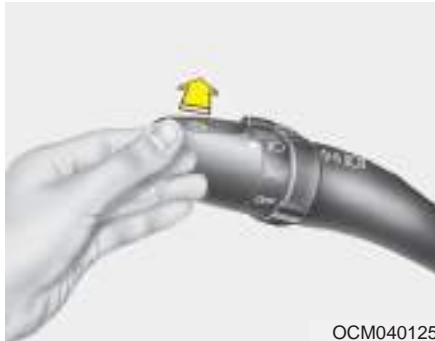

OCM040125

D190500AUN

### High - beam operation

To turn on the high beam headlights, push the lever away from you. Pull it back for low beams.

The high-beam indicator will light when the headlight high beams are switched on.

To prevent the battery from being discharged, do not leave the lights on for a prolonged time while the engine is not running.



OCM040124

### Flashing headlights

To flash the headlights, pull the lever towards you. It will return to the normal (low-beam) position when released. The headlight switch does not need to be on to use this flashing feature.

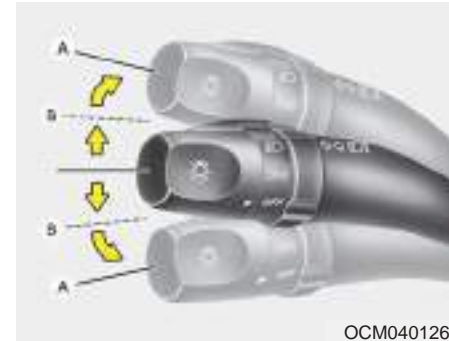

OCM040126

D190600AUN

### Turn signals and lane change signals

The ignition switch must be on for the turn signals to function. To turn on the turn signals, move the lever up or down (A). Green arrow indicators on the instrument panel indicate which turn signal is operating.

They will self-cancel after a turn is completed. If the indicator continues to flash after a turn, manually return the lever to the OFF position.

To signal a lane change, move the turn signal lever slightly and hold it in position (B). The lever will return to the OFF position when released.

## Features of your vehicle

If an indicator stays on and does not flash or if it flashes abnormally, one of the turn signal bulbs may be burned out and will require replacement.

### \* NOTICE

If an indicator flash is abnormally quick or slow, bulb may be burned out or have a poor electrical connection in the circuit.



D190700AFD

### Front fog light (if equipped)

Fog lights are used to provide improved visibility and avoid accidents when visibility is poor due to fog, rain or snow etc. The fog lights will turn on when the fog light switch is pushed (the indicator on the button will illuminate) after the headlight is turned on.

To turn off the fog lights, push the switch again.

### ! CAUTION

*When in operation, the fog lights consume large amounts of vehicle electrical power. Only use the fog lights when visibility is poor.*

D190900AUN

### Daytime running light (if equipped)

Daytime Running Lights (DRL) can make it easier for others to see the front of your vehicle during the day. DRL can be helpful in many different driving conditions, and it is especially helpful after dawn and before sunset.

The DRL system will make the headlights turn OFF when:

1. The parklight switch is ON.
2. Engine stops.

## WIPERS AND WASHERS

### Windshield wiper/washer



### Rear window wiper/washer (if equipped)



OCM040129



#### A : Wiper speed control

- MIST – Single wipe
- OFF – Off
- INT – Intermittent wipe
- LO – Normal wiper speed
- HI – Fast wiper speed

#### B : Intermittent wipe time adjustment

#### C : Wash with brief wipes

#### D : Rear wiper/washer control

-  – Spraying washer fluid
- ON – Normal wipe operation
- OFF – Off
-  – Wash with brief wipes

### Windshield wipers

Operates as follows when the ignition switch is turned ON.

**MIST** : For a single wiping cycle, push the lever upward and release it with the lever in the OFF position. The wipers will operate continuously if the lever is pushed upward and held.

**OFF** : Wiper is not in operation.

**INT** : Wiper operates intermittently at the same wiping intervals. Use this mode in light rain or mist. To vary the speed setting, turn the speed control knob.

**LO** : Normal wiper speed

**HI** : Fast wiper speed

### \* NOTICE

If there is heavy accumulation of snow or ice on the windshield, defrost the windshield for about 10 minutes, or until the snow and/or ice is removed before using the windshield wipers to ensure proper operation.



OCM040133L

D200200AFD

### Windshield washers

In the OFF position, pull the lever gently toward you to spray washer fluid on the windshield and to run the wipers 1-3 cycles. Use this function when the windshield is dirty. The spray and wiper operation will continue until you release the lever. If the washer does not work, check the washer fluid level. If the fluid level is not sufficient, you will need to add appropriate non-abrasive windshield washer fluid to the washer reservoir.

The reservoir filler neck is located in the front of the engine compartment on the passenger side.

### ! CAUTION

*To prevent possible damage to the washer pump, do not operate the washer when the fluid reservoir is empty.*

### ⚠ WARNING

**Do not use the washer in freezing temperatures without first warming the windshield with the defrosters; the washer solution could freeze on contact with the windshield and obscure your vision.**

### ! CAUTION

- *To prevent possible damage to the wipers or windshield, do not operate the wipers when the windshield is dry.*
- *To prevent damage to the wiper blades, do not use gasoline, kerosene, paint thinner, or other solvents on or near them.*
- *To prevent damage to the wiper arms and other components, do not attempt to move the wipers manually.*

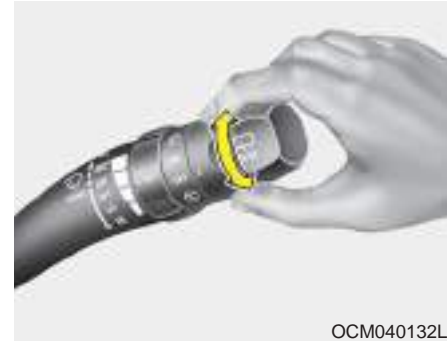

OCM040132L

D200300AFD

### Rear window wiper and washer switch (if equipped)

The rear window wiper and washer switch is located at the end of the wiper and washer switch lever. Turn the switch to desired position to operate the rear wiper and washer.

 - Spraying washer fluid and wiping

ON - Normal wiper operation

OFF - Wiper is not in operation

 - Spraying washer fluid and wiping

## INTERIOR LIGHT

D210000AUN

### ! CAUTION

*Do not use the interior lights for extended periods when the engine is not running. It may cause battery discharge.*

### Automatic turn off function (if equipped)

The interior lights automatically turn off approximately 20 minutes after the ignition switch is turned off.

If your vehicle is equipped with the theft alarm system, the interior lights automatically turn off approximately 3 seconds after the system is armed.



D210100AFD

### Map lamp

This light produces a spot beam for convenient use as a map lamp at night or as a personal lamp for the driver and front passenger.

-  : Push the switch to turn the map lamp on or off.
- DOOR : If the map lamp is pressed in, the light will turn on when the door is opened and turned off when the door is closed. To disable the DOOR mode press out the switch.
- DOME : Push the switch to turn the rear room lamp on or off.



OCM052079L

### Room lamp

The light will turn on and off as follows if the switch is pressed.

- ON : The light turns on and stays on when the switch is pressed. The light turns off and stays off when the switch is pressed again.

## Features of your vehicle

- **DOOR** : The light comes on when any door (or tailgate) is opened regardless of the ignition switch position. When doors are unlocked by the transmitter, the light comes on for approximately 30 seconds as long as any door is not opened. The light goes out gradually after approximately 30 seconds if the door is closed. However, if the ignition switch is ON or all doors are locked, the light will turn off immediately.

If a door is opened with the ignition switch in the ACC or LOCK position, the light stays on for about 20 minutes. However, if a door is opened with the ignition switch in the ON position, the light stays on continuously.



OXM049136

D210300ACM

### Luggage room lamp (if equipped)

- **OFF** : The light stays off at all times.
- **ON** : The light stays on at all times.
- **DOOR** : The luggage room lamp comes on when the tailgate is opened.



OCM040134

### Door courtesy lamp (if equipped)

The door courtesy lamp comes ON when the door is opened to assist entering or exiting the vehicle. It also serves as a warning to passing vehicles that the vehicle door is open.



D210500AUN

**Glove box lamp (if equipped)**

The glove box lamp comes on when the glove box is opened.

The parking lights or headlights must be ON for the glove box lamp to function.



D210600AUN

**Vanity mirror lamp (if equipped)**

Opening the lid of the vanity mirror will automatically turn on the mirror light.



### DEFROSTER

D220000AUN

#### ! CAUTION

*To prevent damage to the conductors bonded to the inside surface of the rear window, never use sharp instruments or window cleaners containing abrasives to clean the window.*

#### \* NOTICE

If you want to defrost and defog on the front windshield, refer to “Windshield Defrosting and Defogging” in this section.



D220100AUN

#### Rear window defroster

The defroster heats the window to remove frost, fog and thin ice from the interior and exterior of the rear window, while engine is running.

To activate the rear window defroster, press the rear window defroster button located in the center facia switch panel. The indicator on the rear window defroster button illuminates when the defroster is ON.

If there is heavy accumulation of snow on the rear window, brush it off before operating the rear defroster.

The rear window defroster automatically turns off after approximately 20 minutes or when the ignition switch is turned off. To turn off the defroster, press the rear window defroster button again.

#### *Outside rearview mirror defroster (if equipped)*

If your vehicle is equipped with the outside rearview mirror defrosters, they will operate at the same time you turn on the rear window defroster.

#### *Wiper deicer (if equipped)*

If your vehicle is equipped with the wiper deicer, it will operate at the same time you turn on the rear window defroster.



## MANUAL CLIMATE CONTROL SYSTEM (IF EQUIPPED)



1. Fan speed control knob
2. Air conditioning button (if equipped)
3. Mode selection button
4. OFF button
5. Air intake control button
6. Temperature control knob
7. MAX A/C button
8. Front windshield defroster button
9. Rear window defroster button

OCM040201N

### Heating and air conditioning

1. Start the engine.
2. Set the mode to the desired position.  
For improving the effectiveness of heating and cooling;
  - Heating: 
  - Cooling: 
3. Set the temperature control to the desired position.
4. Set the air intake control to the outside (fresh) air position.
5. Set the fan speed control to the desired speed.
6. If air conditioning is desired, turn the air conditioning system (if equipped) on.



OCM040223N

#### ※ 2nd row outlet vents (E)

- The air flow of the 2nd row outlet vents is controlled by the front climate control system and delivered through the inside air duct of the front doors. If the door is open or not closed completely, the air flow of the 2nd row outlet vent is not delivered properly. Make sure the front doors are closed completely.
- The air flow of the 2nd row outlet vents may be weaker than the instrument panel vents for the long air duct in the front doors.
- Close the air vents in cold weather. The air flow of the 2nd row outlet vents may cool a little during heating operation. (Use the 2nd row outlet vents during cooling operation.)



**Mode selection**

The mode buttons control the direction of the air flow through the ventilation system.

Air can be directed to the floor, dashboard outlets, or windshield. Six symbols are used to represent MAX A/C, Face, Bi-Level, Floor, Floor-Defrost and Defrost air position. The MAX A/C mode is used to cool the inside of the vehicle faster.



**MAX A/C-Level (B, D, E)**

Air flow is directed toward the upper body and face.

In this mode, the air conditioning and the recirculated air position will be selected automatically.



**Face-Level (B, D, E)**

Air flow is directed toward the upper body and face. Additionally, each outlet can be controlled to direct the air discharged from the outlet.



**Bi-Level (B, D, E, C, F)**

Air flow is directed towards the face and the floor.



**Floor-Level (C, F, A, D)**

Most of the air flow is directed to the floor, with a small amount of the air being directed to the windshield and side window defrosters.



**Floor/Defrost-Level (A, C, D, F)**

Most of the air flow is directed to the floor and the windshield with a small amount directed to the side window defrosters.



**Defrost-Level (A, D)**

Most of the air flow is directed to the windshield with a small amount of air directed to the side window defrosters.



### **Instrument panel vents**

The outlet vents can be opened or closed separately using the thumbwheel. Also, you can adjust the direction of air delivery from these vents using the vent control lever as shown.



### **Temperature control**

The temperature control knob allows you to control the temperature of the air flowing from the ventilation system. To change the air temperature in the passenger compartment, turn the knob to the right position for warm and hot air or left position for cooler air.



### **Air intake control**

The air intake control is used to select the outside (fresh) air position or recirculated air position. To change the air intake control position, press the control button.

**Recirculated air position**



With the recirculated air position selected, air from the passenger compartment will be drawn through the heating system and heated or cooled according to the function selected.

**Outside (fresh) air position**



With the outside (fresh) air position selected, air enters the vehicle from outside and is heated or cooled according to the function selected.

**\* NOTICE**

Prolonged operation of the heater in the recirculated air position (without air conditioning selected) may cause fogging of the windshield and side windows and the air within the passenger compartment may become stale.

In addition, prolonged use of the air conditioning with the recirculated air position selected will result in excessively dry air in the passenger compartment.

**⚠ WARNING**

- Continue using the climate control system in the recirculated air position may allow humidity to increase inside the vehicle which may fog the glass and obscure visibility.
- Do not sleep in a vehicle with the air conditioning or heating system on. It may cause serious harm or death due to a drop in the oxygen level and/or body temperature.
- Continue using the climate control system in the recirculated air position can cause drowsiness or sleepiness, and loss of vehicle control. Set the air intake control to the outside (fresh) air position as much as possible while driving.



OCM052153A

**Fan speed control**

The ignition switch must be in the ON position for fan operation.

The fan speed control knob allows you to control the fan speed of the air flowing from the ventilation system. To change the fan speed, turn the knob to the right for higher speed or left for lower speed.

Pressing the OFF button turns off the fan.



### ***Air conditioning (if equipped)***

Press the A/C button to turn the air conditioning system on (indicator light will illuminate). Press the button again to turn the air conditioning system off.



### ***OFF mode***



Press the OFF button to turn off the air climate control system. However, you can still operate the mode and air intake buttons as long as the ignition switch is in the ON position.

## **System operation**

### ***Ventilation***

1. Set the mode to the  position.
2. Set the air intake control to the outside (fresh) air position.
3. Set the temperature control to the desired position.
4. Set the fan speed control to the desired speed.

### ***Heating***

1. Set the mode to the  position.
2. Set the air intake control to the outside (fresh) air position.
3. Set the temperature control to the desired position.
4. Set the fan speed control to the desired speed.
5. If dehumidified heating is desired, turn the air conditioning system (if equipped) on.
  - If the windshield fogs up, set the mode to the  or  position.

**Operation Tips**

- To keep dust or unpleasant fumes from entering the vehicle through the ventilation system, temporarily set the air intake control to the recirculated air position. Be sure to return the control to the fresh air position when the irritation has passed to keep fresh air in the vehicle. This will help keep the driver alert and comfortable.
- Air for the heating/cooling system is drawn in through the grilles just ahead of the windshield. Care should be taken that these are not blocked by leaves, snow, ice or other obstructions.
- To prevent interior fog on the windshield, set the air intake control to the fresh air position and fan speed to the desired position, turn on the air conditioning system, and adjust the temperature control to desired temperature.

D230503AFD

***Air conditioning (if equipped)***

All HYUNDAI Air Conditioning Systems are filled with environmentally friendly R-134a refrigerant which does not damage to the ozone layer.

1. Start the engine. Push the air conditioning button.
  2. Set the mode to the  position.
  3. Set the air intake control to the outside air or recirculated air position.
  4. Adjust the fan speed control and temperature control to maintain maximum comfort.
- When maximum cooling is desired, set the temperature control to the extreme left position then set the fan speed control to the highest speed.

**\* NOTICE**

- When using the air conditioning system, monitor the temperature gauge closely while driving up hills or in heavy traffic when outside temperatures are high. Air conditioning system operation may cause engine overheating. Continue to use the blower fan but turn the air conditioning system off if the temperature gauge indicates engine overheating.
- When opening the windows in humid weather air conditioning may create water droplets inside the vehicle. Since excessive water droplets may cause damage to electrical equipment, air conditioning should only be used with the windows closed.



### Air conditioning system operation tips

- If the vehicle has been parked in direct sunlight during hot weather, open the windows for a short time to let the hot air inside the vehicle escape.
  - To help reduce moisture inside of the windows on rainy or humid days, decrease the humidity inside the vehicle by operating the air conditioning system.
  - During air conditioning system operation, you may occasionally notice a slight change in engine speed as the air conditioning compressor cycles. This is a normal system operation characteristic.
  - Use the air conditioning system every month only for a few minutes to ensure maximum system performance.
- When using the air conditioning system, you may notice clear water dripping (or even puddling) on the ground under the passenger side of the vehicle. This is a normal system operation characteristic.
  - Operating the air conditioning system in the recirculated air position provides maximum cooling, however, continual operation in this mode may cause the air inside the vehicle to become stale.
  - During cooling operation, you may occasionally notice a misty air flow because of rapid cooling and humid air intake. This is a normal system operation characteristic.

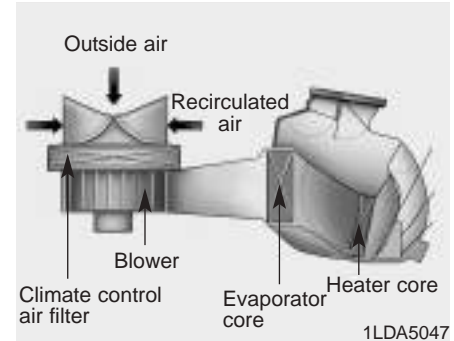

D230300AFD

### Climate control air filter (if equipped)

The climate control air filter installed behind the glove box filters the dust or other pollutants that come into the vehicle from the outside through the heating and air conditioning system. If dust or other pollutants accumulate in the filter over a period of time, the air flow from the air vents may decrease, resulting in moisture accumulation on the inside of the windshield even when the outside (fresh) air position is selected. If this happens, have the climate control air filter replaced by an authorized HYUNDAI dealer.

**\* NOTICE**

- Replace the filter according to the Maintenance Schedule.  
If the car is being driven in severe conditions such as dusty, rough roads, more frequent climate control air filter inspections and changes are required.
- When the air flow rate is suddenly decreased, the system should be checked at an authorized HYUNDAI dealer.

D230400AFD

**Checking the amount of air conditioner refrigerant and compressor lubricant**

When the amount of refrigerant is low, the performance of the air conditioning is reduced. Overfilling also has a bad influence on the air conditioning system.

Therefore, if abnormal operation is found, have the system inspected by an authorized HYUNDAI dealer.

**\* NOTICE**

It is important when servicing the air conditioning system that the correct type and amount of oil and refrigerant is used. Otherwise, damage to the compressor and abnormal system operation may occur.

 **WARNING**

The air conditioning system should be serviced by an authorized HYUNDAI dealer. Improper service may cause serious injury to the person performing the service.

## AUTOMATIC CLIMATE CONTROL SYSTEM (IF EQUIPPED)



1. A/C display
  2. AUTO (automatic control) button
  3. Front blower OFF button
  4. Air conditioning button\*
  5. Driver's temperature control knob
  6. Front fan speed control switch
  7. Air intake control button
  8. Passenger's temperature control knob
  9. Mode selection button
  9. Dual temperature control selection button
  10. Dual temperature control selection button
  11. Front windshield defroster button
  12. Rear window defroster button
- \* if equipped

OCM040150N



### Automatic heating and air conditioning

The automatic climate control system is controlled by simply setting the desired temperature.

The Full Automatic Temperature Control (FATC) system automatically controls the heating and cooling system as follows;

1. Press the AUTO button. The modes, fan speeds, air intake and air-conditioning will be controlled automatically by setting the temperature.

2. Set the temperature switch to the desired temperature.

If the temperature is set to the lowest setting (Lo), the air conditioning system will operate continuously.

3. To turn the automatic operation off, select any button or switch of the following:
  - Mode selection button
  - Air conditioning button
  - Front windshield defroster button
  - Air intake control button
  - Fan speed control switch

The selected function will be controlled manually while other functions operate automatically.

For your convenience and to improve the effectiveness of the climate control, use the AUTO button and set the temperature to 71°F/22°C.





### \* NOTICE

Never place anything over the sensor located on the instrument panel to ensure better control of the heating and cooling system.

### Manual heating and air conditioning

The heating and cooling system can be controlled manually by pressing buttons or turning knob(s) other than the AUTO button. In this case, the system works sequentially according to the order of buttons or knob(s) selected.

1. Start the engine.
2. Set the mode to the desired position.  
To improve the effectiveness of heating and cooling;
  - Heating: 
  - Cooling: 
3. Set the temperature control to the desired position.
4. Set the air intake control to the outside (fresh) air position.
5. Set the fan speed control to the desired speed.
6. If air conditioning is desired, turn the air conditioning system on.

Press the AUTO button in order to convert to full automatic control of the system.

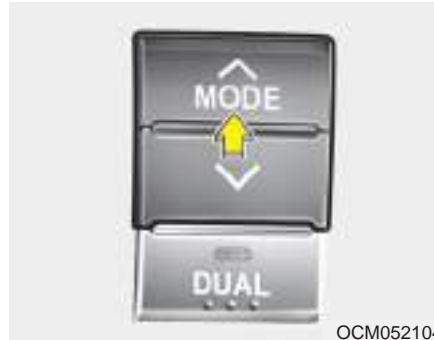

#### Mode selection

The mode selection button controls the direction of the air flow through the ventilation system.

The air flow outlet port is converted as follows:



Refer to the illustration in the “Manual climate control system”.



Air flow is directed toward the upper body and face. Additionally, each outlet can be controlled to direct the air discharged from the outlet.



Air flow is directed towards the face and the floor.



Most of the air flow is directed to the floor, with a small amount of the air being directed to the windshield and side window defrosters.



Most of the air flow is directed to the floor and the windshield with a small amount directed to the side window defrosters.



OCM040151N

**Defrost-Level**

Most of the air flow is directed to the windshield with a small amount of air directed to the side window defrosters.



OCM040142

**Instrument panel vents**

The outlet vents can be opened or closed separately using the thumbwheel. Also, you can adjust the direction of air delivery from these vents using the vent control lever as shown.



OCM040230N

**Temperature control**

The temperature will increase to the maximum (HI) by turning the knob to the right extremely.

The temperature will decrease to the minimum (Lo) by turning the knob to the left extremely.

When turning the knob, the temperature will increase or decrease by 1°F/0.5°C. When set to the lowest temperature setting, the air conditioning will operate continuously.



### Adjusting the driver and passenger side temperature individually

1. Press the DUAL button to operate the driver and passenger side temperature individually. Also, if the passenger side temperature control knob is operated, it will automatically change to the DUAL mode as well.
2. Operate the left temperature control to adjust the driver side temperature. Operate the right temperature control to adjust the passenger side temperature.

When the driver's side temperature is set to the highest (HI) or lowest (Lo) temperature setting, the DUAL mode is deactivated for maximum heating or cooling.

### Adjusting the driver and passenger side temperature equally

1. Press the DUAL button again to deactivate DUAL mode. The passenger side temperature will be set to the same temperature as the driver side.
2. Operate the driver side temperature control switch. The driver and passenger side temperature will be adjusted equally.

### Temperature conversion

You can switch the temperature mode between Centigrade to Fahrenheit as follows:

While pressing the MODE button, press the DUAL button for 3 seconds or more. The display will change from Fahrenheit to Centigrade, or from Centigrade to Fahrenheit.

If the battery has been discharged or disconnected, the temperature mode display will reset to Fahrenheit.



### Outside thermometer

The current outside temperature is displayed in 1°F (1°C) increments. The temperature range is between -40°F ~ 140°F (-40°C ~ 60°C).

- The outside temperature on the display may not change immediately like a general thermometer to prevent the driver from being inattentive.



**Air intake control**

This is used to select the outside (fresh) air position or recirculated air position. To change the air intake control position, push the control button.

**Recirculated air position**



With the recirculated air position selected, air from the passenger compartment will be drawn through the heating system and heated or cooled according to the function selected.

**Outside (fresh) air position**



With the outside (fresh) air position selected, air enters the vehicle from outside and is heated or cooled according to the function selected.

**\* NOTICE**

Prolonged operation of the heater in the recirculated air position (without air conditioning selected) may cause fogging of the windshield and side windows and the air within the passenger compartment may become stale. In addition, prolonged use of the air conditioning with the recirculated air position selected will result in excessively dry air in the passenger compartment.

**⚠ WARNING**

- Continue using the climate control system in the recirculated air position may allow humidity to increase inside the vehicle which may fog the glass and obscure visibility.
- Do not sleep in a vehicle with the air conditioning or heating system on. It may cause serious harm or death due to a drop in the oxygen level and/or body temperature.
- Continue using the climate control system in the recirculated air position can cause drowsiness or sleepiness, and loss of vehicle control. Set the air intake control to the outside (fresh) air position as much as possible while driving.





### **Fan speed control**

The fan speed can be set to the desired speed by operating the fan speed control switch.

To change the fan speed, press ( > ) the switch for higher speed, or push ( < ) the switch for lower speed. To turn the fan speed control off, press the front blower OFF button.



### **Air conditioning**

Press the A/C button to turn the air conditioning system on (indicator light will illuminate).

Press the button again to turn the air conditioning system off.





### **OFF mode**

Press the front blower OFF button to turn off the front air climate control system. However, you can still operate the mode and air intake buttons as long as the ignition switch is in the ON position.

## WINDSHIELD DEFROSTING AND DEFOGGING

### **WARNING - Windshield heating**

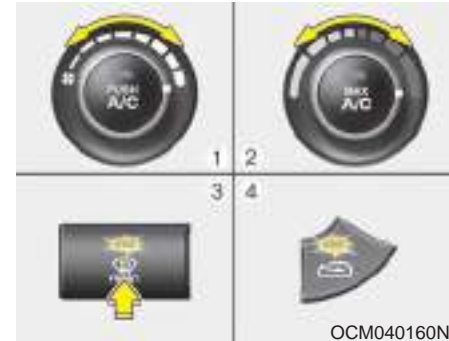

Do not use the  or  position during cooling operation in extremely humid weather. The difference between the temperature of the outside air and the windshield could cause the outer surface of the windshield to fog up, causing loss of visibility. In this case, set the mode selection to the  position and fan speed control to the lower speed.

- For maximum defrosting, set the temperature control to the extreme right/hot position and the fan speed control to the highest speed.
- If warm air to the floor is desired while defrosting or defogging, set the mode to the floor-defrost position.
- Before driving, clear all snow and ice from the windshield, rear window, outside rear view mirrors, and all side windows.
- Clear all snow and ice from the hood and air inlet in the cowl grill to improve heater and defroster efficiency and to reduce the probability of fogging up the inside of the windshield.



### Manual climate control system

#### *To defog inside windshield*

1. Set the fan speed to the desired position.
2. Select desired temperature.
3. Select the  or  position.
4. The outside (fresh) air will be selected automatically.

If the outside (fresh) air position is not selected automatically, press the corresponding button manually.

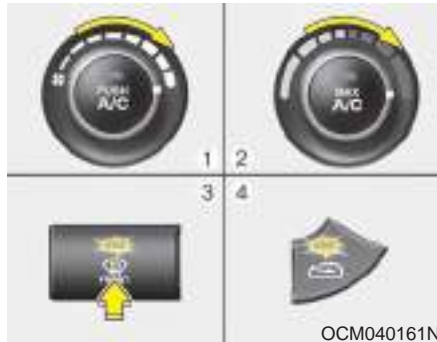

**To defrost outside windshield**

1. Set the fan speed to the highest position.
2. Set the temperature to the extreme hot position.
3. Select the  position.
4. The outside (fresh) air will be selected automatically.

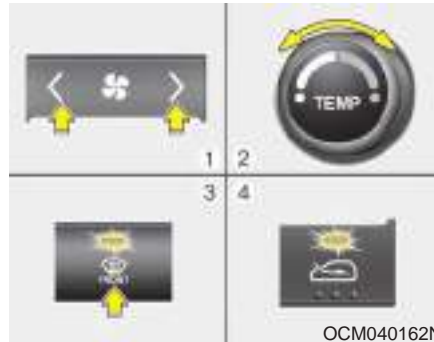

**Automatic climate control system**

**To defog inside windshield**

1. Set the fan speed to the desired position.
2. Select desired temperature.
3. Press the defroster button ().
4. The outside (fresh) air position will be selected automatically.

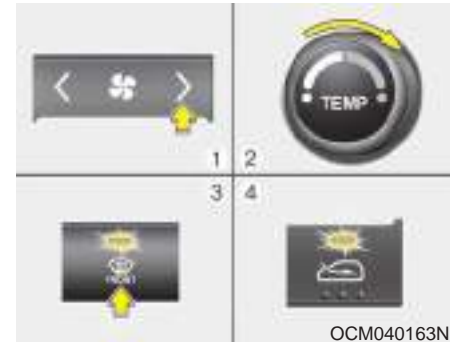

If the outside (fresh) air position is not selected automatically, adjust the corresponding button manually. If the  position is selected, lower fan speed is adjusted to a higher fan speed.



**To defrost outside windshield**

1. Set the fan speed to the highest position.
2. Set the temperature to the extreme hot (HI) position.
3. Press the defroster button ().
4. The outside (fresh) air position will be selected automatically.

## Defogging logic

To reduce the possibility of fogging up inside of the windshield, the air intake or air conditioning are controlled automatically according to certain conditions such as  or  position. To cancel or return to the defogging logic, do the following.



### **Automatic climate control system**

1. Turn the ignition switch to the ON position.
2. Select the defroster position by pressing the defroster button (.
3. While pressing the air conditioning button (A/C), press the air intake control button (Recirculated air button) at least 5 times within 3 seconds.

The A/C display blinks 3 times with 0.5 second of interval. It indicates that the defogging logic is canceled or returned to the programmed status.

If the battery has been discharged or disconnected, it resets to the defog logic status.

## STORAGE COMPARTMENT

D270000AUN

These compartments can be used to store small items required by the driver or passengers.

### ! CAUTION

- *To avoid possible theft, do not leave valuables in the storage compartment.*
- *Always keep the storage compartment covers closed while driving. Do not attempt to place so many items in the storage compartment that the storage compartment cover can not close securely.*



### **WARNING - Flammable materials**

Do not store cigarette lighters, propane cylinders, or other flammable/explosive materials in the vehicle. These items may catch fire and/or explode if the vehicle is exposed to hot temperatures for extended periods.



### **Center console storage (if equipped)**

To open the center console storage pull up the lever.

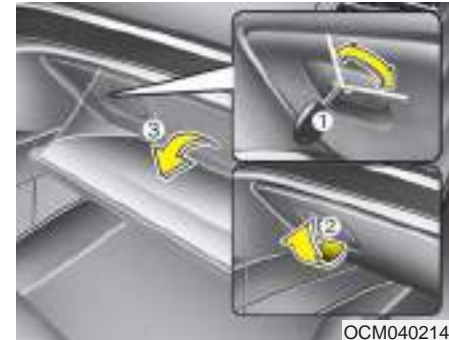

D270200AFD

### **Glove box**

The glove box can be locked and unlocked with a master key (if equipped). To open the glove box, pull the handle and the glove box will automatically open. Close the glove box after use.



### **WARNING**

To reduce the risk of injury in an accident or sudden stop, always keep the glove box door closed while driving.



OCM029130

D270300AUN

### Sunglass holder

To open the sunglass holder, press the cover and the holder will slowly open. Place your sunglasses in the compartment door with the lenses facing out. Push to close.

### WARNING

- Do not keep objects except sunglasses inside the sunglass holder. Such objects can be thrown from the holder in the event of a sudden stop or an accident, possibly injuring the passengers in the vehicle.
- Do not open the sunglass holder while the vehicle is moving. The rear view mirror of the vehicle can be blocked by an open sun-glass holder.



Front

OCM051020L



Center

OCM029021L

### Multi box (if equipped)

The multi box can be used for storing small items.

#### Front

To open the cover, pull up the lever.

#### Center

To open the multi box, pull it out.

## Features of your vehicle

---

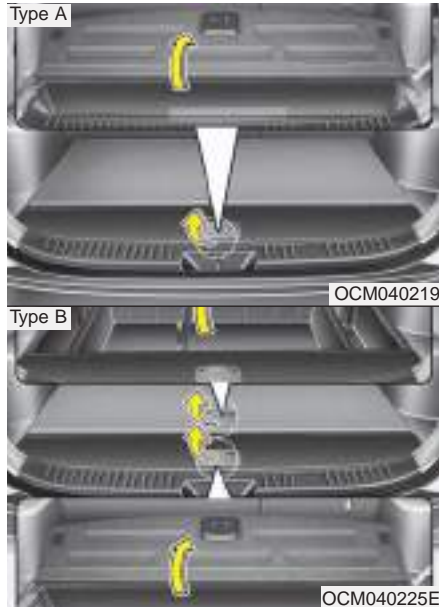

D270500AFD

### **Luggage box (if equipped)**

You can place a first aid kit, a reflector triangle, tools, etc. in the box for easy access.

Grasp the handle on the top of the cover and lift it.

## INTERIOR FEATURES



OCM040168

D280100AFD

### Cigarette lighter

For the cigarette lighter to work, the ignition switch must be in the ACC position or the ON position.

To use the cigarette lighter, push it all the way into its socket. When the element has heated, the lighter will pop out to the "ready" position.

Do not hold the cigarette lighter pressed in. This can damage the heating element and create a fire hazard.

If it is necessary to replace the cigarette lighter, use only a genuine HYUNDAI replacement or its approved equivalent.

### WARNING

- Do not hold the lighter in after it is already heated because it will overheat.
- If the lighter does not pop out within 30 seconds, remove it to prevent overheating.

### ! CAUTION

*Only a genuine HYUNDAI lighter should be used in the cigarette lighter socket. The use of plug-in accessories (shavers, hand-held vacuums, and coffee pots, for example) may damage the socket or cause electrical failure.*

### Ashtray

### WARNING - Ashtray use

- Do not use the vehicle's ashtray as waste receptacles.
- Putting lit cigarettes or matches in an ashtray with other combustible materials may cause a fire.





OCM052127

The front ashtray may be opened by pressing the ashtray lid. To clean the ashtray, the plastic receptacle should be removed by lifting the plastic ash receptacle upward and pulling it out.

D280300AUN

### Cup holder

#### **WARNING - Hot liquids**

- Do not place uncovered cups of hot liquid in the cup holder while the vehicle is in motion. If the hot liquid spills, you may burn yourself. Such a burn to the driver could lead to loss of control of the vehicle.
- To reduce the risk of personal injury in the event of sudden stop or collision, do not place uncovered or unsecured bottles, glasses, cans, etc., in the cup holder while the vehicle is in motion.



OCM052131

D280301AFD

Cups or small beverage cans may be placed in the cup holders.



**Center (if equipped)**

To use the cup holder, pull down the arm rest and push the open button. Close the cover after use.

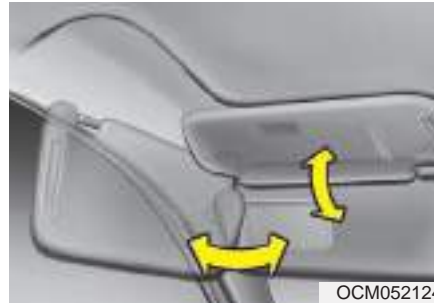

D280400AFD

**Sunvisor**

Use the sunvisor to shield direct light through the front or side windows.

To use the sunvisor, pull it downward.

To use the sunvisor for the side window, pull it downward, unsnap it from the bracket and swing it to the side.

Adjust the sunvisor extension forward or backward.



To use the vanity mirror, pull down the visor and slide the mirror cover.

The ticket holder is provided for holding a tollgate ticket (if equipped).

### **! CAUTION - Vanity mirror lamp (if equipped)**

*Close the vanity mirror cover securely and return the sunvisor to its original position after use. If the vanity mirror is not closed securely, the lamp will stay on and could result in battery discharge.*

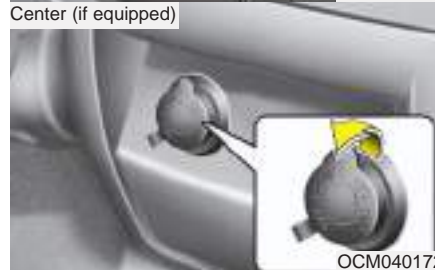

### **Power outlet**

The power outlet is designed to provide power for mobile telephones or other devices designed to operate with vehicle electrical systems. The devices should draw less than 10 amps with the engine running.

### **! CAUTION**

- *Use power outlet only when the engine is running and remove the accessory plug after use. Using the accessory plug for prolonged periods of time with the engine off could cause the battery to discharge.*
- *Only use 12V electric accessories which are less than 10A in electric capacity.*
- *Adjust the air-conditioner or heater to the lowest operating level when using the power outlet.*
- *Close the cover when not in use.*
- *Some electronic devices can cause electronic interference when plugged into a vehicle's power outlet. These devices may cause excessive audio static and malfunctions in other electronic systems or devices used in your vehicle.*



D281300AHM

### AC inverter (if equipped)

The AC inverter supplies 115VAC/150W electric power to operate electric accessories or equipment when the ignition switch is in the ON position or engine is running.

The AC inverter is turned on by pushing in the switch. To turn the AC inverter off, push the switch again.

### \* NOTICE

When pushing the AC inverter switch, the switch indicator illumination is delayed momentarily while the system conducts a self-check.

### ! CAUTION

- *When not using the AC inverter, make sure that the switch is turned off, and is closed the AC inverter cover.*
- *Only use the AC inverter when the engine is running, and remove the plug from the AC inverter after using the accessory. Using when the engine is not running or leaving the accessory plugged in for a long time may cause the battery to discharge.*
- *Do not use electric accessories or equipment with maximum electric power consumption greater than 150W (115VAC).*
- *Some electronic devices can cause electronic interference when plugged into the AC inverter. These devices may cause excessive audio noise and malfunctions in other electronic systems or devices used in your vehicle.*
- *Do not use broken electric accessories or equipment, as they may damage the AC inverter and vehicle's electrical system.*

(Continued)

(Continued)

- *Do not use two or more electric accessories or equipment at the same time.*
- *When input voltage is under 11V, the outlet LED and indicator will blink, and will automatically turn off.*



### WARNING

The AC inverter can be dangerous! When using the AC inverter, carefully observe the following precautions to avoid serious injuries.

- *Do not use heated electric products (coffeepot, toaster, heater, iron, etc.).*
- *Do not insert foreign objects into or touch the AC inverter; you may get shocked.*
- *Do not let children operate or touch the AC inverter.*
- *When not using the AC inverter, close the cover.*

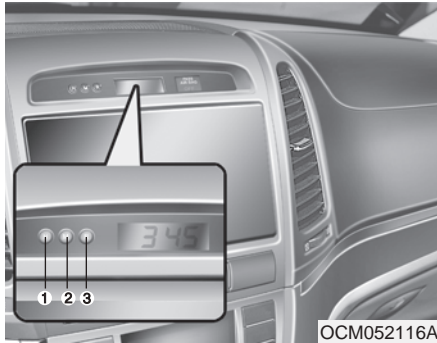

D280600AUN

### Digital clock (if equipped)



#### **WARNING**

**Do not adjust the clock while driving. You may lose your steering control and cause severe personal injury or accidents.**

Whenever the battery terminals or related fuses are disconnected, you must reset the time.

When the ignition switch is in the ACC or ON position, the clock buttons operate as follows:

#### **HOURL (1)**

Pressing the “H” button will advance the time displayed by one hour.

#### **MINUTE (2)**

Pressing the “M” button will advance the time displayed by one minute.

D280603AUN

#### **RESET (3, if equipped)**

To clear away minutes, press the “R” button with your finger, a pencil or similar object. Then the clock will be set precisely on the hour.

For example, if the “R” button is pressed while the time is between 9:01 and 9:29, the display will be reset to 9:00.

9:01 ~ 9:29 display changed to 9:00

9:30 ~ 9:59 display changed to 10:00

#### **Display conversion:**

To change the 12 hour format to the 24 hour format, press the “R” button for more than 4 seconds.

For example, if the “R” button is pressed for more than 4 seconds while the time is 10:15 p.m., the display will be changed to 22:15.

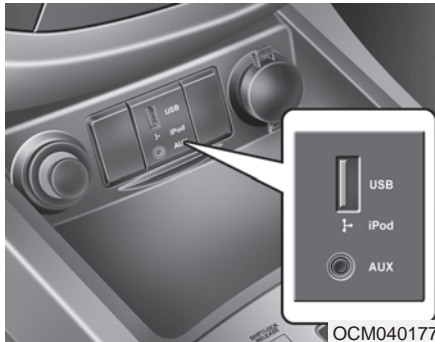

OCM040177

D281400BFD

### Aux, USB and iPod

If your vehicle has an aux and/or USB(universal serial bus) port or iPod port, you can use an aux port to connect audio devices and an USB port to plug in an USB and also an iPod port to plug in an iPod.

### \* NOTICE

When using a portable audio device connected to the power outlet, noise may occur during playback. If this happens, use the power source of the portable audio device.

\* iPod is a trademark of Apple Inc.



OUN026348

D280800AUN

### Clothes hanger (if equipped)

To use the hanger, pull down the upper portion of hanger.

### ! CAUTION

*Do not hang heavy clothes, since those may damage the hook.*

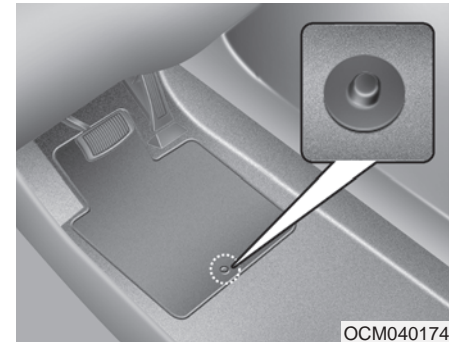

OCM040174

### Floor mat anchor(s) (if equipped)

When using a floor mat on the front floor carpet, make sure it attaches to the floor mat anchor(s) in your vehicle. This keeps the floor mat from sliding forward.

### ! WARNING

- Make sure the floor mat is properly placed on the floor carpet. If the floor mat slips and interferes with the movement of the pedals during driving, it may cause an accident.
- Don't put an additional floor mat on the top of the anchored floor mat, otherwise the additional mat may slide forward and interfere with the movement of the pedals.



### Luggage net (holder) (if equipped)

To keep items from shifting in the cargo area, you can use the four holders located in the cargo area to attach the luggage net.

If necessary, contact your authorized HYUNDAI dealer to obtain a luggage net.

### ! CAUTION

*To prevent damage to the goods or the vehicle, care should be taken when carrying fragile or bulky objects in the luggage compartment.*

### ⚠ WARNING

**To avoid eye injury, DO NOT overstretch the luggage net. ALWAYS keep your face and body out of the luggage net's recoil path. DO NOT use the luggage net when the strap has visible signs of wear or damage.**



D281100AFD

### Cargo security screen (if equipped)

Use the cargo security screen to hide items stored in the cargo area.

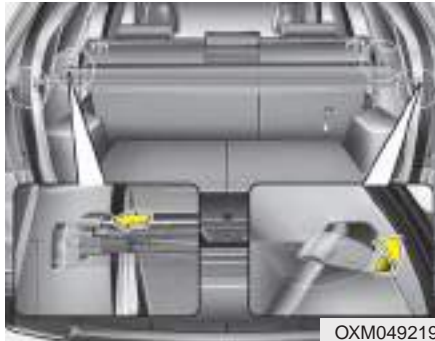

- To use the cargo security screen, pull the handle backward and insert the edges into the slots.

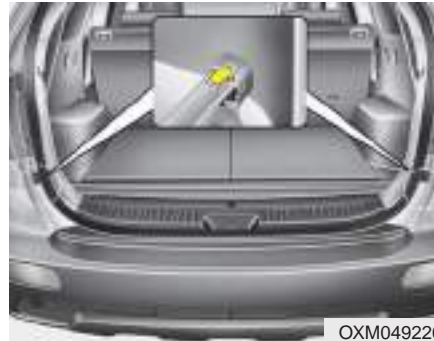

When not in use, place the cargo security screen on the lower portion of the cargo area. (if equipped)

**⚠ WARNING**

- Do not place objects on the cargo security screen. Such objects may be thrown about inside the vehicle and possibly injure vehicle occupants during an accident or when braking.
- Never allow anyone to ride in the luggage compartment. It is designed for luggage only.
- Maintain the balance of the vehicle and locate the weight as far forward as possible.

**! CAUTION**

*Since the cargo security screen may be damaged or malformed, do not put the luggage on it when it is used.*



## EXTERIOR FEATURES



OCM040175

D290100AFD

### Roof rack (if equipped)

If the vehicle has a roof rack, you can load cargo on top of your vehicle.

### \* NOTICE

If the vehicle is equipped with a sunroof, be sure not to position cargo onto the roof rack in such a way that it could interfere with sunroof operation.

### ! CAUTION

- When carrying cargo on the roof rack, take the necessary precautions to make sure the cargo does not damage the roof of the vehicle.
- When carrying large objects on the roof rack, make sure they do not exceed the overall roof length or width.

### ⚠ WARNING

- The following specification is the maximum weight that can be loaded onto the roof rack. Distribute the load as evenly as possible onto the roof rack and secure the load firmly.

ROOF RACK	220 lbs. (100 kg) EVENLY DISTRIBUTED
-----------	---

Loading cargo or luggage in excess of the specified weight limit on the roof rack may damage your vehicle.

(Continued)

(Continued)

- The vehicle center of gravity will be higher when items are loaded onto the roof rack. Avoid sudden starts, braking, sharp turns, abrupt maneuvers or high speeds that may result in loss of vehicle control or rollover resulting in an accident.
- Always drive slowly and turn corners carefully when carrying items on the roof rack. Severe wind updrafts, caused by passing vehicles or natural causes, can cause sudden upward pressure on items loaded on the roof rack. This is especially true when carrying large, flat items such as wood panels or mattresses. This could cause the items to fall off the roof rack and cause damage to your vehicle or others around you.
- To prevent damage or loss of cargo while driving, check frequently before or while driving to make sure the items on the roof rack are securely fastened.

## AUDIO SYSTEM



OHM048154N

### Antenna

D300102AFD

#### Roof antenna

Your car uses a roof antenna to receive both AM and FM broadcast signals. This antenna is a removable type. To remove the antenna, turn it counterclockwise. To install the antenna, turn it clockwise.

### ! CAUTION

- *Before entering a place with a low height clearance, be sure that the antenna is fully folded down or removed.*
- *Be sure to remove the antenna before washing the car in an automatic car wash or it may be damaged.*
- *When reinstalling your antenna, it is important that it is fully tightened and adjusted to the upright position to ensure proper reception. But it could be folded or removed when parking the vehicle or when loading cargo on the roof rack.*
- *When cargo is loaded on the roof rack, do not place the cargo near the antenna pole to ensure proper reception.*



OCM040176N

D300200AFD

### Audio remote control (if equipped)

The steering wheel audio remote control button is installed to promote safe driving.

### ! CAUTION

*Do not operate audio remote control buttons simultaneously.*

## Features of your vehicle

### **MODE (1)**

Press the button to select Radio, or CD (compact disc).

### **SEEK (^ / \) (2)**

If the SEEK button is pressed for 0.8 second or more, it will work as follows in each mode.

#### **RADIO mode**

It will function as the AUTO SEEK select button.

#### **CD PLAYER (CDP) mode**

It will function as the FF/REW button.

#### **CD CHANGER (CDC) mode**

It will function as the DISC UP/DOWN button.

If the SEEK button is pressed for less than 0.8 second, it will work as follows in each mode.

#### **RADIO mode**

It will function as the PRESET STATION select buttons.

#### **CD PLAYER (CDP) mode**

It will function as the TRACK UP/DOWN button.

#### **CD CHANGER (CDC) mode**

It will function as the TRACK UP/DOWN button.

Detailed information for audio control buttons is described in the following pages in this section.

### **VOL (+ / -) (3)**

- Press the up button (+) to increase volume.
- Press the down button (-) to decrease volume.

### **VOICE RECOGNITION (VR) mode (4)**

Detailed information is described in the following pages in this section.

### **FM reception**

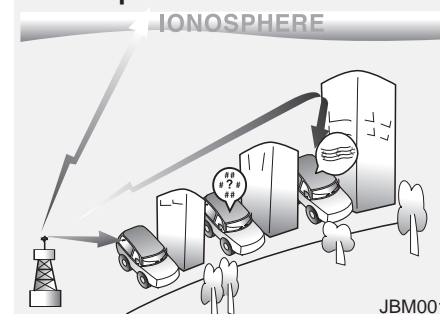

D300800AFD

### **How car audio works**

AM and FM radio signals are broadcast from transmitter towers located around your city. They are intercepted by the radio antenna on your car. This signal is then received by the radio and sent to your car speakers.

When a strong radio signal has reached your vehicle, the precise engineering of your audio system ensures the best possible quality reproduction. However, in some cases the signal coming to your vehicle may not be strong and clear. This can be due to factors such as the distance from the radio station, closeness of other strong radio stations or the presence of buildings, bridges or other large obstructions in the area.

### AM (MW, LW) reception

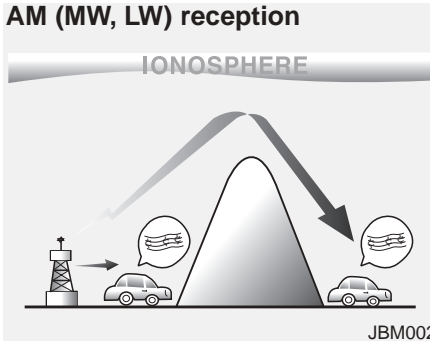

AM (MW, LW) broadcasts can be received at greater distances than FM broadcasts. This is because AM (MW, LW) radio waves are transmitted at low frequencies. These long, low frequency radio waves can follow the curvature of the earth rather than travelling straight out into the atmosphere. In addition, they curve around obstructions so that they can provide better signal coverage.

### FM radio station

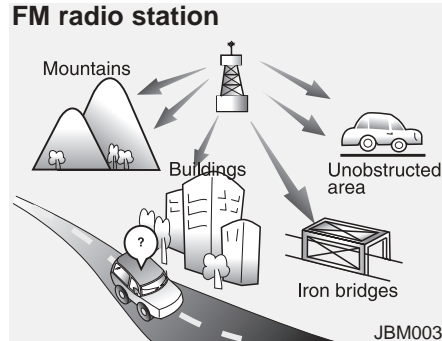

FM broadcasts are transmitted at high frequencies and do not bend to follow the earth's surface. Because of this, FM broadcasts generally begin to fade at short distances from the station. Also, FM signals are easily affected by buildings, mountains, or other obstructions. These can result in certain listening conditions which might lead you to believe a problem exists with your radio. The following conditions are normal and do not indicate radio trouble:

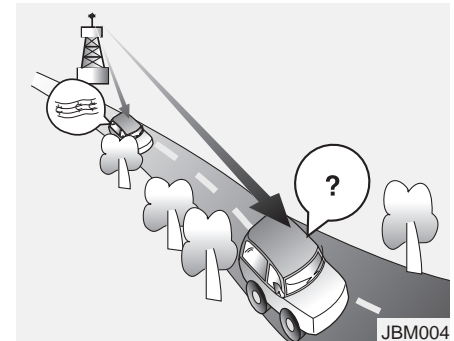

- **Fading** - As your car moves away from the radio station, the signal will weaken and sound will begin to fade. When this occurs, we suggest that you select another stronger station.
- **Flutter/Static** - Weak FM signals or large obstructions between the transmitter and your radio can disturb the signal causing static or fluttering noises to occur. Reducing the treble level may lessen this effect until the disturbance clears.

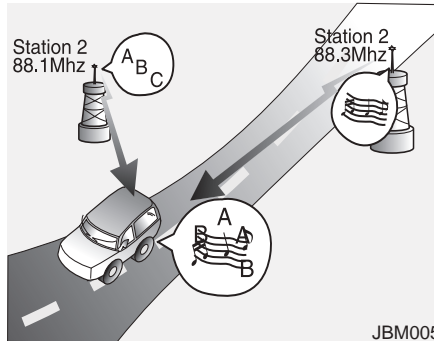

JBM005

- **Station Swapping** - As a FM signal weakens, another more powerful signal near the same frequency may begin to play. This is because your radio is designed to lock onto the clearest signal. If this occurs, select another station with a stronger signal.
- **Multi-Path Cancellation** - Radio signals being received from several directions can cause distortion or fluttering. This can be caused by a direct and reflected signal from the same station, or by signals from two stations with close frequencies. If this occurs, select another station until the condition has passed.

### Satellite radio reception

You may experience problems in receiving XM™ satellite radio signals in the following situations.

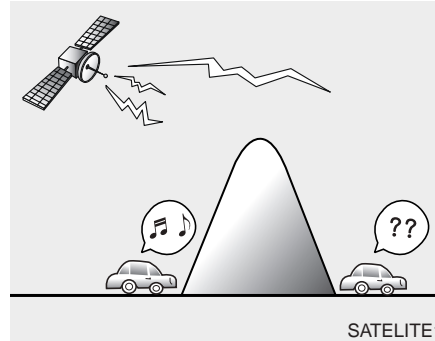

SATELITE1

- If you are driving in a tunnel or a covered parking area.
- If you are driving beneath the top level of a multi-level freeway.
- If you drive under a bridge.
- If you are driving next to a tall vehicle (such as a truck or a bus) that block the signal.
- If you are driving in a valley where the surrounding hills or peaks block the signal from the satellite.

- If you are driving on a mountain road where is blocked by mountains.

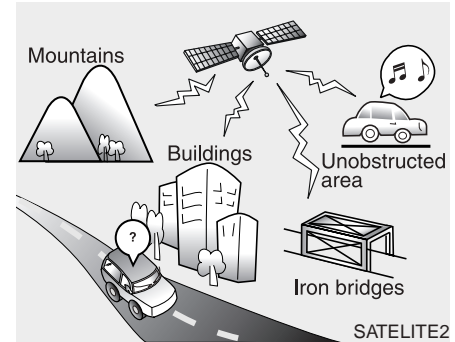

SATELITE2

- If you are driving in an area with tall trees that block the signal (10m or more), for example on a road that goes through a dense forest.
- The signal can become weak in some areas that are not covered by the repeater station network.

Please note that these may be other unforeseen circumstances when there are problems with the reception of XM™ satellite radio signal.

### Using a cellular phone or a two-way radio

When a cellular phone is used inside the vehicle, noise may be produced from the audio equipment. This does not mean that something is wrong with the audio equipment. In such a case, use the cellular phone at a place as far as possible from the audio equipment.

#### ! CAUTION

*When using a communication system such a cellular phone or a radio set inside the vehicle, a separate external antenna must be fitted. When a cellular phone or a radio set is used with an internal antenna alone, it may interfere with the vehicle's electrical system and adversely affect safe operation of the vehicle.*

#### WARNING

**Don't use a cellular phone when you are driving. You must stop at a safe place to use a cellular phone.**

### Care of disc (if equipped)

- If the temperature inside the car is too high, open the car windows for ventilation before using your car audio.
- It is illegal to copy and use MP3/WMA/AAC/WAVE files without permission. Use CDs that are created only by lawful means.
- Do not apply volatile agents such as benzene and thinner, normal cleaners and magnetic sprays made for analogue disc onto CDs.
- To prevent the disc surface from getting damaged. Hold and carry CDs by the edges or the edges of the center hole only.
- Clean the disc surface with a piece of soft cloth before playback (wipe it from the center to the outside edge).
- Do not damage the disc surface or attach pieces of sticky tape or paper onto it.
- Make sure on undesirable matter other than CDs are inserted into the CD player (Do not insert more than one CD at a time).
- Keep CDs in their cases after use to protect them from scratches or dirt.

- Depending on the type of CD-R/CD-RW CDs, certain CDs may not operate normally according to manufacturing companies or making and recording methods. In such circumstances, if you still continue to use those CDs, they may cause the malfunction of your car audio system.

#### \* NOTICE - Playing an Incompatible Copy-Protected Audio CD

Some copy protected CDs, which do not comply with the international audio CD standards (Red Book), may not play on your car audio. Please note that if you try to play copy protected CDs and the CD player does not perform correctly the CDs maybe defective, not the CD player.

**RADIO, SET UP, VOLUME, AUDIO CONTROL(PA910)**



- 1. Power ON/OFF Button & Volume Control Knob
- 2. FM Selection Button
- 3. AM Selection Button
- 4. Automatic Channel Selection Button
- 5. Preset Button
- 6. SCAN Button
- 7. SETUP Button
- 8. Manual Channel Selector & Sound Quality Control Knob

**RADIO, SET UP, VOLUME, AUDIO CONTROL(PA960)**



**RADIO, SET UP, VOLUME CONTROL(PA965)**



- |  |   |
|--|---|
| 1. Power ON/OFF Button & Volume Control Knob | 7. SETUP Button   |
| 4. Automatic Channel Selection Button        | 8. Manual Channel Selector & Sound Quality Control Knob |
| 5. Preset Button                             | 9. FM/AM Selection Button                               |
| 6. SCAN Button                               |   |

**1. Power ON/OFF Button & Volume Control Knob**

Turns on/off the set when the IGNITION SWITH is on ACC or ON. If the button is turned to the right, it increases the volume and left, decreases the volume.

**2. FM Selection Button**

Turns to FM mode and toggles FM1 and FM2 when the button is pressed each time.

**3. AM Selection Button**

Pressing the [AM] button selects the AM band. AM Mode is displayed on the LCD.

**4. Automatic Channel Selection Button**

- When the [SEEK  $\wedge$ ] button is pressed, it increases the band frequency to automatically select channel. Stops at the previous frequency if no channel is found.
- When the [TRACK  $\vee$ ] button is pressed, it reduces the band frequency to automatically select channel. Stops at the previous frequency if no channel is found.



### 5. Preset Button

Push [1]–[6] buttons less than 0.8 second to play the channel saved in each button. Push Preset button for 0.8 second or longer to save current channel to the respective button with a beep.

### 6. SCAN Button

If this button is pressed, the frequencies will become increased and receive the corresponding broadcasts. This function will play the frequencies for 5 seconds (XM MODE:10 seconds) each and find other broadcasts as the frequency increases.

Press the button again when desiring to continue listening to the currently playing broadcast.

### 7. SETUP Button

Press this button to turn to the XM option and the other adjustment mode.

If no action is taken for 5 seconds after pressing the button, it will return to the play mode. (After entering SEPUP mode, move between items using the left, right and PUSH functions of the [TUNE] knob.)

#### ■ PA910

The setup change in the order of SCROLL→SDVC→PHONE→RETURN→P.BASS→XM...

#### ■ PA960/PA965

The setup changes in the order of SCROLL→SURROUND→XM→PHONE...

#### • SCROLL

This function is used to display characters longer than the LCD text display and can be turned ON/OFF through the volume controller.

#### • RETURN

This function displays the previous MODE screen.

#### • SDVC

This function automatically adjusts the volume level according to the speed of the vehicle and can be turned ON/OFF through the volume controller.

#### • POWER BASS(P.BASS)

Based on psychoacoustic technology, this technology overcomes BASS limitations which may occur due to the limited number and size of speakers to offer dynamic BASS sound quality. It is possible to adjust in 3 levels of LOW/MID/HIGH.

OFF → LOW → MID → HIGH

Modes: CD/FM/AUX/IPOD/USB (excluding MW, LW Mode)

### 8. Manual Channel Selector & Sound Quality Control Knob

Turn this control while listening to a radio channel to manually adjust frequency. Turn clockwise to increase frequency and counterclockwise to reduce frequency.

Pressing the button changes the BASS, MIDDLE, TREBLE, FADER and BALANCE TUNE mode. The mode selected is shown on the display. After selecting each mode, rotate the Audio control knob clockwise or counterclockwise.

#### BASS Control

To increase the BASS, rotate the knob clockwise, while to decrease the BASS, rotate the knob counterclockwise.

### **MIDDLE Control**

To increase the MIDDLE, rotate the knob clockwise, while to decrease the MIDDLE, rotate the knob counterclockwise.

### **TREBLE Control**

To increase the TREBLE, rotate the knob clockwise, while to decrease the TREBLE, rotate the knob counterclockwise.

### **FADER Control**

Turn the control knob clockwise to emphasize rear speaker sound (front speaker sound will be attenuated). When the control knob is turned counterclockwise, front speaker sound will be emphasized (rear speaker sound will be attenuated).

### **BALANCE Control**

Rotate the knob clockwise to emphasize right speaker sound (left speaker sound will be attenuated). When the control knob is turned counter clockwise, left speaker sound will be emphasized (right speaker sound will be attenuated).

## **9. FM/AM Selection Button**

Turns to FM or AM mode, and toggles in the order of FM1→FM2→AM→FM1... when the button is pressed each time.

**CDP, AUX(PA910)**



1. CD Loading Slot
2. CD Eject Button
3. INFO Button
4. Automatic Track Selection Button
5. RANDOM Play Button
6. REPEAT Button
7. CD/AUX Selection Button
8. CD Indicator
9. Folder Moving Button
10. Search/ENTER Button
11. SCAN Play Button
12. DISC Selection Button
13. CD LOAD Button

**CDC, AUX(PA960)**



**CDC, AUX(PA965)**



- |                                     |                                |
|-------------------------------------|--------------------------------|
| 1. CD Loading Slot                  | 7. CD/AUX/RSE Selection Button |
| 2. CD Eject Button                  | 9. Folder Moving Button        |
| 3. INFO Button                      | 10. Search/ENTER Button        |
| 4. Automatic Track Selection Button | 11. SCAN Play Button           |
| 5. RANDOM Play Button               | 12. DISC Selection Button      |
| 6. REPEAT Button                    | 13. CD LOAD Button             |

**1. CD Loading Slot**

Please face printed side upward and gently push in. When the ignition switch is on ACC or ON and power is off, power is automatically turned on if the CD is loaded. This CDP supports only 12cm CD. If VCD, Data CD are loaded, "Reading Error" message will appear and CD will be ejected.

**2. CD Eject Button**

Push ▲ button for less than 0.8 seconds to eject the CD during CD playback. This button is enabled when ignition switch is off.

- ALL EJECT(CDC Only)

Press this button for more than 0.8 seconds to eject all discs inside the deck in respective order.

**3. INFO Button**

Displays the information of the current CD TRACK(FILE) as below when the button is pressed each time.

- CDDA : DISC TITLE → DISC ARTIST → TRACK TITLE → TRACK ARTIST → TOTAL TRACK...

- MP3/WMA : FILE NAME→TITLE→ARTIST→ALBUME→FOLDER NAME→TOTAL FILE... (not displayed if the information is not available on the DISC.)

#### 4. Automatic Track Selection Button

- Push [TRACK √] button for less than 0.8 second to play from the beginning of current song.
- Push [TRACK √] button for less than 0.8 second and press again within 1 second to play the previous song.
- Push [TRACK √] button for 0.8 or longer to initiate reverse direction high speed sound search of current song.
- Push [SEEK ^] button for less than 0.8 second to play the next song.
- Push [SEEK ^] button for 0.8 or longer to initiate high speed sound search of current song.

#### 5. RANDOM Play Button

Press this button for less than 0.8 second to activate 'RDM' mode and more than 0.8 seconds to activate 'ALL RDM' mode.

- RDM : Only files/tracks in a folder/disc are played back in a random sequence.
- ALL RDM(MP3/WMA Only) : All files in a disc are played back in the random sequence.

#### 6. REPEAT Button

Press this button for less than 0.8 second to activate 'RPT' mode and more than 0.8 seconds to activate 'FLD RPT' mode.

- RPT : Only a track(file) is repeatedly played back.
- FLD RPT(MP3/WMA Only) : Only files in a folder are repeatedly played back.

#### 7. CD or CD/AUX or CD/AUX/RSE Selection Button

- CD Selection Button  
If the CD is loaded, turns to CD mode. If no CD, it displays "NO Disc" for 3 seconds and returns to the previous mode.

- CD/AUX Selection Button

If the auxiliary device is connected, it switches to the AUX mode from the other mode to play the sound from the auxiliary player. If the CD is loaded, turns to CD mode, and if a device is connected to AUX then it toggles. CD→AUX→CD... when the button is pressed each time. (It will not turn to AUX if the auxiliary device is not connected) If no CD and auxiliary device is not connected, it displays "NO Media" for 3 seconds and returns to the previous mode.

- CD/AUX/RSE Selection Button

If the auxiliary device is connected, it switches to the AUX mode from the other mode to play the sound from the auxiliary player. If the CD is loaded, turns to CD mode, and if a device is connected to AUX and there is a CD in the RSE then it toggles. CD→AUX→RSE→CD... when the button is pressed each time.(It will not turn to AUX and RSE if the auxiliary device is not connected and there is no CD in the RSE)

If no CD and auxiliary device is not connected, it displays "NO Media" for 3 seconds and returns to the previous mode.

### 8. CD Indicator (CDP Only)

When car ignition switch is ACC or ON and if the CD is loaded, this indicator is lighted. If the CD is ejected the light is turned off.

### 9. Folder Moving Button

- Moves [FOLDER ∨] button child folder of the current folder and displays the first song in the folder. Press TUNE/ENTER knob to move to the folder displayed. It will play the first song in the folder.
- Moves [CAT ^], [PTY ^], [FOLDER ^] button parent folder and displays the first song in the folder. Press TUNE/ENTER knob to move to the folder displayed.

### 10. Search/ENTER Button

Turn this button clockwise to display the songs next to the currently played song. Turn the button counterclockwise to display the songs before the currently played song. Press the button to skip and play the selected song.

### 11. SCAN Play Button

Plays first 10 seconds of each song in the DISC. To cancel the mode, press the button once again.

### 12. DISC Selection Button

- [DISC ∨] Change Button changes disc to the previous disc.
- [DISC ^] Change Button changes disc to the next disc.

### 13. CD LOAD Button

Push [LOAD] button to load CDs to available CDC deck (from 1~6). Push [LOAD] button for more than 2 seconds to load into all available decks. The last CD will play. 10 seconds idle status will disable loading process.

**! CAUTION IN USING USB DEVICE**

- *To use the external USB device, make sure the device is not mounted when starting up the vehicle and mount the device after starting up.*
- *If you start the vehicle when the USB device is mounted, it may damage the USB device. (USB is not ESA)*
- *If the vehicle is started up or turned off while the external USB device is connected, the external USB device may not work.*
- *It may not play inauthentic MP3 or WMA files.*
  - 1) *It can only play MP3 files with the compression rate between 8Kbps~320Kbps.*
  - 2) *It can only play WMA music files with the compression rate between 8Kbps~320Kbps.*
- *Take cautions for static electricity when mounting or dismounting the external USB device.*
- *Encoded MP3 PLAYER is not recognizable.*

*(Continued)*

*(Continued)*

- *Depending on the condition of the external USB device, the connected external USB device can be unrecognizable.*
- *When the formatted byte/sector setting of External USB devices is not either 512BYTE or 2048BYTE, then the device will not be recognized.*
- *Only use an USB device formatted to FAT 12/16/32.*
- *USB device without USB IF authentication may not be recognizable.*
- *Make sure the USB connection terminal does not come in contact with human body or any object.*
- *If you repeat mounting or dismounting USB device in a short period of time, it may break the device.*
- *You might hear strange noise when mounting or dismounting a USB device.*

*(Continued)*

*(Continued)*

- *If you dismount the external USB device during playback in USB mode, the external USB device can be damaged or malfunction. Therefore, mount the external USB device when the engine is turned off or in another mode.*
- *Depending on the type and capacity of the external USB device or the type of the files stored in the device, there is a difference in the time taken for recognition of the device, but this is not a trouble. Please wait for a moment.*
- *Do not use the USB device for other purposes than playing music files.*
- *Use of USB accessories such as the recharger or heater using USB I/F may lower the performance or cause trouble.*
- *If you use devices such as the USB hub you purchased separately, the vehicle's audio system may not recognize the USB device. Connect the USB device directly to the multimedia terminal of the vehicle.*

*(Continued)*

**(Continued)**

- *If USB device is divided by logical drives, only the music files on the highest-priority drive are recognized by car audio.*
- *Devices such as MP3 Player/ Cellular phone/Digital camera are not recognizable by standard USB I/F can be unrecognizable.*
- *USB devices other than standardized goods (METAL COVER TYPE USB) can be unrecognizable.*
- *USB flash memory reader (such as CF, SD, microSD, etc.) or external-HDD type devices can be unrecognizable.*
- *Music files protected by DRM (DIGITAL RIGHTS MANAGEMENT) are not recognizable.*
- *The data in the USB memory may be lost while using this AUDIO. It is recommended to back up important data on a personal.*

**(Continued)**

**(Continued)**

- *Please avoid using USB memory products which can be used as key chains or cellular phone accessories as they could cause damage to the USB jack. Please make certain only to use plug type connector products as shown below.*





**USING USB(PA910)**



- 1. INFO Selection Button
- 2. Track Moving Button
- 3. RANDOM Playback Button
- 4. REPEAT Button
- 5. USB Selection Button
- 6. Folder Moving Button
- 7. Search/ENTER Button
- 8. SCAN Selection Button

**USING USB(PA960)**



## USING USB(PA965)



- 1. INFO Selection Button
- 2. Track Moving Button
- 3. RANDOM Playback Button
- 4. REPEAT Button

- 5. USB Selection Button
- 6. Folder Moving Button
- 7. Search/ENTER Button
- 8. SCAN Selection Button

### 1. INFO Selection Button

Displays the information of the file currently played in the order of FILE NAME → TITLE → ARTIST → ALBUM → FOLDER → TOTAL FILE → NORMAL DISPLAY → FILE NAME →... (Displays no information if the file has no song information.)

### 2. Track Moving Button

- Press the [TRACK √] button for less than 0.8 second to play from the beginning of the song currently played. Press the button for less than 0.8 second and press it again within 1 second to move and play the previous track. Press the button for 0.8 second or longer to play the song in reverse direction in fast speed.
- Press the [SEEK ^] button for less than 0.8 second to move to the next-track. Press the button for 0.8 second or longer to play the song in forward direction in fast speed.

### 3. RANDOM Playback Button

Press this button for less than 0.8 seconds to activate 'RDM' mode and more than 0.8 seconds to activate 'ALL RDM' mode.

- RDM : Only files in a folder are played back in a random sequence.
- ALL RDM : All files in a USB memory are played back in the random sequence.

### 4. REPEAT Button

Press this button for less than 0.8 seconds to activate 'RPT' mode and more than 0.8 seconds to activate 'FLD RPT' mode.

- RPT : Only a file is repeatedly played back.
- FLD RPT : Only files in a folder are repeatedly played back.

### 5. USB Selection Button

If USB is connected, it switches to the USB mode from the other mode to play the song files stored in the USB. If no CD and auxiliary device is not connected, it displays "NO Media" for 3 seconds and returns to the previous mode.

### 6. Folder Moving Button

- Moves [FOLDER √] button child folder of the current folder and displays the first song in the folder. Press TUNE/ ENTER knob to move to the folder displayed. It will play the first song in the folder.
- Moves [CAT ^] button parent folder and displays the first song in the folder. Press TUNE/ENTER knob to move to the folder displayed

### 7. Search/ENTER Button

Turn this button clockwise to display the songs next to the currently played song. Turn the button counterclockwise to display the songs before the currently played song. Press the button to skip and play the selected song.

### 8. SCAN Selection Button

Plays 10 seconds of each song in the USB device. Press the button once again to cancel scanning.

### RUNNING iPod®(PA910)



- 1. INFO Selection Button
- 2. Track Moving Button
- 3. RANDOM Playback Button
- 4. REPEAT Button
- 5. iPod Selection Button
- 6. Category Selection Button
- 7. Search/ENTER Button

### RUNNING iPod®(PA960)



iPod® is a trademark of Apple Inc.

### RUNNING iPod®(PA965)



1. INFO Selection Button
2. Track Moving Button
3. RANDOM Playback Button
4. REPEAT Button

5. iPod Selection Button
6. Category Selection Button
7. Search/ENTER Button

In case the iPod exclusive cable is connected to the multiple terminal inside the consol on the right hand side of the driver's seat. When the iPod is connected, the 'iPod' icon will be displayed on the top left corner of the display screen.

#### 1. INFO Selection Button

Displays the information of the file currently played in the order of TITLE→ARTIST→ALBUM→NORMAL DISPLAY→TITLE→... (Displays no information if the file has no song information.)

#### 2. Track Moving Button

- Press the [TRACK ∨] button for less than 0.8 second to play from the beginning of the song currently played. Press the button for less than 0.8 second and press it again within 1 second to move and play the previous track. Press the button for 0.8 second or longer to play the song in reverse direction in fast speed.
- Press the [SEEK ^] button for less than 0.8 second to move to the next track. Press the button for 0.8 second or longer to play the song in forward direction in fast speed.

iPod® is a trademark of Apple Inc.

### 3. RANDOM Playback Button

Press the button for less than 0.8 second to activate or deactivate the random playback of the songs within the current category. Press the button for longer than 0.8 second to randomly play all songs in the entire album of the iPod. Press the button once again to cancel the mode.

### 4. REPEAT Button

Repeats the song currently played.

### 5. iPod Selection Button

If iPod is connected, it switches to the iPod mode from the CD mode to play the song files stored in the iPod. If no CD and auxiliary device is not connected, it displays "NO Media" for 3 seconds and returns to the previous mode.

### 6. Category Selection Button

Moves to the upper category from currently played category of the iPod.

To move to (play) the category (song) displayed, MENU (preset6) You will be able to search through the lower category of the selected category. The order of iPod's category is SONG, ALBUMES ARTISTS, GENRES, and iPod.

### 7. Search/ENTER Button

When you turn the button clockwise, it will display the songs (category) next to the song currently played (category in the same level).

Also, when you turn the button counter-clockwise, it will display the songs (category) before the song currently played (category in the same level).

If you want to listen to the song displayed in the song category, press the button, then it will skip to the selected song and play.

### \* NOTICE FOR USING iPod DEVICE

- Some iPod models might not support the communication protocol and the files will not be played. (iPod models supported: Mini, 4G, Photo, Nano, 5G)
- The order of search or playback of songs in the iPod can be different from the order searched in the audio system.
- If the iPod crashes due to its own trouble, reset iPod. (Reset: Refer to iPod manual)
- iPod may not operate normally on low battery.

### ! CAUTION IN USING iPod DEVICE

- *You need the power cable exclusive for iPod in order to operate iPod with the buttons on the audio system. The PC cable provided by Apple may cause malfunction and do not use it for vehicle use.*
- *When connecting the device with iPod cable, push in the jack fully not to interfere with communication.*
- *When adjusting the sound effects of iPod and the audio system, the sound effects of both devices will overlap each and might cause reduce or distort the quality of the sound.*
- *Deactivate (turn off) the equalizer function of iPod when adjusting the audio system's volume, and turn off the equalizer of the audio system when using the equalizer of iPod.*

(Continued)

(Continued)

- *When the iPod cable is connected, the system can be switched to the AUX mode even without the iPod device and can cause noise. Disconnect iPod cable when you are not using the iPod device.*
- *When the iPod is not used at audio system, iPod cable has to be separate from iPod device. Origin display of iPod may not be displayed.*

### XM SATELLITE RADIO(PA910)



1. XM Selection Button
2. INFO Button
3. Automatic Channel Selection Button
4. SCAN Button
5. CATEGORY Search Button
6. Manual Channel Selection Button
7. Preset Button

### XM SATELLITE RADIO(PA960)





## XM SATELLITE RADIO(PA965)



1. XM Selection Button

2. INFO Button

3. Automatic Channel Selection Button

4. SCAN Button

5. CATEGORY Search Button

6. Manual Channel Selection Button

7. Preset Button

### 1. XM Selection Button

Turns to XM Satellite Radio Mode. XM mode toggles in order to XM1→XM2→XM3→XM1... when the button is pressed each time.

### 2. INFO Button

Displays the information of the current channel in the order of Artist/Song title→Category/Channel name→Current Play Channel→Artist/Song title→Category/Channel name... when the button is pressed each time.

If can not display the whole text information, rotate the tune button to see the next page.

### 3. Automatic Channel Selection Button

- Push [TRACK √] button for less than 0.8 second to select previous channel.
- Push [TRACK √] button for 0.8 second or longer to continuously move to previous channel.
- Push [SEEK ^] button for less than 0.8 second to select next channel.
- Push [SEEK ^] button for 0.8 second or longer to continuously move to next channel.

- Radio ID : Seek or Tune to XM channel 0 to display the Radio ID.

#### 4. SCAN Button

Press to hear a brief sampling of all channel. To cancel the scan mode, press the button once again.

#### 5. CATEGORY Search Button

- Push [FOLDER ∨] button to search previous category.
- Push [CAT ^] button to search next category. To listen to the displayed category, press the TUNE/SETUP button. To scan channel in displayed category, press the scan button. To search channel in displayed category, press seek buttons or turn the tune button clockwise/counterclockwise. (CATEGORY icon is will be turned on in Category mode)

#### 6. Manual Channel Selection Button

While listening to XM broadcast, rotate this control to the right or left to search other channels while listening to current channel. (Turn to the right to search higher channels and left, lower channels)

#### 7. Preset Button

Push [1]~[6] buttons less than 0.8 second to play the channel saved in each button. Push Preset button for 0.8 second or longer to save current channel to the respective button with a beep.

### DVDP (PA965)



1. TRACK UP/DOWN Button

2. RSE Selection Button

3. RSE Hold and RSE Power Off

4. Folder Moving Button

In case RSE is loaded DVD disc and connected auxiliary device at RSE unit that is located the rear seat.

#### 1. TRACK UP/DOWN Button

- Push [TRACK √] button for less than 0.8 second to play from the beginning of current song.
- Push [TRACK √] button for less than 0.8 second and press again within 1 second to play the previous song.
- Push [TRACK √] button for 0.8 second or longer to initiate reverse direction high speed sound search of current song.
- Push [SEEK ^] button for less than 0.8 second to play the next song.
- Push [SEEK ^] button for 0.8 second or longer to initiate high speed sound search of current song.

#### 2. RSE Selection Button

When you press this button, the system will switch to RSE mode and you will be able to listen to the source played in the RSE unit. (If RSE unit has no disc, can not select)

### 3. RSE Hold and RSE Power Off

If you press and hold this button for less than 0.8 second, the LED of the button will light and RSE unit will be locked. If you press and hold this button for more than 0.8 second, RSE unit will be turned off with a beep and [RSE] will disappear from LCD.

### 4. Folder Moving Button

- Press [FOLDER ∨] button to play the previous track.
- Press [CAT ∧] button to play the next

#### **! CAUTION IN USING RSE DEVICE**

*When listening to the CD on the H/UNIT in RSE, the mode cannot be converted to USB on the H/UNIT and **USB** will be displayed on the LCD.*

track.

### BLUETOOTH PHONE OPERATION

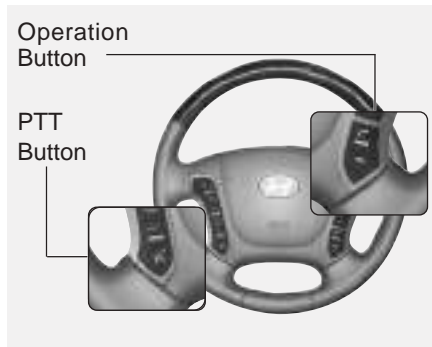

#### ■ General Feature

- This system supports Bluetooth, a wireless system that allows you to make or receive calls without taking your hands from the steering wheel and without using cables to connect the phone and system.
- The phone must be paired to the system before using the hands-free feature. Only one linked cellular phone can be used with the system at a time. The System is available in English, US Spanish, or Canadian French languages.



#### ! CAUTION

***If the vehicle is moving do not use a cellular phone or connect the Bluetooth phone.***

#### \* NOTICE

**Some Bluetooth devices do not offer a perfect compatibility with this system.**

#### ■ Voice Recognition Activation

- The voice recognition engine contained in the Bluetooth System can be activated in the following conditions:
  - Button Activation  
The voice recognition system will be active when the  button is pressed and after the sound of a Beep.
  - Active Listening  
The voice recognition system will be active for a period of time when the Voice Recognition system has asked for a customer response.
- The system can recognize single digits from zero to nine while number greater than ten will not be recognized.
- If the command is not recognized, the system will announce "Pardon" or No input voice signal from microphone. (No response)
- The system shall cancel voice recognition mode in following cases : When pressing the  button and saying cancel following the beep. When not making a call and pressing the  button. When voice recognition has failed 3 consecutive times.

- At any time if you say "help", the system will announce what commands are available.

■ **Menu tree**

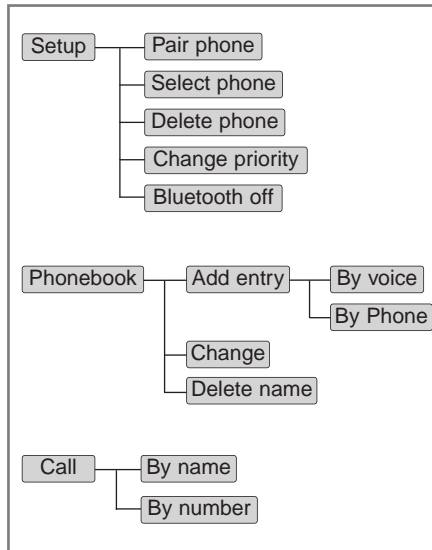

■ **Phone Setup**

• **Pairing phone**

To use the hands-free system, you need to register your phone in the system.

Up to 5 phones can be registered in the system.

1. Press the button.
2. Say "Set Up".
3. Say "Pair Phone".
4. Say "Yes".
5. Say the name of the contact.
6. Say "Yes".
7. The Pairing procedure of the cellular phone varies according to each cellular phone.

**\* NOTICE**

The system may not function in the following cases:

- If 5 phones have already been registered.
- If the system cannot communicate with the phone.

• **To connect phone**

The registered phones can be selected. When the system connects to Bluetooth, the phone previously used is automatically selected.

Select a different phone if necessary. Only the selected phone can be used with the hands-free system.

1. Press the button.
2. Say "Set Up".
3. Say "Select Phone".
4. Say the name of the contact or the number of the contact.
5. Say "Yes".

**When the phone is selected by using the knob:**

Turn the "AUDIO CTRL" knob until "SELECT" is displayed and push the knob.

Turn the "AUDIO CTRL" knob until the desired phone name is displayed and push the knob.

**\* NOTICE**

The system may not function in the following cases:

- If the phone is not found.
- If the system does not recognize the voice command.

### • Deleting phone

The registered phones can be deleted.

1. Press the  button.
2. Say "Set Up".
3. Say "Delete Phone".
4. Say the name of the contact, the number of the contact or "Delete all phone".
5. Say "Yes".

### When the phone is deleted by using the knob:

Turn the "AUDIO CTRL" knob until "DELETE" is displayed and push the knob.

Turn the "AUDIO CTRL" knob until the desired phone name is displayed and push the knob.

### • Changing Priority

The connection priority for registered phones can be changed.

1. Press the  button.
2. Say "Set Up".
3. Say "Change Priority".
4. Say the name of the contact or the number of the contact.
5. Say "Yes".

### When the phone is changed by using the knob:

Turn the "AUDIO CTRL" knob until "PRIORITY" is displayed and push the knob.

Turn the "AUDIO CTRL" knob until the desired phone name is displayed and push the knob.

### • Turning Bluetooth on / off

Bluetooth function can be switched ON/OFF. initial status : Bluetooth ON

1. Press the  button.
2. Say "Set Up".
3. Say "Bluetooth off".
4. Say "Yes".

### • Turning Bluetooth on

1. Press the send or  button.
2. Say "yes".
3. The Bluetooth will be turned on.

### When Bluetooth is off by using the knob:

Turn the "AUDIO CTRL" knob until "BLUETOOTH OFF" is displayed and push the knob. After announcement say "yes" to confirm.

### ■ Phone Book

#### • Adding Entry

Phone numbers and voice tags can be registered. Entries registered in the phone can also be transferred.

#### • Adding Entry by Voice

1. Press the  button.
2. Say "phonebook".
3. Say "add entry".
4. Say "by voice".
5. Say the name of the contact.
6. Say "yes".
7. Say the phone number.
8. Say "store".
9. Say "Home", "Office", "Mobile", "Other" or "default".
10. Say "Yes" to store an additional location for this contact.

#### • Adding Entry by phone

1. Press the  button.
2. Say "phonebook".
3. Say "add entry".
4. Say "by phone".
5. Say "yes".
6. Transfer procedures may vary depending on the cellular phone.

#### \* NOTICE

The system can recognize single digits from zero to nine. Numbers that are ten or greater are not recognized.

To speed up input, it is a good idea to group all digits into a continuous string. However, you can enter each digit individually or group digits together in preferred string lengths.

The display corresponding to each operation appears on the screen as follows:

#### Input operation

1. say: "Nine, nine, five"

Display: "995"

2. say: "Seven, three, four"

Display: "995734"

#### • Changing Name

The registered names can be changed.

1. Press the  button.

2. Say "phonebook".

3. Say "Change name".

4. Say the name of the phonebook [voice tag].

5. Say "yes".

6. Say the name of the phonebook to be changed.

#### • Deleting name

The registered names can be deleted.

1. Press the  button.

2. Say "phonebook".

3. Say "Delete name".

4. Say the name of the contact.

5. Say "yes".

#### ■ Making a phone call

##### • Calling by Name

The system dials the numbers corresponding to the spoken names registered in the system.

1. Press the  button.

2. Say "Call".

3. Say "name".

4. Say "<John>".

6. Say "<at home>".

7. Say "yes".

##### \*Tip

A shortcut to each of the following functions is available.

1. Say "Call name".

2. Say "Call <john>".

3. Say "Call <john at home>".

##### • Dialing by Number

The system will make a phone call by dialing the spoken numbers.

The system can recognize single digits from zero to nine.

1. Press the  button.

2. Say "Call".

3. Say "Number".

4. Say "<digit number>".

5. Say "<added digit number>".

6. Say "Dial".

##### \*Tip

A shortcut to each of the following functions is available.

1. Say "Dial number".

2. Say "Dial <digit>".



### ■ Receiving a phone call

When receiving a phone call, a ring tone is audible and the system changes into telephone mode.

When receiving a phone call, the phone number and the message "Incoming" will be displayed.

- Do either one of the following:  
Press the send switch to take the call.  
Press the end switch to refuse the call.
- To adjust the ring volume, push "+" or "-" on the steering volume controls.  
Volume adjustment cannot be made using the audio system.
- To transfer a call to the phone:  
The received call can be transferred from the hands-free system to the cellular phone that is connected to Bluetooth.  
For details, please refer to your user's manual for the cellular phone or go to the Key matrix in this manual (next page).

### ■ Using the head unit as Bluetooth music

The head unit supports A2DP (Audio Advanced Distribution Profile) and AVRCP (Audio Video Remote Control Profile).

Both profiles are available for listening to the MP3 music via Bluetooth cellular phone supporting above Bluetooth profiles.

To play MP3 music from the Bluetooth cellular phone, press the [AUX] button until the mp3 mode is displayed.

Then try playing music by phone.

When playing music from the Bluetooth cellular phone, the head unit displays MP3 MODE.

### \* NOTICE

- The Bluetooth cellular phones shall feature A2DP and AVRCP functions.
- Some A2DP and AVRCP Bluetooth cellular phones may not play music through the head unit on first try. Please try the below;  
i.e : Menu→File manager→Music→Option→Play via Bluetooth
- Do Please refer to your Bluetooth cellular phone User Guide for more details. To stop music, try stop music by phone then push the FM or CD button.

### ■ Talking on the phone

When talking on the phone, the display will differ depending on whether or not the vehicle is in motion.

Number and "active call" is displayed.



When the call is finished, press the end switch.

### \* NOTICE

In the following situations, your voice may not reach the other party:

1. Talk alternately with the other party on the phone. If you talk at the same time, the voice may not reach each other parties. (This is not a malfunction.) (It is not a malfunction.)
2. Keep the volume of receiving voice to a low level. Otherwise, high volumes may result in an echo. When you talk on the phone, speak clearly towards the microphone.
3. When driving on a rough road.
4. When driving at high speeds.
5. When the window is open.
6. When the air conditioning vents are facing the microphone.
7. When the sound of the air conditioning fan is loud.

■ Key matrix

No.	KEY		Class							
			Paired H/P Empty	Disconnected	Connected		Incoming Call	Outgoing Call	Active Call	2nd Call
					Normal mode	BT SETUP menu				
1		SHORT	Not Paired	Not Connecting	-	-	Accept Call	Call name or number	2nd call 1st Call:waiting 2nd Call:active	2nd Call 2nd Call:waiting 1st Call:active
		LONG	-	-	-	-	-	-	Transfer call:secret call	
2		SHORT	VR MODE Cancel	VR MODE Cancel	VR MODE Cancel	VR MODE Cancel	Reject Call	End Call	End Call	End Call
		LONG [10sec]	-	-	Speaker Adaptation (Only English)	Speaker Adaptation (Only English)	-	-	-	-
3		SHORT	Active	Active	Active	Active	-	-	-	-
		LONG [10sec]	Change language	Change language	Change language	Change language	-	-	-	-

### REAR SEAT ENTERTAINMENT SYSTEM (RSE) (IF EQUIPPED)

D320000AEN

#### Important Safety Information

It is always important to operate your vehicle in a safe manner and to avoid distraction while driving. This manual provides information that will help you safely operate your Rear Seat Entertainment System (RSE). Please read it completely before using the system.

#### This device complies with part 15 of the FCC rules.

Operation is subject to the following two conditions:

1. This device may not cause harmful interference, and
2. This device must accept any interference received, including interference that may cause undesired operation.



#### WARNING

Changes or modifications not expressly approved by the party responsible for compliance could void the user's authority to operate the equipment.

#### Welcome

The Rear Seat Entertainment System is a compact, built-in, easy-to-use entertainment system designed to provide family fun while you are on the road. Enjoy great quality sound from the vehicle speakers, or have a private, quiet listening with the wireless headphones.

The overhead display unit is mounted to the ceiling in the rear passenger area of the vehicle, allowing rear-seat passengers to play DVD movies, video CDs or music CDs. Users may also plug in a game platform or VHS player into an auxiliary input to show the programs through the RSE display. The RSE can also access to the vehicle's front radio programs.

#### System Overview

##### Connections / Setup

Your Rear Seat Entertainment system will play DVD movies, video CDs, music CDs or music MP3 discs, and is designed to make your time on the road more enjoyable. Please follow these instructions carefully to get the most out of your RSE.

#### ! CAUTION

- **Avoid having food or drinks near, in or on the RSE, the wireless headphones or the remote controller.**
- **Direct sunlight may interfere with the headphone's operation and performance.**
- **Normal RSE operation cannot be guaranteed with unofficially duplicated discs.**

*(Continued)*

*(Continued)*

- *To prevent inadvertent vehicle battery discharge when the ignition switch is turned to the ignition ON position or Accessory mode, a battery drain warning message will flash on the RSE monitor screen.*
- *Use of rear seat entertainment system without the engine running will reduce vehicle battery power.*
- *The RSE system is programmed to the assigned DVD format for your region. Please note that your RSE will not read or play DVDs from a different region.*

**\* NOTICE**

The RSE requires a few seconds of set up time after the ignition switch is turned ON or to ACC mode.

Your RSE system is already set up and ready for use, and can be turned on by pushing the **POWER/VOLUME** knob on the RSE control panel or the **POWER ON/OFF** button  on the remote controll. The vehicle's ignition must be turned on or in accessory power mode. The RSE system can also be turned OFF by the Audio Unit.



**Components**

Your RSE consists of several components:

***Monitor (LCD display)***

The **Monitor (LCD display)** where video is viewed, is attached to the ceiling in the rear of the vehicle.



RSE-AUDIO-4

### ***RSE Control Panel***

The **RSE Control Panel**, which includes a digital display and the RSE control buttons, is located in the rear of the armrest console between the front seats.

### ***DVD Player***

The **DVD Player**, where CDs, DVDs and other discs are inserted, is located below the RSE control panel located in the rear of the armrest console between the front seats.



RSE-AUDIO-6

### ***Wireless headphones***

The **Wireless headphones** allows you to hear the audio from the RSE without disturbing other passengers. Two sets, with batteries, are provided.



RSE-AUDIO-7

### ***Remote control***

The **Remote control** allows you to control RSE functions. Batteries are included.



ACT-1

### Opening and Closing the Monitor

To view the monitor, locate the latch on the bottom-center of the ceiling-mounted unit and pull it forward. This will release the monitor from its locked, stow-away position.

Adjust the monitor to the best viewing angle. Do not touch the LCD panel itself to avoid damage or smudging.

### Adjusting the Monitor

Press the **DISP** button on the RSE control panel to adjust the parameters of the monitor. To adjust the brightness, firstly, select the brightness item, then, press the **< REW** (dimmer) or **FF >** (brighter) buttons. The next time the RSE is turned on, the monitor will return to the brightness level it was adjusted to when last used. Brightness can be adjusted regardless of whether the RSE is playing an audio or video source.

While the RSE is playing a video signal, press **DISP** and then press the **^ NEXT** or **∨ PREV** buttons to cycle through other monitor adjustments including **SCREEN SIZE**, **CONTRAST**, **CHROMA** and **HUE**. With any of these settings displayed on the monitor, press the **< REW** or **FF >** buttons to adjust these settings.

To close the monitor, pull the bottom edge towards you and push it up until it clicks and locks into the stow-away position.

### Cleaning the Display

If the LCD display becomes dusty or dirty, clean it by wiping gently with a soft, dry, clean cloth. Do not use chemical cleanser to clean the screen.

### Loading a Disc

To load a disc in the player, insert it part way into the loading slot. The player will automatically grip the disc and pull it the rest of the way in.

### Disc Protection

The player has an Auto-Reload Disc Protection feature to protect discs from accidental damage. If a disc is not removed within 12 seconds after being ejected, it will be pulled back into the player.

### Audio via Vehicle Speakers

To hear the audio from the RSE through the vehicle's speakers, the RSE button (located in the front radio control) must be selected. Regardless of whether RSE audio is selected for the vehicle speakers or not, when the RSE audio is playing it can be heard in the headphones.

### Volume Control

You can adjust the volume of the audio heard in the vehicle speakers from the RSE control panel or the remote control. From the RSE control panel, rotate the **POWER/VOLUME** knob. From the remote control, press "**VOL +**" to increase the volume and "**VOL -**" to decrease the volume.

Adjusting the volume in this way will not affect the wireless headphone volume. To adjust the headphones, turn the **VOL** control wheel on the headphones.



RSE-AUDIO-9

### Headphones

Your RSE comes with two (2) sets of wireless headphones and four (4) AAA 1.5V batteries. To install the batteries, press the button below the battery compartment on the right side of each set of headphones and insert each of the batteries, observing the correct polarity as shown in the headphone battery compartment. Each set of headphones requires two batteries.

To turn the headphones on, push the **POWER** button on the left side of the headphones. Push the button again to turn the headphones off. Adjust the volume by turning the Volume control. The headphones can be adjusted for size, and can be stored more compactly by folding them.

### \* NOTICE

- Conserve the energy of your batteries by turning the headphones off when they are not in use. Headphone batteries will typically work for 48 hours, depending on the volume setting.
  - The headphone has an automatic shutoff feature to extend battery life. The headphones will automatically turn off after 20 seconds if they don't detect a signal from the RSE.
  - In case of poor headphone reception performance, please check the battery condition.
- The headphones perform best when used within 2 - 8 feet (0.6-2 m) of the RSE LCD display. Getting too close or too far away will cause poor reception.
- Audio from the vehicle's CD/radio cannot be heard through the headphones.



### Connecting Other Devices to the RSE

Electronic devices such as video game systems or VHS players can be played through the RSE. These external devices can be connected to the unit via RCA plugs available in the vehicle.

Press the **SOURCE** button on the remote control, or the **SRC** button on the RSE control panel, to select and switch to the external device inputs.

Once the RSE has switched to the external device audio and/or video sources, you can operate the device using its controls. The RSE controls will not control external devices.

For example, to control or play a video game after the RSE has recognized it as the source, you must use the game controls, not the RSE controls.

### ! CAUTION

*Connect only appropriate input sources to the RSE jacks. Be sure to connect audio outputs from the external device to audio inputs in your vehicle, and video outputs to video inputs. Connecting an incorrect input may cause damage to the RSE and/or the external electronic device.*

### \* NOTICE

- To prevent noise, devices connected to the AUX port should have the volume adjusted high.
- If an external power connector is connected to the vehicle, static noise may occur. If noise is heard, verify the AUX device volume is turned up, then test the sound with the power cable disconnected. If necessary, use the AUX device powered from its internal battery, or purchase a ground loop isolator to connect the AUX device to the vehicle.



### RSE Lock Function

Front seat passengers can use the RSE Lock function to prevent rear seat passengers from operating the RSE. To lock the RSE, press and hold the CD/AUX button on the vehicle radio for more than 2 seconds.

"Lock" will appear on the RSE LCD display, as well as on the RSE control panel. None of the RSE control panel or remote controller buttons will function while the RSE is locked. Rear seat passengers will still be able to eject or insert a disc in the player, as well as power on/off the system.

Press and hold the CD/AUX button again to turn off the RSE lock.



RSE-AUDIO-10

### Battery Discharge Warning

To prevent inadvertent vehicle battery discharge when the ignition switch is turned to the ignition ON position or ACC mode, a battery drain warning message will flash on the RSE monitor screen.

## RSE Control Panel Operation

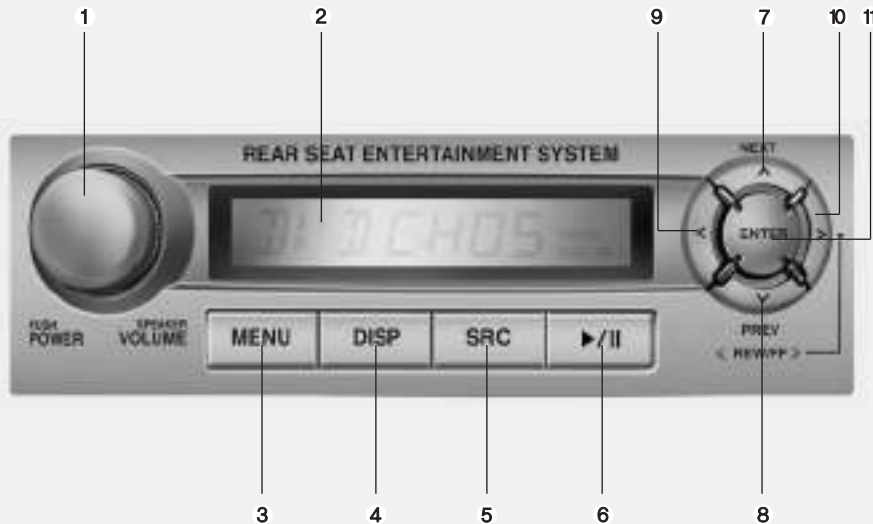

1. ON/OFF and Speaker Volume
2. RSE Display
3. MENU Button
4. DISP (Display) Button
5. SRC (Source) Button
6. Play/Pause Button
- 7 - 11 ^Next / vPrev (Next/Previous) and < REW/FF > (Rewind/Fast Forward) and ENTER Buttons

RSE-EN001

Most RSE functions are available through the RSE control panel.

### 1. ON/OFF and Speaker Volume

Press the **POWER/VOLUME** knob to turn the RSE on or off.

Rotate the knob to adjust the speaker volume. Note that changing the volume by using the **POWER/VOLUME** knob affects only the vehicle speakers. The wireless headset volume is not affected. See the "Headphones" section of this manual for more information.

### 2. RSE Display

This RSE control panel display indicates the current selected source, mode of operation in the current disc, and other information. It will display FRONT to indicate that the selected source is the front vehicle radio and REAR to indicate that the RSE player is the current source. The display will indicate DISC IN when a disc is in loaded the RSE player.

### 3. MENU Button

DVD can be controlled, and any special programming or features accessed, by using the DVD menu. To access the menu while playing a DVD, press the MENU button. Press the button a second time to exit the menu and return to the DVD program at the point it was being viewed.

While viewing the menu, press the  $\wedge$  **NEXT** button to move the cursor up and the  $\vee$  **PREV** button to move the cursor down the menu. Press the **FF >** button to move the cursor to the right, and the **< REW** button to move the cursor to the left.

※ For more details, see the "DVD - Menu" section of this manual.

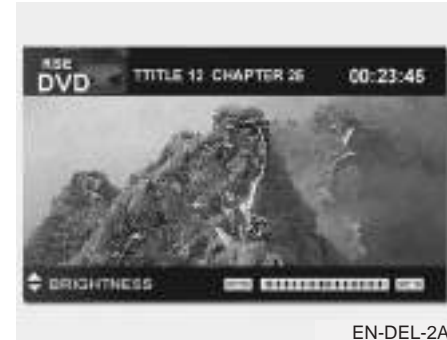

### 4. DISP (Display) Button

Pressing **DISP** enables you to adjust the parameters of the LCD monitor. For more information on how to make these adjustments, see the "Display" section of this manual.



RSE-CM07A

### 5. SRC (Source) Button

After inserting a disc in the RSE, it will automatically use that as the source and begin playing that disc. The RSE control panel will display "DISC IN" when there is disc loaded in the player.

Pressing the **SRC** button will bring out the Source Change Operation. All available modes are presented. You can select any available mode by using the four direction arrow buttons and press the **ENTER** button for completing the selection.

While the RSE is selected as the source by the front vehicle radio, the front vehicle radio will be able to control some RSE functions (e.g. Fast Forward / Reverse, Previous / Next Track, etc.). See your vehicle radio user manual for more information.

### \* NOTICE

When switching from the vehicle radio to the RSE, there is a slight delay while the RSE initializes. The RSE control panel will display "READ" while the disc initializes, then begin playing the disc.

The RSE control panel will display "REAR" if the current source is the RSE player, "FRONT" if the current source is the front vehicle radio and "AUX" if the current source is an auxiliary input.

### 6. Play/Pause Button

You do not need to press the **PLAY/PAUSE**  button after loading a disc to begin playing the disc. The player will start playing automatically.

While a disc is playing, press  to pause. While paused, the elapsed time of the current disc will blink on the monitor status display, and "PAUSE" will be displayed on the RSE control panel. Press the button again to resume play.

### \* NOTICE

The RSE will enter standby mode when the vehicle ignition is turned off. When the vehicle is turned back on within 30 seconds, the RSE will turn on and the DVD/VCD will automatically begin playing again at the point where it paused. If the vehicle is turned off for longer than 30 seconds, the RSE system will not turn on automatically when the vehicle is restarted.

### 7 - 11 **^Next / \Prev (Next/Previous)** **and <REW/FF> (Rewind/Fast Forward) and ENTER Buttons**

The **^NEXT/^PREV** and **<REW/FF>** buttons provide a variety of functions, depending on the media currently being played in the RSE or the source selected. For some of the functions, you will use these buttons to navigate to the desired location or option, then press the **ENTER** button in the center to confirm your selection.

For specific information about using these buttons, see the appropriate section for the various media types in this manual.

### **DVD/VCD Player Operation**

#### *Disc/Format Compatibility*

Your RSE player accepts and plays all DVDs in 4:3 (normal) and 16:9 (widescreen) video formats. With DVDs that offer multiple formats, the default format is 16:9 and will stay that way unless changed by the user. See "Adjusting the Monitor" to learn how to adjust the format.

The DVD player has the capability to play DVD-Video, DVD-R, DVD-RW, CD-DA, CD-R, CD-RW and VCD.

The DVD player was factory programmed with a region code for the assigned market or country. If a DVD is inserted for a region code that doesn't match with the player, an error message will be shown on the overhead monitor and the RSE control panel display.

### **\* NOTICE**

Because there is no universal standard for DVD/VCD programming, your disc may behave differently. Some DVDs may present warning messages about unauthorized duplication, some will go directly to a menu, some may have different on-disc menu and start playing the movie immediately, and some may be unreadable or damaged and an error message will be shown on the monitor.

### **\* NOTICE**

While the player will accept DVD ROM and CD ROM discs, the RSE cannot play discs in these formats.

The player is only capable of reading the bottom side of a disc. When inserting a single-sided disc, the label side should be up. When inserting a two-sided disc, the desired play side should be down.

Press DISP on the RSE control panel or the remote controller, then press the  $\wedge$  **NEXT** or  $\vee$  **PREV** buttons to cycle through monitor adjustments (SCREEN SIZE, BRIGHTNESS, CONTRAST, CHROMA, HUE). When the adjustment for the SCREEN SIZE, use the **< REW** or **FF >** buttons to select the preferred screen size.

### **Menu**

DVDs can be controlled, and any special programming or features accessed, by using the menu. To access the menu while playing a DVD, press the MENU button. Press the button a second time to exit the menu and return to the DVD program at the point it was being viewed. The menu is not available during disc initialization, the beginning credits or any copyright and FBI warnings.

While viewing the menu, press the  $\wedge$  **NEXT** button to move the cursor up and the  $\vee$  **PREV** button to move the cursor down the menu. Press the **FF >** button to move the cursor to the right, and the **< REW** button to move the cursor to the left.

### **\* NOTICE**

**You must repeatedly push any button to move through several items. Pressing and holding a button will not advance the cursor beyond the first item. Press ENTER or Play/Pause to select the desired menu choice.**

### **Playing a DVD/VCD**

You can control your DVD or VCD by using the buttons on the RSE control panel or by using the remote control. Instructions for the controls listed below are the same whether using the RSE control panel or the remote control. However, there are some additional functions that are only available from the remote control. These buttons and their functions are discussed in the "Remote Control" section of this manual.

### **Play/Pause Button**

You do not need to press the **PLAY/PAUSE** button after loading a disc to begin playing the disc. The player will start playing automatically.

While a disc is playing, press **PLAY/PAUSE** to pause. While paused, the elapsed time of the current disc will blink on the monitor status display, and "PAUSE" will be displayed on the RSE control panel. Press the button again to resume play.

### **\* NOTICE**

The RSE will enter standby mode when the vehicle ignition is turned off. When the vehicle is turned back on within 30 seconds, the RSE will turn on and the CD will automatically begin playing again at the point where it paused. If the vehicle is turned off for longer than 30 seconds, the RSE system will not turn on automatically when the vehicle is restarted.

### **Fast Forward/Reverse**

Press and hold the **FF >** or **< REW** button and the player will fast forward or reverse at 32 times the normal speed. Release the **FWD >** or **< REW** button to return to normal speed play.

### **Previous/Next Chapter**

While a DVD/VCD is playing, press the **^ NEXT** button to skip to the next chapter. Press the **v PREV** button to jump to the beginning of the current chapter. Press **v PREV** again to go move through earlier chapters. Press the button repeatedly to move quickly through chapters.

### **\* NOTICE**

Some VCDs do not have track information. If the VCD has no chapter information, pressing either of these buttons will restart the VCD.

While pressing the **^ NEXT** or **v PREV** buttons, the Status Display, including the current medium (DVD or VCD), chapter and title information is displayed. It will automatically disappear after five seconds.

### **\* NOTICE**

**Some DVDs do not permit chapter navigation.**

Instead of using the **v PREV / ^ NEXT** buttons, you can also enter the chapter number using the numbers on the remote controller. While a DVD/VCD is playing, press the number button(s) that correspond to the desired chapter and press **ENTER**.

### ***Stop a Disc***

The disc will automatically stop when any other source (e.g. the vehicle radio or an external game) is selected. When you switch back to the DVD, it will begin playing at the point where it stopped.

While the player is running, press the RSE control panel **POWER/VOLUME** knob, or the **POWER ON/OFF** button  on the remote control, to stop a disc and turn off the RSE system and the DVD player. When the RSE is turned on again, the disc will begin playing at the point where it stopped.

### ***Eject a Disc***

To eject a disc press the  button. A disc can be ejected even when the unit is not turned on.

#### **\* NOTICE**

The player has an **Auto-Reload Disc Protection** feature to protect discs from accidental damage. If a disc is not removed within 12 seconds after being ejected, it will be pulled back into the player.

### **CD Player Operation**

The RSE will play audio CDs in both standard (12 cm) and mini-disc (8 cm) format.

#### **\* NOTICE**

While the player will accept DVD ROM and CD ROM discs, the RSE cannot play discs in these formats.



### **Volume Control**

You can adjust the volume of the audio heard in the vehicle speakers from the RSE control panel or the remote control. From the RSE control panel, rotate the **POWER/VOLUME** knob. From the remote control, press "**VOL +**" to increase and "**VOL -**" to decrease the volume.

Adjusting the volume in this way will not adjust the wireless headphone volume. To adjust the headphones, roll the **VOL** control wheel.

### **Play/Pause**

When a CD is inserted, the RSE will automatically begin playing the first track. Press the **PLAY/PAUSE** button  to pause the CD. Press the button again to resume play. While paused, the elapsed time in the status display at the top of the monitor will blink. The RSE control will display "PAUSE."

When the player reaches the end of the disc, the player will automatically return to the first track and continue playing.

### **Fast Forward / Reverse**

Press and hold the **FF >** or **< REW** button and the player will fast forward or reverse at 10 times the normal speed. Release the button to return to normal speed play.

The audio is muted while the player fast forwards or fast reverses.

### **Previous/Next Track**

While a CD is playing, press the **∨ PREV** button to jump to the beginning of the current track. If less than 10 seconds has elapsed on the current track, pressing **∨ PREV** will go to the previous track. Press the button repeatedly to continue moving through previous tracks.

Press the **∧ NEXT** button to jump to the beginning of the next track. Press the button repeatedly to continue moving through the following tracks.

Instead of using the **∨ PREV / ∧ NEXT** buttons, you can also enter the track number using the numbers on the remote control. While a CD is playing, press the number button(s) that correspond to the desired track and press **ENTER**.

The current track number is shown in the Status Display at the top of the monitor.

### **Stop**

The CD will automatically stop when any other source (e.g. the vehicle radio or an external game) is selected. When you switch back to the CD, it will begin playing at the point where it stopped.

While a CD is playing, you can stop the CD by pressing the **POWER ON/OFF** button  on the remote control or the **POWER/VOLUME** knob on the RSE control panel. When the RSE is turned on again, it will automatically begin playing the CD at the point where it was stopped.

Turning the vehicle off, or selecting a different RSE Source, will also stop playing the CD.

### **Eject**

Press the **EJECT** button  to eject the CD. Discs can be ejected even when the unit is not turned on.

## Using the MP3 Player

Most RSE functions work the same for audio CDs and MP3 discs. The major difference is that audio CDs are organized by "tracks," while MP3 discs are organized using folders and files. Therefore, the navigation functions are somewhat different for MP3 discs.

### \* NOTICE

**While the player will accept DVD ROM and CD ROM discs, the RSE cannot play discs in these formats.**

### *Pause/Play*

When an MP3 disc is inserted, the RSE will automatically begin playing the first file in the disc. Press the **PLAY/PAUSE**  button to pause the file. Press the button again to resume play. While paused, the elapsed time in the status display at the top of the monitor will blink. The RSE control panel will display "PAUSE."

At the end of the disc, the player will automatically return to the first file and continue playing.

### *Fast Forward/Reverse*

Press and hold the **FF >** or **< REW** button and the player will fast forward or reverse at 10 times the normal speed. Release the button to return to normal speed play.

The audio is muted while the player fast forwards or fast reverses.

### *Song List : Navigating Folders and Files*

MP3 discs are organized by named folders, with each folder containing a collection of named music files. You can quickly navigate through the folders and files using the Song List function.

Press the **MENU** button on the RSE control panel or remote control to display the song list. The focused song will be highlighted. And the music note icon appears to left of the song currently playing.

To navigate through the folders, press the **< REW** or **FF >** button to highlight the **FOLDER UP, FOLDER DOWN,** or **HOME** buttons on the monitor, the press **ENTER** to move up or down the folders. Press **ENTER** repeatedly to move through all the folders.

When you reach the desired folder, press the **∨** **PREV** or **∧** **NEXT** buttons to scroll through the list of files in that folder and press **ENTER** to select the desired file. The player will switch to the selected folder and begin playing the desired file.

## Features of your vehicle

Selecting the HOME button on the display and pressing **ENTER** will bring the Song List to the screen with the song currently playing.

Press **MENU** again to leave the Song List. The Song List will automatically disappear after five seconds if no buttons are pressed.

While in normal play mode, press the **A.LANG (FOLD-)** button at any time to jump to the first file in the previous folder, press **S.TITLE (FOLD+)** to jump to the first file in the next folder.



### *Previous/Next File*

While a disc is playing, press the **PREV** button to jump to the beginning of the current file. If less than 10 seconds has elapsed on the current file, pressing **PREV** will go to the previous file. Press it again to select previous files. Press the button repeatedly to continue moving through previous files.

Press the **NEXT** button to jump to the beginning of the next file. Press the button repeatedly to continue moving through the following files.

The current folder name and file name are shown in the Status Display at the top of the monitor.

### Stop

The disc will automatically stop when any other source (e.g. the vehicle radio or an external game) is selected. When you switch back to the disc, it will begin playing at the point where it stopped.

While a disc is playing, you can stop the disc by pressing the **POWER ON/OFF** button  on the remote control or the **POWER/VOLUME** knob on the RSE control panel. When the RSE is turned on again, it will automatically begin playing the disc at the point where it was stopped.

Turning the vehicle off, or selecting a different RSE Source, will also stop playing the disc. When the vehicle is turned on again, or the disc is again selected as the source, the disc will begin playing at the point where it was stopped. The player will automatically resume play at the point where it was stopped unless the disc is ejected.

### Eject

Press the **EJECT** button  to eject the disc. Discs can be ejected even when the unit is not turned on.



### Using the satellite radio

All the preset channels have been listed on this SDAR operation interface. You can use the **FF** or **<REW** button to select the preset station. Press the **ENTER** button to will complete this selection. After the desired station has been selected, the information of this station will list in the information display area.

Also you can select the **CATEGORY** or **CHANNEL** function by using **FF>** and **<REW** buttons. After the focus locates at the **CATEGORY** or **CHANNEL** icon, pressing the **^** **NEXT** or **∨** **PREV** button will activate the category up or down, channel up or down function. When the focus on the **CATEGORY**, if you press the **ENTER** button and move the focus on the **CHANNEL** icon, you can select the channel up or down function in the current category by pressing the **^** **NEXT** or **∨** **PREV** buttons.

Move the focus on the **SCAN** icon, you can activate the scan function by pressing the **ENTER** button. If meantime, the **CATEGORY** icon been highlighted, above operation will activate the scan function in the current category.

### Listening to the Vehicle Radio

To control the vehicle radio from the RSE control panel or remote control, press the **SOURCE** button on the remote control or the **SRC** button on the RSE control panel, then select the desired play mode on the source change operation. Finally, press the **ENTER** button to complete the selection.

The RSE monitor status display and the RSE control panel will indicate the selected source.

### Tuning a Station

While the vehicle radio is the current source, press the **^** **NEXT** or **∨** **PREV** button on the RSE control panel or remote control once to search up or down for the next available station. When the tuner finds a station it will stop at the station and start to play.

Press the **^** **NEXT** or **∨** **PREV** button to seek up or down through all radio stations. When the radio finds a station, it will stop and play that station.

Press the **FF >** or **< REW** button to manually tune up or down one channel. Press and hold the **FF >** or **< REW** button to continue tuning up or down.

Pressing a number on the remote control keypad will tune to the corresponding preset station. For example, if 89.7 has been stored as preset 1 (CH1), then pressing the 1 button on the keypad will tune to that station.

### ***AM, FM1 and FM2 Selection***

When you press the **SOURCE** button, the Source Selection UI will come out, along with the current available mode. You can select the Radio mode by the remote controller. After pressing the **ENTER** button, both RSE and front Radio will play your selection station at the same time.

All of the RSE control panel and remote controller navigation functions can be used to control the front radio when the vehicle front radio is also playing the same radio mode.

### **Viewing Front CD and MP3 Programs**

The RSE can be used to control discs that are loaded and playing in the vehicle radio. To control these discs, you must first select the vehicle radio as the source. Press the **SOURCE** button on the remote control, or the **SRC** button on the RSE control panel. Meanwhile, the Source Change UI will bring out. Use the four direction arrow buttons to select the source of vehicle radio. And press the **ENTER** button for completing the selection.

### ***CD/CD-MP3 Control***

While the vehicle radio is playing a CD or MP3 audio disc, all of the RSE control panel and remote control navigation functions can be used to control the vehicle radio. This includes:

- Pause/Play
- Fast Forward/Reverse
- Previous/Next Track (CD) and Previous/Next File (MP3)

See these sections of the Users Manual for information on using these functions.

All of the RSE control panel and remote control navigation functions can be used to control the front radio when the vehicle front radio is also playing the CD or CD-MP3 mode.

### **AUX Audio and Video Input Controls**

This allows you to display the video output on the RSE monitor, and listen to the audio through the wireless headsets and the vehicle speakers.

To switch to an external auxiliary device, press the **SOURCE** button on the remote control or **SRC** on the RSE control panel, then select the AUX icon button. And press the **ENTER** button for completing.

### Using the Remote Control



RSE-EN004-RE

In addition to buttons and functions available from the RSE control panel, the remote control has several additional buttons and operation control functions. The remote control is an infrared device and should be pointed at the RSE monitor for best results.

**1. POWER On/Off** 

Press the RSE control panel **POWER** button or the **POWER ON/OFF** button  on the remote control to turn the RSE on or off. If a disc is loaded and playing when the RSE is turned off, when the RSE is turned back on the disc will automatically resume playback at the point where it was stopped.

**2. Mute** 

Press the **MUTE** button to mute the audio in the vehicle speakers. The **MUTE** button has no effect on the wireless headphones.

While muted, the RSE control panel, vehicle radio and RSE monitor will all display "**MUTE**." Press the button again, or adjust the volume at RSE control panel or vehicle radio, to un-mute the audio.

**3. Number Buttons** 

The number buttons (**0 through 9**) can be used to directly enter information such as chapters in a DVD, track or file numbers for audio CDs, and preset radio.

To select a DVD or VCD chapter, while a DVD/VCD is playing, press the number button(s) that correspond to the desired chapter and press **ENTER**.

To select a CD track, while a CD is playing press the number button(s) that correspond to the track and press **ENTER**.

To select an MP3 file, while an MP3 disc is playing, press the number button(s) that correspond to the desired file and press **ENTER**.

To select a radio station preset, while the desired band (AM, FM1 or FM2) is selected, press the numbered button that corresponds to the preset on the vehicle radio. There is no need to press **ENTER**.

**4. Source** 

Pressing this **SOURCE** button will bring out the Source Change selection operation. You can select any available mode by using the four direction arrow buttons and press the **ENTER** button for completing the selection.

The RSE control panel will display "REAR" if the current source is the RSE player, and will display "FRONT" if the current source is the vehicle radio.

**5. A.LANG - Alternate Language Folder** 

Where alternate languages are available on a DVD, pressing the **A.LANG** button will allow you to select your preferred language. Press the button repeatedly to cycle through the available languages. When the desired language is displayed, press **ENTER**.

Pressing the **A.LANG** (or **FOLD-**) button during MP3 normal play will immediately bring the player to the first file of the previous folder.

Pressing the **A.LANG** (or **FOLD-**) button during CD or VCD play will do nothing.



### 6. S.Title - Subtitles, Folders +

The S.TITLE button allows you to display or remove language subtitles while playing DVDs. If no language subtitles are available, the display will show an invalid icon. Press the **S. TITLE** button repeatedly to cycle through all of the available languages.

Pressing the **S. TITLE** (or **FOLD+**) button during MP3 normal play will immediately bring the player to the first file of the next folder.

Pressing the **S. TITLE** (or **FOLD+**) button during CD or VCD play will do nothing.

### 7. Menu

Pressing the **MENU** button during DVD play will present the DVD menu.

Pressing the **MENU** button during MP3 disc play will display the Song List on the monitor.

Pressing the **MENU** button during CD or VCD play has no effect.

Press the button again to return to the program. After five seconds with no button press, the menu will automatically close and the program begin playing.

### 8. Title/PBC

While viewing a DVD, press the **TITLE** button on the remote control to jump to the top menu. Press the **< REW / FF >** or **∨ PREV / ^ NEXT** buttons to highlight the desired selection, then press ENTER to make your selection.

Press TITLE again to return to the DVD.

While viewing a VCD, pressing the **TITLE/PBC** button will switch the **PBC** function on and off.

### 9. Return

While viewing any operation, pressing the **RETURN** button will exit the current operation on screen display and resume last play.

### 10. Speaker Volume "VOL +" and "VOL -"

If the audio from the RSE is being played through the vehicle speakers, you can adjust the volume of the speakers with the **"VOL +"** and **"VOL -"** buttons. Adjusting the volume in this way will not adjust the wireless headphone volume. To adjust the headphones, roll the **VOL** control wheel.

## Batteries

The remote control requires a CR2025 battery (included).

## Troubleshooting

Problem	Possible causes / solutions
The disc is automatically pulled back into the player.	The Auto-Reload Disc Protection feature pulls discs back into the player after 12 seconds to protect them from accidental damage. Press the <b>Eject</b> button to release the disc from the player.
The disc becomes stuck or blocked.	Press the <b>Eject</b> button to release the disc. The player will attempt to eject the disc up to three times before performing the Auto-Reload function. Once the Auto-Reload function is complete, press the <b>Eject</b> button again to try to release the disc from the player.
There is no audio in the headphones.	Verify that the headphone is equipped with batteries, and that the batteries are in good condition. Insert or replace 2 AAA batteries to resume headphone function.
The RSE does not work.	<p>Press the <b>PLAY</b> button. If the display does not show "NO DISC," then there is no power.</p> <p>Check the power connection.</p> <p>Check the fuse.</p> <p>Turn the vehicle ignition off and back on to reset the RSE.</p> <p>If the RSE still does not work, contact your HYUNDAI dealer.</p>
The remote control does not work.	<p>Make sure you are pointing the remote control at the face of the RSE at a 45° angle.</p> <p>Change the battery. [Device requires one (1) CR2025 battery.]</p> <p>Use the control buttons on the RSE display panel.</p> <p>If the remote control still does not work, contact your HYUNDAI dealer.</p>

**Before driving / 5-3**  
**Key positions / 5-4**  
**Starting the engine / 5-5**  
**Manual transaxle / 5-7**  
**Automatic transaxle / 5-10**  
**All wheel drive (AWD) / 5-16**  
**Brake system / 5-23**  
**Cruise control system / 5-33**  
**Economical operation / 5-37**  
**Special driving conditions / 5-39**  
**Winter driving / 5-43**

## Driving your vehicle

**5**

**Trailer towing / 5-47**  
**Vehicle load limit / 5-56**  
**Vehicle weight / 5-60**

### **WARNING - ENGINE EXHAUST CAN BE DANGEROUS!**

Engine exhaust fumes can be extremely dangerous. If, at any time, you smell exhaust fumes inside the vehicle, open the windows immediately.

- **Do not inhale exhaust fumes.**

Exhaust fumes contain carbon monoxide, a colorless, odorless gas that can cause unconsciousness and death by asphyxiation.

- **Be sure the exhaust system does not leak.**

The exhaust system should be checked whenever the vehicle is raised to change the oil or for any other purpose. If you hear a change in the sound of the exhaust or if you drive over something that strikes the underneath side of the vehicle, have the exhaust system checked as soon as possible by an authorized HYUNDAI dealer.

- **Do not run the engine in an enclosed area.**

Letting the engine idle in your garage, even with the garage door open, is a hazardous practice. Never run the engine in your garage any longer than it takes to start the engine and back the vehicle out.

- **Avoid idling the engine for prolonged periods with people inside the vehicle.**

If it is necessary to idle the engine for a prolonged period with people inside the vehicle, be sure to do so only in an open area with the air intake set at "Fresh" and fan operating at one of the higher speeds so fresh air is drawn into the interior.

If you must drive with the tailgate open because you are carrying objects that make this necessary:

1. Close all windows.
2. Open side vents.
3. Set the air intake control at "Fresh", the air flow control at "Floor" or "Face" and the fan at one of the higher speeds.

To assure proper operation of the ventilation system, be sure the ventilation air intakes located just in front of the windshield are kept clear of snow, ice, leaves or other obstructions.

**CALIFORNIA PROPOSITION 65 WARNING**

Engine exhaust and a wide variety of automobile components and parts, including components found in the interior furnishings in a vehicle, contain or emit chemicals known to the State of California to cause cancer and birth defects and reproductive harm. In addition, certain fluids contained in vehicles and certain products of component wear contain or emit chemicals known to the State of California to cause cancer and birth defects or other reproductive harm.

**BEFORE DRIVING**

E020100AUN

**Before entering vehicle**

- Be sure that all windows, outside mirror(s), and outside lights are clean.
- Check the condition of the tires.
- Check under the vehicle for any sign of leaks.
- Be sure there are no obstacles behind you if you intend to back up.

E020200AUN

**Necessary inspections**

Fluid levels, such as engine oil, engine coolant, brake fluid, and washer fluid should be checked on a regular basis, with the exact interval depending on the fluid. Further details are provided in Section 7, "Maintenance".

E020300AUN

**Before starting**

- Close and lock all doors.
- Position the seat so that all controls are easily reached.
- Adjust the inside and outside rearview mirrors.

- Be sure that all lights work.
  - Check all gauges.
  - Check the operation of warning lights when the ignition switch is turned to the ON position.
  - Release the parking brake and make sure the brake warning light goes out.
- For safe operation, be sure you are familiar with your vehicle and its equipment.

**WARNING**

All passengers must be properly belted whenever the vehicle is moving. Refer to "Seat belts" in section 3 for more information on their proper use.

**WARNING**

Always check the surrounding areas near your vehicle for people, especially children, before putting a vehicle into D (Drive) or R (Reverse).

## KEY POSITIONS

**⚠ WARNING - Driving under the influence of alcohol or drugs**

Drinking and driving is dangerous. Drunk driving is the number one contributor to the highway death toll each year. Even a small amount of alcohol will affect your reflexes, perceptions and judgement. Driving while under the influence of drugs is as dangerous or more dangerous than driving drunk.

You are much more likely to have a serious accident if you drink or take drugs and drive.

If you are drinking or taking drugs, don't drive. Do not ride with a driver who has been drinking or taking drugs. Choose a designated driver or call a cab.

**⚠ WARNING**

When you intend to park or stop the vehicle with the engine on, be careful not to depress the accelerator pedal for a long period of time. It may overheat the engine or exhaust system and cause fire.



OCM050001

E030100AFD

### Illuminated ignition switch (if equipped)

Whenever a front door is opened, the ignition switch will be illuminated for your convenience, provided the ignition switch is not in the ON position. The light will go off immediately when the ignition switch is turned on or go off after about 30 seconds when the door is closed.



OCM050002

### Ignition switch position

E030201AUN

#### **LOCK**

The steering wheel locks to protect against theft. The ignition key can be removed only in the LOCK position. When turning the ignition switch to the LOCK position, push the key inward at the ACC position and turn the key toward the LOCK position.

E030202AFD

**ACC (Accessory)**

The steering wheel is unlocked and electrical accessories are operative.

**\* NOTICE**

If difficulty is experienced turning the ignition switch to the ACC position, turn the key while turning the steering wheel right and left to release the tension.

E030203AUN

**ON**

The warning lights can be checked before the engine is started. This is the normal running position after the engine is started.

*Do not leave the ignition switch ON if the engine is not running to prevent battery discharge.*

E030204AUN

**START**

Turn the ignition key to the START position to start the engine. The engine will crank until you release the key; then it returns to the ON position. The brake warning lamp can be checked in this position.

** WARNING - Ignition key**

- Never turn the ignition switch to LOCK or ACC while the vehicle is moving. This would result in loss of directional control and braking function, which could cause an accident.
- The anti-theft steering column lock is not a substitute for the parking brake. Before leaving the driver's seat, always make sure the shift lever is engaged in 1<sup>st</sup> gear for the manual transaxle or P (Park) for the automatic transaxle, set the parking brake fully and shut the engine off. Unexpected and sudden vehicle movement may occur if these precautions are not taken.
- Never reach for the ignition switch, or any other controls through the steering wheel while the vehicle is in motion. The presence of your hand or arm in this area could cause a loss of vehicle control, an accident and serious bodily injury or death.
- Do not place any movable objects around the driver's seat as they may move while driving, interfere with the driver and lead to an accident.

**STARTING THE ENGINE**** WARNING**

Always wear appropriate shoes when operating your vehicle. Unsuitable shoes (high heels, ski boots, etc.) may interfere with your ability to use the brake and accelerator pedal, and the clutch (if equipped).

E040100AUN

1. Make sure the parking brake is applied.
2. **Manual Transaxle** - Depress the clutch pedal fully and shift the transaxle into Neutral. Keep the clutch pedal and brake pedal depressed while turning the ignition switch to the start position.

**Automatic Transaxle** - Place the transaxle shift lever in P (Park). Depress the brake pedal fully.

*You can also start the engine when the shift lever is in the N (Neutral) position.*

3. Turn the ignition switch to START and hold it there until the engine starts (a maximum of 10 seconds), then release the key.
4. In extremely cold weather (below 0°F / -18°C) or after the vehicle has not been operated for several days, let the engine warm up without depressing the accelerator.

*Whether the engine is cold or warm, it should be started **without depressing the accelerator.***

### **! CAUTION**

***If the engine stalls while you are in motion, do not attempt to move the shift lever to the P (Park) position. If traffic and road conditions permit, you may put the shift lever in the N (Neutral) position while the vehicle is still moving and turn the ignition switch to the START position in an attempt to restart the engine.***

### **! CAUTION**

***Do not engage the starter for more than 10 seconds. If the engine stalls or fails to start, wait 5 to 10 seconds before re-engaging the starter. Improper use of the starter may damage it.***



## MANUAL TRANSAXLE (IF EQUIPPED)

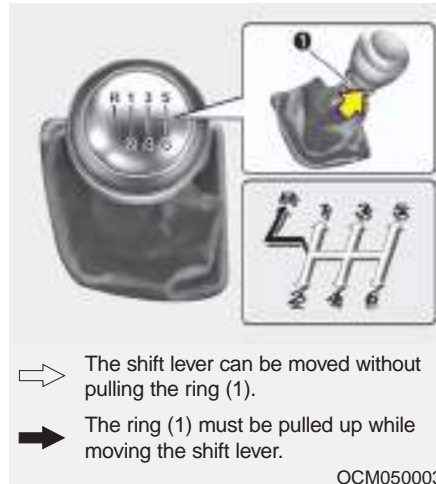

- The shift lever can be moved without pulling the ring (1).
- ➔ The ring (1) must be pulled up while moving the shift lever.

OCM050003

E050000AUN

E050100AUN

### Manual transaxle operation

The manual transaxle has 6 forward gears.

This shift pattern is imprinted on the shift knob. The transaxle is fully synchronized in all forward gears so shifting to either a higher or a lower gear is easily accomplished.

Press the clutch pedal down fully while shifting, then release it slowly.

The gearshift lever must be returned to the neutral position before shifting into R (Reverse). The ring (1) located immediately below the shift knob must be pulled upward while moving the shift lever to the R position.

*Make sure the vehicle is completely stopped before shifting into R (Reverse). Never operate the engine with the tachometer (rpm) in the red zone.*

### ! CAUTION

- *When downshifting from fifth gear to fourth gear, caution should be taken not to inadvertently press the gear shift lever sideways in such a manner that second gear is engaged. Such a drastic downshift may cause the engine speed to increase to the point that the tachometer will enter the red-zone. Such over-revving of the engine may possibly cause engine damage.*
- *Do not downshift more than 2 gears or downshift the gear when the engine is running at high speed (5,000 RPM or higher). Such a downshifting may damage the engine.*

- During cold weather, shifting may be difficult until the transaxle lubricant has warmed up. This is normal and not harmful to the transaxle.
- If you've come to a complete stop and it's hard to shift into 1st or R(Reverse), put the shift lever in N(Neutral) position and release the clutch. Press the clutch pedal back down, and then shift into 1st or R(Reverse) gear position.

### ! CAUTION

- *To avoid premature clutch wear and damage, do not drive with your foot resting on the clutch pedal. Also, don't use the clutch to hold the vehicle stopped on an uphill grade, while waiting for a traffic light, etc.*
- *Do not use the shift lever as a handrest during driving, as this can result in premature wear of the transaxle shift forks.*

### WARNING

- **Before leaving the driver's seat, always set the parking brake fully and shut the engine off. Then make sure the transaxle is shifted into 1st gear when the vehicle is parked on a level or uphill grade, and shifted into R (Reverse) on a downhill grade. Unexpected and sudden vehicle movement can occur if these precautions are not followed in the order identified.**
- **If your vehicle has a manual transaxle not equipped with a ignition lock switch, it may move and cause a serious accident when starting the engine without depressing the clutch pedal while the parking brake is released and the shift lever not in the N (Neutral) position.**

E050101AUN

### ***Using the clutch***

The clutch should be pressed all the way to the floor before shifting, then released slowly. The clutch pedal should always be fully released while driving. Do not rest your foot on the clutch pedal while driving. This can cause unnecessary wear. Do not partially engage the clutch to hold the vehicle on an incline. This causes unnecessary wear. Use the foot brake or parking brake to hold the vehicle on an incline. Do not operate the clutch pedal rapidly and repeatedly.

E050102AUN

### ***Downshifting***

When you must slow down in heavy traffic or while driving up steep hills, downshift before the engine starts to labor. Downshifting reduces the chance of stalling and gives better acceleration when you again need to increase your speed. When the vehicle is traveling down steep hills, downshifting helps maintain safe speed and prolongs brake life.

E050200AUN

## Good driving practices

- Never take the vehicle out of gear and coast down a hill. This is extremely hazardous. Always leave the vehicle in gear.
- Don't "ride" the brakes. This can cause them to overheat and malfunction. Instead, when you are driving down a long hill, slow down and shift to a lower gear. When you do this, engine braking will help slow down the vehicle.
- Slow down before shifting to a lower gear. This will help avoid over-revving the engine, which can cause damage.
- Slow down when you encounter cross winds. This gives you much better control of your vehicle.
- Be sure the vehicle is completely stopped before you attempt to shift into reverse. The transaxle can be damaged if you do not. To shift into reverse, depress the clutch, move the shift lever to neutral, wait three seconds, then shift to the reverse position.
- Exercise extreme caution when driving on a slippery surface. Be especially careful when braking, accelerating or shifting gears. On a slippery surface, an abrupt change in vehicle speed can cause the drive wheels to lose traction and the vehicle to go out of control.

### **WARNING**

- **Always buckle-up! In a collision, an unbelted occupant is significantly more likely to be seriously injured or killed than a properly belted occupant.**
- **Avoid high speeds when cornering or turning.**
- **Do not make quick steering wheel movements, such as sharp lane changes or fast, sharp turns.**
- **The risk of rollover is greatly increased if you lose control of your vehicle at highway speeds.**
- **Loss of control often occurs if two or more wheels drop off the roadway and the driver oversteers to reenter the roadway.**
- **In the event your vehicle leaves the roadway, do not steer sharply. Instead, slow down before pulling back into the travel lanes.**
- **Never exceed posted speed limits.**

## AUTOMATIC TRANSAXLE (IF EQUIPPED)

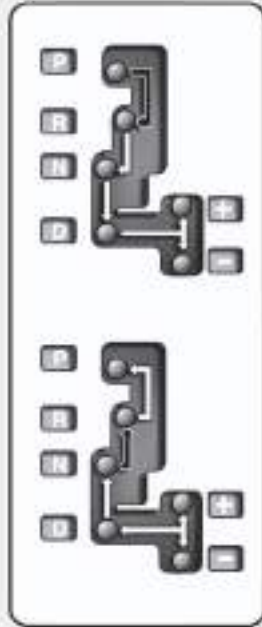

- ➡ Depress the brake pedal when shifting, if your vehicle is equipped shift lock system.
- ⇨ The shift lever can be moved freely.

OCM050010

E060100AFD

**Automatic transaxle operation**

The highly efficient automatic transaxle has 6 forward speeds and one reverse speed. The individual speeds are selected automatically, depending on the position of the shift lever.

**\* NOTICE**

The first few shifts on a new vehicle, if the battery has been disconnected, may be somewhat abrupt. This is a normal condition, and the shifting sequence will adjust after shifts are cycled a few times by the TCM (Transaxle Control Module) or PCM (Powertrain Control Module).

*For smooth operation, depress the brake pedal when shifting from N (Neutral) to a forward or reverse gear.*

**WARNING - Automatic transaxle**

- Always check the surrounding areas near your vehicle for people, especially children, before shifting a vehicle into D (Drive) or R (Reverse).
- Before leaving the driver's seat, always make sure the shift lever is in the P (Park) position; then set the parking brake fully and shut the engine off. Unexpected and sudden vehicle movement can occur if these precautions are not followed in the order identified.

**! CAUTION**

- To avoid damage to your transaxle, do not accelerate the engine in R (Reverse) or any forward gear position with the brakes on.
- When stopped on an upgrade, do not hold the vehicle stationary with engine power. Use the service brake or the parking brake.
- Do not shift from N (Neutral) or P (Park) into D (Drive), or R (Reverse) when the engine is above idle speed.

E060101AFD

**Transaxle ranges**

The indicator lights in the instrument cluster displays the shift lever position when the ignition switch is in the ON position.

**P (Park)**

Always come to a complete stop before shifting into P (Park). This position locks the transaxle and prevents the front wheels from rotating.



### **WARNING**

- Shifting into P (Park) while the vehicle is in motion will cause the drive wheels to lock which will cause you to lose control of the vehicle.
- Do not use the P (Park) position in place of the parking brake. Always make sure the shift lever is latched in the P (Park) position and set the parking brake fully.
- Never leave a child unattended in a vehicle.

### **! CAUTION**

*The transaxle may be damaged if you shift into P (Park) while the vehicle is in motion.*

### **R (Reverse)**

Use this position to drive the vehicle backward.

### **! CAUTION**

*Always come to a complete stop before shifting into or out of R (Reverse); you may damage the transaxle if you shift into R (Reverse) while the vehicle is in motion, except as explained in "Rocking the vehicle", in this manual.*

### **N (Neutral)**

The wheels and transaxle are not engaged. The vehicle will roll freely even on the slightest incline unless the parking brake or service brakes are applied.

### **D (Drive)**

This is the normal forward driving position. The transaxle will automatically shift through a 6-gear sequence, providing the best fuel economy and power.

For extra power when passing another vehicle or climbing grades, depress the accelerator fully, at which time the transaxle will automatically downshift to the next lower gear.

### **\* NOTICE**

**Always come to a complete stop before shifting into D (Drive).**



### Sports mode

Whether the vehicle is stationary or in motion, sports mode is selected by pushing the shift lever from the D (Drive) position into the manual gate. To return to D (Drive) range operation, push the shift lever back into the main gate.

In sports mode, moving the shift lever backwards and forwards will allow you to make gearshifts rapidly. In contrast to a manual transaxle, the sports mode allows gearshifts with the accelerator pedal depressed.

Up (+) : Push the lever forward once to shift up one gear.

Down (-) : Pull the lever backwards once to shift down one gear.

### \* NOTICE

- In sports mode, the driver must execute upshifts in accordance with road conditions, taking care to keep the engine speed below the red zone.
- In sports mode, only the 6 forward gears can be selected. To reverse or park the vehicle, move the shift lever to the R (Reverse) or P (Park) position as required.
- In sports mode, downshifts are made automatically when the vehicle slows down. When the vehicle stops, 1st gear is automatically selected.
- In sports mode, when the engine rpm approaches the red zone shift points are varied to upshift automatically.
- To maintain the required levels of vehicle performance and safety, the system may not execute certain gearshifts when the shift lever is operated.
- When driving on a slippery road, push the shift lever forward into the +(up) position. This causes the transaxle to shift into the 2nd (or 3rd) gear which is better for smooth driving on a slippery road. Push the shift lever to the -(down) side to shift back to the 1st gear.

E060102AFD

### **Shift lock system (if equipped)**

For your safety, the automatic transaxle has a shift lock system which prevents shifting the transaxle from P (Park) or N (Neutral) into R (Reverse) unless the brake pedal is depressed.

To shift the transaxle from P (Park) or N (Neutral) into R (Reverse):

1. Depress and hold the brake pedal.
2. Start the engine or turn the ignition switch to the ON position.
3. Move the shift lever.

If the brake pedal is repeatedly depressed and released with the shift lever in the P (Park) position, a chattering noise near the shift lever may be heard. This is a normal condition.



### WARNING

Always fully depress the brake pedal before and while shifting out of the P (Park) position into another position to avoid inadvertent motion of the vehicle which could injure persons in or around the vehicle.



E060103AUN

### Ignition key interlock system (if equipped)

The ignition key cannot be removed unless the shift lever is in the P (Park) position. If the ignition switch is in any other position, the key cannot be removed.

### Shift-lock override

If the shift lever cannot be moved from the P (Park) or N (Neutral) position into R (Reverse) position with the brake pedal depressed, continue depressing the brake, then do the following:

1. Carefully remove the cap (1) covering the shift-lock override access hole.
2. Insert a screwdriver (or key) into the access hole and press down on the screwdriver (or key).
3. Move the shift lever.
4. Have your vehicle inspected by an authorized HYUNDAI dealer immediately.

E060200AFD

### Good driving practices

- Never move the shift lever from P (Park) or N (Neutral) to any other position with the accelerator pedal depressed.
- Never move the shift lever into "P" when the vehicle is in motion.
- Be sure the vehicle is completely stopped before you attempt to shift into R (Reverse) or D (Drive).
- Never take the vehicle out of gear and coast down a hill. This may be extremely hazardous. Always leave the vehicle in gear when moving.
- Do not "ride" the brakes. This can cause them to overheat and malfunction. Instead, when you are driving down a long hill, slow down and shift to a lower gear. When you do this, engine braking will help slow down the vehicle.
- Slow down before shifting to a lower gear. Otherwise, the lower gear may not be engaged.
- Always use the parking brake. Do not depend on placing the transaxle in P (Park) to keep the vehicle from moving.
- Exercise extreme caution when driving on a slippery surface. Be especially careful when braking, accelerating or shifting gears. On a slippery surface, an abrupt change in vehicle speed can cause the drive wheels to lose traction and the vehicle to go out of control.



- Optimum vehicle performance and economy is obtained by smoothly depressing and releasing the accelerator pedal.

 **WARNING**

- Always buckle-up! In a collision, an unbelted occupant is significantly more likely to be seriously injured or killed than a properly belted occupant.
- Avoid high speeds when cornering or turning.
- Do not make quick steering wheel movements, such as sharp lane changes or fast, sharp turns.
- The risk of rollover is greatly increased if you lose control of your vehicle at highway speeds.
- Loss of control often occurs if two or more wheels drop off the roadway and the driver oversteers to reenter the roadway.
- In the event your vehicle leaves the roadway, do not steer sharply. Instead, slow down before pulling back into the travel lanes.
- Never exceed posted speed limits.

 **WARNING**

If your vehicle becomes stuck in snow, mud, sand, etc., then you may attempt to rock the vehicle free by moving it forward and backward. Do not attempt this procedure if people or objects are anywhere near the vehicle. During the rocking operation the vehicle may suddenly move forward or backward as it becomes unstuck, causing injury or damage to nearby people or objects.

E060203AFD

***Moving up a steep grade from a standing start***

To move up a steep grade from a standing start, depress the brake pedal, shift the shift lever to D (Drive). Select the appropriate gear depending on load weight and steepness of the grade, and release the parking brake. Depress the accelerator gradually while releasing the service brakes.

**When accelerating from a stop on a steep hill, the vehicle may have a tendency to roll backwards. Shifting the shift lever into 2 (Second Gear) will help prevent the vehicle from rolling backwards.**

### ALL WHEEL DRIVE (AWD) (IF EQUIPPED)

Engine power can be delivered to all front and rear wheels for maximum traction. AWD is useful when extra traction is required on road, such as, when driving on slippery, muddy, wet, or snow-covered roads. These vehicles are not designed for challenging off-road use. Occasional off-road use such as established unpaved roads and trails are OK. It is always important when traveling off-highway that the driver carefully reduces the speed to a level that does not exceed the safe operating speed for those conditions. In general, off-road conditions provide less traction and braking effectiveness than normal road conditions. The driver must be especially alert to avoid driving on slopes which tilt the vehicle to either side.

These factors must be carefully considered when driving off-road. Keeping the vehicle in contact with the driving surface and under control in these conditions is always the driver's responsibility for the safety of him/herself and his or her passengers.



#### **WARNING - Off road driving**

**This vehicle is designed primarily for on road use although it can operate effectively off road. However, it was not designed to drive in challenging off-road conditions. Driving in conditions that exceed the vehicle's intended design or the driver's experience level may result in severe injury or death.**

### Tight corner brake effect





#### **! CAUTION - AWD**

***When turning sharply on a paved road at low speed while in all wheel drive, steering control will be difficult.***

Tight corner brake effect is a unique characteristic of all wheel drive vehicles caused by the difference in tire rotation at the four wheels and the zero-degree alignment of the front wheels and suspension.

Sharp turns at low speeds should be carried out with caution.

**ALL Wheel Drive (AWD) transfer mode selection**

Transfer mode	Selection button	Indicator light	Description
<p><b>AWD AUTO</b> (AWD LOCK is deactivated)</p>		 LOCK (Indicator light is not illuminated)	<ul style="list-style-type: none"> <li>When driving in AWD AUTO mode, the vehicle operates similar to conventional 2WD vehicles under normal operating conditions. However, if the system determines that there is a need for the AWD mode, the engine's driving power is distributed to all four wheels automatically without driver intervention.</li> <li>When driving on normal roads and pavement, the vehicle moves similar to conventional 2WD vehicles.</li> </ul>
<p><b>AWD LOCK</b></p>		 LOCK (Indicator light is illuminated)	<ul style="list-style-type: none"> <li>This mode is used for climbing or descending sharp grades, off-road driving, driving on sandy and muddy roads, etc., to maximize traction.</li> <li>This mode automatically begins to deactivate at speeds above 30 km/h (19 mph) and is shifted to AWD AUTO mode at speed above 40 km/h (25 mph). If the vehicle decelerates to speeds below 30 km/h (19 mph), however, the transfer mode is shifted into AWD LOCK mode again.</li> </ul>

**\* NOTICE**

- When driving on normal roads, deactivate the AWD LOCK mode by pushing the AWD LOCK button (the indicator light goes off). Driving on normal roads with AWD LOCK mode(especially, when cornering) may cause mechanical noise or vibration. The noise and vibration will disappear when the AWD LOCK mode is deactivated. Some parts of the power train may be damaged by prolonged driving with the noise and vibration.
- When the AWD LOCK mode is deactivated, a shock may be felt as the drive power is delivered entirely to the front wheels. This shock is not a mechanical failure.

### For safe all wheel drive operation

#### **WARNING - All wheel driving**

The conditions of on-road or off-road that demand four-wheel drive mean all functions of your vehicle are exposed to extreme stress than under normal road conditions. Slow down and be ready for changes in the composition and traction of the surface under your tires. If you have any doubt about the safety of the conditions you are facing, stop and consider the best way to proceed. Do not exceed the ability of yourself or your vehicle to operate safely.

- Do not try to drive in deep standing water or mud since such conditions can stall your engine and clog your exhaust pipes. Do not drive down steep hills since it requires extreme skill to maintain control of the vehicle.



HILL1

- When you are driving up or down hills drive as straight as possible. Use extreme caution in going up or down steep hills, since you may flip your vehicle over depending on the grade, terrain and water/mud conditions.



HILL2

#### **WARNING - Hills**

Driving across the contour of steep hills can be extremely dangerous. This danger can come from slight changes in the wheel angle which can destabilize the vehicle or, even if the vehicle is maintaining stability under power, it can lose that stability if the vehicle stops its forward motion. Your vehicle may roll over without warning and without time for you to correct a mistake that could cause serious injury or death.

- You must consciously take the effort to learn how to corner in a AWD vehicle. Do not rely on your experience in conventional 2WD vehicles in choosing safe cornering speed in AWD mode. For starters, you must drive more slowly in AWD.
- Drive carefully off-road because your vehicle may be damaged by rocks or roots of trees. Become familiar with the off-road conditions where you are going to drive before you begin driving.



OCM050059

**⚠ WARNING - AWD**

Reduce speed when you turn corners. The center of gravity of AWD vehicles is higher than that of conventional 2WD vehicles, making them more likely to roll over when you turn corners too fast.

**⚠ WARNING - Steering wheel**

Do not grab the inside of the steering wheel when you are driving off-road. You may hurt your arm by a sudden steering maneuver or from steering wheel rebound due to impact with objects on the ground. You could lose control of the steering wheel.

- Always hold the steering wheel firmly when you are driving off-road.
- Make sure all passengers are wearing seat belts.

**⚠ WARNING - Wind danger**

If you are driving in heavy wind, the vehicle's higher center of gravity decreases your steering control capacity and requires you to drive more slowly.

- If you need to drive in the water, stop your vehicle, set your transfer to the AWD LOCK mode and drive at less than 5 mph (8 km/h).

**⚠ WARNING - Driving through water**

Drive slowly. If you are driving too fast in water, the water can get into the engine compartment and wet the ignition system, causing your vehicle to suddenly stop. If this happens and your vehicle is in a tilted position, your vehicle may roll over.

### \* NOTICE

- Do not drive in water if the level is higher than the bottom of the vehicle.
- Check your brake condition once you are out of mud or water. Press the brake pedal several times as you move slowly until you feel normal braking forces return.
- Shorten your scheduled maintenance interval if you drive in off-road conditions such as sand, mud or water (see “Maintenance under severe usage conditions” in section 7). Always wash your vehicle thoroughly after off road use, especially cleaning the bottom of the vehicle.
- Since the driving torque is always applied to the 4 wheels the performance of the AWD vehicle is greatly affected by the condition of the tires. Be sure to equip the vehicle with four tires of the same size and type.
- A full time all wheel drive vehicle cannot be towed by an ordinary tow truck. Make sure that the vehicle is placed on a flat bed truck for moving.



### WARNING - AWD driving

- Avoid high cornering speed.
- Do not make quick steering wheel movements, such as sharp lane changes or fast, sharp turns.
- The risk of rollover is greatly increased if you lose control of your vehicle at high speed.
- In a collision, an unbelted person is significantly more likely to die compared to a person wearing a seat belt.
- Loss of control often occurs if two or more wheels drop off the roadway and the driver over steers to re-enter the roadway. In the event your vehicle leaves the roadway, do not steer sharply. Instead, slow down before pulling back into the travel lanes.

### ! CAUTION - Mud or snow

*If one of the front or rear wheels begins to spin in mud, snow, etc. the vehicle can sometimes be driven out by depressing the accelerator pedal further; however avoid running the engine continuously at high rpm because doing so could damage the AWD system.*

### Reducing the risk of a rollover

This multi-purpose passenger vehicle is defined as a Sports Utility Vehicle (SUV). SUV's have higher ground clearance and a narrower track to make them capable of performing in a wide variety of off-road applications. Specific design characteristics give them a higher center of gravity than ordinary vehicles. An advantage of the higher ground clearance is a better view of the road, which allows you to anticipate problems. They are not designed for cornering at the same speeds as conventional passenger vehicles, any more than low-slung sports vehicles are designed to perform satisfactorily in off-road conditions. Due to this risk, driver and passengers are strongly recommended to buckle their seat belts. In a rollover crash, an unbelted person is more likely to die than a person wearing a seat belt. There are steps that a driver can make to reduce the risk of a rollover. If at all possible, avoid sharp turns or abrupt maneuvers, do not load your roof rack with heavy cargo, and never modify your vehicle in any way.

 **WARNING - Rollover**

As with other Sports Utility Vehicle (SUV), failure to operate this vehicle correctly may result in loss of control, an accident or vehicle rollover.

- Utility vehicles have a significantly higher rollover rate than other types of vehicles.
- Specific design characteristics (higher ground clearance, narrower track, etc.) give this vehicle a higher center of gravity than ordinary vehicles.
- A SUV is not designed for cornering at the same speeds as conventional vehicles.
- Avoid sharp turns or abrupt maneuvers.
- In a rollover crash, an unbelted person is significantly more likely to die than a person wearing a seat belt. Make sure everyone in the vehicle is properly buckled up.

 **WARNING**

Your vehicle is equipped with tires designed to provide safe ride and handling capability. Do not use a size and type of tire and wheel that is different from the one that is originally installed on your vehicle. It can affect the safety and performance of your vehicle, which could lead to steering failure or rollover and serious injury. When replacing the tires, be sure to equip all four tires with the tire and wheel of the same size, type, tread, brand and load-carrying capacity. If you nevertheless decide to equip your vehicle with any tire/wheel combination not recommended by HYUNDAI for off road driving, you should not use these tires for highway driving.

 **WARNING - Jacked vehicle**

While the full-time AWD vehicle is being raised on a jack, never start the engine or cause the tires to rotate.

There is the danger that rotating tires touching the ground could cause the vehicle to go off the jack and to jump forward.

## Driving your vehicle

- Full-time AWD vehicles must be tested on a special four wheel chassis dynamometer.

### \* NOTICE

Never engage the parking brake while performing these tests.

- A full-time AWD vehicle should not be tested on a 2WD roll tester. If a 2WD roll tester must be used, perform the following:

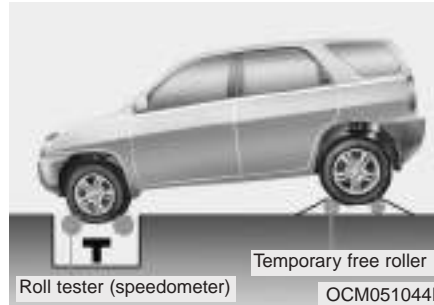

1. Check the tire pressures recommended for your vehicle.
2. Place the front wheels on the roll tester for a speedometer test as shown in the illustration.
3. Release the parking brake.
4. Place the rear wheels on the temporary free roller as shown in the illustration.

### **WARNING - Dynamometer testing**

Keep away from the front of the vehicle while the vehicle is in gear on the dynamometer. This is very dangerous as the vehicle can jump forward and cause serious injury or death.



## BRAKE SYSTEM

E070100AUN

### Power brakes

Your vehicle has power-assisted brakes that adjust automatically through normal usage.

In the event that the power-assisted brakes lose power because of a stalled engine or some other reason, you can still stop your vehicle by applying greater force to the brake pedal than you normally would. The stopping distance, however, will be longer.

When the engine is not running, the reserve brake power is partially depleted each time the brake pedal is applied. Do not pump the brake pedal when the power assist has been interrupted.

Pump the brake pedal only when necessary to maintain steering control on slippery surfaces.



### **WARNING - Brakes**

- Do not drive with your foot resting on the brake pedal. This will create abnormal high brake temperatures, excessive brake lining and pad wear, and increased stopping distances.

(Continued)

### (Continued)

- When descending a long or steep hill, shift to a lower gear and avoid continuous application of the brakes. Continuous brake application will cause the brakes to overheat and could result in a temporary loss of braking performance.
- Wet brakes may impair the vehicle's ability to safely slow down; the vehicle may also pull to one side when the brakes are applied. Applying the brakes lightly will indicate whether they have been affected in this way. Always test your brakes in this fashion after driving through deep water. To dry the brakes, apply them lightly while maintaining a safe forward speed until brake performance returns to normal.

E070101AUN

### *In the event of brake failure*

If service brakes fail to operate while the vehicle is in motion, you can make an emergency stop with the parking brake. The stopping distance, however, will be much greater than normal.



### **WARNING - Parking brake**

Applying the parking brake while the vehicle is moving at normal speeds can cause a sudden loss of control of the vehicle. If you must use the parking brake to stop the vehicle, use great caution in applying the brake.

E070102AUN

### ***Disc brakes wear indicator***

When your brake pads are worn and new pads are required, you will hear a high-pitched warning sound from your front brakes or rear brakes (if equipped). You may hear this sound come and go or it may occur whenever you depress the brake pedal.

Please remember that some driving conditions or climates may cause a brake squeal when you first apply (or lightly apply) the brakes. This is normal and does not indicate a problem with your brakes.

### **! CAUTION**

- ***To avoid costly brake repairs, do not continue to drive with worn brake pads.***
- ***Always replace the front or rear brake pads as pairs.***

### **⚠ WARNING - Brake wear**

**This brake wear warning sound means your vehicle needs service. If you ignore this audible warning, you will eventually lose braking performance, which could lead to a serious accident.**



OCM050015

### **Parking brake**

#### ***Applying the parking brake***

##### **■ Foot type**

To engage the parking brake, first apply the foot brake and then depress the parking brake pedal down as far as possible.



■ **Hand type**

To engage the parking brake, first apply the foot brake and then pull up the parking brake lever as far as possible.

In addition it is recommended that when parking the vehicle on an incline, the shift lever should be in the appropriate low gear on manual transaxle vehicles or in the P (Park) position on automatic transaxle vehicles.

**! CAUTION**

*Driving with the parking brake applied will cause excessive brake pad and brake rotor wear.*



*Releasing the parking brake*

■ **Foot type**

To release the parking brake, depress the parking brake pedal a second time while applying the foot brake. The pedal will automatically extend to the fully released position.



■ **Hand type**

To release the parking brake, first apply the foot brake and pull up the parking brake lever slightly. Secondly press the release button (1) and lower the parking brake lever (2) while holding the button.

If the parking brake does not release or does not release all the way, have the system checked by an authorized HYUNDAI dealer.

### **WARNING**

- To prevent unintentional movement when stopped and leaving the vehicle, do not use the gearshift lever in place of the parking brake. Set the parking brake AND make sure the gearshift lever is securely positioned in 1st (First) gear or R (Reverse) for manual transaxle equipped vehicles and in P (Park) for automatic transaxle equipped vehicles.
- Never allow anyone who is unfamiliar with the vehicle to touch the parking brake. If the parking brake is released unintentionally, serious injury may occur.
- All vehicles should always have the parking brake fully engaged when parking to avoid inadvertent movement of the vehicle which can injure occupants or pedestrians.



Check the brake warning light by turning the ignition switch ON (do not start the engine). This light will be illuminated when the parking brake is applied with the ignition switch in the START or ON position.

Before driving, be sure the parking brake is fully released and the brake warning light is off.

If the brake warning light remains on after the parking brake is released while engine is running, there may be a malfunction in the brake system. Immediate attention is necessary.

If at all possible, cease driving the vehicle immediately. If that is not possible, use extreme caution while operating the vehicle and only continue to drive the vehicle until you can reach a safe location or repair shop.

## Anti-lock brake system (ABS)

### **WARNING**

ABS (or ESC) will not prevent accidents due to improper or dangerous driving maneuvers. Even though vehicle control is improved during emergency braking, always maintain a safe distance between you and objects ahead. Vehicle speeds should always be reduced during extreme road conditions.

The braking distance for vehicle equipped with an anti-lock braking system or (Electronic Stability Control System) may be longer than for those without it in the following road conditions.

During these conditions the vehicle should be driven at reduced speeds:

- Rough, gravel or snow-covered roads.
- With tire chains installed.
- On roads where the road surface is pitted or has different surface height.

(Continued)

(Continued)

The safety features of an ABS (or ESC) equipped vehicle should not be tested by high speed driving or cornering. This could endanger the safety of yourself or others.

The ABS continuously senses the speed of the wheels. If the wheels are going to lock, the ABS system repeatedly modulates the hydraulic brake pressure to the wheels.

When you apply your brakes under conditions which may lock the wheels, you may hear a “tik-tik” sound from the brakes, or feel a corresponding sensation in the brake pedal. This is normal and it means your ABS is active.

In order to obtain the maximum benefit from your ABS in an emergency situation, do not attempt to modulate your brake pressure and do not try to pump your brakes. Press your brake pedal as hard as possible or as hard as the situation warrants and allow the ABS to control the force being delivered to the brakes.

### \* NOTICE

A click sound may be heard in the engine compartment when the vehicle begins to move after the engine is started. These conditions are normal and indicate that the anti-lock brake system is functioning properly.

- Even with the anti-lock brake system, your vehicle still requires sufficient stopping distance. Always maintain a safe distance from the vehicle in front of you.
- Always slow down when cornering. The anti-lock brake system cannot prevent accidents resulting from excessive speeds.
- On loose or uneven road surfaces, operation of the anti-lock brake system may result in a longer stopping distance than for vehicles equipped with a conventional brake system.



W-78

**! CAUTION**

- *If the ABS warning light is on and stays on, you may have a problem with the ABS. In this case, however, your regular brakes will work normally.*
- *The ABS warning light will stay on for approximately 3 seconds after the ignition switch is ON. During that time, the ABS will go through self-diagnosis and the light will go off if everything is normal. If the light stays on, you may have a problem with your ABS. Contact an authorized HYUNDAI dealer as soon as possible.*

**! CAUTION**

- *When you drive on a road having poor traction, such as an icy road, and operate your brakes continuously, the ABS will be active continuously and the ABS warning light may illuminate. Pull your vehicle over to a safe place and stop the engine.*
- *Restart the engine. If the ABS warning light is off, then your ABS system is normal. Otherwise, you may have a problem with the ABS. Contact an authorized HYUNDAI dealer as soon as possible.*

**\* NOTICE**

When you jump start your vehicle because of a drained battery, the engine may not run as smoothly and the ABS warning light may turn on at the same time. This happens because of the low battery voltage. It does not mean your ABS is malfunctioning.

- **Do not pump your brakes!**
- **Have the battery recharged before driving the vehicle.**



OCM050008

E070500AUN-EU

**Electronic stability control (ESC)**

The Electronic Stability Control (ESC) system is designed to stabilize the vehicle during cornering maneuvers. ESC checks where you are steering and where the vehicle is actually going. ESC applies the brakes at individual wheels and intervenes in the engine management system to stabilize the vehicle.

 **WARNING**

Never drive too fast for the road conditions or too quickly when cornering. Electronic stability control (ESC) will not prevent accidents. Excessive speed in turns, abrupt maneuvers and hydroplaning on wet surfaces can still result in serious accidents. Only a safe and attentive driver can prevent accidents by avoiding maneuvers that cause the vehicle to lose traction. Even with ESC installed, always follow all the normal precautions for driving - including driving at safe speeds for the conditions.

The Electronic Stability Control (ESC) system is an electronic system designed to help the driver maintain vehicle control under adverse conditions. It is not a substitute for safe driving practices. Factors including speed, road conditions and driver steering input can all affect whether ESC will be effective in preventing a loss of control. It is still your responsibility to drive and corner at reasonable speeds and to leave a sufficient margin of safety.

When you apply your brakes under conditions which may lock the wheels, you may hear a “tik-tik” sound from the brakes, or feel a corresponding sensation in the brake pedal. This is normal and it means your ESC is active.

**\* NOTICE**

A click sound may be heard in the engine compartment when the vehicle begins to move after the engine is started. These conditions are normal and indicate that the Electronic Stability Control System is functioning properly.

E070501AUN-EU

**ESC operation****ESC ON condition**

-

- When the ignition is turned ON, ESC and ESC OFF indicator lights illuminate for approximately 3 seconds, then ESC is turned on.
- Press the ESC OFF button for at least half a second after turning the ignition ON to turn ESC off. (ESC OFF indicator will illuminate). To turn the ESC on, press the ESC OFF button (ESC OFF indicator light will go off).
- When starting the engine, you may hear a slight ticking sound. This is the ESC performing an automatic system self-check and does not indicate a problem.

### When operating



When the ESC is in operation, ESC indicator light blinks.

- When the Electronic Stability Control is operating properly, you can feel a slight pulsation in the vehicle. This is only the effect of brake control and indicates nothing unusual.
- When moving out of the mud or slippery road, pressing the accelerator pedal may not cause the engine rpm (revolutions per minute) to increase.

E070502AUN-EE

### **ESC operation off**

#### **ESC OFF state**



- To cancel ESC operation, press the ESC OFF button (ESC OFF indicator light illuminates).
- If the ignition switch is turned to LOCK position when ESC is off, ESC remains off. Upon restarting the engine, the ESC will automatically turn on again.

#### ■ ESC indicator light



#### ■ ESC OFF indicator light



E070503BFD

### **Indicator light**

When ignition switch is turned to ON, the indicator light illuminates, then goes off if the ESC system is operating normally.

The ESC indicator light blinks whenever ESC is operating or illuminates when ESC fails to operate.

The ESC OFF indicator light comes on when the ESC is turned off with the button.

### **! CAUTION**

***Driving with varying tire or wheel sizes may cause the ESC system to malfunction. When replacing tires, make sure they are the same size as your original tires.***



 **WARNING**

The Electronic Stability Control system is only a driving aid; use precautions for safe driving by slowing down on curved, snowy, or icy roads. Drive slowly and don't attempt to accelerate whenever the ESC indicator light is blinking, or when the road surface is slippery.

E070504AUN-EE

**ESC OFF usage****When driving**

- ESC should be turned on for daily driving whenever possible.
- To turn ESC off while driving, press the ESC OFF button while driving on a flat road surface.

 **WARNING**

Never press the ESC OFF button while ESC is operating (ESC indicator light blinks).

If ESC is turned off while ESC is operating, the vehicle may slip out of control.

**\* NOTICE**

- When operating the vehicle on a dynamometer, ensure that the ESC is turned off (ESC OFF light illuminated). If the ESC is left on, it may prevent the vehicle speed from increasing, and result in false diagnosis.
- Turning the ESC off does not affect ABS or brake system operation.

E070600AFD

**Good braking practices** **WARNING**

- Whenever you leave or park your vehicle, always set the parking brake as far as possible and fully engage the vehicle's transaxle into the P (Park) position. If the parking brake is not fully engaged, the vehicle may move inadvertently and injure yourself and others.
- All vehicles should always have the parking brake fully engaged when parking to avoid inadvertent movement of the vehicle which can injure occupants or pedestrians.

- After being parked, check to be sure the parking brake is not engaged and that the parking brake indicator light is out before driving away.
- Driving through water may get the brakes wet. They can also get wet when the vehicle is washed. Wet brakes can be dangerous! Your vehicle will not stop as quickly if the brakes are wet. Wet brakes may cause the vehicle to pull to one side.

- To dry the brakes, apply the brakes lightly until the braking action returns to normal, taking care to keep the vehicle under control at all times. If the braking action does not return to normal, stop as soon as it is safe to do so and call an authorized HYUNDAI dealer for assistance.
- Don't coast down hills with the vehicle out of gear. This is extremely hazardous. Keep the vehicle in gear at all times, use the brakes to slow down, then shift to a lower gear so that engine braking will help you maintain a safe speed.
  - Don't "ride" the brake pedal. Resting your foot on the brake pedal while driving can be dangerous because it can result in the brakes overheating and losing their effectiveness. It also increases the wear of the brake components.
  - If a tire goes flat while you are driving, apply the brakes gently and keep the vehicle pointed straight ahead while you slow down. When you are moving slowly enough for it to be safe to do so, pull off the road and stop in a safe place.
  - If your vehicle is equipped with an automatic transaxle, don't let your vehicle creep forward. To avoid creeping forward, keep your foot firmly on the brake pedal when the vehicle is stopped.
  - Use caution when parking on a hill. Firmly engage the parking brake and place the shift lever in P (automatic transaxle) or in first or reverse gear (manual transaxle). If your vehicle is facing downhill, turn the front wheels into the curb to help keep the vehicle from rolling. If your vehicle is facing uphill, turn the front wheels away from the curb to help keep the vehicle from rolling. If there is no curb or if it is required by other conditions to keep the vehicle from rolling, block the wheels.
  - Under some conditions your parking brake can freeze in the engaged position. This is most likely to happen when there is an accumulation of snow or ice around or near the rear brakes or if the brakes are wet. If there is a risk that the parking brake may freeze, apply it only temporarily while you put the gear selector lever in P (automatic transaxle) or in first or reverse gear (manual transaxle) and block the rear wheels so the vehicle cannot roll. Then release the parking brake.
  - Do not hold the vehicle on the upgrade with the accelerator pedal. This can cause the transaxle to overheat. Always use the brake pedal or parking brake.

## CRUISE CONTROL SYSTEM (IF EQUIPPED)



OCM050100

1. Cruise indicator
2. Cruise set indicator

The cruise control system allows you to program the vehicle to maintain a constant speed without resting your foot on the accelerator pedal.

This system is designed to function above approximately 25 mph (40 km/h).

### WARNING

- If the cruise control is left on, (CRUISE indicator light in the instrument cluster illuminated), the cruise control can be switched on accidentally. Keep the cruise control system off (CRUISE indicator light OFF) when the cruise control is not in use, to avoid inadvertently setting a speed.
- Use the cruise control system only when traveling on open highways in good weather.
- Do not use the cruise control when it may not be safe to keep the vehicle at a constant speed, for instance, driving in heavy or varying traffic, or on slippery (rainy, icy or snow-covered) or winding roads or over 6% up-hill or down-hill roads.
- Pay particular attention to the driving conditions whenever using the cruise control system.
- Be careful when driving downhill using the cruise control system, which may increase the vehicle speed.

### **!** CAUTION

*During cruise-speed driving of a manual transaxle vehicle, do not shift into neutral without depressing the clutch pedal, since the engine will be overrevved. If this happens, depress the clutch pedal or release the cruise control ON-OFF switch.*

### \* NOTICE

During normal cruise control operation, when the SET switch is activated or reactivated after applying the brakes, the cruise control will energize after approximately 3 seconds. This delay is normal.



E090100AUN

### To set cruise control speed:

1. Push the Cruise ON-OFF button on the steering wheel to turn the system on. The Cruise indicator light in the instrument cluster will illuminate.
2. Accelerate to the desired speed, which must be more than 25 mph (40 km/h).



3. Push the -SET switch, and release it at the desired speed. The SET indicator light in the instrument cluster will illuminate. Release the accelerator at the same time. The desired speed will automatically be maintained.

*On a steep grade, the vehicle may slow down or speed up slightly while going downhill.*



E090200AFD

### To increase cruise control set speed:

Follow either of these procedures:

- Push the RES+ switch and hold it. Your vehicle will accelerate. Release the switch at the speed you want.
- Push the RES+ switch and release it immediately.

The cruising speed will increase by 1 mph (1.6 km/h) each time the RES+ switch is operated in this manner.



OCM050103N

E090300AFD

### To decrease the cruising speed:

Follow either of these procedures:

- Push the -SET switch and hold it. Your vehicle will gradually slow down. Release the switch at the speed you want to maintain.
- Push the -SET switch and release it immediately.

The cruising speed will decrease by 1 mph (1.6 km/h) each time the -SET switch is operated in this manner.

### To temporarily accelerate with the cruise control on:

If you want to speed up temporarily when the cruise control is on, depress the accelerator pedal. Increased speed will not interfere with cruise control operation or change the set speed.

To return to the set speed, take your foot off the accelerator.



OCM050104N

### To cancel cruise control, do one of the following:

- Press the brake pedal.
- Press the clutch pedal with a manual transaxle.
- Shift into N (Neutral) with an automatic transaxle.
- Press the CANCEL switch located on the steering wheel.
- Decrease the vehicle speed lower than the memory speed by 9 mph (15 km/h).
- Decrease the vehicle speed to less than approximately 25 mph (40 km/h).

Each of these actions will cancel cruise control operation (the SET indicator light in the instrument cluster will go off), but it will not turn the system off. If you wish to resume cruise control operation, push the RES+ switch located on your steering wheel. You will return to your previously preset speed.



### To resume cruising speed at more than approximately 25 mph (40 km/h):

If any method other than the Cruise ON-OFF switch was used to cancel cruising speed and the system is still activated, the most recent set speed will automatically resume when the RES+ switch is pushed.

It will not resume, however, if the vehicle speed has dropped below approximately 25 mph (40 km/h).



### To turn cruise control off, do one of the following:

- Push the Cruise ON-OFF button (the Cruise indicator light in the instrument cluster will go off).
- Turn the ignition off.

*Both of these actions cancel cruise control operation. If you want to resume cruise control operation, repeat the steps provided in "To set cruise control speed" on the previous page.*

## ECONOMICAL OPERATION

Your vehicle's fuel economy depends mainly on your style of driving, where you drive and when you drive.

Each of these factors affects how many miles (kilometers) you can get from a gallon (liter) of fuel. To operate your vehicle as economically as possible, use the following driving suggestions to help save money in both fuel and repairs:

- Drive smoothly. Accelerate at a moderate rate. Don't make "jack-rabbit" starts or full-throttle shifts and maintain a steady cruising speed. Don't race between stoplights. Try to adjust your speed to the traffic so you don't have to change speeds unnecessarily. Avoid heavy traffic whenever possible. Always maintain a safe distance from other vehicles so you can avoid unnecessary braking. This also reduces brake wear.
- Drive at a moderate speed. The faster you drive, the more fuel your vehicle uses. Driving at a moderate speed, especially on the highway, is one of the most effective ways to reduce fuel consumption.
- Don't "ride" the brake or clutch pedal. This can increase fuel consumption and also increase wear on these components. In addition, driving with your foot resting on the brake pedal may cause the brakes to overheat, which reduces their effectiveness and may lead to more serious consequences.
- Take care of your tires. Keep them inflated to the recommended pressure. Incorrect inflation, either too much or too little, results in unnecessary tire wear. Check the tire pressures at least once a month.
- Be sure that the wheels are aligned correctly. Improper alignment can result from hitting curbs or driving too fast over irregular surfaces. Poor alignment causes faster tire wear and may also result in other problems as well as greater fuel consumption.
- Keep your vehicle in good condition. For better fuel economy and reduced maintenance costs, maintain your vehicle in accordance with the maintenance schedule in Section 7. If you drive your vehicle in severe conditions, more frequent maintenance is required (see Section 7 for details).
- Keep your vehicle clean. For maximum service, your vehicle should be kept clean and free of corrosive materials. It is especially important that mud, dirt, ice, etc. not be allowed to accumulate on the underside of the vehicle. This extra weight can result in increased fuel consumption and also contribute to corrosion.
- Travel lightly. Don't carry unnecessary weight in your vehicle. Weight reduces fuel economy.
- Don't let the engine idle longer than necessary. If you are waiting (and not in traffic), turn off your engine and restart only when you're ready to go.

- Remember, your vehicle does not require extended warm-up. After the engine has started, allow the engine to run for 10 to 20 seconds prior to placing the vehicle in gear. In very cold weather, however, give your engine a slightly longer warm-up period.
- Don't "lug" or "over-rev" the engine. Lugging is driving too slowly in too high a gear resulting engine bucking. If this happens, shift to a lower gear. Over-revving is racing the engine beyond its safe limit. This can be avoided by shifting at the recommended speeds.
- Use your air conditioning sparingly. The air conditioning system is operated by engine power so your fuel economy is reduced when you use it.
- Open windows at high speeds can reduce fuel economy.
- Fuel economy is less in crosswinds and headwinds. To help offset some of this loss, slow down when driving in these conditions.

Keeping a vehicle in good operating condition is important both for economy and safety. Therefore, have an authorized HYUNDAI dealer perform scheduled inspections and maintenance.



### **WARNING - Engine off during motion**

**Never turn the engine off to coast down hills or anytime the vehicle is in motion. The power steering and power brakes will not function properly without the engine running. Instead, keep the engine on and downshift to an appropriate gear for engine braking effect. In addition, turning off the ignition while driving could engage the steering wheel lock resulting in loss of vehicle steering which could cause serious injury or death.**



## SPECIAL DRIVING CONDITIONS

E110100AUN

### Hazardous driving conditions

When hazardous driving conditions are encountered such as water, snow, ice, mud, sand, or similar hazards, follow these suggestions:

- Drive cautiously and allow extra distance for braking.
- Avoid sudden braking or steering.
- When braking with non-ABS brakes pump the brake pedal with a light up-and-down motion until the vehicle is stopped.



### WARNING - ABS

**Do not pump the brake pedal on a vehicle equipped with ABS.**

- If stalled in snow, mud, or sand, use second gear. Accelerate slowly to avoid spinning the drive wheels.
- Use sand, rock salt, tire chains, or other non-slip material under the drive wheels to provide traction when stalled in ice, snow, or mud.



### WARNING - Downshifting

**Downshifting with an automatic transaxle, while driving on slippery surfaces can cause an accident. The sudden change in tire speed could cause the tires to skid. Be careful when downshifting on slippery surfaces.**

E110200AEN

### Rocking the vehicle

If it is necessary to rock the vehicle to free it from snow, sand, or mud, first turn the steering wheel right and left to clear the area around your front wheels. Then, shift back and forth between 1st (First) and R (Reverse) in vehicles equipped with a manual transaxle or R (Reverse) and any forward gear in vehicles equipped with an automatic transaxle. Do not race the engine, and spin the wheels as little as possible. If you are still stuck after a few tries, have the vehicle pulled out by a tow vehicle to avoid engine overheating and possible damage to the transaxle.

### ! CAUTION

***Prolonged rocking may cause engine over-heating, transaxle damage or failure, and tire damage.***



### **WARNING - Spinning tires**

Do not spin the wheels, especially at speeds more than 35 mph (56 km/h). Spinning the wheels at high speeds when the vehicle is stationary could cause a tire to overheat which could result in tire damage that may injure bystanders.

### **\* NOTICE**

The ESC system should be turned OFF prior to rocking the vehicle.



### **WARNING**

If your vehicle becomes stuck in snow, mud, sand, etc., then you may attempt to rock the vehicle free by moving it forward and backward. Do not attempt this procedure if people or objects are anywhere near the vehicle. During the rocking operation the vehicle may suddenly move forward or backward as it becomes unstuck, causing injury or damage to nearby people or objects.



OUN056051

E110300AUN

### **Smooth cornering**

Avoid braking or gear changing in corners, especially when roads are wet. Ideally, corners should always be taken under gentle acceleration. If you follow these suggestions, tire wear will be held to a minimum.



OCM053010

E110400AUN

### **Driving at night**

Because night driving presents more hazards than driving in the daylight, here are some important tips to remember:

- Slow down and keep more distance between you and other vehicles, as it may be more difficult to see at night, especially in areas where there may not be any street lights.
- Adjust your mirrors to reduce the glare from other driver's headlights.
- Keep your headlights clean and properly aimed on vehicles not equipped with the automatic headlight aiming feature. Dirty or improperly aimed headlights will make it much more difficult to see at night.

- Avoid staring directly at the headlights of oncoming vehicles. You could be temporarily blinded, and it will take several seconds for your eyes to readjust to the darkness.



E110500AUN

### Driving in the rain

Rain and wet roads can make driving dangerous, especially if you're not prepared for the slick pavement. Here are a few things to consider when driving in the rain:

- A heavy rainfall will make it harder to see and will increase the distance needed to stop your vehicle, so slow down.
- Keep your windshield wiping equipment in good shape. Replace your windshield wiper blades when they show signs of streaking or missing areas on the windshield.

- If your tires are not in good condition, making a quick stop on wet pavement can cause a skid and possibly lead to an accident. Be sure your tires are in good shape.
- Turn on your headlights to make it easier for others to see you.
- Driving too fast through large puddles can affect your brakes. If you must go through puddles, try to drive through them slowly.
- If you believe you may have gotten your brakes wet, apply them lightly while driving until normal braking operation returns.

E110600AUN

### Driving in flooded areas

Avoid driving through flooded areas unless you are sure the water is no higher than the bottom of the wheel hub. Drive through any water slowly. Allow adequate stopping distance because brake performance may be affected.

After driving through water, dry the brakes by gently applying them several times while the vehicle is moving slowly.



1VQA1004

E110700AUN

### Highway driving

#### *Tires:*

Adjust the tire inflation pressures to specification. Low tire inflation pressures will result in overheating and possible failure of the tires.

Avoid using worn or damaged tires which may result in reduced traction or tire failure.

#### \* NOTICE

Never exceed the maximum tire inflation pressure shown on the tires.

#### WARNING

- Underinflated or overinflated tires can cause poor handling, loss of vehicle control, and sudden tire failure leading to accidents, injuries, and even death. Always check the tires for proper inflation before driving. For proper tire pressures, refer to section 8, “Tires and wheels”.
- Driving on tires with no or insufficient tread is dangerous. Worn-out tires can result in loss of vehicle control, collisions, injury, and even death. Worn-out tires should be replaced as soon as possible and should never be used for driving. Always check the tire tread before driving your vehicle. For further information and tread limits, refer to section 7, “Tires and wheels”.

#### *Fuel, engine coolant and engine oil:*

High speed travel consumes more fuel than urban motoring. Do not forget to check both engine coolant and engine oil.

#### *Drive belt:*

A loose or damaged drive belt may result in overheating of the engine.

## WINTER DRIVING



E120000AUN

The more severe weather conditions of winter result in greater wear and other problems. To minimize the problems of winter driving, you should follow these suggestions:

E120100AUN

### Snowy or Icy conditions

To drive your vehicle in deep snow, it may be necessary to use snow tires or to install tire chains on your tires. If snow tires are needed, it is necessary to select tires equivalent in size and type of the original equipment tires. Failure to do so may adversely affect the safety and handling of your vehicle. Furthermore, speeding, rapid acceleration, sudden brake applications, and sharp turns are potentially very hazardous practices.

During deceleration, use engine braking to the fullest extent. Sudden brake applications on snowy or icy roads may cause skids to occur. You need to keep sufficient distance between the vehicle in operation in front and your vehicle. Also, apply the brake gently. It should be noted that installing tire chains on the tire will provide a greater driving force, but will not prevent side skids.

### \* NOTICE

**Tire chains are not legal in all states. Check the state laws before fitting tire chains.**

E120101AUN

### Snow tires

If you mount snow tires on your vehicle, make sure they are radial tires of the same size and load range as the original tires. Mount snow tires on all four wheels to balance your vehicle's handling in all weather conditions. Keep in mind that the traction provided by snow tires on dry roads may not be as high as your vehicle's original equipment tires. You should drive cautiously even when the roads are clear. Check with the tire dealer for maximum speed recommendations.

**⚠ WARNING - Snow tire size**  
**Snow tires should be equivalent in size and type to the vehicle's standard tires. Otherwise, the safety and handling of your vehicle may be adversely affected.**

*Do not install studded tires without first checking local, state and municipal regulations for possible restrictions against their use.*



### Tire chains

Since the sidewalls of radial tires are thinner, they can be damaged by mounting some types of snow chains on them. Therefore, the use of snow tires is recommended instead of snow chains. Do not mount tire chains on vehicles equipped with aluminum wheels; snow chains may cause damage to the wheels. If snow chains must be used, use wire-type chains with a thickness of less than 0.59 in (15 mm). Damage to your vehicle caused by improper snow chain use is not covered by your vehicle manufacturer's warranty.

When using tire chains, attach them to the drive wheels as follows.

2WD : Front wheels

AWD : All four wheels

If a full set of chains is not available for an AWD vehicle, chains may be installed on the front wheels only.

### ! CAUTION

- ***Make sure the snow chains are the correct size and type for your tires. Incorrect snow chains can cause damage to the vehicle body and suspension and may not be covered by your vehicle manufacturer warranty. Also, the snow chain connecting hooks may be damaged from contacting vehicle components causing the snow chains to come loose from the tire. Make sure the snow chains are SAE class "S" certified.***
- ***Always check chain installation for proper mounting after driving approximately 0.3 to 0.6 miles (0.5 to 1 km) to ensure safe mounting. Retighten or remount the chains if they are loose.***

### Chain installation

When installing chains, follow the manufacturer's instructions and mount them as tightly as you can. Drive slowly with chains installed. If you hear the chains contacting the body or chassis, stop and tighten them. If they still make contact, slow down until it stops. Remove the chains as soon as you begin driving on cleared roads.



### WARNING

#### - Mounting chains

**When mounting snow chains, park the vehicle on level ground away from traffic. Turn on the vehicle Hazard Warning flashers and place a triangular emergency warning device behind the vehicle if available. Always place the vehicle in P (Park), apply the parking brake and turn off the engine before installing snow chains.**

**WARNING - Tire chains**

- The use of chains may adversely affect vehicle handling.
- Do not exceed 20 mph (30 km/h) or the chain manufacturer's recommended speed limit, whichever is lower.
- Drive carefully and avoid bumps, holes, sharp turns, and other road hazards, which may cause the vehicle to bounce.
- Avoid sharp turns or locked-wheel braking.

**! CAUTION**

- *Chains that are the wrong size or improperly installed can damage your vehicle's brake lines, suspension, body and wheels.*
- *Stop driving and retighten the chains any time you hear them hitting the vehicle.*

E120200AUN

**Use high quality ethylene glycol coolant**

Your vehicle is delivered with high quality ethylene glycol coolant in the cooling system. It is the only type of coolant that should be used because it helps prevent corrosion in the cooling system, lubricates the water pump and prevents freezing. Be sure to replace or replenish your coolant in accordance with the maintenance schedule in section 7. Before winter, have your coolant tested to assure that its freezing point is sufficient for the temperatures anticipated during the winter.

E120300AFD

**Check battery and cables**

Winter puts additional burdens on the battery system. Visually inspect the battery and cables as described in section 7. The level of charge in your battery can be checked by an authorized HYUNDAI dealer or a service station.

E120400AFD

**Change to "winter weight" oil if necessary**

In some climates it is recommended that a lower viscosity "winter weight" oil be used during cold weather. See section 8 for recommendations. If you aren't sure what weight oil you should use, consult an authorized HYUNDAI dealer.

E120500AUN

**Check spark plugs and ignition system**

Inspect your spark plugs as described in section 7 and replace them if necessary. Also check all ignition wiring and components to be sure they are not cracked, worn or damaged in any way.

E120600AUN

### **To keep locks from freezing**

To keep the locks from freezing, squirt an approved de-icer fluid or glycerine into the key opening. If a lock is covered with ice, squirt it with an approved de-icing fluid to remove the ice. If the lock is frozen internally, you may be able to thaw it out by using a heated key. Handle the heated key with care to avoid injury.

E120700AFD

### **Use approved window washer anti-freeze in system**

To keep the water in the window washer system from freezing, add an approved window washer anti-freeze solution in accordance with instructions on the container. Window washer anti-freeze is available from an authorized HYUNDAI dealer and most auto parts outlets. Do not use engine coolant or other types of anti-freeze as these may damage the paint finish.

E120800AUN

### **Don't let your parking brake freeze**

Under some conditions your parking brake can freeze in the engaged position. This is most likely to happen when there is an accumulation of snow or ice around or near the rear brakes or if the brakes are wet. If there is a risk the parking brake may freeze, apply it only temporarily while you put the shift lever in P (automatic transaxle) or in first or reverse gear (manual transaxle) and block the rear wheels so the vehicle cannot roll. Then release the parking brake.

E120900AUN

### **Don't let ice and snow accumulate underneath**

Under some conditions, snow and ice can build up under the fenders and interfere with the steering. When driving in severe winter conditions where this may happen, you should periodically check underneath the vehicle to be sure the movement of the front wheels and the steering components is not obstructed.

E121000AUN

### **Carry emergency equipment**

Depending on the severity of the weather, you should carry appropriate emergency equipment. Some of the items you may want to carry include tire chains, tow straps or chains, flashlight, emergency flares, sand, a shovel, jumper cables, a window scraper, gloves, ground cloth, coveralls, a blanket, etc.



## TRAILER TOWING

E140000AFD

If you are considering towing with your vehicle, you should first check with your state's Department of Motor Vehicles to determine their legal requirements.

Since laws vary the requirements for towing trailers, cars, or other types of vehicles or apparatus may differ. Ask an authorized HYUNDAI dealer for further details before towing.

### **WARNING - Towing a trailer**

If you don't use the correct equipment and/or drive improperly, you can lose control when you pull a trailer. For example, if the trailer is too heavy, the brakes may not work well - or even at all. You and your passengers could be seriously or fatally injured. Pull a trailer only if you have followed all the steps in this section.

### **WARNING - Weight limits**

Before towing, make sure the total trailer weight, GCW (gross combination weight), GVW (gross vehicle weight), GAW (gross axle weight) and trailer tongue load are all within the limits.

### **! CAUTION**

*Pulling a trailer improperly can damage your vehicle and result in costly repairs not covered by your warranty. To pull a trailer correctly, follow the advice in this section.*

Your vehicle can tow a trailer. To identify what the vehicle trailering capacity is for your vehicle, you should read the information in "Weight of the trailer" that appears later in this section.

Remember that trailering is different than just driving your vehicle by itself. Trailering means changes in handling, durability, and fuel economy. Successful, safe trailering requires correct equipment, and it has to be used properly.

This section contains many time-tested, important trailering tips and safety rules. Many of these are important for your safety and that of your passengers. Please read this section carefully before you pull a trailer.

Load-pulling components such as the engine, transaxle, wheel assemblies, and tires are forced to work harder against the load of the added weight. The engine is required to operate at relatively higher speeds and under greater loads. This additional burden generates extra heat. The trailer also adds considerably to wind resistance, increasing the pulling requirements.

E140100AUN

### Hitches

It's important to have the correct hitch equipment. Crosswinds, large trucks going by, and rough roads are a few reasons why you'll need the right hitch. Here are some rules to follow:

- Will you have to make any holes in the body of your vehicle when you install a trailer hitch? If you do, then be sure to seal the holes later when you remove the hitch.  
If you don't seal them, deadly carbon monoxide (CO) from your exhaust can get into your vehicle, as well as dirt and water.
- The bumpers on your vehicle are not intended for hitches. Do not attach rental hitches or other bumper-type hitches to them. Use only a frame-mounted hitch that does not attach to the bumper.
- HYUNDAI trailer hitch accessory is available at an authorized HYUNDAI dealer.

E140200AUN

### Safety chains

You should always attach chains between your vehicle and your trailer. Cross the safety chains under the tongue of the trailer so that the tongue will not drop to the road if it becomes separated from the hitch.

Instructions about safety chains may be provided by the hitch manufacturer or by the trailer manufacturer. Follow the manufacturer's recommendation for attaching safety chains. Always leave just enough slack so you can turn with your trailer. And, never allow safety chains to drag on the ground.

E140300AUN

### Trailer brakes

If your trailer is equipped with a braking system, make sure it conforms to federal and/or local regulations and that it is properly installed and operating correctly. If your trailer weight exceeds the maximum allowed weight without trailer brakes, then the trailer will also require its own brakes as well. Be sure to read and follow the instructions for the trailer brakes so you'll be able to install, adjust and maintain them properly.

- Don't tap into or modify your vehicle's brake system.



#### **WARNING - Trailer brakes**

**Do not use a trailer with its own brakes unless you are absolutely certain that you have properly set up the brake system. This is not a task for amateurs. Use an experienced, competent trailer shop for this work.**

E140400AUN

**Driving with a trailer**

Towing a trailer requires a certain amount of experience. Before setting out for the open road, you must get to know your trailer. Acquaint yourself with the feel of handling and braking with the added weight of the trailer. And always keep in mind that the vehicle you are driving is now a good deal longer and not nearly so responsive as your vehicle is by itself.

Before you start, check the trailer hitch and platform, safety chains, electrical connector(s), lights, tires and mirror adjustment. If the trailer has electric brakes, start your vehicle and trailer moving and then apply the trailer brake controller by hand to be sure the brakes are working. This lets you check your electrical connection at the same time.

During your trip, check occasionally to be sure that the load is secure, and that the lights and any trailer brakes are still working.

E140401AUN

**Following distance**

Stay at least twice as far behind the vehicle ahead as you would when driving your vehicle without a trailer. This can help you avoid situations that require heavy braking and sudden turns.

E140402AUN

**Passing**

You'll need more passing distance up ahead when you're towing a trailer. And, because of the increased vehicle length, you'll need to go much farther beyond the passed vehicle before you can return to your lane. Due to the added load to the engine when going uphill the vehicle may also take longer to pass than it would on flat ground.

E140403AUN

**Backing up**

Hold the bottom of the steering wheel with one hand. Then, to move the trailer to the left, just move your hand to the left. To move the trailer to the right, move your hand to the right. Always back up slowly and, if possible, have someone guide you.

E140404AUN

**Making turns**

When you're turning with a trailer, make wider turns than normal. Do this so your trailer won't strike soft shoulders, curbs, road signs, trees, or other objects near the edge of the road. Avoid jerky or sudden maneuvers. Signal well in advance before turning or lane changes.

E140405AFD

### ***Turn signals when towing a trailer***

When you tow a trailer, your vehicle has to have a different turn signal flasher and extra wiring. The green arrows on your instrument panel will flash whenever you signal a turn or lane change. Properly connected, the trailer lights will also flash to alert other drivers you're about to turn, change lanes, or stop.

When towing a trailer, the green arrows on your instrument panel will flash for turns even if the bulbs on the trailer are burned out. Thus, you may think drivers behind you are seeing your signals when, in fact, they are not. It's important to check occasionally to be sure the trailer bulbs are still working. You must also check the lights every time you disconnect and then reconnect the wires.

Do not connect a trailer lighting system directly to your vehicle's lighting system. Use only an approved trailer wiring harness.

An authorized HYUNDAI dealer can assist you in installing the wiring harness.



### **WARNING**

**Failure to use an approved trailer wiring harness could result in damage to the vehicle electrical system and/or personal injury.**

E140406AFD

### ***Driving on grades***

Reduce speed and shift to a lower gear before you start down a long or steep downgrade. If you don't shift down, you might have to use your brakes so much that they would get hot and no longer operate efficiently.

On a long uphill grade, shift down and reduce your speed to around 45 mph (70 km/h) to reduce the possibility of engine and transaxle overheating.

If your trailer weighs more than the maximum trailer weight without trailer brakes and you have an automatic transaxle, you should drive in D (Drive) when towing a trailer.

Operating your vehicle in D (Drive) when towing a trailer will minimize heat build up and extend the life of your transaxle.

**! CAUTION**

- **When towing a trailer on steep grades (in excess of 6%) pay close attention to the engine coolant temperature gauge to ensure the engine does not overheat.**

*If the needle of the coolant temperature gauge moves across the dial towards "H" (HOT), pull over and stop as soon as it is safe to do so, and allow the engine to idle until it cools down. You may proceed once the engine has cooled sufficiently.*

- **You must decide driving speed depending on trailer weight and uphill grade to reduce the possibility of engine and transaxle overheating.**

E140407AUN-EA

**Parking on hills**

Generally, if you have a trailer attached to your vehicle, you should not park your vehicle on a hill. People can be seriously or fatally injured, and both your vehicle and the trailer can be damaged if they unexpectedly roll down hill.

**WARNING - Parking on a hill**

**Parking your vehicle on a hill with a trailer attached could cause serious injury or death, should the trailer break loose or brake stops working.**

However, if you ever have to park your trailer on a hill, here's how to do it:

1. Pull the vehicle into the parking space. Turn the steering wheel in the direction of the curb (right if headed down hill, left if headed up hill).
2. If the vehicle has a manual transaxle, place the car in neutral. If the vehicle has an automatic transaxle, place the car in P (Park).
3. Set the parking brake and shut off the vehicle.

4. Place chocks under the trailer wheels on the down hill side of the wheels.
5. Start the vehicle, hold the brakes, shift to neutral, release the parking brake and slowly release the brakes until the trailer chocks absorb the load.
6. Reapply the brakes, reapply the parking brake and shift the vehicle to R (Reverse) for manual transaxle or P (Park) for automatic transaxle.
7. Shut off the vehicle and release the vehicle brakes but leave the parking brake set.

**WARNING - Parking brake**  
It can be dangerous to get out of your vehicle if the parking brake is not firmly set.

**If you have left the engine running, the vehicle can move suddenly. You or others could be seriously or fatally injured.**

### When you are ready to leave after parking on a hill

1. With the manual transaxle in Neutral or automatic transaxle in P (Park), apply your brakes and hold the brake pedal down while you:
  - Start your engine;
  - Shift into gear; and
  - Release the parking brake.
2. Slowly remove your foot from the brake pedal.
3. Drive slowly until the trailer is clear of the chocks.
4. Stop and have someone pick up and store the chocks.

### Maintenance when trailer towing

Your vehicle will need service more often when you regularly pull a trailer. Important items to pay particular attention to include engine oil, automatic transaxle fluid, axle lubricant and cooling system fluid. Brake condition is another important item to frequently check. Each item is covered in this manual, and the Index will help you find them quickly. If you're trailering, it's a good idea to review these sections before you start your trip. Don't forget to also maintain your trailer and hitch. Follow the maintenance schedule that accompanied your trailer and check it periodically. Preferably, conduct the check at the start of each day's driving. Most importantly, all hitch nuts and bolts should be tight.

### **! CAUTION**

- ***Due to higher load during trailer usage, overheating might occur in hot days or during uphill driving. If the coolant gauge indicates over-heating, switch off the A/C and stop the vehicle in a safe area to cool down the engine.***
- ***When towing check transaxle fluid more frequently.***

E140600BFD

**If you do decide to pull a trailer**

Here are some important points if you decide to pull a trailer:

- Consider using a sway control. You can ask a hitch dealer about sway control.
- Do not do any towing with your car during its first 1,200 miles (2,000 km) in order to allow the engine to properly break in. Failure to heed this caution may result in serious engine or transaxle damage.
- When towing a trailer, be sure to consult an authorized HYUNDAI dealer for further information on additional requirements such as a towing kit, etc.
- Always drive your vehicle at a moderate speed (less than 60 mph (100 km/h)).
- On a long uphill grade, do not exceed 45 mph (70 km/h) or the posted towing speed limit, whichever is lower.
- The chart contains important considerations that have to do with weight:

Item		Engine		Gasoline Engine	
				2.4L	3.5L
Maximum trailer weight	lbs. (kg)	Without brake system		1653 (750)	1653 (750)
		With brake system	Without trailer package	2000 (907)	2000 (907)
	With trailer package		2800 (1270)	3500 (1588)	
Maximum permissible static vertical load on the coupling device		lbs. (kg)		280 (127)	350 (159)

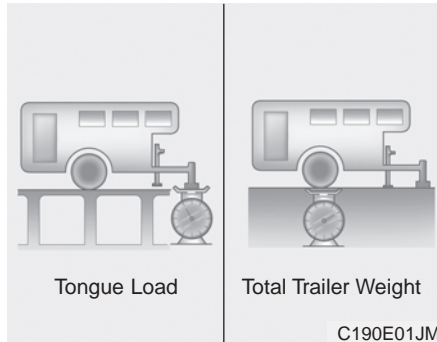

E140601AUN

### ***Weight of the trailer***

What is the maximum safe weight of a trailer? It should never weigh more than the maximum trailer weight with trailer brakes. But even that can be too heavy.

It depends on how you plan to use your trailer. For example, speed, altitude, road grades, outside temperature and how often your vehicle is used to pull a trailer are all important. The ideal trailer weight can also depend on any special equipment that you have on your vehicle.

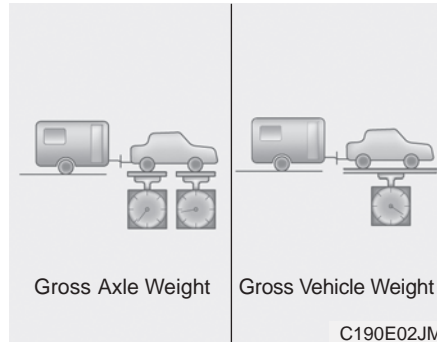

E140602AEN

### ***Weight of the trailer tongue***

The tongue load of any trailer is an important weight to measure because it affects the total gross vehicle weight (GVW) of your vehicle. This weight includes the curb weight of the vehicle, any cargo you may carry in it, and the people who will be riding in the vehicle. And if you will tow a trailer, you must add the tongue load to the GVW because your vehicle will also be carrying that weight.

The trailer tongue should weigh a maximum of 10% of the total loaded trailer weight, within the limits of the maximum permissible trailer tongue load. After you've loaded your trailer, weigh the trailer and then the tongue, separately, to see if the weights are proper. If they aren't, you may be able to correct them simply by moving some items around in the trailer.



 **WARNING - Trailer**

- Never load a trailer with more weight in the rear than in the front. The front should be loaded with approximately 60% of the total trailer load; the rear should be loaded with approximately 40% of the total trailer load.
- Never exceed the maximum weight limits of the trailer or trailer towing equipment. Improper loading can result in damage to your vehicle and/or personal injury. Check weights and loading at a commercial scale or highway patrol office equipped with scales.
- An improperly loaded trailer can cause loss of vehicle control.

## VEHICLE LOAD LIMIT

SEATING CAPACITY NOMBRE DE PLACES		TOTAL	FRONT AVANT	REAR ARRIÈRE
		5	2	5

The combined weight of occupants and cargo should never exceed 420 kg or 930 lbs.  
Le poids total des occupants et du chargement ne doit jamais dépasser 420 kg ou 930 lbs.

TIRE PNEU	SIZE DIMENSIONS	COLD TIRE PRESSURE PRESSION DES PNEUS À FROID
FRONT AVANT	P235/65R17	230kPa, 33psi
REAR ARRIÈRE	P235/65R17	230kPa, 33psi
SPARE DE SECOURS	T165/90R17	420kPa, 60psi

SEE OWNER'S MANUAL FOR ADDITIONAL INFORMATION  
VOIR LE MANUEL DE L'USAGER POUR PLUS DE RENSEIGNEMENTS

OCM050304N

SEATING CAPACITY NOMBRE DE PLACES		TOTAL	FRONT AVANT	REAR ARRIÈRE
		5	2	5

The combined weight of occupants and cargo should never exceed 420 kg or 930 lbs.  
Le poids total des occupants et du chargement ne doit jamais dépasser 420 kg ou 930 lbs.

TIRE PNEU	SIZE DIMENSIONS	COLD TIRE PRESSURE PRESSION DES PNEUS À FROID
FRONT AVANT	P235/60R18	230kPa, 33psi
REAR ARRIÈRE	P235/60R18	230kPa, 33psi
SPARE DE SECOURS	T165/90R17	420kPa, 60psi

SEE OWNER'S MANUAL FOR ADDITIONAL INFORMATION  
VOIR LE MANUEL DE L'USAGER POUR PLUS DE RENSEIGNEMENTS

OCM050305N

E150100AUN

### Tire and loading information label

The label located on the driver's door sill gives the original tire size, cold tire pressures recommended for your vehicle, the number of people that can be in your vehicle and vehicle capacity weight.

### Vehicle capacity weight:

930 lbs. (420 kg)

Vehicle capacity weight is the maximum combined weight of occupants and cargo. If your vehicle is equipped with a trailer, the combined weight includes the tongue load.

E150102AEN

### Seating capacity:

Total : 5 persons  
(Front seat : 2 persons,  
Rear seat : 3 persons)

Seating capacity is the maximum number of occupants including a driver, your vehicle may carry. However, the seating capacity may be reduced based upon the weight of all of the occupants, and the weight of the cargo being carried or towed.

Do not overload the vehicle as there is a limit to the total weight, or load limit including occupants and cargo, the vehicle can carry.

### Towing capacity:

Without trailer brakes:  
1653 lbs (750 kg)

With trailer brakes:

- Without trailer package  
2000 lbs (907 kg)
- With trailer package
  - 2.4 Engine : 2800 lbs (1270 kg)
  - 3.5 Engine : 3500 lbs (1588 kg)

Towing capacity is the maximum trailer weight including its cargo weight, your vehicle can tow.

E150104AUN

### Cargo capacity:

The cargo capacity of your vehicle will increase or decrease depending on the weight and the number of occupants and the tongue load, if your vehicle is equipped with a trailer.

E150104AMG

### Steps For Determining Correct Load Limit

1. Locate the statement "The combined weight of occupants and cargo should never exceed XXX kg or XXX lbs." on your vehicle's placard.

2. Determine the combined weight of the driver and passengers that will be riding in your vehicle.
3. Subtract the combined weight of the driver and passengers from XXX kg or XXX lbs.
4. The resulting figure equals the available amount of cargo and luggage load capacity. For example, if the "XXX" amount equals 1400 lbs. and there will be five 150 lbs. passengers in your vehicle, the amount of available cargo and luggage load capacity is 650 lb (1400-750 (5 x 150) = 650 lbs.)
5. Determine the combined weight of luggage and cargo being loaded on the vehicle. That weight may not safely exceed the available cargo and luggage load capacity calculated in Step 4.
6. If your vehicle will be towing a trailer, load from your trailer will be transferred to your vehicle. Consult this manual to determine how this reduces the available cargo and luggage load capacity of your vehicle.

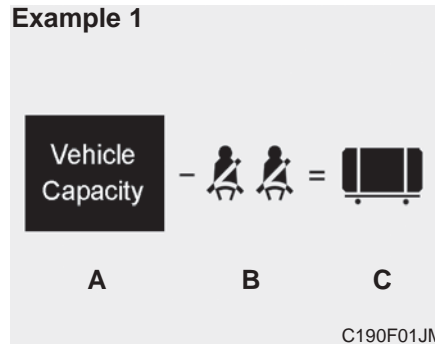

Item	Description	Total
A	Vehicle Capacity Weight	1400 lbs (635 kg)
B	Subtract Occupant Weight 150 lbs (68 kg) x 2	300 lbs (136 kg)
C	Available Cargo and Luggage weight	1100 lbs (499 kg)

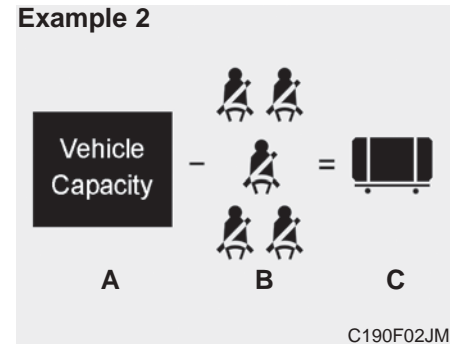

Item	Description	Total
A	Vehicle Capacity Weight	1400 lbs (635 kg)
B	Subtract Occupant Weight 150 lbs (68 kg) x 5	750 lbs (340 kg)
C	Available Cargo and Luggage weight	650 lbs (295 kg)

Refer to your vehicle's tire and loading information label for specific information about your vehicle's capacity weight and seating positions. The combined weight of the driver, passengers and cargo should never exceed your vehicle's capacity weight.

**Example 3**

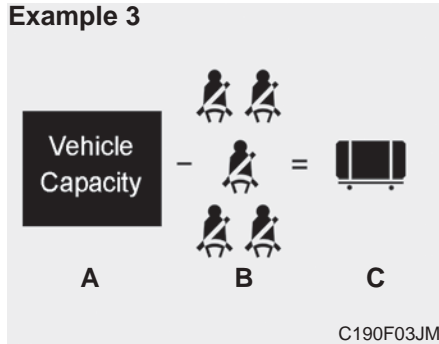

Item	Description	Total
A	Vehicle Capacity Weight	1400 lbs (635 kg)
B	Subtract Occupant Weight 172 lbs (78 kg) × 5	860 lbs (390 kg)
C	Available Cargo and Luggage weight	540 lbs (245 kg)



E150200AUN

**Certification label**

The certification label is located on the driver's door sill at the center pillar.

This label shows the maximum allowable weight of the fully loaded vehicle. This is called the GVWR (Gross Vehicle Weight Rating). The GVWR includes the weight of the vehicle, all occupants, fuel and cargo.

This label also tells you the maximum weight that can be supported by the front and rear axles, called Gross Axle Weight Rating (GAWR).

To find out the actual loads on your front and rear axles, you need to go to a weigh station and weigh your vehicle. Your dealer can help you with this. Be sure to spread out your load equally on both sides of the centerline.

**WARNING - Over loading**

- Never exceed the GVWR for your vehicle, the GAWR for either the front or rear axle and vehicle capacity weight. Exceeding these ratings can cause an accident or vehicle damage. You can calculate the weight of your load by weighing the items (or people) before putting them in the vehicle. Be careful not to overload your vehicle.

**(Continued)**

**(Continued)**

- Do not load your vehicle any heavier than the GVWR, either the maximum front or rear GAWR and vehicle capacity weight. If you do, parts, including tires on your vehicle can break, and it can change the way your vehicle handles and braking ability. This could cause you to lose control and crash. Also, overloading can shorten the life of your vehicle.

The label will help you decide how much cargo and installed equipment your vehicle can carry.

If you carry items inside your vehicle - like suitcases, tools, packages, or anything else - they are moving as fast as the vehicle. If you have to stop or turn quickly, or if there is a crash, the items will keep going and can cause an injury if they strike the driver or a passenger.

** WARNING**

- Overloading your vehicle can cause heat buildup in your vehicle's tires and possible tire failure that could lead to a crash.
- Overloading your vehicle can cause increased stopping distances that could lead to a crash.
- A crash resulting from poor handling vehicle damage, tire failure, or increased stopping distances could result in serious injury or death.

**! CAUTION**

- *Overloading your vehicle may cause damage. Repairs would not be covered by your warranty. Do not overload your vehicle.*
- *Using heavier suspension components to get added durability might not change your weight ratings. Ask your dealer to help you load your vehicle the right way.*

** WARNING - Loose cargo**

Items you carry inside your vehicle can strike and injure occupants in a sudden stop or turn, or in a crash.

- Put items in the cargo area of your vehicle. Try to spread the weight evenly.
- Never stack items, like suitcases, inside the vehicle above the tops of the seats.
- Do not leave an unsecured child restraint in your vehicle.
- When you carry something inside the vehicle, secure it.
- Do not drive with a seat folded down unless necessary.

### VEHICLE WEIGHT

E160000AUN

This section will guide you in the proper loading of your vehicle and/or trailer, to keep your loaded vehicle weight within its design rating capability, with or without a trailer. Properly loading your vehicle will provide maximum return of the vehicle design performance. Before loading your vehicle, familiarize yourself with the following terms for determining your vehicle's weight ratings, with or without a trailer, from the vehicle's specifications and the compliance label:

E160100AUN

#### **Base curb weight**

This is the weight of the vehicle including a full tank of fuel and all standard equipment. It does not include passengers, cargo, or optional equipment.

E160200AUN

#### **Vehicle curb weight**

This is the weight of your new vehicle when you picked it up from your dealer plus any aftermarket equipment.

E160300AUN

#### **Cargo weight**

This figure includes all weight added to the Base Curb Weight, including cargo and optional equipment.

E160400AUN

#### **GAW (Gross axle weight)**

This is the total weight placed on each axle (front and rear) - including vehicle curb weight and all payload.

E160500AUN

#### **GAWR (Gross axle weight rating)**

This is the maximum allowable weight that can be carried by a single axle (front or rear). These numbers are shown on the compliance label.

The total load on each axle must never exceed its GAWR.

E160600AUN

#### **GVW (Gross vehicle weight)**

This is the Base Curb Weight plus actual Cargo Weight plus passengers.

E160700AUN

#### **GVWR (Gross vehicle weight rating)**

This is the maximum allowable weight of the fully loaded vehicle (including all options, equipment, passengers and cargo). The GVWR is shown on the certification label located on the driver's (or front passenger's) door sill.

**Road warning / 6-2**

**In case of an emergency while driving / 6-2**

**If the engine will not start / 6-3**

**Emergency starting / 6-4**

**If the engine overheats / 6-6**

**Tire pressure monitoring system (TPMS) / 6-7**

**If you have a flat tire / 6-13**

**Towing / 6-22**

## What to do in an emergency

**6**

### ROAD WARNING



F010100AUN

#### Hazard warning flasher

The hazard warning flasher serves as a warning to other drivers to exercise extreme caution when approaching, overtaking, or passing your vehicle.

It should be used whenever emergency repairs are being made or when the vehicle is stopped near the edge of a roadway.

Depress the flasher switch with the ignition switch in any position. The flasher switch is located in the center console switch panel. All turn signal lights will flash simultaneously.

- The hazard warning flasher operates whether your vehicle is running or not.
- The turn signals do not work when the hazard flasher is on.
- Care must be taken when using the hazard warning flasher while the vehicle is being towed.

### IN CASE OF AN EMERGENCY WHILE DRIVING

#### If the engine stalls at a crossroad or crossing

If the engine stalls at a crossroad or crossing, set the shift lever in the N (Neutral) position and then push the vehicle to a safe place.

F020200AUN

#### If you have a flat tire while driving

If a tire goes flat while you are driving:

1. Take your foot off the accelerator pedal and let the vehicle slow down while driving straight ahead. Do not apply the brakes immediately or attempt to pull off the road as this may cause a loss of control. When the vehicle has slowed to such a speed that it is safe to do so, brake carefully and pull off the road. Drive off the road as far as possible and park on firm, level ground. If you are on a divided highway, do not park in the median area between the two traffic lanes.



2. When the vehicle is stopped, turn on your emergency hazard flashers, set the parking brake and put the transaxle in P (automatic transaxle) or reverse (manual transaxle).
3. Have all passengers get out of the vehicle. Be sure they all get out on the side of the vehicle that is away from traffic.
4. When changing a flat tire, follow the instruction provided later in this section.

F020300AFD

### If engine stalls while driving

1. Reduce your speed gradually, keeping a straight line. Move cautiously off the road to a safe place.
2. Turn on your emergency flashers.
3. Try to start the engine again. If your vehicle will not start, contact an authorized HYUNDAI dealer or seek other qualified assistance.

## IF THE ENGINE WILL NOT START

F030100AUN

### If engine doesn't turn over or turns over slowly

1. If your vehicle has an automatic transaxle, be sure the shift lever is in N (Neutral) or P (Park) and the emergency brake is set.
2. Check the battery connections to be sure they are clean and tight.
3. Turn on the interior light. If the light dims or goes out when you operate the starter, the battery is discharged.
4. Check the starter connections to be sure they are securely tightened.
5. Do not push or pull the vehicle to start it. See instructions for "Jump starting".

 **WARNING**

If the engine will not start, do not push or pull the vehicle to start it. This could result in a collision or cause other damage. In addition, push or pull starting may cause the catalytic converter to be overloaded and create a fire hazard.

F030200AFD

### If engine turns over normally but does not start

1. Check fuel level.
2. With the ignition switch in the LOCK position, check all connectors at ignition, coil and spark plugs. Reconnect any that may be disconnected or loose.
3. Check the fuel line in the engine compartment.
4. If the engine still does not start, call an authorized HYUNDAI dealer or seek other qualified assistance.

## EMERGENCY STARTING

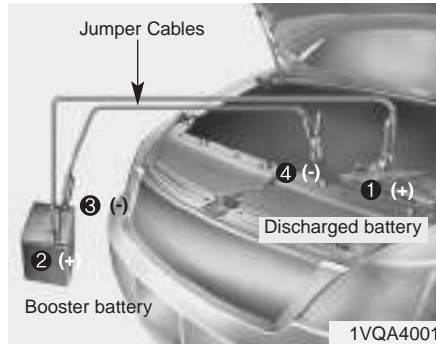

Connect cables in numerical order and disconnect in reverse order.

F040100AUN

### Jump starting

Jump starting can be dangerous if done incorrectly. Therefore, to avoid harm to yourself or damage to your vehicle or battery, follow the jump starting procedures. If in doubt, we strongly recommend that you have a competent technician or towing service jump start your vehicle.

### ! CAUTION

*Use only a 12-volt jumper system. You can damage a 12-volt starting motor, ignition system, and other electrical parts beyond repair by use of a 24-volt power supply (either two 12-volt batteries in series or a 24-volt motor generator set).*

### WARNING - Battery

Never attempt to check the electrolyte level of the battery as this may cause the battery to rupture or explode causing serious injury.

### WARNING - Battery

- Keep all flames or sparks away from the battery. The battery produces hydrogen gas which may explode if exposed to flame or sparks.

If these instructions are not followed exactly, serious personal injury and damage to the vehicle may occur! If you are not sure how to follow this procedure, seek qualified assistance. Automobile batteries contain sulfuric acid. This is poisonous and highly corrosive. When jump starting, wear protective glasses and be careful not to get acid on yourself, your clothing or on the vehicle.

- Do not attempt to jump start the vehicle if the discharged battery is frozen or if the electrolyte level is low; the battery may rupture or explode.

F040101AFD

### ***Jump starting procedure***

1. Make sure the booster battery is 12-volt and that its negative terminal is grounded.
2. If the booster battery is in another vehicle, do not allow the vehicles to touch.
3. Turn off all unnecessary electrical loads.
4. Connect the jumper cables in the exact sequence shown in the illustration. First connect one end of a jumper cable to the positive terminal of the discharged battery (1), then connect the other end to the positive terminal on the booster battery (2). Proceed to connect one end of the other jumper cable to the negative terminal of the booster battery (3), then the other end to a solid, stationary, metallic point (for example, the engine lifting bracket) away from the battery (4). Do not connect it to or near any part that moves when the engine is cranked.

Do not allow the jumper cables to contact anything except the correct battery terminals or the correct ground. Do not lean over the battery when making connections.

**! CAUTION - Battery cables**  
***Do not connect the jumper cable from the negative terminal of the booster battery to the negative terminal of the discharged battery. This can cause the discharged battery to overheat and crack, releasing battery acid.***

5. Start the engine of the vehicle with the booster battery and let it run at 2,000 rpm, then start the engine of the vehicle with the discharged battery.  
*If the cause of your battery discharging is not apparent, you should have your vehicle checked by an authorized HYUNDAI dealer.*

F040200AUN

### **Push-starting**

Your manual transaxle-equipped vehicle should not be push-started because it might damage the emission control system.

Vehicles equipped with automatic transaxle cannot be push-started.

Follow the directions in this section for jump-starting.

 **WARNING**  
**Never tow a vehicle to start it because the sudden surge forward when the engine starts could cause a collision with the tow vehicle.**

### IF THE ENGINE OVERHEATS

F050000AFD

If your temperature gauge indicates overheating, you experience a loss of power, or hear loud pinging or knocking, the engine is probably too hot. If this happens, you should:

1. Pull off the road and stop as soon as it is safe to do so.
2. Place the shift lever in P (automatic transaxle) or neutral (manual transaxle) and set the parking brake. If the air conditioning is on, turn it off.
3. If engine coolant is running out under the vehicle or steam is coming out from the hood, stop the engine. Do not open the hood until the coolant has stopped running or the steaming has stopped. If there is no visible loss of engine coolant and no steam, leave the engine running and check to be sure the engine cooling fan is operating. If the fan is not running, turn the engine off.
4. Check to see if the water pump drive belt is missing. If it is not missing, check to see that it is tight. If the drive belt seems to be satisfactory, check for coolant leaking from the radiator, hoses or under the vehicle. (If the air conditioning had been in use, it is normal for cold water to be draining from it when you stop).



#### WARNING

**While the engine is running, keep hair, hands and clothing away from moving parts such as the fan and drive belts to prevent injury.**

5. If the water pump drive belt is broken or engine coolant is leaking out, stop the engine immediately and call the nearest authorized HYUNDAI dealer for assistance.



#### WARNING

**Do not remove the radiator cap when the engine is hot. This can allow coolant to be blown out of the opening and cause serious burns.**

6. If you cannot find the cause of the overheating, wait until the engine temperature has returned to normal. Then, if coolant has been lost, carefully add coolant to the reservoir to bring the fluid level in the reservoir up to the halfway mark.
7. Proceed with caution, keeping alert for further signs of overheating. If overheating happens again, call an authorized HYUNDAI dealer for assistance.

#### ! CAUTION

***Serious loss of coolant indicates there is a leak in the cooling system and this should be checked as soon as possible by an authorized HYUNDAI dealer.***

## TIRE PRESSURE MONITORING SYSTEM (TPMS)



(1) Low tire pressure telltale /  
TPMS malfunction indicator

Each tire, including the spare (if provided), should be checked monthly when cold and inflated to the inflation pressure recommended by the vehicle manufacturer on the vehicle placard or tire inflation pressure label. (If your vehicle has tires of a different size than the size indicated on the vehicle placard or tire inflation pressure label, you should determine the proper tire inflation pressure for those tires.)

As an added safety feature, your vehicle has been equipped with a tire pressure monitoring system (TPMS) that illuminates a low tire pressure telltale when one or more of your tires is significantly under-inflated. Accordingly, when the low tire pressure telltale illuminates, you should stop and check your tires as soon as possible, and inflate them to the proper pressure. Driving on a significantly under-inflated tire causes the tire to overheat and can lead to tire failure. Under-inflation also reduces fuel efficiency and tire tread life, and may affect the vehicle's handling and stopping ability.

Please note that the TPMS is not a substitute for proper tire maintenance, and it is the driver's responsibility to maintain correct tire pressure, even if under-inflation has not reached the level to trigger illumination of the TPMS low tire pressure telltale.

Your vehicle has also been equipped with a TPMS malfunction indicator to indicate when the system is not operating properly. The TPMS malfunction indicator is combined with the low tire pressure telltale. When the system detects a malfunction, the telltale will flash for approximately one minute and then remain continuously illuminated. This sequence will continue upon subsequent vehicle start-ups as long as the malfunction exists. When the malfunction indicator is illuminated, the system may not be able to detect or signal low tire pressure as intended. TPMS malfunctions may occur for a variety of reasons, including the installation of replacement or alternate tires or wheels on the vehicle that prevent the TPMS from functioning properly. Always check the TPMS malfunction telltale after replacing one or more tires or wheels on your vehicle to ensure that the replacement or alternate tires and wheels allow the TPMS to continue to function properly.

**\* NOTICE**

If the TPMS and Low Tire Pressure do not illuminate for 3 seconds when the ignition switch is turned to the ON position or engine is running, or if they remain illuminated after coming on for approximately 3 seconds, take your car to your nearest authorized HYUNDAI dealer and have the system checked.



**Low tire pressure telltale**

When the tire pressure monitoring system warning indicators are illuminated, one or more of your tires is significantly under-inflated.

If the telltale illuminates, immediately reduce your speed, avoid hard cornering and anticipate increased stopping distances. You should stop and check your tires as soon as possible. Inflate the tires to the proper pressure as indicated on the vehicle's placard or tire inflation pressure label located on the driver's side center pillar outer panel. If you cannot reach a service station or if the tire cannot hold the newly added air, replace the low pressure tire with the spare tire.

Then the TPMS malfunction indicator and the Low Tire Pressure telltale may turn on and illuminate after restarting and about 20 minutes of continuous driving before you have the low pressure tire repaired and replaced on the vehicle.

**! CAUTION**

*In winter or cold weather, the low tire pressure telltale may be illuminated if the tire pressure was adjusted to the recommended tire inflation pressure in warm weather. It does not mean your TPMS is malfunctioning because the decreased temperature leads to a proportional lowering of tire pressure.*

*When you drive your vehicle from a warm area to a cold area or from a cold area to a warm area, or the outside temperature is greatly higher or lower, you should check the tire inflation pressure and adjust the tires to the recommended tire inflation pressure.*



**WARNING - Low pressure damage**

Significantly low tire pressure makes the vehicle unstable and can contribute to loss of vehicle control and increased braking distances.

Continued driving on low pressure tires can cause the tires to overheat and fail.



**TPMS (Tire Pressure Monitoring System) malfunction indicator**

The low tire pressure telltale will illuminate after it blinks for approximately one minute when there is a problem with the Tire Pressure Monitoring System. If the system is able to correctly detect an underinflation warning at the same time as system failure then it will illuminate the TPMS malfunction indicator e.g. if Front Left sensor fails, the TPMS malfunction indicator illuminates, but if the Front Right, Rear Left, or Rear Right tire is under-inflated, the low tire pressure position telltales may illuminate together with the TPMS malfunction indicator.

Have the system checked by an authorized HYUNDAI dealer as soon as possible to determine the cause of the problem.

**! CAUTION**

- *The TPMS malfunction indicator may be illuminated if the vehicle is moving around electric power supply cables or radios transmitter such as at police stations, government and public offices, broadcasting stations, military installations, airports, or transmitting towers, etc. This can interfere with normal operation of the Tire Pressure Monitoring System (TPMS).*
- *The TPMS malfunction indicator may illuminate if snow chains or some separately purchased devices such as notebook computers, mobile charger, remote starter, navigation etc. are used in the vehicle. This can interfere with normal operation of the Tire Pressure Monitoring System (TPMS).*

### Changing a tire with TPMS

If you have a flat tire, the Low Tire Pressure and Position telltales will come on. Have the flat tire repaired by an authorized HYUNDAI dealer as soon as possible or replace the flat tire with the spare tire.

#### **! CAUTION**

***NEVER use a puncture-repairing agent to repair and/or inflate a low pressure tire. The tire sealant can damage the tire pressure sensor. If used, you will have to replace the tire pressure sensor.***

Each wheel is equipped with a tire pressure sensor mounted inside the tire behind the valve stem. You must use TPMS specific wheels. It is recommended that you always have your tires serviced by an authorized HYUNDAI dealer.

Even if you replace the low pressure tire with the spare tire, the Low Tire Pressure and Position telltales will remain on until the low pressure tire is repaired and placed on the vehicle.

After you replace the low pressure tire with the spare tire, the TPMS malfunction indicator may illuminate after a few minutes because the TPMS sensor mounted on the spare wheel is not initiated.

Once the low pressure tire is reinflated to the recommended pressure and installed on the vehicle or the TPMS sensor mounted on the replaced spare wheel is initiated by an authorized HYUNDAI dealer, the TPMS malfunction indicator and the low tire pressure telltale will extinguish within a few minutes of driving. If the indicator is not extinguished after a few minutes of driving, please visit an authorized HYUNDAI dealer.

#### **! CAUTION**

***If a original mounted tire is replaced with the spare tire, the TPMS sensor on the replaced spare wheel should be initiated and the TPMS sensor on the original mounted wheel should be deactivated. If the TPMS sensor on the original mounted wheel located in the spare tire carrier still activates, the tire pressure monitoring system may not operate properly. Have the tire with TPMS serviced or replaced by an authorized HYUNDAI dealer.***



You may not be able identify a low tire by simply looking at it. Always use a good quality tire pressure gauge to measure the tire's inflation pressure. Please note that a tire that is hot (from being driven) will have a higher pressure measurement than a tire that is cold (from sitting stationary for at least 3 hours and driven less than 1 mile (1.6 km) during that 3 hour period).

Allow the tire to cool before measuring the inflation pressure. Always be sure the tire is cold before inflating to the recommended pressure.

A cold tire means the vehicle has been sitting for 3 hours and driven for less than 1 mile (1.6 km) in that 3 hour period.

**! CAUTION**

***Do not use any tire sealant if your vehicle is equipped with a Tire Pressure Monitoring System. The liquid sealant can damage the tire pressure sensors.***

** WARNING - TPMS**

- **The TPMS cannot alert you to severe and sudden tire damage caused by external factors such as nails or road debris.**
- **If you feel any vehicle instability, immediately take your foot off the accelerator, apply the brakes gradually and with light force, and slowly move to a safe position off the road.**

** WARNING - Protecting TPMS**

**Tampering with, modifying, or disabling the Tire Pressure Monitoring System (TPMS) components may interfere with the system's ability to warn the driver of low tire pressure conditions and/or TPMS malfunctions. Tampering with, modifying, or disabling the Tire Pressure Monitoring System (TPMS) components may void the warranty for that portion of the vehicle.**

### **This device complies with Part 15 of the FCC rules.**

Operation is subject to the following two conditions:

1. This device may not cause harmful interference, and
2. This device must accept any interference received, including interference that may cause undesired operation.



#### **WARNING**

**Changes or modifications not expressly approved by the party responsible for compliance could void the user's authority to operate the equipment.**

## IF YOU HAVE A FLAT TIRE



OCM06008N

F070100AFD

### Jack and tools

The jack, jack handle, wheel lug nut wrench are stored in the luggage compartment.

Pull up the luggage box cover to reach this equipment.

- (1) Jack handle
- (2) Jack
- (3) Wheel lug nut wrench

F070101AUN

### Jacking instructions

The jack is provided for emergency tire changing only.

To prevent the jack from “rattling” while the vehicle is in motion, store it properly.

Follow jacking instructions to reduce the possibility of personal injury.

**⚠️ WARNING - Changing tires**

- Never attempt vehicle repairs in the traffic lanes of a public road or highway.
- Always move the vehicle completely off the road and onto the shoulder before trying to change a tire. The jack should be used on firm level ground. If you cannot find a firm level place off the road, call a towing service company for assistance.
- Be sure to use the correct front and rear jacking positions on the vehicle; never use the bumpers or any other part of the vehicle for jack support.

(Continued)

(Continued)

- The vehicle can easily roll off the jack causing serious injury or death. No person should place any portion of their body under a vehicle that is supported only by a jack; use vehicle support stands.
- Do not start or run the engine while the vehicle is on the jack.
- Do not allow anyone to remain in the vehicle while it is on the jack.
- Make sure any children present are in a secure place away from the road and from the vehicle to be raised with the jack.



OCM06009N

F070200AFD

### Removing and storing the spare tire

Your spare tire is stored underneath your vehicle, directly below the cargo area.

To remove the spare tire:

1. Open the tailgate.
2. Find the plastic hex bolt cover and remove the cover.



OCM054010

3. Use the wheel lug nut wrench to loosen the bolt enough to lower the spare tire.

Turn the wrench counterclockwise until the spare tire reaches the ground.



**⚠ WARNING**  
Ensure the spare tire retainer is properly aligned with the center of the spare tire to prevent the spare tire from “rattling”. Otherwise, it may cause the spare tire to fall off the carrier and lead to an accident.

4. After the spare tire reaches the ground, continue to turn the wrench counterclockwise, and draw the spare tire outside. Never rotate the wrench excessively, otherwise the spare tire carrier may be damaged.
5. Remove the retainer (1) from the center of the spare tire.

To store the spare tire:

1. Lay the tire on the ground with the valve stem facing up.
2. Place the wheel under the vehicle and install the retainer (1) through the wheel center.
3. Turn the wrench clockwise until it clicks.



F070300AFD

### Changing tires

1. Park on a level surface and apply the parking brake firmly.
2. Shift the shift lever into R (Reverse) with manual transaxle or P (Park) with automatic transaxle.
3. Activate the hazard warning flasher.



4. Remove the wheel lug nut wrench, jack, jack handle, and spare tire from the vehicle.
5. Block both the front and rear of the wheel that is diagonally opposite the jack position.



### **WARNING - Changing a tire**

- To prevent vehicle movement while changing a tire, always set the parking brake fully, and always block the wheel diagonally opposite the wheel being changed.
- We recommend that the wheels of the vehicle be chocked, and that no person remain in a vehicle that is being jacked.



6. Loosen the wheel lug nuts counter-clockwise one turn each, but do not remove any nut until the tire has been raised off the ground.



7. Place the jack at the front or rear jacking position closest to the tire you are changing. Place the jack at the designated locations under the frame. The jacking positions are plates welded to the frame with two tabs and a raised dot to index with the jack.

**⚠ WARNING - Jack location**  
To reduce the possibility of injury, be sure to use only the jack provided with the vehicle and in the correct jack position; never use any other part of the vehicle for jack support.



8. Insert the jack handle into the jack and turn it clockwise, raising the vehicle until the tire just clears the ground. This measurement is approximately 1.2 in (30 mm). Before removing the wheel lug nuts, make sure the vehicle is stable and that there is no chance for movement or slippage.

9. Loosen the wheel nuts and remove them with your fingers. Slide the wheel off the studs and lay it flat so it cannot roll away. To put the wheel on the hub, pick up the spare tire, line up the holes with the studs and slide the wheel onto them. If this is difficult, tip the wheel slightly and get the top hole in the wheel lined up with the top stud. Then jiggle the wheel back and forth until the wheel can be slid over the other studs.

 **WARNING**

**Wheels and wheel covers may have sharp edges. Handle them carefully to avoid possible severe injury. Before putting the wheel into place, be sure that there is nothing on the hub or wheel (such as mud, tar, gravel, etc.) that interferes with the wheel from fitting solidly against the hub.**

**If there is, remove it. If there is not good contact on the mounting surface between the wheel and hub, the wheel nuts could come loose and cause the loss of a wheel. Loss of a wheel may result in loss of control of the vehicle. This may cause serious injury or death.**

10. To reinstall the wheel, hold it on the studs, put the wheel nuts on the studs and tighten them finger tight. The nuts should be installed with their tapered small diameter ends directed inward. Jiggle the tire to be sure it is completely seated, then tighten the nuts as much as possible with your fingers again.
11. Lower the vehicle to the ground by turning the wheel nut wrench counterclockwise.





OXM069007

Then position the wrench as shown in the drawing and tighten the wheel nuts. Be sure the socket is seated completely over the nut. Do not stand on the wrench handle or use an extension pipe over the wrench handle.

Go around the wheel tightening every other nut until they are all tight. Then double-check each nut for tightness. After changing wheels, have an authorized HYUNDAI dealer tighten the wheel nuts to their proper torque as soon as possible.

**Wheel nut tightening torque:**

Steel wheel & aluminium alloy wheel:  
65~79 lb.ft (9~11 kg.m)

If you have a tire gauge, remove the valve cap and check the air pressure. If the pressure is lower than recommended, drive slowly to the nearest service station and inflate to the correct pressure. If it is too high, adjust it until it is correct. Always reinstall the valve cap after checking or adjusting tire pressure. If the cap is not replaced, air may leak from the tire. If you lose a valve cap, buy another and install it as soon as possible.

After you have changed wheels, always secure the flat tire in its place and return the jack and tools to their proper storage locations.

**! CAUTION**

*Your vehicle has metric threads on the wheel studs and nuts. Make certain during wheel removal that the same nuts that were removed are reinstalled - or, if replaced, that nuts with metric threads and the same chamfer configuration are used. Installation of a non-metric thread nut on a metric stud or vice-versa will not secure the wheel to the hub properly and will damage the stud so that it must be replaced.*

*Note that most lug nuts do not have metric threads. Be sure to use extreme care in checking for thread style before installing aftermarket lug nuts or wheels. If in doubt, consult an authorized HYUNDAI dealer.*

 **WARNING - Wheel studs**  
If the studs are damaged, they may lose their ability to retain the wheel. This could lead to the loss of the wheel and a collision resulting in serious injuries.

To prevent the jack, jack handle, wheel lug nut wrench and spare tire from rattling while the vehicle is in motion, store them properly.

 **WARNING - Inadequate spare tire pressure**  
Check the inflation pressures as soon as possible after installing the spare tire. Adjust it to the specified pressure, if necessary. Refer to “Tires and wheels” in section 8.

F070301AUN

**Important - use of compact spare tire (if equipped)**

Your vehicle is equipped with a compact spare tire. This compact spare tire takes up less space than a regular-size tire. This tire is smaller than a conventional tire and is designed for temporary use only.

### ! CAUTION

- *You should drive carefully when the compact spare is in use. The compact spare should be replaced by the proper conventional tire and rim at the first opportunity.*
- *The operation of this vehicle is not recommended with more than one compact spare tire in use at the same time.*

 **WARNING**

The compact spare tire is for emergency use only. Do not operate your vehicle on this compact spare at speeds over 50 mph (80 km/h). The original tire should be repaired or replaced as soon as is possible to avoid failure of the spare possibly leading to personal injury or death.

The compact spare should be inflated to 60 psi (420 kPa).

### \* NOTICE

Check the inflation pressure after installing the spare tire. Adjust it to the specified pressure, as necessary.

When using a compact spare tire, observe the following precautions:

- Under no circumstances should you exceed 50 mph (80 km/h); a higher speed could damage the tire.
- Ensure that you drive slowly enough for the road conditions to avoid all hazards. Any road hazard, such as a pothole or debris, could seriously damage the compact spare.
- Any continuous road use of this tire could result in tire failure, loss of vehicle control, and possible personal injury.
- Do not exceed the vehicle's maximum load rating or the load-carrying capacity shown on the sidewall of the compact spare tire.
- Avoid driving over obstacles. The compact spare tire diameter is smaller than the diameter of a conventional tire and reduces the ground clearance approximately 1 inch (25 mm), which could result in damage to the vehicle.
- Do not take this vehicle through an automatic car wash while the compact spare tire is installed.
- Do not use tire chains on the compact spare tire. Because of the smaller size, a tire chain will not fit properly. This could damage the vehicle and result in loss of the chain.
- The compact spare tire should not be installed on the front axle if the vehicle must be driven in snow or on ice.
- Do not use the compact spare tire on any other vehicle because this tire has been designed especially for your vehicle.
- The compact spare tire's tread life is shorter than a regular tire. Inspect your compact spare tire regularly and replace worn compact spare tires with the same size and design, mounted on the same wheel.
- The compact spare tire should not be used on any other wheels, nor should standard tires, snow tires, wheel covers or trim rings be used with the compact spare wheel. If such use is attempted, damage to these items or other car components may occur.
- Do not use more than one temporary spare tire at a time.
- Do not tow a trailer while the temporary spare tire is installed.

### TOWING

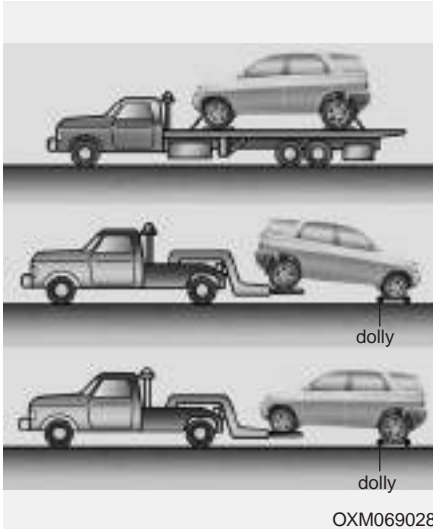

#### Towing service

If emergency towing is necessary, we recommend having it done by an authorized HYUNDAI dealer or a commercial tow-truck service. Proper lifting and towing procedures are necessary to prevent damage to the vehicle. The use of wheel dollies or flatbed is recommended.

*For trailer towing guidelines information, refer to "Trailer towing" in section 5.*

On AWD vehicles, your vehicle must be towed with a wheel lift and dollies or flatbed equipment with all the wheels off the ground.

#### ! CAUTION

*The AWD vehicle should never be towed with the wheels on the ground. This can cause serious damage to the transaxle or the AWD system.*

On 2WD vehicles, it is acceptable to tow the vehicle with the rear wheels on the ground (without dollies) and the front wheels off the ground.

If any of the loaded wheels or suspension components are damaged or the vehicle is being towed with the front wheels on the ground, use a towing dolly under the front wheels.

When being towed by a commercial tow truck and wheel dollies are not used, the front of the vehicle should always be lifted, not the rear.

#### WARNING

**If your vehicle is equipped with side and curtain air bag, set the ignition switch to LOCK or ACC position when the vehicle is being towed.**

**The side and curtain air bag may deploy when the ignitions is ON, and the rollover sensor detects the situation as a rollover.**



OUN046030



OCM054034

**! CAUTION**

- **Do not tow the vehicle backwards with the front wheels on the ground as this may cause damage to the vehicle.**
- **Do not tow with sling-type equipment. Use wheel lift or flatbed equipment.**

When towing your vehicle in an emergency without wheel dollies :

1. Set the ignition switch in the ACC position.
2. Place the transaxle shift lever in N (Neutral).
3. Release the parking brake.

**! CAUTION**

**Failure to place the transaxle shift lever in N (Neutral) may cause internal damage to the transaxle.**



OCM060014

F080300AFD

**Emergency towing**

**If towing is necessary, we recommend you to have it done by an authorized HYUNDAI dealer or a commercial tow truck service.**

If towing service is not available in an emergency, your vehicle may be temporarily towed using a cable or chain secured to the emergency towing hook under the front of the vehicle. Use extreme caution when towing the vehicle. A driver must be in the vehicle to steer it and operate the brakes.

## What to do in an emergency

---

Towing in this manner may be done only on hard-surfaced roads for a short distance and at low speed. Also, the wheels, axles, power train, steering and brakes must all be in good condition.

- Do not use the towing hooks to pull a vehicle out of mud, sand or other conditions from which the vehicle cannot be driven out under its own power.
- Avoid towing a vehicle heavier than the vehicle doing the towing.
- The drivers of both vehicles should communicate with each other frequently.

### **! CAUTION**

- ***Attach a towing strap to the tow hook.***
- ***Using a portion of the vehicle other than the tow hooks for towing may damage the body of your vehicle.***
- ***Use only a cable or chain specifically intended for use in towing vehicles. Securely fasten the cable or chain to the towing hook provided.***

- Before emergency towing, check that the hook is not broken or damaged.
- Fasten the towing cable or chain securely to the hook.
- Do not jerk the hook. Apply steady and even force.
- To avoid damaging the hook, do not pull from the side or at a vertical angle. Always pull straight ahead.



### **WARNING**

Use extreme caution when towing the vehicle.

- Avoid sudden starts or erratic driving maneuvers which would place excessive stress on the emergency towing hook and towing cable or chain. The hook and towing cable or chain may break and cause serious injury or damage.
- If the disabled vehicle is unable to be moved, do not forcibly continue the towing. Contact an authorized HYUNDAI dealer or a commercial tow truck service for assistance.
- Tow the vehicle as straight ahead as possible.
- Keep away from the vehicle during towing.

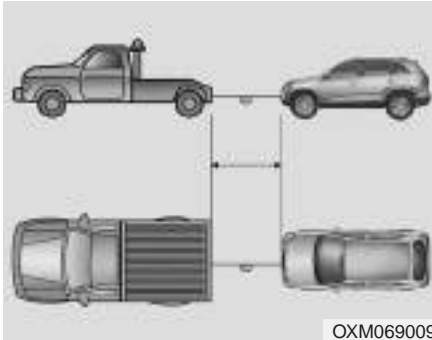

OXM069009

F080301BUN

**Emergency towing precautions**

- Turn the ignition switch to ACC so the steering wheel isn't locked.
  - Place the transaxle shift lever in N (Neutral).
  - Release the parking brake.
  - Press the brake pedal with more force than normal since you will have reduced brake performance.
  - More steering effort will be required because the power steering system will be disabled.
  - If you are driving down a long hill, the brakes may overheat and brake performance will be reduced. Stop often and let the brakes cool off.
- Use a towing strap less than 16 feet (5 m) long. Attach a white or red cloth (about 12 inches (30 cm) wide) in the middle of the strap for easy visibility.
  - Drive carefully so that the towing strap is not loosened during towing.

**! CAUTION - Automatic transaxle**

- **If the car is being towed with all four wheels on the ground, it can be towed only from the front. Be sure that the transaxle is in neutral. Be sure the steering is unlocked by placing the ignition switch in the ACC position. A driver must be in the towed vehicle to operate the steering and brakes.**
- **To avoid serious damage to the automatic transaxle, limit the vehicle speed to 10 mph (15 km/h) and drive less than 1 mile (1.5 km) when towing.**
- **Before towing, check the automatic transaxle fluid leak under your vehicle. If the automatic transmission fluid is leaking, a flatbed equipment or towing dolly must be used.**

**Engine compartment / 7-2**  
**Maintenance services / 7-3**  
**Owner maintenance / 7-4**  
**Scheduled maintenance service / 7-6**  
**Explanation of scheduled maintenance items / 7-11**  
**Engine oil / 7-14**  
**Engine coolant / 7-15**  
**Brake fluid / 7-18**  
**Power steering fluid / 7-19**  
**Washer fluid / 7-20**  
**Parking brake / 7-21**  
**Air cleaner / 7-22**  
**Climate control air filter / 7-24**  
**Wiper blades / 7-26**  
**Battery / 7-29**  
**Tires and wheels / 7-32**

## Maintenance

7

**Fuses / 7-45**  
**Light bulbs / 7-55**  
**Appearance care / 7-63**  
**Emission control system / 7-69**  
**California perchlorate notice / 7-72**



## ENGINE COMPARTMENT

### ■ 2.4 Engine

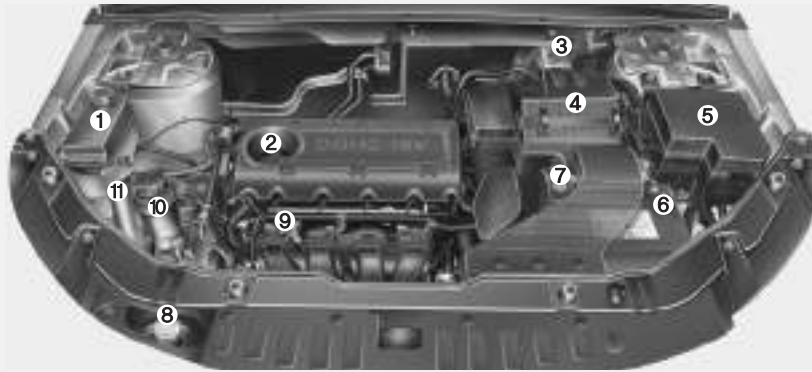

1. Engine coolant reservoir
2. Engine oil filler cap
3. Brake fluid reservoir
4. Air cleaner
5. Fuse box
6. Negative battery terminal
7. Positive battery terminal
8. Radiator cap
9. Engine oil dipstick
10. Power steering fluid reservoir
11. Windshield washer fluid reservoir

### ■ 3.5 Engine

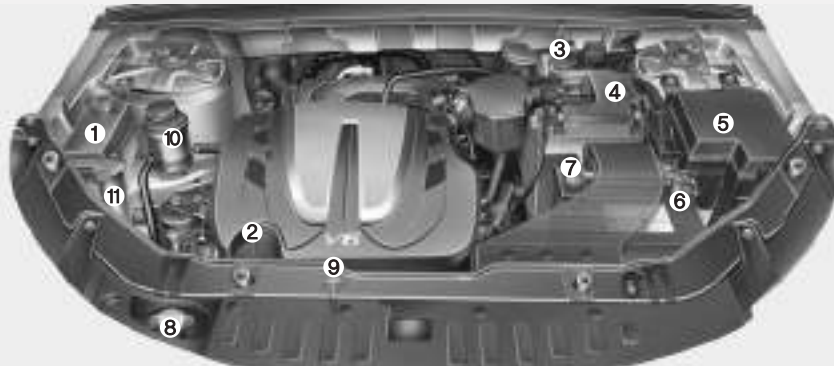

\* The actual engine room in the vehicle may differ from the illustration.

OXM079001/OXM079100

## MAINTENANCE SERVICES

G020000AFD

You should exercise the utmost care to prevent damage to your vehicle and injury to yourself whenever performing any maintenance or inspection procedures.

Should you have any doubts concerning the inspection or servicing of your vehicle, we strongly recommend that you have an authorized HYUNDAI dealer perform this work.

An authorized HYUNDAI dealer has factory-trained technicians and genuine HYUNDAI parts to service your vehicle properly. For expert advice and quality service, see an authorized HYUNDAI dealer.

Inadequate, incomplete or insufficient servicing may result in operational problems with your vehicle that could lead to vehicle damage, an accident, or personal injury.

G020100AEN-EU

### Owner's responsibility

#### \* NOTICE

**Maintenance Service and Record Retention are the owner's responsibility.**

You should retain documents that show proper maintenance has been performed on your vehicle in accordance with the scheduled maintenance service charts shown on the following pages. You need this information to establish your compliance with the servicing and maintenance requirements of your vehicle warranties. Detailed warranty information is provided in your Owner's Handbook & Warranty Information booklet.

Repairs and adjustments required as a result of improper maintenance or a lack of required maintenance are not covered. We recommend you have your vehicle maintained and repaired by an authorized HYUNDAI dealer. An authorized HYUNDAI dealer meets HYUNDAI's high service quality standards and receives technical support from HYUNDAI in order to provide you with a high level of service satisfaction.

G020200AEN-EU

### Owner maintenance precautions

Improper or incomplete service may result in problems. This section gives instructions only for the maintenance items that are easy to perform.

As explained earlier in this section, several procedures can be done only by an authorized HYUNDAI dealer with special tools.

#### \* NOTICE

**Improper owner maintenance during the warranty period may affect warranty coverage. For details, read the separate Owner's Handbook & Warranty Information booklet provided with the vehicle. If you're unsure about any servicing or maintenance procedure, have it done by an authorized HYUNDAI dealer.**



**WARNING - Maintenance work**

- Performing maintenance work on a vehicle can be dangerous. You can be seriously injured while performing some maintenance procedures. If you lack sufficient knowledge and experience or the proper tools and equipment to do the work, have it done by an authorized HYUNDAI dealer.
- Working under the hood with the engine running is dangerous. It becomes even more dangerous when you wear jewelry or loose clothing. These can become entangled in moving parts and result in injury. Therefore, if you must run the engine while working under the hood, make certain that you remove all jewelry (especially rings, bracelets, watches, and necklaces) and all neckties, scarves, and similar loose clothing before getting near the engine or cooling fans.

**OWNER MAINTENANCE**

G030000AFD

The following lists are vehicle checks and inspections that should be performed by the owner or an authorized HYUNDAI dealer at the frequencies indicated to help ensure safe, dependable operation of your vehicle.

Any adverse conditions should be brought to the attention of your dealer as soon as possible.

These Owner Maintenance Checks are generally not covered by warranties and you may be charged for labor, parts and lubricants used.

**Owner maintenance schedule**

G030101AUN

***When you stop for fuel:***

- Check the engine oil level.
- Check coolant level in coolant reservoir.
- Check the windshield washer fluid level.
- Look for low or under-inflated tires.



**WARNING**

**Be careful when checking your engine coolant level when the engine is hot. Scalding hot coolant and steam may blow out under pressure. This could cause burns or other serious injury.**

G030102ACM

**While operating your vehicle:**

- Note any changes in the sound of the exhaust or any smell of exhaust fumes in the vehicle.
- Check for vibrations in the steering wheel. Notice any increased steering effort or looseness in the steering wheel, or change in its straight-ahead position.
- Notice if your vehicle constantly turns slightly or “pulls” to one side when traveling on smooth, level road.
- When stopping, listen and check for unusual sounds, pulling to one side, increased brake pedal travel or “hard-to-push” brake pedal.
- If any slipping or changes in the operation of your transaxle occurs, check the transaxle fluid level.
- Check manual transaxle operation, including clutch operation.
- Check automatic transaxle P (Park) function.
- Check parking brake.
- Check for fluid leaks under your vehicle (water dripping from the air conditioning system during or after use is normal).

G030103AUN

**At least monthly:**

- Check coolant level in the engine coolant reservoir.
- Check the operation of all exterior lights, including the stoplights, turn signals and hazard warning flashers.
- Check the inflation pressures of all tires including the spare.

G030104AUN

**At least twice a year  
(i.e., every Spring and Fall) :**

- Check radiator, heater and air conditioning hoses for leaks or damage.
- Check windshield washer spray and wiper operation. Clean wiper blades with clean cloth dampened with washer fluid.
- Check headlight alignment.
- Check muffler, exhaust pipes, shields and clamps.
- Check the lap/shoulder belts for wear and function.
- Check for worn tires and loose wheel lug nuts.

G030105ACM

**At least once a year :**

- Clean body and door drain holes.
- Lubricate door hinges and checks, and hood hinges.
- Lubricate door and hood locks and latches.
- Lubricate door rubber weatherstrips.
- Check the air conditioning system.
- Check the power steering fluid level.
- Inspect and lubricate automatic transaxle linkage and controls.
- Clean battery and terminals.
- Check the brake (and clutch) fluid level.

### SCHEDULED MAINTENANCE SERVICE

G040000AUN-EU

Follow Normal Maintenance Schedule if the vehicle is usually operated where none of the following conditions apply. If any of the following conditions apply, follow Maintenance Under Severe Usage Conditions.

- Repeated short distance driving.
- Driving in dusty conditions or sandy areas.
- Extensive use of brakes.
- Driving in areas where salt or other corrosive materials are being used.
- Driving on rough or muddy roads.
- Driving in mountainous areas.
- Extended periods of idling or low speed operation.
- Driving for a prolonged period in cold temperatures and/or extremely humid climates.
- More than 50% driving in heavy city traffic during hot weather above 90°F (32°C).

*If your vehicle is operated under the above conditions, you should inspect, replace or refill more frequently than the following Normal Maintenance Schedule. After 120 months or 150,000 miles (240,000 km) continue to follow the prescribed maintenance intervals.*

G040100AEN-EU

**NORMAL MAINTENANCE SCHEDULE**

The following maintenance services must be performed to ensure good emission control and performance. Keep receipts for all vehicle emission services to protect your warranty. Where both mileage and time are shown, the frequency of service is determined by whichever occurs first.

R : Replace                      I : Inspect and, after Inspection, clean, adjust, repair or replace if necessary.

No.	DESCRIPTION	MILES X 1000	7.5	15	22.5	30	37.5	45	52.5	60	67.5	75	82.5	90	97.5	105	112.5	120	127.5	135	142.5	150
		KILOMETERS X 1000	12	24	36	48	60	72	84	96	108	120	132	144	156	168	180	192	204	216	228	240
		MONTHS	6	12	18	24	30	36	42	48	54	60	66	72	78	84	90	96	102	108	114	120
EMISSION CONTROL ITEMS																						
1	ENGINE OIL AND FILTER	Replace every 7,500 miles (12,000 km) or 12 months																				
2	FUEL FILTER				I					I								I				I
3	FUEL LINES, FUEL HOSES AND CONNECTIONS				I					I								I				I
4	VACUUM HOSE	I	I	I	I	I	I	I	I	I	I	I	I	I	I	I	I	I	I	I	I	I
5	CRANKCASE VENTILATION HOSE				I					I					I				I			I
6	VAPOR HOSE AND FUEL FILLER CAP				I					I					I				I			I
7	AIR CLEANER FILTER	I	I	I	R	I	I	I	R	I	I	I	R	I	I	I	R	I	I	I	R	
8	SPARK PLUGS (IRIDIUM COATED)	Replace every 100,000 miles (160,000 km) or 10 years																				
9	VALVE CLEARANCE *1									I									I			
10	FUEL TANK AIR FILTER (IF EQUIPPED)				I					I					I				I			I

\*1 : Inspect for excessive tappet noise and/or engine vibration and adjust if necessary.

**NORMAL MAINTENANCE SCHEDULE (CONT.)**

R : Replace

I : Inspect and, after Inspection, clean, adjust, repair or replace if necessary.

No.	DESCRIPTION	MILES X 1000	7.5	15	22.5	30	37.5	45	52.5	60	67.5	75	82.5	90	97.5	105	112.5	120	127.5	135	142.5	150	
		KILOMETERS X 1000	12	24	36	48	60	72	84	96	108	120	132	144	156	168	180	192	204	216	228	240	
		MONTHS	6	12	18	24	30	36	42	48	54	60	66	72	78	84	90	96	102	108	114	120	
GENERAL ITEMS																							
1	DRIVE BELT (AUTO-TENSIONER, GENERATOR, P/STR'G, A/CON, W/PUMP)				I					I					I				I				I
2	COOLANT	At first, replace at 60,000 miles (96,000 km) or 60 months After that, replace every 30,000 miles (48,000 km) or 24 months																					
3	AUTOMATIC TRANSAXLE FLUID	No check, No service required.																					
4	MANUAL TRANSAXLE FLUID					I					I						I					I	
5	BRAKE / CLUTCH FLUID				I					I				I			I					I	
6	BRAKE HOSES AND LINES		I		I		I		I		I		I		I		I		I		I		I
7	REAR DISC BRAKE/PADS, PARKING BRAKE				I					I				I			I					I	
8	FRONT DISC BRAKE/PADS, CALIPERS AND ROTORS		I		I		I		I		I		I		I		I		I		I		I
9	EXHAUST PIPE AND MUFFLER		I		I		I		I		I		I		I		I		I		I		I
10	SUSPENSION MOUNTING BOLTS		I		I		I		I		I		I		I		I		I		I		I

**NORMAL MAINTENANCE SCHEDULE (CONT.)**

R : Replace

I : Inspect and, after Inspection, clean, adjust, repair or replace if necessary.

No.	DESCRIPTION	MILES X 1000	7.5	15	22.5	30	37.5	45	52.5	60	67.5	75	82.5	90	97.5	105	112.5	120	127.5	135	142.5	150
		KILOMETERS X 1000	12	24	36	48	60	72	84	96	108	120	132	144	156	168	180	192	204	216	228	240
		MONTHS	6	12	18	24	30	36	42	48	54	60	66	72	78	84	90	96	102	108	114	120
GENERAL ITEMS																						
11	STEERING GEAR BOX, LINKAGE & BOOTS /LOWER ARM BALL JOINT, UPPER ARM BALL JOINT		I		I		I		I		I		I		I		I		I		I	
12	POWER STEERING FLUID		I	I	I	I	I	I	I	I	I	I	I	I	I	I	I	I	I	I	I	I
13	POWER STEERING PUMP, BELT AND HOSES		I		I		I		I		I		I		I		I		I		I	
14	DRIVE SHAFTS AND BOOTS		I		I		I		I		I		I		I		I		I		I	
15	AIR CONDITIONING REFRIGERANT		I		I		I		I		I		I		I		I		I		I	
16	CLIMATE CONTROL AIR FILTER (FOR EVAPORATOR AND BLOWER UNIT)	Replace every 15,000 miles (24,000 km) or 12 months																				
17	TRANSFER CASE OIL (AWD) *2	Inspect every 40,000 miles (60,000 km) or 48 months																				
18	REAR AXLE OIL (AWD) *2	Inspect every 40,000 miles (60,000 km) or 48 months																				
19	PROPELLER SHAFT (AWD)		I		I		I		I		I		I		I		I		I		I	

\*2 : Transfer case oil and rear axle oil should be changed anytime they have been submerged in water.



## Maintenance

G040200AEN-EU

### MAINTENANCE UNDER SEVERE USAGE CONDITIONS

The following items must be serviced more frequently on cars normally used under severe driving conditions. Refer to the chart below for the appropriate maintenance intervals.

R : Replace I : Inspect and, after inspection, clean, adjust, repair or replace if necessary

MAINTENANCE ITEM	MAINTENANCE OPERATION	MAINTENANCE INTERVALS	DRIVING CONDITION
ENGINE OIL AND FILTER	R	EVERY 3,750 MILES (6,000 KM) OR 6 MONTHS	A, B, C, D, E, F, G, H, I, K
AIR CLEANER FILTER	R	MORE FREQUENTLY	C, E
SPARK PLUGS	R	MORE FREQUENTLY	B, H
AUTOMATIC TRANSAXLE FLUID	R	EVERY 60,000 MILES (96,000 KM)	A, C, E, F, G, I
MANUAL TRANSAXLE FLUID	R	EVERY 80,000 MILES (12,000 KM)	A, C, E, F, G, I
FRONT DISC BRAKE/PADS, CALIPERS AND ROTORS	I	MORE FREQUENTLY	C, D, G, H
REAR DISC BRAKE/PADS, PARKING BRAKE	I	MORE FREQUENTLY	C, D, G, H
STEERING GEAR BOX, LINKAGE & BOOTS/ LOWER ARM BALL JOINT, UPPER ARM BALL JOINT	I	MORE FREQUENTLY	C, D, E, F, G, H, I
DRIVE SHAFTS AND BOOTS	I	EVERY 7,500 MILES (12,000 KM) OR 6 MONTHS	C, D, E, F, G, H, I, J
TRANSFER CASE OIL (AWD)	R	EVERY 80,000 MILES (120,000 KM)	C, E, G, H, I, J
REAR AXLE OIL (AWD)	R	EVERY 80,000 MILES (120,000 KM)	C, E, G, H, I, J
CLIMATE CONTROL AIR FILTER (FOR EVAPORATOR AND BLOWER UNIT)	R	MORE FREQUENTLY	C, E
PROPELLER SHAFT	I	EVERY 7,500 MILES (12,000 KM) OR 6 MONTHS	C, E

#### SEVERE DRIVING CONDITIONS

- A - Repeatedly driving short distance of less than 5 miles (8 km) in normal temperature or less than 10 miles (16 km) in freezing temperature
- B - Extensive engine idling or low speed driving for long distances
- C - Driving on rough, dusty, muddy, unpaved, graveled or salt- spread roads
- D - Driving in areas using salt or other corrosive materials or in very cold weather
- E - Driving in sandy areas

- F - Driving in heavy traffic area over 90°F (32°C)
- G - Driving on uphill, downhill, or mountain road
- H - Towing a Trailer, or using a camper, or roof rack
- I - Driving as a patrol car, taxi, other commercial use or vehicle towing
- J - Driving over 106 mph (170 km/h)
- K - Frequently driving in stop-and-go conditions

## EXPLANATION OF SCHEDULED MAINTENANCE ITEMS

G050100AUN

### Engine oil and filter

The engine oil and filter should be changed at the intervals specified in the maintenance schedule. If the car is being driven in severe conditions, more frequent oil and filter changes are required.

G050200AUN

### Drive belts

Inspect all drive belts for evidence of cuts, cracks, excessive wear or oil saturation and replace if necessary. Drive belts should be checked periodically for proper tension and adjusted as necessary.

G050300AFD

### Fuel filter (cartridge)

A clogged filter can limit the speed at which the vehicle may be driven, damage the emission system and cause multiple issues such as hard starting. If an excessive amount of foreign matter accumulates in the fuel tank, the filter may require replacement more frequently.

After installing a new filter, run the engine for several minutes, and check for leaks at the connections. Fuel filters should be installed by an authorized HYUNDAI dealer.

G050400AFD

### Fuel lines, fuel hoses and connections

Check the fuel lines, fuel hoses and connections for leakage and damage. Have an authorized HYUNDAI dealer replace any damaged or leaking parts immediately.

G050600AUN

### Vapor hose and fuel filler cap

The vapor hose and fuel filler cap should be inspected at those intervals specified in the maintenance schedule. Make sure that a new vapor hose or fuel filler cap is correctly replaced.

G050700AUN

### **Vacuum crankcase ventilation hoses (if equipped)**

Inspect the surface of hoses for evidence of heat and/or mechanical damage. Hard and brittle rubber, cracking, tears, cuts, abrasions, and excessive swelling indicate deterioration. Particular attention should be paid to examine those hose surfaces nearest to high heat sources, such as the exhaust manifold.

Inspect the hose routing to assure that the hoses do not come in contact with any heat source, sharp edges or moving component which might cause heat damage or mechanical wear. Inspect all hose connections, such as clamps and couplings, to make sure they are secure, and that no leaks are present. Hoses should be replaced immediately if there is any evidence of deterioration or damage.

G050800AFD

### **Air cleaner filter**

A Genuine HYUNDAI air cleaner filter is recommended when the filter is replaced.

G050900AUN

### **Spark plugs**

Make sure to install new spark plugs of the correct heat range.

G051000AFD

### **Valve clearance**

Inspect excessive valve noise and/or engine vibration and adjust if necessary. An authorized HYUNDAI dealer should perform the operation.

G051100AUN

### **Cooling system**

Check the cooling system parts, such as radiator, coolant reservoir, hoses and connections for leakage and damage. Replace any damaged parts.

G051200AUN

### **Coolant**

The coolant should be changed at the intervals specified in the maintenance schedule.

G051300AUN

### **Manual transaxle fluid (if equipped)**

Inspect the manual transaxle fluid according to the maintenance schedule.

G051400AXM

### **Automatic transaxle fluid (if equipped)**

Automatic transaxle fluid should not be checked under normal usage conditions. But in severe conditions, the fluid should be changed at an authorized HYUNDAI dealer in accordance to the scheduled maintenance at the beginning of this chapter.

### **\* NOTICE**

**Automatic transaxle fluid color is basically red.**

**As the vehicle is driven, the automatic transaxle fluid will begin to look darker. It is normal condition and you should not judge the need to replace the fluid based upon the changed color.**

**! CAUTION**

*The use of a non-specified fluid could result in transaxle malfunction and failure.*

*Use only specified automatic transaxle fluid. (Refer to “Recommended lubricants and capacities” in section 8.)*

G051500AUN

**Brake hoses and lines**

Visually check for proper installation, chafing, cracks, deterioration and any leakage. Replace any deteriorated or damaged parts immediately.

G051600AUN

**Brake fluid**

Check brake fluid level in the brake fluid reservoir. The level should be between “MIN” and “MAX” marks on the side of the reservoir. Use only hydraulic brake fluid conforming to DOT 3 or DOT 4 specification.

G051700AUN

**Parking brake**

Inspect the parking brake system including the parking brake lever and cables.

G051900AUN

**Brake pads, calipers and rotors**

Check the pads for excessive wear, discs for run out and wear, and calipers for fluid leakage.

G052100AUN

**Suspension mounting bolts**

Check the suspension connections for looseness or damage. Retighten to the specified torque.

G052200AUN

**Steering gear box, linkage & boots/lower arm ball joint**

With the vehicle stopped and engine off, check for excessive free-play in the steering wheel.

Check the linkage for bends or damage. Check the dust boots and ball joints for deterioration, cracks, or damage. Replace any damaged parts.

G052300AXM

**Power steering pump, belt and hoses**

Check the power steering pump and hoses for leakage and damage. Replace any damaged or leaking parts immediately. Inspect the power steering belt (or drive belt) for evidence of cuts, cracks, excessive wear, oiliness and proper tension. Replace or adjust it if necessary.

G052400AUN

**Drive shafts and boots**

Check the drive shafts, boots and clamps for cracks, deterioration, or damage. Replace any damaged parts and, if necessary, repack the grease.

G052500ACM

**Air conditioning refrigerant/compressor (if equipped)**

Check the air conditioning lines and connections for leakage and damage.

## ENGINE OIL

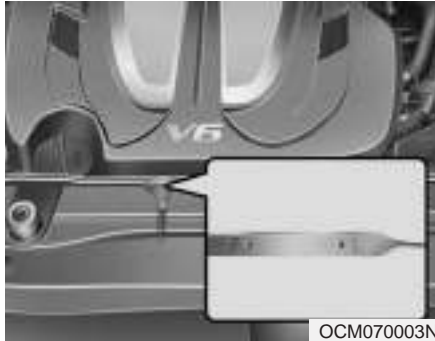

G060100AUN

### Checking the engine oil level

1. Be sure the vehicle is on level ground.
2. Start the engine and allow it to reach normal operating temperature.
3. Turn the engine off and wait for a few minutes (about 5 minutes) for the oil to return to the oil pan.

4. Pull the dipstick out, wipe it clean, and re-insert it fully.

**⚠ WARNING - Radiator hose**  
Be very careful not to touch the radiator hose when checking or adding the engine oil as it may be hot enough to burn you.

5. Pull the dipstick out again and check the level. The level should be between F and L.

**! CAUTION**  
*Do not overfill the engine oil. It may damage the engine.*



If it is near or at L, add enough oil to bring the level to F. **Do not overfill.**

**Use a funnel to help prevent oil from being spilled on engine components.**

*Use only the specified engine oil. (Refer to "Recommended lubricants and capacities" in section 8.)*



G060200AEN-EU

### Changing the engine oil and filter

Have engine oil and filter changed by an authorized HYUNDAI dealer according to the Maintenance Schedule at the beginning of this section.

### CALIFORNIA PROPOSITION 65 WARNING

Engine oil contains chemicals known to the State of California to cause cancer, birth defects, and reproductive harm.

Used engine oil may cause irritation or cancer of the skin if left in contact with the skin for prolonged periods of time. Used engine oil contains chemicals that have caused cancer in laboratory animals. Always protect your skin by washing your hands thoroughly with soap and warm water as soon as possible after handling used oil.

## ENGINE COOLANT

G070000AFD

The high-pressure cooling system has a reservoir filled with year-round antifreeze coolant. The reservoir is filled at the factory.

Check the antifreeze protection and coolant concentration level at least once a year, at the beginning of the winter season, and before traveling to a colder climate.

G070100AFD

### Checking the coolant level

#### WARNING - Removing radiator cap

- Never attempt to remove the radiator cap while the engine is operating or hot. Doing so might lead to cooling system and engine damage and could result in serious personal injury from escaping hot coolant or steam.

(Continued)

### (Continued)

- Turn the engine off and wait until it cools down. Use extreme care when removing the radiator cap. Wrap a thick towel around it, and turn it counterclockwise slowly to the first stop. Step back while the pressure is released from the cooling system. When you are sure all the pressure has been released, press down on the cap, using a thick towel, and continue turning counterclockwise to remove it.
- Even if the engine is not operating, do not remove the radiator cap or the drain plug while the engine and radiator are hot. Hot coolant and steam may still blow out under pressure, causing serious injury.



Check the condition and connections of all cooling system hoses and heater hoses. Replace any swollen or deteriorated hoses.

The coolant level should be filled between F (MAX) and L (MIN) marks on the side of the coolant reservoir when the engine is cool.

If the coolant level is low, add enough specified coolant to provide protection against freezing and corrosion. Bring the level to F (MAX), but do not overfill. If frequent coolant refill is required, see an authorized HYUNDAI dealer for a cooling system inspection.

G070101AUN

### ***Recommended engine coolant***

- Use only soft (de-mineralized) water in the coolant mixture.
- The engine in your vehicle has aluminum engine parts and must be protected by an ethylene-glycol-based coolant to prevent corrosion and freezing.
- DO NOT USE alcohol or methanol coolant or mix them with the specified coolant.
- Do not use a solution that contains more than 60% antifreeze or less than 35% antifreeze, which would reduce the effectiveness of the solution.

For mixture percentage, refer to the following table.

Ambient Temperature	Mixture Percentage (volume)	
	Antifreeze	Water
5°F (-15°C)	35	65
-13°F (-25°C)	40	60
-31°F (-35°C)	50	50
-49°F (-45°C)	60	40



**⚠ WARNING - Radiator cap**  
 Do not remove the radiator cap when the engine and radiator are hot. Scalding hot coolant and steam may blow out under pressure causing serious injury.

G070200AFD

**Changing the coolant**

Have coolant changed by an authorized HYUNDAI dealer according to the Maintenance Schedule at the beginning of this section.

**! CAUTION**

*Put a thick cloth or fabric around the radiator cap before refilling the coolant in order to prevent the coolant from overflowing into engine parts such as generator.*

**⚠ WARNING - Coolant**

- Do not use radiator coolant or antifreeze in the washer fluid reservoir.
- Radiator coolant can severely obscure visibility when sprayed on the windshield and may cause loss of vehicle control or damage to paint and body trim.



## BRAKE FLUID

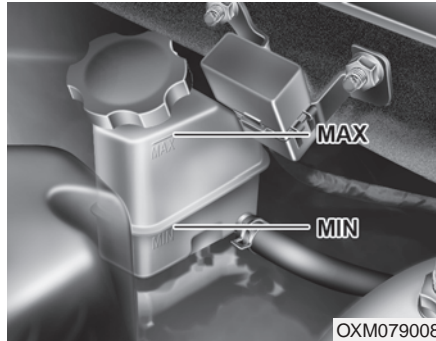

OXM079008

G080100AXM

### Checking the brake fluid level

Check the fluid level in the reservoir periodically. The fluid level should be between MAX and MIN marks on the side of the reservoir.

Before removing the reservoir cap and adding brake fluid, clean the area around the reservoir cap thoroughly to prevent brake fluid contamination.

If the level is low, add fluid to the MAX level. The level will fall with accumulated mileage. This is a normal condition associated with the wear of the brake linings. If the fluid level is excessively low, have the brake system checked by an authorized HYUNDAI dealer.

*Use only the specified brake fluid. (Refer to "Recommended lubricants and capacities" in section 8.)*

*Never mix different types of fluid.*

### **⚠ WARNING - Loss of brake fluid**

**In the event the brake system requires frequent additions of fluid, the vehicle should be inspected by an authorized HYUNDAI dealer.**

### **⚠ WARNING - Brake fluid**

**When changing and adding brake fluid, handle it carefully. Do not let it come in contact with your eyes. If brake fluid should come in contact with your eyes, immediately flush them with a large quantity of fresh tap water. Have your eyes examined by a doctor as soon as possible.**

### **! CAUTION**

**Do not allow brake fluid to contact the vehicle's body paint, as paint damage will result. Brake fluid, which has been exposed to open air for an extended time should never be used as its quality cannot be guaranteed. It should be disposed of properly. Don't put in the wrong kind of fluid. A few drops of mineral-based oil, such as engine oil, in your brake system can damage brake system parts.**

## POWER STEERING FLUID



### Checking the power steering fluid level

With the vehicle on level ground, check the fluid level in the power steering reservoir periodically. The fluid should be between MAX and MIN marks on the side of the reservoir at the normal temperature.

Before adding power steering fluid, thoroughly clean the area around the reservoir cap to prevent power steering fluid contamination.

If the level is low, add fluid to the MAX level.

### \* NOTICE

Check that the fluid level is in the "HOT" range on the reservoir. If the fluid is cold, check that it is in the "COLD" range.

In the event the power steering system requires frequent addition of fluid, the vehicle should be inspected by an authorized HYUNDAI dealer.

*Use only the specified power steering fluid. (Refer to "Recommended lubricants or capacities" in section 8.)*

### Checking the power steering hose

Check the connections for oil leaks, damage and twists in the power steering hose before driving.

### ! CAUTION

- *To avoid damage to the power steering pump, do not operate the vehicle for prolonged periods with a low power steering fluid level.*
- *Never start the engine when the reservoir tank is empty.*
- *When adding fluid, be careful that dirt does not get into the tank.*
- *Too little fluid can result in increased steering effort and/or noise from the power steering system.*
- *The use of the non-specified fluid could reduce the effectiveness of the power steering system and cause damage to it.*

## WASHER FLUID



G120100AUN

### Checking the washer fluid level

The reservoir is translucent so that you can check the level with a quick visual inspection.

Check the fluid level in the washer fluid reservoir and add fluid if necessary. Plain water may be used if washer fluid is not available. However, use washer solvent with antifreeze characteristics in cold climates to prevent freezing.

### **WARNING - Coolant**

- Do not use radiator coolant or antifreeze in the washer fluid reservoir.
- Radiator coolant can severely obscure visibility when sprayed on the windshield and may cause loss of vehicle control or damage to paint and body trim.
- Windshield Washer fluid agents contain some amounts of alcohol and can be flammable under certain circumstances. Do not allow sparks or flame to contact the washer fluid or the washer fluid reservoir. Damage to the vehicle or occupants could occur.
- Windshield washer fluid is poisonous to humans and animals. Do not drink and avoid contacting windshield washer fluid. Serious injury or death could occur.

## PARKING BRAKE



### Checking the parking brake

#### *Type A*

Check whether the stroke is within specification when the parking brake pedal is depressed with 66 lb (30 kg, 294 N) of force. Also, the parking brake alone should securely hold the vehicle on a fairly steep grade. If the stroke is more or less than specified, have the parking brake adjusted by an authorized HYUNDAI dealer.

**Stroke : 8~9 notch**



#### *Type B*

Check the stroke of the parking brake by counting the number of “clicks” heard while fully applying it from the released position. Also, the parking brake alone should securely hold the vehicle on a fairly steep grade. If the stroke is more or less than specified, have the parking brake adjusted by an authorized HYUNDAI dealer.

**Stroke : 5~6 “clicks” at a force of 44 lbs (20 kg, 196 N).**

## AIR CLEANER

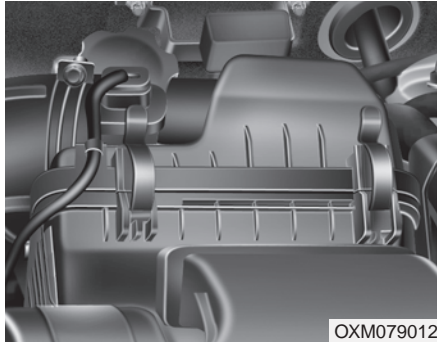

G160100ACM

### Filter replacement

It must be replaced when necessary, and should not be washed.

You can clean the filter when inspecting the air cleaner element.

Clean the filter by using compressed air.



1. Loosen the air cleaner cover attaching clips and open the cover.

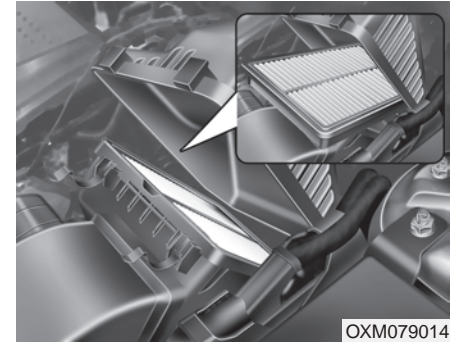

2. Wipe the inside of the air cleaner.  
3. Replace the air cleaner filter.  
4. Lock the cover with the cover attaching clips.

Replace the filter according to the Maintenance Schedule.

*If the vehicle is operated in extremely dusty or sandy areas, replace the element more often than the usual recommended intervals. (Refer to "Maintenance under severe usage conditions" in this section.)*

### **! CAUTION**

- ***Do not drive with the air cleaner removed; this will result in excessive engine wear.***
- ***When removing the air cleaner filter, be careful that dust or dirt does not enter the air intake, or damage may result.***
- ***Use a HYUNDAI genuine part. Use of nongenuine part could damage the air flow sensor or turbo charger.***

### CLIMATE CONTROL AIR FILTER (IF EQUIPPED)

G170100AXM

#### Filter inspection

If the vehicle is operated in the severely air-polluted cities or on dusty rough roads for a long period, it should be inspected more frequently and replaced earlier. When you, the owner, replace the climate control air filter, replace it performing the following procedure, and be careful to avoid damaging other components.

Replace the filter according to the maintenance Schedule.



#### Filter replacement

1. Open the glove box and remove the support strap (1).



2. With the glove box open, remove the stoppers on both sides.

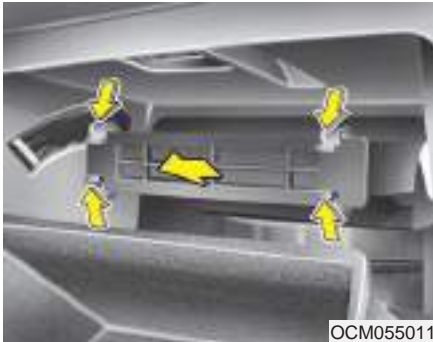

3. Remove the climate control air filter case by pulling out both sides of the cover.



4. Replace the climate control air filter.  
5. Reassemble in the reverse order of disassembly.

**\* NOTICE**

When replacing the climate control air filter install it properly. Otherwise, the system may produce noise and the effectiveness of the filter may be reduced.



## WIPER BLADES

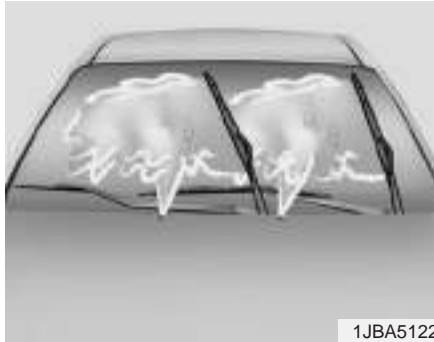

1JBA5122

G180100AUN

### Blade inspection

#### \* NOTICE

Commercial hot waxes applied by automatic car washes have been known to make the windshield difficult to clean.

Contamination of either the windshield or the wiper blades with foreign matter can reduce the effectiveness of the windshield wipers. Common sources of contamination are insects, tree sap, and hot wax treatments used by some commercial car washes. If the blades are not wiping properly, clean both the window and the blades with a good cleaner or mild detergent, and rinse thoroughly with clean water.

#### ! CAUTION

*To prevent damage to the wiper blades, do not use gasoline, kerosene, paint thinner, or other solvents on or near them.*

G180200AUN

### Blade replacement

When the wipers no longer clean adequately, the blades may be worn or cracked, and require replacement.

#### ! CAUTION

*To prevent damage to the wiper arms or other components, do not attempt to move the wipers manually.*

#### ! CAUTION

*The use of a non-specified wiper blade could result in wiper malfunction and failure.*



1LDA5023

**Front windshield wiper blade**

1. Raise the wiper arm and turn the wiper blade assembly to expose the plastic locking clip.

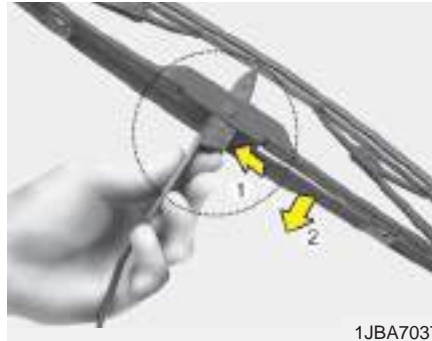

1JBA7037

2. Compress the clip and slide the blade assembly downward.



1JBA7038

3. Lift it off the arm.
4. Install the blade assembly in the reverse order of removal.

**! CAUTION**

*Do not allow the wiper arm to fall against the windshield, since it may chip or crack the windshield.*



G180202AFD

### **Rear window wiper blade**

1. Raise the wiper arm and pull out the wiper blade assembly.



2. Install the new blade assembly by inserting the center part into the slot in the wiper arm until it clicks into place.
3. Make sure the blade assembly is installed firmly by trying to pull it slightly.

To prevent damage to the wiper arms or other components, have an authorized HYUNDAI dealer replace the wiper blade.

## BATTERY







G190100BUN

### For best battery service

- Keep the battery securely mounted.
- Keep the battery top clean and dry.
- Keep the terminals and connections clean, tight, and coated with petroleum jelly or terminal grease.
- Rinse any spilled electrolyte from the battery immediately with a solution of water and baking soda.
- If the vehicle is not going to be used for an extended time, disconnect the battery cables.

### **WARNING - Battery dangers**

-  Always read the following instructions carefully when handling a battery.
-  Keep lighted cigarettes and all other flames or sparks away from the battery.
-  Hydrogen, a highly combustible gas, is always present in battery cells and may explode if ignited.
-  Keep batteries out of the reach of children because batteries contain highly corrosive **SULFURIC ACID**. Do not allow battery acid to contact your skin, eyes, clothing or paint finish.

(Continued)

(Continued)



If any electrolyte gets into your eyes, flush your eyes with clean water for at least 15 minutes and get immediate medical attention.

If electrolyte gets on your skin, thoroughly wash the contacted area. If you feel a pain or a burning sensation, get medical attention immediately.



Wear eye protection when charging or working near a battery. Always provide ventilation when working in an enclosed space.



An inappropriately disposed battery can be harmful to the environment and human health. Dispose the battery according to your local law(s) or regulation.

(Continued)

**(Continued)**

- When lifting a plastic-cased battery, excessive pressure on the case may cause battery acid to leak, resulting in personal injury. Lift with a battery carrier or with your hands on opposite corners.
- Never attempt to recharge the battery when the battery cables are connected.
- The electrical ignition system works with high voltage. Never touch these components with the engine running or the ignition switched on.

Failure to follow the above warnings can result in serious bodily injury or death.



**CALIFORNIA PROPOSITION 65 WARNING**

Battery posts, terminals, and related accessories contain lead and lead compounds, chemicals known to the State of California to cause cancer, birth defects, and reproductive harm. Batteries also contain other chemicals known to the State of California to cause cancer. Wash hands after handling.

G190200AUN

**Battery recharging**

Your vehicle has a maintenance-free, calcium-based battery.

- If the battery becomes discharged in a short time (because, for example, the headlights or interior lights were left on while the vehicle was not in use), recharge it by slow charging (trickle) for 10 hours.
- If the battery gradually discharges because of high electric load while the vehicle is being used, recharge it at 20-30A for two hours.

 **WARNING - Recharging battery**

When recharging the battery, observe the following precautions:

- The battery must be removed from the vehicle and placed in an area with good ventilation.
- Do not allow cigarettes, sparks, or flame near the battery.
- Watch the battery during charging, and stop or reduce the charging rate if the battery cells begin gassing (boiling) violently or if the temperature of the electrolyte of any cell exceeds 120°F (49°C).
- Wear eye protection when checking the battery during charging.
- Disconnect the battery charger in the following order.
  1. Turn off the battery charger main switch.
  2. Unhook the negative clamp from the negative battery terminal.
  3. Unhook the positive clamp from the positive battery terminal.

(Continued)

**(Continued)**

- Before performing maintenance or recharging the battery, turn off all accessories and stop the engine.
- The negative battery cable must be removed first and installed last when the battery is disconnected.

G130300AUN

**Reset items**

Items should be reset after the battery has been discharged or the battery has been disconnected.

- Auto up/down window (See section 4)
- Sunroof (See section 4)
- Trip computer (See section 4)
- Climate control system (See section 4)
- Clock (See section 4)
- Audio (See section 4)

### TIRES AND WHEELS

G200100AUN

#### Tire care

For proper maintenance, safety, and maximum fuel economy, you must always maintain recommended tire inflation pressures and stay within the load limits and weight distribution recommended for your vehicle.

G200200ACM

#### Recommended cold tire inflation pressures

All tire pressures (including the spare) should be checked when the tires are cold. "Cold Tires" means the vehicle has not been driven for at least three hours or driven less than 1 mile (1.6 km).

Recommended pressures must be maintained for the best ride, top vehicle handling, and minimum tire wear.

For recommended inflation pressure refer to "Tire and wheels" in section 8.



OCM070048L

All specifications (sizes and pressures) can be found on a label attached to the vehicle.



#### **WARNING - Tire underinflation**

Severe underinflation (10 psi (70 kPa) or more) can lead to severe heat build-up, causing blowouts, tread separation and other tire failures that can result in the loss of vehicle control leading to severe injury or death. This risk is much higher on hot days and when driving for long periods at high speeds.

**! CAUTION**

- *Underinflation also results in excessive wear, poor handling and reduced fuel economy. Wheel deformation also is possible. Keep your tire pressures at the proper levels. If a tire frequently needs refilling, have it checked by an authorized HYUNDAI dealer.*
- *Overinflation produces a harsh ride, excessive wear at the center of the tire tread, and a greater possibility of damage from road hazards.*

**! CAUTION**

- *Warm tires normally exceed recommended cold tire pressures by 4 to 6 psi (28 to 41 kPa). Do not release air from warm tires to adjust the pressure or the tires will be under-inflated.*
- *Be sure to reinstall the tire inflation valve caps. Without the valve cap, dirt or moisture could get into the valve core and cause air leakage. If a valve cap is missing, install a new one as soon as possible.*

**WARNING - Tire inflation**

Overinflation or underinflation can reduce tire life, adversely affect vehicle handling, and lead to sudden tire failure. This could result in loss of vehicle control and potential injury.

**! CAUTION - Tire pressure**

*Always observe the following:*

- *Check tire pressure when the tires are cold. (After vehicle has been parked for at least three hours or hasn't been driven more than 1 mile (1.6 km) since startup.)*
- *Check the pressure of your spare tire each time you check the pressure of other tires.*
- *Never overload your vehicle. Be careful not to overload a vehicle luggage rack if your vehicle is equipped with one.*
- *Worn, old tires can cause accidents. If your tread is badly worn, or if your tires have been damaged, replace them.*



G200300AUN

### **Checking tire inflation pressure**

Check your tires once a month or more.

Also, check the tire pressure of the spare tire.

G200301AFD

#### ***How to check***

Use a good quality gage to check tire pressure. You can not tell if your tires are properly inflated simply by looking at them. Radial tires may look properly inflated even when they're underinflated.

Check the tire's inflation pressure when the tires are cold. - "Cold" means your vehicle has been sitting for at least three hours or driven no more than 1 mile (1.6 km).

Remove the valve cap from the tire valve stem. Press the tire gage firmly onto the valve to get a pressure measurement. If the cold tire inflation pressure matches the recommended pressure on the tire and loading information label, no further adjustment is necessary. If the pressure is low, add air until you reach the recommended amount.

If you overfill the tire, release air by pushing on the metal stem in the center of the tire valve. Recheck the tire pressure with the tire gage. Be sure to put the valve caps back on the valve stems. They help prevent leaks by keeping out dirt and moisture.

### **WARNING**

- **Inspect your tires frequently for proper inflation as well as wear and damage. Always use a tire pressure gage.**
- **Tires with too much or too little pressure wear unevenly causing poor handling, loss of vehicle control, and sudden tire failure leading to accidents, injuries, and even death. The recommended cold tire pressure for your vehicle can be found in this manual and on the tire label located on the driver's side center pillar.**
- **Worn tires can cause accidents. Replace tires that are worn, show uneven wear, or are damaged.**
- **Remember to check the pressure of your spare tire. HYUNDAI recommends that you check the spare every time you check the pressure of the other tires on your vehicle.**

G200400AXM

### Tire rotation

To equalize tread wear, it is recommended that the tires be rotated every 7,500 miles (12,000 km) or sooner if irregular wear develops.

During rotation, check the tires for correct balance.

When rotating tires, check for uneven wear and damage. Abnormal wear is usually caused by incorrect tire pressure, improper wheel alignment, out-of-balance wheels, severe braking or severe cornering. Look for bumps or bulges in the tread or side of tire. Replace the tire if you find either of these conditions. Replace the tire if fabric or cord is visible. After rotation, be sure to bring the front and rear tire pressures to specification and check lug nut tightness.

Refer to "Tire and wheels" in section 8.

With a full-size spare tire (if equipped)

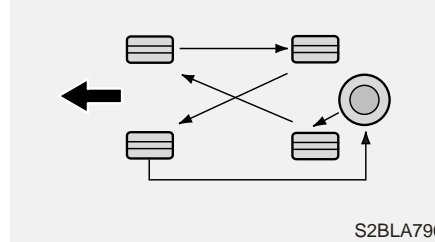

S2BLA790

Without a spare tire

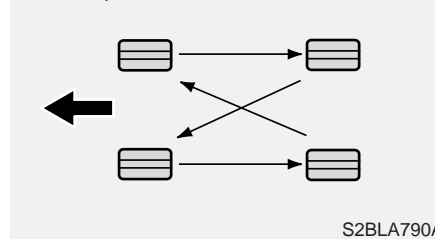

S2BLA790A

Directional tires (if equipped)

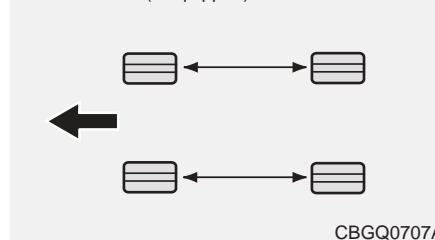

CBGQ0707A

*Disc brake pads should be inspected for wear whenever tires are rotated.*

### \* NOTICE

Rotate radial tires that have an asymmetric tread pattern only from front to rear and not from right to left.

### WARNING

- Do not use the compact spare tire for tire rotation.
- Do not mix bias ply and radial ply tires under any circumstances. This may cause unusual handling characteristics that could result in death, severe injury, or property damage.

G200500AUN

### Wheel alignment and tire balance

The wheels on your vehicle were aligned and balanced carefully at the factory to give you the longest tire life and best overall performance.

In most cases, you will not need to have your wheels aligned again. However, if you notice unusual tire wear or your vehicle pulling one way or the other, the alignment may need to be reset.

If you notice your vehicle vibrating when driving on a smooth road, your wheels may need to be rebalanced.

#### **! CAUTION**

***Improper wheel weights can damage your vehicle's aluminum wheels. Use only approved wheel weights.***



G200600BFD

### Tire replacement

If the tire is worn evenly, a tread wear indicator will appear as a solid band across the tread. This shows there is less than 1/16 in. (1.6 mm) of tread left on the tire. Replace the tire when this happens.

Do not wait for the band to appear across the entire tread before replacing the tire.

#### **⚠ WARNING - Replacing tires**

- Driving on worn-out tires is very hazardous and will reduce braking effectiveness, steering accuracy, and traction.
- Your vehicle is equipped with tires designed to provide for safe ride and handling capability. Do not use a size and type of tire and wheel that is different from the one that is originally installed on your vehicle. It can affect the safety and performance of your vehicle, which could lead to handling failure or rollover and serious injury. When replacing the tires, be sure to equip all four tires with the tire and wheel of the same size, type, tread, brand and load-carrying capacity.

(Continued)

**(Continued)**

- The use of any other tire size or type may seriously affect ride, handling, ground clearance, stopping distance, body to tire clearance, snow tire clearance, and speedometer reliability.
- It is best to replace all four tires at the same time. If that is not possible, or necessary, then replace the two front or two rear tires as a pair. Replacing just one tire can seriously affect your vehicle's handling.
- The ABS works by comparing the speed of the wheels. Tire size can affect wheel speed. When replacing tires, all 4 tires must use the same size originally supplied with the vehicle. Using tires of a different size can cause the ABS (Anti-lock Brake System) and ESC (Electronic Stability Control) (if equipped) to work irregularly.

G200601AUN

***Compact spare tire replacement (if equipped)***

A compact spare tire has a shorter tread life than a regular size tire. Replace it when you can see the tread wear indicator bars on the tire. The replacement compact spare tire should be the same size and design tire as the one provided with your new vehicle and should be mounted on the same compact spare tire wheel. The compact spare tire is not designed to be mounted on a regular size wheel, and the compact spare tire wheel is not designed for mounting a regular size tire.

G200700AUN

**Wheel replacement**

When replacing the metal wheels for any reason, make sure the new wheels are equivalent to the original factory units in diameter, rim width and offset.

**WARNING**

**A wheel that is not the correct size may adversely affect wheel and bearing life, braking and stopping abilities, handling characteristics, ground clearance, body-to-tire clearance, snow chain clearance, speedometer and odometer calibration, headlight aim and bumper height.**

G200800AUN

### Tire traction

Tire traction can be reduced if you drive on worn tires, tires that are improperly inflated or on slippery road surfaces. Tires should be replaced when tread wear indicators appear. To reduce the possibility of losing control, slow down whenever there is rain, snow or ice on the road.

G200900AUN

### Tire maintenance

In addition to proper inflation, correct wheel alignment helps to decrease tire wear. If you find a tire is worn unevenly, have your dealer check the wheel alignment.

When you have new tires installed, make sure they are balanced. This will increase vehicle ride comfort and tire life. Additionally, a tire should always be rebalanced if it is removed from the wheel.

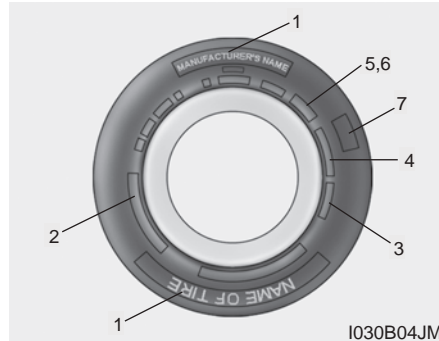

G201000AUN

### Tire sidewall labeling

This information identifies and describes the fundamental characteristics of the tire and also provides the tire identification number (TIN) for safety standard certification. The TIN can be used to identify the tire in case of a recall.

G201001AUN

#### 1. *Manufacturer or brand name*

Manufacturer or Brand name is shown.

G201002ACM

### 2. *Tire size designation*

A tire's sidewall is marked with a tire size designation. You will need this information when selecting replacement tires for your car. The following explains what the letters and numbers in the tire size designation mean.

Example tire size designation:

(These numbers are provided as an example only; your tire size designator could vary depending on your vehicle.)

### **P235/60R18 102H**

P - Applicable vehicle type (tires marked with the prefix "P" are intended for use on passenger vehicles or light trucks; however, not all tires have this marking).

235 - Tire width in millimeters.

60 - Aspect ratio. The tire's section height as a percentage of its width.

R - Tire construction code (Radial).

18 - Rim diameter in inches.

102 - Load Index, a numerical code associated with the maximum load the tire can carry.

H - Speed Rating Symbol. See the speed rating chart in this section for additional information.

**Wheel size designation**

Wheels are also marked with important information that you need if you ever have to replace one. The following explains what the letters and numbers in the wheel size designation mean.

Example wheel size designation:

**7.0JX18**

7.0 - Rim width in inches.

J - Rim contour designation.

18 - Rim diameter in inches.

**Tire speed ratings**

The chart below lists many of the different speed ratings currently being used for passenger cars. The speed rating is part of the tire size designation on the sidewall of the tire. This symbol corresponds to that tire's designed maximum safe operating speed.

Speed Rating Symbol	Maximum Speed
S	112 mph (180 km/h)
T	118 mph (190 km/h)
H	130 mph (210 km/h)
V	149 mph (240 km/h)
Z	Above 149 mph (240 km/h)

G201003AEN

**3. Checking tire life**  
*(TIN : Tire Identification Number)*

Any tires that are over 6 years, based on the manufacturing date, tire strength and performance, decline with age naturally (even unused spare tires). Therefore, the tires (including the spare tire) should be replaced by new ones. You can find the manufacturing date on the tire sidewall (possibly on the inside of the wheel), displaying the DOT Code. The DOT Code is a series of numbers on a tire consisting of numbers and English letters. The manufacturing date is designated by the last four digits (characters) of the DOT code.

**DOT : XXXX XXXX OOOO**

The front part of the DOT means a plant code number, tire size and tread pattern and the last four numbers indicate week and year manufactured.

For example:

DOT XXXX XXXX 1609 represents that the tire was produced in the 16th week of 2009.



**WARNING - Tire age**

Tires degrade over time, even when they are not being used. Regardless of the remaining tread, it is recommended that tires generally be replaced after six (6) years of normal service. Heat caused by not climates or frequent high loading conditions can accelerate the aging process. Failure to follow this Warning can result in sudden tire failure, which could lead to a loss of control and an accident involving serious injury or death.

G201004AUN

**4. Tire ply composition and material**

The number of layers or plies of rubber-coated fabric are in the tire. Tire manufacturers also must indicate the materials in the tire, which include steel, nylon, polyester, and others. The letter "R" means radial ply construction; the letter "D" means diagonal or bias ply construction; and the letter "B" means belted-bias ply construction.

G201005AUN

**5. Maximum permissible inflation pressure**

This number is the greatest amount of air pressure that should be put in the tire. Do not exceed the maximum permissible inflation pressure. Refer to the Tire and Loading Information label for recommended inflation pressure.

G201006AUN

**6. Maximum load rating**

This number indicates the maximum load in kilograms and pounds that can be carried by the tire. When replacing the tires on the vehicle, always use a tire that has the same load rating as the factory installed tire.

G201007BUN

**7. Uniform tire quality grading**

Quality grades can be found where applicable on the tire sidewall between tread shoulder and maximum section width.

For example:

TREADWEAR 200  
TRACTION AA  
TEMPERATURE A

**Tread wear**

The tread wear grade is a comparative rating based on the wear rate of the tire when tested under controlled conditions on a specified government test course. For example, a tire graded 150 would wear one-and-a-half times (1½) as well on the government course as a tire graded 100.

The relative performance of tires depends upon the actual conditions of their use, however, and may depart significantly from the norm because of variations in driving habits, service practices and differences in road characteristics and climate.

These grades are molded on the side-walls of passenger vehicle tires. The tires available as standard or optional equipment on your vehicles may vary with respect to grade.

**Traction - AA, A, B & C**

The traction grades, from highest to lowest, are AA, A, B and C. Those grades represent the tires ability to stop on wet pavement as measured under controlled conditions on specified government test surfaces of asphalt and concrete. A tire marked C may have poor traction performance.

 **WARNING**

The traction grade assigned to this tire is based on straight-ahead braking traction tests, and does not include acceleration, cornering, hydroplaning, or peak traction characteristics.

**Temperature -A, B & C**

The temperature grades are A (the highest), B and C representing the tire's resistance to the generation of heat and its ability to dissipate heat when tested under controlled conditions on a specified indoor laboratory test wheel.

Sustained high temperature can cause the material of the tire to degenerate and reduce tire life, and excessive temperature can lead to sudden tire failure. Grades B and A represent higher levels of performance on the laboratory test wheel than the minimum required by the law.

 **WARNING - Tire temperature**

The temperature grade for this tire is established for a tire that is properly inflated and not overloaded. Excessive speed, underinflation, or excessive loading, either separately or in combination, can cause heat build-up and possible sudden tire failure. This can cause loss of vehicle control and serious injury or death.

G201100AEN

**Tire terminology and definitions**

**Air Pressure:** The amount of air inside the tire pressing outward on the tire. Air pressure is expressed in pounds per square inch (psi) or kilopascal (kPa).

**Accessory Weight:** This means the combined weight of optional accessories. Some examples of optional accessories are, automatic transaxle power seats, and air conditioning.

**Aspect Ratio:** The relationship of a tire's height to its width.

**Belt:** A rubber coated layer of cords that is located between the plies and the tread. Cords may be made from steel or other reinforcing materials.

**Bead:** The tire bead contains steel wires wrapped by steel cords that hold the tire onto the rim.

**Bias Ply Tire:** A pneumatic tire in which the plies are laid at alternate angles less than 90 degrees to the centerline of the tread.



**Cold Tire Pressure:** The amount of air pressure in a tire, measured in pounds per square inch (psi) or kilopascals (kPa) before a tire has built up heat from driving.

**Curb Weight:** This means the weight of a motor vehicle with standard and optional equipment including the maximum capacity of fuel, oil and coolant, but without passengers and cargo.

**DOT Markings:** A code molded into the sidewall of a tire signifying that the tire is in compliance with the U.S. Department of Transportation motor vehicle safety standards. The DOT code includes the Tire Identification Number (TIN), an alphanumeric designator which can also identify the tire manufacturer, production plant, brand and date of production.

**GVWR:** Gross Vehicle Weight Rating

**GAWR FRT:** Gross Axle Weight Rating for the Front Axle.

**GAWR RR:** Gross Axle Weight Rating for the Rear axle.

**Intended Outboard Sidewall:** The side of an asymmetrical tire, that must always face outward when mounted on a vehicle.

**Kilopascal (kPa):** The metric unit for air pressure.

**Load Index:** An assigned number ranging from 1 to 279 that corresponds to the load carrying capacity of a tire.

**Maximum Inflation Pressure:** The maximum air pressure to which a cold tire may be inflated. The maximum air pressure is molded onto the sidewall.

**Maximum Load Rating:** The load rating for a tire at the maximum permissible inflation pressure for that tire.

**Maximum Loaded Vehicle Weight:** The sum of curb weight; accessory weight; vehicle capacity weight; and production options weight.

**Normal Occupant Weight:** The number of occupants a vehicle is designed to seat multiplied by 150 pounds (68 kg).

**Occupant Distribution:** Designated seating positions.

**Outward Facing Sidewall:** The side of a asymmetrical tire that has a particular side that faces outward when mounted on a vehicle. The outward facing sidewall bears white lettering or bears manufacturer, brand, and/or model name molding that is higher or deeper than the same moldings on the inner facing sidewall.

**Passenger (P-Metric) Tire:** A tire used on passenger cars and some light duty trucks and multipurpose vehicles.

**Recommended Inflation Pressure:** Vehicle manufacturer's recommended tire inflation pressure and shown on the tire placard.

**Radial Ply Tire:** A pneumatic tire in which the ply cords that extend to the beads are laid at 90 degrees to the centerline of the tread.

**Rim:** A metal support for a tire and upon which the tire beads are seated.

**Sidewall:** The portion of a tire between the tread and the bead.

**Speed Rating:** An alphanumeric code assigned to a tire indicating the maximum speed at which a tire can operate.

**Traction:** The friction between the tire and the road surface. The amount of grip provided.

**Tread:** The portion of a tire that comes into contact with the road.

**Treadwear Indicators:** Narrow bands, sometimes called "wear bars," that show across the tread of a tire when only 2/32 inch of tread remains.

**UTQGS:** Uniform Tire Quality Grading Standards, a tire information system that provides consumers with ratings for a tire's traction, temperature and treadwear. Ratings are determined by tire manufacturers using government testing procedures. The ratings are molded into the sidewall of the tire.

**Vehicle Capacity Weight:** The number of designated seating positions multiplied by 150 lbs. (68 kg) plus the rated cargo and luggage load.

**Vehicle Maximum Load on the Tire:** Load on an individual tire due to curb and accessory weight plus maximum occupant and cargo weight.

**Vehicle Normal Load on the Tire:** Load on an individual tire that is determined by distributing to each axle its share of the curb weight, accessory weight, and normal occupant weight and driving by 2.

**Vehicle Placard:** A label permanently attached to a vehicle showing the original equipment tire size and recommended inflation pressure.

### All season tires

HYUNDAI specifies all season tires on some models to provide good performance for use all year round, including snowy and icy road conditions. All season tires are identified by ALL SEASON and/or M+S (Mud and Snow) on the tire sidewall. Snow tires have better snow traction than all season tires and may be more appropriate in some areas.

### Summer tires

HYUNDAI specifies summer tires on some models to provide superior performance on dry roads. Summer tire performance is substantially reduced in snow and ice. Summer tires do not have the tire traction rating M+S (Mud and Snow) on the tire side wall. If you plan to operate your vehicle in snowy or icy conditions, HYUNDAI recommends the use of snow tires or all season tires on all four wheels.

### Snow tires

If you equip your car with snow tires, they should be the same size and have the same load capacity as the original tires. Snow tires should be installed on all four wheels; otherwise, poor handling may result.

Snow tires should carry 4 psi (28 kPa) more air pressure than the pressure recommended for the standard tires on the tire label on the driver's side of the center pillar, or up to the maximum pressure shown on the tire sidewall, whichever is less.

Do not drive faster than 75 mph (120 km/h) when your car is equipped with snow tires.

### Tire chains

Tire chains, if necessary, should be installed on the drive wheels as follows.

2WD : Front wheels

AWD : All four wheels

If a full set of chains is not available for a AWD vehicle, chains may be installed on the front wheels only.

Be sure that the chains are installed in accordance with the manufacturer's instructions.

To minimize tire and chain wear, do not continue to use tire chains when they are no longer needed.



### **WARNING - Snow or ice**

- **When driving on roads covered with snow or ice, drive at less than 20 mph (30 km/h).**
- **Use the SAE "S" class or wire chains.**
- **If you hear noise caused by chains contacting the body, retighten the chain to avoid contact with the vehicle body.**
- **To prevent body damage, retighten the chains after driving 0.3~0.6 miles (0.5~1.0 km).**
- **Do not use tire chains on vehicles equipped with aluminum wheels. In unavoidable circumstance, use a wire type chain.**
- **Use wire chains less than 0.59 inches (15mm) to prevent damage to the chain's connection.**

### Radial-ply tires

Radial-ply tires provide improved tread life, road hazard resistance and smoother high speed ride. The radial-ply tires used on this vehicle are of belted construction, and are selected to complement the ride and handling characteristics of your vehicle. Radial-ply tires have the same load carrying capacity, as bias-ply or bias belted tires of the same size, and use the same recommended inflation pressure. Mixing of radial-ply tires with bias-ply or bias belted tires is not recommended. Any combinations of radial-ply and bias-ply or bias belted tires when used on the same vehicle will seriously deteriorate vehicle handling. The best rule to follow is: Identical radial-ply tires should always be used as a set of four.

Longer wearing tires can be more susceptible to irregular tread wear. It is very important to follow the tire rotation interval shown in this section to achieve the tread life potential of these tires. Cuts and punctures in radial-ply tires are repairable only in the tread area, because of sidewall flexing. Consult your tire dealer for radial-ply tire repairs.

## FUSES

### Blade type



Normal



Blown

### Cartridge type



Normal



Blown

### Fusible link



Normal



Blown

1VQA4037

G210000AFD

A vehicle's electrical system is protected from electrical overload damage by fuses.

This vehicle has 2 (or 3) fuse panels, one located in the driver's side panel bolster, the other in the engine compartment near the battery.

If any of your vehicle's lights, accessories, or controls do not work, check the appropriate circuit fuse. If a fuse has blown, the element inside the fuse will be melted.

If the electrical system does not work, first check the driver's side fuse panel. Always replace a blown fuse with one of the same rating.

If the replacement fuse blows, this indicates an electrical problem. Avoid using the system involved and immediately consult an authorized HYUNDAI dealer.

*Three kinds of fuses are used: blade type for lower amperage rating, cartridge type, and fusible link for higher amperage ratings.*



### **WARNING - Fuse replacement**

- Never replace a fuse with anything but another fuse of the same rating.
- A higher capacity fuse could cause damage and possibly a fire.
- Never install a wire instead of the proper fuse - even as a temporary repair. It may cause extensive wiring damage and a possible fire.

### **! CAUTION**

**Do not use a screwdriver or any other metal object to remove fuses because it may cause a short circuit and damage the system.**



G210100AUN

### ***Inner panel fuse replacement***

1. Turn the ignition switch and all other switches off.
2. Open the fuse panel cover.



3. Pull the suspected fuse straight out. Use the removal tool provided in the engine compartment fuse panel.
4. Check the removed fuse; replace it if it is blown.
5. Push in a new fuse of the same rating, and make sure it fits tightly in the clips. If it fits loosely, consult an authorized HYUNDAI dealer.

*If you do not have a spare, use a fuse of the same rating from a circuit you may not need for operating the vehicle, such as the cigar lighter fuse.*

If the headlights or other electrical components do not work and the fuses are OK, check the fuse block in the engine compartment. If a fuse is blown, it must be replaced.



G210101AXM

**Memory fuse (SHUNT connector)**

Your vehicle is equipped with a memory fuse (SHUNT connector) to prevent battery discharge if your vehicle is parked without being operated for prolonged periods. Use the following procedures before parking the vehicle for prolonged periods.

1. Turn off the engine.
2. Turn off the headlights and tail lights.
3. Open the driver's side panel cover and pull out the memory fuse (SHUNT connector).

**\* NOTICE**

- If the memory fuse is pulled up from the fuse panel, the warning chime, audio, clock and interior lamps, etc., will not operate. Some items must be reset after replacement. Refer to "Battery" in this section.
- Even though the memory fuse is pulled up, the battery can still be discharged by operation of the headlights or other electrical devices.



G210200AFD

**Engine compartment panel fuse replacement**

1. Turn the ignition switch and all other switches off.
2. Remove the fuse box cover by pressing the tap and pulling up.

3. Check the removed fuse; replace it if it is blown. To remove or insert the fuse, use the fuse puller in the engine compartment fuse panel.
4. Push in a new fuse of the same rating, and make sure it fits tightly in the clips. If it fits loosely, consult an authorized HYUNDAI dealer.

### ! CAUTION

*After checking the fuse box in the engine compartment, securely install the fuse box cover. If not, electrical failures may occur from water leaking in.*

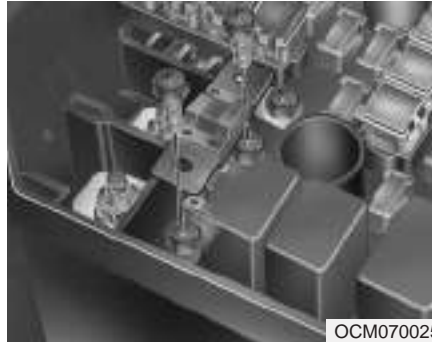

G210201ACM

### **Main fuse**

If the main fuse is blown, it must be removed as follows:

1. Disconnect the negative battery cable.
2. Remove the bolts shown in the picture above.
3. Replace the fuse with a new one of the same rating.
4. Reinstall in the reverse order of removal.

### \* NOTICE

**If the main fuse is blown, consult an Authorized HYUNDAI Dealer.**

G210300AFD

### Fuse/Relay panel description

Inside the fuse/relay box covers, you can find the fuse/relay label describing fuse/relay name and capacity.

#### Driver's side panel



#### Engine compartment

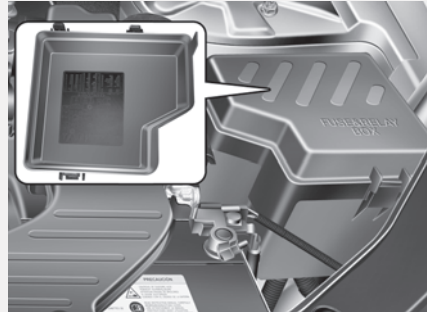

OCM070026/OCM070027

### \* NOTICE

Not all fuse panel descriptions in this manual may be applicable to your vehicle. It is accurate at the time of printing. When you inspect the fuse box on your vehicle, refer to the fuse box label.



## Maintenance

### Driver's side fuse panel

Description	Fuse rating	Protected component
START	10A	Burglar Alarm Relay
P/WDW LH	25A	Power Window Main Switch, Rear Power Window Switch LH
P/WDW RH	25A	Power Window Main Switch, Passenger Power Window Switch, Rear Power Window Switch RH
S/ROOF	20A	Sunroof Motor
P/SEAT	30A	Driver/Passenger Seat Manual Switch, Driver Lumbar Support Switch
SAFETY PWR	25A	Safety Power Window Module
MIRR HTD	10A	Rear Defogger Switch, Driver/Passenger Power Outside Mirror
A/BAG 2	15A	Digital Clock & Telltail
A/BAG 1	15A	SRS Control Module, PODS Module
ROOM LP	10A	Instrument Cluster (IND.), Driver/Passenger Door Lamp, MAP Lamp, Room Lamp, Cargo Lamp, Driver/Passenger Vanity Switch
A/CON	10A	A/C Control Module, Cluster Ionizer, Incar Sensor, Sunroof Motor, Electro Chromic Mirror, Blower Relay, GM02 (Ground), Home Link
AC INVERTER	25A	AC Inverter Module
P/AMP	30A	Amp
P/OUTLET CTR	15A	Center Power Outlet
P/OUTLET	25A	Front Power Outlet & Cigarette Lighter, Rear Power Outlet
C/LIGHTER	15A	Front Power Outlet & Cigarette Lighter
DR LOCK	20A	Door Lock/Unlock Relay, ICM Relay Box (Key Lock/Unlock Relay), BCM, Driver/Passenger Door Lock Actuator, Tail Gate Lock Actuator, Rear Door Lock Actuator LH/RH, GM01 (Ground)
A/BAG IND	10A	Instrument Cluster (IND.)
ESC SW	10A	ESC Switch, Steering Angle Sensor, ICM Relay Box (Sub Start Relay), Driver/Passenger Seat Warmer Control Module, Multifunction Switch (Remote Control)

Description	Fuse rating	Protected component
T/SIG	10A	Hazard Switch
S/WARMER	15A	Driver/Passenger Seat Warmer Control Module
DRL	15A	ICM Relay Box (DRL Relay)
HAZARD	15A	Hazard Relay, Hazard Switch, BCM, Instrument Cluster (IND.), Multifunction Switch (Light), Rear Combination Lamp (OUT) LH/RH, Head Lamp LH/RH
RR WIPER	15A	Rear Wiper Relay, Rear Wiper Motor, Multifunction Switch (Wiper)
A/CON SW	10A	A/C Control Module
CLUSTER	10A	Alternator, Instrument Cluster (IND.), BCM, A/V & Navigation Head Unit, Tire Pressure Monitoring Module, DVD Module
BCM 1	10A	BCM
RR A/CON	15A	Not Used
TPMS	10A	Tire Pressure Monitoring Module
BCM 2	10A	Rheostat, BCM, Instrument Cluster (MICOM), AC Inverter Switch, AC Inverter Module
AUDIO 2	10A	Audio, A/V & Navigation Head Unit, BCM, DVD Module, Digital Clock & Telltale, Power Outside Mirror Switch
BLOWER	30A	Blower Relay, Blower Motor, A/CON SW 10A
STOP LP	15A	Stop Lamp Switch
PDM 1	20A	Not Used
BCM 3	10A	BCM, Ignition Key ILL. & Door Warning Switch, Security Indicator
CLOCK	15A	A/C Control Module, Data Link Connector, Digital Clock & Telltail
AUDIO 1	15A	Audio, A/V & Navigation Head Unit, DVD Module
ATM	10A	Sport Mode Switch, Key Solenoid
PDM 2	15A	Not Used
POWER CONNECTOR		FUSE - ROOM LP 15A, CLOCK 15A, AUDIO 1 15A, BCM 3 10A

## Engine compartment

Description		Fuse rating	Protected component
ALT		175A	FUSIBLE LINK - BLR, B+ 2, P/WDW, ESC 1, ESC 2 FUSE - DEICER, RR HTD, A/CON, FR FOG, H/LP LO LH, H/LP LO RH
BATT		30A	Trailer Power Outlet
IGN 1		40A	Ignition Switch (ACC, IG 1)
ESC 1		40A	Multipurpose Check Connector, ESC Control Module
CON FAN 2		50A	Condenser Fan Relay (High)
ESC 2		20A	ESC Control Module
BLR		40A	FUSE - BLOWER
P/WDW		40A	Power Window Relay, FUSE - SAFETY PWR
B+ 2		50A	FUSE - P/SEAT, TPMS, RR A/CON, S/WARMER, S/ROOF, PDM 2, P/AMP, AC INVERTER, DRL
IGN 2		40A	Ignition Switch (START, IG 2), Start Relay
B+ 1		50A	FUSE - DR LOCK, HAZARD, ATM, PDM 1, STOP LP, POWER CONNECTOR (BCM 3, CLOCK ROOM LP, AUDIO 1)
CON FAN 1		40A	Condenser Fan Relay (Low)
ECU MAIN		40A	Engine Control Relay
1	DEICER	15A	Front Wiper Deicer Relay
2	RR HTD	30A	Rear Defogger Relay
3	-	-	-
4	H/LP LO RH	15A	Head Lamp Low Relay (RH)
5	HORN	15A	Horn Relay

	Description	Fuse rating	Protected component
6	H/LP LO LH	15A	Head Lamp Low Relay (LH)
7	H/LP HI IND	10A	Instrument Cluster (High Beam IND.)
8	-	-	-
9	A/CON	10A	A/CON Relay
10	ATM	15A	AWD ECM, PCM (G4KE), Back-Up Lamp Relay
11	-	-	-
12	TAIL LP RH	10A	Rear Combination Lamp (In)/(Out) RH, Head Lamp RH, Glove Box Lamp, Illuminations
13	FR FOG	10A	Front Fog Lamp Relay
14	SENSOR 3	15A	G4KE - Injector #1~#4, Canister Close Valve Canister Purge Control Solenoid Valve G6DC - PCM, Oil Control Valve #1/2 (Exhaust/Intake) Canister Purge Control Solenoid Valve Canister Close Valve, Variable Intake Manifold Valve #1/2
15	TAIL LP LH	10A	License Lamp, Rear Combination Lamp (In) LH, Rear Combination Lamp (Out) LH, Head Lamp LH
16	FUEL PUMP	15A	Fuel Pump Relay
17	FR WIPER	25A	Front Wiper Relay, Front Wiper Motor, Multifunction Switch (Wiper)
18	TCU	15A	PCM, Battery Sensor
19	ESC	10A	Multipurpose Check Connector (G6DC), AWD ECM, ESC Control Module, Yaw Rate Sensor, Stop Lamp Switch (G6DC)
20	COOLING	10A	Condenser Fan Relay (G6DC)
21	B/UP LP	10A	Back-Up Lamp Relay, Back-Up Lamp Switch (G4KE)
22	H/LP	10A	Head Lamp Low Relay (LH/RH), Front Fog Lamp Relay, Head Lamp High Relay
23	ECU	10A	PCM, Alternator (G6DC), Transaxle Range Switch
24	H/LP HI	20A	Head Lamp High Relay

## Maintenance

	Description	Fuse rating	Protected component
25	SENSOR 1	10A	G4KE - Stop Lamp Switch, Immobilizer Module, A/CON Relay, Fuel Pump Relay, Condenser Fan Relay (Low/High), Crankshaft Position Sensor, Oil Control Valve #1/2, Camshaft Position Sensor #1/2, Oxygen Sensor (Up), Variable Intake Manifold Valve G6DC - PCM, A/CON Relay, Fuel Pump Relay, Injector #1~#6, Immobilizer Module
26	SENSOR 2	15A	G4KE - PCM, Oxygen Sensor (Down) G6DC - PCM, Oxygen Sensor #1~#4, Variable Charge Motion Actuator
27	IGN COIL	20A	G4KE - Condenser, Ignition Coil #1~#4 G6DC - Condenser #1/2, Ignition Coil #1~#6
28	SPARE	10A	-
29	SPARE	15A	-
30	SPARE	20A	-
31	SPARE	25A	-
32	SPARE	30A	-

## LIGHT BULBS

G220000AFD

**WARNING - Working on the lights**

Prior to working on the light, firmly apply the parking brake, ensure that the ignition switch is turned to the “LOCK” position and turn off the lights to avoid sudden movement of the vehicle and burning your fingers or receiving an electric shock.

Use only the bulbs of the specified wattage.

**! CAUTION**

Be sure to replace the burned-out bulb with one of the same wattage rating. Otherwise, it may cause damage to the fuse or electric wiring system.

**! CAUTION**

*If you don't have necessary tools, the correct bulbs and the expertise, consult an authorized HYUNDAI dealer. In many cases, it is difficult to replace vehicle light bulbs because other parts of the vehicle must be removed before you can get to the bulb. This is especially true if you have to remove the headlight assembly to get to the bulb(s). Removing/installing the headlight assembly can result in damage to the vehicle.*

**\* NOTICE**

After heavy, driving rain or washing, headlight and taillight lenses could appear frosty. This condition is caused by the temperature difference between the lamp inside and outside. This is similar to the condensation on your windows inside your vehicle during the rain and doesn't indicate a problem with your vehicle. If the water leaks into the lamp bulb circuitry, have the vehicle checked by an authorized HYUNDAI dealer.



G220100AUN

### Headlight, position light, turn signal light, front fog light bulb replacement

- (1) Headlight (High)
- (2) Headlight (Low)
- (3) Position light / Front turn signal light  
(Front side marker)
- (4) Front fog light (if equipped)



G220101ACM

### Headlight bulb

#### **WARNING - Halogen bulbs**

- Halogen bulbs contain pressurized gas that will produce flying pieces of glass if broken.
- Always handle them carefully, and avoid scratches and abrasions. If the bulbs are lit, avoid contact with liquids. Never touch the glass with bare hands. Residual oil may cause the bulb to overheat and burst when lit. A bulb should be operated only when installed in a headlight.

(Continued)

(Continued)

- If a bulb becomes damaged or cracked, replace it immediately and carefully dispose of it.
- Wear eye protection when changing a bulb. Allow the bulb to cool down before handling it.



1. Open the hood.
2. Loosen the retaining bolts and remove the headlight assembly from the body of the vehicle.
3. Disconnect the power connector from the back of the headlight assembly.



4. Remove the headlight bulb cover by turning it counterclockwise.
5. Disconnect the headlight bulb socket connector.
6. Unsnap the headlight bulb retaining wire by depressing the end and pushing it upward (High beam).
7. Remove the bulb from the headlight assembly.

8. Install a new headlight bulb and snap the headlight bulb retaining wire into position by aligning the wire with the groove on the bulb (High beam).
9. Connect the headlight bulb socket connector.
10. Install the headlight bulb cover by turning it clockwise.
11. Connect the power connector to the back of the headlight assembly.
12. Reinstall the headlight assembly to the body of the vehicle.

**\* NOTICE**

**If the headlight aiming adjustment is necessary after the headlight assembly is reinstalled, consult an authorized HYUNDAI dealer.**





### Turn signal light/Position light

1. Remove the socket from the assembly by turning the socket counterclockwise until the tabs on the socket align with the slots on the assembly.
2. Remove the bulb from the socket by pressing it in and rotating it counterclockwise until the tabs on the bulb align with the slots in the socket. Pull the bulb out of the socket

3. Insert a new bulb by inserting it into the socket and rotating it until it locks into place.
4. Install the socket in the assembly by aligning the tabs on the socket with the slots in the assembly. Push the socket into the assembly and turn the socket clockwise.

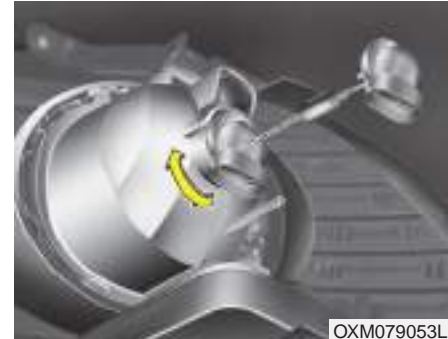

### Front fog light bulbs (if equipped)

1. Remove the front bumper under cover.
2. Reach your hand into the back of the front bumper.
3. Disconnect the power connector from the socket.
4. Remove the bulb-socket from the housing by turning the socket counterclockwise until the tabs on the socket align with the slots on the housing.

5. Install the new bulb-socket into the housing by aligning the tabs on the socket with the slots in the housing. Push the socket into the housing and turn the socket clockwise.
6. Connect the power connector to the socket.
7. Reinstall the front bumper under cover.

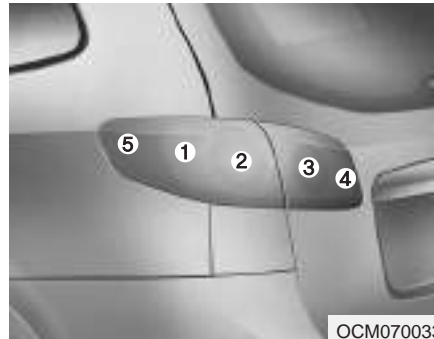

OCM070033

### Rear combination light bulb replacement

- (1) Rear turn signal light
- (2) Stop and tail light
- (3) Tail light
- (4) Back-up light
- (5) Rear side marker

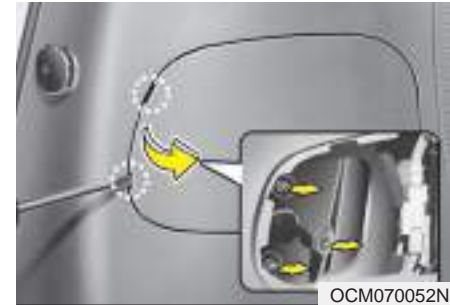

OCM070052N



OCM055026

### Outside light

1. Open the tailgate.
2. Remove the service cover using a flat-blade screwdriver.
3. Loosen the light assembly retaining nuts with a wrench.
4. Remove the rear combination light assembly from the body of the vehicle.

5. Remove the socket from the assembly by turning the socket counterclockwise until the tabs on the socket align with the slots on the assembly.
6. Remove the bulb from the socket by pressing it in and rotating it counterclockwise until the tabs on the bulb align with the slots in the socket. Pull the bulb out of the socket. (Side marker : Remove the bulb from the socket by pulling it out)
7. Insert a new bulb by inserting it into the socket and rotating it until it locks into place.
8. Install the socket in the assembly by aligning the tabs on the socket with the slots in the assembly. Push the socket into the assembly and turn the socket clockwise.
9. Reinstall the light assembly to the body of the vehicle.



4. Remove the bulb from the socket by pressing it in and rotating it counterclockwise until the tabs on the bulb align with the slots in the socket. Pull the bulb out of the socket. (Back-up light : Remove the bulb from the socket by pulling it out)
5. Insert a new bulb by inserting it into the socket and rotating it until it locks into place.
6. Install the socket in the assembly by aligning the tabs on the socket with the slots in the assembly. Push the socket into the assembly and turn the socket clockwise.
7. Install the service cover by putting it into the service hole.

### **Inside light**

1. Open the tailgate.
2. Remove the service cover using a flat-blade screwdriver.
3. Remove the socket from the assembly by turning the socket counterclockwise until the tabs on the socket align with the slots on the assembly.



### High mounted stop light replacement

If the light does not operate, have the vehicle checked by an authorized HYUNDAI dealer.



### License plate light bulb replacement

1. Loosen the lens retaining screws with a philips head screwdriver.
2. Remove the lens.
3. Remove the bulb.
4. Install a new bulb.
5. Reinstall the lens securely with the lens retaining screws.



### Door courtesy lamp bulb replacement (if equipped)

If the light does not operate, have the vehicle checked by an authorized HYUNDAI dealer.

Map lamp



Room lamp

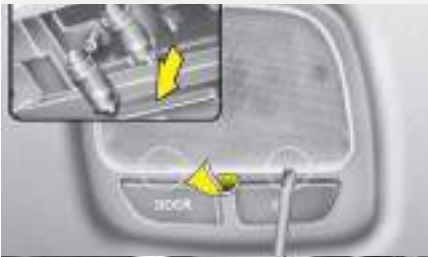

Glove box lamp

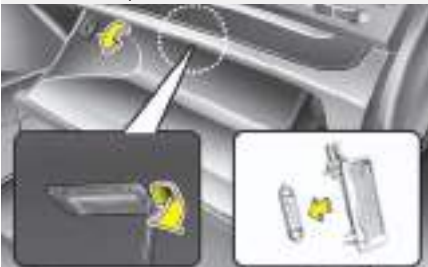

OCM070049L/OCM055033/OCM070045

Luggage room lamp

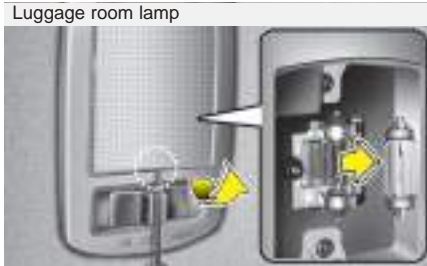

Vanity mirror lamp



OXM079044/OXM079041

G220600AUN

## Interior light bulb replacement

1. Using a flat-blade screwdriver, gently pry the lens from the interior light housing.
2. Remove the bulb by pulling it straight out.

### **WARNING**

**Prior to working on the Interior Lights, ensure that the "OFF" button is depressed to avoid burning your fingers or receiving an electric shock.**

3. Install a new bulb in the socket.
4. Align the lens tabs with the interior light housing notches and snap the lens into place.

### **! CAUTION**

***Use care not to dirty or damage lens, lens tab, and plastic housings.***

## APPEARANCE CARE

### Exterior care

G230101AUN

#### *Exterior general caution*

It is very important to follow the label directions when using any chemical cleaner or polish. Read all warning and caution statements that appear on the label.

G230102CUN

#### *Finish maintenance*

##### **Washing**

To help protect your vehicle's finish from rust and deterioration, wash it thoroughly and frequently at least once a month with lukewarm or cold water.

If you use your vehicle for off-road driving, you should wash it after each off-road trip. Pay special attention to the removal of any accumulation of salt, dirt, mud, and other foreign materials. Make sure the drain holes in the lower edges of the doors and rocker panels are kept clear and clean.

Insects, tar, tree sap, bird droppings, industrial pollution and similar deposits can damage your vehicle's finish if not removed immediately.

Even prompt washing with plain water may not completely remove all these deposits.

A mild soap, safe for use on painted surfaces, may be used.

After washing, rinse the vehicle thoroughly with lukewarm or cold water. Do not allow soap to dry on the finish.

### **! CAUTION**

- *Do not use strong soap, chemical detergents or hot water, and do not wash the vehicle in direct sunlight or when the body of the vehicle is warm.*
- *Be careful when washing the side windows of your vehicle. Especially, with high-pressure water. Water may leak through the windows and wet the interior.*
- *To prevent damage to the plastic parts, do not clean with chemical solvents or strong detergents.*



### **WARNING - Wet brakes**

After washing the vehicle, test the brakes while driving slowly to see if they have been affected by water. If braking performance is impaired, dry the brakes by applying them lightly while maintaining a slow forward speed.



### ! CAUTION

- *Water washing in the engine compartment including high pressure water washing may cause the failure of electrical circuits located in the engine compartment.*
- *Never allow water or other liquids to come in contact with electrical/electronic components inside the vehicle as this may damage them.*

### Waxing

Wax the vehicle when water will no longer bead on the paint.

Always wash and dry the vehicle before waxing. Use a good quality liquid or paste wax, and follow the manufacturer's instructions. Wax all metal trim to protect it and to maintain its luster.

Removing oil, tar, and similar materials with a spot remover will usually strip the wax from the finish. Be sure to re-wax these areas even if the rest of the vehicle does not yet need waxing.

### ! CAUTION

- *Wiping dust or dirt off the body with a dry cloth will scratch the finish.*
- *Do not use steel wool, abrasive cleaners, or strong detergents containing highly alkaline or caustic agents on chrome-plated or anodized aluminum parts. This may result in damage to the protective coating and cause discoloration or paint deterioration.*

G230103AUN

### ***Finish damage repair***

Deep scratches or stone chips in the painted surface must be repaired promptly. Exposed metal will quickly rust and may develop into a major repair expense.

### \* NOTICE

**If your vehicle is damaged and requires any metal repair or replacement, be sure the body shop applies anti-corrosion materials to the parts repaired or replaced.**

B230104AUN

**Bright-metal maintenance**

- To remove road tar and insects, use a tar remover, not a scraper or other sharp object.
- To protect the surfaces of bright-metal parts from corrosion, apply a coating of wax or chrome preservative and rub to a high luster.
- During winter weather or in coastal areas, cover the bright metal parts with a heavier coating of wax or preservative. If necessary, coat the parts with non-corrosive petroleum jelly or other protective compound.

G230105AUN

**Underbody maintenance**

Corrosive materials used for ice and snow removal and dust control may collect on the underbody. If these materials are not removed, accelerated rusting can occur on underbody parts such as the fuel lines, frame, floor pan and exhaust system, even though they have been treated with rust protection.

Thoroughly flush the vehicle underbody and wheel openings with lukewarm or cold water once a month, after off-road driving and at the end of each winter. Pay special attention to these areas because it is difficult to see all the mud and dirt. It will do more harm than good to wet down the road grime without removing it. The lower edges of doors, rocker panels, and frame members have drain holes that should not be allowed to clog with dirt; trapped water in these areas can cause rusting.

**WARNING**

**After washing the vehicle, test the brakes while driving slowly to see if they have been affected by water. If braking performance is impaired, dry the brakes by applying them lightly while maintaining a slow forward speed.**



G230106AUN

### **Aluminum wheel maintenance**

The aluminum wheels are coated with a clear protective finish.

- Do not use any abrasive cleaner, polishing compound, solvent, or wire brushes on aluminum wheels. They may scratch or damage the finish.
- Use only a mild soap or neutral detergent, and rinse thoroughly with water. Also, be sure to clean the wheels after driving on salted roads. This helps prevent corrosion.
- Avoid washing the wheels with high-speed car wash brushes.
- Do not use any acid detergent. It may damage and corrode the aluminum wheels coated with a clear protective finish.

G230107AUN

### **Corrosion protection**

#### **Protecting your vehicle from corrosion**

By using the most advanced design and construction practices to combat corrosion, we produce cars of the highest quality. However, this is only part of the job. To achieve the long-term corrosion resistance your vehicle can deliver, the owner's cooperation and assistance is also required.

#### **Common causes of corrosion**

The most common causes of corrosion on your car are:

- Road salt, dirt and moisture that is allowed to accumulate underneath the car.
- Removal of paint or protective coatings by stones, gravel, abrasion or minor scrapes and dents which leave unprotected metal exposed to corrosion.

#### **High-corrosion areas**

If you live in an area where your car is regularly exposed to corrosive materials, corrosion protection is particularly important. Some of the common causes of accelerated corrosion are road salts, dust control chemicals, ocean air and industrial pollution.

#### **Moisture breeds corrosion**

Moisture creates the conditions in which corrosion is most likely to occur. For example, corrosion is accelerated by high humidity, particularly when temperatures are just above freezing. In such conditions, the corrosive material is kept in contact with the car surfaces by moisture that is slow to evaporate.

Mud is particularly corrosive because it is slow to dry and holds moisture in contact with the vehicle. Although the mud appears to be dry, it can still retain the moisture and promote corrosion.

High temperatures can also accelerate corrosion of parts that are not properly ventilated so the moisture can be dispersed. For all these reasons, it is particularly important to keep your car clean and free of mud or accumulations of other materials. This applies not only to the visible surfaces but particularly to the underside of the car.

#### **To help prevent corrosion**

You can help prevent corrosion from getting started by observing the following:

**Keep your car clean**

The best way to prevent corrosion is to keep your car clean and free of corrosive materials. Attention to the underside of the car is particularly important.

- If you live in a high-corrosion area — where road salts are used, near the ocean, areas with industrial pollution, acid rain, etc.—, you should take extra care to prevent corrosion. In winter, hose off the underside of your car at least once a month and be sure to clean the underside thoroughly when winter is over.
- When cleaning underneath the car, give particular attention to the components under the fenders and other areas that are hidden from view. Do a thorough job; just dampening the accumulated mud rather than washing it away will accelerate corrosion rather than prevent it. Water under high pressure and steam are particularly effective in removing accumulated mud and corrosive materials.
- When cleaning lower door panels, rocker panels and frame members, be sure that drain holes are kept open so that moisture can escape and not be trapped inside to accelerate corrosion.

**Keep your garage dry**

Don't park your car in a damp, poorly ventilated garage. This creates a favorable environment for corrosion. This is particularly true if you wash your car in the garage or drive it into the garage when it is still wet or covered with snow, ice or mud. Even a heated garage can contribute to corrosion unless it is well ventilated so moisture is dispersed.

**Keep paint and trim in good condition**

Scratches or chips in the finish should be covered with "touch-up" paint as soon as possible to reduce the possibility of corrosion. If bare metal is showing through, the attention of a qualified body and paint shop is recommended.

**Bird droppings :** Bird droppings are highly corrosive and may damage painted surfaces in just a few hours. Always remove bird droppings as soon as possible.

**Don't neglect the interior**

Moisture can collect under the floor mats and carpeting to cause corrosion. Check under the mats periodically to be sure the carpeting is dry. Use particular care if you carry fertilizers, cleaning materials or chemicals in the car.

These should be carried only in proper containers and any spills or leaks should be cleaned up, flushed with clean water and thoroughly dried.

### Interior care

G230201BUN

#### **Interior general precautions**

Prevent caustic solutions such as perfume and cosmetic oil from contacting the dashboard because they may cause damage or discoloration. If they do contact the dashboard, wipe them off immediately. See the instructions that follow for the proper way to clean vinyl.

#### **! CAUTION**

***Never allow water or other liquids to come in contact with electrical/electronic components inside the vehicle as this may damage them.***

#### **! CAUTION**

***When cleaning leather products (steering wheel, seats etc.), use neutral detergents or low alcohol content solutions. If you use high alcohol content solutions or acid/alkaline detergents, the color of the leather may fade or the surface may get stripped off.***

G230202AUN

#### ***Cleaning the upholstery and interior trim***

##### **Vinyl**

Remove dust and loose dirt from vinyl with a whisk broom or vacuum cleaner. Clean vinyl surfaces with a vinyl cleaner.

##### **Fabric**

Remove dust and loose dirt from fabric with a whisk broom or vacuum cleaner. Clean with a mild soap solution recommended for upholstery or carpets. Remove fresh spots immediately with a fabric spot cleaner. If fresh spots do not receive immediate attention, the fabric can be stained and its color can be affected. Also, its fire-resistant properties can be reduced if the material is not properly maintained.

#### **! CAUTION**

***Using anything but recommended cleaners and procedures may affect the fabric's appearance and fire-resistant properties.***

G230203AUN

#### ***Cleaning the lap/shoulder belt webbing***

Clean the belt webbing with any mild soap solution recommended for cleaning upholstery or carpet. Follow the instructions provided with the soap. Do not bleach or re-dye the webbing because this may weaken it.

G230204AUN

#### ***Cleaning the interior window glass***

If the interior glass surfaces of the vehicle become fogged (that is, covered with an oily, greasy or waxy film), they should be cleaned with glass cleaner. Follow the directions on the glass cleaner container.

#### **! CAUTION**

***Do not scrape or scratch the inside of the rear window. This may result in damage to the rear window defroster grid.***

## EMISSION CONTROL SYSTEM

G270000AFD

The emission control system of your vehicle is covered by a written limited warranty. Please see the warranty information contained in the Owner's Handbook & Warranty Information booklet in your vehicle.

Your vehicle is equipped with an emission control system to meet all emission regulations.

There are three emission control systems which are as follows.

- (1) Crankcase emission control system
- (2) Evaporative emission control system
- (3) Exhaust emission control system

In order to assure the proper function of the emission control systems, it is recommended that you have your car inspected and maintained by an authorized HYUNDAI dealer in accordance with the maintenance schedule in this manual.

### Caution for the Inspection and Maintenance Test (With Electronic Stability Control (ESC) system)

- **To prevent the vehicle from misfiring during dynamometer testing, turn the Electronic Stability Control (ESC) system off by pressing the ESC switch.**
- **After dynamometer testing is completed, turn the ESC system back on by pressing the ESC switch again.**

G270100AUN

### 1. Crankcase emission control system

The positive crankcase ventilation system is employed to prevent air pollution caused by blow-by gases being emitted from the crankcase. This system supplies fresh filtered air to the crankcase through the air intake hose. Inside the crankcase, the fresh air mixes with blow-by gases, which then pass through the PCV valve into the induction system.

### 2. Evaporative emission control (including ORVR: Onboard Refueling Vapor Recovery) system

The Evaporative Emission Control System is designed to prevent fuel vapors from escaping into the atmosphere. (The ORVR system is designed to allow the vapors from the fuel tank to be loaded into a canister while refueling at the gas station, preventing the escape of fuel vapors into the atmosphere.)

G270201AUN

#### *Canister*

Fuel vapors generated inside the fuel tank are absorbed and stored in the onboard canister. When the engine is running, the fuel vapors absorbed in the canister are drawn into the surge tank through the purge control solenoid valve.

G270202AUN

#### *Purge Control Solenoid Valve (PCSV)*

The purge control solenoid valve is controlled by the Engine Control Module (ECM); when the engine coolant temperature is low during idling, the PCSV closes so that evaporated fuel is not taken into the engine. After the engine warms-up during ordinary driving, the PCSV opens to introduce evaporated fuel to the engine.

G270300AUN

### 3. Exhaust emission control system

The Exhaust Emission Control System is a highly effective system which controls exhaust emissions while maintaining good vehicle performance.

G270301AUN

#### ***Vehicle modifications***

This vehicle should not be modified. Modification of your vehicle could affect its performance, safety or durability and may even violate governmental safety and emissions regulations.

In addition, damage or performance problems resulting from any modification may not be covered under warranty.

G270302AUN-EU

#### ***Engine exhaust gas precautions (carbon monoxide)***

- Carbon monoxide can be present with other exhaust fumes. Therefore, if you smell exhaust fumes of any kind inside your vehicle, have it inspected and repaired immediately. If you ever suspect exhaust fumes are coming into your vehicle, drive it only with all the windows fully open. Have your vehicle checked and repaired immediately.



#### **WARNING - Exhaust**

**Engine exhaust gases contain carbon monoxide (CO). Though colorless and odorless, it is dangerous and could be lethal if inhaled. Follow the instructions on this page to avoid CO poisoning.**



#### **CALIFORNIA PROPOSITION 65 WARNING**

**Engine exhaust and a wide variety of automobile components and parts, including components found in the interior furnishings in a vehicle, contain or emit chemicals known to the State of California to cause cancer and birth defects and reproductive harm. In addition, certain fluids contained in vehicles and certain products of component wear contain or emit chemicals known to the State of California to cause cancer and birth defects or other reproductive harm.**

- Do not operate the engine in confined or closed areas (such as garages) any more than what is necessary to move the vehicle in or out of the area.
- When the vehicle is stopped in an open area for more than a short time with the engine running, adjust the ventilation system (as needed) to draw outside air into the vehicle.
- Never sit in a parked or stopped vehicle for any extended time with the engine running.
- When the engine stalls or fails to start, excessive attempts to restart the engine may cause damage to the emission control system.

G270303BFD

***Operating precautions for catalytic converters (if equipped)*****WARNING - Fire**

**A hot exhaust system can ignite flammable items under your vehicle. Do not park, idle, or drive the vehicle over or near flammable objects, such as dry grass, paper, leaves, etc.**

Your vehicle is equipped with a catalytic converter emission control device.

Therefore, the following precautions must be observed:

- Use only UNLEADED FUEL for gasoline engine.
- Do not operate the vehicle when there are signs of engine malfunction, such as misfire or a noticeable loss of performance.
- Do not misuse or abuse the engine. Examples of misuse are coasting with the ignition off and descending steep grades in gear with the ignition off.

- Do not operate the engine at high idle speed for extended periods (5 minutes or more).
- Do not modify or tamper with any part of the engine or emission control system. All inspections and adjustments must be made by an authorized HYUNDAI dealer.
- Avoid driving with a very low fuel level. If you run out of gasoline, it could cause the engine to misfire and result in excessive loading of the catalytic converter.

Failure to observe these precautions could result in damage to the catalytic converter and to your vehicle. Additionally, such actions could void your warranties.

## **CALIFORNIA PERCHLORATE NOTICE**

G280000AEN

Perchlorate Material-special handling may apply, See [www.dtsc.ca.gov/hazardouswaste/perchlorate](http://www.dtsc.ca.gov/hazardouswaste/perchlorate).

Notice to California Vehicle Dismantlers:  
Perchlorate containing materials, such as air bag inflators, seatbelt pretensioners and keyless remote entry batteries, must be disposed of according to Title 22 California Code of Regulations Section 67384.10 (a).

**Dimensions / 8-2**  
**Bulb wattage / 8-2**  
**Tires and wheels / 8-3**  
**Recommended lubricants and capacities / 8-4**  
**Vehicle identification number (VIN) / 8-7**  
**Vehicle certification label / 8-7**  
**Tire specification and pressure label / 8-8**  
**Engine number / 8-8**  
**Consumer information / 8-9**  
**Reporting safety defects / 8-10**  
**Binding arbitration / 8-10**

**Specifications, Consumer information,  
Reporting safety defects**

**8**



## DIMENSIONS

I010000ACM

Item	mm (in)
Overall length	4650 (183.1)
Overall width	1890 (74.4)
Overall height	1725 (67.9)/1760 (69.3)*
Front tread	1615 (63.6)
Rear tread	1620 (63.8)
Wheelbase	2700 (106.3)

\* with roof rack

## BULB WATTAGE





I030000ACM

Light Bulb		Wattage
Headlights (Low)		55
Headlights (High)		55
Front turn signal lights / Position lights (Front side markers)		27/8
Front fog lights*		27
Stop and tail lights		27/8
Tail lights		8
Rear turn signal lights		27
Back-up lights		16
Rear side markers		5
High mounted stop light*	With spoiler	LED
	Without spoiler	5
License plate lights		5
Map lamp		10
Room lamp		10
Luggage lamp*		10
Glove box lamp*		5
Vanity mirror lamp		5
Door courtesy lamp		5

\* If equipped

## TIRES AND WHEELS

I020000ACM

Item	Tire size	Wheel size	Inflation pressure psi (kPa)				Wheel lug nut torque lb•ft (kg•m, N•m)
			Normal load (  +  )		Maximum load (  +  )		
			Front	Rear	Front	Rear	
Full size tire	P235/65R17	7.0Jx17	33	33	38	42	65~79 (9~11, 88~107)
	P235/60R18	7.0Jx18	(230)	(230)	(260)	(290)	
Compact spare tire (if equipped)	T165/90R17	4.0Tx17	60 (420)	60 (420)	60 (420)	60 (420)	

## RECOMMENDED LUBRICANTS AND CAPACITIES

I040000ACM-EU

To help achieve proper engine and powertrain performance and durability, use only lubricants of the proper quality. The correct lubricants also help promote engine efficiency that results in improved fuel economy.

These lubricants and fluids are recommended for use in your vehicle.

Lubricant		Volume	Classification
Engine oil <sup>1 2</sup> (drain and refill) Recommends 	2.4 Engine	4.86 US qt. (4.6 l)	API Service SM <sup>3</sup> , ILSAC GF-4 or above
	3.5 Engine	5.49 US qt. (5.2 l)	
Manual transaxle fluid	2.4 Engine	1.90 US qt. (1.8 l)	API GL-4, SAE 75W/85
Automatic transaxle fluid	2.4 Engine	7.50 US qt. (7.1 l)	MICHANG ATF SP-IV, SK ATF SP-IV NOCA ATF SP-IV, HYUNDAI genuine ATF SP-IV or other brands meeting the above specification approved by Hyundai Motor Co.,
	3.5 Engine	8.24 US qt. (7.8 l)	
Power steering		1.06 US qt. (1.0 l)	PSF-3
Coolant	2.4 Engine	MT	Mixture of antifreeze and distilled water (Ethylene glycol base coolant for aluminum radiator)
		AT	
	3.5 Engine	AT	

Lubricant		Volume	Classification
Brake/clutch fluid		6.97 US qt. (6.6 l)	FMVSS116 DOT-3 or DOT-4
Rear differential oil (AWD)		0.74 US qt. (0.7 l)	HYPOLID GEAR OIL API GL-5, SAE 75W/90 (SHELL SPIRAX X or equivalent)
Transfer case oil (AWD)	2.4 Engine	0.63 US qt. (0.6 l)	HYPOLID GEAR OIL API GL-5, SAE 75W/90 (SHELL SPIRAX X or equivalent)
	3.5 Engine	0.74 US qt. (0.7 l)	
Fuel		17.96 US gal. (68 l)	Refer to "Fuel requirements" in section 1

\*1 Refer to the recommended SAE viscosity numbers on the next page.

\*2 Engine oils labeled Energy Conserving Oil are now available. Along with other additional benefits, they contribute to fuel economy by reducing the amount of fuel necessary to overcome engine friction. Often, these improvements are difficult to measure in everyday driving, but in a year's time, they can offer significant cost and energy savings.

\*3 If the API service SM engine oil is not available in your country, you are able to use API service SL.

MT : Manual transaxle

AT : Automatic transaxle

I040100AXM

**Recommended SAE viscosity number**

**! CAUTION**

*Always be sure to clean the area around any filler plug, drain plug, or dipstick before checking or draining any lubricant. This is especially important in dusty or sandy areas and when the vehicle is used on unpaved roads. Cleaning the plug and dipstick areas will prevent dirt and grit from entering the engine and other mechanisms that could be damaged.*

Engine oil viscosity (thickness) has an effect on fuel economy and cold weather operating (engine start and engine oil flowability). Lower viscosity engine oils can provide better fuel economy and cold weather performance, however, higher viscosity engine oils are required for satisfactory lubrication in hot weather. Using oils of any viscosity other than those recommended could result in engine damage.

When choosing an oil, consider the range of temperature your vehicle will be operated in before the next oil change. Proceed to select the recommended oil viscosity from the chart.

Temperature Range for SAE Viscosity Numbers											
Temperature	°C	-30	-20	-10	0	10	20	30	40	50	
	(°F)	-10	0	20	40	60	80	100	120		
Gasoline Engine Oil *1							10W-30				
	5W-20, 5W-30										

\*1 : For better fuel economy, it is recommended to use the engine oil of a viscosity grade SAE 5W-20 (API SM / ILSAC GF-4). However, if the engine oil is not available in your country, select the proper engine oil using the engine oil viscosity chart.

## VEHICLE IDENTIFICATION NUMBER (VIN)

Frame number



H010000AEN

The vehicle identification number (VIN) is the number used in registering your vehicle and in all legal matters pertaining to its ownership, etc.

The number is punched on the engine compartment bulkhead.

VIN label



OEN086004N

The VIN is also on a plate attached to the top of the dashboard. The number on the plate can easily be seen through the windshield from outside.

## VEHICLE CERTIFICATION LABEL



OCM056002

H020000AEN

The vehicle certification label attached on the driver's side center pillar gives the vehicle identification number (VIN).

## TIRE SPECIFICATION AND PRESSURE LABEL



The tires supplied on your new vehicle are chosen to provide the best performance for normal driving. The tire label located on the driver's side center pillar gives the tire pressures recommended for your vehicle.

## ENGINE NUMBER

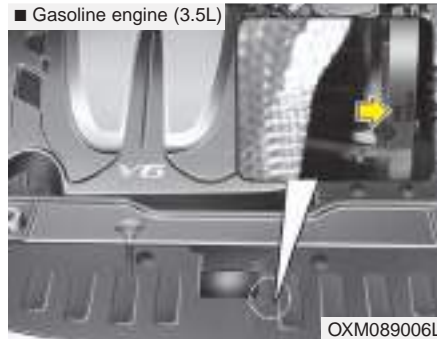

The engine number is stamped on the engine block as shown in the drawing.

## CONSUMER INFORMATION

H050000AEN

This consumer information has been prepared in accordance with regulations issued by the National Highway Traffic Safety Administration of the U.S. Department of Transportation. Your Hyundai dealer will help answer any questions you may have as you read this information.

Hyundai motor vehicles are designed and manufactured to meet or exceed all applicable safety standards.

For your safety, however, we strongly urge you to read and follow all directions in this Owner's Manual, particularly the information under the headings "**NOTICE**", "**CAUTION**" and "**WARNING**".

If, after reading this manual, you have any questions regarding the operation of your vehicle, please contact your nearest Hyundai Motor America Regional Office as listed in the following:

**Eastern Region:** Connecticut, Delaware, Maine, Massachusetts, New Hampshire, New Jersey, New York, Pennsylvania, Rhode Island, Vermont.

Eastern Region  
1100 Cranbury South River Road  
Jamesburg, NJ 08831  
(800) 633-5151

**Southern Region:** Florida, Georgia, North Carolina, South Carolina.

Southern Region  
270 Riverside Parkway, Suite A  
Austell, GA 30168  
(800) 633-5151

**South Central Region:** Alabama, Arkansas, Louisiana, Mississippi, Missouri, New Mexico, Oklahoma, Tennessee, Texas.

South Central Region  
1421 South Beltline Road, Suite 400  
Coppell, TX 75019  
(800) 633-5151

**Central Region:** Illinois, Indiana, Iowa, Kentucky, Michigan, Minnesota, Nebraska, North Dakota, South Dakota, Ohio, Wisconsin, Kansas, Missouri.

Central Region  
1705 Sequoia Drive  
Aurora, Illinois 60506  
(800) 633-5151

**Western Region:** Alaska, Hawaii, Arizona, Colorado, Idaho, Montana, Nevada, Oregon, Utah, Washington, Wyoming.

Western Region  
10550 Talbert Avenue  
P.O.Box 20850  
Fountain Valley, California 92728-0850  
(800) 633-5151

**California Region:** California

California Region  
10550 Talbert Avenue  
P.O. Box 20850  
Fountain Valley, California 92728-0850  
(800) 633-5151



## **REPORTING SAFETY DEFECTS    BINDING ARBITRATION (U.S.A ONLY)**

H070000AEN

If you believe that your vehicle has a defect which could cause a crash or could cause injury or death, you should immediately inform the National Highway Traffic Safety Administration (NHTSA) in addition to notifying HYUNDAI MOTOR AMERICA. If NHTSA receives similar complaints, it may open an investigation, and if it finds that a safety defect exists in a group of vehicles, it may order a recall and remedy campaign. However, NHTSA cannot become involved in individual problems between you, your dealer, or HYUNDAI MOTOR AMERICA.

To contact NHTSA, you may call the Vehicle Safety Hotline toll-free at 1-888-327-4236 (TTY: 1-800-424-9153); go to <http://www.safercar.gov>; or write to: Administrator, NHTSA, 400 Seventh Street, SW., Washington, DC 20590. You can also obtain other information about motor vehicle safety from <http://www.safercar.gov>.

H090000AEN

Any claim or dispute you may have related to your vehicle's warranty or the duties contemplated under the warranty, including claims related to the refund or partial refund of your vehicle's purchase price (excluding personal injury or product liability claims), shall be resolved by binding arbitration. Binding arbitration shall be administered by and through the National Arbitration Forum (NAF) or the American Arbitration Association (AAA), under the Code of Procedure of the entity you select.

You will not be responsible for paying filing and hearing fees above \$275.00. All other arbitration costs shall be borne by Hyundai Motor America. You are not responsible to pay any of the costs Hyundai incurs.

This Binding Arbitration Agreement shall not deprive you of any remedies available to you under applicable law. The parties are waiving their right to seek remedies in court, including the right to a jury trial.

This Binding Arbitration Agreement shall be governed by and interpreted under the Federal Arbitration Act, 9 U.S.C. sections 1-16. Judgment upon any award may be entered in any court having jurisdiction.

You may revoke this Arbitration Agreement by (1) written notice or (2) electronic notice. Written notice must be delivered (via certified mail) to Hyundai Motor America, Attn: Consumer Affairs, 10550 Talbert Avenue, P.O. Box 20849, Fountain Valley, CA 92728-0849.

Electronic notice must be submitted at the following website address: <http://warranty-arbitration.hyundaiUSA.com>. Notice must be received within 90 days after you purchase your vehicle.

Index

I

## Index

### A

Air bags-advanced supplemental restraint system .....	3-36
Air bag warning label .....	3-62
Air bag warning light .....	3-59
Curtain air bag .....	3-50
Driver's and passenger's front air bag .....	3-45
Occupant classification system .....	3-40
Side impact air bag .....	3-49
Air cleaner .....	7-22
All wheel drive (AWD) .....	5-16
Appearance care .....	7-63
Exterior care .....	7-63
Interior care .....	7-668
Audio system .....	4-99
Antenna .....	4-99
Steering wheel audio control .....	4-99
Automatic climate control system .....	4-76
Air conditioning .....	4-82
Automatic heating and air conditioning .....	4-77
Manual heating and air conditioning .....	4-67
Automatic transaxle .....	5-10
Ignition key interlock system .....	5-12
Shift lock system .....	5-13
Sports mode .....	5-14

### B

Battery .....	7-29
Before driving .....	5-3
Brake system .....	5-23
Anti-lock brake system (ABS) .....	5-26
Electronic stability control (ESC) .....	5-28
Parking brake .....	5-24
Power brakes .....	5-23
Brake fluid .....	7-18
Bulb wattage .....	8-2

### C

California Perchlorate Notice .....	7-72
Child restraint system .....	3-28
Placing a passenger seat belt into the auto lock mode .....	3-30
Securing a child restraint seat with tether anchor system .....	3-32
Securing a child restraint seat with child seat lower anchor system .....	3-34
Climate control air filter .....	7-24
Consumer information .....	8-9
Cruise control system .....	5-33

**D**

Defroster .....4-66  
 Dimensions .....8-2  
 Door locks.....4-14  
     Central door lock switch .....4-8  
     Child-protector rear door lock.....4-10

**E**

Economical operation .....5-37  
 Emergency starting .....6-4  
     Jump starting .....6-4  
     Push starting .....6-5  
 Emission control system.....7-69  
     Crankcase emission control system.....7-69  
     Evaporative emission control (including ORVR:  
         Onboard Refueling Vapor Recovery) System .....7-69  
     Exhaust emission control system .....7-70  
 Engine compartment .....2-4, 7-2  
 Engine coolant .....7-15  
 Engine number.....8-8  
 Engine oil.....7-14  
 Explanation of scheduled maintenance items .....7-11  
 Exterior features.....4-98  
     Roof rack .....4-98

**F**

Fuel filler lid .....4-19  
 Fuel requirements .....1-2  
 Fuses .....7-45  
     Fuse/relay panel description.....7-49  
     Main fuse .....7-48  
     Memory fuse.....7-47

**H**

Hazard warning flasher.....4-56  
 Hood.....4-17  
 How to use this manual .....1-2

**I**

If the engine overheats.....6-6  
 If the engine will not start .....6-3  
 If you have a flat tire .....6-13  
     Changing tires.....6-16  
     Compact spare tire.....6-20  
     Jack and tools .....6-13  
     Removing and storing the spare tire.....6-13

## Index

---

In case of an emergency while driving.....	6-2
Indicator symbols on the instrument cluster .....	1-6
Instrument cluster .....	4-40
Engine temperature gauge .....	4-42
Fuel gauge .....	4-43
Instrument panel illumination .....	4-41
Odometer/Tripmeter .....	4-43
Speedometer .....	4-41
Tachometer .....	4-41
Trip computer .....	4-45
Warning and indicators.....	4-48
Instrument panel overview.....	2-3
Interior features.....	4-89
AC inverter .....	4-93
Ashtray .....	4-89
Aux, USB and iPod .....	4-95
Cargo security screen .....	4-96
Cigarette lighter .....	4-89
Clothes hanger .....	4-95
Cup holder .....	4-90
Digital clock .....	4-94
Floor mat anchor(s) .....	4-95
Luggage net (holder) .....	4-119
Outside thermometer .....	4-80
Power outlet.....	4-92
Sunvisor .....	4-91
Interior light .....	4-63
Interior overview.....	2-2

## K

Key positions .....	5-4
Illuminated ignition switch.....	5-4
Keys .....	4-2

## L

Light bulbs .....	7-55
Headlight, position light, turn signal light, side marker light and front fog light bulb replacement.....	7-56
High mounted stop light replacement .....	7-61
Interior light bulb replacement .....	7-62
License plate light bulb replacement.....	7-61
Door courtesy lamp bulb replacement .....	7-61
Rear combination light bulb replacement .....	7-59
Lighting.....	4-57
Battery saver function.....	4-57

**M**

Maintenance services .....7-3  
 Manual climate control system .....4-67  
     Air conditioning .....4-72  
     Climate control air filter .....4-74  
     Heating and air conditioning .....4-68  
     Electric chromic mirror (ECM) with compass .....4-28  
     Electric chromic mirror (ECM) with compass and  
         HomeLink® system .....4-31  
     Inside rearview mirror .....4-28  
     Outside rearview mirror .....4-38  
 Manual transaxle .....5-7

**O**

Owner maintenance .....7-4

**P**

Parking brake .....7-21  
 Power steering fluid .....7-19

**R**

Rear seat entertainment system (RSE) .....4-153  
 Rearview camera .....4-56  
 Recommended lubricants and capacities .....8-4  
     Recommended SAE viscosity number .....8-6  
 Remote keyless entry .....4-3  
 Reporting safety defects .....8-10  
 Road warning .....6-2

**S**

Scheduled maintenance service .....7-6  
     Normal maintenance schedule .....7-7  
     Maintenance under severe usage conditions .....7-10  
 Seat belts .....3-17  
     Pre-tensioner seat belt .....3-22  
     Seat belt - Driver's 3-point system with  
         emergency locking retractor .....3-18  
     Seat belts - Front passenger and rear seat  
         3-point system with combination locking retractor ..3-20  
     Seat belt warning .....3-18  
 Seats .....3-2  
     Armrest .....3-14  
     Headrest .....3-8, 3-12  
     Folding the rear seat .....3-14  
     Front seat adjustment - manual .....3-5  
     Front seat adjustment - power .....3-6

## Index

Lumbar support .....	3-6
Rear seat adjustment .....	3-12
Seatback pocket .....	3-11
Seat warmer .....	3-10
Special driving conditions .....	5-39
Driving at night .....	5-40
Driving in flooded areas .....	5-41
Driving in the rain .....	5-41
Hazardous driving conditions .....	5-39
Highway driving .....	5-42
Rocking the vehicle .....	5-39
Smooth cornering .....	5-40
Starting the engine .....	5-5
Steering wheel .....	4-26
Horn .....	4-27
Power steering .....	4-26
Tilt steering .....	4-26
Storage compartment .....	4-86
Center console storage .....	4-86
Glove box .....	4-86
Multi box .....	4-87
Luggage box .....	4-88
Sunglass holder .....	4-87
Sunroof .....	4-22

## T

Tailgate .....	4-11
Theft-alarm system .....	4-5
Tires pressure monitoring system (TPMS) .....	6-7
Changing a tire with TPMS .....	6-10
Low tire pressure telltale .....	6-8
TPMS (Tire pressure monitoring system) malfunction indicator .....	6-9
Tire specification and pressure label .....	8-8
Tires and wheels .....	7-32, 8-3
All season tires .....	7-43
Checking tire inflation pressure .....	7-34
Compact spare tire replacement .....	7-36
Radial-ply tires .....	7-44
Recommended cold tire inflation pressures .....	7-32
Snow tires .....	7-43
Summer tires .....	7-43
Tire care .....	7-32
Tire chains .....	7-44
Tire maintenance .....	7-38
Tire replacement .....	7-36
Tire rotation .....	7-35
Tire sidewall labeling .....	7-38
Tire terminology and definitions .....	7-41
Tire traction .....	7-38
Wheel alignment and tire balance .....	7-36
Wheel replacement .....	7-36

Towing .....6-22  
 Emergency towing .....6-23  
 Trailer towing.....5-47  
 Driving with a trailer .....5-49  
 Hitches .....5-48  
 Safety chains .....5-48  
 Trailer brakes .....5-48  
 Weight of the trailer (tongue).....5-54

**V**

Vehicle break-in process .....1-5  
 Vehicle certification label .....8-7  
 Vehicle data collection and event data recorders.....1-5  
 Vehicle identification number (VIN).....8-7  
 Vehicle load limit.....5-56  
 Cargo capacity .....5-56  
 Certification label .....5-58  
 Seating capacity .....5-56  
 Tire and loading information label .....5-56  
 Towing capacity .....5-56  
 Vehicle capacity weight .....5-56

Vehicle weight .....5-60  
 Base curb weight .....5-60  
 Cargo weight .....5-60  
 GAW (Gross axle weight) .....5-60  
 GAWR (Gross axle weight rating) .....5-60  
 GVW (Gross vehicle weight) .....5-60  
 GVWR (Gross vehicle weight rating) .....5-60

**W**

Washer fluid .....7-20  
 Windows .....4-13  
 Auto up/down window .....4-14  
 Power window lock button .....4-15  
 Windshield defrosting and defogging.....4-83  
 Defogging logic .....4-85  
 Winter driving .....5-43  
 Snow tires .....5-43  
 Tire chains .....5-44  
 Wiper blades .....7-26  
 Wipers and washers .....4-61